

SELF TAPPING POZIDRIVE SCREWS

ZINC PLATED, PAN HEAD, SIZES 4-10



TOP UPS	
4 x 1/2	555-1220
6 x 3/4	555-1330
8 x 3/4	555-1430
8 x 1 1/2	555-1460
10 x 3/4	555-1530
6 x 1/2	555-1320
8 x 1/2	555-1420
8 x 1	555-1440
10 x 1/2	555-1520
10 x 1	555-1540

500-1010
QTY: 600

SELF TAPPING POZIDRIVE SCREWS

ZINC PLATED, PAN HEAD, SIZES 8-12



TOP UPS	
8 x 1 1/2	555-1460
10 x 3/4	555-1530
10 x 1 1/2	555-1560
12 x 1	555-1640
10 x 1/2	555-1520
10 x 1	555-1540
12 x 3/4	555-1630
12 x 1 1/2	555-1660

500-1020
QTY: 300

SELF TAPPING SLOTTED SCREWS

ZINC PLATED, PAN HEAD, SIZES 4-10



TOP UPS	
4 x 1/2	555-0220
6 x 3/4	555-0330
8 x 3/4	555-0430
8 x 1 1/2	555-0460
10 x 3/4	555-0530
6 x 1/2	555-0320
8 x 1/2	555-0420
8 x 1	555-0440
10 x 1/2	555-0520
10 x 1	555-0540

500-1030
QTY: 600

SELF TAPPING SLOTTED SCREWS

ZINC PLATED, PAN HEAD, SIZES 8-12



TOP UPS	
8 x 1 1/2	555-0460
10 x 3/4	555-0530
10 x 1 1/2	555-0560
12 x 1	555-0640
10 x 1/2	555-0520
10 x 1	555-0540
12 x 3/4	555-0630
12 x 1 1/2	555-0660

500-1040
QTY: 300

SELF TAPPING POZIDRIVE SCREWS

FLANGED HEAD, BLACK



TOP UPS	
6 x 1/2	555-5320
8 x 1/2	555-5420
10 x 1/2	555-5520
6 x 3/4	555-5330
8 x 3/4	555-5430
10 x 3/4	555-5530

500-1050
QTY: 600

SELF TAPPING POZIDRIVE SCREWS

ZINC PLATED, COUNTERSUNK HEAD



TOP UPS	
6 x 1/2	555-3320
6 x 3/4	555-3330
8 x 1/2	555-3420
10 x 3/4	555-3530
10 x 2	555-3580
6 x 5/8	555-3325
6 x 1 1/2	555-3360
8 x 3/4	555-3430
10 x 1	555-3540

500-1060
QTY: 600

SELF TAPPING POZIDRIVE SCREWS

PAN HEAD & COUNTERSUNK, BLACK



TOP UPS	
Pan 6 x 1/2	555-2320
Pan 6 x 3/4	555-2330
Pan 8 x 3/4	555-2430
Pan 10 x 3/4	555-2530
Csk 6 x 1/2	555-4320
Csk 8 x 1/2	555-4420
Csk 10 x 3/4	555-4530
Csk 6 x 5/8	555-4325
Pan 8 x 1/2	555-2420
Pan 10 x 1/2	555-2520
Pan 10 x 1	555-2540
Csk 6 x 3/4	555-4330
Csk 8 x 3/4	555-4430

500-1070
QTY: 600

SELF TAPPING T-DRIVE SCREWS

PAN HEAD, BLACK



TOP UPS	
6 x 13mm	555-6320
8 x 13mm	555-6420
8 x 25mm	555-6440
10 x 19mm	555-6530
6 x 19mm	555-6330
8 x 19mm	555-6430
10 x 13mm	555-6520
10 x 25mm	555-6540

500-1080
QTY: 400

ACME SCREWS

WITH CAPTIVE WASHER



TOP UPS	
8 x 3/4"	555-9510
10 x 3/4"	555-9520
12 x 3/4"	555-9530
14 x 3/4"	555-9540

500-1000

QTY: 200

SPEED FASTENERS

SPIRE NUTS, 'J' TYPE, 'U' TYPE & FLAT



TOP UPS	
U No4 8 x 10	556-4020
U No8 11 X 16	556-4070
U No8 13 x 13	556-4090
U No10 13 x 19	556-4130
J No6 11 x 16	556-4030
J No10 13 x 20	556-3080
J 1/4 Acme 16 x 25	556-3210
Flat No8 10 x 15	556-4660
U No6 11 x 16	556-4040
U No8 11 x 24	556-4080
U No10 12 x 16	556-4120
U No12 15 x 25	556-4160
J No8 11 x 16	556-3060
J No12 15 x 25	556-3100
Flat No6 9 x 14	556-4650

500-1170

QTY: 300

SPEED FASTENERS

PUSH ON CLIPS, ROUND & RECTANGULAR



TOP UPS	
Round 3/32	556-4910
Round 5/32	556-4930
Round 1/4	556-4950
Rect. No6 9 x 14	556-4650
Round 1/8	556-4920
Round 3/16	556-4940
Round 5/16	556-4960
Rect. No10 10 x 15	556-4670

500-1160

QTY: 750

NUMBER PLATE FIXINGS

CAPS, DOMES & SCREWS, NYLON NUTS & BOLTS



TOP UPS	
Nylon N&B White	556-7410
Nylon N&B Black	556-7430
Dome & Screw Yellow	556-7320
Nylon N&B Yellow	556-7420
Dome & Screw White	556-7310
Dome & Screw Black	556-7330

500-1250

QTY: 240

NUMBER PLATE FIXINGS



TOP UPS	
FLIP TOP - WHITE	556-7210
FLIP TOP - BLACK	556-7230
FLIP TOP - YELLOW	556-7220
NUT & BOLT - YELLOW	556-7420
NUT & BOLT - WHITE	556-7410
NUT & BOLT - BLACK	556-7430

500-1252

QTY: 310

NUMBER PLATE FIXINGS

POLYTOPS IN YELLOW, WHITE, BLUE & BLACK



TOP UPS	
P 10 x 18 White	556-7010
P 10 x 18 Blue	556-7040
P 10 x 24 White	556-7110
P 10 x 24 Blue	556-7140
P 10 x 18 Yellow	556-7020
P 10 x 18 Black	556-7030
P 10 x 24 Yellow	556-7120
P 10 x 24 Black	556-7130

500-1255

QTY: 160

HT COURSE SETSCREWS

METRIC, YELLOW PASSIVATED

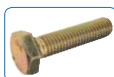

TOP UPS	
M6 x 40	534-2160
M8 x 40	534-3160
M10 x 40	534-3660
M8 x 30	534-3120
M8 x 50	534-3200
M12 x 50	534-4200

500-1410

QTY: 101

HT COURSE SETSCREWS & NUTS

METRIC, YELLOW PASSIVATED

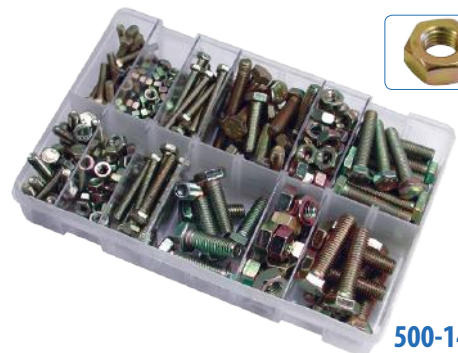
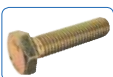

TOP UPS	
Set M5 x 25	534-1600
Nut M5	548-1420
Set M6 x 40	534-2160
Set M8 x 30	534-3120
Nut M8	548-1450
Set M10 x 40	534-3660
Set M5 x 40	534-1660
Set M6 x 25	534-2100
Nut M6	548-1430
Set M8 x 40	534-3160
Set M10 x 30	534-3620
Nut M10	548-1460

500-1415

QTY: 278

M6 HT SELECTION

HT SETSCREWS, NUTS, NYLOCS & WASHERS, YELLOW PASSIVATED



TOP UPS	
Set M6 x 25	534-2100
Nut M6	548-1430
Flat Washer M6	550-1260
Set M6 x 40	534-2160
Nyloc M6	549-1430



500-1440
QTY: 400

M8 HT SELECTION

HT SETSCREWS, NUTS, NYLOCS & WASHERS, YELLOW PASSIVATED



TOP UPS	
Set M8 x 25	534-3100
Nut M8	548-1450
Flat Washer M8	550-1280
Set M8 x 40	534-3160
Nyloc M8	549-1450



500-1450
QTY: 350

M10 HT SELECTION

HT SETSCREWS, NUTS & NYLOCS, YELLOW PASSIVATED



TOP UPS	
Set M10 x 25	534-3600
Nut M10	548-1460
Set M10 x 40	534-3660
Nyloc M10	549-1460



500-1460
QTY: 190

M12 HT SELECTION

HT SETSCREWS, NUTS, NYLOCS & WASHERS, YELLOW PASSIVATED



TOP UPS	
Set M12 x 25	534-4100
Nut M12	548-1470
Flat Washer M12	550-1320
Set M12 x 40	534-4160
Nyloc M12	549-1470



500-1470
QTY: 110

SERRATED FLANGE BOLTS



TOP UPS	
M6 x 16mm	534-7000
M6 x 20mm	534-7010
M6 x 25mm	534-7020
M6 x 30mm	534-7030
M8 x 20mm	534-7100
M8 x 25mm	534-7120
M8 x 30mm	534-7130
M8 x 40mm	534-7140
M10 x 25mm	534-7200
M10 x 30mm	534-7210
M10 x 50mm	534-7240

500-1480
QTY: 54

HT FINE THREAD SELECTION

METRIC, HT SETSCREWS, NUTS & NYLOCS, YELLOW PASSIVATED



TOP UPS	
Set M8 x 40	533-3160
Nyloc M8	549-1350
Set M10 x 50	533-3700
Nyloc M10	549-1360
Nut M8	548-1350
Set M10 x 25	533-3600
Nut M10	548-1360



500-2015
QTY: 150

HT SETSCREWS & NUTS UNF

ZINC PLATED



TOP UPS	
Set 3/16 x 1	530-2100
Set 1/4 x 3/4	530-2580
Set 1/4 x 1 1/2	530-2650
Set 5/16 x 3/4	530-3080
Set 5/16 x 1 1/2	530-3150
Set 3/8 x 1	530-3600
Nut 3/8	548-0250
Nut 3/16	548-0220
Set 1/4 x 1 1/4	530-2620
Nut 1/4	548-0230
Set 5/16 x 1	530-3100
Nut 5/16	548-0240
Set 3/8 x 1 1/2	530-3650

500-2515
QTY: 250

HT SETSCREWS, NUTS & WASHERS

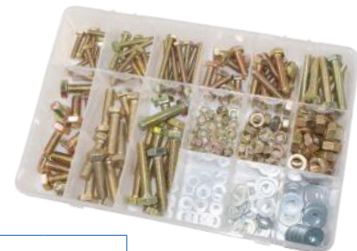

TOP UPS	
HT Setscrew ZG 6mm x 25mm	534-2100
HT Setscrew ZG 6mm x 40mm	534-2160
HT Setscrew ZY 6mm x 50mm	534-2200
HT Setscrew ZY M8 x 25mm	534-3100
HT Setscrew ZG M8 x 40mm	534-3160
HT Setscrew ZG M8 x 25mm	534-3200
HT Setscrew ZY M10 x 25mm	534-3600
HT Setscrew ZG M10 x 40mm	534-3660

TOP UPS	
HT Setscrew ZG M10 x 50mm	534-3700
Steel Nut ZG M6	548-1430
Steel Nut ZG M8	548-1450
Steel Nut ZG M10	548-1460
Steel Washer M6	550-1260
Steel Washer M8	550-1280
Steel Washer M10	550-1300

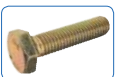

501-1400
QTY: 270

HT SETSCREWS & NUTS UNC

ZINC PLATED



TOP UPS	
Set 1/4 x 1	531-2600
Nut 1/4	548-0430
Set 5/16 x 1 1/2	531-3150
Set 3/8 x 1	531-3600
Nut 3/8	548-0450
Set 1/4 x 1 1/2	531-2650
Set 5/16 x 1	531-3100
Nut 5/16	548-0440
Set 3/8 x 1 1/2	531-3650

500-3015

QTY: 200

BA SCREWS & NUTS

STEEL, ROUND HEAD, ZINC PLATED



TOP UPS	
6BA x 3/4	546-0115
3BA x 1	546-0320
2BA x 3/4	546-0425
2BA x 1 1/2	546-0445
4BA x 3/4	546-0215
2BA x 1/2	546-0415
2BA x 1	546-0435
2BA x 2	546-0455

500-3530

QTY: 750

MACHINE SLOTTED SCREWS & NUTS

ZINC PLATED



TOP UPS	
Screw - M2.5 x 12mm	B211PLX
Screw - M3 x 20mm	B212PLX
Screw - M4 x 25mm	546-6720
Screw - M5 x 25mm	546-6820
Screw - M5 x 50mm	546-6860
Screw - M6 x 35mm	546-6920
Screw - M6 x 35mm	546-6940
Nut - M2.5	B513PLX
Nut - M3	B515PLX
Nut - M4	548-1410
Screw - M5 x 35mm	546-6840
Nut - M5	548-1420
Nut - M6	548-1430
Screw - M6 x 50mm	546-6960

500-3550

QTY: 400

T DRIVE MACHINE PANHEAD SCREWS

ZINC PLATED



TOP UPS	
M4 x 16	546-7110
M5 x 16	546-7210
M5 x 40	546-7520
M6 x 25	546-7330
M4 x 25	546-7130
M5 x 25	546-7230
M6 x 16	546-7310
M6 x 40	546-7350

500-3570

QTY: 300

HEXAGON SOCKET BUTTON HEAD SCREWS



TOP UPS	
M6 x 25mm	555-7000
M8 x 25mm	555-7100
M10 x 25mm	555-7200
M6 x 50mm	555-7050
M8 x 50mm	555-7150
M10 x 50mm	555-7250

500-1260

QTY: 78

SOCKET CAP SCREWS

METRIC COARSE THREAD



TOP UPS	
M5 x 25	545-7220
M6 x 25	545-7320
M8 x 25	545-7520
M10 x 25	545-7620
M5 x 40	545-7240
M6 x 40	545-7340
M8 x 40	545-7540
M10 x 40	545-7640

500-1270

QTY: 120

HEXAGON SOCKET BUTTON HEAD SCREWS

WITH FLANGE



TOP UPS	
M6 x 25mm	555-5000
M8 x 25mm	555-5100
M10 x 25mm	555-5200
M6 x 50mm	555-5050
M8 x 50mm	555-5150
M10 x 50mm	555-5250

500-1280

QTY: 90

HEXAGON SOCKET COUNTERSUNK HEAD SCREWS



TOP UPS	
M6 x 25mm	555-6000
M8 x 25mm	555-6100
M10 x 25mm	555-6200
M6 x 50mm	555-6050
M8 x 50mm	555-6150
M10 x 50mm	555-6250

500-1290

QTY: 73

PINCH, SHANK & WISHBONE BOLTS

COMPLETE WITH NUTS



TOP UPS	
PINCH - FOCUS	532-2305
PINCH - PEUG	532-2605
PINCH - AUDI VW	532-2705
WISHBONE - FIESTA	532-2905
SHANK - FORD	532-2205
PINCH - KA, FIESTA	532-2005

TOP UPS	
WISHBONE - FIESTA	532-2805
PINCH - PEUG	532-2505
PINCH - VAUX	532-2055
SHANK - MONDEO	532-2255
WISHBONE - FOCUS	532-2405
PINCH - MONDEO	532-2105

500-3590

QTY: 32

PINCH BOLT MIDI BOX

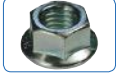

TOP UPS	
Fiesta 08>	532-2015
Clio, Megane, Kangoo	532-2025
Peug 106, 206, 207, 1007	532-2065
Vaux Vect, Signum	532-2055
Peug 205, 306, 307, 309	532-2505
Audi A4, A6 & VW Passat	532-2705
Ford Focus	532-2305
Ford Ka, Escort, Fiesta	532-2005
Ford Mondeo	532-2255

500-3595

QTY: 20

PINCH & SHANK BOLTS

FORD

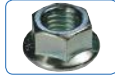

TOP UPS	
Pinch Bolt - Escort, Ka, Fiesta	532-2005
Pinch Bolt - Mondeo	532-2105
Shank Bolt & Nut - Ford	532-2205

500-3600

QTY: 16

TRACK ROD & BALL JOINT BOOTS



TOP UPS	
BOOT1	
BOOT2	
BOOT3	
BOOT4	
BOOT10	
BOOTSEALS	

500-7000

QTY: 20

NYLOC NUTS FOR TRACK ROD ENDS



TOP UPS	
M10 x 1 Ex. Fine Zy	549-1260
M10 x 1.25 Ex. Fine Zy	549-1360
M10 x 1.50 Z Passivated DIN982	549-1460
M12 x 1.1 Type Z Passivated	549-1465
M12 x 1.25 Type Z Passivated	549-1475
M12 x 1.5 Type Z Passivated	549-1485
M12 x 1.75 Z Passivated DIN982	549-1470
M14 x 1.5 Type Z Passivated	549-1440

500-4120

QTY: 70

SNAP RINGS FOR CV JOINTS



TOP UPS	
30 x 1.8mm	CC01
31.5 x 1.9mm	CC02
27 x 1.8mm	CC03
26 x 1.8mm	CC04
25.5 x 1.6mm	CC05
35.5 x 2.3mm	CC06
25.5 x 1.8mm	CC07
26 x 1.5mm	CC08
30.5 x 2mm	CC09
28.5 x 1.8mm	CC10
27 x 1.6mm	CC11
28.5 x 2mm	CC12
29 x 1.8mm	CC13
25.8 x 1.6mm	CC14
29 x 2mm	CC15
22 x 1.5mm	CC16
28 x 1.5mm	CC17
23 x 1.8mm	CC18

TOP UPS	
26.8 x 1.6mm	CC19
29.8 x 2mm	CC20
24 x 2mm	CC21
31 x 2mm	CC22
25 x 1.8mm	CC23
25.4 x 1.8mm	CC24
27 x 1.6mm	CC25
29.5 x 1.8mm	CC26

503-6500

QTY: 260

NEW
LARGE
BOX

COACH BOLTS & NUTS

METRIC



TOP UPS	
M6 x 25	545-1320
M6 x 50	545-1350
M8 x 75	545-1470
M6 x 40	545-1340
M8 x 50	545-1450
M10 x 50	545-1550

500-3610

QTY: 75

NUTS

METRIC

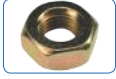

TOP UPS	
FLANGE M6	548-9430
FLANGE M8	548-9450
FLANGE M10	548-9460
FLANGE M12	548-9470
FINE M8	548-1350
FINE M10	548-1360
COARSE M4	548-1410
COARSE M5	548-1420
COARSE M8	548-1450

TOP UPS	
COARSE M10	548-1460
COARSE M12	548-1470
COARSE M14	549-1480
NYLOC M6	549-1430
NYLOC - FINE M8	549-1350
NYLOC M8	549-1450
NYLOC - FINE M10	549-1360
NYLOC M10	549-1460
NYLOC M12	549-1470

501-4000

QTY: 256

LARGE
BOX

STEEL NUTS

METRIC, YELLOW PASSIVATED



TOP UPS	
M4	548-1410
M6	548-1430
M10	548-1460
M14	548-1480
M5	548-1420
M8	548-1450
M12	548-1470
M16	548-1490

500-4010
QTY: 330

NYLON INSERT LOCK NUTS

METRIC, COARSE THREAD, ZINC PLATED



TOP UPS	
M5	549-1420
M8	549-1450
M12	549-1470
M6	549-1430
M10	549-1460

500-4110
QTY: 300

FLANGE NUTS

METRIC, SERRATED, COARSE THREAD, ZINC PLATED

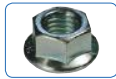

TOP UPS	
M5	548-9420
M8	548-9450
M12	548-9470
M6	548-9430
M10	548-9460

500-4170
QTY: 220

NUTS

UNC & UNF

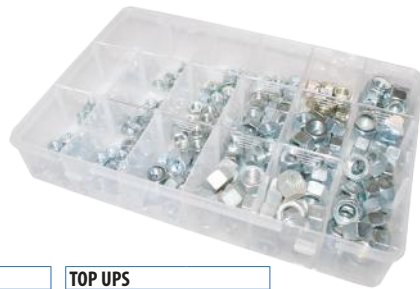

TOP UPS	
1/4 UNC	548-0430
5/16 UNC	548-0440
3/8 UNC	548-0450
1/2 UNC	548-0470
3/16 UNF	548-0220
1/4 UNF	548-0230
5/16 UNF	548-0240
3/8 UNF	548-0250

TOP UPS	
7/16 UNF	548-0260
1/2 UNF	548-0270
NYLOC 3/16 UNF	549-0220
NYLOC 1/4 UNF	549-0230
NYLOC 5/16 UNF	549-0240
NYLOC 3/8 UNF	549-0250
NYLOC 7/16 UNF	549-0260
NYLOC 1/2 UNF	549-0270



501-4100
QTY: 260

WING NUTS

METRIC, SIZES 4, 6 & 8mm



TOP UPS	
4 x 24mm	550-7000
4 x 32mm	550-7010
6 x 20mm	550-7020
6 x 28mm	550-7030
8 x 18mm	550-7040
8 x 24mm	550-7050

500-4180
QTY: 70

THREADED INSERTS

ZINC PASSIVATED



TOP UPS	
M4	549-6410
M6	549-6430
M5	549-6420
M8	549-6450

500-4850
QTY: 115

HEAVY DUTY FLAT WASHERS

METRIC, FORM A, YELLOW PASSIVATED



TOP UPS	
M4	550-1240
M6	550-1260
M10	550-1300
M5	550-1250
M8	550-1280
M12	550-1320

500-4210
QTY: 800

WASHERS

FLAT & SPRING WASHERS



TOP UPS	
6 x 25 MUDGUARD	550-2320
8 x 25	550-2420
8 x 50	550-2450
10 x 50	550-2550
M5 SPRING	550-4050
M6 SPRING	550-4060
M8	550-4080

TOP UPS	
M10	550-4100
M12	550-4120
M4 FORM A	550-1240
M6	550-1260
M8	550-1280
M10	550-1300
M12	550-1320

500-4240
QTY: 355

HEAVY DUTY FLAT WASHERS

IMPERIAL, TABLE 3, ZINC PLATED

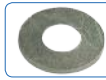

TOP UPS	
1/8	550-0240
1/4	550-0260
3/8	550-0280
1/2	550-0300
3/16	550-0250
5/16	550-0270
7/16	550-0290

500-4220

QTY: 800

HEAVY DUTY FLAT WASHERS

IMPERIAL TABLE 4 (LARGE O.D.), ZINC PLATED

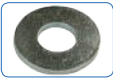

TOP UPS	
3/16	550-0505
5/16	550-0520
7/16	550-0540
1/4	550-0510
3/8	550-0530
1/2	550-0550

500-4230

QTY: 500

REPAIR WASHERS

MUDGUARD TYPE, ZINC PLATED



TOP UPS	
M3 x 12	550-2100
M6 x 25	550-2320
M8 x 40	550-2440
M10 x 50	550-2550
M4 x 20	550-2110
M8 x 25	550-2420
M8 x 50	550-2450

500-4250

QTY: 220

SPRING WASHERS

METRIC, RECTANGULAR SECTION



TOP UPS	
M5	550-4050
M8	550-4080
M12	550-4120
M6	550-4060
M10	550-4100

500-4310

QTY: 800

SPRING WASHERS

IMPERIAL, RECTANGULAR SECTION

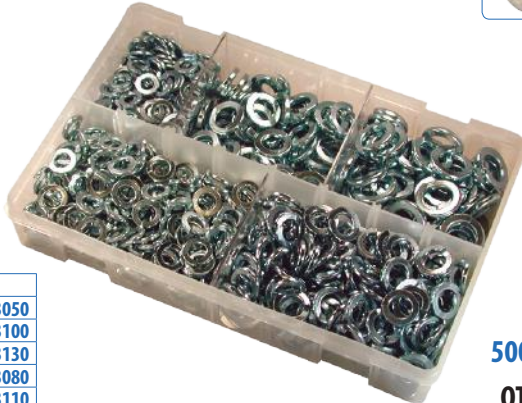

TOP UPS	
1/4	550-3050
3/8	550-3100
1/2	550-3130
5/16	550-3080
7/16	550-3110

500-4320

QTY: 800

LOCK WASHERS

INTERNAL & EXTERNAL



TOP UPS	
In M4	550-5010
In M6	550-5030
In M10	550-5050
Ex M4	550-5510
Ex M6	550-5530
Ex M10	550-5550
In M5	550-5020
In M8	550-5040
In M12	550-5060
Ex M5	550-5520
Ex M8	550-5540
Ex M12	550-5560

500-4340

QTY: 1000

COPPER WASHERS

16 GAUGE



TOP UPS	
6 x 10 x 1.0	551-0060
10 x 15 x 1.5	551-0240
10 x 20 x 1.5	551-0275
13 x 19 x 1.5	551-0400
16.3 x 25 x 1.6	551-0580
19 x 25 x 1.5	551-0700
22 x 28 x 1.5	551-0790
8 x 16 x 1.0	551-0160
10 x 16 x 1.0	551-0250
11 x 17 x 1.5	551-0300
13 x 20 x 1.5	551-0410
17 x 24 x 1.5	551-0630
21 x 26 x 1.5	551-0760

500-4480

QTY: 250

BONDED SEALS

METRIC



TOP UPS	
M10	550-6500
M16	550-6540
M20	550-6580
M24	550-6620
M14	550-6520
M18	550-6560
M22	550-6600

500-4520

QTY: 92

BONDED SEALS

BSP



TOP UPS	
1/8 BSP	550-6020
3/8	550-6060
5/8	550-6100
7/8	550-6140
1/4	550-6040
1/2	550-6080
3/4	550-6120
1	550-6160

500-4530

QTY: 92

FIBRE WASHERS



TOP UPS	
1/4 x 3/8	550-8020
5/16 x 1/2	550-8040
3/8 x 5/8	550-8060
15/32 x 3/4	550-8100
1/2 x 13/16	550-8120
21/32 x 1	550-8150
1/4 x 7/16	550-8030
11/32 x 9/16	550-8050
7/16 x 11/16	550-8070
1/2 x 3/4	550-8110
9/16 x 7/8	550-8130

500-4550

QTY: 600

FIBRE WASHERS

LARGE SIZES



TOP UPS	
9/16 x 7/8	550-8130
3/4 x 1 1/8	550-8170
21/32 x 1	550-8150
1 x 1 1/2	550-8190

500-4555

QTY: 200

SUMP PLUG WASHERS

OE MATCHED SPEC



TOP UPS	
13mm Nylon Ford	551-3430
14mm Copper VW GM	551-0460
15.5mm Comp. Nissan	551-1150
22mm Alu BMW	551-3220
15mm BC Cit/Peug	550-6530
12.25mm BS Ford	550-6510
18mm Comp Renault	551-1180
14.5mm Copper Rover	551-0500

TOP UPS	
14.5mm Nylon Ford	551-3440
16.3mm Copper Mini	551-0580
16mm Copper Cit/Peug	551-1160
18mm Copper Volvo	551-0670
12mm Alu BMW	551-3120
14.5mm Cop.Fib Cit	551-1640
14.5mm Alu Rov/Hon	551-3150
12mm Fibre Toyota	551-8100

500-4410

QTY: 250

SUMP PLUG WASHERS

OE MATCHED SPEC



500-4415

QTY: 80

SUMP PLUGS

OE MATCHED SPEC



TOP UPS	
Ford To 97	551-6010
Early GM/VW	551-6020
Cavalier	551-6100
BMW 3/5 Series	551-6050
Rover 2/400 Cit/Peug	551-6090
Nissan/Toyota	551-6150
Renault Clio	551-6140
Fiat	551-6130
Later VW/Audi	551-6170

TOP UPS	
Ford 98 On	551-6120
GM 1.7D	551-6080
GM 95 On	551-6110
Metro/Montego	551-6070
Citroen/Peugeot	551-6030
Renault	551-6040
Peug/Fiat/Alfa	551-6060
Early VW/Audi	551-6160

500-4420

QTY: 30

SUMP PLUGS

OE MATCHED SPEC



500-4425

QTY: 16

TOP UPS	
Chrysler/Mercedes	551-6300
Alfa Romeo/Fiat	551-6210
BMW/Citroen	551-6360
Ford 98 Onwards	551-6120
Vauxhall Late Type	551-6200
VW Late Type	551-6170
BMW/Mini	551-6125
Ford Late Type	551-6180

TOP UPS	
Citroen/Toyota	551-6350
BMW	551-6260
Daewoo	551-6370
BMW/Chrysler	551-6240
Landrover	551-6390
BMW	551-6220
Chrysler/Daewoo	551-6280

SUMP PLUGS & WASHERS

TOP UPS	
Ford	551-6120
Ford	551-6010
Cit/Peug/Rover	551-6030
Honda/Rover	551-6070
Honda	551-6150
Fiat	551-6130
Audi/VW	551-6130
Audi/Seat	551-6170
Cit/Peug/Rover	551-6090



500-4430

QTY: 27

SUMP PLUGS & WASHERS



TOP UPS

Chrysler, Mercedes, Smart	551-6300
Subaru	551-6460
BMW, Mercedes	551-6240
BMW	551-6220
Citroen	551-6320
Citroen, Ford, Peugeot	551-6250
Alfa Romeo, Fiat	551-6210
Renault, Volvo	551-6440
Saab, Subaru	551-6470
BMW, Mini	551-6270
Chrysler, Daewoo	551-6280
Opel, Saab, Vauxhall	551-6430

TOP UPS

Fiat	551-6330
Citroen	551-6340
Citroen, Toyota	551-6350
Honda, Hyundai, Kia	551-6360
Daewoo, Opel	551-6370
Ford	551-6390
Daewoo, Hyundai	551-6400
Audi, Volkswagen	551-6410
BMW	551-6230
Citroen, Peugeot	551-6260
Opel, Vauxhall	551-6200
Fiat	551-6290

500-4435

QTY: 24

COMMON RAIL DIESEL INJECTION WASHERS



TOP UPS

Inj Wash 14.7 x 7.5 x 3	411-1190
Leak off t piece connector	411-1150
Look off connector 90 DE	411-1140
Leak off clip Siemens	411-1170
Inj wash 15.7 x 7.4 x 2	411-1200
Diesel leak off bungs	451-5395
Inj wash 14.7 x 7.5 x 1.5	411-1180
Injector leak off clip	411-1160

500-5500

QTY: 60

'E' RETAINER CLIPS

METRIC



TOP UPS

3.2mm	557-7530
5mm	557-7550
7mm	557-7570
10mm	557-7600
4mm	557-7540
6mm	557-7560
8mm	557-7580
12mm	557-7620

500-4540

QTY: 800

CIRCLIPS

INTERNAL & EXTERNAL



TOP UPS

In 11mm	557-6260
In 14mm	557-6290
In 18mm	557-6310
In 25mm	557-6370
Ex 11mm	557-6660
Ex 14mm	557-6690
Ex 18mm	557-6730
Ex 25mm	557-6770
In 13mm	557-6280
In 16mm	557-6310
In 22mm	557-6350
In 29mm	557-6390
Ex 13mm	557-6680
Ex 16mm	557-6710
Ex 22mm	557-6750
Ex 32mm	557-6810

500-4590

QTY: 300

SPLIT PINS

METRIC



TOP UPS

1mm x 20	557-1100
2mm x 36	557-1220
3.2mm x 45	557-1385
5mm x 63	557-1585
1.6mm x 25	557-1160
2.5mm x 40	557-1280
4mm x 50	557-1475

500-4600

QTY: 700

SPLIT PINS

IMPERIAL



TOP UPS

1/16 x 7/8	557-0155
5/64 x 1 3/8	557-0220
7/64 x 1 3/4	557-0320
5/32 x 1 3/4	557-0470
5/64 x 7/8	557-0205
3/32 x 1 1/4	557-0265
1/8 x 1 1/4	557-0355

500-4610

QTY: 1000

LARGE SPLIT PINS

IMPERIAL, ZINC PLATED



TOP UPS

7/64 x 1 3/4	557-0320
9/64 x 1 3/4	557-0420
3/16 x 2 1/2	557-0585
1/4 x 3	557-0695
1/8 x 1 3/4	557-0370
5/32 x 1 3/4	557-0470
1/4 x 2 1/2	557-0685
5/16 x 3	557-0795

500-4620

QTY: 220

CLEVIS PINS



TOP UPS

4.5 x 15mm	474-7000
4.5 x 21mm	474-4010
6 x 13mm	474-4020
6 x 18mm	474-4030
6 x 20mm	474-4040
8 x 22mm	474-4050
8 x 25mm	474-4060
9 x 32mm	474-4070

500-6100

QTY: 170

R CLIPS

LARGE



TOP UPS		TOP UPS	
1.2 x 20mm	474-3200	1.6 x 30mm	474-3300
1.2 x 26mm	474-3210	1.6 x 37mm	474-3310
1.8 x 40mm	474-3220	2.3 x 47mm	474-3320
2.0 x 50mm	474-3230	3.0 x 46mm	474-3330
2.3 x 40mm	474-3240	3.0 x 67mm	474-3340
3.2 x 45mm	474-3250	3.7 x 63mm	474-3350

500-4585

QTY: 75

SPRING TENSION PINS

SPRING ROLL PINS



TOP UPS	
2.5mm x 25	557-4040
4mm x 19	557-4100
5mm x 25	557-4160
6.5mm x 25	557-4220
8mm x 25	557-4280
3.2mm x 38	557-4080
4mm x 38	557-4140
5mm x 50	557-4200
6.5mm x 50	557-4260
8mm x 50	557-4320

500-4650

QTY: 380

RIVETS

STANDARD FLANGE, STEEL & ALLOY



TOP UPS	
Alloy 3.2mm x 10	562-2040
Steel 3.2mm x 12	562-1420
Steel 4.8mm x 12	562-1520
Steel 3.2mm x 8	562-1410
Steel 4mm x 12	562-1450
Steel 4.8mm x 16	562-1540

500-4810

QTY: 500

RIVETS

BLACK



TOP UPS	
3.2 x 8mm	562-4000
3.2 x 10mm	562-4010
3.2 x 12mm	562-4020
4 x 12mm	562-4030
4.8 x 12mm	562-4040
4.8 x 16mm	562-4050

500-4800

QTY: 180

BRAKE TUBE NUTS

MALE & FEMALE, FOR USE WITH 4.75MM (3/16) BRAKE PIPE



TOP UPS	
mle M10 x 1.0mm Short	471-0110
mle M10 x 1.0mm Short TFE	471-0140
fmle M10 x 1.0mm	471-0510
mle 3/8 UNF	471-0030
mle M10 x 1.0mm Long	471-0120
mle M12 x 1.0mm	471-0310
fmle Connector M10 x 1.0mm	471-0720
fmle 3/8 UNF	471-0410

500-6150

QTY: 135

BRAKE BLEED SCREWS



TOP UPS	
M6 x 1.0mm Short	472-6210
M8 x 1.25mm	472-6420
M10 x 1.0mm Long	472-6550
3/8 x 24 TPI Short	472-6020
M7 x 1.00mm	472-6330
M10 x 1.0mm Short	472-6530
1/4 x 28 TPI	472-6010
3/8 x 24 TPI Long	472-6030

500-6140

QTY: 75

BRAKE PAD FITTINGS

BRAKE PAD PINS



TOP UPS	
Pin Rover	474-1080
Pin Ford (Short)	474-1100
Pin Metro (Short)	474-1180
Pin Ford (Long)	474-1210
Pin Rover (Long)	474-1240
Pin Vauxhall	474-1140
Pin Vauxhall/Opel	474-1150
Pin Rover	474-1110
Spring Roll Pin	474-1030
Notched Pin Zinc	474-1250

500-6211

QTY: 40

BRAKE PAD FITTINGS

ANTI RATTLE & RETAINING PARTS



TOP UPS	
Clip Nissan	474-3070
Clip Peugeot	474-3020
Clip Nissan	474-3030
Anti-rattle Spring Vauxhall	474-0120
Anti-rattle Spring Audi/VW	474-0320
Anti-rattle Spring Fiesta	474-0030
Spring Pin Fiesta	474-1010
A-clip 3/16"	474-3060
R-clip 3/16"	474-3040
Anti-rattle Spring Nissan	474-0040

500-6231

QTY: 65

BRAKE PAD/SHOE FITTINGS

LOCKING PARTS



TOP UPS		TOP UPS	
Brake Drum Screw	473-1020	Brake Drum Screw	473-1010
Brake Drum Screw	473-1030	Brake Drum Screw	473-1040
Guide Pin Bolt	473-2010	Brake Shoe Lock Washer M10	474-7040
Brake Shoe Lock Washer M8	474-7010	Brake Caliper Bolt	473-0020
Brake Caliper Bolt	473-0010	Brake Shoe Pin	474-8010
Brake Shoe Licking Clip	474-7030	Wavy Washer	474-7050
Brake Pad Clip	474-3040	Brake Pad Clip	474-3060

500-6301
QTY: 120

BRAKE SHOE FITTINGS

ADJUSTER SPRINGS



TOP UPS		TOP UPS	
Shoe Adjuster Spring	474-6060	Shoe Adjuster Spring	474-6050
Shoe Adjuster Spring	474-6030	Shoe Adjuster Spring	474-6040
Shoe Adjuster Spring	474-6550	Shoe Adjuster Spring	474-6540
Shoe Adjuster Spring	474-6020	Shoe Adjuster Spring	474-6090
Shoe Adjuster Spring	474-6100	Shoe Adjuster Spring	474-6120
Shoe Adjuster Spring	474-5050	Shoe Adjuster Spring	474-5040
Shoe Adjuster Spring	474-5190		

500-6311
QTY: 46

BRAKE SHOE FITTINGS

HOLD DOWN PARTS

TOP UPS	
Hold Down Spring	474-9010
Brake Shoe Clip	474-9070
Brake Shoe Pin	474-9110
Hold Down Pin	474-9310
Hold Down Washer	474-9150
Hold Down Spring	474-9170
Hold Down Spring	474-9200
Hold Down Clip	474-9260
Hold Down Washer	474-9140
Bendix T Piece	474-9100
Hold Down Clip	474-9060
Hold Down Spring	474-9080
Hold Down Spring	474-9290
Hold Down Washer	474-9280
Brake Shoe Pin	474-9160
Hold Down Spring	474-9190
Hold Down Spring	474-9230
Brake Shoe Pin	474-9250
Hold Down Spring	474-9090
Bendix Honeycomb Spring	474-9130

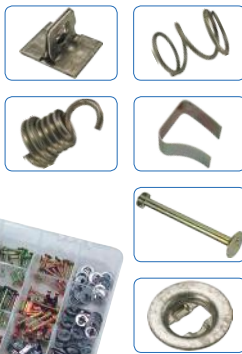

501-6330
QTY: 209

EXPANSION SPRINGS

INCLUDING THROTTLE PULL-OFF SPRINGS



TOP UPS	
5/32 x 1 3/4	558-1130
5/16 x 1 3/4	558-1430
3/8 x 2 3/4	558-1540
Throttle Pull-Off Heavy	558-1910
1/4 x 2 1/2	558-1350
9/32 x 1 1/4	558-1410
5/16 x 3	558-1450
Throttle Pull-off Light	558-1920

500-6120
QTY: 80

GREASE NIPPLES

METRIC & IMPERIAL

TOP UPS	
M6 x 1.00mm Straight	457-0210
M6 x 1.00 45°	457-0310
1/4 UNF Straight Long	457-0070
1/4 UNF 67.5 Degree	457-0110
1/8 Gas Hex Head	457-0080
M8 x 1.00mm Straight	457-0220
1/4 UNF Straight	457-0010
1/8 Gas Straight	457-0030
1/8 Gas 67.5°	457-0130



500-6460
QTY: 135

NYLON HOSE JOINERS

RESISTANT TO HOT WATER, PETROL & DIESEL, COLOURS MAY VARY

LARGE BOX

TOP UPS	
6mm Straight	QC528
6mm T Piece	455-7621
10mm Elbow	455-7441
12mm Straight	455-7051
12mm T Piece	455-7651
16mm Elbow	455-7471
19mm Straight	455-7081
Reducer 12-10mm	455-7251
Reducer 19-16mm	455-7281
Size 4 Y Piece	455-7111
Size 8 Y Piece	455-7141
Size 10 Y Piece	455-7341
Size 5 X Piece	455-7311
Size 10 X Piece	455-7341



TOP UPS	
6mm Elbow	455-7421
10mm Straight	QC527
10mm T Piece	455-7641
12mm Elbow	455-7451
16mm Straight	455-7071
16mm T Piece	455-7671
19mm Elbow	455-7481
Reducer 16-12mm	455-7271

501-5425
QTY: 36

HOSE REPAIR KIT

'O' CLIPS & HOSE JOINERS, IDEAL FOR ROADSIDE REPAIR

TOP UPS		TOP UPS	
O Clip 11-13mm	455-5130	Hose Joiner 6mm	QC528
O Clip 13-15mm	455-5150	Hose Joiner 8mm	QC529
O Clip 15-18mm	455-5180	Hose Joiner 10mm	QC527
O Clip 17-20mm	455-5200	Hose Joiner 12mm	455-7051
O Clip 20-23mm	455-5230	Hose Joiner 16mm	455-7071



500-5420
QTY: 72

'O' CLIPS

ZINC PLATED

TOP UPS	
3-5mm	455-5050
7-9mm	455-5090
11-13mm	455-5130
15-18mm	455-5180
20-23mm	455-5230
5-7mm	455-5070
9-11mm	455-5110
13-15mm	455-5150
17-20mm	455-5200



500-5410
QTY: 125

MINI HOSE CLIPS

ZINC PLATED



TOP UPS	
10mm	10-MC
13mm	13-MC
16mm	16-MC
12mm	12-MC
14mm	14-MC
18mm	18-MC

500-5450

QTY: 80

SPEED COUPLING



TOP UPS	
4mm	458-0010
5mm	458-0020
6mm	458-0030
8mm	458-0040
10mm	458-0050
12mm	458-0060

500-5490

QTY: 24

PRE-INSULATED TERMINALS



TOP UPS	
Red f.push-on 2.8mm	505-1120
Red f.push-on F/I 6.3mm	505-2140
Red Butt	506-2110
Red f.bullet 4.0mm	505-8130
Blue f.push-on 6.3mm	505-1240
Blue m.push-on 6.3mm	505-3240
Blue m.bullet 5.0mm	505-9240
Yellow f.push-on 9.5mm	505-1350

TOP UPS	
Red f.push-on 6.3mm	505-1140
Red m.push-on 6.3mm	505-3140
Red m.bullet 4.0mm	505-9130
Blue piggy back 9.5mm	505-5240
Blue f.push-on F/I 6.3mm	505-2240
Blue butt	506-2220
Blue f.bullet 5.0mm	505-8240
Yellow butt	506-2330

500-5010

QTY: 245

PRE-INSULATED TERMINALS

RINGTYPE



TOP UPS	
Red 3.7mm	505-6130
Blue 3.7mm	505-6230
Blue 6.4mm	505-6250
Blue 10.5mm	505-6270
Yellow 8.4mm	505-6360
Red 5.3mm	505-6140
Blue 5.3mm	505-6240
Blue 8.4mm	505-6260
Yellow 6.4mm	505-6350
Yellow 10.5mm	505-6370

500-5020

QTY: 200

HEATSHRINK SOLDER CONNECTORS

50MM



TOP UPS	
White Heatshrink Solder Butt Connector	506-3550
Red Heatshrink Solder Butt Connector	506-3560
Blue Heatshrink Solder Butt Connector	506-3570
Yellow Heatshrink Solder Butt Connector	506-3580

500-5160

QTY: 100

TUBE TERMINALS



TOP UPS	
16mm x 8mm	508-2350
25mm x 8mm	508-2380
35mm x 10mm	508-2420
50mm x 8mm	508-2445
50mm x 10mm	508-2450
50mm x 12mm	508-2455
70mm x 10mm	508-2475

500-5350

QTY: 70

HEATSHRINK TERMINALS

50MM LENGTHS, POLYOLEFIN, SHRINK RATIO 3:1



TOP UPS	
Black 3.2mm	507-0010
Black 4.8mm	507-0020
Black 6.4mm	507-0030
Black 9.5mm	507-0040
Black 12.7mm	507-0050
Red 3.2mm	507-0110
Red 4.8mm	507-0120
Red 6.4mm	507-0130
Red 9.5mm	507-0140
Red 12.7mm	507-0150

500-5150

QTY: 160

MULTI CONNECTORS



TOP UPS	
2 Way Connectors	506-8110
4 Way Connectors	506-8120
8 Way Connectors	506-8130
Male Connectors	506-5050
Female Connectors	506-5030

500-5310

QTY: 122

SUPERSEAL WATER PROOF CONNECTORS

LARGE BOX



TOP UPS	
1 WAY	506-8210
2 WAY	506-8220
3 WAY	506-8230
4 WAY	506-8240
5 WAY	506-8250
6 WAY	506-8260



501-9700
QTY: 26

MEGA, MIDI & STRIP FUSES

TOP UPS	
Strip Fuse 30amp	513-7030
Strip Fuse 40amp	513-7040
Strip Fuse 50amp	513-7050
Strip Fuse 60amp	513-7060
Strip Fuse 80amp	513-7080
Strip Fuse 100amp	513-7100
Midi Fuse 30amp	513-8030
Midi Fuse 40amp	513-8040
Midi Fuse 50amp	513-8050
Midi Fuse 60amp	513-8060
Midi Fuse 70amp	513-8070
Midi Fuse 80amp	513-8080
Midi Fuse 100amp	513-8100
Midi Fuse 125amp	513-8125
Midi Fuse 150amp	513-8150
Mega Fuse 100amp	514-9100
Mega Fuse 125amp	514-9125



TOP UPS	
Mega Fuse 150amp	514-9150
Mega Fuse 175 amp	514-9175
Mega Fuse 200amp	514-9200
Mega Fuses >500amp	514-9500

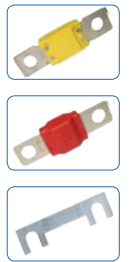

500-5270
QTY: 57

J TYPE FUSES

LOW PROFILE



TOP UPS	
LP J Type 20amp	514-1200
LP Type 25amp	514-1250
LP Type 30amp	514-1300
LP Type 40amp	514-1400
LP Type 50amp	514-1500
LP Type 60amp	514-1600



500-5255
QTY: 30

LOW PROFILE MINI FUSES

TOP UPS	
2amp	514-6020
3amp	514-6030
4amp	514-6040
5amp	514-6050
7.5amp	514-6075
10amp	514-6100
15amp	514-6150
20amp	514-6200
25amp	514-6250
30amp	514-6300



500-5280
QTY: 50

MINI BLADE FUSES

2A-30A



TOP UPS	
2A Grey	514-3020
4A Pink	514-3040
7.5A Brown	514-3070
15A Blue	514-3150
25A Clear	513-3250
3A Purple	514-3030
5A Orange	514-3050
10A Red	514-3100
20A Yellow	514-3200
30A Green	514-3300



500-5240
QTY: 100

STANDARD BLADE FUSES

3A-30A



TOP UPS	
3A Purple	514-2030
5A Orange	514-2050
10A Red	514-2100
20A Yellow	514-2200
30A Green	514-2300
4A Pink	514-2040
7.5A Brown	514-2070
15A Blue	514-2150
25A Clear	514-2250



500-5230
QTY: 100

GLASS, CONTINENTAL & DOMESTIC FUSES



TOP UPS		TOP UPS	
2A Miniature	514-0020	5A Miniature	514-0040
5A Glass	514-0140	15A Glass	514-0180
25A Glass	514-0220	35A Glass	514-0240
8A Continental White	514-1040	16A Continental Red	514-1060
25A Continental Blue	514-1080	13A Domestic	514-7030



500-5210
QTY: 200

PAL & MAXI BLADE FUSES

TOP UPS	
Type 295 60amp	514-5661
Type 295 80amp	514-5681
Type 294 40amp	514-5541
Type 294 50amp	514-5551
Type 294 60amp	514-5561
Type 294 80amp	514-5581
Type 294 100amp	514-5591
Maxi Blade 20amp	514-4021
Maxi Blade 30amp	QC018
Maxi Blade 40amp	QC019
Maxi Blade 50amp	514-4051
Maxi Blade 60amp	QC020
Maxi Blade 70amp	514-4071
Maxi Blade 80amp	514-4081
Maxi Blade 100amp	514-4101



500-5250
QTY: 24

PAL AUTO FUSES



TOP UPS	
Type 293 20amp	514-5221
Type 293 30amp	514-5231
Type 293 40amp	514-5241
Type 293 50amp	514-5251
Type 293 60amp	514-5261
Type 2935 25amp	514-5326
Type 2935 30amp	514-5331
Type 2935 45amp	514-5346
Type 2935 65amp	514-5366
Type 2935 75amp	514-5376
Type 2938 30amp	514-5431
Type 2938 40amp	514-5441
Type 283 30amp	514-5131
Type 283 40amp	514-5141
Type 283 50amp	514-5151
Type 283 80amp	514-5181



500-5260
QTY: 16

STRIP FUSES



TOP UPS	
30A	513-7030
40A	513-7040
50A	513-7050
60A	513-7060
80A	513-7080
100A	513-7100



500-5200
QTY: 60

MEGA FUSES



TOP UPS	
100A Yellow	514-9100
125A Green	514-9125
150A Orange	514-9150
175A White	514-9175
200A Blue	514-9200
225A Light Brown	514-9225
250A Pink	514-9250
300A Grey	514-9300
500A Brown	514-9500



500-5220
QTY: 18

MIDI FUSES



TOP UPS	
30A Orange	513-8030
40A Green	513-8040
50A Red	513-8050
60A Yellow	513-8060
70A Brown	513-8070
80A White	513-8080
100A Blue	513-8100
125A Pink	513-8125
150A Black	513-8150



500-5225
QTY: 27

MAXI BLADE FUSES



TOP UPS	
20A Yellow	514-4020
30A Green	514-4030
40A Orange	514-4040
50A Red	514-4050
60A Blue	514-4060
70A Tan	514-4070
80A Natural	514-4080
100A Violet	514-4100



500-5251
QTY: 48

GROMMETS

BLANKING & CABLE, PVC



TOP UPS	
10mm Blank	513-3020
12.5mm Blank	513-3030
16mm Blank	513-3040
19mm Blank	513-3050
25mm Blank	513-3080
32mm Blank	513-3090
3.5mm x 6mm Cable	513-3110

TOP UPS	
8mm x 10mm Cable	513-3120
8mm x 11mm Cable	513-3140
10mm x 12.5mm Cable	513-3150
12.5mm x 17mm Cable	513-3170
12.5mm x 19mm Cable	513-3180
4.8mm x 8mm Cable	513-3190



500-5120
QTY: 186

GROMMETS

BLANKING, PVC



TOP UPS	
8mm	513-3010
12.5mm	513-3030
19mm	513-3050
32mm	513-3090
10mm	513-3020
16mm	513-3040
25mm	513-3080



500-5110
QTY: 120

GROMMETS

CABLE, PVC



TOP UPS	
6 x 4mm	513-3110
12.5 x 10mm	513-3150
11 x 8mm	513-3140
10 x 8mm	513-3120
12.5 x 10mm	513-3150
17.5 x 12.5mm	513-3170
19 x 12.5mm	513-3180



500-5115
QTY: 200

P CLIPS

RUBBER LINED



TOP UPS	
6mm	6-PC
8mm	8-PC
10mm	10-PC
12mm	12-PC
16mm	16-PC
22mm	22-PC
25mm	25-PC
28mm	28-PC
35mm	35-PC

500-5470

QTY: 28

NYLON P CLIPS



TOP UPS	
4.8mm	513-0510
6mm	513-0520
8mm	513-0525
9mm	513-0530
12mm	513-0540
19mm	513-0550
25mm	513-0560

500-5475

QTY: 110

DASHLIGHT BULBS



TOP UPS	
Panel Bulb 12V, 2W, 8.3D	520-1050
Panel Bulb 12V, 1.2W 8.3D	520-1040
Panel Bulb 12V, 1.2D, W2 x 4.6D	520-1080
Panel Bulb 12V, 2W, B8.3D	520-1030
Panel Bulb 12V, 2W, W2 x 4.6D	520-1100
Panel Bulb 12V, 2W, 8.5D	520-1010
Panel Bulb 12V, 2W, W2 X 4.6D	520-1070
Panel Bulb 12V, 1.2W, 8.5D	520-1060
Panel Bulb 12V, 1.2W, W2 X 4.6D	520-1110
Panel Bulb 12V, 2W, 8.5D	520-1020
Panel Bulb 12V, 2W, W2 x 4.6D	520-1090
297 - 12V, 2.2W	520-2970
286 - 12V, 1.2W	520-2860
286 Green - 12V, 1.2W	520-286G
286T - 12V, 1.2W	520-286T

500-5300

QTY: 75

DIY 'O' RING SPLICING KIT



500-5510

QTY: 1

METRIC 'O' RINGS



TOP UPS	
3mm x 2mm	552-1030
5mm x 2mm	552-1050
7mm x 2mm	552-1070
10mm x 2mm	552-1100
11mm x 2.5mm	552-1110
14mm x 2.5mm	552-1140
17mm x 2.5mm	552-1170
19mm x 3mm	552-1195
22mm x 3mm	552-1220
25mm x 3mm	552-1250
28mm x 3mm	552-1280
32mm x 3mm	552-1320
35mm x 3mm	552-1350
38mm x 3mm	552-1380
42mm x 4mm	552-1420
45mm x 4mm	552-1450

503-5500

QTY: 386

IMPERIAL 'O' RINGS



TOP UPS	
1/8 x 1/16"	552-0050
5/32 x 1/16"	552-0080
3/16 x 1/16"	552-0090
1/32 x 1/16"	552-0110
1/4 x 1/16"	552-0120
5/16 x 1/16"	552-0160
7/16 x 3/32"	552-0170
1/2 x 3/32"	552-0180
3/8 x 3/32"	552-0210
3/8 x 1/16"	552-0240
9/16 x 3/32"	552-0260
5/8 x 3/32"	552-0310
11/16 x 3/32"	552-0330
3/4 x 3/32"	552-0360
3/4 x 1/8"	552-0370
1 1/2 x 3/8"	552-0410
1 5/8 x 3/4"	552-0420
1 3/4 x 3/16"	552-0480
1 1/2 x 1/8"	552-0490
1 7/14 x 1/8"	552-0540

TOP UPS	
1 3/8 x 1/8"	552-0550
1 5/6 x 1/8"	552-0590
1 1/4 x 1/8"	552-0640
1 3/16 x 1/8"	552-0670
1 3/6 x 1/8"	552-0690
7/8 x 1/8"	552-0720
15/16 x 1/8"	552-0740
1 x 1/8"	552-0760
1 1/16 x 1/8"	552-0830
1 1/8 x 1/8"	552-0890

503-5505

QTY: 365

'O' RING AIR CON SEALS

METRIC



TOP UPS	
5.29 x 1.78	
6.07 x 1.78	
6.8 x 1.9	
7.65 x 1.78	
7.8 x 1.9	
8 x 2	
8.8 x 1.9	
10.82 x 1.78	
10.77 x 2.62	
11 x 2	
12 x 2	
13.9 x 1.8	
13.95 x 2.62	
14 x 2	
15 x 2	
17 x 2	
17.17 x 1.78	
17.04 x 3.53	

503-5510

QTY: 270

WINDSCREEN WASHER SPARES



TOP UPS	
Single Jet 3mm Chrome	456-5140
Twin Jet 3mm	456-5150
Twin Jet Chrome	456-5170
T Piece Connector	456-5020
Foot Valve With Filter	456-5040
Single Jet Universal	456-5120
Single Jet 3mm	456-5110
Twin Jet 4.8mm	456-5160
In-Line Connector	456-5010
Angled Connector	456-5030
In-Line Valve	456-5050

500-5480

QTY: 50

EXHAUST MANIFOLD STUDS



TOP UPS	
M8 x 35 Audi	486-0250
M10 x 37 Japanese	486-0070
M8 x 37 Fiat/Alfa Romeo	486-0260
M10 x 55 Ford	486-0180
M8 x 43 Tlbt/Renault	486-0150
M8 x 42 Rover	486-0280
5/16 UNC x 1 11/16 UNF	486-0060
M8 x 45 Nissan	486-0130
M8 x 35 Audi/Fiat	486-0140
M10 x 38 Ford	486-0220
M10 x 52 Ford	486-0320
M8 x 47 VW	486-0290

501-6520
QTY: 110

MANIFOLD NUTS



TOP UPS	
M8 Copper Flashed Locknut	486-2030
M10 Jap Thread Locknut	486-2070
M10 Brass Nut	548-6460
M7 Steel Nut	548-1440
M10 Steel Nut	548-1460
3/8 UNF Steel Nut	548-0250
M10 Copper Flashed Locknut	486-2010
M8 Brass Nut	548-6450
M6 Steel Nut	548-1430
M8 Steel Nut	548-1450
5/16 UNF Steel Nut	548-0240

500-6500
QTY: 260

MANIFOLD SPECIAL BOLTS



TOP UPS	
Bolt/Pin Mondeo/Escort	486-1540
Bolt Opel/Vauxhall	486-1240
Bolt Rover/Honda	486-1460
Bolt Citroen/Peugeot	486-1370
Bolt Escort	486-1390
Bolt Suzuki	486-1440
Bolt Citroen/Peugeot	486-1430
Bolt Opel/Vauxhall	486-1230
Bolt Opel/Vauxhall	486-1380
Bolt Citroen/Peugeot	486-1420
Bolt Mondeo	486-1490
Clip Mondeo	486-1550
Bolt Suzuki	486-1450
Bolt Citroen/Peugeot	486-1410

501-6530
QTY: 38

CORE PLUGS

METRIC, CUP TYPE, ZINC PLATED



TOP UPS	
12.5mm	B787
28mm	B821
34mm	B807
36mm	B808
48mm	B770
22mm	B792
30mm	B822
35mm	B823
44mm	B824
50mm	B825

500-6550
QTY: 59

WOODRUFF KEYS



TOP UPS	
1/2 x 1/6	
1/2 x 3/32	
1/2 x 1/8	
5/8 x 3/32	
5/8 x 1/8	
5/8 x 5/32	
5/8 x 3/16	
3/4 x 1/8	
3/4 x 1/4	
7/8 x 3/16	

500-6560
QTY: 50

ALLOY WHEEL WEIGHTS



TOP UPS	
5G	491-5200
10G	491-5210
15G	491-5220
20G	491-5230

500-5520
QTY: 100

STEEL WHEEL WEIGHTS



TOP UPS	
5G	491-5000
10G	491-5010
15G	491-5020
20G	491-5030

500-5530
QTY: 100

POPULAR BODY & TRIM FASTENERS

UNIVERSAL
CONTENTS MAY VARY



TOP UPS	
Cable Clip 10mm Ren, Peug, Cit	563-0320
Panel Fix Ka, Fiesta	563-9220
Sff Tpr Door Punto	564-1250
Trim Fastener	563-9270
Fix Merc 190E E Class	564-6030
Bonnet Insu Fox Pol Golf Pass	563-5310
9mm Peug, Cit	563-0250
Panel Fix Escort 91/95	563-9230
Panel Fix 8mm Ren, Peug, Cit	563-2690

TOP UPS	
Trim Fasteners	564-0150
Fix 6.5mm Peug, Cit	564-6160
4.7mm PG 106, 205, 306	564-6010
Omega Clip Green 13mm	563-0820
Panel Fix Fiesta, Escort, Merc	563-9210
Nut For 4mm Self Tapper Ford	563-9310
Square Reverse Lock Nut	B547X
Trim/Bonnet Insul Button Ford	563-9120
Multi-step Clip	B530X

501-9600
QTY: 115

BODY TRIM RIVETS



TOP UPS

Expansion Type 5mm x 12mm	563-7240
Push Type Retainer 6.5mm x 13mm	563-7230
Grey Clip Retainer 6.5mm x 10mm	563-7300
BMW Expansion 6mm x 17mm	563-7210
Expansion Type 6mm x 17mm	563-7280
White Clip 5mm x 14mm	563-7290
M/Shield Push Retainer 5mm x 12mm	563-7260
Push In Type 8mm x 14mm	563-7250
Bumper Push In 6mm x 16.5mm	563-7270
Bumper Push Type Retainer 5mm x 20mm	563-7310

500-9000

QTY: 70

BODY TRIM CAPTIVE NUTS



TOP UPS

10 x 10mm Circle White	564-8000
10 x 10mm Square White	564-8440
17 x 10mm White	564-8410
15 x 20mm White	564-8430
15 x 15mm Honda Retainer	564-8450

TOP UPS

10 x 5mm Black	564-8470
17 x 10mm White	564-8480
20 x 10mm BMW/Merc	564-8460
12 x 12mm White	564-8490
11 x 20mm White	563-4380

500-9020

QTY: 100

FIR TREE CLIPS



TOP UPS

7 x 15mm	564-6200
7 x 13mm	564-6290
7 x 25mm	564-6210
8 x 20mm	564-6330
8 x 20mm	564-6240
7.5 x 25mm	564-6250
7 x 20mm	564-6260
9.5 x 13mm	564-6270
9.5 x 15mm	564-6280

500-9050

QTY: 83

SIDE MOULDING CLIPS



TOP UPS

White Side Moulding Clip - Renault Kangoo	564-8600
White Door Panel Retainer - Opel	564-8610
Green Interior Trim Clip - BMW	564-8620
Black Side Moulding Clips - Citroen C4	564-8630
White Clip Panel - Renault/Peugeot	564-8640
White Side Moulding Clip - Citroen C4	564-8650
White Trim Panel Retainer - Fiat Lada	564-8660
Green Side Moulding Clip - Citroen C4	564-8670

500-9060

QTY: 80

BODY TRIM & HARNESS RETAINERS

TOP UPS

Omega Clip	563-0810
Omega Clip	563-0820
Cable Clip	563-0320
Cable Clip	563-0230
Cable Clip	563-0610
Cable Clip	563-0110
Cable Clip	563-0140
Cable Clip	563-0150
Brake Pipe Clip	563-9420
Panel Tie	563-0620
Panel Tie	563-0250
Panel Tie	511-9140
Cable Base	511-0060
Cable Base	511-0050
P Clip	513-0540



501-9500

QTY: 134

LARGE BOX

BODY & TRIM FASTENERS

RENAULT BOX

TOP UPS

Moulding Clip	563-2080
Moulding Fixing	563-2330
Interior Trim Fix 6.5mm	564-6070
Emblem Clip 4mm	564-8420
Plastic Screw Rivet	563-1310
Door Panel Fix 8mm	563-4450
Carpet Button	564-6480
Mudflap Fix Button	564-6180
Soundproofing Fix 6.7mm	564-6230
Door Panel Fix 8.2mm	563-2650
Trim Button 6.7mm	564-6030
Door Panel Fix & Cap 8.2mm	563-2670
Soundproofing Fix 10.9mm	564-6440
Door Panel Fix 7.5mm	562-2620

501-9511

QTY: 186

LARGE BOX



BODY & TRIM FASTENERS

RENAULT BOX 2

TOP UPS

Plastic Nut 7.2x14.2mm	564-8120
Plastic Nut 4.2x7.2x7.2mm	564-8160
Plastic Nut 4.2x11x13mm	564-8190
Cage Nut M6 Mudflap	556-5130
Speed Fastener No6	549-7250
Speed Fastener No6	549-4420
Bayonet Nut M6	556-5230

TOP UPS

Flat Head Screws M6x16mm	536-3070
Flat Head Screw 6.35x17	536-4080
Cable Clip 2.5-8mm	563-0330
Cable Clip 3-8mm	563-0230
Door Stay Clasp 3-3.5mm	564-3660
Locking Fix Dia 6-12mm	563-0630
Locking Fix Dia 6-12mm	563-0620

501-9521

QTY: 138

BODY & TRIM FASTENERS

PEUGEOT/CITROEN BOX 1

TOP UPS

Door Panel Fix 8mm	563-2690
Door Panel Fix 8mm	563-4220
Door Panel Clip	563-4390
Door Panel Fix	563-4370
Door Fixing Boot	563-4380
Door Panel Eyelet	563-4400
Trim Button 6.7mm	564-6030
Trim Button 6.5mm	564-6160
Trim Button 6.7mm	564-6170

TOP UPS

Carpet Button	564-6400
Trim Fix Button 7.2mm	564-6090
Trim Fix Button 6.5mm	564-6080
Trim Fix Button 4.7mm	564-7420
Trim Fix Button 4.7mm	564-6010
Trim Fix Button 4.7mm	564-6020
Window Retaining Clip	564-4140
Grill Clip	564-7130
Moulding Clip	564-7230

501-9531

QTY: 234

LARGE BOX



BODY & TRIM FASTENERS

PEUGEOT/CITROEN BOX 2

TOP UPS	
Plastic Nut 3.5mm	564-8030
Plastic Nut	564-8120
Door Stay Fix	564-3670
Bayonet Nut M6	556-5230
Speed Fastener No6	549-7250
HT Setscrew Captive Washer	536-2080
Cage Screw M6x12	556-5720
Cage Nut M8	556-5460
Cable Clip 10mm Dia	563-0320
Trim Fix 9mm	563-0250
Omega Clip Grey 10mm	563-0810
Omega Clip Green 13mm	563-0820
Self Locking Cable Clip	563-0610
Panel Cable Tie 145 x 5mm	511-9160



501-9541

QTY: 153



BODY & TRIM FASTENERS

FIAT

TOP UPS	
Hex Insert M6 16mm	549-6235
Square Insert M6	549-6530
Plastic Nut Door Pocket	564-1240
Flat Hex Head Screw M6x20	536-4110
Lg Head Screw Torx M6x22	544-2090
Door Stay Clasp 3mm	564-3770
Door Panel & Trim Fix	564-1130
Door Panel Fix	564-1200
Door Panel Fix	564-1230
Plastic Nut 4mm	564-1150
Door Panel Button	564-1140
Bonnet Insulation Button	564-1310
Bonnet Insulation Button	564-6360
Door Fix Button	564-7410
Plastic Fix For Door 4.2mm	564-1250
Mudflap Fixing Button	564-6150



501-9551

QTY: 145



BODY & TRIM FASTENERS

FORD

TOP UPS	
Plastic Nut 4mm	563-9310
Plastic Nut Door Armrest	563-9300
Plastic Nut Door	563-9340
Speed Fastener M6	549-7260
Brake Pipe Clip 4.5mm	563-9420
Cable Clip 3-10mm	563-9210
Door Window Clip	563-9260
Metal Clip For Door Mirror	563-9130
Door Panel Fix	563-9420
Door Panel Fix	563-9250
Door Panel Fix	563-9220
Door Panel Fix	563-9210
Door Panel Fix	563-9230
Trim & Bonnet Insul. Button	563-9120
Panel Cable Tie 128 x 4.5mm	511-9140



501-9571

QTY: 123



BODY TRIM & FASTENERS

BMW & MERCEDES

TOP UPS	
Side Moulding Fix BMW	563-7010
Side Moulding Fix BMW	563-7040
Side Moulding Fix BMW	563-7020
Side Moulding Fix BMW	563-7070
Side Moulding Fix BMW	563-7060
Plastic Rivet Small BMW	563-7210
Plastic Rivet Large BMW	563-7220
Side Trim Fix Merc	563-6010
Trim Fix Merc	563-6020
Trim Fix Merc	563-6030
Trim Fix Merc	563-6040
Trim Fix Merc	563-6050
Trim Fix Merc	563-6060
Trim Fix Merc	563-6070
Wing Trim Fix Merc	563-6080
Door Panel Fix Merc	563-9210
Side Moulding Fix Merc	563-6100
Side Moulding Fix Merc	563-6120



501-9581

QTY: 123



BODY & TRIM FASTENERS

GM

TOP UPS	
564-0160	
564-0020	
564-0060	
564-0040	
564-0140	
564-0130	
564-0140	
564-0150	
564-0120	
564-0100	
564-0050	
564-0080	
564-0010	
564-0030	
564-0090	
564-0070	
564-0110	



501-9590

QTY: 155



FIRST AID PLASTERS

TOP UPS	
75 x 25	593-1060
75 x 50	593-1080
38 x 22	593-1020
63 x 19	593-1040



500-7020

QTY: 120

EMPTY BOX WITH 8 DIVIDERS

EXTRA DIVIDERS AVAILABLE (BOX043X)



500-0010

QTY: 1

EMPTY MIDI BOX WITH 8 DIVIDERS

EXTRA DIVIDERS AVAILABLE (BOX045X)



501-0020

QTY: 1

EMPTY WHITE DISPLAY STAND

FOR 10 ASSORTMENTS, FREE STANDING OR WALL MOUNTED
CONTENTS NOT INCLUDED



500-0990

QTY: 1

ORIFICE TUBE ASSORTMENT



500-8000

QTY: 15

BARB & NUT ASSORTMENT



501-8100

QTY: 24

A/C HOSE REPAIR ASSORTMENT



501-8110

QTY:

SLIM LINE SEALING WASHER ASSORTMENT



500-8040

QTY: 20

MASTER SEALING WASHER ASSORTMENT



500-8050

QTY: 48

A/C CAP & CORE ASSORTMENT



501-8030

QTY: 60

UNIVERSAL SERVICE PART & CAP ASSORTMENT



500-8070

QTY: 16

VALVE CORE ASSORTMENT



500-8020
QTY: 40



ORIFICE TUBE ASSORTMENT



501-8010
QTY: 26



GREEN RUBBER 'O' RING ASSORTMENT



500-8080
QTY: 350

16 BOX 0.14 LITRE ORGANISER

IDEAL FOR OFFICE & DIY, APPROX 280mm x 225mm



503-0020
QTY: 1



EUROPEAN A/C MAINTENANCE ASSORTMENT



500-8060
QTY: 1

LARGE CASE BOX

APPROX 305mm x 405mm



503-0010
QTY: 1



STEEL REPAIR STICK



570-0511

- Stripped threads
- Cracks & holes in metal housings

QTY: 1

PLASTIC REPAIR STICK



570-0521

- Bumpers/trim
- GRP mouldings
- For use on boats/canoes

QTY: 1

ALUMINIUM REPAIR STICK



570-0531

- Repairing/filling
- Cracks in alloy parts

QTY: 1

SUPERGLUE



- Industrial grade cyanoacrylate
- Fast cure for close fitting surfaces
- Available in 2 pack sizes

PART NO.	GRAM	QTY
570-0020	5G	5
570-0022	20G	1

NUTLOCK



570-0330

- Medium strength seal
- Resists most chemicals
- Vibration proof
- Prevents seizing

QTY: 1

RETAINER



570-0350

- Retains cylindrical slip & press fits
- Moisture resistant
- Prevents corrosion

QTY: 1

PIPE THREAD SEALANT



570-0370

- Contains liquid PTFE
- Seals water, oil, gas & air fittings
- Accommodates joint movement
- Fast cure WaterCo. approved

QTY: 1

ANAEROBIC GASKET MAKER



570-0390

- Gaps fill to 0.4mm
- Cures in the absence of air, excess product wont cure outside bond line
- Safely mixes with other liquids

QTY: 1

REAR VIEW MIRROR BONDING KIT



570-0110

- Contains 10 single application kits
- Bonds close fitting metal & glass

QTY: 1

EP2 LITHIUM GREASE



PART NO.	GRAM	QTY
570-2110	400G	5
570-2111	400G	1
570-2112	400G	36

- Multi-purpose

ANTI-SEIZE COPPER GREASE



PART NO.	CONTAINER	QTY
570-2000	400G Tub	6
570-2001	5ML Sachet	10

RED RUBBER BRAKE GREASE



PART NO.	CONTAINER	QTY
570-2002	400G Tub	6
570-2101	5ML Sachet	10

CV JOINT GREASE



PART NO.	CONTAINER	QTY
570-2003	400G Tub	6
AKA2	20G Sachet	1

EXHAUST ASSEMBLY PASTE



PART NO.	CONTAINER	QTY
590-0500	500G Cartridge	1
590-0512	500G Cartridge	12

SEALANT/CAULKING GUN



488-0990

- 310ML cartridge

QTY: 1

CE-LIT RADIATOR SEALANT



570-9000

QTY: 24

SILICONE GASKET



PART NO.	COLOUR	QTY
570-0575	Black	1
570-0580	Red	1
570-0585	Grey	1

- 200ML

GRINDING PASTE



101149A

QTY: 1

- Double ended
- Coarse & fine

GRINDING PASTE



PART NO.	DESCRIPTION	QTY
201147CX	2.5KG Coarse	1
201147FX	2.5KG Fine	1

AUTOSOL METAL POLISH



570-9010

- For chrome, aluminium & metal
- 75ML

QTY: 1

HYLOMAR GASKET SEALANT



590-0540

QTY: 1

HEAD GASKET REPAIR



570-9005

QTY: 1

EXHAUST REPAIR PUTTY



590-0550

QTY: 1

HYLOSIL INSTANT GASKET



590-0560

QTY: 1

VULCANISING CEMENT



• 250ML

491-5310

QTY: 1

BEAD LUBRICANT



• Tyre soap
• 5L

491-5320

QTY: 1

TYRE BEAD SEALER



• 1L

491-5340

QTY: 1

LIQUID BUFFER



• 1L

491-5390

QTY: 1

MULTI PURPOSE CLEANER



• Removes oil, carbon, ink etc
• Safe to use on washable surfaces
• Highly concentrated
• 500ML

570-6200

QTY: 1

DSP MAINTENANCE SPRAY



• Contains PTFE
• Attacks moisture, rust & grime
• 200ML

570-5000

QTY: 6

CONTACT CLEANER



• Fast drying
• Non-residual cleaner
• Safely dissolves oil & grease
• 500ML

570-6150

QTY: 6

WHITE GREASE WITH PTFE



• Repels moisture
• Protects against corrosion
• Resists heat
• 500ML

570-5200

QTY: 6

CHAIN SPRAY



• For chains, wire ropes & open gears
• Lubricates & protects against corrosion & harmful grit
• Resistant to salt
• Water wash-off
• 500ML

570-5250

QTY: 6

BATTERY TERMINAL PROTECTOR



• Repels moisture
• Protects against corrosion
• Indicates battery acid leaks
• 500ML

570-5300

QTY: 6

SILICONE SPRAY



• Can be used on plastic, vinyl, metal, rubber & painted surfaces
• Stable -40°C to 260°C
• 500ML

570-5500

QTY: 6

BRAKE CLEANER



• 500ML

570-6000

QTY: 6

CARB CLEANER



• Cleans engine parts of petrol, oil, grease, glues & gums
• 500ML

570-6100

QTY: 6

AUTO ADHESIVE SPRAY



• Fast acting & strong bonding
• Ideal for interiors
• 500ML

570-7000

QTY: 6

BRAKE & CLUTCH CLEANER



• 2.5L

570-6065

QTY: 1

TAR & GLUE REMOVER



• 5L

570-8086

QTY: 1

WASH & WAX



- Easy to use wash & wax
- Add a cap to a bucket of warm water & wash your car as normal
- 1L

FG5926
QTY: 1

FRESH SHINE



- 500ML

PART NO.	TYPE	QTY
FG4045	Citrus	1
FG4046	Vanilla	1
FG4047	Outdoor	1
FG4048	Strawberry	1

HARDSHELL SHINE



- Easy to use car wax which gently lift away dirt & grime
- 500ML

FG3680
QTY: 1

PASTE WAX



- Contains easy glides silicones
- 250G

FG5966
QTY: 1

METALLIC LIQUID



- 500ML

FG2635
QTY: 1

GLASS CLEANER



- 500ML

FG3675
QTY: 1

WET & BLACK



PART NO.	DESCRIPTION	QTY
FG3668	500ml spray	1
FG4478	500ml aerosol	1

TRIM & TYRE SHINE



- Colourless trim polish & protector suitable for all colours of trim
- 500ML

FG5972
QTY: 1

CARPET CLEANER



- Emergency stain remover for upholstery & carpets
- 400ML

FG4474
QTY: 1

LEATHER CLEANER



- Designed to clean, restore & protect all leather trim
- 500ML

FG5430
QTY: 1

HEADLIGHT RESTORER KIT



- Headlight clarifying compound
- Spray lubricant
- Restoration pads
- Lens sealing wipe
- Lens base coat wipe

FG6690
QTY: 1

BUG & TAR REMOVER



- 500ML

FG3894
QTY: 1

WHEEL CLEANER



- Suitable for all wheel types
- 500ml

FG3670
QTY: 1

SOFT TOP ROOF CLEANER



- Includes a roof cleaner & conditioner
- Removes stubborn stains & making soft tops look brand new

FG6648
QTY: 1

SCRATCH REMOVER



- Formulated to remove light scratches/swirl marks
- Adds colour to help mask scratches
- 150G

PART NO.	COLOUR	QTY
FG6264	Black	1
FG6265	Silver	1
FG6267	Blue	1
FG6893	Grey	1
FG6895	Green	1
FG6897	Red	1
FG6899	White	1

COLOUR ENHANCING POLISH



- Long lasting protection & outstanding shine
- Contains turtle wax chipstick to fill in deep scratches & stonechips for up to 25 washes
- 500ML

PART NO.	COLOUR	QTY
FG6900	Black	1
FG6901	Grey	1
FG6902	Blue	1
FG6903	Green	1
FG6904	Dark red	1
FG6905	Light red	1
FG6906	Silver	1
FG6907	White	1

**FOR FURTHER INFORMATION
ON OUR TURTLE WAX RANGE
CALL 01254-301121
OR VISIT MAFCOBELL.CO.UK**

CLEAR INSTANT GASKET



•40G
0233
 QTY: 1

HIGH TEMPERATURE RED INSTANT GASKET



•200ml
0456
 QTY: 1

HIGH TEMPERATURE BLACK INSTANT GASKET



•200ml
0458
 QTY: 1

BLACK SILICONE SEALANT



•40G
0373
 QTY: 1

CLEAR SILICONE SEALANT



•40G
0374
 QTY: 1

CLEAR RTV SILICONE SEALANT



•310ml
0235
 QTY: 1

BLACK RTV SILICONE SEALANT



•310ml
0236
 QTY: 1

WHITE RTV SILICONE SEALANT



•310ml
0240
 QTY: 1

COCKPIT SHINE



PART NO.	SCENT	SIZE	QTY
0885	Vanilla	500ml	1
0886	New Car	500ml	1
0888	Lemon	500ml	1
0889	Apple	500ml	1
0890	Strawberry	500ml	1
0891	Cherry	500ml	1

SPRAY PAINT



PART NO.	COLOUR	SIZE	QTY
1000	Gloss black	500ml	1
1001	Matt black	500ml	1
1002	Satin black	500ml	1
1005	Grey primer	500ml	1
1006	White primer	500ml	1
1008	Silver wheels	500ml	1
1009	Clear lacquer	500ml	1

BRUSHABLE SEAM SEALER



•1Kg
0978
 QTY: 1

AUTO BODY SEALER



•310ml
0979
 QTY: 1

STONECHIP



PART NO.	COLOUR	SIZE	QTY
0986	Black	1L	1
0987	Grey	1L	1
0988	White	1L	1
Aerosol			
0989	Black	500ml	1
0990	Grey	500ml	1
0991	White	500ml	1

DIESEL STOP SMOKE



•265ml
1441
 QTY: 1

PETROL INJECTOR CLEANER



•265ml
1434
 QTY: 1

DIESEL INJECTOR CLEANER



•265ml
1435
 QTY: 1

HYDRAULIC VALVE LIFTER TREATMENT



•265ml
1437
 QTY: 1

CATALYTIC CONVERTER CLEANER



•265ml
1428
 QTY: 1

DIESEL PARTICULATE FILTER CLEANER



•265ml
1427
 QTY: 1

ENGINE STOP LEAK



•375ml
1430
 QTY: 1

ENGINE FLUSH



•375ml
1436
 QTY: 1

STOP SMOKE FOR OIL



•375ml
1433
 QTY: 1

STOP LEAK POWER STEERING FLUID



1440
QTY: 1

• 375ml

MULTI PURPOSE PROTECTIVE LUBRICANT



2591
QTY: 1

• 400ml

GROOM UPHOLSTERY CLEANER



7003
QTY: 1

• 500ml

DRIVEWAY CLEANER



PART NO.	SIZE	QTY
6830	1L	1
6832	2L	1

PU-FLEX POLYURETHANE ADHESIVE SEALER



570-9020
QTY: 1

- Black
- Humidity curing
- Overpaintable
- Tack free after 2 hours
- 310ml

ENGINE DEGREASANT



PART NO.	TYPE	SIZE	QTY
6729	Aerosol (foam)	500ml	1
6731	Aerosol	500ml	1
6734	Container	5L	1

PRE-INSULATED TERMINALS



500-5010

QTY: 245

• Push-on type

PRE-INSULATED TERMINALS



500-5020

QTY: 200

• Ring type

HEAT SHRINK SOLDER CONNECTORS

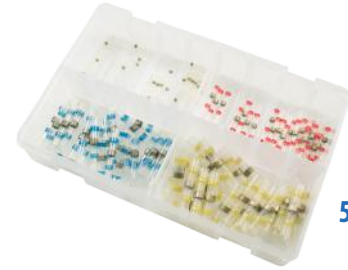

500-5160

QTY: 100

PRE-INSULATED FEMALE SPADE TERMINAL



PART NO.	SIZE	CLR	QTY
QC100	2.8mm	Red	4
QC101	4.8mm	Red	4
QC102	6.3mm	Red	4
505-1120	2.8mm	Red	50
505-1130	4.8mm	Red	50
505-1140	6.3mm	Red	50
QC105	6.3mm	Blue	4
505-1230	4.8mm	Blue	50
505-1240	6.3mm	Blue	50
505-1242	6.3mm	Blue	200
QC108	6.3mm	Yellow	2
QC109	9.5mm	Yellow	2
505-1340	6.3mm	Yellow	50
505-1350	9.5mm	Yellow	50

FULLY INSULATED FEMALE SPADE TERMINAL



PART NO.	SIZE	CLR	QTY
QC110	6.3mm	Red	4
505-2110	2.8mm	Red	50
505-2130	4.8mm	Red	50
505-2140	6.3mm	Red	50
QC111	6.3mm	Blue	4
505-2230	4.8mm	Blue	50
505-2240	6.3mm	Blue	50
505-2242	6.3mm	Blue	200
QC112	6.3mm	Yellow	2
505-2340	6.3mm	Yellow	50
505-2350	9.5mm	Yellow	50

PRE-INSULATED MALE BLADE TERMINAL



PART NO.	SIZE	CLR	QTY
QC103	6.3mm	Red	4
505-3110	2.3mm	Red	50
505-3140	6.3mm	Red	50
QC106	6.3mm	Blue	4
505-3210	2.3mm	Blue	50
505-3240	6.3mm	Blue	50
505-3242	6.3mm	Blue	200
505-3340	6.3mm	Yellow	50

FULLY INSULATED MALE BLADE TERMINAL



PART NO.	SIZE	CLR	QTY
QC113	6.3mm	Red	4
505-4140	6.3mm	Red	50
QC114	6.3mm	Blue	4
505-4240	6.3mm	Blue	50

MALE PIGGY BACK TERMINAL



PART NO.	SIZE	CLR	QTY
QC104	6.3mm	Red	4
505-5140	6.3mm	Red	50
QC107	6.3mm	Blue	4
505-5240	6.3mm	Blue	50

PRE-INSULATED RING TERMINAL



PART NO.	SIZE	CLR	QTY
QC136	5.3mm	Red	4
QC137	6.4mm	Red	4
505-6130	3.7mm	Red	50
505-6140	5.3mm	Red	50
505-6150	6.4mm	Red	50
505-6160	8.4mm	Red	50
QC138	5.3mm	Blue	4
QC139	6.4mm	Blue	4
QC140	8.4mm	Blue	4
QC141	10.5mm	Blue	4
505-6230	3.7mm	Blue	50
505-6240	5.3mm	Blue	50
505-6250	6.4mm	Blue	50
505-6260	8.4mm	Blue	50

PRE-INSULATED FEMALE BULLET CONNECTOR



PART NO.	SIZE	CLR	QTY
QC126	4.0mm	Red	4
505-8130	4.0mm	Red	50
QC128	5.0mm	Blue	4
505-8240	5.0mm	Blue	50
505-8242	5.0mm	Blue	200
QC130	5.0mm	Yellow	2
505-8340	5.0mm	Yellow	50

PRE-INSULATED MALE BULLET CONNECTOR



PART NO.	SIZE	CLR	QTY
QC127	4.0mm	Red	4
505-9130	4.0mm	Red	50
QC129	5.0mm	Blue	4
505-9240	5.0mm	Blue	50
505-9242	5.0mm	Blue	200
QC131	5.0mm	Yellow	2
505-9340	5.0mm	Yellow	50

PART NO.	SIZE	CLR	QTY
505-6270	10.5mm	Blue	50
QC142	6.4mm	Yellow	2
QC143	8.4mm	Yellow	2
QC144	10.5mm	Yellow	2
505-6340	5.3mm	Yellow	50
505-6350	6.4mm	Yellow	50
505-6360	8.4mm	Yellow	50
505-6370	10.5mm	Yellow	50
505-6380	13mm	Yellow	50

PRE-INSULATED FORK TERMINAL



PART NO.	SIZE	CLR	QTY
505-7130	3.7mm	Red	50
505-7140	5.3mm	Red	50
505-7230	3.7mm	Blue	50
505-7240	5.3mm	Blue	50

PRE-INSULATED PIN CONNECTOR



PART NO.	SIZE	CLR	QTY
506-1120	1.9mm	Red	50
506-1220	1.9mm	Blue	50

STANDARD BUTT CONNECTOR



PART NO.	AMP	CLR	QTY
QC121	5	Red	4
506-2110	5	Red	50
QC122	15	Blue	4
506-2220	15	Blue	50
506-2222	15	Blue	200
QC123	30	Yellow	2
506-2330	30	Yellow	50

ADHESIVE LINED HEAT SHRINK BUTT CONNECTOR



PART NO.	CLR	QTY
506-3110	Red	25
506-3220	Blue	25
506-3330	Yellow	10

SNAP-LOCK SPLICE CONNECTOR



PART NO.	CLR	QTY
QC151	Red	4
506-4110	Red	50
QC152	Blue	4
506-4220	Blue	50
506-4222	Blue	200

HEAT SHRINK BUTT CONNECTOR



506-3560

QTY: 25

FEMALE LUCAR TERMINAL



PART NO.	SIZE	DESCRIPTION	QTY
506-5030	6.3mm	Push on, non-insulated	50
506-5040	9.5mm	Push on, non-insulated	50

MALE LUCAR TERMINAL



506-5050

• 6.3mm

QTY: 50

SPADE COVER



506-5340

QTY: 50

BRASS BULLET



506-6040

• 4.6mm diameter
• Crimp/solderless

QTY: 200

SINGLE TERMINAL SLEEVE



506-6010

• Black vinyl insulator

QTY: 50

HEAT SHRINK TUBING



507-0160

• Assorted bag
• Various Colours
• 200mm lengths

QTY: 30

HEAT SHRINK TUBING



PART NO.	SIZE	CLR	PART NO.	SIZE	CLR
Pack Of 10			25m Rolls		
507-0010	3.2mm	Black	507-0015	3.2mm	Black
507-0020	4.8mm	Black	507-0025	4.8mm	Black
507-0030	6.4mm	Black	507-0035	6.4mm	Black
507-0040	9.5mm	Black	507-0045	9.5mm	Black
507-0050	12.7mm	Black	507-0055	12.7mm	Black
507-0110	3.2mm	Red	507-0115	3.2mm	Red
507-0120	4.8mm	Red	507-0125	4.8mm	Red
507-0130	6.4mm	Red	507-0135	6.4mm	Red
507-0140	9.5mm	Red	507-0145	9.5mm	Red
507-0150	12.7mm	Red	507-0155	12.7mm	Red

TERMINAL BLOCK



PART NO.	AMP	WIRE DIAMETER	QTY
506-7010	3	4mm	10
506-7020	5	6mm	10
506-7030	15	10mm	10
506-7040	30	16mm	10

• 12 terminals

MULTIBLOCK WIRING CONNECTOR

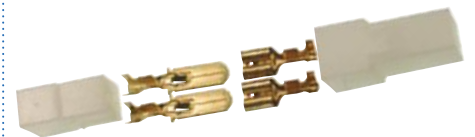

506-8110

• With nylon male & female housings
• Electrical Connectors
• 2 way

QTY: 1

MULTIBLOCK WIRING CONNECTOR

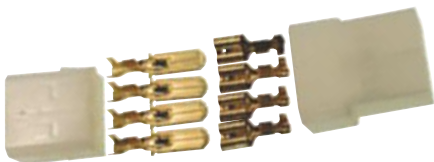

506-8120

• With nylon male & female housings
• Electrical Connectors
• 4 way

QTY: 1

MULTIBLOCK WIRING CONNECTOR

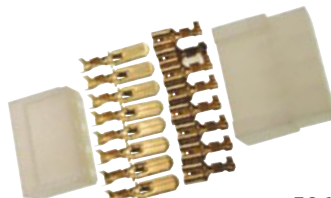

506-8130

• With nylon male & female housings
• Electrical Connectors
• 8 way

QTY: 1

SUPERSEAL WATERPROOF CONNECTORS



TOP UPS

506-8210	1 Way	506-8240	4 Way
506-8220	2 Way	506-8250	5 Way
506-8230	3 Way	506-8260	6 Way

• For where waterproof joint is required, comprising the housing, terminals & seals

SUPERSEAL WATERPROOF CONNECTORS



501-9700

QTY: 26

BLACK INSULATION TAPE



PART NO.	SIZE	QTY
QCS36	19mm x 4.5m	1
507-3010	19mm x 4.5m	10
507-3021	19mm x 10m	1
507-3020	19mm x 10m	10
507-3026	19mm x 20m	1
507-3025	19mm x 20m	10
507-3031	19mm x 33m	1
507-3030	19mm x 33m	10
507-3041	25mm x 33m	1
507-3040	25mm x 33m	10

RED INSULATION TAPE



PART NO.	SIZE	QTY
507-3028	19mm x 20m	1
507-3027	19mm x 20m	10
507-3035	19mm x 33m	1

INSULATION TAPE



PART NO.	SIZE	CLR	QTY
507-3200	19mm x 20m	White	1
507-3038	19mm x 33m	White	1
507-3500	19mm x 20m	Blue	1
507-3400	19mm x 20m	Green	1
507-3300	19mm x 20m	Yellow	1

INSULATION TAPE



507-3900

• 19mm x 20 yards
• 6 rolls of red, blue, yellow, white, green & black
• 10 of each colour

QTY: 60

INSULATION TAPE

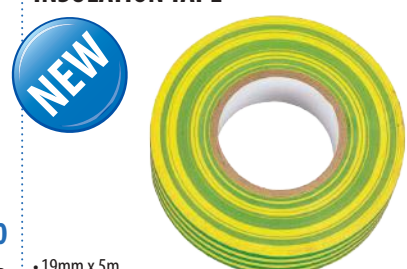

QC915

• 19mm x 5m
• Green & yellow

QTY: 1

SILICONE REPAIR TAPE



507-4010
QTY: 1

- Forms a waterproof & air tight seal
- Up to 700 PSI pressure resistance
- Resistant to oil, solvents, salt & UV
- Withstands temperatures from -60°C to 200°C
- Insulates up to 8000 volts of electricity

SILICONE REPAIR TAPE



507-4020
QTY: 1

- Forms a waterproof & air tight seal
- Up to 700 PSI pressure resistance
- Resistant to oil, solvents, salt & UV
- Withstands temperatures from -60°C to 200°C
- Insulates up to 8000 volts of electricity

SELF-AMALGAMATING TAPE



NEW

507-4100
QTY: 1

• 19mm x 5m

PVC WIRING GROMMETS



PART NO.	PANEL HOLE	WIRING HOLE	QTY
513-3110	6mm	4mm	25
513-3120	10mm	8mm	25
513-3140	11mm	8mm	25
513-3150	12.5mm	10mm	25
513-3160	14mm	11mm	25
513-3170	17.5mm	12.5mm	25
513-3180	19mm	12.5mm	25

ASSORTED BOX OF PVC WIRING GROMMETS



500-5115
QTY: 200

PVC BLANKING GROMMETS



PART NO.	PANEL HOLE	QTY
513-3010	8mm	25
513-3020	10mm	25
513-3030	12.5mm	25
513-3040	16mm	25
513-3050	19mm	25
513-3060	22mm	25
513-3070	24mm	25
513-3080	25mm	25
513-3090	32mm	10

ASSORTED BOX OF PVC BLANKING GROMMETS



500-5110
QTY: 120

ASSORTED BOX OF MIXED GROMMETS



500-5120
QTY: 180

32/0.20 SINGLE CORE

1MM, 16.5AMP



PART NO.	CLR	LENGTH	QTY
508-0125	Black	50m	1
508-0155	Blue	50m	1
508-0175	Brown	50m	1
508-0185	Green	50m	1
508-0265	Purple	50m	1
508-0295	Red	50m	1
508-0335	White	50m	1
508-0345	Yellow	50m	1

• Thin wall

28/0.30 SINGLE CORE

2MM, 25AMP



PART NO.	CLR	LENGTH	QTY
508-0525	Black	50m	1
508-0555	Blue	50m	1
508-0575	Brown	50m	1
508-0585	Green	50m	1
508-0665	Purple	50m	1
508-0695	Red	50m	1
508-0735	White	50m	1
508-0745	Yellow	50m	1

• Thin wall

44/0.30 SINGLE CORE

3MM, 33AMP



PART NO.	CLR	LENGTH	QTY
508-0825	Black	30m	1
508-0835	Brown	30m	1
508-0845	Red	30m	1

• Thin wall

65/0.30 SINGLE CORE AUTO CABLE

4.5MM, 42AMP



PART NO.	CLR	LENGTH	QTY
508-0925	Black	30m	1
508-0935	Brown	30m	1
508-0945	Red	30m	1

• Thin wall

2 X 32/0.20 FLAT TWIN CORE

3.5MM, 16.5AMP



PART NO.	CLR	LENGTH	QTY
508-1125	Black outer with red & Black inner	30m	1

• Thin wall

2 X 28/0.30 FLAT TWIN CORE

3.8MM, 25AMP



PART NO.	CLR	LENGTH	QTY
508-1155	Black outer with red & Black inner	30m	1

• Thin wall

7 CORE CABLE FOR TRAILERS



• Black outer with brown, green, red, yellow, black, blue & white inner

PART NO.	SPEC	AMP	LENGTH	QTY
508-1250	9/0.30	5.75	30m	1
508-1255	24/0.20	14	30m	1

9/0.30 SINGLE CORE

1MM, 8.75AMP



PART NO.	CLR	LENGTH	QTY
508-0120	Black	50m	1
508-0150	Blue	50m	1
508-0170	Brown	50m	1
508-0180	Green	50m	1
508-0260	Purple	50m	1
508-0290	Red	50m	1
508-0330	White	50m	1
508-0340	Yellow	50m	1

28/0.30 SINGLE CABLE

2MM, 17.5AMP



PART NO.	CLR	LENGTH	QTY
508-0520	Black	50m	1
508-0550	Blue	50m	1
508-0570	Brown	50m	1
508-0580	Green	50m	1
508-0660	Purple	50m	1
508-0690	Red	50m	1
508-0730	White	50m	1
508-0740	Yellow	50m	1

44/0.30 SINGLE CORE

3MM, 27.5AMP



PART NO.	CLR	LENGTH	QTY
508-0820	Black	30m	1
508-0830	Brown	30m	1
508-0840	Red	30m	1

• Traditional

65/0.30 SINGLE CORE

4.5MM, 35AMP



PART NO.	CLR	LENGTH	QTY
508-0920	Black	30m	1
508-0930	Brown	30m	1
508-0940	Red	30m	1

• Traditional

2 X 14/0.30 FLAT TWIN CORE

1MM, 8.75AMP



PART NO.	CLR	LENGTH	QTY
508-1120	Black outer with red & Black inner	30m	1

• Traditional

2 X 28/0.30 FLAT TWIN CORE

2MM, 17.5AMP



PART NO.	CLR	LENGTH	QTY
508-1150	Black outer with red & Black inner	30m	1

• Traditional

2 X 13/0.20 TWIN CORE CABLE

0.4MM, 2.5AMP



PART NO.	CLR	LENGTH	QTY
508-1010	B/W STRIPE	30m	1
508-1012	B/W STRIPE	100m	1

• Traditional
• For stereo speakers

BATTERY STARTER CABLE



PART NO.	CLR	DESCRIPTION	AMP	QTY
508-3300	Black	196/0.40	170	1
508-3400	Red	196/0.40	170	1
508-3600	Black	206/0.30	110	1
508-3500	Red	206/0.30	110	1

• Traditional
• 10m reels

MINI REELS



PART NO.	AMP	CLR	LENGTH
508-3010	5	Black	7m
508-3020	5	Blue	7m
508-3030	5	Brown	7m
508-3040	5	Red	7m
508-3050	5	Yellow	7m
508-3110	8	Black	6m
508-3120	8	Blue	6m
508-3130	8	Brown	6m
508-3140	8	Red	6m
508-3150	8	Yellow	6m
508-3200	Speaker cable		7m

• With traditional cable

COPPER CORE IGNITION LEAD



OES000
QTY: 1

• 7mm
• 30m length

BATTERY TO STARTER CABLE



BLACK	RED	LENGTH
508-1510	508-1610	225mm
508-1520	508-1620	300mm
508-1530	508-1630	450mm
508-1540	508-1640	600mm
508-1550	508-1650	760mm
508-1560	508-1660	915mm
508-1570	508-1670	1067mm
508-1580	508-1680	1219mm

• 37/071
• 16mm
• Copper Cable
• Ring to battery
• PVC insulated

SWITCH TO STARTER CABLE



BLACK	RED	LENGTH
508-1710	508-1810	225mm
508-1720	508-1820	300mm
508-1730	508-1830	450mm
508-1740	508-1840	600mm
508-1750	508-1850	760mm
508-1760	508-1860	915mm
508-1770	508-1870	1067mm
508-1780	508-1880	1219mm

• 37/071
• 16mm
• Copper Cable
• Ring to ring
• PVC insulated

BATTERY TO EARTH CABLE



PART NO.	LENGTH
508-2010	225mm
508-2020	300mm
508-2025	375mm
508-2030	450mm
508-2040	600mm
508-2050	760mm

• Braided
• Ring to terminal
• 19mm copper cable

ENGINE TO EARTH CABLE



PART NO.	LENGTH
508-2105	150mm
508-2110	225mm
508-2120	300mm
508-2130	450mm
508-2140	600mm

• Braided
• Ring to ring
• 19mm copper cable

BATTERY RETAINING BRACKET SET



508-2701

• 1 x 355mm angled perforated strip
• 2 x 305mm hooked battery bolts with wing nuts

QTY: 1

PERFORATED STRIP

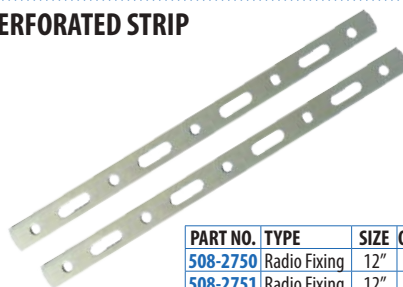

PART NO.	TYPE	SIZE	QTY
508-2750	Radio Fixing	12"	10
508-2751	Radio Fixing	12"	10
508-2752	Perforated	12"	10

COPPER TUBE TERMINALS



PART NO.	LBB ENTRY	CABLE ENTRY	STUD	QTY
508-2350	5.5mm	16mm	8.0mm	10
508-2380	7.0mm	25mm	8.0mm	10
508-2410	-	25mm	10mm	10
508-2420	8.2mm	35mm	10mm	10
508-2440	-	35mm	12mm	10
508-2445	9.5mm	50mm	8.0mm	10
508-2450	9.5mm	50mm	10mm	10
508-2455	9.5mm	50mm	12mm	10
508-2460	-	70mm	12mm	10
508-2475	11.5mm	70mm	10mm	10

ASSORTED BOX OF COPPER TUBE TERMINALS



500-5350

QTY: 170

COPPER TUBE TERMINAL CRIMPING TOOL



400040

• Heavy duty crimping tool for terminals up to 120mm
• The terminal is placed under the spring loaded punch
• Apply pressure by striking the top of the tool with a hammer or alternatively squeezed in a vice

QTY: 1

BATTERY ISOLATOR SWITCH



513-6711

• 2 removable keys
• Waterproof cover
• Max load at 12 volts: 1000amp for 10 seconds
• Max load at 24 volts: 500amp for 10 seconds
• 100amp continuous rating

QTY: 1

BATTERY ISOLATOR SWITCH



- 2 removable keys
- Waterproof cover
- Max load at 12 volts: 1000amp for 10 seconds
- Max load at 24 volts: 500amp for 10 seconds
- 100amp continuous rating
- Ceramic resistor

513-6721
QTY: 1

BATTERY TERMINALS



PART NO.	VOLT	TYPE	MATERIAL	QTY
QC623				1
508-2510	12	+	Brass	10
QC624				1
508-2520	12	-	Brass	10
QC625				1
508-2530	12	+	Zinc Plated Brass	10
QC626				1
508-2540	12	-	Zinc Plated Brass	10
508-2551				1
508-2550	24	+	Zinc Plated Brass	10
508-2561				1
508-2560	24	-	Zinc Plated Brass	10

CARGO POST BATTERY TERMINALS



PART NO.	CABLE	TYPE	QTY
508-2570	M8	+	10
508-2571	M8	-	1
508-2580	M8	-	10
508-2581	M8	-	1
508-2590	M10	+	10
508-2591	M10	+	1
508-2600	M10	-	10
508-2601	M10	-	1

INSULATED JUMP LEAD HANDLES



PART NO.	CLR	TYPE	QTY
515-0011	Red & Black	+ & -	2
515-0021	Red	+	1
515-0031	Black	-	1

ZINC PLATED CROCODILE CLIPS



PART NO.	AMP	QTY
QC616		2
507-2010	5	10
QC617		2
507-2020	25	10
507-2031		2
507-2030	50	10

KEY FOB BATTERY



PART NO.	SIZE MM	CR NO.	QTY
QC650	20 x 1.6	CR2016	1
QC651	20 x 2.5	CR2025	1
QC652	20 x 3.2	CR2032	1
QC653	16 x 2.0	CR1620	1
QC654	12 x 2.0	CR1220	1
QC655	11.5 x 0.5	A76/LR44	1
QC656	28 x 10	LR23/23A	1

COPPER CABLE BOOSTER LEADS



PART NO.	AMP	SIZE	LENGTH	QTY
MBC110/3	110	16mm	3m (10Ft)	1
MBC110/4	110	16mm	4m (13Ft)	1
MBC110/5	110	16mm	5m (16Ft)	1
MBC135/5	135	20mm	5m (16Ft)	1
MBC170/5	170	25mm	5m (16Ft)	1

• Suitable for 12V & 24V

NYLON CABLE TIE BASES



PART NO.	SIZE	SCREW	CLR	QTY
511-0040	4.8mm	M4	Natural	25
511-0050	4.8mm	M5	Black	25
511-0030	7.8mm	M6	Natural	25
511-0060	9.0mm	M5	Natural	25

• Secured with self tapping screws

SELF ADHESIVE PLASTIC CABLE TIES



PART NO.	CABLE DIA	BASE	QTY
513-0110	4.0mm	16 x 16	50
513-0140	10.0mm	25 x 25	50
513-0150	16.0mm	25 x 25	25

WHITE NYLON P-CLIPS



PART NO.	CABLE DIA	QTY
513-0510	4.8mm	50
513-0520	6.0mm	50
513-0525	8.0mm	50
513-0530	9.0mm	50
513-0540	12.0mm	50
513-0550	19.1mm	25
513-0560	25.4mm	25

BLACK NYLON P-CLIPS



PART NO.	SIZE	QTY
513-0012	1/2"	100
513-0014	1/4"	100
513-0018	1/8"	100
513-0034	3/4"	100
513-0058	5/8"	100
513-0316	3/16"	100
513-0516	5/16"	100

RUBBER LINED P-CLIPS



PART NO.	CABLE DIA	QTY
5-PC	5mm	10
6-PC	6mm	10
8-PC	8mm	10
10-PC	10mm	10
12-PC	12mm	10
13-PC	13mm	10
14-PC	14mm	10
16-PC	16mm	10
17-PC	17mm	10
19-PC	19mm	10
22-PC	22mm	10
25-PC	25mm	10
28-PC	28mm	10
35-PC	35mm	10

SOLDER WIRE



PART NO.	DIA	SWG	COIL	QTY
584-9320	1.6mm	18	0.5KG	1
584-9340	3.5mm	14	0.5KG	1

• 60% tin
• 40% lead

SOLDER WIRE



584-9310
QTY: 1

• 2.5mm

240V 3PIN RESILIENT PLUG



PART NO.	AMP	CLR	QTY
E144B	13	Black	5
E144BP	13	Black	100
E144W	13	White	5
E144WP	13	White	100

CABLE TIES

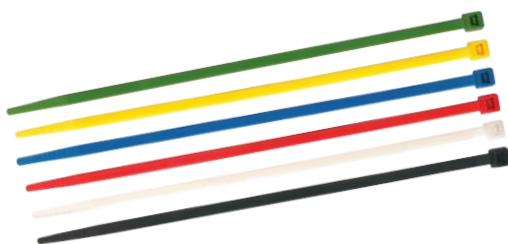

MM	INCHES	CLR	PART NO.	QTY	PART NO.	QTY
SMALL						
100 x 2.5	4 x 3/32"	Black	511-1000	100	511-1002	1000
100 x 2.5	4 x 3/32"	Natural	511-1010	100	-	-
100 x 2.5	4 x 3/32"	Red	511-1030	100	-	-
100 x 2.5	4 x 3/32"	Blue	511-1040	100	-	-
100 x 2.5	4 x 3/32"	Yellow	511-1050	100	-	-
100 x 2.5	4 x 3/32"	Green	511-1060	100	-	-
140 x 3.6	5 x 1/8"	Black	511-2100	100	511-2102	1000
MEDIUM						
200 x 4.8	8 x 3/16"	Black	511-3200	100	511-3202	1000
200 x 4.8	8 x 3/16"	Natural	511-3210	100	-	-
200 x 4.8	8 x 3/16"	Red	511-3230	100	-	-
200 x 4.8	8 x 3/16"	Blue	511-3240	100	-	-
200 x 4.8	8 x 3/16"	Yellow	511-3250	100	-	-
200 x 4.8	8 x 3/16"	Green	511-3260	100	-	-
LARGE						
295 x 4.8	12 x 3/16"	Black	511-3300	100	511-3302	500

MM	INCHES	CLR	PART NO.	QTY	PART NO.	QTY
295 x 4.8	12 x 3/16"	Natural	511-3310	100	-	-
295 x 4.8	12 x 3/16"	Silver	511-3320	100	511-3322	500
295 x 4.8	12 x 3/16"	Red	511-3330	100	-	-
295 x 4.8	12 x 3/16"	Blue	511-3340	100	-	-
295 x 4.8	12 x 3/16"	Yellow	511-3350	100	-	-
295 x 4.8	12 x 3/16"	Green	511-3360	100	-	-
EXTRA LARGE						
370 x 4.8	15 x 3/16"	Black	511-3400	100	511-3402	500
370 x 4.8	15 x 3/16"	Natural	511-3410	100	511-3412	500
370 x 7.6	15 x 5/16"	Black	511-4400	100	511-4402	250
390 x 4.8		Silver	511-5420	100	-	-
430 x 9.0	18 x 1/2"	Black	511-6500	50	511-6502	100
550 x 8.0	23 x 1/4"	Black	511-4600	50	511-4602	100
555 x 12.8		Black	511-6600	50	511-6602	100
CABLE TIES WITH FIXING HEAD						
205 x 4.2		Black	511-3204	50	-	-
400 x 7.9	16 x 5/16"	Black	511-7404	50	-	-

ASSORTED CABLE TIES



- Mixture of black, white & grey
- 100mm x 900
- 140mm x 300
- 200mm x 300
- 295mm x 300
- 370mm x 200

511-0020
QTY: 2000

ASSORTED CABLE TIES



- Mixture of black, white & grey
- 100mm x 1100
- 140mm x 500
- 200mm x 200
- 295mm x 300

511-0000
QTY: 2000

CABLE TIES



• Various sizes from 100mm - 295mm

MTV1-500
QTY: 500

TOGGLE SWITCH



- On/off
- With terminals

QC599
QTY: 1

TOGGLE SWITCH



- On/flash
- 20amp

QC600
QTY: 1

TOGGLE SWITCH



- On/flash
- 20amp

QC601
QTY: 1

TOGGLE SWITCH

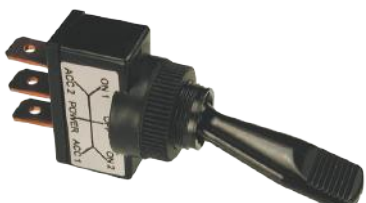

- On/off/on
- 20amp

QC602
QTY: 1

SPLASHPROOF TOGGLE



- Off/on/on
- 20amp

QC603
QTY: 1

SPLASHPROOF TOGGLE SWITCH



- On/off
- 20amp

QC585
QTY: 1

METAL TOGGLE SWITCH



- On/off
- 25amp

QC596
QTY: 1

METAL TOGGLE SWITCH



- On/on
- 25amp

QC597
QTY: 1

METAL TOGGLE SWITCH



- On/off/on
- 25amp

QC598
QTY: 1

AIRCRAFT COVER



• For QC596, 597 and 598

QC583
QTY: 1

MINIATURE TOGGLE



- On/off
- 16amp

QC581
QTY: 1

MINIATURE TOGGLE



- On/off
- 16amp
- Illuminated

QC582
QTY: 1

ILLUMINATED AMBER TOGGLE



- On/off
- 20amp

QC604
QTY: 1

ILLUMINATED BLUE TOGGLE



- On/off
- 20amp

QC595
QTY: 1

ILLUMINATED GREEN TOGGLE



- On/off
- 20amp

QC594
QTY: 1

ILLUMINATED RED TOGGLE

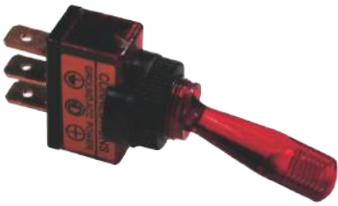

• On/off
• 20amp

QC593
QTY: 1

ROCKER SQUARE FITTING



• On/off
• 16amp

QC605
QTY: 1

ROCKER ROUND FITTING

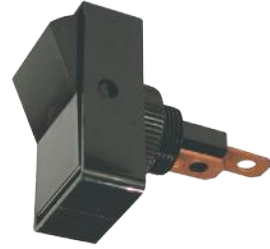

• On/off
• 16amp

QC606
QTY: 1

ILLUMINATED ROCKER



• On/off
• 20amp
• 4pin

QC590
QTY: 1

ILLUMINATED ROCKER



• On/off
• 20amp
• 3pin

QC591
QTY: 1

ILLUMINATED AMBER SQUARE FIT



• On/off
• 16amp

QC608
QTY: 1

ILLUMINATED BLUE SQUARE FIT



• On/off
• 16amp

QC592
QTY: 1

ILLUMINATED GREEN SQUARE FIT



• On/off
• 16amp

QC589
QTY: 1

ILLUMINATED RED SQUARE FIT



• On/off
• 16amp

QC588
QTY: 1

ILLUMINATED AMBER ROUND FIT

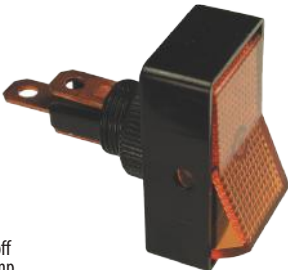

• On/off
• 16amp

QC607
QTY: 1

RED PUSH TYPE ILLUMINATED



• Pull on/push off
• 16amp

QC587
QTY: 1

SWITCH STAND



STAND1
QTY: 52

HEAVY DUTY MOMENTARY



• Push on button
• 16amp

QC584
QTY: 1

AMBER WARNING LIGHT



QC613
QTY: 1

BLUE WARNING LIGHT



QC574
QTY: 1

GREEN WARNING LIGHT



QC575
QTY: 1

RED WARNING LIGHT



QC612
QTY: 1

CHROME HOUSING



QC577
QTY: 1

LED FLASHING



QC576
QTY: 1

• Complete with wire

1 HOLE ROUND SWITCH PANEL



QC614
QTY: 1

1 HOLE SQUARE SWITCH PANEL



QC615
QTY: 1

2 HOLE ROUND SWITCH PANEL



QC580
QTY: 1

DOOR SWITCH



QC609
QTY: 1

LONG DOOR SWITCH



QC610
QTY: 1

ASSORTED BOX OF LOW PROFILE FUSES



500-5280
QTY: 50

LOW PROFILE MINI FUSES



PART NO.	AMP	CLR	QTY	PART NO.	QTY	PART NO.	QTY
QC055	2	Grey	3	514-6020	10	514-6025	50
QC056	3	Violet	3	514-6030	10	514-6035	50
QC057	4	Pink	3	514-6040	10	514-6045	50
QC058	5	Tan	3	514-6050	10	514-6055	50
QC059	7.5	Brown	3	514-6075	10	514-6755	50
QC060	10	Red	3	514-6100	10	514-6105	50
QC061	15	Blue	3	514-6150	10	514-6155	50
QC062	20	Yellow	3	514-6200	10	514-6205	50
QC063	25	Natural	3	514-6250	10	514-6255	50
QC064	30	Green	3	514-6300	10	514-6305	50

LOW PROFILE MINI FUSES

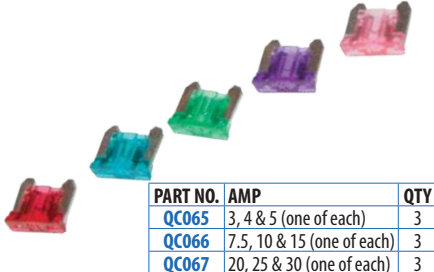

PART NO.	AMP	QTY
QC065	3, 4 & 5 (one of each)	3
QC066	7.5, 10 & 15 (one of each)	3
QC067	20, 25 & 30 (one of each)	3

ASSORTED BOX OF MINI BLADE FUSES



500-5240
QTY: 100

MINI BLADE FUSES



PART NO.	AMP	CLR	QTY	PART NO.	QTY	PART NO.	QTY
QC041	2	Grey	3	514-3020	25	514-3025	50
QC042	3	Violet	3	514-3030	25	514-3035	50
QC043	4	Pink	3	514-3040	25	514-3045	50
QC044	5	Tan	3	514-3050	25	514-3055	50
QC045	7.5	Brown	3	514-3070	25	514-3075	50
QC046	10	Red	3	514-3100	25	514-3105	50
QC047	15	Blue	3	514-3150	25	514-3155	50
QC048	20	Yellow	3	514-3200	25	514-3205	50
QC049	25	Natural	3	514-3250	25	514-3255	50
QC050	30	Green	3	514-3300	25	514-3305	50

MINI BLADE FUSES

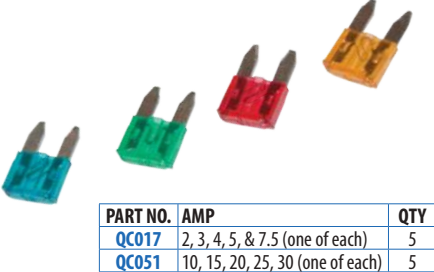

PART NO.	AMP	QTY
QC017	2, 3, 4, 5, & 7.5 (one of each)	5
QC051	10, 15, 20, 25, 30 (one of each)	5

ASSORTED BOX OF STANDARD FUSES



500-5230
QTY: 100

STANDARD FUSES



PART NO.	AMP	CLR	QTY	PART NO.	QTY	PART NO.	QTY
QC091	1	Black	3	-	-	-	-
QC092	2	Grey	3	-	-	-	-
QC001	3	Violet	3	-	-	514-2030	50
QC002	4	Pink	3	-	-	514-2040	50
QC003	5	Tan	3	QC012	20	514-2050	50
QC004	7.5	Brown	3	-	-	514-2070	50
QC005	10	Red	3	QC013	20	514-2100	50
QC006	15	Blue	3	QC014	20	514-2150	50
QC007	20	Yellow	3	QC015	20	514-2200	50
QC008	25	Natural	3	-	-	514-2250	50
QC009	30	Green	3	QC016	20	514-2300	50
QC093	40	Orange	3	-	-	-	-

STANDARD FUSES



PART NO.	AMP	QTY
QC011	3, 4, 7 & 25 (one of each)	5
QC010	5, 10, 15, 20 & 30 (one of each)	5

ASSORTED BOX OF MAXI BLADE FUSES



500-5251
QTY: 48

MAXI BLADE FUSES

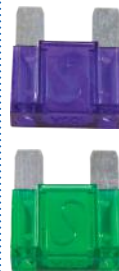

PART NO.	AMP	CLR	QTY	PART NO.	QTY
514-4021	20	Yellow	1	514-4020	10
QC018	30	Green	1	514-4030	10
QC019	40	Orange	1	514-4040	10
514-4051	50	Red	1	514-4050	10
QC020	60	Blue	1	514-4060	10
514-4071	70	Tan	1	514-4070	10
514-4081	80	Natural	1	514-4080	10
514-4101	100	Violet	1	514-4100	10

ASSORTED BOX OF STRIP FUSES



500-5200
QTY: 60

STRIP FUSES



PART NO.	AMP	QTY
513-7030	30	10
513-7040	40	10
513-7050	50	10
513-7060	60	10
513-7080	80	10
513-7100	100	10

STRIP FUSE HOLDER



QC090
QTY: 1

ASSORTED BOX OF MIDI FUSES



500-5225
QTY: 27

MIDI FUSES



PART NO.	AMP	CLR	QTY	PART NO.	QTY
QC070	30	Orange	1	513-8030	10
QC071	40	Green	1	513-8040	10
QC072	50	Red	1	513-8050	10
QC073	60	Yellow	1	513-8060	10
QC074	70	Brown	1	513-8070	10
QC075	80	White	1	513-8080	10
QC076	100	Blue	1	513-8100	10
QC077	125	Pink	1	513-8125	10
QC078	150	Black	1	513-8150	10

MIDI FUSE HOLDER



QC079
QTY: 1

ASSORTED BOX OF MEGA FUSES



500-5220
QTY: 18

MEGA FUSES



PART NO.	AMP	CLR	QTY	PART NO.	QTY
QC080	100	Yellow	1	514-9100	10
QC081	125	Green	1	514-9125	10
QC082	150	Orange	1	514-9150	10
QC083	175	White	1	514-9175	10
QC084	200	Blue	1	514-9200	10
QC085	225	L/Brown	1	514-9225	10
QC086	250	Pink	1	514-9250	10
QC087	300	Grey	1	514-9300	10
QC088	500	Brown	1	514-9500	10

MEGA FUSE HOLDER



QC089
QTY: 1

ASSORTED BOX OF MEGA, MIDI & STRIP FUSES



500-5270
QTY: 57

CONTINENTAL FUSES



PART NO.	AMP	CLR	QTY	PART NO.	QTY
QC021	5	Yellow	3	514-1020	25
QC022	8	White	3	514-1040	25
QC023	16	Red	3	514-1060	25
QC024	25	Blue	3	514-1080	25
QC025	5, 8, 16 & 25 (1 of each)	-	5	-	-
514-8031	Continental fuse holder		1	Samp use	

PAL MINI FEMALE TYPE 2938



PART NO.	AMP	CLR	QTY
514-5431	30	Pink	1
514-5441	40	Green	1

PAL J TYPE



PART NO.	AMP	CLR	QTY
514-5721	20	L/Blue	1
514-5731	30	Pink	1
514-5741	40	Green	1
514-5751	50	Red	1
514-5761	60	Yellow	1

LOW PROFILE J TYPE



PART NO.	AMP	CLR	QTY
514-1200	20	L/Blue	1
514-1250	25	White	1
514-1300	30	Pink	1
514-1400	40	Green	1
514-1500	50	Red	1
514-1600	60	Yellow	1

PAL AUTO FUSES TYPE 283

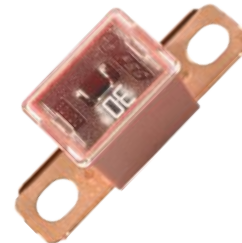

PART NO.	AMP	CLR	QTY
514-5121	20	L/Blue	1
514-5131	30	Pink	1
514-5141	40	Green	1
514-5151	50	Red	1
514-5161	60	Yellow	1
514-5171	70	Brown	1
514-5181	80	Black	1
514-5101	100	Blue	1

ASSORTED BOX OF FUSES



500-5260
QTY: 16

PAL AUTO FUSE TYPE 295

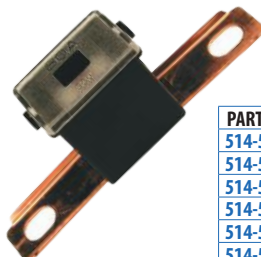

PART NO.	AMP	CLR	QTY
514-5631	30	Pink	1
514-5641	40	Green	1
514-5651	50	Red	1
514-5661	60	Yellow	1
514-5681	80	Black	1
514-5601	100	Blue	1

ASSORTED BOX OF FUSES



500-5250
QTY: 24

- PAL auto 283
- PAL auto 293
- PAL auto 2935
- PAL auto 2938

- PAL auto 295
- PAL female 293
- PAL male 294

PAL MINI CLIP TYPE 2935



PART NO.	AMP	CLR	QTY
514-5326	25	Brown	1
514-5331	30	Green	1

PAL CLIP TYPE 2935



PART NO.	AMP	CLR	QTY
514-5346	45	Red	1
514-5366	65	Black	1
514-5376	75	Grey	1

PAL FEMALE TYPE 293



PART NO.	AMP	CLR	QTY
514-5221	20	Blue	1
514-5231	30	Pink	1
514-5241	40	Green	1
514-5251	50	Red	1
514-5261	60	Yellow	1
514-5281	80	Black	1
514-5291	100	Blue	1

PAL MALE TYPE 294



PART NO.	AMP	CLR	QTY
514-5531	30	Pink	1
514-5541	40	Green	1
514-5551	50	Red	1
514-5561	60	Yellow	1
514-5581	80	Black	1
514-5591	100	Blue	1

MINIATURE GLASS RADIO FUSES



PART NO.	AMP	LENGTH	QTY
514-0010	1	20	25
514-0020	2	20	25
514-0030	3	20	25
514-0040	5	20	25
QC035	3, 5 & 7.5 (1 Of Each)		

STANDARD GLASS FUSES



PART NO.	AMP	LENGTH	QTY	PART NO.	QTY
-	1	30	-	514-0110	25
QC026	2	30	3	514-0120	25
-	5	30	-	514-0140	25
QC027	8	30	3	514-0150	25
QC028	10	30	3	514-0160	25
QC029	15	30	3	514-0180	25
QC030	20	30	3	514-0200	25
QC031	25	30	3	514-0220	25
QC032	35	30	3	514-0240	25
QC033	50	30	3	514-0260	25

DOMESTIC PLUG MAIN FUSES



PART NO.	AMP	QTY
514-7010	3	25
514-7020	5	25
514-7030	13	25
QC038	Assorted Bag	4

STANDARD BLADE FUSE HOLDER



PART NO.	QTY
514-8110	5
QC039	1

• With male side tabs

SELF STRIPPING FUSE HOLDER



PART NO.	DESCRIPTION	QTY
514-8131	-	1
514-8141	Splashproof	1

• Complete with 5amp blade fuse

SPLASHPROOF FUSE HOLDER



514-8151
QTY: 1

• Standard blade fuse

FUSE BOX



PART NO.	DESCRIPTION	QTY
514-8161	4 blade fuses	1
514-8171	6 blade fuses	1

• Complete with transparent cover

MINI BLADE FUSE HOLDER



514-8200
QTY: 1

MAXI BLADE FUSE HOLDER

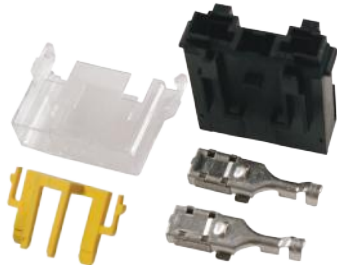

514-8300
QTY: 1

ALTERNATOR TERMINAL KIT



300-0004
QTY: 1

UNIVERSAL ILLUMINATED CIGAR LIGHTER



PART NO.	VOLTAGE	QTY
427-0500	12V	1
427-0510	24V	1

12V UNIVERSAL ILLUMINATED CIGAR LIGHTER



427-0501
QTY: 1

H7 BULB HOLDER



300-0002
QTY: 1

H4 BULB HOLDER

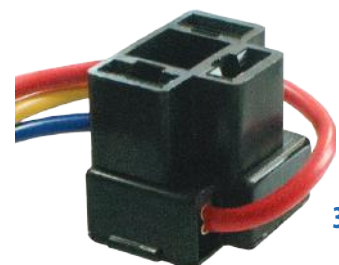

300-0003
QTY: 1

SIDE REPEATER BULB HOLDER



513-5000
QTY: 1

FORD SIDE REPEATER LENS



513-5010
QTY: 1

FIESTA SIDE REPEATER LENS



513-5020
QTY: 1

MONDEO/ESCORT SIDE REPEATER LENS



513-5030
QTY: 1

FOCUS/MONDEO SIDE REPEATER LENS



513-5040
QTY: 1

MINI/DISCOVERY ONE SIDE REPEATER LENS



513-5050
QTY: 1

NEW MINI SIDE REPEATER LENS



513-5060
QTY: 1

12V 286 PANEL



PART NO.	REF	WATT	CAP
BOX OF 5			
520-1080	286B	1.2	W2 x 4.6d
520-1090	286G	1.2	W2 x 4.6d
520-1100	286R	2	W2 x 4.6d
520-1110	286	1.2	W2 x 4.6d
BOX OF 10			
520-1070	286A	1.2	W2 x 4.6d
520-2860	Clear	1.2	W2 x 4.6d
520-286A	Amber	1.2	W2 x 4.6d
520-286G	Green	1.2	W2 x 4.6d
BLISTER PACK OF 2			
MBB286	Clear	1.2	W2 x 4.6d

12V HYPER BULB



PART NO.	REF	WATT	CAP
SINGLE			
520-12085	12085	19	-
520-12188	12188	24	-
520-12271	12271	16	-
520-12275	12275	19	-
520-12276	12276	24	-
520-12277	12277	13	-

12V PANEL



PART NO.	REF	WATT	CAP
BOX OF 5			
520-1000	286G	1.2	W2 x 4.6d
520-1010	285THP	2	B8.5d
520-1020	286T0	1	B8.5d
520-1030	286T	2	B8.3d
520-1040	286TVW	1.2	B8.3d
520-1050	286TW	2	B8.3d
520-1060	286TAC	1.2	B8.5d
BOX OF 10			
520-286T	Clear	1.2	B8.5d

12V 209 SIDELIGHT



PART NO.	REF	WATT	CAP
BOX OF 10			
520-2090	209	15	BA15D

12V 233 SIDE/INSTRUMENT



PART NO.	REF	WATT	CAP
BOX OF 10			
520-2330	233	4	BA9S
SINGLE			
520-2330-1	233	4	BA9S
BLISTER PACK OF 2			
MBB233	233	4	BA9S

12V 207 INTERIOR



PART NO.	REF	WATT	CAP
BOX OF 10			
520-2070	207	5	BA15S
SINGLE			
520-2070-1	207	5	BA15S
BLISTER PACK OF 2			
MBB207	207	5	BA15S

12V 245 SIDE/TAILO



PART NO.	REF	WATT	CAP
BOX OF 10			
520-2450	245	10	BA15S
SINGLE			
520-2450-1	245	10	BA15S
BLISTER PACK OF 2			
MBB245	245	10	BA15S

12V 297



PART NO.	REF	WATT	CAP
BOX OF 10			
520-2970	297	2.2	W2.1x9.5D

12V FESTOON



PART NO.	REF	WATT	CAP
BOX OF 10			
520-2390	239	5	SV8.5
520-239D	239D	5	SV8.5
BLISTER PACK OF 2			
MBB239	239	5	SV8.5
MBB265	265	10	-
MBB269	269	10	-
MBB272	272	10	-

12V 3156



PART NO.	REF	WATT	CAP
BOX OF 10			
520-3156	3156	27	W2.5x16d
BLISTER PACK OF 2			
MBB3156	3156	27	W2.5x16d

12V 180/3157 STOP & TAIL



PART NO.	REF	WATT	CAP
BOX OF 10			
520-3157	3157	27 x 7	W2.5x16d
BLISTER PACK OF 2			
MBB3157	3157	27 x 7	W2.5x16d

12V 343



PART NO.	REF	WATT	CAP
BOX OF 10			
520-3430	343	21	BA15S

12V 380 STOP/TAIL



PART NO.	REF	WATT	CAP
BOX OF 10			
520-3800	380	21/5	BA15S
SINGLE			
520-3800-1	380	21/5	BA15S
BLISTER PACK OF 2			
MBB380	380	21/5	BA15S

12V 335 STOP/FLASHER



PART NO.	REF	WATT	CAP
BOX OF 10			
520-3350	335	21	BA15S

12V 380W SIDE/TAIL



PART NO.	REF	WATT	CAP
BOX OF 10			
520-380W	380W	21	W3
BLISTER PACK OF 2			
MBB380W	380W	21	W3

12V 382R



PART NO.	REF	WATT	CAP
BOX OF 10			
520-382R	382R	21	BA15S

12V 382W



PART NO.	REF	WATT	CAP
BOX OF 10			
520-382W	382W	21	W3
BLISTER PACK OF 2			
MBB382W	382W	21	W3
MBB382WA	382WA	21	W3

12V 382 STOP/FLASHER



PART NO.	REF	WATT	CAP
BOX OF 10			
520-3820	382	21	BA15S
SINGLE			
520-3820-1	382	21	BA15S
BLISTER PACK OF 2			
MBB382	382	21	BA15S

12V 434



PART NO.	REF	WATT	CAP
SINGLE			
520-4340	434	10	G4

12V H1



PART NO.	REF	WATT	CAP
SINGLE			
520-4480-1	448	55	P14.5S
BLISTER PACK OF 1			
MBB448	448	55	P14.5S

12V 433



PART NO.	REF	WATT	CAP
SINGLE			
520-4330	4330	21	BAY9S
520-433A	433A	5	BA9S
520-433B	433B	10	BA9S
520-433C	433C	6	BAX9S
520-433D	433D	21	BAX9S
BLISTER PACK OF 2			
MBB433A	433A	5	BA9S
MBB433C	433C	6	BAX9S
MBB433D	433D	21	BAX9S

12V H4



PART NO.	REF	WATT	CAP
SINGLE			
520-4720-1	472	60/55	P43T
520-4840	484 Off Road Only	100/80	P43T
BLISTER PACK OF 1			
MBB472	472	60/55	P43T

12V H7



PART NO.	REF	WATT	CAP
SINGLE			
520-4990-1	477	55	PX26D
520-4995	Off Road Only	100	PX26D
BLISTER PACK OF 1			
MBB499	477	55	PX26D

12V H3



PART NO.	REF	WATT	CAP
SINGLE			
520-4530-1	453	55	PK22S
BLISTER PACK OF 1			
MBB453	453	55	PK22S

12V 9005



PART NO.	REF	WATT	CAP
SINGLE			
520-9005	9005	65	-
BLISTER PACK OF 1			
MBB9005	9005	65	-

12V 9006



PART NO.	REF	WATT	CAP
SINGLE			
520-9006	9006	55	-
BLISTER PACK OF 1			
MBB9006	9006	55	-

12V H8



PART NO.	REF	WATT	CAP
SINGLE			
520-H080	H8	35	PG19.1

12V D2R GAS DISCHARGE



PART NO.	REF	WATT	CAP
SINGLE			
520-D2R0	D2R	35	32D.3

12V D2S GAS DISCHARGE



PART NO.	REF	WATT	CAP
SINGLE			
520-D2S0	D2S	-	-

12V H11



PART NO.	REF	WATT	CAP
SINGLE			
520-H110	H11	35	PG19.2

12V 501A SIDE/TAIL



PART NO.	REF	WATT	CAP
BOX OF 10			
520-501A	501A	5	W2.1x9.5d
BLISTER PACK OF 2			
MBB501A	501A	5	W2.1x9.5d

12V 566 FOG/TAIL



PART NO.	REF	WATT	CAP
BOX OF 10			
520-5660	566	21/4	BAZ15D
SINGLE			
520-5660-1	566	21/4	BAZ15D
BLISTER PACK OF 2			
MBB566	566	21/4	BAZ15D

12V 501 SIDE/TAIL



PART NO.	REF	WATT	CAP
BOX OF 10			
520-5010	501	5	W2.1x9.5d
SINGLE			
520-5010-1	501	5	W2.1x9.5d
BLISTER PACK OF 2			
MBB501	501	5	W2.1x9.5d
MBB504	504	3	W2.1x9.5d

12V 921



PART NO.	REF	WATT	CAP
BLISTER PACK OF 2			
MBB921	921	21	-
MBB921B	921	16	-

12V 567



PART NO.	REF	WATT	CAP
BLISTER PACK OF 2			
MBB567	567	21/5	BAW15D

12V 581 FLASHER (OFFSET PIN)



PART NO.	REF	WATT	CAP
BOX OF 10			
520-5810	581	21	BAU15S
SINGLE			
520-5810-1	581	21	BAU15S
BLISTER PACK OF 2			
MBB581BL	581	21	BAU15S

24V 149



PART NO.	REF	WATT	CAP
PACK OF 10			
521-1490	149	5	BA15S

24V 150



PART NO.	REF	WATT	CAP
PACK OF 10			
521-1500	150	5	BA15D

12V BULBS



STAND20
QTY: 100

• Contains 100 of the most popular bulbs

24V 242



PART NO.	REF	WATT	CAP
PACK OF 10			
521-2420	242	5	11x38

24V 249

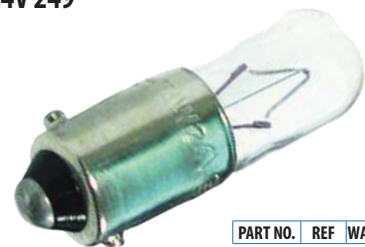

PART NO.	REF	WATT	CAP
PACK OF 10			
521-2490	249	4	BA9S

24V 241



PART NO.	REF	WATT	CAP
PACK OF 10			
521-2410	241	21	BA15S

24V 334



PART NO.	REF	WATT	CAP
PACK OF 10			
521-3340	334	5	BAY15D

24V 346



PART NO.	REF	WATT	CAP
PACK OF 10			
521-3460	346	21	BA15D

24V 290



PART NO.	REF	WATT	CAP
PACK OF 10			
521-2900	290	21	BA15S

24V 460 H3



PART NO.	REF	WATT	CAP
SINGLE			
521-4600	H3	70	-

24V 466 H1

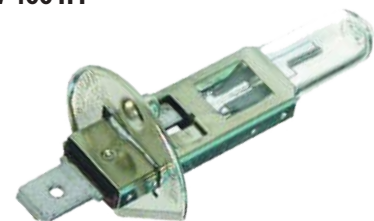

PART NO.	REF	WATT	CAP
SINGLE			
521-4660	H1	70	-

24V 499 H7

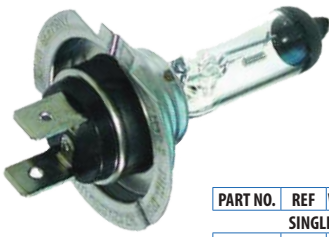

PART NO.	REF	WATT	CAP
SINGLE			
521-4990	H7	70	-

24V 507



PART NO.	REF	WATT	CAP
SINGLE			
521-5070	507	5	-

24V 475 H4

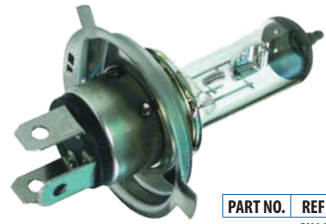

PART NO.	REF	WATT	CAP
SINGLE			
521-4750	H4	75/70	-

1 WIRE ZIRCONIA LAMBDA SENSOR



14-001
QTY: 1

2 WIRE ZIRCONIA LAMBDA SENSOR



14-002
QTY: 1

3 WIRE ZIRCONIA LAMBDA SENSOR



14-003
QTY: 1

4 WIRE ZIRCONIA LAMBDA SENSOR



14-004
QTY: 1

LAMBDA SENSOR FLANGE



425-4090
QTY: 1

REAR PARKING SENSOR SYSTEM



- 4 rear sensors
- Audible buzzer

SPS9040
QTY: 1

ELECTRONIC BATTERY TESTER



GYS-055155
QTY: 1

FORD HEATER VALVE



- Fiesta
- Ka
- Puma

300-0001
QTY: 1

LED HEAD LAMP



515-5190
QTY: 1

WORKVISION HAND LAMP



PART NO.	QTY
515-5100	1
REPLACEMENT RUBBER SEAL	
515-5170	1

COMPRESS MINI COB HAND LAMP



- 1.2w
- 3 hour borntime
- 120 lumen COB LED
- Base magnet
- Rear magnet
- 230V UK charger
- USB charger
- Weatherproof



515-6000
QTY: 1

COMPRESS FLEX COB HAND LAMP



- 3W/300lumen
- 4 hour borntime
- Adjustable beam
- Base magnet
- 230V UK charger
- 12V cigar charger
- Durable hook
- Weatherproof



515-7000
QTY: 1

PEN LIGHT



- 3 x AAA batteries
- Belt clip
- Magnet
- 90 lumen



515-8000
QTY: 1

SBC BUS BULBS



PART NO.	VOLT	WATT
PACK OF 10		
520-8100	12	24
520-8115	24	12

12V INSPECTION LAMP BULB



PART NO.	REF	WATT
PACK OF 10		
R110	R110	50

230V ROUGH SERVICE BULB



PART NO.	REF	WATT
PACK OF 10		
R101	R101	100

• 230V - 12V

HEATER MOTOR RESISTOR



300-0032

QTY: 1

• Fits Vauxhall Corsa & Fiat Punto Grande



• JVC
• Pioneer



101300A

QTY: 2

RADIO REMOVAL TOOL



• Alfa Romeo
• Audi
• Fiat
• Ford
• Renault
• Volkswagen



101301A

QTY: 2

RADIO REMOVAL TOOL



• BMW



101302A

QTY: 2

RADIO REMOVAL TOOL



• Audi
• Ford
• Mercedes
• Renault
• Volkswagen



101303A

QTY: 4

RADIO REMOVAL TOOL



• Ford
• Mercedes
• Porsche



101304A

QTY: 2

RADIO REMOVAL TOOL



• Volkswagen



101305A

QTY: 2

RADIO REMOVAL TOOL



• BMW
• Vauxhall



101306A

QTY: 2

RADIO REMOVAL TOOL



• Ford



101307A

QTY: 2

RADIO REMOVAL TOOL



• Skoda



101308A

QTY: 2

RADIO REMOVAL TOOL



• Blaupunkt
• Clarion
• Peugeot



101309A

QTY: 2

ZINC PLATED UNF HT SETSCREWS



PART NO.	UNF	LENGTH	QTY	PART NO.	UNF	LENGTH	QTY
530-2100	3/16"	1"	50	530-3200	5/16"	2"	50
530-2200	3/16"	2"	50	530-3250	5/16"	2 1/2"	50
530-2580	1/4"	3/4"	50	530-3300	5/16"	3"	50
530-2600	1/4"	1"	50	530-3600	3/8"	1"	50
530-2620	1/4"	1 1/4"	50	530-3650	3/8"	1 1/2"	50
530-2650	1/4"	1 1/2"	50	530-3700	3/8"	2"	50
530-2700	1/4"	2"	50	530-3800	3/8"	3"	50
530-3080	5/16"	3/4"	50	530-4050	7/16"	1 1/2"	50
530-3100	5/16"	1"	50	530-4100	7/16"	2"	50
530-3150	5/16"	1 1/2"	50	530-4420	1/2"	1 1/4"	50

ZINC PLATED UNC HT SETSCREWS



PART NO.	UNF	LENGTH	QTY
531-2600	1/4"	1"	50
531-2650	1/4"	1 1/2"	50
531-3100	5/16"	1"	50
531-3150	5/16"	1 1/2"	50
531-3200	5/16"	2"	50
531-3600	3/8"	1"	50

- High tensile
- Grade S
- BS1768

METRIC HT SETSCREWS



PART NO.	SIZE	LENGTH	PITCH	QTY
533-3160	M8	40mm	1.0mm	50
533-3600	M10	25mm	1.25mm	50
533-3700	M10	50mm	1.25mm	50

- High tensile grade 8.8
- Fine thread
- BS23692 zinc passivated

METRIC HT SETSCREWS



PART NO.	SIZE	LENGTH	PITCH	QTY
536-2080	M6	20mm	1.0mm	50

- High tensile grade 8.8
- Zinc passivated
- With captive washer

METRIC HT BOLTS



PART NO.	SIZE	LENGTH	PITCH	QTY
539-3665	M10	65mm	1.5mm	25
539-3680	M10	80mm	1.5mm	25
539-3695	M10	100mm	1.5mm	25
SHOCK ABSORBER				
539-3795	M12	100mm	1.75mm	25
539-3850	M14	50mm	2.0mm	10
539-3950	M16	50mm	2.0mm	10
539-3970	M16	70mm	2.0mm	10

- High tensile grade 8.8
- Zinc passivated

METRIC HT SETSCREWS



PART NO.	SIZE	LENGTH	PITCH	QTY	PART NO.	SIZE	LENGTH	PITCH	QTY
534-1080	M4	20mm	0.70mm	100	534-3160	M8	40mm	1.25mm	100
534-1120	M4	30mm	0.70mm	100	534-3200	M8	50mm	1.25mm	100
534-1600	M5	25mm	0.80mm	100	534-3240	M8	60mm	1.25mm	100
534-1660	M5	40mm	0.80mm	100	534-3300	M8	75mm	1.25mm	50
534-1700	M5	50mm	0.80mm	100	534-3600	M10	25mm	1.5mm	50
534-2050	M6	10mm	1.0mm	100	534-3620	M10	30mm	1.5mm	50
534-2040	M6	12mm	1.0mm	100	534-3660	M10	40mm	1.5mm	50
534-2060	M6	16mm	1.0mm	100	534-3700	M10	50mm	1.5mm	50
534-2080	M6	20mm	1.0mm	100	534-3740	M10	60mm	1.5mm	50
534-2100	M6	25mm	1.0mm	100	534-3800	M10	75mm	1.5mm	50
534-2160	M6	40mm	1.0mm	100	534-4100	M12	25mm	1.75mm	50
534-2180	M6	45mm	1.0mm	100	534-4160	M12	40mm	1.75mm	50
534-2200	M6	50mm	1.0mm	100	534-4200	M12	50mm	1.75mm	50
534-2600	M7	25mm	1.0mm	100	534-4240	M12	60mm	1.75mm	50
534-2660	M7	40mm	1.0mm	100	534-4300	M12	75mm	1.75mm	25
534-3060	M8	16mm	1.25mm	100	534-4400	M12	100mm	1.75mm	10
534-3080	M8	20mm	1.25mm	100	534-4660	M14	40mm	2.0mm	10
534-3100	M8	25mm	1.25mm	100	534-4800	M14	75mm	2.0mm	10
534-3120	M8	30mm	1.25mm	100	534-5200	M16	50mm	2.0mm	10
534-3140	M8	35mm	1.25mm	100	534-5300	M16	75mm	2.0mm	10

- High tensile grade 8.8
- BS3692 zinc passivated

SERRATED FLANGED SETSCREWS



PART NO.	SIZE	QTY
534-7000	M6 x 16mm	25
534-7010	M6 x 20mm	25
534-7020	M6 x 25mm	25
534-7030	M6 x 30mm	25
534-7100	M8 x 20mm	25
534-7120	M8 x 25mm	25
534-7130	M8 x 30mm	25
534-7140	M8 x 40mm	25
534-7200	M10 x 25mm	25
534-7210	M10 x 30mm	25
534-7230	M10 x 40mm	25
534-7240	M10 x 50mm	25

METRIC COACH BOLTS & NUTS



PART NO.	SIZE	LENGTH	QTY
545-1320	M6	25mm	25
545-1340	M6	40mm	25
545-1350	M6	50mm	25
545-1450	M8	50mm	25
545-1470	M8	75mm	25
545-1550	M10	50mm	25
545-1570	M10	75mm	25

- Cup square head bolts
- BS4933 zinc passivated

METRIC SOCKET CAPSCREWS



PART NO.	SIZE	LENGTH	QTY
545-7120	M4	25mm	25
545-7220	M5	25mm	25
545-7240	M5	40mm	25
545-7310	M6	16mm	25
545-7320	M6	25mm	25
545-7340	M6	40mm	25
545-7520	M8	25mm	25
545-7540	M8	40mm	25
545-7620	M10	25mm	25
545-7640	M10	40mm	25

STEEL BA SCREWS



PART NO.	SIZE	LENGTH	QTY
546-0320	3BA	1"	50
546-0415	2BA	1 1/2"	50
546-0425	2BA	3/4"	50
546-0435	2BA	1"	50
546-0445	2BA	1 1/2"	50
546-0455	2BA	2"	50

- Roundhead with slotted nuts

BRASS BA SCREWS



PART NO.	SIZE	LENGTH	QTY
546-2340	2BA	1"	50
546-2360	2BA	1 1/2"	50

- Roundhead
- Slotted

STEEL MACHINE SCREWS



PART NO.	SIZE	LENGTH	QTY
546-6720	M4	25mm	50
546-6820	M5	25mm	50
546-6840	M5	35mm	50
546-6860	M5	50mm	50
546-6920	M6	25mm	50
546-6940	M6	35mm	50
546-6960	M6	50mm	50

- Panhead
- Slotted
- Zinc plated with nuts

T-DRIVE MACHINE SCREWS



PART NO.	SIZE	LENGTH	QTY
546-7110	M4	16mm	50
546-7130	M4	25mm	50
546-7210	M5	16mm	50
546-7230	M5	25mm	50
546-7250	M5	40mm	50
546-7310	M6	16mm	50
546-7330	M6	25mm	50
546-7350	M6	40mm	50

- Panhead
- 4.8 grade
- Zinc plated

STAINLESS STEEL MACHINE SCREWS



PART NO.	SIZE	LENGTH	QTY
546-8205	M5	12mm (Merc)	50
546-8210	M5	16mm (Merc)	50
546-8320	M6	20mm (Suzuki)	50

- Panhead
- Pozidrive

UNF THREADED BAR



PART NO.	UNF	INCH	LENGTH	QTY
546-9920	5/16"	12"	5	

METRIC THREADED BAR



PART NO.	SIZE	PITCH	LENGTH	QTY
546-9950	M6	1.0mm	300mm	5
546-9951	M6		300mm with nuts	2
546-9960	M8	1.25mm	300mm	5
546-9961	M8		300mm with nuts	2
546-9970	M10	1.5mm	300mm	5
546-9971	M10		300mm with nuts	2

UNF STEEL NUTS



PART NO.	UNF INCH	QTY
548-0220	3/16"	100
548-0230	1/4"	100
548-0240	5/16"	100
548-0250	3/8"	100
548-0260	7/16"	100
548-0270	1/2"	50

• Zinc plated

UNC STEEL NUTS



PART NO.	UNC INCH	QTY
548-0430	1/4"	100
548-0440	5/16"	100
548-0450	3/8"	100
548-0470	1/2"	25

• Zinc plated

METRIC STEEL NUTS



PART NO.	SIZE	PITCH	QTY
548-1350	M8	1.0mm	100
548-1360	M10	1.25mm	100

• Fine thread
• Zinc passivated

METRIC STEEL NUTS



PART NO.	SIZE	PITCH	QTY
548-1410	M4	0.70mm	100
548-1420	M5	0.80mm	100
548-1430	M6	1.00mm	100
548-1440	M7	1.00mm	100
548-1450	M8	1.25mm	100
548-1460	M10	1.50mm	100
548-1470	M12	1.75mm	100
548-1480	M14	2.00mm	50
548-1490	M16	2.00mm	50

• Course thread
• Zinc passivated

BA STEEL NUTS



PART NO.	SIZE	QTY
548-2400	2BA	50

• Zinc plated

SELF LOCKING MANIFOLD NUTS



PART NO.	SIZE	PITCH	QTY
486-2020	M6	1.0mm (Coarse)	25
486-2030	M8	1.25mm (Coarse)	25
486-2010	M10	1.5mm (coarse)	50

• Copper plated

TRI-LOCK FLANGED MANIFOLD NUTS



PART NO.	SIZE	PITCH	QTY
486-2070	M10	1.25mm (Fine)	25

• Zinc plated

UNF NYLON INSERT LOCKING NUTS



PART NO.	UNF	QTY
549-0220	3/16"	50
549-0230	1/4"	50
549-0240	5/16"	50
549-0250	3/8"	50
549-0260	7/16"	25
549-0270	1/2"	25

• P type
• Zinc plated

METRIC SERRATED FLANGE NUTS



PART NO.	SIZE	PITCH	QTY
548-9420	M5	0.8mm	100
548-9430	M6	1.0mm	100
548-9450	M8	1.25mm	100
548-9460	M10	1.5mm	50
548-9470	M12	1.75mm	50

• Zinc plated

METRIC NYLON INSERT LOCKING NUT



PART NO.	SIZE	PITCH	QTY
549-1420	M5	0.8mm (Coarse)	50
549-1430	M6	1.0mm (Coarse)	50
549-1350	M8	1.0mm (Fine)	50
549-1440	M14	1.5mm	50
549-1450	M8	1.25mm (Coarse)	50
549-1260	M10	1.0mm (Extra Fine)	50
549-1360	M10	1.25mm (Fine)	50
549-1460	M10	1.5mm (Coarse)	50
549-1465	M12	1.0mm	50
549-1470	M12	1.75mm (Coarse)	50
549-1475	M12	1.5mm	50
549-1480	M14	2.0mm (Coarse)	25
549-1485	M12	1.5mm	50
549-1486	M12	1.5mm	10
549-1690	M16	2.0mm (Coarse)	25

• P type (DIN982)
• Zinc passivated

THREADED HEXSERTS



PART NO.	SIZE	QTY
549-6310	M4	50
549-6320	M5	50
549-6330	M6	50
549-6340	M8	50

• Half hex inserts

THREADED HEXSERTS



PART NO.	SIZE	QTY
549-6410	M4	50
549-6420	M5	50
549-6430	M6	50
549-6450	M8	50

• Regular inserts

IMPERIAL FLAT WASHERS



PART NO.	I.D INCH	QTY
550-0240	1/8"	200
550-0250	3/16"	200
550-0260	1/4"	200
550-0270	5/16"	200
550-0280	3/8"	200
550-0290	7/16"	200
550-0300	1/2"	100
550-0320	5/8"	50
550-0330	3/4"	50

• Table 3
• Heavy duty zinc plated

IMPERIAL FLAT WASHERS



PART NO.	I.D INCH	QTY
550-0505	3/16"	200
550-0510	1/4"	200
550-0520	5/16"	200
550-0530	3/8"	200
550-0540	7/16"	200
550-0550	1/2"	100
550-0570	5/8"	50
550-0580	3/4"	50

• Table 4
• Large O.D
• Heavy duty zinc plated

METRIC FLAT WASHERS



PART NO.	I.D MM	QTY
550-1240	4mm	200
550-1250	5mm	200
550-1260	6mm	200
550-1280	8mm	200
550-1300	10mm	200
550-1310	11mm	100
550-1320	12mm	100
550-1340	14mm	50
550-1360	16mm	50

• Form A
• Heavy duty zinc passivated

METRIC FLAT WASHERS



PART NO.	I.D	QTY
550-1450	5mm	200
550-1460	6mm	200
550-1480	8mm	200
550-1500	10mm	200
550-1520	12mm	100
550-1540	14mm	50
550-1560	16mm	50

• Form C
• Large O.D
• Heavy duty zinc passivated

REPAIR WASHERS



PART NO.	I.D	O.D	I.D	O.D	QTY
550-2100	3.5mm	12mm	1/8"	1/2"	200
USED WITH RIVETS					
550-2110	4mm	20mm	3/16"	3/4"	100
USED WITH RIVETS					
550-2120	5mm	25mm	3/16"	1"	100
550-2320	6mm	25mm	1/4"	1"	100
550-2340	6mm	40mm	1/4"	1 1/2"	100
550-2420	8mm	25mm	5/16"	1"	100
550-2430	8mm	30mm	5/16"	1 3/8"	100
550-2440	8mm	40mm	5/16"	1 1/2"	100
550-2450	8mm	50mm	5/16"	2"	50
550-2520	10mm	25mm	3/8"	1"	50
550-2540	10mm	40mm	3/8"	1 1/2"	50
550-2550	10mm	50mm	3/8"	2"	50

IMPERIAL SPRING WASHERS



PART NO.	I.D INCH	QTY
550-3060	1/4"	200
550-3080	5/16"	200
550-3100	3/8"	200
550-3110	7/16"	100
550-3130	1/2"	100

• Rectangular System

METRIC SPRING WASHERS



PART NO.	I.D	QTY
550-4050	5mm	200
550-4060	6mm	200
550-4080	8mm	200
550-4100	10mm	200
550-4120	12mm	100
550-4140	14mm	50
550-4160	16mm	50

• Rectangular System

INTERNAL LOCK WASHERS



PART NO.	I.D MM	I.D INCH	QTY
550-5010	4	5/32"	50
550-5020	5	3/16"	50
550-5030	6	1/4"	50
550-5040	8	5/16"	50
550-5050	10	3/8"	50
550-5060	12	1/2"	50

EXTERNAL LOCK WASHERS



PART NO.	I.D MM	I.D INCH	QTY
550-5510	4	5/32"	50
550-5520	5	3/16"	50
550-5530	6	1/4"	50
550-5540	8	5/16"	50
550-5550	10	3/8"	50
550-5560	12	1/2"	50

BSP BONDED SEALS



PART NO.	I.D INCH	QTY
550-6020	1/8" BSP	25
550-6040	1/4" BSP	25
550-6060	3/8" BSP	25
550-6080	1/2" BSP	25
550-6100	5/8" BSP	25
550-6120	3/4" BSP	25
550-6140	7/8" BSP	25
550-6160	1" BSP	25

• Dowty type washers

METRIC BONDED SEALS



PART NO.	I.D MM	QTY
550-6500	10	25
550-6510	12.25 (Ford/Citr Sump)	25
550-6520	14	25
550-6530	15 (Citr/Peug/Ren Sump)	25
550-6540	16	25
550-6560	18	25
550-6580	20	25
550-6600	22	25
550-6620	24	25

• Dowty type washers

FIBRE WASHERS



PART NO.	I.D	O.D	THICK	USES	QTY
550-8020	6mm	9.5mm	1.5	-	25
550-8030	6mm	11.5mm	1.5	-	25
550-8040	8mm	12.5mm	1.5	-	25
550-8050	8.5mm	14mm	1.5	-	25
550-8060	9.5mm	16mm	1.5	-	25
550-8070	11mm	17mm	1.5	-	25
550-8095	12mm	19mm	1.5	-	25
550-8100	12mm	24mm	2.0	Toyota Sump	25
550-8110	12.5mm	19mm	1.5	-	25
550-8120	12.5mm	20.5mm	1.5	-	25
550-8130	14mm	22mm	1.5	-	25
550-8145	16.5mm	25mm	1.5	-	25
550-8160	18.5mm	29mm	2.0	Toyota Sump	25
550-8170	19mm	29mm	1.5	-	25
550-8190	25mm	38mm	2.0	-	25

COPPER & NON-ASBESTOS WASHERS



PART NO.	I.D	O.D	THICK	QTY
551-1640	14.5mm	20mm	2.0	25

• Peugeot Sump

ALUMINIUM WASHERS



PART NO.	I.D	O.D	THICK	USES	QTY
551-3120	12mm	15.5mm	1.5	BMW Sump	25
551-3150	14.5mm	22mm	2	Rover 1.4 Sump	25
551-3220	22mm	27mm	1.5	BMW 3 Series Sump	25

COPPER COMPRESSION WASHERS



PART NO.	I.D	O.D	THICK	USES	QTY
551-1080	11mm	17.5mm	1.5mm	Nissan Sump	25
551-1100	12mm	17mm	1.5mm	Marina Sump	25
551-1150	15.5mm	21mm	2mm	Nissan Sump	25
551-1160	16mm	22mm	2mm	Peug/Citr Sump	25
551-1180	18mm	24mm	2mm	Renault Sump	25
551-1200	20mm	26mm	2mm	Talbot Sump	25

COPPER WASHERS

















PART NO.	I.D MM	O.D MM	THICKNESS	USES	QTY
551-0060	6	10	1.0	Bosch (di)	25
551-0140	8	11.5	1.0	Lucas/Bosch (di)	25
551-0160	8	16	1.0		25
551-0220	10	13	1.0	Bosch (di)	25
551-0230	10	14	1.0	Bosch (di)	25
551-0240	10	15	1.5		25
551-0250	10	16	1.0		25
551-0270	10	19.5	1.0	Perkins (di)	25
551-0275	10	20	1.5		25
551-0280	10	20	2.0	Lucas/Perkins (di)	25
551-0300	11	17	1.5		25
551-0400	13	19	1.5		25
551-0410	13	20	1.5		25
551-0460	14	20	1.5	Bosch (di)	25
551-0500	14.5	19	2.5	Rover Sump	25
551-0580	16.3	25	1.6		25
551-0630	17	24	1.5		25
551-0670	18	24	1.5	Volvo Sump	25
551-0700	19	25	1.5		25
551-0710	19	26	2.0	Volvo Sump	25
551-0760	21	26	1.5		25
551-0780	22	27	1.0	Lucas (di)	25
551-0790	22	28	1.5		25

NYLON (PA6) WASHERS



PART NO.	I.D MM	O.D MM	THICKNESS	USES	QTY
551-3430	13	20	2	Ford OHV Sump	25
551-3440	14.5	22	2	Ford OHV Sump	25

APPLICATION	THREAD	PITCH	LENGTH	HEAD	TRADE PACK	SUMP PLUG KIT
 Escort, Fiesta, Orion, Sierra Mondeo (toww97) OHV/OHC/Zetec	M14	1.5mm	16mm	13mm	551-6010 5	 551-7010 1 Plug, 2 Washers
 Escort/Fiesta 1.6/1.8 D, Focus, Ka Mondeo 98 Onwards	M14	1.5mm	15mm	13mm	551-6120 5	 551-7120 1 Plug
 Mondeo Zetec (later) Transit 2000 Onwards	M14	1.5mm	13mm	13mm	551-6180 5	 551-7180 1 Plug, 1 Washer
 Mondeo 1.8/ 2.0/ 2.5/ 3.0 2000-07			28mm	15mm	551-6190 5	 551-7190 1 Plug, 1 Washer
 Early Vauxhall/Opel VW (Excl Beetle)	M14	1.5mm	12mm	19mm	551-6020 5	 551-7020 1 Plug, 1 Washer
 Vauxhall/Opel 1.7D/1.7TD Incl Astra/Cavalier/Nova/Astramax/Corsa	M14	1.5mm	14mm	22mm	551-6080 5	 551-7080 1 Plug, 1 Washer
 Astra, Cavalier, Carlton, Nova, Asconna, Kadette	M14	1.5mm	13mm	19mm	551-6100 5	 551-7100 1 Plug, 1 Washer
 Vauxhall/Opel Corsa 16V Astra 1.8, 2.0TD Vectra, Omega All 95 On	M14	1.5mm	11mm	6mm	551-6110 5	 551-7110 1 Plug (Captive Washer)
 BMW 316, 318, 320, 325 (E30) 525, 535 (E12) 518, 520, 525, 530, 535 (E34)	M12	1.5mm	18mm	17mm	551-6050 5	 551-7050 1 Plug, 1 Washer
 Metro, Motego, Maestro, Honda Civic (Early Models)	M13	1.25mm	12mm	19mm	551-6070 5	 551-7070 1 Plug, 1 Washer
 Rover 200/400 Diesel Peugeot 106, 306, 405, Partner Citroen C15 Berlingo	M14	1.25mm	13mm	9mm	551-6090 5	 551-7090 1 Plug, 1 Washer
 Citroen AX, BX, XM, ZX, Saxo Rover 200/400 Diesel (To Engine 407684) Peugeot 106, 205, 309, 405	M16	1.5mm	14mm	9mm	551-6030 5	 551-7030 1 Plug, 2 Washers
 Nissan (Incl Vanette) Toyota (Incl MR2) Plus Various Japanese	M12	1.5mm	12mm	14mm	551-6150 5	 551-7150 1 Plug, 1 Washer
 Renault (Incl 12)	M18	1.5mm	15mm	9mm	551-6040 5	 551-7040 1 Plug, 1 Washer
 Renault R9, 11, 19, 21, Express, Clío Super 5	M16	1.5mm	12mm	13mm	551-6140 5	 551-7140 1 Plug, 1 Washer
 Alfa Romeo Peugeot 205 Fiat	M22	1.5mm	15mm	11mm	551-6060 3	 551-7060 1 Plug, 1 Washer
 Fiat Panda 127, Cinquicento Plus Various Models	M22	1.3mm	13mm	13mm	551-6130 5	 551-7130 1 Plug
 Seat Ibiza, Malaga, Toledo Plus VAG (Early Models)	M14	1.5mm	15mm	19mm	551-6160 3	 551-7160 1 Plug, 1 Washer
 VAG (Later Models)	M14	1.5mm	17mm	20mm	551-6170 5	 551-7170 1 Plug (Captive Washer)
 Fiat Vauxhall Opel (Later Models)	M18	1.5mm	21mm	11mm	551-6200 5	 551-7200 1 Plug, 1 Washer
 Rubber Seal Washers (Late Mondeo)	-	-	-	-	551-3450 25	
 Rubber Seal Washers (Vauxhall Later Models)	-	-	-	-	552-1170 20	
 Emergency Sump Plug	-	-	-	-	QC700 1	

SUMP PLUG WASHERS



PART NO.	VEHICLE	TYPE	I.D X O.D	THICKNESS	QTY
551-0790	Alfa Romeo	Copper	22 x 28mm	1.5mm	25
551-3120	BMW	Aluminium	12 x 15.5mm	1.5mm	25
551-3220	BMW 3 Series	Aluminium	22 x 27mm	1.5mm	25
550-6510	Citroen	Bonded Silver	12.25 x 20mm	2mm	25
551-1640	Citroen	Copper & Non-Asbestos	14.5 x 21mm	2mm	25
550-6530	Citroen	Bonded Seal	15 x 24mm	2mm	25
551-1160	Citroen	Copper Compression	16 x 22mm	2mm	25
551-3450	Ford Mondeo	Rubber	12 x 22mm	2mm	25
550-6510	Ford Mondeo	Bonded Seal	12.25 x 24mm	2mm	25
551-3440	Ford OHC	Nylon	14.5 x 22mm	2mm	25
551-3430	Ford OHV	Nylon	13 x 20mm	2mm	25
551-0410	Nissan Cherry	Copper	13 x 20mm	1.5mm	25
551-1080	Nissan	Copper Compression	11 x 17.5mm	1.5mm	25
551-1150	Nissan Sunny	Copper Compression	15.5 x 21mm	2mm	25
550-6510	Peugeot	Bonded Seal	12.25 x 24mm	2mm	25
551-1640	Peugeot	Copper & Non-Asbestos	14.5 x 21mm	2mm	25
550-6530	Peugeot	Bonded Seal	15 x 24mm	2mm	25
551-1160	Peugeot	Copper Compression	16 x 22mm	2mm	25
550-6530	Renault	Bonded Seal	15 x 24mm	2mm	25
551-1180	Renault	Copper Compression	18 x 24mm	2mm	25
551-0500	Rover	Copper	14.5 x 19mm	2.5mm	25
551-3150	Rover 200/400 1.4	Aluminium	14.5 x 22mm	2mm	25
551-1100	Rover Marina	Copper Compression	12 x 17mm	1.5mm	25
551-0580	Rover Mini	Copper	16.3 x 25.4mm	1.6mm	25
551-1200	Talbot Sunbeam Avenger	Copper Compression	20 x 26mm	2mm	25
550-8100	Toyota	Fibre	12 x 24mm	2mm	25
551-0410	Toyota	Copper	13 x 20mm	1.5mm	25
550-8160	Toyota	Fibre	18.5 x 29mm	2mm	25
551-0460	Vauxhall	Copper	14 x 20mm	1.5mm	25
552-1170	Vauxhall	Rubber	17mm	2.5mm	20
551-0710	Volvo 240	Copper	19 x 26mm	2mm	25
551-0670	Volvo 340	Copper	18 x 24mm	1.5mm	25
551-0460	VW	Copper	14 x 20mm	1.5mm	25

SELF TAPPING SLOTTED

SCREWS



PART NO.	SIZE NO.	LENGTH	QTY
555-0220	4	1/2"	100
555-0320	6	1/2"	100
555-0330	6	3/4"	100
555-0335	6	5/8"	100
555-0340	6	1"	100
555-0420	8	1/2"	100
555-0430	8	3/4"	100
555-0440	8	1"	100
555-0460	8	1 1/2"	100
555-0520	10	1/2"	100
555-0530	10	3/4"	100
555-0540	10	1"	100
555-0560	10	1 1/2"	100
555-0620	12	1/2"	100
555-0630	12	3/4"	100
555-0640	12	1/2"	100
555-0660	12	1 1/2"	100
555-0740	14	1"	100

METRIC RUBBER 'O' RINGS

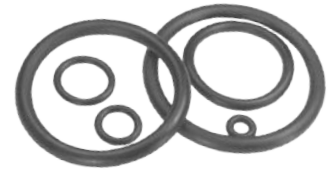

PART NO.	I.D	O.D	QTY
552-1030	3mm	2mm	20
552-1040	4mm	2mm	20
552-1050	5mm	2mm	20
552-1060	6mm	2mm	20
552-1070	7mm	2mm	20
552-1080	8mm	2mm	20
552-1100	10mm	2mm	20
552-1105	10mm	2.5mm	20
552-1110	11mm	2.5mm	20
552-1120	12mm	2.5mm	20
552-1140	14mm	2.5mm	20
552-1160	16mm	2.5mm	20
552-1170	17mm	2.5mm	20
552-1190	19mm	2.5mm	20
552-1195	19mm	3mm	20
552-1200	20mm	3mm	10
552-1220	22mm	3mm	10
552-1240	24mm	3mm	10
552-1250	25mm	3mm	10
552-1270	27mm	3mm	10
552-1280	28mm	3mm	10
552-1300	30mm	3mm	10
552-1320	32mm	3mm	10
552-1330	33mm	3mm	10
552-1350	35mm	3mm	10
552-1360	36mm	3mm	10
552-1380	38mm	3mm	10
552-1385	38mm	4mm	10
552-1420	38mm	4mm	10
552-1420	42mm	4mm	10
552-1450	45mm	4mm	10

SELF TAPPING POZIDRIVE

SCREWS



PART NO.	SIZE NO	LENGTH	QTY
555-1220	4	1/2"	100
555-1320	6	1/2"	100
555-1330	6	3/4"	100
555-1420	8	1/2"	100
555-1430	8	3/4"	100
555-1440	8	1"	100
555-1460	8	1 1/2"	100
555-1520	10	1/2"	100
555-1530	10	3/4"	100
555-1540	10	1"	100
555-1560	10	1 1/2"	100
555-1620	12	1/2"	100
555-1630	12	3/4"	100
555-1640	12	1"	100
555-1660	12	1 1/2"	100

- Pan head
- Zinc plated

SELF TAPPING POZIDRIVE SCREWS



PART NO.	SIZE NO	LENGTH	QTY
555-2320	6	1/2"	100
555-2330	6	3/4"	100
555-2420	8	1/2"	100
555-2430	8	3/4"	100
555-2520	10	1/2"	100
555-2530	10	3/4"	100
555-2540	10	1"	100

- Pan head
- Zinc black

SELF TAPPING T-DRIVE SCREWS



PART NO.	SIZE NO	LENGTH	QTY
555-6320	6	1/2"	50
555-6330	6	3/4"	50
555-6420	8	1/2"	50
555-6430	8	3/4"	50
555-6440	8	1"	50
555-6530	10	3/4"	50
555-6540	10	1"	50

- Pan head
- Black
- For TXI screwdrivers

SELF TAPPING POZIDRIVE SCREWS



PART NO.	SIZE NO	LENGTH	QTY
555-4320	6	1/2"	100
555-4325	6	5/5"	100
555-4330	6	3/4"	100
555-4420	8	1/2"	100
555-4430	8	3/4"	100
555-4460	8	1 1/2"	100
555-4530	10	3/4"	100

- Countersunk head
- Black

HEXAGON BUTTON HEAD SCREWS



PART NO.	SIZE	LENGTH	QTY
555-5000	M6	25mm	25
555-5030	M6	30mm	25
555-5100	M8	25mm	25
555-5140	M8	40mm	25
555-5200	M10	25mm	25

- With flange

HEXAGON SOCKET HEAD SCREWS



PART NO.	SIZE	LENGTH	QTY
555-6000	M6	25mm	25
555-6050	M6	50mm	25
555-6100	M8	25mm	25
555-6150	M8	50mm	25
555-6200	M10	25mm	25
555-6250	M10	50mm	25

HEXAGON SOCKET HEAD SCREWS



PART NO.	SIZE	LENGTH	QTY
555-7000	M6	25mm	25
555-7050	M6	50mm	25
555-7100	M8	25mm	25
555-7150	M8	50mm	25
555-7200	M10	25mm	25
555-7250	M10	50mm	25

SELF TAPPING POZIDRIVE SCREWS



PART NO.	SIZE NO	LENGTH	QTY
555-3320	6	1/2"	100
555-3325	6	5/8"	100
555-3330	6	3/4"	100
555-3360	6	1 1/2"	100
555-3420	8	1/2"	100
555-3430	8	3/4"	100
555-3530	10	3/4"	100
555-3540	10	1"	100
555-3580	10	2"	100
555-3640	12	1"	100
555-3660	12	1 1/2"	100
555-3770	14	1 3/4"	100
555-3780	14	2"	100

- Countersunk head
- Zinc plated

SELF DRILLING POZIDRIVE SCREWS



PART NO.	SIZE NO	LENGTH	QTY
555-9015	6	5/5"	100
555-9075	6	3/4"	100
555-9125	10	3/4"	100
555-9130	10	1"	100
555-9140	10	2"	100

- Pan head
- Zinc plated

B TYPE FLOORBOARD SCREWS



- Pozidrive
- Countersunk head
- Zinc plated

PART NO.	SIZE NO	LENGTH	QTY
555-8220	14	1 3/4"	100
555-8230	14	2"	100

SELF TAPPING POZIDRIVE SCREWS



- Flange head
- Black

PART NO.	SIZE NO	LENGTH	QTY
555-5320	6	1/2"	100
555-5330	6	3/4"	100
555-5420	8	1/2"	100
555-5430	8	3/4"	100
555-5520	10	1/2"	100
555-5530	10	3/4"	100

STAINLESS STEEL MACHINE SCREWS



- Pan head
- Pozidrive

PART NO.	SIZE	LENGTH	QTY
546-8205	M5	12mm	50
546-8210	M5	16mm	50
546-8320	M6	20mm	50

ACME WASHER FACED HEAD TAPPING SCREWS



- Hex head
- Zinc passivated
- Captive washer

PART NO.	SIZE NO	LENGTH	QTY
555-9510	8	3/4"	100
555-9520	10	3/4"	100
555-9530	12	3/4"	100
555-9545	14	3/4"	100

With J Type Nut

PART NO.	SIZE NO	LENGTH	QTY
555-9550	14	3/4"	50

ACME SETSCREW CONE & CAPTIVE WASHER



PART NO.	SIZE NO	LENGTH	QTY
555-9570	8	3/4"	100
555-9575	10	3/4"	100
555-9580	12	3/4"	100
555-9585	14	3/4"	100

With J Type Nut

PART NO.	SIZE NO	LENGTH	QTY
555-9590	14	3/4"	50

SELF DRILLING SCREWS



- Washer faced
- Hex head
- Zinc passivated

PART NO.	SIZE NO	LENGTH	QTY
555-9210	8	1"	100
555-9230	10	1/2"	100
555-9235	10	3/4"	100
555-9240	10	1"	100
555-9260	12	1"	100
555-9270	12	1 1/2"	100
555-9280	12	2"	100
555-9300	14	1"	100
555-9320	14	2"	100

J TYPE SPIRE SPEED NUT



PART NO.	SIZE NO	W X L	QTY
556-3040	6	11 x 16mm	25
556-3060	8	11 x 16mm	25
556-3080	10	13 x 20mm	25
556-3210	14	16 x 25mm	25

U TYPE SPIRE SPEED NUT



PART NO.	SIZE NO	W X L	QTY
556-4020	4	8 x 10mm	25
556-4040	6	11 x 16mm	25
556-4070	8	11 x 16mm	25
556-4090	8	13 x 13mm	25
556-4120	10	12 x 16mm	25
556-4130	10	13 x 19mm	25
556-4160	12	15 x 25mm	25

EXPANSION TYPE SPIRE SPEED NUT



- Zinc passivated

PART NO.	SIZE NO	W X L	QTY
556-4460	8	10 x 14mm	50

FLAT TYPE SPIRE SPEED NUT

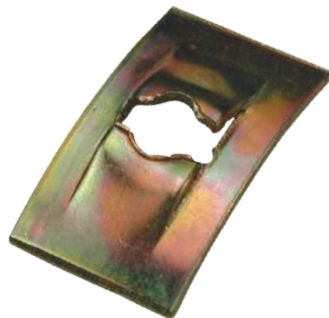

PART NO.	SIZE NO	W X L	QTY
556-4650	6	9 x 14mm	25
556-4660	8	10 x 15mm	25
556-4670	10	10 x 15mm	25
556-4680	10	10 x 17mm	25

FLAT/ROUND SPIRE SPEED NUT



PART NO.	SIZE	QTY
556-4910	3/32"	25
556-4920	1/8"	25
556-4940	3/16"	25
556-4950	1/4"	25
556-4960	5/16"	25

NUMBER PLATE FIXINGS



- No. 10 x 18mm polytop screws
- Pozidrive polymer head self tappers
- Zinc plated

PART NO.	COLOUR	QTY
556-7010	White	100
556-7020	Yellow	100
556-7040	Blue	50
556-7030	Black	100

NUMBER PLATE FIXINGS



- No. 10 x 24mm polytop screws
- Pozidrive polymer head self tappers
- Zinc plated

PART NO.	COLOUR	QTY
556-7110	White	100
556-7120	Yellow	100
556-7140	Blue	50
556-7130	Black	100

FLIP TOP NUMBER PLATE FIXINGS



- 8 x 3/4" self tappers
- Zinc plated

PART NO.	COLOUR	QTY
556-7200	Yellow/White	100
556-7210	White	100
556-7220	Yellow	100
556-7230	Black	100

NUMBER PLATE FIXINGS



- Cap, dome & screws
- 8 x 3/4" self tappers
- Zinc plated

PART NO.	COLOUR	QTY
556-7300	White & Yellow	100
556-7310	White	100
556-7320	Yellow	100
556-7330	Black	100

NUMBER PLATE FIXINGS



PART NO.	COLOUR	QTY
556-7400	White & Yellow	100
556-7410	White	100
556-7420	Yellow	100
556-7430	Black	100

SELF ADHESIVE FIXING PADS



PART NO.	SIZE MM	QTY
583-3822	75 X 25 Number	100
583-3820	Plate	25
583-3812	40 X 25	100
583-3810	Interior Mirror	25

* Double sided

METRIC SPLIT COTTER PINS



PART NO.	DIA	LENGTH	QTY
557-1100	1mm	20mm	100
557-1160	1.6mm	25mm	100
557-1220	2mm	26mm	100
557-1280	2.5mm	40mm	100
557-1385	3.2mm	45mm	100
557-1475	4mm	50mm	100
557-1585	5mm	63mm	100

IMPERIAL SPLIT COTTER PINS



PART NO.	DIA	LENGTH	QTY
557-0155	1/16"	1"	100
557-0175	1/16"	1 1/2"	100
557-0205	5/64"	7/8"	100
557-0220	5/64"	1 3/8"	100
557-0250	3/32"	3/4"	100
557-0265	3/32"	1 1/4"	100
557-0285	3/32"	1 3/4"	100
557-0305	7/64"	1 1/4"	100
557-0320	7/64"	1 3/4"	100
557-0355	1/8"	1 1/4"	100
557-0360	1/8"	1 1/2"	100
557-0370	1/8"	1 3/4"	100
557-0410	9/64"	1 1/2"	100
557-0420	9/64"	1 3/4"	100
557-0470	5/32"	1 3/4"	100
557-0490	5/32"	3 1/4"	100
557-0485	5/32"	2 1/2"	100
557-0575	3/16"	2"	100
557-0585	3/16"	2 1/2"	100
557-0685	1/4"	2 1/2"	100
557-0695	1/4"	3"	100
557-0795	5/16"	3"	100

SPRING ROLL PINS



PART NO.	DIA	LENGTH	DIA	LENGTH	QTY
557-4020	2.5mm	19mm	3/32"	3/4"	25
557-4040	2.5mm	25mm	3/32"	1"	25
557-4060	3.2mm	19mm	1/8"	3/4"	25
557-4080	3.2mm	38mm	1/8"	1 1/2"	25
557-4100	4.0mm	19mm	5/32"	3/4"	25
557-4130	4.0mm	32mm	5/32"	1 1/4"	25
557-4140	4.0mm	38mm	5/32"	1 1/2"	25
557-4160	5.0mm	25mm	3/16"	1"	25
557-4180	5.0mm	38mm	3/16"	1 1/2"	25
557-4200	5.0mm	50mm	3/16"	2"	25
557-4210	5.5mm	25mm	7/32"	1"	25
557-4220	6.5mm	25mm	1/4"	1"	25
557-4240	6.5mm	38mm	1/4"	1 1/2"	10
557-4260	6.5mm	50mm	1/4"	2"	10
557-4280	8.0mm	25mm	5/16"	1"	10
557-4300	8.0mm	38mm	5/16"	1 1/2"	10
557-4320	8.0mm	50mm	5/16"	2"	10
557-4330	8.0mm	57mm	5/16"	2 1/4"	10

EXTERNAL CIRCLIPS



PART NO.	SIZE	QTY
557-6605	4mm	25
557-6620	6mm	25
557-6630	8mm	25
557-6650	10mm	25
557-6660	11mm	25
557-6680	13mm	25
557-6690	14mm	25
557-6710	16mm	25
557-6730	18mm	25
557-6735	19mm	25
557-6745	21mm	25
557-6750	22mm	25
557-6760	24mm	25
557-6770	25mm	25
557-6810	32mm	25

INTERNAL CIRCLIPS



PART NO.	SIZE	QTY
557-6230	8mm	25
557-6240	9.5mm	25
557-6260	11mm	25
557-6280	13mm	25
557-6290	14mm	25
557-6310	16mm	25
557-6330	18mm	25
557-6335	19mm	25
557-6340	20mm	25
557-6350	22mm	25
557-6370	25mm	25
557-6390	29mm	25
557-6400	30mm	25
557-6440	40mm	25
557-6450	41mm	25

E RETAINER CLIPS



PART NO.	SIZE	QTY
557-7530	3.2mm	100
557-7540	4mm	100
557-7550	5mm	100
557-7560	6mm	100
557-7570	7mm	100
557-7580	8mm	100
557-7600	10mm	50
557-7620	12mm	50

EXPANSION SPRINGS



PART NO.	DIA	LENGTH	QTY
558-1130	5/32"	1 3/4"	10
558-1350	1/4"	2 1/2"	10
558-1410	9/32"	1 1/4"	10
558-1430	5/16"	1 3/4"	10
558-1440	5/16"	2 1/2"	10
558-1450	5/16"	3"	10
558-1540	3/8"	2 3/4"	10

THROTTLE PULL-OFF SPRINGS



PART NO.	DIA	LENGTH	QTY
558-1910	5/32"	1 1/4"	10

* Heavy duty

THROTTLE PULL-OFF SPRINGS



PART NO.	DIA	LENGTH	QTY
558-1920	1/4"	9/16"	10

* Light duty

STANDARD FLANGE STEEL RIVETS



PART NO.	DIA	FLANGE DIA	LENGTH	THICKNESS	IMPERIAL EQUIVALENT	QTY
562-1410	3.2mm	6.0mm	8.0mm	3.0-5.0mm	1/8" x 5/16"	250
562-1411	3.2mm	6.0mm	12.0mm	7.0-9.0mm	1/8" x 3/8"	50
562-1412	3.2mm	6.0mm	12.0mm	7.0-9.0mm	1/8" x 3/8"	500
562-1420	3.2mm	6.0mm	12.0mm	7.0-9.0mm	1/8" x 3/8"	250
562-1421	3.2mm	6.0mm	12.0mm	7.0-9.0mm	1/8" x 3/8"	500
562-1422	3.2mm	6.0mm	12.0mm	7.0-9.0mm	1/8" x 3/8"	250
562-1450	4.0mm	8.0mm	12.0mm	6.5-8.5mm	5/32" x 1/2"	250
562-1451	4.0mm	8.0mm	12.0mm	6.5-8.5mm	5/32" x 1/2"	50
562-1452	4.0mm	8.0mm	12.0mm	6.5-8.5mm	5/32" x 1/2"	500
562-1520	4.8mm	9.5mm	12.0mm	6.0-8.0mm	3/16" x 1/2"	250
562-1521	4.8mm	9.5mm	12.0mm	6.0-8.0mm	3/16" x 1/2"	50
562-1522	4.8mm	9.5mm	12.0mm	6.0-8.0mm	3/16" x 1/2"	500
562-1540	4.8mm	9.5mm	16.0mm	10.0-11.5mm	3/16" x 5/8"	250
562-1541	4.8mm	9.5mm	16.0mm	10.0-11.5mm	3/16" x 5/8"	50
562-1542	4.8mm	9.5mm	16.0mm	10.0-11.5mm	3/16" x 5/8"	500
562-1543	4.8mm	-	25.0mm	-	-	250
562-1610	4.8mm	-	25.0mm	-	-	250
562-1611	6.4mm	-	20.0mm	-	-	50
562-1612	6.4mm	-	20.0mm	-	-	500
562-1710	6.4mm	-	25.0mm	-	-	250
562-1711	6.4mm	-	25.0mm	-	-	50
562-1712	6.4mm	-	25.0mm	-	-	500

STANDARD FLANGE ALLOY RIVETS



PART NO.	DIA	FLANGE	LENGTH	THICKNESS	QTY
562-2040	3.2mm	6.2mm	10.0mm	5.5-7.0mm	250

LARGE FLANGE ALLOY RIVETS



PART NO.	DIA	FLANGE DIA	LENGTH	THICKNESS	QTY
562-3230	4.8mm	16.0mm	12.0mm	6.0-8.0mm	100
562-3240	4.8mm	16.0mm	16.0mm	10.0-12.0mm	100
562-3242	4.8mm	16.0mm	16.0mm	10.0-12.0mm	500
562-3260	4.8mm	16.0mm	24.0mm	18.0-20.5mm	100
562-3262	4.8mm	16.0mm	24.0mm	18.0-20.5mm	500

ALUMINIUM/STEEL COUNTERSUNK RIVETS



PART NO.	DIA	LENGTH	QTY
562-3264	3.2mm	12.0mm	250
562-3274	4.0mm	12.0mm	250

TRIFORM ALUMINIUM RIVETS



PART NO.	DIA	LENGTH	QTY
562-3266	4.0mm	18.0mm	250
562-3268	4.8mm	24.0mm	250

ALUMINIUM/STEEL PEEL BACK RIVETS



PART NO.	DIA	LENGTH	QTY
562-3270	4.0mm	18.0mm	250
562-3272	4.8mm	25.0mm	250

STAINLESS STEEL BLIND RIVETS



PART NO.	DIA	LENGTH	QTY
562-3276	4.0mm	12.0mm	250

ALUMINIUM/STEEL BLACK RIVETS



PART NO.	DIA	LENGTH	QTY
562-4000	3.2mm	8mm	250
562-4010	3.2mm	10mm	250
562-4020	3.2mm	12mm	250
562-4030	4mm	12mm	250
562-4040	4.8mm	12mm	250
562-4050	4.8mm	16mm	250



































PINCH, SHANK & WISHBONE BOLTS



SINGLES	PACK OF 10	MAKE	MODEL	FROM	TO	BOLT TYPE
532-2705	532-2700	Audi	A4	95	01	Pinch Bolt
532-2705	532-2700	Audi	A6	94	05	Pinch Bolt
532-2705	532-2700	Audi	Allroad	05	>	Pinch Bolt
532-2605	532-2601	Citroen	AX	86	98	Pinch Bolt
532-2505	532-2501	Citroen	Berlingo	96	08	Pinch Bolt
532-2605	532-2601	Citroen	C1	05	>	Pinch Bolt
532-2605	532-2601	Citroen	C2			Pinch Bolt
532-2605	532-2601	Citroen	Saxo	96	>	Pinch Bolt
532-2505	532-2501	Citroen	Xsara	97	05	Pinch Bolt
532-2505	532-2501	Citroen	Xsara Picasso	00	>	Pinch Bolt
532-2505	532-2501	Citroen	ZX	91	98	Pinch Bolt
532-2005	532-2000	Ford	Fiesta	89	08	Pinch Bolt
532-2015	532-2010	Ford	Fiesta	08	>	Pinch Bolt
532-2205	532-2200	Ford	Fiesta	89	96	Shank Bolt
532-2905	532-2900	Ford	Fiesta	95	01	Wishbone R
532-2805	532-2800	Ford	Fiesta	95	01	Wishbone F
532-2305	532-2300	Ford	Focus	98	04	Pinch Bolt
532-2405	532-2400	Ford	Focus	98	04	Shank Bolt
532-2005	532-2000	Ford	Ka/Street Ka	96	09	Pinch Bolt
532-2105	532-2100	Ford	Mondeo	93	07	Pinch Bolt
532-2205	532-2200	Ford	Mondeo	93	00	Shank Bolt
532-2255	532-2250	Ford	Mondeo	00	07	Shank Bolt
532-2005	532-2000	Ford	Puma	97	00	Pinch Bolt
532-2805	532-2800	Ford	Puma	97	00	Wishbone F
532-2905	532-2900	Ford	Puma	97	00	Wishbone R
532-2605	532-2601	Peugeot	106	91	00	Pinch Bolt
532-2505	532-2501	Peugeot	205	84	99	Pinch Bolt
532-2605	532-2601	Peugeot	206	98	>	Pinch Bolt
532-2605	532-2601	Peugeot	207	06	>	Pinch Bolt
532-2505	532-2501	Peugeot	306	93	02	Pinch Bolt
532-2505	532-2501	Peugeot	307	00	>	Pinch Bolt
532-2605	532-2601	Peugeot	1007	05	>	Pinch Bolt
532-2505	532-2501	Peugeot	Partner	96	08	Pinch Bolt
532-2025	532-2020	Renault	5	72	95	Pinch Bolt
532-2025	532-2020	Renault	Clio	91	98	Pinch Bolt
532-2025	532-2020	Renault	Clio	98	05	Pinch Bolt
532-2025	532-2020	Renault	Kangoo	98	07	Pinch Bolt
532-2025	532-2020	Renault	Logan	06	>	Pinch Bolt
532-2025	532-2020	Renault	Megane	02	>	Pinch Bolt
532-2025	532-2020	Renault	Megane Scenic	02	>	Pinch Bolt
532-2025	532-2020	Renault	Scenic Rx4	00	>	Pinch Bolt
532-2025	532-2020	Renault	Thalia	00	>	Pinch Bolt
532-2025	532-2020	Renault	Twingo	93	>	Pinch Bolt
532-2055	532-2050	Saab	9-3	03	>	Pinch Bolt (YS3F Model)
532-2705	532-2700	Skoda	Superb	02	08	Pinch Bolt
532-2605	532-2601	Toyota	Aygo	05	>	Pinch Bolt
532-2055	532-2050	Vauxhall	Vectra	02	06	Pinch Bolt
532-2055	532-2050	Vauxhall	Signum	03	>	Pinch Bolt
532-2705	532-2700	Volkswagen	Passat	96	00	Pinch Bolt

• All supplied with nuts

MAKE & MODEL TYPE & APPLICATION	PART NO.	QTY	MAKE & MODEL TYPE & APPLICATION	PART NO.	QTY	MAKE & MODEL TYPE & APPLICATION	PART NO.	QTY
VAG Panel cable tie 163 x 4.5mm	511-9170	12	Renault R19, Clio Mk1, Laguna Moulding Clip	563-2080	50	Mercedes 190E, E Class Trim Fix	563-6030	12
Peugeot, Citroen Wings HT setscrew hex M6x20/ Washer	536-2080	15	Renault Clio, Laguna Moulding Fixing	563-2330	10	Mercedes 190E Trim Fix	563-6040	8
Renault (for sheet metal) Screw flanged 6.35x17	536-4080	50	Renault Door Panel Fix Dia 8.2mm	563-2650	50	Mercedes 190E Trim Fix	563-6050	10
Flat bumpers & wings Screw flanged M6x20	536-4110	30	Renault R5 Door Panel Fix With Cap Dia 8.2mm	563-2670	30	Mercedes 190E Trim Fix	563-6060	5
Fiat Punto bumpers & wings Large head screw torx M6x20	544-2090	15	Peugeot, Citroen Door Panel Fix Dia 8mm	563-4220	30	Mercedes 190E Trim Fix	563-6070	5
Hex insert M6 16mm head	549-6235	12	Peugeot, Citroen Door Panel Fix use with 563-4380	563-4370	30	Mercedes 190E Wing Trim Fix	563-6080	5
Square insert M6 hole 9.2x9.2	549-6350	8	Peugeot, Citroen Waterproof Door Fix Boot	563-4380	30	Mercedes E Class Side Body Moulding Fix	563-6100	12
Ford Speed fastener M6 25mm x 16	549-7260	6	Peugeot, Citroen Door Panel Clip	563-4390	50	Mercedes E Class Side moulding Fix	563-6120	6
Renault Speed fastener no6 23mm x 17.5	556-4420	25	Peugeot, Citroen Grommet/Door Panel Use With 563-4390	563-4400	50	BMW 3 Series E34	563-7010	20
Peugeot, Citroen Cage nut M6 mudflap	556-5130	20	Renault, Peugeot, Citroen Door Panel Fix Dia 8mm	563-4450	50	BMW 3 Series E36 Side Moulding Fix	563-7020	6
Renault, Citroen, Peugeot Bayonet Nut M6	556-5230	25	VW Golf Mk2, Fiat Multipla Plastic Side Moulding Fix	563-5190	6	BMW 3 Series E30 Side Moulding Fix	563-7040	6
Peugeot, Citroen Cage nut M8	556-5460	25	VW Golf MK2 & 3 Side Moulding Plug	563-5210	30	BMW 3 Series E36 Lower Side Moulding Fix	563-7060	6
Peugeot, Citroen Cage screw M6 x 12mm	556-5720	20	VW Golf Mk3 Side Moulding Fix	563-5220	6	BMW 3 Series E36 Middle Side Moulding Fix	563-7070	6
Renault Cable Clip Dia 2.5-8mm	563-0330	6	VW Polo, Golf Mk3 Trim & Bonnet Insulation Clip	563-5380	8	BMW Plastic Rivet Dia 6.5mm Small Head	563-7210	10
Peugeot, Citroen Self Locking Cable Clip 3-13mm	563-0610	8	VAG Metal Tailgate Trim Clip	563-5400	10	Ford Trim & Bonnet Insulation Button Dia 8.4mm	563-9120	8
Renault, Citroen, Peugeot Self Locking Cable Clip 6-12mm	563-0620	12	VW Golf Mk3 Door panel Fix	563-5430	10	Ford Metal Clip For Fixing Door Mirror	563-9130	20
Renault Clio Mk1, R19 Self Locking Cable Clip 6-12mm	563-0630	6	VW Golf Mk2 Door Panel Fix	563-5450	6	Ford Escort 91/95 Door Panel Fix	563-9230	20
Omega Clip Grey 10mm	563-0810	25	VW Golf Mk2 Door Panel Fix	563-5460	6	Ford Fiesta Door Panel Fix	563-9240	8
Omega Clip Green 13mm	563-0820	25	Mercedes Side Trim Fix	563-6010	50	Ford Mondeo Door Panel Fix	563-9250	5
Renault, Peugeot, Citroen Plastic Screw Rivet	563-1310	30	Mercedes 190E, E Class Trim Fix	563-6020	12	Ford Escort 91/95 Door Window Seal Clip	563-9260	10

	MAKE & MODEL TYPE & APPLICATION	PART NO.	QTY		MAKE & MODEL TYPE & APPLICATION	PART NO.	QTY		MAKE & MODEL TYPE & APPLICATION	PART NO.	QTY
	Ford Fiesta 89/95 Nut For Door Armrest 4.8mm	563-9300	8		Fiat Uno, Punto, Bravo, Brava Door Stay Clasp Dia 3mm	564-3770	10		Peugeot 205,405, Citroen Plastic Grill Clip	564-7130	8
	Ford Plastic Nut For 4mm Self Tapper	563-9310	25		Peugeot, Citroen Window Retaining Clip	564-4140	20		Peugeot 205, Citroen BX Moulding Clip	564-7230	15
	Ford Cable Clip Dia 3-10mm	563-9410	10		Peugeot 106,205, 306, Citroen Trim Fix Button Dia 4.7mm	564-6010	30		Fiat Fix Button For Doors	564-7410	40
	Ford Brake Pipe Clip	563-9420	6		Peugeot, Citroen Trim Button Dia 4.7mm Head 18mm	564-6020	30		VW Polo, Golf Mk3 Trim Fix	564-7480	10
	Fiat Door panel & Trim Fix	564-1130	25		Renault, Peugeot, Citroen Trim Button Dia 6.7mm Head 20mm	564-6030	40		Peugeot, Citroen Nut For 3.5mm Self Tapper 7x7 Hole	564-8030	40
	Fiat Door Panel Nut For 4mm Self Tapper	564-1150	12		25 Renault Interior Trim Fix Dia 6.5mm	564-6070	40		Renault Nut For 7.2x14.2 For Sheet Metal Screw	564-8120	40
	Fiat Punto Door Socket Nut For 3.5mm Self Tapper 8x8 Hole	564-1240	12		Peugeot, Citroen Vans Trim Fix Button Dia 7.2mm	564-6090	20		Renault Nut 7.2x7.2 For 4.2mm Self Tapper	564-8160	40
	Renault, Peugeot, Citroen Trim Fix Button Dia 6.5mm	564-6080	40		Peugeot, Citroen Trim Fix Button Dia 6.5mm	564-6160	15		Renault Nut 11x13 For 4.2mm Self Tapper	564-8190	15
	Fiat Punto, Brava, Marea Bonnet Insulation Button	564-1310	40		Peugeot 106,405, Citroen Xantia Trim Fix Dia 6.7mm	564-6170	25		Renault Emblem Clip Dia 4mm	564-8420	20
	Renault, Citroen, Peugeot Door Stay Clasp Dia 3-3.5mm	564-3660	20		Renault Megane, Scenic Fix Button Dia 6.2x12.2 Mudflap	564-6180	12				
	Renault, Peugeot, Citroen Fixing For Door Stay	564-3670	50		Renault, Peugeot, Citroen Carpet & Soundproofing Button	564-6480	12				

FIRST AID KIT



- 1 - 10 person
- 2x large sterile dressing
- 2x eye pad sterile dressing
- 6x medium sterile dressing
- 4x triangular bandage
- 10x alcohol free wipes
- 2x bags of washproof plasters
- 1 pair of medium gloves
- 1x bag of safety pins
- 1x steroplast guidance leaflet

593-8018

QTY: 1

WALL BRACKET

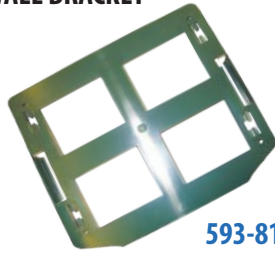

593-8198

QTY: 1

• Wall bracket for use with 593-8018

MINI FIRST AID HOLIDAY KIT



- 1x bandage
- 1x burnshield blott
- 2x eye/wound wash
- 1 pair of gloves
- 4x insect repellent wipes
- 1x low adherent dressing
- 1x microporous tape
- 10x washproof plasters
- 1x triangular bandage
- 2x alcohol free wipes

593-8092

QTY: 1

MINI FIRST AID VEHICLE KIT



- 1x bandage
- 1x foil blanket
- 1 pair of gloves
- 1x low adherent dressing
- 1x microporous tape
- 10x washproof plasters
- Safety pins
- 1x triangular bandage
- 2x alcohol free wipes
- 1x wound dressing
- 1x eye/wound wash pods

593-8093

QTY: 1

FIRST AID KIT



- 11 - 20 person
- 3x large sterile dressing
- 4x eye pad sterile dressing
- 9x medium sterile dressing
- 6x triangular bandage
- 10x alcohol free wipes
- 4x washproof plaster bags
- 2 pairs of medium gloves
- 1 bag of safety pins
- 1x guidance leaflet

593-8019

QTY: 1

FIRST AID KITBAG



- 1 person
- 2x steroplast wound dressing
- 2 pairs of vinyl gloves
- 1x triangular bandage
- 6x washproof plasters
- 2x sterile saline cleansing wipes
- 1 bag of safety pins

593-8124

QTY: 1

VEHICLE PSV FIRST AID KIT



593-8160

QTY: 1

PREMIER BURN CARE KIT



- 8x burnblott
- 2x 10cm x 10cm burnshield
- 1x 20cm x 20cm burnshield
- 2x 7.5cm x 4m conforming bandage
- 1x 10cm x 4m crepe bandage
- 1x microporous tape
- 1 pair of scissors
- 2 pairs of gloves
- 5 x 20ml eyewash

593-8240

QTY: 1

ASSORTED PLASTERS



PART NO.	QTY
595-1000	100
500-7020	120

WORKSHOP SAFETY PACK



- Goggles
- Gloves
- Face mask
- Earplugs

593-6100

QTY: 1

SAFETY GLASSES



593-4011

QTY: 1

SAFETY GOGGLES



- CE approved
- Complies with EN166
- Resists high speed particles (medium protection) & liquid
- Ventilated

593-4015

QTY: 1

FACE SHIELD

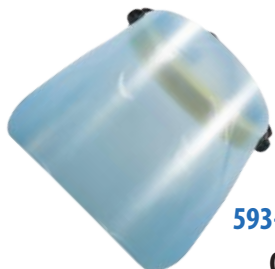

593-4030

QTY: 1

COMFORT DUST MASK



- Non toxic
- Plastic frame & cloth seal for more comfort & movement

PART NO.	QTY
593-5011	1
593-5010	20

EAR PLUGS

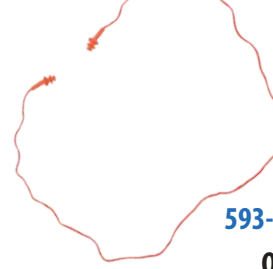

593-4040

QTY: 1

EAR DEFENDERS



593-4025

QTY: 1

EYEWASH STATION



PART NO.	DESCRIPTION	QTY
595-2000	Eyewash station	1
595-2011	Replacement bottle	1

HI-VIZ VESTS



PART NO.	SIZE	QTY
593-6000	Large	1
593-6010	Extra large	1

FIRE EXTINGUISHERS



PART NO.	DESCRIPTION	QTY
596-0010	1KG dry powder	1
596-0030	2 Litre foam	1

DISPOSABLE GLOVES



PART NO.	DESCRIPTION
593-0010	Latex powdered
593-0020	Latex powdered
593-0030	Latex powdered
593-0040	Latex powdered
593-0120	Latex powder free
593-0130	Latex powder free
593-0210	Nitrile powder free
593-0220	Nitrile powder free
593-0230	Nitrile powder free
593-0240	Nitrile powder free
593-0310	Vinyl powdered
593-0320	Vinyl powdered
593-0330	Vinyl powdered
593-0340	Vinyl powdered
593-0410	Vitrile (AQL 1.5)
593-0420	Vitrile (AQL 1.5)
593-0430	Vitrile (AQL 1.5)
593-0440	Vitrile (AQL 1.5)

WORK GLOVES



PART NO.	QTY
593-1000	5 Pairs
593-1001	1 Pair

GRIPPER GLOVES



- Non slip lattice rubber covered cotton gloves
- For handling glass & other items with sheer finish

593-1101

QTY: 1 PAIR

INDUSTRIAL GLOVES



593-1003

QTY: 1 PAIR

BLUE NITRILE GLOVES



PART NO.	SIZE	QTY
593-0500	Small	100
593-0510	Medium	100
593-0520	Large	100
593-0530	X-Large	100

BLACK NITRILE GLOVES



PART NO.	SIZE	QTY
593-0700	Small	100
593-0710	Medium	100
593-0720	Large	100
593-0730	X-Large	100

LATEX POWDERED GLOVES



PART NO.	SIZE	QTY
593-0800	Small	100
593-0810	Medium	100
593-0820	Large	100
593-0830	X-Large	100

LATEX POWDER FREE GLOVES



PART NO.	SIZE	QTY
593-0900	Small	100
593-0910	Medium	100
593-0920	Large	100
593-0930	X-Large	100

PAPER ROLL

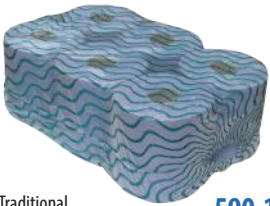

- Traditional
- 2 Ply
- 1950mm x 1500mm
- 6 rolls per pack

590-1050

QTY: 1

DISPOSABLE FLOOR MATS



593-2000

- Pack of 200

QTY: 1

SEAT COVERS



593-3000

- Pack of 100

QTY: 1

MICRONS HEAVY DUTY SEAT COVERS



593-3020

- Pack of 25

QTY: 1

STOCKINETTE



590-1060

QTY: 1

- 800G pollywrapped roll

DISPOSABLE SHOE COVERS



PART NO.	SIZE	QTY
593-3300	Large	1
593-3310	Extra large	1

- Pack of 100

HEAVY DUTY BIN LINERS



593-3500

- Pack of 200

QTY: 1

CLEANER & DEGREASER



- Powerful cleaning action
- Removes oil, carbon, ink etc
- Safe to use on most washable surfaces
- Highly concentrated

570-6200

QTY: 6

SWARFEGA ORANGE



SOR400MP

QTY: 1

- 450ml pump dispenser
- Solvent free deep cleansing

SWARFEGA ORIGINAL



- Original green gel hand cleaner with added conditioner to help maintain the skins moisture levels & leaves your hands smooth

PART NO.	SIZE	QTY
SWA157A	250G	1
SWA304A	500G	1
SWA450MP	450ML	1

CAR SEAT COVER



- This cover is designed for single seat with side impact air bags

PART NO.	COLOUR	QTY
ABCBLK-211	Black	1
ABCGRY-214	Grey	1

CAR SEAT COVER



- This cover has been designed as quick fit
- Rear cover is suitable for many estate cars twin cabs & hatchbacks

PART NO.	COLOUR	QTY
FFRBLK-301	Black	1
FFRGRY-304	Grey	1

CAR SEAT COVER



- Fully adjustable rear car seat cover for seats 120-145cm wide
- Fits most MPV, estate & twin cabs

PART NO.	COLOUR	QTY
UCRBLK-271	Black	1
UCRGRY-274	Grey	1

CAR SEAT COVER



- Double seat cover which fits the front double passenger seat in most vans
- Accepts 3 point seat belts

PART NO.	COLOUR	QTY
VBLK-291	Black	1
VGRY-294	Grey	1

CAR SEAT COVER



- Fits larger single seats or those that have side wings
- Suitable for many cars, vans & 4x4's

PART NO.	COLOUR	QTY
WUFBK-221	Black	1
WUFGRY-224	Grey	1

TECHNICIANS CAR SEAT COVER



- Protects the single seat of vehicles while in garage environments
- Can be used multiple times

PART NO.	COLOUR	QTY
TSCBLK-311	Black	1
TSCGRY-314	Grey	1

UNIVERSAL CAR SEAT COVER



- Fits single seats of most cars & vans
- Protects the front & back of the seat which prevents 'foot scuffing'

PART NO.	COLOUR	QTY
UFBLK-201	Black	1
UFGRY-204	Grey	1

FOR FURTHER INFORMATION ON OUR HEALTH & SAFETY RANGE CALL 01254-301121 OR VISIT MAFCOBELL.CO.UK

Flunkey

- USE IT JUST LIKE LEATHER
- WASHES, DRIES & CLEANS WITHOUT STREAKING
- UNIQUE CONSTRUCTION ENSURING LONG LIFE

THE
PROFESSIONAL
VALET'S
CHOICE

"...the best car cloth in the world - ever"

A super absorbent car cloth that washes, dries & cleans just like a leather. The Flunkey's unique construction makes this cloth much more durable than a chamois & it can be easily machine washed when dirty. Comes with a 1 year guarantee.



**CELLOPHANE WRAPPED FLUNKEY
CAR CLOTH**



**A167A
QTY: 1**

**CELLOPHANE WRAPPED FLUNKEY
IN COUNTER DISPLAY BOX**





















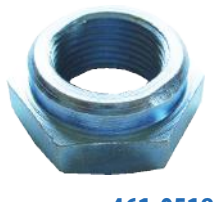
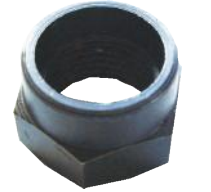



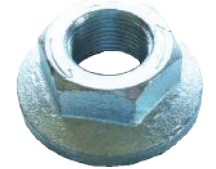
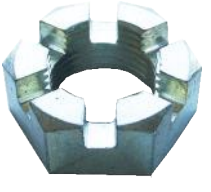



QTY: 20

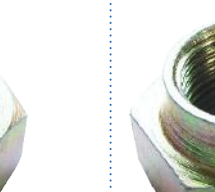

FLUNKEY FLAT PACK



**A167/100
QTY: 100**

<p>CITROEN, PEUGEOT</p>  <p>461-0002 QTY: 1</p>	<p>PEUGEOT</p>  <p>461-0004 QTY: 1</p>	<p>CITROEN, PEUGEOT</p>  <p>461-0006 QTY: 1</p>	<p>PEUGEOT</p>  <p>461-0010 QTY: 1</p>	<p>AUSTIN</p>  <p>461-0012 QTY: 1</p>	<p>AUSTIN</p>  <p>461-0014 QTY: 1</p>
<p>FORD, MAZDA</p>  <p>461-0036 QTY: 1</p>	<p>AUDI, CITROEN, FIAT, PEUGEOT</p>  <p>461-0510 QTY: 1</p>	<p>AUSTIN</p>  <p>461-0512 QTY: 1</p>	<p>CITROEN, PEUGEOT</p>  <p>461-0514 QTY: 1</p>	<p>FORD</p>  <p>461-0516 QTY: 1</p>	<p>AUDI, VOLKSWAGEN</p>  <p>461-0518 QTY: 1</p>
<p>CITROEN, PEUGEOT</p>  <p>461-0520 QTY: 1</p>	<p>RENAULT</p>  <p>461-0522 QTY: 1</p>	<p>MAZDA 323 REAR</p>  <p>461-0524 QTY: 1</p>	<p>RENAULT</p>  <p>461-0526 QTY: 1</p>	<p>ESCORT MK 5 RHS REAR</p>  <p>461-0528 QTY: 1</p>	<p>ESCORT MK 5 LHS REAR</p>  <p>461-0530 QTY: 1</p>
<p>AUSTIN</p>  <p>461-0532 QTY: 1</p>	<p>CITROEN, PEUGEOT</p>  <p>461-0534 QTY: 1</p>	<p>FORD, MAZDA</p>  <p>461-0536 QTY: 1</p>	<p>MAESTRO, MONTEGO, ROVER 200, 400 FRONT</p>  <p>461-0538 QTY: 1</p>	<p>VAUXHALL</p>  <p>461-0540 QTY: 1</p>	<p>FORD</p>  <p>461-0542 QTY: 1</p>
<p>FORD</p>  <p>461-0544 QTY: 1</p>	<p>CITROEN, PEUGEOT</p>  <p>461-0546 QTY: 1</p>	<p>CITROEN, PEUGEOT</p>  <p>461-0701 QTY: 1</p>	<p>CITROEN, PEUGEOT</p>  <p>461-0703 QTY: 1</p>		
<p>FORD</p>  <p>461-0705 QTY: 1</p>	<p>VAUXHALL</p>  <p>461-0707 QTY: 1</p>	<p>VAUXHALL</p>  <p>461-0709 QTY: 1</p>	<p>VAUXHALL</p>  <p>461-0711 QTY: 1</p>		

MAKE	MODEL	NOTES	FROM	TO	HUB NUT FRONT	HUB NUT KIT (F)	GREASE CAP (F)	HUB NUT REAR	HUB NUT KIT (R)	GREASE CAP (R)
Alfa Romeo	145-146-155	-	94	01	-	-	-	461-0510	-	-
Audi	Coupe	-	88	96	461-0518	-	-	-	-	-
Audi	Quattro	-	80	91	461-0510	-	-	-	-	-
Austin	Mini	Small Size	59	00	461-0512	461-0012	-	-	-	-
Austin	Mini	Large Size	59	00	461-0532	461-0014	-	-	-	-
Citroen	Berlingo MPV	-	96	>	461-0514	-	-	-	461-0006	-
Citroen	C2	-	03	>	461-0534	-	-	-	-	-
Citroen	C3	-	02	>	461-0534	-	-	-	-	-
Citroen	C4	-	04	>	461-0546	-	-	-	461-0002	-
Citroen	C5	-	00	>	461-0546	-	-	-	461-0006	-
Citroen	C5	-	00	>	461-0546	-	-	-	461-0002	-
Citroen	Relay Jumper	-	94	02	-	-	-	461-0510	-	-
Citroen	Saxo	-	96	>	-	-	-	461-0510	461-0701	-
Citroen	Saxo	4 Stud Wheel	96	>	461-0534	-	-	-	461-0010	461-0703
Citroen	Xantia	-	93	>	461-0514	-	-	-	461-0006	-
Citroen	Xsara	-	97	>	461-0514	-	-	461-0510	-	-
Citroen	Xsara Picasso	-	00	>	461-0514	-	-	-	-	-
Fiat	Brava/Bravo	-	95	01	-	-	-	461-0510	-	-
Fiat	Doblo	-	01	>	-	-	-	461-0510	-	-
Fiat	Ducato	-	94	02	-	-	-	461-0510	-	-
Fiat	Multipla MPV	-	99	>	-	-	-	461-0510	-	-
Fiat	Punto	-	94	01	-	-	-	461-0510	-	-
Fiat	Tempra	-	90	96	-	-	-	461-0510	-	-
Fiat	Tipo	-	87	95	-	-	-	461-0510	-	-
Ford	Courier Hi-cube	-	96	02	-	-	-	461-0536	461-0036	461-0705
Ford	Escort Mk3 & 4	Including Van	80	90	461-0542	-	-	-	-	-
Ford	Escort Mk5 & 6	-	95	00	461-0544	-	-	461-0536	461-0036	461-0705
Ford	Fiesta Mk5	-	95	01	-	-	-	461-0536	461-0036	-
Ford	Fiesta Mk6	-	01	>	461-0516	-	-	461-0536	461-0036	461-0705
Ford	Focus	-	98	04	461-0516	-	-	461-0536	461-0036	461-0705
Ford	Fusion	-	02	>	461-0516	-	-	461-0536	461-0036	461-0705
Ford	KA	-	96	>	461-0544	-	-	461-0536	461-0036	461-0705
Ford	Mondeo	-	93	>	461-0516	-	-	-	-	-
Mazda	2	-	03	>	-	-	-	461-0536	461-0036	461-0705
Peugeot	106	Rear 18mm Thread	91	00	461-0534	-	-	-	461-0002	-
Peugeot	106	Rear 20mm Thread	91	00	461-0534	-	-	461-0510	461-0004	-
Peugeot	206	2.0hdi, 2.0 s16	98	>	461-0514	-	-	-	-	-
Peugeot	206	1.1, 1.4, 1.6, 1.9d	98	>	461-0534	-	-	461-0510	461-0010	461-0701
Peugeot	306	Deep Type Dish	93	02	-	-	-	-	-	461-0701
Peugeot	306	With Drum Brakes	93	02	461-0514	-	-	-	-	461-0703
Peugeot	307	-	00	>	461-0546	-	-	-	-	-
Peugeot	406	-	95	04	461-0514	-	-	-	461-0006	-
Peugeot	Boxer	-	94	05	-	-	-	-	461-0510	-
Peugeot	Partner MPV & Van	-	96	>	461-0514	-	-	-	461-0006	-
Renault	Clio	With Drum Brakes	91	98	-	-	-	461-0522	-	-
Renault	Clio	With Disc Brakes	91	98	-	-	-	461-0526	-	-
Renault	Clio	-	98	05	461-0522	-	-	461-0522	-	-
Renault	Clio	With Disc Brakes	98	05	461-0526	-	-	461-0526	-	-
Renault	Espace 1	-	84	90	461-0522	-	-	461-0522	-	-
Renault	Espace 11	-	91	96	461-0522	-	-	461-0522	-	-
Renault	Kangoo MPV & Van	-	98	>	461-0522	-	-	461-0522	-	-
Renault	Laguna	-	94	01	461-0522	-	-	461-0522	-	-
Renault	Megane & Scenic MPV	-	96	99	461-0522	-	-	461-0522	-	-
Renault	Megane & Scenic MPV	With Disc Brakes	96	99	461-0526	-	-	461-0526	-	-
Renault	Twingo	1.2	93	>	461-0526	-	-	461-0522	-	-
Vauxhall	Astra Mk4	-	98	04	461-0540	-	461-0709	-	-	-
Vauxhall	Astra Mk4	57mm Diameter Cap	98	04	461-0540	-	461-0707	-	-	-
Vauxhall	Astra Mk5	-	04	>	-	-	461-0709	-	-	-
Vauxhall	Astra Mk5	57mm Diameter Cap	04	>	-	-	461-0707	-	-	-
Vauxhall	Corsa	-	93	00	461-0540	-	461-0709	-	-	-
Vauxhall	Corsa	-	01	>	461-0540	-	461-0709	-	-	461-0711
Vauxhall	Meriva	-	03	>	461-0540	-	461-0709	-	-	-
Vauxhall	Signum	57mm Diameter Cap	03	>	-	-	461-0707	-	-	-
Vauxhall	Vectra	-	95	02	461-0540	-	461-0709	-	-	-
Vauxhall	Vectra	-	02	06	461-0540	-	461-0707	-	-	-
Vauxhall	Zafira	57mm Diameter Cap	98	05	-	-	-	-	-	-
Vauxhall	Zafira	57mm Diameter Cap	05	>	-	-	-	-	-	-
Volkswagen	Beetle	-	69	03	-	-	-	461-0518	-	-
Volkswagen	Golf Mk1	-	74	93	461-0518	-	-	-	-	-
Volkswagen	Golf Mk2	-	83	92	461-0518	-	-	-	-	-
Volkswagen	Gold Mk3	-	91	99	461-0518	-	-	-	-	-
Volkswagen	Golf Mk4	Cabriolet Only	97	02	461-0518	-	-	-	-	-
Volkswagen	Passat Mk3	-	88	97	461-0518	-	-	-	-	-
Volkswagen	Polo	-	75	94	461-0518	-	-	-	-	-
Volkswagen	Polo	-	94	01	461-0518	-	-	-	-	-

<p>VAUXHALL</p>  <p>A223A QTY: 1</p>	<p>FORD FLAME TRAP</p>  <p>A224A QTY: 1</p>	<p>AUSTIN ROVER</p>  <p>A225A QTY: 1</p>	<p>FORD, AUSTIN ROVER</p>  <p>A256A QTY: 1</p>	<p>FORD</p>  <p>A273A QTY: 1</p>
<p>FORD EMISSION VALVE</p>  <p>A277A QTY: 1</p>	<p>FORD</p>  <p>A278A QTY: 1</p>	<p>PEUGEOT, CITROEN</p>  <p>A279A QTY: 1</p>	<p>RENAULT</p>  <p>A280A QTY: 1</p>	<p>VAUXHALL</p>  <p>A281A QTY: 1</p>
<p>RENAULT</p>  <p>A282A QTY: 1</p>	<p>VAUXHALL</p>  <p>A581A QTY: 1</p>	<p>FORD</p>  <p>A582A QTY: 1</p>	<p>FORD</p>  <p>A621A QTY: 1</p>	<p>FORD</p>  <p>A622A QTY: 1</p>
<p>FORD</p>  <p>A665A QTY: 1</p>	<p>VAUXHALL</p>  <p>A666A QTY: 1</p>	<p>FORD</p>  <p>A667A QTY: 1</p>	<p>VOLKSWAGEN</p>  <p>A669A QTY: 1</p>	<p>FORD</p>  <p>A670A QTY: 1</p>
<p>ROVER</p>  <p>A671A QTY: 1</p>	<p>FORD</p>  <p>A672A QTY: 1</p>	<p>FORD</p>  <p>A673A QTY: 1</p>	<p>FORD</p>  <p>A674A QTY: 1</p>	<p>FORD</p>  <p>A675A QTY: 1</p>
<p>FORD FLAME TRAP</p>  <p>A676A QTY: 1</p>	<p>FORD FLAME TRAP</p>  <p>A677A QTY: 1</p>	<p>FORD AIR FILTER BREATHER TUBE</p>  <p>A678A QTY: 1</p>	<p>VAUXHALL PETROL TANK FILTER</p>  <p>A679A QTY: 1</p>	

MAKE	MODEL	FROM	TO	PART NO.	TYPE	MAKE	MODEL	FROM	TO	PART NO.	TYPE
Audi	80	78	96	A669A	Oil Cap	Ford	Transit DOHC	86	>	A665A	Oil Cap
Audi	90	84	91	A669A	Oil Cap	Ford	Transit 2.5D	84	94	A667A	Oil Cap
Audi	100	78	94	A669A	Oil Cap	Ford	Transit	86	91	A277A	Emission Valve
Audi	200	79	91	A669A	Oil Cap	Ford	Transit 2.5D	94	00	A668A	Oil Cap
Audi	A2	01	>	A669A	Oil Cap	Ford	Transit 2.0D FWD	00	>	A278A	Oil Cap
Audi	A3	96	>	A669A	Oil Cap	Peugeot	106 XU eng	91	00	A664A	Oil Cap
Audi	A4	95	01	A669A	Oil Cap	Peugeot	206 HDI eng	98	>	A279A	Oil Cap
Audi	A6	94	05	A669A	Oil Cap	Peugeot	306 HDI eng	93	02	A279A	Oil Cap
Audi	A8	94	02	A669A	Oil Cap	Peugeot	307 HDI eng	00	>	A279A	Oil Cap
Audi	All-road	05	>	A669A	Oil Cap	Peugeot	406 XU eng	95	04	A664A	Oil Cap
Audi	S8	94	01	A669A	Oil Cap	Peugeot	406 HDI eng	95	04	A279A	Oil Cap
Audi	TT	99	>	A669A	Oil Cap	Peugeot	407 HDI eng	04	>	A279A	Oil Cap
Citroen	C1 HDI eng	05	>	A279A	Oil Cap	Peugeot	607 HDI eng	00	>	A279A	Oil Cap
Citroen	C2 HDI eng	03	>	A279A	Oil Cap	Peugeot	807 HDI eng	02	>	A279A	Oil Cap
Citroen	C3 HDI eng	02	>	A279A	Oil Cap	Peugeot	Expert HDI eng	00	>	A279A	Oil Cap
Citroen	C4 HDI eng	04	>	A279A	Oil Cap	Peugeot	Partner HDI eng	96	>	A279A	Oil Cap
Citroen	C5 HDI eng	01	08	A279A	Oil Cap	Renault	Clio 1.9D	91	98	A282A	Oil Cap
Citroen	C8 HDI eng	02	>	A279A	Oil Cap	Renault	Clio 1.2, 1.4, 1.6	98	>	A280A	Oil Cap
Citroen	Dispatch HDI eng	95	>	A279A	Oil Cap	Renault	Clio 1.5dci, 1.9D	98	05	A282A	Oil Cap
Ford	Capri OHC	74	87	A273A	Oil Cap	Renault	Espace 2.0, 2.2dci	02	>	A282A	Oil Cap
Ford	Cortina OHC	70	82	A273A	Oil Cap	Renault	Grand Scenic 1.6	04	>	A280A	Oil Cap
Ford	Cougar 2.0 Zetec	98	01	A665A	Oil Cap	Renault	Kangoo 1.2, 1.4, 1.6v	98	>	A280A	Oil Cap
Ford	Courier 1.3efi	91	02	A672A	Oil Breather Cap	Renault	Kangoo 1.5dci, 1.9D	98	>	A282A	Oil Cap
Ford	Courier 1.6 & 1.8	91	02	A675A	Oil Cap	Renault	Laguna 1.6 16V	94	07	A280A	Oil Cap
Ford	Courier 2.0 Zetec	91	02	A665A	Oil Cap	Renault	Laguna 1.9Dti, 2.0 16v, 2.2dci	94	07	A282A	Oil Cap
Ford	Escort Mk2 OHC	74	80	A273A	Oil Cap	Renault	Master 2.2dci, 2.5dci	00	>	A282A	Oil Cap
Ford	Escort Mk3-4 CVH	80	90	A622A	Oil Cap	Renault	Megane	96	99	A282A	Oil Cap
Ford	Escort Mk3-4 CVH	80	90	A224A	Crank Breather	Renault	Megane	02	>	A280A	Oil Cap
Ford	Escort Mk3-4 1.6efi	80	90	A676A	Flame Trap	Rover	Metro, 100	90	98	A671A	Oil Cap
Ford	Escort Mk3-4 1.6efi	80	90	A677A	Flame Trap	Rover	200 Series	84	00	A671A	Oil Cap
Ford	Escort Mk3-4	86	90	A678A	Air Filter Breather	Rover	400, 600, 800 Series (8v Only)	89	99	A671A	Oil Cap
Ford	Escort 1.6D, 1.8D	80	90	A675A	Oil Cap	Seat	Alhambra 1.8t, 1.9tdi, 2.0i, 2.8	96	>	A669A	Oil Cap
Ford	Escort 1.3 HCS	80	90	A672A	Oil Breather Cap	Seat	Arosa 1.0, 1.4, 1.4tdi, 1.7sdi	97	>	A669A	Oil Cap
Ford	Escort	80	90	A277A	Emission Valve	Seat	Inca 1.4, 1.6, 1.7d, 1.9d, 1.9sdi	95	>	A669A	Oil Cap
Ford	Escort Mk5 & 6 CVH	90	00	A622A	Oil Cap	Seat	Leon 1.4, 1.6, 1.7d, 1.9d, 1.9sdi	99	>	A669A	Oil Cap
Ford	Escort Mk5 & 6 CVH	90	00	A224A	Crank Breather	Skoda	Fabia 1.0, 1.2, 1.4, 1.9sdi, 2.0	00	>	A669A	Oil Cap
Ford	Escort Mk5 & 6 1.3hcs	90	00	A672A	Oil Breather Cap	Skoda	Octavia 1.4, 1.6, 1.8, 1.9sdi, 2.0	96	>	A669A	Oil Cap
Ford	Escort Mk5 & 6 1.4efi	94	01	A676A	Flame Trap	Skoda	Superb 1.8t, 1.9tdi, 2.0	02	>	A669A	Oil Cap
Ford	Escort Mk5 & 6 1.4efi	94	01	A677A	Flame Trap	Vauxhall	Agila 1.0, 1.2	00	>	A281A	Oil Cap
Ford	Escort 1.8D	90	00	A675A	Oil Cap	Vauxhall	Antara 2.4	06	>	A281A	Oil Cap
Ford	Escort	90	00	A277A	Emission Valve	Vauxhall	Astra All Models	79	91	A581A	Oil Cap
Ford	Fiesta OHC	75	83	A273A	Oil Cap	Vauxhall	Astra 1.4NV, C14NZ, X14NZ, C14SE	91	98	A223A	Oil Cap
Ford	Fiesta OHV	83	89	A256A	Oil Cap	Vauxhall	Astra 1.8, 2.0	91	98	A281A	Oil Cap
Ford	Fiesta	83	84	A582A	Oil Cap 3 Pipe	Vauxhall	Astra All Other Models	91	98	A581A	Oil Cap
Ford	Fiesta	84	89	A621A	Oil Cap 2 Pipe	Vauxhall	Astra	98	04	A281A	Oil Cap
Ford	Fiesta	83	89	A224A	Crank Breather	Vauxhall	Astra	04	>	A281A	Oil Cap
Ford	Fiesta CVH	83	89	A622A	Oil Cap	Vauxhall	Corsa X10XE, X12XE	93	00	A281A	Oil Cap
Ford	Fiesta CVH	89	94	A678A	Air Filter Breather Tube	Vauxhall	Corsa All Other Models	93	00	A223A	Oil Cap
Ford	Fiesta 1.3hcs	89	94	A672A	Oil Breather Cap	Vauxhall	Corsa	01	>	A281A	Oil Cap
Ford	Fiesta Zetec	89	96	A582A	Oil Cap	Vauxhall	Meriva 1.6i, 1.6 16V	03	>	A223A	Oil Cap
Ford	Fiesta 1.8D	89	94	A675A	Oil Cap	Vauxhall	Meriva All Other Models	03	>	A281A	Oil Cap
Ford	Fiesta	89	94	A277A	Emission Valve	Vauxhall	Vectra	95	06	A281A	Oil Cap
Ford	Fiesta 1.6efi cvh	89	96	A677A	Flame Trap	Vauxhall	Zafira	95	>	A281A	Oil Cap
Ford	Fiesta CVH	94	02	A678A	Air Filter Breather	Volkswagen	Bora	98	>	A669A	Oil Cap
Ford	Fiesta 1.3hcs	94	02	A672A	Oil Breather Cap	Volkswagen	Golf All Models	74	05	A669A	Oil Cap
Ford	Fiesta Zetec	94	96	A581A	Oil Cap	Volkswagen	LT	75	96	A669A	Oil Cap
Ford	Fiesta 1.8D	94	02	A675A	Oil Cap	Volkswagen	LT	96	>	A669A	Oil Cap
Ford	Fiesta 1.6efi	94	02	A676A	Flame Trap	Volkswagen	Lupo	98	>	A669A	Oil Cap
Ford	Galaxy DOHC & Zetec	96	06	A665A	Oil Cap	Volkswagen	Passat	73	97	A669A	Oil Cap
Ford	Granada 2.3D, 2.5D	85	87	A673A	Oil Cap	Volkswagen	Polo	75	01	A669A	Oil Cap
Ford	Granada 2.3D, 2.5D	87	93	A674A	Oil Cap	Volkswagen	Polo	01	>	A669A	Oil Cap
Ford	Granada DOHC	92	94	A665A	Oil Cap	Volkswagen	Sharan	95	>	A669A	Oil Cap
Ford	Granada	92	>	A277A	Emission Valve	Volkswagen	Transporter	79	92	A669A	Oil Cap
Ford	KA 1.3hcs	96	>	A672A	Oil Breather Cap	Volvo	850 2.5tdi	95	96	A669A	Oil Cap
Ford	Mondeo 1.8D	93	00	A675A	Oil Cap	Volvo	S70 2.5tdi	97	00	A669A	Oil Cap
Ford	Modeo Zetec	93	00	A665A	Oil Cap	Volvo	S80 2.5tdi	99	06	A669A	Oil Cap
Ford	Mondeo	93	00	A277A	Emission Valve	Volvo	V70 2.5tdi	97	07	A669A	Oil Cap
Ford	Mondeo 2.0D, 2.2D	00	07	A278A	Oil Cap						
Ford	Transit OHC	86	00	A273A	Oil Cap						

JUBILEE WORM DRIVE HOSE CLIPS

Jubilee



- The original worm drive hose clip
- All mild steel is zinc protected
- Manufactured UN ISO9000 quality system
- BS5315: 1991 certified product

BAGGED	BOXED	SIZE	RANGE	RANGE	BAND WIDTH	QTY	QTY
455-1092	455-1090	000	9.5 - 12mm	3/8" - 1/2"	9mm	25	10
455-1112	455-1110	M00	11 - 16mm	1/2" - 5/8"	9mm	25	10
455-1132	455-1130	00	13 - 20mm	1/2" - 3/4"	9mm	25	10
455-1162	455-1160	0	16 - 22mm	5/8" - 7/8"	13mm	25	10
455-1172	455-1170	0X	18 - 25mm	3/4" - 1"	13mm	25	10
455-1222	455-1220	1A	22 - 30mm	7/8" - 1 1/8"	13mm	25	10
455-1252	455-1250	1	25 - 35mm	1" - 1 3/8"	13mm	25	10
455-1302	455-1300	1X	30 - 40mm	1 1/8" - 1 5/8"	13mm	25	10
455-1272	455-1270	1M	32 - 45mm	1 1/4" - 1 3/4"	13mm	25	10
455-1352	455-1350	2A	35 - 50mm	1 1/4" - 2 1/8"	13mm	25	10
455-1402	455-1400	2	40 - 55mm	1 1/2" - 2 1/8"	13mm	25	10
-	455-1450	2X	45 - 60mm	1 3/4" - 2 3/8"	13mm	-	10
-	455-1550	3	55 - 70mm	2" - 2 3/4"	13mm	-	10
455-1600	-	3X	60 - 80mm	2 3/8" - 3 1/8"	13mm	10	-
455-1700	-	4	70 - 90mm	2 3/4" - 3 1/2"	13mm	10	-
455-1850	-	4X	85 - 100mm	3 1/4" - 4"	13mm	10	-
455-1900	-	5	90 - 120mm	3 3/4" - 4 1/2"	13mm	10	-
455-1960	-	6	110 - 140mm	4 1/4" - 5 1/2"	13mm	10	-

JUBILEE WORM DRIVE HOSE CLIPS



Jubilee



BOXED	QTY
455-1095	10
455-1115	10
455-1135	10
455-1165	10
455-1175	10
455-1225	10
455-1255	10
455-1305	10
455-1275	10
455-1355	10
455-1405	10
455-1455	10
455-1555	10

- 304 stainless steel
- Suitable for marine applications
- The original worm drive hose clip
- Manufactured in the UK under ISO9000 quality system
- BS315: 1991 certified product

BOX PACKS MERCHANDISER



Jubilee



- Contains 10 of each of the most popular sizes in an outer carton: 10 x 000, 10 x M00, 10 x 00, 10 x 0, 10 x 0X, 10 x 1A, 10 x 1, 10 x 1X, 10 x 1M, 10 x 2A
- Diver not included

JCS100

QTY: 1 PACK

JUBILEE CLIP DISPENSER

Jubilee



- Mild steel
- Strong wire frame
- Can be wall mounted or left free standing
- Contains 10 of each of the most popular sizes: 10 x 000, 10 x M00, 10 x 00, 10 x 0, 10 x 0X, 10 x 1A, 10 x 1, 10 x 1X, 10 x 1M, 10 x 2A
- Also comes with a Jubilee flexdriver

MF113

QTY: 1 PACK

JUBILEE FLEXDRIVER

Jubilee



- Flexible shaft tool used for efficient & rapid adjustment of Jubilee clips
- 7mm A/F socket head
- Length 280mm

400121

QTY: 1

JUBILEE CLIPDRIVER

Jubilee



CDR95

QTY: 1

- Rigid shaft tool for easy adjustment of Jubilee clips
- Length 95mm

JUBILEE CLIPDRIVER

Jubilee



CDR160

QTY: 1

- Rigid shaft tool for easy adjustment of Jubilee clips
- Length 160mm

JUBILEE HIGH TORQUE CLIPS



Jubilee



PART NO.	SIZE NO.	DIA MM	QTY
455-9035/10	HT035	20-35mm	10
455-9040/10	HT040	25-40mm	10
455-9045/10	HT045	25-45mm	10
455-9050/10	HT050	30-50mm	10
455-9070/10	HT070	40-70mm	10
455-9080/10	HT080	60-80mm	10
455-9095/10	HT095	70-95mm	10

JUBILEE HEAVY DUTY BOLT CLAMPS

Jubilee



- Mild Steel
- Zinc plated

PART NO.	MIN-MAX	BAND WIDTH	SCREW HEAD	QTY	PART NO.	MIN-MAX	BAND WIDTH	SCREW HEAD	QTY
455-8019	17-19mm	18mm	8mm	1	455-8085	80-85mm	25mm	13mm	1
455-8022	20-22mm	18mm	8mm	1	455-8091	86-91mm	25mm	13mm	1
455-8025	23-25mm	18mm	8mm	1	455-8097	92-97mm	25mm	13mm	1
455-8028	26-28mm	18mm	8mm	1	455-8103	98-103mm	25mm	13mm	1
455-8031	29-31mm	18mm	8mm	1	455-8112	104-112mm	25mm	13mm	1
455-8035	32-35mm	20mm	10mm	1	455-8121	113-121mm	25mm	13mm	1
455-8039	36-39mm	20mm	10mm	1	455-8130	122-130mm	25mm	13mm	1
455-8043	40-43mm	20mm	10mm	1	455-8139	131-139mm	25mm	13mm	1
455-8047	44-47mm	20mm	10mm	1	455-8148	140-148mm	25mm	13mm	1
455-8051	48-51mm	20mm	10mm	1	455-8161	149-161mm	25mm	13mm	1
455-8055	52-55mm	20mm	10mm	1	455-8174	162-174mm	-	-	1
455-8059	56-59mm	20mm	10mm	1	455-8187	175-187mm	-	-	1
455-8063	60-63mm	20mm	10mm	1	455-8200	188-200mm	-	-	1
455-8067	64-67mm	25mm	13mm	1	455-8213	201-213mm	-	-	1
455-8073	68-73mm	25mm	13mm	1	455-8226	214-226mm	-	-	1
455-8079	74-79mm	25mm	13mm	1	455-8239	227-239mm	-	-	1

JUBILEE MULTIBAND

Jubilee



- Handy pack (10m of band with 25 housing/screws)

455-0000

QTY: 1

JUBILEE AUTOMOTIVE POCKET PACK

Jubilee



455-2970

QTY: 24

SIZE	ADJUSTMENT	QTY
Worm Drive Hose Clips		
00	9.5-12mm	4
0	11-16mm	4
0X	13-20mm	4
1	16-22mm	2
1X	18-25mm	2
Nut & Bolt Clips		
-	7-9mm	4
-	11-13mm	4

JUBILEE O CLIPS



PART NO.	RANGE	QTY
455-5050	3-5mm	25
455-5070	5-7mm	25
455-5090	7-9mm	25
455-5110	9-11mm	25
455-5130	11-13mm	25
455-5150	13-15mm	25
455-5180	15-18mm	25
455-5200	17-20mm	25
455-5230	20-23mm	10
455-5270	23-27mm	10
455-5310	27-31mm	10
455-5340	31-34mm	10
455-5370	34-37mm	10
455-5400	37-40mm	10
455-5430	40-43mm	10
455-4600	43-46mm	10
500-5410	Ass O Clips	125
500-5420	Asst O Clips with hose joiners	72

JUBILEE JUNIOR NUT & BOLT CLIPS



PART NO.	ADJUSTMENT	QTY
455-5509	07-09mm	10
455-5510	08-10mm	10
455-5511	09-11mm	10
455-5512	10-12mm	10
455-5513	11-13mm	10
455-5514	12-14mm	10
455-5515	13-15mm	10
455-5516	14-16mm	10
455-5517	15-17mm	10
455-5518	16-18mm	10
455-5520	18-20mm	10

JUBILEE WORKSHOP PACK



SIZE	ADJUSTMENT	QTY
000	9.5-12mm	24
M00	11-16mm	32
00	13-20mm	28
0	16-22mm	13
0X	18-25mm	14
1A	22-30mm	12
1	25-35mm	13
1X	30-40mm	7

HCP143MS
QTY: 143

JUBILEE WINGSPADE CLIPS



PART NO.	DIA	QTY
455-4512	9.5-12mm	10
455-4516	11-16mm	10
455-4520	13-20mm	10
455-4525	16-25mm	10
455-4532	20-32mm	10
455-4540	25-40mm	10
455-4550	32-50mm	10
455-4560	40-60mm	10
455-4570	50-70mm	10

JUBILEE JUNIOR ASSORTMENT



ADJUSTMENT	QTY
07-09mm	25
08-10mm	25
09-11mm	25
10-12mm	30
11-13mm	30
12-14mm	30



JA165MS
QTY: 143



THE ONLY CLIPS YOU'LL EVER NEED

HOSE CLIPS				
Material	Zinc Plated Mild Steel			
Product Code	Adjustment Scope			
	MM	Inches		
000-MSE	9.5	12	3/8	1/2
M00-MSE	11	15	7/16	5/8
00-MSE	12	20	1/2	25/32
0-MSE	16	22	5/8	7/8
0X-MSE	18	25	3/4	1
1A-MSE	22	30	7/8	1 3/16
01-MSE	25	35	1	1 3/8
1X-MSE	30	40	1 3/16	1 9/16
2A-MSE	35	50	1 3/8	1 31/32
02-MSE	45	55	1 9/16	1 11/64
2X-MSE	45	60	1 25/32	2 3/8
03-MSE	55	70	2	2 3/4
3X-MSE	60	80	2 3/8	3 1/8
04-MSE	70	90	2 3/4	3 1/2
4X-MSE	85	100	3 1/4	4
05-MSE	95	115	3 3/4	4 1/2
06-MSE	110	140	4 1/2	5 1/2
6X-MSE	120	150	5	5 3/4
7-MSE	135	165	5 1/4	6 1/2
7 1/2-MSE	158	190	6 1/4	7 1/2

PREMIUM CLIPS				
Material	201 Stainless Steel			
Product Code	Adjustment Scope			
	MM	Inches		
000-SSS	9.5	12	3/8	1/2
M00-SSS	11	15	7/16	5/8
00-SSS	12	20	1/2	25/32
0-SSS	16	22	5/8	7/8
0X-SSS	18	25	3/4	1
1A-SSS	22	30	7/8	1 3/16
01-SSS	25	35	1	1 3/8
1X-SSS	30	40	1 3/16	1 9/16
2A-SSS	35	50	1 3/8	1 31/32
02-SSS	45	55	1 9/16	1 11/64
2X-SSS	45	60	1 25/32	2 3/8
03-SSS	55	70	2	2 3/4
3X-SSS	60	80	2 3/8	3 1/8
04-SSS	70	90	2 3/4	3 1/2
4X-SSS	85	100	3 1/4	4
05-SSS	95	115	3 3/4	4 1/2
06-SSS	110	140	4 1/2	5 1/2
6X-SSS	120	150	5	5 3/4
7-SSS	135	165	5 1/4	6 1/2
7 1/2-SSS	158	190	6 1/4	7 1/2

P-CLIPS		
Material	Zinc Plated Mild Steel & EPDM Rubber	
Product Code	Adjustment Scope	
	MM	Inches
5-PC	5	13/64
6-PC	6	19/32
8-PC	8	5/16
10-PC	10	3/8
12-PC	12	1/2
13-PC	13	33/64
14-PC	14	35/64
16-PC	16	5/8
17-PC	17	43/64
19-PC	19	3/4
22-PC	22	7/8
25-PC	25	1
28-PC	28	1 7/64
35-PC	35	1 3/8

MINI CLIPS STAND



23-004

Wall mounted stand containing 100 clips

QTY: 1

MILD STEEL CLIPS STAND



23-003-MSE

Free standing/wall mounted
Contains 100 popular sizes (000-2)

QTY: 1

STAINLESS STEEL HOSE CLIPS STAND



23-003-SSS

Free standing/wall mounted
Contains 100 popular sizes (000-2)

QTY: 1

SUREFLEX CLIPS



- Flexible fuel pipe clip in stainless steel
- Supplied open for easy fitment

PART NO.	SIZE	QTY
11-SF	7mm - 11mm	10
19-SF	11mm - 19mm	10

CLIPS FLEXIDRIVE



- Supplied with 4 interchangeable heads
- Spare heads can be stored safely in the soft grip handle

23-001

QTY: 1

SIDE CLOSING O CLIP PLIERS



- Plastic coated handles

455-5000

QTY: 1

MINI HOSE CLIPS



- Ideal for petrol pipe
- Provides effective radial seal

PART NO.	RANGE	QTY
10-MC	8-10mm	10
12-MC	10-12mm	10
13-MC	11-13mm	10
14-MC	12-14mm	10
16-MC	14-16mm	10
18-MC	16-18mm	10
20-MC	18-20mm	10
21-MC	19-21mm	10
23-MCAB	Assorted Box	80

STRAIGHT HOSE CONNECTOR



- Polyamide 66
- Colours may vary

PART NO.	SIZE	QTY
455-7001	3mm	1
455-7011	4mm	1
455-7021	6mm	1
455-7031	8mm	1
455-7041	10mm	1
455-7051	12mm	1
455-7056	14mm	1
455-7061	5mm	1
455-7071	16mm	1
455-7081	20mm	1
455-7091	18mm	1

T-PIECE HOSE CONNECTOR



- Colours may vary

PART NO.	SIZE	QTY
455-7601	3mm	1
455-7611	4mm	1
455-7616	5mm	1
455-7621	6mm	1
455-7631	8mm	1
455-7641	10mm	1
455-7651	12mm	1
455-7661	14mm	1
455-7671	16mm	1
455-7676	18mm	1
455-7681	20mm	1

REDUCER HOSE CONNECTOR



- Colours may vary

PART NO.	SIZE	QTY
455-7201	5mm - 4mm	1
455-7211	6mm - 4mm	1
455-7221	6mm - 5mm	1
455-7231	8mm - 4mm	1
455-7236	8mm - 6mm	1
455-7241	10mm - 6mm	1
455-7246	10mm - 8mm	1
455-7251	12mm - 8mm	1
455-7255	14mm - 10mm	1
455-7261	16mm - 10mm	1
455-7271	16mm - 12mm	1
455-7276	16mm - 14mm	1
455-7281	18mm - 14mm	1
455-7291	20mm - 14mm	1

X-PIECE HOSE CONNECTOR



- Colours may vary

PART NO.	SIZE	QTY
455-7301	4mm	1
455-7311	5mm	1
455-7321	6mm	1
455-7331	8mm	1
455-7341	10mm	1
455-7351	12mm	1
455-7361	14mm	1
455-7371	16mm	1

ELBOW HOSE CONNECTOR



- Colours may vary

PART NO.	SIZE	QTY
455-7401	4mm	1
455-7411	5mm	1
455-7421	6mm	1
455-7431	8mm	1
455-7441	10mm	1
455-7451	12mm	1
455-7461	14mm	1
455-7471	16mm	1
455-7481	18mm	1
455-7491	20mm	1

Y-PIECE HOSE CONNECTOR



- Colours may vary

PART NO.	SIZE	QTY
455-7101	3mm	1
455-7111	4mm	1
455-7121	5mm	1
455-7131	6mm	1
455-7141	8mm	1
455-7151	10mm	1
455-7161	12mm	1
455-7171	14mm	1

STEEL HOSE CONNECTORS



PART NO.	SIZE	QTY
455-6050	3/16"	1
455-6060	1/4"	1
455-6080	5/16"	1
455-6100	3/8"	1
455-6125	1/2"	1
455-6165	5/8"	1
455-6175	3/4"	1
455-6185	1"	1
455-6195	1 1/4"	1
455-6215	1 1/2"	1
455-6225	2"	1
455-6235	2 1/2"	1
455-6245	3"	1
455-6255	4"	1
455-6265	5"	1

SINGLE JET SCREW TYPE



- Tube diameter: 4.8mm
- Fitting: Screw

456-5200

QTY: 5

SINGLE OUTLET WASHER JET



- Tube diameter: 4.8mm
- Fitting: Snap fit

456-5180

QTY: 5

TWIN OUTLET WASHER JET



- Tube diameter: 4.8mm
- Fitting: Snap fit

456-5190

QTY: 5

TWIN BALL WASHER JET



- Tube diameter: 4.8mm
- Fitting: Screw

456-5160

QTY: 5

IN-LINE WASHER CONNECTOR



456-5010

•Tube diameter: 4.8mm

QTY: 10

FOOT VALVE WITH FILTER



456-5040

•Tube diameter: 4.8mm

QTY: 10

NON-RETURN VALVE



456-5050

•Tube diameter: 4.8mm

QTY: 10

ANGLED WASHER CONNECTOR



456-5030

Type: 90 connector
Tube diameter: 4.8mm

QTY: 10

SINGLE OUTLET WASHER JET



456-5110

Tube diameter: 3mm
Fitting: Snap fit

QTY: 5

T-PIECE CONNECTOR



456-5020

•Tube diameter: 4.8mm

QTY: 10

T-PIECE REDUCER



456-5210

•Tube diameter: 4.8mm - 3mm

QTY: 10

CHROME JET



PART NO.	TYPE	TUBE DIA	QTY
456-5140	Single Jet	3mm	5
456-5170	Twin Jet	4.2mm	5

SINGLE OUTLET WASHER JET



456-5120

Tube diameter: 3mm
Fitting: Screw

QTY: 10

TWIN OUTLET WASHER JET



456-5150

Tube diameter: 3mm
Fitting: Snap fit

QTY: 5

WINDSCREEN WASHER SPARES



500-5480

QTY: 50

CLEAR PVC TUBING

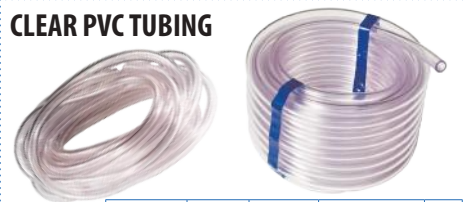

PART NO.	I.D MM	I.D INCH	ROLL LENGTH	QTY
451-3025	2.8	7/64"	30.5M (100FT)	1
451-3030	3.2	1/8"	30.5M (100FT)	1
451-3031	-	-	2.4M (7 1/2FT)	1
451-3050	4.8	3/16"	7.6M (25FT)	1
451-3051	-	-	2.4M (7 1/2FT)	1
451-3060	6.4	1/4"	7.6M (25FT)	1
451-3080	7.9	5/16"	7.6M (25FT)	1

11" STAINLESS STEEL LEFT ARM



CWA1

QTY: 1

•With 5mm fitment

11" STAINLESS STEEL RIGHT ARM



CWA2

QTY: 1

•With 5mm fitment

WIPER REFILLS

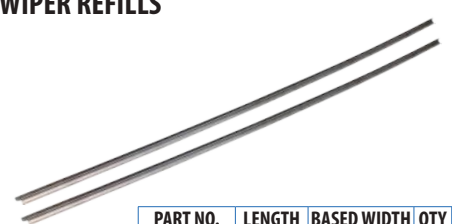

PART NO.	LENGTH	BASED WIDTH	QTY
MWR20/B6	20"	6mm	20
MWR20/B9	20"	9mm	20
MWR24/B6	24"	6mm	20
MWR24/B9	24"	9mm	20
MWR28/B6	28"	6mm	20
MWR28/B9	28"	9mm	20

10" STAINLESS STEEL BLADE



CWB1
QTY: 1

• With 5mm fitment

10" STAINLESS STEEL BLADE



CWB2
QTY: 1

• With 7mm fitment

11" STAINLESS STEEL BLADE



CWB3
QTY: 1

• With 5mm fitment

11" STAINLESS STEEL BLADE



CWB4
QTY: 1

• With 7mm fitment

12" STAINLESS STEEL BLADE



CWB5
QTY: 1

• With 5mm fitment

12" STAINLESS STEEL FLAT BLADE



CWB6
QTY: 10

• With 7mm fitment

10" STAINLESS STEEL FLAT BLADE



CWB7
QTY: 1

10" STAINLESS STEEL BLADE



CWB8
QTY: 1

• With spoon fitment

10" FLAT BLADE



CWB9
QTY: 1

WIPER MOTOR



300-0015
QTY: 1

• Combo (2001 - 2011)
• Corsa (2000 - 2006)
• Tigra (2004 - 2009)

WIPER MOTOR



300-0016
QTY: 1

• Astra (1998 - 2004)
• Vectra (1995 - 2002)

VECTRA C WIPER MOTOR



300-0018
QTY: 1

PUNTO WIPER MOTOR & LINKAGE



300-0011
QTY: 1

PUNTO WIPER MOTOR & LINKAGE



300-0012
QTY: 1

ASTRA G WIPER LINKAGE KIT



300-0017
QTY: 1

CORSA C LINKAGE



300-0020

QTY: 1

• 2000 - 2006

CORSA D LINKAGE



300-0021

QTY: 1

• 2003 onwards

VECTRA C LINKAGE

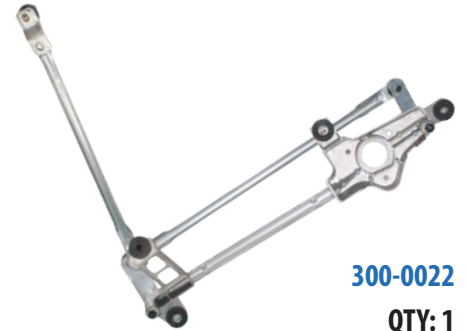

300-0022

QTY: 1

DIESEL INJECTOR PLUG



451-5395

QTY: 10

• Plastic
• Bore 3.4mm

SMALL UNIVERSAL FUEL FILTER



PART NO.	SIZE	QTY
444-0010	6/8mm	10
444-0011	6/8mm	1
444-0012	6/8mm	25

LARGE UNIVERSAL FUEL FILTER



PART NO.	SIZE	QTY
444-0020	6/8mm	10
444-0021	6/8mm	1
444-0022	6/8mm	25

DIESEL NON-RETURN VALVE



411-9021

QTY: 1

• 6mm



DIESEL NON-RETURN VALVE



411-9031

QTY: 1

• 8mm



DIESEL NON-RETURN VALVE



411-9041

QTY: 1

• 10mm



DIESEL NON-RETURN VALVE



411-9051

QTY: 1

• 12mm



DIESEL IN LINE LONG



PART NO.	QTY
444-0080	10
444-0081	1

DIESEL IN LINE SMALL



PART NO.	QTY
444-0090	10
444-0091	1

DIESEL LEAK OFF KIT



451-5231

QTY: 1 KIT

• Bore 3.4mm fabric over braided
• Now complete with 2 injector plugs

FABRIC OVER BRAIDED FUEL HOSE



PART NO.	I.D. MM	O.D. MM	ROLL LENGTH	QTY
451-5221	3.2	-	1m c/w 2 injector plugs	1
451-5230	3.4	7.5	7.6m (25FT)	1
451-5231	-	-	1m c/w 2 injector plugs	1
451-5240	3.5	-	20m	1
451-5250	5.5	-	7.6m (25FT)	1
451-5251	-	-	1m	1
451-5255	5.5	-	20m	1
451-5270	7.5	-	7.6m (25FT)	1
451-5271	-	-	1m	1
451-5275	7.5	-	20m	1

• Conforms to din73379 type b.
• Used for diesel & petrol return leak off
• Temp range -30°C to over 100°C
• Min burst pressure 40bar

RUBBER COVERED REINFORCED FUEL HOSE



- Conforms to saej30r6 & bsau108
- Suitable for standard fuel systems
- Temp range -30°C to over 100°C
- Min burst pressure 40bar

PART NO.	I.D. MM	O.D. MM	LENGTH	QTY
451-5050	4.8	11.6	7.6m (25FT)	1
451-5051	4.8	11.6	1m	1
451-5055	4.8	-	50m	1
451-5060	6.0	12.7	7.6m (25FT)	1
451-5065	6.0	-	50m	1
451-5061	6.0	12.7	1m	1
451-5080	8.0	14.7	7.6m (25FT)	1
451-5081	8.0	14.7	1m	1
451-5085	8.0	-	50m	1
451-5090	10	-	50m	1
451-5095	10	16.7	7.6m (25FT)	1
451-5096	10	16.7	1m	1
451-5110	13	-	50m	1

RUBBER COVERED FUEL INJECTION HOSE



- Conforms to saej30r6 & iso 4639/3/3
- Temp range -40°C to over 125°C
- Min burst pressure 40bar

PART NO.	I.D. MM	O.D. MM	ROLL LENGTH	QTY
451-5450	4.8	11.6	7.6m (25FT)	1
451-5451	4.8	11.6	1m	1
451-5455	4.8	-	50m	1
451-5460	6.0	12.7	7.6m (25FT)	1
451-5461	6.0	12.7	1m	1
455-5465	6.0	-	50m	1
451-5480	8.0	14.7	7.6m (25FT)	1
451-5481	8.0	14.7	1m	1
451-5485	8.0	-	50m	1
451-5490	9.5	-	50m	1
451-5495	9.5	16.7	7.6m (25FT)	1
451-5496	9.5	16.7	1m	1

HEATER HOSE



PART NO.	I.D. MM	O.D. MM	LENGTH	QTY
451-5820	9.5	16.3	10m	1
451-5821	9.5	16.3	1m	1
451-5822	9.5	16.3	20m	1
451-5825	9.5	-	50m	1
451-5840	13	19.5	10m	1
451-5841	13	19.5	1m	1
451-5842	13	19.5	20m	1
451-5845	13	-	50m	1
451-5865	16	22.8	10m	1
451-5861	16	22.8	1m	1
451-5862	16	22.8	20m	1
451-5865	16	-	50m	1
451-5890	19	26.3	10m	1
451-5881	19	26.3	1m	1
451-5885	19	-	50m	1

RADIATOR HOSE



PART NO.	I.D. MM	I.D. INCH	O.D. MM	BURST PRESSURE	QTY
451-5610	13	1/2"	21	60BAR	1
451-5620	16	5/8"	24	40BAR	1
451-5630	19	3/4"	27	35BAR	1
451-5640	22	7/8"	30	35BAR	1
451-5650	25	1"	33	30BAR	1
451-5660	28	1 1/8"	36	30BAR	1
451-5670	32	1 1/4"	40	25BAR	1
451-5680	35	1 3/8"	43	25BAR	1
451-5690	38	1 1/2"	46	20BAR	1
451-5700	42	1 5/8"	50	20BAR	1

PART NO.	I.D. MM	I.D. INCH	O.D. MM	BURST PRESSURE	QTY
451-5710	45	1 3/4"	53	19BAR	1
451-5720	48	1 7/8"	56	18BAR	1
451-5730	51	2"	63	17BAR	1
451-5757	57	-	-	-	1
451-5760	60	-	-	-	1
451-5763	63	-	-	30BAR	1
451-5770	70	-	-	-	1
451-5776	76	-	-	-	1
451-5780	80	-	-	-	1
451-5789	89	-	-	-	1
451-5802	102	-	-	-	1

ELBOW RADIATOR HOSE



PART NO.	I.D. MM	I.D. INCH	QTY
451-5910	9.5	3/8"	1
451-5915	13	1/2"	1
451-5920	16	5/8"	1
451-5925	19	3/4"	1
451-5930	22	7/8"	1
451-5935	25	1"	1
451-5940	28	1 1/8"	1
451-5945	32	1 1/4"	1
451-5950	35	1 3/8"	1
451-5955	38	1 1/2"	1
451-5960	51	-	1
451-5965	60	-	1

UNIVERSAL THERMOSTAT GASKET



MTG1
QTY: 25

CORSA C WATER PUMP PIPE



- Vauxhall Corsa C/Meriva water pump connector pipe is used for replacing black plastic connector which is a common part for snapping

455-7800
QTY: 1

CORSA C WATER PUMP PIPE



- Vauxhall Corsa C/Meriva water pump connector pipe is used for replacing black plastic connector which is a common part for snapping

455-7810
QTY: 1

FLEXIBLE WATER HOSE



PART NO.	I.D. MM	LENGTH	QTY
450-0241	22	1m	1
450-0251	25	1m	1
450-0281	28	1m	1
450-0321	32	1m	1
450-0351	35	1m	1
450-0381	38	1m	1
450-0261	45	1m	1
450-0341	51	1m	1
450-0361	63	1m	1
450-0371	75	1m	1
450-0391	102	1m	1

BY-PASS HOSE



- For rover A series engine
- Supplied with 2 clips
- Display card of 12

PART NO.	QTY
451-5995	1
CS0/12C	1

CLEAR BRAIDED NYLON TUBING



PART NO.	I.D. MM	1.D. INCH	BURST PRESSURE	ROLL LENGTH	QTY
451-3150	4.8	3/16"	63BAR	7.6M (25FT)	1
451-3160	6.4	1/4"	57BAR	7.6M (25FT)	1
451-3161	-	-	-	1M (3FT)	1
451-3180	7.9	5/16"	50BAR	7.6M (25FT)	1
451-3181	-	-	-	1M (3FT)	1
451-3195	9.5	3/8"	45BAR	7.6M (25FT)	1

SEMI RIGID NYLON TUBING



PART NO.	I.D. MM	O.D. MM	O.D. INCH	ROLL LENGTH	QTY
451-1040	2.7	4.5	3/16"	7.6M (25FT)	1
451-1060	4.0	6.4	1/4"	7.6M (25FT)	1
451-1080	5.2	8.0	5/16"	7.6M (25FT)	1

ADVANCED/RETARD RUBBERS



PART NO.	DESCRIPTION	QTY
451-0150	Straight	50
451-0160	Angled	50
451-0170	Mixed	50

ADVANCED/RETARD TUBING



PART NO.	I.D. MM	ROLL LENGTH	QTY
451-0030	3.0	15M	1
451-0035	3.2	30.5M (30FT)	1
451-0040	4.0	15M	1

ADVANCED/RETARD ASSEMBLIES



PART NO.	DESCRIPTION	QTY
451-0110	-	1 Kit
451-0120	2x Angled Ends	1 Kit

DUCT HOSE

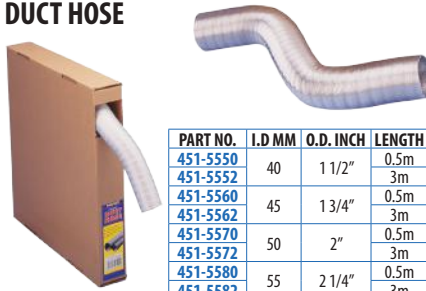

PART NO.	I.D. MM	O.D. INCH	LENGTH	QTY
451-5550	40	1 1/2"	0.5m	1
451-5552	40	1 1/2"	3m	1
451-5560	45	1 3/4"	0.5m	1
451-5562	45	1 3/4"	3m	1
451-5570	50	2"	0.5m	1
451-5572	50	2"	3m	1
451-5580	55	2 1/4"	0.5m	1
451-5582	55	2 1/4"	3m	1
451-5590	60	2 3/8"	0.5m	1
451-5592	60	2 3/8"	3m	1
451-5540	70	2 3/4"	0.5m	1
451-5530	75	3"	0.5m	1

• Polyester coated 2-ply aluminium
• Withstand temperatures up to 300°C

BRAKE SERVO/AIR BRAKE HOSE



PART NO.	I.D. MM	O.D. MM	LENGTH	QTY
451-6010	9.5	17.5	5m	1
451-6011	9.5	17.5	1m	1
451-6012	-	-	20m	1

• Conforms to SAEJ1402
• Min burst pressure 60bar
• Vacuum tested 80%

AIR LINE HOSE



PART NO.	BORE	LENGTH	QTY
451-6140	6mm	20m	1
451-6145	6mm	50m	1
451-6150	8mm	20m	1
451-6155	8mm	50m	1

Hi-Viz Air Line Hose

451-6160	6mm	30m	1
451-6170	8mm	30m	1
451-6180	10mm	30m	1
451-6190	13mm	30m	1

• Suitable for workshop airlines & pneumatic equipment
• Min burst pressure 20bar

EMERGENCY FUEL TRANSFER KIT



300-0006

QTY: 1

• 1 hand operated pump with built in non-return valve
• Complete with 2 x 2.5m lengths of tubing

RE-COIL AIRLINE HOSE



451-0050

QTY: 1

• 6.5mm I.D.
• 7.5m long hose complete with male ends

22 GAUGE COPPER TUBING



470-T200

QTY: 1 ROLL

• Seamless. 7.62m (25ft) roll
• Electronically & pressure tested
• Ink jet marked with material, size & batch
• 4.75 O.D.

22 GAUGE COPPER TUBING



PART NO.	O.D. MM	O.D. INCH	QTY
470-T100	4.75	3/16"	1
470-T115	6.35	1/4"	1
470-T120	8.00	5/16"	1

• Seamless. 7.62m (25ft) roll
• Electronically & pressure tested
• Ink jet marked with material, size & batch

22 GAUGE COPPER NICKEL TUBING



PART NO.	O.D. MM	O.D. INCH	QTY
470-T500	4.75	3/16"	1
470-T510	6.00	-	1
470-T515	6.35	1/4"	1
470-T520	8.00	5/16"	1
470-T530	9.52	3/8"	1
470-T535	10.00	-	1

• Seamless. 7.62m (25ft) roll
• Electronically & pressure tested
• Ink jet marked with material, size & batch

BRAKE PIPE FLARING TOOL



800700

QTY: 1

• 2 piece suitable for O.D. brake piping 3/16" & 4.75mm

BRAKE PIPE FLARING TOOL



800701

QTY: 1

• 5 piece suitable for O.D. brake piping 3/16", 1/4", 5/16", 3/8", 1/2"

BRAKE PIPE FLARING TOOL TURRET



NEW!

800750

QTY: 1

BRAKE PIPE FLARING HAND TOOL



800770

QTY: 1

NEW!

PUNCH 3/16" - 4.75MM

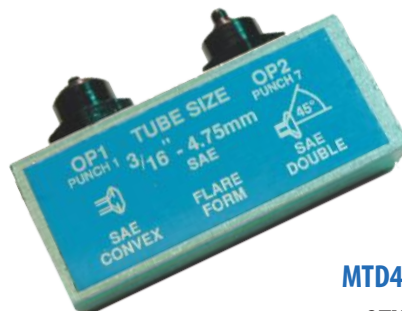

MTD416

QTY: 1

PUNCH 4.75MM WITH BLOCK

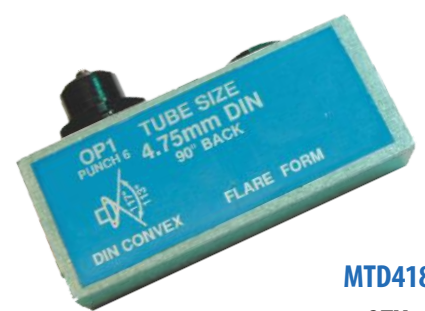

MTD418

QTY: 1

PUNCH 1/4"



MTD406
QTY: 1

PUNCH 5/16"



MTD407
QTY: 1

PUNCH 3/8"

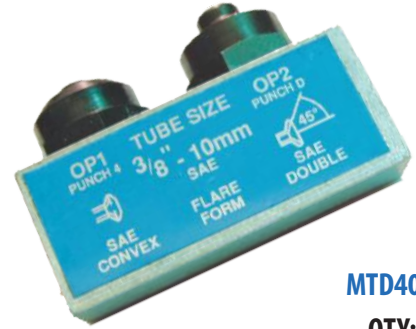

MTD408
QTY: 1

REPLACEMENT PARTS



PART NO.	TUBE SIZE	QTY
MTD410	1/4"	1
MTD411	5/16"	1
MTD412	3/8"	1
MTD415	3/16"	1

BRAKE PIPE BENDING TOOL



400098
QTY: 1

- Bends without kinking
- Comes with 2 roller adaptors
- Suitable for O.D. piping 3/16", 5/16", 1/2" & 5/8"

BRAKE TUBE CUTTER



400088
QTY: 1

- Ideal for use in compact areas
- Suitable for O.D. braking from 3mm (1/8") to 16mm (5/8")

BRAKE/FUEL PIPE SPANNER



104365A
QTY: 1

- 10 & 11mm

FOR 3/16" TUBING



471-0010
QTY: 25

- Type: Male
Diameter: 3/8" UNF
Pitch: 24tpi
Volvo applications

FOR 3/16" TUBING



471-0020
QTY: 25

- Type: Male
Diameter: 3/8" UNF
Pitch: 24tpi
Fully threaded

FOR 3/16" TUBING



471-0030
QTY: 25

- Type: Male
Diameter: 3/8" UNF
Pitch: 24tpi
Mini/Escort applications

FOR 3/16" TUBING



471-0040
QTY: 25

- Type: Male
Diameter: 3/8" BSF
Pitch: 20tpi

FOR 3/16" TUBING



PART NO.	QTY
471-0110	25
471-0112	100
471-0113	500
471-0114	1000

- Type: Male
Diameter: M10
Pitch: 1mm
Short

FOR 3/16" TUBING



471-0120
QTY: 25

- Type: Male
Diameter: M10
Pitch: 1mm
Long

FOR 3/16" TUBING



471-0140
QTY: 25

- Type: Male
Diameter: M10
Pitch: 1mm
Short, fully threaded

FOR 3/16" TUBING



471-0150
QTY: 25

- Type: Male
Diameter: M10
Pitch: 1mm
Long, fully threaded

FOR 3/16" TUBING



Type: Male
Diameter: M10
Pitch: 1.25mm
Long

471-0220
QTY: 25

FOR 3/16" TUBING



Type: Male
Diameter: M12
Pitch: 1mm

PART NO.	QTY
471-0310	25
471-0312	100
471-0313	500

FOR 3/16" TUBING



Type: Female
Diameter: 3/8" UNF
Pitch: 24tpi

471-0410
QTY: 25

FOR 3/16" TUBING

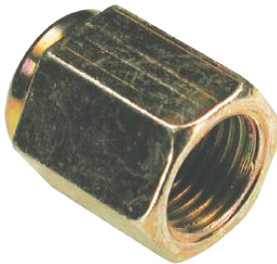

Type: Female
Diameter: M10
Pitch: 1mm

PART NO.	QTY
471-0510	25
471-0511	100
471-0512	500
471-0513	1000

FOR 3/16" TUBING



Type: Male connector
Diameter: 3/8" UNF
Pitch: 24tpi
Male 2 way

471-0610
QTY: 10

FOR 3/16" TUBING



Type: Female connector
Diameter: 3/8" UNF
Pitch: 24tpi
Female 2 way

471-0620
QTY: 10

FOR 3/16" TUBING



Type: 3 way connector
Diameter: 3/8" UNF
Pitch: 24tpi
3 way

471-0631
QTY: 1

FOR 3/16" TUBING



Type: 4 way connector
Diameter: 3/8" UNF
Pitch: 24tpi
4 way

471-0641
QTY: 1

FOR 3/16" TUBING



Type: Male connector
Diameter: M10
Pitch: 1mm
Male 2 way

471-0710
QTY: 10

FOR 3/16" TUBING



Type: Female connector
Diameter: M10
Pitch: 1mm
Female 2 way

471-0720
QTY: 10

FOR 3/16" TUBING



Type: 3 way connector
Diameter: M10
Pitch: 1mm
3 way

PART NO.	QTY
471-0731	1
471-0732	25

FOR 3/16" TUBING



Type: 3 way connector
Diameter: M10
Pitch: 1mm
3 way

471-0733
QTY: 100

FOR 3/16" TUBING



Type: 4 way connector
Diameter: M10
Pitch: 1mm
4 way

471-0741
QTY: 1

FOR 3/16" TUBING



Type: Female
Diameter: M12
Pitch: 1mm

471-0810
QTY: 25

FOR 1/4" TUBING



Type: Male
Diameter: 7/16" UNF
Pitch: 20tpi

471-1010
QTY: 25

FOR 1/4" TUBING



Type: Male
Diameter: M12
Pitch: 1mm

471-1110
QTY: 25

FOR 1/4" TUBING



Type: Female
Diameter: 7/16" UNF
Pitch: 20tpi

471-1410
QTY: 25

FOR 1/4" TUBING



Type: Female
Diameter: M12
Pitch: 1mm

471-1120
QTY: 25

METRIC BRAKE BLEED SCREWS



PART NO.	TYPE	PITCH	LENGTH	QTY
472-6210	M6	1mm	26	25
472-6240	M6	1mm	38	25
472-6310	M7	1mm	21.7	25
472-6320	M7	1mm	28.7	25
472-6330	M7	1mm	30.5	25
472-6350	M7	1mm	38.3	25
472-6420	M8	1.25mm	26.5	25
472-6430	M8	1mm	33.5	25
472-6450	M8	1.25mm	41.5	25
472-6530	M10	1mm	30	25
472-6540	M10	1mm	34	25
472-6550	M10	1mm	36.5	25

IMPERIAL BRAKE BLEED SCREWS



PART NO.	TYPE UNF	PITCH	LENGTH	QTY
472-6010	1/4	28TPI	28	25
472-6020	3/8	24TPI	31	25
472-6030	3/8	24TPI	36.6	25

AUTOMATIC BRAKE BLEED REPLACEMENT NIPPLE



NEW!



• Replacement brake bleed nipple for the popular automatic systems that are currently used in garages

104050A
QTY: 1

DUST CAP FOR BLEED SCREWS



• For brake bleed screw

472-0500
QTY: 25

POZIDRIVE BRAKE DRUM SCREW



• Countersunk
• M6 x 10mm

473-1010
QTY: 25

POZIDRIVE BRAKE DRUM SCREW



• Cheese Head
• M6 x 10mm

473-1020
QTY: 25

POZIDRIVE BRAKE DRUM SCREW



• Countersunk
• M6 x 14mm

473-1030
QTY: 25

GUIDE PIN BOLT



• Sierra
• Granade (girling)

473-2010
QTY: 10

BRAKE PAD CLIP



• 3/16"
• A-clip

474-3060
QTY: 25

BRAKE PAD CLIP



• 3/16"
• M6 x 10m

PART NO.	QTY
474-3040	25
474-3042	100

BRAKE SHOE LOCK WASHER



• M8 internal

474-7010
QTY: 10

BRAKE SHOE LOCK WASHER



474-7040
QTY: 10

FIESTA HOLD DOWN SPRING



474-9010
QTY: 5

T-PIECE



474-9100
QTY: 25

HONEYCOMB SPRING



474-9130
QTY: 25

• Renault, Citroen, Peugeot, Bendix

HOLD DOWN WASHER



474-9140
QTY: 25

• Lock head systems

HOLD DOWN WASHER



474-9150
QTY: 25

• Girling systems

HOLD DOWN SPRING



474-9170
QTY: 25

• Rover

HOLD DOWN SPRING



474-9230
QTY: 10

• Cavalier

HOLD DOWN SPRING



474-9190
QTY: 25

• Ford

BRAKE SHOE SPRING



474-9200
QTY: 25

• Vauxhall/Opel

BRAKE SHOE PIN



474-9110
QTY: 25

• Ford
• 40mm

BRAKE SHOE PIN



474-9160
QTY: 25

• Escort, Fiesta
• 35mm length

BRAKE SHOE PIN



474-9250
QTY: 10

• Fiat
• 29mm length

HOLD DOWN CLIP



474-9260
QTY: 5

• Fiat

HOLD DOWN WASHER



474-9280
QTY: 16

• Sierra, Granada

HOLD DOWN SPRING



474-9290
QTY: 10

• Alfa Romeo, Fiat
• 33mm length

HOLD DOWN PIN



- Audi, VW
- 28mm length

474-9310
QTY: 10

RED RUBBER BRAKE GREASE



PART NO.	SIZE	QTY
570-2101	5ml Sachets	10
570-2002	400G Tub	6
570-2002/1	400G Tub	1

COPPER GREASE



PART NO.	SIZE	QTY
570-2001	5ml Sachets	10
570-2000	400G tub	6

STRAIGHT GREASE NIPPLES



PART NO.	PITCH	QTY
457-0210	6mm/1mm	25
457-0220	8mm/1mm	25

- Metric

STRAIGHT GREASE NIPPLES



PART NO.	PITCH	QTY
457-0010	1/4" UNF	25
457-0030	1/8" GAS/BSP	25

- Imperial

STRAIGHT GREASE NIPPLES



457-0070
QTY: 25

- Imperial
- 1/4" UNF
- Long

ANGLED GREASE NIPPLES



457-0310
QTY: 25

- Metric
- 45°

HEAD TAP GREASE NIPPLES



457-0080
QTY: 25

- Imperial
- 1/8" GAS/BSP
- Hexagon

ANGLED GREASE NIPPLES



PART NO.	PITCH	QTY
457-0110	1/4" UNF	25
457-0130	1/8" GAS/BSP	25

- Imperial
- 45°

SOLDERLESS NIPPLES



467-1310
QTY: 10

- Type: Brass
- Thread: 1/4 UNF
- Length: 3/8"

SOLDERLESS NIPPLES



467-1330
QTY: 10

- Type: Steel - Heavy duty
- Thread: 11/32"
- Length: 1/2"

SOLDERLESS NIPPLES



467-1340
QTY: 10

- Type: Slide entry screw
- Thread: 9/32"
- Length: 1/2"

BOWDEN CABLE



PART NO.	SIZE	QTY
467-0010	1.5mm (0.060")	1
467-0020	1.9mm (0.075")	1

- 30.5m (100ft) roll

UNIVERSAL CABLE



467-0120
QTY: 1

- Type: Bonnet release
- Length: 1.52m (5ft)

UNIVERSAL CABLE



467-0130
QTY: 1

- Type: Choke non locking
- Length: 1.52m (5ft)

UNIVERSAL CABLE



467-0140

Type: Choke - locking
Length: 1.52m (5ft)

QTY: 1

CORE PLUGS



PART NO.	MM	QTY
Cup Type		
B787	12.5	10
B10	18	10
B11	20	10
B792	22	10
B821	28	10
B822	30	10
B807	34	10
B823	35	10
B808	36	10
B12	40	10
B824	44	10

PART NO.	MM	QTY
B13	45	10
B770	48	10
B825	50	10
B788	9/16	10
B789	5/8	10
B791	3/4	10
B683	7/8	10
B688	15/16	10
B349	1 1/8	10
B347	1 1/4	10
B684	1 3/8	10
B336	1 5/16	10

PART NO.	INCH	QTY
B337	1 1/2	10
B338	1 5/8	10
B790	1 3/4	10
B793	1 15/16	10
B685	1 61/64	10
B686	2	10
B794	2.01	10
B815	2 3/16	10
Dish Type		
B82	1 5/8	10
B771	1 3/4	10
B772	2 1/8	10

UNIVERSAL CABLE



467-0190

Type: Pull to stop
Length: 2.75m (9ft)

QTY: 1

NON-ASBESTOS JOINTING GASKET



PART NO.	SIZE	QTY
469-5120	0.8mm (1/32")	1
469-5150	1.6mm (1/16")	1

• 38cm x 102cm

OIL PAPER JOINTING GASKET



PART NO.	SIZE	QTY
33cm x 33cm Sheet		
469-5210	0.4mm (1/64")	25
469-5220	0.8mm (1/32")	25
60cm x 100cm Sheet		
469-5212	0.4mm (1/64")	1
469-5222	0.8mm (1/32")	1
100cm x 300cm Sheet		
469-5214	0.4mm (1/64")	1
469-5224	0.8mm (1/32")	1

• Up to 120°C

CORK JOINTING GASKET



PART NO.	SIZE	QTY
469-5050	1.6mm (1/16")	1
469-5070	3.2mm (1/8")	1

• 61cm x 91cm

GRAPHITE GASKET SHEET

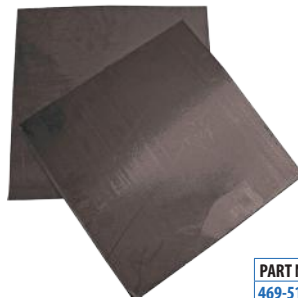

PART NO.	SIZE	QTY
469-5130	1.5mm	2
469-5140	3.0mm	2

• 30cm x 30cm

GEAR LINKAGE

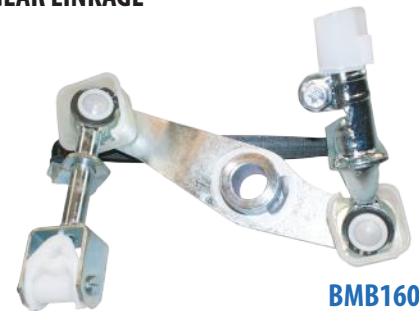

BMB1604

QTY: 1

• Corsa C (up to 2006)

GEAR LINKAGE

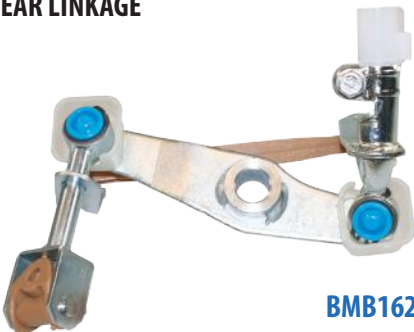

BMB1624

QTY: 1

• Corsa D (2006 onward)

M8 EXHAUST CLAMPS



PART NO.	MM	INCH	QTY	PART NO.	QTY
481-0280	28	1 1/8	10	481-0282	50
481-0320	32	1 1/4	10	481-0322	50
481-0360	36	1 3/8	10	481-0362	50
481-0380	38	1 1/2	10	481-0382	50
481-0420	42	1 9/16	10	481-0422	50
481-0450	45	1 3/4	10	481-0452	50
481-0480	48	1 7/8	10	481-0482	50
481-0500	50	2	10	481-0502	50
481-0520	52	-	10	481-0522	50
481-0540	54	2 1/8	10	481-0542	50
481-0580	58	2 1/4	10	481-0582	50
481-0600	60	2 3/8	10	481-0602	50
481-0650	65	2 1/2	10	481-0652	50
481-0670	67	2 5/8	10	481-0672	50
481-0700	70	2 3/4	10	481-0702	50
481-0750	75	3	10	481-0752	50
481-0800	80	3 1/8	10	481-0802	50
481-0920	92	3 5/8	10	481-0922	50

MANIFOLD CLAMP

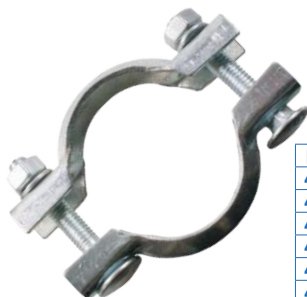

PART NO.	MM	QTY
481-7530	53	5
481-7531		1
481-7660	66	5
481-7661		1
481-7662	25	
481-7690	69	5
481-7691		1
481-7692		25

• Citroen, Fiat, Peugeot & Renault

COPPER LOCKING WIRE



PART NO.	DESCRIPTION	QTY
467-0060	16SWG. 500G	1
467-0070	18SWG. 500G	1
467-0080	20SWG. 500G	1

MINI EXHAUST MOUNTING



B520

QTY: 1

UNIVERSAL EXHAUST PIPE REAR HANGER



485-3001
QTY: 1

CV BOOT KITS DURABOOT RANGE



BAILCAST
Made in Britain

• Starter kit
• Contains 8 duraboot CV kits plus cone & spray in display box

DBCST1
QTY: 1

STRETCHY CV BOOTS



BAILCAST
Made in Britain

PART NO.	QTY
DBC100	1
DBC200	1
DBC300	1
DBC400	1
DBC500	1
DBC600	1
DBC700	1
DBC800	1

Duraboot

• Each kit contains 1 boot, 2 stainless steel ties, grease sachet & instructions

STEERING RACK BOOT KIT

BAILCAST
Made in Britain

NEW!



DBSR100
QTY: 1 PAIR

Duraboot

STEERING RACK BOOT KIT

BAILCAST
Made in Britain

NEW!



DBSR200
QTY: 1 PAIR

Duraboot

STEERING RACK BOOT KIT

BAILCAST
Made in Britain

NEW!



DBSR300
QTY: 1 PAIR

Duraboot

STEERING RACK BOOT KIT

BAILCAST
Made in Britain

NEW!



DBSR400
QTY: 1 PAIR

Duraboot

STEERING RACK BOOT KIT

BAILCAST
Made in Britain

NEW!



DBSR500
QTY: 1 PAIR

Duraboot

STEERING RACK BOOT KIT

BAILCAST
Made in Britain

NEW!



DBSR600
QTY: 1 PAIR

Duraboot

POWER STEERING BOOT KIT

BAILCAST
Made in Britain

NEW!



DBSRPS100
QTY: 1 PAIR

Duraboot

POWER STEERING BOOT KIT

BAILCAST
Made in Britain

NEW!



DBSRPS200
QTY: 1 PAIR

Duraboot

POWER STEERING BOOT KIT

BAILCAST
Made in Britain

NEW!



DBSRPS300
QTY: 1 PAIR

Duraboot

MAXIBOOT CV BOOT KIT

BAILCAST
Made in Britain



CV88
QTY: 1

Duraboot

UNIBOOT CV BOOT KIT

BAILCAST
Made in Britain



CV96
QTY: 1

Duraboot

UNIVERSAL SPLIT CV BOOT

BAILCAST
Made in Britain



CVS18
QTY: 1

Duraboot

• Kit contains 1 boot, 2 stainless steel ties, knife, glue, gloves & grease sachet

NON-POWER STEERING RACK BOOT



- Universal
- Contains 2 boots, 4 cable ties & a fitting cone

C93C
QTY: 1

NON-POWER STEERING RACK BOOT



UBK1
QTY: 1

POWER STEERING RACK BOOT



- Universal
- Contains 2 boots

UBK2
QTY: 1

UNIVERSAL TRIM TO FIT CV BOOT



- Contains 1 boot, 2 cable ties, grease sachet & fitting cone

UCVB2
QTY: 1

DURABOOT PNEUMATIC FITTING TOOL



- For stretching boots over CV joints without dismantling joint
- One model that covers all vehicle models
- Working pressure 4 to 8 bar
- Standard air line fitting
- For joints up to 115mm

DURAGUN2
QTY: 1

DRILL TYPE CV BOOT FITTING TOOL



- For stretching universal CV boots onto drive shaft assemblies
- Designed for two handed operation
- One model that covers all vehicle models
- Simply attach Duralec to drill, mount approved boot type, hold firmly & operate the drill

DURALEC
QTY: 1

FITTING CONE



- Plastic
- Use for stretchy boots

C180
QTY: 1

EAR CLAMP FOR CV BOOTS



- Stainless steel

PART NO.	SIZE	QTY
511-8530	19-40mm	10
511-8532	19-40mm	100
511-8550	50-110mm	10
511-8552	50-110mm	100

CV BOOT CLIPS

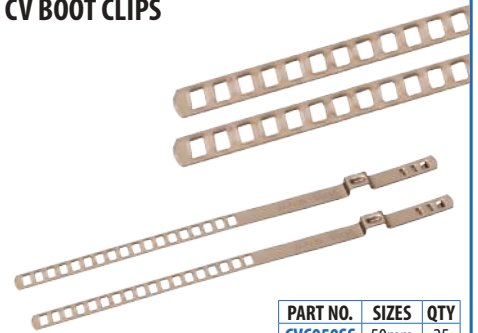

PART NO.	SIZES	QTY
CVC050SS	50mm	25
CVC110SS	110mm	25

CV BOOT CABLE TIES

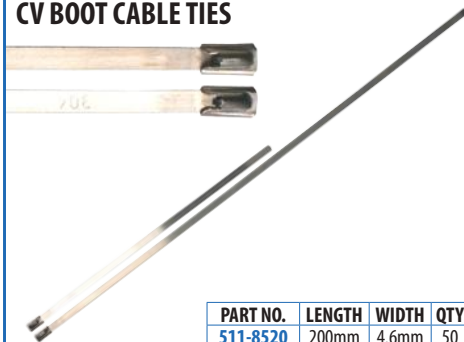

- Stainless steel

PART NO.	LENGTH	WIDTH	QTY
511-8520	200mm	4.6mm	50
511-8540	360mm	4.6mm	50

CV BOOT CABLE TIES

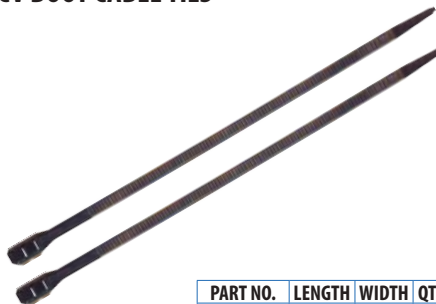

PART NO.	LENGTH	WIDTH	QTY
511-5406	360mm	9mm	50
511-5407	360mm	9mm	100

TRACK ROD END BOOTS



- Each pack contains 1 boot

PART NO.	BIG HOLE	SMALL HOLE	HEIGHT
QC901	25mm	11mm	22.5mm
QC902	30mm	12.5mm	27mm
QC903	35mm	12.5mm	30mm
QC904	30mm	16mm	26.5mm
QC905	25mm	10mm	24mm
QC906	29mm	11mm	26mm
QC908	36.5mm	12mm	30mm
QC909	28mm	18mm	14mm
QC910	40.5mm	18mm	37mm
QC911	Heavy Duty Commercial T.R.E Boot		
QC912	Heavy Duty Commercial T.R.E Boot		
QC913	Heavy Duty Commercial T.R.E Boot		
QC914	Heavy Duty Commercial T.R.E Boot		

TRACK ROD END BOOTS



- Each pack contains 6 boots

PART NO.	BIG HOLE	SMALL HOLE	HEIGHT
BOOT1	25mm	11mm	22.5mm
BOOT2	30mm	12.5mm	27mm
BOOT3	35mm	12.5mm	30mm
BOOT4	30mm	16mm	26.5mm
BOOT5	25mm	10mm	24mm
BOOT6	29mm	11mm	26mm
BOOT8	36.5mm	12mm	30mm
BOOT9	28mm	18mm	14mm
BOOT10	40.5mm	18mm	37mm

BALL JOINT & TRACK ROD END BOOTS



300-0014
QTY: 20

3/16" PIPE SINGLE CLIP



563-9500
QTY: 10

3/16" PIPE TWIN CLIP



563-9510
QTY: 10

3/16" PIPE TRIPLE CLIP



563-9520
QTY: 10

BRAKE HOSE CLIP



563-9540
QTY: 10

WIPER REPAIR CLIP



- Stops the worn wiper linkage ball socket from popping off
- It will fit most vehicles with ball joints up to 14mm in diameter due to its spring construction
- It has been tried and tested on Fiat, Ford (excl Focus or Galaxy), Kia, Rover/MG, Land Rover, Nissan (excl white coloured joints for Micra), Renault (excl Scenic), Seat (excl Alhambra), Smart Car, Vauxhall (excl white joints) & VW (excl Sharan).

QC546
QTY: 1

UNIVERSAL STRAP



• 290mm x 29mm

485-3002
QTY: 1

DIESEL HAND PUMP



• With straight ends

411-0060
QTY: 1

DIESEL HAND PUMP



• With straight & angled ends

411-0085
QTY: 1

DIESEL HAND PUMP



• With angled ends

411-0090
QTY: 1



MRC102
QTY: 1



MRC103
QTY: 1



MRC104
QTY: 1



MRC105
QTY: 1



MRC106
QTY: 1



MRC110
QTY: 1



MRC111
QTY: 1



MRC112
QTY: 1



MRC114
QTY: 1



MRC116
QTY: 1



MRC120
QTY: 1



MRC121
QTY: 1



MRC122
QTY: 1



MRC125
QTY: 1



MRC126
QTY: 1



MRC127
QTY: 1



MRC128
QTY: 1



MRC133
QTY: 1



MRC138
QTY: 1



MRC139
QTY: 1



MRC140
QTY: 1



MRC142
QTY: 1



MRC150
QTY: 1



MRC151
QTY: 1



MRC153
QTY: 1



MRC156
QTY: 1



MRC159
QTY: 1



MRC165
QTY: 1



MRC166
QTY: 1



MRC174
QTY: 1



MRC176
QTY: 1



MRC177
QTY: 1



MRC178
QTY: 1



MRC180
QTY: 1



MRC181
QTY: 1

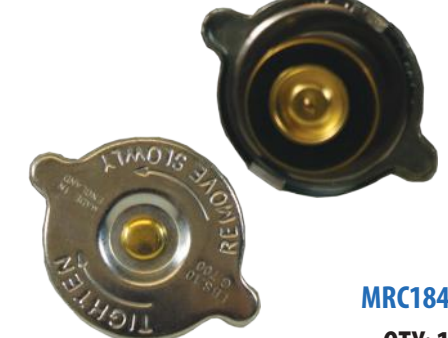

MRC184
QTY: 1



MRC187
QTY: 1



MRC189
QTY: 1



MRC190
QTY: 1



MRC191
QTY: 1



MRC193
QTY: 1



MRC194
QTY: 1



MRC195
QTY: 1



MRC196
QTY: 1



MRC201
QTY: 1



MRC202
QTY: 1



MRC205
QTY: 1

TAX DISC HOLDERS



L2P

- Temper-proof
- Pack of 50

QTY: 1 PACK

TRANSPARENT TAX DISC HOLDERS



PART NO.	DESCRIPTION	QTY
L1C	Card Of 24	1
L1P	Pack of 30	1

LEARNER PLATES

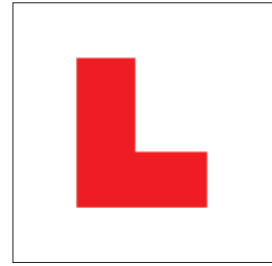

PART NO.	DESCRIPTION	QTY
EQ28	Window Cling 10 Pairs	1
EQ29	Magnetic 10 Pairs	1

HEAVY DUTY CAR MAT



- Cut to fit
- All rubber/TPR construction
- Retail packed
- 4 piece set

PART NO.	COLOUR	QTY
593-2100	Black	1
593-2150	Grey	1

HEAVY DUTY CAR MAT



- Cut to fit
- Part carpet/part rubber
- Retail packed
- 4 piece set

PART NO.	COLOUR	QTY
593-2300	Black	1
593-2350	Grey	1

EXTRA WIDE CAR MAT



- Suitable for 4x4 & SUV's
- Cut to fit
- All rubber/TPR construction
- Retail packed
- 4 piece set

593-2400

QTY: 1

BLACK CARPET CAR MAT



593-2500

QTY: 1

GREY CARPET CAR MAT



593-2501

QTY: 1

CAR MAT STAND



STAND9

QTY: 1

- Contains 7 different types of mats
- 20 sets in total

MHP STAND

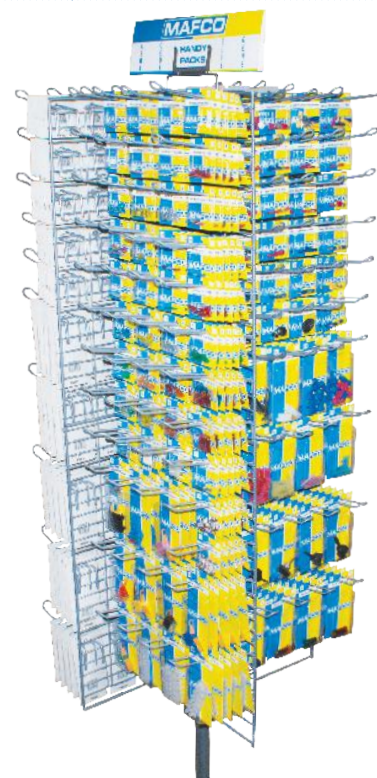

- 165 part numbers on the stand
- 5 of each part number on the stand
- Refills sold in singles
- Top ups always available from stock
- Six monthly stock reviews on this product range
- All items are bar coded
- Cross references available
- Competitively priced
- Many new items will be added to this range over the coming months

MHPSTAND

QTY: 1

DIY ASSORTED WOOD SCREW SET



- 55pc 3 x 12, 30pc 3 x 16, 15pc 3 x 20, 12pc 3 x 25
- 12pc 4 x 16, 10pc 4 x 20, 8pc 4 x 25, 7pc 5 x 20
- Housed in plastic storage case

ARP003
QTY: 149

DIY ASSORTED NUT & BOLT SET



- 30pc M3, 10pc 3 x 20, 23pc M4, 15pc 4 x 8, 10pc M5, 6pc 5 x 6, 10pc M6, 6pc 6 x 12, 30pc 3 x 12, 11pc x 20, 4pc 5 x 20, 5pc 6 x 20
- Housed in plastic storage case

ARP004
QTY: 150

DIY ASSORTED WASHERS



- Assorted types & sizes of metal washers
- Star, circle & c type & circle star
- Housed in plastic storage case

ARP007
QTY: 720

DIY HEAT SHRINK WIRE WRAP



- Sizes: 30pc 2 x 40mm, 25pc 2.5 x 40mm, 20pc 3.5 x 40mm, 20pc 5 x 40mm, 16pc 7 x 80mm, 8pc 10 x 80mm, 8pc 13 x 85mm
- Supplied in storage case

ARP008
QTY: 127

DIY SPRING ASSORTMENT



ARP009
QTY: 150

DIY ASSORTED LOCK NUTS



- Ideal for high vibration applications
- Nylon inserts
- Sizes: M4, M5, M6, M8, M10 & M12
- Plastic storage case

ARP010
QTY: 100

DIY NUTS & BOLTS ASSORTMENT



- Set contains 20 of the most popular sizes
- Plastic storage case

ARP011
QTY: 240

DIY 'O' RINGS ASSORTMENT



- Set contains 18 of the most popular sizes
- Plastic storage case

ARP012
QTY: 225

DIY COTTER PIN ASSORTMENT



- Set contains 6 of the most popular sizes
- Plastic storage case

ARP013
QTY: 500

DIY NAIL ASSORTMENT



- Set contains 9 of the most popular sizes
- Plastic storage case

ARP014
QTY: 550

DIY ROLL PIN ASSORTMENT



- A comprehensive assortment of the most popular sizes
- Plastic storage case

ARP015
QTY: 120

DIY ASSORTED ROUND CLIP SET



- A comprehensive assortment of clips
- Plastic storage case

ARP018
QTY: 390

DIY E-CLIP ASSORTMENT

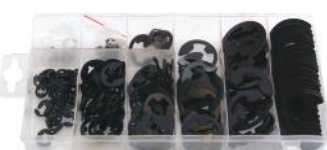

- A comprehensive assortment of e-clips
- Sizes 1.6 - 22mm
- Plastic storage case

ARP019
QTY: 300

DIY HOSE CLAMP ASSORTMENT



- Includes sizes 16, 22, 25, 28, 35 & 40mm
- Housed in plastic storage case

ARP020
QTY: 26

DIY ASSORTED SELF TAPPING SCREWS



- A comprehensive set of self tapping screws
- Housed in plastic storage case

ARP021
QTY: 120

ASSORTED DOME NUTS



- A comprehensive set of dome nuts
- Housed in plastic storage case

ARP022
QTY: 150

NO PLATE CAP BLACK



MHP294

• Small blister

QTY: 2

NO PLATE SCREW & NUT YELLOW 7/8



MHP1089

• Small blister

QTY: 2

NO PLATE SCREW & NUT WHITE 7/8



MHP1090

• Small blister

QTY: 2

NO PLATE SCREW & NUT BLACK 7/8



MHP1091

• Small blister

QTY: 2

NO PLATE SCREW & NUT YELL/WHITE



MHP1093

• Small blister

QTY: 4

NO PLATE SCREWS/CAPS YELLOW



MHP1094

• Small blister

QTY: 2

NO PLATE SCREWS/CAPS WHITE



MHP1095

• Small blister

QTY: 2

NO PLATE SCREWS WHITE & YELLOW



MHP1096

• Small blister

QTY: 2

NO PLATE SECURE SCREW WHITE



MHP1100

• Small blister

QTY: 2

NO PLATE SECURE SCREW BLACK



MHP1099

• Small blister

QTY: 2

NO PLATE SECURE SCREW YELLOW



MHP1098

• Small blister

QTY: 2

VELCRO HOOK & LOOP ADHESIVE BLACK



MHP1124

• Small blister

QTY: 1

SET SCREW BLACK POZIDRIVE FLANGE 1/2 X 6



MHP1036

• Small blister

QTY: 5

SET SCREW BLACK POZIDRIVE FLANGE 1/2 X 8



MHP1038

• Small blister

QTY: 4

SET SCREW BLACK POZIDRIVE 1/2 X 10



MHP1035

• Small blister

QTY: 6

DOUBLE SIDED INTERIOR ADHESIVE PAD

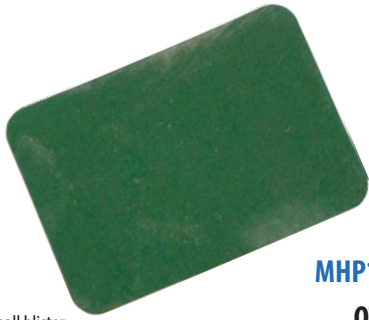

MHP1122

• Small blister

QTY: 1

EXTERNAL CIRCLIPS



MHP659

• Small blister

QTY: 6

INTERNAL CIRCLIPS



MHP660

• Small blister

QTY: 6

ASSORTED E RETAINER CIRCLIPS



MHP1047

• Small blister

QTY: 9

SELF LOCK NUTS M10 x 1.5 PITCH



MHP368

• Small blister

QTY: 3

AUDI/SEAT SUMP PLUG & WASHER



MHP388

• Large blister

QTY: 1

RENAULT SUMP PLUG & WASHER 16MM

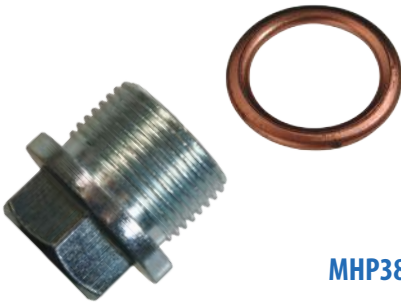

MHP385

• Large blister

QTY: 1

CIT/PEUG SUMP PLUG & WASHER



MHP1068

• Large blister

QTY: 1

BMW SUMP PLUG & WASHER 12MM



MHP387

• Large blister

QTY: 1

VAUX HALL SUMP PLUG & WASHER



MHP390

• Large blister

QTY: 1

VAUX/FORD SUMP PLUG & WASHER

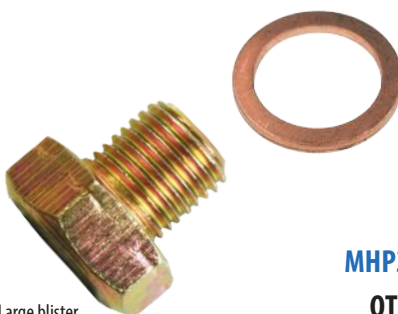

MHP383

• Large blister

QTY: 1

FORD SUMP PLUG & WASHER

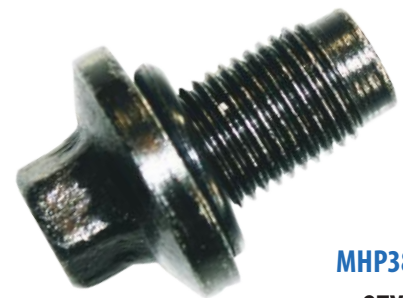

MHP389

• Large blister

QTY: 1

HEAVY DUTY FLAT WASHERS 8 & 10MM



MHP1058

• Large blister

QTY: 10

STEEL SCREW & NUT 2BA X 1



MHP360

• Small blister

QTY: 4

SELF LOCK NUTS M6 X 1 PITCH



MHP366

• Small blister

QTY: 4

SELF LOCK NUTS M8 X 1.25



MHP367

• Small blister

QTY: 4

HEAVY DUTY FLAT WASHER 5 & 6MM



MHP1057

• Large blister

QTY: 10

HT SETSCREW & NUT M5 X 40MM

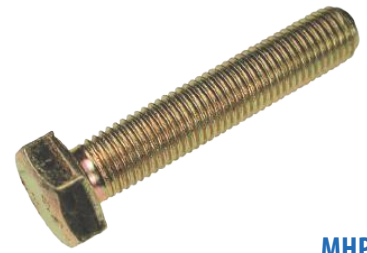

MHP655

• Small blister

QTY: 2

HT SETSCREW & NUT M6 X 40MM

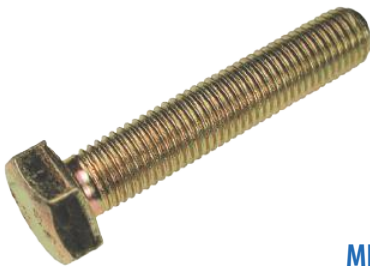

MHP976

• Small blister

QTY: 2

HT SETSCREW & NUT M8 X 40MM



MHP980

• Small blister

QTY: 2

MACHINE SCREW & NUT 2 X 2BA



MHP362

• Large blister

QTY: 3

HEAVY DUTY FLAT WASHER 12MM



MHP1056

• Large blister

QTY: 20

HEAVY DUTY FLAT WASHER 5MM



MHP1052

• Large blister

QTY: 50

HEAVY DUTY FLAT WASHER 6MM



MHP1053

• Large blister

QTY: 50

HEAVY DUTY FLAT WASHER 8MM



MHP1054

• Large blister

QTY: 30

HEAVY DUTY FLAT WASHER 10MM



MHP1055

• Large blister

QTY: 20

ASSORTED SMALL COPPER WASHERS

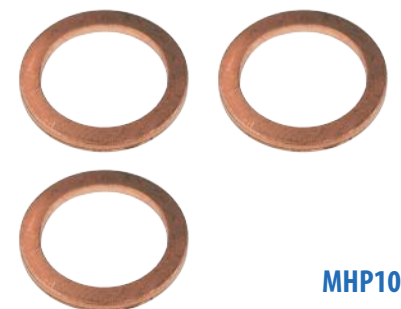

MHP1066

• Large blister

QTY: 15

ASSORTED LARGE COPPER WASHERS

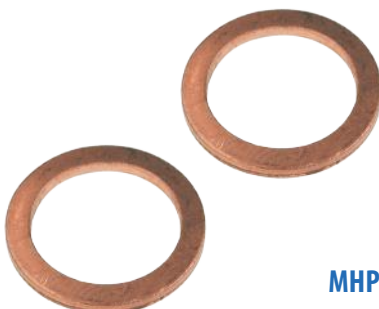

MHP1067

• Large blister

QTY: 10

RED LOW PROFILE FUSE 10AMP



MHP555

• Small blister

QTY: 2

BLUE LOW PROFILE FUSE 15AMP



MHP556

• Small blister

QTY: 2

YELLOW LOW PROFILE FUSE 20AMP



MHP557
QTY: 2

• Small blister

NATURAL LOW PROFILE FUSE 25AMP



MHP558
QTY: 2

• Small blister

GREEN LOW PROFILE FUSE 30AMP



MHP559
QTY: 2

• Small blister

LOW PROFILE FUSE 3/5/7.5/10AMP



MHP560
QTY: 4

• Small blister

LOW PROFILE FUSE 15/20/25/30AMP



MHP561
QTY: 4

• Small blister

RED MINI BLADE FUSE 10AMP



MHP576
QTY: 10

• Small blister

BLUE MINI BLADE FUSE 15AMP



MHP577
QTY: 10

• Small blister

YELLOW MINI BLADE FUSE 20AMP



MHP578
QTY: 10

• Small blister

NATURAL MINI BLADE FUSE 25AMP



MHP579
QTY: 10

• Small blister

MINI BLADE FUSE 2/4/5/7.5AMP



MHP713
QTY: 4

• Small blister

**ASSORTED MINI BLADE FUSES
3/5/10/15/25AMP**



MHP581
QTY: 10

• Small blister

MINI BLADE FUSE 10/15/20/30AMP



MHP714
QTY: 4

• Small blister

RED MINI BLADE FUSE 10AMP



MHP708
QTY: 2

• Small blister

BLUE MINI BLADE FUSE 15AMP



MHP709
QTY: 2

• Small blister

YELLOW MINI BLADE FUSE 20AMP



MHP710
QTY: 2

• Small blister

NATURAL MINI BLADE FUSE 25AMP

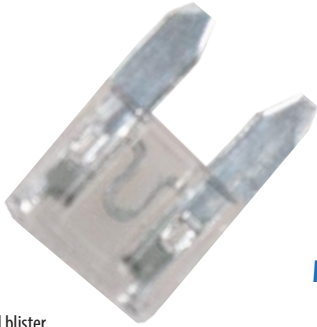

MHP711
QTY: 2

• Small blister

GREEN MINI BLADE FUSE 30AMP



MHP712
QTY: 2

• Small blister

STANDARD RED BLADE FUSE 10AMP



MHP723
QTY: 3

• Small blister

STANDARD BLUE BLADE FUSE 15AMP



MHP725
QTY: 3

• Small blister

STANDARD YELLOW BLADE FUSE 20AMP



MHP727
QTY: 3

• Small blister

STANDARD NATURAL BLADE FUSE 25AMP



MHP729
QTY: 3

• Small blister

STANDARD GREEN BLADE FUSE 30AMP



MHP731
QTY: 3

• Small blister

STANDARD BLADE FUSE 30AMP



MHP582
QTY: 2

• Small blister

STANDARD ORANGE BLADE FUSE 40AMP

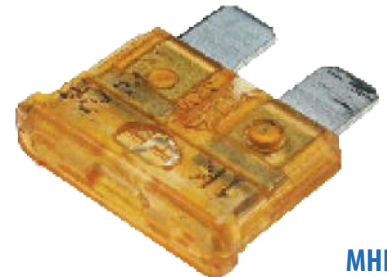

MHP733
QTY: 3

• Small blister

STANDARD BLADE FUSE 3/5/7.5/10AMP



MHP734
QTY: 4

• Small blister

STANDARD BLADE FUSE 3/5/10/15/25AMP



MHP583
QTY: 10

• Small blister

STANDARD BLADE FUSE 15/20/25/30AMP



MHP735
QTY: 4

• Small blister

YELLOW MAXI BLADE FUSE 20AMP

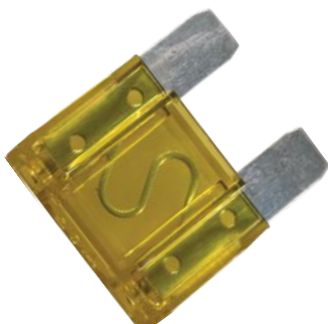

MHP737
QTY: 1

• Small blister

ORANGE MAXI BLADE FUSE 40AMP



MHP738
QTY: 1

• Small blister

RED MAXI BLADE FUSE 50AMP



MHP739
QTY: 1

• Small blister

BLUE MAXI BLADE FUSE 60AMP



MHP740
QTY: 1

• Small blister

NATURAL MAXI BLADE FUSE 80AMP



MHP742
QTY: 1

• Small blister

STANDARD BLADE FUSE HOLDER



MHP780
QTY: 1

• Small blister

GLASS RADIO FUSE 5AMP

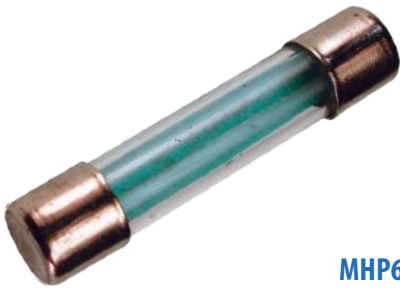

MHP692
QTY: 3

• Small blister

MAXI BLADE FUSE HOLDER

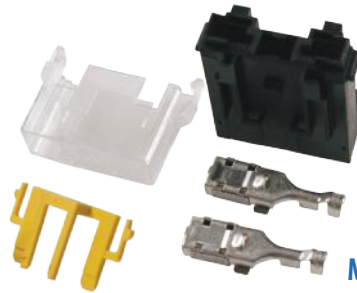

MHP782
QTY: 1

• Large blister

SELF STRIPPING BLADE FUSE HOLDER



MHP779
QTY: 1

• Large blister

PINK PAL 295 FUSE 30AMP

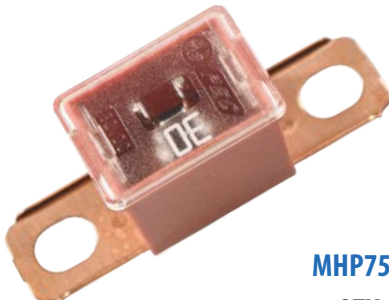

MHP757
QTY: 1

• Large blister

DOMESTIC FUSES 3/5/13AMP



MHP774
QTY: 10

• Small blister

RED PAL 295 FUSE 50AMP

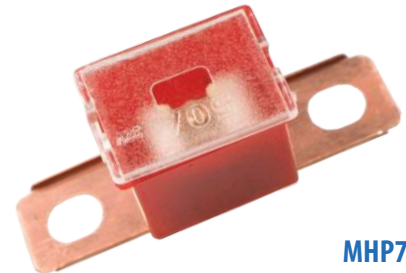

MHP759
QTY: 1

• Large blister

YELLOW PAL 295 FUSE 60AMP

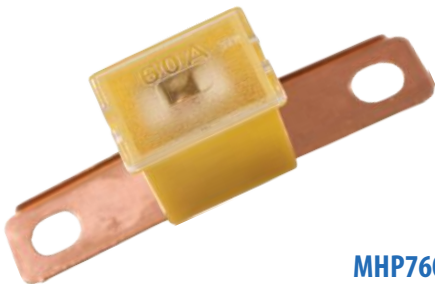

MHP760
QTY: 1

• Large blister

BLACK PAL 295 FUSE 80AMP

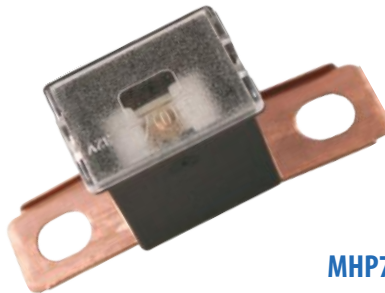

MHP761
QTY: 1

• Large blister

BLUE PAL 295 FUSE 100AMP

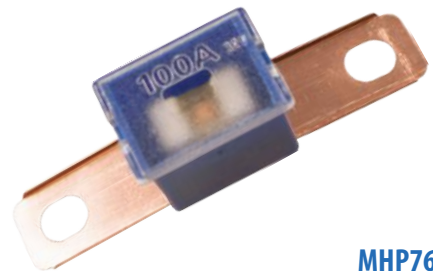

MHP762
QTY: 1

• Large blister

GREEN PAL 295 FUSE 40AMP

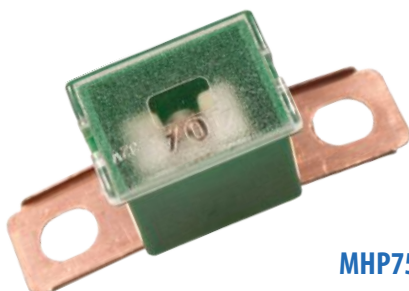

MHP758
QTY: 1

• Large blister

TERMINAL BLOCK 2.5AMP



MHP786
QTY: 1

• Large blister

TERMINAL BLOCK 15AMP



MHP787
QTY: 1

• Large blister

TERMINAL BLOCK 30AMP



MHP788

QTY: 1

• Large blister

BULLET CONNECTORS 5 & 15AMP



MHP642

QTY: 8

• Small blister

SPEAKER TERMINALS 2 & 5AMP

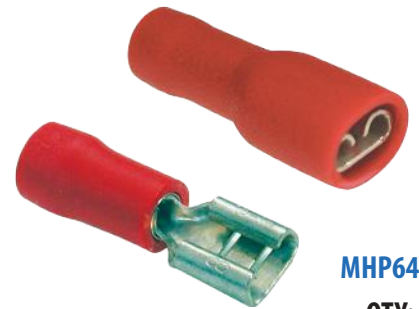

MHP643

QTY: 8

• Small blister

SPADE TERMINALS 15 & 35AMP



MHP644

QTY: 10

• Small blister

BUTT CONNECTORS 5/15/35AMP



MHP645

QTY: 6

• Small blister

RING CONNECTORS 5/15/35AMP



MHP646

QTY: 6

• Small blister

FORK TERMINALS 5/15/35AMP

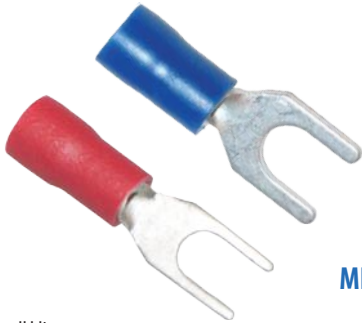

MHP647

QTY: 6

• Small blister

RED BUTT CONNECTORS 5AMP



MHP891

QTY: 3

• Small blister

RED BULLET CONNECTOR MALE



MHP893

QTY: 3

• Small blister

RED BULLET CONNECTOR FEMALE



MHP895

QTY: 3

• Small blister

RED SPADE TERMINAL MALE



MHP898

QTY: 4

• Small blister

RED SPADE TERMINAL FEMALE 2.8MM

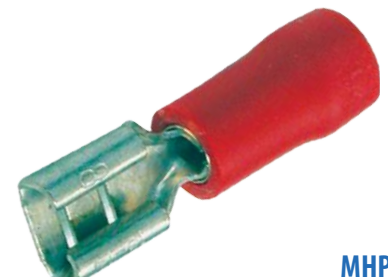

MHP902

QTY: 4

• Small blister

RED SPADE TERMINAL FEMALE 4.8MM

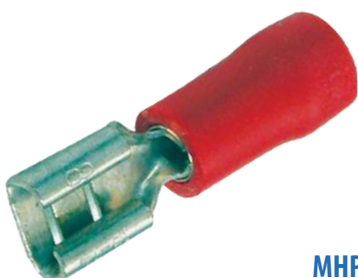

MHP904

QTY: 4

• Small blister

RED SPADE TERMINAL FEMALE 6.3MM

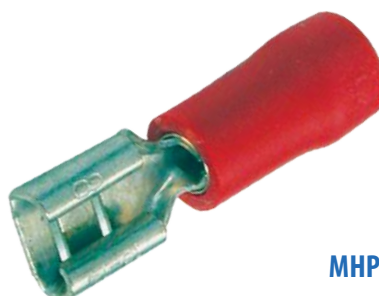

MHP906

QTY: 4

• Small blister

RED FULLY INSULATED SPADE TERMINAL FEMALE 6.3MM



MHP908

QTY: 3

• Small blister

BLUE BUTT CONNECTOR 4MM



MHP918
QTY: 3

• Small blister

BLUE MALE BULLET CONNECTOR 5MM



MHP920
QTY: 3

• Small blister

BLUE FEMALE BULLET CONNECTOR 5MM



MHP922
QTY: 3

• Small blister

BLUE SPADE TERMINAL MALE 6.3MM



MHP925
QTY: 4

• Small blister

BLUE SPADE TERMINAL FEMALE 4.8MM

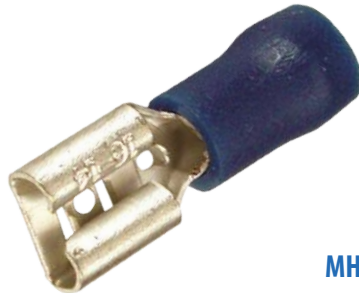

MHP929
QTY: 4

• Small blister

YELLOW RING TERMINAL 5/162



MHP968
QTY: 2

• Small blister

CROCODILE CLIP 5 AMP



MHP797
QTY: 2

• Small blister

BLANKING GROMMETS 8/10/13MM



MHP870
QTY: 3

• Small blister

BLANKING GROMMET 25MM



MHP869
QTY: 1

• Small blister

CROCODILE CLIP 25 AMP



MHP798
QTY: 2

• Large blister

2 PIN MULTIBLOCK CONNECTOR



MHP632
QTY: 1

• Large blister

BLUE SELF STRIPPING CONNECTOR

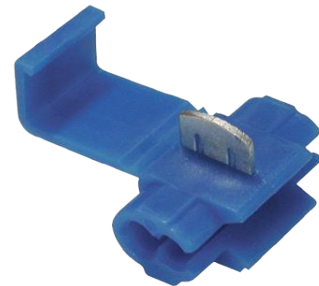

MHP792
QTY: 10

• Large blister

RED/BLUE CABLE CONNECTOR SELF STRIPPING

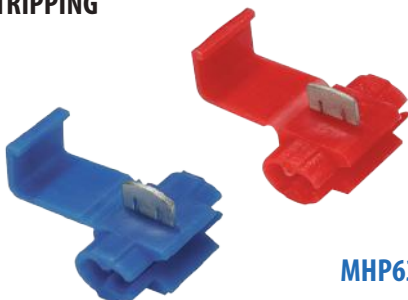

MHP637
QTY: 10

• Large blister

RED CABLE CONNECTOR SELF STRIPPING



MHP636
QTY: 10

• Large blister

YELLOW HEATSHRINK BUTT CONNECTOR 35A



MHP640
QTY: 10

• Large blister

RED HEAT SHRINK BUTT CONNECTOR 5AMP



MHP638

• Large blister

QTY: 10

BLUE HEAT SHRINK BUTT CONNECTOR 15AMP



MHP639

• Large blister

QTY: 10

TOGGLE SWITCH ON/OFF/ON

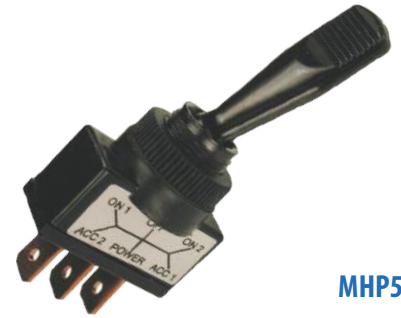

MHP530

• Large blister

QTY: 1

METAL TOGGLE SWITCH ON/OFF

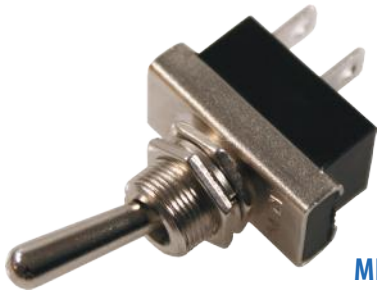

MHP531

• Large blister

QTY: 1

TOGGLE SWITCH ON/OFF



MHP529

• Large blister

QTY: 1

TOGGLE SWITCH ON/FLASH

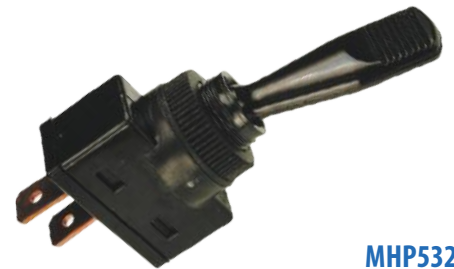

MHP532

• Large blister

QTY: 1

BLUE WARNING LIGHT ROUND



MHP846

• Large blister

QTY: 1

AMBER WARNING LIGHT ROUND



MHP844

• Large blister

QTY: 1

GREEN WARNING LIGHT ROUND



MHP845

• Large blister

QTY: 1

RED WARNING LAMP ROUND

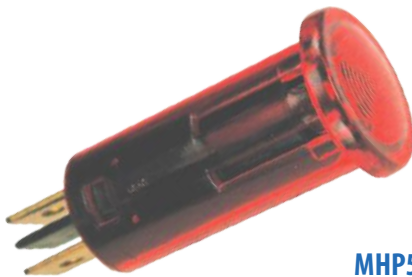

MHP533

• Large blister

QTY: 1

TWIN WASHER JET 4MM



MHP397

• Large blister

QTY: 1

SINGLE WASHER JET 4.8MM



MHP398

• Large blister

QTY: 1

NON RETURN T VALVE



MHP399

• Large blister

QTY: 1

IN-LINE VALVE



MHP400

• Large blister

QTY: 1

STRAIGHT HOSE CONNECTOR 8MM



MHP405

• Large blister

QTY: 2

STRAIGHT HOSE CONNECTOR 13MM



MHP409

• Large blister

QTY: 2

STRAIGHT HOSE CONNECTOR 16MM



MHP410

• Large blister

QTY: 2

BATTERY LEAD TERMINALS 10MM



MHP649

• Large blister

QTY: 2

HOSE CLIP 000 9.5-12MM



MHP420

• Large blister

QTY: 2

HOSE CLIPS 00 12-20MM



MHP421

• Large blister

QTY: 2

HOSE CLIPS 0 16-22MM



MHP422

• Large blister

QTY: 2

HOSE CLIPS 0X 18-25MM



MHP423

• Large blister

QTY: 2

HOSE CLIPS 1A 22-30MM



MHP424

• Large blister

QTY: 2

HOSE CLIP 01 25-35MM



MHP425

• Large blister

QTY: 2

PETROL PIPE CLIPS



MHP413

• Small blister

QTY: 2

PETROL PIPE CLIPS 12-13MM



MHP414

• Small blister

QTY: 2

PETROL PIPE CLIPS 13-14MM



MHP415

• Small blister

QTY: 2

PETROL PIPE CLIP 15-17MM



MHP416

• Small blister

QTY: 2

RIVETS 1/8" X 3/8"

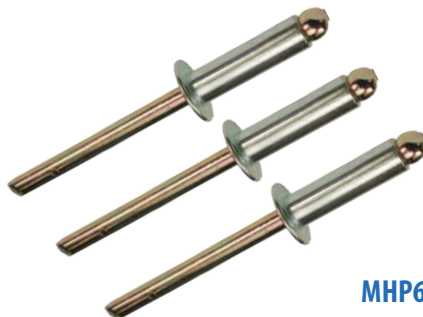

MHP674

• Large blister

QTY: 50

RIVETS 3/16" X 3/4"

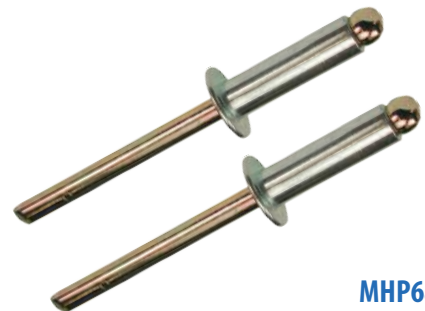

MHP680

• Large blister

QTY: 20

RIVETS 3/16" X 5/8"

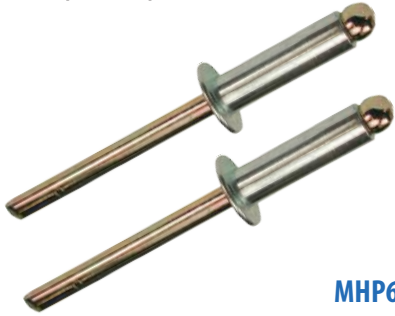

• Large blister

MHP678

QTY: 25

CAR ALARM BATTERY LR23A



• Small blister

MHP432

QTY: 1

CR1220 KEY FOB BATTERY



• Small blister

MHP433

QTY: 1

CR2016 3V LITHIUM KF BATTERY



• Small blister

MHP434

QTY: 1

CR2025 3V LITHIUM KF BATTERY



• Small blister

MHP435

QTY: 1

CR2032 3V LITHIUM KF BATTERY



• Small blister

MHP436

QTY: 1

CR1620 KEY FOB BATTERY



• Small blister

MHP437

QTY: 1

RED LENS REPAIR TAPE



• Large blister

MHP686

QTY: 1

AMBER LENS REPAIR TAPE

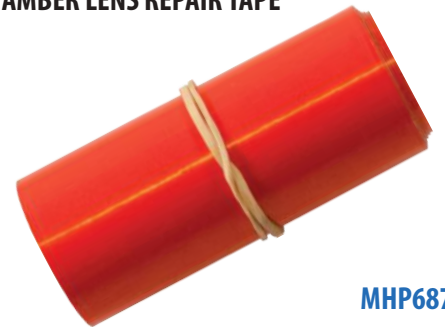

• Large blister

MHP687

QTY: 1

CLEAR LENS REPAIR TAPE



• Small blister

MHP688

QTY: 1

MALE BRAKE PIPE UNION M10 X 1



• Large blister

MHP683

QTY: 10

FEMALE BRAKE PIPE UNION M10 X 1

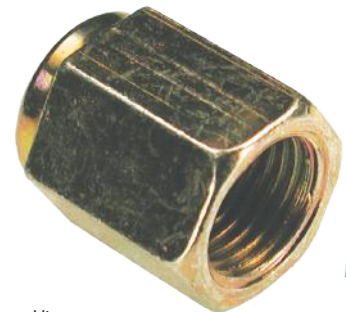

• Large blister

MHP682

QTY: 10

MALE BRAKE PIPE UNION M10

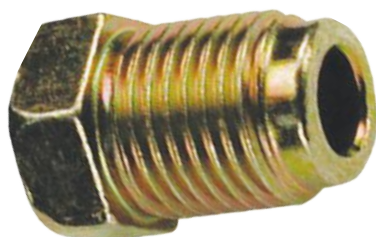

• Small blister

MHP1116

QTY: 2

FEMALE BRAKE PIPE UNION M10



• Small blister

MHP1117

QTY: 2

EVAPORATOR CLEANER & DEODORIZER



- 17 Oz (482g)
- Foaming cleanser eliminates stale odors fast
- Includes improved spray hose
- Safe for all mobile & stationary evaporators
- Fast acting, long lasting odor control formula
- One can may be used for multiple vehicles

SC6984
QTY: 1

ODOR BUSTER AUTO FOGGER



- Each Can is 3 Oz (85g)
- Specially formulated to handle problems associated with moisture & odors in automotive air conditioning systems
- Odor buster auto fogger does not cover up odors, it eliminates them at the source
- Eliminates odors caused by mold, mildew, tobacco smoke & more
- Comes in new car, florida breeze & vanilla scents (4 of each)
- Low VOC's, CARB compliant

SC26913
QTY: 1

FLORIDA BREEZE ODOR BUSTER



- (85g)
- Specially formulated to handle problems associated with moisture & odors in automotive air conditioning systems
- Odor buster auto fogger does not cover up odors, it eliminates them at the source
- Eliminates odors caused by mold, mildew, tobacco smoke & more
- Low VOC's, CARB compliant

SC26296
QTY: 1

NEW CAR ODOR BUSTER



- (85g)
- Specially formulated to handle problems associated with moisture & odors in automotive air conditioning systems
- Odor buster auto fogger does not cover up odors, it eliminates them at the source
- Eliminates odors caused by mold, mildew, tobacco smoke & more
- Low VOC's, CARB compliant

SC27002
QTY: 1

VANILLA ODOR BUSTER



- (85g)
- Specially formulated to handle problems associated with moisture & odors in automotive air conditioning systems
- Odor buster auto fogger does not cover up odors, it eliminates them at the source
- Eliminates odors caused by mold, mildew, tobacco smoke & more
- Low VOC's, CARB compliant

SC28061
QTY: 1

UV AIR CONDITIONING LEAK DETECTION DYE



- 8 Oz (237ml)
- Safe for hybrid & electric A/C systems
- Detectable when exposed to any uv light
- Compatible with pag, ester & mineral oils
- Will not harm A/C systems or recovery equipment
- Anti-wear agents & friction modifiers enhance compressor & A/C system efficiency while reducing compressor wear rates
- Anti-oxidants protect system against formation of sludge & other deposits which can shorten compressor life
- 1/4 Oz (7.5ml) per vehicle

SC22816
QTY: 1

UV AIR CONDITIONING DYE



- 32 Oz (947ml)
- Safe for hybrid & electric A/C systems
- Detectable when exposed to any uv light
- Compatible with pag, ester & mineral oils
- Will not harm A/C systems or recovery equipment
- Anti-wear agents & friction modifiers enhance compressor & A/C system efficiency while reducing compressor wear rates
- Anti-oxidants protect system against formation of sludge & other deposits which can shorten compressor life
- 1/4 Oz (7.5ml) per vehicle

SC24445
QTY: 1

TOTAL LEAK STOP WITH UV DYE



- Stops Leaks In Metal & Rubber Automotive A/C Parts Including Evaporators, Condensers, O-Rings, Gaskets & Hoses
- For Use in R134a, HFO-1234yf, Hybrid & Electric A/C Systems
- Includes O-Ring Conditioner, Proprietary Anti-Wear & Anti-Oxidants Additives
- 1 Can Treats 1 Vehicle
- HFC Free Aerosol

SC39241
QTY: 1

PAG 46 VISCOSITY 80Z



- Advanced Formula Synthetic PAG Lubricant
- High Performance PAG Provides Excellent Resistance to Moisture
- Specially Formulated For Aftermarket Air Conditioning Systems Using R-134a Refrigerant
- Contains Conditioners, Inhibitors & Anti-Wear Agents for Excellent Lubricity & Compressor Protection. Helps Reduce Compressor Wear

SCP46-8
QTY: 1

PAG 46 VISCOSITY 320Z



- Advanced Formula Synthetic PAG Lubricant
- High Performance PAG Provides Excellent Resistance to Moisture
- Specially Formulated For Aftermarket Air Conditioning Systems Using R-134a Refrigerant
- Contains Conditioners, Inhibitors & Anti-Wear Agents for Excellent Lubricity & Compressor Protection. Helps Reduce Compressor Wear

SCP46-32
QTY: 1

PAG 100 VISCOSITY 80Z



- Advanced Formula Synthetic PAG Lubricant
- High Performance PAG Provides Excellent Resistance to Moisture
- Specially Formulated For Aftermarket Air Conditioning Systems Using R-134a Refrigerant
- Contains Conditioners, Inhibitors & Anti-Wear Agents for Excellent Lubricity & Compressor Protection. Helps Reduce Compressor Wear

SCP100-8
QTY: 1

PAG 100 VISCOSITY 320Z



- Advanced Formula Synthetic PAG Lubricant
- High Performance PAG Provides Excellent Resistance to Moisture
- Specially Formulated For Aftermarket Air Conditioning Systems Using R-134a Refrigerant
- Contains Conditioners, Inhibitors & Anti-Wear Agents for Excellent Lubricity & Compressor Protection. Helps Reduce Compressor Wear

SCP100-32
QTY: 1

PAG 150 VISCOSITY 80Z



- Advanced Formula Synthetic PAG Lubricant
- High Performance PAG Provides Excellent Resistance to Moisture
- Specially Formulated For Aftermarket Air Conditioning Systems Using R-134a Refrigerant
- Contains Conditioners, Inhibitors & Anti-Wear Agents for Excellent Lubricity & Compressor Protection. Helps Reduce Compressor Wear

SCP150-8
QTY: 1

PAG 150 VISCOSITY 320Z



- Advanced Formula Synthetic PAG Lubricant
- High Performance PAG Provides Excellent Resistance to Moisture
- Specially Formulated For Aftermarket Air Conditioning Systems Using R-134a Refrigerant
- Contains Conditioners, Inhibitors & Anti-Wear Agents for Excellent Lubricity & Compressor Protection. Helps Reduce Compressor Wear

SCP150-32
QTY: 1

46 VISCOSITY SYNTHETIC VACUUM PUMP OIL 320Z



- Universal, synthetic vacuum pump oil helps extend the life of vacuum pumps
- Advanced high performance formula provides low volatility & high resistance to oxidation
- Non-misting formulation
- Contains conditioners, inhibitors & anti-wear agents for excellent lubricity & pump protection

SC33713
QTY: 1

UNIVERSAL SYNTHETIC PAG OIL WITH UV DYE



- 32oz
- Advanced moisture resistant formula
- Reduces compression wear
- Excellent lubricity & miscibility
- Premium R-134a synthetic lubricant

SC27897
QTY: 1

HAND TURN INJECTOR



- Does not require manifold gauge to use on low side of pressurized systems
- Great for introducing 1/4oz (7.5ml) up to 2oz (60ml) of UV dye, lubricants & leak stop (ST2) to closed A/C systems without adding refrigerant
- Quick connect style for R-134a systems (may also be used on R-12 systems)

SC15290
QTY: 1

TOTAL DYE



- 1 oz. 29.5ml
- Use with motor oil, hydraulic fluid, power steering fluid, brake fluid, diesel fluid, gasoline & transmission fluids
- Mix 1/4 ounce per quart of fluid
- Most effective in clean diesel & engine oils
- Detectable when exposed to U/V light

SC16525
QTY: 1

RADIATOR DYE



- 1 oz
- Fluorescent radiator leak detection
- Add 1 ounce per vehicle

SC16532
QTY: 1

FAST EVAPORATION FLUSH



- 947ml
- Leaves no residue
- Effective cleaner
- Quickly penetrates & removes oil & other contaminants from A/C components
- Non-corrosive
- Extremely flammable
- Our fastest evaporating flush

SC22762
QTY: 1

HYBRID COMPRESSOR OIL



- 7 oz
- Synthetic lubricant specially formulated for electric hybrid air conditioning compressors
- High dielectric protection formula has excellent resistivity to potential electrical current leakage in high voltage hybrid A/C systems
- Contains conditioners, inhibitors & anti-wear agents
- Provides excellent lubricity & compressor protection

SC24940
QTY: 1

GREEN A/C U/V DYE



- 7.5ml sachets
- Effective in R-134a & R-12 refrigeration systems
- Detectable when exposed to U/V light
- Compatible with PAG, ester & mineral oils
- Does not contain solvents
- Will not harm A/C systems or recovery equipment
- Universal A/C dye safe for hybrid & electric vehicles

SCD1-12
QTY: 1

A/C MAINTENANCE ASSORTMENT



- Vehicle coverage 2010 - 2000

500-8060
QTY: 1

GREEN RUBBER O RING ASSORTMENT



500-8080
QTY: 350

BARB & NUT ASSORTMENT



501-8100
QTY: 1

A/C HOSE REPAIR ASSORTMENT



501-8110
QTY: 1

SLIM LINE SEALING WASHER ASSORTMENT



500-8040
QTY: 1

MASTER SEALING WASHER ASSORTMENT



500-8050
QTY: 1

A/C CAP & CORE ASSORTMENT



501-8030
QTY: 1

UNIVERSAL SERVICE PART & CAP ASSORTMENT



500-8070
QTY: 1

VALVE CORE ASSORTMENT



500-8020
QTY: 1

ORIFICE TUBE ASSORTMENT



500-8000
QTY: 1

ORIFICE TUBE ASSORTMENT



501-8010
QTY: 1

DELUXE ORIFICE TUBE SERVICE KIT



SC92311
QTY: 1

NYLON O-RING PICK

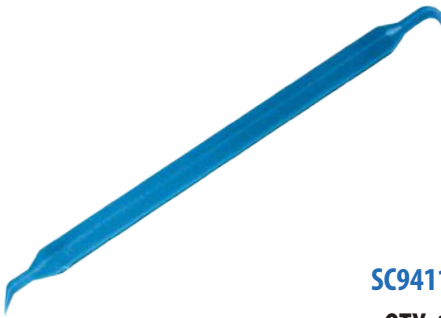

SC9411
QTY: 1



TRAILER BOARD



660-0010

• 3ft (4m cable & bag)

QTY: 1

TOWBALL BOOT



660-0020

• PVC with reflector

QTY: 1

TOWBALL BOOT



660-0021

• PVC (plain)

QTY: 1

TOWBALL COVER



660-0022

• Plastic (black)

QTY: 1

PLUG COVER



660-0023

• PVC

QTY: 1

SOCKET COVER



660-0024

• PVC

QTY: 1

TOWBALL



660-0026

• 50mm

QTY: 1

JOCKEY WHEEL



PART NO.	SIZE	QTY
660-0030	35mm	1
660-0031	42mm	1
660-0032	48mm	1

P/S HITCH



660-0035

• For 50mm for drawbars

QTY: 1

BALL/PIN COUPLING



660-0036

• 50mm

QTY: 1

MUDGUARD



PART NO.	SIZE	QTY
660-0040	490 x 140mm	1
660-0041	620 x 180mm	1

HITCH LOCK



660-0050

• For trailer use

QTY: 1

TRAILER WHEEL WITH 4 PLY TYRE



660-0700

• 400 x 8"

QTY: 1

WHEEL CLAMP



660-0055

• With locking system

QTY: 1

MOUNTING PLATE



660-0081

• Single socket

QTY: 1

MOUNTING PLATE



660-0082

QTY: 1

• 490 x 140mm

STAINLESS STEEL BUMPER PROTECTOR



660-0500

QTY: 1

BLACK BUMPER PROTECTOR



660-0501

QTY: 1

TOWBALL SPACER



PART NO.	SIZE	QTY
660-1000	1/2"	1
660-1001	1"	1

6 HOLE DROP PLATE



660-1020

QTY: 1

• Zinc plated (4")

TOWBALL & NUT

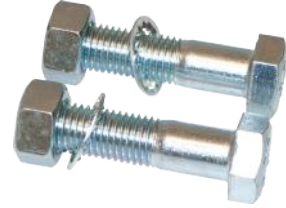

PART NO.	SIZE	QTY
660-1104	16 x 45mm	1 Pair
660-1105	16 x 55mm	1 Pair
660-1106	16 x 65mm	1 Pair
660-1107	16 x 75mm	1 Pair
660-1108	16 x 90mm	1 Pair

TOWBALL & PIN



660-4223

QTY: 1

• 3000kg max load

TOWING MIRROR



660-4224

QTY: 1

• Clip on (wide angle view)

WHEEL CHOCK



660-4229

QTY: 1 PAIR

AMPLIFIER



425-1440

QTY: 1

• Electric 12V
• Used to add towing & charging electrics to vehicles where the indicator & electrical functions are controlled by the ECU

AMPLIFIER



425-1450

QTY: 1

• Flasher 12V
• Used to add towing indicator electrics to vehicles that do not have a separate flasher unit

BATTERY SENSITIVE RELAY



• Charges two batteries simultaneously (vehicle & auxiliary), whilst eliminating the possibility of draining the vehicle start battery

PART NO.	AMP	VOLT	QTY
425-1490	60	12	1
425-1500	140	12	1
425-1510	140	24	1

EURO HOOK UP LEAD



660-0060

QTY: 1

• 230V

SITE CONNECTOR



660-0062

QTY: 1

• 230V

EXTENSION LEAD



660-0015

QTY: 1

• 6m
• 12V

SITE EXTENSION LEAD



660-0063

• 230V

QTY: 1

SUBMERSIBLE PUMP



PART NO.	VOLT	QTY
660-0090	12	1
660-0092	24	1

CONVERSION ADAPTOR



PART NO.	DESCRIPTION	QTY
660-0100	7Pin - 13Pin	1
660-0102	13Pin - 7Pin	1

CONVERSION LEAD



PART NO.	DESCRIPTION	QTY
660-0104	7Pin - 13Pin	1
660-0106	13Pin - 7Pin	1

SENSOR RELAY

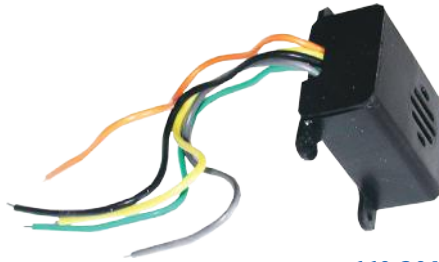

660-2010

• Audible

QTY: 1

7PIN SEAL SOCKET

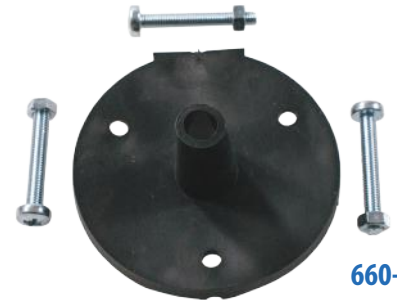

660-3010

• PVC

QTY: 1

UK HOOK-UP ADAPTOR



660-4222

• 230V

QTY: 1

SITE PLUG



660-0064

• 230V

QTY: 1

7PIN PLASTIC PLUG



PART NO.	DESCRIPTION	QTY
660-0070	12N (Black)	1
660-0072	12S (White)	1

7PIN PLASTIC SOCKET



660-0071

• 12N

QTY: 1

7PIN PLASTIC SOCKET



660-0073

• 12S

QTY: 1

7PIN ALUMINIUM PLUG



660-0074

• 12N

QTY: 1

7PIN ALUMINIUM SOCKET



660-0075

• 12N

QTY: 1

PRE-WIRED SOCKET



660-0080

• 12N 7pin

QTY: 1

PRE-WIRED SOCKET



660-0085

• 12N 12S

QTY: 1

PRE-WIRED SOCKET



• 12N with audio

660-0088

QTY: 1

13PIN EURO PLUG



• 12V

660-0108

QTY: 1

13PIN EURO SOCKET



• 12V

660-0110

QTY: 1

AMBER SIDE LAMP



660-4010

QTY: 1

NUMBER PLATE LAMP



• Black

660-4050

QTY: 1

NUMBER PLATE LAMP



• Black

660-4051

QTY: 1

RED/WHITE SIDE LAMP



660-4020

QTY: 1

RED SELF ADHESIVE REFLECTOR

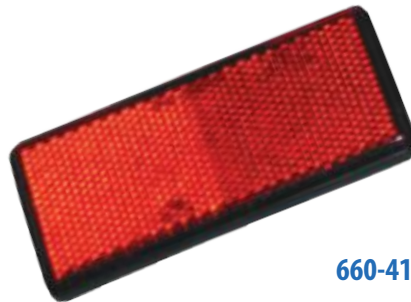

660-4120

QTY: 1

WHITE SELF ADHESIVE REFLECTOR

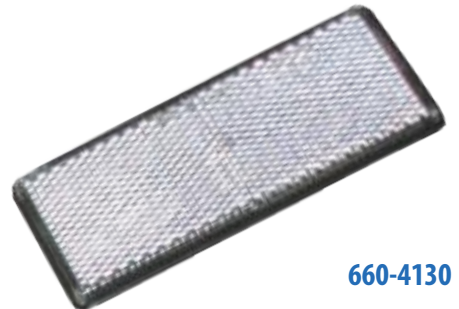

660-4130

QTY: 1

AMBER SELF ADHESIVE REFLECTOR



660-4110

QTY: 1

REFLECTIVE TRIANGLE



• Screw on

660-4180

QTY: 1

REFLECTIVE TRIANGLE



• White outer screw on

660-4181

QTY: 1

REAR FOG LAMP



• Red/grey

660-4206

QTY: 1

FRONT LAMP



• Clear

660-4208

QTY: 1

SQUARE COMBI LAMP

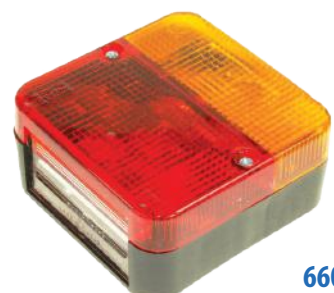

• Red/amber

660-4210

QTY: 1

OBLONG COMBI LAMP

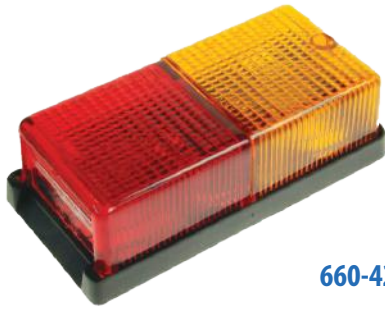

660-4220

• Red/amber

QTY: 1

REAR OBLONG FOG LAMP



660-4227

• With bracket

QTY: 1

OBLONG REVERSE LAMP



660-4228

• With bracket

QTY: 1

LUGGAGE ELASTICS

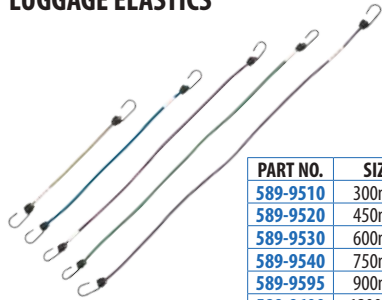

PART NO.	SIZE	QTY
589-9510	300mm	1
589-9520	450mm	1
589-9530	600mm	1
589-9540	750mm	1
589-9595	900mm	1
589-9600	1200mm	1
589-9610	1500mm	1
589-9620	2000mm	1

STEEL TOW ROPE



400160

• 5000kg capacity

QTY: 1

RED RATCHET TIE DOWN STRAP



589-9410

• 25mm x 4m

QTY: 1

ORANGE RATCHET TIE DOWN STRAP



589-9430

• 6.7m

QTY: 1

RED BREAKAWAY CABLE



660-0600

QTY: 1

HEAVY DUTY TOW ROPE



A446

• 12.5ft long (4m x 14mm)

QTY: 1

MINI COMPRESSOR



400159

• 12V

QTY: 1

WINDSCREEN PROTECTOR



400219

QTY: 1

24 LED WORKLIGHT



400225

CDU: 6

25 LED SHAKE 'N' LIGHT



400251

• Dual function

CDU: 12

3 LED MOTION SENSOR LIGHT



400252

CDU: 12

WARNING TRIANGLE



593-6020

QTY: 1

DURABLE GRIP MAT



660-4230

QTY: 1

GB STICKER



MV16

QTY: 1

• With union jack

LARGE GB STICKER



MV17

QTY: 1

HEADLIGHT STICKER



MGF119

QTY: 1

• Repair kit sticker

WHITE LENS TAPE



QC550

QTY: 1

AMBER LENS TAPE



QC551

QTY: 1

RED LENS TAPE



QC552

QTY: 1

FIRST AID HOLIDAY KIT



593-8092

QTY: 1

- 1x bandage
- 1x burnshield blott
- 2x eye/wound wash
- 1 pair of gloves
- 4x insect repellent wipes
- 1x low adherent dressing
- 1x microporous tape
- 10x washproof plasters
- 1x triangular bandage
- 2x alcohol free wipes

FIRST AID VEHICLE KIT



593-8093

QTY: 1

- 1x bandage
- 1x foil blanket
- 1 pair of gloves
- 1x low adherent dressing
- 1x microporous tape
- 10x washproof plasters
- Safety pins
- 1x triangular bandage
- 2x alcohol free wipes
- 1x wound dressing
- 1x eye/wound wash pods

HI-VIZ VEST



PART NO.	SIZE	QTY
593-6000	Large	1
593-6010	X-Large	1

FIRE EXTINGUISHER



596-0010

QTY: 1

**FOR FURTHER INFORMATION
ON OUR TOWING RANGE
CALL 01254-301121 OR
VISIT MAFCOBELL.CO.UK**

COLLAPSIBLE SNOW SHOVEL



400202
QTY: 1

FOLDING SNOW SHOVEL



400259
QTY: 1

SHOE SNOW GRIPS



400217
QTY: 1

ICE SCRAPER/SQUEEGEE



570-6341
QTY: 20

WINDSCREEN PROTECTOR



400219
QTY: 1

WORK SOCKS



• 3 pairs
• Colours & design may vary

PART NO.	DESCRIPTION	QTY
SOCK6-9	Size 6-9	3
SOCK9-12	Size 9-12	3

TRAPPER HAT



• Colours may vary

TRAPPERHAT
QTY: 1



COPPER CABLE BOOSTER LEADS



PART NO.	RATING	SIZE	LENGTH	QTY
MBC110/3	110amp	16mm	3m (10Ft)	1
MBC110/4	110amp	16mm	4m (13Ft)	1
MBC110/5	110amp	16mm	5m (16Ft)	1
MBC135/5	135amp	20mm	5m (16Ft)	1
MBC170/5	170amp	25mm	5m (16Ft)	1

**FOR FURTHER INFORMATION
ON OUR WINTER LINES
RANGE CALL 01254-301121
OR
VISIT MAFCOBELL.CO.UK**

18V CORDLESS SCREWDRIVER



- 22 torque settings
- 500RPM
- Keyless chuck
- Reverse Function
- 3-5 hour charge time
- Complete with carry case

600-1202

QTY: 1

18V CORDLESS HAMMER DRILL



- Comes with 2 batteries
- 16 torque settings
- 2 gears (1150 & 4500RPM)
- Keyless chuck
- 1 hour charge time
- Complete with carry case

600-1221

QTY: 1

500W ANGLE GRINDER



- 500 watt motor
- Additional handle supplied
- Includes flange nut wrench
- Cutting disc not included

600-2101

QTY: 1

850W ANGLE GRINDER



- 850 watt motor
- Additional handle supplied
- Includes flange nut wrench
- Cutting disc not included

600-2102

QTY: 1

BENCH GRINDER



- 150W
- Includes 1 coarse & 1 fine wheel
- Robust high performance motor
- Vibration free operation
- Replacement wheels available
- Coarse 600-2200C
- Fine 600-2200F

600-2211

QTY: 1

4.8V CORDLESS SCREWDRIVER



- Pivot joint
- With lamp
- Reverse function
- Magnetic bit holder
- In case complete with 28 drill bits
- 3-5 hour charge time

600-3150

QTY: 1

WET & DRY VACUUM CLEANER



- 1250W
- 20L capacity
- Includes flange nut wrench
- Replacement filters & bags available
- Dust bags 600-4100D
- Filter 600-4100F



600-4100

QTY: 1

5 PIECE AIR TOOL KIT



- Tyre inflator with gauge
- Spray paint gun with suction cup
- Paint spray gun with gravity cup
- Spiral air hose with quick coupling



610-2000

QTY: 1

150W WELDER



600-1000

QTY: 1

1/2" DR. AIR IMPACT WRENCH



- APL001 1/2" impact wrench
- 10 impact sockets - 9, 10, 11, 13, 14, 17, 19, 22, 24 & 27mm
- 5" extension bar
- Mini oiler

610-1310

QTY: 1

3/8" DR. AIR RATCHET WRENCH



- Includes 7 impact sockets

610-1610

QTY: 1

METRIC HSS TWIST DRILLS



IMPERIAL HSS TWIST DRILLS



BOXED	SIZE	QTY
580-0520	1/16"	10
580-0530	5/64"	10
580-0540	3/32"	10
580-0545	7/64"	10
580-0550	1/8"	10
580-0560	9/64"	10
580-0570	5/32"	10
580-0580	11/64"	10
580-0590	3/16"	10
580-0595	13/64"	10
580-0600	7/32"	10
580-0610	15/64"	10
580-0620	1/4"	10
580-0625	17/64"	10
580-0630	9/32"	10

BOXED	SIZE	QTY
580-0640	19/64"	10
580-0650	5/16"	10
580-0660	21/64"	10
580-0670	11/32"	10
580-0675	23/64"	10
580-0680	3/8"	10
580-0690	25/64"	10
580-0700	13/32"	5
580-0705	27/64"	5
580-0710	7/16"	5
580-0720	29/64"	5
580-0730	15/32"	5
580-0735	31/64"	5
580-0740	1/2"	5

BOXED	SIZE	QTY
580-0010	1.0	10
580-0015	1.5	10
580-0020	2.0	10
580-0025	2.5	10
580-0030	3.0	10
580-0033	3.3	10
580-0035	3.5	10
580-0040	4.0	10
580-0042	4.2	10
580-0045	4.5	10
580-0050	5.0	10
580-0055	5.5	10
580-0060	6.0	10
580-0065	6.5	10
580-0070	7.0	10
580-0075	7.5	10
580-0080	8.0	10
580-0085	8.5	10
580-0090	9.0	10
580-0095	9.5	10
580-0100	10.0	10
580-0105	10.5	5
580-0110	11.0	5
580-0115	11.5	5
580-0120	12.0	5
580-0125	12.5	5
580-0130	13.0	5

WALLETED	SIZE	QTY
580-1042	4.2	2
580-1045	4.5	2
580-1050	5.0	2
580-1055	5.5	2
580-1060	6.0	2
580-1065	6.5	1
580-1070	7.0	1
580-1075	7.5	1
580-1080	8.0	1
580-1085	8.5	1
580-1090	9.0	1
580-1095	9.5	1
580-1100	10.0	1
580-1105	10.5	1
580-1110	11.0	1
580-1115	11.5	1
580-1120	12.0	1
580-1125	12.5	1
580-1130	13.0	1

METRIC COBOLT DRILLS



BOXED	SIZE	QTY	BOXED	SIZE	QTY	BOXED	SIZE	QTY
580-5010	1.0	10	580-5045	4.5	10	580-5080	8.0	10
580-5015	1.5	10	580-5048	4.8	10	580-5085	8.5	10
580-5020	2.0	10	580-5050	5.0	10	580-5090	9.0	10
580-5022	2.2	10	580-5051	5.1	10	580-5095	9.5	10
580-5025	2.5	10	580-5055	5.5	10	580-5100	10.0	10
580-5030	3.0	10	580-5058	5.8	10	580-5105	10.5	5
580-5032	3.2	10	580-5060	6.0	10	580-5110	11.0	5
580-5033	3.3	10	580-5065	6.5	10	580-5115	11.5	5
580-5035	3.5	10	580-5068	6.8	10	580-5120	12.0	5
580-5040	4.0	10	580-5070	7.0	10	580-5125	12.5	5
580-5042	4.2	10	580-5075	7.5	10	580-5130	13.0	5

HSS TWIST DRILLS COUNTER DISPLAY



- Roll forged
- General purpose
- Contains 865 drills

580-4000
QTY: 1 SET

ASSORTED DRILL SETS

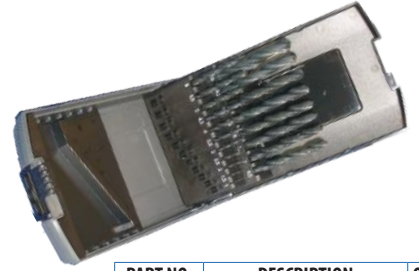

PART NO.	DESCRIPTION	QTY
580-3110	19 Piece Metric HSS Drill Set	1
580-3150	25 Piece Metric HSS Drill Set	1
580-3210	19 Piece Metric Cobolt Drill Set	1

5 PIECE SCREW EXTRACTOR SET



SIZES
1 (3-6mm)
2 (6-8mm)
3 (8-11mm)
4 (11-14mm)
5 (14-18mm)

101030A
QTY: 1 SET

4 PIECE SOCKET TYPE STUD EXTRACTOR SET



- Supplied in metal storage case
- Contains extractors for 6, 8, 10 & 12mm
- Use with 1/2" DR.

400049
QTY: 1 SET

40 PIECE TAP & DIE SET

SIZES	SIZES
M3 x 0.5	M7 x 1.0
M3 x 0.6	M8 x 1.0
M4 x 0.7	M8 x 1.25
M4 x 0.75	M10 x 1.25
M5 x 0.8	M10 x 1.5
M5 x 0.9	M12 x 1.5
M6 x 0.75	M12 x 1.75
M6 x 1.0	1/8" x 27tpi
M7 x 0.75	



- Tungsten steel
- Supplied in plastic storage case
- 17 taps, 17 dies, long handle, adjustable tap wrench T handle tap wrench, die handle, screwdriver, screw pitch gauge

400045
QTY: 1 SET

WIRE FRAME JUNIOR HACKSAW

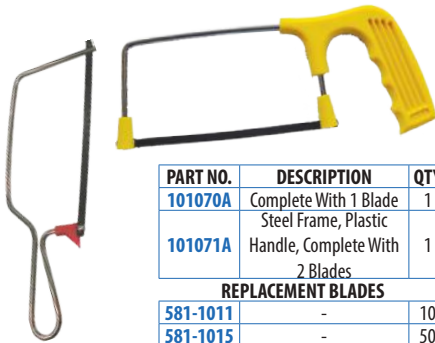

PART NO.	DESCRIPTION	QTY
101070A	Complete With 1 Blade	1
101071A	Steel Frame, Plastic Handle, Complete With 2 Blades	1
REPLACEMENT BLADES		
581-1011	-	10
581-1015	-	50

PROFESSIONAL HACKSAW

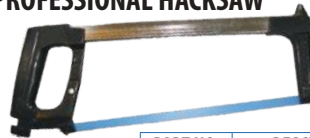

PART NO.	DESCRIPTION	QTY
400050X	Professional Hacksaw	1
REPLACEMENT BLADES		
581-0211	High Speed Steel	10
581-0220	1/2" x 24 Tpi	100
BI-METAL HACKSAW BLADES		
581-0711	Flexible High Speed Steel,	10
581-0720	12 x 18 Tpi	100
581-0811	Flexible High Speed Steel,	10
581-0820	12 x 24 Tpi	100

- Frame complete with high speed steel blade

AUTOMATIC CENTRE PUNCH



101690A
QTY: 1

- Powerful spring loaded centre punch

RETRACTABLE TRIM KNIFE



PART NO.	DESCRIPTION	QTY
581-5010	Retractable Trim Knife	1
REPLACEMENT BLADES		
101162A	Retail Packed	5
581-5092	-	100
581-5097	Safety Dispenser Units	100
	10 x 10	

- Die-cast metal body with blade storage
- Blade shifter controls the extension of the blade (3 positions)

DISPOSABLE TRIMMING KNIFE



581-5160
QTY: 20

SNAP-OFF BLADE KNIFE



PART NO.	DESCRIPTION	QTY
581-5110	9mm Snap-Off Blade Knife	1
REPLACEMENT BLADES		
581-5120	-	10

- 9mm
- Complete with blade

SNAP-OFF BLADE KNIFE



PART NO.	DESCRIPTION	QTY
581-5130	18mm Snap-Off Blade Knife	1
REPLACEMENT BLADES		
581-5140	-	10

- 18mm
- Complete with blade

SNAP-OFF BLADE KNIFE SET



100504A
QTY: 1 SET

- 9mm
- Complete with blade

EMERY ROLLS



PART NO.	GRIT	QTY
582-0010	P120	1
582-0030	P80	1
582-0060	P40	1

- 25mm
- 50m length

EMERY SHEETS

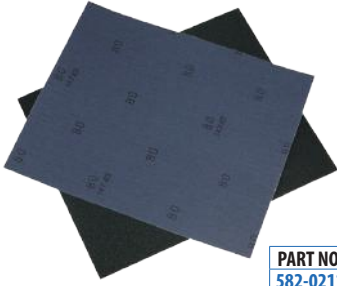

PART NO.	GRIT	QTY
582-0211	P120	50
582-0231	P80	50
582-0251	P40	50

• 230mm x 280mm

WET & DRY

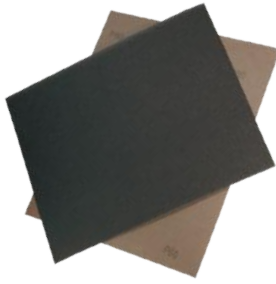

PART NO.	GRIT	QTY
582-0311	P1200	50
582-0309	P1000	50
582-0305	P800	50
582-0331	P600	50
582-0351	P400	50
582-0371	P320	50
582-0381	P240	50
582-0401	P180	50
582-0421	P80	50

• 230mm x 280mm

PRODUCTION PAPER



PART NO.	GRIT	QTY
582-0521	P80	50
582-0531	P60	50
582-0541	P40	50

• 230mm x 280mm

RUBBER SANDING BLOCK



400112

QTY: 1

• 125mm with 3mm metal pins in each end

FLAT METAL CUTTING DISCS



PART NO.	DIAMETER	THICKNESS	HOLE SIZE	QTY
582-4030	76mm	1.6mm	10	5
582-4010	100mm	2.4mm	16	5
582-4020	115mm	2.4mm	22	5
582-4420	115mm	1.0mm	22	5
582-4040	180mm	2.4mm	22	5

METAL CUTTING DISCS



PART NO.	DIAMETER	THICKNESS	HOLE SIZE	QTY
582-4110	100mm	3.2mm	16	5
582-4120	115mm	3.2mm	22	5
582-4140	180mm	3.2mm	22	5

METAL GRINDING DISCS



PART NO.	DIAMETER	THICKNESS	HOLE SIZE	QTY
582-4210	100mm	6.4mm	16	5
582-4220	115mm	6.4mm	22	5
582-4240	180mm	6.4mm	22	5

FLAP DISCS



PART NO.	GRIT	QTY
582-4260	40 Grit	10
582-4280	60 Grit	10
582-4300	80 Grit	10
582-4320	120 Grit	10
582-4330	Mixed Pack	4

WIRE WOOL



PART NO.	THICKNESS	QTY
582-9001	Very Fine	1
582-9011	Fine	1
582-9021	Medium	1
582-9031	Coarse	1

5 PIECE GRINDING STONE SET



700030

QTY: 1 SET

• 5 assorted shapes & abrasive types
• Suitable for use on most metals

WIRE BRUSH



PART NO.	QTY
583-0040	5
DISPLAY CARDED	
101837A	1

• 4 rows of bristles
• Wooden handles

BRUSH SET



400053

QTY: 1 SET

• 1 brass, 1 nylon & 1 stainless steel

BACKING PAD



PART NO.	THICKNESS	QTY
101102A	-	1

SANDING DISCS

700000	5" Coarse	5
700001	5" Medium	5
700002	5" Fine	5

• For sanding discs
• 125mm diameter
• Complete with arbor assembly

ARTIST'S TOUCH-UP BRUSHES



MF134C

QTY: 36

• Sizes: No 2, 4, 6, 8

TOUCH-UP BRUSHES

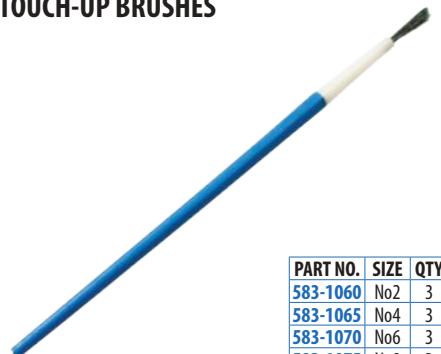

PART NO.	SIZE	QTY
583-1060	No2	3
583-1065	No4	3
583-1070	No6	3
583-1075	No8	3

PREMIUM PAINT BRUSHES



PART NO.	SIZE	QTY	PART NO.	QTY
583-1105	1/2"	5	583-1106	1
583-1110	1"	5	583-1111	1
583-1115	1 1/2"	5	583-1116	1
583-1120	2"	4	583-1121	1
583-1130	3"	4	583-1131	1

GENERAL USE PAINT BRUSHES



PART NO.	SIZE	QTY	PART NO.	QTY
583-1005	1/2"	5	583-1006	1
583-1010	1"	5	583-1011	1
583-1015	1 1/2"	5	583-1016	1
583-1020	2"	4	583-1021	1
583-1030	3"	4	583-1031	1

ASSORTMENT 2 OF EACH

583-1000	1/2", 1", 1 1/2", 2" & 3"	10
----------	---------------------------	----

MIRROR PADS



PART NO.	QTY
583-3810	25
583-3812	100

• 40 x 25mm

NO. PLATE PADS



PART NO.	QTY
583-3820	25
583-3822	100

• 75 x 25mm

VELCRO HOOK & LOOP



PART NO.	QTY
583-3883	10 Pairs
QC531	1 Pair

• Adhesive backed
• 127mm x 25mm

GENERAL USE MASKING TAPE



PART NO.	THICKNESS	QTY
583-3012	25mm	36
583-3010	25mm	5
583-3011	25mm	1
583-3022	50mm	20
583-3020	50mm	5
583-3021	50mm	1

• 50m rolls

GAFFER CLOTH TAPE



PART NO.	THICKNESS	COLOUR	QTY
583-3520	48mm	Black	2
583-3522	48mm	Black	24
583-3510	48mm	Silver	2
583-3512	48mm	Silver	24

• Tank/duct tape
• 50m rolls

BLACK SILICONE REPAIR TAPE



507-4010

QTY: 1

- Forms a waterproof & air tight seal
- Up to 700 PSI pressure resistance
- Resistant to oil, solvents, salt & UV
- Withstands temperatures varying from -60°C to 200°C
- Insulates up to 8000 volts of electricity

RED SILICONE REPAIR TAPE



507-4020

QTY: 1

- Forms a waterproof & air tight seal
- Up to 700 PSI pressure resistance
- Resistant to oil, solvents, salt & UV
- Withstands temperatures varying from -60°C to 200°C
- Insulates up to 8000 volts of electricity

DOUBLE SIDED TAPE

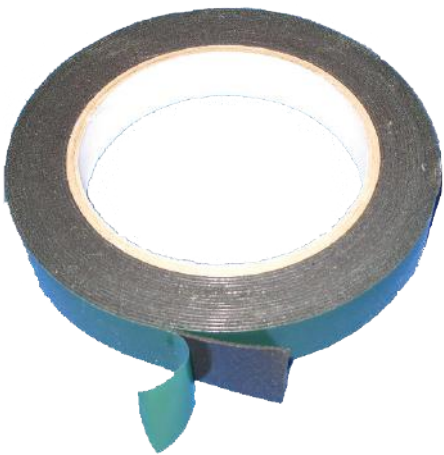

PART NO.	SIZE	QTY
QC544	12mm x 2.5m	1
583-3100	12mm x 5m	1
583-3101	12mm x 5m	5
583-3110	19mm x 5m	1
583-3111	19mm x 5m	5
583-3120	25mm x 5m	1
583-3130	50mm x 5m	1

SELF-AMALGAMATING TAPE



507-4100

QTY: 1

• 19mm x 5m

HARNESSING FLEECE TAPE



507-4150

QTY: 1

• 19mm x 25m

BRASS BODY PADLOCKS



400079

QTY: 1

- Hardened shackle
- A class
- CNS standard
- Complete with 2 keys
- 30mm body width

MEASURING TAPE



400058

QTY: 1

- Blade lock
- Auto return & belt clip
- 5m

HAND GUN RIVETER



DIAMETERS	
2.4mm (3/32")	4.0mm (5/32")
3.2mm (1/8")	4.8mm (3/16")

PART NO.	DESCRIPTION	QTY
100500A	Handgun Riveter	1
400013	In Plastic Storage Case With 100 Assorted Rivets	1

- Interchangeable heads for rivets

SOLDER WIRE



- Flux cored
- Flux content 2-3%
- On roll
- 0.5Kg
- 40% tin
- 60% lead

PART NO.	DESCRIPTION	QTY
584-9320	1.6mm, 16SWG	1
584-9340	3.5mm, 10SWG	1

SOLDER WIRE



- 2.5m
- Clear tube packaging

584-9310

QTY: 1

IMPACT SCREWDRIVER & BIT SET



204034

QTY: 1

- Slotted: 8mm, 10mm
- Phillips: No2, No3

JEWELLERS PRECISION SCREWDRIVER SETS



- Includes slotted & phillips
- In plastic case

PART NO.	DESCRIPTION	QTY
101187A	6 Piece	1
400100	11 Piece	1

ROUND HEAD REVERSIBLE RATCHET



PART NO.	DESCRIPTION	QTY
100242A	3/8"	1
101484A	1/2"	1

- Rubber grip handle

OVAL HEAD REVERSIBLE RATCHET



PART NO.	DESCRIPTION	QTY
514200	1/2"	1
538200	3/8"	1
512200	1/2"	1

- Polished handle with push button quick release

46 PIECE 1/4" DRIVE SOCKET SET



- Includes ratchet, sockets, screwdriver bits, hex key bits, star bits & extension bars
- In plastic case

400147

QTY: 1

29 PIECE 1/4" DRIVE SOCKET SET



- Includes ratchet, sockets, screwdriver bits, hex key bits, star bits & extension bars
- In plastic case

400152

QTY: 1

68 PIECE SOCKET SET

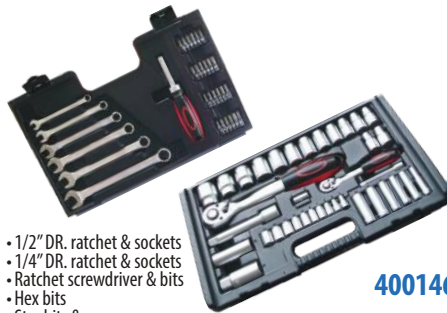

- 1/2" DR. ratchet & sockets
- 1/4" DR. ratchet & sockets
- Ratchet screwdriver & bits
- Hex bits
- Star bits & spanners
- In plastic case

400146

QTY: 1

15 PIECE HEX BIT SET



- Hex bits 4, 5, 6, 7, 8, 10, 12mm - 30mm length
- Hex bits 4, 5, 6, 7, 8, 10, 12mm - 75mm length
- 3/8" DR. bit adaptor
- In plastic storage case

400002

QTY: 1

15 PIECE TXI BIT SET



- Hex bits 4, 5, 6, 7, 8, 10, 12mm - 30mm length
- Hex bits 4, 5, 6, 7, 8, 10, 12mm - 75mm length
- 3/8" DR. bit adaptor
- In plastic storage case

400003

QTY: 1

11 PIECE SPLINE SET



- Spline bits M5, M6, M8, M10, M12 - 30mm length
- Spline bits M5, M6, M8, M10, M12 - 75mm length
- 1/2" DR. bit adaptor
- In plastic storage case

400004

QTY: 1

40 PIECE HEX, TXI & SPLINE BIT SET



- Hex bits 4, 5, 6, 7, 8, 9, 10, 12mm - 30mm & 75mm length
- TXI bits T20, T25, T30, T40, T45, T50, T55 - 30mm & 75mm length
- Spline bits M5, M6, M8, M10, M12 - 30mm & 75mm length
- 3/8" DR. & 1/2" DR. bit adaptors
- In plastic storage case

400005

QTY: 1

16 PIECE 1/4" DR. SOCKET SET



- 1 x 1/4" DR. reversible handle
- 10 x 1/4" DR. metric sockets (4-13mm)
- 3 x 1/4" DR. imperial sockets 1/4", 5/16" & 3/8"
- 1 x 2" (50mm) extension bar
- 1 x plastic bar
- Supplied in blow moulded storage case
- Display packed

400303
QTY: 1

40 PIECE SOCKET SET



- Includes 1/4" & 3/8" DR. sockets
- Ratchet handle
- Extension bar
- Adaptor
- Metric & imperial sockets
- Supplied in blow moulded storage case

400302
QTY: 1

29 PIECE 1/4" DR. PRO SOCKET SET



- 12 x 1/4" DR. sockets (4-13mm)
- 12 x bits & socket
- 1 x 1/4" DR. ratchet handle
- 1 x 1/4" DR. sliding T bar
- 1 x 1/4" DR. extension bar
- 1 x 1/4" DR. universal joint
- 1 x 1/4" DR. spinner handle
- Chrome vanadium steel with satin finish

400273
QTY: 1

25 PIECE 1/2" DR. SOCKET SET



- 18 x 1/2" DR. sockets (8-24)
- 2 x 1/2" DR. extension bars (5", 10")
- 2 x 1/2" DR. spark plug sockets (16mm, 21mm)
- 1 x 1/2" DR. quick release ratchet handle
- 1 x 3 way adaptor
- 1 x 1/2" universal joint
- Supplied in blow moulded carry case

400304
QTY: 1

94 PIECE 1/2" & 1/4" DR. SOCKET SET

- 13 x 1/4" DR. sockets (4-14mm)
- 8 x 1/4" DR. deep sockets (6-13mm)
- 2 x 1/4" extension bars (50 & 100mm)
- 1 x 1/4" DR. universal joint
- 1 x 1/4" DR. spin handle
- 1 x 1/4" DR. sliding T handle
- 1 x 1/4" DR. oval ratchet handle
- 18 x 1/2" DR. sockets (10-32mm)
- 4 x 1/2" DR. deep socket (14-19mm)
- 17 x 1/2" DR. inserted bit sockets (hex: 3-6mm, reg: 4-7mm, phillips: no1, no2, pozi: no1, no2, torx: t8-t30)
- 2 x 1/2" DR. extension bars (125 & 250mm)
- 2 x 1/2" DR. spark plug sockets (16 & 21mm)
- 1 x 1/2" DR. t-m head
- 1 x 1/2" DR. universal joint
- 1 x 1/2" DR. oval ratchet handle
- 1 x 5/16" bits (hex: 8-14mm, reg: 8-12mm, phillips: no3 & no4, pozi: no3 & no4, torx: t40-t55)



400209
QTY: 1

141 PIECE TOOL KIT

- 240mm water pump pliers
- 6mm x 100mm screwdriver
- PH2 x 100mm screwdriver
- Bit handle driver
- 6 x combination wrenches (8-15mm)
- 11 x 25mm screwdriver bits: slotted: 4, 5, 6, 7mm, torx: T10, T15, T20, phillips: PPH1, PH2, PH3,
- 1/4" adaptor
- Black PVC insulation tape (19mm x 3m)
- 4 x hexagon keys (3-6mm)
- 8oz steel claw hammer
- 3/8" DR. ratchet handle
- 9 x 1/4" DR. sockets (5-13mm)
- 8 x 3/8" DR. sockets (10-19mm)
- Snap off blade utility knife
- 150mm combination pliers
- 4 x precision screwdrivers: slotted (2.0, 2.4mm, phillips: PH000, PH00)
- 90 x assorted fasteners including screw, nail & wall plugs



400176
QTY: 1

25 PIECE MINI TOOL KIT

- 6 x precision screwdrivers
- 10 x power bits
- 1 x 1/4" DR. adaptor
- 1 x 2" extension
- 4 x 1/4" DR. sockets
- 1 x long nose plier
- 1 x diagonal cutting plier
- 1 x tweezers
- 1 x DR. handle
- Blister packed



400305
QTY: 1

6 PIECE SCREWDRIVER SET



- Long reach

400266
QTY: 1

6 PIECE SCREWDRIVER SET WITH RACK



- Two tone cushion grips
- Supplied with wall mountable storage rack
- Slotted: 5.5 x 150mm, 5.5 x 125mm, 3.0 x 75mm
- Phillips: PH0 x 100mm, PH1 x 100mm, PH2 x 100mm
- Blister packed

400215
QTY: 1

8 PIECE ELECTRICIAN'S SCREWDRIVER SET



- Fully insulated handle
- Suitable for work up to 1000V
- 100 - 250V mains tester (3 x 60mm)
- Slotted: 0.5 x 3 x 75mm, 0.8 x 4 x 100mm, 1.0 x 5.5 x 125mm, 1.2 x 6.5 x 150mm
- Phillips: PH#0 x 75mm, PH#1 x 100mm, PH#2 x 100mm
- Display packed

400240
QTY: 1

21 PIECE SCREWDRIVER & BIT SET



- Chrome vanadium steel
- Two tone comfort grip handles
- 4 x slotted screwdrivers
- (1 x insulated, 2 x phillips head, 1 x bit holder & 14 screwdriver bits)
- Supplied in blow moulded storage/carry case
- Display packed

400246
QTY: 1

1/2" DR. TORQUE WRENCH



- 465mm length
- 20-210mm range
- Fully chrome plated
- Approved to TUV/UGS standard

512209
QTY: 1

11 PIECE 3/8" DR. STANDARD SOCKET SET



- 7, 8, 9, 10, 11, 12, 13, 14, 15, 17 & 19mm
- Supplied on socket rail

538211
QTY: 1

3/8" DR. EXTENSION BAR



PART NO.	DESCRIPTION	QTY
100241A	125mm (5")	1
538203	250mm (10")	1

REDUCING/INCREASING ADAPTORS



PART NO.	DESCRIPTION	QTY
100243A	Increaser, 3/8" (Female) to 1/2" (Male)	1

1/2" DR. IMPACT SOCKETS



PART NO.	SIZE	QTY
612208	27mm	1
612201	32mm	1
612203	36mm	1
612204	41mm	1
612207	1 13/16"	1

• For use on hub nuts & diesel injectors

8 PIECE 1/2" DR. DEEP SOCKET SET

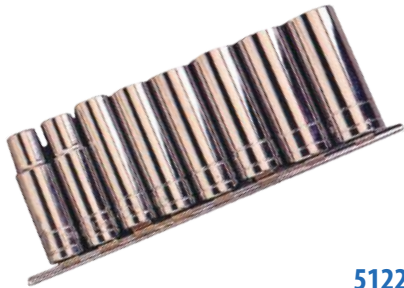

512212

• 12, 13, 14, 17, 19, 21, 22, 23mm
• Supplied on socket rail

QTY: 1

11 PIECE 1/2" DR. DEEP IMPACT SOCKET SET



612001

QTY: 1

1/2" DR. SLIDING T HANDLE



512208

• 250mm

QTY: 1

BREAKER BAR



PART NO.	DESCRIPTION	QTY
400272	3/8" DR. 15"	1
512206	1/2" DR. 24"	1

• Flexible handle

1/2" DR. EXTENSION BAR



PART NO.	LENGTH	QTY
512203	250mm (10")	1
512205	250mm (10") Wobble Bar	1

TECHNICIAN COMBINATION SPANNER SET



800100

• 9 piece metric set: 6, 8, 10, 12, 13, 14, 15, 17, 19mm

QTY: 1

4 PIECE METRIC BOX SPANNER SET



101054A

• Complete with tommy bar
• Sizes: 8 x 9mm, 10 x 11mm, 12 x 13mm, 14 x 15mm

QTY: 1

5 PIECE OFFSET RATCHET RING SPANNER



400114

• Metric: 6 x 8, 10 x 12, 11 x 13, 14 x 17, 19 x 21mm

QTY: 1

4 PIECE TXI SPANNER SET



400115

• TXI: E6 x E8, E10 x E12, E14 x E18, E20 x E24

QTY: 1

6 PIECE SPANNER SET



PART NO.	DESCRIPTION	QTY
101992A	Metric: 8, 10, 12, 13, 14 & 17mm	1
101993A	AF: 3/8, 7/16, 1/2, 9/16, 5/8 & 3/4"	1

24 PIECE SPANNER SET



201996

• Metric: 6, 7, 8, 9, 10, 11, 12, 13, 14, 17, 19 & 22mm
• AF: 1/4, 5/16, 3/8, 7/16, 1/2, 9/16, 5/8, 11/16, 3/4, 13/16, 7/8 & 1"

QTY: 1

COMBINATION SPANNERS



• Chrome vanadium

PART NO.	LENGTH	QTY
100000A	6mm	1
100001A	7mm	1
100002A	8mm	1
100003A	9mm	1
100004A	10mm	1
100005A	11mm	1
100006A	12mm	1
100008A	14mm	1
100009A	15mm	1
100010A	16mm	1
100011A	17mm	1
100012A	18mm	1
100013A	19mm	1
100014A	20mm	1
100015A	21mm	1
100016A	22mm	1

ADJUSTABLE SPANNER



PART NO.	LENGTH	JAW CAPACITY	QTY
101820A	150mm	19mm	1
101821A	200mm	24mm	1
400108	255mm	29mm	1
400109	305mm	34mm	1

STILLSON PIPE WRENCH



• 255mm length
• 35mm jaw capacity

101810A
QTY: 1

SELF GRIP PLIERS



• 250mm length
• 60mm jaw capacity
• Curved jaws

101453A
QTY: 1

G CLAMP



• 150mm (6")

101845A
QTY: 1

COMBINATION PLIERS



PART NO.	DESCRIPTION	QTY
100100A	150mm (6")	1
100102A	200mm (8")	1

LONG NOSE PLIERS



PART NO.	DESCRIPTION	QTY
100108A	150mm (6")	1
100110A	200mm (8")	1

DIAGONAL SIDE CUTTING PLIERS



• 150mm (6")

100104A
QTY: 1

WATERPUMP PLIERS



• 250mm (10")
• With groove joint

100112A
QTY: 1

4 PIECE CIRCLIP PLIER SET



• For internal & external circlips

400007
QTY: 1

O CLIP PLIERS



• Side closing with plastic coated handle

455-5000
QTY: 1

AVIATION TYPE TINSNIPS



• Approved to TUV/GS standards
• Straight cut

101059A
QTY: 1

HEAVY DUTY CRIMPING PLIERS

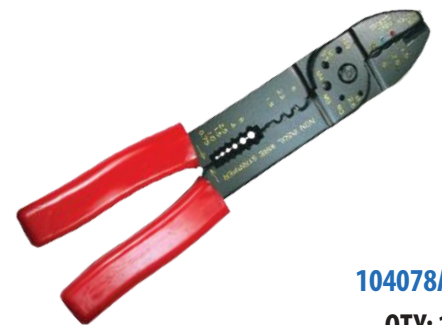

104078A
QTY: 1

RATCHET CRIMPING PLIERS



400011
QTY: 1

WIRE STRIPPER & CUTTING TOOL



104076A
QTY: 1

BRASS CIRCUIT TESTING PROBE



• Testing range 6V - 24V DC

101740A
QTY: 1

MAINS TESTING SCREWDRIVER



101015A

• Testing range 220V - 250V

QTY: 1

DIGITAL MULTI-TESTER



400039

• Range selection
• Measures AC/DC volts, DC amps, resistance, diode & battery test

QTY: 1

FLEXIBLE SPARK PLUG WRENCH



PART NO.	PLUG SIZE	SOCKET SIZE	QTY
101192A	10mm	16mm	1
101191A	14mm	21mm	1

• Rubber insert to protect & hold plug

SPARK PLUG HOLE RE-THREADING TOOL



101193A

QTY: 1

SPARK PLUG HOLE THREAD CHASER TOOL



101194A

QTY: 1

SPARK PLUG HOLE THREAD CHASER TOOL



101195A

QTY: 1

2 PIECE LAMBDA SENSOR THREAD CHASER



101196A

QTY: 1

OXYGEN SENSOR RE-THREADING TOOL



101190A

QTY: 1

METAL COVERED FEELER GAUGE



SPARK PLUG TESTER



101009A

QTY: 1

1/2" DR. PLUG SOCKET



PART NO.	PLUG SIZE	SOCKET SIZE	QTY
101093A	10mm	16mm	1
101518A	14mm	21mm	1

• Rubber insert to protect & hold plug

PART NO.	DESCRIPTION	QTY
101001A	Combination 8 Imperial: 0.002 - 0.015" 8 Metric: 0.5 - 0.38mm	1
101002A	Imperial 10 Imperial: 0.002 - 0.025"	1
101006A	10 Metric: 0.04 - 0.63mm	1

VALVE GRINDING PASTE



101149A

• 1 pot of grinding paste
• Containing both coarse & fine

QTY: 1

VALVE GRINDING PASTE



PART NO.	DESCRIPTION	QTY
201147FX	2.5Kg Tub - Fine	1
201147CX	2.5Kg Tub - Coarse	1

DOUBLE ENDED VALVE GRINDERS



PART NO.	DESCRIPTION	QTY
101035C	20 x 22m Display Card	12
101036A	20 x 22m Single Pack	1

VALVE GRINDING KIT



- 1 x valve grinding stick
- 1 x pot of grinding paste containing both coarse & fine

101153A
QTY: 1

2 PIECE BRAKE PIPE FLARING TOOL



- Bench mounted
- Suitable for O.D brake piping 3/16" & 4.75mm

800700
QTY: 1

5 PIECE BRAKE PIPE FLARING TOOL



- Bench mounted
- Suitable for O.D brake piping 3/16, 1/4, 5/16, 3/8" & 4.75mm

800701
QTY: 1

BRAKE PIPE FLARING TOOL TURRET



800750
QTY: 1

BRAKE PIPE FLARING HAND TOOL



800770
QTY: 1

BRAKE PIPE BENDING TOOL



- With 2 roller adaptors
- Bends without kinking
- Suitable for O.D piping 3/16, 5/16, 1/2 & 5/8"

400098
QTY: 1

REPLACEMENT PARTS



PART NO.	TUBE SIZE	FLARE FORM	QTY
MTD406	1/4" - 6mm	SAE/DIN Convex, SAE/DIN Double	1
MTD407	5/16" - 8mm	SAE Convex, SAE Double	1
MTD408	3/8" - 10mm	SAE Convex, SAE Double	1
MTD416	3/16" - 4.75mm	SAE Convex, SAE Double	1
MTD418	4.75mm	DIN Convex	1

DIE SET



PART NO.	TUBE SIZE	QTY
MTD410	1/4"	1 Pair
MTD411	5/16"	1 Pair
MTD412	3/8"	1 Pair
MTD415	3/16"	1 Pair

BRAKE TUBE CUTTER



- Ideal for use in compact areas
- Suitable for O.D piping from 3mm (1/8") to 16mm (5/8")

400088
QTY: 1

BRAKE/FUEL PIPE SPANNER



- 10 & 11mm

104365A
QTY: 1

AUTOMATIC BRAKE BLEED TUBE



- 1 person operation

PART NO.	PACKAGING	QTY
104051A	Single Pack	1
104051C	Card Of 10	10

AUTOMATIC BRAKE BLEED REPLACEMENT NIPPLE



104050A
QTY: 1

FLEXIBLE HOSE CLAMP



400022
QTY: 1

COIL SPRING COMPRESSORS



- Set of 2
- For 1/2" DR. tool or 21mm spanner

400018
QTY: 1

BALL JOINT SEPARATOR



- Fork type
- 19mm jaw capacity
- 70mm throat depth

101520A
QTY: 1

3 PIECE GEAR PULLER SET



400125
QTY: 1

BALL JOINT SEPARATOR



400019
QTY: 1

- General use
- 19mm jaw capacity
- 38mm max opening capacity

OIL FILTER WRENCH



101092A
QTY: 1

- Chain type with tightening nut
- For use with 1/2" DR.

OIL FILTER WRENCH



101095A
QTY: 1

- Chain type with handle

OIL FILTER WRENCH



400025
QTY: 1

- Strap type
- For use 1/2" DR./21mm spanner

5 PIECE DRAIN PLUG KEY SET



114 PIECE OIL PAN THREAD REPAIR SET



NEW!

- 6 of each plug: M13 x 1.25, M13 x 1.5, M15 x 1.5, M17 x 1.5, M20 x 1.5 & M22 x 1.5
- 6 taps (1 of each size)
- 12 of each washer

400090
QTY: 1

24 PIECE OIL PAN THREAD REPAIR SET



NEW!

- 6 of each plug: M13 x 1.5, M15 x 1.5, M17 x 1.5 & M20 x 1.5
- 1 of each tap to suit
- 10 of each washer

400092
QTY: 1

REPLACEMENT PLUG KEYS

PART NO.	SIZE	QTY
400127	10mm Hex x 12mm Hex	1
400126	14mm Hex x 17mm Hex	1
400128	9mm Hex x 5/16" Hex	1
400129	8mm Hex x 13mm Square	1

- Use with 19mm spanner or socket
- 10mm hex x 12mm hex
- 14mm hex x 17mm hex
- 9mm hex x 5/16" hex
- 8mm hex x 13mm square
- 11mm square x 8" square
- Complete with metal storage case

400116
QTY: 1

OIL PAN THREAD REPAIR SET - M13



NEW!

- 6 sump plugs
- 6 washers
- 1 tap M13 x 1.5

400093
QTY: 1

OIL PAN THREAD REPAIR SET - M15



NEW!

- 6 sump plugs
- 6 washers
- 1 tap M15 x 1.5

400094
QTY: 1

OIL PAN THREAD REPAIR SET - M17



NEW!

- 6 sump plugs
- 6 washers
- 1 tap M17 x 1.5

400095
QTY: 1

OIL PAN THREAD REPAIR SET - M20



NEW!

- 6 sump plugs
- 6 washers
- 1 tap M20 x 1.5

400096
QTY: 1

STEERING RACK END REMOVAL TOOL

NEW!



- Saves time & provides easy removal & installation for 35-45mm ends

400132
QTY: 1

STEERING RACK END REMOVAL TOOL

NEW!



- Saves time & provides easy removal & installation for 28-35mm ends

400133
QTY: 1

UNIVERSAL DRAIN PLUG KEY



- Metric
- 8 male keys

101129A

QTY: 1

ROUND FUNNEL



- 6 1/2" diameter
- Detachable flexible spout

400028

QTY: 1

STEEL BODY OIL CAN



- 570ml

PART NO.	DESCRIPTION	QTY
201421	With Rigid Spout	1
201425	With Flexible Spout	1

PRESSURE SPRAY



- 1L capacity
- Suitable for brake cleaner

201430

QTY: 1

LIQUID MEASURE POURER



PART NO.	DESCRIPTION	QTY
201426	1L Capacity	1
201427	3L Capacity	1
201428	5L Capacity	1
201429	Flexible Spout	1

ANTI FREEZE TESTER



- Can be used with hot or cold engine

400155

QTY: 1

BATTERY HYDROMETER



- Provides quick & clear indication of liquid battery condition

101044A

QTY: 1

HEAVY DUTY LEVER GREASE GUN

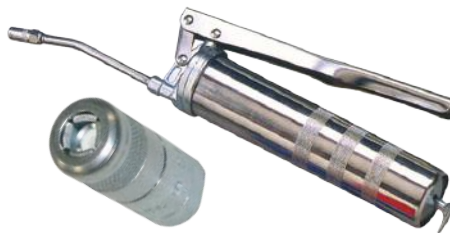

- 500ml capacity
- Cartridge or bulk fill

PART NO.	DESCRIPTION	QTY
400027	Heavy Duty Lever Grease Gun	1
400029	Grease Gun Nipple Union	1

CARTRIDGE GUN



- Takes up to 310ml cartridge

488-0990

QTY: 1

DENT PULLER/GLASS HOLDER



- 100mm (4") diameter
- Powerful suction cup

400038

QTY: 1

HOSE CLIP DRIVER



- 7" flexdriver
- 280mm length

400121

QTY: 1

HOSE CLIP DRIVER



- Complete with 4 different fittings which can be stored in the handle

23-001

QTY: 1

RUBBER AIR LINE HOSE



PART NO.	BORE	ROLL LENGTH	QTY
451-6140	6mm	21m (60ft)	1
451-6150	8mm	21m (60ft)	1

RE-COIL AIR LINE HOSE



451-0050

QTY: 1

PTFE THREAD SEALING TAPE



- 12mm wide
- 10m length
- On plastic spools

583-3410

QTY: 1

FEMALE PCL AIRFLOW COUPLINGS



- Compatible with standard adaptors
- 1/4" BSP
- Parallel thread

456-8010
QTY: 2

MALE PCL AIRFLOW COUPLINGS



- Compatible with standard adaptors
- 1/4" BSP
- Taper thread

456-8020
QTY: 2

PCL AIRFLOW TWIN COUPLING



- With standard male adaptor

456-8031
QTY: 1

PCL STANDARD SCREWED ADAPTOR



- Female
- Airflow & vertex couplings
- 1/4" BSP
- Parallel thread

456-8110
QTY: 5

PCL STANDARD SCREWED ADAPTOR



- Male
- Airflow & vertex couplings
- 1/4" BSP
- Taper thread

456-8120
QTY: 5

PCL STANDARD INTEGRAL ADAPTOR



- Male
- Airflow & vertex couplings/tailpiece
- 1/4" BSP
- Taper thread

PART NO.	HOSE BORE SIZE	QTY
456-8210	6.35mm (1/4")	5
456-8220	7.90mm (5/16")	5

PCL UNIONS



- Double male
- 1/4" BSP
- Parallel thread

456-8450
QTY: 5

PCL SCREWED TAILPIECE



- Male
- 1/4" BSP thread

PART NO.	HOSE BORE SIZE	QTY
456-8310	6.35mm (1/4")	5
456-8320	7.90mm (5/16")	5

PCL HOSE CONNECTOR



- Male
- 1/4" BSP thread

PART NO.	HOSE BORE SIZE	QTY
456-8910	6.35mm (1/4")	5
456-8920	7.90mm (5/16")	5

PCL BLOWGUN



- 28 PSI
- With safety nozzle

456-8991
QTY: 1

DIAL TYPE TYRE PRESSURE GAUGE



- Plastic
- Approved to TUV/GS standard
- Calibrated 0 - 60 PSI

400118
QTY: 1

TYRE INFLATER



610-1110
QTY: 1

PCL TYRE PRESSURE GAUGE



- Pencil type
- Complete with valve remover & pocket clip
- Calibrated 6 - 50 PSI

101028A
QTY: 1

4-IN-1 TYRE REPAIR TOOL

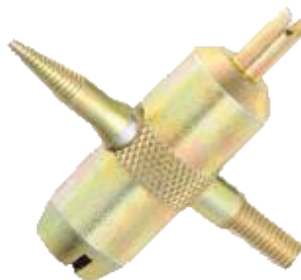

- Re-threads inside & outside threads of the valve stem
- Removes valve cores & extracts damaged cores

QC533
QTY: 1

1/2" DR. TELESCOPIC WHEEL NUT WRENCH



- Complete with 17mm & 19mm sockets
- Max length 530mm (21")

400023
QTY: 1

4 WAY WHEEL WRENCH



204023

• 17, 19, 21 & 22mm

QTY: 1

ADHESIVE WHEEL WEIGHTS



491-4060

• 600 strips
• 100 in box

QTY: 1

WHEEL WEIGHTS



PART NO.	WEIGHT	QTY
491-5000	5G	100
491-5010	10G	100
491-5020	15G	100
491-5030	20G	100
491-5035	25G	100
491-5050	30G	100
491-5060	35G	50
491-5070	40G	50
491-5080	45G	50
491-5090	50G	50
491-5100	60G	50

• Zinc for standard steel wheels

WHEEL WEIGHTS



PART NO.	WEIGHT	QTY
491-5200	5G	100
491-5210	10G	100
491-5220	15G	100
491-5230	20G	100
491-5240	25G	100
491-5250	30G	100
491-5260	35G	50
491-5270	40G	50
491-5280	45G	50
491-5290	50G	50
491-5300	60G	50

• For alloy wheels

VULCANISING CEMENT



491-5310

• 250ml
• Use only in well ventilated areas
• Keep away from heat, sparks, flame or other source of ignition

QTY: 1

TYRE BEAD SEALER



491-5340

• 1 Litre
• Use only in well ventilated areas
• Keep away from heat, sparks, flame or other source of ignition

QTY: 1

TYRE MOUNTING PASTE



491-5480

• 5Kg

QTY: 1

TYRE SOAP BEAD LUBRICANT



491-5320

QTY: 1

PASTE BRUSH



PART NO.	SIZE	QTY
491-5330	Small	1
491-5335	Large	1

VALVE CORE REMOVER



491-5360

QTY: 1

TUBELESS TYRE VALVE



PART NO.	LENGTH	HOLE	TYPE	QTY
491-5370	48.5	11.5	TR414	25
491-5380	61.5	11.5	TR418	25

TYRE VALVE CAPS



491-4002

QTY: 100

PLASTIC TYRE VALVE DUST CAPS



QC532

QTY: 5

WIRED PLUG PATCHES

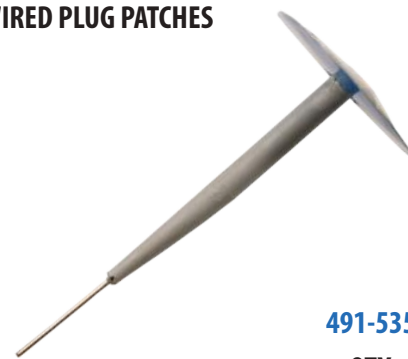

491-5350

QTY: 40

• 6mm

BUFFING STONE



491-5400

QTY: 1

LIQUID BUFFER



• 1 Litre

491-5390
QTY: 1

TYRE LEVER



• 500mm (20")

491-5410
QTY: 1

VALVE TOOL



491-5420
QTY: 1

YELLOW MARKERS



491-5440
QTY: 12

WHEEL WEIGHT PLIER



491-5470
QTY: 1

VALVE TOOL



• Alloy wheels
• Plastic handle

491-5430
QTY: 1

PCL TYRE INFLATER NOZZLE



456-8510
QTY: 1

WELDING TIP CLEANERS



492-0090
QTY: 1

PCL TYRE INFLATER



456-8992
QTY: 1

WELDING ELECTRODES



PART NO.	SIZE	QTY
492-0040	2.5mm	1
492-0050	3.2mm	1

MIG WIRE



• 5Kg roll

PART NO.	SIZE	QTY
492-0060	0.6mm	1
492-0070	0.8mm	1

GAS WELDING RODS



PART NO.	SIZE	QTY
492-0010	1.6mm	1
492-0020	2.4mm	1
492-0030	3.2mm	1

WELDING TIPS

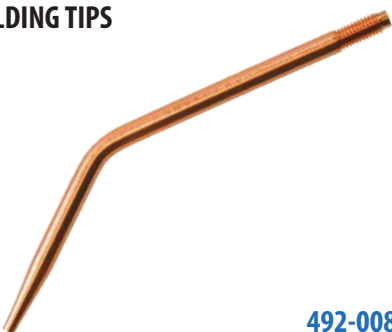

• Pack of 3
• No: 2, 3 & 5

492-0080
QTY: 1

WELDING GOGGLES



492-0100
QTY: 1

FLIP FRONT WELDING GOGGLES



492-0110
QTY: 1

WELDING SPARK TRIPLE FLINT GUN



PART NO.	DESCRIPTION	QTY
492-0120	Gun	1
492-0130	Replacement Flints	10

MIG TIPS



- No 15 type
- M6 thread

492-0140

QTY: 10

3 PIECE 8" SUPERIOR PLIER SET



- Drop forged, heat treated
- Set includes combination, long nose diagonal cutting pliers
- Heavy duty PVC handles with slip guards
- Blister packed

400224
QTY: 1

LAZY TONGUE HAND RIVETER



- Robust, durable heavy duty design
- Single pull action for fast continuous riveting
- Supplied with interchangeable tips & fitting spanner for various rivet sizes
- Approx size 32" (800mm)
- Riveting sizes 2.4, 3.2, 4.0 & 4.8mm
- Supplied in colour box

400248
QTY: 1

5 PIECE FILE SET



- Made from carbon steel
- Set includes flat, round, curved, triangular & square files
- Approx size 8" (200mm) in length
- With storage wallet
- Blister packed

400208
QTY: 1

6 PIECE WARDING FILE SET



- Plastic handles
- Set includes flat parallel, flat taper, round, square, three square & half round files
- Display packed

400207
QTY: 1

5 PIECE PARALLEL PIN PUNCH SET



- Made of hardened steel with knurled handle
- Includes sizes 1/8", 3/16", 1/4", 5/16", 3/8"
- Approx length 8" (200mm)
- Display packed

400205
QTY: 1

36 PIECE PUNCH SET



- Full set of alpha-numeric characters
- Approx 60mm in length
- Made from carbon steel
- Hardened & tempered with sandblasted finish
- Supplied in storage case
- Blister packed

400206
QTY: 1

9 PIECE LONG MAGNETIC HEX KEY SET



- Chrome vanadium steel with plastic handle
- Sizes 1.5mm - 10mm
- Extra long for increased reach & leverage
- Display packed

400271
QTY: 1

14 PIECE 1/4" DRIVE METRIC SOCKET SET



- 1/4" drive ratchet handle
- 13 x sockets (4 - 14mm including 4.5 & 5.5mm)
- Display clip

400301
QTY: 1

10 PIECE T-HANDLE HEX KEY SET



- Fully heat treated blades
- T-handles design provides greater torque
- Includes sizes 2, 2.5, 3, 4, 4.5, 5, 5.5, 6, 8 & 10
- With storage rack
- Colour box

400236
QTY: 1

10 PIECE HEX KEY SET



- Includes sizes 1.5, 2, 2.5, 3, 3.5, 4, 5, 6, 8 & 10mm
- Each hex key is held on key-ring type holder
- Display packed

400201
QTY: 1

3 PIECE PRY BAR SET



- Go-thru design for greater striking force
- Blade lengths: 100, 170 & 300mm
- Comfortable grip handles with guards

400267
QTY: 1

SINGLE FOOT PUMP WITH GAUGE



- Pressure gauge marked 0 - 100 PSI & 0 - 7kg
- Single barrel foot pump supplied with delivery hose & connectors for bicycles & inflatable toys etc
- Blister packed

400171
QTY: 1

DOUBLE FOOT PUMP WITH GAUGE



- Pressure gauge mark 0 - 100 PSI & 0 - 7kg
- Ideal for emergency work
- Can be carried in a car boot
- With delivery hose
- Blister packed

400172
QTY: 1

45 PIECE SOCKET SET



- Includes high torque ratchet screwdriver
- 1/4" & 3/8" dual drive ratchet
- Dual function pipe/adjustable wrench
- Socket sizes 4 - 10mm & 15/32" - 3/4" AF
- Assorted screwdriver bits
- With storage case

400228
QTY: 1

2 TON HYDRAULIC FLOOR JACK



- Lifting range approx 145 - 320mm
- Supplied with one piece handle
- Two rolling wheels for easy manoeuvrability
- Excellent stability
- Supplied in heavy duty blow moulded storage case

400174
QTY: 1

LED WARNING TRIANGLE



- 4 bright white LED's on the front & 9 red LED's on the back
- Approx 50 hours working time
- Requires 4 x AA batteries (not included)
- 90° swivel base
- Increases safety by warning other vehicles & pedestrians

400232
QTY: 1

7 PIECE CAR TRIM REMOVAL TOOL

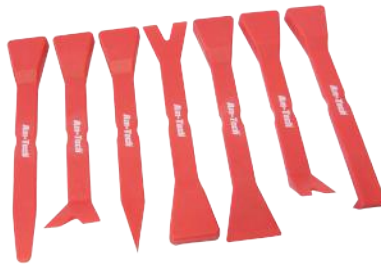

- For removing automotive trim, door panels, dashboard fascias
- Non marking & non scratching
- Manufactured from strong impact resistant nylon

400268
QTY: 1

AUTOMOTIVE COMPRESSION TESTER KIT



- Gauge with dual scale
- Two adaptors to test more vehicles
- Checks valves & ring wear, excessive carbon & late timing
- With blow moulded storage case
- Blister packed

400238
QTY: 1

6 PIECE JUMBO SPANNER SET



- Made from drop forged, heat treated steel
- Polished heads
- Set includes sizes 35, 38, 41, 44, 48 & 50mm
- Boxed

400233
QTY: 1

5 PIECE STUBBY GEAR WRENCH SET



- Drop forged
- Sizes 10, 12, 13, 17 & 19mm
- With 72 tooth
- Design allows access to confined work areas
- Display packed

400239
QTY: 1

5 PIECE COMBINATION WRENCH SET



- Includes sizes 8, 10, 13, 14 & 17mm
- Drop forged & polished
- Supplied with plastic storage rack

400260
QTY: 1

48 PIECE SCREWDRIVER & BIT SET



- 18 x sockets: 5.5, 6, 7, 8, 9, 10, 11, 12, 13 SAE: 3/16", 7/32", 1/4", 5/16", 11/32", 3/8", 7/16", 15/32", 1/2"
- 1 x adaptor
- 1 x soft grip driver handle
- 28 x 25mm driver bits torx: T10, T15, T20, T25, T27, T30 #2, #3, #4, #5, #5.5, #6, #8, square: #0, #1, #3 phillips: #0, #1, #2, #3 slotted: 3, 4, 5, 6mm pozi: #0, #1, #2
- Chrome vanadium steel bits

400203
QTY: 1

4 PIECE HOOK & PICK SET



- Ideal for separating wires, removing small fuses, O rings, retrieving washers & loose parts
- Plastic handles
- Display packed

400241
QTY: 1

BIKE TOOL & PUNCTURE REPAIR KIT



- Multi-function tool folds to fit easily in your pocket
- Includes 1/4" drive sockets, hex keys, socket adaptor, spanner, screwdrivers & nylon storage pouch
- Puncture repair kit with glue & patches
- Blister packed

400231
QTY: 1

BICYCLE FLASH LIGHT SET



- Includes one red & one white flashlight
- Two working modes, steady & flashing
- Includes batteries & mounting brackets
- Uses 2 x AAA batteries (included)
- Blister packed

400230
QTY: 2

BIKE LIGHT & TOOL SET



- Includes 8mm x 1000mm cable lock, 2 x bicycle flashlights (1 red & 1 white), multi-function bicycle repair tool & puncture repair kit
- Flashlights come with batteries included
- Repair tools come with handy storage pouch

400263
QTY: 4

24 LED WORK LIGHT



- 24 long life, super bright LEDs (12,000 MCD)
- Rubber coated for added protection
- Swivel hanging hook & strong magnetic fixing
- Weatherproof & shockproof
- 3 x AA batteries (included)
- Ideal for boating, camping, mechanics & emergency repairs
- Blister packed

400250
QTY: 1

LED BOOK READING LIGHT



- Can be clipped on to books, maps, car visors, seat belts etc
- Ideal for map reading and travel use
- On/off switch
- Adjustable angle lamp
- Uses 3 button batteries (included)
- Blister packed

400226
QTY: 1

16LB X 27 MAGNETIC PICK UP TOOL



- Strong magnet
- Telescopic up to approx 25" (625mm)
- Comfortable contoured grip
- Great for hard to reach areas
- Picks up to 16lb in weight
- Display packed

400243
QTY: 1

3 PIECE INSPECTION TOOL KIT



- 4 x 1/4" stainless steel magnetic dish
- 1 x 1/4" diameter inspection mirror
- 5lb telescopic magnetic pick up tool
- Blister packed

400242
QTY: 1

20 PIECE WET & DRY SANDING SHEETS

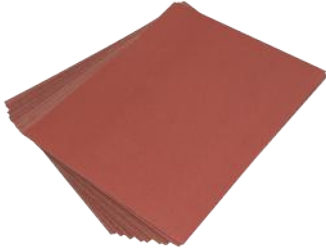

- Can be used for sanding metal, wood, plastic & painted surfaces
- Contents: 5 coarse, 5 medium, 5 fine, 5 extra fine
- Ideal for decorating & D.I.Y use
- Display packed

400247
QTY: 20

73MM SHACKLESS PADLOCK



- Heavy duty chrome plated steel padlock
- Supplied with 2 keys
- Two part shrouded hasp
- Ideal for van doors, sheds, garages & general security
- Blister packed

400244
QTY: 1

8 LITRE PRESSURE SPRAYER



- Translucent container with measurement markings
- Spray lance for reaching awkward places
- Shoulder strap for ease of use
- Fully adjustable nozzle & trigger lock
- Heavy duty pump mechanism
- Lance clips onto sprayer for storage
- Ideal for gardening (watering plants etc)

400264
QTY: 1

MINI ENGRAVER KIT

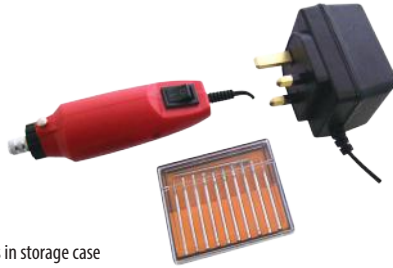

- Suitable for use on glass, ceramics & metals
- Supplied with 10 piece diamond tipped bits in storage case
- Lightweight design with on/off switch
- Bit shark 2.35mm
- No load speed 12000rpm
- Transformer input 230V AC, output 12V DC
- 2m cable length
- Blister packed

400223
QTY: 1

4.8V CORDLESS SCREWDRIVER



- Forward & reverse function
- Including 20 piece screwdriver bits, 3 piece twist drill bits, 1 piece magnetic connector
- 1 x 800mah NI-CD battery
- 5-8 hours charging time

400245
QTY: 1

THE FOLLOWING PRODUCTS ARE SOLD IN CDU'S WHEN YOU ORDER ONE YOU RECEIVE ONE COMPLETE CDU

2-IN-1 STUBBY PIPE WRENCH

SUPPLIED IN CDU OF 12



CDU 12

- The jaw reverses to change function
- Can be used as an adjustable wrench or pipe wrench
- Two tone grip for comfort & ease of use
- Heavy duty frame
- Drop forged steel
- Hardened & tempered
- Inch & metric gauges

400253
QTY: 1

HAND HELD MINI GASKET SCRAPER

SUPPLIED IN CDU OF 12



CDU 12

- Ideal for removing labels, paint & stickers from windows, mirrors, tiles & much more
- Design ideal for use in compact areas
- Fitted handle for better grip & great control
- Includes heavy duty razor blade & safety guard

400310
QTY: 1

12-IN-1 RATCHET SCREWDRIVER

SUPPLIED IN CDU OF 12



CDU 12

- Hi-torque ratchet screwdriver with comfortable cushion soft grip
- Includes 12 x 25mm CR-V assorted power bits stored in the handle
- With forward/reverse action

400213
QTY: 1

9-IN-1 SCREWDRIVER BIT SET

SUPPLIED IN CDU OF 12



CDU 12

- High quality aluminium driver with magnetic head to hold bits securely
- Chrome vanadium bits phillips: PH00, PH0, PH1, slotted: 1mm, 1.5mm, 2mm torx: T6, T7, T8
- Bit storage facility in head
- Ideal for small electronics, glasses, jewellery and most mobile phones

400249
QTY: 1

9-IN-1 LED SCREWDRIVER

SUPPLIED IN CDU OF 4



CDU 4

- Complete with 9 x 25mm screwdriver bits (slotted: 4, 5, 6mm phillips: PH1, PH2, PH3 star: T10, T15, T20)
- Magnetic bit holder with telescopic shaft that extends to approx 440mm
- Requires 3 x AAA batteries (included)
- 9 super bright LED's for illumination

400270
QTY: 1

31 PIECE SCREWDRIVER & BIT SET

SUPPLIED IN CDU OF 12



CDU 12

- 30 x assorted driver bits: 1.5, 2, 2.5, 3, 3.5, 4, T3, T4, T5, T6, T7, T8, T10, T15, 1, 1.3, 1.5, 2, 2.5, 3, 4, PH000, PH0, PH1, PH2, 3.0, 3.0, 1.0, 2.0, 2.6
- One piece driver handle
- Manufactured from chrome vanadium steel

400300
QTY: 1

9 FUNCTION MULTI-TOOL

SUPPLIED IN CDU OF 12



CDU
12

- Manufactured from stainless steel
- Supplied with handy storage pouch
- Multi-tool includes: pliers, wire cutter, hammer head, slotted screwdriver, bottle opener, mini file, knife, cross point screwdriver
- Handle locks safely when not in use

400256
QTY: 1

12-IN-1 MULTI FUNCTION TOOL

SUPPLIED IN CDU OF 10



CDU
10

- Manufactured from stainless steel
- Multi-tool includes: plier, phillips screwdriver, screwdriver, knife, file, wire cutter, mini axe, hammer, can opener, hex wrench, fish scaler & hook remover
- Supplied with handy storage pouch

400285
QTY: 1

MOBILE PHONE CHARGER

SUPPLIED IN CDU OF 4



CDU
4

- No need for mains power
- Handy pocket size
- Safe use with over voltage protection for the circuit and mobile phone
- Connectors for nokia, samsung, motorola, iphone & sony ericsson
- Charging time: approx 1 - 3 hours

400254
QTY: 1

LED LIGHT WITH SWIVEL HEAD

SUPPLIED IN CDU OF 12



CDU
12

- Handy torch with 4 colours: white, red, blue & green
- ABS material with soft grip
- 360° rotating head & magnetic base
- Approx 116mm length
- Belt clip & wrist strap
- Uses 3 x AAA batteries (not included)
- Ideal for fishing, camping & automotive use

400227
QTY: 1

25 LED SLIM-LINE WORK LIGHT

SUPPLIED IN CDU OF 12



CDU
12

- 3 working modes: torch - work light - dual mode
- Super bright, long life LED's
- Slim ergonomic design with soft touch finish
- Complete with handy wrist strap
- Requires 4 x AAA batteries (included)

400255
QTY: 1

24 LED WORK LIGHT

SUPPLIED IN CDU OF 12



CDU
12

- 24 long life, super bright LEDs (12,000 MCD)
- Rubber coated for added protection
- Swivel hanging hook & strong magnetic fixing
- Weatherproof & shockproof
- 3 x AA batteries (included)
- Ideal for boating, camping, mechanics & emergency repairs

400225
QTY: 1

72 LED WORK LIGHT

SUPPLIED IN CDU OF 5



CDU
5

- 72 super bright, long life LEDs
- Ideal for home, garage, camping & automotive repairs
- 3 strong magnets on the back
- 360° swivel hanging hook
- Rubber coated for added protection
- Requires 4 x AA batteries (Included)
- To operate, open the battery case & remove the plastic contact

400234
QTY: 1

9 LED MINI TORCH SET

SUPPLIED IN CDU OF 6



CDU
6

- Aluminium body with knurled barrel for extra grip
- Rubber on/off push button
- Handy wrist strap
- Each torch requires 3 x AAA batteries (included)
- Blister packed (3 in a pack)

400237
QTY: 3

SHAKE N LIGHT

SUPPLIED IN CDU OF 12



CDU
12

- 9 super bright, long life LEDs
- 3 settings - on/dim/off
- 3 independent light heads that swivel
- Battery operated, no wires needed
- Fully mountable with screws or adhesive pads (both are included)
- Requires 6 x AAA batteries (not included)

400251
QTY: 1

3 LED MOTION SENSOR LIGHT

SUPPLIED IN CDU OF 12



CDU
12

- Detection range: 3.5m
- Automatically switches on when motion is detected
- Requires 3 AAA batteries (supplied)
- Can be surface mounted using the adhesive pad provided

400252
QTY: 1

NON-SLIP DASHBOARD PAD

SUPPLIED IN CDU OF 24



CDU
24

- Manufactured from silica gel
- Clings to any dash contour
- Ideal for the car dashboard for mobile & other items such as MP3 players, glasses & keys etc
- 14.5 x 9cm (approx)

400221
QTY: 1

NO SPILL FUNNEL

SUPPLIED IN CDU OF 12



CDU
12

- Suitable for hot & cold liquids
- No spill joint to connect to any filling neck
- Easier & more efficient than common funnels
- Made from durable plastic
- Can be used with antifreeze, lubricant oil, diesel oil, gasoline & cooling fluids

400280
QTY: 1

A			
ABRASIVE ROLLS	103	BLOWGUN	114
ABRASIVE SHEETS	104	BLUE PAPER ROLL	52
ACME SCREWS	2, 46	BODY PANEL SEALER	25
ADHESIVE LINES BUTT CONNECTOR	26	BODY & TRIM FASTENERS	16, 17, 49, 50
ADHESIVE PLASTERS	18, 51	BODY SEALER	24
ADHESIVE REFLECTOR	98	BOLTS	48
ADHESIVE SEALER	25	BONDED SEALS	7, 8, 43
ADHESIVE WHEEL WEIGHTS	115	BONNET RELEASE CABLE	70
ADJUSTABLE SPANNERS	109	BOOST (10K)	24
ADVANCE/RETARD ASSEMBLIES	64	BOOSTER CABLE HANDLES	30
ADVANCE/RETARD RUBBERS	64	BOOSTER CABLES	30, 101
ADVANCE/RETARD TUBING	64	BOWDEN CABLE	70
AEROSOLS - MAFCO BRANDED	22	BOX SPANNERS	108
AIR CONDITIONING	92 TO 94	BRAIDED HOSE	63
AIR CONDITIONING CAP & CORE	19, 93	BRAIDED NYLON TUBING	64
AIR CONDITIONING O RINGS	15, 93	BRAKE & CLUTCH CLEANER	21
AIR GUN	102	BRAKE BLEED SCREW DUST CAPS	68
AIR TOOLS	102, 114	BRAKE BLEED SCREWS	10, 68
AIRLINE COUPLINGS	114	BRAKE BLEED TUBE	111
AIRLINE HOSE	65, 113	BRAKE CLEANER	22
ALARM	97	BRAKE CLEANER SPRAYER	113
ALARM FOB BATTERIES	30, 91	BRAKE DRUM SCREWS	68
ALLEN KEYS	117	BRAKE HARDWARE	68, 69
ALTERNATOR TERMINAL KIT	35	BRAKE HOSE CLAMP	111
ALUMINIUM DUCT HOSE	65	BRAKE PAD ANTI-RATTLE SPRINGS	10, 68, 69
ALUMINIUM WASHERS	43	BRAKE PAD PINS & CLIPS	11, 68
AMBERSIL	25	BRAKE PIPE	65
AMPLIFIER	96	BRAKE PIPE BENDING TOOL	66, 111
ANAEROBIC GASKET MAKER	21	BRAKE PIPE CLIP	73, 74
ANGLE GRINDER	102	BRAKE PIPE FLARING TOOLS	65, 66, 111
ANTI FREEZER TESTER	113	BRAKE PIPE SPANNER	66, 111
ANTI-SEIZE COPPER GREASE	21, 70	BRAKE PIPE TUBE CUTTER	66, 111
ASSORTED CABLE TIES	31	BRAKE PIPE UNIONS	10, 66, 67, 68
ASSORTMENT DISPLAY RACK	19	BRAKE SERVO HOSE	65
ASSORTMENT SECTION	1 TO 20	BRAKE SHOE FITTINGS	11, 68, 69
AUTO ADHESIVE SPRAY	22	BRAKE SHOE HOLD DOWN PIN & CLIPS	11, 68, 69
AUTOMATIC CENTRE PUNCH	103	BRASS BA NUTS	42
AUTOSOL	21	BRASS BA SCREWS	41
B		BRASS BULLET CONNECTORS	27
BA NUTS	4, 42	BRASS PADLOCKS	105
BA SCREWS	4, 41	BREAKAWAY CABLE	99
BACKING PADS FOR SANDING DISCS	104	BREAKER BAR	108
BALL JOINT BOOTS	5, 73	BRUSHABLE SEAM SEALER	24
BALL JOINT SEPARATORS	111, 112	BRUSHES - PAINT	105
BARB & NUT	19, 93	BRUSHES - TOUCH UP	104
BATTERY HYDROMETER	113	BRUSHES - WIRE	104
BATTERY ISOLATOR SWITCH	29, 30	BUG & TAR REMOVER	23
BATTERY RETAINING BRACKET	29	BULB HOLDER	35, 36
BATTERY STARTER CABLE	29	BULBS	36 to 40
BATTERY TERMINAL	12, 29, 30	BULBS - INSPECTION LAMPS	39
BATTERY TERMINAL PROTECTOR	22	BULB STAND	38
BATTERY TESTER	39	BULLET CONNECTORS	12, 26
BATTERY/STARTER CABLES	29	BUMPER PROTECTOR	96
BEAD LUBRICANT	22	BUS BULBS	39
BENCH GRINDER	102	BUTT CONNECTORS	25
BIKE LIGHTS	118	BUTTON HEAD SCREWS	4, 45
BIKE TOOL KIT	118	BY-PASS HOSE	64
BIN LINERS	52	C	
BLADE FUSES	13, 33	CABLE	28, 29
BLADE TERMINALS	12, 26	CABLE TIE BASES	30
BLADES FOR KNIFES	103	CABLE TIES	30, 31, 73
BLANKING GROMMETS	14, 28	CAP & CORE	19
BLEED SCREWS	10, 68	CAR CLOTH - FLUNKY	53
BLOCK CONNECTORS	12, 13, 27	CAR MATS	79
		CAR TRIM REMOVAL TOOL	118
		CARB CLEANER	22
		CARGO POST BATTERY TERMINALS	30
		CARPET CLEANER	23
		CARTRIDGE GUN	21, 113
		CATALYTIC CONVERTER CLEANER	24
		CAULKING GUN	21, 113
		CE-LIT RADIATOR SEALANT	21
		CHAIN SPRAY	22
		CHEMICALS SECTION	21 TO 25
		CHOKE CABLE	70, 71
		CIGAR LIGHTERS	35
		CIRCLIP PLIERS	109
		CIRCLIPS	9, 47
		CIRCUIT TESTER	109
		CLAMP FOR FLEXI BRAKE HOSE	111
		CLEVIS PINS	9
		CLIP ON TOWING MIRROR	96
		COACH BOLTS	4, 41
		COCKPIT SHINE	24
		COB HAND LAMP	39
		COIL SPRING COMPRESSORS	111
		COBOLT DRILL	103
		COLOUR MAGIC	23
		COMBINATION PLIERS	109
		COMBINATION SPANNERS	108
		COMMON RAIL DIESEL INJ WASHERS	9
		COMPRESSION TESTER	118
		CONTACT CLEANER	22
		CONTINENTAL FUSES	13, 34
		COOLSEAL BUTT CONNECTORS	26
		COPPER WASHERS	7, 43
		COPPER PIPE	65
		COPPER COMPRESSION WASHERS	43
		COPPER GREASE	21, 70
		COPPER LOCKING WIRE	71
		COPPER NICKEL BRAKE PIPE	65
		COPPER TUBE TERMINALS	12, 29
		COPPER TUBE TERMINAL CRIMPING TOOL	29
		CORDLESS DRILL	102
		CORDLESS SCREWDRIVER	102, 119
		CORE PLUGS	16, 71
		CORK JOINTING PAPER	71
		COTTER PINS	47
		CRIMPING PLIERS	109
		CRIMPING TOOL	29
		CROCODILE CLIPS	31
		CUTTING DISCS	104
		CV BOOT CLIPS	73
		CV BOOT FITTING TOOL	73
		CV BOOT KITS	72, 73
		CV GREASE	21
		CYCLE LIGHTS	118
		CYCLE TOOL KIT	118
		D	
		DASHBOARD LIGHTS	15, 36
		DENT PULLER	113
		DIESEL HAND PUMP/PRIMER	74
		DIESEL INJECTOR CLEANER	24
		DIESEL INJECTOR PLUGS	63
		DIESEL INJECTION WASHERS	9
		DIESEL LEAK OFF KIT	63
		DIESEL NON-RETURN VALVE	63
		DIESEL PARTICULATE FILTER CLEANER	24
		DIESEL STOP SMOKE	24

DISPLAY RACK FOR ASSORTMENTS	19	FLANGED BOLTS	3	HEAT SHRINK CONNECTORS	12, 26
DISPOSABLE FLOOR MATS	52	FLANGED SERRATED NUTS	6, 42	HEAT SHRINK TUBING	12, 17, 27
DISPOSABLE OVER SHOE COVERS	52	FLAP DISCS	104	HEATER HOSE	64
DISPOSABLE SEAT COVERS	52	FLAT WASHERS	6, 7, 42, 43	HEATER VALVE	39
DOMESTIC FUSES	13, 35	FLEECE TAPE	105	HEAVY DUTY BOLT CLAMPS	58
DOOR SWITCH	33	FLEXIBLE WATER HOSE	64	HEX BITS	106
DOUBLE SIDED TAPE	105	FLOOR MATS	52, 79	HEXAGON KEYS	117
DOWTY WASHERS	43	FLUNKEY CAR CLOTH	53	HEXSERTS	42
DRAIN PLUG KEYS	112, 113	FLUSH (AIR CON)	92	HIGH TEMP GASKET MAKER	24
DRILL	102	FOOT PUMP	117	HITCH LOCK	95
DRILL BITS	102, 103	FORK TERMINALS	26	HI-VIZ VEST	51, 100
DRIVEWAY CLEANER	25	FUEL FILTERS	63	HOBBY KNIFE	103
DRIVE SHAFT BOOTS	72	FUEL HOSE	63, 64	HOOK SET	115
DROP PLATE	96	FUEL INJECTION HOSE	64	HOSE	63, 64, 65
DSP SPRAY	22	FUEL PIPE SPANNER	111	HOSE CLIP - JUBILEE	58, 59
DURABOOT	72, 73	FUEL TRANSFER KIT	65	HOSE CLIP - MINI	12, 60
DURAGUN	73	FUNNEL	113, 120	HOSE CLIP - STAINLESS STEEL	58, 59
DUCT HOSE	65	FUSE BOX	35	HOSE CLIP DRIVER	58, 60, 113
DUCT TAPE	105	FUSE HOLDERS	34, 35	HOSE JOINERS	11, 60
DUST CAPS FOR BRAKE BLEED SCREWS	68	FUSES	13, 33 TO 35	HOSE REPAIR	19
DUST MASK	51	G		HOUSEHOLD FUSES	13, 35
E		GB STICKER	100	HOUSEHOLD PLUGS	30
EAR DEFENDERS	51	G CLAMP	109	HSS DRILL BITS	102, 103
EAR PLUGS	51	GAFFER TAPE	105	HUB NUTS	54, 55
EARTH LEAD	29	GASKET MAKER	21, 24	HYDRAULIC VALVE LIFTER TREATMENT	24
ELASTIC CLAWS	99	GASKET MATERIALS	71	HYLOMAR GASKET SEALANT	21
ELECTRIC DRILL	102	GASKET FIX	21	HYLOSIL INSTANT GASKET	21
ELECTRIC SCREWDRIVER	102	GEAR LINKAGES	71	I	
ELECTRIC WELDER	102	GEAR PULLERS	112	ICE SCRAPER	101
ELECTRICAL CONTACT CLEANER	22	GLASS CLEANER	23	ILLUMINATED SWITCH	31, 32
ELECTRICAL SECTION	26 TO 40	GLASS FUSES	13, 35	IMPACT SCREWDRIVER SET	106
ELECTRICAL TERMINALS	12, 26, 27	GLASS HOLDER	113	IMPACT SOCKETS	108
ELECTRICAL WIRING CABLE	28, 29	GLOVES - DISPOSABLE	51, 52	INJECTOR CLEANER	24
ELWIS HAND LAMP	39	GLOVES - GENERAL WORK	51	IN-LINE FILTER	63
EMERGENCY REPAIR TAPE	28, 105	GLOVES - GRIPPER	51	INSTANT GASKET	21, 24
EMERY ROLL	103	GLOVES - WELDING	51	INSULATION TAPE	27
EMERY SHEETS	104	GOGGLES - SAFETY	51	J	
EMPTY BOXES	18, 19, 20	GOLD GREASE	21, 70	JEWELLERS SCREWDRIVER SET	106
ENGINE DEGREASER	25	GREASE	21, 81	JOBBER DRILLS	102
ENGINE FLUSH	24	GREASE GUN	113	JOCKEY WHEEL	95
ENGINE STOP LEAK	24	GREASE NIPPLES	11, 70	JOINTING PAPER	71
ENGRAVER	119	GRINDER	102	J-TYPE FUSES	13, 34
EPOXY STICKS	21	GRINDING DISCS	104	JUBILEE CLIPS	58, 59
E-RETAINER CLIPS	9, 47	GRINDING STONE SET	104	JUG	113
EXHAUST CLAMPS	71	GRIPPER GLOVES	51	JUMP LEAD HANDLES	30
EXHAUST GASKET PAPER	71	GROMMETS	14, 28	JUMP LEADS	30, 101
EXHAUST MANIFOLD BOLTS	16	GROOM UPHOLSTERY CLEANER	24	JUNIOR HACKSAW	103
EXHAUST MANIFOLD NUTS	16	GUNK	25	JUNIOR HACKSAW BLADES	103
EXHAUST MANIFOLD STUDS	16	GUNK ENGINE DEGREASER	25	K	
EXHAUST MOUNTINGS	71	GUNK DRIVEWAY CLEANER	25	KEY FOB BATTERIES	30, 91
EXHAUST REPAIR PASTE	21	H		KNIFE	103
EXHAUST SEALING PASTE	21	HACKSAW BLADES	103	KNIFE BLADES	103
EXPANSION SPRINGS	11, 47	HACKSAWS	103	L	
EXTENSION BARS FOR SOCKETS	108	HALOGEN BULBS	37	L PLATE	79
EXTENSION LEAD	96	HAMMER DRILL	102	LAMBDA SENSORS	39
EYE WASH SOLUTION	51	HAND PRIMER PUMP	74	LAMBDA SENSOR THREAD CHASER	110
EYE WASH STATION	51	HAND RIVETER	106	LATEX GLOVES	52
F		HANDLAMP	39	LAZY TONGUE RIVETER	117
FACE SHIELD	51	HANDLAMP SPARES	39	LEAK DETECTION DYE	92, 93
FASTENERS SECTION	41 TO 50	HARNESING FLEECE TAPE	105	LEAK STOP	92
FEELER GAUGES	110	HAT	101	LEATHER CLEANER	23
FIBRE WASHERS	8, 43	HEAD GASKET REPAIR	21	LENS REPAIR TAPE	91, 100
FILE	117	HEADLIGHT BULB HOLDER	36	LETTER & NUMBER PUNCH	117
FIRE EXTINGUISHER	51, 100	HEADLIGHT REPAIR STICKER	100	LICENSE HOLDER	79
FIRST AID KITS	51, 100	HEADLIGHT RESTORER	23	LIQUID BUFFER	22, 115

LITHIUM GREASE	21	OIL POURERS	113	ROCKER SWITCHES	32
LOCK WASHERS	7, 43	ORIFICE TUBES	20, 94	ROUGH SERVICE BULBS	40
LOCKING NUTS	42	OVER SHOE COVERS	52	RUBBER GREASE	21, 70
LOCKING WIRE	71	P		RUBBER HOSE	64
LONG NOSE PLIERS	109, 117	P CLIPS	15, 30	S	
LOW PROFILE J TYPE FUSES	13, 34	PAG OIL	92, 93	SAFETY GLASSES	51
LOW PROFILE MINI FUSES	13, 33	PADLOCKS	105	SAFETY GOGGLES	51
LUCAR TERMINALS	27	PAINT	24	SANDING BLOCK	104
LUGGAGE ELASTICS	99	PAINT BRUSHES	105	SANDING DISC BACKING PAD	104
M		PAL FUSES	13, 14, 34, 35	SCRAPER - ICE	101
MACHINE SCREWS	4, 41, 46	PAPER ROLL - BLUE	52	SCRATCH REMOVER	23
MAGNET	118	PARKING SENSORS	39	SCREW EXTRACTOR SET	103
MAINS PLUGS	30	PCL CONNECTORS	114	SCREWDRIVER SET	106, 107, 119
MAINS TESTING SCREWDRIVER	110	PCL TOOLS	102	SCREWDRIVER SET - ELECTRICAL	107
MAINTENANCE SPRAY	22	PERFORATED STRIP	29	SCREWDRIVER SET - PRECISION	106, 119
MANIFOLD BOLTS	16, 42	PETROL INJECTOR CLEANER	24	SCREWS	41, 45, 46
MANIFOLD NUTS	16, 42	PETROL PIPE	64	SEALANT GUN	21, 113
MANIFOLD STUDS	16, 42	PETROL PIPE CLIPS	59, 60	SEALING WASHERS	19
MASKING TAPE	105	PICK SET	118	SEAM SEALER	24
MAT	52, 79	PIGGY BACK TERMINALS	12, 26	SEAT COVERS	52
MAXI BLADE FUSES	13, 14, 33	PIN CONNECTORS	26	SELF AMALGAMATING TAPE	28, 105
MEASURING TAPE	105	PINCH BOLTS & NUTS	5, 48	SELF DRILLING SCREWS	45, 46
MEGA FUSES	13, 14, 34	PIPE THREAD SEALANT	21	SELF GRIP PLIERS	109
METAL POLISH	21	PIPES & PARTS SECTION	59 TO 74	SELF TAPPING SCREWS	1, 45, 46
METAL TOGGLE SWITCH	31	PIPE WRENCH	109	SERRATED FLANGED SETSCREWS	41
MIDI FUSES	13, 14, 34	PLASTERS	22	SERVO HOSE	65
MIG WIRE	116	PLIERS	109, 117	SETSCREWS	2, 3, 4, 41
MINIATURE TOGGLE SWITCH	31	PLUG PATCHES	115	SHANK BOLTS	5, 48
MINIATURE GLASS RADIO FUSES	35	PLUGS (3PIN)	30	SIDE CUTTING PLIERS	104
MINI BLADE FUSES	13, 33	POLISH	23	SIDE REPEATER BULB HOLDER	36
MINI BYPASS HOSE	64	POLYTOP SCREWS	46	SIDE REPEATER LENSES	36
MINI COMPRESSOR	99	POP RIVETS	47, 48	SILICONE GASKET	21
MINI HOSE CLIPS	12	POWER STEERING STOP LEAK	24	SILICONE REPAIR TAPE	28, 105
MINI REELS	29	PPF CLEANER	24	SILICONE SEALER	21, 24
MIRROR BONDING KITS	21	PRECISION SCREWDRIVER SET	106	SILICONE SPRAY	22
MIRROR FIXING PADS	47, 105	PRE-HEATER DUCT HOSE	65	SLIMLINE WASHERS	19
MOBILE PHONE CHARGER	120	PRE-INSULATED TERMINALS	12, 26	SNAP RINGS	5
MOTOR HEATER RESISTOR	40	PRESSURE SPRAYER	113, 119	SNOW GRIPS	101
MOUNTING PASTE	110	PRE-WIRED SOCKETS	97, 98	SNOW SHOVEL	101
MOUNTING PLATE	95, 96	PRIMER PUMP	74	SOCKET CAP SCREWS	41
MUDGUARD	95	PRODUCTION PAPER	104	SOCKET HEAD SCREWS	45
MULTIBLOCK CONNECTORS	12, 27	PTFE TAPE	113	SOCKET RATCHETS	106, 107
MULTI-PURPOSE CLEANER	22	PUFLEX	25	SOCKET SETS	106 TO 108, 117
MULTI-PURPOSE PROTECTIVE LUBRICANT	22, 24	PUNCH	117	SOCKS	101
MULTI-TESTER	110	PUSH TYPE SWITCHES	32	SOFT TOP ROOF CLEANER	23
N		PVC TUBING	61	SOLDER	30, 106
NIPPLES - GREASE	70	R		SOLDERLESS NIPPLES	70
NIPPLES - SOLDERLESS	70	RADIATOR CAPS	75 TO 78	SPADE TERMINALS	12, 26
NON-RETURN VALVE	61, 63	RADIATOR DYE	93	SPANNER SETS	108, 109
NUMBER PLATE FIXING PADS	47, 105	RADIATOR HOSE	64	SPANNERS	108, 109
NUMBER PLATE FIXINGS	2, 46, 81	RADIATOR SEALANT	21	SPARK PLUG TESTER	110
NUT LOCK	21	RADIO FIXING STRIP	29	SPARK PLUG THREAD TESTER	110
NUTS	5, 6, 42	RADIO REMOVAL TOOLS	40	SPARK PLUG WRENCH	110
NUTSERTS	42	RATCHET RING SPANNERS	108	SPEAKER CABLE	29
NYLON TUBING	64	RATCHETS FOR SOCKETS	106, 107	SPEED COUPLINGS	12
NYLON WASHERS	43	R-CLIPS	10	SPEED FASTENERS	2, 46
NYLON-INSERT LOCKING NUTS	5, 6, 42	REAR VIEW MIRROR BOND KIT	21	SPIRE SPEED NUTS	2, 46
O		RED RUBBER GREASE	21, 70	SPLASH-PROOF SWITCH	31
O CLIP PLIERS	60, 109	REDUCER FOR SOCKETS	108	SPLICE CONNECTORS	26
O CLIPS	11, 59	REFLECTIVE TRIANGLE	98	SPLINE BITS	106
O RINGS	15, 18, 20, 45	REPAIR WASHERS	7, 43	SPLIT PINS	9, 47
OIL CAN	113	RETAINER	21	SPRAY GLUE	22
OIL FILLER CAPS	56, 57	RING TERMINALS	12, 26	SPRAY PAINT	24
OIL FILTER WRENCHES	112	RIVETER	106	SPRING ROLL PINS	10, 47
OIL JOINTING PAPER	71	RIVETS	10, 47, 48, 106	SPRING WASHERS	7, 43

STAINLESS STEEL HOSE CLIPS	59	TUBE TERMINALS	12	WIRE WOOL	104
STAINLESS STEEL TIES	73	TUBING	64	WIRING GROMMETS	14, 28
STANDARD BLADE FUSES	13, 33	TURTLEWAX	23	WISHBONE BOLTS	5, 48
STARTER CABLE	29	TWIST DRILLS	102	WOODRUFF KEYS	16
STEEL NUTS	4, 42	TXI BIT SET	106	WORK GLOVES	51
STEERING RACK BOOTS	72, 73	TXI SPANNER SET	108	WORK GLOVES - GRIPPER	51
STEERING RACK END REMOVAL TOOL	112	TYRE BEAD SEALER	22, 115	WORK SOCKS	101
STILLSON PIPE WRENCH	109	TYRE CONSUMABLES	115, 116	WORKLAMPS	39, 99, 118, 120
STONECHIP	24	TYRE INFLATER	114, 116	WORKSHOP SECTION	102 TO 116
STOP CABLE	71	TYRE LEVERS	115	WRENCH - OIL FILTER	112
STOP LEAK POWER STEERING FLUID	24	TYRE PRESSURE GAUGE	114	WRENCH - SPARK PLUG	110
STOP SMOKE	24	TYRE VALVE	115	WRENCH - TORQUE	107
STOP SMOKE FOR OIL	24	TYRE VALVE REPAIR TOOL	114	WRENCH - WHEEL NUT	114, 115
STRIP FUSES	13, 14, 34	TYRE WEIGHTS	115	Y	
STUD EXTRACTORS	103	U		YELLOW MARKERS	116
SUBMERSIBLE PUMP	97	UNIVERSAL EXHAUST HANGER	71		
SUMP PLUG WASHERS	8, 9, 44, 45	UNIVERSAL THERMOSTAT GASKETS	64		
SUMP PLUGS	8, 9, 44	UNIVERSAL SERVICE PART & CAPS	19		
SUMP PLUG THREAD KIT	112	UPHOLSTERY CLEANER	24		
SUMP PLUG TOOL	112	V			
SUPERGLUE	21	VAC HOSE	64		
SUPERSEAL CONNECTORS	13, 27	VACUUM CLEANER	102		
SWARFEGA	52	VALVE CORES	20		
SWITCH PANELS	33	VALVE GRINDERS	110		
SWITCHES	31 TO 33	VALVE GRINDING KITS	110, 111		
T		VALVE GRINDING PASTE	110		
TANK TAPE	105	VAN DOOR LOCK	119		
TAP & DIE SET	103	VELCRO HOOK & LOOP	105		
TAPE MEASURE	105	VINYL GLOVES	51		
TAR & GLUE REMOVER	22, 23	VULCANISING CEMENT	22		
TAX DISC HOLDERS	79	W			
T-DRIVE MACHINE SCREWS	4, 41	WARNING LIGHTS	32		
T-DRIVE SELF TAPPING SCREWS	10, 45	WARNING TRIANGLES	99, 118		
TERMINAL BLOCKS	27	WASH & WAX	23		
TERMINAL CRIMPING PLIERS	109	WASHERS	6, 7, 17, 43 TO 45		
TERMINALS ELECTRICAL	12, 26, 27	WASHER JETS	15, 60, 61		
THERMOSTAT GASKET	64	WATER HOSE	64		
THREADED BAR	41, 42	WATERPROOF CONNECTORS	13		
THREADED INSERTS	6, 42	WATERPUMP PIPE	64		
THROTTLE PULL-OFF SPRINGS	11, 47	WATERPUMP PLIERS	109		
TINSNIPS	109	WELDER	102		
TOGGLE SWITCHES	31, 32	WELDING CONSUMABLES	116		
TOOL KITS	106, 107, 117	WET & BLACK	23		
TORCH	120	WET & DRY PAPER	104, 119		
TORQUE WRENCH	107	WET & DRY VAC	102		
TOW BALL NUT & BOLT	96	WHEEL CLEANER	23		
TOW BALLS	95	WHEEL LOCK	95		
TOW ROPES	99	WHEEL NUT WRENCH	114, 115		
TOWBALL SOCKETS & PLUGS	97, 98	WHEEL WEIGHTS	16, 115		
TOWING CABLE (7 CORE)	28	WHITE GREASE WITH PTFE	22		
TOWING & OUTDOOR SECTION	95 TO 100	WINDSCREEN COVER	101		
TOWING LAMPS	98, 99	WINDSCREEN WASHER CONNECTORS	15, 60, 61		
T-PIECES	11, 15	WINDSCREEN WASHER JETS	15, 60, 61		
TRACK ROD END BOOTS	5	WINDSCREEN WASHER TUBING	61		
TRACK ROD END NUTS	5, 73	WINDSCREEN WASHER VALVES	61		
TRAILER BOARD	95	WING NUTS	6		
TRAILER CABLE	29	WIPER BLADE REFILLS	61		
TRAILER HITCH LOCK	95	WIPER BLADES	61, 62		
TRAILER JACK	95	WIPER LINKAGE	62, 63		
TRAILER WHEEL	95	WIPER MOTOR	62, 63		
TRAPPER HAT	101	WIPER REPAIR CLIP	74		
TRIM KNIFE	103	WIRE - ELECTRICAL	28, 29, 30		
TRIM KNIFE BLADES	103	WIRE BRUSHES	104		
TRIM & TYRE SHINE	23	WIRE CUTTING PLIERS	109		
TROLLEY JACK	117	WIRE STRIPPER	109		

PART NO.	PAGE	400027	113	400234	120	000-SSS	59	101190A	110	25-PC	30, 59	451-0150	64
0233	24	400028	113	400236	117	00-MSE	59	101191A	110	28-PC	30, 59	451-0160	64
0235	24	400029	113	400237	120	00-SSS	59	101192A	110	2A-MSE	59	451-0170	64
0236	24	400038	113	400238	118	01-MSE	59	101193A	110	2A-SSS	59	451-1040	64
0240	24	400039	110	400239	118	01-SSS	59	101194A	110	2X-MSE	59	451-1060	64
0373	24	400040	29	400240	107	02-MSE	59	101195A	110	2X-SSS	59	451-1080	64
0374	24	400045	103	400241	118	02-SSS	59	101196A	110	300-0001	39	451-3025	61
0456	24	400049	103	400242	118	03-MSE	59	101300A	40	300-0002	35	451-3030	61
0458	24	400053	104	400243	118	03-SSS	59	101301A	40	300-0003	35	451-3031	61
0885	24	400058	105	400244	119	04-MSE	59	101302A	40	300-0004	35	451-3050	61
0886	24	400079	105	400245	119	04-SSS	59	101303A	40	300-0006	65	451-3051	61
0888	24	400088	66, 111	400246	107	05-MSE	59	101304A	40	300-0011	62	451-3060	61
0889	24	400090	112	400247	119	05-SSS	59	101305A	40	300-0012	62	451-3080	61
0890	24	400092	112	400248	117	06-MSE	59	101306A	40	300-0014	73	451-3150	64
0891	24	400093	112	400249	119	06-SSS	59	101307A	40	300-0015	62	451-3160	64
0978	24	400094	112	400250	118	0-MSE	59	101308A	40	300-0016	62	451-3161	64
0979	24	400095	112	400251	99, 120	0-SSS	59	101309A	40	300-0017	62	451-3180	64
0986	24	400096	112	400252	99, 120	0X-MSE	59	101453A	109	300-0018	62	451-3181	64
0987	24	400098	66	400253	119	0X-SSS	59	101484A	106	300-0020	63	451-3195	64
0988	24	400098	111	400254	120	100000A	108	101518A	110	300-0021	63	451-5050	64
0989	24	400100	106	400255	120	100001A	108	101520A	111	300-0022	63	451-5051	64
0990	24	400108	109	400256	120	100002A	108	101690A	103	300-0032	40	451-5055	64
0991	24	400109	109	400259	101	100003A	108	101740A	109	35-PC	30, 59	451-5060	64
1000	24	400112	104	400260	118	100004A	108	101810A	109	3X-MSE	59	451-5061	64
1001	24	400114	108	400263	118	100005A	108	101820A	109	3X-SSS	59	451-5065	64
1002	24	400115	108	400264	119	100006A	108	101821A	109	400050X	103	451-5080	64
1005	24	400116	112	400266	107	100008A	108	101837A	104	411-0060	74	451-5081	64
1006	24	400118	114	400267	117	100009A	108	101845A	109	411-0085	74	451-5085	64
1008	24	400121	58, 113	400268	118	100010A	108	101992A	108	411-0090	74	451-5090	64
1009	24	400125	112	400270	119	100011A	108	101993A	108	411-9021	63	451-5095	64
1427	24	400126	112	400271	117	100012A	108	104050A	68, 111	411-9031	63	451-5096	64
1428	24	400127	112	400272	108	100013A	108	104051A	111	411-9041	63	451-5110	64
1430	24	400128	112	400273	107	100014A	108	104051C	111	411-9051	63	451-5221	63
1433	24	400129	112	400280	120	100015A	108	104076A	109	425-1440	96	451-5230	63
1434	24	400132	112	400285	120	100016A	108	104078A	109	425-1450	96	451-5231	63
1435	24	400133	112	400300	119	100100A	109	104365A	66, 111	425-1490	96	451-5231	63
1436	24	400146	106	400301	117	100102A	109	10-MC	60	425-1500	96	451-5240	63
1437	24	400147	106	400302	107	100104A	109	10-PC	30, 59	425-1510	96	451-5250	63
1440	25	400152	106	400303	107	100108A	109	11-SF	60	425-4090	39	451-5251	63
1441	24	400155	113	400304	107	100110A	109	12-MC	60	427-0500	35	451-5255	63
2591	25	400159	99	400305	107	100112A	109	12-PC	30, 59	427-0501	35	451-5270	63
6729	25	400160	99	400310	119	100241A	108	13-MC	60	427-0510	35	451-5271	63
6731	25	400171	117	512200	106	100242A	106	13-PC	30, 59	444-0010	63	451-5275	63
6734	25	400172	117	512203	108	100243A	108	14-001	39	444-0011	63	451-5395	63
6830	25	400174	117	512206	108	100500A	106	14-002	39	444-0012	63	451-5450	64
6832	25	400176	107	512208	108	100540A	103	14-003	39	444-0020	63	451-5451	64
7003	25	400201	117	512209	107	101001A	110	14-004	39	444-0021	63	451-5455	64
201421	113	400202	101	512212	108	101002A	110	14-MC	60	444-0022	63	451-5460	64
201425	113	400203	118	514200	106	101006A	110	14-PC	30, 59	444-0080	63	451-5461	64
201426	113	400205	117	538200	106	101009A	110	16-MC	60	444-0081	63	451-5480	64
201427	113	400206	117	538203	108	101015A	110	16-PC	30, 59	444-0090	63	451-5481	64
201428	113	400207	117	538211	107	101028A	114	17-PC	30, 59	444-0091	63	451-5495	64
201429	113	400208	117	612001	108	101030A	103	18-MC	60	450-0241	64	451-5496	64
201430	113	400209	107	612201	108	101035C	110	19-PC	30, 59	450-0251	64	451-5530	65
201996	108	400213	119	612203	108	101036A	110	19-SF	60	450-0261	64	451-5540	65
204023	115	400215	107	612204	108	101044A	113	1A-MSE	59	450-0281	64	451-5550	65
204034	106	400217	101	612207	108	101054A	108	1A-SSS	59	450-0321	64	451-5552	65
400002	106	400219	99, 101	612208	108	101059A	109	1X-MSE	59	450-0341	64	451-5560	65
400003	106	400221	120	700000	104	101070A	103	1X-SSS	59	450-0351	64	451-5562	65
400004	106	400223	119	700001	104	101071A	103	201147CX	21, 110	450-0361	64	451-5570	65
400005	106	400224	117	700002	104	101092A	112	201147FX	21, 110	450-0371	64	451-5572	65
400007	109	400225	99, 120	700030	104	101093A	110	20-MC	60	450-0381	64	451-5580	65
400011	109	400226	118	800100	108	101095A	112	21-MC	60	450-0391	64	451-5582	65
400013	106	400227	120	800700	65, 111	101102A	104	22-PC	30, 59	451-0030	64	451-5590	65
400018	111	400228	117	800701	65, 111	101129A	113	23-001	60, 113	451-0035	64	451-5592	65
400019	112	400230	118	800750	65, 111	101149A	21, 110	23-003-MSE	59	451-0040	64	451-5610	64
400022	111	400231	118	800770	65, 111	101153A	111	23-003-SSS	59	451-0050	65, 113	451-5620	64
400023	114	400232</											

451-5650	64	455-1170	58	455-5518	59	455-7611	60	456-8120	114	469-5150	71	473-1020	68
451-5660	64	455-1172	58	455-5520	59	455-7616	60	456-8210	114	469-5210	71	473-1030	68
451-5670	64	455-1175	58	455-6050	60	455-7621	60	456-8220	114	469-5212	71	473-2010	68
451-5680	64	455-1220	58	455-6060	60	455-7631	60	456-8310	114	469-5214	71	474-3040	68
451-5690	64	455-1222	58	455-6080	60	455-7641	60	456-8320	114	469-5220	71	474-3042	68
451-5700	64	455-1225	58	455-6100	60	455-7651	60	456-8450	114	469-5222	71	474-3060	68
451-5710	64	455-1250	58	455-6125	60	455-7661	60	456-8510	116	469-5224	71	474-7010	68
451-5720	64	455-1252	58	455-6165	60	455-7671	60	456-8910	114	470-T100	65	474-7040	68
451-5730	64	455-1255	58	455-6175	60	455-7676	60	456-8920	114	470-T115	65	474-9010	68
451-5757	64	455-1270	58	455-6185	60	455-7681	60	456-8991	114	470-T120	65	474-9100	69
451-5760	64	455-1272	58	455-6195	60	455-7800	64	456-8992	116	470-T200	65	474-9110	69
451-5763	64	455-1275	58	455-6215	60	455-8019	58	457-0010	70	470-T500	65	474-9130	69
451-5770	64	455-1300	58	455-6225	60	455-8022	58	457-0030	70	470-T510	65	474-9140	69
451-5776	64	455-1302	58	455-6235	60	455-8025	58	457-0070	70	470-T515	65	474-9150	69
451-5780	64	455-1305	58	455-6245	60	455-8028	58	457-0080	70	470-T520	65	474-9160	69
451-5789	64	455-1350	58	455-6255	60	455-8031	58	457-0110	70	470-T530	65	474-9170	69
451-5802	64	455-1352	58	455-6265	60	455-8035	58	457-0130	70	470-T535	65	474-9190	69
451-5820	64	455-1355	58	455-7001	60	455-8039	58	457-0210	70	471-0010	66	474-9200	69
451-5821	64	455-1400	58	455-7011	60	455-8043	58	457-0220	70	471-0020	66	474-9230	69
451-5822	64	455-1402	58	455-7021	60	455-8047	58	457-0310	70	471-0030	66	474-9250	69
451-5825	64	455-1405	58	455-7031	60	455-8051	58	461-0002	54, 55	471-0040	66	474-9260	69
451-5840	64	455-1450	58	455-7041	60	455-8055	58	461-0004	54, 55	471-0110	66	474-9280	69
451-5841	64	455-1455	58	455-7051	60	455-8059	58	461-0006	54, 55	471-0112	66	474-9290	69
451-5842	64	455-1550	58	455-7056	60	455-8063	58	461-0010	54, 55	471-0113	66	474-9310	69
451-5845	64	455-1555	58	455-7061	60	455-8067	58	461-0012	54, 55	471-0114	66	481-0280	71
451-5860	64	455-1600	58	455-7071	60	455-8073	58	461-0014	54, 55	471-0120	66	481-0282	71
451-5861	64	455-1700	58	455-7081	60	455-8079	58	461-0036	54, 55	471-0140	66	481-0320	71
451-5862	64	455-1850	58	455-7091	60	455-8085	58	461-0510	54, 55	471-0150	66	481-0322	71
451-5865	64	455-1900	58	455-7101	60	455-8091	58	461-0512	54, 55	471-0220	66	481-0360	71
451-5880	64	455-1960	58	455-7111	60	455-8097	58	461-0514	54, 55	471-0310	67	481-0362	71
451-5881	64	455-2970	58	455-7121	60	455-8103	58	461-0516	54, 55	471-0312	67	481-0380	71
451-5885	64	455-4512	59	455-7131	60	455-8112	58	461-0518	54, 55	471-0313	67	481-0382	71
451-5910	64	455-4516	59	455-7141	60	455-8121	58	461-0520	54, 55	471-0410	67	481-0420	71
451-5915	64	455-4520	59	455-7151	60	455-8130	58	461-0522	54, 55	471-0510	67	481-0422	71
451-5920	64	455-4525	59	455-7161	60	455-8139	58	461-0524	54, 55	471-0511	67	481-0450	71
451-5925	64	455-4532	59	455-7171	60	455-8148	58	461-0526	54, 55	471-0512	67	481-0452	71
451-5930	64	455-4540	59	455-7201	60	455-8161	58	461-0528	54, 55	471-0513	67	481-0480	71
451-5935	64	455-4550	59	455-7211	60	455-8174	58	461-0530	54, 55	471-0610	67	481-0482	71
451-5940	64	455-4560	59	455-7221	60	455-8187	58	461-0532	54, 55	471-0620	67	481-0500	71
451-5945	64	455-4570	59	455-7231	60	455-8200	58	461-0534	54, 55	471-0631	67	481-0502	71
451-5950	64	455-4600	59	455-7236	60	455-8213	58	461-0536	54, 55	471-0641	67	481-0520	71
451-5955	64	455-5000	60, 109	455-7241	60	455-8226	58	461-0538	54, 55	471-0710	67	481-0522	71
451-5960	64	455-5050	59	455-7246	60	455-8239	58	461-0540	54, 55	471-0720	67	481-0540	71
451-5965	64	455-5070	59	455-7251	60	455-9035/10	58	461-0542	54, 55	471-0731	67	481-0542	71
451-5995	64	455-5090	59	455-7255	60	455-9040/10	58	461-0544	54, 55	471-0732	67	481-0580	71
451-6010	65	455-5110	59	455-7261	60	455-9045/10	58	461-0546	54, 55	471-0733	67	481-0582	71
451-6011	65	455-5130	59	455-7271	60	455-9050/10	58	461-0701	54, 55	471-0741	67	481-0600	71
451-6012	65	455-5150	59	455-7276	60	455-9070/10	58	461-0703	54, 55	471-0810	67	481-0602	71
451-6140	65, 113	455-5180	59	455-7281	60	455-9080/10	58	461-0705	54, 55	471-1010	67	481-0650	71
451-6145	65	455-5200	59	455-7291	60	455-9095/10	58	461-0707	54, 55	471-1110	67	481-0652	71
451-6150	65, 113	455-5230	59	455-7301	60	456-5010	61	461-0709	54, 55	471-1120	68	481-0670	71
451-6155	65	455-5270	59	455-7311	60	456-5020	61	461-0711	54, 55	471-1410	68	481-0672	71
451-6160	65	455-5310	59	455-7321	60	456-5030	61	467-0010	70	472-0500	68	481-0700	71
451-6170	65	455-5340	59	455-7331	60	456-5040	61	467-0020	70	472-6010	68	481-0702	71
451-6180	65	455-5370	59	455-7341	60	456-5050	61	467-0060	71	472-6020	68	481-0750	71
451-6190	65	455-5400	59	455-7351	60	456-5110	61	467-0070	71	472-6030	68	481-0752	71
455-0000	58	455-5430	59	455-7361	60	456-5120	61	467-0080	71	472-6210	68	481-0800	71
455-1090	58	451-5465	64	455-7371	60	456-5140	61	467-0120	70	472-6240	68	481-0802	71
455-1092	58	451-5485	64	455-7401	60	456-5150	61	467-0130	70	472-6310	68	481-0920	71
455-1095	58	451-5490	64	455-7411	60	456-5160	60	467-0140	70	472-6320	68	481-0922	71
455-1110	58	455-5509	59	455-7421	60	456-5170	61	467-0190	71	472-6330	68	481-7530	71
455-1112	58	455-5510	59	455-7431	60	456-5180	60	467-1310	70	472-6350	68	481-7531	71
455-1115	58	455-5511	59	455-7441	60	456-5190	60	467-1330	70	472-6420	68	481-7660	71
455-1130	58	455-5512	59	455-7451	60	456-5200	60	467-1340	70	472-6430	68	481-7661	71
455-1132	58	455-5513	59	455-7461	60	456-5210	61	469-5050	71	472-6450	68	481-7662	71
455-1135	58	455-5514	59	455-7471	60	456-8010	114	469-5070	71	472-6530	68	481-7690	71
455-1160	58	455-5515	59	455-7481	60	456-8020	114	469-5120	71	472-6540	68	481-7691	71
455-1162	58	455-5516	59	455-7491	60	456-8031	114	469-5130	71	472-6550	68	481-7692	71
455-1165	58	455-5517	59	455-7601	60	456-8110	114	469-5140	71	473-1010	68	485-3001	71

485-3002	74	500-1050	1	500-5150	12	501-9541	18	506-3220	26	507-4100	28, 105	508-1760	29
486-2010	42	500-1060	1	500-5160	12, 26	501-9551	18	506-3330	26	507-4150	105	508-1770	29
486-2020	42	500-1070	1	500-5200	14, 34	501-9571	18	506-3560	26	508-0120	28	508-1780	29
486-2030	42	500-1080	1	500-5210	13	501-9581	18	506-4110	26	508-0125	28	508-1810	29
486-2070	42	500-1160	2	500-5220	14, 34	501-9590	18	506-4220	26	508-0150	28	508-1820	29
488-0990	21, 113	500-1170	2	500-5225	14, 34	501-9600	16	506-4222	26	508-0155	28	508-1830	29
492-0140	116	500-1250	2	500-5230	13, 33	501-9700	13, 27	506-5030	27	508-0170	28	508-1840	29
491-4060	115	500-1252	2	500-5240	13, 33	503-0010	20	506-5040	27	508-0175	28	508-1850	29
491-5000	115	500-1255	2	500-5250	13, 34	503-0020	20	506-5050	27	508-0180	28	508-1860	29
491-5010	115	500-1260	4	500-5251	14, 33	593-3500	52	506-5340	27	508-0185	28	508-1870	29
491-5020	115	500-1270	4	500-5255	13	503-5500	15	506-6010	27	508-0260	28	508-1880	29
491-5030	115	500-1280	4	500-5260	14, 34	503-5505	15	506-6040	27	508-0265	28	508-2010	29
491-5035	115	500-1290	4	500-5270	13, 34	503-5510	15	506-7010	27	508-0290	28	508-2020	29
491-5050	115	500-1410	2	500-5280	13, 33	503-6500	5	506-7020	27	508-0295	28	508-2025	29
491-5060	115	500-1415	2	500-5300	15	505-1120	26	506-7030	27	508-0330	28	508-2030	29
491-5070	115	500-1440	3	500-5310	12	505-1130	26	506-7040	27	508-0335	28	508-2040	29
491-5080	115	500-1450	3	500-5350	12, 29	505-1140	26	506-8110	27	508-0340	28	508-2050	29
491-5090	115	500-1460	3	500-5410	11, 59	505-1230	26	506-8120	27	508-0345	28	508-2105	29
491-5100	115	500-1470	3	500-5420	11, 59	505-1240	26	506-8130	27	508-0520	28	508-2110	29
491-5200	115	500-1480	3	500-5450	12	505-1242	26	506-8210	27	508-0525	28	508-2120	29
491-5210	115	500-2015	3	500-5470	15	505-1340	26	506-8220	27	508-0550	28	508-2130	29
491-5220	115	500-2515	3	500-5475	15	505-1350	26	506-8230	27	508-0555	28	508-2140	29
491-5230	115	500-3015	4	500-5480	15, 61	505-2110	26	506-8240	27	508-0570	28	508-2350	29
491-5240	115	500-3530	4	500-5490	12	505-2130	26	506-8250	27	508-0575	28	508-2380	29
491-5250	115	500-3550	4	500-5500	9	505-2140	26	506-8260	27	508-0580	28	508-2420	29
491-5260	115	500-3570	4	500-5510	15	505-2230	26	507-0010	27	508-0585	28	508-2440	29
491-5270	115	500-3590	5	500-5520	16	505-2240	26	507-0015	27	508-0660	28	508-2445	29
491-5280	115	500-3595	5	500-5530	16	505-2242	26	507-0020	27	508-0665	28	508-2450	29
491-5290	115	500-3600	5	500-6100	9	505-2340	26	507-0025	27	508-0690	28	508-2455	29
491-5300	115	500-3610	5	500-6120	11	505-2350	26	507-0030	27	508-0695	28	508-2460	29
491-5310	22, 115	500-4010	6	500-6140	10	505-3110	26	507-0035	27	508-0730	28	508-2475	29
491-5320	22, 115	500-4110	6	500-6150	10	505-3140	26	507-0040	27	508-0735	28	508-2510	30
491-5330	115	500-4120	5	500-6211	10	505-3210	26	507-0045	27	508-0740	28	508-2520	30
491-5335	115	500-4170	6	500-6301	11	505-3240	26	507-0050	27	508-0745	28	508-2530	30
491-5340	22, 115	500-4180	6	500-6311	11	505-3242	26	507-0055	27	508-0820	29	508-2540	30
491-5350	115	500-4210	6	500-6460	11	505-3340	26	507-0110	27	508-0825	28	508-2550	30
491-5360	115	500-4220	7	500-6500	16	505-6130	26	507-0115	27	508-0830	29	508-2551	30
491-5370	115	500-4230	7	500-6550	16	505-6140	26	507-0120	27	508-0835	28	508-2560	30
491-5380	115	500-4240	6	500-6560	16	505-6150	26	507-0125	27	508-0845	28	508-2561	30
491-5390	22, 115	500-4250	7	500-7000	5	505-6160	26	507-0135	27	508-0920	29	508-2570	30
491-5400	115	500-4310	7	500-7020	18	505-6230	26	507-0140	27	508-0930	29	508-2571	30
491-5410	115	500-4320	7	500-8000	19, 94	505-6240	26	507-0145	27	508-0940	29	508-2580	30
491-5420	116	500-4340	7	500-8020	20, 94	505-6250	26	507-0150	27	508-1010	29	508-2590	30
491-5430	116	500-4410	8	500-8040	19, 93	505-6260	26	507-0155	27	508-1012	29	508-2591	30
491-5440	116	500-4415	8	500-8050	19, 93	505-6270	26	507-0160	27	508-1120	29	508-2600	30
491-5470	116	500-4420	8, 44	500-8060	20, 93	505-6340	26	507-0210	30	508-1150	29	508-2601	30
491-5480	115	500-4425	8	500-8070	19, 93	505-6350	26	507-2020	30	508-1250	28	508-2701	29
492-0010	116	500-4430	8	500-8080	20, 93	505-6360	26	507-2030	30	508-1255	28	508-2750	29
492-0020	116	500-4435	9	500-9000	17	505-6370	26	507-2031	30	508-1510	29	508-2751	29
492-0030	116	500-4480	7	500-9020	17	505-6380	26	507-3010	27	508-1520	29	508-2752	29
492-0040	116	500-4520	7	500-9050	17	505-7130	26	507-3020	27	508-1530	29	508-3010	29
492-0050	116	500-4530	8	500-9060	17	505-7140	26	507-3021	27	508-1540	29	508-3020	29
492-0060	116	500-4540	9	501-0020	18	505-7230	26	507-3025	27	508-1550	29	508-3030	29
492-0070	116	500-4550	8	507-0130	27	505-7240	26	507-3026	27	508-1560	29	508-3040	29
492-0080	116	500-4555	8	501-1400	3	505-8130	26	507-3027	27	508-1570	29	508-3050	29
492-0090	116	500-4585	10	501-4000	5	505-8240	26	507-3028	27	508-1580	29	508-3110	29
492-0100	116	500-4590	9	501-4100	6	505-8242	26	507-3030	27	508-1610	29	508-3120	29
492-0110	116	500-4600	9	501-5425	11	505-8340	26	507-3031	27	508-1620	29	508-3130	29
492-0120	116	500-4610	9	501-6330	11	505-9130	26	507-3035	27	508-1630	29	508-3140	29
492-0130	116	500-4620	9	501-6520	16	505-9240	26	507-3038	27	508-1640	29	508-3150	29
4X-MSE	59	500-4650	10	501-6530	16	505-9242	26	507-3040	27	508-1650	29	508-3200	29
4X-SSS	59	500-4800	10	501-8010	20, 94	505-9340	26	507-3041	27	508-1660	29	508-3300	29
500-0010	18	500-4810	10	501-8030	19, 93	506-1120	26	507-3200	27	508-1670	29	508-3400	29
500-0990	19	500-4850	6	501-8100	19, 93	506-1220	26	507-3300	27	508-1680	29	508-3500	29
500-1000	2	500-5010	12, 26	501-8110	19, 93	506-2110	26	507-3400	27	508-1710	29	508-3600	29
500-1010	1	500-5020	12, 26	501-9500	17	506-2220	26	507-3500	27	508-1720	29	511-0000	31
500-1020	1	500-5110	14, 28	501-9511	17	506-2222	26	507-3900	27	508-1730	29	511-0020	31
500-1030	1	500-5115	14, 28	501-9521	17	506-2330	26	507-4010	28, 105	508-1740	29	511-0030	30
500-1040	1	500-5120	14, 28	501-9531	17	506-3110	26	507-4020	28, 105	508-1750	29		

511-0040	30	513-3010	28	514-2150	33	514-5661	34	520-1110	36	521-4990	39	534-2160	41
511-0050	30	513-3020	28	514-2200	33	514-5681	34	520-12085	36	521-5070	39	534-2180	41
511-0060	30	513-3030	28	514-2250	33	514-5721	34	520-12188	36	530-2100	41	534-2200	41
511-1000	30	513-3040	28	514-2300	33	514-5731	34	520-12271	36	530-2200	41	534-2600	41
511-1002	30	513-3050	28	514-3020	33	514-5741	34	520-12275	36	530-2580	41	534-2660	41
511-1010	30	513-3060	28	514-3025	33	514-5751	34	520-12276	36	530-2600	41	534-3060	41
511-1030	30	513-3070	28	514-3030	33	514-5761	34	520-12277	36	530-2620	41	534-3080	41
511-1040	30	513-3080	28	514-3035	33	514-6020	33	520-2070	36	530-2650	41	534-3100	41
511-1050	30	513-3090	28	514-3040	33	514-6025	33	520-2070-1	36	530-2700	41	534-3120	41
511-1060	30	513-3110	28	514-3045	33	514-6030	33	520-2090	36	530-3080	41	534-3140	41
511-2100	30	513-3120	28	514-3050	33	514-6035	33	520-2330	36	530-3100	41	534-3160	41
511-2102	30	513-3140	28	514-3055	33	514-6040	33	520-2330-1	36	530-3150	41	534-3200	41
511-3200	30	513-3150	28	514-3070	33	514-6045	33	520-2390	36	530-3200	41	534-3240	41
511-3202	30	513-3160	28	514-3075	33	514-6050	33	520-239D	36	530-3250	41	534-3300	41
511-3204	30	513-3170	28	514-3100	33	514-6055	33	520-2450	36	530-3300	41	534-3600	41
511-3210	30	513-3180	28	514-3105	33	514-6075	33	520-2450-1	36	530-3600	41	534-3620	41
511-3230	30	513-5000	36	514-3150	33	514-6100	33	520-2860	36	530-3650	41	534-3660	41
511-3240	30	513-5010	36	514-3155	33	514-6105	33	520-286A	36	530-3700	41	534-3700	41
511-3250	30	513-5020	36	514-3200	33	514-6150	33	520-286G	36	530-3800	41	534-3740	41
511-3260	30	513-5030	36	514-3205	33	514-6155	33	520-286T	36	530-4050	41	534-3800	41
511-3300	30	513-5040	36	514-3250	33	514-6200	33	520-2970	36	530-4100	41	534-4100	41
511-3302	30	513-5050	36	514-3255	33	514-6205	33	520-3156	36	530-4420	41	534-4160	41
511-3310	30	513-5060	36	514-3300	33	514-6250	33	520-3157	36	531-2600	41	534-4200	41
511-3320	30	513-6711	29	514-3305	33	514-6255	33	520-3350	37	531-2650	41	534-4240	41
511-3322	30	513-6721	30	514-4020	33	514-6300	33	520-3800	37	531-3100	41	534-4300	41
511-3330	30	513-7030	34	514-4021	33	514-6305	33	520-3800-1	37	531-3150	41	534-4400	41
511-3340	30	513-7040	34	514-4030	33	514-6755	33	520-380W	37	531-3200	41	534-4660	41
511-3350	30	513-7050	34	514-4040	33	514-7010	35	520-3820	37	531-3600	41	534-4800	41
511-3360	30	513-7060	34	514-4050	33	514-7020	35	520-3820-1	37	532-2000	48	534-5200	41
511-3400	30	513-7080	34	514-4051	33	514-7030	35	520-382R	37	532-2005	48	534-5300	41
511-3402	30	513-7100	34	514-4060	33	514-8031	34	520-382W	37	532-2010	48	534-7000	41
511-3410	30	513-8030	34	514-4070	33	514-8110	35	520-4270-1	37	532-2015	48	534-7010	41
511-3412	30	513-8040	34	514-4071	33	514-8131	35	520-4330	37	532-2020	48	534-7020	41
511-4400	30	513-8050	34	514-4080	33	514-8141	35	520433A	37	532-2025	48	534-7030	41
511-4402	30	513-8060	34	514-4081	33	514-8151	35	520-433B	37	532-2050	48	534-7100	41
511-4600	30	513-8070	34	514-4100	33	514-8161	35	520-433C	37	532-2055	48	534-7120	41
511-4602	30	513-8080	34	514-4101	33	514-8171	35	520-433D	37	532-2100	48	534-7130	41
511-5406	73	513-8100	34	514-5101	34	514-8200	35	520-4340	37	532-2105	48	534-7140	41
511-5407	73	513-8125	34	514-5121	34	514-8300	35	520-4480-1	37	532-2200	48	534-7200	41
511-5420	30	513-8150	34	514-5131	34	514-9100	34	520-4530-1	37	532-2205	48	534-7210	41
511-6500	30	514-0010	35	514-5141	34	514-9125	34	520-4840	37	532-2250	48	534-7230	41
511-6502	30	514-0020	35	514-5151	34	514-9150	34	520-4990-1	37	532-2255	48	534-7240	41
511-6600	30	514-0030	35	514-5161	34	514-9150	34	520-4995	37	532-2300	48	536-2080	41
511-6602	30	514-0040	35	514-5171	34	514-9175	34	520-5010	38	532-2305	48	536-2080	49
511-7404	30	514-0110	35	514-5181	34	514-9200	34	520-5010-1	38	532-2400	48	536-4080	49
511-8520	73	514-0120	35	514-5221	35	514-9225	34	520-501A	38	532-2405	48	536-4110	49
511-8530	73	514-0140	35	514-5231	35	514-9250	34	520-5660	38	532-2501	48	539-3665	41
511-8532	73	514-0150	35	514-5241	35	514-9300	34	520-5660-1	38	532-2505	48	539-3680	41
511-8540	73	514-0160	35	514-5251	35	514-9500	34	520-5810	38	532-2601	48	539-3695	41
511-8550	73	514-0180	35	514-5261	35	515-0011	30	520-5810-1	38	532-2605	48	539-3795	41
511-8552	73	514-0200	35	514-5281	35	515-0021	30	520-8100	39	532-2700	48	539-3850	41
511-9170	49	514-0220	35	514-5291	35	515-0031	30	520-8115	39	532-2705	48	539-3950	41
513-0012	30	514-0240	35	514-5326	35	515-5100	39	520-9005	37	532-2800	48	539-3970	41
513-0014	30	514-0260	35	514-5331	35	515-5170	39	520-9006	37	532-2805	48	532-2501	48
513-0018	30	514-1020	34	514-5346	35	515-5190	39	520-D2R0	37	532-2900	48	544-2090	49
513-0034	30	514-1040	34	514-5366	35	515-6000	39	520-D250	37	532-2905	48	545-1320	41
513-0058	30	514-1060	34	514-5376	35	515-7000	39	520-H080	37	533-3160	41	545-1340	41
513-0110	30	514-1080	34	514-5431	34	515-8000	39	520-H110	38	533-3600	41	545-1350	41
513-0140	30	514-1200	34	514-5441	34	520-1000	36	521-1490	38	533-3700	41	545-1450	41
513-0150	30	514-1250	34	514-5531	35	520-1010	36	521-1500	38	534-1080	41	545-1470	41
513-0316	30	514-1300	34	514-5541	35	520-1020	36	521-2410	38	534-1120	41	545-1550	41
513-0510	30	514-1400	34	514-5551	35	520-1030	36	521-2420	38	534-1600	41	545-1570	41
513-0516	30	514-1500	34	514-5561	35	520-1040	36	521-2490	38	534-1660	41	545-7120	41
513-0520	30	514-1600	34	514-5581	35	520-1050	36	521-2900	38	534-1700	41	545-7220	41
513-0525	30	514-2030	33	514-5591	35	520-1060	36	521-3340	38	534-2040	41	545-7240	41
513-0530	30	514-2040	33	514-5601	34	520-1070	36	521-3460	38	534-2050	41	545-7310	41
513-0540	30	514-2050	33	514-5631	34	520-1080	36	521-4600	38	534-2060	41	545-7320	41
513-0550	30	514-2070	33	514-5641	34	520-1090	36	521-4660	38	534-2080	41	545-7340	41
513-0560	30	514-2100	33	514-5651	34	520-1100	36	521-4750	39	534-2100	41	545-7520	41

545-7540	41	549-1260	42	550-2540	43	551-0400	43	552-1060	45	555-3320	45	555-9545	46
545-7620	41	549-1350	42	550-2550	43	551-0410	43, 45	552-1070	45	555-3325	45	555-9550	46
545-7640	41	549-1360	42	550-3060	43	551-0460	43, 45	552-1080	45	555-3330	45	555-9570	46
546-0320	41	549-1420	42	550-3080	43	551-0500	43, 45	552-1100	45	555-3360	45	555-9575	46
546-0415	41	549-1430	42	550-3100	43	551-0580	43, 45	552-1105	45	555-3420	45	555-9580	46
546-0425	41	549-1440	42	550-3110	43	551-0630	43	552-1110	45	555-3430	45	555-9585	46
546-0435	41	549-1450	42	550-3130	43	551-0670	43, 45	552-1120	45	555-3530	45	555-9590	46
546-0445	41	549-1460	42	550-4050	43	551-0700	43	552-1140	45	555-3540	45	556-3040	46
546-0455	41	549-1465	42	550-4060	43	551-0710	43, 45	552-1160	45	555-3580	45	556-3060	46
546-2340	41	549-1470	42	550-4080	43	551-0760	43	552-1170	45	555-3640	45	556-3080	46
546-2360	41	549-1475	42	550-4100	43	551-0780	43	552-1170	45	555-3660	45	556-3210	46
546-6720	41	549-1480	42	550-4120	43	551-0790	43, 45	552-1190	45	555-3770	45	556-4020	46
546-6820	41	549-1485	42	550-4140	43	551-1080	43, 45	552-1195	45	555-3780	45	556-4040	46
546-6840	41	549-1486	42	550-4160	43	551-1100	43, 45	552-1200	45	555-4320	45	556-4070	46
546-6860	41	549-1690	42	550-5010	43	551-1150	43, 45	552-1220	45	555-4325	45	556-4090	46
546-6920	41	549-6235	49	550-5020	43	551-1160	43, 45	552-1240	45	555-4330	45	556-4120	46
546-6940	41	549-6310	42	550-5030	43	551-7170	44	552-1250	45	555-4420	45	556-4130	46
546-6960	41	549-6320	42	550-5040	43	551-1180	43, 45	552-1270	45	555-4430	45	556-4160	46
546-7110	41	549-6330	42	550-5050	43	551-1200	43, 45	552-1280	45	555-4460	45	556-4420	49
546-7130	41	549-6340	42	550-5060	43	551-1640	43, 45	552-1300	45	555-4530	45	556-4460	46
546-7210	41	549-6350	49	550-5510	43	551-3120	43, 45	552-1320	45	555-5000	45	556-4650	46
546-7230	41	549-6410	42	550-5520	43	551-3150	43, 45	552-1330	45	555-5030	45	556-4660	46
546-7250	41	549-6420	42	550-5530	43	551-3220	43, 45	552-1350	45	555-5100	45	556-4670	46
546-7310	41	549-6430	42	550-5540	43	551-3430	43, 45	552-1360	45	555-5140	45	556-4680	46
546-7330	41	549-6450	42	550-5550	43	551-3440	43, 45	552-1380	45	555-5200	45	556-4910	46
546-7350	41	549-7260	49	550-5560	43	551-3450	44, 45	552-1385	45	555-5320	46	556-4920	46
546-8205	41, 46	550-0240	42	550-6020	43	551-6010	44	552-1420	45	555-5330	46	556-4940	46
546-8210	41, 46	550-0250	42	550-6040	43	551-6020	44	552-1420	45	555-5420	46	556-4950	46
546-8320	41, 46	550-0260	42	550-6060	43	551-6030	44	552-1450	45	555-5430	46	556-4960	46
546-9920	41	550-0270	42	550-6080	43	551-6040	44	555-0220	45	555-5520	46	556-5130	49
546-9950	42	550-0280	42	550-6100	43	551-6050	44	555-0320	45	555-5530	46	556-5230	49
546-9951	42	550-0290	42	550-6120	43	551-6060	44	555-0330	45	555-6000	45	556-5460	49
546-9960	42	550-0300	42	550-6140	43	551-6070	44	555-0335	45	555-6050	45	556-5720	49
546-9961	42	550-0320	42	550-6160	43	551-6080	44	555-0340	45	555-6100	45	556-7010	46
546-9970	42	550-0330	42	550-6500	43	551-6090	44	555-0420	45	555-6150	45	556-7020	46
546-9971	42	550-0505	42	550-6510	43, 45	551-6100	44	555-0430	45	555-6200	45	556-7030	46
548-0220	42	550-0510	42	550-6520	43	551-6110	44	555-0440	45	555-6250	45	556-7040	46
548-0230	42	550-0520	42	550-6530	43, 45	551-6120	44	555-0460	45	555-6320	45	556-7110	46
548-0240	42	550-0530	42	550-6540	43	551-6130	44	555-0520	45	555-6330	45	556-7120	46
548-0250	42	550-0540	42	550-6560	43	551-6140	44	555-0530	45	555-6420	45	556-7130	46
548-0260	42	550-0550	42	550-6580	43	551-6150	44	555-0540	45	555-6430	45	556-7140	46
548-0270	42	550-0570	42	550-6600	43	551-6160	44	555-0560	45	555-6440	45	556-7200	46
548-0430	42	550-0580	42	550-6620	43	551-6170	44	555-0620	45	555-6530	45	556-7210	46
548-0440	42	550-1240	43	550-8020	43	551-6180	44	555-0630	45	555-6540	45	556-7220	46
548-0450	42	550-1250	43	550-8030	43	551-6190	44	555-0640	45	555-7000	45	556-7230	46
548-0470	42	550-1260	43	550-8040	43	551-6200	44	555-0660	45	555-7050	45	556-7300	46
548-1350	42	550-1280	43	550-8050	43	551-7010	44	555-0740	45	555-7100	45	556-7310	46
548-1360	42	550-1300	43	550-8060	43	551-7020	44	555-1220	45	555-7150	45	556-7320	46
548-1410	42	550-1310	43	550-8070	43	551-7030	44	555-1320	45	555-7200	45	556-7330	46
548-1420	42	550-1320	43	550-8095	43	551-7040	44	555-1330	45	555-7250	45	556-7400	46
548-1430	42	550-1340	43	550-8100	43, 45	551-7050	44	555-1420	45	555-8220	46	556-7410	46
548-1440	42	550-1360	43	550-8110	43	551-7060	44	555-1430	45	555-8230	46	556-7420	46
548-1450	42	550-1450	43	550-8120	43	551-7070	44	555-1440	45	555-9015	45	556-7430	46
548-1460	42	550-1460	43	550-8130	43	551-7080	44	555-1460	45	555-9075	45	557-0155	47
548-1470	42	550-1480	43	550-8145	43	551-7090	44	555-1520	45	555-9125	45	557-0175	47
548-1480	42	550-1500	43	550-8160	43, 45	551-7100	44	555-1530	45	555-9130	45	557-0205	47
548-1490	42	550-1520	43	550-8170	43	551-7110	44	555-1540	45	555-9140	45	557-0220	47
548-2400	42	550-1540	43	550-8190	43	551-7120	44	555-1560	45	555-9210	46	557-0250	47
548-9420	42	550-1560	43	551-0060	43	551-7130	44	555-1620	45	555-9230	46	557-0265	47
548-9430	42	550-2100	43	551-0140	43	551-7140	44	555-1630	45	555-9235	46	557-0285	47
548-9450	42	550-2110	43	551-0160	43	551-7150	44	555-1640	45	555-9240	46	557-0305	47
548-9460	42	550-2120	43	551-0220	43	551-7160	44	555-1660	45	555-9260	46	557-0320	47
548-9470	42	550-2320	43	551-0230	43	551-7170	44	555-2320	45	555-9270	46	557-0355	47
549-0220	42	550-2340	43	551-0240	43	551-7180	44	555-2330	45	555-9280	46	557-0360	47
549-0230	42	550-2420	43	551-0250	43	551-7190	44	555-2420	45	555-9300	46	557-0370	47
549-0240	42	550-2430	43	551-0270	43	551-7200	44	555-2430	45	555-9320	46	557-0410	47
549-0250	42	550-2440	43	551-0275	43	552-1030	45	555-2520	45	555-9510	46	557-0420	47
549-0260	42	550-2450	43	551-0280	43	552-1040	45	555-2530	45	555-9520	46	557-0470	47
549-0270	42	550-2520	43	551-0300	43	552-1050	45	555-2540	45	555-9530	46	557-0485	47

557-0490	47	558-1130	47	563-5210	49	570-0390	21	580-0595	102	580-5060	103	583-0040	104
557-0575	47	558-1350	47	563-5220	49	570-0511	21	580-0600	102	580-5065	103	583-1000	105
557-0585	47	558-1410	47	563-5380	49	570-0521	21	580-0610	102	580-5068	103	583-1005	105
557-0685	47	558-1430	47	563-5400	49	570-0531	21	580-0620	102	580-5070	103	583-1006	105
557-0695	47	558-1440	47	563-5430	49	570-0575	21	580-0625	102	580-5075	103	583-1010	105
557-0795	47	558-1450	47	563-5450	49	570-0580	21	580-0630	102	580-5080	103	583-1011	105
557-1100	47	558-1540	47	563-5460	49	570-0585	21	580-0640	102	580-5085	103	583-1015	105
557-1160	47	558-1910	47	563-6010	49	570-2000	21, 70	580-0650	102	580-5090	103	583-1016	105
557-1220	47	558-1920	47	563-6020	49	570-2001	21, 70	580-0660	102	580-5095	103	583-1020	105
557-1280	47	562-1410	47	563-6030	49	570-2002	21, 70	580-0670	102	580-5100	103	583-1021	105
557-1385	47	562-1411	47	563-6040	49	570-2002/1	70	580-0675	102	580-5105	103	583-1030	105
557-1475	47	562-1412	47	563-6050	49	570-2003	21	580-0680	102	580-5110	103	583-1031	105
557-1585	47	562-1420	47	563-6060	49	570-2101	21, 70	580-0690	102	580-5115	103	583-1060	104
557-4020	47	562-1421	47	563-6070	49	570-2110	21	580-0700	102	580-5120	103	583-1065	104
557-4040	47	562-1422	47	563-6080	49	570-2111	21	580-0705	102	580-5125	103	583-1070	104
557-4060	47	562-1450	47	563-6100	49	570-2112	21	580-0710	102	580-5130	103	583-1075	104
557-4080	47	562-1451	47	563-6120	49	570-5000	22	580-0720	102	581-0211	103	583-1105	105
557-4100	47	562-1452	47	563-6120	49	570-5200	22	580-0730	102	581-0220	103	583-1106	105
557-4130	47	562-1520	47	563-7010	49	570-5250	22	580-0735	102	581-0711	103	583-1110	105
557-4140	47	562-1521	47	563-7020	49	570-5300	22	580-0740	102	581-0720	103	583-1111	105
557-4160	47	562-1522	47	563-7040	49	570-6000	22	580-0740	102	581-0811	103	583-1115	105
557-4180	47	562-1540	47	563-7060	49	570-6065	22	580-1010	102	581-0820	103	583-1116	105
557-4200	47	562-1541	47	563-7070	49	570-6100	22	580-1015	102	581-1011	103	583-1120	105
557-4210	47	562-1542	47	563-7210	49	570-6100	22	580-1020	102	581-1015	103	583-1121	105
557-4210	47	562-1542	47	563-9120	49	570-6150	22	580-1025	102	581-1015	103	583-1121	105
557-4220	47	562-1543	47	563-9130	49	570-6200	22	580-1030	102	581-5010	103	583-1130	105
557-4240	47	562-1610	47	563-9230	49	570-6200	52	580-1033	102	581-5092	103	583-1131	105
557-4260	47	562-1611	47	563-9240	49	570-6341	101	580-1035	102	581-5097	103	583-3010	105
557-4280	47	562-1612	47	563-9250	49	570-7000	22	580-1040	102	581-5110	103	583-3011	105
557-4300	47	562-1710	47	563-9260	49	570-8086	22	580-1042	102	581-5120	103	583-3012	105
557-4320	47	562-1711	47	563-9300	50	570-9000	21	580-1045	102	581-5130	103	583-3020	105
557-4330	47	562-1712	47	563-9310	50	570-9005	21	580-1050	102	581-5140	103	583-3021	105
557-6230	47	562-2040	47	563-9410	50	570-9010	21	580-1055	102	581-5160	103	583-3022	105
557-6240	47	562-3230	47	563-9420	50	570-9020	25	580-1060	102	582-0010	103	583-3100	105
557-6260	47	562-3240	47	563-9500	73	580-0010	102	580-1065	102	582-0030	103	583-3101	105
557-6280	47	562-3242	47	563-9510	73	580-0015	102	580-1070	102	582-0060	103	583-3110	105
557-6290	47	562-3260	47	563-9520	74	580-0020	102	580-1075	102	582-0211	104	583-3111	105
557-6310	47	562-3262	47	564-1130	50	580-0025	102	580-1080	102	582-0231	104	583-3120	105
557-6330	47	562-3264	47	564-1150	50	580-0030	102	580-1085	102	582-0251	104	583-3130	105
557-6335	47	562-3266	47	564-1240	50	580-0033	102	580-1090	102	582-0305	104	583-3410	113
557-6340	47	562-3268	47	564-1310	50	580-0035	102	580-1095	102	582-0309	104	583-3510	105
557-6350	47	562-3270	48	564-3660	50	580-0040	102	580-1100	102	582-0311	104	583-3512	105
557-6370	47	562-3272	48	564-3670	50	580-0042	102	580-1105	102	582-0331	104	583-3520	105
557-6390	47	562-3274	47	564-3770	50	580-0045	102	580-1110	102	582-0351	104	583-3522	105
557-6400	47	562-3276	48	564-4140	50	580-0050	102	580-1115	102	582-0371	104	583-3810	47, 105
557-6440	47	562-4000	48	564-6010	50	580-0055	102	580-1120	102	582-0381	104	583-3810	105
557-6450	47	562-4010	48	564-6020	50	580-0060	102	580-1125	102	582-0401	104	583-3812	47, 105
557-6605	47	562-4020	48	564-6030	50	580-0065	102	580-1130	102	582-0421	104	583-3820	47, 105
557-6620	47	562-4030	48	564-6070	50	580-0070	102	508-2581	30	582-0521	104	583-3822	47, 105
557-6630	47	562-4040	48	564-6080	50	580-0075	102	580-3110	103	582-0531	104	583-3883	105
557-6650	47	562-4050	48	564-6090	50	580-0080	102	580-3150	103	582-0541	104	584-9310	30, 106
557-6660	47	582-4300	104	564-6090	50	580-0085	102	580-3210	103	582-4010	104	584-9320	30, 106
557-6680	47	563-0330	49	564-6160	50	580-0090	102	580-4000	103	582-4020	104	584-9340	30, 106
557-6690	47	563-0610	49	564-6170	50	580-0095	102	580-5010	103	582-4030	104	589-9410	99
557-6710	47	563-0620	49	564-6180	50	580-0100	102	580-5015	103	582-4040	104	589-9430	99
557-6730	47	563-0630	49	564-6480	50	580-0105	102	580-5020	103	582-4110	104	589-9510	99
557-6735	47	563-0810	49	564-7130	50	580-0110	102	580-5022	103	582-4120	104	589-9520	99
557-6745	47	563-0820	49	564-7230	50	580-0115	102	580-5025	103	582-4140	104	589-9530	99
557-6750	47	563-1310	49	564-7410	50	580-0120	102	580-5030	103	582-4210	104	589-9540	99
557-6760	47	563-2080	49	564-7480	50	580-0125	102	580-5032	103	582-4220	104	589-9595	99
557-6770	47	563-2330	49	564-8030	50	580-0125	102	580-5032	103	582-4240	104	589-9600	99
557-6770	47	563-2330	49	564-8120	50	580-0130	102	580-5033	103	582-4260	104	589-9610	99
557-6810	47	563-2650	49	564-8160	50	580-0130	102	580-5035	103	582-4280	104	589-9620	99
557-7530	47	563-2670	49	564-8190	50	580-0150	102	580-5040	103	582-4280	104	589-9620	99
557-7540	47	563-4220	49	564-8190	50	580-0150	102	580-5042	103	582-4320	104	590-0500	21
557-7550	47	563-4370	49	564-8420	50	580-0150	102	580-5045	103	582-4330	104	590-0512	21
557-7560	47	563-4380	49	570-0020	21	580-0150	102	580-5045	103	582-4420	104	590-0540	21
557-7570	47	563-4390	49	570-0022	21	580-0155	102	580-5048	103	582-9001	104	590-0550	21
557-7570	47	563-4390	49	570-0110	21	580-0160	102	580-5050	103	582-9011	104	590-0560	21
557-7580	47	563-4400	49	570-0110	21	580-0170	102	580-5051	103	582-9021	104	590-1050	52
557-7600	47	563-4450	49	570-0330	21	580-0175	102	580-5055	103	582-9031	104	590-1060	52
557-7600	47	563-4450	49	570-0350	21	580-0180	102	580-5058	103				
557-7620	47	563-5190	49	570-0370	21	580-0190	102						

593-0010	51	593-8240	51	660-1107	96	ARP004	80	CWA2	61	FG6906	23	MHP1094	81
593-0020	51	595-1000	51	660-1108	96	ARP007	80	CWB1	62	FG6907	23	MHP1095	81
593-0030	51	595-2000	51	660-2010	97	ARP008	80	CWB2	62	GYS-055155	39	MHP1096	81
593-0040	51	595-2011	51	660-3010	97	ARP009	80	CWB3	62	HCP143MS	59	MHP1098	81
593-0120	51	500-7020	51	660-4010	98	ARP013	80	CWB4	62	JA165MS	59	MHP1099	81
593-0130	51	596-0010	51, 100	660-4020	98	ARP014	80	CWB5	62	JCS100	58	MHP1100	81
593-0210	51	596-0030	51	660-4050	98	ARP015	80	CWB6	62	L1C	79	MHP1116	91
593-0220	51	5-PC	30, 59	660-4051	98	ARP018	80	CWB7	62	L1P	79	MHP1117	91
593-0230	51	600-1000	102	660-4110	98	ARP019	80	CWB8	62	L2P	79	MHP1122	82
593-0240	51	600-1202	102	660-4120	98	ARP020	80	CWB9	62	M00-MSE	59	MHP1124	81
593-0310	51	600-1221	102	660-4130	98	ARP021	80	DBC100	72	M00-555	59	MHP294	81
593-0320	51	600-2101	102	660-4180	98	ARP022	80	DBC200	72	MBB207	36	MHP360	82
593-0330	51	600-2102	102	660-4181	98	B10	71	DBC300	72	MBB233	36	MHP362	83
593-0340	51	600-2211	102	660-4206	98	B11	71	DBC400	72	MBB239	36	MHP366	82
593-0410	51	600-3150	102	660-4208	98	B12	71	DBC500	72	MBB245	36	MHP367	83
593-0420	51	600-4100	102	660-4210	98	B13	71	DBC600	72	MBB265	36	MHP368	82
593-0430	51	610-1110	114	660-4220	99	B336	71	DBC700	72	MBB269	36	MHP383	82
593-0440	51	610-1310	102	660-4222	97	B337	71	DBC800	72	MBB272	36	MHP385	82
593-0500	52	610-1610	102	660-4223	96	B338	71	DBCST1	72	MBB286	36	MHP387	82
593-0510	52	610-2000	102	660-4224	96	B347	71	DBSR100	72	MBB3156	36	MHP388	82
593-5011	52	660-0010	95	660-4227	99	B349	71	DBSR200	72	MBB3157	36	MHP389	82
593-0520	52	660-0015	96	660-4228	99	B520	71	DBSR300	72	MBB380	37	MHP390	82
593-0530	52	660-0020	95	660-4229	96	B683	71	DBSR400	72	MBB380W	37	MHP397	89
593-0700	52	660-0021	95	660-4230	100	B684	71	DBSR500	72	MBB382	37	MHP398	89
593-0710	52	660-0022	95	593-6010	51	B685	71	DBSR600	72	MBB382W	37	MHP399	89
593-0720	52	660-0023	95	6-PC	30, 59	B686	71	DBSRPS100	72	MBB382WA	37	MHP400	89
593-0730	52	660-0024	95	6X-MSE	59	B688	71	DBSRPS200	72	MBB433A	37	MHP405	89
593-0800	52	660-0026	95	6X-555	59	B770	71	DBSRPS300	72	MBB433C	37	MHP409	90
593-0810	52	660-0030	95	7 1/2-MSE	59	B771	71	DURAGUN2	73	MBB433D	37	MHP410	90
593-0820	52	660-0031	95	7 1/2-555	59	B772	71	DURALEC	73	MBB448	37	MHP413	90
593-0830	52	660-0032	95	7-MSE	59	B787	71	E144B	30	MBB453	37	MHP414	90
593-0900	52	660-0035	95	7-555	59	B788	71	E144BP	30	MBB472	37	MHP415	90
593-0910	52	660-0036	95	8-PC	30, 59	B789	71	E144W	30	MBB499	37	MHP416	90
593-0920	52	660-0040	95	A167/100	53	B790	71	E144WP	30	MBB501	38	MHP420	90
593-0930	52	660-0041	95	A167A	53	B791	71	EQ28	79	MBB501A	38	MHP421	90
593-1000	51	660-0050	95	A223A	56, 57	B792	71	EQ29	79	MBB504	38	MHP422	90
593-1001	51	660-0055	95	A224A	56, 57	B793	71	FFRBLK-301	52	MBB566	38	MHP423	90
593-1002	51	660-0060	96	A225A	56, 57	B794	71	FFRGRY-304	52	MBB567	38	MHP424	90
593-1101	51	660-0062	96	A256A	56, 57	B807	71	FG2635	23	MBB581BL	38	MHP425	90
593-2000	52	660-0063	97	A273A	56, 57	B808	71	FG3668	23	MBB9005	37	MHP432	91
593-2100	79	660-0064	97	A277A	56, 57	B815	71	FG3670	23	MBB9006	37	MHP433	91
593-2150	79	660-0070	97	A278A	56, 57	B82	71	FG3675	23	MBB921	38	MHP434	91
593-2300	79	660-0071	97	A279A	56, 57	B821	71	FG3680	23	MBB921B	38	MHP435	91
593-2350	79	660-0072	97	A280A	56, 57	B822	71	FG3894	23	MBC110/3	30, 101	MHP436	91
593-2400	79	660-0073	97	A281A	56, 57	B823	71	FG4045	23	MBC110/4	30, 101	MHP437	91
593-2500	79	660-0074	97	A282A	56, 57	B824	71	FG4046	23	MBC110/5	30, 101	MHP529	89
593-2501	79	660-0075	97	A446	99	B825	71	FG4047	23	MBC135/5	30, 101	MHP530	89
593-3000	52	660-0080	97	A581A	56, 57	BMB1604	71	FG4048	23	MBC170/5	30, 101	MHP531	89
593-3020	52	660-0081	95	A582A	56, 57	BMB1624	71	FG4474	23	MF113	58	MHP532	89
593-3300	52	660-0082	96	A621A	56, 57	B00T1	73	FG4478	23	MF134C	104	MHP533	89
593-3310	52	660-0085	97	A622A	56, 57	B00T10	73	FG5430	23	MGF119	100	MHP555	83
593-4011	51	660-0088	98	A665A	56, 57	B00T2	73	FG5926	23	MHP1035	81	MHP556	83
593-4015	51	660-0090	97	A666A	56, 57	B00T3	73	FG5966	23	MHP1036	81	MHP557	84
593-4025	51	660-0092	97	A667A	56, 57	B00T4	73	FG5972	23	MHP1038	81	MHP558	84
593-4030	51	660-0100	97	A669A	56, 57	B00T5	73	FG6264	23	MHP1047	82	MHP559	84
593-4040	51	660-0102	97	A670A	56, 57	B00T6	73	FG6265	23	MHP1052	83	MHP560	84
593-5010	51	660-0104	97	A671A	56, 57	B00T8	73	FG6267	23	MHP1053	83	MHP561	84
593-6000	51	660-0106	97	A672A	56, 57	B00T9	73	FG6648	23	MHP1054	83	MHP576	84
593-6000	100	660-0108	98	A673A	56, 57	C180	73	FG6690	23	MHP1055	83	MHP577	84
593-6010	100	660-0110	98	A674A	56, 57	C50/12C	64	FG6893	23	MHP1056	83	MHP578	84
593-6020	99	660-0500	96	A675A	56, 57	C93C	72	FG6895	23	MHP1057	83	MHP579	84
593-6100	51	660-0600	99	A676A	56, 57	CDR160	58	FG6897	23	MHP1058	82	MHP581	84
593-8018	51	660-0700	95	A677A	56, 57	CDR95	58	FG6899	23	MHP1066	83	MHP582	85
593-8019	51	660-1000	96	A678A	56, 57	CV88	72	FG6900	23	MHP1067	83	MHP583	85
593-8092	51, 100	660-1001	96	A679A	56, 57	CV96	72	FG6901	23	MHP1068	82	MHP632	88
593-8093	51, 100	660-1020	96	ABCBLK-211	52	CVC050SS	73	FG6902	23	MHP1089	81	MHP636	88
593-8124	51	660-1104	96	ABCGRY-214	52	CVC110SS	73	FG6903	23	MHP1090	81	MHP637	88
593-8160	51	660-1105	96	AKA2	21	CVS18	72	FG6904	23	MHP1091	81	MHP638	89
593-8198	51	660-1106	96	ARP003	80	CWA1	61	FG6905	23	MHP1093	81		

MHP639	89	MHP908	87	MV17	100	QC072	34	QC584	32	SC27002	92
MHP640	88	MHP918	88	MWR20/B6	61	QC073	34	QC585	31	SC27897	93
MHP642	87	MHP920	88	MWR20/B9	61	QC074	34	QC587	32	SC28061	92
MHP643	87	MHP922	88	MWR24/B6	61	QC075	34	QC588	32	SC33713	92
MHP644	87	MHP925	88	MWR24/B9	61	QC076	34	QC589	32	SC39241	92
MHP645	87	MHP929	88	MWR28/B6	61	QC077	34	QC590	32	SC6984	92
MHP646	87	MHP968	88	MWR28/B9	61	QC078	34	QC591	32	SC92311	94
MHP647	87	MHP976	83	OES000	29	QC079	34	QC592	32	SC9411	94
MHP649	90	MHP980	83	QC001	33	QC080	34	QC593	32	SCD1-12	93
MHP655	83	MHPSTAND	79	QC002	33	QC081	34	QC594	31	SCP100-32	92
MHP659	82	MRC102	75	QC003	33	QC082	34	QC595	31	SCP100-8	92
MHP660	82	MRC103	75	QC004	33	QC083	34	QC596	31	SCP150-32	92
MHP674	90	MRC104	75	QC005	33	QC084	34	QC597	31	SCP150-8	92
MHP678	91	MRC105	75	QC006	33	QC085	34	QC598	31	SCP46-32	92
MHP680	90	MRC106	75	QC007	33	QC086	34	QC599	31	SCP46-8	92
MHP682	91	MRC110	75	QC008	33	QC087	34	QC600	31	SD540	58
MHP683	91	MRC111	75	QC009	33	QC088	34	QC601	31	SOCK6-9	101
MHP686	91	MRC112	75	QC010	33	QC089	34	QC602	31	SOCK9-12	101
MHP687	91	MRC114	75	QC011	33	QC090	34	QC603	31	SOR400MP	52
MHP688	91	MRC116	75	QC012	33	QC091	33	QC604	31	SPS9040	39
MHP692	86	MRC120	75	QC013	33	QC092	33	QC605	32	STAND1	32
MHP708	84	MRC121	75	QC014	33	QC093	33	QC606	32	STAND20	38
MHP709	84	MRC122	75	QC015	33	QC100	26	QC607	32	STAND9	79
MHP710	84	MRC125	75	QC016	33	QC101	26	QC608	32	SWA157A	52
MHP711	85	MRC126	75	QC017	33	QC102	26	QC609	33	SWA304A	52
MHP712	85	MRC127	76	QC018	33	QC103	26	QC610	33	SWA450MP	52
MHP713	84	MRC128	76	QC019	33	QC105	26	QC612	32	TRAPPERHAT	101
MHP714	84	MRC133	76	QC020	33	QC106	26	QC613	32	TSCBLK-311	52
MHP723	85	MRC138	76	QC021	34	QC108	26	QC614	33	TSCGRY-314	52
MHP725	85	MRC139	76	QC022	34	QC109	26	QC615	33	UBK1	73
MHP727	85	MRC140	76	QC023	34	QC110	26	QC616	30	UBK2	73
MHP729	85	MRC142	76	QC024	34	QC111	26	QC617	30	UCRBLK-271	52
MHP731	85	MRC150	76	QC025	34	QC112	26	QC623	30	UCRGRY-274	52
MHP733	85	MRC151	76	QC026	35	QC121	26	QC624	30	UCVB2	73
MHP734	85	MRC153	76	QC027	35	QC122	26	QC625	30	UFBLK-201	52
MHP735	85	MRC156	76	QC028	35	QC123	26	QC626	30	UFGRY-204	52
MHP737	85	MRC159	76	QC029	35	QC126	26	QC650	30	VBLK-291	52
MHP738	85	MRC165	76	QC030	35	QC127	26	QC650	30	VGRY-294	52
MHP739	85	MRC166	76	QC031	35	QC128	26	QC652	30	WUFBLK-221	52
MHP740	86	MRC174	76	QC032	35	QC129	26	QC653	30	WUFGRY-224	52
MHP742	86	MRC176	77	QC035	35	QC130	26	QC654	30		
MHP757	86	MRC177	77	QC038	35	QC131	26	QC655	30		
MHP758	86	MRC178	77	QC039	35	QC136	26	QC656	30		
MHP759	86	MRC180	77	QC041	33	QC137	26	QC700	44		
MHP760	86	MRC181	77	QC042	33	QC138	26	QC901	73		
MHP761	86	MRC184	77	QC043	33	QC139	26	QC902	73		
MHP762	86	MRC187	77	QC044	33	QC140	26	QC903	73		
MHP774	86	MRC189	77	QC045	33	QC141	26	QC904	73		
MHP779	86	MRC190	77	QC046	33	QC142	26	QC905	73		
MHP780	86	MRC191	77	QC047	33	QC143	26	QC906	73		
MHP782	86	MRC193	77	QC048	33	QC144	26	QC908	73		
MHP786	86	MRC194	77	QC049	33	QC151	26	QC909	73		
MHP787	86	MRC195	77	QC050	33	QC152	26	QC910	73		
MHP788	87	MRC196	77	QC051	33	QC531	105	QC911	73		
MHP792	88	MRC201	77	QC055	33	QC533	114	QC912	73		
MHP797	88	MRC202	78	QC056	33	QC536	27	QC913	73		
MHP798	88	MRC205	78	QC057	33	QC544	105	QC914	73		
MHP844	89	MTD406	65, 111	QC058	33	QC546	74	QC915	27		
MHP845	89	MTD407	66, 111	QC059	33	QC550	100	R101	40		
MHP846	89	MTD408	66, 111	QC060	33	QC551	100	R110	40		
MHP869	88	MTD410	66, 111	QC061	33	QC552	100	SC15290	93		
MHP870	88	MTD411	66, 111	QC062	33	QC574	32	SC16525	93		
MHP891	87	MTD412	66, 111	QC063	33	QC575	32	SC16532	93		
MHP893	87	MTD415	66, 111	QC064	33	QC576	33	SC22762	93		
MHP895	87	MTD416	65, 111	QC065	33	QC577	32	SC22816	92		
MHP898	87	MTD418	65, 111	QC066	33	QC580	33	SC24445	92		
MHP902	87	MTG1	64	QC067	33	QC581	31	SC24940	93		
MHP904	87	MTV1-500	31	QC070	34	QC582	31	SC26296	92		
MHP906	87	MV16	100	QC071	34	QC583	31	SC26913	92		