

Architectural Hardware

Header System | Architectural U-Channels | Commercial Spider Fittings | Glass Canopy Brackets



Who We Are

Glass & Glazing Hardware is a trusted supplier of premium architectural and glazing hardware solutions across the United States. We provide high quality products including shower hardware, sliding systems, railing components, and door fittings designed for durability, performance, and modern design. Backed by industry expertise and dependable service, we support contractors, glaziers, and designers with reliable solutions built to get the job done right.



Contact Us



-  ggh-usa.com
-  1-877-999-4628
-  sales@ggh-usa.com



Table Of Contents

01 Header System

06 Smoke Baffle

02 Architectural U-Channels

08 Architectural U-Channels

09 Door Rail System

03 Commercial Spider Fittings

12 Commercial Spider Fittings - SPY Series

13 SPY Series Fasteners - SPY Series

04 Glass Canopy Brackets

16 Double Arm Connector

16 Canopy Bracket

17 Architectural Railing Post - Blank

GGH Finishes

At Glass & Glazing Hardware, we believe the finish is more than just surface-level—it's the final touch that defines the look, feel, and performance of your space. That's why GGH offers a curated selection of premium finishes across our product lines, designed to complement a wide range of architectural styles and applications.

This color tower was created for one-time distribution only. For the most up-to-date selection of available finishes, please visit our website at ggh-usa.com.

The following finishes were available at the time this catalog was printed:

Chrome, Brushed Nickel, Matte Black, Satin Brass, Polished Nickel, Brushed Bronze, Gun Metal, Oil Rubbed Bronze, White, Antique Brass, Polish Brass, Brushed Stainless Steel, Polished Stainless Steel, Satin Anodized, and Custom Finishes.

Frameless Shower Hardware



Railing Hardware



Commercial Finishes



04 DOOR RAIL & ARCHITECTURAL HARDWARE

Smoke Baffle Header System



Smoke Baffle

Finishes

Check the website for available finishes, in-stock products. As we build our inventory, more finishes will be available.

- Matte Black
- Satin Anodized
- Brushed Stainless
- Custom Finishes

Specification:

- Durable Build:** Constructed from high-quality 6060 T6 Aluminum for superior strength and corrosion resistance.
- Endcap sold separately.

120" / 240'

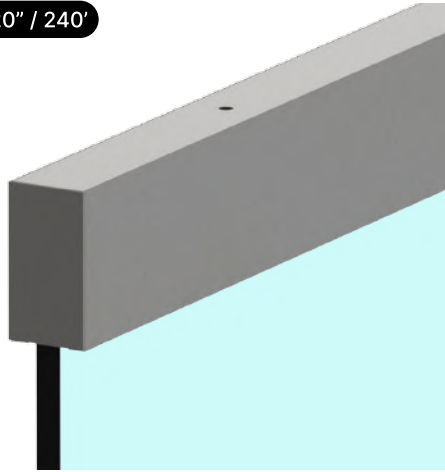

SMKBFLKIT
Smoke Baffle Kit with Cladding & Endcap

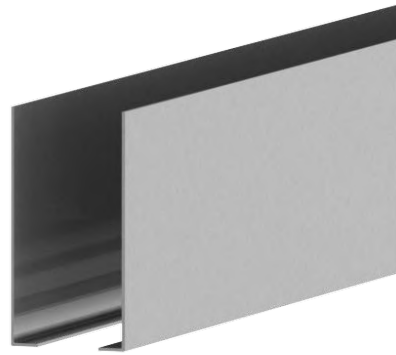

SMKBFLCLD
Cladding for Smoke Baffle



SMKBFLEND
End Caps for Smoke Baffle



04 DOOR RAIL & ARCHITECTURAL HARDWARE

Architectural U-Channels



Architectural U-Channels

Finishes

Check the website for available finishes, in-stock products. As we build our inventory, more finishes will be available.



For glass fabrication details, CAD files, and the latest product information, please visit our website.

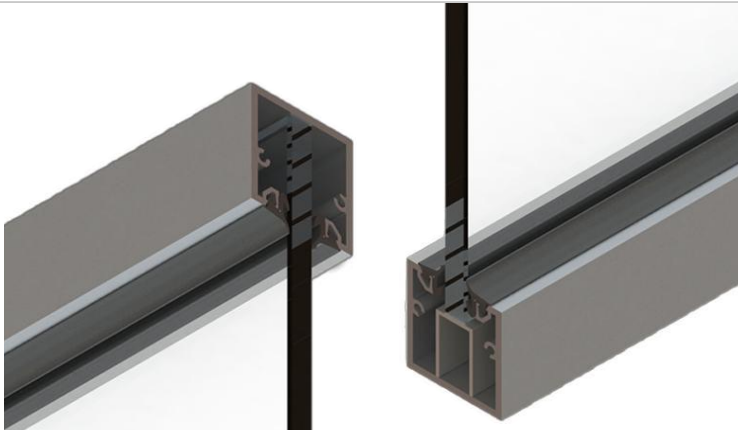

Specification

- **Compatible with:** The 4" Architectural Door Rail System for seamless storefront installations.
- **Length:** 240" (20ft)
- **Clearance Options:** Includes a reversible saddle for 1/4" or 3/4" clearance
- **Roll-In Gasket:** Includes roll-in gasket for 1/2" glass

AU120

Architectural U-Channels with Roll-In Gaskets - 120" Length



Door Rail System



DSTOP2
Door Rail System - Single Door Stop



DSTOP6
Door Rail System - Single Door Stop





Commercial Spider Fittings



Commercial Spider Fittings - SPY Series

Finishes

Check the website for available finishes, in-stock products. As we build our inventory, more finishes will be available.

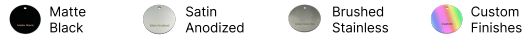

Specification

- **Versatile Applications:** Ideal for commercial building facades, glass canopies, and interior partition walls.
- **High Load Capacity:** Designed to hold large glass panels securely, maintaining structural integrity and aesthetic appeal.
- **Durable Finish:** Available in brushed or polished stainless steel to suit different environment needs and withstand the elements.



SPYFM4
Fin Mount Spider Fittings
Quad Arm



SPYFM2V
Fin Mount Spider Fittings
Double Arm V-Shape



SPYFM2Y
Fin Mount Spider Fittings
Double Arm Y-Shape



SPYFM1R
Fin Mount Spider Fittings
Single Arm Right



SPYFM1L
Fin Mount Spider Fittings
Single Arm Left



SPYFM2
Fin Mount Spider Fittings
Double Arm



SPYFM1
Fin Mount Spider Fittings
Single Arm



SPYPM4
Post Mount Spider Fittings
Quad Arm



SPYPM4C
Post Mount Spider Fittings
Quad Arm Corner



Commercial Spider Fittings - SPY Series





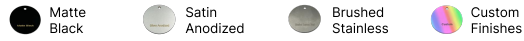

Finishes

Check the website for available finishes, in-stock products. As we build our inventory, more finishes will be available.

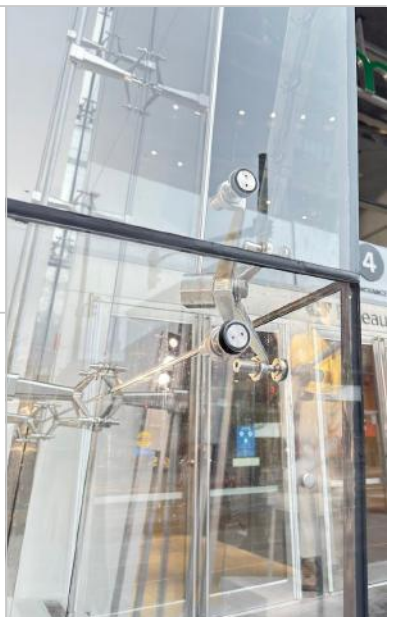

Specification

- **Versatile Applications:** Ideal for commercial building facades, glass canopies, and interior partition walls.
- **High Load Capacity:** Designed to hold large glass panels securely, maintaining structural integrity and aesthetic appeal.
- **Durable Finish:** Available in brushed or polished stainless steel to suit different environment needs and withstand the elements.

 <p>SPYPM3 Post Mount Spider Fittings Triple Arm</p>	 <p>SPYPM2V Post Mount Spider Fittings Double Arm V-Shape</p>	 <p>SPYPM2 Post Mount Spider Fittings Double Arm</p>	
 <p>SPYPM2C Post Mount Spider Fittings Double Arm Corner</p>	 <p>SPYPM1 Post Mount Spider Fittings Single Arm</p>	 <p>SPYPM1R Post Mount Spider Fittings Single Arm Left or Right</p>	

SPY Series Fasteners – SPY Series

For glass fabrication details, CAD files, and the latest product information, please visit our website. Stock and finish availability may vary by product.



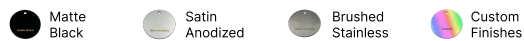

Finishes

Check the website for available finishes, in-stock products. As we build our inventory, more finishes will be available.



Specification

- **High-Quality Material:** Made from 316 Alloy Stainless Steel for superior strength and weather resistance.
- **Fastening Mechanism:** Interior/exterior fixed or swivel mount that can tilt 6° for even stress distribution.
- **Suitable Glass Thickness:** 5/16" to 7/8" (8mm to 23mm)

 <p>SPYFARIG818 Rigid For 8mm to 18mm Glass</p>	<p>(5/16" to 19/32")</p>  <p>SPYFASWEXT1523 Exterior Swivel For 8mm to 15mm Glass</p>	<p>5/16" to 11/16"</p>  <p>SPYFASW1826 Interior Swivel For 8mm to 18mm Glass</p>	<p>11/16" to 1-1/32"</p>  <p>SPYFASWEXT815 Interior Swivel For 18mm to 26mm Glass</p>	<p>5/8" to 7/8"</p>  <p>SPYFASW818 Exterior Swivel For 15mm to 23mm Glass</p>
---	---	--	---	---



04 DOOR RAIL & ARCHITECTURAL HARDWARE

Glass Canopy Brackets



Double Arm Connector

Finishes

Check the website for available finishes, in-stock products. As we build our inventory, more finishes will be available.

-  Matte Black
-  Brushed Stainless
-  Custom Finishes

Specification

- **Premium Material:** Made from high-quality stainless steel for strength and long-lasting durability.
- **Removable Round Adapter:** Allows easy customization for round or flat posts for versatile installation.

Adjustable



PROARMADJ

Double Arm Glass Connector - Adjustable

Fixed



PROARM

Double Arm Glass Connector - Fixed

Canopy Bracket

Finishes

Check the website for available finishes, in-stock products. As we build our inventory, more finishes will be available.

-  Matte Black
-  Brushed Stainless
-  Custom Finishes

*Custom configuration and size available based upon request
sales@ggh-usa.com



24"



GC2401

Glass Canopy Bracket (24" Height)

36"



GC3601

Glass Canopy Bracket (36" Height)



Ask us about
FACTORY DIRECT PROGRAM

Architectural Railing Post - Blank

Pro Series - Engineered

*All Post Endcaps and Saddle Support sold separately

Finishes

Check the website for available finishes, in-stock products. As we build our inventory, more finishes will be available.

- Matte Black
- Brushed Stainless
- Custom Finishes

Square

1-9/16" X 1-9/16"

44"
(1117mm)

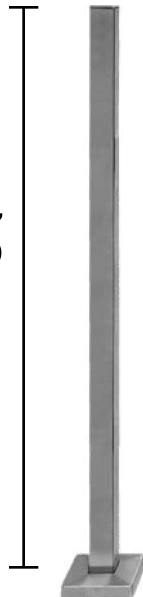
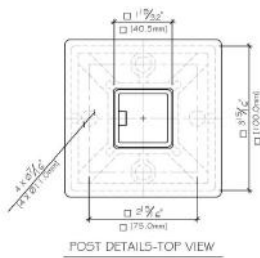

← Base Plate With Cap Included

Sold Separately



Specification

- **Material:** Constructed from high-quality Stainless Steel 316, offering superior durability and resistance to corrosion.
- **Customizable Design:** Blank posts with no pre-drilled holes, allowing for fabrication based on project-specific needs.
- **Applications:** Ideal for both residential and commercial installations, suitable for interior and exterior use.
- **Warranty:** Backed by a full 5-year warranty for peace of mind.

SPRO44B

Square Pro Series Railing Post - 44" Height

Round

1-11/16" Ø

44"
(1117mm)

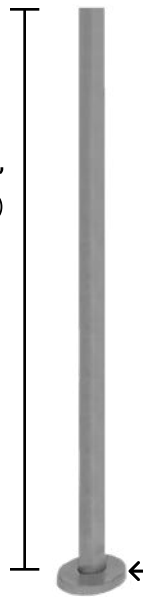
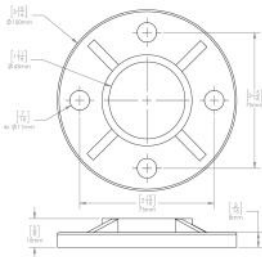

← Base Plate With Cap Included

Sold Separately

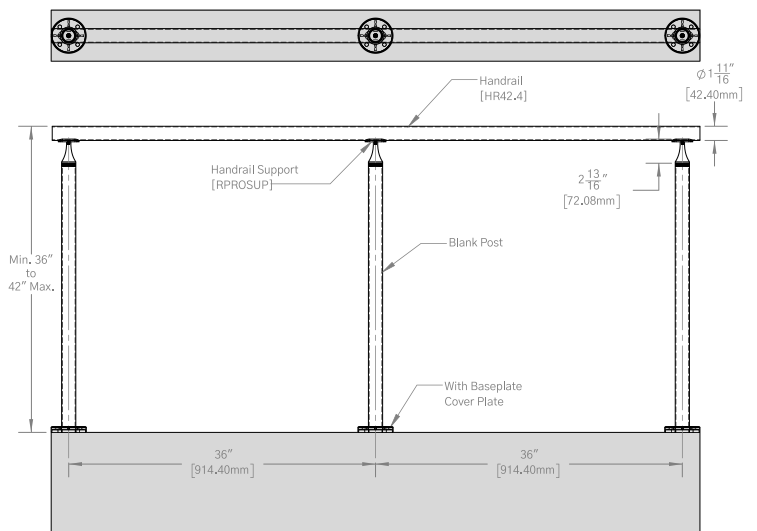

RPRO44B

Round Pro Railing Post - 44" Base Height - Blank