

LC DP Group ●



UB
UBAG

**BLEU
BLANC
SAC**

KWOO



2026

**Bienvenue,
Welcome,**



**fête ses 10 ans.
celebrates its
10th anniversary.**

10 ans d'innovation, de qualité et d'excellence : bienvenue chez LCDP Group

Fort de 10 années d'expérience, LCDP Group (anciennement Ubag) est devenu un acteur incontournable de l'industrie promotionnelle et publicitaire, avec des millions de pièces vendues et une réputation solide bâtie sur la qualité, la rigueur et un savoir-faire reconnu.

Notre collection de sacs est aujourd'hui la plus large du marché. Elle offre une diversité inégalée et répond aux besoins spécifiques de chaque client. L'ensemble de nos produits est imprimé à 100 % dans nos ateliers en France, garantissant un contrôle total à chaque étape de la production et une qualité irréprochable.

L'ADN du groupe repose sur un engagement constant envers l'excellence et la performance. Chaque produit est conçu de manière méthodique et ciblée, selon des processus rigoureux, et répond à un benchmark extrêmement exigeant. Notre objectif est de proposer des solutions innovantes et performantes, tout en intégrant systématiquement l'équation essentielle « prix / qualité », devenue aujourd'hui incontournable pour l'ensemble de nos clients.

L'année 2026 marquera une transition stratégique majeure pour LCDP Group, constituant une étape clé avant le déploiement d'un programme de développement ambitieux déjà en cours. En imprimant 100 % de nos produits en France, nous garantissons l'une des empreintes carbone les plus faibles du marché, un avantage significatif face à nos confrères. Cette démarche nous permet de maîtriser notre impact environnemental tout en proposant des produits de qualité supérieure, dans une logique de développement durable qui guide l'ensemble de nos actions et qui deviendra très rapidement une exigence incontournable dans la chaîne d'approvisionnement.

LCDP Group, un choix gagnant et serein pour l'avenir.
Laurent Lafon - Président

10 years of innovation, quality and excellence : welcome to LCDP Group

With 10 years of experience, LCDP Group (formerly Ubag) has become a key player in the promotional and advertising industry, with millions of pieces sold and a solid reputation built on quality, rigor and recognized know-how.

Our collection of bags is today the widest on the market. It offers unparalleled diversity and meets the specific needs of each client. All of our products are 100% printed in our workshops in France, guaranteeing total control at each stage of production and impeccable quality.

The group's DNA is based on a constant commitment to excellence and performance. Each product is designed in a methodical and targeted way, according to rigorous processes, and meets an extremely demanding benchmark. Our goal is to offer innovative and efficient solutions, while systematically integrating the essential equation « price / quality », which has become today unavoidable for all of our clients.

The year 2026 will mark a major strategic transition for LCDP Group, constituting a key step before the deployment of an ambitious development program already underway. By printing 100% of our products in France, we guarantee one of the lowest carbon footprints on the market, a significant advantage over our colleagues. This approach allows us to control our environmental impact while offering superior quality products, in a logic of sustainable development that guides all of our actions and which will very quickly become an essential requirement in the supply chain.

LCDP Group, a winning and serene choice for the future.
Laurent Lafon, Chairman



10 ANNIVERSARY

years

2016 THE 1st COLLECTION

UB
UBAG®

Bags for you, bags for all.

www.ubagcollection.com

UB

UBAG®

2017 THE 2nd COLLECTION
38 PRODUITS / PRODUCTS
21 NOUVEAUTÉS / NEW PRODUCTS

NON TISSÉ / NON WOVEN | COTON / COTTON | POLYESTER
NON TISSÉ / NON WOVEN | COTON / COTTON | JUTE /
POLYESTER | PP TISSÉ LAMINÉ / PP NON TISSÉ LAMINATED | JEAN

Bags for you,



for



www.ubagcollection.com

UB
UBAG®

2018 THE 3rd COLLECTION
60 PRODUITS / PRODUCTS
22 NOUVEAUTÉS / NEW PRODUCTS

NON TISSÉ / NON WOVEN | COTON / COTTON | JUTE /
POLYESTER | PP TISSÉ LAMINÉ / PP NON TISSÉ LAMINATED | JEAN

www.ubagcollection.com

UB
UBAG®

2019
10 NOUVEAUTÉS
NEW PRODUCTS

MUST HAVE
UB Sunset page 9

NEW
MAXI TÔTE BAG
UB Kate page 25

THE 4th COLLECTION
70 PRODUITS / PRODUCTS

NON TISSÉ / NON WOVEN | COTON / COTTON | JUTE /
POLYESTER | PP TISSÉ LAMINÉ / PP NON TISSÉ LAMINATED | JEAN

GOOD DEAL
UB Joy page 12

www.ubagcollection.com

UB
UBAG®

2020
12 NOUVEAUTÉS
NEW PRODUCTS

THE 5th COLLECTION
82 PRODUITS / PRODUCTS

COTON ORGANIQUE / ORGANIC COTTON | COTON
RECYCLÉ / RECYCLED COTTON | COTON
NON TISSÉ / NON WOVEN | JUTE / POLYESTER |
PP TISSÉ LAMINÉ / PP NON TISSÉ LAMINATED | JEAN

www.ubagcollection.com

UB
UBAG®

2021
86 PRODUITS
PRODUCTS

COTON ORGANIQUE / ORGANIC COTTON | COTON
RECYCLÉ / RECYCLED COTTON | COTON
NON TISSÉ / NON WOVEN | JUTE / POLYESTER |
PP TISSÉ LAMINÉ / PP NON TISSÉ LAMINATED | JEAN

DÉCOUVREZ NOS
NOUVEAUTÉS
DISCOVER OUR
NEW PRODUCTS

www.ubagcollection.com

UB
UBAG®

THE BRAND
12 NEW

2022
97 PRODUITS
PRODUCTS

COTON ORGANIQUE / ORGANIC COTTON | COTON
RECYCLÉ / RECYCLED COTTON | COTON
NON TISSÉ / NON WOVEN | JUTE / POLYESTER |
PP TISSÉ LAMINÉ / PP NON TISSÉ LAMINATED | JEAN

www.ubagcollection.com

UB
UBAG®

2023
23 NEW
PRODUCTS
PRODUCTS

Bags for you, bags for all.

www.ubagcollection.com

Une marque engagée.

UB
UBAG®

2024

À la mode !

- Les essentiels
- Les valeurs sûres
- Les indémodables
- Les grands classiques
- Les nouveautés

Le fait en France
par UBAG pages 22-29

**BLEU
BLANC
SAC®**

UB
UBAG®

2025
N/TV

**BLEU
BLANC
SAC**

FAIT EN FRANCE

Passez votre commande en quelques clics sur
www.lcdpgroup.com
Place your order in a few clicks



NEW

- NEW **Tommy** 20-21
- NEW **Tyler** 22-23
- NEW **Teddy** 24-25
- NEW **Timéo** 26-27







- NEW** KWOO Stanley 34-35
- NEW** KWOO Globe 36-37
- NEW** KWOO City 38-39
- KWOO Chelsea 42-43
- KWOO Wall Street 44-45
- KWOO Manhattan 46-47
- KWOO Mac Kinley 50-51
- KWOO K2 52-53
- KWOO Everest 54-55
- KWOO Denali 56-57
- KWOO Fuji 58-59
- KWOO Utah 60-61

KWOO



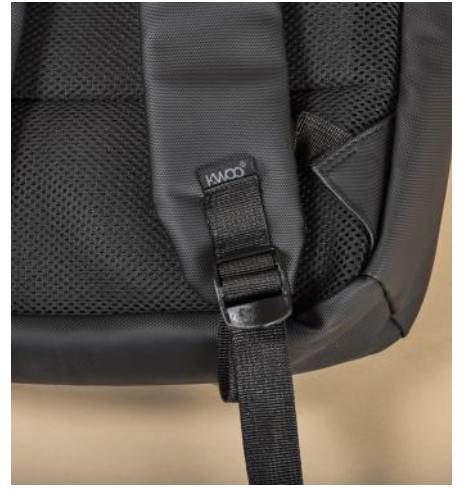



- Fernand 64
- NEW • Clement 65
- Felix 66
- Fred 67
- Francine 68
- NEW • Camille 69
- Francis 70
- Florent 71
- Firmin 72

BLEU BLANC SAC

FAIT EN FRANCE



FAIT EN
FRANCE

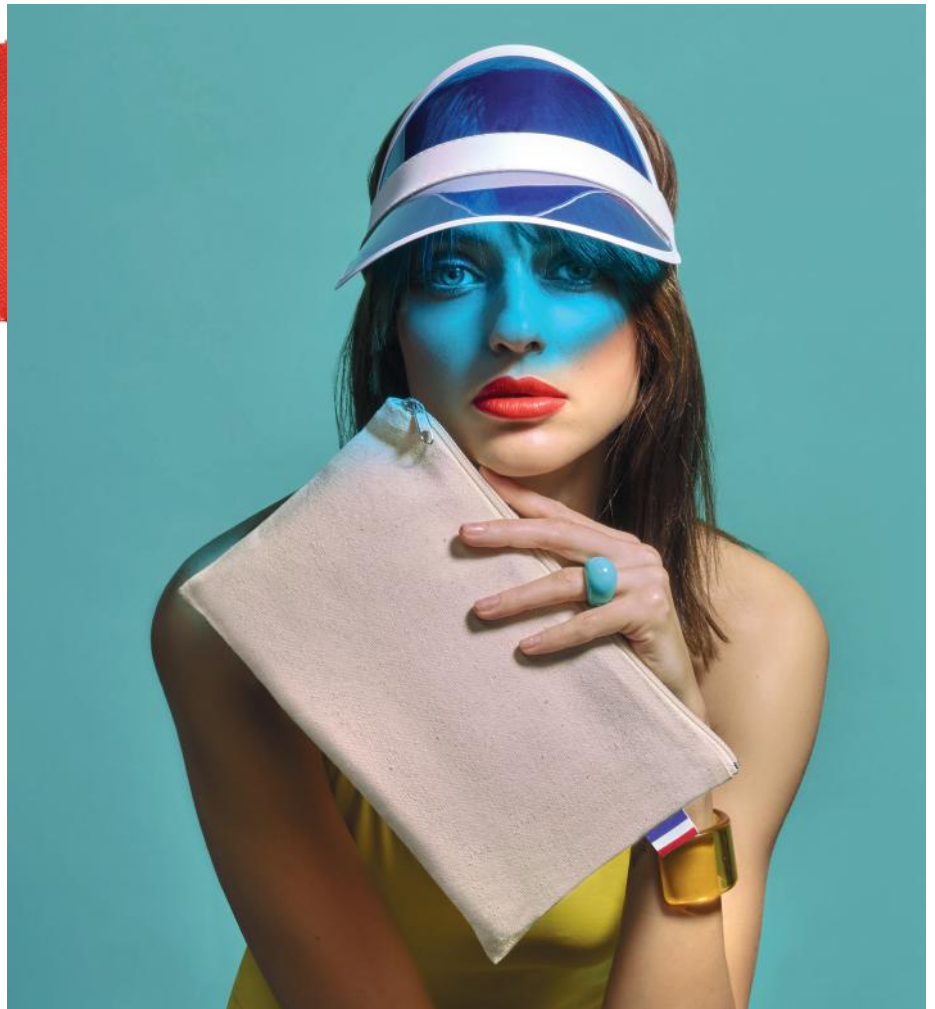





UB

UBAG



Polyester recyclé (RPET) & Coton recyclé

Recycled polyester (RPET) & Recycled cotton

NEW UB Bogota 77 | **NEW** UB Kensington 78 | **NEW** UB Baltimore 79 | **NEW** UB Santa Barbara 80 | **NEW** UB Bayside 81 | UB Michigan 82 | UB Cadix 83 | UB Punjab 84-85 | UB Santa Fe 86 | UB Zanzibar 87 | UB Vastra S 89 | UB Vastra L 89 | UB Goteborg 89 | UB Kalmar 90 | UB Malmo 90 | UB Stockholm 90 | UB Roy 92 | UB Romy 92 | UB Zac 93 | UB Palm Beach 94-95 | UB Seattle 96 | UB Augusta 97 | UB Vegas 97 | UB Madison 98 | UB Broadway 99 | UB Columbus 99 | UB Tulum 100-101 | UB Merida 100-101 | UB Maya 100-101 | UB Java 102-103 |

Cotton BIO 100% Organic cotton

UB Mia 105 | UB Maui 106 | UB Nepal 107 | UB Recife 108 | UB Grace 109 | UB Jill 110 | UB Moorea 111 | UB Borneo 112 | UB Marilyn 113 | UB Lou 114

Coton Cotton

UB Lisa S 116 | UB Elona M 116 | UB Loren L 116 | UB Atoll 117 | UB Charles 118 | UB Henri 118 | UB Louis 119 | UB Cancún 120-121 | UB Hawaï 122-123 | UB Caracas 124-125 | UB Salvador 124-125 | UB Memphis 126 | UB Kate 127 | UB Sarasota 128 | UB Atlanta 128 | UB Marietta 129 | UB Reno 130 | UB Richmond 131 | UB Porto 132 | UB Tibet 132 | UB Kelly 133 | UB Corfu 134 | UB Portland 135 | UB Denver 136 | UB Palma 137 | UB Nassau 138 | UB Tampa 138 | UB Keywest 139 | UB Soho 139 | UB Berkeley 140 | UB Bel air 141 | UB Madras 142 | UB Malibu 143 | UB Prato 144 | UB Siena 144 | UB Lily 145 | UB New York 146 | UB Paris 146 | UB Davos 147 | UB Antigua 148 | UB Sunny 149 | UB Nashville 150 | UB Cincinnati 151 | UB Houston 152 | UB San Antonio 152 | UB Austin 153 | UB Dallas 153 | UB Bora-Bora 154-155 | UB Tahiti 154-155 |

UB Hydra 156 | UB Mykonos 157 | UB Faubourg 158-159 | UB Princesse 160 | UB Croisette 161 | UB Alix 162

Non Tissé Non Woven

UB London 164-165 | UB Monte-Carlo 166 | UB Daytona 167 | UB Beverly 168 | UB Tel-Aviv 169 | UB Barcelona 170 | UB Miami 171 | UB Madrid 172 | UB Venice 173 | UB Oslo 174 | UB Tribeca 174 | UB Chicago 175 | UB Harvard 175 | UB Boston 176 | UB Pearth 177

Isotherme

UB Bahamas 179 | UB Calgary 180 | UB Toronto 180 | **NEW** UB Ontario 181 | UB Riviera 182

Bi-Matière Bi-Material

UB Melbourne 184 | UB Sydney 185 | UB Panama S 186 | UB Panama L 186 | UB Cork 187 | UB Sunset 188

Jute

NEW UB Phuket 190-191 | UB Havana 192 | UB Cuba 192 | UB Ipanema 192 | UB Baia 193 | UB Ios 194 | UB Cortina 195 | UB Vail 195 | UB Vienna 195 | UB Claudia 196 | UB Brasilia 197 | UB Darwin 198-199 | UB Brisbane 198-199 | UB Cairns 198-199 | UB Copacabana 200 | UB Belem 201 | UB Naxos 202 | UB Paros 203 | UB Roma 204 | UB Kos 205 | UB Capri 206

Polyester

UB Punjab 208-209 | UB Camberra 210 | UB Campo 211 | UB Joy 212 | UB Jane 213 | UB Rio 214

PP Tissé Laminé PP Woven Laminated

UB Orlando 216-217



Sérigraphies / Impressions numériques / Transferts / Broderies / Logistiques LCDP Group 100% Français & Normand



Depuis plusieurs années, LCDP Group c'est 100% de marquages réalisés en France pour privilégier l'économie du pays dans lequel nous vivons. Les bénéfices sont multiples, de la qualité à la proximité, un meilleur contrôle et la création d'emplois sur le territoire français. La réduction de l'impact environnemental et des économies pour le consommateur sont aussi des avantages considérables.

Marquez LCDP Group, c'est marquer FRANÇAIS !

10M

millions
de pièces
en stock



30 000

pièces
produites
par jour



CO2

L'empreinte carbone
**la plus basse
du marché**

**5 Jours
max**

Expédition de
vos commandes
sérigraphiées et
numériques sous
**5 jours ouvrés
maximum**

Une démarche RSE toujours en mouvement

A CSR approach always moving

24/48
heures max

Livraison en France
**sous 24 à 48h
maximum**
(hors Corse)



Des produits
innovants dans des
matières toujours
**plus respectueuses
de l'environnement**

Certifié jusqu'au bout des anses, Certified to the very ends of the handles



**STANDARD
100**

Le STANDARD 100 by OEKO-TEX® est un label de qualité qui garantit que les produits ne contiennent pas de substances toxiques, visant à certifier les qualités sanitaires et écologiques des textiles et cuirs ; Garantissant l'absence de produits toxiques pour le corps et pour l'environnement. Oeko-Tex désigne également l'Association Internationale pour la Recherche et l'Essai des Textiles Écologiques composée de 18 instituts de recherche indépendants. Tous les sacs coton de la collection Ubag sont certifiés Oeko-tex n°15.HIN.71730 HOHENSTEIN HTTI.

The STANDARD 100 by OEKO-TEX® is a worldwide standardized testing and certification system for all raw, semi-finished and finished textile products at all processing stages as well as for all accessory materials.



Fairtrade/Max Havelaar : Fair trade est un terme anglais qui correspond en français au commerce équitable, un système d'échange basé sur la recherche d'une plus grande équité que dans le commerce conventionnel. Ce système consiste plus concrètement en un partenariat commercial fondé sur le dialogue, la transparence et le respect. Le commerce équitable favorise le développement durable, protège les producteurs et tente de sensibiliser l'opinion sur ces enjeux. Principes : le paiement d'un prix juste, l'égalité entre les sexes, le respect de bonnes conditions de travail, etc...

Fairtrade connects consumers, consumers, businesses and small producer organizations and changes trade through more equitable prices for smallholder families, as well as humane working conditions and dignified income people employed in plantations in developing countries.



BSCI : La Business Social Compliance Initiative

Initiative menée par des entreprises qui se sont engagées à améliorer les conditions de travail dans leurs chaînes d'approvisionnement internationales.

An initiative led by companies committed to improving working conditions in their international supply chains.



OHSAS 18001 : 2007

Un modèle de système de gestion de la santé et de la sécurité au travail.

A model occupational health and safety management system.



ISO 9001 : 2015

Spécifie les exigences relatives au système de management de la qualité.

Specifies the requirements for the quality management system.



ISO 14001 : 2015

Norme internationalement reconnue qui établit les exigences relatives à un système de management environnemental.

An internationally recognized standard that establishes the requirements for an environmental management system.



GOTS La certification permet la commercialisation de tous textiles biologiques dans le monde entier avec un cahier des charges permettant :

- Procédés de production et de transformation respectueux de l'environnement
 - Respect et Amélioration des conditions de travail
 - Promotion de l'utilisation de fibres biologiques
- Interdiction d'intrants dangereux comme les métaux lourds toxiques, les solvants aromatiques, etc.

Associé au logo GOTS, les produits commercialisés sont donc contrôlés comme conformes aux cahier des charges GOTS, gage de garantie tout au long de la filière jusqu'aux consommateurs.

The GOTS Organic Textile Reference System is recognized as a global reference for textiles made from organic fibers. It sets high-level environmental criteria throughout the organic textile supply chain and also requires compliance with social criteria.



CU810858

Global Recycled Standard : La certification GRS permet d'officialiser une allégation d'étiquetage sur la composition d'un produit.

Tous les maillons de la chaîne de production doivent être certifiés pour garantir la traçabilité et la teneur en éléments recyclés dans le produit fini

CU810858GRS-2022-00167664.

GRS certification enables a labelling claim to be made about the composition of a product. Every link in the production chain must be certified to guarantee traceability and the recycled content of the finished product.



Sur Mesure : Demandez-nous la lune, on prépare déjà la fusée.

CUSTOM MADE : Ask us the moon, we're already building the rocket.



1 Avec vos logos *With your logos*
Impression sérigraphique, broderie, paillettes,
encre gonflante, transfert, etc.
Silkscreen printing, embroidery, glitter, raised ink, transfer, etc.

2 Votre matière *The fabric*
Non tissé, coton, polyester, PP, etc.
Non-woven, cotton, polyester, PP, etc.

3 Vos dimensions de poignées
Your dimensions of handles

4 Votre coloris *Your colour*

5 Votre taille de sac *Your bag size*
Largeur x hauteur x soufflet *Width x height x gusset*

6 Vos finitions spécifiques
Your Special finishes
Velcro, fermeture éclair, hangtag, etc.
Velcro, zippé, hangtag, etc.

7 Un conditionnement sur mesure *Made-to-measure packing*
Polybag, gencod sur carton, étiquette personnalisée, etc.
Polybags, EAN-barcode on boxes, personalised labels, etc.

LCDP Group, c'est également un service sur mesure performant, à votre écoute et toujours au fait des dernières tendances ! *LCDP Group is also a special high-quality manufacturing service, guided by listening to customers' wishes and always at the cutting edge!*

Autre chose ? *You want more?*
+33 (0)1 79 97 07 67 | www.lcdpgroup.com



Votre commande
100% personnalisée en import direct.
Your 100% personalized order in direct import.

Une fois que tous ces paramètres seront finalisés, nos équipes mettront tout en œuvre pour vous réaliser un produit à la hauteur de vos souhaits, dans le respect de votre cahier des charges, du délai de livraison et de votre budget.

Once all details have been setted, our teams do as much as possible to meet your requirements, complying with your specifications, delivery times and your budget.

**Pour des raisons de confidentialité, les logos ne sont pas les logos originaux des commandes reçues.*

For confidentiality reasons, the logos are not the original logos of the orders received.



« Put your UPRON. Show your style. »

UPRON conçoit des tabliers pensés pour allier utilité, durabilité et esthétique.

Les produits **UPRON** offrent confort, résistance et finitions soignées.

Chaque tablier est imaginé comme un véritable support d'image, capable de valoriser ceux qui le portent et de s'inscrire dans le temps.

Que vous soyez artisan, barista ou créateur, **UPRON** accompagne vos gestes au quotidien. Chaque couture, poche, attache est conçu pour être à la fois pratique et élégant.

Plus qu'une protection, c'est une expression : votre tablier devient l'expression de votre savoir-faire.

Mettez un tablier, affirmez un style !



NEW

UPRON Tommy 220

80% recycled cotton - 20% recycled polyester



Double poche
Double pocket



RECYCLED COTTON

Tablier coton/polyester recyclé double poche avant Apron in recycled cotton/polyester with double front pocket

220gsm | 80% coton recyclé / 20% polyester recyclé | 70x100cm | Double poche avant

Longueur des liens : 100 cm

Hauteur de la zone poches : 67 cm

Zone de marquage/print area : Zone1 : 15x12cm | Zone2 : 25x12cm | Zone3 : 14x12cm

25 50 | 10kg | 60x40x25cm

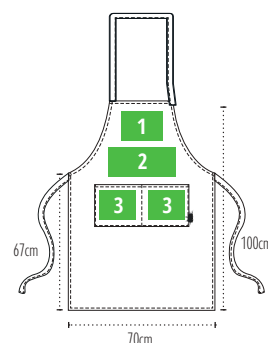



325



350



365



370



380

NEW

UPRON Tyler 180

35% recycled cotton - 65% recycled polyester



Double poche
Double pocket



RECYCLED COTTON

Tablier en coton recyclé double poche avant Apron in recycled cotton with double front pocket

180gsm | 80% coton recyclé / 20% polyester recyclé | 70x100cm | Double poche avant

Longueur des liens : 100 cm

Hauteur de la zone poches : 40 cm

Zone de marquage/print area : Zone1 : 15x12cm | Zone2 : 25x12cm | Zone3 : 14x12cm

25 50 | 8kg | 60x40x20cm

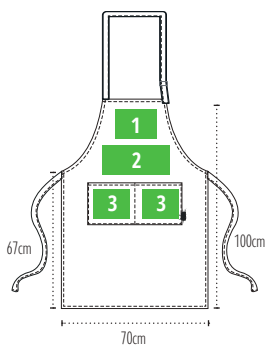

R010



R057



R077



R080

NEW

UPRON Teddy 150

35% recycled cotton - 65% recycled polyester



Poche simple
Simple pocket



RECYCLED COTTON

Tablier en coton recyclé avec 1 poche avant Apron in recycled cotton with one front pocket

150gsm | 35% coton recyclé / 65% polyester recyclé | 60x90cm | 1 poche avant

Longueur des liens : 100 cm

Hauteur de la zone poches : 20 cm

Zone de marquage/print area : Zone1 : 15x12cm | Zone2 : 25x12cm | Zone3 : 20x12cm

25 50 | 8kg | 60x40x20cm

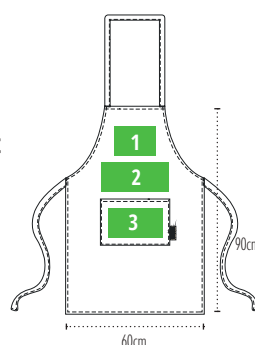

R001



R080



NEW

UPRON Timéo 150

35% cotton - 65% polyester



STANDARD
100



Double poche
Double pocket



Tablier coton-polyester double poche avant Apron in cotton-polyester with double front pocket

150gsm | 35% coton / 65% polyester | 75x100cm | Double poche avant et sangle cou réglable

Longueur des liens : 100 cm

Hauteur de la zone poches : 20 cm

Zone de marquage/print area : Zone1 : 15x12cm | Zone2 : 25x12cm | Zone3 : 14x12cm

25 50 | 8kg | 60x40x20cm

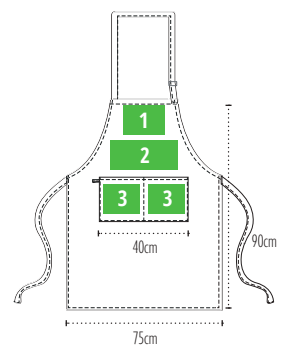



002



010



020



026



057



063



071



080

KWOO

«Le sac des désirs n'a pas de fond.»

Proverbe japonais

KWOO est une marque novatrice, moderne et urbaine, conçue pour les citadins actifs qui recherchent à la fois légèreté et solidité dans leurs accessoires quotidiens.

Être utile tous les jours, que ce soit pour le travail ou le week-end, KWOO offre des produits alliant praticité et style.

Chaque création est pensée pour être fonctionnelle sans compromis sur le design, permettant de répondre aux exigences d'un mode de vie urbain et dynamique.

Choisir KWOO, c'est opter pour la simplicité, la durabilité et une élégance résolument moderne.







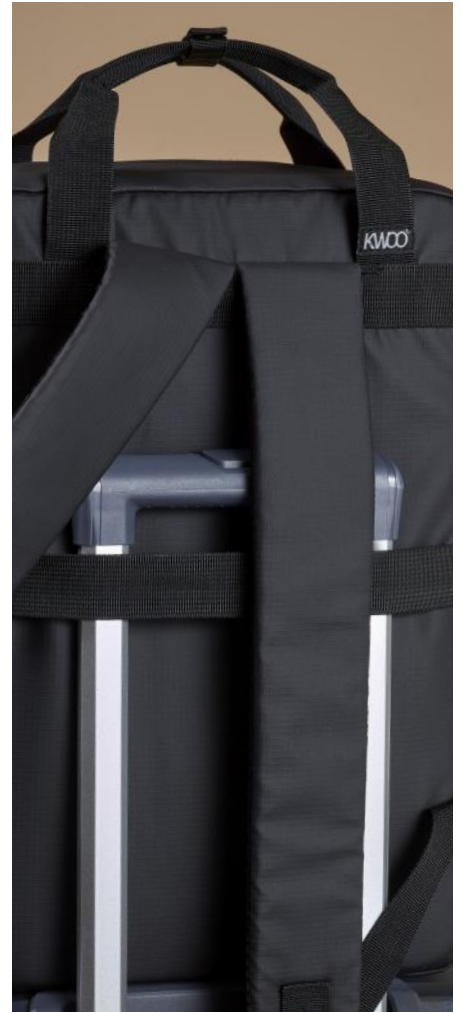

KWOO
3 NEWS





Zip rétro-réfléchissant haute visibilité & Waterproof



080

NEW KWOOSTanley 26L

Sac à dos avec grand compartiment de rangement. Poche avant zippée.
Backpack with large storage compartment. Zipped front pocket.

26L | PVC 900D | 900D polyester/PVC |
Lining/Doublure: 100% polyester 210D noir | 41x51x12cm
Anses ajustables / Adjustable handles : 46x7cm
Zone de marquage/print area : 10x15cm

1 20 | 10kg | 50x41x47cm

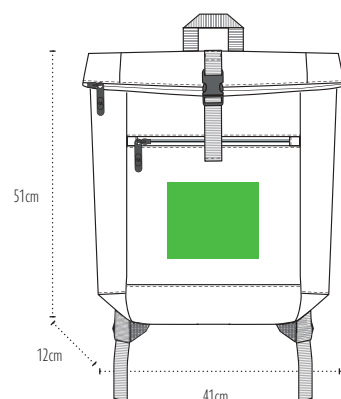



NEW KWOO Globe 18L

Sac à dos week-end/cabine multifonctions (à dos, porté main) avec un compartiment de rangement, un compartiment ordinateur, un compartiment pour chaussures et une poche extérieure.
Multifunctional (backpack, handheld) weekend/cabin backpack with storage compartment, computer compartment, shoes compartment and external pocket.

18L | PVC 900 | 900D polyester/PVC |

Compartiment principal + poche avant + poches internes + poche chaussures

Lining/Doublure: 100% polyester 210D noir | 30x40x15cm

Zone de marquage/print area : 10x10cm

1  15 | 10kg | 54x44x37cm



Norme
Européenne
A4E

Airlines For Europe
Personal item/ Underseat

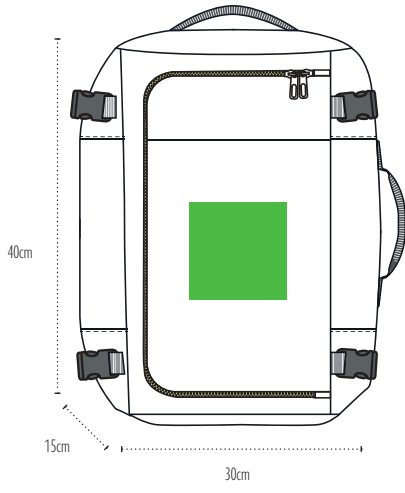

080





080

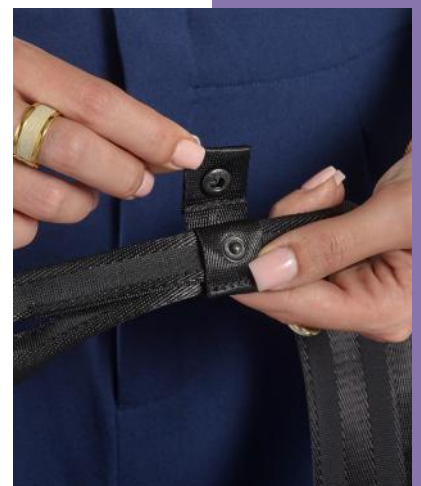
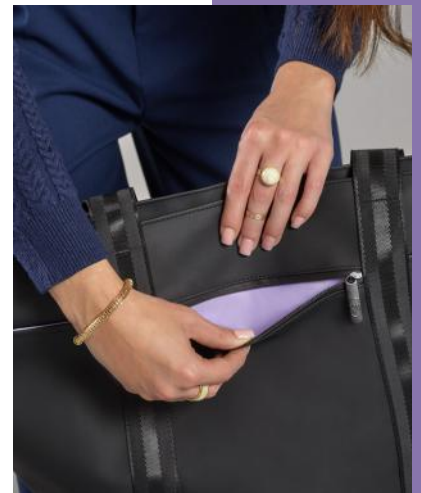
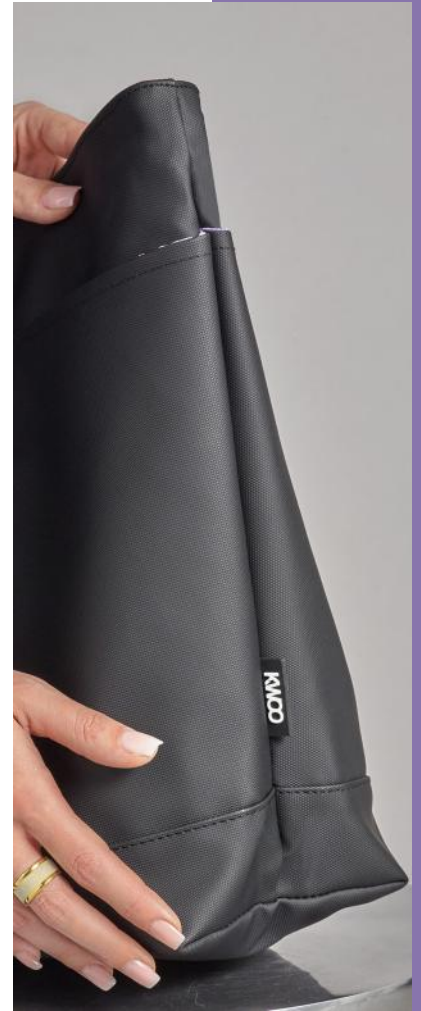
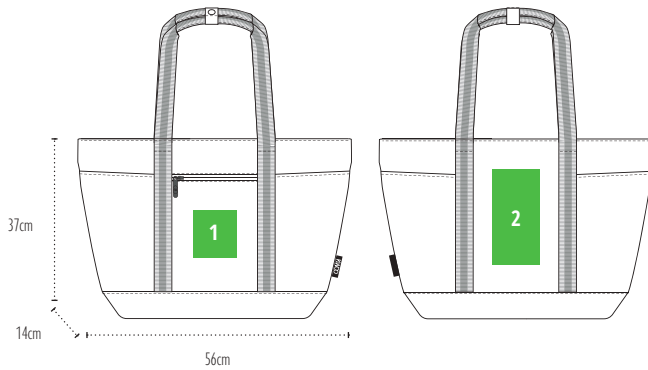

NEW KWOO City 30L

Grand sac à main avec compartiments de rangements intérieurs.
 Poche extérieure zippée et 4 compartiments extérieurs.
 Large handbag with interior storage compartments.
 Zippered exterior pocket and 4 exterior compartments.

30L | PVC 900D | 900D polyester/PVC | 1 compartiment principal + poches internes
 Lining/Doublure: 100% polyester 210D lilas | 56x37+14cm
 Anses ajustables / Adjustable handles : 26x3,5cm
 Zone de marquage/print area : Zone1: 10x15cm | Zone2: 10x20cm

1 15 | 12kg | 58x41x27cm



KWOO

CORPORATE





KWOO Chelsea 17L

Sac à dos avec un compartiment de rangement, un compartiment pour ordinateur et une poche extérieure. Port USB-C.

Backpack with storage compartment, laptop compartment and outside pocket. USB-C port.

17L | 100% polyester oxford avec enduit PU waterproof

Lining/Doublure: 100% polyester gris avec motif /polyester grey with pattern | 30x44x12cm

Anses ajustables / Adjustable handles : 18x3,5cm

Zone de marquage/print area : 13x13cm

 1  10 | 8kg | 50x41x50cm

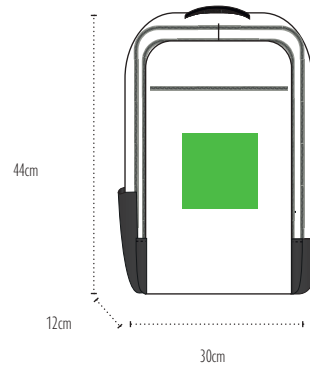

080





KWOO Wall Street 22L

Sac à dos avec deux compartiments de rangement, un compartiment pour ordinateur et une poche extérieure. Port USB-C.
Backpack with two storage compartments, a laptop compartment and an outside pocket. USB-C port.

22L | 100% polyester oxford avec enduit PU waterproof

Lining/Doublure: 100% polyester gris avec motif /polyester grey with pattern | 32x45x15cm

Anses ajustables / Adjustable handles : 18x3,5cm

Zone de marquage/print area : 11x20cm

 1  10 | 10kg | 50x41x55cm



080



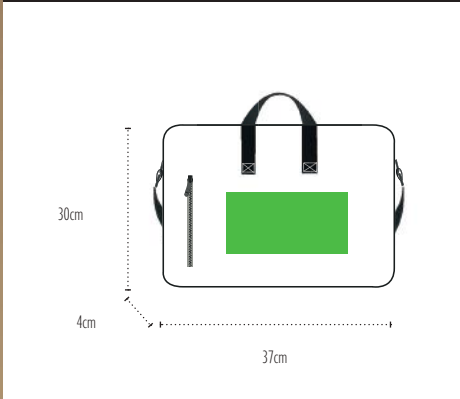

080





KWOO Manhattan

Sacoche porte ordinateur avec compartiment de rangement et une poche extérieure. Port USB-C.
Computer bag with storage compartment and outside pocket. USB-C port.

100% polyester oxford avec enduit PU waterproof

Lining/Doublure: 100% polyester gris avec motif /polyester grey with pattern | 37x30x4cm

Anses / handles : 40x3,5cm

Bandoulière ajustable / adjustable strap : 135x2,5cm

Zone de marquage/print area : 22x14cm

1  20 | 10kg | 60x42x34cm

KWOO
OUTDOOR





057



079



080

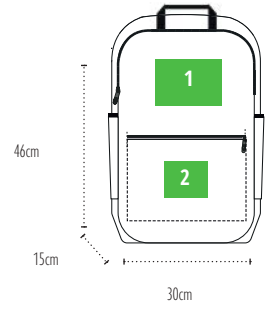

KWOO Mac Kinley 21L

Sac à dos avec deux compartiments de rangement, un compartiment pour ordinateur et deux poches extérieures.
Backpack with two storage compartments, a laptop compartment and two outside pockets.

21L | 100% polyuréthane ribstop (PU) avec enduction polyester waterproof

Lining/Doublure: 100% polyester 210D | 30x46x15cm

Anses ajustables / Adjustable handles : 26x2,5cm

Zone de marquage/print area : Zone1 : 14x19cm | Zone2 : 12x11cm

 1  15 | 15kg | 50x36x67cm

Zip rétro-réfléchissant haute visibilité & Waterproof





057

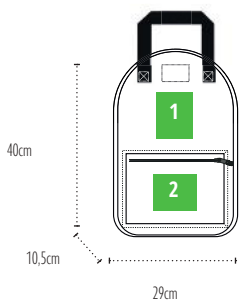

079



080



KWOO K2 13L

Sac à dos avec un compartiment de rangement et une poche extérieure.
Backpack with storage compartment and outside pocket.

13L | 100% polyuréthane ribstop (PU) avec enduction polyester waterproof

Lining/Doublure: 100% polyester 210D | 29x40x10,5cm

Anses ajustables / Adjustable handles : 42x3,5cm

Zone de marquage/print area : Zone1 : 10x13cm | Zone2 : 11x12cm

1 20 | 15kg | 46x36x45cm









057



079



080

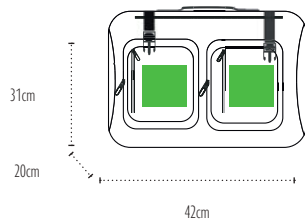

KWOO Everest 27L

Sac multifonctions (à dos, porté main, porté bandoulière) avec un compartiment de rangement, un compartiment pour chaussures et deux poches extérieures.
Multi usage bag with reflective front zipper and adjustable handle

27L | 100% polyuréthane ribstop (PU) avec enduction polyester waterproof

Lining/Doublure: 100% polyester 210D | 31x42x20cm

Anses ajustables / Adjustable handles : 43x8cm

Bandoulière ajustable / adjustable strap : 135x3,5cm

Zone de marquage/print area : 11x10cm

1 15 | 15kg | 53x36x46cm

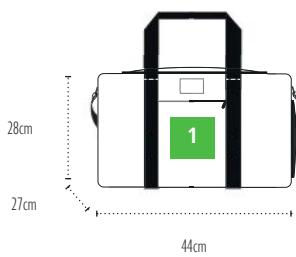

057



079



080



KWOO Denali 34L

Sac week-end/sport avec un compartiment de rangement, un compartiment pour chaussures et une poche extérieure.
 Travel and sport bag with full lining

34L | 100% polyuréthane ribstop (PU) avec enduction polyester waterproof

Lining/Doublure: 100% polyester 210D | 44x28x27cm

Anses / Handles: 48x3,5cm

Bandoulière ajustable / adjustable strap: 135x3,5cm

Zone de marquage/print area : Zone1 : 11x13cm | Zone2 : 11x13cm

1 20 | 15kg | 60x36x48cm

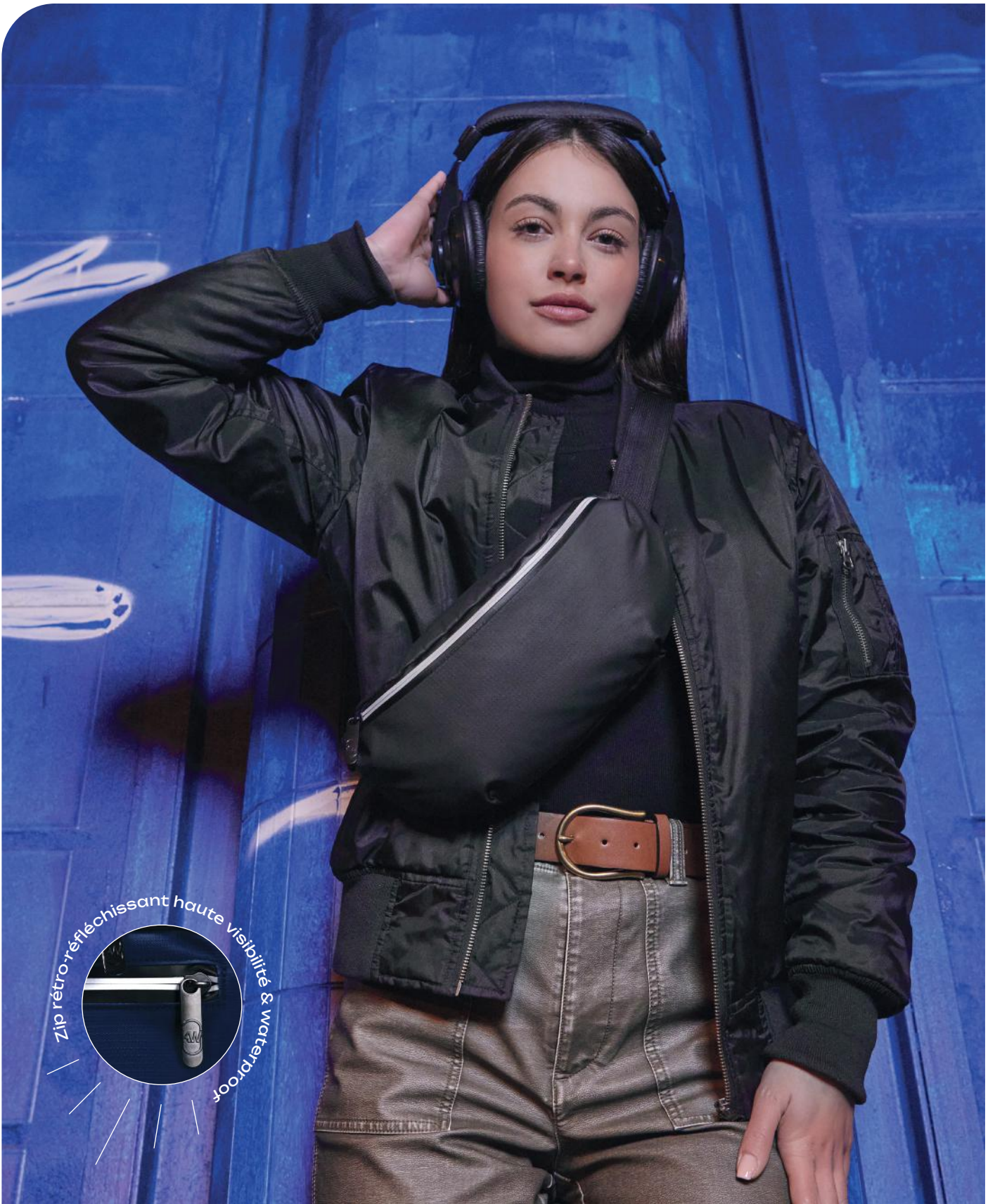

Zip rétro-réfléchissant haute visibilité & water-proof

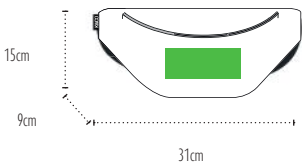

057



079



080



KWOO Fuji

**Banane avec une poche zippée au dos.
Chest bag with zipped back pocket.**

100% polyuréthane ribstop (PU) avec enduction polyester waterproof

Lining/Doublure: **100% polyester 210D** | 31x15+9cm

Bandoulière ajustable / adjustable strap : **92x3,5cm**

Zone de marquage/print area : **13x7cm**

 50  50 | 15kg | 56x43x34cm



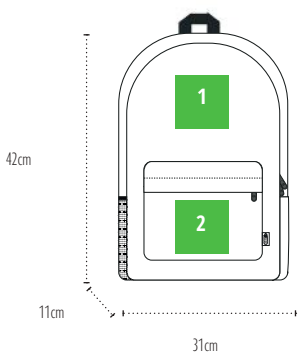

R350



R077



R080



R390



KWOO Utah 600D 15L

Sac à dos avec une poche extérieure zippée.
Backpack with external zipped pocket.

15L | 100% RPET certifié GRS / with certificate GRS
Lining/Doublure: 100% polyester 210D black | 31x42x11cm
Bandoulière ajustable / adjustable strap : 17x2,5cm
Zone de marquage/print area : Zone1 : 13x13cm | Zone2 : 13x13cm

1  25 | 10kg | 43x33x47cm



Le sac à la française!

BLEU BLANC SAC (BBS) est une marque qui incarne l'excellence et le savoir-faire du Fait en France, en particulier dans la confection de sacs de haute qualité. Fabriqués en région parisienne dans un atelier intégré, chaque sac bénéficie d'une attention minutieuse, où chaque pièce est soigneusement repassée une par une pour garantir une finition irréprochable.

La marque se distingue par son engagement envers la qualité, offrant des sacs qui allient à la fois élégance, robustesse et praticité. Avec BLEU BLANC SAC, vous choisissez la référence du Fait en France, un gage de qualité, de durabilité et de style, mais aussi d'un acte RSE indispensable pour les générations futures.

FAIT EN FRANCE

BLEU BLANC SAC





BBS Fernand 150
Coton



**OEKO
TEX®**
STANDARD
100



Tote bag

150grs/gsm | 100% coton/cotton | 38x42cm

Anses / Handles: 65x2,5cm

Zone de marquage/print area : 28x28cm

 200 | 17kg | 60x40x30cm

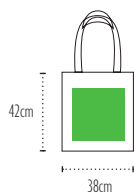

001



057



080

NEW

BBS Clement 150

Coton



**OEKO
TEX®**
STANDARD
100

FAIT EN
FRANCE



Tote bag avec anses tricolores Tote bag with tricolored handles

150grs/gsm | 100% coton/cotton | 38x42cm

Anses / Handles : 65x3cm

Zone de marquage/print area : 28x28cm

 150 | 15kg | 60x40x28cm

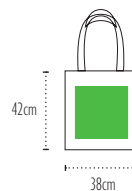

001



057



BBS Felix 220
Coton



**OEKO
TEX®**
STANDARD
100



Tote bag

220grs/gsm | 100% coton/cotton | 38x42cm

Anses / Handles : 65x2,5cm

Zone de marquage/print area : 28x28cm

 50 | 12kg | 60x40x20cm

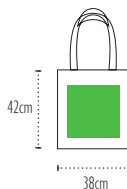

001



057



080

BBS Fred 220 **16L**
Coton

FAIT EN
FRANCE



OEKO
TEX®

STANDARD
100



Tote bag avec soufflets
Tote bag with gussets

220grs/gsm | 16L | 100% coton/cotton | 38x42x10cm

Anses / Handles : 65x3cm

Zone de marquage/print area : 28x28cm

 50 | 7kg | 60x40x20cm

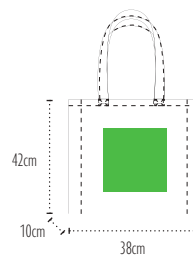

001



BBS Francine 220
Coton



**OEKO
TEX®**
STANDARD
100



Trousse coton
Cotton pouch

220grs/gsm | 100% coton/cotton | 26x17cm
Zone de marquage/print area : **18x10cm**

 200 | 7kg | 60x40x20cm

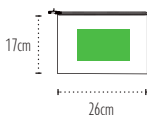

001

057

080

NEW

BBS Camille 220

Coton



OEKO
TEX®

STANDARD
100

FAIT EN
FRANCE



Duffle bag avec anses tricolores
Duffle bag with tricolored handles

220grs/gsm | 100% coton/cotton | 50xØ24cm

Anses / Handles : 125x3cm

Zone de marquage/print area : 15x15cm

Zone de marquage sur poche/print area on pocket : 15x12cm

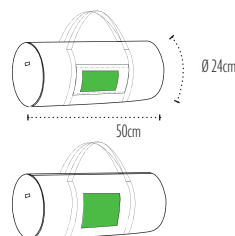

001



057

 25 | 12kg | 60x40x20cm



BBS Francis 220 19L

Coton



OEKO
TEX®

STANDARD
100



Sac shopping grand format avec soufflets Extra size tote bag full gussets

220grs/gsm | 19L | 100% coton/cotton | 45x35x12cm

Anses / Handles : 65x3cm

Zone de marquage/print area : 28x28cm

 50 | 10kg | 60x40x20cm

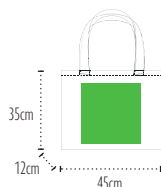

001



057



080

BBS Florent 220

Coton

FAIT EN
FRANCE



OEKO
TEX®

STANDARD
100



Grand sac T bottom Large bag T bottom

220grs/gsm | 100% coton/cotton | 47x35+15cm

Anses / Handles : 70x2,5cm

Zone de marquage/print area : 28x24cm

 50 | 8kg | 60x40x20cm

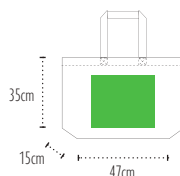

001



057



080



BBS Firmin 150
Coton



STANDARD
100



Sac à pain / Bread bag

150grs/gsm | 100% coton/cotton | 24x58cm

Anses / Handles : 65x2,5cm

Zone de marquage/print area : 16x22cm

 100 | 8kg | 60x40x30cm

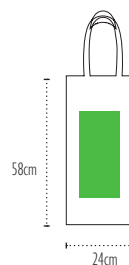

001

UB
UBAG





UBAG Bogota p.77



UBAG Baltimore p.79



UBAG Ontario p.181



UBAG Kensington p.78



UBAG Santa Barbara p.80

7 NEW



UBAG Bayside p.81



UBAG Phuket p.190-191

Polyester
recyclé (RPET)
Coton recyclé

5 NEW *with*
love for planet!



STANDARD
100



NEW UBAG Bogota 150

55% recycled cotton - 45% recycled polyester



RECYCLED COTTON



Existe en 100% RPET / Available in 100% RPET version.

Pages 84-85 : Punjab



Sac shopping coton polyester recyclé Cotton polyester recycled shopping bag

150grs/gsm | 55% coton recyclé/recycled cotton /
45% polyester recyclé/polyester recycled | 38x42cm

Anses / Handles : 65x2,5cm

Zone de marquage/print area : 28x28cm

50 100 | 9kg | 60x40x30cm

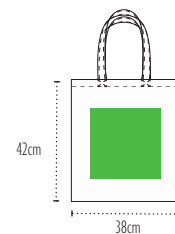

R001

NEW UBAG Kensington 510

60% recycled cotton - 40% recycled polyester



RECYCLED COTTON 



Grand sac zippé en coton recyclé avec soufflets. Poche intérieure.
Large zippered bag made from recycled cotton with gussets. Inside pocket.

510grs/gsm | 60% coton recyclé/recycled cotton / 40% polyester recyclé/
recycled polyester avec poche intérieure / with pocket inside | 47x35x18cm

Anses / Handles : 66x3cm

Zone de marquage/print area : 12x22cm

 25  25 | 15kg | 60x40x25cm



NEW UBAG Baltimore 320

60% recycled cotton - 40% recycled polyester



RECYCLED COTTON



Sac T bottom zippé en coton recyclé. Poche intérieure.
Zippered T-bottom bag made from recycled cotton. Inside pocket.

320grs/gsm | 60% coton recyclé/recycled cotton / 40% polyester recyclé/recycled polyester
avec poche devant et intérieure / with pocket in front and inside | 42x38+10cm

Anses teintées / Tinted handles : 54x3cm

Zone de marquage/print area : Zone1 : 18x14cm | Zone2 : 22x14cm

25 50 | 12kg | 60x40x25cm

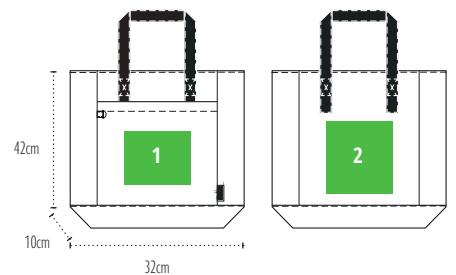

NEW UBAG Santa Barbara 360

60% recycled cotton - 40% recycled polyester

XXL
SIZE



RECYCLED COTTON 



Sac XXL en coton recyclé avec t bottom tissage panier
XXL bag in recycled cotton basket weave with t bottom

360grs/gsm | 60% coton recyclé/recycled cotton /
40% polyester recyclé/polyester recycled | 57x39+18cm
Anses en coton plate ton sur ton / Handles in flat cotton webbing tone on tone : 60x4cm
Zone de marquage/print area : 28x24cm

 25  50 | 15kg | 60x40x33cm

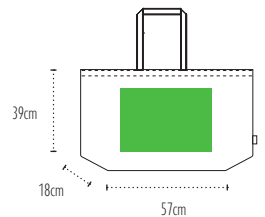

NEW UBAG Bayside 360

60% recycled cotton - 40% recycled polyester



RECYCLED COTTON 



Sac de plage en coton recyclé chiné Beach bag in recycled cotton melanged full gussets

360grs/gsm | 60% coton recyclé/recycled cotton /
40% polyester recyclé/polyester recycled | 42x38x14cm

Anses avec cordons aux extrémités munis d'un tube en plastique /
Handles with noddles at the end with plastic tube : 77x2,7cm

Zone de marquage/print area : 28x22cm

 25  25 | 12kg | 60x40x20cm

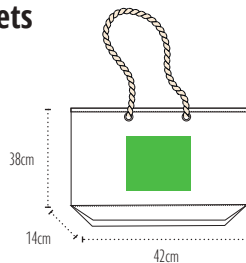

R003



R046



R056

UBAG Michigan

80% recycled cotton - 20% recycled polyester



RECYCLED COTTON 



Sac shopping T bottom recyclé avec poche extérieure en coton Recycled T-bottom shopping bag with cotton front pocket

220grs/gsm | 70% coton recyclé/recycled cotton /
30% polyester recyclé/polyester recycled | 35x40+10cm
Anses / Handles : 55x2,5cm
Zones de marquage/print area : poche/pocket : 17x12cm | 25x25cm

 50  100 | 15kg | 60x40x35cm

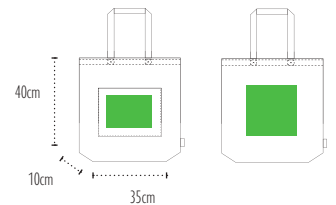

UBAG Cadix 
80% recycled cotton - 20% recycled polyester



RECYCLED COTTON 



Sac shopping T bottom recyclé avec doubles anses
Recycled T-bottom shopping bag with double handles

140grs/gsm | 80% coton recyclé/recycled cotton /
20% polyester recyclé/polyester recycled | 38x42+12cm
Anses / Handles : 65x2,5cm
Zone de marquage/print area : **28x28cm**

 50  100 | 15kg | 60x40x25cm



R001

UBAG Punjab 140

100% RPET



Depuis plusieurs années maintenant, la révolution du recyclage s'est amorcée. La mutation se fait dans toutes les filières, à commencer par celle du plastique. Seulement, si les mesures gouvernementales incitent au changement, quelle est la marge de manœuvre des industriels qui doivent se réinventer ? Le plastique est décrié, alors qu'il sait se réinventer. C'est le cas du PET, matière intégralement recyclable utilisée pour la production de bouteilles plastiques, dont l'empreinte carbone est réduite de près de 80% sous sa forme recyclée, dite RPET.



Tote bag

140grs/gsm | 100% PET recyclé / recycled PET | 38x42cm

Anses / Handles : 65x2,5cm

Zone de marquage/print area : 28x28cm

 100  200 | 15kg | 60x40x25cm

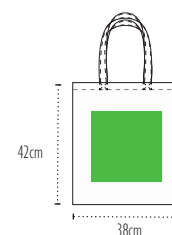

Coloris effet chiné.
Ce produit étant fabriqué à base de matières collectées puis recyclées, des variations de couleurs peuvent être constatées.

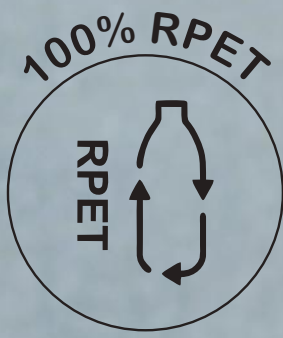

UBAG Santa Fe 140

70% recycled cotton - 30% recycled polyester



RECYCLED COTTON



Sac à dos recyclé Recycled drawstring bag

140grs/gsm | 70% coton recyclé/recycled cotton /
30% polyester recyclé/polyester recycled | 37x41cm
Anses / Handles : 142x0,5cm
Zone de marquage/print area : 26x24cm

50 100 | 15kg | 60x40x35cm

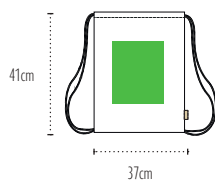

R001 R020 R055 R057 R080

UBAG Zanzibar 450

80% recycled cotton - 20% recycled polyester

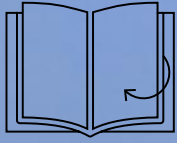

Existe en isotherme
Available in an
insulated.

Page 177 : Bahamas



RECYCLED
COTTON 



Grand sac T bottom recyclé Large recycled T-bottom bag

450grs/gsm | 80% coton recyclé/recycled cotton /
20% polyester recyclé/polyester recycled | 58x41+16cm
Anses / Handles : 62x3,5cm | Poignées en sangle de coton plate/
Handles in flat cotton webbing
Zone de marquage/print area : 28x28cm

 20  20 | 15kg | 60x40x30cm

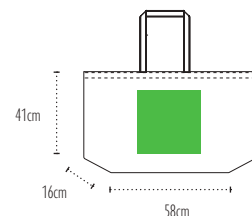

R001

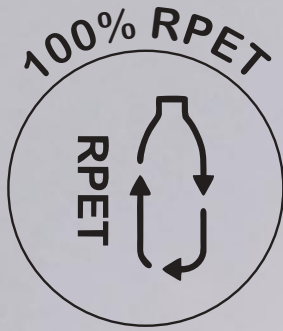

I used
to be a
plastic
bottle



RPET

Je suis votre
nouveau sac en
PET recyclé
I'am your new bag
in recycled PET

Plus de gaspillage
No more waist

Feutre RPET

Depuis plusieurs années maintenant, la révolution du recyclage s'est amorcée. C'est le cas du PET, matière intégralement issue de la récupération de bouteilles plastiques, dont l'emprunte carbone est réduite de près de 80% sous sa forme recyclée, dite RPET.



UBAG Vastra S

Feutrine

Pochette zippée taille S T bottom feutrine en PET recyclé
T bottom zippéd pouch small size felt recycled PET

100% PET recyclé / recycled PET | 22x12+6cm

Zone de marquage/print area : 10x6cm

 50  150 | 6kg | 47x30x40cm



R089

R095

UBAG Vastra L

Feutrine

Pochette zippée taille L T bottom feutrine en PET recyclé
T bottom zippéd pouch large size felt recycled PET

100% PET recyclé / recycled PET | 28x18+9cm

Anses / Handles : 65x2,5cm

Zone de marquage/print area : 18x10cm

 50  150 | 10kg | 59x39x40cm



R089

R095



UBAG Goteborg

Feutrine

Sac zippé feutrine en PET recyclé T bottom
Felt PET recycled bag with T bottom and zippér

100% PET recyclé / recycled PET | 52x35+17cm

Anses / Handles : 72x3cm | 100% Recycled Polycotton flat webbing

Zone de marquage/print area : 28x13cm

 5  25 | 7kg | 54x37x40cm



R089/R095 R095/R080



UBAG Kalmar

Feutrine

Sacoche porte documents en feutrine PET recyclé
Document holder felt PET recycled

16L | 100% PET recyclé / recycled PET | 38,5x30x8cm

Anses / Handles : 13x3,5cm

Zone de marquage/print area : 28x14cm

Zone de marquage poche/print pocket area : 28x12cm

10 20 | 7kg | 48x39x40cm

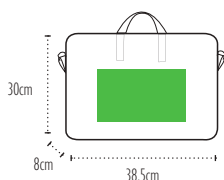

R089



R095



UBAG Malmo

Feutrine



Sac feutrine en PET recyclé T bottom
Felt PET recycled bag with T bottom

100% PET recyclé / recycled PET | 46x32+13cm

Cordelettes / Ropes : 65xØ1 | 100% polycotton with noddles

Zone de marquage/print area : 28x18cm

5 25 | 7kg | 49x36x40cm



R089

R095

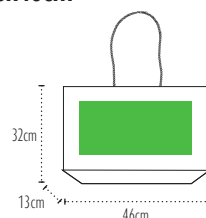

UBAG Stockholm

Feutrine

Sac feutrine PET recyclé
Felt PET recycled bag

100% PET recyclé / recycled PET | 36x40cm

Anses / Handles : 65x2,5cm

Zone de marquage/print area : 28x28cm

50 50 | 5kg | 48x40x28cm

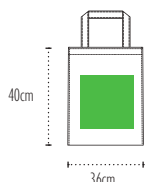

R089

R095



I used
to be a
plastic
bottle

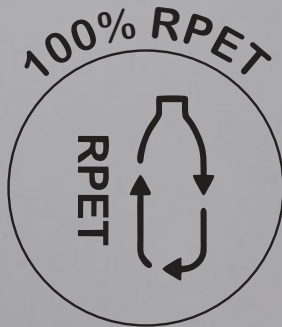

The Lab Family



UBAG Roy 340
80% recycled cotton
20% recycled polyester



UBAG Romy 340
80% recycled cotton
20% recycled polyester



RECYCLED COTTON



Sacochette porte ordinateur/documents recyclé avec rembourrage intérieur de protection. Poignées et bandoulière ajustable. / Recycled laptop/document bag with protective inner padding. Handles and adjustable shoulder strap.

340grs/gsm | 80% coton recyclé/recycled cotton / 20% polyester recyclé/polyester recycled | 38x28x6cm
Anses / Handles : 45x3cm | Sangle coton tressé ajustable / Adjustable braided cotton strap : (123.5x3cm)
Zone de marquage/print area : 28x14cm

20 20 | 15kg | 51x46x25cm



**Banane recyclé avec bandoulière ajustable
Recycled cotton chest bag**

340grs/gsm | 80% coton recyclé/recycled cotton / 20% polyester recyclé/polyester recycled | 25x15+8cm
Anses / Handles : 105x3,5cm
Sangles plates en coton tressé / Flat cotton webbing
Zone de marquage/print area : 14x6cm

25 50 | 15kg | 51x46x25cm



UBAG Zac 340

80% recycled cotton - 20% recycled polyester



RECYCLED COTTON

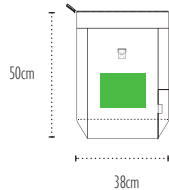

R057



R077



R080

Sac à dos recyclé avec rembourrage intérieur de protection Recycled backpack with protective inner padding

340grs/gsm | 80% coton recyclé/recycled cotton /
20% polyester recyclé/polyester recycled | 38x50+12cm

Anses ajustables / Adjustable handles : 87,5x3,5cm Sangles en coton tressé / cotton webbing
Zone de marquage/print area : 24x14cm

10 20 | 15kg | 51x46x25cm

UBAG Palm Beach 360

80% recycled cotton - 20% recycled polyester



RECYCLED COTTON 





R020



R026



R055



R057



R077



R080



Poche intérieure zippée

NEW



R090

Duffel bag recyclé avec poche intérieure zippée Recycled duffel bag with interior zip pocket

360grs/gsm | 30L | 80% coton recyclé/recycled cotton
20% polyester recyclé/recycled polyester | Ø25x50cm

Anses / Handles : 115x4cm

Zone de marquage poche/print area on pocket : 15x15cm

 25  25 | 15kg | 60x40x30cm

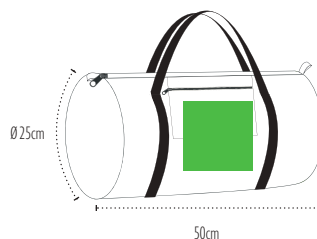

Coloris effet chiné.
Ce produit étant fabriqué à base de matières collectées puis recyclées, des variations de couleurs peuvent être constatées.

Les 100% Recyclés

(96% coton recyclé
4% RPET)

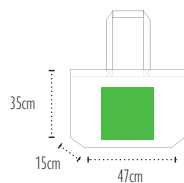

Grand sac shopping T bottom recyclé Big size T bottom recycled shopping bag

150grs/gsm | 96% coton recyclé/recycled cotton /
4% PET recyclé/recycled PET | 47x35+15cm

Anses / Handles : 70x2,5cm

Zone de marquage/print area : 28x24cm

 25  50 | 6kg | 60x40x28cm



UBAG Augusta 150
100% recycled



UBAG Vegas 150
100% recycled



Pochette recyclée avec zip en nylon
Recycled pouch with nylon zippér

150grs/gsm | 96% coton recyclé/recycled cotton /
4% PET recyclé/recycled PET | 26x17cm

Zone de marquage/print area : **18x10cm**

100 200 | 7kg | 60x40x13cm

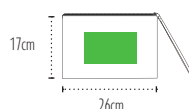

Tote bag recyclé
Recycled tote bag

150grs/gsm | 96% coton recyclé/recycled cotton /
4% PET recyclé/recycled PET | 38x42cm

Anses / Handles : **65x2,5cm**

Zone de marquage/print area : **28x28cm**

50 200 | 15kg | 60x40x32cm



Les 100% Recyclés

(96% coton recyclé
4% RPET)

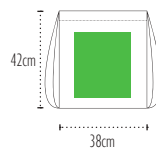

320 350 365 370 380

Sac à dos recyclé Recycled backpack bag

150grs/gsm | 96% coton recyclé/recycled cotton / 4% PET
recyclé/recycled PET | 38x42cm

Cordelettes / Ropes : Ø5mm

Zone de marquage/print area : 26x24cm

50 200 | 19kg | 60x40x35cm



UBAG Broadway 150
100% recycled



Colombus 150
100% recycled



Tote bag recyclé avec soufflets
Recycled tote bag with gussets

150grs/gsm | 16L | 96% coton recyclé/recycled cotton / 4% PET recyclé/recycled PET | 38x42x8cm

Anses / Handles : 65x2,5cm

Zone de marquage/print area : 28x28cm

25 100 | 13kg | 60x40x20cm



Sac a dos recyclé avec anses
Recycled drawstring bag with handles

150grs/gsm | 96% coton recyclé/recycled cotton / 4% PET recyclé/recycled PET | 38x42cm Anses / Handles : 65x2,5cm

Cordelettes / Ropes : Ø5mm

Zone de marquage/print area : 26x24cm

50 100 | 11kg | 60x40x18cm

ASPECT JUTE

100% RECYCLÉ / RECYCLED



UBMaya

UBMerida

UBTulum



001

UBAG Tulum 200

80% recycled cotton - 20% recycled polyester

Sac shopping en coton et polyester recyclé / Recycled cotton and polyester shopping bag

200grs/gsm | 11L | 80% coton recyclé/recycled cotton / 20% polyester recyclé/recycled polyester | 25x25x17cm

Anses / Handles : 32x2cm Coton tressé boudiné / Rounded cotton webbing

Zone de marquage/print area : 16x16cm

 50  100 | 14kg | 60x40x26cm

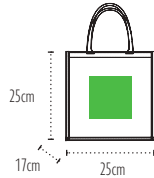

UBAG Merida 200

80% recycled cotton - 20% recycled polyester

Sac shopping en coton et polyester recyclé / Recycled cotton and polyester shopping bag

200grs/gsm | 17L | 80% coton recyclé/recycled cotton / 20% polyester recyclé/recycled polyester | 30x30x19cm

Anses / Handles : 39x2,5cm Coton tressé boudiné / Rounded cotton webbing

Zone de marquage/print area : 22x22cm

 50  100 | 16kg | 60x40x30cm

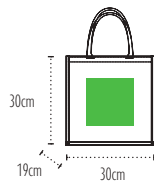

001

UBAG Maya 200

80% recycled cotton - 20% recycled polyester

Sac shopping en coton et polyester recyclé / Recycled cotton and polyester shopping bag

200grs/gsm | 21L | 80% coton recyclé/recycled cotton / 20% polyester recyclé/recycled polyester | 40x35x15cm

Anses / Handles : 42x2,5cm Coton tressé boudiné / Rounded cotton webbing

Zone de marquage/print area : 28x25cm

 25  50 | 11kg | 60x40x33cm

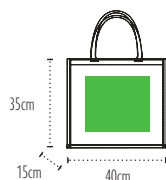

001



R001



R020



R045



R055



R057



R070



R080



R089

RECYCLED
COTTON 

Tote bag recyclé
Recycled tote bag

140grs/gsm | 80% coton recyclé/recycled cotton /
20% polyester recyclé/recycled polyester | 38x42cm

Anses / Handles : 65x2,5cm

Zone de marquage/print area : 28x28cm

 100  200 | 15kg | 60x40x27cm

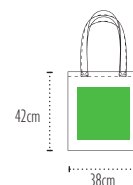

Coloris effet chiné.
Ce produit étant fabriqué à base de matières
collectées puis recyclées, des variations de
couleurs peuvent être constatées.



100%
Coton
BIO

*Responsable, il
respecte la planète.*
Respirant et
durable, il vous
accompagne en
toute saison.



UBAG Mia
Organic cotton



073



045



030



020



PLIABLE/FOLDABLE

Sac filet coton organique repliable certifié GOTS
Organic cotton foldable mesh bag certified GOTS

100% coton organique/organic cotton | 40x36cm

Anses / Handles : **69x2,5cm**

Zone de marquage poche/print area on pocket : **6x7cm**

25 **100** | **11kg** | **60x40x31cm**

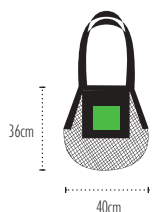

UBAG

105

UBAG Maui 150

Cotton double certification



STANDARD 100



GLOBAL ORGANIC TEXTILE STANDARD - GOTS



FAIRTRADE

MAX HAVELAAR



Tote bag coton organique double certification GOTS & MAX HAVELAAR

150grs/gsm | 100% coton organique certifié commerce équitable/
Organic and Fair trade Cotton certified | 38x42cm

Anses / Handles : 65x2,5cm

Zone de marquage/print area : 28x28cm

50 200 | 17kg | 60x40x28cm

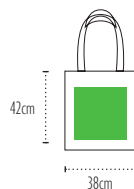

001



080

UBAG Nepal 150

Organic cotton



STANDARD
100



Tote bag coton organique certifié GOTS Tote bag organic cotton certified GOTS

150grs/gsm | 100% coton organique/organic cotton | 38x42cm |

Anses / Handles : 65x2,5cm |

Zone de marquage/print area : 28x28cm

50 200 | 17kg | 60x40x28cm

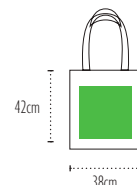

001



080

UBAG Recife 220
Organic cotton



Tote bag coton organique certifié GOTS
Tote bag organic cotton certified GOTS

220grs/gsm | 100% coton organique/organic cotton | 38x42cm
Anses / Handles : 65x2,5cm
Zone de marquage/print area : 28x28cm

50 100 | 14kg | 60x40x18cm



001

010

057

080

UBAG Grace 300
Organic cotton



STANDARD
100



Tote bag coton organique certifié GOTS
Tote bag organic cotton certified GOTS

300grs/gsm | 100% coton organique/organic cotton | 38x42cm

Anses / Handles : 65x2,5cm

Zone de marquage/print area : 28x28cm

25 50 | 10kg | 60x40x18cm

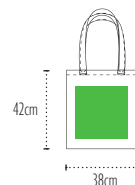

001

080

UBAG Jill 150

Organic cotton

16L

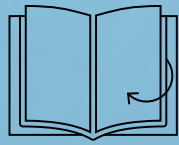

Existe en non organique / Available in non-organic.

Page 138 : Nassau



Tote bag coton Organique certifié GOTS avec soufflets Tote bag organic cotton certified GOTS with full gussets

150grs/gsm | 16L | 100% coton organique/organic cotton | 38x42x10cm

Anses / Handles : 65x2,5cm

Zone de marquage/print area : 28x28cm

25 100 | 12kg | 60x40x25cm

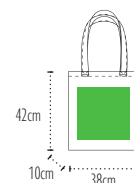

001

080

UBAG Moorea 220 16L

Organic cotton



STANDARD 100



GLOBAL ORGANIC TEXTILE STANDARD

GOTS

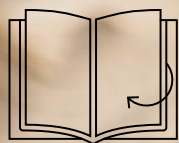

Existe en non organique / Available in non-organic.

Page 139 : **Keywest**



Tote bag coton organique certifié GOTS avec soufflets Tote bag organic cotton certified GOTS with gussets

220grs/gsm | 16L | 100% coton organique/organic cotton | 38x42x10cm

Anses / Handles : 65x2,5cm

Zone de marquage/print area : **28x28cm**

50 100 | 17kg | 60x40x30cm

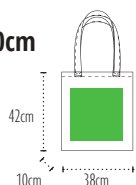

001

010

057

080

UBAG

111

UBAG Borneo 220 19L

Organic cotton



**XL
SIZE**



Existe en non organique / Available in non-organic.
Page 143 : Malibu



Sac shopping grand format coton organique certifié GOTS avec soufflet Large size shopping bag organic cotton certified GOTS

220grs/gsm | 19L | 100% coton organique/organic cotton | 45x35x12cm

Anses / Handles : 65x3cm

Zone de marquage/print area : 28x28cm

25 50 10kg | 60x40x20cm

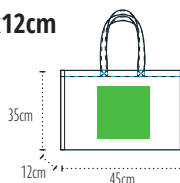

001



057



080

UBAG Marilyn 320

Organic cotton



Pochette coton organique certifié GOTS zippée avec dragonne amovible Zipped organic cotton certified GOTS pouch with amovible slider

320grs/gsm | 100% coton organique/organic cotton | 26x17cm

Anses / Handles : 69x2,5cm

Zone de marquage/print area : 18x10cm

25 100 | 7kg | 60x40x13cm

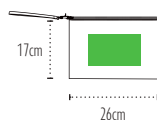

- 080/080 Noir / Noir / Black / Black
- 001/090 Naturel/Gris moyen / Natural/Medium grey
- 001/080 Naturel / Noir / Natural / Black
- 001/020 Naturel / Rouge / Natural / Red
- 001/057 Naturel / Marine / Natural / Navy
- 001/001 Naturel / Naturel / Natural / Natural

UBAG Lou 130 **XXS/XS/S/M/L/XL**

Organic cotton



6 Tailles Sizes

Pochon certifié GOTS / Pouch certified GOTS

130grs/gsm | 100% coton organique/organic cotton | 2 cordons/ropes | 6 Tailles/Sizes

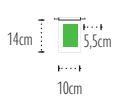

XXS 10x14cm

Zone de marquage/print area : **6x8cm**

50 400 | 5kg | 40x30x23cm

XS 15x20cm

Zone de marquage/print area : **7x14cm**

50 400 | 7kg | 48x35x23cm

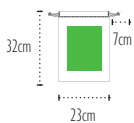
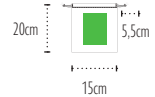

S 23x32cm

Zone de marquage/print area : **14x25cm**

50 400 | 17kg | 60x40x23cm

M 30x45cm

Zone de marquage/print area : **20x28cm**

50 200 | 12kg | 50x45x12cm

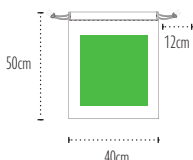
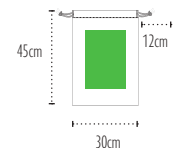

L 40x50cm

Zone de marquage/print area : **28x28cm**

50 200 | 17kg | 60x56x20cm

XL 50x75cm

Zone de marquage/print area : **28x28cm**

25 100 | 15kg | 85x66x12cm

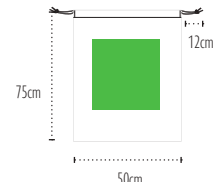

100%
Cotton

Naturel & sain.

Il se porte toute
l'année. Il est
*souple, doux
et confortable.*



STANDARD
100



Pochette zippée T bottom | T bottom zippéd pouch

400grs/gsm | 100% coton brossé/brushed cotton

Lisa S : 19,5x11,5+6cm | Elona M : 28,5x18,5+8,5cm | Loren L : 32x22+11cm

Lisa S : 25 200 | 11kg | 60x40x16cm

Elona M : 25 200 | 18kg | 60x40x22cm

Loren L : 25 100 | 11kg | 60x40x17cm



S : 10x6cm
M : 20x10cm
L : 25x14cm





UBAG Atoll 320

Cotton

OEKO
TEX®

STANDARD
100

Trousse en coton
Cotton pouch

320grs/gsm | 100% coton naturel/natural cotton | 20x12x10cm

Zone de marquage/print area : **14x8cm**

 50  100 | 11kg | 60x40x25cm

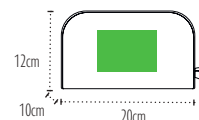

001

UBAG Charles 180
Cotton



**OEKO
TEX®**
STANDARD
100

UBAG Henri 180
Cotton



001

Tote bag avec anses tricolores
Tote bag with tricolored handles

180grs/gsm | 100% coton/cotton | 38x42cm

Anses / Handles : **65x3cm** Sangles plates en coton tressé / Flat cotton webbing

Rayures tricolores : Bleu/Blanc/Rouge / Tricolored stripes: Blue/White/Red

Zone de marquage/print area : **28x28cm**

50 100 | 11kg | 51x46x25cm



001

010

055

Tote bag coton avec soufflets et anses tricolores
Tote bag with gussets and tricolored handles

180grs/gsm | 100% coton/cotton | 45x35x12cm

Anses / Handles : **65x3cm** Sangles plates en coton tressé / Flat cotton webbing

Rayures tricolores : Bleu/Blanc/Rouge / Tricolored stripes: Blue/White/Red

Zone de marquage/print area : **28x28cm**

25 50 | 8kg | 51x46x15cm

UBAG Louis 180
Cotton



**OEKO
TEX®**
STANDARD
100



001

010

055

Duffel bag en coton avec anses tricolores
Duffel bag in cotton with tricolored handles

180grs/gsm | 100% coton/cotton | Ø24x50cm

Anses / Handles : **115x3cm** Sangles plates en coton tressé / Flat cotton webbing

Rayures tricolores : Bleu/Blanc/Rouge / Tricolored stripes: Blue/White/Red

Zone de marquage/print area : **15x15cm** | Zone de marquage sur poche/print area on pocket : **15x12cm**

25 50 | 11kg | 60x40x20cm

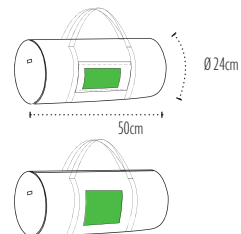

UBAG Cancùn 110

Cotton



STANDARD 100

Tote bag

110grs/gsm | 100% coton/cotton | 38x42cm | Anses / Handles : 65x2,5cm

Zone de marquage/print area : 28x28cm

50 200 | 12kg | 60x40x23cm



UBAG Phoenix 130

Cotton



STANDARD 100

Tote bag

130grs/gsm | 100% coton/cotton | 38x42cm | Anses / Handles : 65x2,5cm

Zone de marquage/print area : 28x28cm

50 200 | 14kg | 60x40x23cm

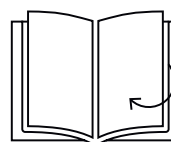

Existe avec anses de couleurs / Available with colored handles

Page 128 : Atlanta



1 ★
★
★
MEILLEURS VENTES
TOP SALES



UBAG Hawai 150

Cotton



STANDARD
100



22 COLORIS



001

010

020

026

030



032

034

035

040

044



045

052

053

055

057



063

069

070

071

074



080

090

Tote bag

150grs/gsm | 100% coton/cotton | 38x42cm

Anses / Handles : 65x2,5cm 100% coton/cotton

Zone de marquage/print area : 28x28cm

50  200 | 17kg | 60x40x28cm

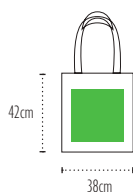

UBAG Caracas 180

Cotton

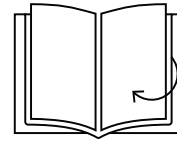

Existe avec soufflet
Available with full gusset.

Page 138 : Tampa

Tote bag

180grs/gsm | 100% coton/cotton | 38x42cm

Anses / Handles : 65x2,5cm

Zone de marquage/print area : 28x28cm

50 100 | 11kg | 60x40x18cm

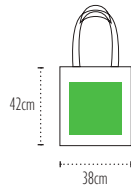

001



057



080

UBAG Salvador 220

Cotton



Tote bag

220grs/gsm | 100% coton/cotton | 38x42cm

Anses / Handles : 65x2,5cm

Zone de marquage/print area : 28x28cm

50 100 | 12kg | 60x40x18cm

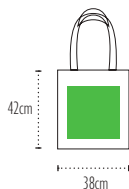

001



010



057



080



1 ★
★
★
MEILLEURS VENTES
TOP SALES

UBAG Memphis 110

Cotton



OEKO
TEX®
STANDARD
100



MINI

Mini tote bag

110grs/gsm | 100% coton/cotton | 23,5x25cm

Anses / Handles : 25x2,5cm

Zone de marquage/print area : 17x17cm

50 400 | 11kg | 60x40x23cm

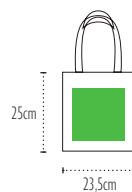

001



080

UBAG Kate 130

80% coton recyclé / 20% polyester recyclé



MAXI

Maxi Tote bag

130grs/gsm | 80% coton recyclé/recycled cotton /
20% polyester recyclé/polyester recycled | 44x46cm

Anses / Handles : 65x2,5cm

Zone de marquage/print area : 28x28cm

25 100 | 10kg | 51x46x20cm

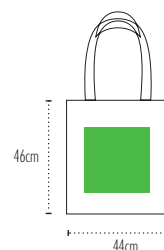

001

UBAG Sarasota 130
Cotton



Atlanta 130
Cotton



MINI

MAXI

1 ★ ★ ★
MEILLEURS VENTES
TOP SALES

MINI

Tote bag avec anses colorées
Tote bag with dyed handles

130grs/gsm | 100% coton/cotton | 26x32cm
Anses / Handles : 50x2,5cm
Zone de marquage/print area : 15x20cm

50 200 | 9kg | 60x40x17cm

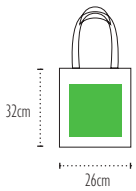

MAXI

Tote bag avec anses colorées
Tote bag with dyed handles

130grs/gsm | 100% coton/cotton | 38x42cm
Anses / Handles : 70x2,5cm
Zone de marquage/print area : 28x28cm

50 200 | 14kg | 60x40x23cm

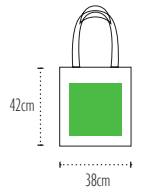

001/001 001/020 001/030 001/040 001/045 001/053 001/055 001/057 001/070 001/073 001/074 001/080

001/020 001/030 001/040 001/045 001/053 001/055 001/057 001/070 001/073 001/074 001/080

UBAG Marietta 220

Cotton



OEKO
TEX®

STANDARD
100



Tote bag coton avec anses colorées Cotton tote bag with dyed handles

220grs/gsm | 100% coton/cotton | 38x42cm

Anses / Handles : 70x2,5cm

Zone de marquage/print area : 28x28cm

 50  100 | 13kg | 60x40x18cm

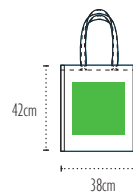

UBAG Reno 120

Cotton



STANDARD
100



Sac pliable bicolore Bicolore foldable bag

120grs/gsm | 100% coton/cotton | 38x42x12cm

Anses / Handles : 65x2,5cm

Zone de marquage/print area : 28x28cm

50 200 | 18kg | 60x40x30cm

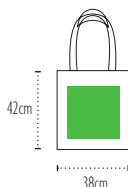

12cm **PLIABLE/FOLDABLE**



001/045 001/053 001/055 001/057 001/080

UBAG Richmond 320

Natural cotton

17L



OEKO
TEX®

STANDARD
100



Poche intérieure zippée



Tote bag avec soufflets. Poche intérieure zippée, poche extérieure et anses assorties
Gusseted tote bag. Zipped inside pocket, outside pocket and matching handles

320grs/gsm | 17L | 100% coton naturel / natural cotton | 35x38x13cm

Poche frontale / front pocket : 100% coton teinté 240 grs / dyed cotton 240 gsm

Poche intérieure / internal pocket : 100% teinté 240 grs avec fermeture éclair / dyed cotton 240 gsm with zip

Anses / Handles : 63x2cm | Sangle ronde en coton (teintée) / Round cotton webbing (dyed)

Zone de marquage/print area : poche/pocket 17x15cm | 25x25cm

50 50 | 15kg | 60x40x30cm

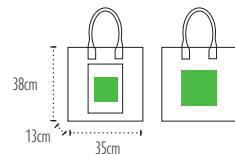

001/020



001/057



001/070



001/080

UBAG

UBAG Porto 130

Cotton



OEKO
TEX®

STANDARD
100

Tibet 130

Cotton



Sac bandoulière Shoulder strap bag

130grs/gsm | 100% coton/cotton | 34x40cm

Anses / Handles : 107x2,5cm

Zone de marquage/print area : 26x28cm

50 200 | 12kg | 60x40x23cm



001

Sac besace Shoulder strap bag

130grs/gsm | 100% coton/cotton | 28x35,5x20cm

Anses / Handles : 97x6cm

Zone de marquage/print area : 20x28cm

25 100 | 9kg | 60x40x20cm



001

080

090

UBAG Kelly 220

Cotton



STANDARD
100



Tote bag T bottom

220grs/gsm | 100% coton/cotton | 34x34+8cm

Anses / Handles : 65x2,5cm

Sangles plates en coton tressé / Flat cotton webbing

Zone de marquage/print area : 25x25cm

50 100 | 11kg | 60x40x20cm

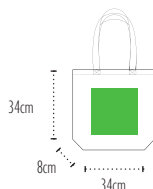

001



010



020



057



080

UBAG

133

UBAG Corfu 130
Cotton



STANDARD
100



Tote bag une face filet coton et dos uni coton
Cotton mesh tote bag on one side and back cotton only

130grs/gsm | 100% coton/cotton | 38x42cm

Anses / Handles : 65x2,5cm

Zone de marquage/print area : 28x28cm

50 200 | 14kg | 60x40x23cm

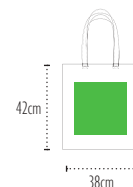

001

UBAG Portland 130

Cotton



STANDARD
100



Sac à pain / Bread bag

130grs/gsm | 100% coton/cotton | 27x64cm

Anses / Handles : 65x2,5cm

Zone de marquage/print area : 16x28cm

 50  100 | 8kg | 70x30x16cm



001

UBAG
135

UBAG Denver 110

Cotton



OEKO
TEX®

STANDARD
100

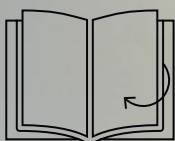

Existe en 100%
recyclé / Available
in 100% recycled.

Page 86 : Santa Fe



001

020

030

045

053

055

057

080

090

Sac a dos / Drawstring bag

110grs/gsm | 100% coton/cotton | 37x43cm

Cordelettes / Ropes : Ø5mm | 100% coton naturel/natural cotton

Zone de marquage/print area : 24x26cm

50 200 | 15kg | 60x40x30cm

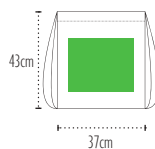

UBAG Palma 170

Cotton



OEKO
TEX®

STANDARD
100



001/020

001/030

001/053

001/055

001/057

001/070

Duffel bag en coton avec poche avant Duffel bag in cotton with front pocket

170grs/gsm | 100% coton/cotton | Ø24x50cm

Anses / Handles : 115x4cm Sangles plates en coton tressé / Flat cotton webbing

Dimensions poche extérieure / Outside pocket size : 20x20,5cm

Zone de marquage/print area : 15x15cm | Zone de marquage sur poche/print area on pocket : 15x12cm

10 50 | 12kg | 60x40x20cm

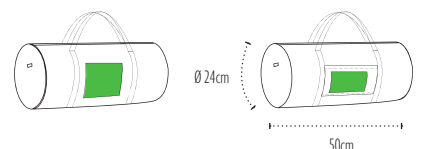

UBAG

UBAG Nassau 150

Cotton



Tampa 180

Cotton

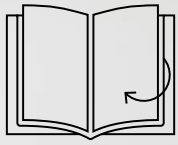

Existe en 100% coton
organique / Available
in 100% organic cotton.

Page 110 : Jill



Tote bag avec soufflets/Tote bag with full gussets

Nassau 150grs/gsm | **Tampa** 180grs/gsm | 16L
100% coton/cotton | 38x42x10cm

Zone de marquage/print area : 28x28cm

Nassau 25 100 | 12kg | 60x40x25cm

Tampa 25 100 | 15kg | 60x40x30cm



UBAG Keywest 220

Cotton

16L



OEKO
TEX®
STANDARD
100

Soho 300

Cotton

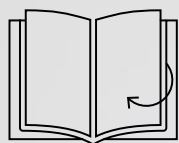

Existe en 100% coton
organique / Available
in 100% organic cotton.

Page 111 : Moorea



Tote bag avec soufflets/Tote bag with full gussets

Keywest 220grs/gsm | **Soho** 300grs/gsm | 16L
100% coton/cotton | 38x42x10cm

Zone de marquage/print area : 28x28cm

Keywest 25 100 | 17kg | 60x40x30cm

Soho 10 50 | 12kg | 60x40x20cm

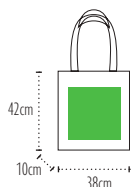

001

010

057

080

UBAG Berkeley 220 16L

Cotton



OEKO
TEX®
STANDARD
100

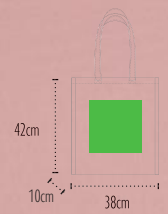

Tote bag coton avec poignées et soufflets colorés Cotton tote bag with dyed handles and gussets

220grs/gsm | 16L | 100% coton/cotton | 38x42x10cm

Anses / Handles : 65x2,5cm 100% coton/cotton

Zone de marquage/print area : 28x28cm

50 100 | 17kg | 60x40x30cm



UBAG Bel air 220 **16L**

Cotton



**OEKO
TEX®**
STANDARD
100



SAC ZIPPÉ

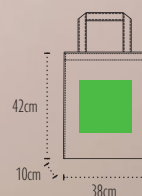

Tote bag zippé avec soufflets
Zipped tote bag with full gussets

220grs/gsm | 16L | 100% coton canvas/canvas cotton | 38x42x10cm

Anses / Handles : 65x2,5cm

Zone de marquage/print area : 26x28cm

25 50 | 10kg | 60x40x23cm



001

010

020

057

UBAG

141

UBAG Madras 220

Cotton



STANDARD
100

MUST
HAVE



Grand sac T bottom Large bag T bottom

220grs/gsm | 100% coton/cotton | 47x35+15cm

Anses / Handles : 70x2,5cm

Zone de marquage/print area : 28x24cm

25 50 | 8kg | 60x40x16cm

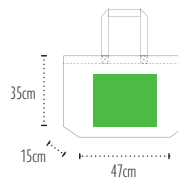

001



057



080

UBAG Malibu 220 19L

Cotton



Existe en coton certifié
organique GOTS /
Available in GOTS
certified organic cotton.

Page 112 : **Borneo**



Sac shopping grand format avec soufflets Extra size tote bag full gussets

220grs/gsm | 19L | 100% coton/cotton | 45x35x12cm

Anses / Handles : 65x3cm

Zone de marquage/print area : 28x24cm

 10  50 | 10kg | 60x40x20cm

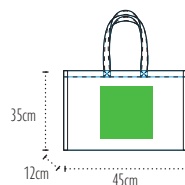

UBAG Prato 220 5L

Cotton



OEKO
TEX®
STANDARD
100

SAC À PRESSION



UBAG Siena 220 17L

Cotton



OEKO
TEX®
STANDARD
100



Prato 001



Siena 001

Tote bag coton avec soufflets et fermeture par pressions
Cotton tote bag with gussets and closure by snaps

220grs/gsm | 5L | 100% coton/cotton | 24x25,5x8cm

Anses / Handles : 35,5x2,5cm 100% coton/cotton

Zone de marquage/print area : 16x16cm

50 100 | 10kg | 60x40x20cm

Tote bag coton avec soufflets et fermeture par pressions
Cotton tote bag with gussets and closure by snaps

220grs/gsm | 17L | 100% coton/cotton | 30x30x19cm

Anses / Handles : 38x2,5cm

Zone de marquage/print area : 22x22cm

50 100 | 14kg | 60x40x20cm

UBAG Lily 300 30L
Cotton



**OEKO
TEX®**
STANDARD
100



FOND DE SAC CIRUCULAIRE



Sac shopping / Shopping bag

300grs/gsm | 30L | 100% coton/cotton | 36x27cm

Anses / Handles : 78x4cm

Zone de marquage/print area : 28x19cm

50 50 | 15kg | 60x40x25cm

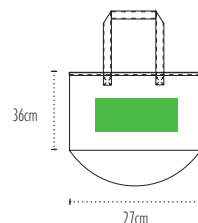

001

UBAG New york 280

Cotton



OEKO
TEX®
STANDARD
100

UBAG Paris 220

Cotton



Sac zippé T bottom avec poche intérieure T bottom zippéd shopping bag with inside pocket

280grs/gsm | 100% coton/cotton | 51x38+15cm
Anses / Handles : 70x3cm | Poche intérieure / Inside pocket : 17.5x18cm
Zone de marquage/print area : 28x28cm

10 50 | 12kg | 60x40x25cm

Sac zippé bicolore T bottom avec poche intérieure T bottom bicolor zippéd shopping bag with inside pocket

220grs/gsm | 100% coton/cotton | 51x38+15cm
Anses / Handles : 87x3cm | Poche intérieure / Inside pocket : 17.5x18cm
Zone de marquage/print area : 28x20cm

10 50 | 11kg | 60x40x20cm

UBAG Davos 220
Cotton



**OEKO
TEX®**

STANDARD
100

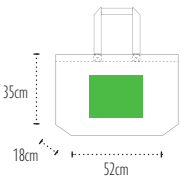

Sac T bottom avec bouton bois
T bottom shopping bag with wooden button

320grs/gsm | 100% coton/cotton | 52x35+18cm

Anses / Handles : 61x4cm Sangles plates en coton tressé / Flat cotton webbing

Zone de marquage/print area : 28x24cm

 25  25 | 7kg | 60x40x15cm

UBAG Antigua 630

Cotton



STANDARD
100



Sac shopping zippé bicolore coton / Cotton bicolor shopping bag with zipper

630grs/gsm | 100% canvas coton/cotton | 56x36+14cm

Anses / Handles : 70x3,5cm

Zone de marquage/print area : 28x17cm

25 25 | 15kg | 60x40x30cm

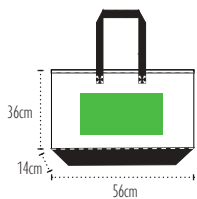

001/020



001/044



001/050



001/057



001/078

UBAG Sunny 220

Cotton



OEKO
TEX®

STANDARD
100



Grand sac shopping sans soufflets Large shopping bag without gussets

220grs/gsm | 100% coton canvas/cotton canvas | 55x39cm

Anses / Handles : 70x3cm

Zone de marquage/print area : 28x28cm

50 100 | 13kg | 60x40x18cm

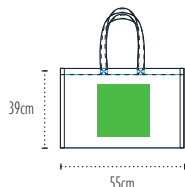

UBAG Nashville 90

Cotton/Lurex



Tote bag en coton lurex Lurex cotton tote bag

90grs/gsm | Coton-Lurex/metallic fabric

75% coton/cotton / 13% Polyester / 12% Metallized fiber | 38x42cm

Anses / Handles : 65x2,5cm

Zone de marquage/print area : 28x28cm

 100  200 | 15kg | 45x40x24cm

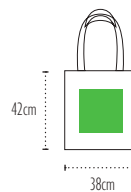

402

UBAG Cincinnati 90

Cotton/Lurex



Duffel bag en coton lurex doublé en coton avec une poche avant Lurex lined cotton duffel bag with front pocket

90grs/gsm | Coton-Lurex/metallic fabric

75% coton/cotton / 13% Polyester / 12% Fibre métallisée/Metallized fiber | 50xØ24cm

Anses / Handles : 120x4cm

Poche extérieur / Outside pocket : 20x22cm

Zone de marquage/print area : poche/pocket : 15x12cm | 15x15cm

25 50 | 15kg | 54x40x23cm

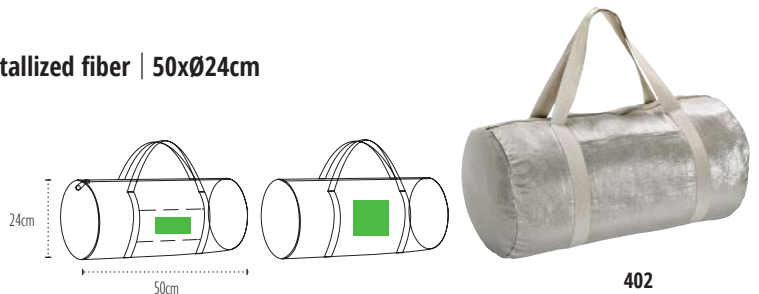

402

The Jean's



UBAG Houston 220
Jeans



**OEKO
TEX®**
STANDARD
100

San Antonio 220
Jeans

Duffel bag en jean / Duffel bag in jean

220grs/gsm | 70% coton/cotton - 30% Polyester | Ø25x50cm

Anses / Handles : 115x4cm

Zone de marquage/print area : **15x15cm**

Zone de marquage sur poche/print area on pocket : **15x12cm**

 50  50 | 11kg | 60x40x23cm

Pochette jean / Jean pouch

220grs/gsm | 70% coton/cotton - 30% Polyester | 26x17cm

Zone de marquage/print area : **18x10cm**

 50  100 | 5kg | 60x40x10cm

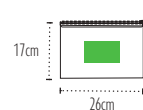
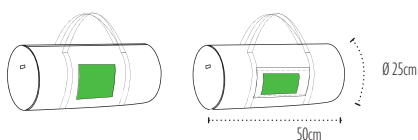

Family



UBAG Austin 220
Jeans



Dallas 260
Jeans

Sac à dos jean avec anses / Jean gym bag with handles

220grs/gsm | 70% coton/cotton - 30% Polyester | 37x43cm
Anses / Handles : 65x2,5cm | Cordelettes / Cords : Ø5mm | 100% cotton
Zone de marquage/print area : 26x24cm

50 100 | 12kg | 60x40x18cm

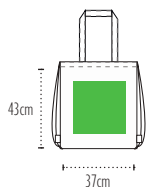

Tote bag jeans

260grs/gsm | 60% coton/cotton - 20% Polyester - 20% viscose |
38x42cm
Anses / Handles : 60x2,5cm
Zone de marquage/print area : 28x28cm

50 100 | 15kg | 45x40x24cm

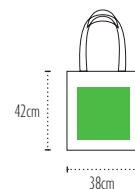

SO
CHIC



UBAG Bora-Bora 320

Cotton



STANDARD
100

Pochette coton / Cotton pouch

320grs/gsm | 100% coton/cotton | 26x17cm (avec frange / with fringe)

Zone de marquage/print area : 18x10cm

50 100 | 15kg | 60x40x13cm

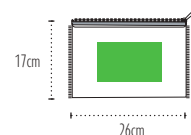

044



054



078



001



080



UBAG Tahiti 320

Cotton



STANDARD
100

Sac t bottom grande taille zippé avec poche extérieure zippée Large zippéd t bottom bag with external zippéd pocket

320grs/gsm | 100% coton/cotton | 57x38+18cm (avec frange / with fringe)

Anses / Handles : 60x4cm Sangles plates en coton tressé / Flat cotton webbing

Poche frontale zippée avec frange / Ziped front pocket with fringe : 33x18,5cm

Zone de marquage/print area : 28x28cm | Zone de marquage sur poche/print area on pocket : 20x12cm

25 50 | 17kg | 60x40x27cm

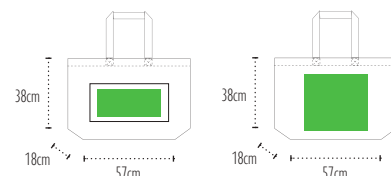

UBAG Hydra 180

Cotton



Tote bag rayé Striped tote bag

180grs/gsm | 90% coton/10% polyester /
90% cotton/10% polyester

38x42cm | Anses / Handles : 70x2,5cm

Zone de marquage/print area : 28x28cm

50 100 | 9kg | 51x46x25cm

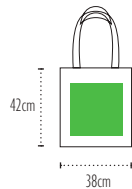

001/520



001/545



001/550



001/565



001/570

UBAG Mykonos 180

Cotton



SO
CHIC

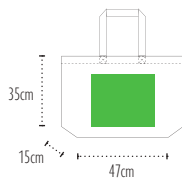

001/520



001/545

Sac shopping rayé avec bouton bois Striped shopping bag with wooden button

180grs/gsm | 90% coton/10% polyester / 90% cotton/10% polyester

47x35+15cm | Anses / Handles : 70x2,5cm

Zone de marquage/print area : 28x22cm

50  100 | 10kg | 51x46x30cm



001/550



001/565



001/570

UBAG

157

UBAG Faubourg 220

Cotton

26L



STANDARD
100



Sac shopping en coton canvas laminé Cotton canvas laminated shopping bag

220grs/gsm | 26L | 100% coton canvas/cotton canvas | 43x30x20cm

Anses / Handles : 65x3cm Coton tressé boudiné / Rounded cotton webbing

Zone de marquage/print area : 28x14cm

25 50 | 12kg | 46x36x40cm

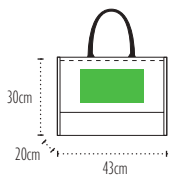

001/020



001/030



1 ★
★
★
**MEILLEURS VENTES
TOP SALES**



001/045



001/053



001/057



001/080

UBAG Princesse 340 26L

Cotton



STANDARD
100



Sac shopping en coton canvas laminé avec fond rigide amovible Cotton canvas laminated shopping bag with removable hard bottom

340grs/gsm | 26L | 100% coton canvas/cotton canvas | 43x30x20cm

Anses / Handles : 60x4cm Coton tressé boudiné / Rounded cotton webbing

Zone de marquage/print area : 28x18cm

 25  25 | 11kg | 45x34x36cm

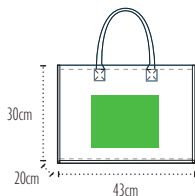

001/020



001/057



001/080

UBAG Croisette 340

Cotton

43L



STANDARD
100



ZIP



Sac shopping zippé en coton canvas laminé avec fond rigide amovible
Laminated cotton canvas zippered shopping bag with removable hard bottom

340grs/gsm | 43L | 100% coton canvas/cotton canvas | 56x38x20cm

Anses / Handles : 60x4cm Coton tressé boudiné / Rounded cotton webbing | Poche intérieure / Inside pocket : 25x15cm

Zone de marquage/print area : 28x24cm

20 20 | 15kg | 62x42x25cm



UBAG Alix 150

Cotton



OEKO
TEX®

STANDARD
100



1★
★
★
MEILLEURS VENTES
TOP SALES

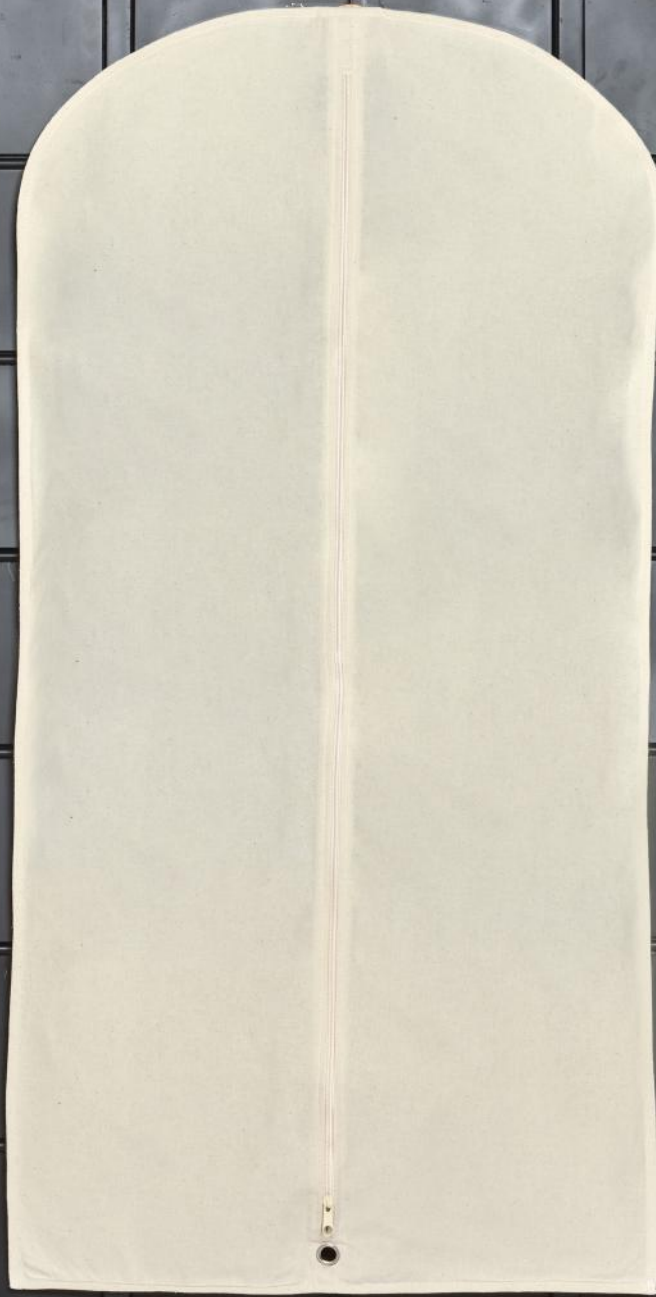

Housse coton Cotton garment bag

150grs/gsm | 100% coton/cotton | 60x110cm
Zone de marquage/print area : 28x28cm | 23x25cm

25 50 | 13kg | 60x35x25cm

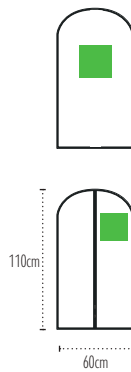

001



010



080

Non tissé
Non woven

“Il n’y a pas
de *hasards*,
il n’y a que
des *rendez-vous*.”

Paul Eluard

UBAG London 80 31L

Non woven



Sac shopping à soufflets grande taille Shopping bag large size with gussets

80grs/gsm | 31L | 100% polypropylène | 50x40x15cm

Anses / Handles : 60x3cm

Zone de marquage/print area : 28x28cm

50 200 | 13kg | 53x53x43,5cm





040



045



053



055



057



070



075



080



090

UBAG Monte Carlo 80 16L

Non woven

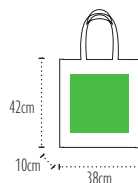

035

053

070

075

Tote bag à soufflets uni et bicolore Tote bag plain color and bicolor full gussets

80grs/gsm | 16L | 100% polypropylène | 38x42x10cm

Anses / Handles : 60x3cm

Zone de marquage/print area : 28x28cm

50 200 | 11kg | 45x41,5x54cm



080/030

080/035

080/040

080/045

080/053

065/060

080/090

UBAG Daytona 80

Non woven

1
MEILLEURS VENTES
TOP SALES

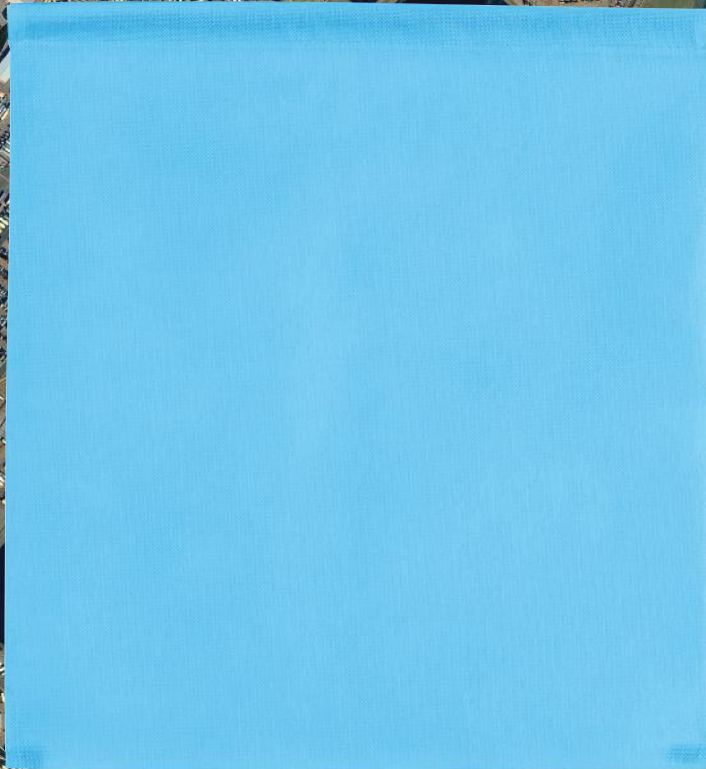

010

020

030

035

040

045

050

053

055

057

070

080

090

Sac à dos ficelle

Drawstring backpack

80grs/gsm | 100% polypropylène | 37x41cm

Cordelettes / Cords : Ø2mm | polyester

Zone de marquage/print area : 26x24cm

50 200 | 9kg | 44x40x35cm

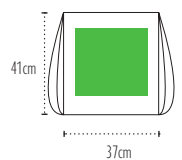

UBAG Beverly 80

Non woven



Tote bag anses longues
Tote bag long handles

80grs/gsm | 100% polypropylène | 38x42cm

Anses / Handles : 60x2,5cm

Zone de marquage/print area : 28x28cm

 50  200 | 8kg | 45x42x40cm

1 ★
★
★
MEILLEURS VENTES
TOP SALES



Tote bag bicolore à soufflets
Tote bag bicolor with gussets

80grs/gsm | 100% polypropylène | 38x29x10cm

Anses / Handles : 60x2,5cm

Zone de marquage/print area : 26x12cm

50 200 | 9kg | 60x41x32cm

UBAG Barcelona 80

Non woven



Tote bag à soufflets large
Tote bag with large gussets

80grs/gsm | 100% polypropylène | 34x30x20cm

Anses / Handles : 63x2,5cm

Zone de marquage/print area : 25x20cm

 50  200 | 10kg | 37x32x58cm

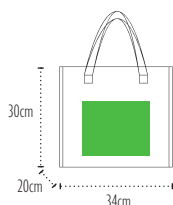

020/010

030/090

045/090

070/090

UBAG Miami 100 30L

Non woven

MUST
HAVE



Duffel bag non tissé bicolore Bicolor non woven duffel bag

100grs/gsm | 30L | 100% polypropylène | Ø25x50cm

Anses / Handles : 45x3cm | non tissé 100grs/non woven 100gsm

Bandoulière réglable/Adjustable strap | 105x3cm

Zone de marquage/print area : 15x15cm

50  100 | 13kg | 56x42x40cm

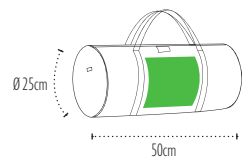

020/090



080/090



090/080

UBAG

UBAG Madrid 80 15L

Non woven



Tote bag anses contrastées Tote bag Contrasted handles

80grs/gsm | 15L | 100% polypropylène | 28x35x15cm

Anses / Handles : 65x2,5cm

Zone de marquage/print area : 15x20cm

50 200 | 8kg | 58x38x31cm



UBAG Venice 80 11L

Non woven



Tote bag uni à soufflets Tote bag plain with gussets

80grs/gsm | 11L | 100% polypropylène | 38x29x10cm

Anses / Handles : 60x2,5cm

Zone de marquage/print area : 26x20cm

 50  200 | 9kg | 41x33x54cm

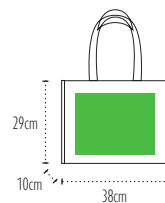

020



040



045

UBAG

173

UBAG Oslo 130 10L

Non woven

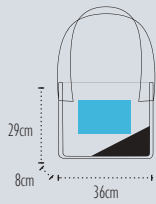

010/080

020/080



045/080

070/080

090/080



Besace rabat, compartiment et étui stylos
Flap shoulder bag with compartment and pencil case

130grs/gsm | 10L | 100% polypropylène | 36x29x8cm

Anses / Handles : 130x5cm

Zone de marquage/print area : 24x12cm

25 100 | 10kg | 52x40x34cm

UBAG Tribeca 130 10L

Non woven

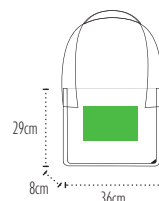

010/080

010/090

020/080

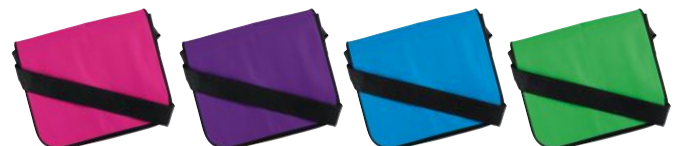

030/080

035/080

053/080

070/080

Besace rabat, compartiment et étui stylos
Flap shoulder bag with compartment and pencil case

130grs/gsm | 10L | 100% polypropylène | 36x29x8cm

Anses / Handles : 130x5cm

Zone de marquage/print area : 24x12cm

25 100 | 11kg | 42x40x38cm

UBAG Chicago 100 10L

Non woven



Sacoche porte documents premium Premium document holder

100grs/gsm | 10L | 100% polypropylène | 40x28x7cm

Anses / Handles : 38x4cm/110x4cm | Bandoulière réglables / Adjustable strap

Zone de marquage/print area : 20x14cm

25 100 | 12kg | 60x45x52cm

UBAG Harvard 80 8L

Non woven



Sacoche congrès premium Premium document holder

80grs/gsm | 8L | 100% polypropylène | 38x28x6cm

Anses / Handles : 44x2,5cm

Zone de marquage/print area : 26x13cm

50 200 | 12kg | 60x41x40cm



UBAG Boston 80

Non woven



020



045



055



057



070



080

Sacoche congrès Document holder

80grs/gsm | 100% polypropylène | 38x29,5cm

Anses / Handles : 26x2,5cm

Zone de marquage/print area : 26x15cm

 50  200 | 8kg | 41x40x32cm

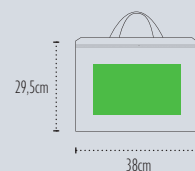

CORDON DE SERRAGE

UBAG Pearth 80 90L

Non woven

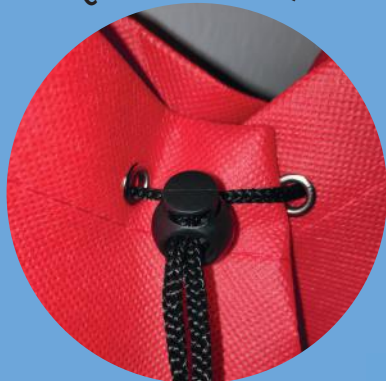

Sac marin / Sailor bag

80grs/gsm | 90L | non tissé 80grs/80gsm non woven | Ø44x49cm

Anses / Handles : 3,5cm | Bandoulière réglables / Adjustable strap

Zone de marquage/print area : 28x28cm

50 100 | 11kg | 54x48x40cm



Isotherme

1NEW “Il faut
juger à *froid* et
agir à *chaud*.” Paul Valéry

UBAG Bahamas 260

80% Recycled cotton - 20% Recycled polyester



Grand sac recyclé isotherme et zippé avec des poignées cordes
Large recycled isothermal zipped bag with rope handles

260grs/gsm | 80% coton recyclé / recycled cotton /
20% Polyester recyclé / recycled polyester | 55x39+15cm

Anses / Handles : 77x1,5cm

Zone de marquage/print area : 28x28cm

 10  20 | 8kg | 51x46x38cm





UBAG Calgary

Jute

UBAG Toronto

Jute

Sac isotherme jute avec poche coton Cooler jute bag with front cotton pocket

100% jute 14x15 | intérieur isotherme/inside aluminium foil
30x25x18cm

Poche / Pocket : 100% coton 130grs/130gsm cotton | 20x18cm

Anses / Handles : 79x3cm Sangles plates en coton tressé /
Flat cotton webbing

Zone de marquage/print area : 12x10cm

20 40 | 9kg | 63x52x20cm

Sac isotherme jute avec poche coton petit modèle Small size cooler jute bag with front cotton pocket

100% jute 14x15 | intérieur isotherme/inside aluminium foil
25x16x16cm

Poche / Pocket : 100% coton 130grs/130gsm cotton | 20x10cm

Anses / Handles : 59x2,5cm Sangles plates en coton tressé /
Flat cotton webbing

Zone de marquage/print area : 12x5cm

25 50 | 8kg | 56x51x15cm

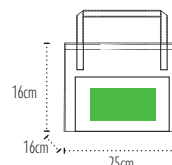
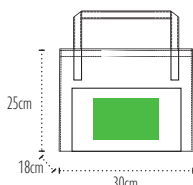

001



**XL
SIZE**



NEW

UBAG Ontario

Jute

**Sac isotherme en jute avec poche coton
Cooler jute bag with front cotton pocket**

100% jute 14x15 | intérieur isotherme/inside aluminium foil | 32x39x17cm

Anses / Handles : 69x3,5cm Sangles plates en coton tressé / Flat cotton webbing

Zone de marquage/print area : 18x20cm

25 50 | 12kg | 60x40x33cm

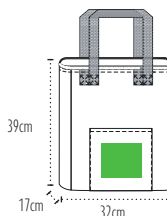

001

UBAG



001

Sac coton canvas et jute isotherme Canvas cotton and jute isotherm bag

100% coton canvas/canvas cotton | 25L | 43x34x16cm

Poche / Pocket : 100% coton 130grs/130gsm cotton | 20x18cm

Anses / Handles : 42x4cm Coton tressé boudiné / Cotton webbing with cord inside

Soufflet / Gusset : 100% jute 14x15 / 14x15 jute

Zone de marquage/print area : 24x20cm

 25  25 | 10kg | 60x40x30cm

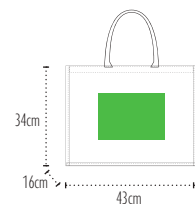

Bi-matière

Qui ne se
ressemble pas,
s'assemble !

UBAG Melbourne 220

Cotton & Jute



STANDARD
100



Sac coton canvas et jute t bottom zippé avec poche intérieure
Cotton canvas and jute t bottom bag with zip and inside pocket

220grs/gsm | 100% cotton canvas ,100% Jute 14x15 avec lamination intérieure PP /
100% canvas cotton, 100% 14x15 jute with inside coating P.P lamination | 34x36+15cm

Anses / Handles : 45x3cm | Poche intérieure / Inside pocket : 16x17cm

Zone de marquage/print area : 22x18cm

 25  50 | 10kg | 60x40x16cm

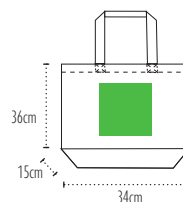

001



OEKO
TEX®

STANDARD
100

UBAG Sydney 220

Cotton & Jute



Sac coton canvas et jute t bottom zippé avec poche intérieure Cotton canvas and jute t bottom bag with zip and inside pocket

Epiement / Yoke : **100% 14x15 jute lamination intérieure / 100% 14x15 jute with inside PP lamination**
220grs/gsm | 100% coton/cotton | 51x37+16cm

Anses / Handles : **60x4cm** Sangles plates en coton tressé / Flat cotton webbing

Poche intérieure / Inside pocket : **16x17cm**

Zone de marquage/print area : **24x18cm**

 25  25 | 7kg | 60x40x18cm

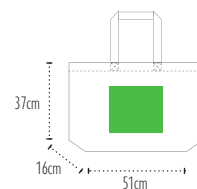

001

UBAG

185

UBAG Panama S 220

100% Cotton



STANDARD
100

Pochette zippée T bottom coton et jute avec dragonne T-bottom cotton and jute zipped pouch with hand strap

220grs/gsm | 100% coton / cotton , 100% jute / jute,
14x15 fond avec lamination/ bottom with lamination | 22x16+5cm

Dragonne : 18x1cm

Zone de marquage/print area : 14x7cm

100 | 15kg | 51x46x30cm

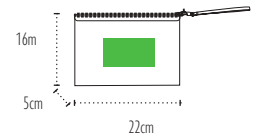

001



UBAG Panama L 220

100% Cotton



STANDARD
100

Pochette zippée T bottom coton et jute avec dragonne T-bottom cotton and jute zipped pouch with hand strap

220grs/gsm | 100% coton / cotton , 100% jute / jute,
14x15 fond avec lamination/ bottom with lamination | 28,5x20+6,5cm

Dragonne : 18x1cm

Zone de marquage/print area : 20x11cm

100 | 15kg | 51x46x30cm

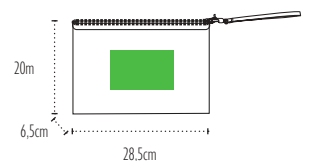

001

UBAG Cork 320

100% Natural cotton



OEKO
TEX®

STANDARD
100



Sac bouteille coton et jute avec anses rondes
Cotton and jute bottle bag with cotton webbing handles

320grs/gsm | 100% coton naturel/natural cotton ,100% jute naturel/natural jute,
14x15 avec lamination intérieure PP/ with lamination in pp /
100% canvas cotton, 100% 14x15 jute with inside coating P.P lamination | 11x35x10cm
Anses / Handles : 28xØ1,5cm | sangle ronde coton beige / round webbing cotton beige
Zone de marquage/print area : 6x15cm

50 100 | 15kg | 60x40x27cm

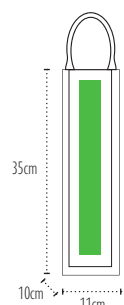

001

UBAG Sunset 320 **28L**
Cotton & Jute

**OEKO
TEX®**
STANDARD
100

**MUST
HAVE**



001/001

001/020

001/030



001/055

001/057

001/063



001/070

001/076

001/080

001/090

Sac shopping coton avec soufflets jute
Cotton shopping bag with jute gussets

320grs/gsm | 28L | 100% cotton canvas ,100% Jute 14x15 avec lamination intérieure PP /
100% canvas cotton, 100% 14x15 jute with inside coating P.P lamination | 42x33x20cm

Anses / Handles : 61x3cm Sangles plates en coton tressé / Flat cotton webbing

Zone de marquage/print area : 28x24cm

25 50 | 16kg | 60x40x25cm

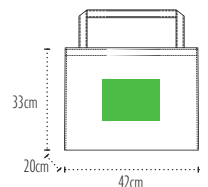

Jute

1NEW *Robuste*
et très *résistante*
pour tout
supporter.

NEW UBAG Phuket
Jute



PORTÉ
ÉPAULE

SAC DOUBLE PORTÉE

Sac shopping jute avec doubles anses coton plates
Flat cotton webbing twice handles jute shopping bag

100% Jute 14x15 avec lamination intérieure PP / 100% 14x15 jute with inside coating P.P lamination | 50x37x16cm

Double anses / Double handles : 65x4cm / 36x4cm

Zone de marquage/print area : 28x28cm

 25  50 | 17kg | 55x45x40cm



PORTÉ
MAIN

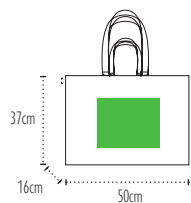

001

UBAG Havana 17L

Jute

Sac shopping en Jute avec anses plates en coton
Flat cotton webbing handles Jute shopping bag

17L | 100% Jute 14x15 avec lamination intérieure PP /
with inside coating P.P lamination | 30x30x19cm

Anses / Handles : 39x3cm Sangles plates en coton tressé / Flat cotton
webbing, off-white color

Zone de marquage/print area : 15x15cm

20 100 | 20kg | 64x33x46cm

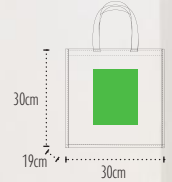

UBAG Cuba 11L

Jute

Sac shopping en Jute avec anses plates en coton
Flat cotton webbing handles Jute shopping bag

11L | 100% Jute 14x15 avec lamination intérieure PP /
with inside coating P.P lamination | 25x26x17cm

Anses / Handles : 32x2,5cm Sangles plates en coton tressé / Flat cotton
webbing, off-white color

Zone de marquage/print area : 15x15cm

20 100 | 14kg | 46x40x37cm

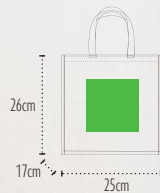

UBAG Ipanéma 21L

Jute

Sac shopping en Jute avec anses plates en coton
Flat cotton webbing handles Jute shopping bag

21L | 100% Jute 14x15 avec lamination intérieure PP /
with inside coating P.P lamination | 35x40x15cm

Anses / Handles : 42x3cm Sangles plates en coton tressé / Flat cotton
webbing, off-white color

Zone de marquage/print area : 20x25cm

10 100 | 24kg | 42x39x68cm

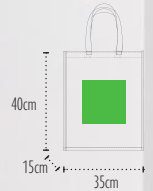



Sac shopping en Jute avec anses plates en coton
Flat cotton webbing handles Jute shopping bag

100% Jute 14x15 avec lamination intérieure PP /
with inside coating P.P lamination | 55x35+15cm

Anses / Handles : **60x4cm** Sangles plates en coton tressé / Flat cotton webbing, off-white color

Zone de marquage/print area : **28x28cm**

 10  100 | 24kg | 59x39x52cm

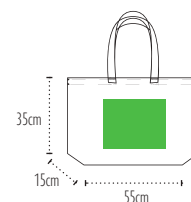

001

UBAG los

Jute

OEKO
TEX®
STANDARD
100



Sac shopping en jute tissée doby avec poche coton extérieure
Dobby weave jute shopping bag with outside cotton pocket

100% jute tissé 4oz / 110gsm / 100% weave jute 4oz / 110gsm | 50x35+16cm

Anses / Handles : **60x4cm** Coton tressé boudiné / Rounded cotton webbing

Poche / Pocket : **25x25cm** Poche en coton 113grs / 113gsm cotton pocket

Zone de marquage/print area : **18x18cm**

 25  25 | 12kg | 55x37x40cm

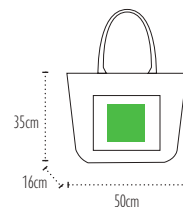

001

UBAG Cortina

Lurex or / gold

Sac shopping jute scintillante lurex anses rondes Rounded handles glitter lurex jute shopping bag

100% Jute 14x15 avec lamination intérieure PP et mélange fil lurex or /
100% 14x15 Jute with inside coating P.P lamination and gold lurex yarn | 42x33x19cm

Anses / Handles : 56x4cm Coton tressé boudiné / Rounded cotton webbing with cord inside

Zone de marquage/print area : 28x24cm

10  50 | 16kg | 60x40x40cm

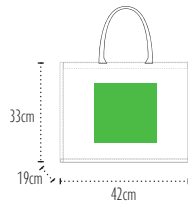

UBAG Vail

Lurex or / gold

Sac mini jute scintillante lurex anses rondes Rounded handles glitter lurex jute mini bag

100% Jute 14x15 avec lamination intérieure PP et mélange fil lurex or /
100% 14x15 Jute with cord inside coating P.P lamination and gold lurex yarn | 26x22x14cm

Anses / Handles : 36x4cm Coton tressé boudiné / Rounded cotton webbing with cord inside

Zone de marquage/print area : 15x15cm

20  100 | 17kg | 60x40x43cm

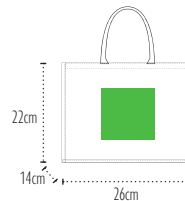

UBAG Vienna

Lurex or / gold

Sac bouteille jute scintillante lurex anses rondes Rounded handles glitter lurex jute bottle bag

[page 137 : existe en coton et jute / exists in cotton and jute : Cork]

100% Jute 14x15 avec lamination intérieure PP et mélange fil lurex or /
100% 14x15 Jute with cord inside coating P.P lamination and gold lurex yarn | 11x35x11cm

Anses / Handles : 22x2cm Coton tressé boudiné / Rounded cotton webbing with cord inside

Zone de marquage/print area : 6x15cm

20  100 | 13kg | 60x40x40cm

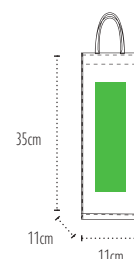

UBAG Claudia 28L

Jute



STANDARD
100



Sac shopping jute naturel avec rayures Natural jute shopping bag with stripes

28L | 100% Jute 14x15 avec lamination intérieure PP /
100% 14x15 jute with inside coating P.P lamination | 43x34x19cm

Anses / Handles : 60x3cm Juco canvas

Zone de marquage/print area : 28x17cm

25 50 | 15kg | 46x36x36cm

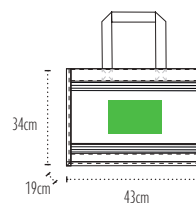

001/080

UBAG Brasilia

Jute



001/020



001/030



001/053



001/057



001/070



001/080



001/090

Sac shopping jute naturel avec anses et soufflets de couleurs Natural jute shopping bag with dyed handles and gussets

17L | 100% Jute 14x15 avec lamination intérieure PP /
100% 14x15 jute with inside coating P.P lamination | 30x30x19cm
Anses / Handles : 40x3cm Coton tressé boudiné / Rounded cotton webbing
Zone de marquage/print area : 22x22cm

25 50 | 11kg | 36x36x42cm

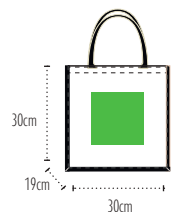



FACTORY

1 ★
★
★
**MEILLEURS VENTES
TOP SALES**

UBAG Darwin 8L

Jute

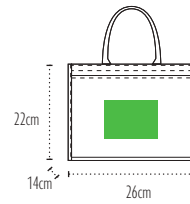

001

Sac shopping jute naturel avec anses et poche avant en coton
Natural jute shopping bag with cotton handles and front pocket

8L | 100% Jute 14x15 avec lamination intérieure PP / 100% 14x15 jute with inside coating P.P lamination | 26x22x14cm

Anses / Handles : **32x2cm** Coton tressé boudiné / Rounded cotton webbing

Poche / Pocket : **25x18cm** Poche en coton 150grs / 150gsm cotton pocket

Zone de marquage/print area : **16x11cm**

 25  100 | 16kg | 52x31x51cm

UBAG Brisbane 17L

Jute

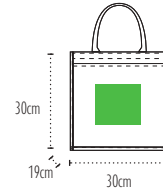

001

Sac shopping jute naturel avec anses et poche avant en coton
Natural jute shopping bag with cotton handles and front pocket

17L | 100% Jute 14x15 avec lamination intérieure PP / 100% 14x15 jute with inside coating P.P lamination | 30x30x19cm

Anses / Handles : **39x2cm** Coton tressé boudiné / Rounded cotton webbing

Poche / Pocket : **27x24cm** Poche en coton 150grs / 150gsm cotton pocket

Zone de marquage/print area : **16x18cm**

 25  50 | 11kg | 36x36x42cm

UBAG Cairns 26L

Jute

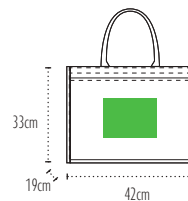

001

Sac shopping jute naturel avec anses et poche avant en coton
Natural jute shopping bag with cotton handles and front pocket

26L | 100% Jute 14x15 avec lamination intérieure PP / 100% 14x15 jute with inside coating P.P lamination | 42x33x19cm

Anses / Handles : **50x2cm** Coton tressé boudiné / Rounded cotton webbing

Poche / Pocket : **41x29cm** Poche en coton 150grs / 150gsm cotton pocket

Zone de marquage/print area : **28x20cm**

 25  50 | 16kg | 46x38x42cm

UBAG Copacabana 28L

Jute

LE GRAND



Sac shopping en Jute avec anses rondes Rounded handles Jute shopping bag

28L | 100% Jute 14x15 avec lamination intérieure PP /
with inside coating P.P lamination | 43x34x19cm

Anses / Handles : 40x2cm Coton tressé boudiné / Rounded cotton webbing
Zone de marquage/print area : 28x24cm

10 50 | 14kg | 42x37x47cm

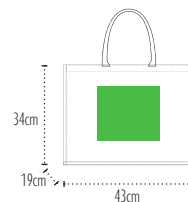

001

UBAG Belem 19L

Jute

LE PETIT



Sac shopping jute anses rondes
Rounded handles jute shopping bag

19L | 100% Jute 14x15 avec lamination intérieure PP /
with inside coating P.P lamination | 36x27x20cm

Anses / Handles : **40x2cm** Coton tressé boudiné / Rounded cotton webbing

Zone de marquage/print area : **28x17cm**

 **50**  **50** | **10kg** | **60x40x20cm**

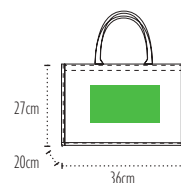

001

UBAG Naxos 28L

Jute



001/010

001/020

001/055

001/057

001/063

001/070

001/076

001/080

Sac shopping jute naturel avec anses et piping couleurs coton Natural jute shopping bag with dyed cotton handles and piping

28L | 100% Jute 14x15 avec lamination intérieure PP /
with inside coating P.P lamination | 40x36x19cm

Anses / Handles : 40x2cm Coton tressé boudiné, ton sur ton avec les piping /
Rounded cotton webbing, color ton to ton with piping

Zone de marquage/print area : 28x24cm

 25  50 | 14kg | 51x46x30cm

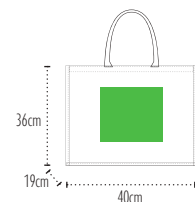

UBAG Paros 28L

Jute



001/020



001/045



001/080



001/055



001/057



001/075



Sac shopping jute avec poignées en toile de coton teintée Jute shopping bag with dyed cotton canvas handles

28L | 100% Jute 14x15 avec lamination intérieure PP /
with inside coating P.P lamination | 43x34x19cm

Anses / Handles : 60x3cm Sangle en coton teint tressé / Dyed flat cotton webbing

Zone de marquage/print area : 28x24cm

25  50 | 14kg | 60x40x26cm

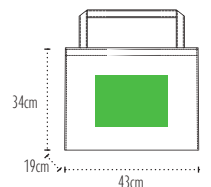

UBAG Roma 22L

Jute



POCHETTE
INCLUDE
POUCH
INCLUDED

Sac Jute avec soufflets/pochette et poignées corde Jute shopping bag with full gussets/pouch and cord handles

22L | 100% Jute 14x15 avec lamination intérieure /
100% Jute 14x15 with inside PP lamination | 42x38x14cm

Anses / Handles : 77cm 100% tresse de coton / 100% twisted cotton cord
Zone de marquage/print area : 28x28cm

25  25 | 10kg | 60x40x27cm





Sac shopping jute couleurs anses rondes
Rounded handles dyed jute shopping bag

28L | 100% Jute 14x15 avec lamination intérieure PP /
with inside coating P.P lamination | 43x34x19cm

Anses / Handles : **40x2cm** Coton tressé boudiné / Rounded cotton webbing

Zone de marquage/print area : **28x24cm**

25 50 | 13kg | 51x46x30cm

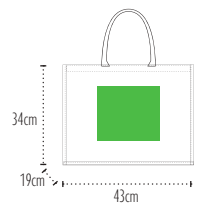

044

053

056

063

076

080

090

UBAG Capri

Jute



Sac shopping T botton jute avec fermeture velcro Jute T botton shopping bag with velcro closure

100% Jute 14x15 avec lamination intérieure LDPE /
100% Jute 14x15 with inside LDPE lamination | 44x35+13cm

Anses / Handles : 66x4cm Coton tressé boudiné / Rounded cotton webbing with cord inside

Zone de marquage/print area : 28x20cm

 25  50 | 13kg | 60x40x38cm



010/020

010/030



010/053

010/055

010/057

010/070

Polyester

*Il ne se froisse pas,
résiste, ne déteint
pas, ne rétrécit pas.
Élastique & léger
simplifiez-vous
la vie.*

UBAG Punjab 140

100% RPET



RPET

Je suis votre
nouveau sac en
PET recyclé
I'am your new bag
in recycled PET

Plus de gaspillage
No more waist

Depuis plusieurs années maintenant, la révolution du recyclage s'est amorcée. La mutation se fait dans toutes les filières, à commencer par celle du plastique. Seulement, si les mesures gouvernementales incitent au changement, quelle est la marge de manœuvre des industriels qui doivent se réinventer ? Le plastique est décrié, alors qu'il sait se réinventer. C'est le cas du PET, matière intégralement recyclable utilisée pour la production de bouteilles plastiques, dont l'empreinte carbone est réduite de près de 80% sous sa forme recyclée, dite RPET.



Tote bag

140grs/gsm | 100% PET recyclé / recycled PET | 38x42cm

Anses / Handles : 65x2,5cm

Zone de marquage/print area : 28x28cm

 100  200 | 15kg | 60x40x25cm

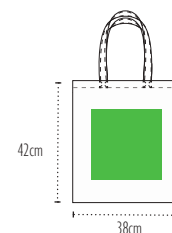

Coloris effet chiné.
Ce produit étant fabriqué à base de matières
collectées puis recyclées, des variations de
couleurs peuvent être constatées.

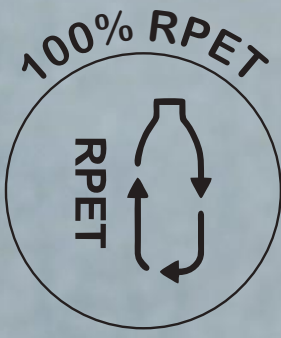

UBAG Canberra 210D

Polyester



010



020



030



040



045



053



055



057



080



090



Sac de sport / Gymbag

210D | 100% polyester | 36x43cm

Cordelettes / Cords : Ø6mm | polyester

Zone de marquage/print area : 28x28cm

 50  100 | 13kg | 60x40x38cm

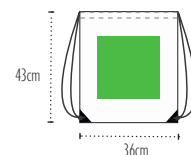

UBAG Campo 420D 30L

Polyester



020



055



057



080



090

Duffel bag en polyester 420D / Duffel bag in 420D polyester

420D | 30L | 100% polyester | Ø25x50cm

Anses / Handles : 115x4cm

Zone de marquage/print area : 15x15cm

25 50 | 13kg | 60x40x38cm

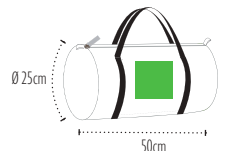

UBAG

UBAG Joy 190T

Polyester



PLIABLE/FOLDABLE

Sac pliable polyester Polyester foldable bag

100% Polyester 190T | 37x39cm

Anses / Handles : 51x2,5cm

Zone de marquage/print area : 22x15cm

50 200 | 9kg | 44x40x24cm

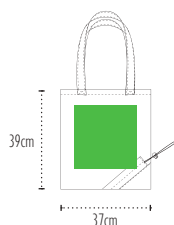



PLIABLE/FOLDABLE

Sac pliable polyester T bottom avec poche zippée T bottom polyester foldable bag with zippéd pocket

100% Polyester 190T | 37x41+10cm

Anses / Handles : 58x2,5cm | Poche intérieure / Pocket inside : 12x13cm

Zone de marquage/print area : 22x22cm | côté poche/pocket side : 15x20cm

50 200 | 9kg | 48x40x14cm

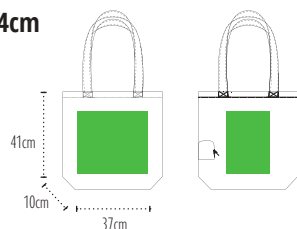

UBAG Rio 150

Polyester



FLUO COLORS

Tote bag fluo
Tote bag neon

100% polyester 150grs/gsm | 38x42cm

Anses / Handles : 60x2,5cm

Zone de marquage/print area : 28x28cm

 50  200 | 14kg | 47x40x26cm

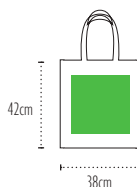

010



200



210

PP Tissé

Résistant
à toutes épreuves !



UBAG Orlando 120 32L

PP woven laminated

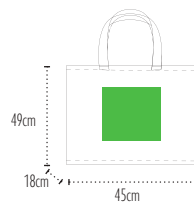

010



020



040



045



053



055



057



073



080



025



063



076

Sac shopping en PP tissé laminé avec anses courtes Short handles PP woven laminated shopping bag

120grs/gsm | 32L | PP tissé, 80% de matière recyclée / PP woven, 80% recycled material | Lamination brillante à l'extérieur / Shiny lamination outside | 45x39x18cm

Anses / Handles : 35x3cm Sangles en PP / PP webbing

Zone de marquage/print area : 28x28cm

25 100 | 11kg | 48x42x29cm

Sac réutilisable en polypropylène (PP) tissé.
(jusqu'à 80% de matières recyclées utilisées pour sa fabrication)

Re-useable bag in polypropylène (PP) woven.
(until 80% of recyclable fabric used for his making)





Gamme couleur

COLOUR RANGE

CR : COTON RECYCLÉ / RECYCLED COTTON CO : COTON ORGANIQUE / ORGANIC COTTON
C : COTON / COTTON N : NON TISSÉ / NON WOVEN J : JUTE P : POLYESTER
PP : PP TISSÉ LAMINÉ / PP WOVEN LAMINATED ♻️ : RPET K : BAGAGERIE KWOO LUGGAGE

Les unis Plain colors

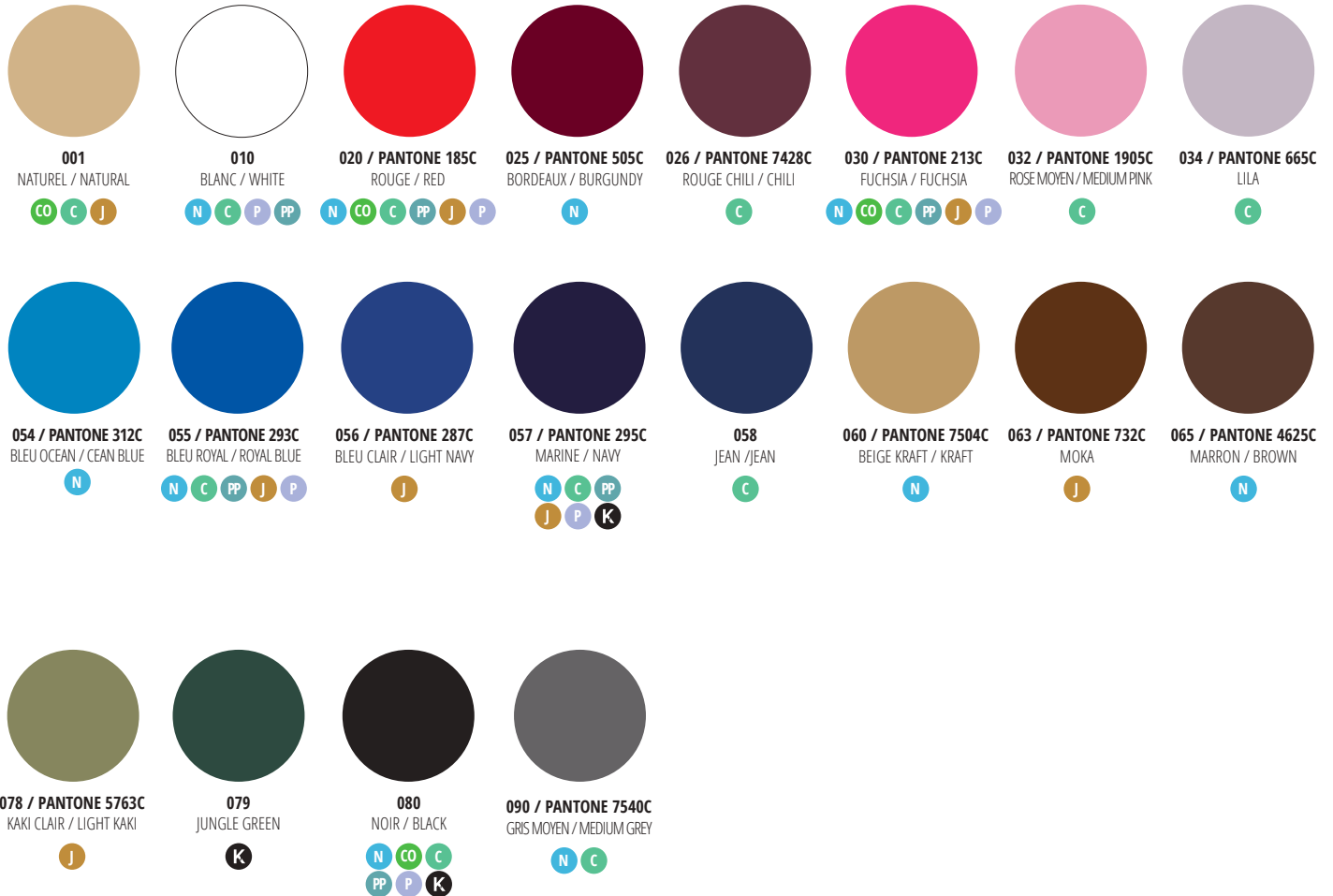

Les recyclés The recycled











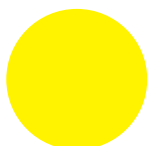



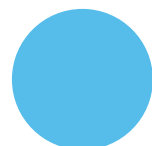

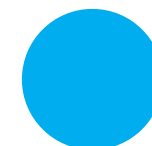
Les recyclés chinés The melanges recycled

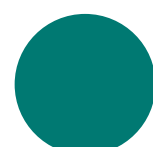

Les correspondances couleurs pantone ne sont données qu'à titre indicatif et peuvent varier. Aucune réclamation ne sera acceptée si une différence de couleur est constatée. Le coton naturel ne subit aucun traitement et le coloris peut également varier d'une production à une autre.







Corresponding Pantone colours are only given as an approximate indication and may vary. No claim will be accepted on the basis of a difference in colour. Natural cotton does not undergo any form of treatment, and colours may vary from one batch to another.

 035 / PANTONE 527C VIOLET / PURPLE N C	 040 / PANTONE 102C JAUNE / YELLOW N C PP	 043 / PANTONE 167C TERRACOTA N C PP	 044 / PANTONE 152C CORAIL / CORAL J C	 045 / PANTONE 021C ORANGE / ORANGE N CO C PP P	 050 / PANTONE 2915C BLEU CIEL / SKY BLUE N	 052 / PANTONE 326C BLEU CARAIBE/CARIBBEAN BLUE C	 053 / PANTONE PROCESS BLUE TURQUOISE / TURQUOISE N CO C PP
 069 / PANTONE 338C MENTHE/MINT C	 070 / PANTONE 368C VERT POMME/APPLE GREEN	 071 / PANTONE 3435C VERT BOUTEILLE/BOTTLE GREEN C	 072 / PANTONE 7481C VERT EMERAUDE/ ERAUDE GREEN N C J P	 073 / PANTONE GREEN C VERT VIF / BRIGHT GREEN CO PP	 074 / PANTONE 5753C OLIVE / OLIVE GREEN C	 075 / PANTONE 330C VERT ANGLAIS / ENGLISH GREEN N C	 076 / PANTONE 343C VERT FORÊT / FOREST GREEN J

Les métaliques The Metallics

Les rayures The Stripes

 501 / PANTONE 871C GOLD PP	 502 / PANTONE 877C SILVER PP	 503 / PANTONE 8021C COOPER PP	 001 / 520 NATUREL / ROUGE NATUREL / RED C	 001 / 545 NATUREL / SAFFRAN NATUREL / SAFFRON C	 001 / 550 NATUREL / BLEU NATUREL / BLUE C	 001 / 565 NATUREL / BEIGE NATUREL / BEIGE C	 001 / 570 NATUREL / VERT NATUREL / GREEN C
---	--	---	--	--	---	--	---

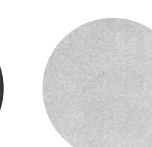
 R053 TURQUOISE CHINÉ / TURQUOISE MELANGE CR	 R055 BLEU ROYAL CHINÉ / ROYAL BLUE MELANGE CR	 R056 INDIGO CR	 R057 MARINE CHINÉ / NAVY MELANGE CR	 R070 VERT POMME CHINÉ / APPLE GREEN MELANGE CR	 R077 KAKI FONCÉ / DARK KAKI CR	 R080 NOIR / BLACK CR	 R089 GRIS CHINÉ / GREY MELANGE CR
---	--	--	--	---	--	--	--

Les fluos The neons

Lurex Lurex

 200 / PANTONE 809C JAUNE FLUO / NEON YELLOW P	 210 / PANTONE 804C ORANGE FLUO / NEON ORANGE P	 401 LUREX OR NATUREL / NATURAL LUREX GOLD J	 420 LUREX OR ROUGE / RED LUREX GOLD J	 402 LUREX ARGENT / SILVER LUREX C
---	---	--	--	--

**LC
DP**
Group ●



UB
UBAG

**BLEU
BLANG
SAC**

KWOO

UPRON