



Creative Display Solutions

# The Display Handbook 2024



# A creative solution for every need

## Create greater brand awareness and stand out from the crowd

We provide high-quality, innovative visual communication solutions. Our wide range of display options offers the ideal platform for delivering attention-grabbing brand messaging that adds real value for their clients.



Best seller



1 Year hardware guarantee



5 Year hardware guarantee



Comes with bag



Illuminated product



Available for use outdoors



Custom sizes available



Made in Europe



Use with fabric graphic



Use with PVC graphic



Use with self-adhesive graphic



Use with rigid panel graphic



Direct printing onto hardware



# Contents

Outstanding Print and Finishing Capabilities	6
In-house 3D Design Solutions	8
Sustainable Creative Display Solutions	10
A solution for every requirement	12
New Product Fastframe™	14
<b>Lightboxes</b>	<b>16</b>
Illuminova™	18
Illumigo™	23
<b>Display Stands</b>	<b>26</b>
Modulate™	28
Vector	40
Fastframe™	60
Arena Structures	72
Hanging structures	76
<b>Display Blackwalls</b>	<b>78</b>
Pop-up backwalls	80
Fabric tube walls	86
Tension walls	88
<b>Display Banners</b>	<b>90</b>
Tension textile systems	92
Roller banners (economy)	95
Roller banners (standard)	97
Roller banners (premium)	99
Tension banners (X Banner)	103
<b>Display Signs</b>	<b>104</b>
Free-standing signs	106
Wall mounted signs	110
Suspended signs	111
<b>Flag Banner</b>	<b>112</b>
Free-standing flags	114
Post / wall mounted flags	118
Mobile flags	119
<b>Tents</b>	<b>120</b>
Pop-up tents	122
Inflatable tents	125
<b>Counters</b>	<b>126</b>
Promotional counters	128
illuminated promotional counters	131
<b>Barriers</b>	<b>132</b>
Pedestrian control barriers	134
<b>Ancillaries</b>	<b>136</b>
Literature holders (standard)	138
Lighting	139
Lighting ancillaries	141
Portable transportation cases	142
Custom projects and made to measure graphics	144
<b>Applications</b>	<b>146</b>



# This catalogue will show you a Creative Display Solutions

A European made products for a Creative Display Solutions, with over 25 years' experience. We supply our customers with high quality innovative visual communication solutions that offer real value for their clients.

## Exceptional customer service lies at the heart of our business



**Dedicated customer support**



**High quality printing solutions**



**Large scale printing capacity**





## Large stock availability

With European logistics hubs located in the UK, France, Italy, Poland, Spain and Portugal, we have over 10,000 square metres of permanent storage capacity available. This means that we're able to maintain high local stock levels to minimise transport and delivery costs.



## Fast, reliable delivery in 24-48 hours

We have ample storage to offer immediate availability for the majority of our standard products, with designated transport providing speedy delivery in 24-48 hours. While custom products will take longer to be despatched, we pride ourselves on reactivity and performance in all aspects of our logistics process to make sure you receive your order without delay. We also offer white label deliveries direct to your customer for a faster turnaround.



## Environmentally conscious and reusable solutions

The growing need for environmentally conscious solutions is a key focus of ours. We offer a variety of sustainable choices, supporting you and your client's environmental policies.

We only use water-based inks with non-toxic chemicals for a safer, more environmentally friendly approach and all our aluminium-framed solutions can be recycled and are designed to be reused.

Our sublimation, UV and latex printing processes are environmentally friendly and our fabric graphic media is fire retardant, supporting unlimited reuse of graphics.

**25** years  
of creative  
display solutions

# Outstanding Print and Finishing Capabilities

## Let us service your print requirements

Unlock the full potential of extensive product range with our in-house print services. Our cutting-edge print systems, backed by a seasoned team of finishing specialists, allows you to offer your clients a broader portfolio of Creative Display Solutions. By tapping into our expertise, you can expand your business without distractions, risk or investment.



### 10,000m<sup>2</sup> printed per day

Through ongoing investment in our European print capabilities, we ensure reliability, efficiency and consistency across all our locations, leveraging the latest print innovations to produce up to 10,000m<sup>2</sup> of high-quality graphics per day.

From simple one-off prints, through to 3.2m wide exhibition boards, we combine fast turnaround times with stringent quality control and print colour profiling. We offer dye-sublimation printing for high-definition print that won't wash or peel off and that doesn't affect the feel or quality of the fabric, in addition to Latex and UV printing for a clean and durable finish, producing vivid colours suitable for both indoor and outdoor applications.



### A wide choice of substrates

By offering a variety of fully tested textiles and PVC materials, we give you access to a comprehensive portfolio of vibrant, long-lasting printed products in one place. We carefully select the materials we use to meet your requirements in terms of sustainability, quality, colour rendition, vibrancy, and cost.



### Expert finishing

Our highly experienced in-house sewing and finishing team works tirelessly to complete projects to the highest standards. We can manufacture a variety of standard and custom-built designs, many with complex shapes and finishes for maximum impact. All our products are tested before they leave our workshops to ensure customer satisfaction.



## European Print Plant List Highlights

- 5x HP stitch S1000
- 4x HP Stitch 500
- 1x HP 3.2 Latex
- 2x Durst Rhotex 325
- 1x Durst Rho P10 250
- 1x Durst UV : Rho 312R



HP Stitch S1000 dye sublimation printer for vibrant results and colour consistency



Zund Cutting Machine

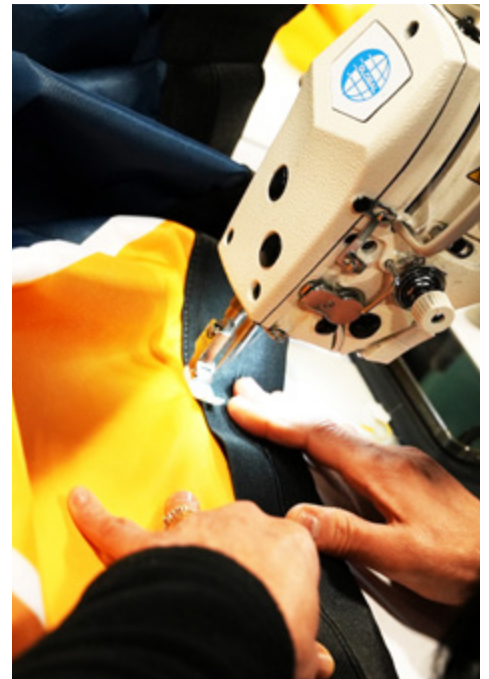
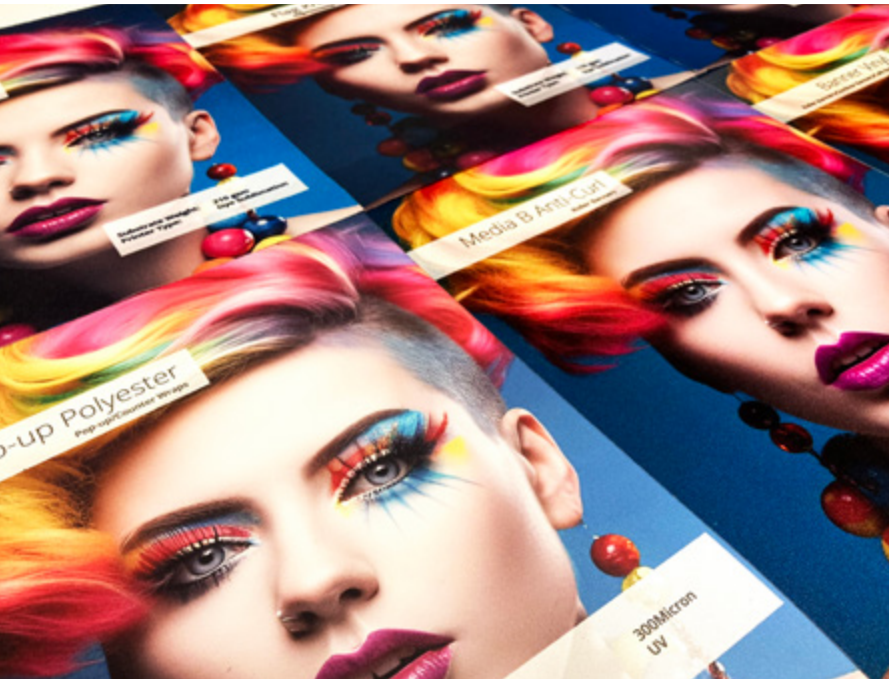

Expand your business horizons by providing your clients with unparalleled access to Creative Display Solutions that empower brands.



# A solution for every requirement

## Our comprehensive range of Creative Display Solutions

We're proud to be an European supplier for Creative Display Solutions. Our goal is to offer a comprehensive range of innovative products for a variety of industries and applications, all from a single source. This collection contains our portfolio of Creative Display Solutions including our latest products.

### 01 Lightboxes

Create outstanding visual impact with Back lit or edge lit LED graphics, ideal for temporary, permanent and customised application.



### 02 Display Stands

Complete exhibition stand solutions, incorporating hanging structures, modular stands, towers and customised stands





## 03 Display Backwalls

Large format graphic backdrops ideal for conferences, promotional activities and events



## 04 Display Banners

Portable display options, ideal for temporary deployment



## 05 Display Signs

Professional wall, floor and suspended signage solutions



## 06 Flag Banners

Attract attention at a distance through movement with eye-catching flag solutions



## 07 Tents

Perfect temporary shelters, pop-up shops and market stall for outdoor use



## 08 Counters

Adaptable and portable temporary counters for promotional, display and exhibition applications



## 09 Barriers

Easy and convenient barrier systems to manage queues, control crowds and create temporary areas



## 10 Ancillaries

Accessories designed to increase the functionality of a chosen product range



**NEW**  
**PRODUCT**

Introducing your **innovative**  
and **cost-effective** modular  
Display Solution.



For more information see pages 60-71

**FASTFRAME™** is a unique, **sustainable** and **user-friendly** Display Solution.



### **More versatile than a pop-up**

- › Highly configurable
- › Seamless graphics
- › Easy to change Silicone Edge Graphics (SEG)
- › Many applications



### **More flexible than a roller banner**

- › Assembled in seconds
- › Lightweight, highly portable
- › One frame, multiple graphics
- › Single or double-sided graphics
- › Expandable, no joints
- › Washable stretch fabric
- › Cost savings through repeated use



### **More configurable than an exhibition stand**

- › Expandable – add modules over time
- › Quick change design
- › Excellent space utilisation
- › Toolless construction
- › Seamless graphic overlay





# Lightboxes

For outstanding visual impact in interior spaces, lightboxes are the perfect option. Vibrant graphics, edge lit or Back lit with energy saving LEDs, create focal points that add depth and drama to retail spaces, exhibition stands, commercial properties and beyond.

Whether wall mounted, free-standing or suspended at height, LED lightboxes are the ideal showcase for brand messaging and statement imagery. We offer two ranges of lightbox solutions. The Illuminova™ range combines vivid SEG fabric graphics with a sleek profile in a choice of standard or custom dimensions. For instant pop-up displays, our portable Illumigo™ range is available in a variety of standard sizes to bring your retail space to life.

## illumiNOVA™

The Illuminova™ range encompasses wall mounted, hanging and free-standing LED lightboxes in a choice of standard or custom sizes. Ideal for adding visual interest to feature walls and shop windows as well as transforming areas with low ambient lighting. Easily refreshed with updated graphics, Illuminova™ provides the perfect framework to display enhanced vibrant messaging.

## iLLUMiGO™

The Illumigo™ LED lightbox range combines stunning graphic illumination with instant, tool-free assembly. For ease of transportation and storage, the aluminium LED frames are lightweight and come in a handy carry case. Simply update the SEG graphics, for a fresh and sustainable way to transform spaces with light.



## 30mm Illuminova™ wall mounted



With its sleek and narrow profile, the 30mm Illuminova™ LED Back lit wall-mounted lightbox is ideal for showcasing standout messaging in interior displays. Illuminated using a powerful linkable LED display system for consistent lighting across the graphic. Available in standard and custom sizes



<b>Material</b>	Aluminium
<b>Profile width</b>	30 mm
<b>Profile Colour</b>	Anodised Silver
<b>Assembly</b>	Connectors assemble using Allen key
<b>Mounting</b>	Wall mounted
<b>Graphic area</b>	Single-sided
<b>Graphic attachment</b>	Silicone Edged Graphics (3 mm silicone)
<b>LED System</b>	Back lit

• Available fully assembled or in Kit form

illuminova™ 30mm 594x854mm	ILLNO-30-05X08	Ⓞ 594(w) x 854(h) x 30(d) mm
illuminova™ 30mm 854x1189mm	ILLNO-30-08X11	Ⓞ 854(w) x 1189(h) x 30(d) mm
illuminova™ 30mm 1000x1000mm	ILLNO-30-10X10	Ⓞ 1000(w) x 1000(h) x 30(d) mm
illuminova™ 30mm 2000x1000mm	iLLNO-30-20X10	Ⓞ 2000(w) x 2000(h) x 30(d) mm



Back lit panels

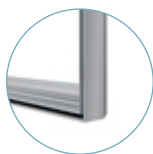

30mm profile

## 75mm Illuminova™ wall mounted



Create a striking focal point with the 75mm Illuminova™ LED edge lit wall mounted lightbox. Available in standard and custom sizes, the linkable LED lighting system delivers consistent lighting for a dramatic visual display.



<b>Material</b>	Aluminium
<b>Profile width</b>	75 mm
<b>Profile Colour</b>	Anodised Silver or custom White or Black
<b>Assembly</b>	Connectors assemble using Allen key
<b>Mounting</b>	Wall mounted
<b>Graphic area</b>	Single-sided
<b>Graphic attachment</b>	Silicone Edged Graphics (3 mm silicone)
<b>LED System</b>	Edge lit + Pre-installed LED lighting

illuminova™ 75mm wall mounted 1000x1000mm	iLLNO-75-10X10	⊙ 1000(w) x 1000(h) x 75(d) mm
illuminova™ 75mm wall mounted 1500x1500mm	iLLNO-75-15X15	⊙ 1500(w) x 1500(h) x 75(d) mm
illuminova™ 75mm wall mounted 2000x1000mm	ILLNO-75-20X10	⊙ 2000(w) x 1000(h) x 75(d) mm
illuminova™ 75mm wall mounted 2000x2000mm	ILLNO-75-20X20	⊙ 2000(w) x 2000(h) x 75(d) mm
illuminova™ 75mm wall mounted 3000x2000mm	ILLNO-75-30X20	⊙ 3000(w) x 2000(h) x 75(d) mm

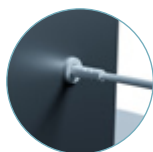

Cable system



LED strip lighting



Numbered system for  
easy assembly

## 100mm Illuminova™ Free-standing



The double-sided 100mm Illuminova™ LED edge lit free-standing lightbox creates a dramatic visual statement for your interior displays. The plug and play linkable LED display system makes for a simple set up, whilst the SEG graphics can be easily replaced to support new messaging.

Material	Aluminium
Profile width	100 mm
Profile Colour	Anodised Silver
Assembly	Connectors assemble using Allen key
Graphic area	Double-sided
Mounting	Free-standing
Graphic attachment	Silicone Edged Graphics 3mm (SEG)
LED System	Pre-installed LED lighting + edge light

illuminova™ 100MM 3000X2000MM	ILLNO-100-30X20	Ⓜ 3000(w) x 2007(h) x 550(d) mm
-------------------------------	-----------------	---------------------------------

Measurements include feet



Available in standard and custom sizes



Mitred sections assemble with screw-in connectors



Cable system



LED strip lighting



## 125mm Illuminova™ Free-standing



For outstanding visual impact, the robust double-sided 125mm Illuminova™ LED edgelit free-standing lightbox is a must. Available in standard and custom sizes, the plug and play linkable LED display system ensures vibrant lighting across the SEG graphic.

<b>Material</b>	Aluminium
<b>Profile width</b>	125 mm
<b>Profile Colour</b>	Anodised silver or custom white or black
<b>Assembly</b>	Connectors assemble using Allen key
<b>Double-sided</b>	Double-sided
<b>Mounting</b>	Free-standing
<b>Graphic attachment</b>	Silicone Edged Graphics 3mm (SEG)
<b>LED System</b>	Pre-installed LED lighting + edge light

Illuminova™ 125mm 3000x2500mm	ILLNO-125-30X25	Ⓜ 3000(w) x 2507(h) x 550(d) mm
Illuminova™ 125mm 4000x2000mm	ILLNO-125-40X20	Ⓜ 4000(w) x 2007(h) x 550(d) mm

Measurements include feet

Available in standard and custom sizes



Cable system



LED strip lighting



Mitred sections assemble with screw-in connectors

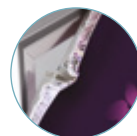

Graphic attaches with silicone edging (SEG)

## 125mm Illuminova™ Hanging Structure



Ideal for exhibitions and retail venues, the 125mm Illuminova™ hanging LED structure is the perfect medium for brand messaging and wayfinding. Sleek, yet lightweight and robust, the double-sided aluminium frame is edge lit with energy efficient LEDs for an eye-catching suspended display. Available in standard and custom sizes, this vibrant lightbox creates the perfect backdrop for dynamic SEG graphics.

<b>Material</b>	Aluminium
<b>Profile width</b>	125 mm
<b>Profile Colour</b>	Anodised. White and black are available as custom
<b>Assembly</b>	Sling (cables not included). Connectors assemble using Allen key
<b>Double-sided</b>	Double-sided
<b>Mounting</b>	Hanging
<b>Graphic attachment</b>	Silicone Edged Graphics 3mm (SEG)
<b>LED System</b>	Pre-installed LED lighting + edge light

illuminova™ 125mm hanging 2500x1000mm	ILLNOH-125-25X10	⊗ 2500(w) x 1000(h) x 125(d) mm
illuminova™ 125mm hanging 3500x1000mm	ILLNOH-125-35X10	⊗ 3500(w) x 1000(h) x 125(d) mm
illuminova™ 125mm hanging 5000x1250mm	ILLNOH-125-50X12	⊗ 5000(w) x 1250(h) x 125(d) mm

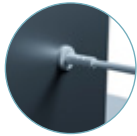

Cable system



LED strip lighting

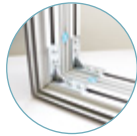

Mitred sections assemble with screw-in connectors

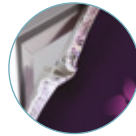

Graphic attaches with silicone edging (SEG)



# ILLUMiGO

## Illumigo™ One



Illumigo™ One is a vibrant portable single-sided lightbox with the option to have a rear-facing textile graphic unit. Standing 2000mm high and 850mm wide, the slim 60mm profile has a white powder coated finish and benefits from tool-free plug and play assembly due to an easy to follow numeric system, rollable LED panel and pre-assembled twist-out feet.



Material	Aluminium
Profile width	60 mm
Profile Colour	White
Assembly	Tool-free
Graphic area	Single-sided
Graphic attachment	Silicone Edged Graphics (3 mm silicone)
Application	Self-supporting with pivoting feet fixed to the structure
Transport	Protective box with carry handle

Illumigo™ One	ILLGO-ONE-EU	Ⓞ 850(w) x 2010(h) x 390(d) mm
---------------	--------------	--------------------------------

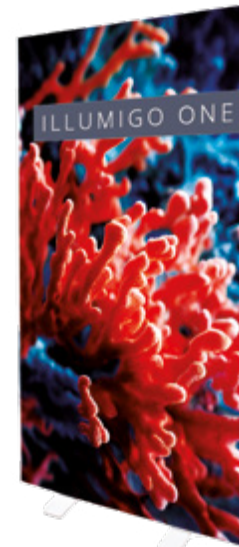

Tool-free assembly

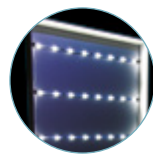

Rollable LED panel

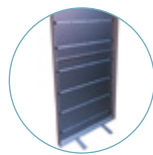

Single-sided frame



Optional Illumigo™ bag

← 850 mm →

## Illumigo™



Illumigo™ is an innovative portable LED lightbox that comes in a protective compartmented box with handle for ease of transportation. Deploys tool-free in minutes thanks to pre-assembled LED lighting and push-fit optional dye-sublimated graphics.



Material	Aluminium
Profile width	100 mm
Profile Colour	White
Assembly	Tool-free
Graphic area	Double-sided
Graphic attachment	Silicone Edged Graphics (3 mm silicone)
Application	Self-supporting with pivoting feet fixed to the structure
Transport	Protective box with carry handle

Illumigo™ - 2x1	ILLGO-2X1-EU	Ⓞ 1000(w) x 2000(h) x 400(d) mm
Illumigo™ bag	ILLGO-BAG	Ⓞ 460(w) x 1160(h) x 400(d) mm



Supplied with twin twist-out feet



Numbered system for easy assembly



Pre-installed LED lights



Branded protective compartmented box



Optional Illumigo™ bag

## Illumigo™ Retail



Illumigo™ Retail is an innovative portable LED lightbox that is specifically designed for retail environments because of its size and stability. The 1600 x 600mm double-sided illuminated display comes in a protective compartmented box with handle for ease of transportation. Deploys tool-free in minutes thanks to pre-assembled LED lighting and push-fit optional dye-sublimated graphics.



<b>Material</b>	Aluminium
<b>Profile width</b>	100 mm
<b>Profile Colour</b>	White
<b>Assembly</b>	Tool-free
<b>Graphic area</b>	Double-sided
<b>Graphic attachment</b>	Silicone Edged Graphics (3 mm silicone)
<b>Application</b>	Self-supporting with flat base fixed to the structure
<b>Transport</b>	Protective box with carry handle

Illumigo™ Retail	ILLGO-RETAIL-EU	ⓐ 600(w) x 1600(h) x 285(d) mm
------------------	-----------------	--------------------------------



Pre-installed LED lights



Connector



Branded protective compartmented box



Optional Illumigo™ bag

## Illumigo™ 2x2



Illumigo™ is a complete portable 2x2m double-sided aluminium lightbox display system. Simple to deploy with tool-free assembly. Just remove from the box, twist out the feet from the base panel and use the matching numerical system to connect the remaining extrusions remembering to insert the horizontal bar. SEG graphics fit into the frame channel and the power cable inserts under the base panel. Plug and play in less than 10 minutes!



<b>Material</b>	Aluminium
<b>Profile width</b>	100 mm
<b>Profile Colour</b>	White
<b>Assembly</b>	Tool-free
<b>Graphic area</b>	Double-sided
<b>Graphic attachment</b>	Silicone Edged Graphics (3 mm silicone)
<b>Application</b>	Self-supporting with pivoting feet fixed to the structure
<b>Transport</b>	Protective box with carry handle

Illumigo™ 2x2	ILLGO-2X2-EU	ⓐ 2000(w) x 2000(h) x 390(d) mm
---------------	--------------	---------------------------------



Metal straight connector



Numbered system for easy assembly

## Illumigo™ Counter



This versatile and quick to set-up double-sided counter lightbox is a great all-rounder not only at events but in retail environments from shopping centres to pop-up shops. Part of the Illumigo™ range, the Illumigo™ Counter is easy to assemble with a two-part counter-top that secures using a pair of twist out top locators and locking screws. Building the unit is intuitive and tool-free as all the parts are numbered and simply slot together. Two optional graphics complete the look to create an impactful counter ideal for attracting attention in retail, event or exhibition environments.

Material	Aluminium 100 mm, MDF table top
Assembly	Tool-free
Collapsible	Yes
Counter top	White
Graphic attachment	Silicone Edged Graphics (3 mm silicone)
Transport	Protective box with carry handle
LED System	Led strips included

Illumigo™	ILLGO-COUNTER-EU	📏 1045(h) x 1040(w) x 420(d) mm
Illumigo™ Bag	ILLGO-BAG	📏 1160(h) x 460(w) x 190(d) mm



Optional Illumigo™ bag



Protective compartmented box



Pre-assembled LEDs in the frame



Steel side feet for stability



# Display Stands

Display stands are the perfect solution for an array of different applications. From exhibitions, conferences, events, retail event zones to window displays and product showrooms; their uses are unlimited. The perfect stand will showcase and increase the opportunity to interact with existing and potential customers by creating engaging, and innovative brand promotion and messaging.

Our Display Stands range of products include hanging structures to attract interest from a distance along with versatile modular stand components to create truly contemporary and captivating exhibition spaces. The collective modular systems; Modulate™, Vector, Arena and Fastframe™, are all designed to work in unison, to deliver a re-usable and reconfigurable exhibition stand. Graphics can be easily updated, and layouts refreshed over and over again. These hard working modular solutions offer exceptional return on investment as well as a sustainable approach to creative display.

Creating an effective display stand that drives results is extremely straightforward with this collection of pre-configured solutions. Simply select a design for inspiration whilst considering floor size and parameters of price-point. For a more unique stand construction, the modular range can also be customised - incorporating precise requirements with all the benefits that modular exhibition systems offer for complete creative innovation.



## Stand component systems

### Modulate™

Modulate™ is the fusion between two of our original concepts: Formulate and Vector. The range is composed of various frames made of aluminium tubes, equipped with the patented magnet system: MagLink. Modulate™ provides a custom build solution through its hundreds of possible configurations using the various modules.

### Vector

One of the simplest and most versatile communication solutions on the market, Vector is an aluminium frame system with a stretched fabric graphic that adapts to any environment. With a variety of different profiles, all applications are possible: suspended, wall-mounted, self-supporting, double-sided or illuminated utilising Illuminova™.

### Fastframe™

A unique pre-assembled foldable framework for fast construction and endless Creative Display Solutions - the perfect seamless backdrop for visually striking SEG graphics.

### Arena

Arena is a tubular aluminium gantry structure that is both extremely strong and light. The different sections can be assembled according to the space and can be covered with fabric or vinyl graphics.

### Hanging Structures

Select one of our lightweight Formulate hanging structures to compliment your stand design, which uses a lightweight 30mm tubular system that can be neatly wrapped in a fabric printed graphic.

# Considerations for exhibitions

## Why exhibit at a trade show?

Trade shows remain the preferred communication channel for companies seeking to increase their reputation and promote their image.

The benefits of a trade show are vast and very attractive. They enable several actions to be carried out in a relatively short period of time:

- Brand positioning
- Prospecting
- Market research
- Product launches
- Building customer loyalty
- Business networking

## The centrepiece: your stand

The success of any trade show depends on its cost vs quality and ROI for generating leads and meeting other sales / marketing objectives.

### 1. Location:

How much space? How many open sides?

### 2. The design:

Which media: textile, rigid, flexible panels?

Need to communicate in height: sign, extension or extension of storage room?

Do you need a storeroom to store equipment?

What kind of lighting?

### 3. Use:

How often?

Will it need to be scalable in shape and size?

What means of transport do you have?

Will the stand be reused in another environment i.e. customer showroom, inhouse events etc.?

### 4. The budget :

What is the budget for the stand?

Over how many shows will it pay for itself?

## The keys to success

To have a successful trade show, it is essential to:

- Set 3 to 5 objectives that will guide the marketing strategy of the event
- Ensure maximum visual impact with a quality stand that will enhance the company's image (openings, suspended communication, graphics, materials, etc.)
- Implement effective communication and promotion: before, during and after the event (emailing, invitation, social networks, stand promotion, etc.)

## Why choose a modular stand?

- Lightweight and compact
- Reconfigurable
- Quick payback
- Durable
- Easy to assemble
- Standard or custom made
- Unlimited message renewal
- Ergonomically friendly

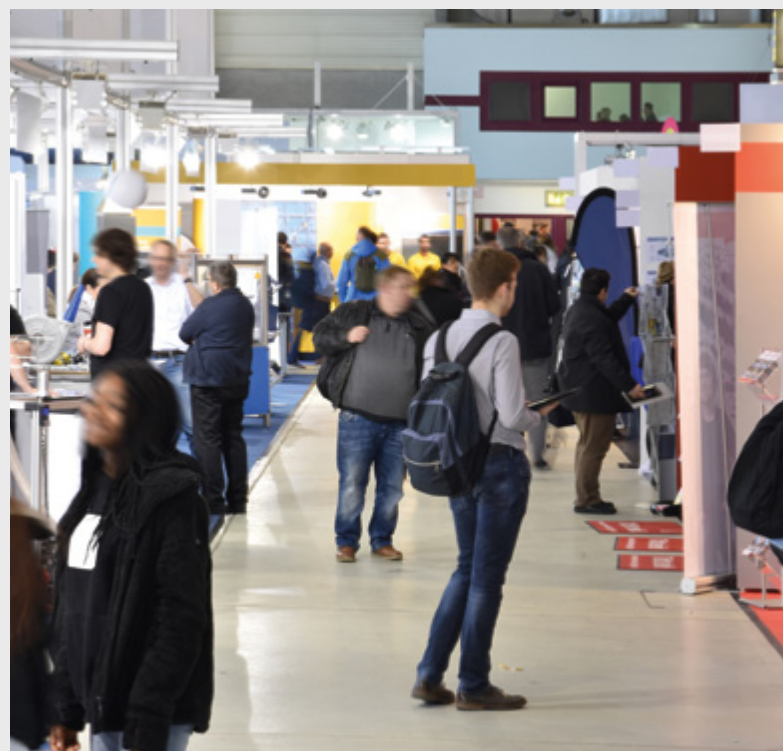



MODULATE™



# Modulate™

## The best way to attract attention

Modulate™ is the result of the fusion of two original concepts that have proven successful in the exhibition and retail world; Formulate tubular solutions and the modularity of Vector frames.

Modulate™ is a collection of various frames made from aluminum tubes and covered with a printed textile cover. These frames can be easily connected to each other by means of powerful magnets placed inside each structure.

Based on this simple magnetic principle, it is possible to combine the different Modulate™ frames to create configurations for all communication areas: at the point of sale, at trade shows, in exhibition areas, in shopping centres or simply within companies themselves.

### MagLink connector, simple, fast and reconfigurable



Thanks to the exclusive MagLink magnetic system integrated into the structure, you can connect the frames to each other simply by bringing them together.

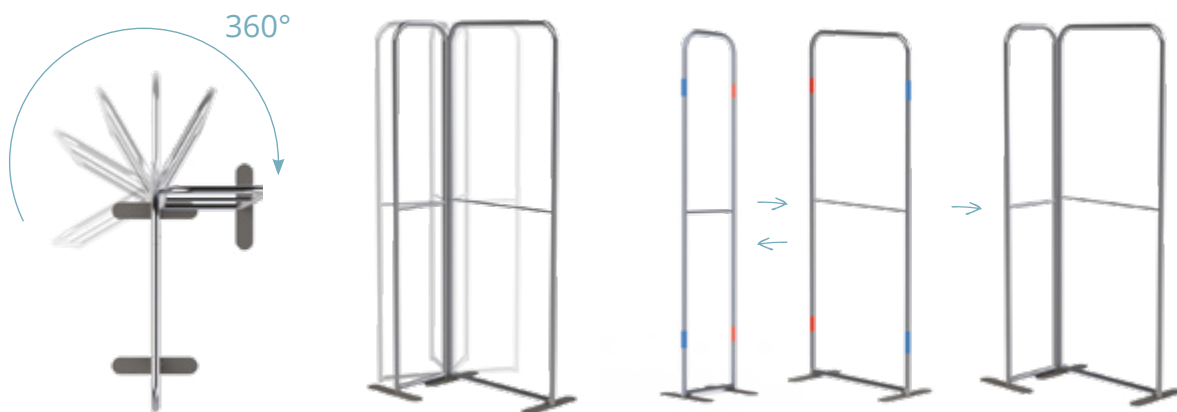

Optional 400 mm extension to change the height of the structures



MagLink connectors 360° in each post



Modulate™ carry bag with dedicated slots for feet and graphics



Intuitive marking on each section for easy assembly



Self-locking system with elastic posts and push-fit button



Rounded or straight corners with the reference MOD-SQ-ANGLE



2 stabilising feet with Twist & Lock system, supplied with each frame



Central reinforcement bar (18 mm diameter)



Double-sided custom printed fabric graphic that zips closed

## Tool-less assembly

Modulate™ structures are easy to assemble without tools. Each section is marked with numbers and colours and connected with push buttons. Once the structure is assembled, the Twist & Lock feet will rotate a quarter of a turn until they lock into a perfectly stable self-supporting frame. Finally pull-on the printed fabric graphic which perfectly fits to the contour of the frame.

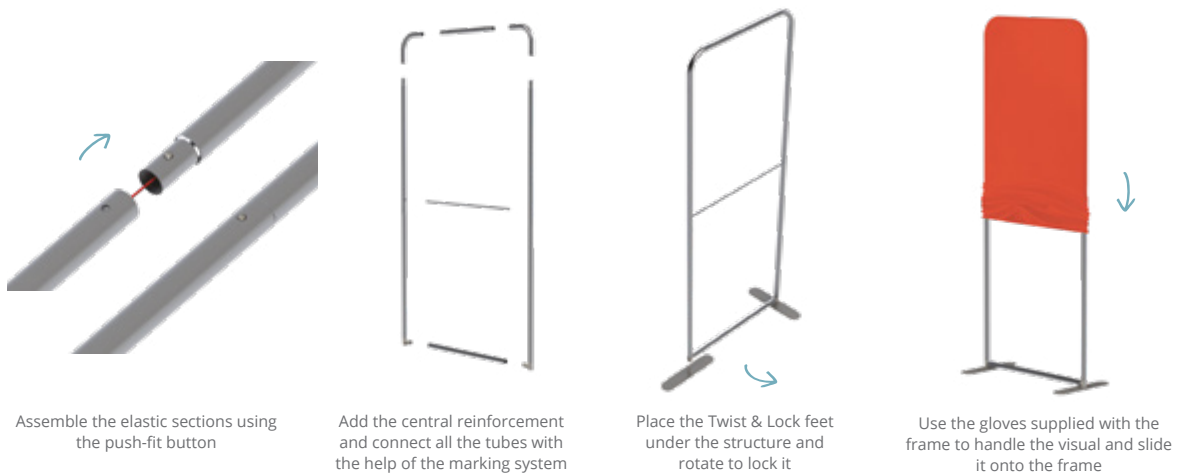

## Twist & Lock Foot installation

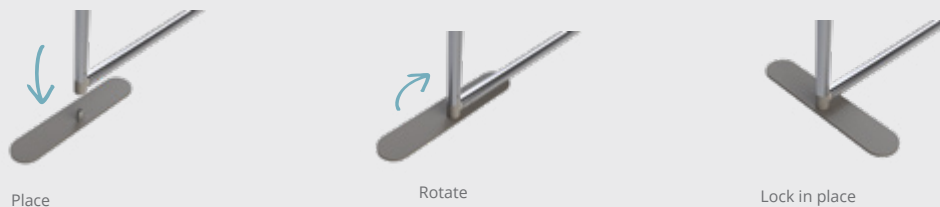

## Structures with unique technological innovations!

To add versatility to Modulate™ structures, a 400 mm tubular extension can be added. With this extension, which is easily placed between two sections, you can use the same frame with two different heights.

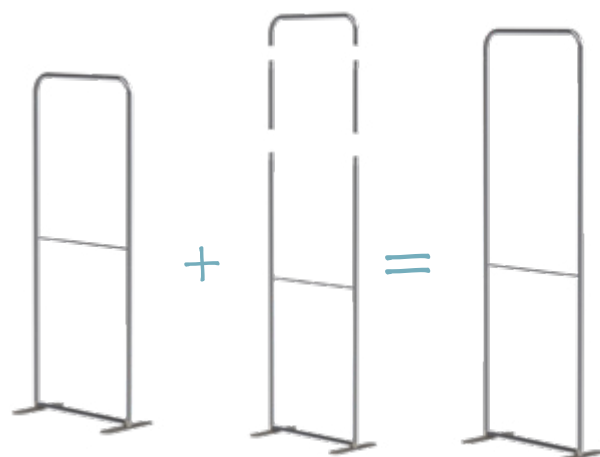

## Standard Modulate™ Frames

Modulate™ is an innovative double-sided display system that consists of a set of lightweight aluminium frames covered with a custom printed tension fabric graphic. Frames connect together using powerful magnets encased inside each element and can be joined at any angle to create shaped displays or backwalls. Frames are completed by pulling a tension-fit fabric graphic over the frame and zipping at the base. Frames are available in various widths and two height options. Each frame is supplied with two stabilising feet which can be used if required for extra stability. The Modulate™ Straight frames can be used on their own or combined with other frames to create hundreds of configurations.

Material	Aluminium
Tube	30mm Ø
Assembly	Tool-free push-button connectors
Shape	Straight
Graphic area	Double-sided
Graphic attachment	Zipped tension-fit graphic
Application	Free-standing with feet (included)
Transport	Modulate™ carry bag with dedicated pockets for the feet and graphics



## Modulate™ Straight

### Modulate™ Straight 420, 424



Straight 420 rounded corners	MOD-S-420	Ⓞ 418(w) x 2000(h) x 400(d) mm
Straight 424 rounded corners	MOD-S-424	Ⓞ 418(w) x 2400(h) x 400(d) mm
Straight 420 square corners	MOD-S-420-SQ	Ⓞ 418(w) x 2000(h) x 400(d) mm
Straight 424 square corners	MOD-S-424-SQ	Ⓞ 418(w) x 2400(h) x 400(d) mm



### Modulate™ Straight 820, 824



Straight 820 rounded corners	MOD-S-820	Ⓞ 818(w) x 2000(h) x 400(d) mm
Straight 824 rounded corners	MOD-S-824	Ⓞ 818(w) x 2400(h) x 400(d) mm
Straight 820 square corners	MOD-S-820-SQ	Ⓞ 818(w) x 2000(h) x 400(d) mm
Straight 824 square corners	MOD-S-824-SQ	Ⓞ 818(w) x 2400(h) x 400(d) mm

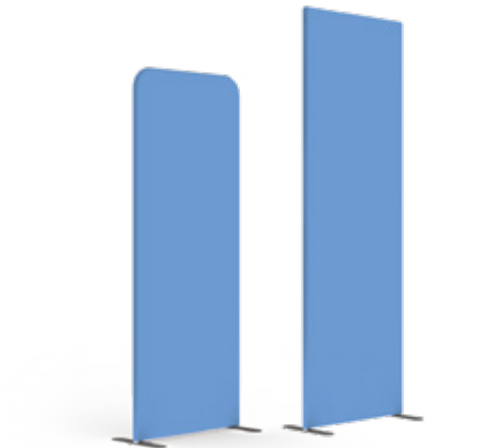

## Modulate™ Straight 1020, 1024



Straight 1020 rounded corners	MOD-S-1020	1018(w) x 2000(h) x 400(d) mm
Straight 1024 rounded corners	MOD-S-1024	1018(w) x 2400(h) x 400(d) mm
Straight 1020 square corners	MOD-S-1020-SQ	1018(w) x 2000(h) x 400(d) mm
Straight 1024 square corners	MOD-S-1024-SQ	1018(w) x 2400(h) x 400(d) mm



## Modulate™ Straight 1820, 1824



Straight 1820 rounded corners	MOD-S-1820	1818(w) x 2000(h) x 400(d) mm
Straight 1824 rounded corners	MOD-S-1824	1818(w) x 2400(h) x 400(d) mm
Straight 1820 square corners	MOD-S-1820-SQ	1818(w) x 2000(h) x 400(d) mm
Straight 1824 square corners	MOD-S-1824-SQ	1818(w) x 2400(h) x 400(d) mm



## Modulate™ Straight 2020, 2024



Straight 2020 rounded corners	MOD-S-2020	2018(w) x 2000(h) x 400(d) mm
Straight 2024 rounded corners	MOD-S-2024	2018(w) x 2400(h) x 400(d) mm
Straight 2020 square corners	MOD-S-2020-SQ	2018(w) x 2000(h) x 400(d) mm
Straight 2024 square corners	MOD-S-2024-SQ	2018(w) x 2400(h) x 400(d) mm

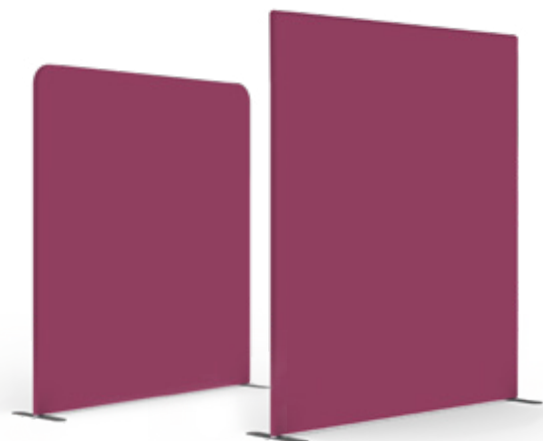

## Modulate™ Slope

### Modulate™ Slope



<b>Material</b>	Aluminium
<b>Tube</b>	30mm Ø
<b>Assembly</b>	Tool-free push-button connectors
<b>Shape</b>	Straight
<b>Graphic area</b>	Double-sided
<b>Graphic attachment</b>	Zipped tension-fit graphic
<b>Application</b>	Free-standing with feet (included)
<b>Transport</b>	Modulate™ carry bag with dedicated pockets for the feet and graphics

Slope 1	MOD-SS-824-01	818(w) x 2300(h) x 400(d) mm
Slope 2	MOD-SS-824-02	818(w) x 2400(h) x 400(d) mm



Slope 1

Slope 2

### Modulate™ Door



The Modulate™ Door frame joins magnetically to other frames in the Modulate™ range and is tool-free in its design. Constructed from lightweight aluminium tubing with magnets held in the frames to join backwalls together. Complete with optional tension-fit fabric graphic, the door is ideal for store room areas or meeting rooms.

<b>Material</b>	Aluminium
<b>Tube</b>	30mm Ø
<b>Assembly</b>	Tool-free push-button connectors
<b>Shape</b>	Straight
<b>Graphic area</b>	Double-sided
<b>Graphic attachment</b>	Zipped tension-fit graphic
<b>Application</b>	Free-standing with feet (included)
<b>Transport</b>	Modulate™ carry bag with dedicated pockets for the feet and graphics

Modulate™ door Rounded corners	MOD-S-DOOR-820	800(w) x 2000(h) x 120(d) mm
	MOD-S-DOOR-824	800(w) x 2400(h) x 120(d) mm
Modulate™ door Square corners	MOD-S-DOOR-820-SQ	800(w) x 2000(h) x 120(d) mm
	MOD-S-DOOR-824-SQ	800(w) x 2400(h) x 120(d) mm

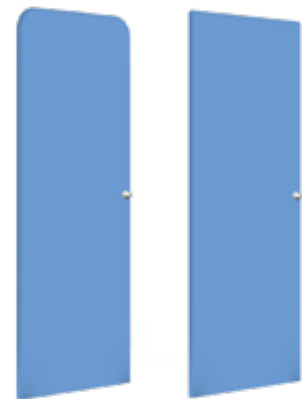

2 handles and 1 stop for Modulate™ door included



An adjustable foot included



2 Twist & Lock square feet



The Modulate™ Door can be used with either a left or right-hand handle

## Modulate™ ancillaries

### Modulate™ Half Feet (pair)

MOD-HALF-FOOT-P	⊗ 80(w) x 6(h) x 215(d) mm
-----------------	----------------------------



### Modulate™ Feet (pair)

MOD-FOOT-P	⊗ 80(w) x 6(h) x 400(d) mm
------------	----------------------------



### Modulate™ 400mm Extension Kit

MOD-EXT400MM	⊗ 3 tubes 400(h) x 30 (Ø) mm
--------------	------------------------------



### Spotlight Clamp for Formulate / Modulate™ Tube

US903	⊗ 48(w) x 32(h) x 50(d) mm
-------	----------------------------



### Modulate™ Counter



Modulate™ Counter consists of an innovative aluminium tubular frame, counter-top, and printed tension fabric graphic. Powerful magnets encased inside the frame enables two or more counters to connect using simple magnetic principles. The counter can be used on its own or combined to make a long reception or bar area. Modulate™ Counter can be deployed in minutes, thanks to the tool-less construction. The printed tension fabric graphic will either sit on or under the counter-top to suit the application.

<b>Material</b>	Ø 30mm Aluminium tubes, MDF tabletop/shelf
<b>Assembly</b>	Push-fit button
<b>Collapsible</b>	Yes
<b>Counter top</b>	Black
<b>Shelves</b>	1 (Optional)
<b>Graphic attachment</b>	Zip system
<b>Transport</b>	One padded carry bag, internal flap

Modulate™ Counter	FORM-MOD-CNTR	⊗ 1015(h) x 800(w) x 600(d) mm
Shelf	FORM-MOD-CNTR-02	⊗ 9(h) x 770(w) x 571(d) mm

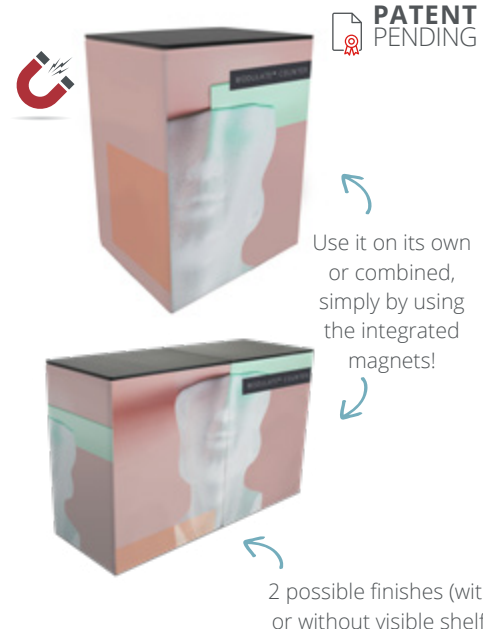

## Pre-configured Modulate™ stand examples

This section showcases examples of various pre-configured Modulate™ Stands that can be achieved using the various Modulate™ hardware and ancillaries.

### Modulate™ Stand 9m<sup>2</sup>



Material	Aluminium
Tube	30mm Ø
Assembly	Tool-free push-button connectors
Graphic area	Double-sided
Graphic attachment	Zipped tension-fit graphic

Straight 2024 square corners (x2)	MOD-S-2024-SQ
Straight 824 square corners (x3)	MOD-S-824-SQ
Door Modulate™	MOD-S-DOOR-824-SQ
Pair of half flat feet (x2)	MOD-HALF-FOOT-P
Modulate™ counter	FORM-MOD-CNTR
Internal shelf	FORM-MOD-CNTR-02

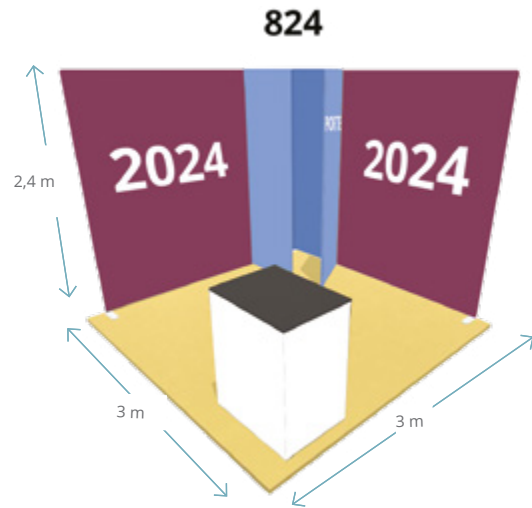

Modulate™ cupboard  
perfect for storage

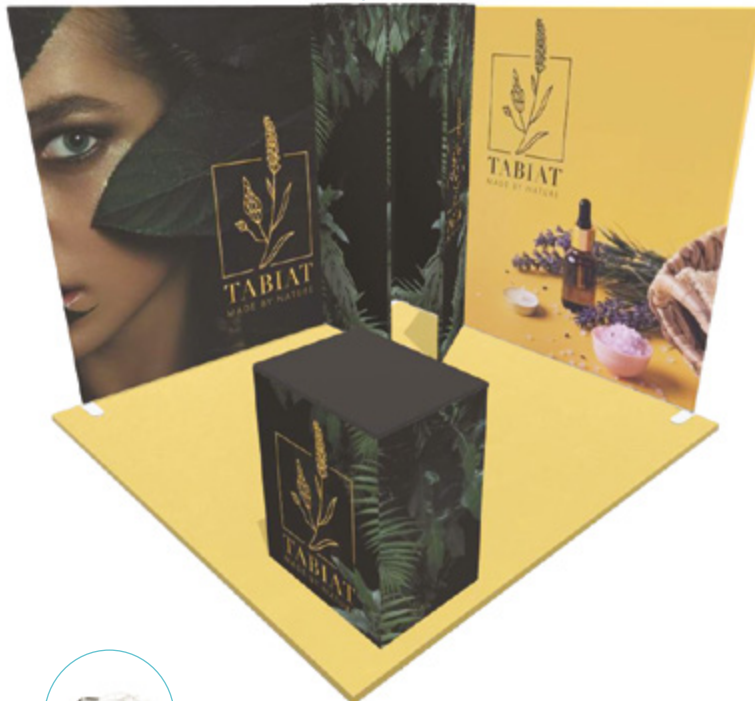

Optional Spot  
LED-STRIP-ARM-BDLK



Clamp US903



Supplied with product bags



## Modulate™ Stand 12m<sup>2</sup>



Material	Aluminium
Tube	30mm Ø
Assembly	Tool-free push-button connectors
Graphic area	Double-sided
Graphic attachment	Zipped tension-fit graphic

Straight 2024 square corners (x3)	MOD-S-2024-SQ
Straight 1024 square corners	MOD-S-1024-SQ
Straight 824 right angles (x4)	MOD-S-824-SQ
Modulate™ Door	MOD-S-DOOR-824-SQ
Pair of half flat feet x4	MOD-HALF-FOOT-P



Possibility to add  
PS950-1000-LED-BDLK  
spotlights



Half feet  
Twist & Lock  
MOD-HALF-FOOT-P  
grey



2 handles and 1 stop  
for Modulate™ Door  
MOD-S-DOOR-SP-01  
included

## Modulate™ Stand 15m<sup>2</sup>



Material	Aluminium
Tube	30mm Ø
Assembly	Tool-free push-button connectors
Graphic area	Double-sided
Graphic attachment	Zipped tension-fit graphic

Straight 2024 square corners (x3)	MOD-S-2024-SQ
Straight 1024 square corners	MOD-S-1024-SQ
Straight 824 square corners (x3)	MOD-S-824-SQ
Slope 2	MOD-SS-824-02
Door Modulate™	MOD-S-DOOR-824-SQ
Pair of half flat feet x4	MOD-HALF-FOOT-P
Modulate™ counter	FORM-MOD-CNTR
Internal shelf	FORM-MOD-CNTR-02

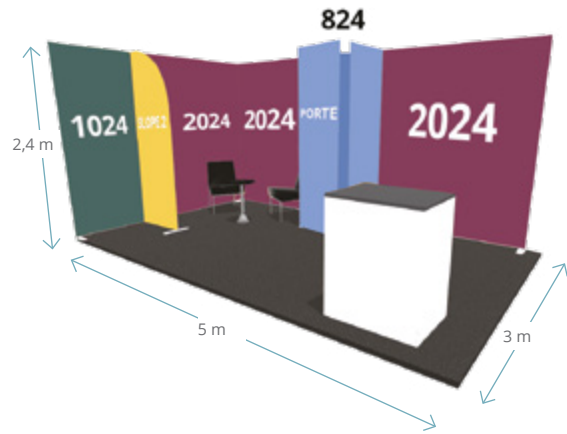

Configure the stand interior with additional Modulate™ frames



Possibility to add PS950-1000-LED-BDLK spotlights



Half feet Twist & Lock MOD-HALF-FOOT-P



Accessorise with a Modulate™ counter

## Modulate™ Stand 18m<sup>2</sup>



The Modulate™ range is ideal for the design of small and medium sized exhibition stands. The assembly of Modulate™ structures is simple, without tools and allows unlimited modularity and evolution of your configurations.

Material	Aluminium
Tube	30mm Ø
Assembly	Tool-free push-button connectors
Graphic area	Double-sided
Graphic attachment	Zipped tension-fit graphic

Straight 2024 square corners (x4)	MOD-S-2024-SQ
Straight 1024 square corners	MOD-S-1024-SQ
Straight 824 square corners (x4)	MOD-S-824-SQ
Door Modulate™	MOD-S-DOOR-824-SQ



Modulate™ cupboard - door with handle (without lock)

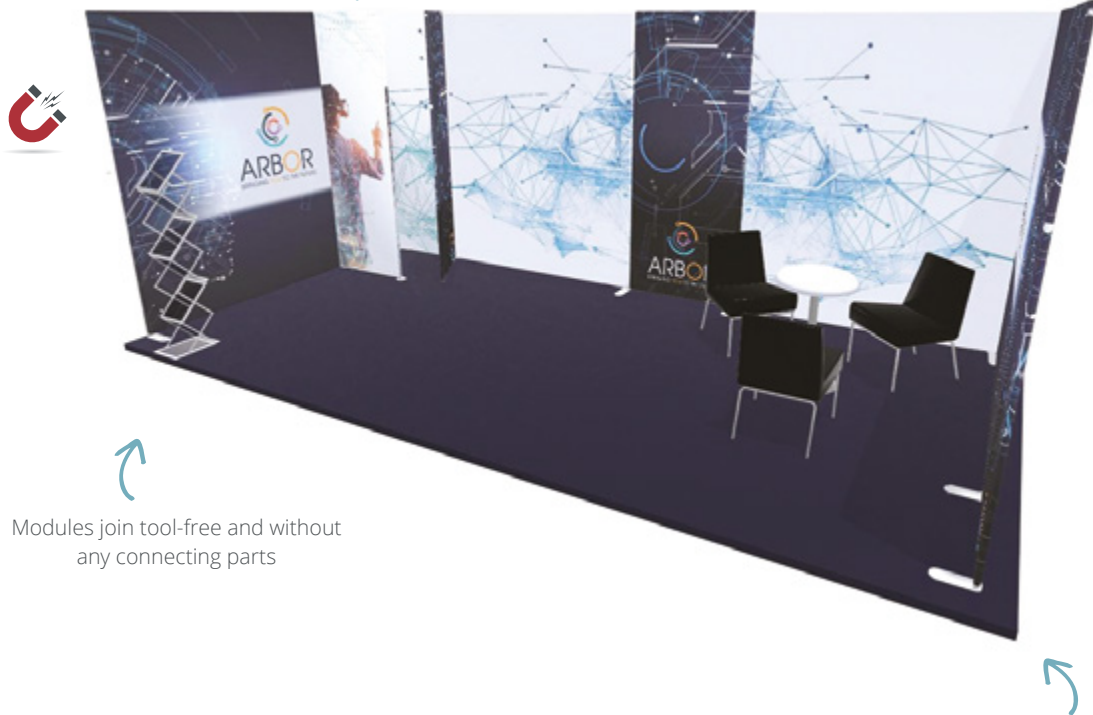

Modules join tool-free and without any connecting parts

The ease of assembly of the range allows for reconfigurable and reusable solutions: mix and match structures in an instant!

VECTOR



# Vector

## Visual marketing for every budget

Whether wall mounted or free-standing, the diverse range of Vector aluminium profiles provides a solution for every need and every budget.

Vector offers optimal visual impact and original designs that can be adapted to any event: showrooms, point of sale, exhibitions, museums and many others.

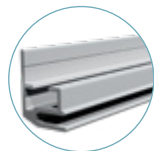

Quick Fix 20 mm

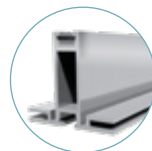

50 mm

## Illuminova™ brings your Vector stand to light

Add eye-catching Illuminova™ lightbox modules to your Vector display stand. Available in 4 standard LED modules (I, J, P, and Q), both systems can be combined to create a striking mix of simplicity and illumination to your exhibition stand.

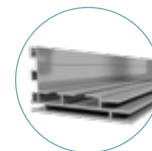

75 mm LED

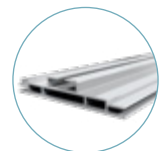

100 mm LED

## Anodised aluminium profiles

The Vector and Illuminova™ modules are available in a range of aluminium profiles to suit each application. For more information, please consult the table below.



VECTOR	Wall mounted	Free-standing	Illuminated	Double-sided	Premium range	Various colours
20 mm	x					x
50 mm		x		x	x	
75 mm LED	x	x	x		x	x
100 mm LED		x	x	x		

For Illuminova™ products, please see page 18

## Vector Modules

### An ultra-compact solution

From free-standing textile walls to exhibition stands, the Vector range offers a versatile and adaptable solution for all your events. The Vector frame system with stretched fabric covering is one of the simplest communication solutions on the market, particularly in a stand environment. Scalable, reconfigurable, ultra-portable: go from a 9 m<sup>2</sup> to a 15 m<sup>2</sup> stand with ease. Easily create stands of all sizes and shapes and accessorise them with spotlights, counters, document holders, and anything else you need to display.

### A compact solution for portability and optimised storage

#### Choose the Vector Modules:

- 50 mm aluminium profiles
- Different modules: walls, arches, LEDs, storage...
- Packaged in numbered sections of 1250 mm
- Delivered in a cardboard box with assembly instructions, accompanied by the visual of your choice
- In stock all year round
- Each module is already perforated on 4 sides and equipped with the necessary screws: easily assemble different modules together, one Allen key is the only tool you will need.
- Reconfigurable and reusable: store the stand at home in a small box (1350 x 400 x 300 mm)
- Excellent return on investment



Go from a 3m<sup>2</sup> stand to a 15m<sup>2</sup> stand in the blink of an eye!



## Vector Modules – Walls



Material	Aluminium
Profile width	50mm
Profile Colour Tube	Anodised
Assembly	Connectors assemble using Allen key
Graphic area	Single and double-sided
Graphic attachment	SEG 3mm

Module A	MODULE-VFF-A	⊗ 2950(w) x 2500(h) x 50(d) mm
Module B	MODULE-VFF-B	⊗ 1950(w) x 2500(h) x 50(d) mm
Module C	MODULE-VFF-C	⊗ 950(w) x 2500(h) x 50(d) mm
Module M	MODULE-VFF-M	⊗ 2850(w) x 2500(h) x 50(d) mm
Module N	MODULE-VFF-N	⊗ 1850(w) x 2500(h) x 50(d) mm
Module O	MODULE-VFF-O	⊗ 450(w) x 2500(h) x 50(d) mm
Module L	MODULE-VFF-L	⊗ 2800(w) x 2500(h) x 620(d) mm



## Post Module



Material	Aluminium
Profile width	50mm
Profile Colour Tube	Anodised
Assembly	Connectors assemble using Allen key, Screw-in strips

Module E	MODULE-VFF-E	⊗ 50(w) x 50(d) x 2500(h) mm
----------	--------------	------------------------------



## Illuminova™ Modules



Material	Aluminium
Profile width	75mm and 100mm
Profile Colour Tube	Anodised
Assembly	Connectors assemble using Allen key
Graphic area	Single and double-sided
Graphic attachment	SEG 3mm
LED System	Pre-installed LED lighting



Module I	MODULE-VFF-I	Ⓞ 950(w) x 2550(h) x 550(d) mm
Module J	MODULE-VFF-J	Ⓞ 950(w) x 2500(h) x 75(d) mm
Module P	MODULE-VFF-P	Ⓞ 1850(w) x 2500(h) x 100(d) mm
Module Q	MODULE-VFF-Q	Ⓞ 1850(w) x 1000(h) x 100(d) mm

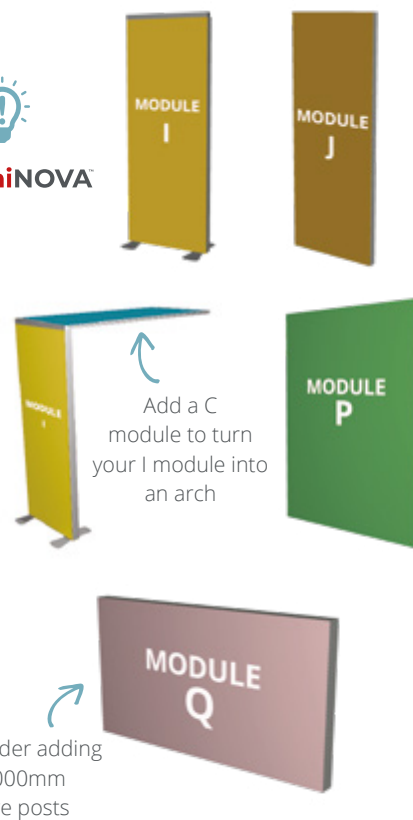

## Modules Vector - Arches



Material	Aluminium
Profile width	50 mm
Profile Colour Tube	Anodised
Assembly	Connectors assemble using Allen key
Graphic area	Single and double-sided
Graphic attachment	SEG 3mm

Module D	MODULE-VFF-D	Ⓞ 2550(h) x 950(l) x 2600(p) mm
Module H	MODULE-VFF-H	Ⓞ 2550(h) x 950(l) x 2600(p) mm



## Vector Modules - Storage

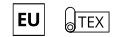

Material	Aluminium
Profile width	50 mm
Profile Colour Tube	Anodised
Assembly	Connectors assemble using Allen key
Graphic area	Single and double-sided
Graphic attachment	SEG 3mm

Module F - door and extension hardware	MODULE-VFF-F-2	⊕ 2500(h) x 950(l) x 50(p) mm Extension: 545 (h) x 950 (l) mm. Door: 1930 (h) x 940 (l) mm
Module G - corner storage room hardware	MODULE-VFF-G-2	⊕ 2500(h) x 1050(l) x 1050(d) mm
Module G3 - storage room hardware	MODULE-VFF-G3-2	⊕ 2500(h) x 1050(l) x 1050(d) mm



## Vector Modules Extensions



Material	Aluminium
Profile width	50mm
Profile Colour	Anodised
Assembly	Connectors assemble using Allen key
Graphic area	Single or double-sided
Graphic attachment	SEG 3mm

Module K	MODULE-VFF-K	⊕ 1050(w) x 1000(h) x 1050(d) mm
----------	--------------	----------------------------------

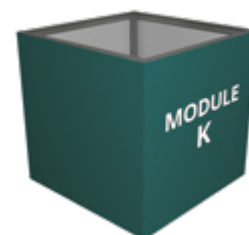



## Vector standard stand designs

This section showcases examples of various pre-configured Vector Stands that can be achieved using the various Vector hardware and ancillaries.

### Vector Stand 9m<sup>2</sup>



Material	Aluminium
Profile width	50mm
Profile Colour	Anodised
Assembly	Connectors assemble using Allen key
Graphic area	Single or double-sided
Graphic attachment	SEG 3mm

Module B (x2)	MODULE-VFF-B
Module G	MODULE-VFF-G-2
Pair of angled feet	SLF1P

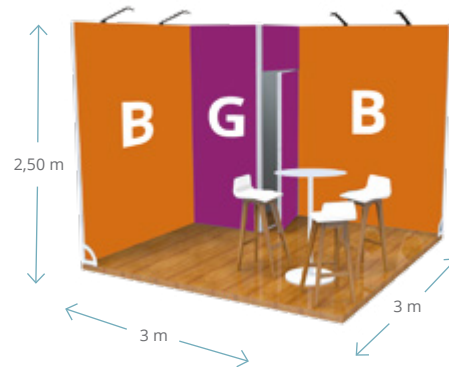

Scalable stands go from 9m<sup>2</sup> to 15m<sup>2</sup>

Screw together Module B to the corresponding post to form the desired configuration.



Possibility to add LED Exhibition Light  
Code : LED-EXHIB-ARM-BDLK



Angle foot  
Code: SLF1P



Return with lock and key set

## Vector Stand 12m<sup>2</sup> - Design 1



<b>Material</b>	Aluminium
<b>Profile width</b>	50mm
<b>Profile Colour</b>	Anodised
<b>Assembly</b>	Connectors assemble using Allen key
<b>Graphic area</b>	Single or double-sided
<b>Graphic attachment</b>	SEG 3mm

Module C (x2)	MODULE-VFF-C
Cross bar 900 mm (x3)	LN605-900-L2
Module F	MODULE-VFF-F-2
Module V (x4)	MODULE-LN-V
Module L	MODULE-VFF-L
Module E (x2)	MODULE-VFF-E
Cross bar 950 mm (x12)	LN605-950-L2
Pair of angled feet	SLF1P

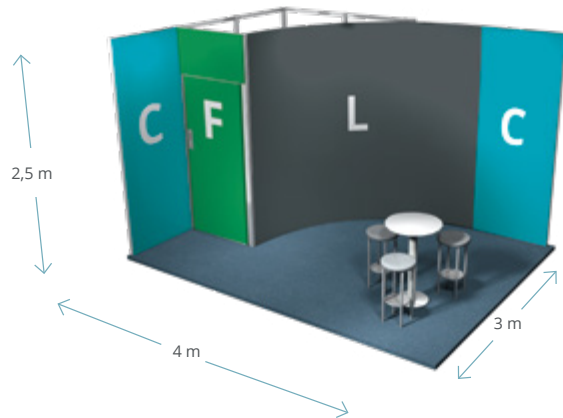

Possibility to add  
LED Floodlight  
Code: LED-FLOOD-ARM-BDLK



Square post to  
create 90° angles



Return with lock  
and key set

## Vector Stand 12m<sup>2</sup> - Design 2

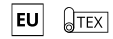

<b>Material</b>	Aluminium
<b>Profile width</b>	50mm
<b>Profile Colour</b>	Anodised
<b>Assembly</b>	Connectors assemble using Allen key
<b>Graphic area</b>	Single or double-sided
<b>Graphic attachment</b>	SEG 3mm

Module C	MODULE-VFF-C
Module H	MODULE-VFF-H
Module G	MODULE-VFF-G-2
Module B (x2)	MODULE-VFF-B
Pair of angled feet	SLF1P

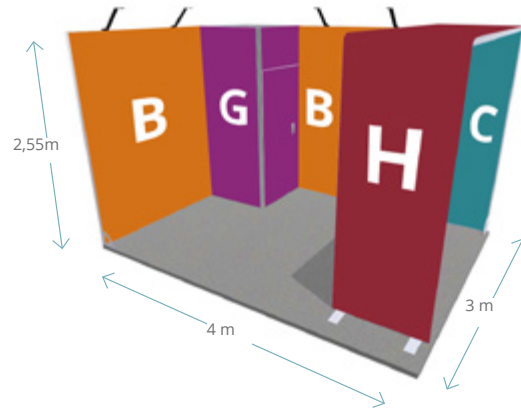

Vector graphic



Return with lock and key set

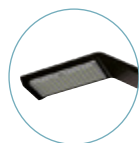

LED Exhibition Light

## Vector Stand 15m<sup>2</sup> - Design 1

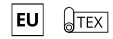

Material	Aluminium
Profile width	50mm
Profile Colour	Anodised
Assembly	Connectors assemble using Allen key
Graphic area	Single or double-sided
Graphic attachment	SEG 3mm

Module B (x2)	MODULE-VFF-B
Module-G3	MODULE-VFF-G3-2
Pair of angled feet	SLF1P

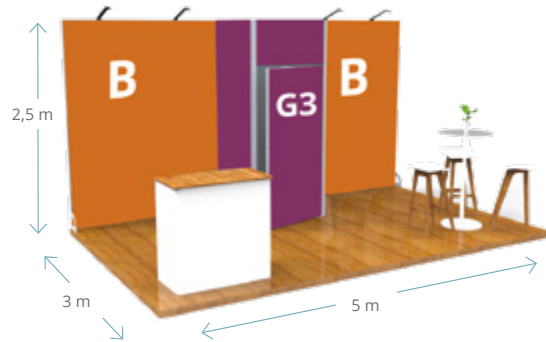

Scalable stands go from 9m<sup>2</sup> to 15m<sup>2</sup>



Square post to create 90° angles



Possibility to add LED Exhibition Light  
Code: LED-EXHIB-ARM-BDLK



Return with lock and key set

## Vector Stand 15m<sup>2</sup> - Design 2

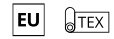

<b>Material</b>	Aluminium
<b>Profile width</b>	50mm
<b>Profile Colour</b>	Anodised
<b>Assembly</b>	Connectors assemble using Allen key
<b>Graphic area</b>	Single or double-sided
<b>Graphic attachment</b>	SEG 3mm

Module F	MODULE-VFF-F-2
Module B (x3)	MODULE-VFF-B
Module C (x3)	MODULE-VFF-C
Module J	MODULE-VFF-J
Module O	MODULE-VFF-O
Module E (x6)	MODULE-VFF-E
Module K	MODULE-VFF-K
Pair of angled feet	SLF1P

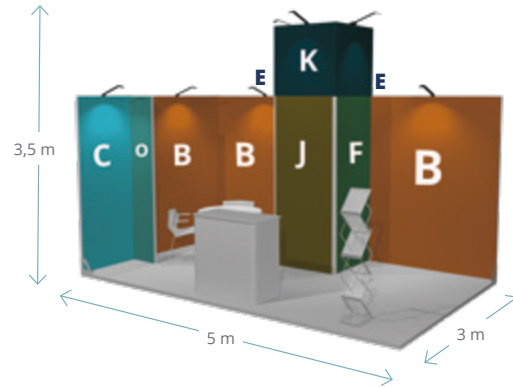

**Module LED**  
Using a J-Module is a great way to add light to your stand and get noticed

**Raise the backwall**  
Gain visibility and originality with this large reserve that can be personalised on all 4 sides



Square post to create 90° angles



Possibility to add LED Exhibition Light  
Code: LED-EXHIB-ARM-BDLK



Return with lock and key set

## Vector Stand 18m<sup>2</sup>

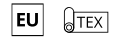

Material	Aluminium
Profile width	50mm
Profile Colour	Anodised
Assembly	Connector with Allen key
Graphic area	Single or double-sided
Graphic attachment	SEG 3mm

Module G	MODULE-VFF-G-2
Module B (x3)	MODULE-VFF-B
Module C	MODULE-VFF-C
Module H	MODULE-VFF-H
illuminova™ 125mm hanging 1000 x 2500mm	iLLNOH-125-25X10
Pair of angled feet	SLF1P

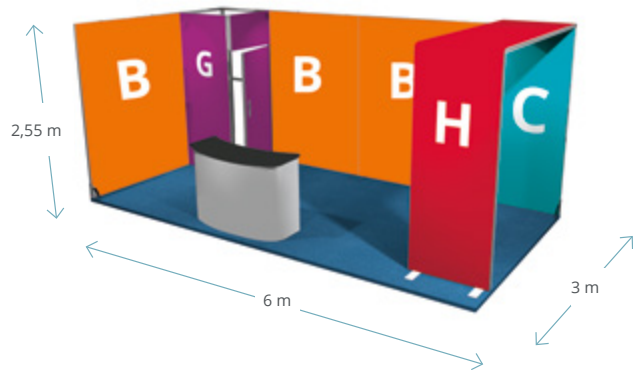

**illuminova™**



Rounded corner for a full graphic



Return with lock and key set

## Vector Stand 24m<sup>2</sup>



<b>Material</b>	Aluminium
<b>Profile width</b>	50mm
<b>Profile Colour</b>	Anodised
<b>Assembly</b>	Connectors assemble using Allen key
<b>Graphic area</b>	Single or double-sided
<b>Graphic attachment</b>	SEG 3mm

Module B (x2)	MODULE-VFF-B
Module N (x2)	MODULE-VFF-N
Module D (x2)	MODULE-VFF-D
Module C	MODULE-VFF-C
Module F	MODULE-VFF-F-2
Module E (x4)	MODULE-VFF-E
Module Q	MODULE-VFF-Q
Posts (x2) 1000 mm	LN616-CUSTOM-M
Pair of angled feet	SLF1P

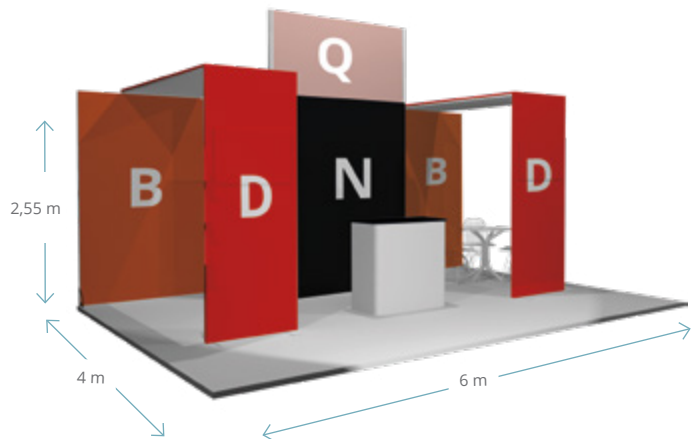

## Vector free-standing module configurations and ancillaries

### 3m Wall



**Material** 50 mm aluminium profile frame  
**Graphic** Fabric graphic with 3mm SEG

Module A (x1)	MODULE-VFF-A
Pair of half-moon feet	LN155



### 6m Wall



Module A (x2)	MODULE-VFF-A
Flat feet (x4)	LN155





## Vector Modules ancillaries

### Quick-fix Mounting Bracket

For hanging frames on shell schemes

Mounting bracket | LN134



### Quarter Side Feet (pair)

SLF1P | 220(h) x 220(w) x 5(d) mm



### Flat Foot for retail

Metal foot for free-standing frames  
Available colour: Silver

FX295 | 7(h) x 180(w) x 550(d) mm



### Flat Foot

Metal foot for free-standing frames

LN155 | 7(h) x 75(w) x 450(d) mm



### Side flat feet (pair)

SLF4P | 100(w) x 185(h) x 450(d) mm



## Custom Vector stands

The Vector range offers a versatile and adaptable solution for any event. The frame system is scalable and reconfigurable and is dressed with an optional custom printed stretched fabric graphic. The Vector range offers a versatile and adaptable solution for any event.

### Vector Custom Stand 24m<sup>2</sup>

Material	Aluminium
Profile width	50mm
Profile colour	Anodised
Assembly	Connectors assemble using Allen key
Graphic area	Single or double-sided
Graphic attachment	SEG 3mm

Add a touch of originality to your VECTOR stand by integrating FORMULATE



### Vector Custom Stand 40m<sup>2</sup>

Material	Aluminium
Profile width	50mm
Profile colour	Anodised
Assembly	Connectors assemble using Allen key
Graphic area	Single or double-sided
Graphic attachment	SEG 3mm



## Vector Custom Stand 40m<sup>2</sup>

Material	Aluminium
Profile width	50mm
Profile colour	Anodised
Assembly	Connectors assemble using Allen key
Graphic area	Single or double-sided
Graphic attachment	SEG 3mm



## Vector Custom Stand 50m<sup>2</sup>

Material	Aluminium
Profile width	50mm
Profile colour	Anodised
Assembly	Connectors assemble using Allen key
Graphic area	Single or double-sided
Graphic attachment	SEG 3mm



## Vector Custom Stand 60m<sup>2</sup> - Design 1

Material	Aluminium
Profile width	50mm
Profile colour	Anodised
Assembly	Connectors assemble using Allen key
Graphic area	Single or double-sided
Graphic attachment	SEG 3mm



## Vector Custom Stand 60m<sup>2</sup> - Design 2

Material	Aluminium
Profile width	50mm
Profile colour	Anodised
Assembly	Connectors assemble using Allen key
Graphic area	Single or double-sided
Graphic attachment	SEG 3mm

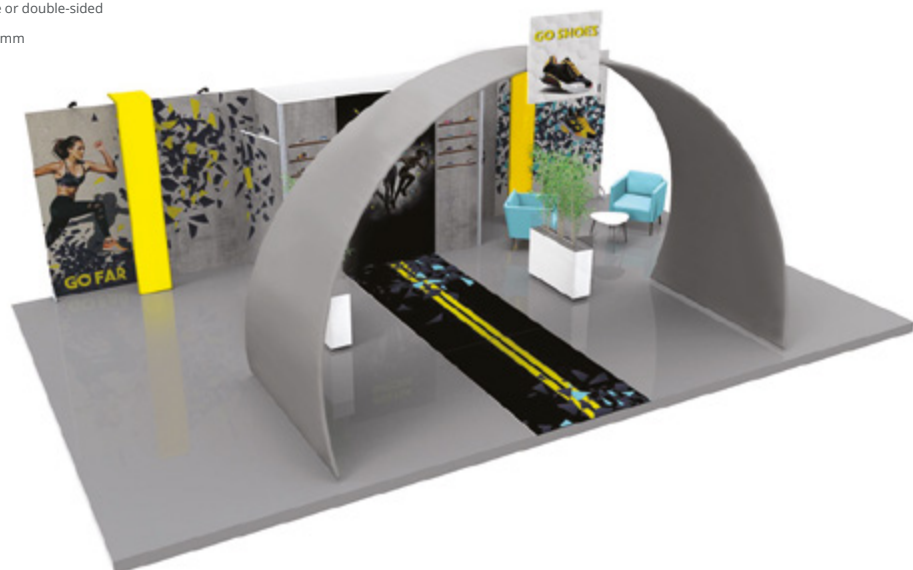

## Vector Custom Stand 80m<sup>2</sup>

Material	Aluminium
Profile width	50mm
Profile colour	Anodised
Assembly	Connectors assemble using Allen key
Graphic area	Single or double-sided
Graphic attachment	SEG 3mm

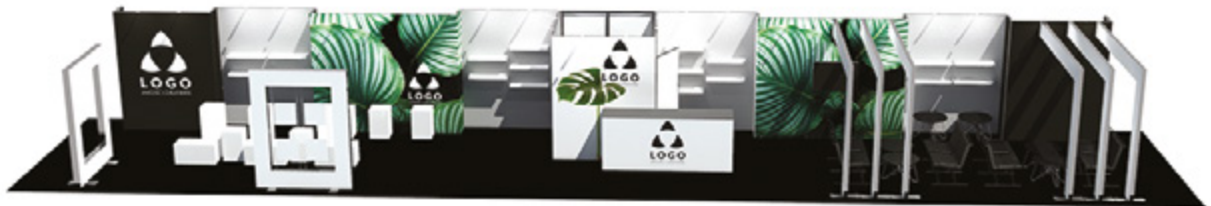
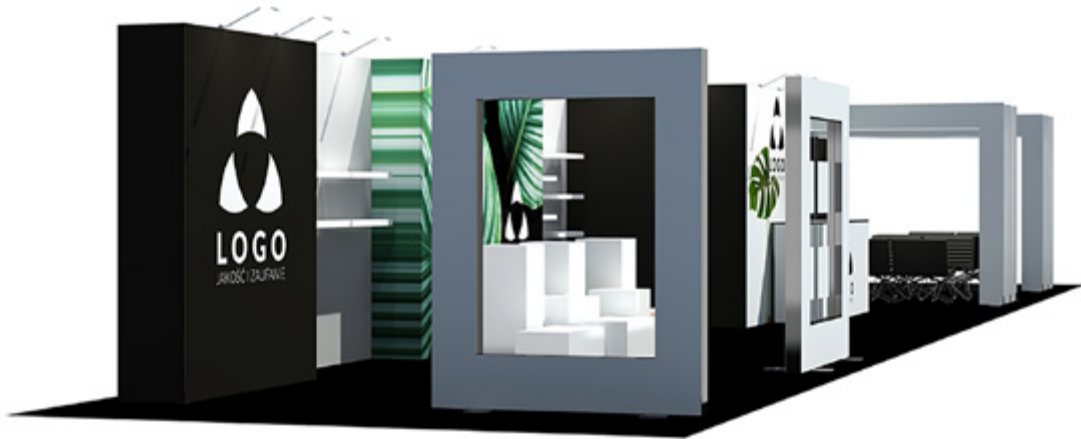

# Ancillaries

## Dome base (single)

---

LN102 |  ∅ 450 mm



## Linear foot (pair)

---

Weights: 1,2 kg

SLF1P |  220(w) x 220(h) x 5(d) mm



## Flat foot (single)

---

Metal for self-supporting frame

Weights: 1,75 kg

LN155 |  7(h) x 100(w) x 450(d) mm



## LCD screen bracket

---

Mounting on post or crossbar

LN124 |  Screen 37" - 70" (94 - 177 cm)



## Roll of magnetic tape

---

EM303 | Polarity A-30m x 4 mm



## Steel tape

---

EM351 | 15m x 12,7 mm





Namaste  
مرحبا  
Bem Vindo  
Selamat Datang  
Croeso  
Willkommen  
Welcome  
Bienvenidos  
Bienvenue  
أهلا وسهلا  
Welkom  
Croeso  
Namaste  
أهلا وسهلا  
مرحبا  
Selamat Datang  
Croeso  
Bem Vindo  
Willkommen  
Benvenuti  
Benvenuti  
Willkommen

**Welcome**

مرحبا  
أهلا وسهلا  
مرحبا  
أهلا وسهلا  
مرحبا  
أهلا وسهلا

# Transform your space in seconds using **FASTFRAME™**



## 1. Folded state

The lightweight frame is pre-assembled in a convenient, portable carry bag.



## 2. Unfold

From its pre-assembled state, the frame can then be effortlessly unfolded and locked in place with a central support rod.



## 3. Components

Feet can be added if required to give additional rigidity to the frame.



## 4. Install graphics

Your graphics, available in a Standard or Premium finish, can then be applied to the fully assembled frame.

## **Sustainable** exhibitions

**With sustainability a key theme for event organisers and exhibitors alike, modular exhibition systems offer an environmentally conscious choice.**

- » Made from aluminium, an infinitely recyclable material
- » Using polyester graphic materials which can be recycled multiple times
- » Graphics printed using water based inks
- » One system for multiple display applications





Enjoy **many benefits**, such as:

**NEW**  
PRODUCT



### **An efficient tool-less frame**

Unit can be constructed and ready in a short amount of time.



### **Lightweight and ultra slim**

Unit is highly portable, making travel and storage much easier.



### **Seamless graphic**

Apply a single graphic to connected frames to create a large seamless display.



### **Sustainable**

Multiple use, not single use.



### **Interchangeable graphics**

Display multiple messages time and time again.

## **FASTFRAME™** utilises **Silicone Edge Graphics**

- » Fabric graphics are edged with a silicone strip which slots into the channel of the frame for easy installation
- » This is more cost-effective than alternative options and can be re-used multiple times
- » The graphics are printed using water based inks which is more eco-friendly
- » Seamless graphics can be applied to the connected frames for large displays
- » Graphics can be reproduced to deliver new messages

#### **Polyester Stretch Graphics**

Stretch textile fabric, 3mm silicone edge.

#### **Black Back Graphics**

Black back textile (black out), 3mm silicone edge.

Material	Aluminium
Profile width	40 mm
Profile Colour	Silver
Assembly	Tool-free
Graphic area	Single and Double-sided
Graphic attachment	Silicone Edged Graphics (3 mm silicone)
Application	Free-standing
Transport	Fastframe™ carry bag

# FASTFRAME™

## FASTFRAME™ 1000x500 - 2 Pack



Fastframe™	FF-100X50	1000(w) x 500(h) x 40(d) mm
Fastframe™ (Black back graphic)	G-FF-100X50-BB	1000(w) x 500(h)
Fastframe™ (Polyester stretch graphic)	G-FF-100X50-PS	1000(w) x 500(h)

**NEW  
PRODUCT**



Portable carry bag



Feet can be added if required.  
Feet sold separately

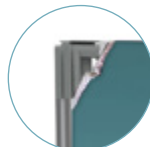

Silicone edged (SEG) graphic



## FASTFRAME™ 1000x1000 - 2 Pack



Fastframe™	FF-100X100	1000(w) x 1000(h) x 40(d) mm
Fastframe™ (Black back graphic)	G-FF-100X100-BB	1000(w) x 1000(h)
Fastframe™ (Polyester stretch graphic)	G-FF-100X100-PS	1000(w) x 1000(h)

**NEW  
PRODUCT**



Portable carry bag



Feet can be added if required.  
Feet sold separately



Silicone edged (SEG) graphic



## FASTFRAME™ 1000x2000



Fastframe™	FF-100X200	Ⓢ 1004(w) x 2007(h) x 400(d) mm
Fastframe™ (Black back graphic)	G-FF-100X200-BB	Ⓢ 1000(w) x 2000(h)
Fastframe™ (Polyester stretch graphic)	G-FF-100X200-PS	Ⓢ 1000(w) x 2000(h)

**NEW  
PRODUCT**



Portable carry bag



Includes 2 x feet

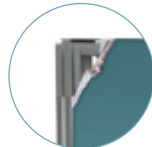

Silicone edged  
(SEG) graphic



## FASTFRAME™ 1000x2400



Fastframe™	FF-100X240	Ⓢ 1004(w) x 2407(h) x 400(d) mm
Fastframe™ (Black back graphic)	G-FF-100X240-BB	Ⓢ 1000(w) x 2400(h)
Fastframe™ (Polyester stretch graphic)	G-FF-100X240-PS	Ⓢ 1000(w) x 2400(h)

**NEW  
PRODUCT**



Portable carry bag



Includes 2 x feet



Silicone edged  
(SEG) graphic



# FASTFRAME™

## FASTFRAME™ 1200x2400



Fastframe™	FF-120X240	📏 1204(w) x 2407(h) x 400(d) mm
Fastframe™ (Black back graphic)	G-FF-120X240-BB	📏 1200(w) x 2400(h)
Fastframe™ (Polyester stretch graphic)	G-FF-120X240-PS	📏 1200(w) x 2400(h)

**NEW**  
PRODUCT

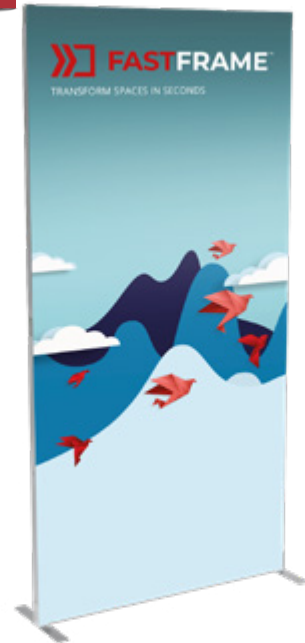

Portable carry bag



Includes 2 x feet



Silicone edged  
(SEG) graphic

## FASTFRAME™ Starter Kit



Fastframe™ Starter Kit	Price on demand	📏 1004(w) x 2007(h) x 400(d) mm
------------------------	-----------------	---------------------------------

**NEW**  
PRODUCT

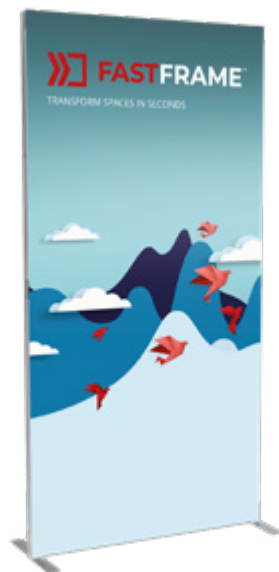

### Fastframe™ Starter Kit



Portable carry bag



1 frame  
1000 x 2000mm  
Includes feet



5 graphics  
1000 x 2000mm

## FASTFRAME™ Backwall Kit



Fastframe™ Backwall Kit	Price on demand	@ 2004(w) x 2007(h) x 400(d) mm
-------------------------	-----------------	---------------------------------



### Fastframe™ Backwall Kit



Portable carry bag



2 frames  
1000 x 2000mm  
Includes feet



4 graphics  
1000 x 2000mm,  
2 graphics  
2000 x 2000mm



## FASTFRAME™ Pop-up Kit



Fastframe™ Pop-up Kit	Price on demand	@ 2690(w) x 2007(h) x 940(d) mm
-----------------------	-----------------	---------------------------------



Dimensions based on configuration shown

### Fastframe™ Pop-up Kit



Portable carry bag



3 frames  
1000 x 2000mm  
Includes feet



1 graphic  
2000 x 3000mm,  
3 graphics  
1000 x 2000mm



2  
45° connector  
kit



# FASTFRAME™ Feet

## Full foot (Single)

---

FF-FF | 50(w) x 99(h) x 400(d) mm



## Middle Full Foot (Single)

---

FF-MFF | 50(w) x 89(h) x 400(d) mm



## Half Middle Foot (Single)

---

FF-HFM | 51(w) x 89(h) x 220(d) mm



## Small Middle Foot (Single)

---

FF-SMF | 40(w) x 89(h) x 97(d) mm



## Side Half Feet (Pair)

---

FF-SHF | 50(w) x 98(h) x 220(d) mm



# FASTFRAME™ Connectors

## 45° Connector Kit - Top & Bottom

FF-45C | 45(w) x 108(h) x 95(d) mm



## 90° Connector Kit - Top & Bottom

FF-90C | Top 81.5(w) x 60.7(h) x 81.5(d) mm  
Bottom 81.5(w) x 60.7(h) x 81.5(d) mm



## 90° Middle Connector Kit - Pair

FF-90MC | 40(w) x 55(h) x 40(d) mm



## 90° Left Inside Connector Kit - Pair

FF-90LIC | 40(w) x 55(h) x 40(d) mm



## 90° Right Inside Connector Kit - Pair

FF-90RIC | 55(w) x 85(h) x 55(d) mm



## Arch Connector Kit - 4 Brackets

FF-ACC | 90(w) x 105(h) x 60(d) mm



## Cross Connector Kit - Top & Bottom

FF-CC | Top 142(w) x 94.3(h) x 100.7(d) mm  
Bottom 141.3(w) x 90(h) x 100.4(d) mm



# FASTFRAME™ Connectors and Lighting

## T-Shape Connector Kit - Top & Bottom

FF-TC	Top	100.5(w) x 91(h) x 94.7(d) mm
	Bottom	100(w) x 91.1(h) x 97.4(d) mm



## Y Shape Connector Kit - Top & Bottom

FF-YC	Top	107(w) x 97.3(h) x 107(d) mm
	Bottom	107(w) x 107(h) x 94.3(d) mm



## 2-Way Connector - Single

FF-2WC	41(w) x 82(h) x 21(d) mm
--------	--------------------------



## 4-Way Connector - Single

FF-4WC	150(w) x 12.12(h) x 19.6(d) mm
--------	--------------------------------



## LED Exhibition Light - 2 x Lights

LED-EXHIB-ARM-BDLK	50(w) x 455(h) x 55(d) mm
--------------------	---------------------------

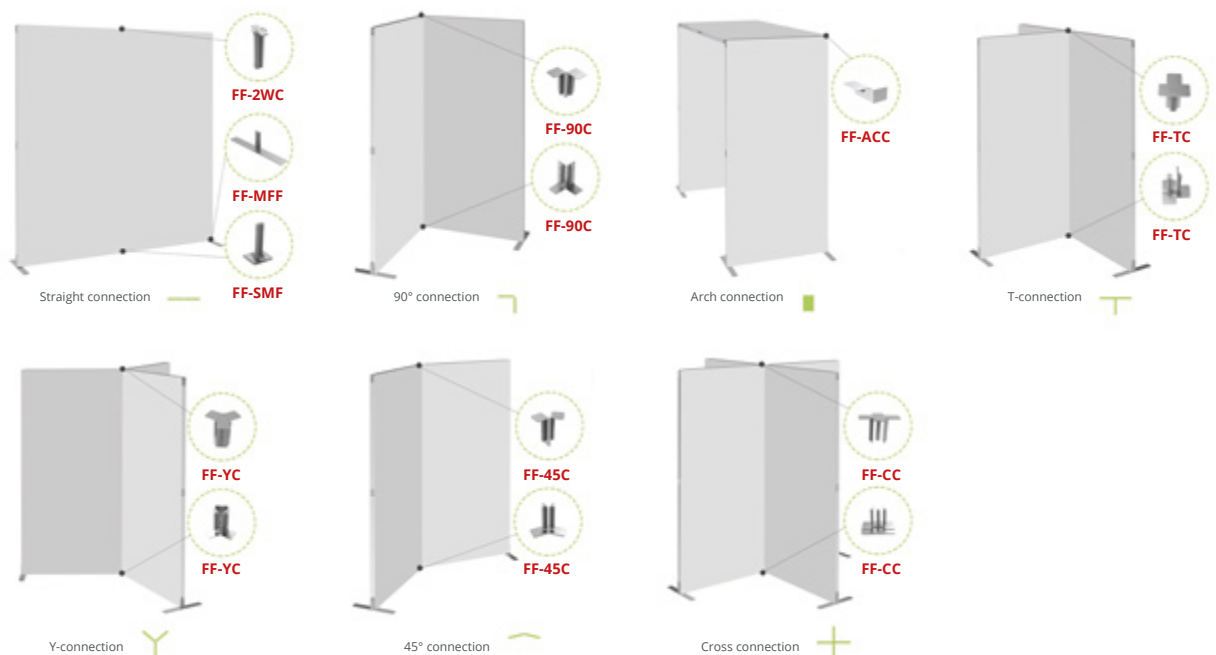



# Fastframe™ Stand 12m<sup>2</sup>



Quick and easy to assemble and disassemble. Add energy saving LED lighting to illuminate the back walls for more standout.

Material	Aluminium and ABS/nylon
Profile width	40mm
Profile colour	Silver
Assembly	Pre-assembled folding
Graphic area	Single or double-sided
Graphic attachment	SEG 3mm

Fastframe™ 1200x2400mm	FF-120X240
Fastframe™ 1200x2400mm graphic	G-FF-120X240-BB/PS
Fastframe™ 1000x2400mm (5)	FF-100X240
Fastframe™ 1000x2400mm (5) graphics	G-FF-100X240-BB/PS
Fastframe™ middle full foot (5)	FF-MFF
LED exhibition lights (5)	LED-EXHIB-ARM-BDLK
Fastframe™ pair side half feet	FF-SHF
Fastframe™ middle half foot (2)	F-HFM
Fastframe™ 45 degree connector kit (2)	FF-45C

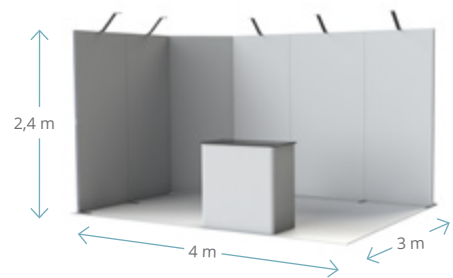

Portable carry bag



Feet can be added if required

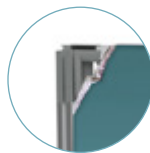

Silicone edged (SEG) graphic

Graphics available in black back or polyester stretch, seamless graphics are available



FASTFRAME™ Counter: Coming Soon

# Fastframe™ Stand 15m<sup>2</sup>



Quick and easy to assemble and disassemble. Add energy saving LED lighting to illuminate the back walls for more stand out.

Material	Aluminium and ABS/nylon
Profile width	40mm
Profile colour	Silver
Assembly	Pre-assembled folding
Graphic area	Single or double-sided
Graphic attachment	SEG 3mm

Fastframe™ 1000x2000mm	FF-100X200
Fastframe™ 1000x2000mm graphic	G-FF-100X200-BB/PS
Fastframe™ 1200x2400mm	FF-120X240
Fastframe™ 1200x2400mm (5) graphics	G-FF-120X240-BB/PS
Fastframe™ 1000x2400mm	FF-100X240
Fastframe™ 1000x2400mm (2) graphics	G-FF-100X240-BB/PS
LED exhibition lights (5)	LED-EXHIB-ARM-BDLK
Fastframe™ middle full foot (4)	FF-MFF
Fastframe™ 90 degree connector kit	FF-90C
Fastframe™ ARCH KIT	FF-ACC
Fastframe™ two-way connector (4)	FF-2WC

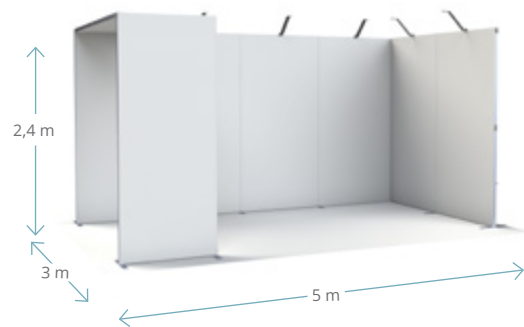

Portable carry bag



Feet can be added if required

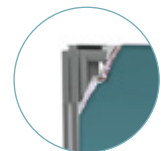

Silicone edged (SEG) graphic

Graphics available in black back or polyester stretch, seamless graphics are available



FASTFRAME™ Counter: Coming Soon

# Fastframe™ Stand 24m<sup>2</sup>



Quick and easy to assemble and disassemble. Add energy saving LED lighting to illuminate the back walls for more standout.

Material	Aluminium and ABS/nylon
Profile width	40mm
Profile colour	Silver
Assembly	Pre-assembled folding
Graphic area	Single or double-sided
Graphic attachment	SEG 3mm

Fastframe™ 1000x2400mm	FF-100X240
Fastframe™ 1000x2400mm (8) graphics	G-FF-100X240-BB/PS
Fastframe™ 1000x2000mm	FF-100X200
Fastframe™ 1000x2000mm (4) graphics	G-FF-100X200-BB/PS
Fastframe™ middle full foot (5)	FF-MFF
Fastframe™ pair side half feet (5)	FF-SHF
Fastframe™ Y-connector kit	FF-YC
Fastframe™ arch kit	FF-ACC
Fastframe™ two-way connector (5)	FF-2WC
Fastframe™ 90 degree connector kit	FF-90C

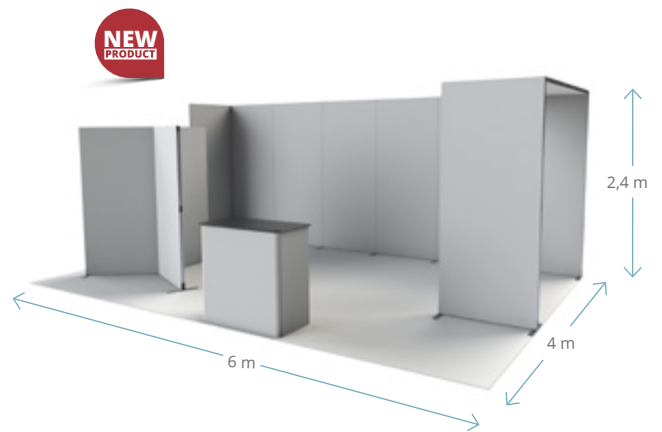

Portable carry bag



Feet can be added if required

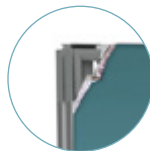

Silicone edged (SEG) graphic

Graphics available in black back or polyester stretch, seamless graphics are available

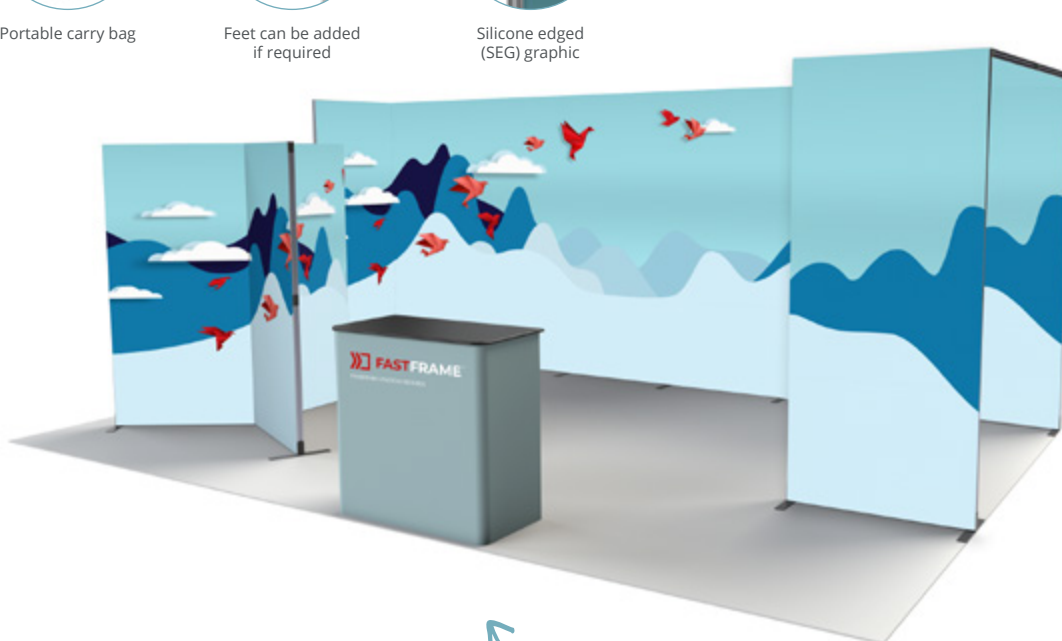

FASTFRAME™ Counter: Coming Soon



# Arena Structures

## Arena Gantry structures for your stand

These 25mm diameter aluminium tubes have been assembled and welded into sections of various sizes to form the basis of an imposing and solid architecture.

A wide range of sections are available to make this solution compatible with your project requirements. With 13 components in various lengths and designs, you can create the right structure for you, and your chosen mode of transport.

### Simple, tool-free assembly

Simple assembly - sections are connected using the supplied bolt and wing-nut fixings, and no tools are required. The double-sided graphics are attached to the gantry using a bungee cord. Create maximum brand visibility using sections up to 6m long without the need for reinforcement.

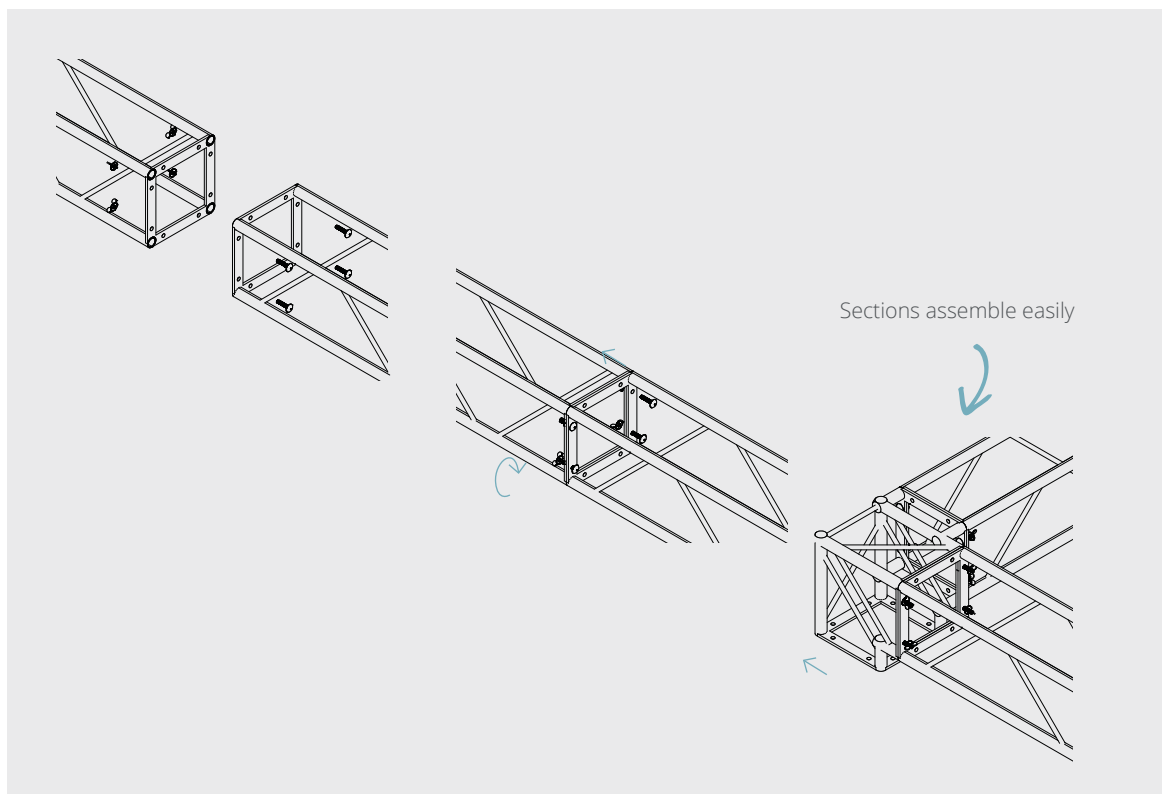

# Arena components

## Arena Straight Sections

The Arena Straight Sections are available in a variety of lengths, they are strong but lightweight with a natural silver grey finish. The system is quick and easy to assemble using bolt and wing-nut fixings. This aluminium tubular system is both modular and scalable, where different sections can be assembled and reused according to the needs of each project. The structure can then be dressed with interchangeable UV printed PVC graphics.

UT-S250	Section 250mm
UT-S500	Section 500mm
UT-S750	Section 750mm
UT-S1000	Section 1000mm
UT-S1250	Section 1250mm
UT-S1500	Section 1500mm
UT-S2000	Section 2000mm



## Arena Junction Sections

The Arena Junction Sections are available in a variety of configurations including: 3-way T-junction, 4-way corner junction. The choice of sections enables a custom build design for your application to create a modular and scalable system. The structure can then be dressed with interchangeable UV printed PVC graphics.



90° angle 2 connections  
UT-C21



Corner connection  
3 connections  
UT-C30



T-junction 3 connections  
UT-C35



T-junction 4 connections  
UT-C40



4-way corner connector  
UT-C41



Foot 250mm  
UT-BS250

# Arena Gantry stand designs

## Arena Custom Stand 16m<sup>2</sup>

Material	Aluminium
Colour	Anodised
Graphic area	Single or double-sided
Graphic attachment	Bungee fixings
Graphic option	Vinyl



## Arena Custom Stand 36m<sup>2</sup>

Material	Aluminium
Colour	Anodised
Graphic area	Single or double-sided
Graphic attachment	Bungee fixings
Graphic option	Vinyl



# Arena Gantry free-standing design

## Arena Custom Structure

Material	Aluminium
Colour	Anodised
Graphic area	Single or double-sided
Graphic attachment	Bungee fixings
Graphic option	Vinyl



## Arena Hanging Structure



The Arena hanging structure is a tubular aluminium stage structure used as a light bridge or suspended sign with 6m sides to draw attention to your brand.

Material	Aluminium
Colour	Anodised
Graphic area	Single or double-sided
Graphic attachment	Bungee fixings
Graphic option	Vinyl



# Hanging structures

Formulate suspended signs have been specially designed to allow for easy and safe installation. The lightweight aluminium tubular structure makes them ideal for use on exhibition stands, in shopping arcades or in high traffic areas.

## Formulate Square Hanging Structure



<b>Material</b>	Aluminium tubes
<b>Tube</b>	Ø 30 mm
<b>Assembly</b>	Push-fit button
<b>Shape</b>	Square
<b>Graphic area</b>	Double-sided
<b>Graphic attachment</b>	Zipped tension fabric graphic
<b>Application</b>	Suspended pitons included, Slings not included
<b>Availability</b>	Basic range - in stock

Square Formulate 800	FORM-SQU-80	Ⓞ 1500(w) x 800(h) x 1500(d) mm
Square Formulate 1000	FORM-SQU-100	Ⓞ 3000(w) x 1000(h) x 3000(d) mm
Square Formulate 1500	FORM-SQU-150	Ⓞ 4500(w) x 1500(h) x 4500(d) mm



## Formulate Circular Hanging Structure



<b>Material</b>	Aluminium tubes
<b>Tube</b>	Ø 30 mm
<b>Assembly</b>	Push-fit button
<b>Shape</b>	Circle
<b>Graphic area</b>	Double-sided
<b>Graphic attachment</b>	Zipped tension fabric graphic
<b>Application</b>	Suspended pitons included, Slings not included
<b>Availability</b>	Basic range - in stock

Circular Formulate 800	FORM-RNG-80	Ⓞ 1500(w) x 800(h) x 1500(d) mm
Circular Formulate 1000	FORM-RNG-100	Ⓞ 3000(w) x 1000(h) x 3000(d) mm
Circular Formulate 1500	FORM-RNG-150	Ⓞ 4500(w) x 1500(h) x 4500(d) mm





## Formulate Rectangular Hanging Structure



<b>Material</b>	Aluminium tubes
<b>Tube</b>	Ø 30 mm
<b>Assembly</b>	Push-fit button
<b>Shape</b>	Rectangle
<b>Graphic area</b>	Double-sided
<b>Graphic attachment</b>	Zipped tension fabric graphic
<b>Application</b>	Suspended pitons included, Slings not included
<b>Availability</b>	Basic range - in stock

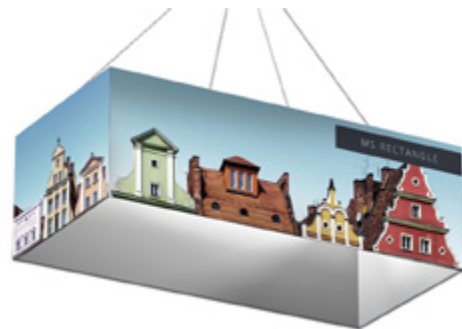

Formulate Rectangle 250	FORM-RTG-M100	Ⓞ 2500(w) x 1000(h) x 1200(d) mm
Formulate Rectangle 350	FORM-RTG-L100	Ⓞ 3500(w) x 1000(h) x 2500(d) mm
Formulate Rectangle 500	FORM-RTG-XL120	Ⓞ 5000(w) x 1200(h) x 2500(d) mm

## MS Panel



<b>Material</b>	Aluminium tubes
<b>Tube</b>	Ø 30 mm
<b>Assembly</b>	Push-fit button
<b>Shape</b>	Rectangle
<b>Graphic area</b>	Double-sided
<b>Graphic attachment</b>	Zipped tension fabric graphic
<b>Application</b>	Suspended pitons included, Slings not included
<b>Availability</b>	Basic range - in stock



Formulate Panel 250	FORM-FLT-M100	Ⓞ 2500(w) x 1000(h) x 30(d) mm
Formulate Panel 350	FORM-FLT-L100	Ⓞ 3500(w) x 1000(h) x 30(d) mm
Formulate Panel 500	FORM-FLT-XL120	Ⓞ 5000(w) x 1200(h) x 30(d) mm



## Display Backwalls

Display Backwalls create a dramatic backdrop to events, presentations, product demonstrations, pop-up shops or window displays. They are also ideal for smaller spaces, or as large static advertising boards in public spaces such as museums, reception areas, public transportation hubs and other large spaces.

Segmented frame walls are fully configurable, professional grade backwalls, where flexibility, ease of storage, reusing, portability and assembly are important. The pop-up display backwalls are constructed from lightweight aluminium scissor mechanisms that are easy to transport, assemble and store, and are ideal for small exhibitions or events as well as static displays. For a simple backdrop, the Pegasus tension walls offer a cost effective, easy solution to meet those needs. Configurable in both height and width, the tension wall is quick to assemble and makes an ideal backdrop to temporary or short-term presentations.

## Display Backwalls

Backwalls can be configured in a variety of ways, based on the application, with each offering a different method of construction, illumination and use.



# Pop-up backwalls

## Impact Pop-up Straight



A great entry level display backwall that is perfect for use at an exhibition, event or for a demonstration backdrop. Frames are available in a variety of widths, and are quick and easy to deploy using the self-locating locking arms. Magnetic tape attaches to the back of the graphic panels enabling them to be attached directly to the mag bars which are mounted to the frames.

<b>Material</b>	Aluminium structure, plastic connectors
<b>Assembly</b>	Magnetic connectors
<b>Shape</b>	Straight
<b>Graphic area</b>	Single-sided (with or without D-ends) / double-sided (optional)
<b>Graphic attachment</b>	Mag bars, hangers and kickers
<b>Application</b>	Free-standing

3x2 Straight	IMP-3X2S	Ⓞ 1970(w) x 2225(h) x 306(d) mm
3x3 Straight	IMP-3X3S	Ⓞ 2700(w) x 2225(h) x 306(d) mm
3x4 Straight	IMP-3X4S	Ⓞ 3435(w) x 2225(h) x 306(d) mm



Magnetic bars



Magnetic Locking arms



Hook-over graphic attachment

## Impact Pop-up Straight Bundle



Impact Pop-up straight bundles are a great entry level display backwall kit that contains everything you will need to get you up and running at a show, event or demonstration - they even come with a counter and lighting!

<b>Material</b>	Aluminium structure, plastic connectors
<b>Assembly</b>	Magnetic connectors
<b>Shape</b>	Straight
<b>Graphic area</b>	Single-sided (with or without D-ends) / double-sided (optional)
<b>Graphic attachment</b>	Mag bars, hangers and kickers
<b>Application</b>	Free-standing

3x2 Straight	99-XX-106	Ⓞ 1970(w) x 2225(h) x 306(d) mm
3x3 Straight	99-XX-107	Ⓞ 2700(w) x 2225(h) x 306(d) mm
3x4 Straight	99-XX-108	Ⓞ 3435(w) x 2225(h) x 306(d) mm



### Impact Pop-up Bundle

#### Impact Pop-up Kit



Carry bag



Straight or curved frame system



Hangers, kickers and mag bars



1x Roll of self-adhesive magnetic tape (EM301)



Zenith transport and counter base case



Thermoformed table top in beech



2x PS950-1000-LED-BDLK lights

# Impact Pop-up Curved



A great entry level display backwall that is perfect for use at an exhibition, event or for a demonstration backdrop. Frames are available in a variety of widths, and are quick and easy to deploy using the self-locating locking arms. Magnetic tape attaches to the back of the graphic panels enabling them to be attached directly to the mag bars which are mounted to the frames.

<b>Material</b>	Aluminium structure, plastic connectors
<b>Assembly</b>	Magnetic connectors
<b>Shape</b>	Curved
<b>Graphic area</b>	Single-sided (with or without D-ends) / double-sided (optional)
<b>Graphic attachment</b>	Mag bars, hangers and kickers
<b>Application</b>	Free-standing

3x2 Curved	IMP-3X2C	Ⓞ 1930(w) x 2225(h) x 485(d) mm
3x3 Curved	IMP-3X3C	Ⓞ 2540(w) x 2225(h) x 685(d) mm
3x4 Curved	IMP-3X4C	Ⓞ 3070(w) x 2225(h) x 960(d) mm



Magnetic bars



Magnetic Locking arms



Hook-over graphic attachment

# Impact Pop-up Curved Bundle









Impact Pop-up curved bundles are a great entry level display backwall kit that contains everything you will need to get you up and running at a show, event or demonstration - they even come with a counter and lighting!

<b>Material</b>	Aluminium structure, plastic connectors
<b>Assembly</b>	Magnetic connectors
<b>Shape</b>	Curved
<b>Graphic area</b>	Single-sided (with or without D-ends) / double-sided (optional)
<b>Graphic attachment</b>	Mag bars, hangers and kickers
<b>Application</b>	Free-standing

3x2 Curved	99-XX-110	Ⓞ 1930(w) x 2225(h) x 485(d) mm
3x3 Curved	99-XX-071	Ⓞ 2540(w) x 2225(h) x 685(d) mm
3x4 Curved	99-XX-070	Ⓞ 3070(w) x 2225(h) x 960(d) mm



## Impact Pop-up Bundle

<p><b>Impact Pop-up Kit</b></p>  <p>Carry bag</p>	 <p>Straight or curved frame system</p>	 <p>Hangers, kickers and mag bars</p>	 <p>1x Roll of self-adhesive magnetic tape (EM301)</p>	 <p>Zenith transport and counter base case</p>	 <p>Thermoformed table top in beech</p>	 <p>2x PS950-1000-LED-BDLK lights</p>
--	--	--	---	--	--	--

## Quick+ Straight Kit



The premium Quick+ Straight display backwall is a full magnetic system that can be used single or double-sided. Use with optional interchangeable, vibrant UV printed PVC graphics. Deploys tool-free in seconds straight out of the supplied protective padded bag giving you a brilliant backwall display for your event or shell scheme. Quick+ displays are also available in a curved display and come in 3 different sizes.

<b>Material</b>	Aluminium structure, plastic connectors
<b>Assembly</b>	Magnetic connectors
<b>Shape</b>	Straight
<b>Graphic area</b>	Single-sided (with or without D-ends) / double-sided (optional)
<b>Graphic attachment</b>	Mag bars, hangers and kickers
<b>Application</b>	Free-standing

3x2 Straight	WH222-S-CA	Ⓞ 1970(w) x 2225(h) x 306(d) mm
3x3 Straight	WH223-S-CA	Ⓞ 2700(w) x 2225(h) x 306(d) mm
3x4 Straight	WH224-S-CA	Ⓞ 3435(w) x 2225(h) x 306(d) mm

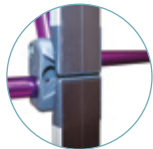

Square end magnetic bars

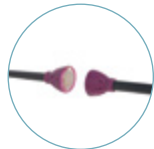

Magnetic locking arms



Magnetic hanger

## Quick+ Curved Kit



The premium Quick+ Curved display backwall is a full magnetic system that can be used single or double-sided. Use with optional interchangeable, vibrant UV printed PVC graphics. Deploys tool-free in seconds straight out of the supplied protective padded bag giving you a brilliant backwall display for your event or shell scheme. Quick+ displays are also available in a straight display and come in 3 different sizes.

<b>Material</b>	Aluminium structure, plastic connectors
<b>Assembly</b>	Magnetic connectors
<b>Shape</b>	Curved
<b>Graphic area</b>	Single-sided (with or without D-ends) / double-sided (optional)
<b>Graphic attachment</b>	Mag bars, hangers and kickers
<b>Application</b>	Free-standing

3x2 Curved	WH222-C-CA	Ⓞ 1930(w) x 2225(h) x 485(d) mm
3x3 Curved	WH223-C-CA	Ⓞ 2540(w) x 2225(h) x 685(d) mm
3x4 Curved	WH224-C-CA	Ⓞ 3070(w) x 2225(h) x 960(d) mm



Square end magnetic bars

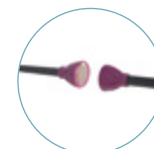

Magnetic locking arms



Magnetic hanger



## Quick+ Straight Bundle



The Premium Quick+ Straight Display Bundle includes the full magnetic display backwall kit which can be used single or double-sided, the unique Zenith transit case which converts to a counter and two PS950-1000 LED lights. Use with optional interchangeable, vibrant UV printed PVC graphics. Deploys tool-free in seconds, giving you a brilliant backwall display for your event or shell scheme. Quick+ displays are also available in a curved display bundle and come in 3 different sizes.

<b>Material</b>	Aluminium structure, plastic connectors
<b>Assembly</b>	Magnetic connectors
<b>Shape</b>	Straight
<b>Graphic area</b>	Single-sided (with or without D-ends) / double-sided (optional)
<b>Graphic attachment</b>	Mag bars, hangers and kickers
<b>Application</b>	Free-standing

3x2 Straight	99-XX-101Q	Ⓞ 1970(w) x 2225(h) x 306(d) mm
3x3 Straight	99-XX-102Q	Ⓞ 2700(w) x 2225(h) x 306(d) mm
3x4 Straight	99-XX-103Q	Ⓞ 3435(w) x 2225(h) x 306(d) mm



### Quick+ Bundle

#### Quick+ Kit



Padded nylon carry bag



Quick+ Structure Straight / Curved



Hangers, kickers and mag bars



1x Roll of self-adhesive magnetic tape (EM301)



Zenith transport and counter base case



Thermoformed table top in beech



2x PS950-1000-LED-BDLK lights

## Quick+ Curved Bundle



The Premium Quick+ Curved Display Bundle includes the full magnetic display backwall kit which can be used single or double-sided, the unique Zenith transit case which converts to a counter and two PS950-1000 LED lights. Use with optional interchangeable, vibrant UV printed PVC graphics. Deploys tool-free in seconds, giving you a brilliant backwall display for your event or shell scheme. Quick+ displays are also available in a straight display bundle and come in 3 different sizes.

<b>Material</b>	Aluminium structure, plastic connectors
<b>Assembly</b>	Magnetic connectors
<b>Shape</b>	Curved
<b>Graphic area</b>	Single-sided (with or without D-ends) / double-sided (optional)
<b>Graphic attachment</b>	Mag bars, hangers and kickers
<b>Application</b>	Free-standing

3x2 Curved	99-XX-016Q	Ⓞ 1930(w) x 2225(h) x 485(d) mm
3x3 Curved	99-XX-017Q	Ⓞ 2540(w) x 2225(h) x 685(d) mm
3x4 Curved	99-XX-020Q	Ⓞ 3070(w) x 2225(h) x 960(d) mm



### Quick+ Bundle

#### Quick+ Kit



Padded nylon carry bag



Quick+ Structure Straight / Curved



Hangers, kickers and mag bars



1x Roll of self-adhesive magnetic tape (EM301)



Zenith transport and counter base case



Thermoformed table top in beech



2x PS950-1000-LED-BDLK lights

# Hop-up Impact Straight



Impact Hop-ups are simple lightweight interlocking frame structures that deploy in minutes. Complete with tension-fit graphics that can stay on even when packed away.

Graphic stays on structure once packed down

<b>Material</b>	Aluminium structure, plastic connectors
<b>Assembly</b>	Lock together with clips
<b>Shape</b>	Straight
<b>Graphic area</b>	Single-sided (with or without returns) or double-sided (optional)
<b>Graphic attachment</b>	Hook and loop
<b>Application</b>	Free-standing

3x2 quads	HUI3X2	Ⓞ 1525(w) x 2260(h) x 295(d) mm
3x3 quads	HUI3X3	Ⓞ 2260(w) x 2260(h) x 295(d) mm
3x4 quads	HUI3X4	Ⓞ 2995(w) x 2260(h) x 295(d) mm
3x5 quads	HUI3X5	Ⓞ 3730(w) x 2260(h) x 295(d) mm



Graphics attach with hook and loop fastener



Plastic connectors



Easy to transport



Carry bag

**Ancillaries :**

Stabilising feet (pair)	ES508	Ⓞ N/A
-------------------------	-------	-------

# Hop-up Impact Curved



Impact Hop-ups are simple lightweight interlocking frame structures that deploy in minutes. Complete with tension-fit graphics that can stay on even when packed away.

<b>Material</b>	Aluminium structure, plastic connectors
<b>Assembly</b>	Lock together with clips
<b>Shape</b>	Curved
<b>Graphic area</b>	Single-sided (with or without returns)
<b>Graphic attachment</b>	Hook and loop
<b>Application</b>	Free-standing

3x3 quads	HOP-2-3X3-C	Ⓞ 2310(w) x 2270(h) x 570(d) mm
3x4 quads	HOP-2-3x4-C	Ⓞ 2950(w) x 2260(h) x 810(d) mm



Easy to transport



Plastic connectors

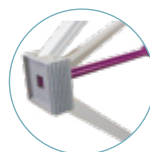

Graphics attach with hook and loop fastener

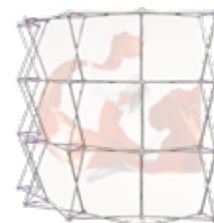



# FASTFRAME™ Backwall Kit



Fastframe™ Backwall Kit	Price on demand	@ 2004(w) x 2007(h) x 400(d) mm
-------------------------	-----------------	---------------------------------



## Fastframe™ Backwall Kit



Portable carry bag



2 frames  
1000 x 2000mm  
Includes feet



4 graphics  
1000 x 2000mm,  
2 graphics  
2000 x 2000mm

# FASTFRAME™ Pop-up Kit



Fastframe™ Pop-up Kit	Price on demand	@ 2690(w) x 2007(h) x 940(d) mm
-----------------------	-----------------	---------------------------------

Dimensions based on configuration shown



## Fastframe™ Pop-up Kit



Portable carry bag



3 frames  
1000 x 2000mm  
includes feet



1 graphic  
2000 x 3000mm,  
3 graphics  
1000 x 2000mm



2  
45° connector  
kit

# Fabric tube walls

## Formulate Straight



Formulate Straight backwalls are constructed of lightweight 30mm diameter push-fit aluminium tubing for tool-free simple deployment. Complete with optional double-sided dye-sublimated tension-fit fabric graphics that zip at the base to perfectly contour the shaped aluminium structure and maximize your brand message. Formulate displays offer a variety of great shapes with clean lines, ideal for creating picture backwalls or defining areas in rooms by screening or zoning.

<b>Material</b>	Aluminium tubing
<b>Tube</b>	Ø 30 mm
<b>Assembly</b>	Push-fit / Allen key
<b>Shape</b>	Straight
<b>Graphic area</b>	Double-sided
<b>Graphic attachment</b>	Zippered tension fabric graphic
<b>Application</b>	Free-standing with feet (included)



2000 mm	FORM-STR-20	Ⓞ 2000(w) x 2380(h) x 400(d) mm
2400 mm	FORM-STR-24	Ⓞ 2350(w) x 2380(h) x 400(d) mm
3000 mm	FORM-STR-30	Ⓞ 2950(w) x 2380(h) x 400(d) mm
4000 mm	FORM-STR-40	Ⓞ 3950(w) x 2380(h) x 400(d) mm
5000 mm	FORM-STR-50	Ⓞ 4950(w) x 2380(h) x 400(d) mm
6000 mm	FORM-STR-60	Ⓞ 5950(w) x 2380(h) x 400(d) mm



Bungee tubes



Numbered system for easy assembly



Gloves included

## Formulate Horizontal Curve



Formulate Horizontal Curve displays are an eye-catching shape, constructed of lightweight 30mm diameter push-fit aluminium tubing, combined with a zippered tension-fit graphics for tool-free impressive backwalls. Formulate displays offer a variety of great shapes with clean lines, ideal for creating picture backwalls or defining areas in rooms by screening or zoning. The optional double-sided tension fabric graphics perfectly contour the shaped aluminium structures and maximise your brand message.

<b>Material</b>	Aluminium tubes
<b>Tube</b>	Ø 30 mm
<b>Assembly</b>	Push-fit button
<b>Shape</b>	Horizontal curve
<b>Graphic area</b>	Double-sided
<b>Graphic attachment</b>	Zippered tension fabric graphic
<b>Application</b>	Free-standing

2400 mm	FORM-CUR-24	Ⓞ 2350(w) x 2380(h) x 500(d) mm
3000 mm	FORM-CUR-30	Ⓞ 2950(w) x 2380(h) x 500(d) mm
6000 mm	FORM-CUR-60	Ⓞ 5910(w) x 2380(h) x 900(d) mm



Zippered tension fabric graphic



Bungee tubes



Numbered system for easy assembly



Possibility to add LED Spotlights and Ancillaries

**NEW  
PRODUCT**



Display Backwalls

# Tension walls

## Horizon



Horizon is the ideal solution for large scale promotions. Use single-sided or double-sided to maximise the impact for brand displays. Link individual units together to form a display wall. Securely weighted by twin water filled bases for total stability.

<b>Material</b>	Aluminium, moulded grey plastic base
<b>Pole</b>	Adjustable height (1500-2400 mm)
<b>Graphic area</b>	Single or double-sided
<b>Graphic attachment</b>	Eyelets
<b>Base capacity</b>	28 litres per tank
<b>Wind resistance</b>	Up to 12 mph / 19 km/h

Horizon	UB203	Ⓞ 2500(w) x 1500/3000(h) x 800(d) mm
---------	-------	--------------------------------------



Telescopic pole for adjustable height



Graphic attaches with eyelets

## Pegasus



The large-format Pegasus tension banner has telescopic poles and can adjust to 2.5m wide and tall - perfect for large format imagery and brand messaging. Tool-free assembly for quick and simple deployment, Pegasus packs down into a supplied carry bag, and is suitable for vinyl or fabric graphics with pole pockets.

<b>Material</b>	Aluminium
<b>Assembly</b>	Telescopic poles / screws
<b>Shape</b>	Straight
<b>Graphic area</b>	Single or double-sided
<b>Graphic attachment</b>	Pole pocket
<b>Application</b>	Free-standing with feet (included)

Pegasus	UB165-S	Ⓞ 1429/2540(w) x 1000/2515(h) x 442(d) mm
---------	---------	---

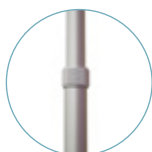

Telescopic poles



Poles slide into graphic pole pocket



Quick and easy installation



# Pegasus 3m



The most compact 3m wide video wall! Ideal for large format photo calls for group meetings, political events or product launches.

<b>Material</b>	Aluminium
<b>Assembly</b>	Telescopic twist-lock poles
<b>Shape</b>	Straight
<b>Graphic area</b>	Single sided
<b>Graphic attachment</b>	Pole pocket
<b>Application</b>	Free-standing with feet (included)

Pegasus 3 m	UB167-S	📏 1845/3180(w) x 1835/2610(h) x 440(d) mm
-------------	---------	---



← from 1845 to 3180 mm →



Quick and easy installation

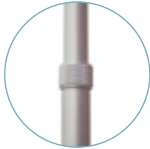

Telescopic poles



# Display Banners

Portable display banners are ideal for a temporary but stable communications tool.

Our unique range of Display Banners are highly portable, quick to deploy and suitable for a broad range of applications. Choose from the economy range through to premium options for use indoors or select specifically designed solutions for outdoor applications.

Alternatively the fabric systems are a premium display solution, featuring aluminium tubing, with double-sided high-quality dye sublimated fabric graphics. Easy to deploy with tool-free assembly.

## Display Banners

Affordable by nature, the roller banner range delivers a convenient, tool-free solution, with retractable graphics that deploy in seconds. Choose from a range of indoor or outdoor designs that best suits your application, with single or double-sided graphic options.

Tension banners are constructed of lightweight materials and offer the best value for money.



# Tension textile systems

## Formulate Monolith



Monolith; the gentle giant, with weighted base for high traffic areas and practical, changeable fabric graphics for multiple brand messaging. This tall double-sided display banner comes in a variety of widths, from 600mm up to 1500mm, and is trusted for stability and easy deployment.

<b>Material</b>	Aluminium tubes, steel base
<b>Tube</b>	Ø 30 mm
<b>Assembly</b>	Push-fit button, Allen key
<b>Graphic area</b>	Double-sided
<b>Graphic attachment</b>	Zippered tension fabric graphic
<b>Application</b>	Free-standing with metal base (included)
<b>Transport</b>	Padded with compartments

600 mm	FORM-MON-600	Ⓞ 600(w) x 2380(h) x 300(d) mm
900 mm	FORM-MON-900	Ⓞ 900(w) x 2380(h) x 300(d) mm
1200 mm	FORM-MON-1200	Ⓞ 1200(w) x 2380(h) x 300(d) mm
1500 mm	FORM-MON-1500	Ⓞ 1500(w) x 2380(h) x 300(d) mm



Hinged metal base (from sizes 900mm wide upward)



Bungee tubes

## Formulate Monolith Eco



The Formulate Monolith Eco is an ideal alternative to a roller banner as it provides a cost effective option for the budget conscious whilst delivering an uninterrupted double-sided stretch fabric display. It comes with powder coated steel feet for increased stability that connect to the aluminium tubular frame. The tension graphic hugs the frame and is zippered at the base to hold it in place.

<b>Material</b>	Aluminium tubes, powder coated steel feet
<b>Tube</b>	25mm
<b>Assembly</b>	Push-fit, tool-free
<b>Graphic area</b>	Single or double-sided
<b>Graphic attachment</b>	Tension fabric graphic
<b>Application</b>	Free-standing with feet (included)
<b>Transport</b>	Simple carry bag

800 mm	FORM-MON-ECO-800	Ⓞ 800(w) x 2009(h) x 378(d) mm
1000 mm	FORM-MON-ECO-1000	Ⓞ 1000(w) x 2009(h) x 378(d) mm



Bungee tubes



Numbered system on tubes for easy assembly



## Vector Media



Vector Media is a versatile display which accepts a variety of changeable media substrates; from SEG stretch fabric to rollable PVC. Each side of the frame has a channel for SEG fabrics, alternatively you can also use PVC with magnetic tape that magnetise to the inner frame profile.

<b>Material</b>	Aluminium
<b>Profile width</b>	35 mm
<b>Profile Colour</b>	Silver
<b>Assembly</b>	Tool-free
<b>Graphic area</b>	Single or double-sided
<b>Graphic attachment</b>	For textile graphics: 3 mm SEG For PVC graphics: magnetic tape (included)
<b>Application</b>	Free-standing solid foot

Vector Media	VF-MEDIA-16X06	📏 600(w) x 1610(h) x 280(d) mm
--------------	----------------	--------------------------------

PVC or fabric graphic, the choice is yours!

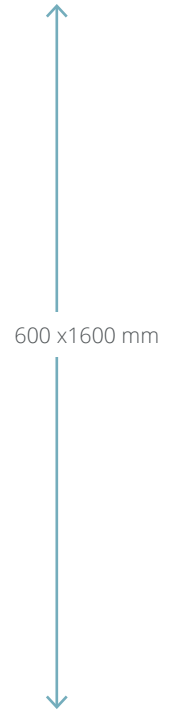
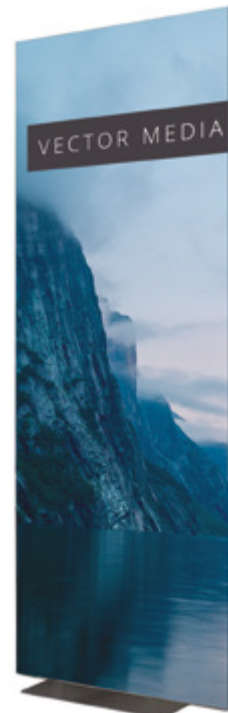

Fabric graphic with silicone edging (SEG)



PVC graphic with magnetic tape

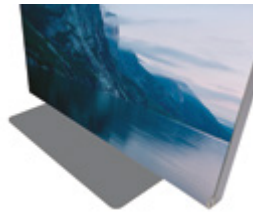

600mm



Wasp  
Beijing Lite  
Blizzard

800mm



Wasp  
Mantis  
Mosquito  
Grasshopper  
Orient+  
Barracuda  
Beijing Lite  
Blizzard

850mm



Wasp  
Mantis  
Mosquito  
Grasshopper  
Dragonfly 2  
Orient+  
Merlin  
Delta Lite  
Thunder 2

1000mm



Wasp  
Mantis  
Mosquito  
Dragonfly 2  
Orient+  
Barracuda  
Fastframe™

1200mm



Orient+  
Mosquito  
Barracuda  
Fastframe™

1500mm



Mosquito  
Orient+  
Barracuda

2000mm



Orient+  
Mosquito  
Barracuda

2400mm



Barracuda

Outdoor



Thunder 2  
Blizzard

Table Top



Breeze A4  
Breeze A3

# Roller banners (economy)

## Wasp



The Wasp roller banner is an entry level product, ideal for short-term events or displays, where cost is a primary consideration. Despite its affordable price, Wasp is made to exacting quality standards and carries a full manufacturer's warranty, so you can be confident it will perform as expected.

<b>Material</b>	Aluminium, plastic end caps on rail and feet tips
<b>Rail</b>	Snap rail
<b>Pole</b>	Aluminium three-part bungee pole
<b>Leader</b>	Self-adhesive
<b>Graphic area</b>	Single-sided
<b>Feet</b>	Twin, twist-out feet
<b>Transport</b>	Simple nylon bag

600 mm	UB204-600-05	⊗ 615(w) x 1710/2080(h) x 320(d) mm
800 mm	UB204-800-03	⊗ 815(w) x 2080(h) x 320(d) mm
850 mm	UB204-850-03	⊗ 865(w) x 2080(h) x 320(d) mm
1000 mm	UB204-1000-03	⊗ 1015(w) x 2080(h) x 320(d) mm

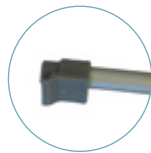

Pole top



Pole bracket



Carry bag

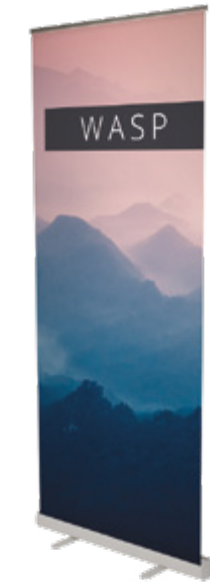

## Mantis



The Mantis roller banner is suitable for budget conscious users, who need a cost-effective roller banner with a little more durability for busier areas. With a weighted base, the unit provides enhanced stability over the unweighted banners in the range. Despite its economical price, Mantis is made to exacting quality standards and carries a full manufacturer's warranty, so you can be confident it will perform as expected.

<b>Material</b>	Aluminium, plastic end caps on rail
<b>Rail</b>	Snap
<b>Pole</b>	Bungee
<b>Leader</b>	Self-adhesive
<b>Graphic area</b>	Single-sided
<b>Feet</b>	Twin, twist-out feet
<b>Transport</b>	Padded nylon bag with side opening

800 mm	UB216-800-01	⊗ 818(w) x 2085(h) x 280(d) mm
850 mm	UB216-850-01	⊗ 868(w) x 2085(h) x 280(d) mm
1000 mm	UB216-1000-01	⊗ 1018(w) x 2085(h) x 280(d) mm



Pole top



Rigidising bracket in base for increased strength and longevity of banner



## Mosquito



The Mosquito roller banner is an industry standard workhorse. This roller banner offers a blend of affordability, durability and robustness that is often copied, but never equalled. It is constructed from more robust componentry, allowing it to perform reliably in high traffic applications, or where there are likely to be repeated deployments of the roller banner.

<b>Material</b>	Aluminium and plastic
<b>Rail</b>	Snap rail
<b>Pole</b>	Aluminium three-part bungee pole
<b>Leader</b>	Self-adhesive
<b>Graphic area</b>	Single-sided
<b>Feet</b>	Twin, twist-out feet
<b>Transport</b>	Nylon bag with inner protection (double skin)

800 mm	UB197	⊗ 860(w) x 2105(h) x 285(d) mm
850 mm	UB196	⊗ 910(w) x 2105(h) x 285(d) mm
1000 mm	UB197-1000	⊗ 1060(w) x 2105(h) x 285(d) mm
1200 mm	UB197-1200	⊗ 1260(w) x 2105(h) x 285(d) mm
1500 mm	UB197-1500	⊗ 1560(w) x 2105(h) x 285(d) mm
2000 mm	UB197-2000	⊗ 2060(w) x 2105(h) x 285(d) mm



Nylon bag with padded inner protection



Three-part bungee pole



Rigidising bracket in base for increased strength and longevity of banner



## Grasshopper



The Grasshopper roller banner is an industry standard workhorse. A popular, classic-style lightweight economy banner with twin twist-out feet for stability. This roller banner offers a blend of affordability, durability and robustness.

<b>Material</b>	Aluminium and plastic
<b>Rail</b>	Adhesive Rail
<b>Pole</b>	Aluminium three-part bungee pole
<b>Leader</b>	Self-adhesive
<b>Graphic area</b>	Single-sided
<b>Feet</b>	Twin, twist-out feet
<b>Transport</b>	Nylon bag with inner protection (double skin)

800 mm	UB191	⊗ 860(w) x 2105(h) x 285(d) mm
850 mm	UB193	⊗ 910(w) x 2105(h) x 285(d) mm

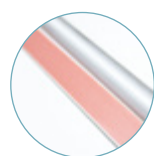

Self-adhesive rail



Three-part bungee pole



Rigidising bracket in base for increased strength and longevity of banner

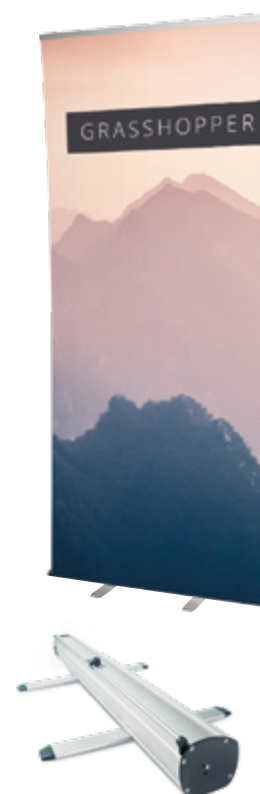

# Roller banners (standard)

## Dragonfly 2



Economical and cost-effective double-sided roller banner with pole storage in base. Comes with padded nylon bag for ease of transportation.

<b>Material</b>	Aluminium, plastic end caps on rail
<b>Rail</b>	Snap rail with end caps
<b>Pole</b>	Aluminium three-part bungee pole
<b>Leader</b>	Self-adhesive
<b>Graphic area</b>	Double-sided
<b>Feet</b>	Twin, twist-out feet
<b>Transport</b>	Padded nylon bag

850 mm	UB199-850-01	⊗ 890(w) x 2105(h) x 395(d) mm
1000 mm	UB199-1000-01	⊗ 1040(w) x 2105(h) x 395(d) mm

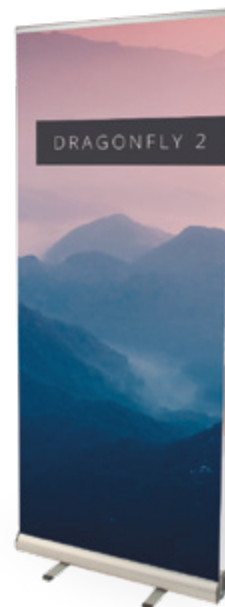

Double-sided



Three-part bungee pole



Nylon padded carry bag included

## Orient +



The Orient + is a trusted market leading roller banner that delivers stability whilst still being cost-effective. With its front-loading graphic that pulls up from the front of the base, the banner design ensures your brand message has maximum visibility from floor to top rail. It comes with our manufacturer's quality warranty, giving peace of mind.

<b>Material</b>	Aluminium and plastic
<b>Rail</b>	Patented Dual action self-adhesive and snap rail
<b>Pole</b>	Hybrid adjustable height telescopic pole
<b>Leader</b>	Self-adhesive or Hook and Loop
<b>Graphic area</b>	Single-sided
<b>Feet</b>	Adjustable
<b>Transport</b>	Padded nylon bag with side opening and foam reinforced ends

800 mm	WH353-800-003	⊗ 840(w) x 1595/2220(h) x 185(d) mm
850 mm	WH353-850-003	⊗ 890(w) x 1595/2220(h) x 185(d) mm
1000 mm	WH353-1000-003	⊗ 1040(w) x 1595/2220(h) x 185(d) mm
1200 mm	WH353-1200-003	⊗ 1240(w) x 1595/2220(h) x 185(d) mm
1500 mm	WH353-1500-003	⊗ 1540(w) x 1595/2220(h) x 185(d) mm
2000 mm	WH353-2000-003	⊗ 2040(w) x 1595/2220(h) x 185(d) mm



Hybrid telescopic pole



Pole top



Banner components

## Delta Lite



The Delta Lite roller banner is highly stylish and has great stability thanks to the wide footprint aluminium base. This elegant banner has great design details including the chrome finished end covers. With adjustable levelling feet and telescopic pole, Delta Lite is excellent value for money. It comes with our manufacturer's quality warranty, giving you peace of mind that it will perform every time.

<b>Material</b>	Aluminium, chrome base end covers
<b>Rail</b>	Snap rail with end caps
<b>Pole</b>	Hybrid adjustable height telescopic pole
<b>Leader</b>	Self-adhesive
<b>Graphic area</b>	Single-sided
<b>Feet</b>	Adjustable
<b>Transport</b>	Padded nylon bag

850 mm	UB205-850-004	Ⓞ 903(w) x 1625/2224(h) x 203(d) mm
--------	---------------	-------------------------------------



Snap rail



Hybrid telescopic pole



## Thunder 2



The Thunder 2 double-sided retractable roller banner is ideal for outdoor use as it is strong and durable yet very easy to assemble and transport. Standing 2m high, Thunder 2 will display your message on both sides for maximum viewing impact.

<b>Material</b>	Plastic, aluminium and steel
<b>Pole</b>	Three part bungee pole
<b>Graphic area</b>	Double-sided
<b>Graphic attachment</b>	Self-adhesive leader / top snap rail
<b>Ground fixing</b>	4 pegs (included)
<b>Wind resistance</b>	Up to 7 mph / 11 km/h (unpegged) up to 24 mph / 39 km/h (if pegged)
<b>Transport</b>	Padded bag

Thunder 2	UB185-850-01	Ⓞ 884(w) x 2100(h) x 740(d) mm
-----------	--------------	--------------------------------



Three-part bungee pole

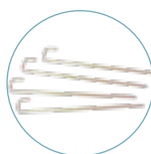

Ground pegs

↗  
Use outdoors



# Roller banners (premium)

## Merlin



Merlin is a sleek and elegant premium roller banner with an interchangeable graphic cassette which extends the life of the banner as graphics are quick and easy to change. The graphic cartridge is housed independently from the main base unit so it is simple to remove and replace with new graphics and old graphics can also be reused, just by swapping the cassette. A great value-for-money solution if the message or marketing campaign changes regularly. The Merlin roller banner comes with our manufacturer's quality warranty, giving peace of mind that it will perform every time.

<b>Material</b>	Aluminium and plastic
<b>Rail</b>	Snap rail
<b>Pole</b>	Hybrid adjustable height telescopic pole
<b>Leader</b>	Cassette banner with adhesive leader
<b>Graphic area</b>	Single-sided
<b>Feet</b>	Adjustable
<b>Transport</b>	Padded nylon with side opening and foam reinforced ends

850 mm	UB160-850-01	⊗ 915(w) x 1655/2315(h) x 195(d) mm
--------	--------------	-------------------------------------



Interchangeable graphic cassette - swap messaging in seconds



Replacement cassette - 850 mm UB175-850-01

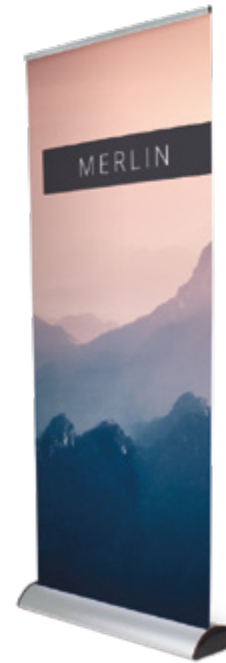

## Barracuda



The original best-selling premium Barracuda roller banner delivers a reliable, enduring display which is backed up by a life-time manufacturer's hardware warranty. The stylish anodised aluminium base has an elegant pinstripe detail on the front casing. Barracuda is height adjustable and has a large internal graphic housing and tensioner.

<b>Material</b>	Aluminium and plastic
<b>Rail</b>	Patented snap rail
<b>Pole</b>	Hybrid adjustable height telescopic pole
<b>Leader</b>	Self-adhesive slider
<b>Graphic area</b>	Single-sided
<b>Feet</b>	Adjustable
<b>Transport</b>	Padded nylon with side opening and foam reinforced ends

800 mm	WH321C-800A3	⊗ 860(w) x 1605/2210(h) x 200(d) mm
1000 mm	WH321C-1000A3	⊗ 1060(w) x 1605/2210(h) x 200(d) mm
1200 mm	WH321C-1200A3	⊗ 1260(w) x 1605/2210(h) x 200(d) mm
1500 mm	WH321C-1500A3	⊗ 1560(w) x 1605/2210(h) x 200(d) mm
2000 mm	WH321C-2000A3	⊗ 2060(w) x 1605/2210(h) x 200(d) mm
2400 mm	WH321C-2400A3	⊗ 2460(w) x 1605/2210(h) x 200(d) mm



Hybrid telescopic pole



Rail cap



Ratchet graphic tensioner

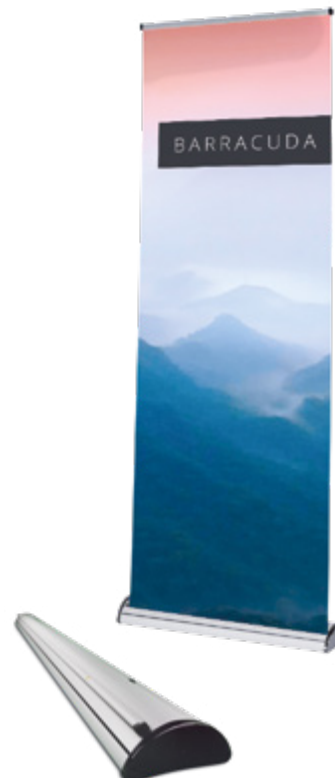

# FASTFRAME™

## FASTFRAME™ 1000x500 - 2 Pack



Fastframe™	FF-100X50	📏 1000(w) x 500(h) x 40(d) mm
Fastframe™ (Black back graphic)	G-FF-100X50-BB	📏 1000(w) x 500(h)
Fastframe™ (Polyester stretch graphic)	G-FF-100X50-PS	📏 1000(w) x 500(h)

**NEW  
PRODUCT**



Portable carry bag



Feet can be added if required.  
Feet sold separately

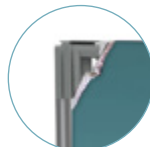

Silicone edged (SEG) graphic



## FASTFRAME™ 1000x1000 - 2 Pack



Fastframe™	FF-100X100	📏 1000(w) x 1000(h)
Fastframe™ (Black back graphic)	G-FF-100X100-BB	📏 1000(w) x 1000(h)
Fastframe™ (Polyester stretch graphic)	G-FF-100X100-PS	📏 1000(w) x 1000(h)

**NEW  
PRODUCT**



Portable carry bag



Feet can be added if required.  
Feet sold separately



Silicone edged (SEG) graphic





## FASTFRAME™ 1000x2000



Fastframe™	FF-100X200	Ⓞ 1004(w) x 2007(h) x 400(d) mm
Fastframe™ (Black back graphic)	G-FF-100X200-BB	Ⓞ 1000(w) x 2000(h)
Fastframe™ (Polyester stretch graphic)	G-FF-100X200-PS	Ⓞ 1000(w) x 2000(h)

**NEW  
PRODUCT**



Portable carry bag



Includes 2 x feet

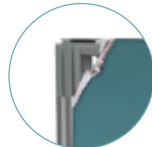

Silicone edged  
(SEG) graphic



## FASTFRAME™ 1000x2400



Fastframe™	FF-100X240	Ⓞ 1004(w) x 2407(h) x 400(d) mm
Fastframe™ (Black back graphic)	G-FF-100X240-BB	Ⓞ 1000(w) x 2400(h)
Fastframe™ (Polyester stretch graphic)	G-FF-100X240-PS	Ⓞ 1000(w) x 2400(h)

**NEW  
PRODUCT**



Portable carry bag



Includes 2 x feet



Silicone edged  
(SEG) graphic



# FASTFRAME™

## FASTFRAME™ 1200x2400



Fastframe™	FF-120X240	Ⓞ 1204(w) x 2407(h) x 400(d) mm
Fastframe™ (Black back graphic)	G-FF-120X240-BB	Ⓞ 1200(w) x 2400(h)
Fastframe™ (Polyester stretch graphic)	G-FF-120X240-PS	Ⓞ 1200(w) x 2400(h)

**NEW**  
PRODUCT

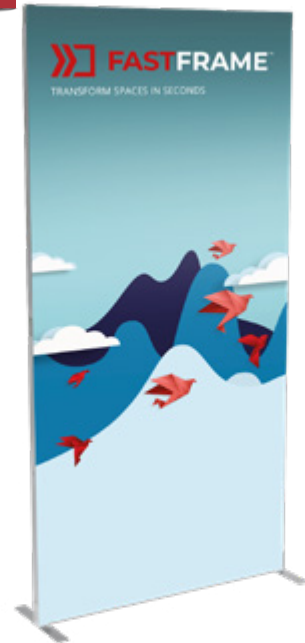

Portable carry bag



Includes 2 x feet



Silicone edged  
(SEG) graphic

## Breeze



The Breeze mini roller banner is ideal for use on a tabletop, counter, or reception desk. Ultra-light and simple to assemble, it delivers a professional, smart display that is elegant and stylish.

<b>Material</b>	Aluminium, plastic end caps on rail
<b>Rail</b>	Self-adhesive
<b>Pole</b>	Aluminium, two-part pole
<b>Leader</b>	Self-adhesive
<b>Graphic area</b>	Single-sided
<b>Transport</b>	Padded nylon bag

Breeze A4	WH360	Ⓞ 332(w) x 440(h) x 82(d) mm
Breeze A3	WH361	Ⓞ 238(w) x 335(h) x 80(d) mm



Two-piece support pole



# Tension banners (X Banner)

## Beijing Lite



The Beijing Lite is a basic X-Banner with an ultra-light frame. It is very easy to assemble and compact once packed down.

<b>Material</b>	Fibreglass
<b>Graphic area</b>	Single-sided
<b>Graphic attachment</b>	Eyelets
<b>Application</b>	Free-standing
<b>Transport</b>	Budget drawstring carry bag

600 mm	WH358-6X16-01	ⓐ 600(w) x 1800(h) x 650(d) mm
800 mm	WH358-8X18-01	ⓐ 800(w) x 1800(h) x 650(d) mm



Banner reverse



Graphic attaches with eyelets

## Blizzard



Blizzard is a great all-rounder as it is ideal for all kinds of corporate, sporting and outdoor events. Its simple design makes it very easy to assemble on-site, and because it's adjustable, it can accommodate different graphic sizes to suit your application.



<b>Material</b>	Plastic and metal
<b>Pole</b>	Adjustable in width and height
<b>Graphic area</b>	Single-sided
<b>Graphic attachment</b>	Eyelets
<b>Base capacity</b>	12 litres
<b>Wind resistance</b>	Up to 18 mph / 29 km/h
<b>Transport</b>	Non-padded bag

Blizzard	UB701	ⓐ 600/800(w) x 1600/2100(h) x 540(d) mm
----------	-------	---



Non-padded bag included





# Display Signs

We deliver a comprehensive range of professional display signage solutions for a variety of uses from navigational signs to advertising, information, decorative and display needs.

Display signage solutions are versatile, reusable, durable, and reliable, ensuring investment in hardware is maximised, whilst allowing the flexibility to update marketing messages frequently.

## Display Signs

With a wide choice of installation options such as wall, suspended or free-standing, we are proud to offer one of the most comprehensive ranges on the market.



# Free-standing signs

## Wedge



Wedge is a weighted clamping banner base range that comes in 2 parts and is designed to hold a variety of rigid substrates for indoor or temporary outdoor usage. Available in four sizes from 300mm up to 1000mm, Wedge can be used in tandem with a second pair of bases to create larger displays.

<b>Material</b>	Powder coated steel
<b>Graphic area</b>	Single or double-sided
<b>Graphic attachment</b>	Screwed to base
<b>Graphic option</b>	Rigid panel from 18-40mm thickness - optional extra 1500mm height max.
<b>Application</b>	Free-standing

Wedge 300 mm	UB102-300-S	Ⓞ 300(w) x 85(h) x 360(d) mm
Wedge 600 mm	UB102-600-S	Ⓞ 600(w) x 85(h) x 360(d) mm
Wedge 800 mm	UB102-800-S	Ⓞ 800(w) x 85(h) x 360(d) mm
Wedge 1000 mm	UB102-1000-S	Ⓞ 1000(w) x 85(h) x 360(d) mm



## Sentry



Sentry is a handy and versatile way of imparting brand messaging or wayfinding information quickly and tool-free using the 'snap action' poster area which can be deployed either landscape or portrait. A3 and A4 sizes are available and the weighted base aids deployment in high foot-fall areas.

<b>Material</b>	25mm aluminium profile, clear PVC protection sheet
<b>Colour</b>	Anodised silver finish, chromed corners
<b>Mounting</b>	Free-standing
<b>Graphic attachment</b>	Snap rail
<b>Graphic option</b>	Suitable for substrates up to 420 microns
<b>Positioning</b>	Portrait or Landscape

Sentry A4	SL104	Ⓞ 245(w) x 1005(h) x 326(d) mm
Sentry A3	SL103	Ⓞ 245(w) x 1075(h) x 326(d) mm



Snap frame

## Symbol



Symbol is constructed of robust weighted steel and angled for optimal viewing and reading for better engagement with prospective customers. Interchangeable graphics slide in to the recess channel and fix in place tool-free with a turnscrew.



<b>Material</b>	Steel
<b>Profile colour</b>	Black
<b>Assembly</b>	Allen key and thumb screws
<b>Graphic attachment</b>	Thumbscrews
<b>Graphic option</b>	Rigid PVC and Dibond (3-5 mm thickness)
<b>Weight</b>	7.2 kg
<b>Wind speed</b>	18 mph

Symbol	IP01	420(w) x 1280(h) x 450(d) mm (A4) 480(w) x 1280(h) x 450(d) mm (A3)
--------	------	--



Content detail



Tool-free locking mechanism



Quick change graphic

## Whirlwind



The Whirlwind signage solution is a heavy duty, weather resistant swing sign with a wheeled base for ease of deployment. Base can be filled with a whopping 25 litres of water to keep in place. Double-sided graphics are held securely in a front loading 'snap-action' double-sided panel and it all flat packs for ease of transportation. A perfect piece of kit!



<b>Material</b>	Aluminium, steel, plastic base, PVC sheet cover
<b>Graphic area</b>	Double-sided
<b>Graphic attachment</b>	Snap rail
<b>Graphic option</b>	Banner vinyl
<b>Application</b>	Free-standing

Whirlwind - A1	UB207-A1	780(w) x 1165(h) x 500(d) mm
Whirlwind - A0	UB207-A0	1010(w) x 1554(h) x 625(d) mm



Tool-free snap rail



Wheels for easy transportation

## A-sign Board



Pavement signage is a marketing stalwart. No high street would be without one, and the A-sign Board is one of the best. Simple to use with double-sided 'snap-action' front loading frames, complete with protective PVC sheeting to shield graphics which can be changed over and over again to keep up with brand messaging or offers.



<b>Material</b>	Aluminium, steel, PVC sheet cover
<b>Graphic area</b>	Double-sided
<b>Graphic attachment</b>	Snap rail
<b>Wind speed</b>	18 mph
<b>Weight</b>	10.56 kg

A-sign Board A1	VF204-C	Ⓞ 638(w) x 1060(h) x 825(d) mm
-----------------	---------	--------------------------------



Snap frame



## Formulate Shadow



Formulate Shadow is a no fuss outdoor sign offering customers a viable alternative to traditional outdoor signs that typically rely on water or sand for stability.



<b>Material</b>	Steel
<b>Assembly</b>	Push-fit button/Allen key
<b>Tube</b>	32 mm
<b>Graphic area</b>	Double-sided
<b>Graphic attachment</b>	Zippered tension fabric graphic
<b>Wind resistance</b>	Up to 18 mph / 29 km/h
<b>Weight</b>	12.7 kg

Formulate Shadow	FORM-ODS	Ⓞ 800(w) x 1174(h) x 420(d) mm
------------------	----------	--------------------------------



Integrated castors



Base with handle





## Monsoon



Monsoon is a perfect all-weather sturdy single or double-sided 'A' frame banner with bungeed PVC eyelet banner graphics - perfect for displaying brand messaging or wayfinding information.

<b>Material</b>	Aluminium tubes (25 mm), plastic connectors
<b>Graphic area</b>	Single or double-sided
<b>Graphic attachment</b>	Eyelets and looped bungee cords
<b>Wind resistance</b>	Up to 24 mph / 39 km/h



Monsoon 2500 mm	UB707-C	Ⓞ 2500(w) x 1000(h) x 640(d) mm
Monsoon 3000 mm	UB711-C	Ⓞ 3000(w) x 1250(h) x 795(d) mm



Eyeletted graphic attaches to frames with bungee cord



Metal hinge

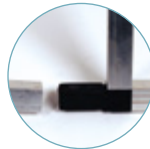

Interlocking sections



## Stowaway



Make brand messaging or wayfinding information literally pop with the Stowaway pop-out display banner that deploys in seconds for use either indoors or secured outside with pegs supplied.

<b>Material</b>	Sprung steel pole
<b>Graphic area</b>	Double-sided
<b>Graphic attachment</b>	Elasticated pole pocket
<b>Ground fixing</b>	4 pegs (included)
<b>Transport</b>	Carry bag included
<b>Wind Speed</b>	18 mph (when pegged)



Stowaway 1400 mm	UB736-03A	Ⓞ 1420(w) x 700(h) x 400/480(d) mm
Stowaway 2000 mm	UB736-01A	Ⓞ 2020(w) x 1000(h) x 400/480(d) mm



Internal hook and loop straps



Portable carry bag

## Formulate Round Table



The Formulate Round Table is a popular table shape for reception with a welded base for extra stability. Display your message at 360° angle with optional washable tension fabric graphic.

If you already have a display table and are looking for a custom printed tablecloth to promote your messaging, then contact us for a custom made quote. So whether you are looking for a large table cloth with hem, or smaller option with a slim silhouette, we can create a striking made to measure graphic to suit.

<b>Material</b>	Polypropylene
<b>Assembly</b>	Push-fit buttons
<b>Graphic area</b>	360°
<b>Transport</b>	Carry bag included

Formulate Round Table	FORM-TS-01A	Ⓞ 1000(h) x 600(dia) mm
-----------------------	-------------	-------------------------



Padded carry bag included



Simple assembly using numbered system

Custom printed tablecloth to promote your messaging



## Wall mounted signs

### Trappa Frame



The Trappa 'snap-action' Frame delivers a professional look and is quick to fix to a wall and easy to update. Posters can be changed, simply by opening the frame edges.

<b>Material</b>	25mm aluminium profile, clear PVC protection sheet
<b>Colour</b>	Anodised silver finish
<b>Mounting</b>	Wall*
<b>Graphic attachment</b>	Snap rail
<b>Graphic option</b>	Suitable for substrates up to 420 microns
<b>Positioning</b>	Portrait or Landscape

Trappa A4	AT401-C	Ⓞ 241(w) x 328(h) x 13(d) mm
Trappa A3	AT402-C	Ⓞ 328(w) x 451(h) x 13(d) mm
Trappa A1	AT404-C	Ⓞ 625(w) x 872(h) x 13(d) mm



Trappa snap frame

\*: Wall mounting screws not included

# Suspended signs

## Twista Lite



Twista Lite delivers a smart, modern poster display system that is quick and simple to deploy via the 'snap-action' rail. Versatile, as well as functional, it can be displayed single-sided on walls or double-sided when suspended from ceilings.

<b>Material</b>	Aluminium (rail), plastic (end caps, hooks)
<b>Colour</b>	Grey
<b>Mounting</b>	Wall / Ceiling
<b>Graphic area</b>	Single or double-sided
<b>Graphic attachment</b>	Snap rail

500 mm Kit	TWLHR-500	Ⓞ 500(w) x 31(h) x 12(d) mm
600 mm Kit	TWLHR-600	Ⓞ 600(w) x 31(h) x 12(d) mm
800 mm Kit	TWLHR-800	Ⓞ 800(w) x 31(h) x 12(d) mm
850 mm Kit	TWLHR-850	Ⓞ 850(w) x 31(h) x 12(d) mm
1000 mm Kit	TWLHR-1000	Ⓞ 1000(w) x 31(h) x 12(d) mm
1500 mm Kit	TWLHR-1500	Ⓞ 1500(w) x 31(h) x 12(d) mm
Twista closed grey hook	TWLHR-CG	
Twista left grey moulding	TWLHR-LG	
Twista right grey moulding	TWLHR-RG	
3100 mm (rail only)	TWLHR-3100	Ⓞ 3100(w) x 31(h) x 12(d) mm

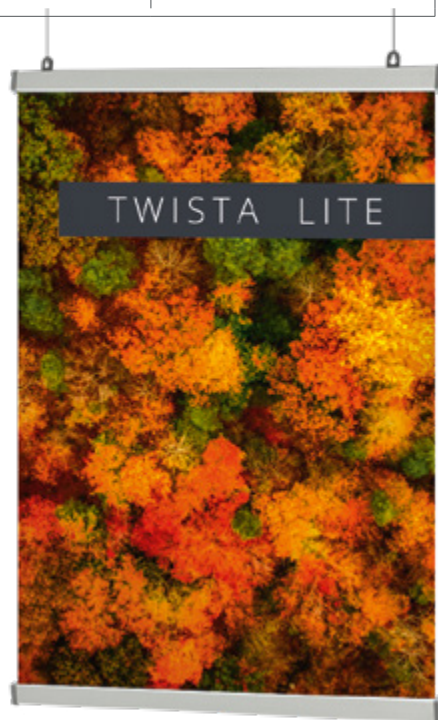

The snap rail clamps media securely



Top rail with hanging



Snap rail



# Flag Banners

Draw attention to branding, products, services, or business premises with custom printed flags. Instantly noticeable due to their height, shape, and movement, our all-fibre flag poles are durable and flexible, easy to assemble and quick to deploy, making them an extremely effective means of advertising.

Choose from a range of free-standing, post / wall mounted, mobile and specialist hardware that can be used in a variety of applications such as car forecourts, festivals, and beach flags.

Alternatively, deploy taller or multiple flags to increase visibility and attention to branding. Our all-fibre flag poles are reusable with interchangeable graphics for greater return on investment. To protect this investment, it is recommended that flags be kept securely in place by selecting an appropriate base suitable for the desired application and location from the specifically designed range.

## Flag Banners

Available as single or double-sided options and printed using hardy, UV resistant media, flag graphics can be utilised indoors or outside with standard or custom flag shapes.



# Free-standing flags

## Zoom+ Quill / Feather / Crest Flag



Zoom+ flags are a popular and versatile, lightweight flexible flag system, with black finish all fibre poles. Choose Feather, Quill or Crest shaped graphics. Ideal for advertising and used for all types of indoor and outdoor displays. Optional custom printed flag graphics are available in a range of sizes from small to extra-large and with a choice of single or double-sided options (small, medium, and large). The eye-catching shape creates movement in the wind and is a great for attracting attention.



<b>Material</b>	GRP fibre glass pole
<b>Graphic area</b>	Single-sided or double-sided (double-sided only available up to large)
<b>Graphic attachment</b>	Pole pocket
<b>Wind resistance</b>	Up to 63 mph / 101 km/h*

Zoom + Small	UF-ZM-SM	⊗ 550/800(w) x 2100/2600(h) mm
Zoom + Medium	UF-ZM-ME	⊗ 600/900(w) x 2800/3200(h) mm
Zoom + Large	UF-ZM-LA	⊗ 800/1100(w) x 3500/4000(h) mm
Zoom + Extra large	UF-ZM-EXLA	⊗ 850/1200(w) x 4600/4900(h) mm

\* Under controlled test conditions



**Ancillaries :**

Bag (optional)	AB-ZML-01
----------------	-----------



Graphic attaches on to hook

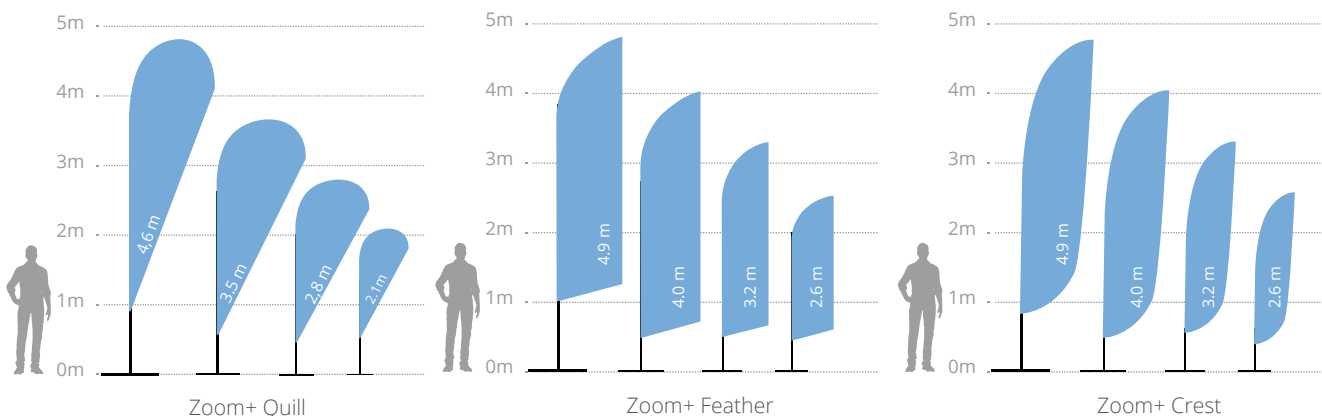

## Zoom+ Edge Flag



Zoom+ is a popular and versatile, lightweight rectangular shaped flag system with black finish all-fibre poles. Ideal for all types of indoor and outdoor displays. Quick and easy to deploy and can withstand winds of approximately 13 -18m/h (21-29km/h). Optional custom printed flag graphic available in single and double-sided options (small, medium, and large), and all flag graphics have a printed pole pocket. The flag moves naturally in breezy/windy conditions and is ideal for attracting attention on car forecourts, at exhibitions and events, or outside a building or premises.



<b>Material</b>	Aluminium and GRP
<b>Graphic area</b>	Single-sided or double-sided (double-sided only available up to large)
<b>Graphic attachment</b>	Pole pocket
<b>Wind resistance</b>	Up to 18 mph / 29 km/h

Zoom + Edge Small	UF-ZME-SM	Ⓜ 750(w) x 2080(h) mm
Zoom + Edge Medium	UF-ZME-ME	Ⓜ 750(w) x 2900(h) mm
Zoom + Edge Large	UF-ZME-LA	Ⓜ 750(w) x 4000(h) mm
Zoom + Edge Extra large	UF-ZME-EXLA	Ⓜ 750(w) x 5000(h) mm

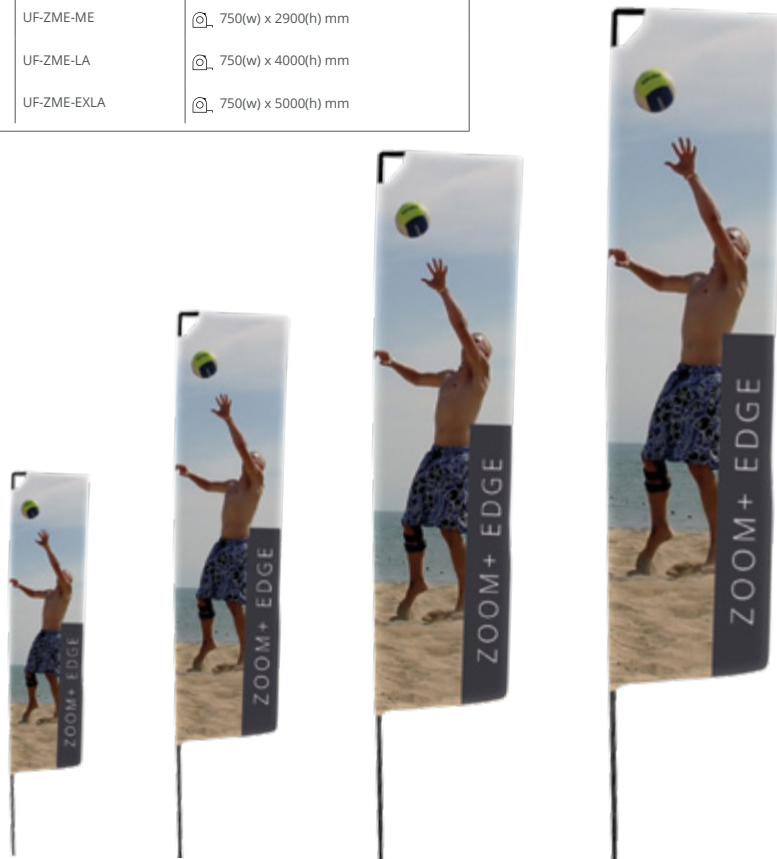

Graphic attaches on to hook

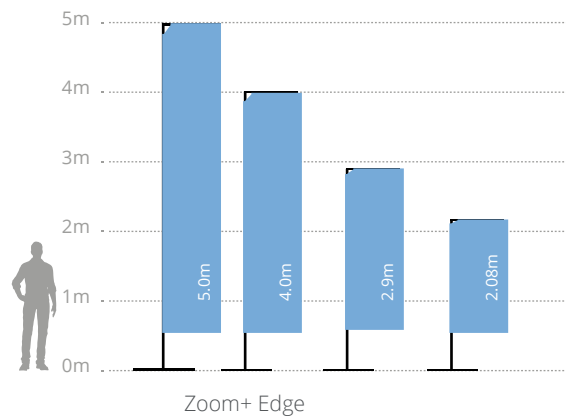

# Free-standing flag bases

Weighted bases																			
Base	Product	Code				Utilisation		Zoom + Quill				Zoom + Feather				Zoom + Edge			
						Int.	Ext.	S	M	L	XL	S	M	L	XL	S	M	L	XL
	Large water base	UF-ZMLWB	50 x 50 x 26 cm	3.3 - 33 kg	30l	✓	✓	✓	✓	✓	✓	✓	✓	✓	✓	✓	✓	✓	✓
	Stackable water base	UF-ZMSWB	64.2 x 64.2 x 27.7 cm	3.6 - 30 kg	26l	✓	✓	✓	✓	✓	✓	✓	✓	✓	✓	✓	✓	✓	✓
	Parasol base	UF-ZMGMB	44 x 44 x 25 cm	1.2 - 23 kg	23l	✓	✓	✓	✓	✓	✓	✓	✓	✓	✓	✓	✓	✓	✓

Metal and cement bases																			
Base	Product	Code			Utilisation		Zoom + Quill				Zoom + Feather				Zoom + Edge				
					Int.	Ext.	S	M	L	XL	S	M	L	XL	S	M	L	XL	
	Zoom+ Small cross base	UF-ZMSCB-01	140 x 475 x 410 mm	1.05kg	✓	✓	*				✓	*				✓	*		
	Zoom + Large cross base	UF-ZMLCB-01	240 x 400 x 400 mm	1.5 kg	✓	✓	✓	✓	✓	✓	✓	✓	✓	✓	✓	✓	✓	✓	✓
	Zoom + Concrete base	UF-ZMCEM	Ø 450 x 350 mm	22.5 kg	✓	✓	✓	✓	✓	✓	✓	✓	✓	✓	✓	✓	✓	✓	✓
	Zoom + Small square base 7,5 kg	UF-ZMLSQ-01	180 x 400 x 400 mm	7.5 kg	✓	✓	*	*			✓	✓	*	*		✓	✓	*	*
	Zoom + Large square base 12.5kg	UF-ZMLSQ-03	180 x 450 x 450 mm	12.5kg	✓	✓	✓	✓	✓	✓	✓	✓	✓	✓	✓	✓	✓	✓	✓
	Zoom + Drive on car foot	UF-ZMCF5-01	605 x 195 x 125 mm	1.7 kg	✓	✓	✓	✓	✓	✓	✓	✓	✓	✓	✓	✓	✓	✓	✓

Spikes																			
Base	Product	Code			Utilisation		Zoom + Quill				Zoom + Feather				Zoom + Edge				
					Int.	Ext.	S	M	L	XL	S	M	L	XL	S	M	L	XL	
	Zoom + Ground spike	UF-ZMGS-01	600 mm	1.16kg		✓	✓	✓	✓	✓	✓	✓	✓	✓	✓	✓	✓	✓	✓
	Zoom + Budget ground spike	UF-ZMBGS-01	600 mm	1kg		✓	✓				✓	✓			✓	✓			



\*Use with Weighting ring UB719-C



\*\* Use with Heavy duty pegs FX620



## Zoom+ Arch



The Zoom+ Arch stands out at any outdoor event or activity. With an overall height of 3m to the top of the graphic and a 4m width, it's perfect to use as a focal point or to attract attention. Simple and quick to assemble, it can be deployed in minutes and when used with the optional stackable bases, provides an extremely stable display that can be used in wind speeds of up to 20mph.

<b>Material</b>	GRP fibre glass pole - chrome steel end caps, plastic hook
<b>Graphic area</b>	Single-sided
<b>Graphic attachment</b>	Pole pocket
<b>Wind resistance</b>	Up to 19 km/h

Zoom+ Arch	ZOOM+ARCH	Ⓞ 4000(w) x 2500/3000(h) mm
Stackable base (optional) recommended that 2 bases either side are used	UF-ZMSWB	Ⓞ 642(w) x 277(h) x 642(d) mm



Supplied with 1 x 6-part bungee pole, 2 x base rods and hooks



Graphic attaches on to plastic hook



Water fillable base



Handle for easy transportation



## Wind Dancer



An imposing telescopic flag which stands 5m high when fully assembled and is certain to make an impact at any outdoor event, Wind Dancer comes complete with a base which can be filled with either water or sand. The 3.5m flag height makes an impressive statement when the flagpole is deployed at its full 5m height, and is particularly impactful when used in large crowded areas because of its dominating presence.

<b>Material</b>	Aluminium pole, plastic base
<b>Pole</b>	Telescopic
<b>Graphic area</b>	Single-sided
<b>Graphic attachment</b>	Eyelets
<b>Base capacity</b>	66 litres
<b>Wind resistance</b>	Up to 18 mph / 29 km/h

Wind Dancer	WD105	Ⓞ 1000(w) x 2900/5300(h) x 1000(d) mm
-------------	-------	---------------------------------------

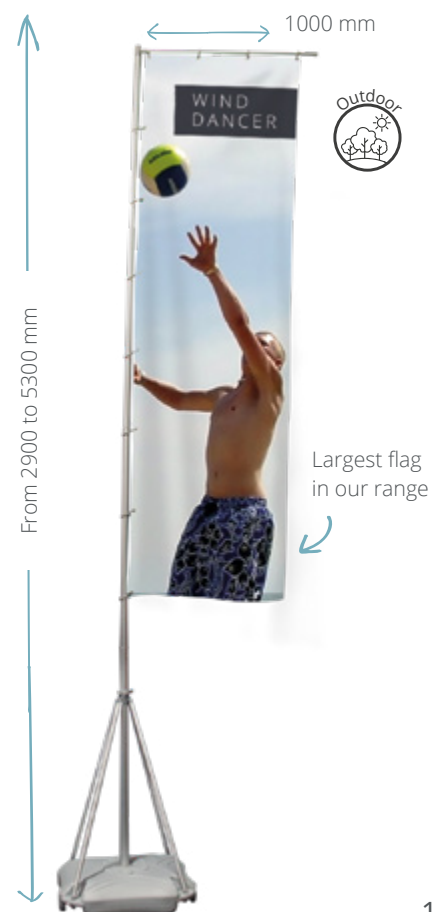

# Post / wall mounted flags

## Mistral

1 TEX PVC

The Mistral is a fixed outdoor flag system designed for mounting to lampposts or building exteriors and is perfect for advertising or promoting a brand or event. The mechanism attaches directly to a pole, posts, or wall and can be moved to accommodate varying graphic heights. An eye-catching solution that can also be used for information and wayfinding, this flag is especially effective when repeated over a series of posts.



Material	Aluminium castings and GRP tubes
Tube	Height adjustable
Graphic area	Single-sided or double-sided
Graphic attachment	Pole pocket
Wind resistance	Up to 40 km/h

Mistral	UB725-01	890(w) x 2000(h) mm
---------	----------	---------------------

Can be fixed to a pole or wall



Post fixing

Clamp  
(Ø 300mm max)

# Mobile flags

## Street Flag



Street flag is the ideal advertising medium when on the move or when you want to attract attention in a crowded space! Perfectly suited to promote events, highlight presence at trade shows or to organise a group of people on excursions! Rugged and lightweight, the backpack can be used with four different flag shapes and comes complete with fibre poles.

<b>Material</b>	Reinforced nylon backpack, fibre poles
<b>Graphic area</b>	Single-sided
<b>Graphic attachment</b>	Pole pocket
<b>Graphic shapes</b>	Feather - Quill - Edge

Street Flag	UF-ZMSTF-01	📏 310(w) x 540(h) x 80(d) mm
-------------	-------------	------------------------------

X-banner



One bag can be used with 4 flag shapes!

Feather



Quill



Edge



Zippered compartment to store graphics



Reinforced shoulder straps, adjustable strap and side mesh pocket



Storage for poles and rods



# Tents

Take advantage of outdoor events with a temporary structure and create additional marketing opportunities. Offer customers protection and shelter from the weather by choosing custom-printed tents that also provide an attractive brand marketing solution.

Conventional pop-up tents and gazebos are fantastic provisional outdoor or indoor structures which provide a unique way to advertise in a vibrant impactful manner with fully printed canopies and walls.

Constructed from robust steel or aluminium in a variety of sizes that are easy to transport, assemble, deploy and pack away, pop-up tents are ideal for short term events, fairs and exhibitions.

## Tents

For a more unique and unconventional structure, choose the Bora Inflatable Tent. Simple to inflate for rapid deployment with an appealing eye-catching shape, the Bora, like pop-up tents, also offers optional printed canopies and walls. Customisable areas make highly effective brand messaging, ensuring maximum impact at events. As with all custom-printed graphics, they can easily be replaced so that hardware is used multiple times, improving return on investment.



# Pop-up tents

## Zoom Tent Eco



The Zoom Tent Eco is the most cost-effective gazebo in our range. Quick and easy to deploy, the 3x3m tent can easily accommodate a 2.4m wide table making it a great solution for street markets, golf days or sporting events. Made from steel with a white powder coated finish, the frame easily shelters up to five people and folds completely into a portable wheeled carry bag. Custom fully printed canopy and walling is an optional extra.



<b>Material</b>	Steel frame, plastic joins
<b>Graphic area</b>	Double-sided (wall) / single-sided (canopy)
<b>Graphic attachment</b>	Hook and loop
<b>Ground fixing</b>	Pegs and ropes (included)
<b>Wind resistance</b>	Up to 18 mph / 29 km/h
<b>Transport</b>	Wheeled standard

Zoom Tent Eco 3x3	FD33-SQF	Ⓜ 3310(w) x 3315/3510(h) x 3310(d) mm
Canopy	FD33-CTW	Colour : White
Wall	FD33-FWW	Colour : White



Locking post



Winder for opening and closing



## Zoom Tent



Ensure your event's a success come rain or shine by using an easy to deploy vibrant lightweight aluminium pop-up tent frame system. The Zoom Tent folds out and returns in minutes with tool-free deployment. Dress with a custom full printed canopy, full and half walls. Available in a range of sizes.



<b>Material</b>	Aluminium frame, plastic joints
<b>Graphic area</b>	Double-sided (wall, half wall) / single-sided (canopy)
<b>Graphic colours</b>	White - Black (standard) / Full Graphic (optional)
<b>Graphic attachment</b>	Hook and loop / Pocket (half wall)
<b>Ground fixing</b>	Pegs and ropes (included)
<b>Wind resistance</b>	Up to 18 mph / 29 km/h
<b>Transport</b>	Wheeled Standard

3x3 frame	ZT33-XAF-01	Ⓞ 2920(w) x 3160(h) x 2920(d) mm
3x4.5 frame	ZT345-XAF-01	Ⓞ 4300(w) x 3160(h) x 2920(d) mm
3x6 frame	ZT36-XAF-01	Ⓞ 5800(w) x 3160(h) x 2920(d) mm

Canopy	ZTXX-CTW	Colours : White
Canopy	ZTXX-CTK	Colours : Black
Wall	ZTXX-FWW	Colours : White
Wall	ZTXX-FWK	Colours : Black
Half wall	ZTXX-HWW	Colours : White
Half wall	ZTXX-HWK	Colours : Black



### Ancillaries :

7.5 kg Weight	ZT-BASE
Half wall bar 2-3 m	ZT33-MTB



Pop-up frame



Tent weight (optional)



Automatic locking



Crank to tighten the canopy







# Inflatable tents

## Bora Tent



The Bora Inflatable Tent is a sturdy and attractive option for outdoor displays. Create shade and shelter for a registration desk, refreshment area or meeting point that fully shows off a brand. As one of the largest products in the range, there is plenty of print area on the canopy and backwalls (optional extra) for brand messaging. The backwalls zip in, so can be changed for a different message from the canopy if you wish. The Bora Tent uses trapped air technology: silent and free-standing once inflated.



<b>Material</b>	TPU, Polyester inner coat
<b>Graphic area</b>	Single-sided
<b>Graphic attachment</b>	Zip system (standard) / hook and loop (full graphic)
<b>Ground fixing</b>	Pegs (optional)
<b>Wind resistance</b>	Up to 24 mph / 39 km/h (if pegged)
<b>Transport</b>	Standard (included)

Bora Tent	INFT3-2Z	3200(w) x 2450(h) x 3200(d) mm
-----------	----------	--------------------------------



400W electric pump (optional) INFTA-PE4EU



Inflation valve



Carry bag included



# Counters

Temporary counters add a professional touch to any exhibition, event or retail environment. They provide a useful area for display or presentation space, and the ability to add a graphic creates additional marketing opportunities as well as offering a convenient storage facility.

Our counters are available in a range of price points and shapes, depending on requirements. Add impact to a welcome desk or a reception area in a public space with an illuminated counter or choose an outdoor option to promote a product or service at an open-air event.

## Counters

Counters are the perfect partner for a promotional display or event to complement a backdrop or add focus to an area and are the ideal companions for any marketing campaign.



# Promotional counters

## Pop-up Counta



The Pop-up Counta is convenient lightweight pop-up counter that offers a substantial area to welcome guests yet packs down for easy transportation in a reinforced D-shaped wheeled trolley case.

The counter comes with shelves for storage and a beech-coloured counter-top. Often used for exhibitions, in supermarkets as a demonstration unit and for events.

<b>Material</b>	Aluminium, plastic and MDF tabletop
<b>Assembly</b>	Self-locking magnetic
<b>Collapsible</b>	Yes
<b>Counter top</b>	Foldable - Beech colour
<b>Shelves</b>	4
<b>Graphic attachment</b>	Magnetic hangers, bars and tape (included). Suitable for 440 microns min. substrate (optional extra)
<b>Transport</b>	1 Wheeled trolley case

Pop-up 2x2	PUC22C-C	📏 1260(w) x 965(h) x 430(d) mm
------------	----------	--------------------------------



Structure



Magnetic fixing



Wheeled carry bag

## Hop-up Counta



Hop-up Counta is a durable lightweight hop-up counter, quick and easy to assemble with a single wrap around fabric graphic which stays on when collapsed and packed away. The unit is fitted with a beech effect counter top and provides a perfect welcome for guests.

<b>Material</b>	Aluminium, plastic, MDF tabletop and polycarbonate shelf
<b>Assembly</b>	Plastic locking arms
<b>Collapsible</b>	Yes
<b>Counter top</b>	Beech
<b>Shelves</b>	1
<b>Graphic attachment</b>	Hook and loop
<b>Transport</b>	One wheeled carry bag

Hop-up	HU301-001-C	📏 1060(w) x 1020(h) x 360(d) mm
--------	-------------	---------------------------------

Counter folds up with the graphic



Counter components



Plastic locking arm



Carry bag included

Shelf included



## Modulate™ Counter



Modulate™ Counter consists of an innovative aluminium tubular frame, counter top, and printed tension fabric graphic. Powerful magnets encased inside the frame enables two or more counters to connect using simple magnetic principles. The counter can be used on its own or combined to make a long reception or bar area. Modulate™ Counter can be deployed in minutes, thanks to the tool-less construction. The printed tension fabric graphic will either sit on or under the counter-top to suit the application.

PATENT PENDING

MODULATE™

Material	Ø 30mm Aluminium tubes, MDF tabletop/shelf
Assembly	Push-fit button
Collapsible	Yes
Counter top	Black
Shelves	1 (Optional)
Graphic attachment	Zip system
Transport	One padded carry bag, internal flap

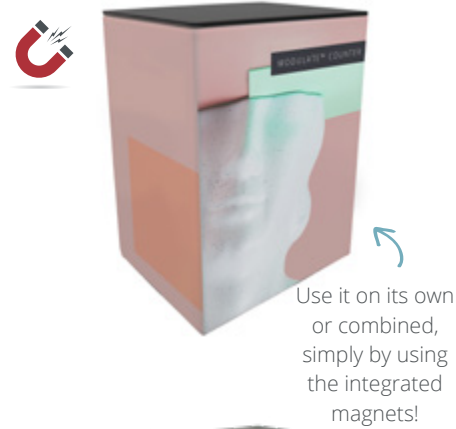

Modulate™ Counter	FORM-MOD-CNTR	800(w) x 1015(h) x 600(d) mm
Shelf	FORM-MOD-CNTR-02	770(w) x 9(h) x 571(d) mm



Tabletop is held in place by plastic moulding underneath



Optional shelf

## Basic Curved Counter



With a Double-D shape counter-top, the Basic Curved Counter delivers a functional and stylish look which is perfect to use for a reception desk or meeting point. The Counter is made from a rollable Corex tambour wrap to create the curved shape which push-fits into the thermoformed counter-top and base. A graphic can also be applied to the curved base to promote a message or brand. There is an opening for storage at the rear of the unit.

Material	MDF tabletop/base, Corex wrap
Assembly	Push-fit - Tool-free
Collapsible	Yes
Counter top	Beech / black
Transport	2 carry bags - included

Basics Curved Counter beech/beech	PK922-BEBE	910(w) x 925(h) x 480(d) mm
Basics Curved Counter black/beech	PK922-BLKBE	910(w) x 925(h) x 480(d) mm
Basics Curved Counter black/white	PK922-BLKW	910(w) x 925(h) x 480(d) mm



Interchangeable tabletops and bases

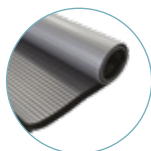

Grey counter wrap



Carry bag included



# Counta



Counta is a lightweight portable indoor PVC demonstrator unit which includes a header panel, poles and shelf supporting poles. Printed graphics can be applied as vinyl directly onto the base wrap.

Available in white. Perfect for use in retail environments, one-off events and promotions.

Material	PVC
Assembly	Push-fit - Tool-free
Collapsible	Yes
Counter top	No
Shelves	1
Graphic attachment	Self-adhesive
Transport	Carry bag

Counta	PC607	<ul style="list-style-type: none"> <li>📏 Counter and front graphic - 805(w) x 2195(h) x 450(d) mm</li> <li>📏 Front graphic - 680(w) x 280(h) x 20(d) mm</li> </ul>
--------	-------	--

Carrying bag included



Shelf for storage



Promotional counter, ideal for a retail



# illuminated Promotional Counters

## Illumigo™ Counter



This versatile and quick to set-up double-sided counter lightbox is a great all-rounder not only at events but in retail environments from shopping centres to pop-up shops. Part of the Illumigo™ range, the Illumigo™ Counter is easy to assemble with a two-part counter top that secures using a pair of twist out top locators and locking screws. Building the unit is intuitive and tool-free as all the parts are numbered and simply slot together. Two optional graphics complete the look to create an impactful counter ideal for attracting attention in retail, event or exhibition environments.



Material	Aluminium 100 mm, MDF table top
Assembly	Tool-free
Collapsible	Yes
Counter top	White
Graphic attachment	Silicone Edged Graphics (3 mm silicone)
Transport	Protective box with carry handle
LED System	LED strips included



Illumigo™	ILLGO-COUNTER-EU	📏 1040(w x 1045(h) ) x 420(d) mm
Illumigo™ Bag	ILLGO-BAG	📏 460(w) x 1160(h) x 190(d) mm



Optional Illumigo™ bag



Protective compartmented box



Pre-assembled LEDs in the frame



Steel side feet for stability





# Barriers

Barrier systems improve queue management and help with crowd control.

For pedestrian control, café barriers can be used to make an attractive, professional and functional barrier, creating a temporary space that can be easily reconfigured to suit your needs.

Café barriers are easy to store, assemble, deploy and move to suit your requirements. They are available in economy and premium solutions, depending on your application and budget.



## Barriers

Queue management systems can be used to control queues, providing structured and manageable lanes to help marshal customers and are also suitable for indoor or outdoor use.



# Pedestrian control barriers

A cost-effective way of defining areas outside restaurants, bars, shopping centre and coffee shops, a complete Café Barrier system requires two posts and bases. To secure the graphic, there are two options; dependent on budget and where the system is being deployed.

If the Café Barrier is exposed to strong winds, we recommend a two-rail option ensuring the graphic is secured top and bottom to each post and base. If winds are not an issue but the budget is tight, then we suggest a single rail with two spring clips securing the bottom of the graphic.

Rails are available in 1m, 1.5m and 2m sizes, so it is quick and easy to calculate the number of café barriers required to define your space. To connect multiple barriers, add a choice of rails/spring clips plus one additional pole and base. For vibrant hardwearing graphics we can print on PVC.

## Economy Café



<b>Material</b>	Aluminium
<b>Graphic area</b>	Double-sided / or single-sided
<b>Graphic attachment</b>	Looped top rail. Looped bottom rail or spring clips
<b>Weight</b>	9.13 kg



Graphic rail 1000 mm	UB214-1000	⊘ 1140(w) x 25(h) mm
Graphic rail 1500 mm	UB214-1500	⊘ 1940(w) x 25(h) mm
Graphic rail 2000 mm	UB214-2000	⊘ 2440(w) x 25(h) mm
Base	UB214B	⊘ 360 (Ø) mm
Post	UB214P	⊘ 960(h) mm
Spring clips (pair)	UB214-SC	

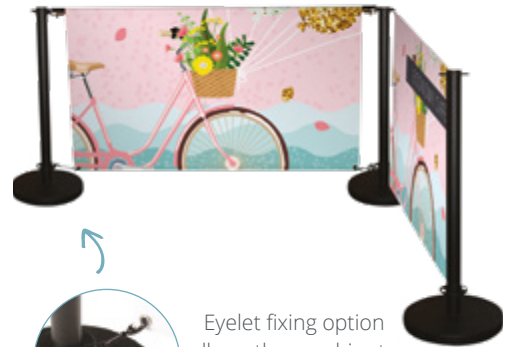

Eyelet fixing option allows the graphics to follow the movements of the wind



Spring clips for securing eyelet graphic



Graphic rail



Base and post

## Deluxe Café



<b>Material</b>	Aluminium chrome look finish
<b>Graphic area</b>	Single / double-sided
<b>Graphic attachment</b>	Looped top rail. Looped bottom rail or spring clips
<b>Weight</b>	8.63 kg



Graphic rail 1000 mm	UB215-1000	⊘ 1140(w) mm
Graphic rail 1500 mm	UB215-1500	⊘ 1940(w) mm
Graphic rail 2000 mm	UB215-2000	⊘ 2440(w) mm
Base	UB215B	⊘ 360 (Ø) mm
Post	UB215P	⊘ 960(h) mm
Spring clips (pair)	UB215-SC	







# Ancillaries

The range of ancillary products include literature holders, lighting solutions for various hardware ranges and transportation cases. These ancillaries offer flexibility and perfectly complement our product solutions.

## Ancillaries

Enhance an exhibition stand by selecting various supporting products from our range of ancillaries that are often used to help promote your brand in a more impactful way, professionally display your latest literature, or add points of interest, making your stand more visible by using spot lights.



# Literature holders (standard)

## Zed-up Lite



Zed-up Lite are a popular range of aluminium literature stands that are stylish and highly portable. Quick and easy to deploy, Zed-up Lite is ideal for exhibitions and displays, folding down for easy transportation in a heavy duty hard case.

<b>Material</b>	Acrylic and anodised aluminium
<b>Colour</b>	Silver
<b>Documents sizes</b>	A4
<b>Pockets</b>	6
<b>Double-sided</b>	Yes
<b>Transport</b>	Hard case (included)

A4 (6 pockets)	AS315-002	Ⓞ 256(w) x 1460(h) x 370(d) mm
----------------	-----------	--------------------------------



Rigid carry case included



# Lighting (standard)

## Powerspot 950/1000 LED



Economical black LED spotlight particularly suitable for use with Pop-up stands.

<b>Material</b>	Aluminium and plastic
<b>Positioning</b>	270° - Straight arm
<b>Watt output</b>	12 watt (1400 Lumens/5500 Kelvins)
<b>Watt consumption</b>	12 Watt (1400 Lumens/5500 Kelvins)
<b>Linked lights</b>	2 max
<b>Double kit includes</b>	2 spotlights + 2.5m linking lead + 1 transformer
<b>Power lead UK &amp; Euro</b>	Yes (cross head screwdriver needed)



Double kit	PS950-1000-LED-BDLK	ⓐ, 103(w) x 425(h) x 29(d) mm
------------	---------------------	-------------------------------



Transformer included

# Lighting (premium)

## LED Floodlight



The LED Floodlight is the new stylish and economical way to illuminate a range of exhibition stands including Pop-ups, Formulate and a range of modular systems. Despite the compact design, this small LED light is still capable of producing 1200 Lumens but still only consuming a small amount of energy, making it far more efficient than the halogen equivalents. Link up to 5 lights together from one transformer, with handy linking cables.

<b>Material</b>	Aluminium and plastic
<b>Watt output</b>	80 watt
<b>Watt consumption</b>	12 watt (1200 Lumens/5631 Kelvin)
<b>Linked lights</b>	Link up to five to one transformer
<b>Double kit includes</b>	2 spotlights + 2.5m linking lead + 1 transformer
<b>Power lead UK &amp; Euro</b>	Yes (cross head screwdriver needed)



Double kit	LED-FLOOD-ARM-BDLK	ⓐ, 295(w) x 483(h) x 60(d) mm
------------	--------------------	-------------------------------



Transportation box



Transformer included

Connect up to 5 lights with one transformer

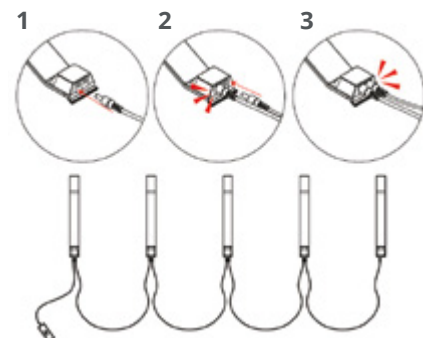

## LED Strip Light



The LED Strip light is designed to work with a wide range of exhibition stands including, Pop-ups, Formulate and a range of modular stands. It has a unique wide head design feature, allowing for a wider spread of light, helping you illuminate more of your message. Link up to 5 lights together from one transformer, with handy linking cables.

<b>Material</b>	Aluminium and plastic
<b>Watt output</b>	80 watt
<b>Watt consumption</b>	12 watt (1200 Lumens/5631 Kelvin)
<b>Linked lights</b>	Link up to five to one transformer
<b>Double kit includes</b>	2 spotlights + 2.5m linking lead + 1 transformer
<b>Power lead UK &amp; Euro</b>	Yes (cross head screwdriver needed)

Double kit	LED-STRIP-ARM-BDLK	📏 100(w) x 520(h) x 35(d) mm
------------	--------------------	------------------------------



Transportation box



Transformer included

## LED Exhibition Light



Specifically designed to work in conjunction with the Vector channel; this latest design requires no extra fitting, just plug in and switch on. Not only does the slick design make the LED Exhibition Light stand out from the crowd, the clever design cast out of aluminium allows any heat to dissipate over the entire body of the light, stopping any localised heat, which allows for long use with no overheating. Link up to 5 lights together from one transformer, with handy linking cables.

<b>Material</b>	Aluminium and plastic
<b>Watt output</b>	80 watt
<b>Watt consumption</b>	12 watt (1200 Lumens/5631 Kelvin)
<b>Linked lights</b>	Link up to five to one transformer
<b>Double kit includes</b>	2 spotlights + 2.5m linking lead + 1 transformer
<b>Power lead UK &amp; Euro</b>	Yes (cross head screwdriver needed)

Double kit	LED-EXHIB-ARM-BDLK	📏 50(w) x 455(h) x 55(d) mm
------------	--------------------	-----------------------------



Transportation box



Transformer included



# Lighting ancillaries

## Recommended fixings for lighting

Integrated fixing					
	Universal fixing kit <b>US901-C</b>	Vector fitting <b>VLF</b>	LED fitting for Quick+ <b>US902-C</b>	30mm Ø Tube clamp <b>US903</b>	
Compatible with :					
 Spot LED Flood <b>LED-FLOOD-ARM-BDLK</b>	> Quick +	> Arena	> Vector	> Quick Impact > Quick + > Hop Up	> Formulate > Modulate™
 Spot LED Strip <b>LED-STRIP-ARM-BDLK</b>	> Quick +	> Arena	> Vector	> Quick Impact > Quick + > Hop Up	> Formulate > Modulate™
 Spot LED Exhibition <b>LED-EXHIB-ARM-BDLK</b>	> Linear > Vector	/	/	/	> Formulate > Modulate™
 Powerspot 950-1000 LED <b>PS950-1000-LED-BDLK</b>	> Quick Impact > Quick + > Hop-up	> Arena	> Vector	/	> Formulate > Modulate™

### Convert your UK plug into EU version



Unscrew



Lift the lid



Pull the plug to  
extract it

# Portable transportation cases

## Zenith



Tough moulded polyethylene Zenith case offers a multitude of features. Versatile ultra-portable transport solution with maximum storage for pop-ups, backwalls, roller banners and extrusions, they also double up as counters with optional extra graphic wrap and table top. The standard case will house a 3x5 pop-up system and graphics. Secure Internal dividers protect graphics and the case can be locked using padlocks (not supplied).

<b>Material</b>	Medium-density polyethylene (MDPE) / Metal
<b>Wheels</b>	2
<b>Handle</b>	1
<b>Accessories</b>	Beech table top / graphic wrap

Zenith	AC600	Ⓞ (External dimensions) 600(w) x 956(h) x 400(d) mm
Tabletop (beech)	CO401-C	Ⓞ 15(h) x 640 (l) x 420 (p) mm



Zenith case thermoformed tabletop in beech



Foam protected lid holds two LED lights



Graphic wrap (optional)

## Illumigo™ Bag



Wheeled bag for Illumigo™ 2x1, Retail, ONE or the Illumigo™ counter.

Material	Nylon and inner MDF
Colour	Black
Wheels	Yes
Handle	2

Illumigo™ bag	ILLGO-BAG	Ⓞ (Internal dimensions) 460(w) x 1160(h) x 190(d) mm
---------------	-----------	--



Wheeled bag



Inner compartment for graphic



Carry handle

## Modular carrying bag



Ideal wheeled bag for transporting, protecting and storing exhibition stands, especially those made from standard modules (Vector & Formulate).

Material	Nylon
Colour	Black
Wheels	Yes
Handle	2

Modular Bag	AB-MODULAR-01	Ⓞ 340(w) x 1400(h) x 290(d) mm
-------------	---------------	--------------------------------



Carry handle



Wheels ø40mm



With graphic storage





# Applications

At Ultima Displays we provide Creative Display Solutions that suit a multitude of industry applications.

Our display products are not only multi-functional and in many cases reconfigurable, but they can also be used for an array of different applications across a multitude of industries.

From retail or educational settings, outdoor sporting events to hospitality and corporate events; our Creative Display Solutions are suitable for more than just exhibitions.

The following pages are a guide for where our popular products are often used to enhance brand messaging in a vibrant and eyeing-catching way.



## Retail

In the age of digitalisation, the main challenge for retail is to consider the customer experience at the point of sale.

### Window displays



### Commercial events



### Retail signage



### Pop-up store



### Seasonal campaigns



### Sales



### Shop openings



### Click and collect



### Car showroom

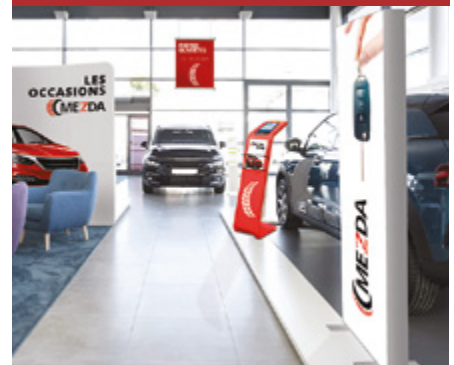

## Leisure Activities

The leisure industry represents an important part of the economy. From hospitality through to galleries, promoting the benefits of improved well-being and quality of life is essential with innovative displays that catch the eye.



### Interior signage



### Outdoor signage



### Posters



### Music venues



### Hospitality signage



### Suspended signage



### Fairs and markets



### Cinema foyers



### Art galleries





## Cultural Events

Social events with a national or international scope involve a large audience and can have a huge impact. Organisation is often extremely complex and requires significant communication resources.

### Award ceremonies

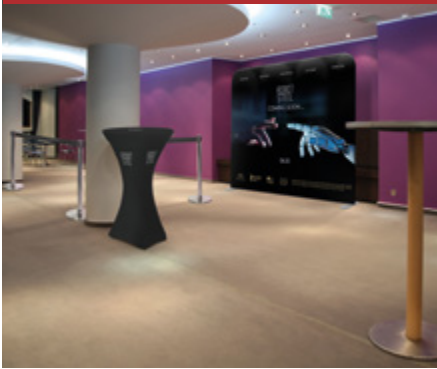

### Award ceremonies



### Professional sporting events



### Amateur sporting events



### Fundraising



### Festivals



### Military open days



### Electoral campaigns



### Fashion shoot





## Corporate Events

Corporate events are essential for companies to maintain close relationships and partnerships with their customers, business partners or employees.



### Product launches



### Brand launches

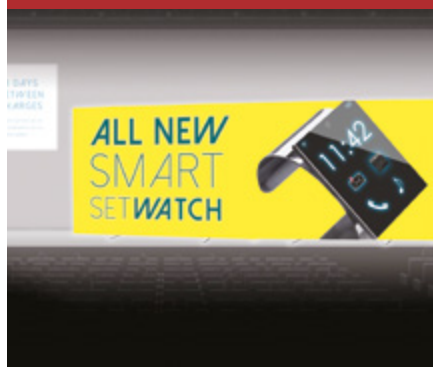

### Sales meetings



### Outdoor corporate events



### Corporate meetings



### Corporate dinners



### Gala events



### Open days



### Showrooms





## University Events

Educational, artistic and cultural events offer encounters, projects and practical experiments. The aim is to ensure artistic and cultural educational coherence for all pupils.

### Open days



### Campus life



### Graduation ceremonies



### Freshers week



### Graduation shows

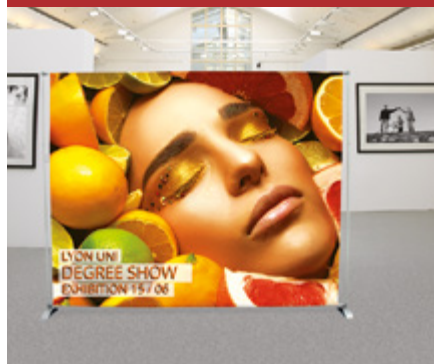

### Career and job fairs



### Ceremony staging



### Student services



### Gown hire



## Conference

Preparing a conference is an excellent opportunity for brand exposure at high value-added events. Brand messaging should communicate exceptional, new, or informative and important information relating to your business.



### Conferences



### Seminars



### Press conferences



### Product launch



### Concourse advertising



### Roadshows



### Networking



### Trade show



### Annual General Meetings (AGMs)





## Exhibitions

From planning to execution: give your brand the exposure it deserves with original, renewable and customised solutions.

Exhibition reception area



Exhibition shell system



Merchandising stand



Exhibition literature stand



Art gallery exhibition



Reconfigurable exhibition



Virtual exhibition



Reconfigurable stand



Exhibition - suspended



## Outdoor

Custom printed flags, signage, and tents invigorate any outdoor activity and attract attention to help brands or businesses stand out.



### Car dealerships



### Sporting meets and races



### Festivals



### Sales



### Museums



### Outdoor music events



### Clubs



### Inflatable



### Shelter





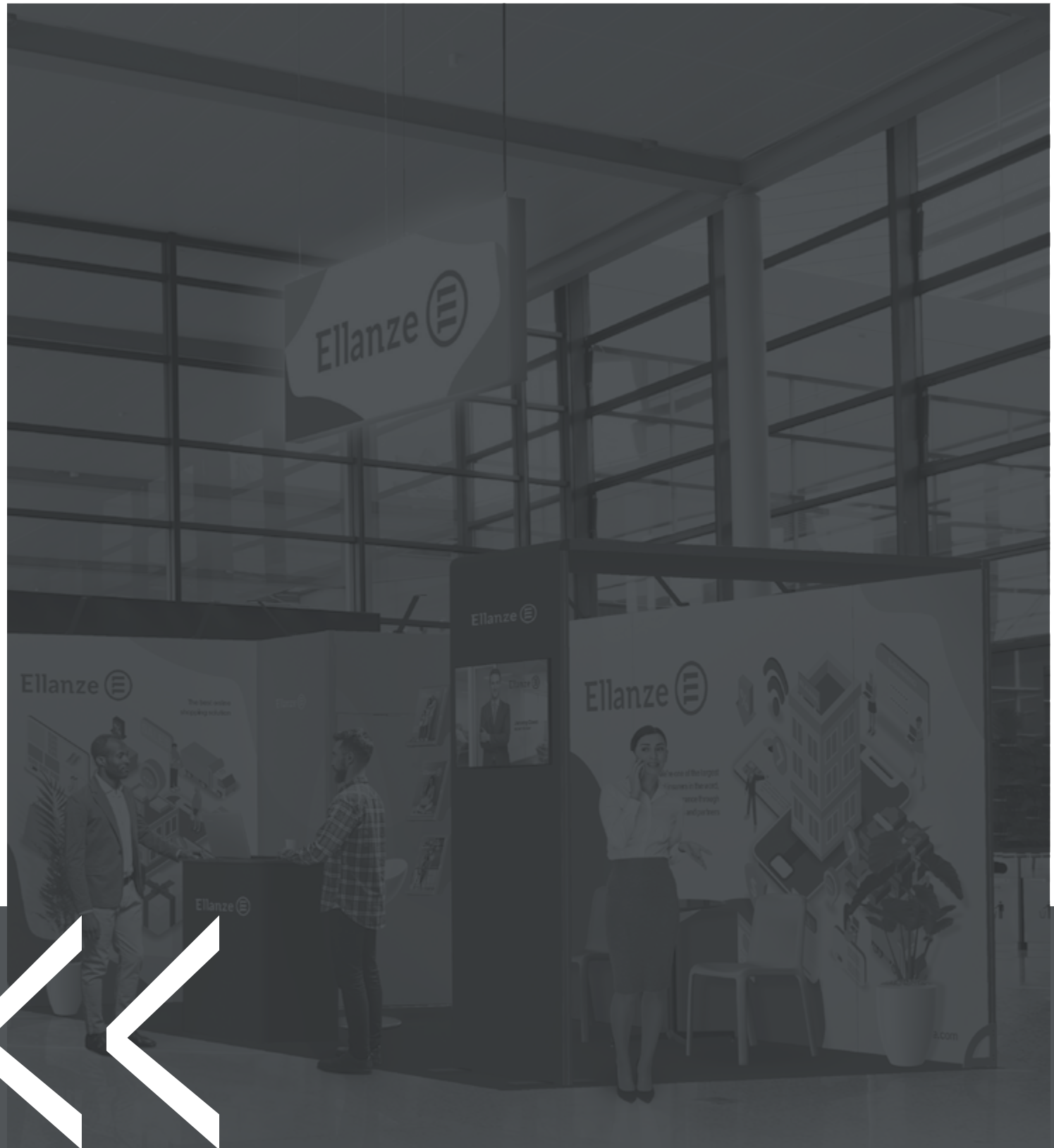

TERTZIA AB  
Basteråsvägen 23  
511 72 FRITSLA  
Sverige  
+46 (0)320 749 00  
info@reklamsaker.se

[www.reklamsaker.se](http://www.reklamsaker.se)

**25** years  
of creative  
display solutions

EN\_2024