

VARIOfit[®]

2024

The perfect form

of transport

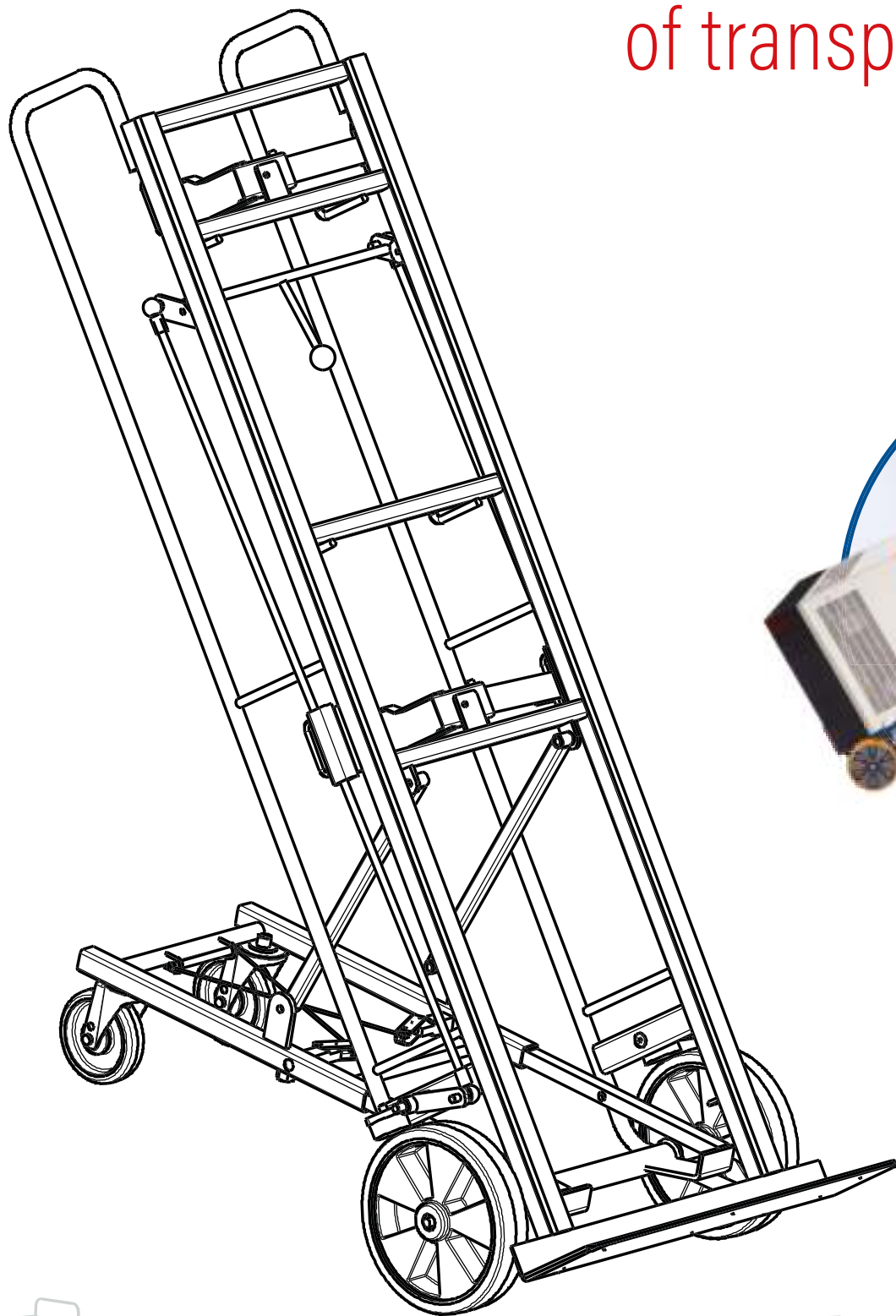

2 CONTENTS

PRODUCT CATALOGUE

Ergonomics and safety

Your health is also important to us: Hand and foot protection, easy running of the trolleys, and maximum safety through our braking systems



Information
p. 6, 164, 165

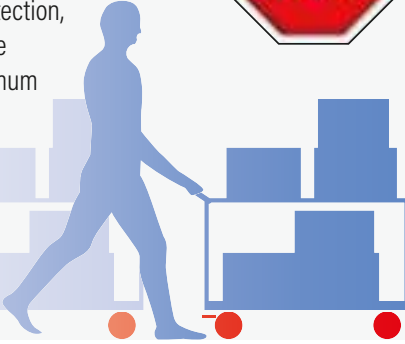

Sustainable through quality

Sustainable means long-lasting. We place the highest value on good quality, this saves your resources, costs and time.



Information
p. 5



Customizing – our daily business!

We manufacture complete new designs for customer-specific applications

Information p. 176



As standard – NEW

There are almost all products in RAL 5010 gentian blue and in RAL 7016 anthracite grey

And on request

Also available in almost all other colours: p. 177



NEWS

Materiallifter 90-91

Euro system dollies with push bar 60-63

Light table trolleys with larger load surfaces 22-23

Shaft with automatic braking solution and coupling 131

New accessories such as forklift pockets and rubber mats 174

RAL 7016 as standard on almost the entire range



The perfect form of transport

SYSTEM TROLLEYS

Plattform trolleys	7	Tubular-support trolleys	19	Euro container trolleys	47-49
Push bar trolleys	8-10	Sheet-material trolleys/stands	19	Small order-picking trolleys	50-51
System trolleys	11-12	Box trolleys	20-21	Material stands	52-53
Heavy-duty trolleys	13	Table trolleys	NEW 22-24	Crate dollies	55
Folding push bar trolleys	14-15	Heavy-duty table trolleys	26-27	Euro system dollies	NEW 56-63
C+C trolleys	16	Table trolleys with pan	28-29	Push-handle dollies	64-65
Side-frame trolleys	18	Shelf trolleys	30-46		

ESD

ESD shelf trolleys	67-69	ESD material stands	71	ESD table trolleys	73
ESD euro container/small order picking trolley/push-handle dolly	70	ESD push bar trolleys/ESD euro system dollies	72	ESD heavy-duty table trolleys	74
				ESD workshop trolleys	75

WORKSHOP/STORAGE

Workshop trolleys	76-83	Sheet-material trolleys/trucks	88-89	Order-picking trolleys	93-94
Workpiece trolleys	84-85	Materiallifter	NEW 90-91	Additional articles for order picking trolleys	95
Carrier-spar trolleys	86-87				

TRUCKS

Tubular steel trucks	97-102	Aluminium stair-climber trucks	108-109	Bulky goods truck	112
Aluminium trucks	103-105	Chair & furniture trucks	110	Lightweight folding trucks/Parcel trucks	113
Stair-climber trucks	106-107	Appliance trucks	111		

TYRE, STEEL-CYLINDER, DRUM AND PALLET HANDLING

Tyre handling	114-115	Handling of steel-cylinder	118-121	Handling of pallets	NEW 128-139
Accessories for tyre rack/tyre trolley	116-117	Handling of drums	122-126		

TRAILER

Hand trucks	140-141	Bicycle trailers	142
Roll truck, roll stand	141	Hand platform trolleys	143-145

HEAVY-DUTY

Quick-lift jacks and two-wheeled platforms	146-147	Two-wheeled platforms	148	Heavy-duty trolleys	150-151
		Long-goods trolley and dolly	149	Industrial trailers	152-153

SPECIAL

Dollies and dolly collector/Triple-Dogs	154-156	Table transporter	157	Disposal	160-161
		Document and book trolleys	158-159	Loading and unloading	162

ACCESSORIES

Summary of castors	168-171	General accessories	NEW 174-175
Accessories for trucks	172-173		

System trolleys

ESD

Workshop/Storage

Trucks

Tyre, Steel-cylinder, Drum, Pallet Handling

Trailers

Heavy-duty

Special

Accessories

VARIOfit.eu

Behind every strong brand is a strong manufacturer

EXPERIENCE VARIOfit® lets you and your customers profit from the flexibility of an experienced manufacturer.

THE BEGINNING Everything started when the company was set up in 1960 and the first trolley was patented: the Möbelhund® (the furniture mover).

QUALITY Continuing developments, TÜV certifications, a complex in-house, partially automated powder coating plant in addition to expansion of product and production facilities have made CORDES into a manufacturer that is a competent partner for the specialist trade and its users at all times.



LOGISTICS Our almost 550 employees process around 800 metric tons of steel a month on a footprint of approximately 85,000 m² and on a production and stacking ground of 43,000 m². Thanks to proven logistics and our narrow-aisle warehouse with more than 7,000 pallet bays served by the latest equipment, direct delivery of even large quantities is no problem.

DELIVERY Our standard items leave our warehouse within a few working days and with around 2,000 truckloads a year, as well as neutral delivery direct to the end customer, CORDES is a byword for fast and reliable delivery thanks to an efficient logistics chain.

THAT MEANS: CORDES stands for quality products and for speedy, reliable delivery based on an efficient logistics chain.



Convince yourself of the perfect form of transportation . . .



MODULAR SYSTEM

Four basic platforms of different sizes form the base for sturdy bolt-on fitting of almost all super-structures. So this products allow trouble-free modification to cater for changed equipments. This keeps **VARIOfit®** affordable for the customer and ensures that it maintains its value.



FACILITY AND SAFENESS

Thanks to their new wheels with thermoplastic tyres, **VARIOfit®** trucks and trolleys leave no marks even on light-coloured floors. Their sealed precision ball bearings of deepgroove design are not only robust and impact-resistant, but also extremely easy-running. And it goes without saying that their swivel castors are equipped with wheel brakes and foot guards as required by EU standards.



SPECIAL EQUIPMENT

VARIOfit®, as the name suggests, stands for unusually variable trucks and trolleys. In addition to its special product variants, **VARIOfit®** offers virtually unlimited possibilities for modification to suit customers' individual wishes.



INNOVATIVE L-SECTION FRAMES

Only **VARIOfit®** trucks have the L-section frame developed exclusively by CORDES to ensure maximum load-bearing capacity. This specially designed frame makes **VARIOfit®** trucks and trolleys extremely robust and light.



LOGISTICS CHAIN

With its efficient logistics chain, CORDES supplies direct to the end customer. This guarantees speedy delivery. It also means that products are normally dispatched within a few working days - and the customer can depend on it.



since 2011

EasySTOP CENTRAL BRAKE SYSTEM

The first central foot brake. Since 2011 it has been possible to bring trolleys to a stop in this easy but safe manner.

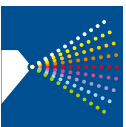

POWDER COATING

After thorough preliminary treatment, **VARIOfit®** products are powder-coated, then stove enamelled to optimise and enhance their surface finish. This makes them resistant to impacts and scratches and gives them the robustness they need for a long service life.



TÜV CERTIFICATE

TÜV (the German technical inspection authority) stands for quality and safety. Most **VARIOfit®** products bear this mark. The TÜV mark can be awarded to trolleys with a payload of up to 500 kg and trucks with a capacity of 250 kg.



6 CENTRAL FOOT BRAKE

VARIOfit[®]



EasySTOP where and how you need it – define the operating range yourself

FOUR-SIDED You can have our proven **EasySTOP** central brake system fitted on any of the four sides. The truck or trolley can be customized as required to satisfy local conditions perfectly. The pedal can be mounted on 1, 2, 3 or 4 sides.

Stay flexible and benefit from a number of advantages

- Being able to apply and release the central brake you can brake either 2 wheels or 4 wheels with only one pedal operation
- When combined with a drawbar/coupling, the central brake is automatically released on hitching up. This prevents driving with braked castors.
- 4 swivel castors ensure more manoeuvrability even in narrow spaces and decrease the turning circle.



DOUBLE is BETTER... Use all advantages of our Double **EasySTOP** central brake system and stand out from the competition!

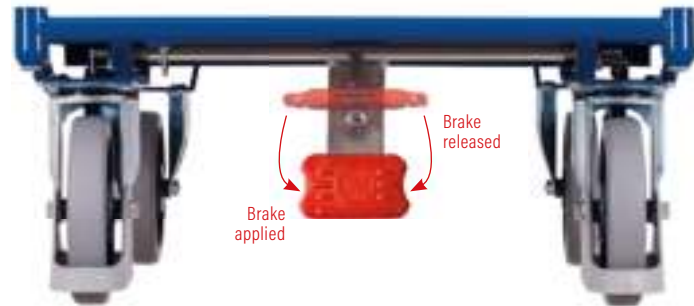

Since 2017 standard in nearly all **VARIOfit**[®] trucks and trolleys!

- Easy stop: Simply press the **EasySTOP** brake once - this arrests both swivel castors
- Easy go: Return the pedal to its starting position - quick and easy
- Safety: Fixed position with easy access by trolley operator permits instant braking
- Adjustable braking action
- Pedal can be operated with normal shoes or safety footwear
- Braking always possible regardless of wheel position
- Firm standing
- Ergonomic: Light actuation, short travel
- Versatile: **EasySTOP** pedal can be mounted on all four sides, customised to your needs

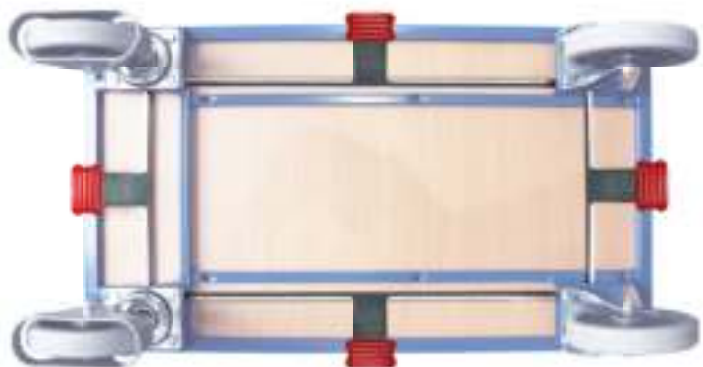

Define the operating range yourself

ONE BASE - MANY FACILITIES 7



RAL 5010 RAL 7016

CONSTRUCTION

- Modular system
- Base structure with innovative frame section

FEATURES

- Load surface of wood-based board, surface finish beech or coated dark grey

FITTINGS

- 2 **EasySTOP** swivel castors, 2 fixed castors
- Grey non-marking thermoplastic rubber tyres on plastic wheel rim with precision deepgroove ball bearings, with foot guard
- Available in 2 colours, RAL 5010 gentian blue or RAL 7016 anthracite grey, powder-coated

Our modular system
Available in two colours



The base

- Four basic platforms of different sizes form the basis for almost all types of bodies that are mounted using a sturdy screwed connection.
- So it's also easy to adapt these products to different requirements.
- In this way **VARIOfit**® remains affordable and retains its intrinsic value for the customer.



Platform trolley

Article-no. + /Colour	Dimension W x D x H (mm)	Weight kg	Loading surface W x D (mm)	Load cap. kg	Wheel diam. mm
sw-500.000 / AG	910 x 500 x 255	20.5	910 x 500	400	160 x 40
sw-600.000 / AG	1060 x 600 x 295	25.0	1060 x 600	500	200 x 40
sw-700.000 / AG	1060 x 700 x 295	26.0	1060 x 700	500	200 x 40
sw-800.000 / AG	1260 x 800 x 295	32.0	1260 x 800	500	200 x 40



8 PUSH BAR TROLLEYS



Available in 2 colours

EasySTOP

System trolleys



Wheels also available in grey

CONSTRUCTION

- Modular system
- Base structure with innovative frame section, or of round pipe

FEATURES

- Load surface of wood-based board, surface finish beech or coated dark grey or of waterproof bonded plywood, surface finish screen printed, anti-slip

FITTINGS

- 2 **EasySTOP** swivel castors, 2 fixed castors
- Grey non-marking thermoplastic rubber tyres on plastic wheel rim with precision deepgroove ball bearings, with food guard, or elastic solid-rubber tyres on cast aluminium wheel rim with precision deepgroove ball bearings, black, with foot guard, wheels also available in grey
- Available in 2 colours, RAL 5010 gentian blue or RAL 7016 anthracite grey, powder-coated

BEST SELLER

Push bar trolley

Article-no. + /Colour	Dimension WxDxH (mm)	Weight kg	Loading surface WxD (mm)	Load cap. kg	Wheel diam. mm
sw-500.100 / AG	975 x 500 x 975	25.0	880 x 500	400	160 x 40
sw-600.100 / AG	1125 x 600 x 1015	29.5	1030 x 600	500	200 x 40
sw-700.100 / AG	1125 x 700 x 1015	33.5	1030 x 700	500	200 x 40
sw-800.100 / AG	1325 x 800 x 1015	37.0	1230 x 800	500	200 x 40

Also available in ESD design on page 72

Push bar trolley

Article-no. + /Colour	Dimension WxDxH (mm)	Weight kg	Loading surface WxD (mm)	Load cap. kg	Wheel diam. mm
sw-500.103 / AG	950 x 500 x 990	23.5	850 x 500	400	160 x 40
sw-700.103 / AG	1100 x 700 x 1030	28.0	1000 x 700	400	200 x 40
sw-700.104 / AG	1300 x 700 x 1030	32.5	1200 x 700	400	200 x 40

Light version | tubular steel push bar trolley

Article-no. + /Colour	Dimension WxDxH (mm)	Weight kg	Loading surface WxD (mm)	Load cap. kg	Wheel diam. mm
sw-450.103 / AG	950 x 450 x 945	17.0	850 x 450	200	125 x 30
sw-600.109 / AG	1100 x 600 x 945	22.5	1000 x 600	200	125 x 30

Push bar trolley | with screen printing plate

Article-no. + /Colour	Dimension WxDxH (mm)	Weight kg	Loading surface WxD (mm)	Load cap. kg	Wheel diam. mm
sw-700.180 / AG	1130 x 700 x 1015	36.0	1025 x 700	1000	200 x 50
sw-800.180 / AG	1330 x 800 x 1015	44.0	1225 x 800	1000	200 x 50
sw-800.181 / AG	1730 x 800 x 1015	51.0	1625 x 800	1000	200 x 50
sw-800.184 / AG	2130 x 800 x 1015	58.0	2025 x 800	1000	200 x 50

Elastic solid-rubber tyres



RAL 5010 RAL 7016

CONSTRUCTION

- Modular system
- Base structure with innovative frame section, or of round pipe

FEATURES

- Load surface of wood-based board, surface finish beech or coated dark grey

FITTINGS

- 2 **EasySTOP** swivel castors, 2 fixed castors
- Grey non-marking thermoplastic rubber tyres on plastic wheel rim with precision deepgroove ball bearings, with food guard
- Available in 2 colours, RAL 5010 gentian blue or RAL 7016 anthracite grey, powder-coated

Available in 2 colours
Variations of push bars
EasySTOP



System trolleys

Push bar trolley | with bended tubes



Article-no. + /Colour	Dimension W x D x H (mm)	Weight kg	Loading surface W x D (mm)	Load cap. kg	Wheel diam. mm
sw-500.119 / AG	975 x 500 x 935	21.5	880 x 500	250	125 x 30
sw-600.119 / AG	1125 x 600 x 935	25.0	1030 x 600	250	125 x 30



Double-end push bar trolley | with bended tubes



Article-no. + /Colour	Dimension W x D x H (mm)	Weight kg	Loading surface W x D (mm)	Load cap. kg	Wheel diam. mm
sw-500.219 / AG	1040 x 500 x 935	26.0	850 x 500	250	125 x 30
sw-600.219 / AG	1190 x 600 x 935	30.0	1000 x 600	250	125 x 30



Push bar trolley | with vertical tubes



Article-no. + /Colour	Dimension W x D x H (mm)	Weight kg	Loading surface W x D (mm)	Load cap. kg	Wheel diam. mm
sw-500.105 / AG	950 x 500 x 990	25.5	850 x 500	400	160 x 40
sw-700.105 / AG	1100 x 700 x 1030	31.0	1000 x 700	400	200 x 40
sw-700.106 / AG	1300 x 700 x 1030	33.5	1200 x 700	400	200 x 40



Table trolley | with push bar



Article-no. + /Colour	Dimension W x D x H (mm)	Weight kg	Loading surface W x D (mm)	Load cap. kg	Wheel diam. mm
sw-500.503 / AG	955 x 505 x 990	31.5	850 x 500	400	160 x 40
sw-700.503 / AG	1105 x 705 x 1030	40.0	1000 x 700	400	200 x 40
sw-700.504 / AG	1305 x 705 x 1030	47.5	1200 x 700	400	200 x 40



Load capacity shelf: 120 kg**

**Static distributed load; Total load of the transport device must not be exceeded!

10 PUSH BAR TROLLEYS

RAL 5010 RAL 7016

Available in 2 colours
Dead man's brake

System trolleys

Brake applied
Brake released



AG



CONSTRUCTION

- Base structure with innovative frame section
- Fixed welded tubular push bar with dead man's brake, additional handle beneath the push bar

FEATURES

- Load surface of wood-based board, surface finish beech or coated dark grey

FITTINGS

- 2 swivel castors with dead man's brake, 2 fixed castors
- Grey non-marking thermoplastic rubber tyres on plastic wheel rim with precision deepgroove ball bearings, with foot guard
- Available in 2 colours, RAL 5010 gentian blue or RAL 7016 anthracite grey, powder-coated

Push bar trolley with dead man's brake

Article-no. + /Colour	Dimension W x D x H (mm)	Weight kg	Loading surface W x D (mm)	Load cap. kg	Wheel diam. mm
sw-600.125 / AG	945 x 600 x 1015	25.5	800 x 600	250	125 x 30

STORE-ROOM TROLLEY

Available in 2 colours or aluminium

Fixed welded

EasySTOP



CONSTRUCTION

- Robust welded steel or aluminium construction
- Transverse strut in push bar

FEATURES

- Load surface of wood-based board, surface finish beech or coated dark grey or of waterproof bonded plywood, surface finish screen printed, anti-slip

FITTINGS

- 2 **EasySTOP** swivel castors, 2 fixed castors
- Grey non-marking thermoplastic rubber tyres on plastic wheel rim with precision deepgroove ball bearings, with foot guard
- Available in 2 colours, RAL 5010 gentian blue or RAL 7016 anthracite grey, powder-coated or aluminium



RAL 5010

RAL 7016

ALU minimum

BEST SELLER

Store-room trolley

Article-no. + /Colour	Dimension W x D x H (mm)	Weight kg	Loading surface W x D (mm)	Load cap. kg	Wheel diam. mm
sw-450.801 / AG	1115 x 450 x 970	16.0	890 x 450	200	125 x 30
sw-600.800 / AG	1265 x 600 x 970	22.0	1040 x 600	200	125 x 30



Aluminium store-room trolley

Article-no.	Dimension W x D x H (mm)	Weight kg	Loading surface W x D (mm)	Load cap. kg	Wheel diam. mm
ap-421.000	995 x 440 x 975	9.5	845 x 440	200	125 x 30





RAL 5010 RAL 7016

CONSTRUCTION

- Modular system
- Base structure with innovative frame section

FEATURES

- Load surface of wood-based board, surface finish beech or coated dark grey
- End and side walls of mesh with size 50 x 50 mm
- Side walls 515 mm high and removable

FITTINGS

- 2 **EasySTOP** swivel castors, 2 fixed castors
- Grey non-marking thermoplastic rubber tyres on plastic wheel rim with precision deepgroove ball bearings, with foot guard
- Available in 2 colours, RAL 5010 gentian blue or RAL 7016 anthracite grey, powder-coated

Available in 2 colours
End and side walls of mesh
Side walls removable
EasySTOP



System trolleys

Single-end trolley | with mesh



Article-no. + /Colour	Dimension W x D x H (mm)	Weight kg	Loading surface W x D (mm)	Load cap. kg	Wheel diam. mm
sw-500.101 / AG	975 x 500 x 975	25.0	880 x 500	400	160 x 40
sw-600.101 / AG	1125 x 600 x 1015	30.0	1030 x 600	500	200 x 40
sw-700.101 / AG	1125 x 700 x 1015	31.5	1030 x 700	500	200 x 40
sw-800.101 / AG	1325 x 800 x 1015	36.5	1230 x 800	500	200 x 40



Double-end trolley | with mesh



Article-no. + /Colour	Dimension W x D x H (mm)	Weight kg	Loading surface W x D (mm)	Load cap. kg	Wheel diam. mm
sw-500.201 / AG	1040 x 500 x 975	30.5	850 x 500	400	160 x 40
sw-600.201 / AG	1190 x 600 x 1015	36.0	1000 x 600	500	200 x 40
sw-700.201 / AG	1190 x 700 x 1015	38.5	1000 x 700	500	200 x 40
sw-800.201 / AG	1390 x 800 x 1015	45.0	1200 x 800	500	200 x 40



Three-sided trolley | with mesh



Article-no. + /Colour	Dimension W x D x H (mm)	Weight kg	Loading surface W x D (mm)	Load cap. kg	Wheel diam. mm
sw-500.301 / AG	1040 x 500 x 975	32.0	850 x 475	400	160 x 40
sw-600.301 / AG	1190 x 600 x 1015	38.0	1000 x 575	500	200 x 40
sw-700.301 / AG	1190 x 700 x 1015	41.5	1000 x 675	500	200 x 40
sw-800.301 / AG	1390 x 800 x 1015	47.5	1200 x 775	500	200 x 40



Side wall fixing

Four-sided trolley | with mesh



Article-no. + /Colour	Dimension W x D x H (mm)	Weight kg	Loading surface W x D (mm)	Load cap. kg	Wheel diam. mm
sw-500.401 / AG	1040 x 500 x 975	37.0	850 x 450	400	160 x 40
sw-600.401 / AG	1190 x 600 x 1015	42.5	1000 x 550	500	200 x 40
sw-700.401 / AG	1190 x 700 x 1015	45.0	1000 x 650	500	200 x 40
sw-800.401 / AG	1390 x 800 x 1015	53.0	1200 x 750	500	200 x 40



**BEST
SELLER**

12 SYSTEM TROLLEYS



RAL 5010

RAL 7016

Available in 2 colours

End and side walls of wood-based board

Side walls removable

EasySTOP

System trolleys



AG



515 mm

Side wall fixing



CONSTRUCTION

- Modular system
- Base structure with innovative frame section

FEATURES

- Load surface, end and side walls of wood-based board, surface finish beech or coated dark grey
- Side walls 515 mm high and removable

FITTINGS

- 2 **EasySTOP** swivel castors, 2 fixed castors
- Grey non-marking thermoplastic rubber tyres on plastic wheel rim with precision deepgroove ball bearings, with foot guard
- Available in 2 colours, RAL 5010 gentian blue or RAL 7016 anthracite grey, powder-coated

Single-end trolley | with board

Article-no. + /Colour	Dimension W x D x H (mm)	Weight kg	Loading surface W x D (mm)	Load cap. kg	Wheel diam. mm
sw-500.102 / AG	975 x 500 x 975	26.0	880 x 500	400	160 x 40
sw-600.102 / AG	1125 x 600 x 1015	30.0	1030 x 600	500	200 x 40
sw-700.102 / AG	1125 x 700 x 1015	33.0	1030 x 700	500	200 x 40
sw-800.102 / AG	1325 x 800 x 1015	39.0	1230 x 800	500	200 x 40

Double-end trolley | with board

Article-no. + /Colour	Dimension W x D x H (mm)	Weight kg	Loading surface W x D (mm)	Load cap. kg	Wheel diam. mm
sw-500.202 / AG	1040 x 500 x 975	30.5	850 x 500	400	160 x 40
sw-600.222 / AG	1190 x 600 x 1015	34.5	1000 x 600	500	200 x 40
sw-700.202 / AG	1190 x 700 x 1015	40.0	1000 x 700	500	200 x 40
sw-800.202 / AG	1390 x 800 x 1015	45.5	1200 x 800	500	200 x 40

Three-sided trolley | with board

Article-no. + /Colour	Dimension W x D x H (mm)	Weight kg	Loading surface W x D (mm)	Load cap. kg	Wheel diam. mm
sw-500.302 / AG	1040 x 500 x 975	38.0	850 x 475	400	160 x 40
sw-600.302 / AG	1190 x 600 x 1015	45.0	1000 x 575	500	200 x 40
sw-700.302 / AG	1190 x 700 x 1015	48.5	1000 x 675	500	200 x 40
sw-800.302 / AG	1390 x 800 x 1015	56.0	1200 x 775	500	200 x 40



Four-sided trolley | with board

Article-no. + /Colour	Dimension W x D x H (mm)	Weight kg	Loading surface W x D (mm)	Load cap. kg	Wheel diam. mm
sw-500.400 / AG	1040 x 500 x 975	43.5	850 x 450	400	160 x 40
sw-600.400 / AG	1190 x 600 x 1015	51.0	1000 x 550	500	200 x 40
sw-700.400 / AG	1190 x 700 x 1015	54.0	1000 x 650	500	200 x 40
sw-800.400 / AG	1390 x 800 x 1015	61.0	1200 x 750	500	200 x 40



RAL 5010 RAL 7016

CONSTRUCTION

- Modular system
- Base structure with innovative frame section

FEATURES

- Load surface, end and side walls of waterproof bonded plywood, surface finish screen printed, anti-slip
- Side walls 515 mm high and removable

FITTINGS

- 2 **EasySTOP** swivel castors, 2 fixed castors
- Elastic solid-rubber tyres on cast aluminium wheel rim with precision deepgroove ball bearings, black, with foot guard, wheels also available in grey
- Available in 2 colours, RAL 5010 gentian blue or RAL 7016 anthracite grey, powder-coated

Available in 2 colours
Load surface and walls screen printed
Side walls removable
EasySTOP



System trolleys

Single-end trolley | with screen printing plate

Article-no. + /Colour	Dimension W x D x H (mm)	Weight kg	Loading surface W x D (mm)	Load cap. kg	Wheel diam. mm
sw-700.182 / AG	1130 x 700 x 1015	38.5	1025 x 700	1000	200 x 50
sw-800.182 / AG	1330 x 800 x 1015	47.5	1225 x 800	1000	200 x 50
sw-800.183 / AG	1730 x 800 x 1015	54.5	1625 x 800	1000	200 x 50
sw-800.185 / AG	2130 x 800 x 1015	62.0	2025 x 800	1000	200 x 50



Double-end trolley | with screen printing plate

Article-no. + /Colour	Dimension W x D x H (mm)	Weight kg	Loading surface W x D (mm)	Load cap. kg	Wheel diam. mm
sw-700.212 / AG	1195 x 700 x 1015	45.5	995 x 700	1000	200 x 50
sw-800.212 / AG	1395 x 800 x 1015	54.5	1195 x 800	1000	200 x 50
sw-800.213 / AG	1795 x 800 x 1015	61.5	1595 x 800	1000	200 x 50
sw-800.226 / AG	2195 x 800 x 1015	69.5	1995 x 800	1000	200 x 50



Three-sided trolley | with screen printing plate

Article-no. + /Colour	Dimension W x D x H (mm)	Weight kg	Loading surface W x D (mm)	Load cap. kg	Wheel diam. mm
sw-700.322 / AG	1195 x 700 x 1015	54.5	995 x 665	1000	200 x 50
sw-800.322 / AG	1395 x 800 x 1015	66.5	1195 x 765	1000	200 x 50
sw-800.323 / AG	1795 x 800 x 1015	72.0	1595 x 765	1000	200 x 50
sw-800.324 / AG	2195 x 800 x 1015	80.5	1995 x 765	1000	200 x 50



Four-sided trolley | with screen printing plate

Article-no. + /Colour	Dimension W x D x H (mm)	Weight kg	Loading surface W x D (mm)	Load cap. kg	Wheel diam. mm
sw-700.465 / AG	1195 x 700 x 1015	58.5	995 x 650	1000	200 x 50
sw-800.465 / AG	1395 x 800 x 1015	71.5	1195 x 750	1000	200 x 50
sw-800.299 / AG	1795 x 800 x 1015	82.5	1595 x 750	1000	200 x 50
sw-800.466 / AG	2195 x 800 x 1015	94.5	1995 x 750	1000	200 x 50



14 FOLDING PUSH BAR TROLLEYS



Folding push bar
Loadable beyond the loading surface
EasySTOP
or dead man's brake

System trolleys

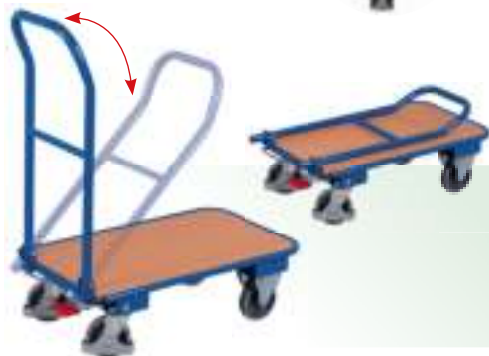

CONSTRUCTION

- Welded steel construction
- Folding push bar or tubular push bar with transverse strut and dead man's brake, additional handle beneath the push bar

FEATURES

- Load surface of wood-based board, surface finish beech or coated dark grey

FITTINGS

- 2 **EasySTOP** swivel castors, 2 fixed castors or 2 swivel castors with dead man's brake, 2 fixed castors
- Grey non-marking thermoplastic rubber tyres on plastic wheel rim with precision deepgroove ball bearings, with foot guard
- Available in 2 colours, RAL 5010 gentian blue or RAL 7016 anthracite grey, powder-coated

BEST SELLER

Folding push bar trolley

Article-no. + /Colour	Dimension W x D x H (mm)	Weight kg	Loading surface W x D (mm)	Load cap. kg	Wheel diam. mm
sw-450.802 / AG	815 x 450 x 940	15.0	720 x 450	150	125 x 30
sw-600.802 / AG	995 x 600 x 980	23.5	900 x 600	250	160 x 40

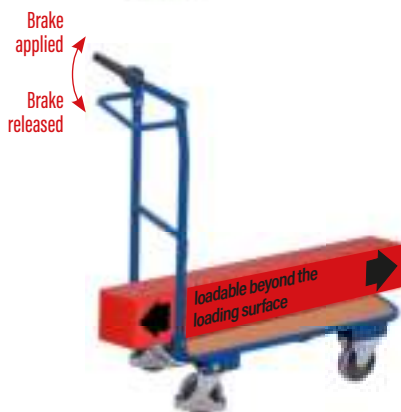

Folding push bar trolley | with dead man's brake

Article-no. + /Colour	Dimension W x D x H (mm)	Weight kg	Loading surface W x D (mm)	Load cap. kg	Wheel diam. mm
sw-450.831 / AG	865 x 450 x 1005	17.5	720 x 450	150	125 x 30



Folding push bar trolley | with 2 push bars

Article-no. + /Colour	Dimension W x D x H (mm)	Weight kg	Loading surface W x D (mm)	Load cap. kg	Wheel diam. mm
sw-450.803 / AG	850 x 450 x 940	18.5	720 x 450	150	125 x 30
sw-600.812 / AG	1030 x 600 x 980	27.0	900 x 600	250	160 x 40



Upper shelf lockable in folded state, lower load surface also usable with shelf folded

Folding push bar trolley | with 2 shelves

Article-no. + /Colour	Dimension W x D x H (mm)	Weight kg	Loading surface W x D (mm)	Load cap. kg	Wheel diam. mm
sw-450.836 / AG	890 x 450 x 970	28.0	720 x 450	150	125 x 30

Load capacity shelf: 70 kg**



ALU
minium

CONSTRUCTION

- Welded aluminium construction
- Folding push bar with transverse strut

FEATURES

- Load surface of diamond-tread plate or pasted with 3 mm grooved rubber mat, black

FITTINGS

- 2 **EasySTOP** swivel castors, 2 fixed castors
- Grey non-marking thermoplastic rubber tyres on plastic wheel rim with precision deepgroove ball bearings, with foot guard

Folding push bar
Loadable beyond the loading surface
EasySTOP

System trolleys

Aluminium folding push bar trolley

**BEST
SELLER**



Article-no.	Dimension W x D x H (mm)	Weight kg	Loading surface W x D (mm)	Load cap. kg	Wheel diam. mm
ap-450.803	815 x 450 x 950	10.0	720 x 450	150	125 x 30
ap-600.803	995 x 600 x 990	17.5	900 x 600	150	160 x 40



Aluminium folding push bar trolley | with grooved rubber mat



Article-no.	Dimension W x D x H (mm)	Weight kg	Loading surface W x D (mm)	Load cap. kg	Wheel diam. mm
ap-450.810	815 x 450 x 950	12.0	720 x 450	150	125 x 30
ap-600.812	995 x 600 x 990	19.5	900 x 600	150	160 x 40



Upper shelf lockable in folded state, lower load surface also usable with shelf folded

Aluminium folding push bar trolley | with 2 shelves

Article-no.	Dimension W x D x H (mm)	Weight kg	Loading surface W x D (mm)	Load cap. kg	Wheel diam. mm
ap-450.813	890 x 450 x 970	18.0	720 x 450	150	125 x 30

Load capacity shelf: 70 kg**



**Static distributed load; Total load of the transport device must not be exceeded!

Trolleys nestable
Optionally with 2 load surfaces

System trolleys



CONSTRUCTION

- Welded steel construction
- Push bar with vertical tubes or 4 side frames
- Trolleys nestable

FEATURES

- Load surfaces of wood-based board, surface finish beech or coated dark grey or of waterproof bonded plywood, surface finish screen printed, anti-slip

FITTINGS

- 2 swivel castors with brakes, 2 fixed castors
- Grey non-marking thermoplastic rubber tyres on plastic wheel rim with precision deepgroove ball bearings, with foot guard
- Available in 2 colours, RAL 5010 gentian blue or RAL 7016 anthracite grey, powder-coated

Hang-on wire basket on page 175

C + C trolley

Article-no. + /Colour	Dimension W x D x H (mm)	Weight kg	Loading surface W x D (mm)	Load cap. kg	Wheel diam. mm
sw-500.108 / AG	990 x 640 x 965	28.5	880 x 500	400	160 x 40
sw-700.108 / AG	1140 x 840 x 1005	35.5	1030 x 700	500	200 x 40

Hang-on wire basket on page 175

C + C trolley | with load surface of screen printing plate

Article-no. + /Colour	Dimension W x D x H (mm)	Weight kg	Loading surface W x D (mm)	Load cap. kg	Wheel diam. mm
sw-500.111 / AG	990 x 640 x 965	28.5	880 x 500	400	160 x 40
sw-600.111 / AG	1140 x 740 x 1005	33.0	1030 x 600	500	200 x 40
sw-700.111 / AG	1140 x 840 x 1005	38.5	1030 x 700	500	200 x 40

Hang-on wire basket on page 175

C + C trolley | with 2 load surfaces of screen printing plate

Article-no. + /Colour	Dimension W x D x H (mm)	Weight kg	Loading surface W x D (mm)	Load cap. kg	Wheel diam. mm
sw-500.112 / AG	990 x 640 x 965	36.5	880 x 500	400	160 x 40
sw-600.112 / AG	1140 x 740 x 1005	43.0	1030 x 600	500	200 x 40
sw-700.120 / AG	1140 x 840 x 1005	50.0	1030 x 700	500	200 x 40

Load capacity shelf: 80 kg**

C + C trolley | with 4 side frames

Article-no. + /Colour	Dimension W x D x H (mm)	Weight kg	Loading surface W x D (mm)	Load cap. kg	Wheel diam. mm
sw-500.114 / AG	950 x 640 x 955	29.0	880 x 445	400	160 x 40
sw-600.114 / AG	1100 x 740 x 995	32.5	1030 x 545	500	200 x 40
sw-700.121 / AG	1100 x 840 x 995	34.0	1030 x 645	500	200 x 40

INDIVIDUALLY

- Opportunities for modification in line with customers' individual wishes

UNIQUE PIECE

- Deliveries of small series from one piece upwards
- Product approval drawings
- Fair prices even for small quantities

CUSTOMER FOCUSED

- Analysing parameters such as uses, handling, workflows and much more in close cooperation with the customer

TAILORED

- Products in special sizes, special colours and complete new designs

Our custom-made products in comparison



Your challenges inspire our innovative solutions



18 SIDE-FRAME TROLLEYS



RAL 5010

RAL 7016

Side walls of wood or mesh, tubular walls or 4 brackets
EasySTOP longitudinal for transporting long goods

System trolleys



AG

CONSTRUCTION

- Modular system
- Base structure with innovative frame section

FEATURES

- Load surface and side walls of wood-based board, surface finish beech or coated dark grey, side walls alternatively of mesh with size 50 x 50 mm or with vertical tubular tubes or with 4 tubular side frames

FITTINGS

- 2 swivel and 2 fixed castors, with **EasySTOP** (1 swivel and 1 fixed castor is braked on one longitudinal side)
- Grey non-marking thermoplastic rubber tyres on plastic wheel rim with precision deepgroove ball bearings, with foot guard
- Available in 2 colours, RAL 5010 gentian blue or RAL 7016 anthracite grey, powder-coated



Side-frame trolley | with board sides

Article-no. + /Colour	Dimension WxDxH (mm)	Weight kg	Loading surface WxD (mm)	Load cap. kg	Wheel diam. mm
sw-600.200 / AG	1060 x 600 x 1045	44.5	1060 x 540	500	200 x 40
sw-700.200 / AG	1060 x 700 x 1045	46.0	1060 x 640	500	200 x 40
sw-800.200 / AG	1260 x 800 x 1045	53.0	1260 x 740	500	200 x 40



NEW



Side-frame trolley | with mesh sides

Article-no. + /Colour	Dimension WxDxH (mm)	Weight kg	Loading surface WxD (mm)	Load cap. kg	Wheel diam. mm
sw-600.239 / AG	1060 x 600 x 1045	34.5	1060 x 540	500	200 x 40
sw-700.231 / AG	1060 x 700 x 1045	37.5	1060 x 640	500	200 x 40
sw-800.237 / AG	1260 x 800 x 1045	49.5	1260 x 740	500	200 x 40



Side-frame trolley | with tubular side walls

Article-no. + /Colour	Dimension WxDxH (mm)	Weight kg	Loading surface WxD (mm)	Load cap. kg	Wheel diam. mm
sw-600.203 / AG	1060 x 600 x 1045	30.5	1060 x 540	500	200 x 40
sw-700.203 / AG	1060 x 700 x 1045	33.5	1060 x 640	500	200 x 40
sw-800.203 / AG	1260 x 800 x 1045	44.5	1260 x 740	500	200 x 40



Side-frame trolley | with 4 tubular side frames

Article-no. + /Colour	Dimension WxDxH (mm)	Weight kg	Loading surface WxD (mm)	Load cap. kg	Wheel diam. mm
sw-500.204 / AG	910 x 500 x 990	30.0	910 x 440	400	160 x 40
sw-600.204 / AG	1060 x 600 x 1030	35.0	1060 x 540	500	200 x 40
sw-700.204 / AG	1060 x 700 x 1030	37.0	1060 x 640	500	200 x 40
sw-800.204 / AG	1260 x 800 x 1030	43.5	1260 x 740	500	200 x 40



RAL 5010 RAL 7016

CONSTRUCTION

- Modular system
- Base structure with innovative frame section

FEATURES

- Load surface of wood-based board, surface finish beech or coated dark grey
- Use of up to 7 tubular supports possible

FITTINGS

- 2 swivel and 2 fixed castors, with **EasySTOP** (1 swivel and 1 fixed castor is braked on one longitudinal side)
- Grey non-marking thermoplastic rubber tyres on plastic wheel rim with precision deepgroove ball bearings, with foot guard
- Available in 2 colours, RAL 5010 gentian blue or RAL 7016 anthracite grey, powder-coated

Use of up to 7 tubular supports possible
EasySTOP longitudinal for transporting long goods



Tubular-support trolley | with 2 tubular supports



Article-no. + /Colour	Dimension W x D x H (mm)	Weight kg	Loading surface W x D (mm)	Load cap. kg	Wheel diam. mm
sw-700.205 / AG	1070 x 700 x 1040	40.5	990 x 640	500	200 x 40
sw-800.205 / AG	1270 x 800 x 1040	47.0	1190 x 740	500	200 x 40

ADDITIONAL ARTICLE Tubular supports

Article-no. + /Colour	For loading surface W x D (mm)	Weight kg
zsw-700.205 / AG	990 x 640	5.0
zsw-800.205 / AG	1190 x 740	5.0



System trolleys

RAL 5010 RAL 7016

SHEET-MATERIAL TROLLEY / SHEET-MATERIAL STAND

CONSTRUCTION

- Welded steel construction
- Without tubular support
- With one approach roller at end

FEATURES

- 7 alternative positions for inserting tubular supports, clearance between supports 95 mm

FITTINGS

- 2 swivel castors with brakes, 2 fixed castors
- Grey non-marking thermoplastic rubber tyres on plastic wheel rim with precision deepgroove ball bearings, or elastic solid-rubber tyres on cast aluminium wheel rim with precision deepgroove ball bearings, black, with foot guard, wheels also available in grey

One approach roller at end
Use of up to 7 tubular supports possible
Optionally elastic solid-rubber tyres

Sheet-material trolley | (without tubular support)

Article-no. + /Colour	Dimension W x D x H (mm)	Weight kg	Loading surface W x D (mm)	Load cap. kg	Wheel diam. mm
sw-1282 / AG	TR 1310 x 800 x 310	41.5	1200 x 800	500	200 x 40
sw-1283 / AG	ER 1310 x 800 x 310	44.5	1200 x 800	1200	200 x 50
sw-1284 / AG	TR 1710 x 800 x 310	47.0	1600 x 800	500	200 x 40
sw-1285 / AG	ER 1710 x 800 x 310	49.0	1600 x 800	1200	200 x 50

TR = Thermoplastic rubber tyres, ER = Elastic solid-rubber tyres



Sheet-material stand | (without tubular support)

Article-no. + /Colour	Dimension W x D x H (mm)	Weight kg	Loading surface W x D (mm)	Load cap. kg
zu-1286 / AG	1310 x 800 x 75	33.5	1200 x 800	1200
zu-1287 / AG	1710 x 800 x 75	39.5	1600 x 800	1200

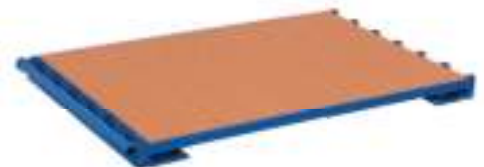

ADDITIONAL ARTICLE Feet for sheet-material stand

Article-no. + /Colour	Ground clearance (mm)	Weight kg
gzu-1286 / AG	100	1.5



ADDITIONAL ARTICLE Tubular support

Article-no. + /Colour	Dimension W x H (mm)	Weight kg
zsw-1290 / AG	1200 x 300	2.5
zsw-1291 / AG	1200 x 600	3.5
zsw-1292 / AG	1200 x 900	4.5
zsw-1293 / AG	1600 x 300	3.0
zsw-1294 / AG	1600 x 600	4.0
zsw-1295 / AG	1600 x 900	5.0



20 BOX TROLLEYS



RAL 5010

RAL 7016

Side walls of wood-based board or mesh
End and side walls individually removable

EasySTOP

System trolleys



Side wall fixing

AG

CONSTRUCTION

- Modular system
- Base structure with innovative frame section

FEATURES

- Load surface, end and side walls of wood-based board, surface finish beech or coated dark grey or end and side walls of mesh with size 50 x 50 mm
- End and side walls 200 mm high and individually removable

FITTINGS

- 2 **EasySTOP** swivel castors, 2 fixed castors
- Grey non-marking thermoplastic rubber tyres on plastic wheel rim with precision deepgroove ball bearings, with foot guard
- Available in 2 colours, RAL 5010 gentian blue or RAL 7016 anthracite grey, powder-coated

Box trolley | with board panels

Article-no. + /Colour	Dimension WxDxH (mm)	Weight kg	Loading surface WxD (mm)	Load cap. kg	Wheel diam. mm
sw-500.402 / AG	975 x 500 x 975	30.5	860 x 450	400	160 x 40
sw-600.402 / AG	1125 x 600 x 1015	35.0	1010 x 550	500	200 x 40
sw-700.402 / AG	1125 x 700 x 1015	39.5	1010 x 650	500	200 x 40
sw-800.402 / AG	1325 x 800 x 1015	45.5	1210 x 750	500	200 x 40

Box trolley | with mesh

Article-no. + /Colour	Dimension WxDxH (mm)	Weight kg	Loading surface WxD (mm)	Load cap. kg	Wheel diam. mm
sw-500.457 / AG	975 x 500 x 975	29.0	860 x 450	400	160 x 40
sw-600.457 / AG	1125 x 600 x 1015	33.0	1010 x 550	500	200 x 40
sw-700.457 / AG	1125 x 700 x 1015	37.0	1010 x 650	500	200 x 40
sw-800.457 / AG	1325 x 800 x 1015	43.0	1210 x 750	500	200 x 40

BOX TROLLEYS



RAL 5010

RAL 7016

FEATURES

- End and side walls 710 mm high
- With flap-down half wall on one side



710 mm

Box trolley | with board panels

Article-no. + /Colour	Dimension WxDxH (mm)	Weight kg	Loading surface WxD (mm)	Load cap. kg	Wheel diam. mm
sw-700.406 / AG	1060 x 715 x 1095	73.0	1000 x 650	500	200 x 40
sw-800.406 / AG	1260 x 815 x 1095	84.0	1200 x 750	500	200 x 40

Box trolley | with mesh

Article-no. + /Colour	Dimension WxDxH (mm)	Weight kg	Loading surface WxD (mm)	Load cap. kg	Wheel diam. mm
sw-700.404 / AG	1060 x 715 x 1095	50.5	1000 x 650	500	200 x 40
sw-800.404 / AG	1260 x 815 x 1095	57.0	1200 x 750	500	200 x 40

BEST
SELLER



RAL 5010 RAL 7016

CONSTRUCTION

- Fix welded angle-steel construction
- Horizontal tubular push bar

FEATURES

- Load surface, end and side walls of wood-based board, surface finish beech or coated dark grey or end and side walls of mesh with size 50 x 50 mm
- Internal height 800 mm, flap-down half wall on one side
- Double-flap lid, lies flat against side, lockable by device for padlock

FITTINGS

- 2 **EasySTOP** swivel castors, 2 fixed castors
- Grey non-marking thermoplastic rubber tyres on plastic wheel rim with precision deepgroove ball bearings, with foot guard
- Available in 2 colours, RAL 5010 gentian blue or RAL 7016 anthracite grey, powder-coated

Lockable lid
Device for padlock
EasySTOP

Box trolley | with board panels and lid | welded |

Article-no. + /Colour	Dimension W x D x H (mm)	Weight kg	Loading surface W x D (mm)	Load cap. kg	Wheel diam. mm
sw-700.407 / AG	1130 x 730 x 1150	82.0	970 x 670	500	200 x 40
sw-800.407 / AG	1330 x 830 x 1150	96.0	1170 x 770	500	200 x 40



System trolleys



Box trolley | with mesh and lid | welded |

Article-no. + /Colour	Dimension W x D x H (mm)	Weight kg	Loading surface W x D (mm)	Load cap. kg	Wheel diam. mm
sw-700.405 / AG	1130 x 730 x 1150	72.0	975 x 680	500	200 x 40
sw-800.405 / AG	1330 x 830 x 1150	77.5	1175 x 780	500	200 x 40



RAL 5010 RAL 7016

FEATURES

- Load surface, end and side walls of steel
- Internal height 810 mm, flap-down half wall on one side

- Without lid or single-flap lid, lies flat against side, with 2 gas pressure springs, lid lockable by device for padlock

Steel box trolley | with lid | welded |

Article-no. + /Colour	Dimension W x D x H (mm)	Weight kg	Loading surface W x D (mm)	Load cap. kg	Wheel diam. mm
sw-700.415 / AG	1165 x 730 x 1115	99.0	990 x 690	500	200 x 40
sw-800.415 / AG	1365 x 830 x 1115	115.0	1190 x 790	500	200 x 40



Steel box trolley | welded |

Article-no. + /Colour	Dimension W x D x H (mm)	Weight kg	Loading surface W x D (mm)	Load cap. kg	Wheel diam. mm
sw-700.414 / AG	1130 x 720 x 1105	85.5	990 x 690	500	200 x 40
sw-800.414 / AG	1330 x 820 x 1105	101.0	1190 x 790	500	200 x 40



STEEL BOX TROLLEYS

22 LIGHT TABLE TROLLEYS



2 or 3 load surfaces with edge
Optionally with drawers
EasySTOP

System trolleys



CONSTRUCTION

- Modular system
- Base structure with innovative frame section
- Floors set in angle-steel frame

FEATURES

- Load surfaces of wood-based board, surface finish beech or coated dark grey
- Load surfaces with 15 mm high edge

- Optionally 2 lockable drawers, extractable until 70%, with sliding runners and cylinder lock

FITTINGS

- 2 **EasySTOP** swivel castors, 2 fixed castors
- Grey non-marking thermoplastic rubber tyres on plastic wheel rim with precision deepgroove ball bearings, with foot guard
- Available in 2 colours, RAL 5010 gentian blue or RAL 7016 anthracite grey, powder-coated



Table trolley | with 2 load surfaces



Article-no. + /Colour	Dimension W x D x H (mm)	Weight kg	Loading surface W x D (mm)	Load cap. kg	Wheel diam. mm
sw-500.501 / AG	1025 x 525 x 850	28.0	835 x 490	250	125 x 30
sw-600.501 / AG	1175 x 625 x 850	33.5	985 x 590	250	125 x 30
sw-701.501 / AG	NEW 1175 x 725 x 850	38.5	985 x 690	250	125 x 30
sw-801.501 / AG	NEW 1375 x 825 x 850	45.0	1185 x 790	250	125 x 30

Load capacity shelf: 80 kg**



Inside dimensions of the drawers W: 400 x D: 450 x H: 80 mm (2x)
Load capacity per drawer: 25 kg
Drawer divider set on page 80



Table trolley | with 2 load surfaces and 2 drawers

Article-no. + /Colour	Dimension W x D x H (mm)	Weight kg	Loading surface W x D (mm)	Load cap. kg	Wheel diam. mm
sw-600.504 / AG	1175 x 625 x 850	46.0	985 x 590	250	125 x 30

Also available in ESD design on page 73

Load capacity shelf 80 kg**



Table trolley | with 3 load surfaces



Article-no. + /Colour	Dimension W x D x H (mm)	Weight kg	Loading surface W x D (mm)	Load cap. kg	Wheel diam. mm
sw-500.603 / AG	1025 x 525 x 850	37.0	835 x 490	250	125 x 30
sw-600.601 / AG	1175 x 625 x 850	44.5	985 x 590	250	125 x 30
sw-700.661 / AG	NEW 1175 x 725 x 850	50.5	985 x 690	250	125 x 30
sw-800.661 / AG	NEW 1375 x 825 x 850	60.5	1185 x 790	250	125 x 30

Load capacity shelf: 80 kg**



RAL 5010 RAL 7016

CONSTRUCTION

- Modular system
- Base structure with innovative frame section
- Floors set in angle-steel frame
- Optionally tubular push bar with dead man's brake, additional handle beneath the push bar

FEATURES

- Load surfaces of wood-based board, surface finish beech or coated dark grey
- Load surfaces with 15 mm high edge

- Optionally 2 lockable drawers, extractable until 70%, with sliding runners and cylinder lock

FITTINGS

- 2 **EasySTOP** swivel castors, 2 fixed castors, or 2 swivel castors with dead man's brake, 2 fixed castors
- Grey non-marking thermoplastic rubber tyres on plastic wheel rim with precision deepgroove ball bearings, with foot guard
- Available in 2 colours, RAL 5010 gentian blue or RAL 7016 anthracite grey, powder-coated

2 or 3 load surfaces with edge
Optionally with drawers
EasySTOP
or dead man's brake



System trolleys

BEST SELLER

Table trolley | with 2 load surfaces

Article-no. + /Colour	Dimension WxDxH (mm)	Weight kg	Loading surface WxD (mm)	Load cap. kg	Wheel diam. mm
sw-500.500 / AG	975 x 525 x 1010	28.5	835 x 490	250	125 x 30
sw-600.500 / AG	1125 x 625 x 1010	34.0	985 x 590	250	125 x 30
sw-701.500 / AG	NEW 1125 x 725 x 1010	38.5	985 x 690	250	125 x 30
sw-801.500 / AG	NEW 1325 x 825 x 1010	45.5	1185 x 790	250	125 x 30

Also available in ESD design on page 73

Load capacity shelf: 80 kg**



Table trolley | with 2 load surfaces and dead man's brake

Article-no. + /Colour	Dimension WxDxH (mm)	Weight kg	Loading surface WxD (mm)	Load cap. kg	Wheel diam. mm
sw-600.548 / AG	1175 x 625 x 1045	37.5	985 x 590	250	125 x 30

Load capacity shelf: 80 kg**



Inside dimensions of the drawers W: 400 x D: 450 x H: 80 mm (2x)
Load capacity per drawer: 25 kg
Drawer divider set on page 80

Table trolley | with 2 load surfaces and 2 drawers

Article-no. + /Colour	Dimension WxDxH (mm)	Weight kg	Loading surface WxD (mm)	Load cap. kg	Wheel diam. mm
sw-600.503 / AG	1125 x 625 x 1010	46.0	985 x 590	250	125 x 30

Also available in ESD design on page 73

Load capacity shelf: 80 kg**



BEST SELLER

Table trolley | with 3 load surfaces

Article-no. + /Colour	Dimension WxDxH (mm)	Weight kg	Loading surface WxD (mm)	Load cap. kg	Wheel diam. mm
sw-500.600 / AG	975 x 525 x 1010	37.5	835 x 490	250	125 x 30
sw-600.600 / AG	1125 x 625 x 1010	45.0	985 x 590	250	125 x 30
sw-700.660 / AG	NEW 1125 x 725 x 1010	51.0	985 x 690	250	125 x 30
sw-800.660 / AG	NEW 1325 x 825 x 1010	61.0	1185 x 790	250	125 x 30

Also available in ESD design on page 73

Load capacity shelf: 80 kg**



**Static distributed load; Total load of the transport device must not be exceeded!

24 TABLE TROLLEYS



Load surfaces flush with frame

Upper shelf replaceable

EasySTOP

System trolleys



CONSTRUCTION

- Modular system
- Base structure with innovative frame section

FEATURES

- Load surfaces of wood-based board, surface finish beech or coated dark grey
- Load surfaces flush with frame
- Upper shelf replaceable

FITTINGS

- 2 **EasySTOP** swivel castors, 2 fixed castors
- Grey non-marking thermoplastic rubber tyres on plastic wheel rim with precision deepgroove ball bearings, with foot guard
- Available in 2 colours, RAL 5010 gentian blue or RAL 7016 anthracite grey, powder-coated

Table trolley | with 2 load surfaces

Article-no. + /Colour	Dimension W x D x H (mm)	Weight kg	Loading surface W x D (mm)	Load cap. kg	Wheel diam. mm
sw-500.502 / AG	1045 x 500 x 935	30.0	850 x 500	200	125 x 30
sw-600.502 / AG	1195 x 600 x 935	34.0	1000 x 600	200	125 x 30

Load capacity shelf: 80 kg**

TABLE TROLLEYS



Fixed welded construction

Edge 17 mm high

CONSTRUCTION

- Welded steel or aluminium construction

FEATURES

- Load surfaces of wood-based board, surface finish beech or coated dark grey
- Load surfaces with 17 mm high edge

FITTINGS

- 2 swivel castors with brakes, 2 fixed castors
- Grey non-marking thermoplastic rubber tyres on plastic wheel rim with precision deepgroove ball bearings, with foot guard
- Available in 2 colours, RAL 5010 gentian blue or RAL 7016 anthracite grey, powder-coated or aluminium



Steel table trolley

Article-no. + /Colour	Dimension W x D x H (mm)	Weight kg	Loading surface W x D (mm)	Load cap. kg	Wheel diam. mm
st-402.000 / AG	1090 x 600 x 970	33.0	970 x 570	200	125 x 30

Load capacity shelf: 100 kg**

Aluminium table trolley

Article-no.	Dimension W x D x H (mm)	Weight kg	Loading surface W x D (mm)	Load cap. kg	Wheel diam. mm
ap-412.000	1090 x 600 x 975	24.0	970 x 570	200	125 x 30

Load capacity shelf: 100 kg**

INDIVIDUALLY

- Opportunities for modification in line with customers' individual wishes

UNIQUE PIECE

- Deliveries of small series from one piece upwards
- Product approval drawings
- Fair prices even for small quantities

CUSTOMER FOCUSED

- Analysing parameters such as uses, handling, workflows and much more in close cooperation with the customer

TAILORED

- Products in special sizes, special colours and complete new designs

Our custom-made products in comparison



STANDARD

Individually thought out

The best solution for each of your ideas



STANDARD



Customizing

26 HEAVY-DUTY TABLE TROLLEYS



Load surfaces flush with frame

Wood-based board
or galvanised sheet

EasySTOP

System trolleys



CONSTRUCTION

- Modular system
- Base structure with innovative frame section

FEATURES

- Load surfaces of wood-based board, surface finish beech or coated dark grey, or covered with galvanised sheet (folded over load surface)
- Load surfaces flush with frame

FITTINGS

- 2 **EasySTOP** swivel castors, 2 fixed castors
- Grey non-marking thermoplastic rubber tyres on plastic wheel rim with precision deepgroove ball bearings, with foot guard
- Available in 2 colours, RAL 5010 gentian blue or RAL 7016 anthracite grey, powder-coated

BEST SELLER

Heavy-duty table trolley | with 2 load surfaces

Article-no. + /Colour	Dimension W x D x H (mm)	Weight kg	Loading surface W x D (mm)	Load cap. kg	Wheel diam. mm
sw-500.504 / AG	1040 x 500 x 880	34.0	850 x 500	400	160 x 40
sw-600.510 / AG	1190 x 600 x 920	40.5	1000 x 600	500	200 x 40
sw-700.500 / AG	1190 x 700 x 920	46.0	1000 x 700	500	200 x 40
sw-800.500 / AG	1390 x 800 x 920	51.5	1200 x 800	500	200 x 40

Also available in ESD design on page 74

Load capacity shelf: 200 kg**



Heavy-duty table trolley | with 2 load surfaces covered with galvanised sheet

Article-no. + /Colour	Dimension W x D x H (mm)	Weight kg	Loading surface W x D (mm)	Load cap. kg	Wheel diam. mm
sw-700.505 / AG	1190 x 700 x 920	55.0	1000 x 700	500	200 x 40
sw-800.505 / AG	1390 x 800 x 920	65.0	1200 x 800	500	200 x 40

Load capacity shelf: 200 kg**



BEST SELLER

Heavy-duty table trolley | with 3 load surfaces

Article-no. + /Colour	Dimension W x D x H (mm)	Weight kg	Loading surface W x D (mm)	Load cap. kg	Wheel diam. mm
sw-500.650 / AG	1040 x 500 x 880	44.5	850 x 500	400	160 x 40
sw-600.512 / AG	1190 x 600 x 920	54.5	1000 x 600	500	200 x 40
sw-700.600 / AG	1190 x 700 x 920	55.5	1000 x 700	500	200 x 40
sw-800.600 / AG	1390 x 800 x 920	67.5	1200 x 800	500	200 x 40

Also available in ESD design on page 74

Load capacity shelf: 200 kg**



Heavy-duty table trolley | with 4 load surfaces

Article-no. + /Colour	Dimension W x D x H (mm)	Weight kg	Loading surface W x D (mm)	Load cap. kg	Wheel diam. mm
sw-700.700 / AG	1190 x 700 x 1235	74.5	1000 x 700	500	200 x 40
sw-800.700 / AG	1390 x 800 x 1235	87.5	1200 x 800	500	200 x 40

Load capacity shelf: 200 kg**



RAL 5010 RAL 7016

CONSTRUCTION

- Modular system
- Base structure with innovative frame section

FEATURES

- Load surfaces of waterproof bonded plywood, surface finish screen printed, anti-slip
- Load surfaces flush with frame

FITTINGS

- 2 **EasySTOP** swivel castors, 2 fixed castors
- Elastic solid-rubber tyres on cast aluminium wheel rim with precision deepgroove ball bearings, black, with foot guard, wheels also available in grey
- Available in 2 colours, RAL 5010 gentian blue or RAL 7016 anthracite grey, powder-coated

Load surfaces flush with frame
Surfaces of waterproof bonded plywood
EasySTOP



Heavy-duty table trolley | with 2 load surfaces

Article-no. + /Colour	Dimension W x D x H (mm)	Weight kg	Loading surface W x D (mm)	Load cap. kg	Wheel diam. mm
sw-700.530 / AG	1190 x 700 x 925	60.5	995 x 700	1000	200 x 50
sw-800.502 / AG	1390 x 800 x 925	66.5	1195 x 800	1000	200 x 50
sw-800.511 / AG	1790 x 800 x 925	82.5	1595 x 800	1000	200 x 50
sw-800.514 / AG	2190 x 800 x 925	95.5	1995 x 800	1000	200 x 50

Load capacity shelf: 500 kg**



Heavy-duty table trolley | with 3 load surfaces

Article-no. + /Colour	Dimension W x D x H (mm)	Weight kg	Loading surface W x D (mm)	Load cap. kg	Wheel diam. mm
sw-700.617 / AG	1190 x 700 x 925	73.5	995 x 700	1000	200 x 50
sw-800.617 / AG	1390 x 800 x 925	92.0	1195 x 800	1000	200 x 50
sw-800.618 / AG	1790 x 800 x 925	105.5	1595 x 800	1000	200 x 50
sw-800.619 / AG	2190 x 800 x 925	135.0	1995 x 800	1000	200 x 50

Load capacity shelf: 500 kg**



System trolleys

**Static distributed load; Total load of the transport device must not be exceeded!

28 TABLE TROLLEYS WITH PAN



Oil-tight pans
Edge 40 mm high
EasySTOP

System trolleys



CONSTRUCTION

- Welded steel construction, screwed

FEATURES

- Oil-tight pans and with 40 mm high edge

FITTINGS

- 2 **EasySTOP** swivel castors, 2 fixed castors
- Grey non-marking thermoplastic rubber tyres on plastic wheel rim with precision deepgroove ball bearings, with foot guard
- Available in 2 colours, RAL 5010 gentian blue or RAL 7016 anthracite grey, powder-coated



Table trolley | with 2 load surfaces

Article-no. + /Colour	Dimension W x D x H (mm)	Weight kg	Loading surface W x D (mm)	Load cap. kg	Wheel diam. mm
sw-500.510 / AG	985 x 500 x 910	36.5	845 x 495	400	160 x 40
sw-700.510 / AG	1135 x 700 x 950	50.0	995 x 695	400	200 x 40

Load capacity shelf: 100 kg**

Table trolley | with 3 load surfaces

Article-no. + /Colour	Dimension W x D x H (mm)	Weight kg	Loading surface W x D (mm)	Load cap. kg	Wheel diam. mm
sw-500.610 / AG	985 x 500 x 910	44.5	845 x 495	400	160 x 40
sw-700.610 / AG	1135 x 700 x 950	63.5	995 x 695	400	200 x 40

Load capacity shelf: 100 kg**

Table trolley | with 2 load surfaces

Article-no. + /Colour	Dimension W x D x H (mm)	Weight kg	Loading surface W x D (mm)	Load cap. kg	Wheel diam. mm
sw-500.523 / AG	1015 x 500 x 1025	36.5	845 x 495	400	160 x 40
sw-700.523 / AG	1165 x 700 x 1065	50.0	995 x 695	400	200 x 40

Load capacity shelf: 100 kg**

Table trolley | with 3 load surfaces

Article-no. + /Colour	Dimension W x D x H (mm)	Weight kg	Loading surface W x D (mm)	Load cap. kg	Wheel diam. mm
sw-500.698 / AG	1015 x 500 x 1025	45.0	845 x 495	400	160 x 40
sw-700.623 / AG	1165 x 700 x 1065	63.5	995 x 695	400	200 x 40

Load capacity shelf: 100 kg**



RAL 5010 RAL 7016

CONSTRUCTION

- Welded steel construction, screwed

FEATURES

- Oil-tight pans with 25 mm high edge
- Alternative with removable steel-sheet pan (113 l), sides 200 mm high, 2 handles
- Or with screwed drip tray (60 l), sides 100 mm high, incl. galvanised grating, mesh size 30 x 30 mm, conical outlet cock 1/4"

FITTINGS

- 2 **EasySTOP** swivel castors, 2 fixed castors
- Grey non-marking thermoplastic rubber tyres on plastic wheel rim with precision deepgroove ball bearings, with foot guard
- Available in 2 colours, RAL 5010 gentian blue or RAL 7016 anthracite grey, powder-coated

Oil-tight pans
Edge 25 mm high
Removable or screwed
Steel-sheet pan



Table trolley | with 2 load surfaces and removable steel-sheet pan



Article-no. + /Colour	Dimension W x D x H (mm)	Weight kg	Loading surface W x D (mm)	Load cap. kg	Wheel diam. mm
sw-600.507 / AG	1180 x 610 x 1055	49.5	995 x 595	250	125 x 30

Load capacity shelf: 80 kg**

ADDITIONAL ARTICLE Removable steel-sheet pan

Article-no. + /Colour	Dimension W x D x H (mm)	Weight kg	Loading surface W x D (mm)	Volume l
gsw-600.507 / AG	1075 x 590 x 235	12.5	985 x 585	113

Table trolley | with 2 load surfaces



Article-no. + /Colour	Dimension W x D x H (mm)	Weight kg	Loading surface W x D (mm)	Load cap. kg	Wheel diam. mm
sw-600.506 / AG	1170 x 610 x 845	37.0	995 x 595	250	125 x 30

Load capacity shelf: 80 kg**



Table trolley | with 2 load surfaces and galvanised grating



Article-no. + /Colour	Dimension W x D x H (mm)	Weight kg	Loading surface W x D (mm)	Load cap. kg	Wheel diam. mm
sw-600.505 / AG	1125 x 610 x 1020	58.0	995 x 595	250	125 x 30

Load capacity shelf: 80 kg**

System trolleys

**Static distributed load; Total load of the transport device must not be exceeded!



Shelves and trays
Variable removable
EasySTOP



System trolleys



CONSTRUCTION

- Modular system
- Base structure with innovative frame section

FEATURES

- Load surface, shelves and trays of wood-based board, surface finish beech or coated dark grey
- Shelves and trays replaceable and variable removable, tray height 45 mm inside and 60 mm outside

FITTINGS

- 2 **EasySTOP** swivel castors, 2 fixed castors
- Grey non-marking thermoplastic rubber tyres on plastic wheel rim with precision deepgroove ball bearings, with foot guard
- Available in 2 colours, RAL 5010 gentian blue or RAL 7016 anthracite grey, powder-coated

Shelf trolley | low

Article-no. + /Colour	Dimension W x D x H (mm)	Weight kg	Loading surface W x D (mm)	Load cap. kg	Wheel diam. mm
sw-500.205 / AG	910 x 500 x 990	31.5	850 x 500	250	160 x 40
sw-600.205 / AG	1060 x 600 x 990	43.0	1000 x 600	250	160 x 40
sw-700.239 / AG	1060 x 700 x 990	48.0	1000 x 700	250	160 x 40
sw-800.239 / AG	1260 x 800 x 990	52.5	1200 x 800	250	160 x 40

Load capacity shelf: 80 kg**

Shelf trolley | low

Article-no. + /Colour	Dimension W x D x H (mm)	Weight kg	Loading surface Tray W x D (mm)	Load cap. kg	Wheel diam. mm
sw-500.207 / AG	910 x 500 x 990	34.0	815 x 455	250	160 x 40
sw-600.207 / AG	1060 x 600 x 990	43.0	965 x 555	250	160 x 40
sw-700.242 / AG	1060 x 700 x 990	51.0	965 x 655	250	160 x 40
sw-800.242 / AG	1260 x 800 x 990	63.5	1165 x 755	250	160 x 40

Load capacity shelf: 80 kg**

Shelf trolley | low

Article-no. + /Colour	Dimension W x D x H (mm)	Weight kg	Loading surface Tray W x D (mm)	Load cap. kg	Wheel diam. mm
sw-500.208 / AG	910 x 500 x 990	35.0	815 x 455	250	160 x 40
sw-600.208 / AG	1060 x 600 x 990	43.5	965 x 555	250	160 x 40
sw-700.243 / AG	1060 x 700 x 990	52.5	965 x 655	250	160 x 40
sw-800.243 / AG	1260 x 800 x 990	64.5	1165 x 755	250	160 x 40

Load capacity shelf: 80 kg**

ADDITIONAL ARTICLES Shelves for shelf trolleys

Article-no. + /Colour	Dimension W x D x H (mm)	Weight kg	For loading surface W x D (mm)	Load cap. kg
zsw-500.205 / G	845 x 485	6.5	850 x 500	80
zsw-600.210 / G	995 x 585	8.0	1000 x 600	80
zsw-700.210 / G	995 x 685	10.5	1000 x 700	80
zsw-800.210 / G	1195 x 785	14.5	1200 x 800	80



RAL 5010 RAL 7016

CONSTRUCTION

- Modular system
- Base structure with innovative frame section

FEATURES

- Load surface, shelves and trays of wood-based board, surface finish beech or coated dark grey
- Shelves and trays replaceable and variable removable, tray height 45 mm inside and 60 mm outside

FITTINGS

- 2 **EasySTOP** swivel castors, 2 fixed castors
- Grey non-marking thermoplastic rubber tyres on plastic wheel rim with precision deepgroove ball bearings, with foot guard
- Available in 2 colours, RAL 5010 gentian blue or RAL 7016 anthracite grey, powder-coated

Shelves and trays
Variable removable
EasySTOP



System trolleys

Shelf trolley | low



Article-no. + /Colour	Dimension W x D x H (mm)	Weight kg	Loading surface W x D (mm)	Load cap. kg	Wheel diam. mm
sw-500.206 / AG	910 x 500 x 990	37.0	850 x 500	250	160 x 40
sw-600.206 / AG	1060 x 600 x 990	46.0	1000 x 600	250	160 x 40
sw-700.240 / AG	1060 x 700 x 990	54.5	1000 x 700	250	160 x 40
sw-800.240 / AG	1260 x 800 x 990	67.0	1200 x 800	250	160 x 40

Also available in ESD design on page 69

Load capacity shelf: 80 kg**



Shelf trolley | low



Article-no. + /Colour	Dimension W x D x H (mm)	Weight kg	Loading surface Tray W x D (mm)	Load cap. kg	Wheel diam. mm
sw-500.210 / AG	910 x 500 x 990	38.0	815 x 455	250	160 x 40
sw-600.210 / AG	1060 x 600 x 990	47.0	965 x 555	250	160 x 40
sw-700.241 / AG	1060 x 700 x 990	55.5	965 x 655	250	160 x 40
sw-800.241 / AG	1260 x 800 x 990	68.5	1165 x 755	250	160 x 40

Load capacity shelf: 80 kg**



Shelf trolley | low



Article-no. + /Colour	Dimension W x D x H (mm)	Weight kg	Loading surface Tray W x D (mm)	Load cap. kg	Wheel diam. mm
sw-500.209 / AG	910 x 500 x 990	45.0	815 x 455	250	160 x 40
sw-600.209 / AG	1060 x 600 x 990	51.5	965 x 555	250	160 x 40
sw-700.244 / AG	1060 x 700 x 990	60.0	965 x 655	250	160 x 40
sw-800.244 / AG	1260 x 800 x 990	69.5	1165 x 755	250	160 x 40

Load capacity shelf: 80 kg**



ADDITIONAL ARTICLES Trays for shelf trolleys

Article-no. + /Colour	Dimension W x D x H (mm)	Weight kg	For loading surface W x D (mm)	Load cap. kg
zsw-500.209 / G	815 x 455 x 45	6.5	850 x 500	80
zsw-600.209 / G	965 x 555 x 45	9.0	1000 x 600	80
zsw-700.209 / G	965 x 655 x 45	10.5	1000 x 700	80
zsw-800.209 / G	1165 x 755 x 45	15.0	1200 x 800	80



**Static distributed load; Total load of the transport device must not be exceeded!

32 SHELF TROLLEYS



Shelves and trays
Variable removable
EasySTOP or dead man's brake



System trolleys

CONSTRUCTION

- Modular system
- Base structure with innovative frame section
- Optionally tubular push bar with dead man's brake, additional handle beneath the push bar

FEATURES

- Load surface and shelves of wood-based board, surface finish beech or coated dark grey
- Shelves replaceable and variable removable

FITTINGS

- 2 **EasySTOP** swivel castors, 2 fixed castors or 2 swivel castors with dead man's brake, 2 fixed castors
- Grey non-marking thermoplastic rubber tyres on plastic wheel rim with precision deepgroove ball bearings, with foot guard
- Available in 2 colours, RAL 5010 gentian blue or RAL 7016 anthracite grey, powder-coated



Shelf trolley | high

Article-no. + /Colour	Dimension W x D x H (mm)	Weight kg	Loading surface W x D (mm)	Load cap. kg	Wheel diam. mm
sw-500.211 / AG	910 x 500 x 1530	42.0	850 x 500	250	160 x 40
sw-600.211 / AG	1060 x 600 x 1530	51.0	1000 x 600	250	160 x 40
sw-700.245 / AG	1060 x 700 x 1530	60.0	1000 x 700	250	160 x 40
sw-800.245 / AG	1260 x 800 x 1530	73.0	1200 x 800	250	160 x 40

Also available in ESD design on page 69

Load capacity shelf: 80 kg**

Shelf trolley | high with dead man's brake

Article-no. + /Colour	Dimension W x D x H (mm)	Weight kg	Loading surface W x D (mm)	Load cap. kg	Wheel diam. mm
sw-600.265 / AG	1220 x 610 x 1530	56.5	1000 x 600	250	160 x 40

Load capacity shelf: 80 kg**

Shelf trolley | high

Article-no. + /Colour	Dimension W x D x H (mm)	Weight kg	Loading surface W x D (mm)	Load cap. kg	Wheel diam. mm
sw-500.212 / AG	910 x 500 x 1530	54.0	850 x 500	250	160 x 40
sw-600.212 / AG	1060 x 600 x 1530	68.5	1000 x 600	250	160 x 40
sw-700.246 / AG	1060 x 700 x 1530	80.5	1000 x 700	250	160 x 40
sw-800.246 / AG	1260 x 800 x 1530	101.5	1200 x 800	250	160 x 40

Also available in ESD design on page 69

Load capacity shelf: 80 kg**



RAL 5010 RAL 7016

CONSTRUCTION

- Modular system
- Base structure with innovative frame section

FEATURES

- Load surface and trays of wood-based board, surface finish beech or coated dark grey
- Trays replaceable and variable removable, tray height 45 mm inside and 60 mm outside

FITTINGS

- 2 **EasySTOP** swivel castors, 2 fixed castors
- Grey non-marking thermoplastic rubber tyres on plastic wheel rim with precision deepgroove ball bearings, with foot guard
- Available in 2 colours, RAL 5010 gentian blue or RAL 7016 anthracite grey, powder-coated

Shelves and trays
Variable removable
EasySTOP



System trolleys

Shelf trolley | high



Article-no. + /Colour	Dimension W x D x H (mm)	Weight kg	Loading surface Tray W x D (mm)	Load cap. kg	Wheel diam. mm
sw-500.213 / AG	910 x 500 x 1530	45.0	815 x 455	250	160 x 40
sw-600.213 / AG	1060 x 600 x 1530	56.0	965 x 555	250	160 x 40
sw-700.247 / AG	1060 x 700 x 1530	65.5	965 x 655	250	160 x 40
sw-800.247 / AG	1260 x 800 x 1530	80.0	1165 x 755	250	160 x 40

Load capacity shelf: 80 kg**



Shelf trolley | high



Article-no. + /Colour	Dimension W x D x H (mm)	Weight kg	Loading surface Tray W x D (mm)	Load cap. kg	Wheel diam. mm
sw-500.214 / AG	910 x 500 x 1530	60.0	815 x 455	250	160 x 40
sw-600.214 / AG	1060 x 600 x 1530	72.5	965 x 555	250	160 x 40
sw-700.248 / AG	1060 x 700 x 1530	85.5	965 x 655	250	160 x 40
sw-800.248 / AG	1260 x 800 x 1530	105.0	1165 x 755	250	160 x 40

Load capacity shelf: 80kg**



ADDITIONAL ARTICLES Trays for shelf trolleys

Article-no. + /Colour	Dimension W x D x H (mm)	Weight kg	For loading surface W x D (mm)	Load cap. kg
zsw-500.209 / G	815 x 455 x 45	6.5	850 x 500	80
zsw-600.209 / G	965 x 555 x 45	9.0	1000 x 600	80
zsw-700.209 / G	965 x 655 x 45	10.5	1000 x 700	80
zsw-800.209 / G	1165 x 755 x 45	15.0	1200 x 800	80

ADDITIONAL ARTICLES Shelves for shelf trolleys

Article-no. + /Colour	Dimension W x D x H (mm)	Weight kg	For loading surface W x D (mm)	Load cap. kg
zsw-500.205 / G	845 x 485	6.5	850 x 500	80
zsw-600.210 / G	995 x 585	8.0	1000 x 600	80
zsw-700.210 / G	995 x 685	10.5	1000 x 700	80
zsw-800.210 / G	1195 x 785	14.0	1200 x 800	80



**Static distributed load; Total load of the transport device must not be exceeded!

34 PARCEL TROLLEYS



RAL 5010

RAL 7016

Mesh sides and ends
Side walls variable removable
EasySTOP

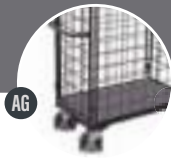

System trolleys

CONSTRUCTION

- Modular system
- Base structure with innovative frame section

FEATURES

- Load surfaces of wood-based board, surface finish beech or coated dark grey
- Optionally removable shelves for insertion at 120 mm intervals

- Mesh sides and ends, mesh size 120 x 120 mm
- Side walls replaceable and variable removable

FITTINGS

- 2 **EasySTOP** swivel castors, 2 fixed castors
- Grey non-marking thermoplastic rubber tyres on plastic wheel rim with precision deepgroove ball bearings, with foot guard
- Available in 2 colours, RAL 5010 gentian blue or RAL 7016 anthracite grey, powder-coated



Three-sided parcel trolley | high

Article-no. + /Colour	Dimension WxDxH (mm)	Weight kg	Loading surface WxD (mm)	Load cap. kg	Wheel diam. mm
sw-500.306 / AG	1040 x 525 x 1780	43.0	850 x 500	400	160 x 40
sw-600.306 / AG	1190 x 625 x 1820	52.0	1000 x 600	500	200 x 40
sw-700.306 / AG	1190 x 725 x 1820	60.5	1000 x 700	500	200 x 40
sw-800.306 / AG	1390 x 825 x 1820	68.5	1200 x 800	500	200 x 40



Four-sided parcel trolley | high

Article-no. + /Colour	Dimension WxDxH (mm)	Weight kg	Loading surface WxD (mm)	Load cap. kg	Wheel diam. mm
sw-500.405 / AG	1040 x 540 x 1780	49.0	850 x 500	400	160 x 40
sw-600.405 / AG	1190 x 640 x 1820	57.5	1000 x 600	500	200 x 40
sw-700.403 / AG	1190 x 740 x 1820	68.0	1000 x 700	500	200 x 40
sw-800.403 / AG	1390 x 840 x 1820	76.0	1200 x 800	500	200 x 40



Three-sided parcel trolley | low

Article-no. + /Colour	Dimension WxDxH (mm)	Weight kg	Loading surface WxD (mm)	Load cap. kg	Wheel diam. mm
sw-500.313 / AG	1040 x 525 x 1180	35.0	850 x 500	400	160 x 40
sw-600.313 / AG	1190 x 625 x 1220	43.0	1000 x 600	500	200 x 40
sw-700.313 / AG	1190 x 725 x 1220	50.5	1000 x 700	500	200 x 40
sw-800.313 / AG	1390 x 825 x 1220	57.5	1200 x 800	500	200 x 40



Four-sided parcel trolley | low

Article-no. + /Colour	Dimension WxDxH (mm)	Weight kg	Loading surface WxD (mm)	Load cap. kg	Wheel diam. mm
sw-500.420 / AG	1040 x 540 x 1180	40.0	850 x 500	400	160 x 40
sw-600.420 / AG	1190 x 640 x 1220	47.0	1000 x 600	500	200 x 40
sw-700.220 / AG	1190 x 740 x 1220	54.5	1000 x 700	500	200 x 40
sw-800.220 / AG	1390 x 840 x 1220	61.5	1200 x 800	500	200 x 40



RAL 5010 RAL 7016

CONSTRUCTION

- Modular system
- Base structure with innovative frame section

FEATURES

- Load surfaces and shelves of wood-based board, surface finish beech or coated dark grey
- Optionally removable shelves for insertion at 120 mm intervals

- Mesh sides and ends, mesh size 120 x 120 mm
- Side walls replaceable and variable removable

FITTINGS

- 2 **EasySTOP** swivel castors, 2 fixed castors
- Grey non-marking thermoplastic rubber tyres on plastic wheel rim with precision deepgroove ball bearings, with foot guard
- Available in 2 colours, RAL 5010 gentian blue or RAL 7016 anthracite grey, powder-coated

Mesh sides and ends
Side walls variable removable
Optionally shelves
EasySTOP



System trolleys

Shelf trolley | low



Article-no. + /Colour	Dimension W x D x H (mm)	Weight kg	Loading surface W x D (mm)	Load cap. kg	Wheel diam. mm
sw-500.235 / AG	1035 x 520 x 1180	55.0	850 x 500	400	160 x 40
sw-600.235 / AG	1185 x 620 x 1220	63.0	1000 x 600	500	200 x 40
sw-700.215 / AG	1185 x 720 x 1220	67.5	1000 x 700	500	200 x 40
sw-800.215 / AG	1385 x 820 x 1220	79.0	1200 x 800	500	200 x 40

Load capacity shelf: 80 kg**



Shelf trolley | low



Article-no. + /Colour	Dimension W x D x H (mm)	Weight kg	Loading surface W x D (mm)	Load cap. kg	Wheel diam. mm
sw-500.307 / AG	1040 x 525 x 1180	59.0	850 x 500	400	160 x 40
sw-600.307 / AG	1190 x 625 x 1220	66.5	1000 x 600	500	200 x 40
sw-700.303 / AG	1190 x 725 x 1220	70.5	1000 x 700	500	200 x 40
sw-800.303 / AG	1390 x 825 x 1220	85.0	1200 x 800	500	200 x 40

Load capacity shelf: 80 kg**



Shelf trolley | low



Article-no. + /Colour	Dimension W x D x H (mm)	Weight kg	Loading surface W x D (mm)	Load cap. kg	Wheel diam. mm
sw-500.460 / AG	1040 x 540 x 1180	61.5	850 x 500	400	160 x 40
sw-600.460 / AG	1190 x 640 x 1220	73.0	1000 x 600	500	200 x 40
sw-700.460 / AG	1190 x 740 x 1220	76.5	1000 x 700	500	200 x 40
sw-800.460 / AG	1390 x 840 x 1220	92.0	1200 x 800	500	200 x 40

Load capacity shelf: 80 kg**



ADDITIONAL ARTICLES Shelves for parcel/shelf trolleys

Article-no. + /Colour	Dimension W x D x H (mm)	Weight kg	For loading surface W x D (mm)	Load cap. kg
zsw-500.218 / G	835 x 470	8.0	850 x 500	80
zsw-600.218 / G	985 x 570	10.0	1000 x 600	80
zsw-700.218 / G	985 x 670	12.0	1000 x 700	80
zsw-800.218 / G	1185 x 770	16.0	1200 x 800	80



ADDITIONAL ARTICLES Side walls for parcel/shelf trolleys, low

Article-no. + /Colour	Dimension W x D x H (mm)	Weight kg	For loading surface W x D (mm)
gsw-500.303 / AG	925 x 925	5.5	850 x 500
gsw-700.303.2 / AG	1075 x 925	6.0	1000 x 600
gsw-700.303.2 / AG	1075 x 925	6.0	1000 x 700
gsw-800.303.2 / AG	1275 x 925	8.0	1200 x 800



**Static distributed load; Total load of the transport device must not be exceeded!



RAL 5010

RAL 7016

Mesh ends
Optionally shelves
EasySTOP or dead man's brake

System trolleys



CONSTRUCTION

- Modular system
- Base structure with innovative frame section
- Optionally tubular push bar with dead man's brake, additional handle beneath the push bar

FEATURES

- Load surface and shelves of wood-based board, surface finish beech or coated dark grey
- Optionally removable shelves for insertion at 120 mm intervals
- Mesh ends, mesh size 120 x 120 mm

FITTINGS

- 2 **EasySTOP** swivel castors, 2 fixed castors or 2 swivel castors with dead man's brake, 2 fixed castors
- Grey non-marking thermoplastic rubber tyres on plastic wheel rim with precision deepgroove ball bearings, with foot guard
- Available in 2 colours, RAL 5010 gentian blue or RAL 7016 anthracite grey, powder-coated



Shelf trolley | high

Article-no. + /Colour	Dimension W x D x H (mm)	Weight kg	Loading surface W x D (mm)	Load cap. kg	Wheel diam. mm
sw-500.236 / AG	1035 x 520 x 1780	64.0	850 x 500	400	160 x 40
sw-600.236 / AG	1185 x 620 x 1820	81.0	1000 x 600	500	200 x 40
sw-700.216 / AG	1185 x 720 x 1820	84.0	1000 x 700	500	200 x 40
sw-800.216 / AG	1385 x 820 x 1820	102.5	1200 x 800	500	200 x 40

Load capacity shelf: 80 kg**



Brake applied
Brake released



Shelf trolley | high with dead man's brake

Article-no. + /Colour	Dimension W x D x H (mm)	Weight kg	Loading surface W x D (mm)	Load cap. kg	Wheel diam. mm
sw-700.280 / AG	1195 x 715 x 1825	83.0	1000 x 700	500	200 x 40

Load capacity shelf: 80 kg**



Shelf trolley | high

Article-no. + /Colour	Dimension W x D x H (mm)	Weight kg	Loading surface W x D (mm)	Load cap. kg	Wheel diam. mm
sw-500.237 / AG	1035 x 520 x 1780	70.0	850 x 500	400	160 x 40
sw-600.237 / AG	1185 x 620 x 1820	87.5	1000 x 600	500	200 x 40
sw-700.217 / AG	1185 x 720 x 1820	95.5	1000 x 700	500	200 x 40
sw-800.217 / AG	1385 x 820 x 1820	116.0	1200 x 800	500	200 x 40

Load capacity shelf: 80 kg**

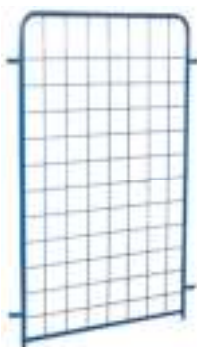

ADDITIONAL ARTICLES Side walls for parcel/shelf trolleys, high

Article-no. + /Colour	Dimension W x D x H (mm)	Weight kg	For loading surface W x D (mm)
gsw-500.304 / AG	925 x 1525	8.0	850 x 500
gsw-700.304.2 / AG	1075 x 1525	9.0	1000 x 600
gsw-700.304.2 / AG	1075 x 1525	9.0	1000 x 700
gsw-800.304.2 / AG	1275 x 1525	10.5	1200 x 800



RAL 5010 RAL 7016

CONSTRUCTION

- Modular system
- Base structure with innovative frame section

FEATURES

- Load surface and shelves of wood-based board, surface finish beech or coated dark grey
- Optionally removable shelves for insertion at 120 mm intervals
- Mesh sides and ends, mesh size 120 x 120 mm
- Side walls replaceable and variable removable

FITTINGS

- 2 **EasySTOP** swivel castors, 2 fixed castors
- Grey non-marking thermoplastic rubber tyres on plastic wheel rim with precision deepgroove ball bearings, with foot guard
- Available in 2 colours, RAL 5010 gentian blue or RAL 7016 anthracite grey, powder-coated

Mesh sides and ends
Side walls variable removable
Optionally shelves
EasySTOP



System trolleys

Shelf trolley | high



Article-no. + /Colour	Dimension W x D x H (mm)	Weight kg	Loading surface W x D (mm)	Load cap. kg	Wheel diam. mm
sw-500.304 / AG	1040 x 525 x 1780	73.5	850 x 500	400	160 x 40
sw-600.304 / AG	1190 x 625 x 1820	86.5	1000 x 600	500	200 x 40
sw-700.304 / AG	1190 x 725 x 1820	91.0	1000 x 700	500	200 x 40
sw-800.304 / AG	1390 x 825 x 1820	103.0	1200 x 800	500	200 x 40

Load capacity shelf: 80 kg**



Shelf trolley | high



Article-no. + /Colour	Dimension W x D x H (mm)	Weight kg	Loading surface W x D (mm)	Load cap. kg	Wheel diam. mm
sw-500.311 / AG	1040 x 540 x 1780	83.5	850 x 500	400	160 x 40
sw-600.311 / AG	1190 x 640 x 1820	96.5	1000 x 600	500	200 x 40
sw-700.311 / AG	1190 x 740 x 1820	101.0	1000 x 700	500	200 x 40
sw-800.311 / AG	1390 x 840 x 1820	113.0	1200 x 800	500	200 x 40

Load capacity shelf: 80 kg**



Shelf trolley | high



Article-no. + /Colour	Dimension W x D x H (mm)	Weight kg	Loading surface W x D (mm)	Load cap. kg	Wheel diam. mm
sw-500.305 / AG	1040 x 525 x 1780	78.5	850 x 500	400	160 x 40
sw-600.305 / AG	1190 x 625 x 1820	91.5	1000 x 600	500	200 x 40
sw-700.305 / AG	1190 x 725 x 1820	96.0	1000 x 700	500	200 x 40
sw-800.305 / AG	1390 x 825 x 1820	108.0	1200 x 800	500	200 x 40

Load capacity shelf: 80 kg**



ADDITIONAL ARTICLES Side wall with folding top half for parcel/shelf trolleys, high

Article-no. + /Colour	Dimension W x D x H (mm)	Weight kg	For loading surface W x D (mm)
gsw-500.305 / AG	945 x 1525	9.0	850 x 500
gsw-600.305 / AG	1095 x 1525	10.5	1000 x 600
gsw-700.305 / AG	1095 x 1525	12.0	1000 x 700
gsw-800.305 / AG	1295 x 1525	15.0	1200 x 800



**Static distributed load; Total load of the transport device must not be exceeded!

38 SHELF TROLLEYS



RAL 5010 RAL 7016

End and side walls open or with mesh
Folding shelves
Fixed welded tubular push bar
EasySTOP

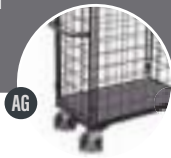

System trolleys

CONSTRUCTION

- Welded steel construction
- Base structure with innovative frame section

FEATURES

- Load surface and shelves of wood-based board, surface finish beech or coated dark grey
- Folding shelves
- End and side walls open or with mesh, mesh size 100 x 200 mm

FITTINGS

- 2 **EasySTOP** swivel castors, 2 fixed castors
- Grey non-marking thermoplastic rubber tyres on plastic wheel rim with precision deepgroove ball bearings, with foot guard
- Available in 2 colours, RAL 5010 gentian blue or RAL 7016 anthracite grey, powder-coated



Shelf trolley | high with folding shelves

Article-no. + /Colour	Dimension W x D x H (mm)	Weight kg	Loading surface W x D (mm)	Load cap. kg	Wheel diam. mm
sw-700.250 / AG	1200 x 700 x 1890	73.0	975 x 700	500	200 x 40
sw-800.250 / AG	1400 x 800 x 1890	84.5	1175 x 800	500	200 x 40

Load capacity shelf: 50 kg**

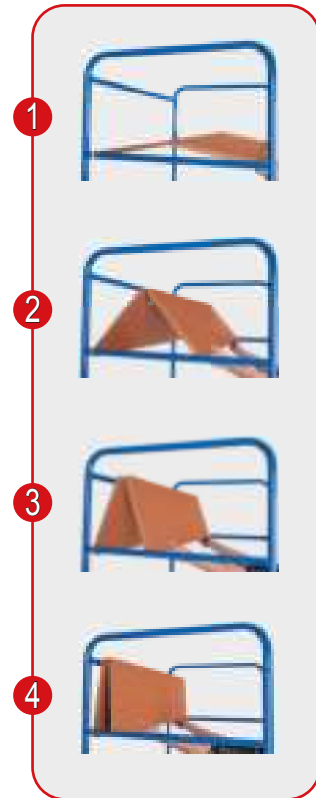

Shelf trolley | high with folding shelves

Article-no. + /Colour	Dimension W x D x H (mm)	Weight kg	Loading surface W x D (mm)	Load cap. kg	Wheel diam. mm
sw-700.238 / AG	1200 x 700 x 1890	67.5	975 x 700	500	200 x 40
sw-800.238 / AG	1400 x 800 x 1890	80.0	1175 x 800	500	200 x 40

Load capacity shelf: 50 kg**

INDIVIDUALLY

- Opportunities for modification in line with customers' individual wishes

UNIQUE PIECE

- Deliveries of small series from one piece upwards
- Product approval drawings
- Fair prices even for small quantities

CUSTOMER FOCUSED

- Analysing parameters such as uses, handling, workflows and much more in close cooperation with the customer

TAILORED

- Products in special sizes, special colours and complete new designs

Our custom-made products in comparison



STANDARD

Special designs?
Please feel free
to contact us!

STANDARD



Customizing

40 SHELF TROLLEYS



Walls, roof and doors with mesh
Optionally with double wing door, lockable
EasySTOP

System trolleys



CONSTRUCTION

- Fixed welded angle-steel construction
- End and side walls, roof and doors with mesh sides 50 x 50 mm

FEATURES

- Load surfaces and optionally shelves of wood-based board, surface finish beech or coated dark grey
- Shelf supports for variable insertion at 50 mm intervals
- Double wing doors with espagnolette bolt lock and T-handle or lever

- Cylinder lock, incl. 2 keys (different locking)
- Push/pull bar with soft plastic grip cover

FITTINGS

- 2 **EasySTOP** swivel castors, 2 fixed castors
- Grey non-marking thermoplastic rubber tyres on plastic wheel rim with precision deepgroove ball bearings, with foot guard
- Available in 2 colours, RAL 5010 gentian blue or RAL 7016 anthracite grey, powder-coated



PRICE PERFORMANCE

Shelf trolley | fixed welded

Article-no. + /Colour	Dimension W x D x H (mm)	Weight kg	Loading surface W x D (mm)	Load cap. kg	Wheel diam. mm
sw-700.410 / AG	1115 x 730 x 1810	103.5	1045 x 685	500	200 x 40
sw-800.410 / AG	1315 x 830 x 1810	120.5	1245 x 785	500	200 x 40

Also available in ESD design on page 67

Load capacity shelf: 80 kg**



Shelf trolley | fixed welded

Article-no. + /Colour	Dimension W x D x H (mm)	Weight kg	Loading surface W x D (mm)	Load cap. kg	Wheel diam. mm
sw-700.440 / AG	1115 x 810 x 1810	77.0	1045 x 685	500	200 x 40
sw-800.440 / AG	1315 x 910 x 1810	89.5	1245 x 785	500	200 x 40

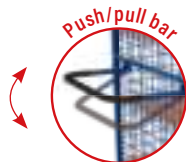

Adjusts to the height of the person pulling when the trolley is being pulled and is flush with the frame when not in use



Rests against the cross tube when pushed, for safe and comfortable pushing



Can be opened 270° and is flush with the frame

NEW

Shelf trolley | fixed welded

Article-no. + /Colour	Dimension W x D x H (mm)	Weight kg	Loading surface W x D (mm)	Load cap. kg	Wheel diam. mm
sw-700.946 / AG	1115 x 730 x 1810	77.0	1045 x 685	500	200 x 40
sw-800.984 / AG	1315 x 830 x 1810	89.5	1245 x 785	500	200 x 40



RAL 5010 RAL 7016

CONSTRUCTION

- Fixed welded angle-steel construction
- End and side walls, roof and doors with mesh sides 50 x 50 mm

FEATURES

- Load surfaces and optionally shelves of wood-based board, surface finish beech or coated dark grey
- Shelf supports for variable insertion at 50 mm intervals
- Double wing doors with espagnolette bolt lock and T-handle or lever

- Cylinder lock, incl. 2 keys (different locking)
- Push/pull bar with soft plastic grip cover

FITTINGS

- 2 **EasySTOP** swivel castors, 2 fixed castors
- Grey non-marking thermoplastic rubber tyres on plastic wheel rim with precision deepgroove ball bearings, with foot guard
- Available in 2 colours, RAL 5010 gentian blue or RAL 7016 anthracite grey, powder-coated

Walls, roof and doors with mesh
Double wing door, lockable
EasySTOP



System trolleys



Shelf trolley | fixed welded



Article-no. + /Colour	Dimension W x D x H (mm)	Weight kg	Loading surface W x D (mm)	Load cap. kg	Wheel diam. mm
sw-700.411 / AG	1115 x 810 x 1810	117.5	1045 x 685	500	200 x 40
sw-800.411 / AG	1315 x 910 x 1810	140.0	1245 x 785	500	200 x 40

Load capacity shelf: 80 kg**



Shelf trolley | fixed welded



Article-no. + /Colour	Dimension W x D x H (mm)	Weight kg	Loading surface W x D (mm)	Load cap. kg	Wheel diam. mm
sw-700.987 / AG	1115 x 730 x 1810	117.5	1045 x 685	500	200 x 40
sw-800.987 / AG	1315 x 830 x 1810	140.0	1245 x 785	500	200 x 40

Also available in ESD design on page 67

Load capacity shelf: 80 kg**



ADDITIONAL ARTICLES Shelves for shelf trolleys

Article-no. + /Colour	Dimension W x D x H (mm)	Weight kg	For loading surface W x D (mm)	Load cap. kg
-----------------------	-----------------------------	--------------	-----------------------------------	-----------------

SHELVES OF WOOD-BASED BOARD

zsw-700.411 / G	1030 x 660	11.5	1045 x 685	80
zsw-800.411 / G	1230 x 760	16.0	1245 x 785	80

SHELVES OF PLYWOOD

zsw-700.412	1030 x 660	11.0	1045 x 685	120
zsw-800.412	1230 x 760	14.5	1245 x 785	120

SHELVES OF WATERPROOF BONDED PLYWOOD surface finish screen printed

zsw-700.416	1030 x 660	11.5	1045 x 685	120
zsw-800.416	1230 x 760	15.5	1245 x 785	120

GROUND SHELVES OF WATERPROOF BONDED PLYWOOD surface finish screen printed

zsw-700.441 *	1045 x 685		1045 x 685	according to the shelf trolley
zsw-800.441 *	1245 x 785		1245 x 785	

*In exchange for wood-based board, as ex-factory equipment



**Static distributed load; Total load of the transport device must not be exceeded!

42 SHELF TROLLEYS



RAL 5010

RAL 7016

Walls, roof and doors of galvanised steel sheet
Optionally with double wing door, lockable

System trolleys



CONSTRUCTION

- Fixed welded angle-steel construction
- End and side walls, roof and doors of galvanised steel sheet

FEATURES

- Load surfaces and optionally shelves of wood-based board, surface finish beech or coated dark grey
- Shelf supports for variable insertion at 100 mm intervals
- Double wing doors with espagnolette bolt lock and T-handle or lever

- Cylinder lock, incl. 2 keys (different locking)
- Push/pull bar with soft plastic grip cover

FITTINGS

- 2 **EasySTOP** swivel castors, 2 fixed castors
- Grey non-marking thermoplastic rubber tyres on plastic wheel rim with precision deepgroove ball bearings, with foot guard
- Available in 2 colours, RAL 5010 gentian blue or RAL 7016 anthracite grey, powder-coated



For suitable models on request

Shelf trolley | fixed welded

Article-no. + /Colour	Dimension W x D x H (mm)	Weight kg	Loading surface W x D (mm)	Load cap. kg	Wheel diam. mm
sw-700.412 / AG	1115 x 730 x 1810	123.0	1045 x 685	500	200 x 40
sw-800.412 / AG	1315 x 830 x 1810	153.0	1245 x 785	500	200 x 40

Also available in ESD design on page 68

Load capacity shelf: 80 kg**



Can be opened 270° and is flush with the frame

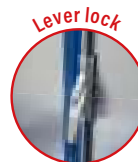

Shelf trolley | fixed welded

Article-no. + /Colour	Dimension W x D x H (mm)	Weight kg	Loading surface W x D (mm)	Load cap. kg	Wheel diam. mm
sw-700.448 / AG	1115 x 810 x 1810	107.0	1045 x 685	500	200 x 40
sw-800.448 / AG	1315 x 910 x 1810	124.0	1245 x 785	500	200 x 40

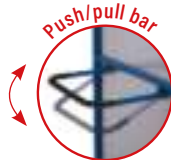

Adjusts to the height of the person pulling when the trolley is being pulled and is flush with the frame when not in use



Rests against the cross tube when pushed, for safe and comfortable pushing



Shelf trolley | fixed welded

NEW

Article-no. + /Colour	Dimension W x D x H (mm)	Weight kg	Loading surface W x D (mm)	Load cap. kg	Wheel diam. mm
sw-700.668 / AG	1115 x 730 x 1810	107.0	1045 x 685	500	200 x 40
sw-800.668 / AG	1315 x 830 x 1810	124.0	1245 x 785	500	200 x 40



RAL 5010 RAL 7016

CONSTRUCTION

- Fixed welded angle-steel construction
- End and side walls, roof and doors of galvanised steel sheet

FEATURES

- Load surfaces and optionally shelves of wood-based board, surface finish beech or coated dark grey
- Shelf supports for variable insertion at 100 mm intervals
- Double wing doors with espagnolette bolt lock and T-handle or lever

- Cylinder lock, incl. 2 keys (different locking)
- Push/pull bar with soft plastic grip cover

FITTINGS

- 2 **EasySTOP** swivel castors, 2 fixed castors
- Grey non-marking thermoplastic rubber tyres on plastic wheel rim with precision deepgroove ball bearings, with foot guard
- Available in 2 colours, RAL 5010 gentian blue or RAL 7016 anthracite grey, powder-coated

Walls, roof and doors of galvanised steel sheet
Double wing door, lockable
EasySTOP



System trolleys



Shelf trolley | fixed welded



Article-no. + /Colour	Dimension W x D x H (mm)	Weight kg	Loading surface W x D (mm)	Load cap. kg	Wheel diam. mm
sw-700.413 / AG	1115 x 810 x 1810	138.0	1045 x 685	500	200 x 40
sw-800.413 / AG	1315 x 910 x 1810	171.5	1245 x 785	500	200 x 40

Load capacity shelf: 80 kg**



Shelf trolley | fixed welded



Article-no. + /Colour	Dimension W x D x H (mm)	Weight kg	Loading surface W x D (mm)	Load cap. kg	Wheel diam. mm
sw-700.988 / AG	1115 x 730 x 1810	138.0	1045 x 685	500	200 x 40
sw-800.988 / AG	1315 x 830 x 1810	171.5	1245 x 785	500	200 x 40

Also available in ESD design on page 68

Load capacity shelf: 80 kg**



ADDITIONAL ARTICLES Shelves for shelf trolleys

Article-no. + /Colour	Dimension W x D x H (mm)	Weight kg	For loading surface W x D (mm)	Load cap. kg
-----------------------	-----------------------------	--------------	-----------------------------------	-----------------

SHELVES OF WOOD-BASED BOARD

zsw-700.413 / G	1030 x 660	11.5	1045 x 685	80
zsw-800.413 / G	1230 x 760	16.0	1245 x 785	80

SHELVES OF PLYWOOD

zsw-700.414	1030 x 660	11.0	1045 x 685	120
zsw-800.414	1230 x 760	14.5	1245 x 785	120

SHELVES OF WATERPROOF BONDED PLYWOOD surface finish screen printed

zsw-700.417	1030 x 660	11.5	1045 x 685	120
zsw-800.417	1230 x 760	15.5	1245 x 785	120

GROUND SHELVES OF WATERPROOF BONDED PLYWOOD surface finish screen printed

zsw-700.441 *	1045 x 685		1045 x 685	according to the shelf trolley
zsw-800.441 *	1245 x 785		1245 x 785	

*In exchange for wood-based board, as ex-factory equipment

**Static distributed load; Total load of the transport device must not be exceeded!



44 SHELF TROLLEYS



Tilting shelves with edge
Shelves of wood-based board,
variable insertion

EasySTOP

System trolleys



CONSTRUCTION

- Modular system
- Base structure with innovative frame section
- Fixed welded tubular push bar

FEATURES

- Load surfaces of wood-based board, surface finish beech or coated dark grey
- For sloping or horizontal insertion, shelf support interval 120 mm

- Gradient when sloping 15 degrees
- 15 mm high edge on the long side

FITTINGS

- 2 **EasySTOP** swivel castors, 2 fixed castors
- Grey non-marking thermoplastic rubber tyres on plastic wheel rim with precision deepgroove ball bearings, with foot guard
- Available in 2 colours, RAL 5010 gentian blue or RAL 7016 anthracite grey, powder-coated



Shelf trolley | with 2 wooden shelves

Article-no. + /Colour	Dimension W x D x H (mm)	Weight kg	Loading surface W x D (mm)	Load cap. kg	Wheel diam. mm
sw-540.200 / AG	1510 x 550 x 1235	56.0	1355 x 550	250	160 x 40
sw-640.200 / AG	1805 x 650 x 1275	64.5	1650 x 650	400	200 x 40

Load capacity shelf: 80 kg**



Shelf trolley | with 3 wooden shelves

Article-no. + /Colour	Dimension W x D x H (mm)	Weight kg	Loading surface W x D (mm)	Load cap. kg	Wheel diam. mm
sw-540.201 / AG	1510 x 550 x 1535	72.0	1355 x 550	250	160 x 40
sw-640.201 / AG	1805 x 650 x 1575	87.0	1650 x 650	400	200 x 40

Load capacity shelf: 80 kg**



For suitable
shelf trolleys
on request



Shelves for
insertion diagonally
or horizontal

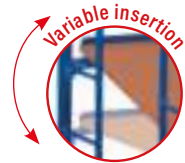

Shelf trolley | with 4 wooden shelves

Article-no. + /Colour	Dimension W x D x H (mm)	Weight kg	Loading surface W x D (mm)	Load cap. kg	Wheel diam. mm
sw-540.202 / AG	1510 x 550 x 1815	87.0	1355 x 550	250	160 x 40
sw-640.202 / AG	1805 x 650 x 1855	101.5	1650 x 650	400	200 x 40

Load capacity shelf: 80 kg**



ADDITIONAL ARTICLES Wooden shelves for shelf trolleys

Article-no. + /Colour	Dimension W x D x H (mm)	Weight kg	For loading surface W x D (mm)	Load cap. kg
zsw-540.202 / AG	1320 x 535	12.5	1355 x 550	80
zsw-640.202 / AG	1615 x 635	16.0	1650 x 650	80



RAL 5010 RAL 7016

CONSTRUCTION

- Modular system
- Base structure with innovative frame section
- Fixed welded tubular push bar

FEATURES

- Load surfaces with mesh size 50 x 50 mm
- For sloping or horizontal insertion, shelf support interval 120 mm

- Gradient when sloping 15 degrees
- 15 mm high edge on the long side

FITTINGS

- 2 **EasySTOP** swivel castors, 2 fixed castors
- Grey non-marking thermoplastic rubber tyres on plastic wheel rim with precision deepgroove ball bearings, with foot guard
- Available in 2 colours, RAL 5010 gentian blue or RAL 7016 anthracite grey, powder-coated

Tilting shelves with edge
Shelves of mesh,
variable insertion
EasySTOP



System trolleys

Shelf trolley | with 2 mesh shelves



Article-no. + /Colour	Dimension W x D x H (mm)	Weight kg	Loading surface W x D (mm)	Load cap. kg	Wheel diam. mm
sw-540.223 / AG	1510 x 550 x 1235	47.0	1355 x 550	250	160 x 40
sw-640.223 / AG	1805 x 650 x 1275	56.5	1650 x 650	400	200 x 40

Load capacity shelf: 50 kg**



Shelf trolley | with 3 mesh shelves



Article-no. + /Colour	Dimension W x D x H (mm)	Weight kg	Loading surface W x D (mm)	Load cap. kg	Wheel diam. mm
sw-540.225 / AG	1510 x 550 x 1535	59.5	1355 x 550	250	160 x 40
sw-640.225 / AG	1805 x 650 x 1575	66.0	1650 x 650	400	200 x 40

Load capacity shelf: 50 kg**



Shelves for
insertion diagonally
or horizontal

Shelf trolley | with 4 mesh shelves



Article-no. + /Colour	Dimension W x D x H (mm)	Weight kg	Loading surface W x D (mm)	Load cap. kg	Wheel diam. mm
sw-540.212 / AG	1510 x 550 x 1815	71.0	1355 x 550	250	160 x 40
sw-640.212 / AG	1805 x 650 x 1855	79.0	1650 x 650	400	200 x 40

Load capacity shelf: 50 kg**



ADDITIONAL ARTICLES Mesh shelves for shelf trolleys

Article-no. + /Colour	Dimension W x D x H (mm)	Weight kg	For loading surface W x D (mm)	Load cap. kg
zsw-540.212 / AG	1320 x 535	9.5	1355 x 550	50
zsw-640.212 / AG	1615 x 635	10.5	1650 x 650	50



**Static distributed load; Total load of the transport device must not be exceeded!

46 SHELF TROLLEYS



GALVANISED

Galvanised
Tilting shelves with edge
Shelves of mesh
Variable insertion

System trolleys

CONSTRUCTION

- Modular system
- Base structure with innovative frame section
- Fixed welded tubular push bar

FEATURES

- Load surfaces with mesh size 50 x 50 mm
- For sloping or horizontal insertion, shelf support interval 120 mm

- Gradient when sloping 15 degrees
- 15 mm high edge on the long side

FITTINGS

- 2 **EasySTOP** swivel castors, 2 fixed castors
- Grey non-marking thermoplastic rubber tyres on plastic wheel rim with precision deepgroove ball bearings, with foot guard
- Galvanised



Shelf trolley | with 2 mesh shelves | galvanized



Article-no.	Dimension W x D x H (mm)	Weight kg	Loading surface W x D (mm)	Load cap. kg	Wheel diam. mm
sw-540.224	1510 x 550 x 1235	47.0	1355 x 550	250	160 x 40
sw-640.224	1805 x 650 x 1275	56.5	1650 x 650	400	200 x 40

Load capacity shelf: 50 kg**



Shelf trolley | with 3 mesh shelves | galvanized



Article-no.	Dimension W x D x H (mm)	Weight kg	Loading surface W x D (mm)	Load cap. kg	Wheel diam. mm
sw-540.226	1510 x 550 x 1535	59.5	1355 x 550	250	160 x 40
sw-640.226	1805 x 650 x 1575	66.0	1650 x 650	400	200 x 40

Load capacity shelf: 50 kg**



Shelves for insertion diagonally or horizontal



Shelf trolley | with 4 mesh shelves | galvanized



Article-no.	Dimension W x D x H (mm)	Weight kg	Loading surface W x D (mm)	Load cap. kg	Wheel diam. mm
sw-540.218	1510 x 550 x 1815	71.0	1355 x 550	250	160 x 40
sw-640.218	1805 x 650 x 1855	79.0	1650 x 650	400	200 x 40

Load capacity shelf: 50 kg**



ADDITIONAL ARTICLES Galvanised mesh shelves for shelf trolley

Article-no.	Dimension W x D x H (mm)	Weight kg	For loading surface W x D (mm)	Load cap. kg
zsw-540.218	1320 x 535	9.5	1355 x 550	50
zsw-640.218	1615 x 635	10.5	1650 x 650	50

RAL 5010 **RAL 7016**

CONSTRUCTION

- Welded steel construction
- Screwed

FEATURES

- Tilts to 17° or 32° by bolting
- Open shelves with 27 mm high edge
- Clearance between cross tubes: 125 mm
- Hole spacing for screwing shelves: 150 mm
- Suitable for euro size container 600 x 400 mm (W x D)

FITTINGS

- 4 swivel castors, 2 of them with brakes
- Grey non-marking thermoplastic rubber tyres on plastic wheel rim with precision deepgroove ball bearings, with foot guard
- Available in 2 colours, RAL 5010 gentian blue or RAL 7016 anthracite grey, powder-coated

Open shelves with edge
Tilting shelves
Two tilt angles

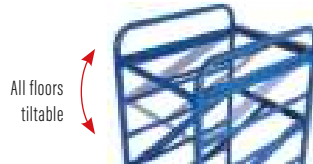

Suitable plastic crates on page 48

Euro container trolley

Article-no. + /Colour	Dimension W x D x H (mm)	Weight kg	Loading surface W x D (mm)	Load cap. kg	Wheel diam. mm
sw-610.100 / AG	520 x 665 x 1125	33.5	410 x 610	200	125 x 30

Load capacity shelf: 50 kg**

Suitable plastic crates on page 48

Euro container trolley

Article-no. + /Colour	Dimension W x D x H (mm)	Weight kg	Loading surface W x D (mm)	Load cap. kg	Wheel diam. mm
sw-610.200 / AG	935 x 665 x 1125	38.5	825 x 610	200	125 x 30

Load capacity shelf: 50 kg**



Suitable plastic crates on page 48

Euro container trolley

Article-no. + /Colour	Dimension W x D x H (mm)	Weight kg	Loading surface W x D (mm)	Load cap. kg	Wheel diam. mm
sw-610.300 / AG	1350 x 665 x 1700	69.5	1240 x 610	250	160 x 40

Load capacity shelf: 50 kg**



System trolleys

**Static distributed load; Total load of the transport device must not be exceeded!

48 EURO CONTAINER TROLLEYS

RAL 5010 RAL 7016

Open shelves with plastic crates and edge
Tilting shelves
Two tilt angles

System trolleys

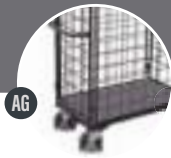

AG



CONSTRUCTION

- Welded steel construction
- Screwed

FEATURES

- Tilts to 17° or 32° by bolting
- Open shelves with 27 mm high edge and plastic crates
- Clearance between cross tubes: 125 mm
- Hole spacing for screwing shelves: 150 mm
- Suitable for euro size container 600 x 400 mm (W x D)

FITTINGS

- 4 swivel castors, 2 of them with brakes
- Grey non-marking thermoplastic rubber tyres on plastic wheel rim with precision deepgroove ball bearings, with foot guard
- Available in 2 colours, RAL 5010 gentian blue or RAL 7016 anthracite grey, powder-coated

Incl. euro size container
600 x 400 x 170 mm (W x D x H)

Euro container trolley | with 3 plastic crates

Article-no. + /Colour	Dimension W x D x H (mm)	Weight kg	Loading surface W x D (mm)	Load cap. kg	Wheel diam. mm
sw-610.102 / AG	520 x 665 x 1160	38.5	410 x 610	200	125 x 30

Load capacity shelf: 50 kg**

Incl. euro size container
600 x 400 x 170 mm (W x D x H)

Euro container trolley | with 6 plastic crates

Article-no. + /Colour	Dimension W x D x H (mm)	Weight kg	Loading surface W x D (mm)	Load cap. kg	Wheel diam. mm
sw-610.202 / AG	935 x 665 x 1160	47.5	825 x 610	200	125 x 30

Load capacity shelf: 50 kg**

Incl. euro size container
600 x 400 x 170 mm (W x D x H)

Euro container trolley | with 15 plastic crates

Article-no. + /Colour	Dimension W x D x H (mm)	Weight kg	Loading surface W x D (mm)	Load cap. kg	Wheel diam. mm
sw-610.302 / AG	1350 x 665 x 1785	92.0	1240 x 610	250	160 x 40

Load capacity shelf: 50 kg**

ADDITIONAL ARTICLES Plastic crates

Article-no.	Dimension W x D x H (mm)	Weight kg	Volume l
fk-040.004	600 x 400 x 170	1.5	35
fk-040.000	600 x 400 x 220	3.3	45

**Static distributed load; Total load of the transport device must not be exceeded!

RAL 5010 RAL 7016

CONSTRUCTION

- Welded steel construction
- Screwed

FEATURES

- Tilts to 17° or 32° by bolting
- Load surfaces of wood-based board, surface finish beech or coated dark grey
- Shelves with edge 15 mm high
- Clearance between cross tubes: 125 mm
- Hole spacing for screwing shelves: 150 mm
- Suitable for euro size container 600 x 400 mm (W x D)

FITTINGS

- 4 swivel castors, 2 of them with brakes
- Grey non-marking thermoplastic rubber tyres on plastic wheel rim with precision deepgroove ball bearings, with foot guard
- Available in 2 colours, RAL 5010 gentian blue or RAL 7016 anthracite grey, powder-coated

Wooden shelves with edge
Tilting shelves
Two tilt angles



System trolleys

Euro container trolley | with 3 wooden shelves

Article-no. + /Colour	Dimension W x D x H (mm)	Weight kg	Loading surface W x D (mm)	Load cap. kg	Wheel diam. mm
sw-610.101 / AG	520 x 665 x 1125	40.5	410 x 610	200	125 x 30

Load capacity shelf: 50 kg**



Euro container trolley | with 3 wooden shelves

Article-no. + /Colour	Dimension W x D x H (mm)	Weight kg	Loading surface W x D (mm)	Load cap. kg	Wheel diam. mm
sw-610.201 / AG	935 x 665 x 1125	52.5	825 x 610	200	125 x 30

Load capacity shelf: 50 kg**



Euro container trolley | with 5 wooden shelves

Article-no. + /Colour	Dimension W x D x H (mm)	Weight kg	Loading surface W x D (mm)	Load cap. kg	Wheel diam. mm
sw-610.301 / AG	1350 x 665 x 1700	103.0	1240 x 610	250	160 x 40

Load capacity shelf: 50 kg**



Also available in ESD design on page 70

**Static distributed load; Total load of the transport device must not be exceeded!

50 SMALL ORDER-PICKING TROLLEYS



RAL 5010

RAL 7016

Open shelves or with plastic crates
or wooden shelves with edge
Fixed shelves

System trolleys



CONSTRUCTION

- Welded steel construction

FEATURES

- Open shelves or with 3 plastic crates (600 x 400 x 220 mm (W x D x H) / 45 l), or of wood-based board, surface finish beech or coated dark grey (edge 10 mm high)
- Suitable for euro size container 600 x 400 mm (W x D)
- Middle and upper shelf fixed

FITTINGS

- 2 **EasySTOP** swivel castors, 2 fixed castors
- Grey non-marking thermoplastic rubber tyres on plastic wheel rim with precision deepgroove ball bearings, with foot guard
- Available in 2 colours, RAL 5010 gentian blue or RAL 7016 anthracite grey, powder-coated



Suitable plastic crates on page 48

Small order-picking trolley

Article-no. + /Colour	Dimension W x D x H (mm)	Weight kg	Loading surface W x D (mm)	Load cap. kg	Wheel diam. mm
sw-400.800 / AG	815 x 455 x 1185	21.0	610 x 410	200	125 x 30

Load capacity shelf: 50 kg**



Incl. euro size container
600 x 400 x 220 mm (W x D x H)

Small order-picking trolley | with 3 plastic crates

Article-no. + /Colour	Dimension W x D x H (mm)	Weight kg	Loading surface W x D (mm)	Load cap. kg	Wheel diam. mm
sw-400.804 / AG	815 x 455 x 1385	25.5	610 x 410	200	125 x 30

Load capacity shelf: 50 kg**

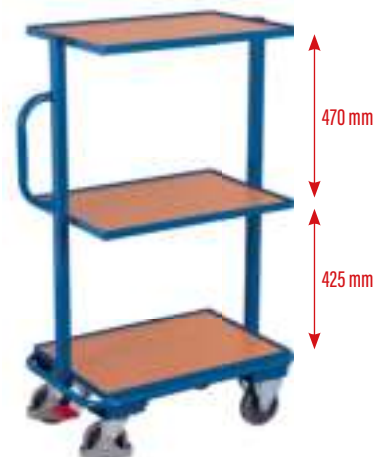

Suitable plastic crates on page 48

Small order-picking trolley | with 3 wooden shelves

Article-no. + /Colour	Dimension W x D x H (mm)	Weight kg	Loading surface W x D (mm)	Load cap. kg	Wheel diam. mm
sw-400.801 / AG	815 x 455 x 1185	26.0	610 x 410	200	125 x 30

Load capacity shelf: 50 kg**



RAL 5010 RAL 7016

CONSTRUCTION

- Welded steel construction

FEATURES

- Open shelves or with 3 plastic crates (600 x 400 x 220 mm (W x D x H) / 45 l), or of wood-based board, surface finish beech or coated dark grey (edge 10 mm high)
- Suitable for euro size container 600 x 400 mm (W x D)
- Middle and upper shelf tilts to 15° or 30°

FITTINGS

- 2 **EasySTOP** swivel castors, 2 fixed castors
- Grey non-marking thermoplastic rubber tyres on plastic wheel rim with precision deepgroove ball bearings, with foot guard
- Available in 2 colours, RAL 5010 gentian blue or RAL 7016 anthracite grey, powder-coated

Open shelves or with plastic crates
or wooden shelves with edge
Tilting shelves
Two tilt angles



System trolleys

Suitable plastic crates on page 48

Small order-picking trolley | tiltable



Article-no. + /Colour	Dimension W x D x H (mm)	Weight kg	Loading surface W x D (mm)	Load cap. kg	Wheel diam. mm
sw-400.802 / AG	815 x 455 x 1185	22.0	610 x 410	200	125 x 30

Load capacity shelf: 50 kg**



Incl. euro size container
600 x 400 x 220 mm (W x D x H)

Small order-picking trolley | with 3 plastic crates | tiltable



Article-no. + /Colour	Dimension W x D x H (mm)	Weight kg	Loading surface W x D (mm)	Load cap. kg	Wheel diam. mm
sw-400.805 / AG	815 x 455 x 1385	28.5	610 x 410	200	125 x 30

Load capacity shelf: 50 kg**



Suitable plastic crates on page 48

Small order-picking trolley | with 3 wooden shelves | tiltable



Article-no. + /Colour	Dimension W x D x H (mm)	Weight kg	Loading surface W x D (mm)	Load cap. kg	Wheel diam. mm
sw-400.803 / AG	815 x 455 x 1185	29.5	610 x 410	200	125 x 30

Also available in ESD design on page 70

Load capacity shelf: 50 kg**



**Static distributed load; Total load of the transport device must not be exceeded!

Height adjustable
Fixed or one-sided tiltable
Edge on one side or all sides

System trolleys



CONSTRUCTION

- Welded steel construction

FEATURES

- Load surface with edge on one side (22 mm high) or edge on all sides (18 mm high)
- Height adjustable in steps of 25 mm
- Fixed or tilting on one side to 15° or 30°, secure positioning by spring catch
- Suitable for euro size container 600 x 400 mm (W x D)

FITTINGS

- 4 swivel castors, 2 of them with brakes
- Grey non-marking thermoplastic rubber tyres on plastic wheel rim with precision deepgroove ball bearings, with foot guard
- Available in 2 colours, RAL 5010 gentian blue or RAL 7016 anthracite grey, powder-coated

Suitable plastic crates on page 48

Material stand

Article-no. + /Colour	Dimension W x D x H (mm)	Weight kg	Loading surface W x D (mm)	Load cap. kg	Wheel diam. mm
sw-405.000 / AG	610 x 410 x 770-1020	16.0	605 x 405	150	75 x 25

Also available in ESD design on page 71



Height adjustable in steps of 25 mm



Suitable plastic crates on page 48

Material stand

BEST-SELLER

Article-no. + /Colour	Dimension W x D x H (mm)	Weight kg	Loading surface W x D (mm)	Load cap. kg	Wheel diam. mm
sw-405.001 / AG	610 x 410 x 535-810	14.5	605 x 405	150	75 x 25

Also available in ESD design on page 71



Material stand | one-sided tiltable

Article-no. + /Colour	Dimension W x D x H (mm)	Weight kg	Loading surface W x D (mm)	Load cap. kg	Wheel diam. mm
sw-405.002 / AG	600 x 410 x 715-1085	15.0	510 x 410	150	75 x 25

Also available in ESD design on page 71



Material stand | one-sided tiltable

Article-no. + /Colour	Dimension W x D x H (mm)	Weight kg	Loading surface W x D (mm)	Load cap. kg	Wheel diam. mm
sw-405.005 / AG	600 x 410 x 520-775	13.5	510 x 410	150	75 x 25

Also available in ESD design on page 71

RAL 5010 RAL 7016

CONSTRUCTION

- Welded steel construction
- Platform bolted to frame, permitting variable extension with other types of platform

FEATURES

- Load surface with edge on one side (22 mm high)
- One-sided tiltable to 15° or 30°
- Zero-play adjustable telescopic system, self-locking
- Continuously adjustable by hand crank, height adjustment range 660 - 1035 mm
- Platform height adjustable even under full load

FITTINGS

- 4 swivel castors, 2 of them with brakes
- Grey non-marking thermoplastic rubber tyres on plastic wheel rim with precision deepgroove ball bearings, with foot guard
- Available in 2 colours, RAL 5010 gentian blue or RAL 7016 anthracite grey, powder-coated

Infinitely height adjustable with hand crank

Tiltable

Edge on one side



System trolleys



Material stand | with hand crank

Article-no. + /Colour	Dimension W x D x H (mm)	Weight kg	Loading surface W x D (mm)	Load cap. kg	Wheel diam. mm
sw-405.012 / AG	600 x 415 x 680-1055	19.0	510 x 410	150	75 x 25

54 CUSTOMIZING

IN COMPARISON



Our custom-made products in comparison

INDIVIDUALLY

- Opportunities for modification in line with customers' individual wishes

UNIQUE PIECE

- Deliveries of small series from one piece upwards
- Product approval drawings
- Fair prices even for small quantities

CUSTOMER FOCUSED

- Analysing parameters such as uses, handling, workflows and much more in close cooperation with the customer

TAILORED

- Products in special sizes, special colours and complete new designs



STANDARD



The best solution for every task



STANDARD

Customizing

RAL 5010 RAL 7016

CONSTRUCTION

- Welded steel construction

FEATURES

- Open load surface or of wood-based board, surface finish beech or coated dark grey or with ribbed rubber covering or with diamond-tread

FITTINGS

- 4 swivel castors, 2 of them with brakes
- Grey non-marking thermoplastic rubber tyres on plastic wheel rim with precision deepgroove ball bearings, with foot guard
- Available in 2 colours, RAL 5010 gentian blue or RAL 7016 anthracite grey, powder-coated

Open load surface or of wood-based board or with ribbed rubber covering or with diamond-tread



System trolleys

Crate dolly



Article-no. + /Colour	Dimension W x D x H (mm)	Weight kg	Loading surface W x D (mm)	Load cap. kg	Wheel diam. mm
sw-500.010 / AG	500 x 500 x 170	8.5	500 x 500	400	125 x 30



Crate dolly | with board load surface



Article-no. + /Colour	Dimension W x D x H (mm)	Weight kg	Loading surface W x D (mm)	Load cap. kg	Wheel diam. mm
sw-500.011 / AG	500 x 500 x 185	11.5	500 x 500	400	125 x 30



Crate dolly | with ribbed rubber covering



Article-no. + /Colour	Dimension W x D x H (mm)	Weight kg	Loading surface W x D (mm)	Load cap. kg	Wheel diam. mm
sw-500.013 / AG	500 x 500 x 185	12.0	500 x 500	400	125 x 30



Crate dolly | with diamond-tread load surface



Article-no. + /Colour	Dimension W x D x H (mm)	Weight kg	Loading surface W x D (mm)	Load cap. kg	Wheel diam. mm
sw-500.012 / AG	500 x 500 x 170	12.0	500 x 500	400	125 x 30



With or without load surface
Board flush with frame or with edge
Suitable for euro size container



AG

System trolleys

CONSTRUCTION

- Welded angle-steel construction

FEATURES

- Versions without or with load surface of wood-based board, surface finish beech or coated dark grey
- Flush with frame or edge 10 mm high
- Suitable for euro size container 600 x 400 mm (W x D)

FITTINGS

- 4 swivel castors, 2 of them with brakes
- Grey non-marking thermoplastic rubber tyres on plastic wheel rim with precision deepgroove ball bearings, with foot guard
- Available in 2 colours, RAL 5010 gentian blue or RAL 7016 anthracite grey, powder-coated



Suitable plastic crates on page 48

Euro system dolly

Article-no. + /Colour	Dimension W x D x H (mm)	Weight kg	Loading surface W x D (mm)	Load cap. kg	Wheel diam. mm
sw-410.003 / AG	610 x 415 x 205	8.5	605 x 410	250	125 x 30



Shown with euro size container
600 x 400 x 170 mm (W x D x H)
Suitable plastic crates on page 48

Euro system dolly | with board (edge 10 mm)

Article-no. + /Colour	Dimension W x D x H (mm)	Weight kg	Loading surface W x D (mm)	Load cap. kg	Wheel diam. mm
sw-410.010 / AG	610 x 415 x 205	10.0	605 x 410	250	125 x 30



Suitable plastic crates on page 48

Euro system dolly | with board

Article-no. + /Colour	Dimension W x D x H (mm)	Weight kg	Loading surface W x D (mm)	Load cap. kg	Wheel diam. mm
sw-410.009 / AG	610 x 415 x 205	10.0	610 x 415	250	125 x 30



RAL 5010 RAL 7016

CONSTRUCTION

- Welded angle-steel construction

FEATURES

- Versions without or with load surface of wood-based board, surface finish beech or coated dark grey
- Flush with frame or edge 10 mm high
- Suitable for euro size container 600 x 400 mm (W x D)

FITTINGS

- 4 swivel castors, 2 of them with **EasySTOP**
- Grey non-marking thermoplastic rubber tyres on plastic wheel rim with precision deepgroove ball bearings, with foot guard
- Available in 2 colours, RAL 5010 gentian blue or RAL 7016 anthracite grey, powder-coated

With or without load surface
Board flush with frame or with edge
Suitable for euro size container

EasySTOP



Suitable plastic crates on page 48

Euro system dolly



Article-no. + /Colour	Dimension W x D x H (mm)	Weight kg	Loading surface W x D (mm)	Load cap. kg	Wheel diam. mm
sw-410.063 / AG	610 x 415 x 235	9.5	605 x 410	250	125 x 30



System trolleys

Suitable plastic crates on page 48

Euro system dolly | with board (edge 10 mm)



Article-no. + /Colour	Dimension W x D x H (mm)	Weight kg	Loading surface W x D (mm)	Load cap. kg	Wheel diam. mm
sw-410.070 / AG	610 x 415 x 235	11.0	605 x 410	250	125 x 30



Suitable plastic crates on page 48

Euro system dolly | with board



Article-no. + /Colour	Dimension W x D x H (mm)	Weight kg	Loading surface W x D (mm)	Load cap. kg	Wheel diam. mm
sw-410.069 / AG	610 x 415 x 235	11.0	610 x 415	250	125 x 30



58 EURO SYSTEM DOLLIES

RAL 5010 RAL 7016

With or without load surface
Board flush with frame or with edge
Suitable for euro size container
With sockets



AG

System trolleys

CONSTRUCTION

- Welded angle-steel construction

FEATURES

- Versions without or with load surface of wood-based board, surface finish beech or coated dark grey
- Flush with frame or edge 10 mm high
- Suitable for euro size container 600 x 400 mm (W x D)
- 4 sockets

FITTINGS

- 4 swivel castors, 2 of them with brakes
- Grey non-marking thermoplastic rubber tyres on plastic wheel rim with precision deepgroove ball bearings, with foot guard
- Available in 2 colours, RAL 5010 gentian blue or RAL 7016 anthracite grey, powder-coated



Suitable plastic crates on page 48

Euro system dolly | with sockets

Article-no. + /Colour	Dimension W x D x H (mm)	Weight kg	Loading surface W x D (mm)	Load cap. kg	Wheel diam. mm
sw-410.000 / AG	675 x 415 x 205	9.0	605 x 410	250	125 x 30



Suitable plastic crates on page 48

Euro system dolly | with board (edge 10 mm) and sockets

Article-no. + /Colour	Dimension W x D x H (mm)	Weight kg	Loading surface W x D (mm)	Load cap. kg	Wheel diam. mm
sw-410.001 / AG	675 x 415 x 205	10.5	605 x 410	250	125 x 30



Suitable plastic crates on page 48

Euro system dolly | with board and sockets

Article-no. + /Colour	Dimension W x D x H (mm)	Weight kg	Loading surface W x D (mm)	Load cap. kg	Wheel diam. mm
sw-410.002 / AG	675 x 415 x 205	10.5	610 x 415	250	125 x 30



RAL 5010 RAL 7016

CONSTRUCTION

- Welded angle-steel construction

FEATURES

- Versions without or with load surface of wood-based board, surface finish beech or coated dark grey
- Flush with frame or edge 10 mm high
- Suitable for euro size container 600 x 400 mm (W x D)
- 4 sockets

FITTINGS

- 4 swivel castors, 2 of them with **EasySTOP**
- Grey non-marking thermoplastic rubber tyres on plastic wheel rim with precision deepgroove ball bearings, with foot guard
- Available in 2 colours, RAL 5010 gentian blue or RAL 7016 anthracite grey, powder-coated

With or without load surface
Board flush with frame or with edge
Suitable for euro size container

EasySTOP



System trolleys

Suitable plastic crates on page 48

Euro system dolly | with sockets



Article-no. + /Colour	Dimension W x D x H (mm)	Weight kg	Loading surface W x D (mm)	Load cap. kg	Wheel diam. mm
sw-410.060 / AG	675 x 415 x 235	10.0	605 x 410	250	125 x 30



Suitable plastic crates on page 48

Euro system dolly | with board (edge 10 mm) and sockets



Article-no. + /Colour	Dimension W x D x H (mm)	Weight kg	Loading surface W x D (mm)	Load cap. kg	Wheel diam. mm
sw-410.061 / AG	675 x 415 x 235	11.5	605 x 410	250	125 x 30



Suitable plastic crates on page 48

Euro system dolly | with board and sockets



Article-no. + /Colour	Dimension W x D x H (mm)	Weight kg	Loading surface W x D (mm)	Load cap. kg	Wheel diam. mm
sw-410.062 / AG	675 x 415 x 235	11.5	610 x 415	250	125 x 30



Load surfaces with edge
Suitable for euro size container
With sockets

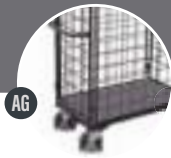

AG

System trolleys



CONSTRUCTION

- Welded angle-steel construction

FEATURES

- Load surfaces of wood-based board, surface finish beech or coated dark grey
- Load surfaces with edge 10 mm high
- Suitable for euro size container 600 x 400 mm (W x D)
- 4 sockets

FITTINGS

- 4 swivel castors, 2 of them with brakes
- Grey non-marking thermoplastic rubber tyres on plastic wheel rim with precision deepgroove ball bearings, with foot guard
- Available in 2 colours, RAL 5010 gentian blue or RAL 7016 anthracite grey, powder-coated

Suitable plastic crates on page 48

Euro system dolly | with board (edge 10 mm) and push bar



Article-no. + /Colour	Dimension W x D x H (mm)	Weight kg	Loading surface W x D (mm)	Load cap. kg	Wheel diam. mm
sw-410.011 / AG	740 x 415 x 970	13.5	605 x 410	250	125 x 30

Suitable plastic crates on page 48

Euro system dolly | with 2 load surfaces (edge 10 mm)



Article-no. + /Colour	Dimension W x D x H (mm)	Weight kg	Loading surface W x D (mm)	Load cap. kg	Wheel diam. mm
sw-410.500 / AG	675 x 415 x 635	19.0	605 x 410	250	125 x 30

Also available in ESD design on page 72

Load capacity shelf: 80 kg**



410 mm

Suitable plastic crates on page 48

Euro system dolly | with 2 load surfaces (edge 10 mm) and push bar



Article-no. + /Colour	Dimension W x D x H (mm)	Weight kg	Loading surface W x D (mm)	Load cap. kg	Wheel diam. mm
sw-410.526 / AG	770 x 415 x 950	20.0	605 x 410	250	125 x 30

Load capacity shelf: 80 kg**



400 mm

RAL 5010 RAL 7016

CONSTRUCTION

- Welded angle-steel construction

FEATURES

- Load surfaces of wood-based board, surface finish beech or coated dark grey
- Load surfaces flush with frame
- Suitable for euro size container 600 x 400 mm (W x D)
- 4 sockets

FITTINGS

- 4 swivel castors, 2 of them with brakes
- Grey non-marking thermoplastic rubber tyres on plastic wheel rim with precision deepgroove ball bearings, with foot guard
- Available in 2 colours, RAL 5010 gentian blue or RAL 7016 anthracite grey, powder-coated

Load surfaces flush with frame
Suitable for euro size container
With sockets



System trolleys

Suitable plastic crates on page 48

Euro system dolly | with board and push bar



Article-no. + /Colour	Dimension W x D x H (mm)	Weight kg	Loading surface W x D (mm)	Load cap. kg	Wheel diam. mm
sw-410.039 / AG	740 x 415 x 970	14.0	610 x 415	250	125 x 30



Suitable plastic crates on page 48

Euro system dolly | with 2 load surfaces



Article-no. + /Colour	Dimension W x D x H (mm)	Weight kg	Loading surface W x D (mm)	Load cap. kg	Wheel diam. mm
sw-410.501 / AG	675 x 415 x 635	19.0	610 x 415	250	125 x 30

Also available in ESD design on page 72

Load capacity shelf: 80 kg**



NEW

Suitable plastic crates on page 48

Euro system dolly | with 2 load surfaces and push bar



Article-no. + /Colour	Dimension W x D x H (mm)	Weight kg	Loading surface W x D (mm)	Load cap. kg	Wheel diam. mm
sw-410.551 / AG	770 x 415 x 950	20.0	610 x 415	250	125 x 30

Load capacity shelf: 80 kg**



**Static distributed load; Total load of the transport device must not be exceeded!

62 EURO SYSTEM DOLLIES



RAL 5010

RAL 7016

Load surfaces with edge
Suitable for euro size container
With sockets
EasySTOP

System trolleys



CONSTRUCTION

- Welded angle-steel construction

FEATURES

- Load surfaces of wood-based board, surface finish beech or coated dark grey
- Load surfaces with edge 10 mm high
- Suitable for euro size container 600 x 400 mm (W x D)
- 4 sockets

FITTINGS

- 4 swivel castors, 2 of them with **EasySTOP**
- Grey non-marking thermoplastic rubber tyres on plastic wheel rim with precision deepgroove ball bearings, with foot guard
- Available in 2 colours, RAL 5010 gentian blue or RAL 7016 anthracite grey, powder-coated



Suitable plastic crates on page 48



Euro system dolly | with board (edge 10 mm) and push bar

Article-no. + /Colour	Dimension W x D x H (mm)	Weight kg	Loading surface W x D (mm)	Load cap. kg	Wheel diam. mm
sw-410.071 / AG	740 x 415 x 1000	14.5	605 x 410	250	125 x 30



Shown with euro size container
600 x 400 x 170 mm (W x D x H)
Suitable plastic crates on page 48

Euro system dolly | with 2 load surfaces (edge 10 mm)

Article-no. + /Colour	Dimension W x D x H (mm)	Weight kg	Loading surface W x D (mm)	Load cap. kg	Wheel diam. mm
sw-410.540 / AG	675 x 415 x 665	20.0	605 x 410	250	125 x 30

Also available in ESD design on page 72

Load capacity shelf: 80 kg**



Suitable plastic crates on page 48

Euro system dolly | with 2 load surfaces (edge 10 mm) and push bar

Article-no. + /Colour	Dimension W x D x H (mm)	Weight kg	Loading surface W x D (mm)	Load cap. kg	Wheel diam. mm
sw-410.552 / AG	770 x 415 x 990	21.0	605 x 410	250	125 x 30

Load capacity shelf: 80 kg**



RAL 5010 RAL 7016

CONSTRUCTION

- Welded angle-steel construction

FEATURES

- Load surfaces of wood-based board, surface finish beech or coated dark grey
- Load surfaces flush with frame
- Suitable for euro size container 600 x 400 mm (W x D)
- 4 sockets

FITTINGS

- 4 swivel castors, 2 of them with **EasySTOP**
- Grey non-marking thermoplastic rubber tyres on plastic wheel rim with precision deepgroove ball bearings, with foot guard
- Available in 2 colours, RAL 5010 gentian blue or RAL 7016 anthracite grey, powder-coated

Load surfaces flush with frame

Suitable for euro size container

With sockets

EasySTOP

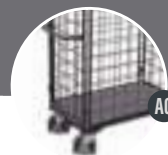

System trolleys

Suitable plastic crates on page 48

Euro system dolly | with board and push bar



Article-no. + /Colour	Dimension W x D x H (mm)	Weight kg	Loading surface W x D (mm)	Load cap. kg	Wheel diam. mm
sw-410.079 / AG	740 x 415 x 1000	14.5	610 x 415	250	125 x 30



Suitable plastic crates on page 48

Euro system dolly | with 2 load surfaces



Article-no. + /Colour	Dimension W x D x H (mm)	Weight kg	Loading surface W x D (mm)	Load cap. kg	Wheel diam. mm
sw-410.541 / AG	675 x 415 x 665	20.0	610 x 415	250	125 x 30

Also available in ESD design on page 72

Load capacity shelf: 80 kg**



NEW

Suitable plastic crates on page 48

Euro system dolly | with 2 load surfaces and push bar



Article-no. + /Colour	Dimension W x D x H (mm)	Weight kg	Loading surface W x D (mm)	Load cap. kg	Wheel diam. mm
sw-410.553 / AG	770 x 415 x 990	21.0	610 x 415	250	125 x 30

Load capacity shelf: 80 kg**



**Static distributed load; Total load of the transport device must not be exceeded!

64 PUSH-HANDLE DOLLIES

RAL 5010 RAL 7016

Screw-on handle
Open load surface or tubular steel load surface
Suitable for euro size container

System trolleys



CONSTRUCTION

- Welded steel construction

FEATURES

- Open load surface or tubular steel load surface
- Open load surface suitable for euro size container 600 x 400 mm (W x D)
- Screw-on handle

FITTINGS

- 1 or 2 swivel castors with brakes, 2 fixed castors
- Grey non-marking thermoplastic rubber tyres on plastic wheel rim with precision deepgroove ball bearings, with foot guard
- Available in 2 colours, RAL 5010 gentian blue or RAL 7016 anthracite grey, powder-coated

Suitable plastic crates on page 48

Push-handle dolly



Article-no. + /Colour	Dimension W x D x H (mm)	Weight kg	Loading surface W x D (mm)	Load cap. kg	Wheel diam. mm
sw-450.807 / AG	890 x 420 x 875	11.0	615 x 415	250	125 x 30



Incl. euro size container
600 x 400 x 220 mm (W x D x H)

Push-handle dolly with plastic crate



Article-no. + /Colour	Dimension W x D x H (mm)	Weight kg	Loading surface W x D (mm)	Load cap. kg	Wheel diam. mm
sw-450.806 / AG	890 x 420 x 875	13.0	615 x 415	250	125 x 30



Push-handle dolly with tubular steel load surface



Article-no. + /Colour	Dimension W x D x H (mm)	Weight kg	Loading surface W x D (mm)	Load cap. kg	Wheel diam. mm
sw-450.805 / AG	785 x 450 x 875	8.5	565 x 450	150	125 x 30



Push-handle dolly with tubular steel load surface



Article-no. + /Colour	Dimension W x D x H (mm)	Weight kg	Loading surface W x D (mm)	Load cap. kg	Wheel diam. mm
sw-500.801 / AG	880 x 500 x 880	9.5	605 x 500	250	125 x 30



RAL 5010 RAL 7016

CONSTRUCTION

- Welded steel construction

FEATURES

- Load surfaces of wood based-board, surface finish beech or coated dark grey
- Load surfaces flush with frame
- Screw-on handle

FITTINGS

- 1 or 2 swivel castors with brakes, 2 fixed castors
- Grey non-marking thermoplastic rubber tyres on plastic wheel rim with precision deepgroove ball bearings, with foot guard
- Available in 2 colours, RAL 5010 gentian blue or RAL 7016 anthracite grey, powder-coated

Screw-on handle
Load surfaces of wood-based board



System trolleys

Push-handle dolly | with board



Article-no. + /Colour	Dimension W x D x H (mm)	Weight kg	Loading surface W x D (mm)	Load cap. kg	Wheel diam. mm
sw-450.804 / AG	785 x 450 x 875	9.5	565 x 450	150	125 x 30



Push-handle dolly | with board



Article-no. + /Colour	Dimension W x D x H (mm)	Weight kg	Loading surface W x D (mm)	Load cap. kg	Wheel diam. mm
sw-500.800 / AG	880 x 500 x 880	11.0	605 x 500	250	125 x 30



RAL 5010 RAL 7016

FEATURES

- 2 load surfaces of wood based-board, surface finish beech or coated dark grey

FITTINGS

- 2 **EasySTOP** swivel castors, 2 fixed castors



PUSH-HANDLE DOLLY WITH 2 LOAD SURFACES

Push-handle dolly | with 2 load surfaces



Article-no. + /Colour	Dimension W x D x H (mm)	Weight kg	Loading surface W x D (mm)	Load cap. kg	Wheel diam. mm
sw-450.800 / AG	940 x 455 x 910	16.0	610 x 455	250	125 x 30



Also available in ESD design on page 70

Load capacity shelf: 100 kg**

**Static distributed load; Total load of the transport device must not be exceeded!

66 ESD TROLLEYS

ELECTROSTATIC DISCHARGE

Electrostatic discharge



ESD

PROBLEM

Moving over various ground materials can cause electrostatic charging of the user and the transport equipment.

DANGER

Delicate goods and goods from the electronics segment can be damaged or even completely destroyed by electrostatic charges and the resulting discharges.

SOLUTION

The **VARIOfit**® ESD transport devices therefore ensure that, due to their electrically conductive construction, the load surfaces of conductive decorative chipboard in light grey and the ESD powder coating in RAL 7024 graphite grey, especially those goods are protected from e.g. overvoltage damage according to EN 61340.



VARIOfit®
ESD TROLLEYS



CONSTRUCTION

- Fixed welded angle-steel construction
- End and side walls, roof and doors with mesh sides 50 x 50 mm

FEATURES

- Load surface and shelves of electrically conductive faced chipboard light grey
- Shelves inserted in angle-steel frame, shelf supports for variable insertion at 50 mm intervals
- Double wing door with espagnolette bolt lock and T-handle

- Cylinder lock, incl. 2 keys (different locking)
- Push/pull bar with soft plastic grip cover

FITTINGS

- 2 **EasySTOP** swivel castors, 2 fixed castors
- Grey non-marking electrically conductive thermoplastic rubber tyres on plastic wheel rim with precision deepgroove ball bearings, with foot guard
- Available in RAL 7024 graphite grey, electrically conductive, powder-coated

Electrostatic discharge
Walls, roof and doors with mesh
Optionally with double wing door, lockable
EasySTOP

ESD shelf trolley | fixed welded

Article-no.	Dimension W x D x H (mm)	Weight kg	Loading surface W x D (mm)	Load cap. kg	Wheel diam. mm
sw-700.860	1115 x 730 x 1810	103.5	1045 x 685	500	200 x 40
sw-800.860	1315 x 830 x 1810	120.5	1245 x 785	500	200 x 40

Load capacity shelf: 80 kg**



Rests against the cross tube when pushed, for safe and comfortable pushing

Flush with the frame when not in use

Can be opened 270° and is flush with the frame

ESD shelf trolley | fixed welded

Article-no.	Dimension W x D x H (mm)	Weight kg	Loading surface W x D (mm)	Load cap. kg	Wheel diam. mm
sw-700.867	1115 x 730 x 1810	117.5	1045 x 685	500	200 x 40
sw-800.867	1315 x 830 x 1810	140.0	1245 x 785	500	200 x 40

Load capacity shelf: 80 kg**



ESD

ADDITIONAL ARTICLES ESD shelves of plywood for shelf trolleys

Article-no.	Dimension W x D x H (mm)	Weight kg	For loading surface W x D (mm)	Load cap. kg
zsw-700.421	1030 x 660	11.5	1045 x 685	80
zsw-800.421	1230 x 760	16.0	1245 x 785	80



**Static distributed load; Total load of the transport device must not be exceeded!



RAL 7024

Electrostatic discharge
Walls, roof and doors of galvanised steel sheet
Optionally with double wing door, lockable
EasySTOP

ESD



CONSTRUCTION

- Fixed welded angle-steel construction
- End and side walls, roof and door of galvanised steel sheet

FEATURES

- Load surface and shelves of electrically conductive faced chipboard light grey
- Shelves inserted in angle steel frame, shelf supports for variable insertion at 100 mm intervals
- Double wing door with espagnolette bolt lock and T-handle

- Cylinder lock, incl. 2 keys (different locking)
- Push/pull bar with soft plastic grip cover

FITTINGS

- 2 **EasySTOP** swivel castors, 2 fixed castors
- Grey non-marking electrically conductive thermoplastic rubber tyres on plastic wheel rim with precision deepgroove ball bearings, with foot guard
- Available in RAL 7024 graphite grey, electrically conductive, powder-coated

ESD shelf trolley | fixed welded

Article-no.	Dimension W x D x H (mm)	Weight kg	Loading surface W x D (mm)	Load cap. kg	Wheel diam. mm
sw-700.872	1115 x 730 x 1810	123.0	1045 x 685	500	200 x 40
sw-800.872	1315 x 830 x 1810	153.0	1245 x 785	500	200 x 40

Load capacity shelf: 80 kg**



T-handle lock

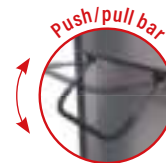

Push/pull bar



Double wing door

Adjusts to the height of the person pulling when the trolley is being pulled and is flush with the frame when not in use

Can be opened 270° and is flush with the frame

ESD shelf trolley | fixed welded

Article-no.	Dimension W x D x H (mm)	Weight kg	Loading surface W x D (mm)	Load cap. kg	Wheel diam. mm
sw-700.868	1115 x 730 x 1810	138.0	1045 x 685	500	200 x 40
sw-800.868	1315 x 830 x 1810	171.5	1245 x 785	500	200 x 40

Load capacity shelf: 80 kg**

ADDITIONAL ARTICLES ESD shelves of plywood for shelf trolleys

Article-no.	Dimension W x D x H (mm)	Weight kg	For loading surface W x D (mm)	Load cap. kg
zsw-700.422	1000 x 660	11.5	1045 x 685	80
zsw-800.422	1200 x 760	16.0	1245 x 785	80



CONSTRUCTION

- Modular system
- Base structure of innovative frame section

FEATURES

- Load surface and shelves of electrically conductive faced chipboard light grey
- Flush inserted in angle-steel frame
- Shelves replaceable and variable removable

FITTINGS

- 2 **EasySTOP** swivel castors, 2 fixed castors
- Grey non-marking electrically conductive thermoplastic rubber tyres on plastic wheel rim with precision deepgroove ball bearings, with foot guard
- Available in RAL 7024 graphite grey, electrically conductive, powder-coated

Electrostatic discharge
Shelves flush with the frame
Replaceable and removable
EasySTOP

ESD shelf trolley | low

Article-no.	Dimension W x D x H (mm)	Weight kg	Loading surface W x D (mm)	Load cap. kg	Wheel diam. mm
sw-500.257	910 x 500 x 990	41.5	850 x 500	250	160 x 40
sw-600.257	1060 x 600 x 990	52.0	1000 x 600	250	160 x 40
sw-700.257	1060 x 700 x 990	56.5	1000 x 700	250	160 x 40
sw-800.257	1260 x 800 x 990	62.5	1200 x 800	250	160 x 40

Load capacity shelf: 80 kg**



ESD shelf trolley | high

Article-no.	Dimension W x D x H (mm)	Weight kg	Loading surface W x D (mm)	Load cap. kg	Wheel diam. mm
sw-500.258	910 x 500 x 1530	45.5	850 x 500	250	160 x 40
sw-600.258	1060 x 600 x 1530	56.0	1000 x 600	250	160 x 40
sw-700.258	1060 x 700 x 1530	61.5	1000 x 700	250	160 x 40
sw-800.258	1260 x 800 x 1530	67.0	1200 x 800	250	160 x 40

Load capacity shelf: 80 kg**

ESD shelf trolley | high

Article-no.	Dimension W x D x H (mm)	Weight kg	Loading surface W x D (mm)	Load cap. kg	Wheel diam. mm
sw-500.259	910 x 500 x 1530	54.0	850 x 500	250	160 x 40
sw-600.259	1060 x 600 x 1530	72.5	1000 x 600	250	160 x 40
sw-700.259	1060 x 700 x 1530	81.0	1000 x 700	250	160 x 40
sw-800.259	1260 x 800 x 1530	107.0	1200 x 800	250	160 x 40

Load capacity shelf: 80 kg**



ESD

ADDITIONAL ARTICLES Shelves for ESD shelf trolleys

Article-no.	Dimension W x D x H (mm)	Weight kg	For loading surface W x D (mm)	Load cap. kg
zsw-500.557	845 x 485	5.5	850 x 500	80
zsw-600.557	995 x 585	7.5	1000 x 600	80
zsw-700.557	995 x 685	9.0	1000 x 700	80
zsw-800.557	1195 x 785	12.5	1200 x 800	80

**Static distributed load; Total load of the transport device must not be exceeded!

70 ESD EURO CONTAINER TROLLEY



RAL 7024

Electrostatic discharge
Tilting shelves

ESD



CONSTRUCTION

- Welded steel construction
- screwed

FEATURES

- Tilts to 17° or 32° by bolting
- Load surfaces of electrically conductive faced chipboard light grey (15 mm high edge)
- Clearance between cross tubes: 125 mm
- Hole spacing for screwing shelves: 150 mm

- Suitable for euro size container 600 x 400 mm (W x D)

FITTINGS

- 4 swivel castors, 2 of them with brakes
- Grey non-marking electrically conductive thermoplastic rubber tyres on plastic wheel rim with precision deepgroove ball bearings, with foot guard
- Available in RAL 7024 graphite grey, electrically conductive, powder-coated

ESD euro container trolley | with 5 ESD shelves

Article-no.	Dimension W x D x H (mm)	Weight kg	Loading surface W x D (mm)	Load cap. kg	Wheel diam. mm
sw-610.315	1350 x 665 x 1700	103.0	1240 x 610	250	160 x 40

Load capacity shelf: 50 kg**

ESD SMALL ORDER-PICKING TROLLEY



RAL 7024



FEATURES

- Load surfaces with 10 mm high edge
- Middle and upper shelf tilts to 15° or 30°

FITTINGS

- 2 **EasySTOP** swivel castors, 2 fixed castors

ESD small order-picking trolley | with 3 ESD shelves, tiltable

Article-no.	Dimension W x D x H (mm)	Weight kg	Loading surface W x D (mm)	Load cap. kg	Wheel diam. mm
sw-400.844	815 x 455 x 1185	29.5	610 x 410	200	125 x 32

Load capacity shelf: 50 kg**



ESD PUSH-HANDLE DOLLY



RAL 7024

FEATURES

- Load surfaces flush with frame
- Screw-on handle

FITTINGS

- 2 **EasySTOP** swivel castors, 2 fixed castors

ESD push-handle dolly | with 2 load surfaces

Article-no.	Dimension W x D x H (mm)	Weight kg	Loading surface W x D (mm)	Load cap. kg	Wheel diam. mm
sw-450.832	940 x 455 x 910	17.0	610 x 455	200	125 x 32

Load capacity shelf: 100 kg**





RAL 7024

CONSTRUCTION

- Welded steel construction

FEATURES

- Load surface with edge on one side (22 mm high) or edge on all sides (18 mm high)
- Height adjustable in steps of 25 mm
- Fixed or tilting on one side to 15° or 30°, secure positioning by spring catch
- Suitable for euro size container 600 x 400 mm (W x D)

FITTINGS

- 4 swivel castors, 2 of them with brakes
- Grey non-marking electrically conductive thermoplastic rubber tyres on plastic wheel rim with precision deepgroove ball bearings, with foot guard
- Available in RAL 7024 graphite grey, electrically conductive, powder-coated

Electrostatic discharge
Height adjustable
Fixed or one-sided tiltable

ESD material stand

Article-no.	Dimension W x D x H (mm)	Weight kg	Loading surface W x D (mm)	Load cap. kg	Wheel diam. mm
sw-405.040	610 x 410 x 770-1020	16.0	605 x 405	150	80 x 25

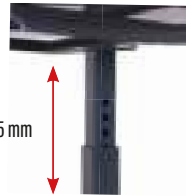

Height adjustable in steps of 25 mm

ESD material stand

Article-no.	Dimension W x D x H (mm)	Weight kg	Loading surface W x D (mm)	Load cap. kg	Wheel diam. mm
sw-405.041	610 x 410 x 535-810	14.5	605 x 405	150	80 x 25

ESD material stand | one-sided tiltable

Article-no.	Dimension W x D x H (mm)	Weight kg	Loading surface W x D (mm)	Load cap. kg	Wheel diam. mm
sw-405.042	600 x 410 x 715-1085	15.0	510 x 410	150	80 x 25



One-sided tiltable to 15° or 30°

ESD material stand | one-sided tiltable

Article-no.	Dimension W x D x H (mm)	Weight kg	Loading surface W x D (mm)	Load cap. kg	Wheel diam. mm
sw-405.045	600 x 410 x 520-775	13.5	510 x 410	150	80 x 25



ESD

72 ESD PUSH BAR TROLLEY



RAL 7024

Electrostatic discharge
EasySTOP

CONSTRUCTION

- Modular system
- Base structure with innovative frame section

FEATURES

- Load surface of electrically conductive faced chipboard light grey

FITTINGS

- 2 **EasySTOP** swivel castors, 2 fixed castors
- Grey non-marking electrically conductive thermoplastic rubber tyres on plastic wheel rim with precision deepgroove ball bearings, with foot guard
- Available in RAL 7024 graphite grey, electrically conductive, powder-coated



ESD

ESD push bar trolley



Article-no.	Dimension W x D x H (mm)	Weight kg	Loading surface W x D (mm)	Load cap. kg	Wheel diam. mm
sw-500.141	975 x 500 x 975	25.0	880 x 500	400	160 x 40
sw-600.141	1125 x 600 x 1015	29.5	1030 x 600	500	200 x 40
sw-700.141	1125 x 700 x 1015	33.5	1030 x 700	500	200 x 40
sw-800.141	1325 x 800 x 1015	37.0	1230 x 800	500	200 x 40

ESD EURO SYSTEM DOLLY



RAL 7024

CONSTRUCTION

- Modular system
- Welded angle-steel construction

FEATURES

- Load surfaces of electrically conductive faced chipboard light grey
- Load surfaces flush with frame or with edge 10 mm high
- Suitable for Euro size container 600 x 400 mm (W x D)
- 4 sockets

FITTINGS

- 4 swivel castors, 2 of them with **EasySTOP** or 4 swivel castors, 2 of them with brakes
- Grey non-marking electrically conductive thermoplastic rubber tyres on plastic wheel rim with precision deepgroove ball bearings, with foot guard
- Available in RAL 7024 graphite grey, electrically conductive, powder-coated



410 mm



ESD euro system dolly with **EasySTOP** and 2 load surfaces (edge 10 mm)

Article-no.	Dimension W x D x H (mm)	Weight kg	Loading surface W x D (mm)	Load cap. kg	Wheel diam. mm
sw-410.556	675 x 415 x 665	20.0	605 x 410	250	125 x 32

Load capacity shelf: 80 kg**

ESD euro system dolly with 2 load surfaces (edge 10 mm)

Article-no.	Dimension W x D x H (mm)	Weight kg	Loading surface W x D (mm)	Load cap. kg	Wheel diam. mm
sw-410.516	675 x 415 x 635	19.0	605 x 410	250	125 x 32

Load capacity shelf: 80 kg**

ESD euro system dolly with **EasySTOP** and 2 load surfaces

Article-no.	Dimension W x D x H (mm)	Weight kg	Loading surface W x D (mm)	Load cap. kg	Wheel diam. mm
sw-410.546	675 x 415 x 665	20.0	610 x 415	250	125 x 32

Load capacity shelf: 80 kg**

ESD euro system dolly with 2 load surfaces

Article-no.	Dimension W x D x H (mm)	Weight kg	Loading surface W x D (mm)	Load cap. kg	Wheel diam. mm
sw-410.536	675 x 415 x 635	19.0	610 x 415	250	125 x 32

Load capacity shelf: 80 kg**



RAL 7024

CONSTRUCTION

- Modular system
- Base structure of innovative frame section
- Floors set in angle-steel frame

FEATURES

- Load surfaces of electrically conductive faced chipboard light grey
- Load surfaces with 15 mm high edge
- Optionally 2 lockable drawers, extractable until 70%, with sliding runners and cylinder lock

FITTINGS

- 2 **EasySTOP** swivel castors, 2 fixed castors
- Grey non-marking electrically conductive thermoplastic rubber tyres on plastic wheel rim with precision deepgroove ball bearings, with foot guard
- Available in RAL 7024 graphite grey, electrically conductive, powder-coated

Electrostatic discharge
2 or 3 load surfaces with edge
Optionally with drawers
EasySTOP

ESD table trolley with 2 load surfaces



Article-no.	Dimension W x D x H (mm)	Weight kg	Loading surface W x D (mm)	Load cap. kg	Wheel diam. mm
sw-500.557	975 x 525 x 1010	29.5	835 x 495	250	125 x 32
sw-600.557	1125 x 625 x 1010	35.0	985 x 595	250	125 x 32

Load capacity shelf: 80 kg**



ESD

ESD table trolley with 3 load surfaces



Article-no.	Dimension W x D x H (mm)	Weight kg	Loading surface W x D (mm)	Load cap. kg	Wheel diam. mm
sw-500.657	975 x 525 x 1010	38.0	835 x 495	250	125 x 32
sw-600.657	1125 x 625 x 1010	46.0	985 x 595	250	125 x 32

Load capacity shelf: 80 kg**



Inside dimensions of the drawers: W: 400 x D: 450 x H: 80 mm (2x)
Load capacity per drawer: 25 kg
Drawer divider set on page 80

ESD table trolley with 2 load surfaces and 2 drawers



Article-no.	Dimension W x D x H (mm)	Weight kg	Loading surface W x D (mm)	Load cap. kg	Wheel diam. mm
sw-600.939	1175 x 625 x 850	46.0	985 x 590	250	125 x 32

Load capacity shelf: 80 kg**



Inside dimensions of the drawers: W: 400 x D: 450 x H: 80 mm (2x)
Load capacity per drawer: 25 kg
Drawer divider set on page 80

ESD table trolley with 2 load surfaces and 2 drawers



Article-no.	Dimension W x D x H (mm)	Weight kg	Loading surface W x D (mm)	Load cap. kg	Wheel diam. mm
sw-600.959	1125 x 625 x 1010	46.0	985 x 590	250	125 x 32

Load capacity shelf: 80 kg**



**Static distributed load; Total load of the transport device must not be exceeded!

74 ESD HEAVY-DUTY TABLE TROLLEYS



RAL 7024

Electrostatic discharge
Load surfaces flush with frame
EasySTOP

CONSTRUCTION

- Modular system
- Base structure with innovative frame section

FEATURES

- Load surfaces of electrically conductive faced chipboard light grey
- Load surfaces flush with frame

FITTINGS

- 2 **EasySTOP** swivel castors, 2 fixed castors
- Grey non-marking electrically conductive thermoplastic rubber tyres on plastic wheel rim with precision deepgroove ball bearings, with foot guard
- Available in RAL 7024 graphite grey, electrically conductive, powder-coated

ESD



ESD heavy-duty table trolley | with 2 load surfaces



Article-no.	Dimension W x D x H (mm)	Weight kg	Loading surface W x D (mm)	Load cap. kg	Wheel diam. mm
sw-500.562	1040 x 500 x 880	33.5	850 x 500	400	160 x 40
sw-600.562	1190 x 600 x 920	41.0	1000 x 600	500	200 x 40
sw-700.562	1190 x 700 x 920	48.5	1000 x 700	500	200 x 40
sw-800.562	1390 x 800 x 920	54.5	1200 x 800	500	200 x 40

Load capacity shelf: 200 kg**



ESD heavy-duty table trolley | with 3 load surfaces



Article-no.	Dimension W x D x H (mm)	Weight kg	Loading surface W x D (mm)	Load cap. kg	Wheel diam. mm
sw-500.662	1040 x 500 x 880	44.5	850 x 500	400	160 x 40
sw-600.662	1190 x 600 x 920	53.5	1000 x 600	500	200 x 40
sw-700.662	1190 x 700 x 920	59.0	1000 x 700	500	200 x 40
sw-800.662	1390 x 800 x 920	70.0	1200 x 800	500	200 x 40

Load capacity shelf: 200 kg**





CONSTRUCTION

- Welded steel construction
- Base structure with innovative frame section
- Floors set in angle-steel frame

FEATURES

- Load surfaces of electrically conductive faced chipboard light grey
- Load surfaces with 15 mm high edge
- Cupboard with 1 fixed and 2 variable cupboard shelves
- Drawers with sliding runners and cylinder lock

FITTINGS

- 2 **EasySTOP** swivel castors, 2 fixed castors
- Grey non-marking electrically conductive thermoplastic rubber tyres on plastic wheel rim with precision deepgroove ball bearings, with foot guard
- Available in RAL 7024 graphite grey, electrically conductive, powder-coated

Inside dimensions cupboard: W: 470 x D: 575 x H: 575 mm
2 variable cupboard shelves
Load capacity per cupboard shelf: 30 kg

ESD workshop trolley | with 3 load surfaces

Article-no.	Dimension W x D x H (mm)	Weight kg	Loading surface W x D (mm)	Load cap. kg	Wheel diam. mm
sw-600.773	1125 x 625 x 1010	62.5	985 x 590	250	125 x 32

Load capacity shelf: 80 kg**

Inside dimensions drawer: W: 390 x D: 535 x H: 95 mm (3x)
W: 390 x D: 535 x H: 155 mm (1x)
Load capacity per drawer: 25 kg
Drawer divider set on page 80

ESD workshop trolley | with 3 load surfaces

Article-no.	Dimension W x D x H (mm)	Weight kg	Loading surface W x D (mm)	Load cap. kg	Wheel diam. mm
sw-600.775	1125 x 625 x 1010	80.5	985 x 590	250	125 x 32

Load capacity shelf: 80 kg**

Electrostatic discharge
Load surfaces with edge
Wing door and drawers lockable
EasySTOP



CONSTRUCTION

- Sheet steel construction

FEATURES

- Working surface of 18 mm electrically conductive faced chipboard light grey
- Cupboards with 1 fixed and 2 variable cupboard shelves
- Drawers with sliding runners and cylinder lock

FITTINGS

- 2 **EasySTOP** swivel castors, 2 fixed castors
- Grey non-marking electrically conductive thermoplastic rubber tyres on plastic wheel rim with precision deepgroove ball bearings, with foot guard
- Available in RAL 7024 graphite grey, electrically conductive, powder-coated

Inside dimensions cupboard: W: 560 x D: 515 x H: 660 mm
2 variable cupboard shelves
Load capacity per cupboard shelf: 30 kg
Inside dimensions drawer: W: 290 x D: 475 x H: 95 mm (6x)
Load capacity per drawer: 25 kg
Drawer divider set on page 81



Removable shelves for insertion at 30 mm intervals

ESD workshop trolley | with 6 drawers

Article-no.	Dimension W x D x H (mm)	Weight kg	Loading surface W x D (mm)	Load cap. kg	Wheel diam. mm
sw-985.021	1110 x 600 x 960	86.0	1000 x 600	400	160 x 40

Load capacity shelf: 120 kg**

ESD WORKSHOP TROLLEY

Wing door and drawers lockable
Trolleys with simultaneous locking
EasySTOP



**Static distributed load; Total load of the transport device must not be exceeded!



Load surfaces with edge
Wing doors lockable
Trolleys with simultaneous locking
EasySTOP

Workshop/Storage



CONSTRUCTION

- Welded steel construction
- Base structure with innovative frame section
- Floors set in angle-steel frame

FEATURES

- Load surfaces of wood-based board, surface finish beech or coated dark grey
- Load surfaces with 15 mm high edge
- Cupboard with 1 fixed and 1 or 2 variable cupboard shelves

FITTINGS

- 2 **EasySTOP** swivel castors, 2 fixed castors
- Grey non-marking thermoplastic rubber tyres on plastic wheel rim with precision deepgroove ball bearings, with foot guard
- Available in 2 colours, trolley and front RAL 5010 gentian blue or RAL 7016 anthracite grey, body RAL 7035 light grey, powder-coated

Inside dimensions cupboard: W: 470 x D: 575 x H: 575 mm
2 variable cupboard shelves
Load capacity per cupboard shelf: 30 kg

Workshop trolley | with 3 load surfaces

Article-no. + /Colour	Dimension W x D x H (mm)	Weight kg	Loading surface W x D (mm)	Load cap. kg	Wheel diam. mm
sw-600.603 / AG	1125 x 625 x 1010	62.5	985 x 590	250	125 x 30

Also available in ESD design on page 75

Load capacity shelf: 80 kg**

Inside dimensions cupboard: W: 470 x D: 575 x H: 575 mm (2x)
2 variable cupboard shelves
Load capacity per cupboard shelf: 30 kg

Workshop trolley | with 1 load surface

Article-no. + /Colour	Dimension W x D x H (mm)	Weight kg	Loading surface W x D (mm)	Load cap. kg	Wheel diam. mm
sw-600.604 / AG	1125 x 625 x 1010	76.0	985 x 590	250	125 x 30

Load capacity shelf: 80 kg**



Inside dimensions cupboard: W: 890 x D: 575 x H: 575 mm
1 variable cupboard shelf
Load capacity per cupboard shelf: 30 kg

Workshop trolley | with 1 load surface

Article-no. + /Colour	Dimension W x D x H (mm)	Weight kg	Loading surface W x D (mm)	Load cap. kg	Wheel diam. mm
sw-600.640 / AG	1125 x 625 x 1010	67.5	985 x 590	250	125 x 30

Load capacity shelf: 80 kg**



RAL 5010 RAL 7016

CONSTRUCTION

- Welded steel construction
- Base structure with innovative frame section
- Floors set in angle-steel frame

MERKMALE

- Load surfaces of wood-based board, surface finish beech or coated dark grey
- Load surfaces with 15 mm high edge
- Cupboard with 1 fixed and 2 variable cupboard shelves
- Drawers with sliding runners and cylinder lock

FITTINGS

- 2 **EasySTOP** swivel castors, 2 fixed castors
- Grey non-marking thermoplastic rubber tyres on plastic wheel rim with precision deepgroove ball bearings, with foot guard
- Available in 2 colours, trolley and front RAL 5010 gentian blue or RAL 7016 anthracite grey, body RAL 7035 light grey, powder-coated

Load surfaces with edge
Wing door and drawers lockable
Trolleys with simultaneous locking
EasySTOP

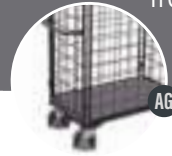

Inside dimensions drawer: W: 390 x D: 535 x H: 95 mm (3x)
W: 390 x D: 535 x H: 155 mm (1x)
Load capacity per drawer: 25 kg
Drawer divider set on page 80

Workshop trolley | with 3 load surfaces | 🔑

Article-no. + /Colour	Dimension W x D x H (mm)	Weight kg	Loading surface W x D (mm)	Load cap. kg	Wheel diam. mm
sw-600.605 / AG	1125 x 625 x 1010	80.5	985 x 590	250	125 x 30

Also available in ESD design on page 75

Load capacity shelf: 80 kg**



Workshop/Storage

Inside dimensions drawer: W: 390 x D: 535 x H: 95 mm (3x)
W: 390 x D: 535 x H: 155 mm (1x)
Load capacity per drawer: 25 kg
Drawer divider set on page 80
Inside dimensions cupboard: W: 470 x D: 575 x H: 575 mm
2 variable cupboard shelves
Load capacity per cupboard shelf: 30 kg

Workshop trolley | with 1 load surface | 🔑

Article-no. + /Colour	Dimension W x D x H (mm)	Weight kg	Loading surface W x D (mm)	Load cap. kg	Wheel diam. mm
sw-600.606 / AG	1125 x 625 x 1010	94.5	985 x 590	250	125 x 30

Load capacity shelf: 80 kg**



Inside dimensions drawer: W: 390 x D: 535 x H: 95 mm (6x)
W: 390 x D: 535 x H: 155 mm (2x)
Load capacity per drawer: 25 kg
Drawer divider set on page 80

Workshop trolley | with 1 load surface | 🔑

Article-no. + /Colour	Dimension W x D x H (mm)	Weight kg	Loading surface W x D (mm)	Load cap. kg	Wheel diam. mm
sw-600.608 / AG	1125 x 625 x 1010	112.0	985 x 590	250	125 x 30

Load capacity shelf: 80 kg**



**Static distributed load; Total load of the transport device must not be exceeded!



RAL 5010

RAL 7016

Working surface with edge on three sides
Wing door and drawers lockable
Trolleys with simultaneous locking
EasySTOP

Workshop/Storage



CONSTRUCTION

- Welded steel construction
- Base structure with innovative frame section
- Floors set in angle-steel frame

FEATURES

- Working surface of beech finish plywood with 80 mm high edge
- Load surfaces of wood-based board, surface finish beech or coated dark grey
- Load surfaces with 15 mm high edge
- Cupboards with 1 fixed and 2 variable cupboard shelves
- Drawers with sliding runners and cylinder lock

FITTINGS

- 2 **EasySTOP** swivel castors, 2 fixed castors
- Grey non-marking thermoplastic rubber tyres on plastic wheel rim with precision deepgroove ball bearings, with foot guard
- Available in 2 colours, trolley and front RAL 5010 gentian blue or RAL 7016 anthracite grey, body RAL 7035 light grey, powder-coated

Inside dimensions cupboard: W: 470 x D: 575 x H: 575 mm
2 variable cupboard shelves
Load capacity per cupboard shelf: 30 kg

Workshop trolley | with 3 load surfaces

Article-no. + /Colour	Dimension W x D x H (mm)	Weight kg	Loading surface W x D (mm)	Load cap. kg	Wheel diam. mm
sw-600.610 / AG	1220 x 640 x 955	68.5	1125 x 630	400	160 x 40

Load capacity shelf: 80 kg**

Inside dimensions drawer: W: 400 x D: 450 x H: 80 mm
Load capacity per drawer: 25 kg
Drawer divider set on page 80

Inside dimensions cupboard: W: 470 x D: 575 x H: 575 mm
2 variable cupboard shelves
Load capacity per cupboard shelf: 30 kg

Workshop trolley | with 2 load surfaces

Article-no. + /Colour	Dimension W x D x H (mm)	Weight kg	Loading surface W x D (mm)	Load cap. kg	Wheel diam. mm
sw-600.611 / AG	1220 x 640 x 955	65.5	1125 x 630	400	160 x 40

Load capacity shelf: 80 kg**

Inside dimensions drawer: W: 390 x D: 535 x H: 95 mm (3x)
W: 390 x D: 535 x H: 155 mm (1x)
Load capacity per drawer: 25 kg
Drawer divider set on page 80

Workshop trolley | with 3 load surfaces

Article-no. + /Colour	Dimension W x D x H (mm)	Weight kg	Loading surface W x D (mm)	Load cap. kg	Wheel diam. mm
sw-600.612 / AG	1220 x 640 x 955	86.0	1125 x 630	400	160 x 40

Load capacity shelf: 80 kg**

Inside dimensions drawer: W: 390 x D: 535 x H: 95 mm (3x)
W: 390 x D: 535 x H: 155 mm (1x)
Load capacity per drawer: 25 kg
Drawer divider set on page 80

Inside dimensions cupboard: W: 470 x D: 575 x H: 575 mm
2 variable cupboard shelves
Load capacity per cupboard shelf: 30 kg

Workshop trolley | with 1 load surface

Article-no. + /Colour	Dimension W x D x H (mm)	Weight kg	Loading surface W x D (mm)	Load cap. kg	Wheel diam. mm
sw-600.613 / AG	1220 x 640 x 955	101.5	1125 x 630	400	160 x 40

Load capacity shelf: 80 kg**



RAL 5010 RAL 7016

CONSTRUCTION

- Welded steel construction
- Base structure with innovative frame section

FEATURES

- Load surfaces of wood-based board, surface finish beech or coated dark grey
- Load surfaces flush with frame
- Cupboards with 1 fixed and 2 variable cupboard shelves
- Drawers with sliding runners and cylinder lock

FITTINGS

- 2 **EasySTOP** swivel castors, 2 fixed castors
- Grey non-marking thermoplastic rubber tyres on plastic wheel rim with precision deepgroove ball bearings, with foot guard
- Available in 2 colours, trolley and front RAL 5010 gentian blue or RAL 7016 anthracite grey, body RAL 7035 light grey, powder-coated

Load surfaces flush with frame
Wing door and drawers lockable
EasySTOP



Inside dimensions drawer: W: 390 x D: 535 x H: 95 mm (3x)
W: 390 x D: 535 x H: 155 mm (1x)
Load capacity per drawer: 25 kg
Drawer divider set on page 80

Workshop trolley | with 2 load surfaces |



Article-no. + /Colour	Dimension W x D x H (mm)	Weight kg	Loading surface W x D (mm)	Load cap. kg	Wheel diam. mm
sw-600.602 / AG	1190 x 600 x 930	82.5	1060 x 600	500	200 x 40

Load capacity shelf: 200 kg**



Workshop/Storage

Inside dimensions cupboard: W: 470 x D: 575 x H: 575 mm
2 variable cupboard shelves
Load capacity per cupboard shelf: 30 kg

Workshop trolley | with 2 load surfaces |



Article-no. + /Colour	Dimension W x D x H (mm)	Weight kg	Loading surface W x D (mm)	Load cap. kg	Wheel diam. mm
sw-600.607 / AG	1190 x 600 x 930	64.0	1060 x 600	500	200 x 40

Load capacity shelf: 200 kg**



RAL 5010 RAL 7016

CONSTRUCTION

- Welded steel construction
- Base structure with innovative frame section

MERKMALE

- Load surfaces of waterproof bonded plywood, surface finish screen printed, anti slip
- Load surfaces flush with frame
- Cupboard with 1 fixed and 2 variable cupboard shelves

FITTINGS

- 2 **EasySTOP** swivel castors, 2 fixed castors
- Elastic-solid rubber tyres on cast aluminium wheel rim with precision deepgroove ball bearings, black, with foot guard, wheels also available in grey
- Available in 2 colours, trolley and front RAL 5010 gentian blue or RAL 7016 anthracite grey, body RAL 7035 light grey, powder-coated

Load surfaces flush with frame
Waterproof bonded plywood
Wing door lockable
EasySTOP



Inside dimensions cupboard sw-700.620: W: 470 x D: 675 x H: 575 mm
Inside dimensions cupboard sw-800.620: W: 570 x D: 775 x H: 575 mm
Load capacity per cupboard shelf: 30 kg

Heavy-duty workshop trolley | with 2 load surfaces |

Article-no. + /Colour	Dimension W x D x H (mm)	Weight kg	Loading surface W x D (mm)	Load cap. kg	Wheel diam. mm
sw-700.620 / AG	1190 x 700 x 930	81.0	1060 x 700	1000	200 x 50
sw-800.620 / AG	1390 x 800 x 930	96.5	1260 x 800	1000	200 x 50

Load capacity shelf: 500 kg**



**Static distributed load; Total load of the transport device must not be exceeded!



RAL 5010

RAL 7016

Load surfaces flush with frame
Wing door and drawers lockable
Trolleys with simultaneous locking
EasySTOP

Workshop/Storage



CONSTRUCTION

- Welded steel construction
- Base structure with innovative frame section

FEATURES

- Load surfaces of wood-based board, surface finish beech or coated dark grey
- Load surfaces flush with frame
- Cupboard with 1 fixed and 2 variable cupboard shelves
- Drawers with sliding runners and cylinder lock

FITTINGS

- 2 **EasySTOP** swivel castors, 2 fixed castors
- Grey non-marking thermoplastic rubber tyres on plastic wheel rim with precision deepgroove ball bearings, with foot guard
- Available in 2 colours, trolley and front RAL 5010 gentian blue or RAL 7016 anthracite grey, body RAL 7035 light grey, powder-coated

Inside dimensions drawer: W: 390 x D: 535 x H: 95 mm (3x)
W: 390 x D: 535 x H: 155 mm (1x)
Load capacity per drawer: 25 kg
Inside dimensions cupboard: W: 470 x D: 575 x H: 575 mm
2 variable cupboard shelves
Load capacity per cupboard shelf: 30 kg

Workshop trolley | with 1 load surface

Article-no. + /Colour	Dimension W x D x H (mm)	Weight kg	Loading surface W x D (mm)	Load cap. kg	Wheel diam. mm
sw-600.698 / AG	1190 x 600 x 930	103.5	1060 x 600	500	200 x 40

Load capacity shelf: 200 kg**



Inside dimensions drawer: W: 390 x D: 535 x H: 95 mm (6x)
W: 390 x D: 535 x H: 155 mm (2x)
Load capacity per drawer: 25 kg

Workshop trolley | with 1 load surface

Article-no. + /Colour	Dimension W x D x H (mm)	Weight kg	Loading surface W x D (mm)	Load cap. kg	Wheel diam. mm
sw-600.619 / AG	1190 x 600 x 930	117.0	1060 x 600	500	200 x 40

Load capacity shelf: 200 kg**



Made of galvanised sheet steel
Pluggable
4 longitudinal dividers, 12 dividing plates
For products on pages: 22, 23, 73, 75, 77-80

ADDITIONAL ARTICLE Drawer divider set

Article-no.	Dimension W x D x H (mm)	Weight kg
zsw-600.604	390 x 535 x 65	1.0

A: Division grid compartment height: 25 mm
B: Compartment width: 120 mm

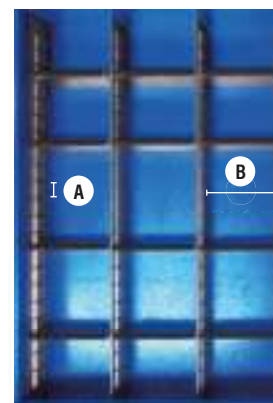



RAL 5010 RAL 7016

CONSTRUCTION

- Welded steel construction

FEATURES

- Working surface of beech finish plywood without edge
- Cupboard with 1 fixed and 2 variable cupboard shelves
- Removable shelves for insertion at 30 mm interval
- Drawers with sliding runners and cylinder lock

FITTINGS

- 2 **EasySTOP** swivel castors, 2 fixed castors
- Grey non-marking thermoplastic rubber tyres on plastic wheel rim with precision deepgroove ball bearings, with foot guard
- Available in 2 colours, trolley and front RAL 5010 gentian blue or RAL 7016 anthracite grey, body RAL 7035 light grey, powder-coated

Working surface without edge
Wing door and drawers lockable
Trolleys with simultaneous locking
EasySTOP

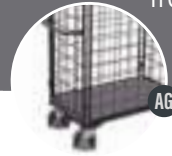

Inside dimensions cupboard: W: 560 x D: 515 x H: 660 mm
2 variable cupboard shelves
Load capacity per cupboard shelf: 30 kg
Inside dimensions drawer: W: 290 x D: 475 x H: 95 mm (1x)
W: 290 x D: 475 x H: 155 mm (2x)
W: 290 x D: 475 x H: 130 mm (1x)
Load capacity per drawer: 25 kg

Workshop trolley | with 4 drawers |



Article-no. + /Colour	Dimension W x D x H (mm)	Weight kg	Loading surface W x D (mm)	Load cap. kg	Wheel diam. mm
sw-985.000 / AG	1100 x 600 x 960	83.5	1000 x 600	400	160 x 40

Load capacity shelf: 120 kg**



Workshop/Storage



Removable shelves for insertion at 30 mm interval

Inside dimensions cupboard: W: 560 x D: 515 x H: 660 mm
2 variable cupboard shelves
Load capacity per cupboard shelf: 30 kg
Inside dimensions drawer: W: 290 x D: 475 x H: 95 mm (6x)
Load capacity per drawer: 25 kg

Workshop trolley | with 6 drawers |



Article-no. + /Colour	Dimension W x D x H (mm)	Weight kg	Loading surface W x D (mm)	Load cap. kg	Wheel diam. mm
sw-985.001 / AG	1100 x 600 x 960	86.0	1000 x 600	400	160 x 40

Also available in ESD design on page 75

Load capacity shelf: 120 kg**



A: Division grid compartment height: 25 mm
B: Compartment width: 135 mm

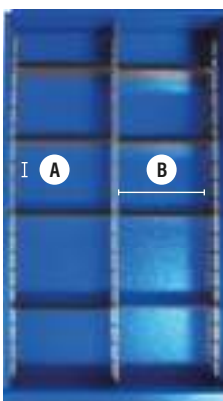

Made of galvanised sheet steel
Pluggable
3 longitudinal dividers, 8 dividing plates
For products on pages: 75, 81, 82

ADDITIONAL ARTICLE Drawer divider set

Article-no.	Dimension W x D x H (mm)	Weight kg
zsw-985.003	290 x 473 x 65	1.0



**Static distributed load; Total load of the transport device must not be exceeded!

82 WORKSHOP TROLLEYS



RAL 5010 RAL 7016

Working surface with edge on three sides
Wing door and drawers lockable
Trolleys with simultaneous locking
EasySTOP



CONSTRUCTION

- Welded steel construction

FEATURES

- Working surface of beech finish plywood with 80 mm high edge
- Cupboards with 1 fixed and 2 variable cupboard shelves
- Removable shelves for insertion at 30 mm interval
- Drawers with sliding runners and cylinder lock

FITTINGS

- 2 **EasySTOP** swivel castors, 2 fixed castors
- Grey non-marking thermoplastic rubber tyres on plastic wheel rim with precision deepgroove ball bearings, with foot guard
- Available in 2 colours, trolley and front RAL 5010 gentian blue or RAL 7016 anthracite grey, body RAL 7035 light grey, powder-coated

Inside dimensions cupboard: W: 560 x D: 515 x H: 660 mm
2 variable cupboard shelves
Load capacity per cupboard shelf: 30 kg
Inside dimensions drawer: W: 290 x D: 475 x H: 95 mm (1x)
W: 290 x D: 475 x H: 155 mm (2x)
W: 290 x D: 475 x H: 130 mm (1x)
Load capacity per drawer: 25 kg
Drawer divider set on page 81



Workshop/Storage



Workshop trolley | with 4 drawers and edge

Article-no. + /Colour	Dimension W x D x H (mm)	Weight kg	Loading surface W x D (mm)	Load cap. kg	Wheel diam. mm
sw-985.002 / AG	1125 x 610 x 1040	85.0	1000 x 600	400	160 x 40

Load capacity shelf: 120 kg**



Workshop trolley | with 6 drawers and edge

Article-no. + /Colour	Dimension W x D x H (mm)	Weight kg	Loading surface W x D (mm)	Load cap. kg	Wheel diam. mm
sw-985.003 / AG	1125 x 610 x 1040	87.5	1000 x 600	400	160 x 40

Load capacity shelf: 120 kg**



Cabinet | with hinged door | and 1 load surface

Article-no. + /Colour	Dimension W x D x H (mm)	Weight kg	Loading surface W x D (mm)	Load cap. kg	Wheel diam. mm
sw-500.014 / AG	575 x 660 x 905	39.0	550 x 650	150	125 x 30

Load capacity shelf: 120 kg**



Cabinet | with 4 drawers | and 1 load surface

Article-no. + /Colour	Dimension W x D x H (mm)	Weight kg	Loading surface W x D (mm)	Load cap. kg	Wheel diam. mm
sw-500.015 / AG	575 x 660 x 905	54.0	550 x 650	150	125 x 30

Load capacity shelf: 120 kg**

Inside dimensions cupboard: W: 470 x D: 575 x H: 575 mm
2 variable cupboard shelves
Load capacity per cupboard shelf: 30 kg

Inside dimensions drawer: W: 390 x D: 535 x H: 95 mm (3x)
W: 390 x D: 535 x H: 155 mm (1x)
Load capacity per drawer: 25 kg
Drawer divider set on page 80



Additional articles
Pegboard tool panel
Holder selection
Material crates



For workshop trolley with roll-off edge

■ ADDITIONAL ARTICLE Pegboard tool panel

Article-no. + /Colour	Dimension W x H (mm)	Weight kg
zsw-100.500 / AG	995 x 450	7.0

■ ADDITIONAL ARTICLES Holder selection

Article-no.	28 pcs.	18 pcs.
zsw-280.000 28 Pieces	1 x 1 x Drill holder	
zsw-180.000 18 Pieces	6 x 3 x Double tool holder	
	1 x 0 x Machine holder	
	2 x 0 x Saw holder	
	1 x 1 x Screwdriver holder	
	1 x 1 x Spanner holder	
	6 x 5 x Tool holder with rising end	
	8 x 2 x Tool holder with vertical end	
	0 x 3 x Tool clamp	
	2 x 2 x Holder for pliers	

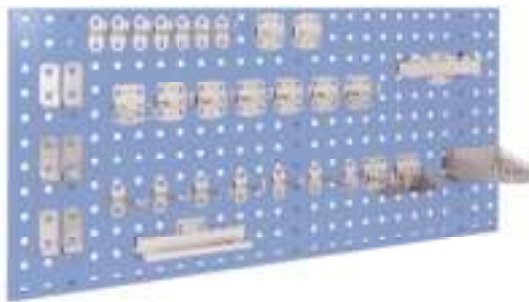

■ ADDITIONAL ARTICLE Material crate / green

Article-no.	Colour	Dimension W x D x H (mm)	Weight kg
fk-105.002	green	105 x 85 x 45	0.1

■ ADDITIONAL ARTICLE Material crate / red

Article-no.	Colour	Dimension W x D x H (mm)	Weight kg
fk-140.002	red	140 x 230 x 130	0.3

■ ADDITIONAL ARTICLE Material crate / yellow

Article-no.	Colour	Dimension W x D x H (mm)	Weight kg
fk-105.003	yellow	105 x 160 x 75	0.2

■ ADDITIONAL ARTICLE Material crate / blue

Article-no.	Colour	Dimension W x D x H (mm)	Weight kg
fk-140.003	blue	140 x 290 x 130	0.4

84 WORKPIECE TROLLEYS



RAL 5010

RAL 7016

2 vertical push bars

Wire mesh structure with slope of grid 8%

Optionally with additional top shelf

EasySTOP



CONSTRUCTION

- Modular system
- Base structure with innovative frame section
- Screwed superstructure made of angle steel with welded mesh 75 x 75 mm

FEATURES

- Load surface and additional top shelf of wood-based board, surface finish beech or coated dark grey
- Additional top shelf with 15 mm high edge, usable load surface: 1185 x 265 mm
- 2 vertical, fixed welded push bars
- Height of superstructure 1260 mm, slope of grid 8%

FITTINGS

- 2 **EasySTOP** swivel castors, 2 fixed castors
- Grey non-marking thermoplastic rubber tyres on plastic wheel rim with precision deepgroove ball bearings, with foot guard
- Available in 2 colours, RAL 5010 gentian blue or RAL 7016 anthracite grey, powder-coated

Workshop/Storage



Workpiece trolley

Article-no. + /Colour	Dimension W x D x H (mm)	Weight kg	Loading surface W x D (mm)	Load cap. kg	Wheel diam. mm
sw-800.800 / AG	1370 x 800 x 1560	89.5	1260 x 2x245	500	200 x 40



Workpiece trolley | with top shelf

Article-no. + /Colour	Dimension W x D x H (mm)	Weight kg	Loading surface W x D (mm)	Load cap. kg	Wheel diam. mm
sw-800.801 / AG	1370 x 800 x 1585	97.5	1260 x 2x245	500	200 x 40

Load capacity shelf: 50 kg**



ADDITIONAL ARTICLE Bar for slide down safety

Article-no. + /Colour	Dimension W x H (mm)	Weight kg	Piece
gsw-800.203.1 / AG	1260 x 100	3.5	2



Additional articles
Different carrier variants
Material crates

■ ADDITIONAL ARTICLE Thorn bracket

Article-no.	Dimension mm	Weight kg	Load cap. kg
zsw-800.800	10 diam. x 210	0.3	10
zsw-800.801	10 diam. x 310	0.4	10



■ ADDITIONAL ARTICLE Pipe carrier

Article-no.	Dimension mm	Weight kg	Load cap. kg
zsw-800.802	16 diam. x 305	0.4	15
zsw-800.803	22 diam. x 305	0.5	25
zsw-800.804	27 diam. x 305	0.6	25

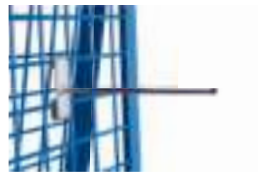

■ ADDITIONAL ARTICLE Corrugated bracket

Article-no.	Dimension mm	Weight kg	Load cap. kg
zsw-800.805	320	0.8	25



■ ADDITIONAL ARTICLE Fork bracket

Article-no.	Dimension mm	Weight kg	Load cap. kg
zsw-800.806	50 x 295	0.8	25

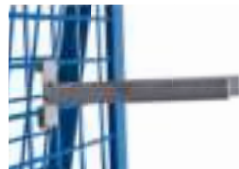

■ ADDITIONAL ARTICLE Material box

Article-no.	Dimension W x D x H (mm)	Weight kg	Load cap. kg
zsw-800.807	265 x 150 x 110	1.5	25
zsw-800.808	1200 x 265 x 110	4.5	50



Workshop/Storage



■ ADDITIONAL ARTICLE Material crate / green

Article-no.	Colour	Dimension W x D x H (mm)	Weight kg
fk-105.000	green	105 x 85 x 45	0.1

■ ADDITIONAL ARTICLE Material crate / red

Article-no.	Colour	Dimension W x D x H (mm)	Weight kg
fk-140.000	red	140 x 230 x 130	0.3



■ ADDITIONAL ARTICLE Material crate / yellow

Article-no.	Colour	Dimension W x D x H (mm)	Weight kg
fk-105.001	yellow	105 x 160 x 75	0.2

■ ADDITIONAL ARTICLE Material crate / blue

Article-no.	Colour	Dimension W x D x H (mm)	Weight kg
fk-140.001	blue	140 x 290 x 130	0.4



One-sided

Height of carrier-spars continuously adjustable

4 carrier-spars per upright

Width continuously adjustable



CONSTRUCTION

- Welded steel construction

FEATURES

- 4 carrier-spars per upright
- Circa carrier-spar length 595 mm, height continuously adjustable, with scale for adjusting arrangement
- Load capacity per carrier-spar: 20 kg
- Width continuously adjustable

FITTINGS

- 2 swivel castors, 1 of them with direction lock, 2 swivel castors with brakes
- Grey non-marking thermoplastic rubber tyres on plastic wheel rim with precision deepgroove ball bearings, with foot guard
- Available in 2 colours, RAL 5010 gentian blue or RAL 7016 anthracite grey, powder-coated



Carrier-spar trolley | one-sided

Article-no. + /Colour	Dimension W x D x H (mm)	Weight kg	Load cap. kg	Wheel diam. mm
sw-130.006 / AG	540-1400 x 800 x 1800	49.0	400	160 x 40
sw-160.006 / AG	540-1700 x 800 x 1800	50.5	400	160 x 40

Load capacity carrier-spar arm: 20 kg**

Workshop/Storage

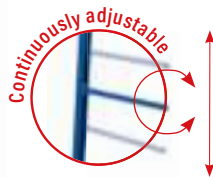

Carrier-spar trolley | one-sided

Article-no. + /Colour	Dimension W x D x H (mm)	Weight kg	Load cap. kg	Wheel diam. mm
sw-210.006 / AG	840-2200 x 800 x 1800	72.5	400	160 x 40
sw-310.006 / AG	840-3200 x 800 x 1800	76.5	400	160 x 40

Load capacity carrier-spar arm: 20 kg**



ADDITIONAL ARTICLES Carrier-spars and slip off safety

Article-no. + /Colour	Dimension	Load cap. kg	Product variant
zsw-596.000 / AG	595 mm x 3/4"	20.0	Carrier-spar
zsw-596.001 / AG	595 mm x 3/4"	20.0	Carrier-spar with shrink hose
zsw-596.002	1 mm	-	Shrink hose*
zsw-596.003 / AG	595 mm x 3/4"	20.0	Carrier-spar with slip off safety
zsw-070.000	diam. 70 mm	-	Slip off safety*
zsw-596.004 / AG	595 mm x 3/4"	20.0	Carrier-spar with shrink hose and slip off safety

* As ex-factory equipment

**Total load of the transport device must not be exceeded!



CARRIER-SPAR TROLLEYS 87

RAL 5010 RAL 7016

CONSTRUCTION

- Welded steel construction

FEATURES

- 8 carrier-spars per upright
- Circa carrier-spar length 375 mm, height continuously adjustable, with scale for adjusting arrangement
- Load capacity per carrier-spar: 20 kg
- Width continuously adjustable

FITTINGS

- 2 swivel castors, 1 of them with direction lock, 2 swivel castors with brakes
- Grey non-marking thermoplastic rubber tyres on plastic wheel rim with precision deepgroove ball bearings, with foot guard
- Available in 2 colours, RAL 5010 gentian blue or RAL 7016 anthracite grey, powder-coated

Two-sided

Height of carrier-spars continuously adjustable

8 carrier-spars per upright

Width continuously adjustable



Carrier-spar trolley | two-sided

Article-no. + /Colour	Dimension W x D x H (mm)	Weight kg	Load cap. kg	Wheel diam. mm
sw-130.007 / AG	540-1400 x 830 x 1800	57.0	400	160 x 40
sw-160.007 / AG	540-1700 x 830 x 1800	59.0	400	160 x 40

Load capacity carrier-spar arm: 20 kg**



As ex-factory equipment



Workshop/Storage

Carrier-spar trolley | two-sided

Article-no. + /Colour	Dimension W x D x H (mm)	Weight kg	Load cap. kg	Wheel diam. mm
sw-210.007 / AG	840-2200 x 830 x 1800	80.0	400	160 x 40
sw-310.007 / AG	840-3200 x 830 x 1800	84.0	400	160 x 40

Load capacity carrier-spar arm: 20 kg**



ADDITIONAL ARTICLES Carrier-spars and slip off safety

Article-no. + /Colour	Dimension	Load cap. kg	Product variant
zsw-376.000 / AG	375 mm x 3/4"	20.0	Carrier-spar
zsw-376.001 / AG	375 mm x 3/4"	20.0	Carrier-spar with shrink hose
zsw-376.002	1 mm	-	Shrink hose*
zsw-376.003 / AG	375 mm x 3/4"	20.0	Carrier-spar with slip off safety
zsw-070.000	diam. 70 mm	-	Slip off safety*
zsw-376.004 / AG	375 mm x 3/4"	20.0	Carrier-spar with shrink hose and slip off safety

* As ex-factory equipment

**Total load of the transport device must not be exceeded!



VARIOfit



One-sided load surface of plywood
Load surface with 5° inclination

Workshop/Storage



AG



EasySTOP on longitudinal and narrow side

CONSTRUCTION

- Welded steel construction

FEATURES

- One-sided load surface of plywood, tilts to 5°
- Height of side tubular support: 915 mm

FITTINGS

- 2 swivel and 2 fixed castors, with **EasySTOP** (can be operated on one longitudinal and narrow side) or 2 swivel castors with brakes, 2 fixed castors with rhombic layout
- Grey non-marking thermoplastic rubber tyres on plastic wheel rim with precision deepgroove ball bearings, with foot guard
- Available in 2 colours, RAL 5010 gentian blue or RAL 7016 anthracite grey, powder-coated

NEW

Sheet-material trolley

Article-no. + /Colour	Dimension W x D x H (mm)	Weight kg	Loading surface W x D (mm)	Load cap. kg	Wheel diam. mm
pl-150.010 / AG	1500 x 680 x 1200	47.5	1500 x 370	500	200 x 40

Sheet-material trolley | with rhombic layout

Article-no. + /Colour	Dimension W x D x H (mm)	Weight kg	Loading surface W x D (mm)	Load cap. kg	Wheel diam. mm
pl-150.011 / AG	1500 x 680 x 1200	47.5	1500 x 370	500	200 x 40

Wheels in rhombic layout, info on page 166

SHEET-MATERIAL TROLLEY ONE-/TWO-SIDED

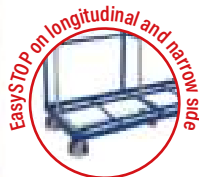

EasySTOP on longitudinal and narrow side

NEW

CONSTRUCTION

- Welded steel construction

FEATURES

- One-sided or two-sided load surfaces
- Tilts to 5°, sheet supports faced with rubber profile
- Base support width for one-sided layout: 430 mm, for two-sided layout: 2 x 270 mm

FITTINGS

- 2 swivel and 2 fixed castors, with **EasySTOP** (can be operated on one longitudinal and narrow side)
- Elastic-solid rubber tyres on cast aluminium wheel rim with precision deepgroove ball bearings, black, with foot guard, wheels also available in grey
- Available in 2 colours, RAL 5010 gentian blue or RAL 7016 anthracite grey, powder-coated

Sheet-material trolley | one-sided

Article-no. + /Colour	Dimension W x D x H (mm)	Weight kg	Loading surface W x D (mm)	Load cap. kg	Wheel diam. mm
sw-1305 / AG	1380 x 880 x 1700	53.5	1380 x 430	1200	200 x 50
sw-1605 / AG	1680 x 880 x 1700	64.0	1680 x 430	1200	200 x 50
sw-2005 / AG	2080 x 880 x 1700	81.5	2080 x 430	1200	200 x 50

Sheet-material trolley | two-sided

Article-no. + /Colour	Dimension W x D x H (mm)	Weight kg	Loading surface W x D (mm)	Load cap. kg	Wheel diam. mm
sw-1306 / AG	1380 x 880 x 1705	59.0	1380 x 2x270	1200	200 x 50
sw-1606 / AG	1680 x 880 x 1705	70.0	1680 x 2x270	1200	200 x 50
sw-2006 / AG	2080 x 880 x 1705	87.0	2080 x 2x270	1200	200 x 50

RAL 5010 **RAL 7016**

CONSTRUCTION

- Welded steel construction

FEATURES

- Sheet-steel platform, toe plate sloping towards supporting frame, tilt 22°
- Also available: Version with variable panel retainer, for panel stack max. 200 x 1500 mm (D x H)

FITTINGS

- Pneumatic tyres on steel wheel rim or solid-rubber tyres on special plastic wheel rim with precision deepgroove ball bearings and plastic wheel cap, additional 2 support rollers
- Available in 2 colours, RAL 5010 gentian blue or RAL 7016 anthracite grey, powder-coated

For lengthways transport of large panels
Sheet-steel platform, toe plate sloping
towards supporting frame



Sheet-material truck

Article-no. + /Colour	Dimension W x D x H (mm)	Weight kg	Toe plate W x D (mm)	Load cap. kg	Wheel diam. mm
sk-710.035 / AG	P 1260 x 680 x 1425	18.5	500 x 200	250	260 x 85
sk-710.036 / AG	SR 1260 x 680 x 1425	20.0	500 x 200	250	260 x 65

P = Pneumatic tyres, SR = Solid-rubber tyres



Workshop/Storage



Sheet-material truck with panel retainer

Article-no. + /Colour	Dimension W x D x H (mm)	Weight kg	Toe plate W x D (mm)	Load cap. kg	Wheel diam. mm
sk-710.045 / AG	P 1260 x 680 x 1440	20.0	500 x 200	250	260 x 85
sk-710.046 / AG	SR 1260 x 680 x 1440	21.5	500 x 200	250	260 x 65

P = Pneumatic tyres, SR = Solid-rubber tyres

Ergonomic lifting and moving of loads



CONSTRUCTION

- Welded steel construction

FEATURES

- Infinitely adjustable lifting range from 55 - 1300 mm using a hand crank
- Distance of load centre of gravity: 230 mm from mast
- Hand crank with self-locking winch
- Brake lever at an ergonomic height, brake acting on the solid-rubber tyres / swivel castors
- Large push bar for easy and simple manoeuvring
- Push bar with soft plastic grip cover

FITTINGS

- Solid-rubber tyres on special plastic wheel rim with precision deepgroove ball bearings and plastic wheel cap, 2 front swivel castors made of polyurethane or 2 swivel castors with foot guard of grey non-marking thermoplastic rubber on plastic wheel rim with precision deepgroove ball bearings, 2 polyurethane cradle rollers at the front
- Available in 2 colours, RAL 5010 gentian blue or RAL 7016 anthracite grey, powder-coated

NEW

Materiallifter | incl. forklift forks

Article-no. + /Colour	Dimension W x D x H (mm)	Forklift forks W (CW)* x D (mm)	Weight kg	Lifting range mm	Load cap. kg	Wheel diam. mm
sg-154.008 / AG	SR 575 x 845 x 1545	300 x 450	56.0	55-1300	250	260 x 65
sg-154.009 / AG	TR 620 x 730 x 1545	300 x 450	51.5	55-1300	250	160 x 40

*CW = Clear width

SR = Solid-rubber tyres, TR = Thermoplastic rubber tyres

Workshop/Storage



For screwing onto the plate of the forklift forks

ADDITIONAL ARTICLE Loading platform of diamond-tread

Article-no.	Dimension W x D (mm)	Weight kg	Suitable for	Load cap.
zsg-154.000	500 x 460	8.5	sg-154.008/09	According to the materiallifter



The platform is screwed to the back plate of the forklift forks and rests on the forklift forks



Load capacity, dimensions and load suspension means can be customised on request

RAL 5010 **RAL 7016**

CONSTRUCTION

- Welded steel construction

FEATURES

- Infinitely adjustable lifting range from 55 - 1300 mm using a hand crank
- Hand crank with self-locking winch
- Brake lever at an ergonomic height, brake acting on the solid-rubber tyres / swivel castors
- Large push bar for easy and simple manoeuvring
- Push bar with soft plastic grip cover

FITTINGS

- Solid-rubber tyres on special plastic wheel rim with precision deepgroove ball bearings and plastic wheel cap, 2 front swivel castors made of polyurethane or 2 swivel castors with foot guard of grey non-marking thermoplastic rubber on plastic wheel rim with precision deepgroove ball bearings, 2 polyurethane cradle rollers at the front
- Available in 2 colours, RAL 5010 gentian blue or RAL 7016 anthracite grey, powder-coated

Various configuration options
Simple exchange of the load suspension means



Workshop/Storage

NEW

Materiallifter

Article-no. + /Colour	Dimension W x D x H (mm)	Weight kg	Lifting range mm	Load cap. kg	Wheel diam. mm
sg-154.018* / AG	SR 575 x 845 x 1545	48.5	55-1300	250	260 x 65
sg-154.019* / AG	TR 620 x 730 x 1545	44.0	55-1300	250	160 x 40

*Can only be used in conjunction with below mentioned additional articles

SR = Solid-rubber tyres, TR = Thermoplastic rubber tyres

ADDITIONAL ARTICLE Forklift forks for materiallifter

Article-no.	Dimension W (CW)* x D (mm)	Weight kg	Suitable for	Load cap.
zsg-154.001	300 x 450	7.5	sg-154.008/09 sg-154.018/19	According to the materiallifter

*CW = Clear width



ADDITIONAL ARTICLE Forklift forks for materiallifter adjustable

Article-no.	Dimension W (CW)* x D (mm)	Weight kg	Suitable for	Load cap.
zsg-154.002	60-390 x 450	10.5	sg-154.008/09 sg-154.018/19	According to the materiallifter

*CM = Clear width



Forklift forks adjustable

ADDITIONAL ARTICLE Thorn for materiallifter

Article-no.	Dimension diam. x D (mm)	Weight kg	Suitable for	Load cap.
zsg-154.003	20-50 x 450	6.5	sg-154.008/09 sg-154.018/19	According to the materiallifter

Thorn diameter of 20-50 mm can be customised by the customer



ADDITIONAL ARTICLE Loading platform of diamond-tread

Article-no.	Dimension W x D (mm)	Weight kg	Suitable for	Load cap.
zsg-154.000	500 x 460	8.5	sg-154.008/09	According to the materiallifter

Only together with forklift forks (zsg-154.001)





Our
custom-made
products in
comparison

INDIVIDUALLY

- Opportunities for modification in line with customers' individual wishes

UNIQUE PIECE

- Deliveries of small series from one piece upwards
- Product approval drawings
- Fair prices even for small quantities

CUSTOMER FOCUSED

- Analysing parameters such as uses, handling, workflows and much more in close cooperation with the customer

TAILORED

- Products in special sizes, special colours and complete new designs

Palletlifter

Simple, robust technology
No oil required for hydraulics
Low dead weight

Actuating the brake:
Using the lever on the push bar

Quick lifting:
Without hydraulics
using a foot pedal

For moving display pallets
600 x 400 mm



RAL 5010 RAL 7016

CONSTRUCTION

- Welded steel construction
- Base structure with innovative frame section
- Floors set in angle-steel frame

FEATURES

- Load surfaces of wood-based board, surface finish beech or coated dark grey
- Load surface with 15 mm high edge
- Step treads of waterproof bonded plywood, surface finish screen printed, anti-slip
- Steps lift automatically in the unloaded condition via a gas pressure spring

FITTINGS

- 2 swivel castors with brakes, 2 fixed castors
- Grey non-marking thermoplastic rubber tyres on plastic wheel rim with precision deepgroove ball bearings, with foot guard
- Available in 2 colours, RAL 5010 gentian blue or RAL 7016 anthracite grey, powder-coated

Steps lift automatically via gas pressure spring
Antislip treads



Order-picking trolley | with 2 shelves, low

Article-no. + /Colour	Dimension W x D x H (mm)	Weight kg	Loading surface W x D (mm)	Load cap. kg	Wheel diam. mm
sw-600.614 / AG	1455 x 625 x 1320	40.0	985 x 590	250	125 x 30

Shelf heights: 185 / 805 mm
Height of top step: 500 mm
Step height: 230 mm



Load capacity shelf: 80 kg**

Order-picking trolley | with 3 shelves, low

Article-no. + /Colour	Dimension W x D x H (mm)	Weight kg	Loading surface W x D (mm)	Load cap. kg	Wheel diam. mm
sw-600.615 / AG	1455 x 625 x 1320	50.0	985 x 590	250	125 x 30

Shelf heights: 185 / 490 / 805 mm
Height of top step: 500 mm
Step height: 230 mm



Load capacity shelf: 80 kg**

Order-picking trolley | with 3 shelves, high

Article-no. + /Colour	Dimension W x D x H (mm)	Weight kg	Loading surface W x D (mm)	Load cap. kg	Wheel diam. mm
sw-600.616 / AG	1695 x 625 x 1900	64.5	985 x 590	250	160 x 40

Shelf heights: 225 / 845 / 1465 mm
Height of top step: 980 mm
Step height: 230 mm



Load capacity shelf: 80 kg**

Order-picking trolley | with 4 shelves, high

Article-no. + /Colour	Dimension W x D x H (mm)	Weight kg	Loading surface W x D (mm)	Load cap. kg	Wheel diam. mm
sw-600.617 / AG	1695 x 625 x 1900	77.0	985 x 590	250	160 x 40

Shelf heights: 225 / 695 / 1170 / 1645 mm
Height of top step: 980 mm
Step height: 230 mm



Load capacity shelf: 80 kg**

Workshop/Storage

**Static distributed load; Total load of the transport device must not be exceeded!

Galvanised
Various configuration options



Workshop/Storage



CONSTRUCTION

- Welded steel construction

FEATURES

- Load surface, end and side walls and roof with mesh sides 50 x 100 mm or 100 x 50 mm
- 1 horizontal push bar or 2 vertical push bars painted RAL 2008 bright red orange
- Document pocket DIN A4 across
- Optionally 2 sheets for lable

FITTINGS

- 2 swivel castors with brakes, 2 fixed castors
- Grey non-marking thermoplastic rubber tyres on plastic wheel rim with precision deepgroove ball bearings, with foot guard
- Galvanised

Order-picking trolley | galvanised

Article-no.	Dimension W x D x H (mm)	Weight kg	Loading surface W x D (mm)	Load cap. kg	Wheel diam. mm
sw-520.200	1860 x 650 x 1850	86.5	1675 x 615	300	125 x 30

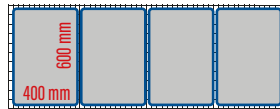

Load surface use for Euro size containers



Order-picking trolley | galvanised

Article-no.	Dimension W x D x H (mm)	Weight kg	Loading surface W x D (mm)	Load cap. kg	Wheel diam. mm
sw-490.100	1435 x 490 x 1820	43.5	1250 x 460	300	125 x 30

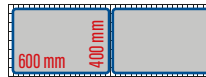

Load surface use for Euro size containers

ADDITIONAL ARTICLES



ADDITIONAL ARTICLE

EasySTOP central brake

Article-no.

rsa-125.500

As ex-factory equipment

ADDITIONAL ARTICLE

EasySTOP central brake
accessible from both sides

Article-no.

rsa-000.050

2 brakes applied

rsa-000.051

4 brakes applied

As ex-factory equipment

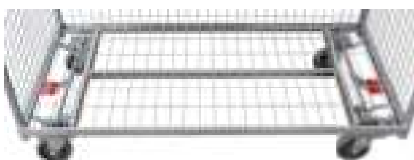

Additional articles
for order-picking trolleys

ADJUSTMENT

- Customise the order-picking trolleys according to your processes

CONFIGURATION

- Configure according to your wishes and requirements



ADDITIONAL ARTICLE

Article-no.	Weight kg
-------------	--------------

COUPLING AND DRAWBAR

rsa-000.060	-
-------------	---

As ex-factory equipment



MIDDLE WHEEL (Enables turning on the spot)

rsa-125.600	1.5
-------------	-----

As ex-factory equipment



3-TREAD STEPS

zsw-200.000	8.5
-------------	-----

As ex-factory equipment



PUSH AND PULL BAR

zsw-100.004	1.2
-------------	-----



DRINKS HOLDER

zsw-100.001	0.3
-------------	-----



PLASTIC DIVIDER

zsw-490.103	1.4
zsw-520.203	1.7



ADDITIONAL ARTICLE

Article-no.	Weight kg
-------------	--------------

SHELVES OF WIRE MESH BASE replaceable

zsw-490.100	4.5
zsw-520.200	5.5



SHELVES OF SHEET STEEL BASE replaceable

zsw-490.102	5.5
zsw-520.202	6.5



SHELVES OF WATERPROOF BONDED PLYWOOD, SURFACE FINISH SCREEN PRINTED replaceable

zsw-490.106	10.0
zsw-520.206	11.0



SHELVES OF WIRE MESH BASE WITH SCANNER RAIL replaceable

zsw-490.101	6.5
zsw-520.201	8.0



CLOTHES RAIL

zsw-490.104	1.5
zsw-520.204	1.5



FRONT WALL

zsw-490.105	7.5
zsw-520.205	8.5

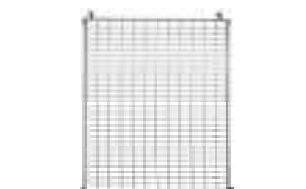

Workshop/Storage

Quality characteristics

QUALITY CHARACTERISTICS ■ WHEELS

- Plastic safety handles
- Precision deepgroove ball bearings
- Wheel mounting
- Plastic skirts
- Puncture-proof tyres

- Solid-rubber tyres with groove profile
- Puncture-proof tyres with groove profile
- Pneumatic tyres with groove profile



1 Plastic safety handles

Using improved materials, their flexibility reduces the risk of breakage and ensures optimum user safety.



2 Precision deepgroove ball bearings

Sealed and maintenance-free precision deepgroove ball bearings. Guaranteed easy running when loaded, even on sloping or rough surfaces.



3 Wheel mounting

The **VARIOfit**® truck wheels (pneumatic, solid-rubber and puncture-proof tyres) are secured with a lock nut which is screwed onto the axle. This prevents the wheels from working loose during use.



4 Plastic skirts

Specially developed by **VARIOfit**®, provide optimum safety. They continue past the bend in the tube to ensure there is no chance of catching or jamming.



5 Puncture-proof tyres

Same good running characteristics as pneumatic tyres. Filled with foamed ethylene vinyl acetate. Absorbs shocks, absorbs vibrations and is very directionally stable. Resistant to nails, curbs or other physical impacts. Optimum tyres for heavy loads and daily use. On steel wheel rim with precision deepgroove ball bearings and plastic hub cap.

SOLID-RUBBER TYRES
with groove profile



PUNCTURE-PROOF TYRES
with groove profile



PNEUMATIC TYRES
with groove profile



RAL 5010 RAL 7016

CONSTRUCTION

- Welded steel construction
- Toe of sheet steel

FEATURES

- Plastic safety handles
- Bended transverse struts
- Suitable carrying bars on page 111

FITTINGS

- Pneumatic tyres on steel wheel rim or solid-rubber tyres on special plastic wheel rim with precision deepgroove ball bearings and plastic wheel cap
- Support roller with grey, non-marking thermoplastic rubber tyres on plastic wheel rim with precision deepgroove ball bearings, 2 swivel castors, with gas pressure spring and 1 non-slip pedal on axle
- Available in 2 colours, RAL 5010 gentian blue or RAL 7016 anthracite grey, powder-coated

Plastic safety handles
Optionally with support roller



BEST SELLER

Tubular steel truck

Article-no. + /Colour	Dimension WxDxH (mm)	Weight kg	Toe plate WxD (mm)	Load cap. kg	Wheel diam. mm
sk-710.015 / AG	P 570 x 530 x 1105	12.5	320 x 250	200	260 x 85
sk-710.016 / AG	SR 570 x 530 x 1105	14.5	320 x 250	200	260 x 65

P = Pneumatic tyres, SR = Solid-rubber tyres

Tubular steel truck

Article-no. + /Colour	Dimension WxDxH (mm)	Weight kg	Toe plate WxD (mm)	Load cap. kg	Wheel diam. mm
sk-710.010 / AG	P 570 x 585 x 1310	17.0	320 x 250	250	260 x 85
sk-710.011 / AG	SR 570 x 585 x 1310	19.0	320 x 250	250	260 x 65

P = Pneumatic tyres, SR = Solid-rubber tyres



Trucks

Tubular steel truck | with 2 additional support roller

Article-no. + /Colour	Dimension WxDxH (mm)	Weight kg	Toe plate WxD (mm)	Load cap. kg	Wheel diam. mm
sk-710.055 / AG	P 575 x 585 x 1305	21.5	320 x 250	250	260 x 85
sk-710.065 / AG	SR 575 x 585 x 1305	23.5	320 x 250	250	260 x 65

P = Pneumatic tyres, SR = Solid-rubber tyres

Plastic safety handles
Toe of sheet steel



CONSTRUCTION

- Welded steel construction
- Toe of sheet steel

FEATURES

- Plastic safety handles
- Bended transverse struts or verticle struts
- Suitable carrying bars on page 111

FITTINGS

- Pneumatic tyres on steel wheel rim or solid-rubber tyres on special plastic wheel rim with precision deepgroove ball bearings and plastic wheel cap
- Available in 2 colours, RAL 5010 gentian blue or RAL 7016 anthracite grey, powder-coated

Tubular steel truck

Article-no. + /Colour	Dimension W x D x H (mm)	Weight kg	Toe plate W x D (mm)	Load cap. kg	Wheel diam. mm
sk-710.020 / AG	P 620 x 460 x 1110	13.5	400 x 150	250	260 x 85
sk-710.021 / AG	SR 620 x 460 x 1110	15.5	400 x 150	250	260 x 85

P = Pneumatic tyres, SR = Solid-rubber tyres

Trucks



Tubular steel truck | with large toe plate

Article-no. + /Colour	Dimension W x D x H (mm)	Weight kg	Toe plate W x D (mm)	Load cap. kg	Wheel diam. mm
sk-710.213 / AG	P 570 x 585 x 1310	21.0	480 x 300	250	260 x 85
sk-710.214 / AG	SR 570 x 585 x 1310	23.0	480 x 300	250	260 x 85

P = Pneumatic tyres, SR = Solid-rubber tyres



Tubular steel truck

Article-no. + /Colour	Dimension W x D x H (mm)	Weight kg	Toe plate W x D (mm)	Load cap. kg	Wheel diam. mm
sk-710.030 / AG	P 550 x 740 x 1600	20.0	300 x 260	250	260 x 85
sk-710.031 / AG	SR 550 x 740 x 1600	22.0	300 x 260	250	260 x 85

P = Pneumatic tyres, SR = Solid-rubber tyres

RAL 5010 RAL 7016

CONSTRUCTION

- Welded steel construction
- Toe of sheet steel

FEATURES

- Plastic safety handles
- Partially with bended transverse struts
- Plastic skids are replaceable and mounted completely on the tube
- Suitable carrying bars on page 111

FITTINGS

- Pneumatic tyres on steel wheel rim or solid-rubber tyres on special plastic wheel rim with precision deepgroove ball bearings and plastic wheel cap
- Optionally with puncture-proof tyres
- Available in 2 colours, RAL 5010 gentian blue or RAL 7016 anthracite grey, powder-coated

Plastic safety handles

Plastic skids



Trucks

Tubular steel truck

BEST SELLER



Article-no. + /Colour		Dimension W x D x H (mm)	Weight kg	Toe plate W x D (mm)	Load cap. kg	Wheel diam. mm
sk-710.005 / AG	P	550 x 615 x 1305	18.0	320 x 250	250	260 x 85
sk-710.006 / AG	SR	550 x 615 x 1305	19.5	320 x 250	250	260 x 65

P = Pneumatic tyres, SR = Solid-rubber tyres

Tubular steel truck with puncture-proof tyres

Article-no. + /Colour		Dimension W x D x H (mm)	Weight kg	Toe plate W x D (mm)	Load cap. kg	Wheel diam. mm
sk-710.014 / AG		550 x 615 x 1305	18.5	320 x 250	250	260 x 85

Tubular steel truck with large toe plate

BEST SELLER



Article-no. + /Colour		Dimension W x D x H (mm)	Weight kg	Toe plate W x D (mm)	Load cap. kg	Wheel diam. mm
sk-710.201 / AG	P	570 x 655 x 1315	20.0	480 x 300	250	260 x 85
sk-710.202 / AG	SR	570 x 655 x 1315	22.0	480 x 300	250	260 x 65

P = Pneumatic tyres, SR = Solid-rubber tyres



Plastic safety handles
Optionally with folding toe plate

CONSTRUCTION

- Welded steel construction
- Toe of sheet steel (optionally foldable)

MERKMALE

- Plastic safety handles
- Partially with bended transverse struts
- Plastic skids are replaceable and mounted completely on the tube
- Suitable carrying bars on page 111

FITTINGS

- Pneumatic tyres on steel wheel rim or solid-rubber tyres on special plastic wheel rim with precision deepgroove ball bearings and plastic wheel cap
- Available in 2 colours, RAL 5010 gentian blue or RAL 7016 anthracite grey, powder-coated



Tubular steel truck | with folding toe plate

Article-no. + /Colour	Dimension W x D x H (mm)	Weight kg	Toe plate W x D (mm)	Load cap. kg	Wheel diam. mm
sk-710.217 / AG	P 570 x 610 x 1300	21.0	320 x 255	200	260 x 85
sk-710.218 / AG	SR 570 x 610 x 1300	23.0	320 x 255	200	260 x 85

P = Pneumatic tyres, SR = Solid-rubber tyres

Trucks



Tubular steel truck | with folding toe plate

Article-no. + /Colour	Dimension W x D x H (mm)	Weight kg	Toe plate W x D (mm)	Load cap. kg	Wheel diam. mm
sk-710.215 / AG	P 570 x 545 x 1300	18.5	320 x 255	250	260 x 85
sk-710.216 / AG	SR 570 x 545 x 1300	20.0	320 x 255	250	260 x 85

P = Pneumatic tyres, SR = Solid-rubber tyres

Tubular steel truck | with large toe plate

Article-no. + /Colour	Dimension W x D x H (mm)	Weight kg	Toe plate W x D (mm)	Load cap. kg	Wheel diam. mm
sk-710.203 / AG	P 570 x 650 x 1305	19.5	480 x 300	250	260 x 85
sk-710.204 / AG	SR 570 x 650 x 1305	21.0	480 x 300	250	260 x 85

P = Pneumatic tyres, SR = Solid-rubber tyres

RAL 5010 RAL 7016

CONSTRUCTION

- Welded steel construction
- Toe of sheet steel

FEATURES

- Plastic safety handles
- Bended transverse struts and verticle struts
- Optionally with 2 stands for parking the truck
- Suitable carrying bars on page 111

FITTINGS

- Pneumatic tyres on steel wheel rim or solid-rubber tyres on special plastic wheel rim with precision deepgroove ball bearings and plastic wheel cap
- Available in 2 colours, RAL 5010 gentian blue or RAL 7016 anthracite grey, powder-coated

Plastic safety handles
Large toe plate



Tubular steel truck with large toe plate



Article-no. + /Colour	Dimension W x D x H (mm)	Weight kg	Toe plate W x D (mm)	Load cap. kg	Wheel diam. mm
sk-710.205 / AG	P 690 x 600 x 1110	18.0	480 x 300	250	260 x 85
sk-710.206 / AG	SR 690 x 600 x 1110	20.0	480 x 300	250	260 x 65

P = Pneumatic tyres, SR = Solid-rubber tyres

Tubular steel truck with large toe plate



Article-no. + /Colour	Dimension W x D x H (mm)	Weight kg	Toe plate W x D (mm)	Load cap. kg	Wheel diam. mm
sk-710.207 / AG	P 690 x 710 x 1200	22.5	480 x 300	250	260 x 85
sk-710.208 / AG	SR 690 x 710 x 1200	24.0	480 x 300	250	260 x 65

P = Pneumatic tyres, SR = Solid-rubber tyres



Trucks

Tubular steel truck



Article-no. + /Colour	Dimension W x D x H (mm)	Weight kg	Toe plate W x D (mm)	Load cap. kg	Wheel diam. mm
sk-710.117 / AG	P 690 x 550 x 1200	20.0	480 x 140	250	260 x 85
sk-710.118 / AG	SR 690 x 550 x 1200	21.5	480 x 140	250	260 x 65

P = Pneumatic tyres, SR = Solid-rubber tyres



Plastic safety handles
Optionally 2 stands for parking



CONSTRUCTION

- Welded steel construction
- Toe of sheet steel

FEATURES

- Plastic safety handles
- Bended transverse struts and verticle struts
- Optionally with 2 stands for parking the truck
- Suitable carrying bars on page 111

FITTINGS

- Pneumatic tyres on steel wheel rim or solid-rubber tyres on special plastic wheel rim with precision deepgroove ball bearings and plastic wheel cap
- Available in 2 colours, RAL 5010 gentian blue or RAL 7016 anthracite grey, powder-coated

Tubular steel truck

Article-no. + /Colour	Dimension W x D x H (mm)	Weight kg	Toe plate W x D (mm)	Load cap. kg	Wheel diam. mm
sk-1151 / AG	P 550 x 430 x 1100	14.5	400 x 110	200	260 x 85
sk-1150 / AG	SR 550 x 430 x 1100	16.5	400 x 110	200	260 x 85

P = Pneumatic tyres, SR = Solid-rubber tyres

Tubular steel truck

Article-no. + /Colour	Dimension W x D x H (mm)	Weight kg	Toe plate W x D (mm)	Load cap. kg	Wheel diam. mm
sk-1153 / AG	P 620 x 440 x 1110	15.5	450 x 120	250	260 x 85
sk-1152 / AG	SR 620 x 440 x 1110	17.0	450 x 120	250	260 x 85

P = Pneumatic tyres, SR = Solid-rubber tyres

Tubular steel truck

Article-no. + /Colour	Dimension W x D x H (mm)	Weight kg	Toe plate W x D (mm)	Load cap. kg	Wheel diam. mm
sk-1155 / AG	P 620 x 470 x 1110	16.5	450 x 120	250	260 x 85
sk-1154 / AG	SR 620 x 470 x 1110	18.0	450 x 120	250	260 x 85

P = Pneumatic tyres, SR = Solid-rubber tyres

Tubular steel truck

Article-no. + /Colour	Dimension W x D x H (mm)	Weight kg	Toe plate W x D (mm)	Load cap. kg	Wheel diam. mm
sk-1251 / AG	P 620 x 500 x 1220	19.5	450 x 150	250	260 x 85
sk-1250 / AG	SR 620 x 500 x 1220	21.0	450 x 150	250	260 x 85

P = Pneumatic tyres, SR = Solid-rubber tyres

ALU
minium

CONSTRUCTION

- Welded aluminium construction

FEATURES

- Very light and handy
- Plastic safety handles
- Bended transverse struts
- Optionally with replaceable plastic skids mounted completely on the tube

FITTINGS

- Pneumatic tyres on steel wheel rim or solid-rubber tyres on special plastic wheel rim with precision deepgroove ball bearings and plastic wheel cap

Plastic safety handles
Optionally with plastic skids

Aluminium truck



Article-no.		Dimension W x D x H (mm)	Weight kg	Toe plate W x D (mm)	Load cap. kg	Wheel diam. mm
ap-710.015	P	570 x 530 x 1075	9.5	320 x 250	150	260 x 85
ap-710.016	SR	570 x 530 x 1075	11.0	320 x 250	150	260 x 65

P = Pneumatic tyres, SR = Solid-rubber tyres



Aluminium truck



Article-no.		Dimension W x D x H (mm)	Weight kg	Toe plate W x D (mm)	Load cap. kg	Wheel diam. mm
ap-710.010	P	570 x 610 x 1305	11.0	320 x 250	200	260 x 85
ap-710.011	SR	570 x 610 x 1305	13.0	320 x 250	200	260 x 65

P = Pneumatic tyres, SR = Solid-rubber tyres



**BEST
SELLER**

Aluminium truck



Article-no.		Dimension W x D x H (mm)	Weight kg	Toe plate W x D (mm)	Load cap. kg	Wheel diam. mm
ap-710.005	P	570 x 615 x 1300	12.5	320 x 250	200	260 x 85
ap-710.006	SR	570 x 615 x 1300	13.5	320 x 250	200	260 x 65

P = Pneumatic tyres, SR = Solid-rubber tyres



Trucks

Plastic safety handles
Plastic skirts
Optionally with folding toe plate

CONSTRUCTION

- Welded aluminium construction

FEATURES

- Very light and handy
- Plastic safety handles
- Partially bended transverse struts
- Optionally with folding toe plate
- Plastic skirts are replaceable and mounted completely on the tube

FITTINGS

- Pneumatic tyres on steel wheel rim or solid-rubber tyres on special plastic wheel rim with precision deepgroove ball bearings and plastic wheel cap
- Optionally with puncture-proof tyres



**BEST
SELLER**

Aluminium truck | with puncture-proof tyres

Article-no.	Dimension W x D x H (mm)	Weight kg	Toe plate W x D (mm)	Load cap. kg	Wheel diam. mm
ap-710.214	570 x 615 x 1300	13.0	320 x 250	200	260 x 85

Trucks



Aluminium truck | with large toe plate

Article-no.		Dimension W x D x H (mm)	Weight kg	Toe plate W x D (mm)	Load cap. kg	Wheel diam. mm
ap-710.107	P	605 x 660 x 1305	14.0	480 x 300	200	260 x 85
ap-710.204	SR	605 x 660 x 1305	15.0	480 x 300	200	260 x 85

P = Pneumatic tyres, SR = Solid-rubber tyres



Aluminium truck | with folding toe plate

Article-no.		Dimension W x D x H (mm)	Weight kg	Toe plate W x D (mm)	Load cap. kg	Wheel diam. mm
ap-710.211	P	550 x 640 x 1300	13.0	380 x 280	200	260 x 85
ap-710.212	SR	550 x 640 x 1300	16.0	380 x 280	200	260 x 85

P = Pneumatic tyres, SR = Solid-rubber tyres

ALU
minium

CONSTRUCTION

- Welded aluminium construction

FEATURES

- Very light and handy
- Plastic safety handles
- Partially bended transverse struts and vertical struts

FITTINGS

- Pneumatic tyres on steel wheel rim or solid-rubber tyres on special plastic wheel rim with precision deepgroove ball bearings and plastic wheel cap

Plastic safety handles
Large toe plate

Aluminium truck | with large toe plate



Article-no.		Dimension W x D x H (mm)	Weight kg	Toe plate W x D (mm)	Load cap. kg	Wheel diam. mm
ap-710.103	P	570 x 635 x 1310	12.0	480 x 300	200	260 x 85
ap-710.202	SR	570 x 635 x 1310	13.5	480 x 300	200	260 x 65

P = Pneumatic tyres, SR = Solid-rubber tyres



Aluminium truck | with large toe plate



Article-no.		Dimension W x D x H (mm)	Weight kg	Toe plate W x D (mm)	Load cap. kg	Wheel diam. mm
ap-710.205	P	690 x 600 x 1110	11.5	480 x 300	200	260 x 85
ap-710.206	SR	690 x 600 x 1110	13.5	480 x 300	200	260 x 65

P = Pneumatic tyres, SR = Solid-rubber tyres



Trucks

SOLID-RUBBER TYRES
with groove profile

PUNCTURE-PROOF TYRES
with groove profile

PNEUMATIC TYRES
with groove profile



P
SR

Plastic safety handles
Three-arm star wheels



AG



Star wheel clamp



Trucks

CONSTRUCTION

- Welded steel construction
- Toe of sheet steel

FEATURES

- Plastic safety handles
- Partially bended transverse struts
- Three-arm star wheels, screwed
- Suitable carrying bars on page 111

FITTINGS

- Star wheels of grey non-marking thermoplastic rubber tyres on plastic wheel rim with precision deepgroove ball bearings
- Available in 2 colours, RAL 5010 gentian blue or RAL 7016 anthracite grey, powder-coated

Incl. star wheel clamp

Stair-climber truck | with 2 three-arm star wheels

Article-no. + /Colour	Dimension W x D x H (mm)	Weight kg	Toe plate W x D (mm)	Load cap. kg	Wheel diam. mm
sk-1300 / AG	TR 610 x 630 x 1310	23.5	300 x 255	200	160 x 40

TR = Thermoplastic rubber tyres

Stair-climber truck | with 2 three-arm star wheels

Article-no. + /Colour	Dimension W x D x H (mm)	Weight kg	Toe plate W x D (mm)	Load cap. kg	Wheel diam. mm
sk-710.212 / AG	TR 620 x 625 x 1310	22.0	320 x 245	200	160 x 40

TR = Thermoplastic rubber tyres



Stair-climber truck | with 2 three-arm star wheels

Article-no. + /Colour	Dimension W x D x H (mm)	Weight kg	Toe plate W x D (mm)	Load cap. kg	Wheel diam. mm
sk-710.210 / AG	TR 620 x 675 x 1310	24.0	480 x 295	200	160 x 40

TR = Thermoplastic rubber tyres

RAL 5010 **RAL 7016**

CONSTRUCTION

- Welded steel construction
- Toe of sheet steel

FEATURES

- Plastic safety handles
- Partially bended transverse struts
- Five-arm star wheels, screwed
- Suitable carrying bars on page 111

FITTINGS

- Star wheels of grey non-marking thermoplastic rubber tyres on plastic wheel rim with precision deepgroove ball bearings
- Pneumatic tyres on steel wheel rim or solid-rubber tyres on special plastic wheel rim with precision deepgroove ball bearings and plastic wheel cap
- Available in 2 colours, RAL 5010 gentian blue or RAL 7016 anthracite grey, powder-coated

Plastic safety handles
Five-arm star wheels



Stair-climber truck | with 2 five-arm star wheels

Article-no. + /Colour	Dimension WxDxH (mm)	Weight kg	Toe plate WxD (mm)	Load cap. kg	Wheel diam. mm
sk-1301 / AG P	610 x 705 x 1310	25.5	300 x 285	200	260 x 85
sk-1303 / AG SR	610 x 705 x 1310	27.5	300 x 285	200	260 x 65

P = Pneumatic tyres, SR = Solid-rubber tyres

Stair-climber truck | with 2 five-arm star wheels

Article-no. + /Colour	Dimension WxDxH (mm)	Weight kg	Toe plate WxD (mm)	Load cap. kg	Wheel diam. mm
sk-710.211 / AG P	610 x 675 x 1310	24.5	300 x 250	200	260 x 85
sk-710.222 / AG SR	610 x 675 x 1310	26.5	300 x 250	200	260 x 65

P = Pneumatic tyres, SR = Solid-rubber tyres



Stair-climber truck | with 2 five-arm star wheels

Article-no. + /Colour	Dimension WxDxH (mm)	Weight kg	Toe plate WxD (mm)	Load cap. kg	Wheel diam. mm
sk-710.209 / AG P	610 x 725 x 1310	27.5	480 x 300	200	260 x 85
sk-710.236 / AG SR	610 x 725 x 1310	29.5	480 x 300	200	260 x 65

P = Pneumatic tyres, SR = Solid-rubber tyres



Trucks

Plastic safety handles
Very light and handy
Three-arm star wheels

CONSTRUCTION

- Welded aluminium construction

FEATURES

- Very light and handy
- Plastic safety handles
- Partially bended transverse struts
- Three-arm star wheels, screwed

FITTINGS

- Star wheels of grey non-marking thermoplastic rubber tyres on plastic wheel rim with precision deepgroove ball bearings



Incl. star wheel clamp

Aluminium stair-climber truck | with 2 three-arm star wheels

Article-no.		Dimension W x D x H (mm)	Weight kg	Toe plate W x D (mm)	Load cap. kg	Wheel diam. mm
ap-1300	TR	610 x 630 x 1310	16.0	300 x 255	200	160 x 40

TR = Thermoplastic rubber tyres

Trucks



Aluminium stair-climber truck | with 2 three-arm star wheels

Article-no.		Dimension W x D x H (mm)	Weight kg	Toe plate W x D (mm)	Load cap. kg	Wheel diam. mm
ap-710.208	TR	620 x 625 x 1310	15.0	320 x 245	200	160 x 40

TR = Thermoplastic rubber tyres



Aluminium stair-climber truck | with 2 three-arm star wheels

Article-no.		Dimension W x D x H (mm)	Weight kg	Toe plate W x D (mm)	Load cap. kg	Wheel diam. mm
ap-710.210	TR	620 x 675 x 1310	16.0	480 x 295	200	160 x 40

TR = Thermoplastic rubber tyres

ALU
minium

CONSTRUCTION

- Welded aluminium construction

FEATURES

- Very light and handy
- Plastic safety handles
- Partially bended transverse struts
- Five-arm star wheels, screwed

FITTINGS

- Star wheels of grey non-marking thermoplastic rubber tyres on plastic wheel rim with precision deepgroove ball bearings
- Pneumatic tyres on steel wheel rim or solid-rubber tyres on special plastic wheel rim with precision deepgroove ball bearings and plastic wheel cap

Plastic safety handles
Very light and handy
Five-arm star wheels

Aluminium stair-climber truck | with 2 five-arm star wheels

Article-no.		Dimension W x D x H (mm)	Weight kg	Toe plate W x D (mm)	Load cap. kg	Wheel diam. mm
ap-1301	P	610 x 705 x 1310	18.5	300 x 285	200	260 x 85
ap-1302	SR	610 x 705 x 1310	20.5	300 x 285	200	260 x 65

P = Pneumatic tyres, SR = Solid-rubber tyres

Aluminium stair-climber truck | with 2 five-arm star wheels

Article-no.		Dimension W x D x H (mm)	Weight kg	Toe plate W x D (mm)	Load cap. kg	Wheel diam. mm
ap-710.207	P	610 x 675 x 1310	18.0	300 x 250	200	260 x 85
ap-710.228	SR	610 x 675 x 1310	20.0	300 x 250	200	260 x 65

P = Pneumatic tyres, SR = Solid-rubber tyres



Aluminium stair-climber truck | with 2 five-arm star wheels

Article-no.		Dimension W x D x H (mm)	Weight kg	Toe plate W x D (mm)	Load cap. kg	Wheel diam. mm
ap-710.209	P	610 x 725 x 1310	19.5	480 x 300	200	260 x 85
ap-710.298	SR	610 x 725 x 1310	21.5	480 x 300	200	260 x 65

P = Pneumatic tyres, SR = Solid-rubber tyres



Trucks

Plastic safety handles
 Chair support with continuous height adjustment
 Non-slip covering



AG

CONSTRUCTION

- Welded steel or aluminium construction

FEATURES

- Plastic safety handles
- Bended transverse struts
- Chair support with non-slip covering, removable, with continuous height adjustment, length: 505 mm
- Furniture trucks with transparent soft tube cover, toe with non-slip covering
- Suitable carrying bars on page 111

FITTINGS

- Pneumatic tyres on steel wheel rim or solid-rubber tyres on special plastic wheel rim with precision deepgroove ball bearings and plastic wheel cap
- Steel chair and furniture trucks available in 2 colours, RAL 5010 gentian blue or RAL 7016 anthracite grey, powder-coated



Chair truck

Article-no. + /Colour	Dimension W x D x H (mm)	Weight kg	Toe plate W x D (mm)	Load cap. kg	Wheel diam. mm
sk-710.028 / AG	P 570 x 795 x 1305	20.0	320 x 250	250	260 x 85
sk-710.029 / AG	SR 570 x 795 x 1305	22.0	320 x 250	250	260 x 65

P = Pneumatic tyres, SR = Solid-rubber tyres

Trucks



Aluminium chair truck

Article-no.	Dimension W x D x H (mm)	Weight kg	Toe plate W x D (mm)	Load cap. kg	Wheel diam. mm
ap-710.058	P 570 x 795 x 1305	12.0	320 x 250	250	260 x 85
ap-710.059	SR 570 x 795 x 1305	13.5	320 x 250	250	260 x 65

P = Pneumatic tyres, SR = Solid-rubber tyres



The transparency soft tube cover protects the goods from minor damage



The non-slip cover prevents the loaded goods from slipping off the toe



Furniture truck

Article-no. + /Colour	Dimension W x D x H (mm)	Weight kg	Toe plate W x D (mm)	Load cap. kg	Wheel diam. mm
sk-710.230 / AG	P 620 x 635 x 1400	17.5	360 x 335	250	260 x 85
sk-710.231 / AG	SR 620 x 635 x 1400	19.5	360 x 335	250	260 x 65

P = Pneumatic tyres, SR = Solid-rubber tyres



Aluminium Furniture truck

Article-no.	Dimension W x D x H (mm)	Weight kg	Toe plate W x D (mm)	Load cap. kg	Wheel diam. mm
ap-710.200	P 640 x 625 x 1410	12.5	360 x 320	200	260 x 85
ap-710.201	SR 640 x 625 x 1410	14.5	360 x 320	200	260 x 65

P = Pneumatic tyres, SR = Solid-rubber tyres

RAL 5010 RAL 7016

CONSTRUCTION

- Welded steel construction
- Toe of sheet steel

FEATURES

- Plastic safety handles
- Partially bended transverse struts
- Optionally with 2 stands for parking the truck
- Toes and bars optionally with hollow rubber profile
- Optionally with 2 three-arm star wheels with star wheel clamp

FITTINGS

- Star wheels of grey non-marking thermoplastic rubber tyres on plastic wheel rim with precision deepgroove ball bearings
- Pneumatic tyres on steel wheel rim or solid-rubber tyres on special plastic wheel rim with precision deepgroove ball bearings and plastic wheel cap
- Available in 2 colours, RAL 5010 gentian blue or RAL 7016 anthracite grey, powder-coated

Plastic safety handles
Optionally stands
Optionally star wheels



Appliance truck



Article-no. + /Colour		Dimension W x D x H (mm)	Weight kg	Toe plate W x D (mm)	Load cap. kg	Wheel diam. mm
sk-1399 / AG	P	705 x 575 x 1455	25.0	450 x 120	250	260 x 85
sk-1400 / AG	SR	705 x 575 x 1455	27.0	450 x 120	250	260 x 65

P = Pneumatic tyres, SR = Solid-rubber tyres

Appliance truck with 2 three-arm star wheels



Article-no. + /Colour		Dimension W x D x H (mm)	Weight kg	Toe plate W x D (mm)	Load cap. kg	Wheel diam. mm
sk-1157 / AG	TR	640 x 525 x 1155	21.5	450 x 150	250	160 x 40

TR = Thermoplastic rubber tyres



Appliance truck



Article-no. + /Colour		Dimension W x D x H (mm)	Weight kg	Toe plate W x D (mm)	Load cap. kg	Wheel diam. mm
sk-1156 / AG	P	640 x 425 x 1145	17.5	450 x 150	250	260 x 85
sk-1163 / AG	SR	640 x 425 x 1145	19.5	450 x 150	250	260 x 65

P = Pneumatic tyres, SR = Solid-rubber tyres

Additional carrying bars for all trucks on pages
97-102, 106-107, 110-111 available

ADDITIONAL ARTICLE Carrying bar for stair climbing (1 pair)

Article-no. + /Colour	Length (mm)	Weight kg
gsk-1156 / AG	855	3.0



112 BULKY GOODS TRUCK

RAL 5010 RAL 7016

Especially developed for bulky goods
3 levels height-adjustable supporting wheels
Brake lever



CONSTRUCTION

- Welded steel construction

FEATURES

- Foldable height-adjustable supporting wheels to reduce the clearance height
- Supporting wheels element can be adjusted in 3 levels with just one handle
- Handles of round tube with soft plastic grip cover, black
- Contact surface with grey hollow rubber profile
- Toe plate with vulcanised rubber
- Incl. 4 eyes at heights 600 and 1600 mm for fastening the goods using 2 integrated tension belts

- Incl. 2 hooks per cross strut for fastening the tension belts when not in use
- With brake lever acting on the polyurethane wheels

FITTINGS

- Polyurethane tyres 92° Shore A on cast aluminium wheel rim with precision deepgroove ball bearings
- Supporting wheels of grey non-marking thermoplastic rubber tyres on plastic wheel rim with precision deepgroove ball bearings
- Available in 2 colours, RAL 5010 gentian blue or RAL 7016 anthracite grey, powder-coated

Trucks



Supporting wheels

element can be adjusted in 3 levels with just one handle



Foldable height-adjustable supporting wheels to reduce the clearance height, e.g. to drive through door frames

OPTI-MISED

Bulky goods truck | with supporting wheels

Article-no. + /Colour	Dimension W x D x H (mm)	Weight kg	Toe plate W x D (mm)	Load cap. kg	Wheel diam. mm
sk-710.093 / AG	PO 600 x 400 x 1700	43.5	600 x 150	550	250 x 50

PO = Polyurethane tyres



1 Dimensions (D x H)
400 x 1700 mm



2 Dimensions (D x H)
1410 x 1370 mm



3 Dimensions (D x H)
1575 x 1160 mm



4 Dimensions (D x H)
1685 x 920 mm

RAL 5010 RAL 7016

CONSTRUCTION

- Welded steel construction

FEATURES

- Double-fold for easy transport
- Handle with soft plastic cover
- Locking and unlocking by cable

FITTINGS

- Pneumatic tyres on steel wheel rim with precision deepgroove ball bearings and plastic wheel cap
- Available in 2 colours, RAL 5010 gentian blue or RAL 7016 anthracite grey, powder-coated

Bowden cable for lock-out release
Double-fold



Folded only 420 x 322 x 645 mm (W x D x H)

Lightweight folding truck

Article-no. + /Colour	Dimension W x D x H (mm)	Weight kg	Toe plate W x D (mm)	Load cap. kg	Wheel diam. mm
sk-710.420 / AG	P 430 x 715 x 1165	9.5	375 x 450	80	230 x 55

P = Pneumatic tyres



Trucks

RAL 5010 RAL 7016

PARCEL TRUCKS

FEATURES

- Either only toe plate foldable or double-fold version for easy transport

FITTINGS

- Pneumatic tyres on steel wheel rim, black, or grey non-marking thermoplastic rubber tyres on plastic wheel rim with precision deepgroove ball bearings

Parcel truck

Article-no. + /Colour	Dimension W x D x H (mm)	Weight kg	Toe plate W x D (mm)	Load cap. kg	Wheel diam. mm
pr-4001 / AG	P 490 x 635 x 1025	14.0	295 x 390	150	220 x 70
pr-4000 / AG	TR 475 x 625 x 1025	11.0	295 x 390	150	200 x 40

P = Pneumatic tyres, TR = Thermoplastic rubber tyres



Parcel truck | double-fold version

Article-no. + /Colour	Dimension W x D x H (mm)	Weight kg	Toe plate W x D (mm)	Load cap. kg	Wheel diam. mm
pr-4003 / AG	P 490 x 635 x 1025	15.5	295 x 390	100	220 x 70
pr-4002 / AG	TR 475 x 625 x 1025	12.0	295 x 390	100	200 x 40

P = Pneumatic tyres, TR = Thermoplastic rubber tyres



Transport of complete tyre stacks
For tyre diameter 540 - 820 mm
Lever system with gas pressure springs



AG

Tyre absorption



Tyre handling



1 non-slip pedal each on axle and supporting wheel



Tyre truck with telescopic extension complete extended and loaded with 2 sets of tyres

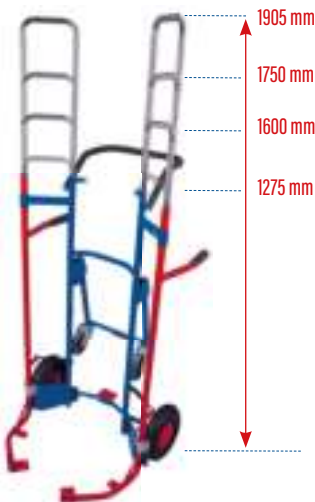

CONSTRUCTION

- Welded steel construction

FEATURES

- For tyre diameter 540 - 820 mm
- Wheel protection guards
- Easy pick up, transport and set down of whole stacks of tyres
- Large push bar with soft plastic grip cover, black
- Lever system with gas pressure springs
- Tyre truck with telescopic extension, extensible in 4 steps
- Optionally with fold-out supporting wheels, as well as non-slip pedal each on axle and supporting wheel

FITTINGS

- Pneumatic tyres on steel wheel rim or solid-rubber tyres on special plastic wheel rim with precision deepgroove ball bearings and plastic wheel cap
- Supporting wheels of grey non-marking thermoplastic rubber tyres on plastic wheel rim with precision deepgroove ball bearings, 2 swivel castors
- Frame available in 2 colours, RAL 5010 gentian blue or RAL 7016 anthracite grey, moveable pickup arms powder-coated RAL 3000 flame red, powder-coated

Tyre truck | low

Article-no. + /Colour	Dimension W x D x H (mm)	Weight kg	Load cap. kg	Wheel diam. mm
sk-710.302 / AG	P 705 x 660 x 1165	19.0	200	260 x 85
sk-710.303 / AG	SR 705 x 660 x 1165	21.0	200	260 x 85

P = Pneumatic tyres, SR = Solid-rubber tyres

Tyre truck | high

Article-no. + /Colour	Dimension W x D x H (mm)	Weight kg	Load cap. kg	Wheel diam. mm
sk-710.300 / AG	P 705 x 740 x 1600	22.0	200	260 x 85
sk-710.301 / AG	SR 705 x 740 x 1600	23.0	200	260 x 85

P = Pneumatic tyres, SR = Solid-rubber tyres

Tyre truck | with 2 supporting wheels

Article-no. + /Colour	Dimension W x D x H (mm)	Weight kg	Load cap. kg	Wheel diam. mm
sk-710.304 / AG	P 705 x 740 x 1600	26.0	200	260 x 85
sk-710.305 / AG	SR 705 x 740 x 1600	28.0	200	260 x 85

P = Pneumatic tyres, SR = Solid-rubber tyres



Tyre truck | with telescopic extension

Article-no. + /Colour	Dimension W x D x H (mm)	Weight kg	Load cap. kg	Wheel diam. mm
sk-710.306 / AG	P 705 x 740 x 1275-1905	27.0	200	260 x 85
sk-710.307 / AG	SR 705 x 740 x 1275-1905	29.5	200	260 x 85

P = Pneumatic tyres, SR = Solid-rubber tyres

GALVANISED

CONSTRUCTION

- Welded steel construction

FEATURES

- For tyre diameter 540 - 820 mm
- Wheel protection guards
- Easy pick up, transport and set down of whole stacks of tyres

- Large push bar with soft plastic grip cover, black
- Lever system with gas pressure springs

FITTINGS

- Pneumatic tyres on steel wheel rim or solid-rubber tyres on special plastic wheel rim with precision deepgroove ball bearings and plastic wheel cap
- Galvanised frame

Transport of complete tyre stacks
For tyre diameter 540 - 820 mm
Lever system with gas pressure springs



Tyre truck | low | galvanised

Article-no.		Dimension W x D x H (mm)	Weight kg	Load cap. kg	Wheel diam. mm
sk-710.312	P	705 x 660 x 1165	19.0	200	260 x 85
sk-710.313	SR	705 x 660 x 1165	21.0	200	260 x 65

P = Pneumatic tyres, SR = Solid-rubber tyres

Tyre truck | high | galvanised

Article-no.		Dimension W x D x H (mm)	Weight kg	Load cap. kg	Wheel diam. mm
sk-710.310	P	705 x 740 x 1600	22.0	200	260 x 85
sk-710.311	SR	705 x 740 x 1600	23.0	200	260 x 65

P = Pneumatic tyres, SR = Solid-rubber tyres

RAL 5010 RAL 7016

TYRE RACK AND TYRE TROLLEY

CONSTRUCTION

- Welded steel construction

FEATURES

- Incl. document pocket DIN A4 high
- Galvanised connecting tubes, boltmounted, hence variable width
- For tyre diameter of 540 - 820 mm

FITTINGS

- 2 swivel castors with brakes, 2 fixed castors
- Grey non-marking thermoplastic rubber tyres on plastic wheel rim with precision deepgroove ball bearings, with foot guard
- Optionally with 4 plastic feets
- Available in 2 colours, RAL 5010 gentian blue or RAL 7016 anthracite grey, powder-coated

Tyre rack | with 2 levels

Article-no. + /Colour	Dimension W x D x H (mm)	Weight kg	Loading surface W x D (mm)	Load cap. kg
sw-646.004 / AG	1205 x 750 x 1325	23.0	1140 x 395	300

Load capacity floor tubes: 150 kg**

Tyre trolley | with 2 levels

Article-no. + /Colour	Dimension W x D x H (mm)	Weight kg	Loading surface W x D (mm)	Load cap. kg	Wheel diam. mm
sw-646.003 / AG	1205 x 780 x 1430	27.0	1140 x 395	300	125 x 30

Load capacity floor tubes: 150 kg**



Tyre handling

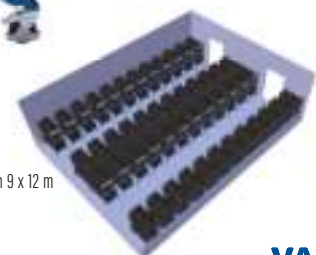

Tyre magazine on 9 x 12 m
(48 tyre trolleys)

ADDITIONAL ARTICLE Connection tube galvanised for tyre rack and trolley

Article-no.	For using length mm	Tyres per level diam. up to 225 mm
zsw-646.104	940	4 x
zsw-646.103	1800	8 x

**Total load of the transport device must not be exceeded!

Shelf
Distance pieces
Plastic clips

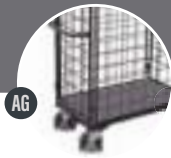

AG

CONSTRUCTION

- Welded steel construction

FEATURES

- Galvanised connecting tubes, boltmounted
- For tyre diameter of 540 - 820 mm
- Inserting the shelf means that the middle shelf can then only be used for tyre diameter 540 - 650 mm

FITTINGS

- Available in 2 colours, RAL 5010 gentian blue or RAL 7016 anthracite grey, powder-coated



ADDITIONAL ARTICLE Shelf for tyre rack and tyre trolley

Article-no. + /Colour	Dimension WxDxH (mm)	Weight kg	Loading surface WxD (mm)	Load cap. kg
gsw-646.003 / AG	1205 x 605 x 750	11.0	1140 x 395	150



Putting the galvanised distance pieces in the tubes of the tyre rack/trolley you can store tyres with diameter up to 820 mm instead of 650 mm in the second level even if a further level is installed

ADDITIONAL ARTICLE Distance pieces for tyre rack and tyre trolley

Article-no.	Piece	Dimension W (mm)	Weight kg
zsw-646.009	4	160	0.4

Tyre handling



¹ For lower pipes of the tyre truck
² For right pipes of the tyre truck
³ For left pipes of the tyre truck (clipboard)

ADDITIONAL ARTICLE Plastic clips for tyre rack and tyre trolley

Article-no.	Piece	Dimension diam. / W (mm)	Weight kg
zsw-646.005	4	33.7 / 670 ¹	0.8
Set = 8 pieces	2	33.7 / 300 ²	
	2	33.7 / 270 ³	

¹ For pipes of the upper level
² For pipes of the lower level

ADDITIONAL ARTICLE Plastic clips for shelf for tyre rack and tyre trolley

Article-no.	Piece	Dimension diam. / W (mm)	Weight kg
zsw-646.006	4	33.7 / 275 ¹	0.4
Set = 8 pieces	4	33.7 / 260 ²	

RAL 5010 RAL 7016



Plastic feet
Extension tube
Push/pull bar



ADDITIONAL ARTICLE Plastic feet for tyre rack

Article-no.	Piece	Dimension (mm)	Weight kg	Load cap. kg
zsw-646.007	4	70	0.8	300



ADDITIONAL ARTICLE Extension tube for tyre rack / tyre trolley

Article-no.	Piece	Dimension diam. / W / w (mm)	Weight kg	Load cap. kg
zsw-646.008	2	26.9 / 1220 / 1130	2.0	150



Tyre handling

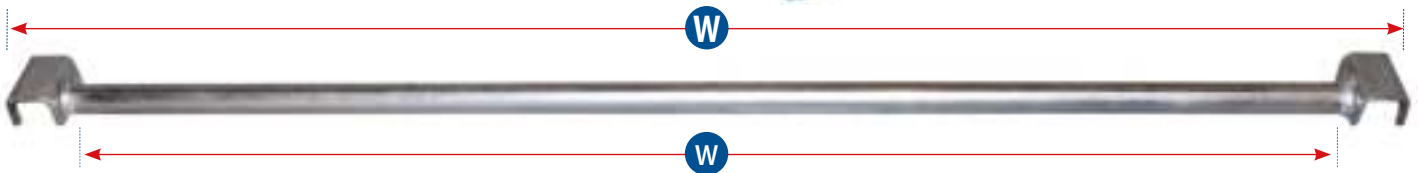

With soft plastic cover, black

ADDITIONAL ARTICLE Push/pull bar for tyre trolley

Article-no. + /Colour	Dimension W (mm)	Weight kg
zsw-646.004 / AG	370	1.3



Security features
Information



CORRECT POSITIONING FOR INCREASED SAFETY

The point where the steel-cylinder rests on the back of the truck is above the chain guard. This ensures that the steel-cylinder is held securely and is prevented from slipping off the blade.

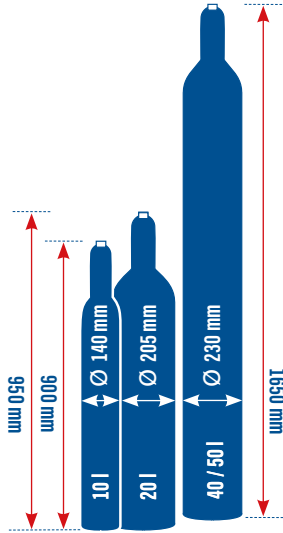
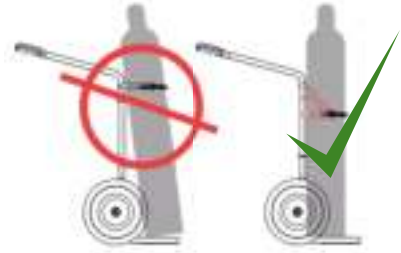

1 Gas cylinder

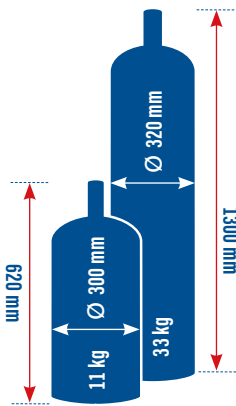

2 Propane gas cylinder



Handling of steel-cylinder and drums

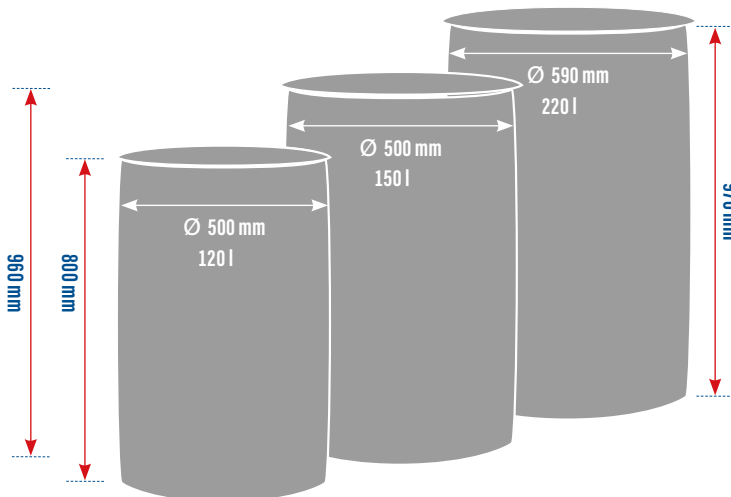

3 Plastic drums

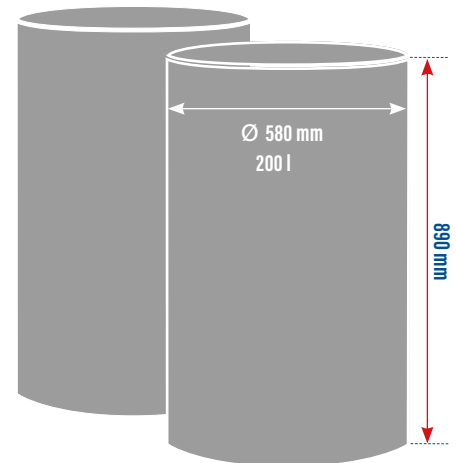

4 Steel sheet drums

RAL 5010 RAL 7016

CONSTRUCTION

- Welded steel construction
- Toe of sheet steel with edge surrounded on three sides

FEATURES

- Plastic safety handles
- For easy transport of steel-cylinders with a capacity of 20, 40 or 50 l, diam. 210 – 250 mm
- Cylinder holder with safety chains

FITTINGS

- Pneumatic tyres on steel wheel rim or solid-rubber tyres on special plastic wheel rim with precision deepgroove ball bearings and plastic wheel cap
- Available in 2 colours, RAL 5010 gentian blue or RAL 7016 anthracite grey, powder-coated

Plastic safety handles
Cylinder holder with safety chains
Toe with edge surrounded on three sides



Steel-cylinder truck | for 1 steel-cylinder of 40 - 50 l capacity



Article-no. + /Colour	Dimension W x D x H (mm)	Weight kg	Toe Plate		Wheel diam. mm
			W x D (mm)	Load cap. kg	
fk-1201 / AG	P 465 x 445 x 1185	9.5	255 x 260	100	260 x 85
fk-1200 / AG	SR 465 x 445 x 1185	11.0	255 x 260	100	260 x 65

P = Pneumatic tyres, SR = Solid-rubber tyres

Steel-cylinder truck | for 1 steel-cylinder of 20, 40 - 50 l capacity

Article-no. + /Colour	Dimension W x D x H (mm)	Weight kg	Toe Plate		Wheel diam. mm
			W x D (mm)	Load cap. kg	
fk-1201.001 / AG	P 465 x 445 x 1185	9.5	255 x 260	100	260 x 85
fk-1200.001 / AG	SR 465 x 445 x 1185	11.0	255 x 260	100	260 x 65

P = Pneumatic tyres, SR = Solid-rubber tyres

Steel-cylinder truck | for propane gas cylinder

Article-no. + /Colour	Dimension W x D x H (mm)	Weight kg	Toe Plate		Wheel diam. mm
			W x D (mm)	Load cap. kg	
fk-1206/11 / AG	P 570 x 555 x 1250	11.5	360 x 365	100	260 x 85
fk-1204/11 / AG	SR 570 x 555 x 1250	13.0	360 x 365	100	260 x 65

P = Pneumatic tyres, SR = Solid-rubber tyres

Steel-cylinder truck | for propane gas cylinder

Article-no. + /Colour	Dimension W x D x H (mm)	Weight kg	Toe Plate		Wheel diam. mm
			W x D (mm)	Load cap. kg	
fk-1206/33 / AG	P 570 x 555 x 1250	11.5	360 x 365	100	260 x 85
fk-1204/33 / AG	SR 570 x 555 x 1250	13.0	360 x 365	100	260 x 65

P = Pneumatic tyres, SR = Solid-rubber tyres

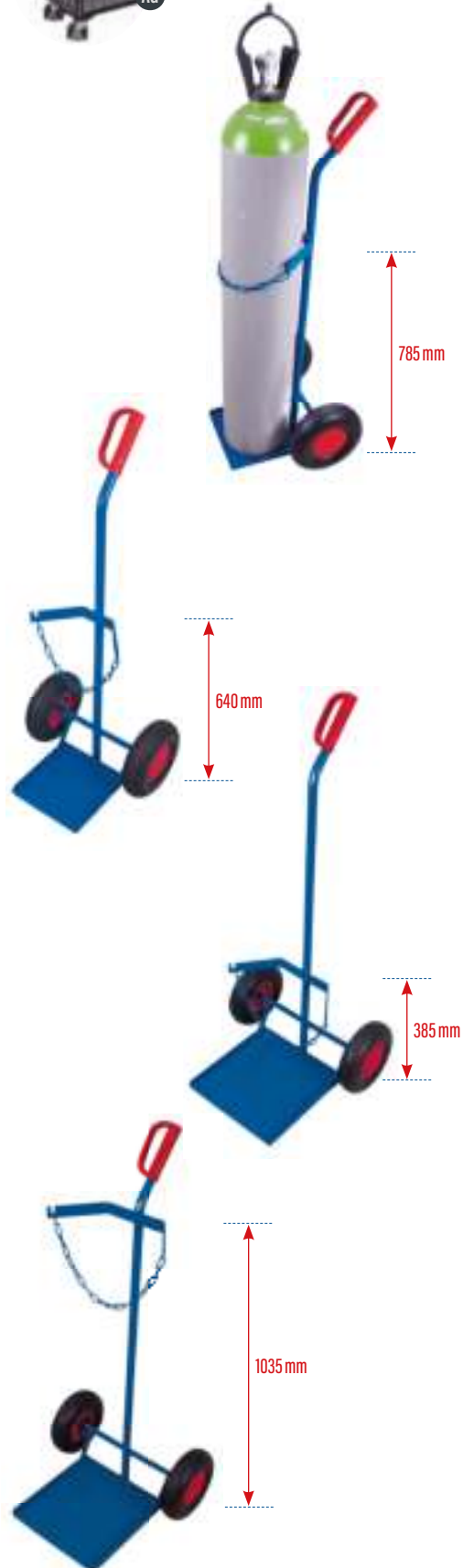

Handling of steel-cylinder

Plastic safety handles
Cylinder holder with safety chains
Toe with edge surrounded
on three sides



AG

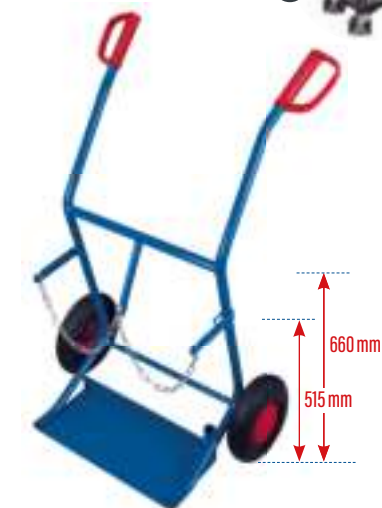

Handling of steel-cylinder

CONSTRUCTION

- Welded steel construction
- Toe of sheet steel with edge surrounded on three sides

FEATURES

- Plastic safety handles
- For easy transport of steel-cylinders with a capacity of 20, 40 or 50 l, diam. 210 - 250 mm
- Cylinder holder with safety chains
- Optionally with additional supporting wheel, fixed welded, not to be foldable

FITTINGS

- Pneumatic or solid-rubber tyres on steel wheel rim (solid-rubber tyres with diam. 260 x 65 mm on special plastic wheel rim) with precision deepgroove ball bearings and plastic wheel cap
- Supporting wheel of grey non-marking thermoplastic rubber tyre on plastic wheel rim with precision deepgroove ball bearings, 1 swivel castor
- Available in 2 colours, RAL 5010 gentian blue or RAL 7016 anthracite grey, powder-coated

Steel-cylinder truck | for 2 steel-cylinders of 20 l capacity

Article-no. + /Colour	Dimension W x D x H (mm)	Weight kg	Toe Plate W x D (mm)	Load cap. kg	Wheel diam. mm
fk-1101 / AG	P 710 x 570 x 1110	15.0	470 x 210	100	260 x 85
fk-1100 / AG	SR 710 x 570 x 1110	17.0	470 x 210	100	260 x 85

P = Pneumatic tyres, SR = Solid-rubber tyres

Steel-cylinder truck | for 2 steel-cylinders of 40 - 50 l capacity

Article-no. + /Colour	Dimension W x D x H (mm)	Weight kg	Toe Plate W x D (mm)	Load cap. kg	Wheel diam. mm
fk-1301 / AG	P 855 x 975 x 1240	24.5	515 x 250	200	400 x 100
fk-1300 / AG	SR 855 x 975 x 1240	37.5	515 x 250	200	400 x 80

P = Pneumatic tyres, SR = Solid-rubber tyres

Steel-cylinder truck | for 2 steel-cylinders of 40 - 50 l capacity

Article-no. + /Colour	Dimension W x D x H (mm)	Weight kg	Toe Plate W x D (mm)	Load cap. kg	Wheel diam. mm
fk-1303 / AG	P 855 x 975 x 1240	29.0	515 x 250	200	400 x 100
fk-1302 / AG	SR 855 x 975 x 1240	42.0	515 x 250	200	400 x 80

P = Pneumatic tyres, SR = Solid-rubber tyres

ADDITIONAL ARTICLE Toolbox for steel-cylinder trucks

Article-no. + /Colour	Dimension W x D x H (mm)	Weight kg	For article
zfk-460.000 / AG	460 x 210 x 155	5.0	fk-1300/1301
zfk-460.001 / AG	460 x 210 x 155	5.0	fk-1000
zfk-460.002 / AG	460 x 210 x 155	5.0	fk-1100/1101
zfk-460.003 / AG	460 x 210 x 155	5.0	fk-1302/1303



RAL 5010 RAL 7016

CONSTRUCTION

- Welded steel construction
- Optionally push bar with dead man's brake, additional handle beneath the push bar

FEATURES

- Push bar vertical or horizontal
- 2 shelves with hole cutouts diam. 160 mm or 170 mm
- Load surfaces of waterproof bonded plywood, surface finish screen printed, antislip
- For 24 or 18 bottles

FITTINGS

- 2 **EasySTOP** swivel castors, 2 fixed castors or 2 swivel castors with dead man's brake, 2 fixed castors
- Grey non-marking thermoplastic rubber tyres on plastic wheel rim with precision deepgroove ball bearings, with foot guard
- Available in 2 colours, RAL 5010 gentian blue or RAL 7016 anthracite grey, powder-coated

For 24 bottles, hole cutout diam. 160 mm

Steel-cylinder trolley with dead man's brake

Article-no. + /Colour	Dimension W x D x H (mm)	Weight kg	Loading surface W x D (mm)	Load cap. kg	Wheel diam. mm
sw-700.287 / AG	1280 x 775 x 1095	63.5	1120 x 760	500	200 x 40

For 24 bottles, hole cutout diam. 160 mm

Steel-cylinder trolley

Article-no. + /Colour	Dimension W x D x H (mm)	Weight kg	Loading surface W x D (mm)	Load cap. kg	Wheel diam. mm
sw-700.295 / AG	1265 x 775 x 1000	60.0	1120 x 760	500	200 x 40

For 18 bottles, hole cutout diam. 170 mm

Steel-cylinder trolley



Article-no. + /Colour	Dimension W x D x H (mm)	Weight kg	Loading surface W x D (mm)	Load cap. kg	Wheel diam. mm
sw-700.337 / AG	1265 x 775 x 1000	60.0	1120 x 760	500	200 x 40



Brake applied
Brake released

Shelves with hole cutouts
Waterproof bonded plywood
EasySTOP or dead man's brake



Handling of steel-cylinder

RAL 5010 RAL 7016

STEEL-CYLINDER TRUCK / STEEL-CYLINDER STAND

CONSTRUCTION

- Welded steel construction
- Toe of sheet steel with edge surrounded on three sides

FEATURES

- Steel-cylinder truck suitable for steel-cylinders with a capacity of 10 l, diam. 140 mm
- Steel-cylinder stand suitable for steel-cylinders with a capacity of 40 or 50 l, diam. 210 - 250 mm

- Steel-cylinder stand incl. hole for wall fastening
- Cylinder holder with safety chains

FITTINGS

- Grey non-marking thermoplastic rubber tyres on plastic wheel rim with precision deepgroove ball bearings
- Available in 2 colours, RAL 5010 gentian blue or RAL 7016 charcoal grey powder coated

Steel-cylinder truck for 2 steel-cylinders of 10 l capacity



Article-no. + /Colour	Dimension W x D x H (mm)	Weight kg	Toe Plate W x D (mm)	Load cap. kg	Wheel diam. mm
fk-1000 / AG	TR 565 x 370 x 1045	11.5	410 x 210	50	200 x 40

TR = Thermoplastic rubber tyres

Steel-cylinder stand for 2 steel-cylinders of 40 - 50 l capacity

Article-no. + /Colour	Dimension W x D x H (mm)	Weight kg	Toe Plate W x D (mm)	Load cap. kg
fk-1001 / AG	570 x 285 x 1100	13.0	555 x 275	200

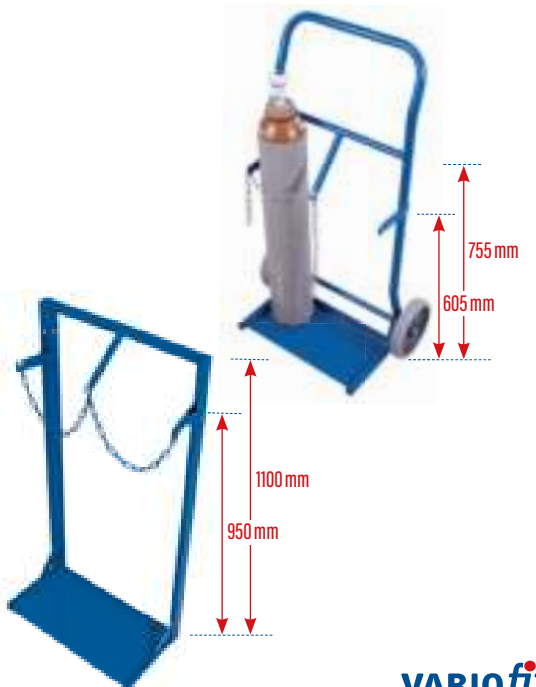

Available in 2 colours
Push bar and webbing strap



AG

CONSTRUCTION

- Welded steel construction of flat steel

FEATURES

- Edge height: 40 mm
- For upright transport of 200 l drums
- Optionally with screwed push bar and webbing strap for securing load

FITTINGS

- 4 swivel castors, 2 of them with brakes
- Grey non-marking thermoplastic rubber tyres on plastic wheel rim with precision deepgroove ball bearings
- Available in 2 colours, RAL 5010 gentian blue or RAL 7016 anthracite grey, powder-coated

BEST SELLER

Drum dolly

Article-no. + /Colour	Dimension W x D diam. x H (mm)	Weight kg	Loading surface Drums	Load cap. kg	Wheel diam. mm
sw-610.000 / AG	TR 715 x 610 x 160	9.5	200 l	250	80 x 30

TR = Thermoplastic rubber tyre



Incl. webbing strap to secure the drum

Drum dolly with push bar

Article-no. + /Colour	Dimension W x D diam. x H (mm)	Weight kg	Loading surface Drums	Load cap. kg	Wheel diam. mm
sw-610.010 / AG	TR 715 x 610 x 930	13.5	200 l	250	80 x 30

TR = Thermoplastic rubber tyre

DRUM TRUCK FOR PLASTIC DRUMS

Suitable for 120-220 l plastic drums
Plastic skids
Webbing strap

CONSTRUCTION

- Welded steel construction
- Toe of sheet steel

FEATURES

- Plastic safety handles
- Bended transverse struts
- Plastic skids are replaceable and mounted completely on the tube
- Webbing strap for securing load

FITTINGS

- Suitable for the transport of 120 - 220 l plastic drums
- Liquid can be drained in horizontal position
- Pneumatic tyres on steel wheel rim or solid-rubber tyres on steel wheel rim, with precision deepgroove ball bearings and plastic wheel cap
- Available in 2 colours, RAL 5010 gentian blue or RAL 7016 anthracite grey, powder-coated



Incl. webbing strap to secure the drum
Liquid can be drained in horizontal position

Drum truck for plastic drums

Article-no. + /Colour	Dimension W x D x H (mm)	Weight kg	Toe Plate W x D (mm)	Load cap. kg	Wheel diam. mm
fk-1110 / AG	p 660 x 470 x 1190	18.0	470 x 160	250	260 x 85
fk-1109 / AG	SR 660 x 470 x 1190	20.0	470 x 160	250	260 x 65

P = Pneumatic tyres, SR = Solid-rubber tyres

RAL 5010 RAL 7016

CONSTRUCTION

- Fixed welded, foldable construction made of section steel
- Swiveling push bar with dead man's brake

FEATURES

- Push bar with black shrink tube cover
- Firm and secure stand at an incline of up to 25°
- Absorption of standing drum
- 4 welded-on safety eyelets for fixing the drum trolley using tension belts
- 2 welded-on eyelets to secure the drum
- Integrated tension belt
- Suitable for the transport of 60 or 200 liter steel sheet drums with rim
- 2 supporting wheels

FITTINGS

- Solid-rubber tyres on special plastic wheel rim with precision deepgroove ball bearings and plastic wheel cap
- Supporting wheels of elastic solid-rubber tyres on cast aluminium wheel rim with precision deepgroove ball bearings, black
- Available in 2 colours, RAL 5010 gentian blue or RAL 7016 anthracite grey, powder-coated

Absorption of standing drum
Swiveling push bar
With dead man's brake



Brake released
Brake applied



4 safety eyelets

For fixing the drum trolley using tension belts



Handling of drums

Drum trolley



Article-no. + /Colour	Dimension W x D x H (mm)	Weight kg	Loading surface Drums	Load cap. kg	Wheel diam. mm
zu-3344 / AG	SR 655 x 1390 x 1040	38.0	200 l	250	260 x 65 / 125 x 30

SR = Solid-rubber tyre



Suitable for 200 l sheet steel drums
Plastic safety handles



CONSTRUCTION

- Welded steel construction

FEATURES

- Plastic safety handles
- For the transport of 200 l sheet steel drums with rim, not suitable for plastic drums (drum truck for plastic drum on page 122)
- Optionally with 1 supporting swivel castor with brake or with 2 supporting wheels mounted on one axle

FITTINGS

- Pneumatic tyres on steel wheel rim or solid-rubber tyres on special plastic wheel rim with precision deepgroove ball bearings and plastic wheel cap
- Supporting wheels of grey non-marking thermo-plastic rubber tyres on plastic wheel rim with precision deepgroove ball bearings
- Available in 2 colours, RAL 5010 gentian blue or RAL 7016 anthracite grey, powder-coated

Drum truck

Article-no. + /Colour	Dimension W x D x H (mm)	Weight kg	Loading surface Drums	Load cap. kg	Wheel diam. mm
fk-1103 / AG	P 735 x 1600 x 410	14.0	200 l	250	260 x 85
fk-1102 / AG	SR 735 x 1600 x 410	16.0	200 l	250	260 x 65

P = Pneumatic tyres, SR = Solid-rubber tyres

Drum truck with 1 supporting swivel castor with brake

Article-no. + /Colour	Dimension W x D x H (mm)	Weight kg	Loading surface Drums	Load cap. kg	Wheel diam. mm
fk-1105 / AG	P 735 x 1445 x 870	18.0	200 l	250	260 x 85
fk-1104 / AG	SR 735 x 1445 x 870	20.0	200 l	250	260 x 65

P = Pneumatic tyres, SR = Solid-rubber tyres

Handling of drums



Drum truck with 2 supporting wheels

Article-no. + /Colour	Dimension W x D x H (mm)	Weight kg	Loading surface Drums	Load cap. kg	Wheel diam. mm
zu-3342 / AG	P 735 x 1430 x 870	19.5	200 l	250	260 x 85
zu-3341 / AG	SR 735 x 1430 x 870	21.5	200 l	250	260 x 65

P = Pneumatic tyres, SR = Solid-rubber tyres

RAL 5010 **RAL 7016**

CONSTRUCTION

- Welded steel construction

FEATURES

- For moving, storing and emptying 200 l sheet steel drums
- Lever with plastic safety handle
- Drum support either on 4 plastic wheels or on 2 steel rollers for thin-walled drums

FITTINGS

- 2 swivel castors with brakes, 2 polyamide wheels on one axle
- Polyamide tyres with precision deepgroove ball bearings, white
- Available in 2 colours, RAL 5010 gentian blue or RAL 7016 anthracite grey, powder-coated

Suitable for 200 l sheet steel drums
Lever with plastic safety handle



Drum dispenser | with 4 plastic wheels

Article-no. + /Colour	Dimension W x D x H (mm)	Weight kg	Loading surface Drums	Load cap. kg	Wheel diam. mm
zu-3201 / AG PT	895 x 715 x 690	17.5	200 l	250	125 x 40

PT = Polyamide tyres

2 steel rollers Ø 60 mm
Length 500 mm
For thin-walled drums

Drum dispenser | with 2 steel rollers

Article-no. + /Colour	Dimension W x D x H (mm)	Weight kg	Loading surface Drums	Load cap. kg	Wheel diam. mm
zu-3202 / AG PT	895 x 715 x 670	24.0	200 l	250	125 x 40

PT = Polyamide tyres

Mobile on 2 wheels Ø 125 mm
Inside dimensions of drip tray: W: 1145 x D: 475 x H: 295 mm

Drum dispenser | with drip tray 203 l capacity

Article-no. + /Colour	Dimension W x D x H (mm)	Weight kg	Loading surface Drums	Load cap. kg	Wheel diam. mm
zu-3203 / AG PT	1505 x 715 x 670	68.5	200 l	250	125 x 40

PT = Polyamide tyres

ADDITIONAL ARTICLE 10 l drip tray

Article-no.	Dimension W x D x H (mm)	Weight kg	Volume l
zu-3150	460 x 350 x 150	2.5	10.0



RAL 5010 RAL 7016

Galvanised grating
Oil-tight welded
Optionally with outlet cock



CONSTRUCTION

- Welded steel oil-tight

FEATURES

- Galvanised grating, mesh size 30 x 30 mm
- Drip tray with capacity of 42.5 l

FITTINGS

- 2 **EasySTOP** swivel castors, 2 fixed castors
- Grey non-marking thermoplastic rubber tyres on plastic wheel rim with precision deepgroove ball bearings, with foot guard
- Available in 2 colours, RAL 5010 gentian blue or RAL 7016 anthracite grey, powder-coated

Push bar trolley | with drip tray

Article-no. + /Colour	Dimension W x D x H (mm)	Weight kg	Loading surface W x D (mm)	Load cap. kg	Wheel diam. mm
sw-600.121 / AG	1100 x 600 x 1010	37.0	990 x 590	250	125 x 30

DRIP TRAYS

RAL 5010 RAL 7016

FEATURES

- For 2 or 4 drums of 200 l capacity
- Ground clearance: 100 mm

FITTINGS

- 4 or 6 feet



Drip tray with grating | for 2 drums of 200 l capacity

Article-no. + /Colour	Dimension W x D x H (mm)	Weight kg	Loading surface W x D (mm)	Load cap. kg
aw-800.000 / AG	1200 x 800 x 360	69.0	1190 x 790	500

Handling of drums



For articles with steel-sheet pan and self-tipper



ADDITIONAL ARTICLE Outlet cock

Article-no.

zsw-000.500

As ex-factory equipment

Drip tray with grating | for 4 drums of 200 l capacity

Article-no. + /Colour	Dimension W x D x H (mm)	Weight kg	Loading surface W x D (mm)	Load cap. kg
aw-120.000 / AG	1200 x 1200 x 285	84.5	1190 x 1190	1000

Outlet cock is not included in scope of delivery



Drip tray with grating | for 4 drums of 200 l capacity

Article-no. + /Colour	Dimension W x D x H (mm)	Weight kg	Loading surface W x D (mm)	Load cap. kg
aw-800.002 / AG	2390 x 800 x 250	109.5	2380 x 790	1000

INDIVIDUALLY

- Opportunities for modification in line with customers' individual wishes

UNIQUE PIECE

- Deliveries of small series from one piece upwards
- Product approval drawings
- Fair prices even for small quantities

CUSTOMER FOCUSED

- Analysing parameters such as uses, handling, workflows and much more in close cooperation with the customer

TAILORED

- Products in special sizes, special colours and complete new designs

Our custom-made products in comparison



Customised for every application





For pallets or cage pallets
Incl. catching corners and fastening eyelets
EasySTOP



CONSTRUCTION

- Welded steel construction

FEATURES

- For pallets or cage pallets
- Incl. catching corners and fastening eyelets

FITTINGS

- 2 **EasySTOP** swivel castors, 2 fixed castors
- Grey non-marking thermoplastic rubber tyres on plastic wheel rim or polyamide tyres or elastic solid-rubber tyres on cast aluminium wheel rim with precision deepgroove ball bearings, black, wheels also available in grey or polyurethane tyres 92° Shore A, with foot guard
- Available in 2 colours, RAL 5010 gentian blue or RAL 7016 anthracite grey, powder-coated



Steel-frame dolly

Article-no. + /Colour	Dimension WxDxH (mm)	Weight kg	Loading surface WxD (mm)	Load cap. kg	Wheel diam. mm
sw-870.041 / AG	TR 870 x 670 x 350	25.0	810 x 610	500	200 x 40
sw-870.015 / AG	TR 1070 x 870 x 350	28.0	1010 x 810	500	200 x 40
sw-870.000 / AG	TR 1270 x 870 x 350	32.0	1210 x 810	500	200 x 40
sw-870.020 / AG	TR 1270 x 1070 x 350	32.5	1210 x 1010	500	200 x 40

TR = Thermoplastic rubber tyres



Steel-frame dolly

Article-no. + /Colour	Dimension WxDxH (mm)	Weight kg	Loading surface WxD (mm)	Load cap. kg	Wheel diam. mm
sw-870.441 / AG	PT 870 x 670 x 350	25.0	810 x 610	1050	200 x 50
sw-870.415 / AG	PT 1070 x 870 x 350	27.5	1010 x 810	1050	200 x 50
sw-870.400 / AG	PT 1270 x 870 x 350	31.5	1210 x 810	1050	200 x 50
sw-870.420 / AG	PT 1270 x 1070 x 350	32.5	1210 x 1010	1050	200 x 50

PT = Polyamide tyres



Steel-frame dolly

Article-no. + /Colour	Dimension WxDxH (mm)	Weight kg	Loading surface WxD (mm)	Load cap. kg	Wheel diam. mm
sw-870.042 / AG	ER 870 x 670 x 350	29.5	810 x 610	1200	200 x 50
sw-870.036 / AG	ER 1070 x 870 x 350	32.5	1010 x 810	1200	200 x 50
sw-870.001 / AG	ER 1270 x 870 x 350	35.5	1210 x 810	1200	200 x 50
sw-870.501 / AG	ER 1270 x 1070 x 350	37.5	1210 x 1010	1200	200 x 50

ER = Elastic solid-rubber tyres



Steel-frame dolly

Article-no. + /Colour	Dimension WxDxH (mm)	Weight kg	Loading surface WxD (mm)	Load cap. kg	Wheel diam. mm
sw-870.341 / AG	PO 870 x 670 x 350	39.0	810 x 610	1800	200 x 50
sw-870.315 / AG	PO 1070 x 870 x 350	44.0	1010 x 810	1800	200 x 50
sw-870.300 / AG	PO 1270 x 870 x 350	47.5	1210 x 810	1800	200 x 50
sw-870.514 / AG	PO 1270 x 1070 x 350	49.5	1210 x 1010	1800	200 x 50

PO = Polyurethane tyres

Handling of pallets



RAL 5010 RAL 7016

CONSTRUCTION

- Welded steel construction

FEATURES

- For pallets or cage pallets
- Incl. catching corners and fastening eyelets
- 4 galvanised connecting tubes for insert into edges
- Angle-steel-frame stackable on connecting tubes
- Variable removable

FITTINGS

- 2 **EasySTOP** swivel castors, 2 fixed castors
- Grey non-marking thermoplastic rubber tyres on plastic wheel rim with precision deepgroove ball bearings or elastic solid-rubber tyres on cast aluminium wheel rim with precision deepgroove ball bearings, black with foot guard, wheels also available in grey
- Available in 2 colours, RAL 5010 gentian blue or RAL 7016 anthracite grey, powder-coated

Angle-steel-frame variable removable
Incl. catching corners and fastening eyelets
EasySTOP

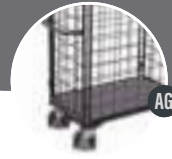

Steel-frame dolly with 2 angle-steel-frames

BEST SELLER



Article-no. + /Colour	Dimension WxDxH (mm)	Weight kg	Loading surface WxD (mm)	Load cap. kg	Wheel diam. mm
sw-870.113 / AG	TR 870 x 670 x 720	40.5	810 x 610	500	200 x 40
sw-870.114 / AG	TR 1070 x 870 x 720	44.0	1010 x 810	500	200 x 40
sw-870.100 / AG	TR 1270 x 870 x 720	48.0	1210 x 810	500	200 x 40
sw-870.506 / AG	TR 1270 x 1070 x 720	49.5	1210 x 1010	500	200 x 40

TR = Thermoplastic rubber tyres



Steel-frame dolly with 2 angle-steel-frames

BEST SELLER

Article-no. + /Colour	Dimension WxDxH (mm)	Weight kg	Loading surface WxD (mm)	Load cap. kg	Wheel diam. mm
sw-870.115 / AG	ER 870 x 670 x 720	45.0	810 x 610	1200	200 x 50
sw-870.116 / AG	ER 1070 x 870 x 720	48.5	1010 x 810	1200	200 x 50
sw-870.101 / AG	ER 1270 x 870 x 720	50.5	1210 x 810	1200	200 x 50
sw-870.507 / AG	ER 1270 x 1070 x 720	54.5	1210 x 1010	1200	200 x 50

ER = Elastic solid-rubber tyres



Handling of pallets

RAL 5010 RAL 7016

CONSTRUCTION

- Welded steel construction

FEATURES

- Incl. 4 catching corners and fastening eyelets
- Height adjustment by internal spring-loaded bolt
- Add-on frame can be bolted to dolly

FITTINGS

- Available in 2 colours, RAL 5010 gentian blue or RAL 7016 anthracite grey, powder-coated



ACCESSORIES | ADD-ON FRAME

Loading heights

- 1: 650 mm
- 2: 605 mm
- 3: 555 mm
- 4: 505 mm



Add-on frame

Article-no. + /Colour	Dimension WxDxH (mm)	Weight kg	Loading surface WxD (mm)	Load cap. kg
zsw-870.101 / AG	870 x 670	14.5	810 x 610	in accordance with the steel-frame dolly
zsw-870.102 / AG	1070 x 870	16.5	1010 x 810	
zsw-870.103 / AG	1270 x 870	17.0	1210 x 810	
zsw-870.104 / AG	1270 x 1070	17.5	1210 x 1010	



Suitable for **VARIOfit®** steel-frame dollies
 Lockable in in three basic positions
 Additional tilt lock on the handle



CONSTRUCTION

- Robust welded steel construction

FEATURES

- Incl. 4 catching corners and fastening eyelets
- Lockable in three basic positions
- Basic position: horizontal position as well as tipping position approx. 18° per side
- Additional tilt lock on the handle
- Handle at both ends with red dipping caps

- Centre of gravity of the loaded goods 450 mm
- Securing the tipping unit to the steel-frame dolly with linchpins

FITTINGS

- Available in 2 colours, RAL 5010 gentian blue or RAL 7016 anthracite grey, powder-coated



Handling of pallets



Additional tilt lock



Securing the tipping unit to the steel-frame dolly with linchpins



Release the basic position by pressing down the handle



The desired tilt position can be reached by swivelling the tipping unit and locked by releasing the handle



OPTI-MISED

Tipping unit | for steel-frame dollies

Article-no. + /Colour	Dimension W x D x H (mm)	Weight kg	Loading surface W x D (mm)	Load cap. kg
sw-810.014 / AG	1595 x 870 x 700	58,5	1210 x 810	*

*In accordance with the steel-frame dolly

RAL 5010 RAL 7016 GALVANISED

ADJUSTMENT

- Customise the steel-frame dollies according to your processes

CONFIGURATION OPTIONS

- Configure according to your wishes and requirements

Additional articles
Push bar variations
Drawbar and coupling

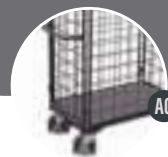

Universal for all sizes
Only for combined order with steel-frame dolly
(Sockets fixed welded, push bar screw)

ADDITIONAL ARTICLE Push bar for steel-frame dollies

Article-no. + /Colour	Dimension D x H (mm)	Weight kg
zsw-870.002 / AG	500 x 765	5.5



Universal for all sizes
Customised to your profile possible on request

ADDITIONAL ARTICLE Push bar with lever release for steel-frame dollies

Article-no. + /Colour	Dimension W x D x H (mm)	Weight kg
zsw-870.540 / AG	450 x 335 x 825	6.0



Maximum of 5 steel-frame dollies per tugger train
Maximum travel speed: 6 km/h
Maximum towing weight: 3.500 kg
Universal for all sizes
Only for combined order with steel-frame dolly (fixed welded)

ADDITIONAL ARTICLE Shaft and coupling for steel-frame dollies

Article-no. + /Colour	Dimension H (mm)	Weight kg
zsw-870.003 / AG	680	5.0

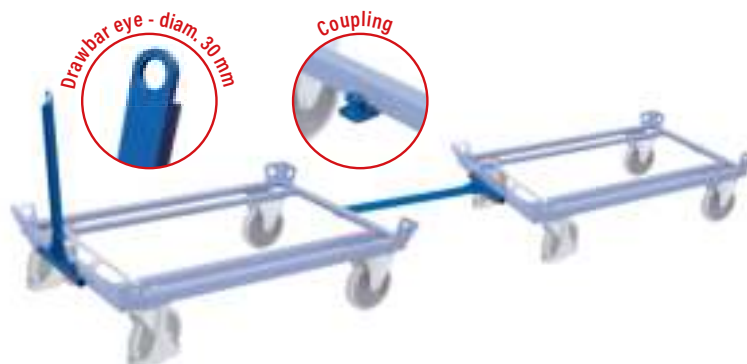

NEW

Maximum of 5 steel-frame dollies per tugger train
Maximum travel speed: 6 km/h
Maximum towing weight: 3.500 kg
Universal for all sizes
Only for combined order with steel-frame dolly (fixed welded)

ADDITIONAL ARTICLE Shaft with automatic brake solution and coupling

Article-no.	Dimension H (mm)	Weight kg
zsw-870.019	580	5.0



The brake is automatically released when the shaft is pushed down

All sides closed
 Optionally 1 side wall with fold-down upper half
 Can be folded to save space



Handling of pallets

CONSTRUCTION

- Welded steel construction

FEATURES

- Suitable for Euro and Industry pallets
- Stackable, but do not move when stacked
- Grilled, mesh size 100 x 100 mm

- Either all sides closed, or 1 side wall with fold-down upper half
- Optionally replaceable pallet converter separation grid

FITTINGS

- Available in 2 colours, RAL 5012 light blue or RAL 7016 anthracite grey, powder-coated

Pallet converter | Type 62

Article-no. + /Colour	Pallet dim. W x D (mm)	Fill height (mm)	Weight kg	Stacking	Support load kg
pa-080.020 / AG	1200 x 800	400	16.0	4	1500
pa-080.021 / AG	1200 x 800	600	19.0	4	1500
pa-100.015 / AG	*1200 x 1000	400	17.5	4	1500
pa-100.016 / AG	*1200 x 1000	600	20.5	4	1500

*ATTENTION: Industrial pallet dimensions, not suitable for Euro pallets

Pallet converter | Type 64

Article-no. + /Colour	Pallet dim. W x D (mm)	Fill height (mm)	Weight kg	Stacking	Support load kg
pa-080.027 / AG	1200 x 800	800	24.5	4	1000
pa-080.028 / AG	1200 x 800	1000	27.5	4	1000
pa-080.029 / AG	1200 x 800	1200	31.0	4	750
pa-080.030 / AG	1200 x 800	1600	40.0	3	750
pa-100.022 / AG	*1200 x 1000	800	26.0	4	1000
pa-100.023 / AG	*1200 x 1000	1000	29.0	4	1000
pa-100.024 / AG	*1200 x 1000	1200	32.5	4	750
pa-100.025 / AG	*1200 x 1000	1600	41.5	3	750

*ATTENTION: Industrial pallet dimensions, not suitable for Euro pallets

Mesh size 100 x 100 mm, only for Type 62 and 64

Pallet converter | separation grid

Article-no. + /Colour	Dimension W x H (mm)	Weight kg
zpa-080.055 / AG	750 x 400	2.9
zpa-080.056 / AG	750 x 600	3.8
zpa-100.014 / AG	950 x 400	3.9
zpa-100.015 / AG	950 x 600	4.6
zpa-080.051 / AG	750 x 800	4.2
zpa-080.052 / AG	750 x 1000	5.0
zpa-080.053 / AG	750 x 1200	5.8
zpa-080.054 / AG	750 x 1600	7.6
zpa-100.022 / AG	950 x 800	5.4
zpa-100.023 / AG	950 x 1000	5.8
zpa-100.024 / AG	950 x 1200	6.5
zpa-100.025 / AG	950 x 1600	8.8

Pallet converter | separation grid, sloping

Article-no. + /Colour	Dimension W x H (mm)	Weight kg
zpa-080.061 / AG	750 x 800/400	4.5
zpa-080.062 / AG	750 x 1000/500	5.2
zpa-080.063 / AG	750 x 1200/600	5.6
zpa-080.064 / AG	750 x 1600/800	7.7
zpa-100.010 / AG	950 x 800/400	5.5
zpa-100.011 / AG	950 x 1000/500	5.9
zpa-100.012 / AG	950 x 1200/600	6.6
zpa-100.013 / AG	950 x 1600/800	8.9

Mesh size 100 x 100 mm, only for Type 64



GALVA-
NISED

CONSTRUCTION

- Welded steel construction

FEATURES

- Suitable for Euro and Industry pallets
- Stackable, but do not move when stacked
- Grilled, mesh size 100 x 100 mm

- Either all sides closed, or 1 side wall with fold-down upper half
- Optionally replaceable pallet converter separation grid

FITTINGS

- Hot-galvanised

All sides closed
Optionally 1 side wall with fold-down upper half
Hot-galvanised

Pallet converter | Typ 62 | galvanised

Article-no.	Pallet dim. W x D (mm)	Fill height (mm)	Weight kg	Stacking	Support load kg
vpa-080.020	1200 x 800	400	16.0	4	1500
vpa-080.021	1200 x 800	600	19.0	4	1500
vpa-100.015	*1200 x 1000	400	17.5	4	1500
vpa-100.016	*1200 x 1000	600	20.5	4	1500

*ATTENTION: Industrial pallet dimensions, not suitable for Euro pallets

Pallet converter | Typ 64 | galvanised

Article-no.	Pallet dim. W x D (mm)	Fill height (mm)	Weight kg	Stacking	Support load kg
vpa-080.027	1200 x 800	800	24.5	4	1000
vpa-080.028	1200 x 800	1000	27.5	4	1000
vpa-080.029	1200 x 800	1200	31.0	4	750
vpa-080.030	1200 x 800	1600	40.0	3	750
vpa-100.022	*1200 x 1000	800	26.0	4	1000
vpa-100.023	*1200 x 1000	1000	29.0	4	1000
vpa-100.024	*1200 x 1000	1200	32.5	4	750
vpa-100.025	*1200 x 1000	1600	41.5	3	750

*ATTENTION: Industrial pallet dimensions, not suitable for Euro pallets

Mesh size 100 x 100 mm, only for Type 62 and 64

Pallet converter | separation grid | galvanised

Article-no.	Dimension W x H (mm)	Weight kg
zpa-080.155	750 x 400	3.1
zpa-080.156	750 x 600	3.8
zpa-100.114	950 x 400	3.9
zpa-100.115	950 x 600	4.6
zpa-080.151	750 x 800	4.4
zpa-080.152	750 x 1000	5.1
zpa-080.153	750 x 1200	5.8
zpa-080.154	750 x 1600	7.6
zpa-100.122	950 x 800	5.4
zpa-100.123	950 x 1000	5.8
zpa-100.124	950 x 1200	6.5
zpa-100.125	950 x 1600	8.8

Pallet converter | separation grid, sloping | galvanised

Article-no.	Dimension W x H (mm)	Weight kg
zpa-080.161	750 x 800/400	4.5
zpa-080.162	750 x 1000/500	5.2
zpa-080.163	750 x 1200/600	5.9
zpa-080.164	750 x 1600/800	7.7
zpa-100.110	950 x 800/400	5.5
zpa-100.111	950 x 1000/500	5.9
zpa-100.112	950 x 1200/600	6.6
zpa-100.113	950 x 1600/800	8.9



Mesh size 100 x 100 mm, only for Type 64



V-cutout
Stackable
Can be folded to save space



AG



CONSTRUCTION

- Welded steel construction

FEATURES

- Suitable for Euro and Industry pallets
- Stackable, but do not move when stacked
- Grilled, mesh size 100 x 100 mm
- 1 side wall with V-cutout

FITTINGS

- Available in 2 colours, RAL 5012 light blue or RAL 7016 anthracite grey, powder-coated

Pallet converter | Type 63

Article-no. + /Colour	Pallet dim. W x D (mm)	Fill height (mm)	Weight kg	Stacking	Support load kg
pa-080.023 / AG	1200 x 800	800	22.5	3	1000
pa-080.024 / AG	1200 x 800	1000	26.0	3	1000
pa-080.025 / AG	1200 x 800	1200	29.0	3	750
pa-080.026 / AG	1200 x 800	1600	37.0	3	750
pa-100.018 / AG	*1200 x 1000	800	23.5	3	1000
pa-100.019 / AG	*1200 x 1000	1000	27.0	3	1000
pa-100.020 / AG	*1200 x 1000	1200	30.5	3	750
pa-100.021 / AG	*1200 x 1000	1600	43.5	3	750

*ATTENTION: Industrial pallet dimensions, not suitable for Euro pallets



Handling of pallets

PALLET CONVERTER TYPE 65

Can be folded to save space
Access to stored goods from all sides

FEATURES

- All sides open, the stored goods can be accessed from all sides
- Stabilised by hooking together 2 horizontal frames at top

FITTINGS

- Available in 2 colours, RAL 5012 light blue or RAL 7016 anthracite grey, powder-coated

Pallet converter | Type 65

Article-no. + /Colour	Pallet dim. W x D (mm)	Fill height (mm)	Weight kg	Stacking	Support load kg
pa-080.005 / AG	1200 x 800	800	22.0	3	1500
pa-080.006 / AG	1200 x 800	1000	24.0	3	1500
pa-080.007 / AG	1200 x 800	1200	27.5	3	750
pa-080.008 / AG	1200 x 800	1600	31.5	3	750
pa-100.000 / AG	*1200 x 1000	800	25.5	3	1500
pa-100.001 / AG	*1200 x 1000	1000	27.5	3	1500
pa-100.002 / AG	*1200 x 1000	1200	29.5	3	750
pa-100.003 / AG	*1200 x 1000	1600	33.5	3	750

*ATTENTION: Industrial pallet dimensions, not suitable for Euro pallets



GALVA-NISED

CONSTRUCTION

- Welded steel construction

FEATURES

- Suitable for Euro and Industry pallets
- Stackable, but do not move when stacked
- Grilled, mesh size 100 x 100 mm
- 1 side wall with V-cutout

FITTINGS

- Hot-galvanised

V-cutout
Stackable
Hot-galvanised

Pallet converter | Type 63 | galvanised

Article-no.	Pallet dim. W x D (mm)	Fill height (mm)	Weight kg	Stacking	Support load kg
vpa-080.023	1200 x 800	800	22.5	3	1000
vpa-080.024	1200 x 800	1000	26.0	3	1000
vpa-080.025	1200 x 800	1200	29.0	3	750
vpa-080.026	1200 x 800	1600	37.0	3	750
vpa-100.018	*1200 x 1000	800	23.5	3	1000
vpa-100.019	*1200 x 1000	1000	27.0	3	1000
vpa-100.020	*1200 x 1000	1200	30.5	3	750
vpa-100.021	*1200 x 1000	1600	43.5	3	750

*ATTENTION: Industrial pallet dimensions, not suitable for Euro pallets



GALVA-NISED

PALLET CONVERTER TYPE 65, GALVANISED

FEATURES

- All sides open, the stored goods can be accessed from all sides
- Stabilised by hooking together 2 horizontal frames at top

FITTINGS

- Hot-galvanised

Can be folded to save space
Access to stored goods
from all sides

Pallet converter | Type 65 | galvanised

Article-no.	Pallet dim. W x D (mm)	Fill height (mm)	Weight kg	Stacking	Support load kg
vpa-080.005	1200 x 800	800	22.0	3	1500
vpa-080.006	1200 x 800	1000	24.0	3	1500
vpa-080.007	1200 x 800	1200	27.5	3	750
vpa-080.008	1200 x 800	1600	31.5	3	750
vpa-100.000	*1200 x 1000	800	25.5	3	1500
vpa-100.101	*1200 x 1000	1000	27.5	3	1500
vpa-100.002	*1200 x 1000	1200	29.5	3	750
vpa-100.003	*1200 x 1000	1600	33.5	3	750

*ATTENTION: Industrial pallet dimensions, not suitable for Euro pallets



Handling of pallets

With clamping function
For subsequent fitting on a loaded pallet



AG

CONSTRUCTION

- Welded steel construction

FEATURES

- Suitable for Euro and Industry pallets
- Stackable, but do not move when stacked
- For subsequent fitting on a loaded pallet

- Frame parts secured by manual clamping function
- Stabilised by hooking together 2 horizontal frames at top

FITTINGS

- Available in 2 colours, RAL 5012 light blue or RAL 7016 anthracite grey, powder-coated



Pallet converter | Type 65K

Article-no. + /Colour	Pallet dim. W x D (mm)	Fill height (mm)	Weight kg	Stacking	Support load kg
pa-080.300 / AG	1200 x 800	800	26.5	3	1500
pa-080.301 / AG	1200 x 800	1000	30.0	3	1500
pa-080.302 / AG	1200 x 800	1200	32.5	3	750
pa-080.303 / AG	1200 x 800	1600	34.5	3	750
pa-100.304 / AG	*1200 x 1000	800	29.0	3	1500
pa-100.305 / AG	*1200 x 1000	1000	31.0	3	1500
pa-100.306 / AG	*1200 x 1000	1200	32.5	3	750
pa-100.307 / AG	*1200 x 1000	1600	36.5	3	750

*ATTENTION: Industrial pallet dimensions, not suitable for Euro pallets



Handling of pallets

PALLET CONVERTER TYPE 66

End walls with vertical tubular bars
Side walls open
Stabilising tube

FEATURES

- End walls are fitted with vertical tubular bars
- Side walls open
- Incl. connecting tube for stabilising the frame

FITTINGS

- Available in 2 colours, RAL 5012 light blue or RAL 7016 anthracite grey, powder-coated

Pallet converter | Type 66

Article-no. + /Colour	Pallet dim. W x D (mm)	Fill height (mm)	Weight kg	Stacking	Support load kg
pa-080.009 / AG	1200 x 800	800	26.5	4	500
pa-080.010 / AG	1200 x 800	1000	29.0	3	500
pa-080.011 / AG	1200 x 800	1200	31.5	3	300
pa-100.004 / AG	*1200 x 1000	800	29.0	4	500
pa-100.005 / AG	*1200 x 1000	1000	31.0	3	500
pa-100.006 / AG	*1200 x 1000	1200	36.5	3	300

*ATTENTION: Industrial pallet dimensions, not suitable for Euro pallets



GALVA-NISED

CONSTRUCTION

- Welded steel construction

FEATURES

- Suitable for Euro and Industry pallets
- Stackable, but do not move when stacked
- For subsequent fitting on a loaded pallet

- Frame parts secured by manual clamping function
- Stabilised by hooking together 2 horizontal frames at top

FITTINGS

- Hot-galvanised

With clamping function
For subsequent fitting on a loaded pallet
Hot-galvanised

Pallet converter | Type 65K | galvanised

Article-no.	Pallet dim. W x D (mm)	Fill height (mm)	Weight kg	Stacking	Support load kg
vpa-080.300	1200 x 800	800	26.5	3	1500
vpa-080.301	1200 x 800	1000	30.0	3	1500
vpa-080.302	1200 x 800	1200	32.5	3	750
vpa-080.303	1200 x 800	1600	34.5	3	750
vpa-100.304	*1200 x 1000	800	29.0	3	1500
vpa-100.305	*1200 x 1000	1000	31.0	3	1500
vpa-100.306	*1200 x 1000	1200	32.5	3	750
vpa-100.307	*1200 x 1000	1600	36.5	3	750

*ATTENTION: Industrial pallet dimensions, not suitable for Euro pallets



GALVA-NISED

PALLET CONVERTER TYPE 66, GALVANISED

FEATURES

- End walls are fitted with vertical tubular bars
- Side walls open
- Incl. connecting tube for stabilising the frame

FITTINGS

- Hot-galvanised

End walls with vertical tubular bars
Side walls open
Stabilising tube
Hot-galvanised

Pallet converter | Type 66 | galvanised

Article-no.	Pallet dim. W x D (mm)	Fill height (mm)	Weight kg	Stacking	Support load kg
vpa-080.009	1200 x 800	800	26.5	4	500
vpa-080.010	1200 x 800	1000	29.0	3	500
vpa-080.011	1200 x 800	1200	31.5	3	300
vpa-100.004	*1200 x 1000	800	29.0	4	500
vpa-100.005	*1200 x 1000	1000	31.0	3	500
vpa-100.006	*1200 x 1000	1200	36.5	3	300

*ATTENTION: Industrial pallet dimensions, not suitable for Euro pallets



Handling of pallets

All 4 sides with diagonal tubes
For subsequent fitting on a loaded pallet



CONSTRUCTION

- Welded steel construction

FEATURES

- Suitable for Euro and Industry pallets
- Stackable, but do not move when stacked
- All 4 sides with diagonal tubes running from bottom corners to meet at top centre

- For subsequent fitting on a loaded pallet

FITTINGS

- Available in 2 colours, RAL 5012 light blue or RAL 7016 anthracite grey, powder-coated

Pallet converter | Type 68

Article-no. + /Colour	Pallet dim. W x D (mm)	Fill height (mm)	Weight kg	Stacking	Support load kg
pa-080.012 / AG	1200 x 800	800	37.5	3	2000
pa-080.013 / AG	1200 x 800	1000	40.5	3	2000
pa-080.014 / AG	1200 x 800	1200	44.0	3	2000
pa-080.015 / AG	1200 x 800	1600	51.5	3	2000
pa-100.007 / AG	*1200 x 1000	800	39.0	3	2000
pa-100.008 / AG	*1200 x 1000	1000	41.0	3	2000
pa-100.009 / AG	*1200 x 1000	1200	45.0	3	2000
pa-100.010 / AG	*1200 x 1000	1600	53.0	3	2000

*ATTENTION: Industrial pallet dimensions, not suitable for Euro pallets



Handling of pallets

PALLET CONVERTER TYPE 75

Side walls with 4 vertical tubular bars
End walls open

FEATURES

- Side walls with 4 vertical tubular bars
- End walls open

FITTINGS

- Available in 2 colours, RAL 5012 light blue or RAL 7016 anthracite grey, powder-coated

Pallet converter | Type 75

Article-no. + /Colour	Pallet dim. W x D (mm)	Fill height (mm)	Weight kg	Stacking	Support load kg
pa-080.016 / AG	1200 x 800	755	29.0	4	2000
pa-080.017 / AG	1200 x 800	955	31.5	4	2000
pa-080.018 / AG	1200 x 800	1155	34.0	3	1000
pa-080.019 / AG	1200 x 800	1555	39.0	3	1000
pa-100.011 / AG	*1200 x 1000	755	30.5	4	1000
pa-100.012 / AG	*1200 x 1000	955	33.0	4	1000
pa-100.013 / AG	*1200 x 1000	1155	36.0	3	500
pa-100.014 / AG	*1200 x 1000	1555	41.0	3	500

*ATTENTION: Industrial pallet dimensions, not suitable for Euro pallets



GALVA-
NISED

CONSTRUCTION

- Welded steel construction

FEATURES

- Suitable for Euro and Industry pallets
- Stackable, but do not move when stacked

- All 4 sides with diagonal tubes running from bottom corners to meet at top centre
- For subsequent fitting on a loaded pallet

FITTINGS

- Hot-galvanised

All 4 sides with diagonal tubes
For subsequent fitting on a loaded pallet
Hot-galvanised

Pallet converter | Type 68 | galvanised

Article-no.	Pallet dim. W x D (mm)	Fill height (mm)	Weight kg	Stacking	Support load kg
vpa-080.012	1200 x 800	800	37.5	3	2000
vpa-080.013	1200 x 800	1000	40.5	3	2000
vpa-080.014	1200 x 800	1200	44.0	3	2000
vpa-080.015	1200 x 800	1600	51.5	3	2000
vpa-100.007	*1200 x 1000	800	39.0	3	2000
vpa-100.008	*1200 x 1000	1000	41.0	3	2000
vpa-100.009	*1200 x 1000	1200	45.0	3	2000
vpa-100.010	*1200 x 1000	1600	53.0	3	2000

*ATTENTION: Industrial pallet dimensions, not suitable for Euro pallets



GALVA-
NISED

FEATURES

- Side walls with 4 vertical tubular bars
- End walls open

FITTINGS

- Hot-galvanised

PALLET CONVERTER TYPE 75, GALVANISED

Side walls with 4 vertical tubular bars
End walls open
Hot-galvanised

Pallet converter | Type 75 | galvanised

Article-no.	Pallet dim. W x D (mm)	Fill height (mm)	Weight kg	Stacking	Support load kg
vpa-080.016	1200 x 800	755	29.0	4	2000
vpa-080.017	1200 x 800	955	31.5	4	2000
vpa-080.018	1200 x 800	1155	34.0	3	1000
vpa-080.019	1200 x 800	1555	39.0	3	1000
vpa-100.011	*1200 x 1000	755	30.5	4	1000
vpa-100.012	*1200 x 1000	955	33.0	4	1000
vpa-100.013	*1200 x 1000	1155	36.0	3	500
vpa-100.014	*1200 x 1000	1555	41.0	3	500

*ATTENTION: Industrial pallet dimensions, not suitable for Euro pallets



Available in 2 colours
Plastic handles and stand
Reflective films



CONSTRUCTION

- Welded steel construction

FEATURES

- Reflective films
- Screwed hand drawbar with plastic handles and stand
- Load surface and optionally side walls of waterproof bonded plywood, surface finish screen printed, anti-slip

FITTINGS

- Pneumatic or solid-rubber tyres on steel wheel rim (solid-rubber tyres with diam. 260 x 65 mm on special plastic wheel rim) with precision deepgroove ball bearings
- Available in 2 colours, RAL 5010 gentian blue or RAL 7016 anthracite grey, powder-coated



Hand truck | without side walls

Article-no. + /Colour	Dimension W x D x H (mm)	Weight kg	Loading surface W x D (mm)	Load cap. kg	Wheel diam. mm
zu-1290 / AG	P 1560 x 685 x 780	19.0	785 x 435	200	260 x 85
zu-1291 / AG	P 1600 x 810 x 860	25.5	825 x 535	400	400 x 100
zu-1292 / AG	P 1900 x 810 x 860	28.5	1125 x 535	400	400 x 100
zu-1278 / AG	P 1770 x 910 x 860	30.0	1000 x 635	400	400 x 100

P = Pneumatic tyres



Hand truck | without side walls

Article-no. + /Colour	Dimension W x D x H (mm)	Weight kg	Loading surface W x D (mm)	Load cap. kg	Wheel diam. mm
zu-1276 / AG	SR 1560 x 645 x 780	21.0	785 x 435	200	260 x 65
zu-1277 / AG	SR 1600 x 770 x 860	38.0	825 x 535	400	400 x 80
zu-1263 / AG	SR 1900 x 770 x 860	41.5	1125 x 535	400	400 x 80
zu-1264 / AG	SR 1770 x 870 x 860	43.0	1000 x 635	400	400 x 80

SR = Solid-rubber tyres

Trailers



Hand truck | with side walls

Article-no. + /Colour	Dimension W x D x H (mm)	Weight kg	Loading surface W x D (mm)	Load cap. kg	Wheel diam. mm
zu-1280 / AG	P 1560 x 685 x 780	22.0	765 x 435	200	260 x 85
zu-1281 / AG	P 1600 x 810 x 860	28.0	805 x 535	400	400 x 100
zu-1282 / AG	P 1900 x 810 x 860	32.5	1105 x 535	400	400 x 100
zu-1279 / AG	P 1770 x 910 x 860	33.5	975 x 635	400	400 x 100

P = Pneumatic tyres



Hand truck | with side walls

Article-no. + /Colour	Dimension W x D x H (mm)	Weight kg	Loading surface W x D (mm)	Load cap. kg	Wheel diam. mm
zu-1284 / AG	SR 1560 x 645 x 780	24.0	765 x 435	200	260 x 65
zu-1283 / AG	SR 1600 x 770 x 860	41.0	805 x 535	400	400 x 80
zu-1285 / AG	SR 1900 x 770 x 860	45.5	1105 x 535	400	400 x 80
zu-1272 / AG	SR 1770 x 870 x 860	47.0	975 x 635	400	400 x 80

SR = Solid-rubber tyres

RAL 5010 RAL 7016

CONSTRUCTION

- Welded steel construction

FEATURES

- Reflective films
- Railing 220 mm high
- Screwed hand drawbar with plastic handles and stand
- Load surface and optionally side walls of waterproof bonded plywood, surface finish screen printed, anti-slip

FITTINGS

- Pneumatic tyres on plastic wheel rim with precision deepgroove ball bearings
- Available in 2 colours, RAL 5010 gentian blue or RAL 7016 anthracite grey, powder-coated

Available in 2 colours
Plastic handles and stand
Reflective films



Lightweight hand truck

Article-no. + /Colour	Dimension W x D x H (mm)	Weight kg	Loading surface W x D (mm)	Load cap. kg	Wheel diam. mm
zu-1181 / AG	P 1575 x 625 x 765	16.0	690 x 425	150	310 x 55

P = Pneumatic tyres

RAL 5010 RAL 7016

CONSTRUCTION

- Welded steel construction

FEATURES

- Pull bar with horizontal handle, screwed (mountable on the right or left side)

FITTINGS

- Pneumatic tyres on steel wheel rim with precision deepgroove ball bearings
- Available in 2 colours, RAL 5010 gentian blue or RAL 7016 anthracite grey, powder-coated

Pull bar with horizontal handle
Mountable on the right or left side

Roll truck

Article-no. + /Colour	Dimension W x D x H (mm)	Weight kg	Loading surface W x D (mm)	Load cap. kg	Wheel diam. mm
sk-1310 / AG	P 2700 x 865 x 840	32.0	1590 x 575	400	400 x 100

P = Pneumatic tyres



RAL 5010 RAL 7016

CONSTRUCTION

- Welded steel construction
- Demountable version

FEATURES

- Galvanised loading bar for rolls
- Width adjustable increments of 120 mm

- Height adjustable increments of 100 mm

FITTINGS

- 4 feet
- Available in 2 colours, RAL 5010 gentian blue or RAL 7016 anthracite grey, powder-coated

ROLL STAND

Roll stand

Article-no. + /Colour	Dimension W x D x H (mm)	Weight kg	Load cap. kg
sg-100.030 / AG	1340-2060 x 1005 x 920-1120	20.5	100



Bolted drawbar
Bicycle trailer coupling with adapter
Reflective films



CONSTRUCTION

- Welded steel construction

FEATURES

- Reflective films
- Bolted drawbar with welded-on hemispherical shell and plastic handles
- Bicycle trailer coupling is supplied loose for self-assembly on the bicycle frame
- Universal fitting with adaptor for saddle tubes for 26 - 31 mm diameter

- Maximum load: 40 kg, lean load: 4 kg
- Load surface and optionally side walls of waterproof bonded plywood, surface finish screen printed, anti-slip

FITTINGS

- Pneumatic tyres on steel wheel rim with precision deepgroove ball bearings
- Available in 2 colours, RAL 5010 gentian blue or RAL 7016 anthracite grey, powder-coated

Only for internal material-transport

Bicycle trailer | without side walls

Article-no. + /Colour	Dimension W x D x H (mm)	Weight kg	Loading surface W x D (mm)	Load cap. kg	Wheel diam. mm
zu-1380 / AG	P 1795 x 685 x 735	20.0	785 x 435	200	260 x 85
zu-1381 / AG	P 1835 x 810 x 810	24.0	825 x 535	400	400 x 100
zu-1382 / AG	P 2135 x 810 x 810	28.5	1125 x 535	400	400 x 100

P = Pneumatic tyres

Only for internal material-transport

Bicycle trailer | with side walls

Article-no. + /Colour	Dimension W x D x H (mm)	Weight kg	Loading surface W x D (mm)	Load cap. kg	Wheel diam. mm
zu-1390 / AG	P 1795 x 685 x 735	23.0	765 x 435	200	260 x 85
zu-1391 / AG	P 1835 x 810 x 810	29.5	805 x 535	400	400 x 100
zu-1392 / AG	P 2135 x 810 x 810	34.0	1105 x 535	400	400 x 100

P = Pneumatic tyres

LIGHTWEIGHT BICYCLE TRAILER

Trailers

CONSTRUCTION

- Welded steel construction

FEATURES

- Reflective films
- Railing 220 mm high
- Bolted drawbar with welded-on hemispherical shell
- Bicycle trailer coupling is supplied loose for self-assembly on the bicycle frame

- Universal fitting with adaptor for saddle tubes for 26 - 31 mm diameter
- Load surface and side walls of waterproof bonded plywood, surface finish screen printed, anti-slip

FITTINGS

- Pneumatic tyres on steel wheel rim with precision deepgroove ball bearings
- Available in 2 colours, RAL 5010 gentian blue or RAL 7016 anthracite grey, powder-coated



Lightweight bicycle trailer

Article-no. + /Colour	Dimension W x D x H (mm)	Weight kg	Loading surface W x D (mm)	Load cap. kg	Wheel diam. mm
zu-1180 / AG	P 1595 x 625 x 765	16.0	690 x 425	150	310 x 55

P = Pneumatic tyres

RAL 5010 RAL 7016

CONSTRUCTION

- Welded steel construction

FEATURES

- Reflective films
- Optionally side walls with fastener
- 3 sides foldable, height of side wall: 210 mm
- Safety handle of drawbar with soft plastic grip cover black
- Automatic driving and parking brake, acting on the front wheels in two drawbar positions, control of the braking effect even on downgrade

- Automatically damped return to rest position
- Load surface and optionally side walls of water-proof bonded plywood, surface finish screen printed, anti-slip

FITTINGS

- Pneumatic or solid-rubber tyres on steel wheel rim (solid-rubber tyres with diam. 260 x 65 mm on special plastic wheel rim) with precision deepgroove ball bearings
- Available in 2 colours, RAL 5010 gentian blue or RAL 7016 anthracite grey, powder-coated

Automatic driving and parking brake
Optionally foldable side walls
Reflective films



Hand platform trolley | without side walls

Article-no. + /Colour	Dimension W x D x H (mm)	Weight kg	Loading surface W x D (mm)	Load cap. kg	Wheel diam. mm
zu-05102 / AG	P 1120 x 700 x 1200	47.5	1000 x 700	700	260 x 85
zu-05101 / AG	SR 1120 x 700 x 1200	51.0	1000 x 700	700	260 x 65
zu-05122 / AG	P 1320 x 800 x 1200	53.0	1200 x 800	700	260 x 85
zu-05121 / AG	SR 1320 x 800 x 1200	57.0	1200 x 800	700	260 x 65

P = Pneumatic tyres, SR = Solid-rubber tyres



Hand platform trolley | without side walls

Article-no. + /Colour	Dimension W x D x H (mm)	Weight kg	Loading surface W x D (mm)	Load cap. kg	Wheel diam. mm
zu-05132 / AG	P 1265 x 800 x 1340	62.0	1200 x 800	1000	400 x 100
zu-05131 / AG	SR 1265 x 800 x 1340	88.5	1200 x 800	1000	400 x 80
zu-05162 / AG	P 1665 x 800 x 1340	68.5	1600 x 800	1000	400 x 100
zu-05161 / AG	SR 1665 x 800 x 1340	95.0	1600 x 800	1000	400 x 80
zu-05202 / AG	P 2065 x 1000 x 1340	84.0	2000 x 1000	1000	400 x 100
zu-05201 / AG	SR 2065 x 1000 x 1340	110.0	2000 x 1000	1250	400 x 80

P = Pneumatic tyres, SR = Solid-rubber tyres



Hand platform trolley | with side walls

Article-no. + /Colour	Dimension W x D x H (mm)	Weight kg	Loading surface W x D (mm)	Load cap. kg	Wheel diam. mm
zu-15102 / AG	P 1135 x 730 x 1200	68.5	985 x 680	700	260 x 85
zu-15101 / AG	SR 1135 x 730 x 1200	72.5	985 x 680	700	260 x 65
zu-15122 / AG	P 1335 x 830 x 1200	76.0	1185 x 780	700	260 x 85
zu-15121 / AG	SR 1335 x 830 x 1200	79.5	1185 x 780	700	260 x 65

P = Pneumatic tyres, SR = Solid-rubber tyres



Trailers

Hand platform trolley | with side walls

Article-no. + /Colour	Dimension W x D x H (mm)	Weight kg	Loading surface W x D (mm)	Load cap. kg	Wheel diam. mm
zu-15132 / AG	P 1280 x 830 x 1340	85.0	1185 x 780	1000	400 x 100
zu-15131 / AG	SR 1280 x 830 x 1340	111.0	1185 x 780	1000	400 x 80
zu-15162 / AG	P 1680 x 830 x 1340	93.5	1585 x 780	1000	400 x 100
zu-15161 / AG	SR 1680 x 830 x 1340	120.0	1585 x 780	1000	400 x 80
zu-15202 / AG	P 2080 x 1030 x 1340	112.0	1985 x 980	1000	400 x 100
zu-15201 / AG	SR 2080 x 1030 x 1340	138.5	1985 x 980	1250	400 x 80

P = Pneumatic tyres, SR = Solid-rubber tyres



Automatic driving and parking brakes
Removable walls of tubular grid
Reflective films



AG

CONSTRUCTION

- Welded steel construction

FEATURES

- Reflective films
- Removable side walls of tubular grid
- End walls screwed, side walls suspended
- Height of tubular grid walls: 755 mm
- Safety handle of drawbar with soft plastic grip cover black
- Automatic driving and parking brake, acting on the front wheels in two drawbar positions, control of the braking effect even on downgrade

- Automatically damped return to rest position
- Load surface of waterproof bonded plywood, surface finish screen printed, anti-slip

FITTINGS

- Pneumatic or solid-rubber tyres on steel wheel rim (solid-rubber tyres with diam. 260 x 65 mm on special plastic wheel rim) with precision deepgroove ball bearings
- Available in 2 colours, RAL 5010 gentian blue or RAL 7016 anthracite grey, powder-coated



Hand platform trolley | with 2 tubular grid side walls

Article-no. + /Colour	Dimension W x D x H (mm)	Weight kg	Loading surface W x D (mm)	Load cap. kg	Wheel diam. mm
zu-42120 / AG	P 1120 x 715 x 1200	61.0	940 x 700	700	260 x 85
zu-42119 / AG	SR 1120 x 715 x 1200	65.0	940 x 700	700	260 x 65
zu-42122 / AG	P 1320 x 815 x 1200	67.5	1140 x 800	700	260 x 85
zu-42121 / AG	SR 1320 x 815 x 1200	71.0	1140 x 800	700	260 x 65

P = Pneumatic tyres, SR = Solid-rubber tyres



Hand platform trolley | with 2 tubular grid side walls

Article-no. + /Colour	Dimension W x D x H (mm)	Weight kg	Loading surface W x D (mm)	Load cap. kg	Wheel diam. mm
zu-42132 / AG	P 1265 x 815 x 1340	76.5	1140 x 800	1000	400 x 100
zu-42131 / AG	SR 1265 x 815 x 1340	103.0	1140 x 800	1000	400 x 80
zu-42162 / AG	P 1665 x 815 x 1340	83.0	1540 x 800	1000	400 x 100
zu-42161 / AG	SR 1665 x 815 x 1340	109.5	1540 x 800	1000	400 x 80
zu-42202 / AG	P 2065 x 1015 x 1340	99.5	1940 x 1000	1000	400 x 100
zu-42201 / AG	SR 2065 x 1015 x 1340	126.0	1940 x 1000	1250	400 x 80

P = Pneumatic tyres, SR = Solid-rubber tyres



Hand platform trolley | with 4 tubular grid side walls

Article-no. + /Colour	Dimension W x D x H (mm)	Weight kg	Loading surface W x D (mm)	Load cap. kg	Wheel diam. mm
zu-45102 / AG	P 1120 x 715 x 1200	74.0	940 x 640	700	260 x 85
zu-45101 / AG	SR 1120 x 715 x 1200	78.0	940 x 640	700	260 x 65
zu-45122 / AG	P 1320 x 815 x 1200	82.0	1140 x 740	700	260 x 85
zu-45121 / AG	SR 1320 x 815 x 1200	86.0	1140 x 740	700	260 x 65

P = Pneumatic tyres, SR = Solid-rubber tyres



Hand platform trolley | with 4 tubular grid side walls

Article-no. + /Colour	Dimension W x D x H (mm)	Weight kg	Loading surface W x D (mm)	Load cap. kg	Wheel diam. mm
zu-45132 / AG	P 1265 x 815 x 1340	91.0	1140 x 740	1000	400 x 100
zu-45131 / AG	SR 1265 x 815 x 1340	117.5	1140 x 740	1000	400 x 80
zu-45162 / AG	P 1665 x 815 x 1340	103.0	1540 x 740	1000	400 x 100
zu-45161 / AG	SR 1665 x 815 x 1340	129.5	1540 x 740	1000	400 x 80
zu-45202 / AG	P 2065 x 1015 x 1340	123.0	1940 x 940	1000	400 x 100
zu-45201 / AG	SR 2065 x 1015 x 1340	149.0	1940 x 940	1250	400 x 80

P = Pneumatic tyres, SR = Solid-rubber tyres

RAL 5010 RAL 7016

QUALITY CHARACTERISTICS

- Automatic driving and parking brake, acting on the front wheels in two drawbar positions
- Control the braking effect even on downgrade
- Automatically damped return to rest position
- Braking point and braking effect manually adjustable
- Big fastener
- Red and white reflective films
- Can be extended with a drawbar eye and/or coupling

Quality characteristics

Additional articles

Drawbar eye on the drawbar

Coupling

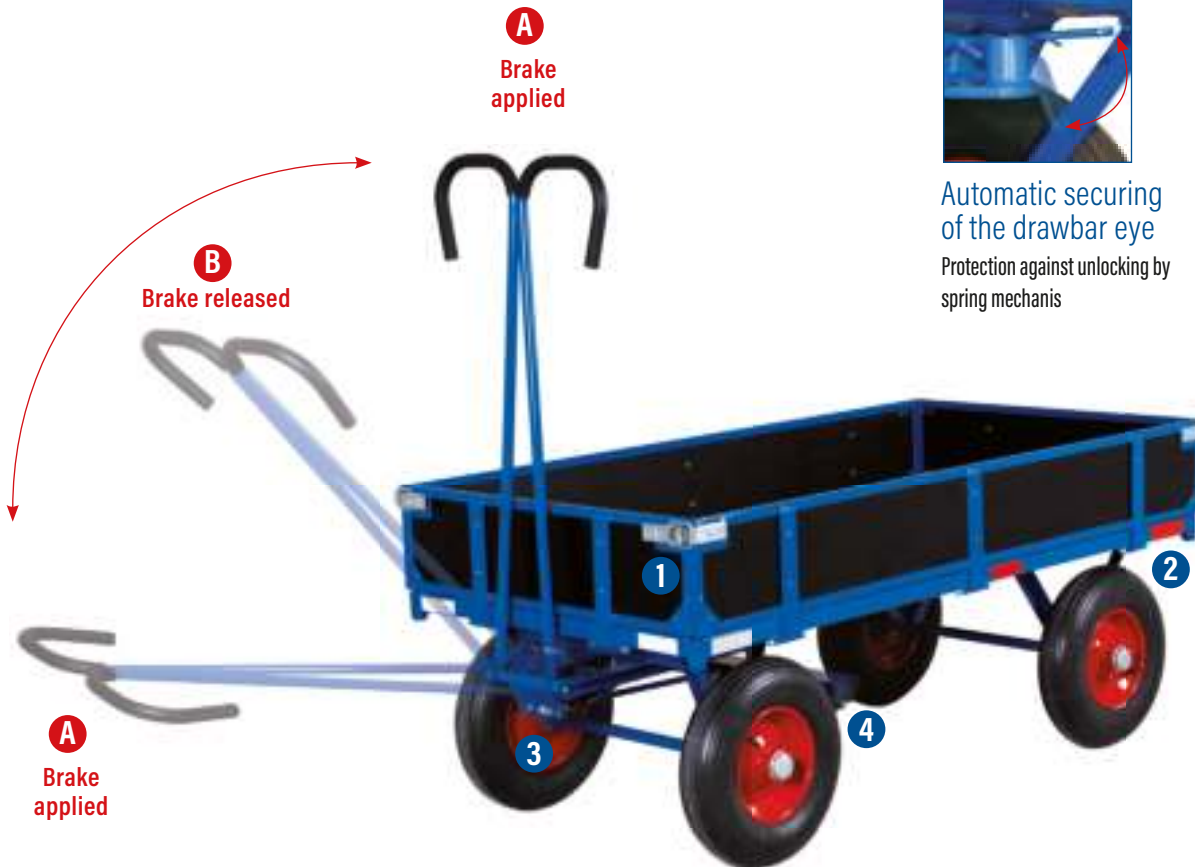

Automatic securing of the drawbar eye

Protection against unlocking by spring mechanism



Drawbar eye and/or coupling

All hand platform trolleys are optionally expandable, with the possibility to move the hand platform trolleys with the help of a towing vehicle, either individually or in a train formation



1 Big fastener

For easy and secure closing of the side walls



2 Reflective films

In red and white for your safety especially in the dark



3 Braking point/Braking effect

Manually adjustable

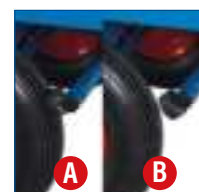

4 Brake position

A = Brake applied
B = Brake released

ADDITIONAL ARTICLE for hand platform trolleys

Article-no.+/Colour

01-1030 / AG

Drawbar eye on drawbar

01-1031 / AG

Coupling at the end

As ex-factory equipment



RAL 5010 RAL 7016

Without safety catch
Suitable for two-
wheeled platforms with
a load capacity of 500 kg



CONSTRUCTION

- With ball head of diameter 48 mm

FEATURES

- Ball without safety catch
- 2 plastic handles
- Suitable for two-wheeled platforms with a load capacity of 500 kg

FITTINGS

- Grey non-marking thermoplastic rubber tyres on plastic wheel rim with precision deepgroove ball bearings
- Available in 2 colours, RAL 5010 gentian blue or RAL 7016 anthracite grey, powder-coated

Quick-lift jack

Article-no. + /Colour	Dimension W x D x H (mm)	Weight kg	For two-wheeled platforms with load cap. kg	Wheel diam. mm
zu-1100 / AG	TR 400 x 270 x 1205	7.0	500	200 x 40

TR = Thermoplastic rubber tyres

TWO-WHEELED PLATFORMS

RAL 5010 RAL 7016

4-times stackable when
unloaded
Ball socket without safety catch

CONSTRUCTION

- Welded steel construction

FEATURES

- 2 support runners
- Ball socket without safety catch
- Load surface and optionally walls of wood-based board, surface finish beech or coated dark grey
- Walls permanently screwed, usable height: 315 mm
- Optionally with stacking corners and locating cups

FITTINGS

- 4-times stackable when unloaded, stacking height: 590 mm
- 2 fixed castors, 2 stands
- Grey non-marking thermoplastic rubber tyres on plastic wheel rim with precision deepgroove ball bearings
- Available in 2 colours, RAL 5010 gentian blue or RAL 7016 anthracite grey, powder-coated



Two-wheeled platform

Article-no. + /Colour	Dimension W x D x H (mm)	Weight kg	Loading surface W x D (mm)	Load cap. kg	Wheel diam. mm
zu-1109 / AG	905 x 495 x 285	28.5	895 x 495	500	200 x 40
zu-1110 / AG	1005 x 695 x 285	36.0	995 x 695	500	200 x 40
zu-1112 / AG	1205 x 795 x 285	41.5	1195 x 795	500	200 x 40
zu-1116 / AG	1605 x 895 x 285	49.5	1595 x 895	500	200 x 40

Stacking height 590 mm

Heavy-duty



Two-wheeled platform | with end walls

Article-no. + /Colour	Dimension W x D x H (mm)	Weight kg	Loading surface W x D (mm)	Load cap. kg	Wheel diam. mm
zu-1120 / AG	1090 x 780 x 660	43.0	1000 x 700	500	200 x 40
zu-1121 / AG	1290 x 880 x 660	46.0	1200 x 800	500	200 x 40

Stacking height 590 mm



Two-wheeled platform | with 4 walls

Article-no. + /Colour	Dimension W x D x H (mm)	Weight kg	Loading surface W x D (mm)	Load cap. kg	Wheel diam. mm
zu-1122 / AG	1090 x 780 x 660	52.5	975 x 675	500	200 x 40
zu-1123 / AG	1290 x 880 x 660	55.0	1175 x 775	500	200 x 40

RAL 2002

CONSTRUCTION

- Steel construction with ball head of diameter 47 mm

FEATURES

- With locking system
- Reliable engagement with two-wheeled platform

FITTINGS

- Elastic solid-rubber tyres with ball bearings, black
- Available in RAL 2002 vermilion, painted

With locking system
Suitable for two-wheeled platforms with a load capacity of 1000 - 3000 kg



Safety quick-lift jack

Article-no.		Dimension W x D x H (mm)	Weight kg	For two-wheeled platforms with load cap. kg	Wheel diam. mm
zsw-1000	ER	385 x 270 x 1275	18.0	1000	180 x 45
zsw-1500	ER	390 x 305 x 1305	22.0	1500	250 x 50
zsw-2000	ER	440 x 305 x 1305	25.0	2000	250 x 80
zsw-3000	ER	440 x 305 x 1305	25.0	3000	250 x 80

ER = Elastic solid-rubber tyres

RAL 5010 **RAL 7016**

CONSTRUCTION

- Welded steel construction

FEATURES

- 2 support runners
- Ball socket with safety catch
- Load surface of waterproof bonded plywood, surface finish screen printed, anti-slip

FITTINGS

- Elastic solid-rubber tyres on cast aluminium wheel rim with precision deepgroove ball bearings, mounted on a single axle
- Available in 2 colours, RAL 5010 gentian blue or RAL 7016 anthracite grey, powder-coated



TWO-WHEELED PLATFORMS

2 support runners
Ball socket with safety catch

Two-wheeled platform

Article-no. + /Colour		Dimension W x D x H (mm)	Weight kg	Loading surface W x D (mm)	Load cap. kg	Wheel diam. mm
zu-1130 / AG	ER	1005 x 700 x 315	46.5	990 x 700	1000	200 x 50
zu-1131 / AG	ER	1205 x 800 x 315	57.0	1190 x 800	1000	200 x 50
zu-1132 / AG	ER	1605 x 900 x 315	62.5	1590 x 900	1000	200 x 50
zu-1133 / AG	ER	2005 x 1000 x 315	69.5	1990 x 1000	1000	200 x 50

ER = Elastic solid-rubber tyres



Heavy-duty

148 TWO-WHEELED PLATFORMS

RAL 5010 RAL 7016

2 support runners

Ball socket with safety catch



AG

CONSTRUCTION

- Welded steel construction

FEATURES

- 2 support runners
- Ball socket with safety catch
- Load surface of waterproof bonded plywood, surface finish screen printed, anti-slip

FITTINGS

- Elastic solid-rubber tyres or polyurethane tyres on cast aluminium wheel rim with precision deep-groove ball bearings, mounted on a single axle
- Available in 2 colours, RAL 5010 gentian blue or RAL 7016 anthracite grey, powder-coated

Two-wheeled platform

Article-no. + /Colour	Dimension W x D x H (mm)	Weight kg	Loading surface W x D (mm)	Load cap. kg	Wheel diam. mm
zu-1134 / AG	ER 1005 x 700 x 340	51.0	990 x 700	1500	250 x 50
zu-1135 / AG	ER 1205 x 800 x 340	54.5	1190 x 800	1500	250 x 50
zu-1136 / AG	ER 1605 x 900 x 340	68.0	1590 x 900	1500	250 x 50
zu-1137 / AG	ER 2005 x 1000 x 340	86.0	1990 x 1000	1500	250 x 50
zu-1138 / AG	ER 2505 x 800 x 340	91.5	2490 x 800	1500	250 x 50
zu-1141 / AG	PO 1205 x 800 x 340	57.0	1190 x 800	2000	250 x 50
zu-1142 / AG	PO 1605 x 900 x 340	71.0	1590 x 900	2000	250 x 50
zu-1143 / AG	PO 2005 x 1000 x 340	88.5	1990 x 1000	2000	250 x 50
zu-1144 / AG	PO 2505 x 800 x 340	94.5	2490 x 800	2000	250 x 50
zu-1147 / AG	PO 1205 x 800 x 340	54.5	1190 x 800	3000	250 x 50
zu-1148 / AG	PO 1605 x 900 x 340	72.5	1590 x 900	3000	250 x 50
zu-1149 / AG	PO 2005 x 1000 x 340	90.5	1990 x 1000	3000	250 x 50
zu-1150 / AG	PO 2505 x 800 x 340	96.0	2490 x 800	3000	250 x 50

ER = Elastic solid-rubber tyres, PO = Polyurethane tyres



Heavy-duty



Two-wheeled platform

Article-no. + /Colour	Dimension W x D x H (mm)	Weight kg	Loading surface W x D (mm)	Load cap. kg	Wheel diam. mm
zu-1139 / AG	ER 3305 x 800 x 390	97.0	3290 x 800	1500	250 x 50
zu-1140 / AG	ER 4005 x 800 x 390	187.5	3990 x 800	1500	250 x 50
zu-1145 / AG	PO 3305 x 800 x 390	161.5	3290 x 800	2000	250 x 50
zu-1146 / AG	PO 4005 x 800 x 390	194.0	3990 x 800	2000	250 x 50
zu-1151 / AG	PO 3305 x 800 x 390	161.5	3290 x 800	3000	250 x 50
zu-1152 / AG	PO 4005 x 800 x 390	194.0	3990 x 800	3000	250 x 50

ER = Elastic solid-rubber tyres, PO = Polyurethane tyres

RAL 5010 RAL 7016

CONSTRUCTION

- Welded steel construction

FEATURES

- Push-fit tubular steel stanchions, galvanised
- Fill height of the stanchions: 610 mm
- Clear depth between the stanchions: 615 mm
- Centre free for loading by crane or stacker truck

FITTINGS

- Centre wheel set diam. 360 x 60 mm of elastic solid-rubber or polyurethane, at each end wall one swivel castor with brake diam. 200 x 50 mm
- Elastic solid-rubber or polyurethane tyres on cast aluminium wheel rim with precision deepgroove ball bearings, with foot guard, elastic solid-rubber tyres also available in grey
- Available in 2 colours, RAL 5010 gentian blue or RAL 7016 anthracite grey, powder-coated

Push-fit tubular steel stanchions
Centre free for loading by crane
or stacker truck

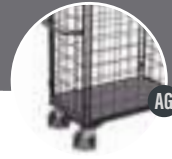

AG

Long-goods trolley | with 4 stanchions

Article-no. + /Colour	Dimension W x D x H (mm)	Weight kg	Loading surface W x D (mm)	Fill height mm	Load cap. kg	Wheel diam. mm
sw-2500 / AG	ER 2500 x 760 x 1030	115.0	2500 x 615	610	2000	360 x 60 / 200 x 50
sw-2501 / AG	PO 2500 x 760 x 1030	123.0	2500 x 615	610	3000	360 x 60 / 200 x 50

ER = Elastic solid-rubber tyres, PO = Polyurethane tyres



Wheels also available in grey

RAL 5010 RAL 7016

CONSTRUCTION

- Welded steel construction

FEATURES

- Push-fit tubular steel stanchions, galvanised
- Fill height of the stanchions: 610 mm
- Clear width between the stanchions: 625 mm
- Load surface of waterproof bonded plywood, surface finish screen printed, anti-slip

FITTINGS

- 4 swivel castors, 2 of them with brake
- Elastic solid-rubber tyres on cast aluminium wheel rim with precision deepgroove ball bearings, with foot guard, wheels also available in grey
- Available in 2 colours, RAL 5010 gentian blue or RAL 7016 anthracite grey, powder-coated

LONG-GOODS DOLLY

Push-fit tubular steel stanchions



Wheels also available in grey

Long-goods dolly

Article-no. + /Colour	Dimension W x D x H (mm)	Weight kg	Loading surface W x D (mm)	Fill height mm	Load cap. kg	Wheel diam. mm
sw-700.710 / AG	700 x 700 x 940	51.5	625 x 625	610	1200	200 x 50



Heavy-duty



Plug-in stanchions
End walls with horizontal push bar
EasySTOP on one longitudinal
and narrow sides



AG



NEW



CONSTRUCTION

- Modular system
- Welded steel construction

FEATURES

- Without or with load surface of waterproof bonded plywood, surface finish screen printed, anti-slip
- Optionally end walls with vertical tubes
- End walls with horizontal push bar
- Height of end walls: 800 mm
- Optionally galvanised, plug-in stanchions
- Length of stanchion: 625 mm

FITTINGS

- 2 swivel and 2 fixed castors, with **EasySTOP** (can be operated on one longitudinal and narrow side)
- Grey non-marking thermoplastic rubber tyres on plastic wheel rim with precision deepgroove ball bearings, with foot guard
- From 1200 kg load capacity elastic solid-rubber tyres on cast aluminium wheel rim with precision deepgroove ball bearings, black, with foot guard, wheels also available in grey
- Available in 2 colours, RAL 5010 gentian blue or RAL 7016 anthracite grey, powder-coated

Heavy-duty trolley



Article-no. + /Colour			Dimension W x D x H (mm)	Weight kg	Loading surface W x D (mm)	Load cap. kg	Wheel diam. mm
zu-1225	AG	TR	1380 x 880 x 305	42.0	1380 x 880	500	200 x 40
zu-1226	AG	ER	1380 x 880 x 305	47.0	1380 x 880	1200	200 x 50
zu-1227	AG	TR	1680 x 880 x 305	49.5	1680 x 880	500	200 x 40
zu-1228	AG	ER	1680 x 880 x 305	53.0	1680 x 880	1200	200 x 50
zu-1229	AG	TR	2080 x 880 x 305	55.5	2080 x 880	500	200 x 40
zu-1230	AG	ER	2080 x 880 x 305	60.5	2080 x 880	1200	200 x 50

TR = Thermoplastic rubber tyres, ER = Elastic solid-rubber tyres

Stanchion trolley



Article-no. + /Colour			Dimension W x D x H (mm)	Weight kg	Loading surface W x D (mm)	Load cap. kg	Wheel diam. mm
sw-1310	AG	TR	1380 x 880 x 930	47.5	1380 x 805	500	200 x 40
sw-1300	AG	ER	1380 x 880 x 930	52.0	1380 x 805	1200	200 x 50
sw-1610	AG	TR	1680 x 880 x 930	53.0	1680 x 805	500	200 x 40
sw-1600	AG	ER	1680 x 880 x 930	57.0	1680 x 805	1200	200 x 50
sw-2010	AG	TR	2080 x 880 x 930	62.5	2080 x 805	500	200 x 40
sw-2000	AG	ER	2080 x 880 x 930	67.0	2080 x 805	1200	200 x 50

TR = Thermoplastic rubber tyres, ER = Elastic solid-rubber tyres

Heavy-duty

Single-end trolley | with vertical tubes



Article-no. + /Colour			Dimension W x D x H (mm)	Weight kg	Loading surface W x D (mm)	Load cap. kg	Wheel diam. mm
sw-1312	AG	TR	1475 x 900 x 1105	59.5	1345 x 880	500	200 x 40
sw-1302	AG	ER	1475 x 900 x 1105	64.0	1345 x 880	1200	200 x 50
sw-1612	AG	TR	1775 x 900 x 1105	67.5	1645 x 880	500	200 x 40
sw-1602	AG	ER	1775 x 900 x 1105	72.0	1645 x 880	1200	200 x 50
sw-2012	AG	TR	2175 x 900 x 1105	82.0	2045 x 880	500	200 x 40
sw-2002	AG	ER	2175 x 900 x 1105	86.5	2045 x 880	1200	200 x 50

TR = Thermoplastic rubber tyres, ER = Elastic solid-rubber tyres



RAL 5010 RAL 7016

CONSTRUCTION

- Modular system
- Welded steel construction

FEATURES

- Load surface of waterproof bonded plywood, surface finish screen printed, anti-slip
- End and side walls with vertical tubes
- End walls with horizontal push bar
- Height of end and side walls: 800 mm
- Side walls removable

FITTINGS

- 2 swivel and 2 fixed castors, with **EasySTOP** (can be operated on one longitudinal and narrow side)
- Grey non-marking thermoplastic rubber tyres on plastic wheel rim with precision deepgroove ball bearings, with foot guard
- From 1200 kg load capacity elastic solid-rubber tyres on cast aluminium wheel rim with precision deepgroove ball bearings, black, with foot guard, wheels also available in grey
- Available in 2 colours, RAL 5010 gentian blue or RAL 7016 anthracite grey, powder-coated

End walls with horizontal push bar

Side walls removable

EasySTOP on one longitudinal and narrow sides



NEW

Double-end trolley | with vertical tubes

Article-no. + /Colour	Dimension W x D x H (mm)	Weight kg	Loading surface		Load cap. kg	Wheel diam. mm
			W x D (mm)	kg		
sw-1313 / AG	TR 1575 x 900 x 1105	68.0	1305 x 880	500	200 x 40	
sw-1303 / AG	ER 1575 x 900 x 1105	72.5	1305 x 880	1200	200 x 50	
sw-1613 / AG	TR 1875 x 900 x 1105	76.0	1605 x 880	500	200 x 40	
sw-1603 / AG	ER 1875 x 900 x 1105	80.5	1605 x 880	1200	200 x 50	
sw-2013 / AG	TR 2275 x 900 x 1105	90.5	2005 x 880	500	200 x 40	
sw-2003 / AG	ER 2275 x 900 x 1105	95.0	2005 x 880	1200	200 x 50	

TR = Thermoplastic rubber tyres, ER = Elastic solid-rubber tyres



Three-sided trolley | with vertical tubes

Article-no. + /Colour	Dimension W x D x H (mm)	Weight kg	Loading surface		Load cap. kg	Wheel diam. mm
			W x D (mm)	kg		
sw-1317 / AG	TR 1575 x 900 x 1105	78.0	1305 x 845	500	200 x 40	
sw-1307 / AG	ER 1575 x 900 x 1105	82.0	1305 x 845	1200	200 x 50	
sw-1617 / AG	TR 1875 x 900 x 1105	86.5	1605 x 845	500	200 x 40	
sw-1607 / AG	ER 1875 x 900 x 1105	89.5	1605 x 845	1200	200 x 50	
sw-2017 / AG	TR 2275 x 900 x 1105	96.0	2005 x 845	500	200 x 40	
sw-2007 / AG	ER 2275 x 900 x 1105	99.5	2005 x 845	1200	200 x 50	

TR = Thermoplastic rubber tyres, ER = Elastic solid-rubber tyres



Four-sided trolley | with vertical tubes

Article-no. + /Colour	Dimension W x D x H (mm)	Weight kg	Loading surface		Load cap. kg	Wheel diam. mm
			W x D (mm)	kg		
sw-1314 / AG	TR 1575 x 900 x 1105	86.5	1305 x 810	500	200 x 40	
sw-1304 / AG	ER 1575 x 900 x 1105	90.5	1305 x 810	1200	200 x 50	
sw-1614 / AG	TR 1875 x 900 x 1105	95.0	1605 x 810	500	200 x 40	
sw-1604 / AG	ER 1875 x 900 x 1105	97.5	1605 x 810	1200	200 x 50	
sw-2014 / AG	TR 2275 x 900 x 1105	104.5	2005 x 810	500	200 x 40	
sw-2004 / AG	ER 2275 x 900 x 1105	108.0	2005 x 810	1200	200 x 50	

TR = Thermoplastic rubber tyres, ER = Elastic solid-rubber tyres



Heavy-duty

Pulse-welded steel construction
Turnable steering with heavy-duty
precision deepgroove ball bearings

CONSTRUCTION

- Extremely robust, pulse-welded steel-section construction

FEATURES

- With rounded corners
- Turnable steering with heavy-duty precision deepgroove ball bearings
- Steering ring with safety stop in accordance with German accident prevention regulations (UVV)
- Maximum speed: 6 km/h
- Standard drawbar eye for 30 mm coupling bolts

- Compatible towing hitch height: 400 - 600 mm
- Load surface of waterproof bonded plywood, surface finish screen printed, anti-slip

FITTINGS

- Heavy-duty wheels in robust welded-steel construction with elastic solid-rubber tyres or heavy-duty pneumatic wheels with industrial tread
- The hubs are fitted with dustproof encapsulated, pre-lubricated bearings in accordance with DIN ISO 355 or 15-1981.
- Available in RAL 2004 pure orange

Industrial trailer | with 1-axle turnable steering

Article-no.	Loading surface W x D (mm)	Fill height mm	Weight kg	Load cap. kg	Wheel diam. mm
zu-1001	SR 2000 x 1000	510	285.0	2000	360 x 60
zu-1002	P 2000 x 1000	540	270.0	2000	410 x 110
zu-1003	SR 2500 x 1250	510	335.0	2000	360 x 60
zu-1004	P 2500 x 1250	540	315.0	2000	410 x 110
zu-1005	SR 3000 x 1500	510	390.0	2000	360 x 60
zu-1006	P 3000 x 1500	540	375.0	2000	410 x 110
zu-1007	SR 2000 x 1000	530	285.0	3000	400 x 75
zu-1008	P 2000 x 1000	560	270.0	3000	460 x 140
zu-1009	SR 2500 x 1250	530	335.0	3000	400 x 75
zu-1010	P 2500 x 1250	560	320.0	3000	460 x 140
zu-1011	SR 3000 x 1500	530	390.0	3000	400 x 75
zu-1012	P 3000 x 1500	560	375.0	3000	460 x 140
zu-1013	SR 2000 x 1000	530	315.0	5000	400 x 130
zu-1014	P 2000 x 1000	700	310.0	5000	530 x 160
zu-1015	SR 2500 x 1250	530	355.0	5000	400 x 130
zu-1016	P 2500 x 1250	700	350.0	5000	530 x 160
zu-1017	SR 3000 x 1500	530	400.0	5000	400 x 130
zu-1018	P 3000 x 1500	700	395.0	5000	530 x 160

P = Pneumatic tyres, SR = Solid-rubber tyres

Industrial trailer | with 2-axle turnable steering

Article-no.	Loading surface W x D (mm)	Fill height mm	Weight kg	Load cap. kg	Wheel diam. mm
zu-1031	SR 2000 x 1000	510	300.0	2000	360 x 60
zu-1032	P 2000 x 1000	540	285.0	2000	410 x 110
zu-1033	SR 2500 x 1250	510	350.0	2000	360 x 60
zu-1034	P 2500 x 1250	540	335.0	2000	410 x 110
zu-1035	SR 3000 x 1500	510	405.0	2000	360 x 60
zu-1036	P 3000 x 1500	540	390.0	2000	410 x 110
zu-1037	SR 2000 x 1000	530	300.0	3000	400 x 75
zu-1038	P 2000 x 1000	560	285.0	3000	460 x 140
zu-1039	SR 2500 x 1250	530	350.0	3000	400 x 75
zu-1040	P 2500 x 1250	560	335.0	3000	460 x 140
zu-1041	SR 3000 x 1500	530	405.0	3000	400 x 75
zu-1042	P 3000 x 1500	560	395.0	3000	460 x 140
zu-1043	SR 2000 x 1000	530	330.0	5000	400 x 130
zu-1044	P 2000 x 1000	700	325.0	5000	530 x 160
zu-1045	SR 2500 x 1250	530	370.0	5000	400 x 130
zu-1046	P 2500 x 1250	700	365.0	5000	530 x 160
zu-1047	SR 3000 x 1500	530	415.0	5000	400 x 130
zu-1048	P 3000 x 1500	700	410.0	5000	530 x 160

P = Pneumatic tyres, SR = Solid-rubber tyres

1-axle turnable steering



2-axle turnable steering



Heavy-duty

RAL
2004



Additional articles
Push-fit stanchions
Side walls
Tubular steel walls

ADDITIONAL ARTICLE Four push-fit stanchions, usable length: 600 mm

Article-no.

zu-1069

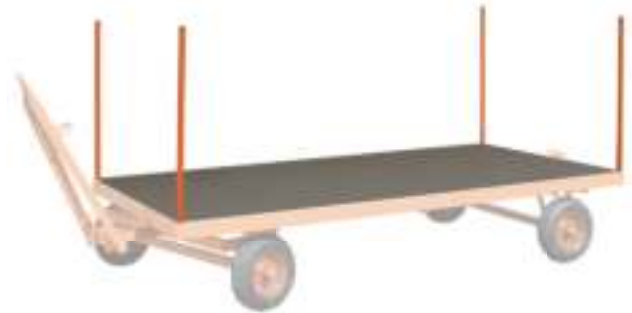

2 sides foldable
Front wall fixed but removable
4 locks

ADDITIONAL ARTICLE 4 side walls, 400 mm high

Article-no. For loading surface
W x D (mm)

zu-1060	2000 x 1000
zu-1061	2500 x 1250
zu-1062	3000 x 1500

As ex-factory equipment



ADDITIONAL ARTICLE 2 tubular-steel end walls, 750 mm high, removable

Article-no. For loading surface
W x D (mm)

zu-1063	2000 x 1000
zu-1064	2500 x 1250
zu-1065	3000 x 1500



ADDITIONAL ARTICLE 4 tubular-steel walls, 750 mm high, removable, sides insertable

Article-no. For loading surface
W x D (mm)

zu-1066	2000 x 1000
zu-1067	2500 x 1250
zu-1068	3000 x 1500



Heavy-duty

Colour blue (other colours on request)

Practical and in a double pack

CONSTRUCTION

- Plywood panel with non-slip covering

FEATURES

- All dolly products are available in packaging units of 2 dollies

FITTINGS

- 4 swivel castors
- Polyamide tyres with precision deepgroove ball bearings, white or grey non-marking thermoplastic rubber tyres on plastic wheel rim with precision deepgroove ball bearings
- Colour blue



Dollies | with polyamide swivel castors

Article-no.	Dimension W x D x H (mm)	Weight kg	Loading surface W x D (mm)	Load cap. kg	Wheel diam. mm
mh-934.003	600 x 350 x 145	5.0	600 x 350	500	100 x 36
mh-938.000	600 x 350 x 175	6.0	600 x 350	500	125 x 40
mh-951.013	600 x 300 x 145	5.5	600 x 300	500	100 x 36

Packaging units of 2 dollies



Dollies | with thermoplastic rubber swivel castors

Article-no.	Dimension W x D x H (mm)	Weight kg	Loading surface W x D (mm)	Load cap. kg	Wheel diam. mm
mh-935.003	600 x 350 x 145	5.5	600 x 350	300	100 x 32
mh-939.000	600 x 350 x 175	6.0	600 x 350	300	125 x 30
mh-935.020	600 x 300 x 145	5.5	600 x 300	300	100 x 32

Packaging units of 2 dollies



Dollies | with thermoplastic rubber swivel castors (Premium)

Article-no.	Dimension W x D x H (mm)	Weight kg	Loading surface W x D (mm)	Load cap. kg	Wheel diam. mm
mh-949.050	600 x 350 x 145	5.0	600 x 350	350	100 x 32
mh-948.050	600 x 350 x 175	6.0	600 x 350	350	125 x 30
mh-949.051	600 x 300 x 145	5.0	600 x 300	350	100 x 32

Packaging units of 2 dollies



Non-slip covering in different colours on request!

DOLLY COLLECTOR

RAL 5012 RAL 7016

Special

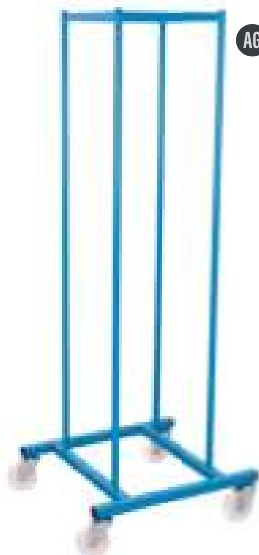

AG

CONSTRUCTION

- Welded steel construction

FEATURES

- For approx. 40 dollies measuring 600 x 300 mm (W x D) or 600 x 350 mm (W x D)

FITTINGS

- 4 swivel castors
- Polyamide tyres with precision deepgroove ball bearings, white
- Available in 2 colours, RAL 5012 light blue or RAL 7016 anthracite grey, powder-coated

Dolly collector in special dimensions on request

Dolly collector

Article-no. + /Colour	Dimension W x D x H (mm)	Weight kg	Loading surface dolly	Load cap. kg	Wheel diam. mm
mh-942.500 / AG	700 x 740 x 2000	22.0	40x	250	125 x 40

Black

CONSTRUCTION

- Plywood panel with rubber buffer or with bonded grooved rubber mat

FEATURES

- Dolly Europa surrounded with rubber cover as additional collision protection for walls and doors
- All dolly products are available in packaging units of 2 dollies

FITTINGS

- 4 swivel castors
- Polyamide tyres with precision deepgroove ball bearings, white or grey non-marking thermoplastic rubber tyres on plastic wheel rim with precision deepgroove ball bearings
- Colour black

Practical and in a double pack
Europa rubber buffer
or bonded grooved rubber mat
Colour black

Dolly Europa | with polyamide swivel castors

Article-no.	Dimension W x D x H (mm)	Weight kg	Loading surface W x D (mm)	Load cap. kg	Wheel diam. mm
mh-936.003	600 x 350 x 145	5.5	600 x 350	500	100 x 36

Packaging units of 2 dollies



Dolly Europa | with thermoplastic rubber swivel castors

Article-no.	Dimension W x D x H (mm)	Weight kg	Loading surface W x D (mm)	Load cap. kg	Wheel diam. mm
mh-937.003	600 x 350 x 145	6.5	600 x 350	300	100 x 32

Packaging units of 2 dollies



Dolly Europa | with thermoplastic rubber swivel castors (Premium)

Article-no.	Dimension W x D x H (mm)	Weight kg	Loading surface W x D (mm)	Load cap. kg	Wheel diam. mm
mh-949.300	600 x 350 x 145	6.0	600 x 350	350	100 x 32

Packaging units of 2 dollies



Dollies | with polyamide swivel castors

Article-no.	Dimension W x D x H (mm)	Weight kg	Loading surface W x D (mm)	Load cap. kg	Wheel diam. mm
mh-934.017	600 x 350 x 145	5.0	600 x 350	500	100 x 36
mh-938.500	600 x 350 x 175	6.0	600 x 350	500	125 x 40
mh-951.500	600 x 300 x 145	4.5	600 x 300	500	100 x 36

Packaging units of 2 dollies



Dollies | with thermoplastic rubber swivel castors

Article-no.	Dimension W x D x H (mm)	Weight kg	Loading surface W x D (mm)	Load cap. kg	Wheel diam. mm
mh-935.014	600 x 350 x 145	6.0	600 x 350	300	100 x 32
mh-939.500	600 x 350 x 175	6.5	600 x 350	300	125 x 30
mh-935.500	600 x 300 x 145	5.5	600 x 300	300	100 x 32

Packaging units of 2 dollies



Special

Ply-wood

Practical and in a double pack

Colour natural

Recessed grip

CONSTRUCTION

- Plywood panel, raw

FEATURES

- Recessed grip
- All dolly products are available in packaging units of 2 dollies

FITTINGS

- 3 swivel castors
- Polyamide tyres with precision deepgroove ball bearings, white or grey non-marking thermoplastic rubber tyres on plastic wheel rim with precision deepgroove ball bearings



Triple-Dog | with polyamide swivel castors

Article-no.	Dimension W x D x H (mm)	Weight kg	Loading surface W x D (mm)	Load cap. kg	Wheel diam. mm
mh-540.000	540 x 540 x 145	3.0	540 x 540	300	100 x 36

Packaging units of 2 dollies

Triple-Dog | with thermoplastic rubber swivel castors

Article-no.	Dimension W x D x H (mm)	Weight kg	Loading surface W x D (mm)	Load cap. kg	Wheel diam. mm
mh-540.500	540 x 540 x 145	3.5	540 x 540	200	100 x 32

Packaging units of 2 dollies

DOLLIES

Blue

CONSTRUCTION

- Plywood panel with non-slip covering

FEATURES

- All dolly products are available in packaging units of 2 dollies

FITTINGS

- 4 swivel castors
- Polyamide tyres with precision deepgroove ball bearings, white or grey non-marking thermoplastic rubber tyres on plastic wheel rim with precision deepgroove ball bearings
- Colour blue



Dolly | with polyamide swivel castors

Article-no.	Dimension W x D x H (mm)	Weight kg	Loading surface W x D (mm)	Load cap. kg	Wheel diam. mm
mh-938.024	600 x 600 x 175	10.5	600 x 600	900	125 x 40

Packaging units of 2 dollies

Special



Dolly | with thermoplastic rubber swivel castors

Article-no.	Dimension W x D x H (mm)	Weight kg	Loading surface W x D (mm)	Load cap. kg	Wheel diam. mm
mh-950.003	600 x 600 x 255	11.5	600 x 600	750	200 x 40

Packaging units of 2 dollies

RAL 5010 RAL 7016

CONSTRUCTION

- Welded steel construction

FEATURES

- Support with ribbed rubber covering and 4 white rubber studs
- Push bar with 2 plastic handles, reversible, lockable
- Incl. lever for locking the lifting movement
- Diagonal and lengthwise transport of tables

FITTINGS

- 2 castors on one axle and 2 swivel castors
- Grey non-marking thermoplastic rubber tyres on plastic wheel rim with precision deepgroove ball bearings
- Available in 2 colours, RAL 5010 gentian blue or RAL 7016 anthracite grey, powder-coated

Saves min. 50% work
Diagonal and lengthwise
pick-up of tables

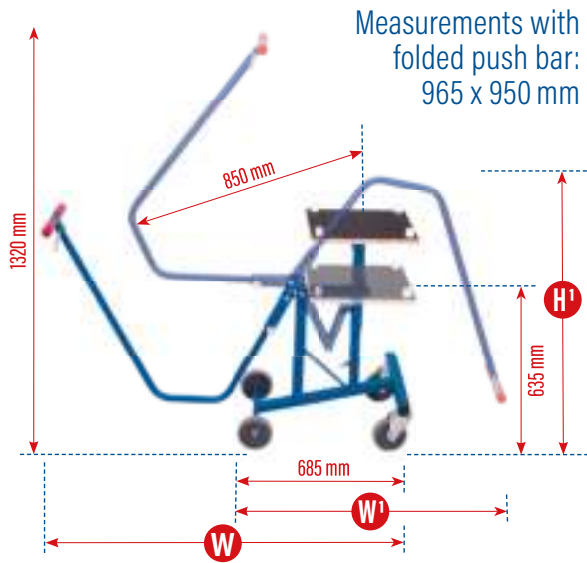

1 Table support

with rubber pads, guaranteed non-damaging engagement and non-slip transport

2 Adjustment

of tolerance with a screw

3 Clamp

for push bar

4 Swivel castor

with thermoplastic rubber tyres, maintenance-free precision deepgroove ball bearings

5 Lift

is automatically locked in final position, the table is lowered by operation a release lever on the push bar

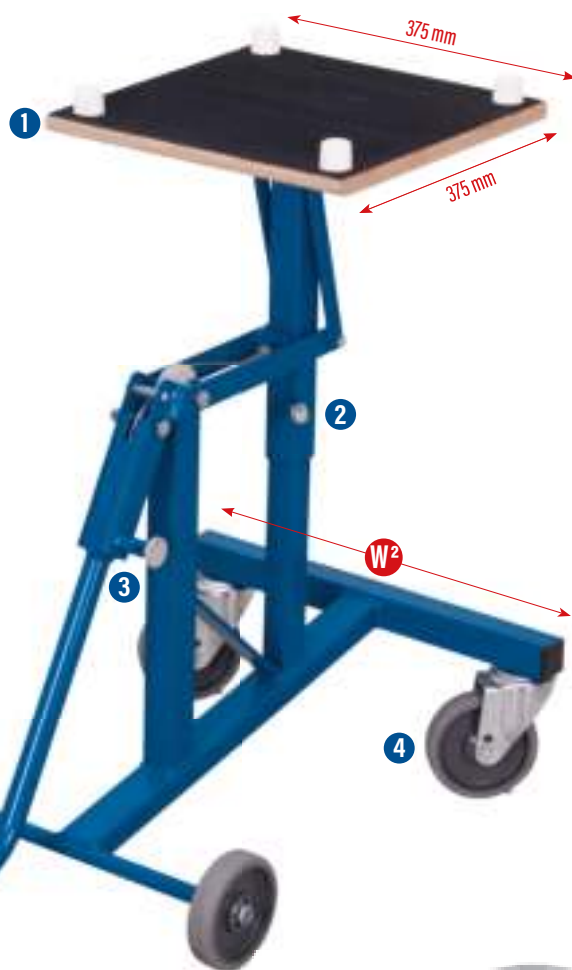

PRICE PERFORMANCE

Table transporter

Article-no. + /Colour	Dimension W x D x H (mm)	Weight kg	Loading surface W x D (mm)	Load cap. kg	Wheel diam. mm
sw-490.001 / AG	1350 x 490 x 815	17.5	375 x 375	100	125 x 30
	W ¹ x W ² x H ¹ (mm)				
	965 x 490 x 950				Measurement with folded push bar



Special

Filing and transporting files and books



AG



CONSTRUCTION

- Welded steel construction

FEATURES

- Document compartment enclosed on 3 sides
- End and side wall height: 505 mm
- Load surface inclined at 10° towards back
- 1 push bar at each end

FITTINGS

- 4 swivel castors with brakes
- Grey non-marking thermoplastic rubber tyres on plastic wheel rim with precision deepgroove ball bearings
- Available in 2 colours, RAL 7035 light grey or RAL 7016 anthracite grey, powder-coated

Document trolley

Article-no. + /Colour	Dimension W x D x H (mm)	Weight kg	Loading surface W x D x H (mm)	Load cap. kg	Wheel diam. mm
sw-500.380 / AG	625 x 550 x 1025	25.0	550 x 500 x 420	100	100 x 32

DOCUMENT TROLLEY WITH 12 COMPARTMENTS



Fixed welded
EasySTOP



345 mm

CONSTRUCTION

- Robust angle-steel construction

FEATURES

- 6 compartments on each side
- Superstructure and compartments of waterproof bonded plywood, surface finish screen printed
- Shelves with 9° inclination to the middle wall
- One push bar directed upwards on each end side

FITTINGS

- 2 **EasySTOP** swivel castors, 2 fixed castors
- Grey non-marking thermoplastic rubber tyres on plastic wheel rim with precision deepgroove ball bearings, with foot guard
- Available in 2 colours, RAL 5010 gentian blue or RAL 7016 anthracite grey, powder-coated

*Compartment size: 340 x 320 x 345 mm (W x D x H)

Document trolley with 12 compartments

Article-no. + /Colour	Dimension W x D x H (mm)	Weight kg	Loading surface compartments*	Load cap. kg	Wheel diam. mm
sw-700.995 / AG	1105 x 700 x 1185	66.5	2 x 6	400	200 x 40

Load capacity shelf: 30 kg**

BOOK TROLLEY

Special



275 mm

CONSTRUCTION

- Welded steel construction

FEATURES

- 3 sloping shelves for transport and storage of books
- Shelves with 5° inclination to the rear wall
- 1 push bar at each end

FITTINGS

- 4 swivel castors, 2 of them with brakes
- Grey non-marking thermoplastic rubber tyres on plastic wheel rim with precision deepgroove ball bearings
- Available in 2 colours, RAL 5010 gentian blue or RAL 7016 anthracite grey, powder-coated

Book trolley

Article-no. + /Colour	Dimension W x D x H (mm)	Weight kg	Loading surface W x D (mm)	Load cap. kg	Wheel diam. mm
sw-300.000 / AG	1085 x 300 x 900	26.0	830 x 265	150	75 x 25

Load capacity shelf: 50 kg**



RAL 5010 RAL 7016

CONSTRUCTION

- Welded steel construction

FEATURES

- 10 compartments at each end
- Shelves of waterproof bonded plywood, surface finish screen printed, tilt 5° to the middle wall
- Middle wall with mesh 50 x 100 mm
- Side walls of perforated sheet
- 2 vertical push bars on one side

- Push bars projecting 100 mm
- Base frame with surrounding protective strip of plastic profile

FITTINGS

- 2 **EasySTOP** swivel castors, 2 fixed castors
- Grey non-marking thermoplastic rubber tyres on plastic wheel rim with precision deepgroove ball bearings, with foot guard
- Available in 2 colours, RAL 5010 gentian blue or RAL 7016 anthracite grey, powder-coated

Filing and transport of files
Fixed welded
EasySTOP

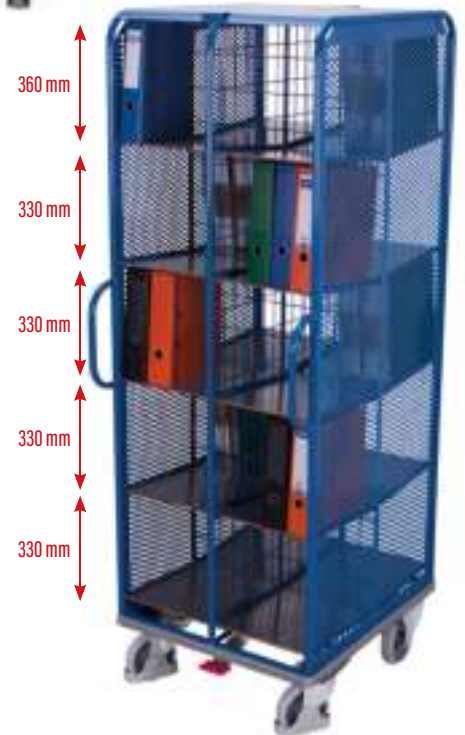

*Compartment size: 305 x 345 x 330 mm (W x D x H)

Document trolley | with 20 compartments

Article-no. + /Colour	Dimension W x D x H (mm)	Weight kg	Loading surface compartments*	Load cap. kg	Wheel diam. mm
sw-574.002 / AG	690 x 860 x 2015	69.0	2 x 10	500	160 x 40

Load capacity shelf: 25 kg**



RAL 5010

CONSTRUCTION

- Robust angle-steel construction

FEATURES

- 9 compartments for files
- Superstructure and compartments of wood-based board, surface finish beech
- Compartments lockable by roller shutter with cylinder lock
- Recessed grip at end
- Base frame with surrounding protective strip of plastic profile

FITTINGS

- 2 **EasySTOP** swivel castors, 2 fixed castors
- Grey non-marking thermoplastic rubber tyres on plastic wheel rim with precision deepgroove ball bearings, with foot guard
- Base frame available in RAL 5010 gentian blue, powder-coated

DOCUMENT TROLLEY WITH 9 COMPARTMENTS

Lockable by roller shutter
EasySTOP



*Compartment size: 250 x 400 x 330 mm (W x D x H)

Document trolley | with 9 compartments | lockable

Article-no.	Dimension W x D x H (mm)	Weight kg	Loading surface Compartments*	Load cap. kg	Wheel diam. mm
sw-474.000	875 x 490 x 1460	76.0	9	400	160 x 40

Load capacity shelf: 50 kg**



**Static distributed load; Total load of the transport device must not be exceeded!

Easy bulk material disposal
Unlocking mechanism when tipping
Optionally wheelsets



CONSTRUCTION

- Welded steel construction
- With roll-away system

FEATURES

- Tipping by manual release or by contact with container to be filled
- Automatic return after trough is emptied
- Fork-lift tunnel for safe transport

FITTINGS

- Various wheel types with different load capacities optionally available
- Possibility to retrofitting wheels
- Optionally with outlet cock (as ex-factory equipment)
- Available in 2 colours, RAL 5012 light blue or RAL 7016 anthracite grey, painted



Self-tipper

Article-no. + /Colour	Dimension W x D x H (mm)	Weight kg	Bulk-edge height (mm)	Load cap. kg	Volume l
sw-300.004 / AG	1385 x 880 x 615	93.5	615	1500	300
sw-500.004 / AG	1485 x 1400 x 615	121.0	615	2000	520
sw-600.004 / AG	1535 x 860 x 865	118.0	865	2000	600
sw-100.004 / AG	1525 x 1205 x 1070	168.5	1070	2000	1000



ADDITIONAL ARTICLES Wheelsets for self-tipper

Article-no.		Load cap. kg	Wheel diam. mm
zsw-000.500	Outlet cock (on page 126)*	-	-
rsa-200.400	Thermoplastic rubber tyres	500	200 x 40
rsa-200.401	Polyamide tyres	1050	200 x 50
rsa-200.402	Elastic solid-rubber tyres	1050	200 x 50
rsa-200.403	Polyurethane tyres 92° Shore A	1500	200 x 50
rsa-200.404	Polyurethane tyres 92° Shore A	2000	200 x 50

*As ex-factory equipment

The type of wheels used may reduce the load capacity

Wheelset consisting of: 2 swivel castor with brake and foot guard and 2 fixed castor



Thermoplastic rubber tyre



Polyamide tyre



Elastic solid-rubber tyre



Polyurethane tyre 92° Shore A
load capacity 1500 kg



Polyurethane tyre 92° Shore A
load capacity 2000 kg

Automatic reset and lock
after emptying



RAL 5010 RAL 7016

CONSTRUCTION

- Welded steel construction

FEATURES

- Holder for 240 l plastic sacks
- Foldable open fixing frame for securing waste collection sack
- Sack opening with 40° inclination

FITTINGS

- Available in 2 colours, RAL 5010 gentian blue or RAL 7016 anthracite grey, powder-coated

Holder for 240 l plastic sacks
Fixing frame for securing waste collection sack



Sack opening with 40° inclination

Waste collection stands

Article-no. + /Colour	Dimension W x D x H (mm)	Weight kg	Volume l
sw-240.100 / AG	635 x 500 x 1210	13.0	240

Sack opening with 40° inclination

Waste collection stands

Article-no. + /Colour	Dimension W x D x H (mm)	Weight kg	Volume l
sw-240.200 / AG	480 x 400 x 1210	11.0	240



RAL 2009

CONSTRUCTION

- Welded steel construction

FEATURES

- Holders for plastic sacks and cleaning tools
- Push bars with 2 innovative plastic safety handles
- Lockable sheet steel compartment

FITTINGS

- Rear axle with pneumatic tyres on steel wheel rim with precision deepgroove ball bearings
- Front axle with grey non-marking thermoplastic rubber tyres on plastic wheel rim with precision deepgroove ball bearings
- Available in RAL 2009 traffic orange, powder-coated

CLEANING TROLLEY

Push bars with plastic safety handles
Lockable

Incl. sheet steel compartment with triangular lock (without accessories)

Cleaning trolley

Article-no.	Dimension W x D x H (mm)	Weight kg	Load cap. kg	Wheel diam. mm
sw-780.100	P 1125 x 780 x 1045	38.5	100	400 x 100

P = Pneumatic tyres



Special

Bridge plate for loading and unloading vehicles

CONSTRUCTION

- Lightly but strong aluminium construction of diamond-tread plate

FEATURES

- Inclination 7°
- Easy and safely handling
- Integrated grip holes
- With positioning aids that also secure against slipping
- Inclined and chamfered access areas
- Anti-slip surface



Bridge plate

Article-no.	Dimension W x D x H (mm)	Weight kg	Load cap. kg
sg-100.008	1250 x 995 x 120	35.0	1200

RAMP

Only to be used on flat surfaces
Movable lip for further height levelling

CONSTRUCTION

- Welded steel construction

FEATURES

- Only to be used on flat surfaces with full support of the side rails
- Inclination 7°
- Rising from 0 to 200 mm, movable lip for further height levelling
- Height under the lip 190 mm, angled 10° in the front area

- Safety-tread steel plate for the lip 10/12 mm
- Safety-tread steel plate for the ramp 6/8 mm
- Chain with hook on both sides to prevent shifting
- With retractable lifting stirrup for transporting/positioning the ramp by lift truck

FITTINGS

- Available in RAL 9017 traffic black (industrial paint)



Ramp | with movable lip

Article-no.	Dimension W x D x H (mm)	Weight kg	Lip depth (mm)	Load cap. kg
sg-200.520	2000 x 1815 x 200	282.5	300	7500

INDIVIDUALLY

- Opportunities for modification in line with customers' individual wishes

UNIQUE PIECE

- Deliveries of small series from one piece upwards
- Product approval drawings
- Fair prices even for small quantities

CUSTOMER FOCUSED

- Analysing parameters such as uses, handling, workflows and much more in close cooperation with the customer

TAILORED

- Products in special sizes, special colours and complete new designs

Our custom-made products in comparison



VARIOfit[®]



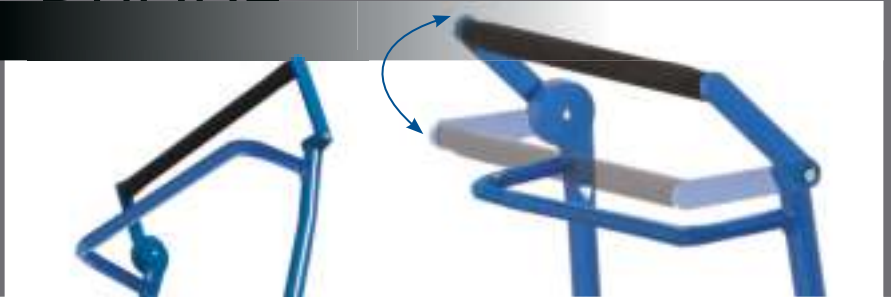

Smooth-running, well thought-out and user-friendly

The **VARIOfit®** dead man's brake provides a further braking system. The design is typically **VARIOfit®**: high quality, smooth-running, well thought-out and user-friendly. The design was chosen so that the bowden cable is integrated in the push bar and all parts of the brake system are inside the truck or trolley contours. As a result, there are no protruding parts that could interfere with the operator when using the truck or trolley. The truck or trolley is always braked and secured against rolling away unintentionally until the push bar is depressed and the dead man's brake is thus released. On releasing the push bar, the dead man's brake is activated automatically and the truck or trolley is braked safely again. The additional handle beneath the push bar allows an ergonomic movement of the trucks when the brake is released.

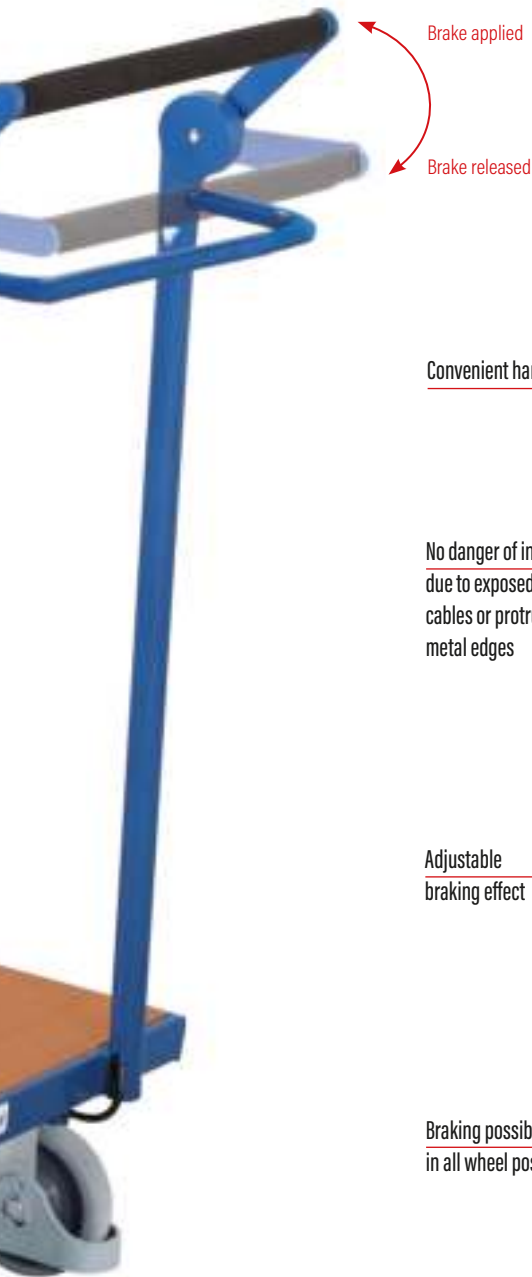

Convenient handling

No danger of injury due to exposed bowden cables or protruding metal edges

Adjustable braking effect

Braking possible in all wheel positions

Stops instantly if push/pull bar is released

Additional handle allows an ergonomic movement when the brake is released

Safe steering with brake released

Firm standing

Page 10



Page 14



Page 23



Page 32



Page 36



Page 121



Page 123

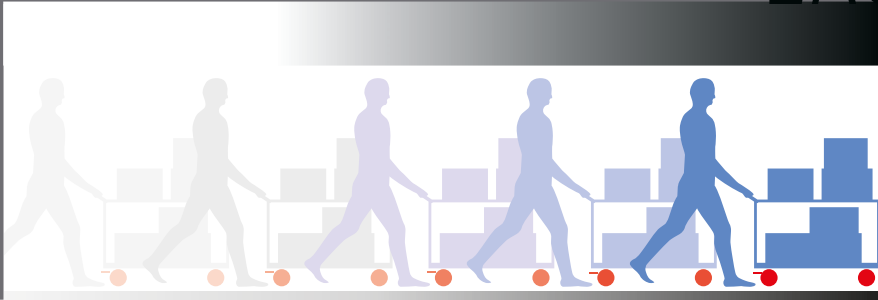

Easy runners, distance no problem

With their maintenance-free precision deepgroove ball bearings and optimised tyres, these **VARIOfit®** wheels offer about 50% less initial resistance than normal castors. So the truck is easy to start moving even when heavily loaded. This saves time, money and effort in day-to-day use. And of course only **VARIOfit®** supplies them as standard with the **VARIOfit®** foot guard.

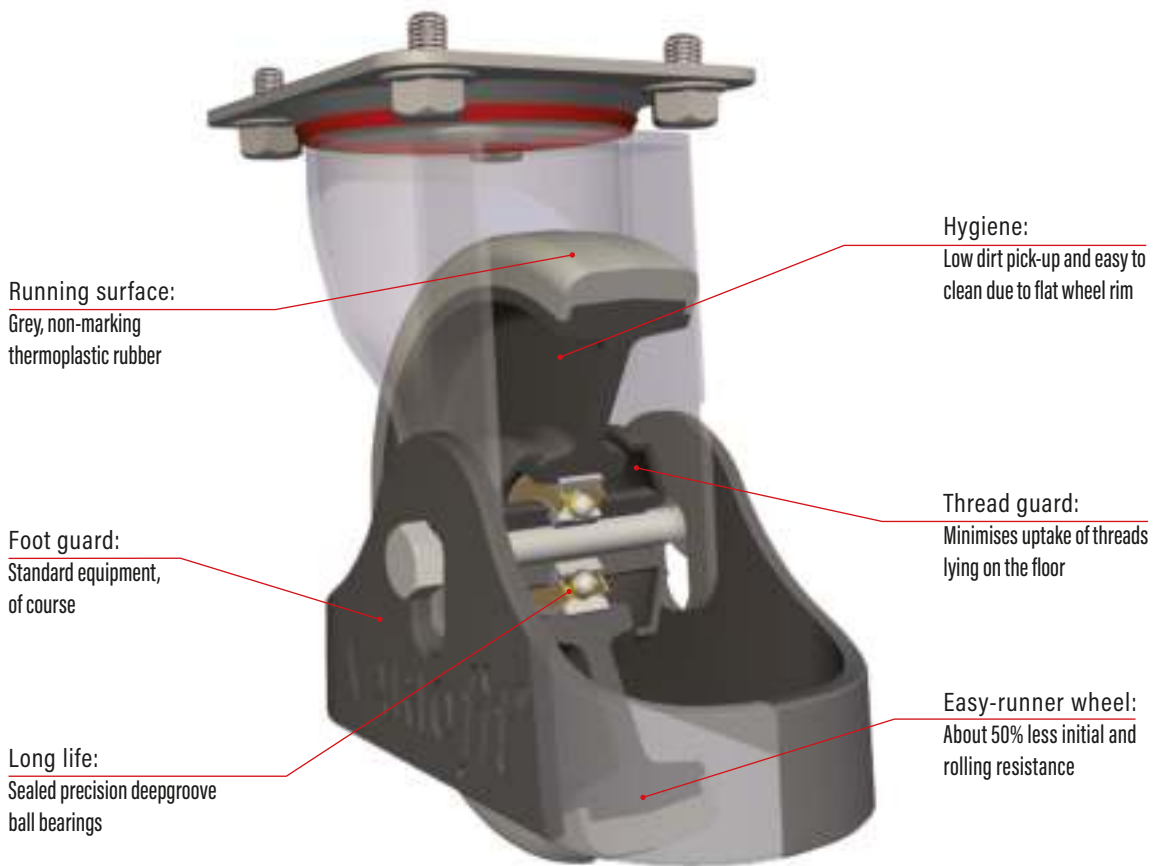

VARIOfit® easy-runner wheels: they need a minimum of effort to get the truck moving, even when heavily loaded. That also means less effort when pushing and reduces materials handling times.



Conventional wheels need a lot of strength to set the truck in motion and keep it moving.



Combined with EasySTOP the perfect solution



WHAT IS A CASTOR?

- A castor consists of at least one wheel, a fixed or swivelling fork and axle and a means of attachment (e.g. to a truck or trolley)
- There are three basic types of castors: Swivel and fixed castors with top plates and bolt-hole castors



Roller bearing

- Robust, sturdy, largely maintenance-free bearing
- Low bearing friction
- Impact-resistant
- Permanent lubrication
- The most widely used bearing for low-speed trucks and trolleys



Precision deepgroove ball bearings

- Sealed, maintenance-free precision deepgroove ball bearings
- Guaranteed easy running when loaded, even on sloping or rough surfaces as well as on large strain and high speed
- Minimum bearing friction
- Impact-resistant

WHEELS AND CASTOR TYPES



Wheel



Fixed castor



Swivel castor



Swivel castor with brake

ARRANGEMENT OF SWIVEL AND FIXED CASTORS

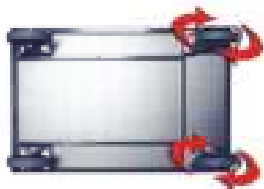

Two swivel and two fixed castors

- Commonest layout
- Good direction stability
- Good cornering



Four swivel castors

- Highly manoeuvrable, suitable for cramped conditions
- Improved directional stability thanks to lockable swivel castors



One swivel and two fixed castors

- Suitable for light loads
- Highly manoeuvrable
- Tends to tip if load concentrated at front



Two swivel and two fixed castors

- Rhombic layout
- Good direction stability
- Lightly turn on spot
- Tends to tip if load concentrated at corners
- Fixed castors are slightly higher



Thermoplastic rubber tyre

Standard castors by **VARIOfit**® trucks and trolleys. Suitable for the most several grounds and applications in the daily use.

■ FEATURES

- Precision deepgroove ball bearings
- High carrying capacity
- Low noise
- Low rolling resistance
- Non-marking
- High wear-resistance
- Resistant to chemicals (oils, gases, acids, solvents and organic substances)
- (-20° / +80°C / 65° Shore A)

65°
Shore A



Pneumatic tyre

Suitable for uneven ground, e.g. with differences in level, especially outdoors.

■ FEATURES

- Roller bearing
- Low carrying capacity
- Good ride comfort
- Low noise

75°
Shore D



Polyamide tyre

For use on level ground in wet areas.

■ FEATURES

- Precision deepgroove ball bearings
- High carrying capacity
- Resistant to chemicals (salts, fats, acids, alkalies)
- (-40° / +90°C / 75° Shore D)

72°
Shore A



Elastic solid-rubber tyre

Recommended for heavy loads even on poor grounds and with sensitive payloads.

■ FEATURES

- Precision deepgroove ball bearings
- High carrying capacity
- Low noise
- Low rolling resistance
- High wear-resistance
- (-20° / +80°C / 72° Shore A)

65°
Shore A



Electrically conductive thermoplastic rubber tyre (ESD)

Suitable where there is a need to prevent static charging of the trolley and payload.

■ FEATURES

- Precision deepgroove ball bearings
- High carrying capacity
- Low noise
- Non-marking
- Low rolling resistance
- High wear-resistance
- (-20° / +80°C / 65° Shore A)

POLYURETHANE TYRES

For use in the industrial sector with heavy loads and for mixed indoor/outdoor applications. Polyurethane can be selected specifically for your field of application.

Polyurethane tyre

Suitable for high stress situations on rough ground, e.g. thresholds and outdoors areas.

■ FEATURES

- Precision deepgroove ball bearings
- High carrying capacity
- Low noise
- High abrasion resistance
- High cut resistance
- Low rolling resistance
- High wear-resistance
- (-20° / +80°C / 92° Shore A)

92°
Shore A



Polyurethane tyre

Particularly suitable in high-friction situations, e.g. for motorised trolleys.

■ FEATURES

- Precision deepgroove ball bearings
- High carrying capacity
- Low noise
- High abrasion resistance
- High cut resistance
- Low rolling resistance
- High wear-resistance
- (-20° / +80°C / 96° Shore A)

96°
Shore A



Thermoplastic rubber tyres

Pneumatic tyres

WHAT DOES SHORE MEAN?

Shore hardness is a material parameter for elastomers and plastics and is defined in the standards DIN EN ISO 868 and DIN ISO 7619-1. The main part of the Shore hardness tester is a spring-loaded needle made of hardened steel. The depth to which it penetrates

the material to be tested is a measure of the Shore hardness which is measured on a scale of 0 Shore (2.5 millimetre penetration depth) to 100 Shore (0 millimetre penetration depth). A high number thus signifies high hardness.



Thermoplastic rubber tyres | Fixed castor | 65° Shore A

Article-no.	Dimension W x D (mm)	Overall height mm	Top-plate outer dim. mm	Bolt hole spacing mm	Weight kg	Load cap. kg
bpg-200.050	200 x 40	235	110 x 4 x 135	75/80 x 105	1.5	225
bpg-160.050	160 x 40	195	110 x 4 x 135	75/80 x 105	1.4	200
bpg-125.050	125 x 30	155	80 x 4 x 105	75/80 x 60	0.6	110



Thermoplastic rubber tyres | Swivel castor | 65° Shore A

Article-no.	Dimension W x D (mm)	Overall height mm	Top-plate outer dim. mm	Bolt hole spacing mm	Weight kg	Load cap. kg
lpg-200.050	200 x 40	235	110 x 4 x 135	75/80 x 105	2.0	225
lpg-160.050	160 x 40	195	110 x 4 x 135	75/80 x 105	1.7	200
lpg-125.050	125 x 30	155	80 x 4 x 105	75/80 x 60	0.8	110



Thermoplastic rubber tyres | Swivel castor with brake | 65° Shore A

Article-no.	Dimension W x D (mm)	Overall height mm	Top-plate outer dim. mm	Bolt hole spacing mm	Weight kg	Load cap. kg
dpg-200.050	200 x 40	235	110 x 4 x 135	75/80 x 105	2.4	225
dpg-160.050	160 x 40	195	110 x 4 x 135	75/80 x 105	2.1	200
dpg-125.050	125 x 30	155	80 x 4 x 105	75/80 x 60	0.9	110



Pneumatic tyres | Fixed castor

Article-no.	Dimension W x D (mm)	Overall height mm	Top-plate outer dim. mm	Bolt hole spacing mm	Weight kg	Load cap. kg	Pressure bar
bpl-230.000	230 x 65	250	110 x 4 x 135	75/80 x 105	2.0	130	3.5
bpl-200.000	200 x 50	235	110 x 4 x 135	75/80 x 105	1.9	75	2.5
bpl-150.001	150 x 30	178	80 x 4 x 105	75/80 x 60	0.8	50	2.5



Pneumatic tyres | Swivel castor

Article-no.	Dimension W x D (mm)	Overall height mm	Top-plate outer dim. mm	Bolt hole spacing mm	Weight kg	Load cap. kg	Pressure bar
lpl-230.000	230 x 65	250	110 x 4 x 135	75/80 x 105	2.5	130	3.5
lpl-200.000	200 x 50	235	110 x 4 x 135	75/80 x 105	2.3	75	2.5
lpl-150.001	150 x 30	178	80 x 4 x 105	75/80 x 60	1.0	50	2.5



Pneumatic tyres | Swivel castor with brake

Article-no.	Dimension W x D (mm)	Overall height mm	Top-plate outer dim. mm	Bolt hole spacing mm	Weight kg	Load cap. kg	Pressure bar
dpl-230.000	230 x 65	250	110 x 4 x 135	75/80 x 105	2.9	130	3.5
dpl-200.000	200 x 50	235	110 x 4 x 135	75/80 x 105	2.7	75	2.5
dpl-150.001	150 x 30	178	80 x 4 x 105	75/80 x 60	1.3	50	2.5



Polyamide tyres
Pneumatic tyres

Polyamide tyres | Fixed castor | 75° Shore D

Article-no.	Dimension W x D (mm)	Overall height mm	Top-plate outer dim. mm	Bolt hole spacing mm	Weight kg	Load cap. kg
bpp-200.002	200 x 50	235	110 x 4 x 135	75/80 x 105	1.9	350
bpp-150.000	150 x 40	185	110 x 4 x 135	75/80 x 105	1.5	350
bpp-125.002	125 x 38	155	80 x 4 x 105	75/80 x 60	1.3	200



Polyamide tyres | Swivel castor | 75° Shore D

Article-no.	Dimension W x D (mm)	Overall height mm	Top-plate outer dim. mm	Bolt hole spacing mm	Weight kg	Load cap. kg
lpp-200.002	200 x 50	235	110 x 4 x 135	75/80 x 105	2.3	350
lpp-150.000	150 x 40	185	110 x 4 x 135	75/80 x 105	1.8	350
lpp-125.008	125 x 38	155	80 x 4 x 105	75/80 x 60	1.5	200



Polyamide tyres | Swivel castor with brake | 75° Shore D

Article-no.	Dimension W x D (mm)	Overall height mm	Top-plate outer dim. mm	Bolt hole spacing mm	Weight kg	Load cap. kg
dpp-200.002	200 x 50	235	110 x 4 x 135	75/80 x 105	2.6	350
dpp-150.000	150 x 40	185	110 x 4 x 135	75/80 x 105	2.0	350
dpp-125.002	125 x 38	155	80 x 4 x 105	75/80 x 60	1.7	200



ADDITIONAL SURCHARGE for polyamide tyres | Set | 75° Shore D

Article-no.	Dimension W x D (mm)
rsa-200.014	200 x 50
rsa-150.014	150 x 40
rsa-125.014	125 x 38

In exchange for standard execution
As ex-factory equipment

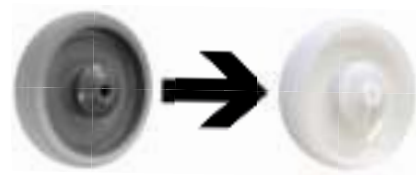

ADDITIONAL SURCHARGE for pneumatic tyres | Set
(Caution: lower carrying capacity)

Article-no.	Dimension W x D (mm)	Load cap. / trolley kg	
rsa-230.003	230 x 65	390	instead 160 x 40, 200 x 40 TR**
rsa-200.003	200 x 50	225	instead 160 x 40, 200 x 40 TR**
rsa-150.002	150 x 30	150	instead 125 x 30 TR**

In exchange for standard execution
As ex-factory equipment
**TR = Thermoplastic rubber tyres

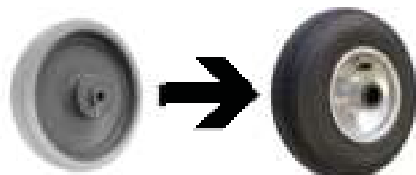

170 SUMMARY OF CASTORS

Elastic solid-rubber tyres
Polyurethane tyres



Also available in grey



Elastic solid-rubber tyres | Fixed castor | 72° Shore A

Article-no.	Dimension W x D (mm)	Overall height mm	Top-plate outer dim. mm	Bolt hole spacing mm	Weight kg	Load cap. kg
bpg-200.006	200 x 50	235	110 x 4 x 135	75/80 x 105	2.8	350
bpg-160.007	160 x 50	195	110 x 4 x 135	75/80 x 105	2.1	300
bpg-125.007	125 x 40	155	80 x 4 x 105	75/80 x 60	1.5	200



Also available in grey



Elastic solid-rubber tyres | Swivel castor | 72° Shore A

Article-no.	Dimension W x D (mm)	Overall height mm	Top-plate outer dim. mm	Bolt hole spacing mm	Weight kg	Load cap. kg
lpg-200.006	200 x 50	235	110 x 4 x 135	75/80 x 105	3.0	350
lpg-160.007	160 x 50	195	110 x 4 x 135	75/80 x 105	2.3	300
lpg-125.007	125 x 40	155	80 x 4 x 105	75/80 x 60	1.6	200



Also available in grey



Elastic solid-rubber tyres | Swivel castor with brake | 72° Shore A

Article-no.	Dimension W x D (mm)	Overall height mm	Top-plate outer dim. mm	Bolt hole spacing mm	Weight kg	Load cap. kg
dpg-200.006	200 x 50	235	110 x 4 x 135	75/80 x 105	3.3	350
dpg-160.007	160 x 50	195	110 x 4 x 135	75/80 x 105	2.6	300
dpg-125.007	125 x 40	155	80 x 4 x 105	75/80 x 60	1.9	200

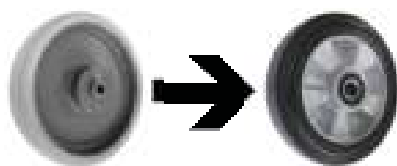

ADDITIONAL SURCHARGE for elastic solid-rubber tyres | Set | 72° Shore A

Article-no.	Dimension W x D (mm)
rsa-200.012	200 x 50
rsa-160.018	160 x 50
rsa-125.012	125 x 40

In exchange for standard execution
As ex-factory equipment



Polyurethane tyres | Fixed castor, swivel castor, swivel castor with brake | 92° Shore A

Article-no.	Dimension W x D (mm)	Overall height mm	Top-plate outer dim. mm	Bolt hole spacing mm	Weight kg	Load cap. kg
bpt-200.001	200 x 50	235	110 x 4 x 135	75/80 x 105	2.5	500
lpt-200.007	200 x 50	235	110 x 4 x 135	75/80 x 105	2.9	500
dpt-200.001	200 x 50	235	110 x 4 x 135	75/80 x 105	3.4	500

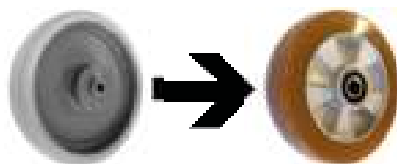

ADDITIONAL SURCHARGE for polyurethane tyres | Set | 92° Shore A

Article-no.	Dimension W x D (mm)
rsa-200.063	200 x 50

In exchange for standard execution
As ex-factory equipment



ESD tyres
Polyurethane tyres

ESD tyres | Fixed castor | 65° Shore A

Article-no.	Dimension W x D (mm)	Overall height mm	Top-plate outer dim. mm	Bolt hole spacing mm	Weight kg	Load cap. kg
bpg-200.036	200 x 40	235	110 x 4 x 135	75/80 x 105	1.6	225
bpg-160.036	160 x 40	195	110 x 4 x 135	75/80 x 105	1.4	200
bpg-125.036	125 x 32	155	80 x 4 x 105	75/80 x 60	0.8	110



ESD tyres | Swivel castor | 65° Shore A

Article-no.	Dimension W x D (mm)	Overall height mm	Top-plate outer dim. mm	Bolt hole spacing mm	Weight kg	Load cap. kg
lpg-200.036	200 x 40	235	110 x 4 x 135	75/80 x 105	2.0	225
lpg-160.036	160 x 40	195	110 x 4 x 135	75/80 x 105	1.7	200
lpg-125.036	125 x 32	155	80 x 4 x 105	75/80 x 60	1.0	110



ESD tyres | Swivel castor with brake | 65° Shore A

Article-no.	Dimension W x D (mm)	Overall height mm	Top-plate outer dim. mm	Bolt hole spacing mm	Weight kg	Load cap. kg
dpg-200.036	200 x 40	235	110 x 4 x 135	75/80 x 105	2.4	225
dpg-160.036	160 x 40	195	110 x 4 x 135	75/80 x 105	2.1	200
dpg-125.036	125 x 32	155	80 x 4 x 105	75/80 x 60	1.1	110



ADDITIONAL SURCHARGES for ESD tyres | Set | 65° Shore A

Article-no.	Dimension W x D (mm)
rsa-200.016	200 x 40
rsa-160.016	160 x 40
rsa-125.016	125 x 32

In exchange for standard execution
As ex-factory equipment

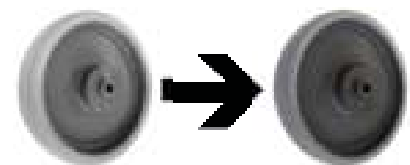

Polyurethane tyres | Fixed castor, swivel castor, swivel castor with brake | 96° Shore A

Article-no.	Dimension W x D (mm)	Overall height mm	Top-plate outer dim. mm	Bolt hole spacing mm	Weight kg	Load cap. kg
bpd-200.000	200 x 50	235	110 x 4 x 135	75/80 x 105	2.5	350
lpd-200.000	200 x 50	235	110 x 4 x 135	75/80 x 105	2.8	350
dpd-200.000	200 x 50	235	110 x 4 x 135	75/80 x 105	3.3	350



ADDITIONAL SURCHARGES for polyurethane tyres | Set | 96° Shore A

Article-no.	Dimension W x D (mm)
rsa-200.065	200 x 50

In exchange for standard execution
As ex-factory equipment

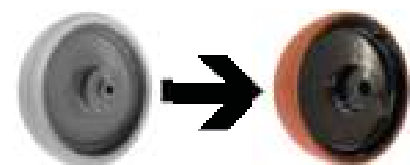

Pneumatic tyre
Solid-rubber tyre
Puncture-proof tyre



Pneumatic tyre | with groove profile

Article-no.	Dimension W x D (mm)	Weight kg	Load cap. kg	Pressure bar
lug-400.008	400 x 100	2.9	300	2.0



Solid-rubber tyre | 80° Shore A

Article-no.	Dimension W x D (mm)	Weight kg	Load cap. kg
ebg-400.008	400 x 80	11.0	450



Puncture-proof tyre

Article-no.	Dimension W x D (mm)	Weight kg	Load cap. kg
lug-390.003	390 x 90	3.2	150

■ **ADDITIONAL SURCHARGE** for puncture-proof tyre | pair

Article-no.	Piece	Dimension W x D (mm)
rsa-390.001	2	390 x 90

In exchange for pneumatic tyre (400 mm)
As ex-factory equipment



Safety handle

Article-no.	Piece	Weight kg
kca-000.160	1	0.2



Plastic skids

Article-no.	Piece	Weight kg	Usable for
kap-710.009	1	0.3	all handtrucks with skids



Plastic cap

Article-no.	Piece	Weight kg	Usable for	diam. mm
k00-000.186	1	0.1	lug-260.008	117
k00-000.257	1	0.1	ebg-260.000	192



Gas pressure spring

Article-no.	Version	Weight kg	Usable for
k00-000.228	new	0.4	tyre trucks
k00-000.178	old	0.1	tyre trucks



Pneumatic tyre | with groove profile

Article-no.	Dimension W x D (mm)	Weight kg	Load cap. kg	Pressure bar
lug-260.008	260 x 85	1.5	150	2.5

FEATURES

- Moves 30% easier
- Groove profile absorbs less dirt
- Low noise moving profile



Solid-rubber tyre | with groove profile

Article-no.	Dimension W x D (mm)	Weight kg	Load cap. kg
ebg-260.000	260 x 65	2.5	200



Puncture-proof tyre

Article-no.	Dimension W x D (mm)	Weight kg	Load cap. kg
lug-260.011	260 x 85	1.5	150

ADDITIONAL SURCHARGE for puncture-proof tyre | pair

Article-no.	Piece	Dimension W x D (mm)
rsa-260.005	2	260 x 85

In exchange for pneumatic tyre (260 mm)
As ex-factory equipment



Optionally load surfaces
Forklift pockets

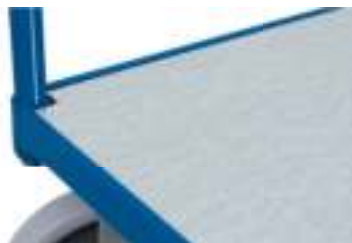

ADDITIONAL SURCHARGE
for galvanised steel load surface

Article-no.	Dimension W x D (mm)
zsw-500.500	850 x 500
zsw-600.500	1000 x 600
zsw-700.500	1000 x 700
zsw-800.500	1200 x 800

As ex-factory equipment

FEATURES

- Galvanised steel sheet folded over load surface



ADDITIONAL SURCHARGE
for plastic load surface

Article-no.	Dimension W x D (mm)
zsw-500.600	850 x 500
zsw-600.602	1000 x 600
zsw-700.600	1000 x 700
zsw-800.600	1200 x 800

As ex-factory equipment

FEATURES

- Abrasion-resistant surface
- Weather-resistant
- Resistant to oil and most acids
- Recyclable



ADDITIONAL SURCHARGE for rubber mat | black

Article-no.	Dimension W x D (mm)
zsw-500.630	850 x 500
zsw-600.630	1000 x 600
zsw-700.630	1000 x 700
zsw-800.630	1200 x 800

As ex-factory equipment



FEATURES

- Made of rubber granulate PKD720
- 3 mm thick
- Glued to the load surface
- Anti-slip



ADDITIONAL SURCHARGE for load surface of plywood, surface finish screen printed

Article-no.	Dimension W x D (mm)
zsw-500.740	850 x 500
zsw-600.740	1000 x 600
zsw-700.740	1000 x 700
zsw-800.740	1200 x 800

As ex-factory equipment



FEATURES

- Film/screen-coated
- Surface finish screen printed
- Anti-slip



ADDITIONAL SURCHARGE for forklift pockets made of flat steel

Artikel-Nr. + /Colour	Dimension W x D (mm)
zsw-000.210 / AG	200 x 100

As ex-factory equipment



FEATURES

- 2 forklift pockets on one long side
- Only for trolleys with a depth of at least 600 mm



Clipboard
Wire basket
Protective strip/Revolving buffers
2 swivel tyres

Clipboard for DIN A4

Article-no.	Decor	Format DIN	Weight kg
zsw-000.000	beech	A4 high	1.0
zsw-000.003	beech	A4 transversely	1.5
zsw-000.000/G	grey	A4 high	1.0
zsw-000.003/G	grey	A4 transversely	1.5

FEATURES

- Of wood-based board, surface finish beech or coated dark grey
- With paper grip and pencil holder
- Attached by tube clamps on the push bar



For articles on page 16

Hang-on wire basket

Article-no.	Dimension W x D x H (mm)	Weight kg
zu-so-1073	520 x 200 x 230	1.5



Protective strip | made of plastic profile

Article-no.	Dimension H (mm)
zsw-000.030	30

As ex-factory equipment

FEATURES

- Attached around the basic frame, protects door frames and walls from damage, scratches, etc.
- Cannot be retrofitted!
- Only for L-profile construction



Revolving buffers | of light grey plastics

Article-no.	Dimension W x D (mm)
zsw-000.002	100 x 24

As ex-factory equipment

FEATURES

- Suitable for narrow passages, to protect walls from damage, scratches, etc.
- Overall width increases by 70 mm
- 1 set = 4 buffers
- Cannot be retrofitted!



ADDITIONAL SURCHARGE for 2 swivel tyres

Article-no.	Tyres
rsa-000.000	TR = Thermoplastic rubber tyres
rsa-000.004	P = Pneumatic tyres
rsa-000.005	ER = Elastic solid-rubber tyres

As ex-factory equipment

FEATURES

- This makes the trolley highly manoeuvrable and it can turn on the spot





Customizing – our daily business!

CHANGEABLE VARIOfit[®] is the brand for especially variable materials handling equipment.

CUSTOMER-FOCUSED In addition to these product variants, **VARIOfit[®]** offers almost unlimited opportunities for modification in line with customers' individual wishes.

SERVICE In a generous extended production department for special equipment we have created the possibility of offering and supplying not only the usual large quantities, but also sample items and small series (from one piece upwards). Our service includes product approval drawings, short delivery times and reasonable prices.

DEVELOPMENT Every day we develop and produce special equipment in line with customers' requirements. In close cooperation with our customers we analyse parameters such as uses, handling, workflows etc. to design the "made of measure" equipment for the goods you want to transport. A locally business call is for us self-evident.

We offer you products in...

- Special sizes
- Special colours
- Complete new designs for customer-specific applications



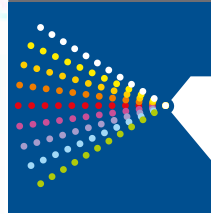

Special colour – depending on the purpose!

COLOURFUL VARIETY Customize the transport devices not only technically, but also optically to your wishes, requirements and circumstances.

IMAGE COLOUR "Corporate Identity" is only one of many reasons for opting out of the standard.

FINISHING In the usual **VARIOfit®** quality, after thorough pretreatment, the finishing of the surface takes place in our automatic powder coating system.

PROTECTIVE COATING The powder coating ensures permanent surface protection as well as impact- and scratch-resistance.



INDEX

A	PAGE	D	PAGE	F	PAGE
Add-on frame	129	Distance piece	116	Four-sided	
Aluminium Store-room trolley	10, 15	Document trolley	158 - 159	<i>Box trolley</i>	20-21
Aluminium table trolley	24	Dolly	154-156	<i>Parcel trolley</i>	34-35
Aluminium truck	103-105, 108-110	Dolly collector	154	<i>Systemtrolley</i>	11-13
Anti-slip	174 (Acc.)	Dolly Europa	155	<i>Shelf trolley</i>	37, 40-43, 67-68 (ESD), 151
Antistatic (ESD)	66-75, 167 + 171 (Acc.)	Double wing door	40-43, 66-68 + 75 (ESD), 76-82	Furniture truck	110
Appliance truck	111	Double-end push bar trolley	9	G	
B		Double-end trolley	11-13	Galvanised	
Ball socket	146-148	Drawbar	95, 131, 140-145, 152	<i>Pallet Handling</i>	133, 135, 137, 139
Bicycle trailer	142	Drawbar eye	131, 145, 152	<i>Shelf trolley</i>	42-43, 46, 68 (ESD), 94
Book trolley	158	Drawer	22-23, 73, 75 (ESD), 76-82	<i>Steel load surface</i>	26, 174 (Acc.)
Box shelf trolley	34-43, 47-49, 66-68 + 70 (ESD)	Drawer cabinet	73 + 75 (ESD), 76-82	<i>Table trolley</i>	26
Box trolley	20-21	Drawer divider set	80-81	<i>Tyre rack</i>	115
Box trolley with board panels	20-21	Drip tray	29, 125-126	Gas pressure spring	21, 93, 97, 114-115, 173 (Acc.)
Brake lever	90-91, 112	Drum dispenser	125	Grating	29, 126
Bridge plate	162	Drum dolly	122	H	
Bulk material	160	Drum trolley	123, 126	Hand platform trolley	143-145
Bulky goods truck	112	Drum truck	122, 124	Hand truck	140-141
C		E		Handling of drums	122-126
C+C trolley	16	EasySTOP (Explanation)	2, 5, 6, 7	Hang-on wire basket	175 (Acc.)
Cabinet	75 (ESD), 76-82	Elastic solid-rubber tyres	167 + 170 (Acc.)	Heavy-duty	
Carrie-spar trolley	86-87	Electrostatic discharge (ESD)	66-75, 167 + 171 (Acc.)	<i>Hand platform trolley</i>	143-144
Carrying bars	111	ESD trolley	66-75	<i>Push bar trolley</i>	8, 13
Catching corners	128-131	ESD tyre	167 + 171 (Acc.)	<i>Steel-frame dolly</i>	128
Chair truck	110	Euro boxes	47-52, 56-64, 70-71 (ESD), 94	<i>Stanchion trolley</i>	150-152
Clamping device	136-137	Euro container trolley	47-49, 70 (ESD)	<i>Table trolley</i>	27
Cleaning trolley	161	Euro system dolly	56-63, 72 (ESD)	<i>Workshop trolley</i>	79
Clipboard	175 (Acc.)	Extension tube	117	Holder selection	83
Corrugated bracket	85	F		I	
Coupling	6, 95, 131, 142, 145, 152	Feet	19, 115, 117, 126, 141, 146	Industrial trailer	152-153
Crate dolly	55	Folding push bar trolley	14-15	L	
D		Folding toe	100, 113 104 (Aluminium)	Lightweight folding truck	113
Dead man's brake (Explanation)	164	Folding truck	113	Loading platform	90-91
<i>Push bar / folding push bar trolley</i>	10, 14	Fork bracket	85	Lock	158-159
<i>Shelf trolleys</i>	32, 36	Forklift forks	90-91	<i>Disposal</i>	161
<i>Steel-cylinder / drum handling</i>	121, 123	Forklift pockets	174 (Acc.)	<i>Document trolley</i>	158-159
<i>Table trolley</i>	23			<i>Shelf trolley</i>	40-43, 66-68 (ESD)

INDEX

L	PAGE	P	PAGE	S	PAGE
Lock		Polyurethane tyre	167 + 170-171 (Acc.)	Stackable	132-139, 146
<i>Workshop trolley</i>	75 (ESD), 76-82	Protective strip	158-159, 175 (Acc.)	Stacking corners	146
<i>Table and box trolley</i>	21-23	Puncture-proof tyre	172-173 (Acc.)	Stair-climber truck	106-109
Long-goods dolly	149	Push bar trolley	8-10, 72 (ESD), 126	Star wheels	106-109, 111
Long-goods trolley	149	Push-handle dolly	64-65, 70 (ESD)	Steel box trolley	21
M		Push/pull bar	40-43, 66-68, 95, 117, 164	Steel-frame dolly	128-131
Material box	85	Q		Steel-cylinder stand	121
Material crate	83, 85	Quick-lift jack	146-147	Steel-cylinder trolley	121
Materiallifter	90-91	R		Steel-cylinder truck	118-121
Material stand	52-53, 71 (ESD)	Ramp	162	Step tread	93, 95
Mesh box trolley	20-21	Reflective films	140-145	Store-room trolley	10
Mesh system trolley	11, 18	Revolving buffers	175 (Acc.)	Supporting roller	97, 112, 114, 120, 123-124
Mesh shelf trolley	40-41, 45-46, 67 (ESD), 94-95, 159	Roll stand	141	System dolly	56-63, 72 (ESD)
Mesh workpiece trolley	84	Roll truck	141	T	
N		Roller shutter locking	159	Table transporter	157
Non-slip covering	44, 110, 154, 156	Rubber mat	174 (Acc.)	Table trolley	9, 22-29, 73-74 (ESD)
O		Rubber mat, grooved	15, 55, 155, 157	Three-sided	
Oil-tight loading surface	28-29, 125-126	S		<i>System trolley</i>	11-13
Order-picking trolley	93-95	Safety chain	118-121	<i>Shelf trolley</i>	34-35, 37-38
Outlet cock	29, 126, 160 (Acc.)	Safety handle	173 (Acc.)	<i>Heavy-duty trolley</i>	151
P		Safety quick-lift jack	147	Thorn	91
Pallet converter	132-139	Screen-printed panel	174 (Acc.)	Thorn bracket	85
Parcel trolley	34	Self-tipper	160	Tipping unit	130
Parcel truck	113	Separation grid	132-133	Toolbox	120
Pegboard tool pane	83	Sheet-material stand	19	Trailer	140-145, 152-153
Pipe carrier	85	Sheet-material trolley	19, 88	Tray	30-33
Plastic cap	173 (Acc.)	Sheet-material truck	89	Triple-Dog	156
Plastic clip	116, 158-159, 175 (Acc.)	Shelf trolley	30-33, 35-46, 66-69 (ESD)	Tubular bar	19
Plastic crate	47-48, 50-51, 62, 64	Shrink hose	86-87, 123	Tubular-steel truck	97-102
Plastic load surface	174 (Acc.)	Side frame trolley	16, 18-19	Turnable steering	152
Plastic skid	96, 99-100, 103-104, 122, 173 (Acc.)	Singel-end trolley	11-13, 150-151	Two-wheeled platform	146-148
Platform trolley	7	Skid	96, 99-100, 103-104, 122, 173 (Acc.)	Tyre rack	115-117
Pneumatic tyre	96, 167-168, 172-173 (Acc.)	Slide down safety	84	Tyre trolley	115-117
Polyamide tyre	167 + 169 (Acc.)	Slip off safety	86-87	Tyre truck	114-115
		Small order-picking trolley	50-51, 70 (ESD)	<i>with telescopic extension</i>	114
		Solid-rubber tyre	96, 172-173 (Acc.)	W	
				Waste collection stand	161
				Waterproof	174 (Acc.)
				Workpiece trolley	84-85
				Workshop trolley	75 (ESD), 76-83

www.variofit.eu

Cordes GmbH & Co. KG

Weißfelder Straße 1 • D - 21698 Harsefeld

tel.: +49 (0) 4164 816 0 • fax: +49 (0) 4164 816 28 300

email: info@cordes.eu • info@variofit.eu

Ergonomics
and
safety



Easy
STOP

Sustainable
thanks
to quality



TUV
SUD

RAL
7016

RAL
5010

Available in
2 colours as
standard ...



or almost any other

Customised products -
our daily
business!



Your **VARIOfit**® dealer

