

 GENORAY



**PAPAYA** <sup>Plus</sup> **Slim**

The World's First & Only  
3-in-1 OPG Unit  
Panoramic  
Cephalometric &  
Semi-Tomography Imaging

**UNICORN** <sup>®</sup>  
**DenMart**   
Behind The Best Indian Dentists

## In House Manufacturing

**G**enoray is a Medical & Dental equipment manufacturer that offers in-house manufacturing of its products. This means that the company has complete control over the production process, from design to assembly, allowing for strict quality control. Genoray's in-house manufacturing capabilities include injection molding, PCB assembly, cable assembly, and final product assembly. By keeping manufacturing in-house, Genoray ensures that its products meet high standards of quality and reliability while also allowing for faster turnaround times and the ability to make modifications quickly. This approach enables Genoray to maintain a competitive edge in the market and provide its customers with top-quality medical & dental equipment.

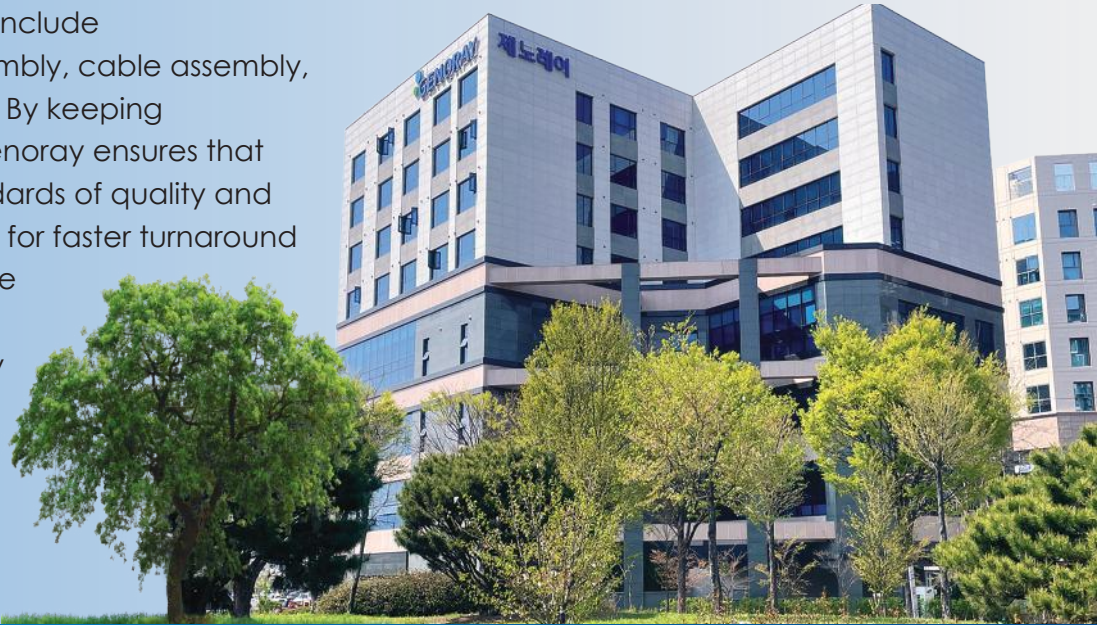

### Continuous R&D Investment

- ▲ 8-10% Investment in Annual Sales
- ▲ 30% of all Researchers have Masters & Doctorates
- ▲ R&D Performance - 72 Cases (Government, External & Self)
- ▲ Intellectual Property - 47 Patents, 27 Trademarks
- ▲ Certification Status - 85 Cases (Domestic & International)



### R&D through cross-over by Different Sectors

- ▲ Integrated Management of Medical & Dental Research
- ▲ Specialized Technology by Sector - R&D



### Internalization of Core Technology

- ▲ Manufacturing Technology of X-Ray Generators
- ▲ Inhouse development of Flat Panel Detectors
- ▲ 3D Image Processing with Correction Algorithm
- ▲ Dedicated Software Development - THEIA, TRIANNA

## Ultimate Panoramic Imaging

High Resolution X-Ray Imaging System

PAPAYA uses the advanced CMOS sensor, which improves image quality while keeping radiation exposure to a minimum, Genoray has shown that it puts patient's safety first.



## Multi-Focus Function

Improves Image Analysis & avoids the need of re-exposure.

The Multi-focus function overcomes patient mis-positioning. The user is therefore able to find the most optimally-focused choice from a selection of images.

**5 panoramas**  
**OPTIMAL IMAGE**

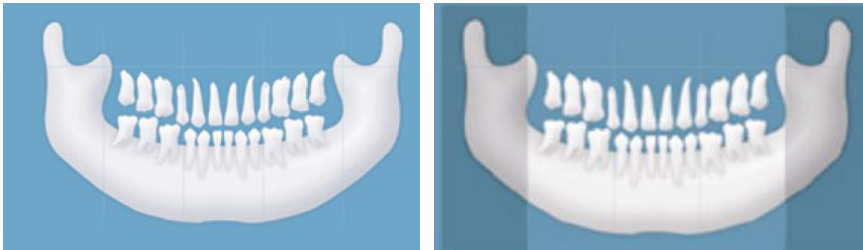
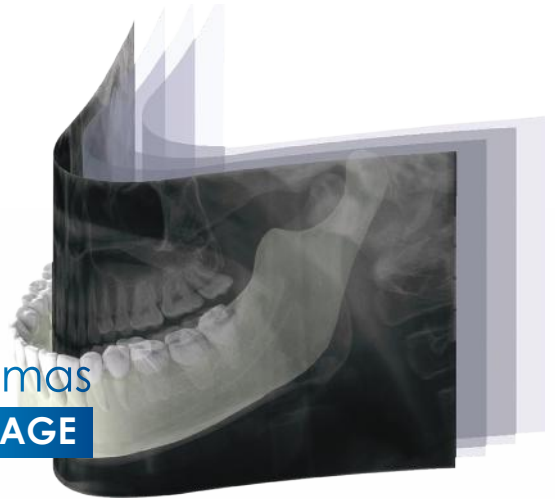

## Protection From Unwanted Radiation

Segmental selection 2D scan saves from unwanted radiation.

## User Friendly

PAPAYA increases user friendliness while maximizing efficiency



**Face-to-face positioning**



**Multi-role remote with emergency stop switch**

Machine's and hand switch's LED display shows the current status of machine



**9 different jaw shapes**

Fit each individual's jaw shape



**Voice support system**

Machine's operation status is guided by voice support system



**Wheelchair accessible**



**Dental Crop**

Provides full mouth IOS images

**According to exposure mode, LED color changes.**



## 20 Different Exposure Modes

Different 2D images for various diagnosis purpose

PAPAYA supports various exposure programs, fulfilling all diagnostic needs.

Standard panoramic, orthogonal panoramic, bitewing panoramic, child panoramic, TMJ lateral double, horizontal & vertical X-ray segmentation, TMJ PA double, TMJ LAT-PA, TMJ LAT-PA double, sinus lateral, sinus PA and CUST are supported.



|                      |          |             |          |              |               |        |               |
|----------------------|----------|-------------|----------|--------------|---------------|--------|---------------|
| <b>Panoramic</b>     | Standard | Orthogonal  | Bitewing | <b>TMJ</b>   | Lateral       | PA     | Double Lat-PA |
| <b>Sinus</b>         | Lateral  | Lateral Mid | PA       | <b>CUST</b>  | Cross Section |        |               |
| <b>Cephalometric</b> | Lateral  | AP          | PA       | Water's View | SMV           | Carpus |               |

## Smart & compact design!

Papaya: This smart design will allow for easy and fast setting installation.

Not only that, its compact design requires minimum space & is easily accessible for your patients.



Fast, HD & Normal Scan Mode



User friendly LED indication

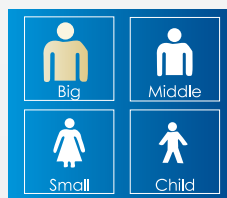

4 different patient selection



Even more, Tomography! (optional)

## Tomography Imaging

### Cubical Semi-Tomography Technology (CUST)

PAPAYA CUST is a 3D imaging function that provides cross-sectional information for **implant planning**.

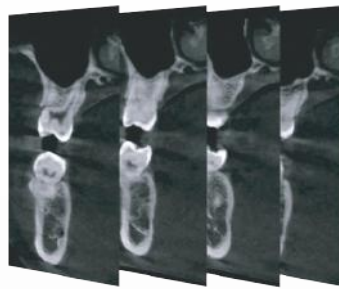
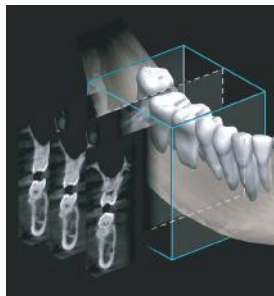

**Dental Cross Sectional View**

- ▲ Complements the panoramic image and provides a tomographic image required for implant planning
- ▲ When planning the implant, CUST images help the patient understand the procedure
- ▲ PAPAYA with CUST function is economical compared to CBCT



## Exposure Programs

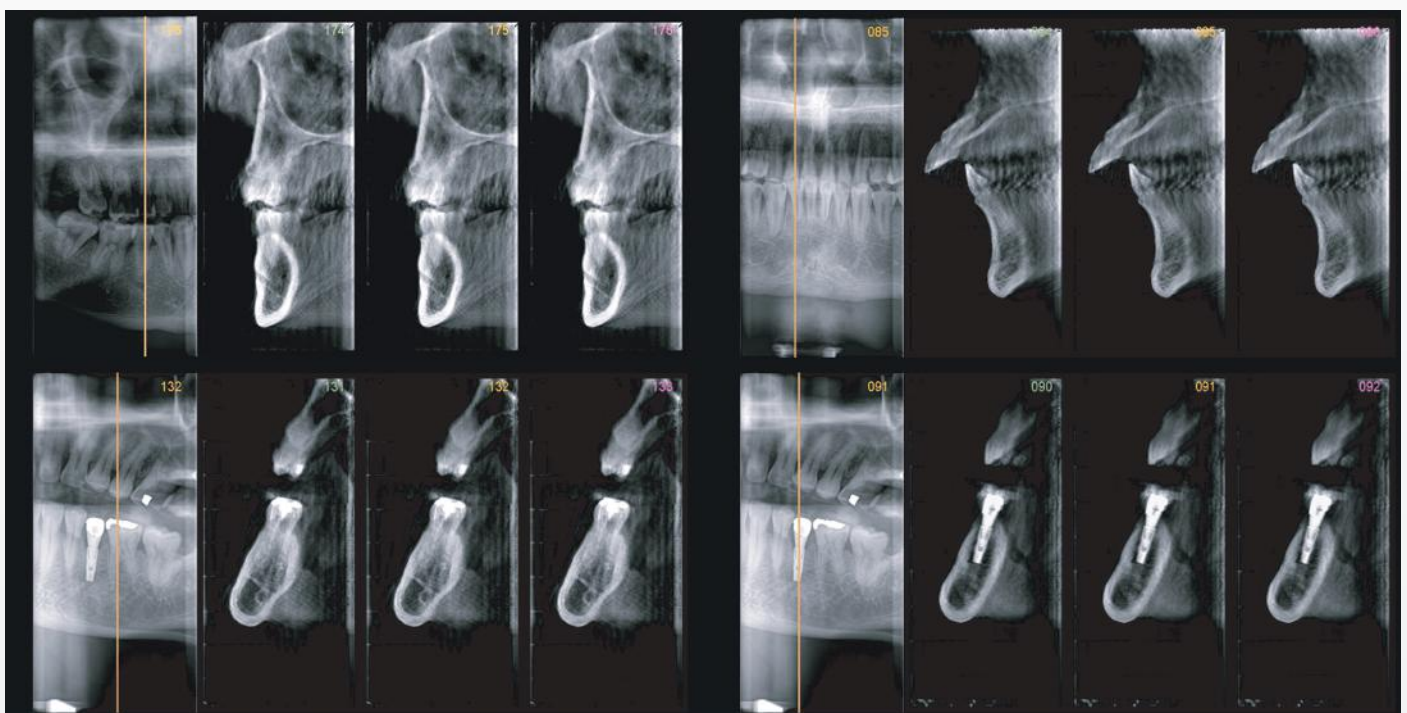

## Cephalometric

Advanced Solution For Orthodontic Diagnosis

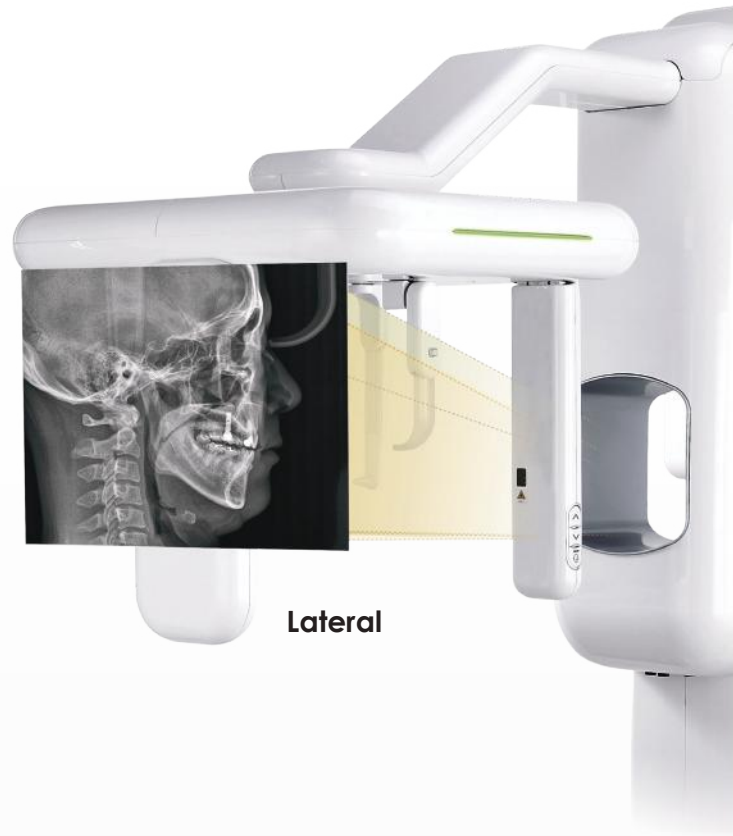
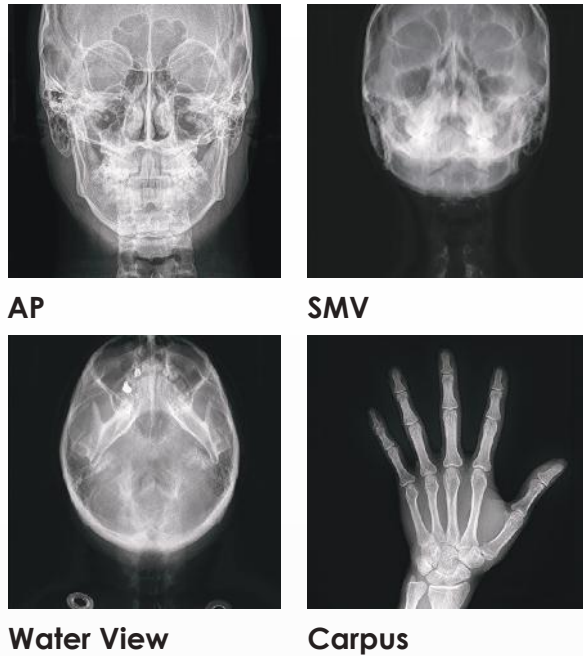

- ▲ The optimized mechanical structure is designed for symmetrical balance, enhanced safety and durability
- ▲ To optimise result, the sensor automatically positions for each exposure mode
- ▲ Only 4 seconds for scanning, a cephalo image in fast mode reduces motion artifacts

## PAPAYA Operational Software

PAPAYA exposure modes are prepared and initiated using clear step by step pictorial software.

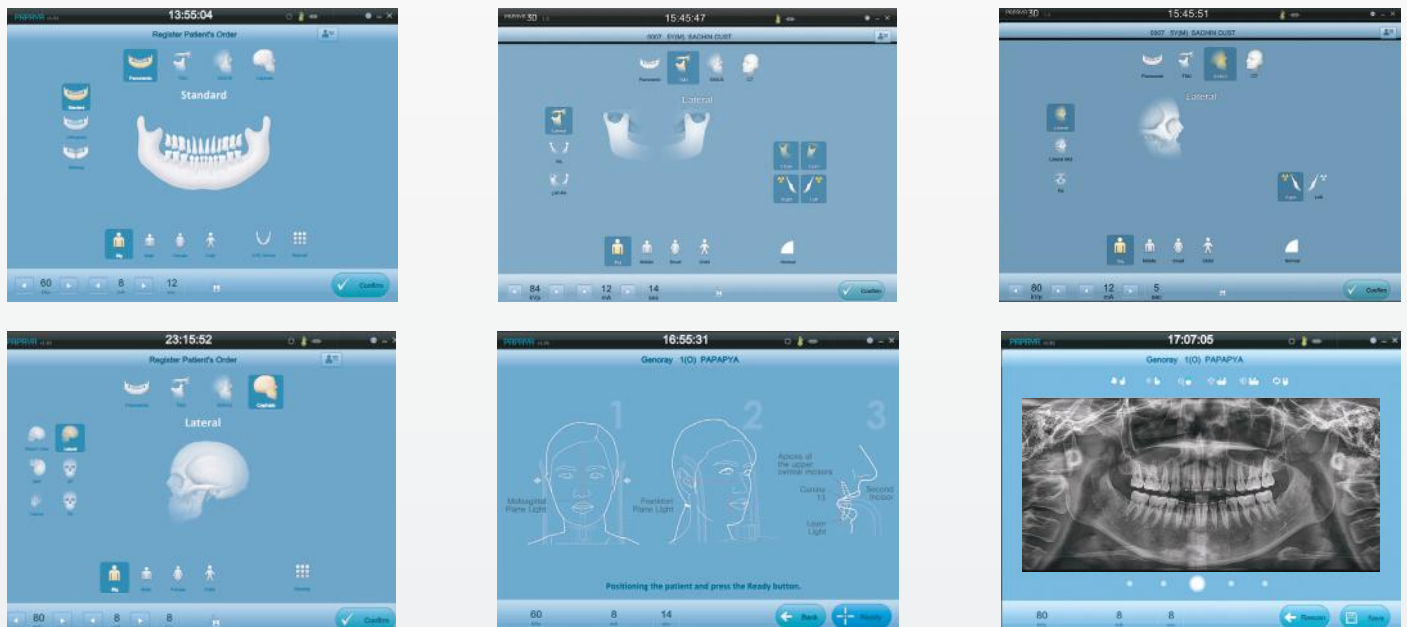

# TRIANA

TRIANA is able to manage all images from all devices. (panoramic, cephalometric, intraoral sensor, CBCT, Intraoral camera and digital camera)

|                                             |                                                  |
|---------------------------------------------|--------------------------------------------------|
| Image viewing                               | Zoom, Panning, Comparing, Window leveling        |
| Measurement                                 | Distance, Angle                                  |
| Annotations                                 | Line, Arrow, Text, Stamp                         |
| Implant simulation, DICOM 3.0 compatibility | Storage (DICOM send), film printer, worklist etc |
| Image enhancement, Printing                 | Paper, Film printer, WYSWYG                      |
| Image import/export                         | bmp, jpg, gif, png, dcm etc                      |

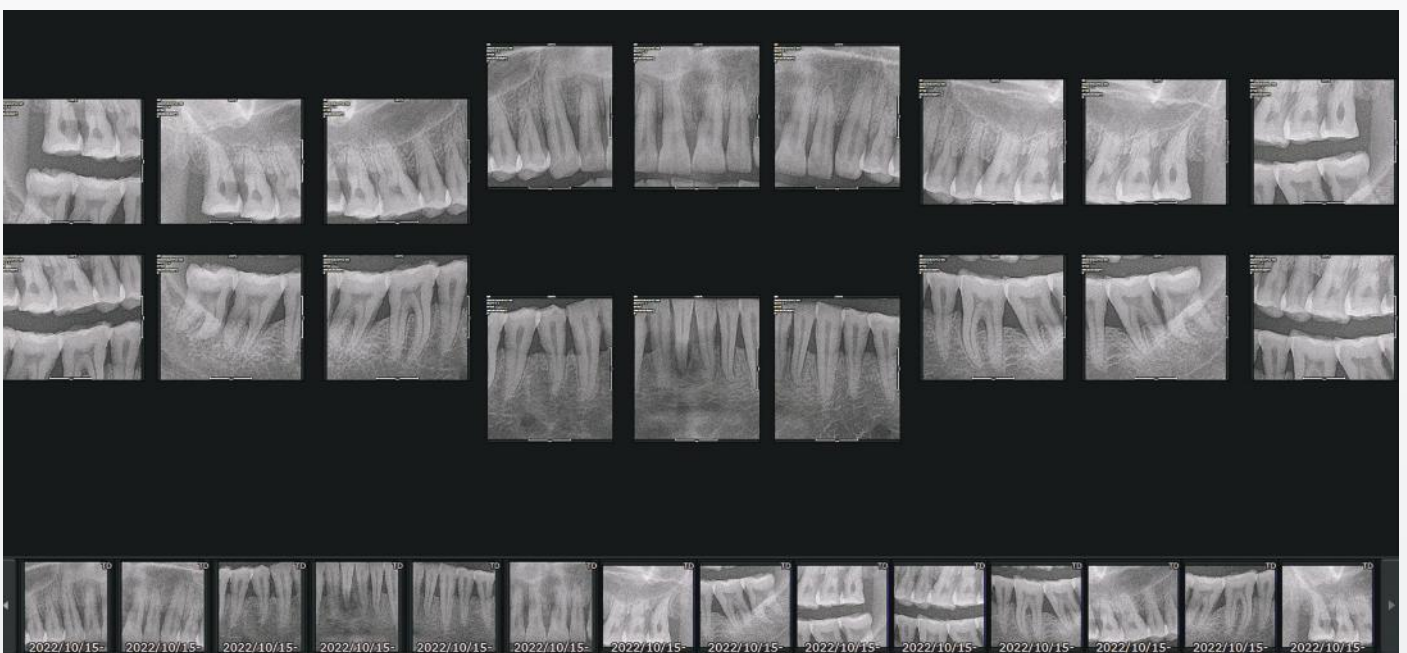
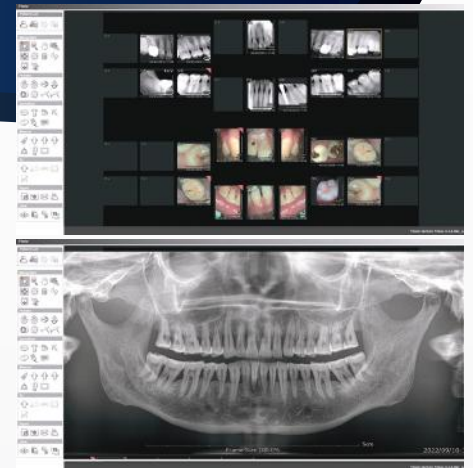

### Technical Specification - PAPAYA

|                      |          |
|----------------------|----------|
| Exposure Time        | 4-17 sec |
| Focal Spot           | 0.5mm    |
| Target Angle         | 5°       |
| Sensor Tehnology     | CMOS     |
| Maximum Tube Voltage | 90kV     |
| Minimum Tube Voltage | 60kV     |
| X-Ray Tube           | Canon    |

### Sensor

|             | PAPAYA     | PAPAYA Plus |
|-------------|------------|-------------|
| Pixel Pitch | 75x75 µm   | 75x75 µm    |
| Active Area | 152x6.5 mm | 228x6.5 mm  |

### CUST Specification

|                       |              |
|-----------------------|--------------|
| X-ray beam            | Fan Beam     |
| Volumetric image size | 50X50X103 mm |
| Number of slices      | 256          |
| Slice thickness       | 0.195 mm     |
| Measurement error     | <1 mm        |

## Dimensions

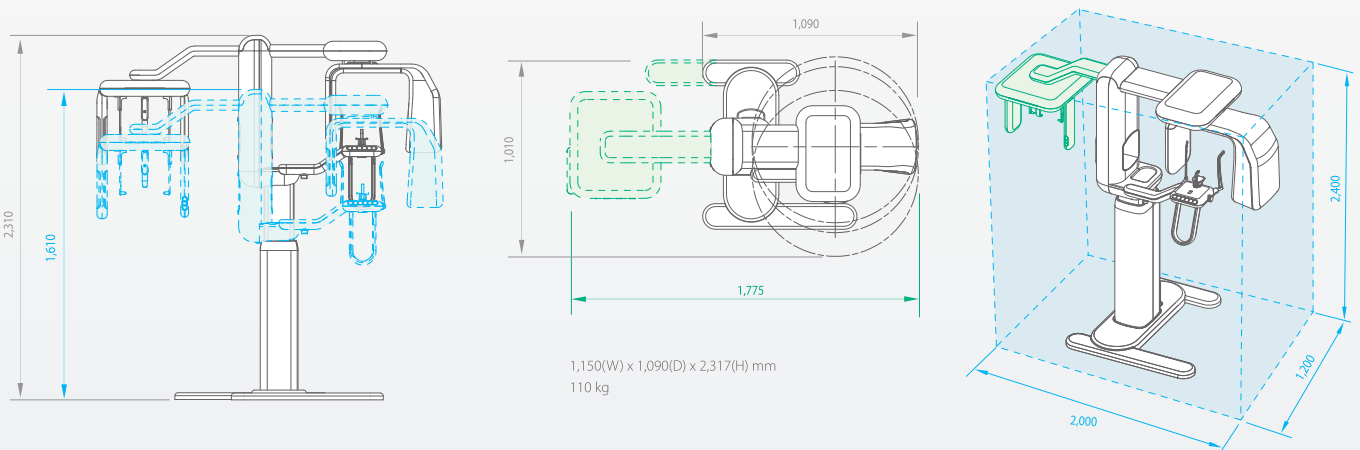



## Our Esteemed Clients of OPG

| Andhra Pradesh |                                                |                 |
|----------------|------------------------------------------------|-----------------|
| S. No.         | Doctor Name                                    | City            |
| 1              | CMC Vellore Hospital                           | Chittoor        |
| 2              | Dr. Tirumal Rao                                | Kadapa          |
| 3              | Dr. Sarveshwara Rao                            | Eluru           |
| 4              | Star Dental Centre Pvt Ltd                     | Kakinada        |
| 5              | Maj Dr Batchu Santhosh                         | Nandyal         |
| 6              | Dr. A Swaroop Kumar Reddy                      | Nellore         |
| 7              | Sri Surga Multi Speciality Dental Clinic       | Vijaywada       |
| 8              | Thomson Scan                                   | Visakhapatnam   |
| 9              | Dr. Ambati Ishwarya                            | Warangal        |
| 10             | Dr. Deepthi Gadam                              | Srikakulam      |
| 11             | Dr. Nemaly Chaithanyaa                         | Madanapalle     |
| 12             | Dr. Podugu Kalyan Chakravarthy                 | Srikakulam      |
| 13             | Dr. S Chandra Sekhara Reddy                    | Anantapur       |
| 14             | Dr. Surya Kumari Ittamsetti                    | Visakhapatnam   |
| 15             | Dr. V. Rammohan Reddy                          | Chittoor        |
| 16             | Dr. Vinod Birra                                | Visakhapatnam   |
| 17             | Dr. Y Ramana Reddy                             | Nellore         |
| 18             | Dr. Sowmya                                     | Anantapur       |
| 19             | Krishna Institute of Medical Sciences Limited  | Nellore         |
| 20             | Sowjanya Dental Hospital                       | Guntur          |
| 21             | Sri Chaitanya Multi Speciality Dental Hospital | Jangareddigudem |
| 22             | Amrutha Multispeciality Dental Clinic          | Srikakulam      |
| 23             | Dr. A Swaroop Kumar Reddy                      | Nellore         |
| 24             | Dr. A Swaroop Kumar Reddy                      | Nellore         |
| 25             | Dr. A Swaroop Kumar Reddy                      | Nellore         |
| 26             | Dr. Anupoju Someswara Rao                      | Visakhapatnam   |
| 27             | Dr. G Leela Krishna Mohan                      | Vijaywada       |
| 28             | Dr. Kalyan Chakravarthy P                      | Srikakulam      |
| 29             | Dr. M. Venkata Gangadhar                       | Rajahmundry     |
| 30             | Dr. Sajjan Anand Gubbala                       | Amalapuram      |
| 31             | Dr. V. Raghvendra                              | Kadiri          |
| 32             | Dr. Deepthi Gadam                              | Srikakulam      |
| 33             | Dr. Deepthi Gadam                              | Srikakulam      |
| 34             | Dr. Kranthikumar Yangla                        | Vijaywada       |
| 35             | Dr. Lakshman Rao                               | Tiruvuru        |
| 36             | Dr. Ravi Chandra Koganti                       | Visakhapatnam   |
| 37             | Dr. Vinjamuri Anil Dev Dutt                    | Visakhapatnam   |
| 38             | Dr. Kishor                                     | Kurnool         |
| 39             | Dr. Ramamoorthy                                | Amalapuram      |
| 40             | Dr. Y. Indraneel                               | Kavali          |
| 41             | Krishna Institute Of Medical Sciences Limited  | Ongole          |
| 42             | R N Labs & Diagnostic                          | Vizianagaram    |
| 43             | Vijju Dental Clinic                            | Elamanchili     |
| 44             | Aditya Educational Society                     | Srikakulam      |
| 45             | Dr. Alapati Kranthi Kumar                      | Visakhapatnam   |
| 46             | Dr. Bharath                                    | Godavari        |

| 47    | Dr. Bonthu Jagadesh Babu                                    | Narsipatnam   |
|-------|-------------------------------------------------------------|---------------|
| 48    | Dr. Ch. Venkateshwararao                                    | Vijaywada     |
| 49    | Dr. Chandra Sekhar Chadalavada                              | Guntur        |
| 50    | Dr. Raviteja Borugadda                                      | Vijaywada     |
| 51    | Dr. Rohini Gouda                                            | Warangal      |
| 52    | Dr. Sanjay Dutt                                             | Vijaywada     |
| 53    | Dr. Anil Kumar Katta                                        | Guntur        |
| 54    | Dr. G Vamsi Krishna                                         | Srikakulam    |
| 55    | Dr. Kalyan Ksvk                                             | Rajahmundry   |
| 56    | Dr. Lakshmi Narayana Metta                                  | Srikakulam    |
| 57    | Dr. Ramesh Naidu Balaga                                     | Srikakulam    |
| 58    | Dr. S. Suryaprakash                                         | Kadapa        |
| 59    | Dr. Venkat Kale                                             | Prakasam      |
| 60    | Dr. Venkata Ranjit Kumar Peravali                           | Guntur        |
| 61    | Dr. Votturi Kartheek                                        | Chittoor      |
| 62    | Dr. V. Sunil Kumar Reddy                                    | Kadapa        |
| 63    | Gadam Multispeciality Dental Hospital And Implant Centre    | Visakhapatnam |
| 64    | Garlapati Kavitha Reddy                                     | Warangal      |
| 65    | Sms Dental Hospital                                         | Visakhapatnam |
| 66    | Star Dental Centre Pvt. Ltd                                 | Vijaywada     |
| 67    | Tirumala Multi Speciality Hospitals (India) Private Limited | Vizianagaram  |
| 68    | Vamsi Krishna Dental Hospital                               | Kadapa        |
| 69    | Dr. Raviteja Borugadda                                      | Vijaywada     |
| 70    | Dr. G Kanchan Sagar                                         | West Godavari |
| 71    | Dr. Ram Chand Bandla                                        | Guntur        |
| 72    | Ravitej Dental Care                                         | Chirala       |
| 73    | Dr. A Swaroop kumar reddy                                   | Nellore       |
| 74    | Sri Padmavathi Diagnostic Centre                            | Nellore       |
| 75    | Dr. Prathyusha                                              | Guntur        |
| 76    | Sri Surga Multi Speciality Dental Clinic                    | Vijaywada     |
| 77    | Dr. Sana Naqvi                                              | Hyderabad     |
| 78    | Vijju Dental Clinic                                         | Yelamanchili  |
| 79    | Dr. Kopuri Raj Kumar                                        | Guntur        |
| 80    | Dr. C Tejadeepthi                                           | Hyderabad     |
| 81    | Dr. Lakshmi Narayana Metta                                  | Srikakulam    |
| 82    | Harikrishna Inst. of Oncology Pvt. Ltd.                     | Hyderabad     |
| 83    | Dr. Vijay Kumar Reddy                                       | Hyderabad     |
| 84    | Dr. Kishor                                                  | Kurnool       |
| 85    | Aaradhya Dental Clinic                                      | Kadapa        |
| 86    | All India Inst. of Medical Sciences (A.P)                   | Vijaywada     |
| 87    | Sun Imaging & Diagnostics                                   | Visakhapatnam |
| 88    | Dr. J Ravi Rakesh Dev                                       | Guntur        |
| 89    | Dr. Siva Nagini                                             | Hyderabad     |
| Assam |                                                             |               |
| 90    | Dr. Santanu Borah                                           | Nagaon        |
| 91    | Dr. Abhijit Das                                             | Tinsukia      |
| Bihar |                                                             |               |
| 92    | Dr. Kumar Sharad Bhusan                                     | Darbhanga     |

## Our Esteemed Clients of OPG

|                     |                                                       |                    |
|---------------------|-------------------------------------------------------|--------------------|
| 93                  | Dr. Sanjeev Kumar Bisen                               | Patna West         |
| 94                  | Dr. Amod Kumar Srivastava                             | Gopalganj          |
| 95                  | Dr. Ashutosh Trivedi C/o Oro Dental Speciality Clinic | Patna West         |
| 96                  | Dr. Parthsarathi Gautam                               | Chapra             |
| 97                  | Sarjug Dental College & Hospital                      | Darbhanga          |
| 98                  | Dr. Atish Kumar                                       | Sitamarhi          |
| 99                  | Dr. Fahad Siddiquee                                   | Gaya               |
| 100                 | Dr. Shaheed Akhatar                                   | West Champaran     |
| 101                 | Gautam Digital X-Ray And Opg Centre                   | Patna West         |
| 102                 | Global Health Patliputra Pvt Ltd.                     | Patna East         |
| 103                 | Lalan Kumar Patel                                     | Patna West         |
| 104                 | Mr. Surendra Prasad Singh                             | Gaya               |
| 105                 | Vaishnavi Diagnostic Centre                           | Patna East         |
| 106                 | Dr. Vivek Kumar                                       | Bhagalpur          |
| 107                 | Mr. Surjit Jha                                        | Madhubani          |
| 108                 | Mr. Vivek Kumar                                       | Bihar Sarif        |
| 109                 | Narayan Medical College & Hospital                    | Sasaram            |
| <b>Chandigarh</b>   |                                                       |                    |
| 110                 | Dr. Kuldeep Singh                                     | Mohali             |
| 111                 | Dr. Pushpinder Mangat                                 | Chandigarh         |
| 112                 | Dr. Avni Dixit                                        | Chandigarh         |
| 113                 | Puneet Singh Talwar                                   | Panchkula          |
| 114                 | Dr. Poonam Rani                                       | Chandigarh         |
| 115                 | Dr. Harjap Singh                                      | Chandigarh         |
| 116                 | Dr. Sarabjeet Singh                                   | Chandigarh         |
| 117                 | Dr. Kochars House Of Smiles                           | Chandigarh         |
| 118                 | Star Dental Center Pvt Ltd,                           | Panchkula          |
| 119                 | Star Dental Centre Pvt Ltd                            | Chandigarh         |
| 120                 | Dr. Ravi Kumar                                        | Chandigarh         |
| 121                 | Dr. Navneet Randhawa                                  | Mohali             |
| <b>Chhattisgarh</b> |                                                       |                    |
| 122                 | Dr. Abhay Premprakash Agrawal                         | Bilaspur           |
| 123                 | Dr. Pooja Verma                                       | Nagri              |
| 124                 | Asa Diagnostic                                        | Rajnandgao         |
| 125                 | Dr. Abhishek Goyal                                    | Dhamtari           |
| 126                 | Dr. Shobhan S Shahare                                 | Durg               |
| 127                 | Dr. Manu Rajmohan                                     | Raipur             |
| 128                 | Dr. Saurabh Kumar Jain                                | Raipur             |
| 129                 | Dr. Ashish Soni                                       | Bilaspur           |
| 130                 | Dr. Ayush Singh                                       | Koriya             |
| 131                 | Dr. Shailendra Singh Chaturvedi                       | Bilaspur           |
| 132                 | Dr. Dilpreet Kaur Rajkhokar                           | Mahasamund         |
| 133                 | O. M. R. Diagnostices                                 | Ambikapur          |
| 134                 | Adwani Diagnostics Centre                             | Raipur             |
| 135                 | Dr. Pooja Verma - Chhattisgarh                        | Nagri              |
| <b>Delhi</b>        |                                                       |                    |
| 136                 | Dr. Pratul Mehra                                      | Sarvodhya Enclave  |
| 137                 | Dr. Anurag Gupta                                      | Safdarjung Enclave |
| 138                 | Dr. Abu Nasar                                         | Jamia Nagar        |

|     |                                                          |                    |
|-----|----------------------------------------------------------|--------------------|
| 139 | Dr. Manish Gupta                                         | Greater Kailash-2  |
| 140 | Dr. Manish Gupta                                         | Greater Kailash-2  |
| 141 | Dr. Shashi Bhushan                                       | Gulmohar Park      |
| 142 | Dr. Shashi Bhushan                                       | Gulmohar Park      |
| 143 | Star Dental Centre Pvt. Ltd, Sda                         | Safdarjung         |
| 144 | Dr. Gautam Suhag C/O National Industrial Training Centre | Dwarka Mod         |
| 145 | Dr. Reema Nafis                                          | Sarita Vihar       |
| 146 | Dr. Sachin Gupta                                         | Shahdara           |
| 147 | Dr. Saurabh Gupta                                        | South Extension    |
| 148 | Global Health Research Group                             | Greater Kailash    |
| 149 | Shanti Dental Clinic                                     | Patel Nagar        |
| 150 | Star Dental Center Pvt. Ltd.                             | Mayur Vihar        |
| 151 | Star Dental Center                                       | Dwarka             |
| 152 | Star Dental Center                                       | Shivalik           |
| 153 | Star Dental Center                                       | Vikaspuri          |
| 154 | Star Dental Center                                       | Rohini             |
| 155 | Star Dental Center                                       | Saket              |
| 156 | Star Dental Centre Pvt. Ltd.                             | Derawal Nagar      |
| 157 | Star Dental Centre Pvt. Ltd.                             | Janak Puri         |
| 158 | Venkateshwar Centre Of Dental Excellent Pvt Ltd          | Dwarka             |
| 159 | Dr. Kapil Arora                                          | Lajpat Nagar       |
| 160 | Dr. Mona Singh Kawatra                                   | Janak Puri         |
| 161 | Dr. Nitesh Chitkara                                      | Rohini             |
| 162 | Dr. Hemant Gupta                                         | Rohini             |
| 163 | Manipal Hospitals                                        | Dwarka             |
| 164 | Star Dental Centre Pvt. Ltd.                             | Adarsh Nagar       |
| 165 | Star Dental Centre Pvt. Ltd.                             | Vasant Kunj        |
| 166 | The Dental Experience                                    | Greater Kailash    |
| 167 | Star Dental Centre Pvt. Ltd.                             | Vikaspuri          |
| 168 | Dr. Rohit Yadav                                          | Ghaziabad          |
| 169 | Dr. Tara Khilnani                                        | Panchsheel Enclave |
| 170 | Dr. Kunal Puri                                           | Greater Kailash-1  |
| 171 | Dr. Smita Saraf                                          | Pitampura          |
| 172 | Dr. Pankaj Madhukar                                      | Saket              |
| 173 | Dr. Honey Verma                                          | Gurugram           |
| 174 | Dr. Shivani Nivedita                                     | Dwarka Mod         |
| 175 | Dr. Vaibhav Gulati                                       | Pitampura          |
| 176 | Mata Gujri Society For Medical Aid & Research            | Greater Kailash    |
| 177 | Care Redefined - UP                                      | Noida              |
| 178 | First Consult                                            | East Of Kailash    |
| 179 | Dr. Pranjal Sirohi                                       | Greater Noida      |
| 180 | Dr. Javed                                                | Jasola             |
| 181 | Dr. Viney Sachdeva                                       | Greater Kailash-2  |
| 182 | Dr. Satendra Singh                                       | Bhajanpura         |
| 183 | Dr. Anshul Phogaat                                       | Safdarjung Enclave |
| 184 | Apollo Clinic Model Town                                 | Gujrawala Town     |
| 185 | Kailash Dental                                           | Patel Nagar        |
| 186 | The Dental Hub And Implant Centre                        | Vasant Kunj        |

## Our Esteemed Clients of OPG

|                |                                       |                   |
|----------------|---------------------------------------|-------------------|
| 187            | Dr. Sapna Siwath                      | Pitampura         |
| <b>Goa</b>     |                                       |                   |
| 188            | Dr. Suhail Ahmed Shariff              | Goa               |
| 189            | Dr. Karishma Parkar                   | Goa               |
| 190            | Dr. Dhiraj Vivekanand Naik            | Madgaon           |
| <b>Gujarat</b> |                                       |                   |
| 191            | Dr. Amit Parikh                       | Vadodara          |
| 192            | Dr. Vipul Patel                       | Rajkot            |
| 193            | Dr. Vikas Kumbhani                    | Ahmedabad         |
| 194            | Dr. Aadarsh Desai                     | Ahmedabad         |
| 195            | Dr. Snehal Chauhan                    | Gandhidham        |
| 196            | Dr. Vikas Bhambhani                   | Gandhidham        |
| 197            | Dr. Vijay Bhatiya                     | Jamnagar          |
| 198            | Haria L G Rotary Hospital             | Vapi              |
| 199            | Goenka Dental College & Hospital      | Gandhi Nagar City |
| 200            | Dr. Rishma Ankitkumar Patel           | Navasari          |
| 201            | Dr. Shailesh B Modh                   | Banaskantha       |
| 202            | Dr. Dhvani Patel                      | Vapi              |
| 203            | Dr. Sweta Patel                       | Vapi              |
| 204            | Dr. Jigar Soni                        | Vadodara          |
| 205            | Dr. Mihir Shah                        | Ahmedabad         |
| 206            | Zaveri M V Dispensary                 | Palanpur          |
| 207            | Dr. Vipul Patel                       | Rajkot            |
| 208            | Denta Scan                            | Ahmedabad         |
| 209            | Dr. Abhishek Jain                     | Bardoli           |
| 210            | Dr. Nirav Surani                      | Rajkot            |
| 211            | Dr. Nutan D Thakkar                   | Gandhi Nagar City |
| 212            | Dr. Rajni B Patel                     | Mehsana           |
| 213            | Dr. Prashant Shah                     | Vadodra           |
| 214            | Dr. Dhaval Trivedi                    | Vadodra           |
| 215            | Dr. Khushbu Patel                     | Valsad            |
| 216            | Dr. Nirali Patel                      | Surat             |
| 217            | Dr. Samir Rateda                      | Lunawada          |
| 218            | Dr. Saroj Singh                       | Kachchh           |
| 219            | Dr. Ghanshyam Patel                   | Ahmedabad         |
| 220            | Dr. Jolly D. Patel                    | Ahmedabad         |
| 221            | Dr. Prashant Shah                     | Vadodra           |
| 222            | Kailash Cancer Hospital               | Vadodra           |
| 223            | Patel Mayur Jagdishbhai               | Surat             |
| 224            | Wadekar Hospital                      | Surat             |
| 225            | Inst. of Forensic Sciences University | Gandhi Nagar City |
| 226            | Dr. Kamal Patel                       | Mehsana           |
| 227            | Dr. Pankaj Ishwarbhai Hotchandani     | Ahmedabad         |
| 228            | Dr. Mantra H. Parikh                  | Una               |
| 229            | Dr. Mantra H. Parikh                  | Una               |
| 230            | Setu Dental Clinic                    | Ahmedabad         |
| 231            | Karnavati Medical & Educational Trust | Gandhi Nagar City |
| 232            | Dr. Prachi Kapuriya                   | Vadodra           |
| 233            | Siddharth Desai                       | Valsad            |
| 234            | Dr. Rushi Virani                      | Jamnagar          |

|                          |                               |              |
|--------------------------|-------------------------------|--------------|
| 235                      | Dr. Bhargav A Shah            | Ahmedabad    |
| 236                      | Dr. Krunal Jodiya             | Surat        |
| 237                      | Dr. Manthan Rathi             | Ahmedabad    |
| <b>Haryana</b>           |                               |              |
| 238                      | Dr. Ravi Batra                | Gurugram     |
| 239                      | Dr. Anil Yadav                | Gurugram     |
| 240                      | Anjali Labs Jmjk Pvt. Ltd .   | Hisar        |
| 241                      | Dr. Chander Prakash           | Gurugram     |
| 242                      | Dr. Harish Yadav              | Gurugram     |
| 243                      | Dr. Surinder Sharma           | Panchkula    |
| 244                      | Global Health Private Limited | Gurugram     |
| 245                      | Hai Dent Cosmo Llp            | Gurugram     |
| 246                      | Star Dental Centre Pvt. Ltd.  | Haryana      |
| 247                      | Dr. Vijay Kumar Taneja        | Panipat      |
| 248                      | Dr. Abhishek Khurana          | Sirsa        |
| 249                      | Dr. Rakesh Raghav             | Gurugram     |
| 250                      | Dr. Akshi Arvind              | Gurugram     |
| 251                      | Dr. Nisha Bali Banari         | Gurugram     |
| 252                      | Dr. Pooja Yadav               | Gurugram     |
| 253                      | Dr. Vipul Goel                | Gurugram     |
| 254                      | Dr. Rishi Rana                | Gurugram     |
| 255                      | Star Dental Centre Pvt. Ltd.  | Gurugram     |
| 256                      | Dr. Ravjot Ahuja              | Faridabad    |
| 257                      | Star Dental Centre Faridabad  | Faridabad    |
| 258                      | Manav Rachna Dental College   | Faridabad    |
| 259                      | Dr. Anubhav Chopra            | Gurugram     |
| 260                      | Civil Hospital                | Faridabad    |
| 261                      | Dr. Ankur Jain                | Gurugram     |
| 262                      | Dr. Harsh Yadav               | Gurugram     |
| <b>Himachal Pradesh</b>  |                               |              |
| 263                      | Dr. Raghav Verma              | Dharamshala  |
| 264                      | Officer Commanding            | Kangra       |
| 265                      | Dr. Heena Sharma              | Kangra       |
| 267                      | Dr. Sachin Upadhyay           | Kullu        |
| 268                      | Dr. Bhavna Devi               | Sundar Nagar |
| <b>Jammu And Kashmir</b> |                               |              |
| 269                      | SNM Hospital                  | Leh          |
| 270                      | Dr. Faiz Ahmad Bhat           | Srinagar     |
| 271                      | Block Medical Office          | Srinagar     |
| <b>Jharkhand</b>         |                               |              |
| 272                      | Dr. Meenakshi Singh           | Ranchi       |
| 273                      | Dr. Sanju Gupta               | Ramgarh      |
| 274                      | Dr. Bhaskar Lal               | Ranchi       |
| 275                      | Dr. Sagarmani Seth            | Koderma      |
| 276                      | Dr. Manish Kumar              | Giridih      |
| 277                      | M/S Digimax Imaging Centre    | Dhanbad      |
| <b>Karnataka</b>         |                               |              |
| 278                      | Dr. Mohd. Fayaz Pasha         | Bengaluru    |
| 279                      | Special Smiles Pvt. Ltd.      | Bangalore    |
| 280                      | Dr. Sharan Prakash Shetgar    | Gulbarga     |

## Our Esteemed Clients of OPG

|               |                                         |                          |
|---------------|-----------------------------------------|--------------------------|
| 281           | Dr. Ramesh Kaluti                       | Bagalkot                 |
| 282           | Thirthalli Diagnostic Centre Llp        | Shimoga                  |
| 283           | Dr. B. N. Narase Gowda                  | Bengaluru                |
| 284           | Dr. Prashanth                           | Bengaluru                |
| 285           | Dr. Ramanath Dheemanth                  | Bengaluru                |
| 286           | Dr. Sridhar N                           | Bengaluru                |
| 287           | Dr. Jayaram Diagnostic Center Pvt. Ltd. | Bengaluru                |
| 288           | Gulbarga Dental Scanning Center         | Gulbarga                 |
| 289           | Sharma Dental Spa Llp                   | Bengaluru                |
| 290           | Special Smiles Pvt. Ltd.                | Bengaluru                |
| 291           | Vats And Param Inc                      | Bengaluru                |
| 292           | Shivam Diagnostic Centre                | Coorg                    |
| 293           | Dr. Ajaz Pasha K M                      | Bengaluru                |
| 294           | Dr. Niranjn Paramshettys                | Hubli                    |
| 295           | Dr. Sudha B N                           | Chikkamagaluru           |
| 296           | K. S. Satheeshkumar                     | Bengaluru                |
| 297           | Core The Dentofacial Centre             | Bengaluru                |
| 298           | Dr. Km Pramod                           | Bengaluru (East & South) |
| 299           | Plaza Dental Care                       | Yadgir                   |
| 300           | Dr. Darshit Patel                       | Bengaluru                |
| 301           | Dr. Sumalatha Mds                       | Haveri                   |
| 302           | Dr. Niranjn ParamshettyS                | Hubli                    |
| 303           | Agasthya Diagnostic Center              | Koppal                   |
| 304           | Surya Diagnostics                       | Mandya                   |
| 305           | Alphacrown Healthcare Private Limited   | Bengaluru                |
| 306           | Dr. P. Manjunath                        | Bengaluru                |
| 307           | Dr. Pallapoiu Vasavi                    | Bengaluru                |
| 308           | KDC Dental Care                         | Bijapur                  |
| 309           | Dr. Shilpa S Kiran                      | Bengaluru                |
| 310           | Vats And Param Inc                      | Bengaluru                |
| 311           | Lakshmi Medical Agency                  | Bellary                  |
| 312           | Anjana Xray Centre                      | Bellary                  |
| 313           | Dr. Shashidhar Manikappa                | Bidar                    |
| 314           | Dr. Yamini K                            | Bengaluru                |
| 315           | Dr. Narendra Babu P N                   | Tumkur                   |
| 316           | Dr. Niranjn Paramshetty                 | Bengaluru                |
| 317           | Dr. Basavaraj Shivappa Katakol          | Bellary                  |
| 318           | KD Dental Care                          | Bagalkot                 |
| <b>Kerala</b> |                                         |                          |
| 319           | Mr. Jaisal P                            | Malappuram               |
| 320           | Mr. Vishnu K. S.                        | Cochin                   |
| 321           | Dr. Bindu Rachel Thomas                 | Cochin                   |
| 322           | Dr. Bindu Rachel Thomas                 | Cochin                   |
| 323           | Dr. Nirmal George Saibu                 | Kollam                   |
| 324           | Dr. Sanjay Kumar                        | Palakkad                 |
| 325           | Dr. Wesly Kuruvila Abraham              | Cochin                   |
| 326           | Dr. Shajahan P. A                       | Thrissur                 |
| 327           | Dr. John. F. Alapatt                    | Thrissur                 |

|                       |                                                   |                    |
|-----------------------|---------------------------------------------------|--------------------|
| 328                   | Jubilee Mission Medical College Hospital          | Thrissur           |
| 329                   | M/S Clinique Dentistry                            | Thrissur           |
| 330                   | Mr. Ramvinod Ramachandran Kuzhiyilayyathu         | Kollam             |
| 331                   | Mr. Razal Ahamed Koya                             | Malappuram         |
| 332                   | Dr. Varghese K Paulose                            | Ernakulam          |
| 333                   | Gids Enterprises Pvt. Ltd.                        | Alleppey           |
| 334                   | Mr. Prakash Rose Vihar Kuttappan                  | Alappuzha          |
| 335                   | Military Dental Centre, Pangode                   | Trivandram         |
| 336                   | Dr. Naveen R                                      | Trivandram         |
| 337                   | Mr. Vinuraj K. G.                                 | Kottayam           |
| 338                   | Sankars Healthcare Scans And Diagnostics          | Alappuzha          |
| 339                   | Dr. Tony Thomas                                   | Palakkad           |
| 340                   | Mr. Jaisal P                                      | Malappuram         |
| 341                   | Spring Garden Dental Care Centre                  | Thiruvananthapuram |
| 342                   | Dr. Satheesh Sankar                               | Pathanamthitta     |
| 343                   | Dr. Sajjad Mohammed A                             | Kottayam           |
| <b>Madhya Pradesh</b> |                                                   |                    |
| 344                   | Dr. Nitish Shrivastava                            | Gwalior            |
| 345                   | Dr. Gagan Namdev                                  | Sehore             |
| 346                   | Ms. Tanya Garg                                    | Sagar              |
| 347                   | RKDF Medical College Hospital And Research Centre | Bhopal             |
| 348                   | Dr. Atul Verma                                    | Bhopal             |
| 349                   | Dr. Vipalv Joshi                                  | Bhopal             |
| 350                   | Krishna Hospital                                  | Sagar              |
| 351                   | Mayank X-Ray                                      | Chhindwara         |
| 352                   | R.K.D.F.Dental Collage And Research Center        | Bhopal             |
| 353                   | Dr. Vikas Batra                                   | Ratlam             |
| 354                   | Dr. Neeta Marwaha                                 | Bhopal             |
| 355                   | RKDF Medical College Hospital And Research Centre | Bhopal             |
| <b>Maharashtra</b>    |                                                   |                    |
| 356                   | Dr. Nilesh Mundada                                | Aurangabad         |
| 357                   | Dr. Danish Virani                                 | Pune               |
| 358                   | Dr. Amrut V. Tamhankar                            | Panvel             |
| 359                   | Mr. Praful Kothari                                | Pune City          |
| 360                   | Dr. Rahul Upendra Vedpathak                       | Nagpur             |
| 361                   | Smile Plus Dental Care                            | Nagpur             |
| 362                   | Mr. Prashant                                      | Mumbai             |
| 363                   | Dr. Rukhsana Sakarwala                            | Mumbai Central     |
| 364                   | Dr. Shahare Shobhan                               | Nagpur             |
| 365                   | Dr. Bharat Singh Rathod                           | Mumbai             |
| 366                   | Dr. Subodh                                        | Thane              |
| 367                   | Dr. Harsh Ashok Vyas                              | Mumbai             |
| 368                   | Dr. Harsh Ashok Vyas                              | Mumbai             |
| 369                   | Aaditya Dental College                            | Parbhani           |
| 370                   | Dr. Ashish Shah                                   | Grant Road         |
| 371                   | Dr. Shreyas Shah                                  | Kharghar           |

## Our Esteemed Clients of OPG

|     |                                                      |             |
|-----|------------------------------------------------------|-------------|
| 372 | Dr. Amit Maheshwari                                  | Andheri     |
| 373 | Dr. Lalit Manek                                      | Mulund      |
| 374 | Dr. Karanjit Singh Chaudhary                         | Mumbai      |
| 375 | Dr. Anuradha Vyas                                    | Grant Road  |
| 376 | Dr. Rikin Gogri                                      | Goregaon    |
| 377 | Yavatmal Cbct Centre                                 | Yavatmal    |
| 378 | Dr. Abhirav Karve                                    | Thane       |
| 379 | Dr. Aishwarya Joshi                                  | Panvel      |
| 380 | Dr. Sharad Mishra                                    | Mira Road   |
| 381 | Dr. Vimal Gala                                       | Mulund      |
| 382 | Dr. Vishal Tapadia                                   | Pune City   |
| 383 | Dr. Twinkle Jain                                     | Malad       |
| 384 | Leena Builders                                       | Thane       |
| 385 | Asain Institute Of Medical Science                   | Dombivali   |
| 386 | Dr. Ashish & Dr. Varsha Khasbage                     | Buldhana    |
| 387 | Dr. Dhananjay Barde                                  | Nagpur      |
| 388 | Dr. Joshua Mall C/O Dr. Divya Raniwala               | Pune        |
| 389 | Dr. Prathmesh Joshi                                  | Pune        |
| 390 | Dr. Aditi Sameer Natu                                | Pune        |
| 391 | Dr. R. Suryanarayan                                  | Mumbai      |
| 392 | Rastrasant Tukdoji Regional Cancer Hospital & Cancer | Nagpur      |
| 393 | Tata Memorial Centre                                 | Parle       |
| 394 | Dr. Nikita Tejwani Motwani                           | Andheri     |
| 395 | Dr. Hitesh Burhanpurkar                              | Mumbai      |
| 396 | Way To Care And Cure Diagnostic Centre               | Kharghar    |
| 397 | Dr. Ajit Shetty c/o Core Mumbai                      | Mumbai      |
| 398 | Dr. Sachin Gupta                                     | Kandivali   |
| 399 | Dr. Madhavi Jadav                                    | Bhayandar   |
| 400 | Orofit Pvt. Ltd.                                     | Nashik      |
| 401 | Orofit Pvt. Ltd.                                     | Nashik      |
| 402 | Dr. Aditi Sameer Natu                                | Sion        |
| 403 | DR. SHIV CHADDA.                                     | Bandra      |
| 404 | Dr Dheeraj Nimbaji Patil                             | Mumbai      |
| 405 | Dr. Nishant Gandhi                                   | Powai       |
| 406 | Dr. Nilesh Fatale                                    | Pune City   |
| 407 | Dr. Deepali Ananya Hazare                            | Nagpur      |
| 408 | Dr. Payal Agarwal                                    | Charni Road |
| 409 | Apurva Dental Clinic                                 | Boriwali    |
| 410 | Dr. Nitesh Jain                                      | Boriwali    |
| 411 | Dr. Trishla Kasliwal                                 | Mumbai      |
| 412 | Dr. Jenish Parmar                                    | Chembur     |
| 413 | Dr. Trishla Kasliwal                                 | Mumbai      |
| 414 | Dr. Chitrang Thaker                                  | Goregaon    |
| 415 | All India Institute Of Medical Sciences              | Nagpur      |
| 416 | Dr. Dinesh Hingorani                                 | Pune        |
| 417 | Smile Gallery Dental Clinic                          | Boriwali    |
| 418 | Dr. Hetal Chheda                                     | Boriwali    |
| 419 | Madhav Mission C/o Dr. Ashutosh Deshpande            | Kolhapur    |

| Odisha      |                                             |             |
|-------------|---------------------------------------------|-------------|
| 420         | The Dental Shoppe                           | Bhubaneswar |
| 421         | Dr. Kanhu Charan Sahoo                      | Bhubaneswar |
| Pondicherry |                                             |             |
| 422         | Guarantee Clinical Lab                      | Pondicherry |
| 423         | Dr. V. Savariraju                           | Pondicherry |
| Punjab      |                                             |             |
| 424         | Dr. Bhupinder Singh Parhar                  | Jalandhar   |
| 425         | Dr. Deepak Dawar                            | Zirakpur    |
| 426         | Dr. Baljit Singh                            | Hoshiarpur  |
| 427         | Dr. Anjali                                  | Mohali      |
| 428         | Dr. Jagdish Chander                         | Jalandhar   |
| 429         | Shaheed Kartar Singh Sarabha Dental College | Ludhiana    |
| 430         | Dr. Aman Preet Singh                        | Mohali      |
| 431         | Dr. Parminder Singh New                     | Jalandhar   |
| 432         | Dr. Parminder Singh New                     | Jalandhar   |
| 433         | Kumar Dental Co.                            | Jalandhar   |
| 434         | Kumar Dental Co.                            | Jalandhar   |
| 435         | Dr. Deepak Dawar                            | Zirakpur    |
| 436         | Dr. Ajay Saini                              | Mahilpur    |
| 437         | Dr. Deepak Dawar                            | Zirakpur    |
| 438         | Dr. Deepak Dawar                            | Zirakpur    |
| 439         | Dr. Gursimran Singh Marwah                  | Jalandhar   |
| 440         | Dr. Sindhuja Shreedhar.                     | Mohali      |
| 441         | Dr. Vikas Kaushal                           | Kotkapura   |
| 442         | Dr. Vikas Jindal                            | Ludhiana    |
| 443         | Sushma Memorial Dental Hospital             | Kaurthala   |
| 444         | Dr. Garima                                  | Mohali      |
| 445         | Dr. Sanjay Bhardwaj                         | Hoshiarpur  |
| 446         | Dr. Gourab Gupta                            | Mohali      |
| 447         | Ranbaj Hospital                             | Mohali      |
| 448         | Dr. Hemant Bansal                           | Patiala     |
| 449         | Dr. Mandeep Singh Brar                      | Moga        |
| Rajasthan   |                                             |             |
| 450         | Dr. Abhishek Jayaswal                       | Chittorgarh |
| 451         | Dr. Bhargav V Gupta                         | Sirohi      |
| 452         | Dr. Bhargav V Gupta                         | Sirohi      |
| 453         | Dr. Krishna Kant Bohra                      | Kankroli    |
| 454         | Dr. Smita Singh                             | Udaipur     |
| 455         | Dr. Yusuf Mohammed                          | Bhilwara    |
| 456         | Star Dental Centre Pvt. Ltd.                | Jaipur      |
| 457         | Raj Rajeshwari Education & Research Society | Udaipur     |
| 458         | Dr. Sourav Singh                            | Udaipur     |
| 459         | Atharv Dental Care Centre                   | Banswara    |
| 460         | Dr. Udai Raj Singh Jadon                    | Kota        |
| Tamil Nadu  |                                             |             |
| 461         | Dr. Dhandapani Arunachalam                  | Chennai     |
| 462         | Dr. Muthusamy Narasimman                    | Chennai     |

## Our Esteemed Clients of OPG

|                  |                                                      |                |
|------------------|------------------------------------------------------|----------------|
| 463              | Dr. Sunil C Varghese                                 | Chennai        |
| 464              | Dr. S. Suganya                                       | Cuddalore      |
| 465              | Dr. K. Saravanan                                     | Coimbatore     |
| 466              | Dr. Suresh Babu Stephen                              | Thoothukudi    |
| 467              | Dr. Vinoth Chandran S. R.                            | Dindigul       |
| 468              | Rootz Dental Care & Implant Center                   | Chennai        |
| 469              | Dr. B. Akilananth                                    | Coimbatore     |
| 470              | Saveetha Institute of Technical And Medical Sciences | Chennai        |
| 471              | Anbu Dental Clinic                                   | Madurai        |
| 472              | Dr. N Madan                                          | Tiruvannamalai |
| 473              | Dr. A Satish                                         | Chennai        |
| 474              | Dr. Archana Narayana Swamy                           | Chennai        |
| 475              | Dr. D. Djaynishanth                                  | Pondicherry    |
| 476              | Dr. Kirubaharan                                      | Coimbatore     |
| 477              | Ms. Shanthy K                                        | Chennai        |
| 478              | Opal Dentistry                                       | Chennai        |
| 479              | RKM Dentoscan                                        | Chennai        |
| 480              | Sams Dental Lounge                                   | Coimbatore     |
| 481              | Saveetha Medical College And Hospital                | Chennai        |
| 482              | ANBU Dental Clinic                                   | Madurai        |
| 483              | Dr. Dharmesh Kumar Raja                              | Madurai        |
| 484              | Dr. Rajesh MDS                                       | Tirupur        |
| 485              | Malligai Dental Hospital                             | Chennai        |
| 486              | Dr. Bhagavathy                                       | Tirunelveli    |
| 487              | Dr. P. Ashwan                                        | Chennai        |
| 488              | Dr. Mithrajan                                        | Dindigul       |
| 489              | Dr. Jai Sudhaa Mds                                   | Coimbatore     |
| 490              | East Coast Hospital Ltd                              | Pondicherry    |
| 491              | Dr. S. Suganya                                       | Cuddalore      |
| 492              | Salus Dental Scans                                   | Tirupur        |
| 493              | Dr. Selva Kumar, MDS                                 | Chennai        |
| 494              | Dr. Selva Kumar, MDS                                 | Chennai        |
| 495              | Dr. Fathima Rameesha                                 | Paramkudi      |
| 496              | Dr. G. Karthick Rajan                                | Coimbatore     |
| 497              | Dr. Sathesh, M.D.S.                                  | Tiruvannamalai |
| 498              | Rootz Dental Care And Implant Center                 | Chennai        |
| 499              | Dr. R Arun Jaikumar                                  | Cuddalore      |
| 500              | Dr. J. Thabassum                                     | Coimbatore     |
| <b>Telangana</b> |                                                      |                |
| 501              | Amrutha Dental Private Limited                       | Hyderabad      |
| 502              | Dr. Jitendar Reddy                                   | Hyderabad      |
| 503              | Mr. P V Ravi Chandra                                 | Hyderabad      |
| 504              | Virinchi Hospital                                    | Hyderabad      |
| 505              | Dr. Ch. Swathi Chaitanya                             | Hyderabad      |
| 506              | Dr. Ramvilas Reddy                                   | Hyderabad      |
| 507              | Dr. Siva Nagini                                      | Hyderabad      |
| 508              | Opal Dentistry                                       | Hyderabad      |
| 509              | Dr. Shraavan Kumar Nagole                            | Hyderabad      |

|                      |                                           |               |
|----------------------|-------------------------------------------|---------------|
| 510                  | Dr. Atluri Padma Mohan                    | Hyderabad     |
| 511                  | Dr. Kadiyala Rajendra                     | Hyderabad     |
| 512                  | Dr. Meka Prasad                           | Hyderabad     |
| 513                  | Arya Health Care                          | Hyderabad     |
| 514                  | Dr. Alla Raghunadha Reddy                 | Hyderabad     |
| 515                  | Dr. K. Shraavan Kumar                     | Hyderabad     |
| 516                  | Dr. Nadeem Kuresi                         | Hyderabad     |
| 517                  | Indira Diagnostic Centre                  | Kamareddy     |
| 518                  | Srikanth Super Speciality Dental Hospital | Karimnagar    |
| 519                  | The Tooth Company                         | Hyderabad     |
| 520                  | Dr. Anwesh Indo                           | Hyderabad     |
| 521                  | Dr. B. Vishnu Chaitanya                   | Hyderabad     |
| 522                  | Dr. Rayudu Naren Kishore                  | Kothapet      |
| 523                  | Eledent International Digital Dentistry   | Hyderabad     |
| 524                  | Pro Dental                                | Hyderabad     |
| 525                  | Root Dental                               | Hyderabad     |
| 526                  | Arya Health Care                          | Hyderabad     |
| 527                  | Dr. Alla Raghunadha Reddy                 | Hyderabad     |
| 528                  | Dr. K Shraavan Kumar                      | Hyderabad     |
| 529                  | Dr. Nadeem Kuresi                         | Hyderabad     |
| 530                  | Indira Diagnostic Centre                  | Kamareddy     |
| 531                  | Srikanth Super Speciality Dental Hospital | Karimnagar    |
| 532                  | The Tooth Company                         | Hyderabad     |
| 533                  | Dr. Anwesh Indo                           | Hyderabad     |
| 534                  | Dr. B. Vishnu Chaitanya                   | Hyderabad     |
| 535                  | Dr. Rayudu Naren Kishore                  | Kothapet      |
| 536                  | Eledent International Digital Dentistry   | Hyderabad     |
| 537                  | Root Dental                               | Hyderabad     |
| 538                  | Advaita Reddys Dental Hospital            | Hyderabad     |
| 539                  | Sampath Gowd Dr.                          | Hyderabad     |
| 540                  | Dr. Gowds Dental Hospital                 | Hyderabad     |
| 541                  | Dr. Srikanth Goud                         | Hyderabad     |
| 542                  | Sree College Of Pharmacy                  | Khammam       |
| 543                  | Raju Dental                               | Hyderabad     |
| 544                  | Dr. Ramvilas Reddy                        | Hyderabad     |
| <b>Uttar Pradesh</b> |                                           |               |
| 545                  | Dr. Sumit Tandon                          | Bareilly      |
| 546                  | Dr. Ashutosh Gupta                        | Raibareilly   |
| 547                  | Dr. Ashutosh Gupta                        | Raibareilly   |
| 548                  | Dr. Pranshu Singh                         | Meerut        |
| 549                  | Dr. Rahul Vaid                            | Meerut        |
| 550                  | Dr. Raj Kumar Sharma                      | Bazpur        |
| 551                  | Dr. Vipul Srivastava (Lucknow)            | Lucknow       |
| 552                  | Akhil Kumar Goel And Sons Huf             | Muzaffarnagar |
| 553                  | Dr. Ajay Vikram Singh                     | Agra          |
| 554                  | Dr. Amit Sachdeva                         | Noida         |
| 555                  | Dr. Ashwani Kumar Verma                   | Gorakhpur     |

## Our Esteemed Clients of OPG

|     |                                                       |               |
|-----|-------------------------------------------------------|---------------|
| 556 | Dr. R. S. Dubey                                       | Lucknow       |
| 557 | Medicos Diagnostic Centre                             | Deoria        |
| 558 | Sangam Dental Centre                                  | Allahabad     |
| 559 | Vedanta Health Centre                                 | Meerut        |
| 560 | Vivekanand Polyclinic & Institute of Medical Sciences | Lucknow       |
| 561 | Military Dental Centre                                | Allahabad     |
| 562 | Subharti Dental College                               | Meerut        |
| 563 | Kailash Hospital And Research                         | Noida         |
| 564 | Care Redefined                                        | Noida         |
| 565 | Dr. Ahujas Dental & Implant Clinic                    | Ghaziabad     |
| 566 | Dr. Sumit Pathak                                      | Greater Noida |
| 567 | Dr. Tarun Agrawal                                     | Agra          |
| 568 | Dr. Madhureema Chopra                                 | Ghaziabad     |
| 569 | Dr. Praveen Rai                                       | Lucknow       |
| 570 | Dr. Alok Sachan                                       | Kanpur        |
| 571 | Dr. Rohit Gupta                                       | Kanpur        |
| 572 | Kanti Devi Medical College Hospital & Research Center | Mathura       |
| 573 | Medanta Holdings Pvt. Ltd.                            | Lucknow       |
| 574 | Nayafi Healthcare & Research Pvt. Ltd.                | Mathura       |
| 575 | New R. P. Diagnostic Centre                           | Ghaziabad     |
| 576 | Nirmala Medical Store                                 | Meerut        |
| 577 | Satyam Diagnostic Centre                              | Lakhimpur     |
| 578 | Satyam Diagnostic Centre                              | Firozabad     |
| 579 | Dr. Sumeet Grover                                     | Ghaziabad     |
| 580 | Max Hospital                                          | Vaishali      |
| 581 | Star Dental Centre Pvt. Ltd.                          | Noida         |
| 582 | Dr. Sumit Pathak                                      | Greater Noida |
| 583 | Dr. Sanjeev Awasthi                                   | Lucknow       |
| 584 | Dr. Anand Vijay Singh                                 | Shahjahanpur  |

|                    |                                                  |                    |
|--------------------|--------------------------------------------------|--------------------|
| 585                | Dr. Atul Tripathi                                | Allahabad          |
| 586                | Aayush Pathology Lab & Digital X-Ray Center      | Padrauna           |
| 587                | Dr. Rakesh Kumar Gupta                           | Padrauna           |
| 588                | Satyam Diagnostic Centre                         | Hardoi             |
| 589                | Dr. Nirukt Yadav                                 | Bulandshahr        |
| 590                | Dr. Rohit Sharma                                 | Gautam Buddh Nagar |
| 591                | Sushila Dental Clinic                            | Mathura            |
| 592                | Dr. J Gupta                                      | Prayagraj          |
| 593                | Complete Prosthetic Solutions Llp                | Agra               |
| 594                | Chandra Dental College                           | Barabanki          |
| <b>Uttarakhand</b> |                                                  |                    |
| 595                | Dr. Vijay Kumar                                  | Rishikesh          |
| <b>West Bengal</b> |                                                  |                    |
| 596                | Burnpur Hospital                                 | Asansol            |
| 597                | Dr. Santanu Pattanayak                           | Medinipore         |
| 598                | Dental Avenue                                    | Kolkata            |
| 599                | Medisphere Polyclinic                            | Burdwan            |
| 600                | North Bengal Dental Medical College              | Siliguri           |
| 601                | Avant Dental                                     | Kolkata            |
| 602                | Balaji Health Care                               | Siliguri           |
| 603                | Dhuliyon Diagnostic & Healthcare Private Limited | Murshidabad        |
| 604                | Dr. Bhaswati Barman Basu                         | North 24 Parganas  |
| 605                | Dr. Vishal Kumar Poddar                          | Malda              |
| 606                | Mr. Mahboob Alam                                 | Uttar Dinajpur     |
| 607                | Dr. Vishal Kumar Poddar                          | Malda              |
| 608                | Upasana Healthcare And Diagnostic Centre         | Medinipore         |



**WHERE TRUST COMES FIRST**



**Partnering with Dentists for over two decades  
creating a world full of healthy smiles together.**

**For any Sales & Support**

 9821184441, 9599281852, 8448398852

 [sales@unicorndenmart.com](mailto:sales@unicorndenmart.com)



SCAN TO VISIT OUR WEBSITE



Corporate Office: 3 Local Shopping Centre, MOR Land, Near J Block DDA Market,  
New Rajender Nagar, New Delhi – 110060

\* Accessories shown may not be a part of standard equipment. Specifications are subject to change without notice.

Ver 5/2023