



INDEX	PAGE(S)
R Mobile Cabinet	38 - 39
Preconfigured Models . . .	40 - 43
Accessories	44 - 49
Components	50 - 54
L Compact Mobile Cabinet	55
Preconfigured Models . . .	56 - 57
Accessories	58 - 62
Components	63 - 65

R MOBILE CABINET

Rousseau's R Heavy-Duty Mobile Cabinet is one of the safest and most secure on the market. With a simple upward movement with just one hand on one of the drawer's ergonomic handles, the drawer opens with incredible ease, and the lock-in mechanism is activated so none of the other drawers can open.

The R Heavy-Duty Mobile Cabinet is manufactured to meet the rigorous demands of industrial applications and is therefore one of the most durable on the market. Our research and development department has put the cabinet through multiple demanding tests for load capacity, impact resistance, and wear and tear, so we are confident in its excellent durability. Fitted with high-quality, resistant casters, it has been designed for intensive use in harsh work environments.

There is also an extensive range of options and accessories available to further customize it to your needs. There are 5 different tops, 2 types of handle (on the front and side), foldaway shelves and hanging side cabinets. Furthermore, you no longer need to worry about replacing complete units as your business grows and evolves because these options and accessories can be easily retrofitted.

CUSTOMIZE YOUR R MOBILE CABINET WITH THE MYMODEL-R ONLINE CONFIGURATOR

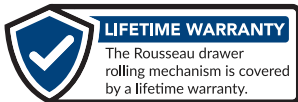

R HEAVY-DUTY MOBILE CABINET

THE ROUSSEAU DIFFERENCE



The integrated lock-in mechanism activates easily with just one hand (right or left).



The full-width ergonomic handle provides a comfortable grip when opening the drawer.

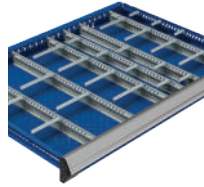

Variety of drawer accessories available: partitions, dividers, plastic bins, protective foam, etc.



Polyurethane casters for excellent maneuverability without marking floors.



Variety of cabinet accessories available: foldaway shelves, storage cabinets, wood tops, etc.



Industry-leading 400lb. load capacity per drawer.

GENERAL DIMENSIONS

HEIGHTS AVAILABLE



NOTE: The total height shown includes 6" casters and a 1 1/4"H top.

WIDTH × DEPTH × HEIGHT

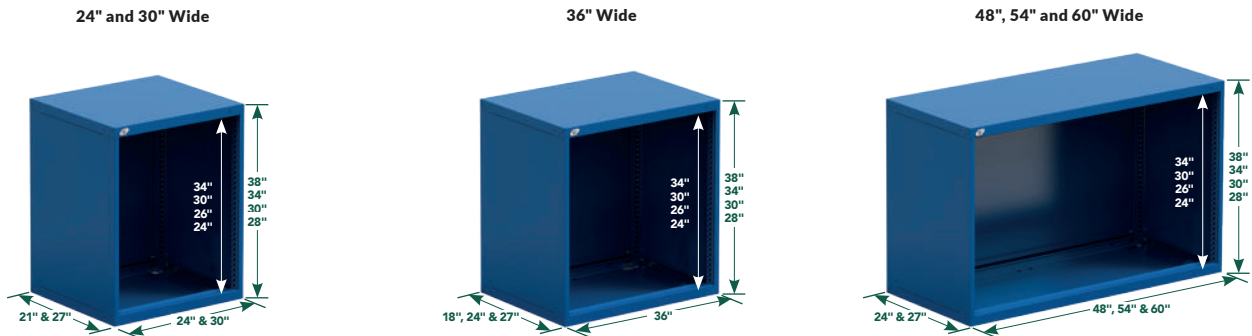

PRECONFIGURED MODELS

HERE ARE SOME OF OUR MOST POPULAR PRECONFIGURED MODELS OF R HEAVY-DUTY MOBILE CABINETS

- Preconfigured models for 24"W cabinets have 4" casters, including two rigid and two swivel casters with total-lock brakes, as well as an econo lock-in mechanism (B)
- Preconfigured models for 30"W cabinets, or wider, have 6" casters, including two rigid and two swivel casters with total-lock brakes, as well as an integrated lock-in mechanism (A)
- All cabinets are fitted with a True One-Drawer-at-a-Time System
- The cabinets include a key lock on the cabinet housing (and on the door)  352-356
- To add a LP safety hasp, an L50 digital lock or a L100 smart lock to a door or to your R mobile cabinet, see page 45
- To add a stainless steel, painted steel, steel with rubber mat, wood or marine edge stainless steel top, see page 46
- All preconfigured models are factory assembled and ready to use. The doors are factory installed with hinges on the right-hand side. The hinges can be installed on the left upon request

NOTE: For interior drawer dimensions, see pages 272-275.

IMPORTANT

Drawer compartments are included in all models. See the number of compartments and suggested layouts below.

To order drawers without compartments, replace the last two digits of the model number with the next even number up.

e.g., R5BCD-2801 with
R5BCD-2802 without

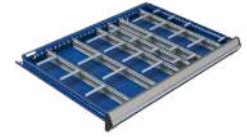

DRAWER DIMENSIONS	NUMBER OF COMPARTMENTS (LAYOUT CODE)		
	3"H TO 5"H	6"H TO 8"H	9"H AND HIGHER
24"W x 21"D	12 (0308)	9 (0206)	4 (0102)
24"W x 27"D	20 (0316)	12 (0209)	6 (0104)
30"W x 21"D	24 (0518)	12 (0308)	6 (0203)
30"W x 27"D	25 (0420)	12 (0308)	9 (0206)
36"W x 18"D	24 (0518)	8 (0304)	6 (0203)
36"W x 24"D	30 (0524)	12 (0308)	9 (0206)
48"W x 24"D	40 (0732)	15 (0410)	8 (0304)
48"W x 27"D	32 (0724)	15 (0410)	8 (0304)
54"W x 24"D	40 (0930)	18 (0512)	10 (0405)
54"W x 27"D	40 (0930)	18 (0512)	10 (0405)
60"W x 24"D	70 (1356)	24 (0716)	12 (0308)
60"W x 27"D	84 (1370)	21 (0614)	12 (0308)



Always distribute the load evenly to prevent the mobile cabinet from tipping.

24" WIDE (W x D x H)

Each model includes two front handles



4 DRAWERS	
R5BCD-2801	24" x 21" x 33 1/4"
R5BCG-2801	24" x 27" x 33 1/4"



5 DRAWERS	
R5BCD-3053	24" x 21" x 35 1/2"
R5BCG-3053	24" x 27" x 35 1/2"



5 DRAWERS	
R5BCD-3401	24" x 21" x 39 1/4"
R5BCG-3401	24" x 27" x 39 1/4"



7 DRAWERS	
R5BCD-3851	24" x 21" x 43 1/4"
R5BCG-3851	24" x 27" x 43 1/4"

30" AND 36" WIDE (W x D x H)

Each model includes one side handle



1 DRAWER / 1 DOOR / 1 SHELF	
R5BDD-2801	30" x 21" x 35 1/2"
R5BDG-2801	30" x 27" x 35 1/2"
R5BEC-2801	36" x 18" x 35 1/2"
R5BEE-2801	36" x 24" x 35 1/2"



4 DRAWERS	
R5BDD-2803	30" x 21" x 35 1/2"
R5BDG-2803	30" x 27" x 35 1/2"
R5BEC-2803	36" x 18" x 35 1/2"
R5BEE-2803	36" x 24" x 35 1/2"



6 DRAWERS	
R5BDD-3001	30" x 21" x 37 1/2"
R5BDG-3001	30" x 27" x 37 1/2"
R5BEC-3001	36" x 18" x 37 1/2"
R5BEE-3001	36" x 24" x 37 1/2"



5 DRAWERS

R5BDD-3005	30" × 21" × 37 1/2"
R5BDG-3005	30" × 27" × 37 1/2"
R5BEC-3005	36" × 18" × 37 1/2"
R5BEE-3005	36" × 24" × 37 1/2"



4 DRAWERS

R5BDD-3019	30" × 21" × 37 1/2"
R5BDG-3019	30" × 27" × 37 1/2"
R5BEC-3019	36" × 18" × 37 1/2"
R5BEE-3019	36" × 24" × 37 1/2"



7 DRAWERS

R5BDD-3801	30" × 21" × 45 1/2"
R5BDG-3801	30" × 27" × 45 1/2"
R5BEC-3801	36" × 18" × 45 1/2"
R5BEE-3801	36" × 24" × 45 1/2"

48" WIDE (W × D × H)

Each model includes one side handle



6 DRAWERS

R5BHE-3001	48" × 24" × 37 1/2"
R5BHG-3001	48" × 27" × 37 1/2"



4 DRAWERS

R5BHE-3019	48" × 24" × 37 1/2"
R5BHG-3019	48" × 27" × 37 1/2"



5 DRAWERS

R5BHE-3009	48" × 24" × 37 1/2"
R5BHG-3009	48" × 27" × 37 1/2"



5 DRAWERS

R5BHE-3011	48" × 24" × 37 1/2"
R5BHG-3011	48" × 27" × 37 1/2"



1 DRAWER / 1 DOUBLE DOOR /
1 SHELF

R5BHE-3013	48" × 24" × 37 1/2"
R5BHG-3013	48" × 27" × 37 1/2"



1 ROLL-OUT SHELF / 4 DRAWERS

R5BHE-3015	48" × 24" × 37 1/2"
R5BHG-3015	48" × 27" × 37 1/2"

PRECONFIGURED MODELS

54" WIDE (W x D x H)

Each model includes one side handle



5 DRAWERS

R5BJE-3001	54" x 24" x 37½"
R5BJG-3001	54" x 27" x 37½"



4 DRAWERS

R5BJE-3003	54" x 24" x 37½"
R5BJG-3003	54" x 27" x 37½"



4 DRAWERS

R5BJE-3005	54" x 24" x 37½"
R5BJG-3005	54" x 27" x 37½"



5 DRAWERS

R5BJE-3007	54" x 24" x 37½"
R5BJG-3007	54" x 27" x 37½"



4 DRAWERS

R5BJE-3009	54" x 24" x 37½"
R5BJG-3009	54" x 27" x 37½"



7 DRAWERS

R5BJE-3011	54" x 24" x 37½"
R5BJG-3011	54" x 27" x 37½"

60" WIDE (W x D x H)

Each model includes one side handle



5 DRAWERS

R5BKE-3023	60" x 24" x 37½"
R5BKG-3023	60" x 27" x 37½"



4 DRAWERS

R5BKE-3025	60" x 24" x 37½"
R5BKG-3025	60" x 27" x 37½"



4 DRAWERS

R5BKE-3027	60" x 24" x 37½"
R5BKG-3027	60" x 27" x 37½"



5 DRAWERS

R5BKE-3029	60" x 24" x 37½"
R5BKG-3029	60" x 27" x 37½"



5 DRAWERS

R5BKE-3031	60" x 24" x 37½"
R5BKG-3031	60" x 27" x 37½"



6 DRAWERS

R5BKE-3033	60" x 24" x 37½"
R5BKG-3033	60" x 27" x 37½"

48" WIDE (2 × 24"W) AND 60" WIDE (2 × 30"W)

Each model includes one side handle and one brace to join the cabinets



8 DRAWERS

R5DHG-3011	48" × 27" × 37½"
R5DKG-3011	60" × 27" × 37½"



7 DRAWERS

R5DHG-3013	48" × 27" × 37½"
R5DKG-3013	60" × 27" × 37½"



8 DRAWERS / 1 ROLL-OUT SHELF

R5DHG-3009	48" × 27" × 37½"
R5DKG-3009	60" × 27" × 37½"



8 DRAWERS / 1 DOOR / 2 SHELVES

R5DHG-3801	48" × 27" × 45½"
R5DKG-3801	60" × 27" × 45½"



10 DRAWERS

R5DHG-3809	48" × 27" × 45½"
R5DKG-3809	60" × 27" × 45½"



10 DRAWERS

R5DHG-3807	48" × 27" × 45½"
R5DKG-3807	60" × 27" × 45½"



SECURITY ACCESSORIES AND RECOMMENDATIONS

VERTICAL SECURITY BAR

RB10



- Locks all drawers in a cabinet with a padlock on the right (A) or left (B)
- Safety hasp is located at the top of the bar to facilitate access
- Covers a bank of drawers from 20" to 34" high
- More than one bar on the same cabinet can be installed (for different users)
- To order: Specify the type of lock required, LP for a safety hasp or L3 for a key lock and which side the bar is to be installed on, e.g., RB10-20LPA for a safety hasp and the right-hand side



352-353

PRODUCT NO.	HEIGHT
RB10-20_ _ _	20"
RB10-24_ _ _	24"
RB10-26_ _ _	26"
RB10-30_ _ _	30"
RB10-34_ _ _	34"

NOTE: Vertical security bar A is not compatible with a drawer lock.

TRUE ONE-DRAWER-AT-A-TIME SYSTEM

RB15



- Prevents multiple drawers from opening at the same time, which ensures the cabinet's stability and users' safety
- To order: Add A to the cabinet product number, e.g., RA30-302738A, [see page 52](#)
- To retrofit this mechanism, order an RB15 and specify the number of drawers and roll-out shelves in the cabinet, e.g., RB15-38-07 for a cabinet with seven drawers
- One kit per cabinet

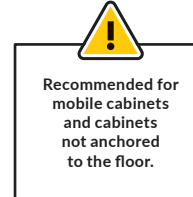

PRODUCT NO.	CABINET HEIGHT
RB15-28_ _ _	28"
RB15-30_ _ _	30"
RB15-34_ _ _	34"
RB15-38_ _ _	38"

R CABINET BUMPERS

RB9J



- Protects R cabinets from bumps and damage
- Protection kit for all four corners of cabinets
- Vertical bumpers and endcaps made from resistant soft PVC
- Quick and easy installation with double-sided adhesive tape
- Tool-free installation
- To order: Specify the housing height required, e.g., RB9J-30 02 for installation on a 30"H R cabinet and an RD01 side housing

PRODUCT NO.	COMPATIBLE WITH
RB9J- _ _ 01	RA30 cabinet
RB9J- _ _ 02	RA30 cabinet and RD01 side housing
RB9J- _ _ 03	RA30 cabinet and 1 RC02 / RC04 side panel
RB9J- _ _ 04	RA30 cabinet and 2 RC02 / RC04 side panels

NOTES: Not compatible with RB10 vertical security bars.
Not compatible with RC00 foldaway shelves.
Not compatible with RB75, RB76 and RB79 doors with frame.

SECURITY PANEL

RF91



- Blocks access between two drawers with locks
- Usable space in the cabinet is reduced by 1"
- Installs between two drawers
- Divides the cabinet up for use by more than one user
- To order: Specify the width and depth required, e.g., RF91-36 24 for a 36"W x 24"D panel

PRODUCT NO.
RF91- _ _ _

KEY LOCK FOR CABINET

L3



352

- Locks all drawers and roll-out shelves in the cabinet at the same time
- Drawer and roll-out shelf positions can be reconfigured
- Easy to retrofit
- To order: Add L3 to the cabinet product number, e.g., RA30-302738L3
- For replacement parts or to retrofit, see [page 352](#)

PRODUCT NO.

L3

CABINET SAFETY HASP

LP



353

- Locks all drawers and roll-out shelves in the cabinet at the same time
- Drawer and roll-out shelf positions can be reconfigured
- An alternative to an RB10 Vertical Security Bar
- Easy to retrofit
- To order: Add LP to the cabinet product number, e.g., RA30-302738LP
- For replacement parts or to retrofit, see [page 353](#)

PRODUCT NO.

LP

DIGITAL LOCK FOR CABINET

L50



354

- Electronically locks all drawers in the cabinet at the same time
- No key required
- Up to 20 different users can be programmed
- 4- to 8-digit access codes
- Simplifies access management to drawers
- To order: Add L50 to the housing product number, e.g., RA30-302738L50
- For replacement parts or to retrofit, see [page 354](#)

PRODUCT NO.

L50

SMART LOCK FOR CABINET

L100



355

- Handy unlocking via a transponder or smartphone
- User-friendly and intuitive
- No key required
- Easy and comprehensive management
- To order: Add L100 to the housing product number, e.g., RA30-302738L100
- For replacement parts or to retrofit, see [page 356](#)

N° DE PRODUIT

L100

NOTE: NFC transponders are not included with the lock, they must be ordered separately (pack of 5). See [page 356](#).

DIGITAL LOCK FOR DOORS

L50



354

- Electronically locks a cabinet door
- No key required
- Up to 20 different users can be programmed
- 4- to 8-digit access codes
- Compatible with single, double and polycarbonate swing doors, with or without frame (RB61, RB62 RB43, RB67, RB66, RB49, RB75, RB76 and RB79)
- To order: Add L50 to the door product code, e.g. RB61-3620L50
- For replacement parts or to retrofit, see [page 354](#)

PRODUCT NO.

L50

SMART LOCK FOR DOORS

L100



355

- Handy unlocking via a transponder or smartphone
- User-friendly and intuitive
- No key required
- Easy and comprehensive management
- Compatible with single, double and polycarbonate swing doors, with or without frame (RB61, RB62 RB43, RB67, RB66, RB49, RB75, RB76 and RB79)
- To order: Add L100 to the door product code, e.g. RB61-3620L100
- For replacement parts or to retrofit, see [page 356](#)

N° DE PRODUIT

L100

NOTE: NFC transponders are not included with the lock, they must be ordered separately (pack of 5). See [page 356](#).

ACCESSORIES

CABINET TOPS

STEEL TOP WITH RUBBER MAT

RC32

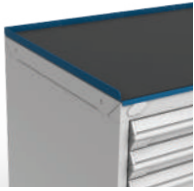

- ½"-thick non-slip neoprene surface
- Includes edges on the sides and back
- Height: 1"

LAMINATED HARDWOOD TOP

WS14



- Top for general industrial applications
- Made from varnished hardwood slats
- Includes a 90° radius front edge for extra comfort
- High impact resistance
- Attractive appearance
- Thickness: 1¾"

STAINLESS STEEL TOP

RC35



- 16ga stainless steel: RC35-WWDD
- 12ga stainless steel: RC35-WWDD-12
- Acts as a work surface and protects the cabinet from impacts
- Particle board top with stainless steel cover (#4 brushed finish)
- Excellent corrosion and chemical resistance
- Top complies with CARB regulations on formaldehyde emissions
- Includes welded corners for an attractive appearance
- Thickness: 1¾"
- To order a 12ga stainless steel top, add 12 to the product number

MARINE EDGE STAINLESS STEEL TOP

RC35



- Marine edge 16ga stainless steel: RC35-WWDD-16M
- Marine edge 12ga stainless steel: RC35-WWDD-12M
- Prevents small objects or liquids from falling or spilling from the work surface
- Acts as a work surface and protects the cabinet from impacts
- Particle board top with stainless steel cover (#4 brushed finish)
- Excellent corrosion and chemical resistance
- Top complies with CARB regulations on formaldehyde emissions
- Includes welded corners for an attractive appearance
- Thickness: 1¾"
- To order: Specify the steel gauge required, e.g., RC35-WWDD-16M for a marine edge 16ga stainless steel top

PAINTED STEEL TOP

RC37



- Acts as a work surface and protects the cabinet from impacts
- Particle board top with painted steel cover
- Top complies with CARB regulations on formaldehyde emissions
- Includes welded corners for an attractive appearance
- Thickness: 1¾"



DIMENSIONS		TYPE OF TOP				
W	D	STEEL WITH RUBBER MAT	LAMINATED HARDWOOD	STAINLESS STEEL	MARINE EDGE STAINLESS STEEL	PAINTED STEEL
24"	21"	RC32-2421-01	WS14-2421A	RC35-2421-__*		
	27"	RC32-2427-01	WS14-2427A	RC35-2427-__		
30"	21"	RC32-3021-01	WS14-3021A	RC35-3021-__*		
	27"	RC32-3027-01	WS14-3027A	RC35-3027-__	RC35-3027-__M	RC37-3027
36"	18"	RC32-3618-01	WS14-3618A			RC37-3618
	24"	RC32-3624-01	WS14-3624A	RC35-3624-__	RC35-3624-__M	RC37-3624
48"	24"	RC32-4824-01	WS14-4824A	RC35-4824-__	RC35-4824-__M	RC37-4824
	27"	RC32-4827-01	WS14-4827A	RC35-4827-__	RC35-4827-__M	RC37-4827
54"	24"	RC32-5424-01	WS14-5424A	RC35-5424-__*	RC35-5424-__M	RC37-5424
	27"	RC32-5427-01	WS14-5427A	RC35-5427-__*	RC35-5427-__M	RC37-5427
60"	24"	RC32-6024-01	WS14-6024A	RC35-6024-__	RC35-6024-__M	RC37-6024
	27"	RC32-6027-01	WS14-6027A	RC35-6027-__	RC35-6027-__M	RC37-6027
66"	24"	RC32-6624-01	WS14-6624A	RC35-6624-__	RC35-6624-__M	RC37-6624
	27"	RC32-6627-01	WS14-6627A	RC35-6627-__	RC35-6627-__M	RC37-6627
72"	24"	RC32-7224-01	WS14-7224A	RC35-7224-__	RC35-7224-__M	RC37-7224
	27"	RC32-7227-01	WS14-7227A	RC35-7227-__	RC35-7227-__M	RC37-7227
78"	24"	RC32-7824-01	WS14-7824A	RC35-7824-__	RC35-7824-__M	RC37-7824
	27"	RC32-7827-01	WS14-7827A	RC35-7827-__	RC35-7827-__M	RC37-7827

NOTES: * 16ga only

For compatibility with doors with frame, choose a top 3" deeper than your cabinet, e.g., 27"D cabinet + door with 3"D frame = 30"D top

TOPS ACCESSORIES

FOLDAWAY SHELF

RC00

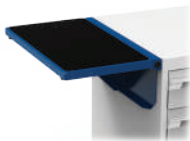

- Load capacity: 50lb. (evenly distributed)
- Includes a protective rubber surface
- Compatible with optional RC01 side and back stops for foldaway shelf

PRODUCT NO.	W x D
RC00-151801	15" x 18"
RC00-152101	15" x 21"
RC00-152401	15" x 24"
RC00-152701	15" x 27"

SIDE OR BACK STOPS FOR FOLDAWAY SHELF

RC01



- Use the 15" stop for front or back of shelf
- Use the 18", 21", 24" or 27" stop for the sides
- Height: 1"

PRODUCT NO.	WIDTH
RC01-15	15"
RC01-18	18"
RC01-21	21"
RC01-24	24"
RC01-27	27"

BACK OR SIDE STOPS

WS18 / WS98



- Painted steel: WS18
- Stainless steel: WS98
- Can be installed on back or sides depending on top dimensions
- Installs on WS14 and RC37 tops
- Height: 5". Clears top by approx. 3¼"
- To order: Add the type of steel required to the product number

PRODUCT NO.	WIDTH
WS__-2405	24"
WS__-2705	27"
WS__-3005	30"
WS__-3605	36"
WS__-4205	42"
WS__-4805	48"
WS__-5405	54"
WS__-6005	60"
WS__-7205	72"

NOTE: Not compatible with RC32 and RC35 tops.

ACCESSORIES

HANGING SIDE CABINETS

HANGING SIDE CABINET - SIDE ACCESS



352

- Side housing specifically designed to be installed on the side of RA30 cabinets
- The shelves are adjustable in 1" increments c/c
- The shelves are compatible with SH52 Partial Dividers
- Includes holes on the top so a common work surface can be installed on the main RA30 cabinet
- Door opens 180° for full access to items stored inside
- Door includes a key lock
- 600lb. load capacity
- Choice of doors. Add one of the following to the product number:
 - 01: Solid door
 - 02: Polycarbonate door

HEIGHT	WIDTH×DEPTH		NO. OF SHELVES (RD05)
	24"W×14"D	27"W×14"D	
24"	R5QCA-24__	R5QPA-24__	1
28"	R5QCA-28__	R5QPA-28__	2
30"	R5QCA-30__	R5QPA-30__	2
34"	R5QCA-34__	R5QPA-34__	2
38"	R5QCA-38__	R5QPA-38__	3
For Cabinet	24"D	27"D	



R5XE-1001

NOTE: For compatibility with a work surface, choose a top 12" wider than your cabinet, e.g., RC__-4824 for a 36"W×24"D mobile cabinet

HANGING SIDE CABINET - FRONT ACCESS



352

- Side housing specifically designed to be installed on the side of RA30 cabinets
- The shelves are adjustable in 1" increments c/c
- The shelves are compatible with SH52 Partial Dividers
- Roll-out shelf: 175lb. load capacity, 75% extension
- Includes holes on the top so a common work surface can be installed on the main RA30 cabinet
- Door opens 180° for full access to items stored inside
- Door includes a key lock
- 500lb. load capacity
- Choice of configurations. Add one of the following to the product number:
 - Shelves (RB20):
 - 03: Solid door
 - 05: Polycarbonate door
 - Roll-out shelves (RF55):
 - 04: Solid door
 - 06: Polycarbonate door

HEIGHT	WIDTH×DEPTH				NO. OF SHELVES (RB20)	NO. OF ROLL-OUT SHELVES (RF55)
	24"W×18"D	24"W×21"D	24"W×24"D	24"W×27"D		
28"	R5QCC-28__	R5QCD-28__	R5QCE-28__	R5QCG-28__	2	2
30"	R5QCC-30__	R5QCD-30__	R5QCE-30__	R5QCG-30__	2	2
34"	R5QCC-34__	R5QCD-34__	R5QCE-34__	R5QCG-34__	2	2
38"	R5QCC-38__	R5QCD-38__	R5QCE-38__	R5QCG-38__	3	3
For Cabinet	18"D	21"D	24"D	27"D		



It is recommended to install this product on a 48"W cabinet or wider

NOTE: For compatibility with a work surface, choose a top 24" wider than your cabinet, e.g., RC__-7224 for a 48"W×24"D mobile cabinet

SIDE PANELS

SIDE UTILITY PANEL

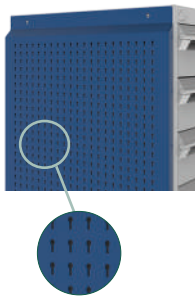

- 5S storage accessory
- Maximizes the cabinet's storage space
- Installs on the sides of R cabinets
- Quick and easy installation
- Includes perforations spaced 1" apart c/c for hanging a range of hooks
- Load capacity: 50lb./sq. ft., 500lb. max. per panel
- Compatible with: WM9F, WM9G, WM9H, WM9J and WM9L light-duty hooks; WM9A and WM9B heavy-duty hooks, [see page 262](#)
- Compatible with: WM9C rails; WM9D, WM9M, WM9N, WM9Q, WM9P, WM9R and WM9S holders; EA50 mounts; EA52 holders; EA28 and WM21 shelves, [see pages 262-263](#)
- Available in all standard R cabinet dimensions (depth, height)
- To order: Specify the housing height required, e.g., RC02-2434 for a 24"D x 34"H housing

PRODUCT NO.	CABINET DEPTH	NO. OF HOLES
RC02-18 __	18"	15
RC02-21 __	21"	18
RC02-24 __	24"	21
RC02-27 __	27"	24

NOTE: Full height installation only.

SIDE PANEL FOR PLASTIC BINS

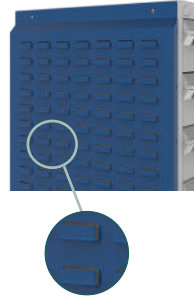

- 5S storage accessory
- Maximizes the cabinet's storage space
- Installs on the sides of R cabinets
- Quick and easy installation
- Holds RG20 plastic bins, [see page 297](#)
- Compatible with all commercially available brands of plastic bins with a hanging lip
- Available in all standard R cabinet dimensions (depth, height)
- To order: Specify the housing height required: RC04-2434 for a 24"D x 34"H housing

PRODUCT NO.	CABINET DEPTH
RC04-18 __	18"
RC04-21 __	21"
RC04-24 __	24"
RC04-27 __	27"

NOTE: Full height installation only.

AVAILABLE COMBINATIONS

To find the right combination for your intended usage, ask yourself:

How wide do I want the cabinet and what load capacity do I need? Here are the different options available:



The height of the cabinet must not exceed 40" to ensure stability when the cabinet is moving

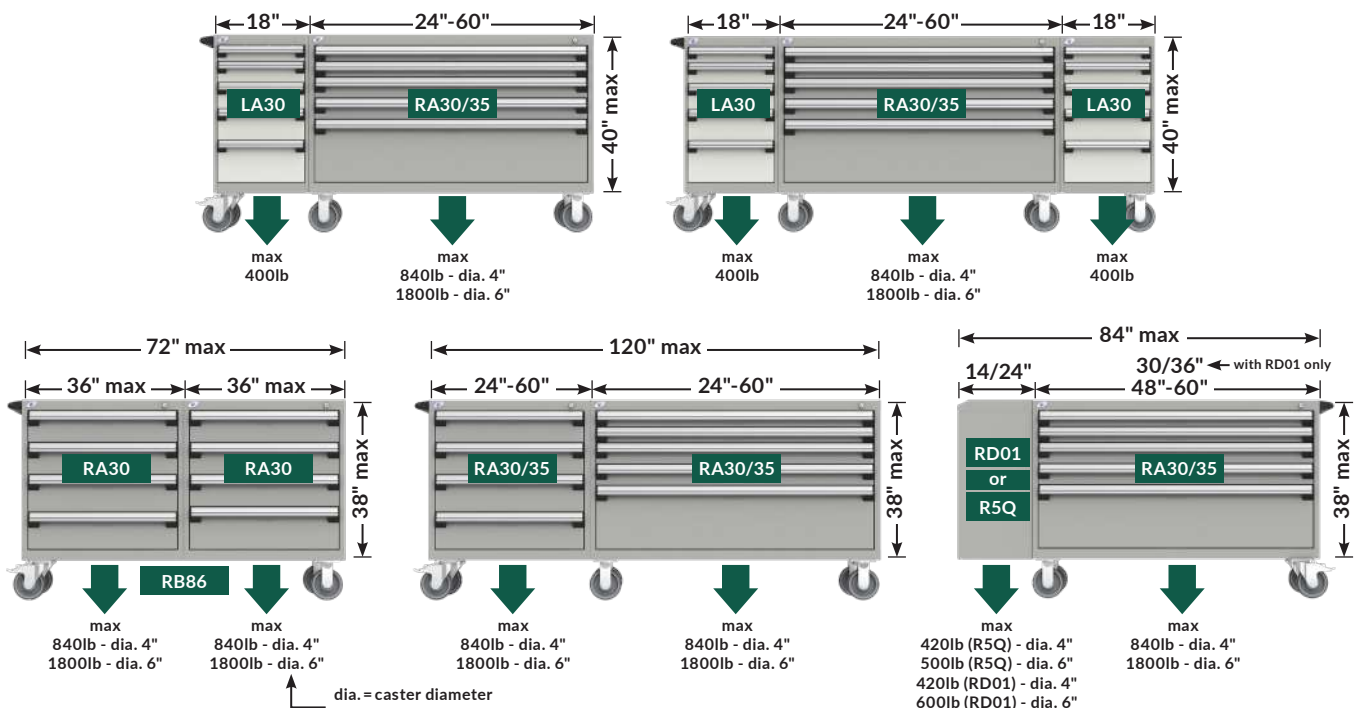

HOUSINGS

R HEAVY-DUTY CABINET HOUSING

RA30

- Compatible with modular drawers, roll-out shelves and shelves
- Compatible with integrated doors
- The housing units include knockouts:
 - on the top for installing accessories or work surfaces
 - on the sides and back for installing accessories
- A cabinet lock allows users to lock all drawers and roll-out shelves in the cabinet at the same time.
- Four types of lock available: L3 for a key lock, LP for a safety hasp, L50 for an digital lock or L100 for a smart lock
- To order: Specify the type of door and lock required, e.g., RA30-362438L3 for a R Heavy-duty Cabinet with a L3 key lock
- To order a true One-Drawer-at-a-Time mechanism, add A to the product number

NOTE: NFC transponders are not included with the smart lock, they must be ordered separately (pack of 5). See page 356.



352-356

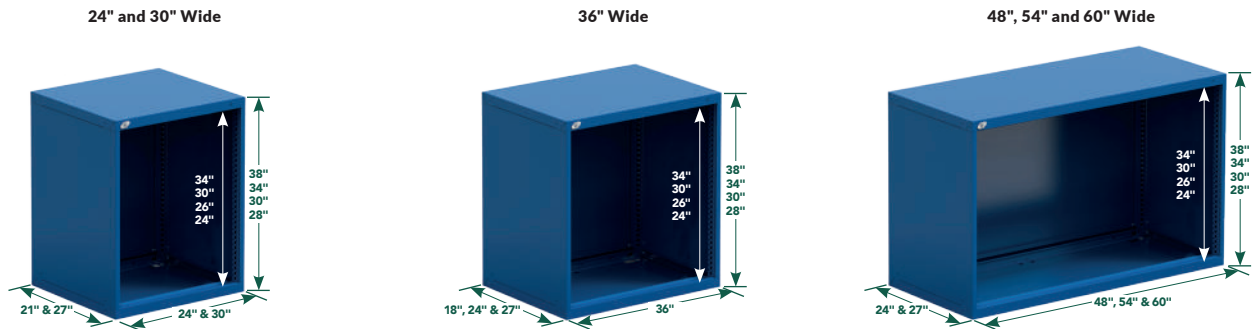

PRODUCT NO.	TOTAL HEIGHT	INSIDE HEIGHT
24" x 21"		
RA30-242124__	24"	20"
RA30-242128__	28"	24"
RA30-242130__	30"	26"
RA30-242134__	34"	30"
RA30-242138__	38"	34"
24" x 27"		
RA30-242724__	24"	20"
RA30-242728__	28"	24"
RA30-242730__	30"	26"
RA30-242734__	34"	30"
RA30-242738__	38"	34"
30" x 21"		
RA30-302124__	24"	20"
RA30-302128__	28"	24"
RA30-302130__	30"	26"
RA30-302134__	34"	30"
RA30-302138__	38"	34"
30" x 27"		
RA30-302724__	24"	20"
RA30-302728__	28"	24"
RA30-302730__	30"	26"
RA30-302734__	34"	30"
RA30-302738__	38"	34"
36" x 18"		
RA30-361824__	24"	20"
RA30-361828__	28"	24"
RA30-361830__	30"	26"
RA30-361834__	34"	30"
RA30-361838__	38"	34"
36" x 24"		
RA30-362424__	24"	20"
RA30-362428__	28"	24"
RA30-362430__	30"	26"
RA30-362434__	34"	30"
RA30-362438__	38"	34"

PRODUCT NO.	TOTAL HEIGHT	INSIDE HEIGHT
36" x 27"		
RA30-362724__	24"	20"
RA30-362728__	28"	24"
RA30-362730__	30"	26"
RA30-362734__	34"	30"
RA30-362738__	38"	34"
48" x 24"		
RA30-482424__	24"	20"
RA30-482428__	28"	24"
RA30-482430__	30"	26"
RA30-482434__	34"	30"
RA30-482438__	38"	34"
48" x 27"		
RA30-482724__	24"	20"
RA30-482728__	28"	24"
RA30-482730__	30"	26"
RA30-482734__	34"	30"
RA30-482738__	38"	34"
54" x 24"		
RA30-542424__	24"	20"
RA30-542428__	28"	24"
RA30-542430__	30"	26"
RA30-542434__	34"	30"
RA30-542438__	38"	34"

PRODUCT NO.	TOTAL HEIGHT	INSIDE HEIGHT
54" x 27"		
RA30-542724__	24"	20"
RA30-542728__	28"	24"
RA30-542730__	30"	26"
RA30-542734__	34"	30"
RA30-542738__	38"	34"
60" x 24"		
RA30-602424__	24"	20"
RA30-602428__	28"	24"
RA30-602430__	30"	26"
RA30-602434__	34"	30"
RA30-602438__	38"	34"
60" x 27"		
RA30-602724__	24"	20"
RA30-602728__	28"	24"
RA30-602730__	30"	26"
RA30-602734__	34"	30"
RA30-602738__	38"	34"

BRACES FOR DOUBLE MOBILE CABINET

RB86



- Sold in pairs
- For attaching two housings together (36"W or smaller) to create a double mobile cabinet
- All cabinet tops are compatible with double cabinets, see page 46
- Cabinets are factory assembled

PRODUCT NO.
RB86-01



DOORS

SINGLE INTEGRATED DOOR, SOLID, POLYCARBONATE OR WIRE MESH



RB62 / RB61 / RB43



352-356

- Single integrated door: RB62
- Single polycarbonate integrated door: RB61
- Single wire mesh integrated door: RB43
- Single door for 18"W, 24"W, 30"W and 36"W cabinets
- RB62 integrated doors have a closed back finish to increase rigidity and enhance aesthetics
- RB61 integrated polycarbonate doors have excellent impact resistance
- RB43 integrated wire mesh doors with frame promote airflow and provide visibility of the interior without opening
- Integrated doors are adjustable vertically and horizontally
- Compatible with RB21/RB20 Shelf
- Opens 180° for full access to items stored inside
- Factory installed on RA30 cabinet housings
- Some integrated door heights can be combined with drawers mounted above or below. For the latter case, you must order an RB20/RB21 shelf and install it above the bank of drawers
- Four types of lock available: L3 for a key lock, LP for a safety hasp, L50 for an digital lock or L100 for a smart lock

- To order: Specify the type of door and lock required, e.g., RB61-3034L50 for a 30"W x 34"H integrated polycarbonate door and L50 digital lock
- For a retrofit lock mechanism on a single integrated solid, polycarbonate or wire mesh door, [see pages 352-356](#)

PRODUCT NO.	W x H
RB__-2420__	24" x 20"
RB__-2424__	24" x 24"
RB__-2426__	24" x 26"
RB__-2430__	24" x 30"
RB__-2434__	24" x 34"
RB__-3020__	30" x 20"
RB__-3024__	30" x 24"
RB__-3026__	30" x 26"

PRODUCT NO.	W x H
RB__-3030__	30" x 30"
RB__-3034__	30" x 34"
RB__-3620__	36" x 20"
RB__-3624__	36" x 24"
RB__-3626__	36" x 26"
RB__-3630__	36" x 30"
RB__-3634__	36" x 34"

NOTES: Not compatible with RF31 / RF35 drawers or RF40 / RF44 roll-out shelves
NFC transponders are not included with the smart lock, they must be ordered separately (pack of 5). [See page 356.](#)

DOUBLE INTEGRATED DOORS, SOLID, POLYCARBONATE OR WIRE MESH



RB67 / RB66 / RB49



352-356

- Double integrated doors: RB67
- Double polycarbonate integrated doors: RB66
- Double wire mesh integrated doors: RB49
- Double doors for 30"W, 36"W, 48"W, 54"W and 60"W cabinets
- RB67 double integrated doors have a closed back finish to increase rigidity and enhance aesthetics
- RB66 double integrated polycarbonate doors have excellent impact resistance
- RB49 double integrated wire mesh doors promote airflow and provide visibility of the interior without opening
- Integrated doors are adjustable vertically and horizontally
- Compatible with RB21 shelf
- Opens 180° for full access to items stored inside
- Factory installed on RA30 cabinet housings
- Some integrated door heights can be combined with drawers mounted above or below. You must order an RB21 shelf and install it above the bank of drawers for drawers mounted below, or an RB65 crossbar for drawers mounted above

- Four types of lock available: L3 for a key lock, LP for a safety hasp, L50 for an digital lock or L100 for a smart lock
- To order: Specify the type of door and lock required, e.g., RB66-4820L3 for a 48"W x 20"H double integrated polycarbonate doors and a key lock
- For a retrofit lock mechanism on a double integrated solid, polycarbonate or wire mesh door, [see pages 352-356](#)

PRODUCT NO.	W x H
RB__-3020__	30" x 20"
RB__-3024__	30" x 24"
RB__-3026__	30" x 26"
RB__-3030__	30" x 30"
RB__-3034__	30" x 34"
RB__-3040__	30" x 40"
RB__-3054__	30" x 54"
RB__-3620__	36" x 20"
RB__-3624__	36" x 24"
RB__-3626__	36" x 26"
RB__-3630__	36" x 30"
RB__-3634__	36" x 34"
RB__-4820__	48" x 20"
RB__-4824__	48" x 24"
RB__-4826__	48" x 26"
RB__-4830__	48" x 30"

PRODUCT NO.	W x H
RB__-4834__	48" x 34"
RB__-5420__	54" x 20"
RB__-5424__	54" x 24"
RB__-5426__	54" x 26"
RB__-5430__	54" x 30"
RB__-5434__	54" x 34"
RB__-6020__	60" x 20"
RB__-6024__	60" x 24"
RB__-6026__	60" x 26"
RB__-6030__	60" x 30"
RB__-6034__	60" x 34"

NOTES: Not compatible with RF31 / RF35 drawers or RF40 / RF44 roll-out shelves.
NFC transponders are not included with the smart lock, they must be ordered separately (pack of 5). [See page 356.](#)

CROSSBAR FOR DOUBLE INTEGRATED DOORS

RB65



- Required for double integrated doors with drawers above
- Required a crossbar for double integrated doors with an digital lock or a smart lock and drawers above, complete the following product code L50

PRODUCT NO.	WIDTH
RB65-30__	30"
RB65-36__	36"
RB65-48__	48"
RB65-54__	54"
RB65-60__	60"

COMPONENTS

DRAWERS, SHELVES AND LOCKING / SECURITY MECHANISMS

HEAVY-DUTY MODULAR DRAWER



RF31 / RF35



- Painted steel drawer: RF31
- Drawer with stainless steel front and light gray 071 painted steel interior: RF35
- 400lb. load capacity, 100% extension
- Heavy-duty construction
- Easy to install
- Vast choice of accessories available to customize the drawer to your storage needs, [see pages 294-298](#)
- Drawer heights available: 03", 04", 05", 06", 07", 08", 09", 10", 12" and 14"
- For preconfigured modular drawers with compartments, [see pages 276-293](#)
- To order: Add the drawer height to the product number, specify the type of drawer front required (painted steel or stainless steel) and the type of lock-in mechanism required, e.g., RF31-362406A

A lock-in mechanism (A or B) is mandatory for all mobile applications.



352-356

PRODUCT NO.	W x D
RF__-2421__	24" x 21"
RF__-2427__	24" x 27"
RF__-3021__	30" x 21"
RF__-3027__	30" x 27"
RF__-3618__	36" x 18"
RF__-3624__	36" x 24"
RF__-4824__	48" x 24"
RF__-4827__	48" x 27"
RF__-5424__	54" x 24"
RF__-5427__	54" x 27"
RF__-6024__	60" x 24"
RF__-6027__	60" x 27"

HEAVY-DUTY 3-SIDED ACCESS ROLL-OUT SHELF



RF44

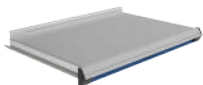

- 400lb. load capacity, 100% extension
- Heavy-duty construction
- Easy to install
- Galvanized steel top with 1½"H back
- Total height: 5"
- Can be used as a work surface
- To order: Specify the type of lock-in mechanism required, e.g., RF44-3624A

PRODUCT NO.	W x D
RF44-2421_	24" x 21"
RF44-2427_	24" x 27"
RF44-3021_	30" x 21"
RF44-3027_	30" x 27"
RF44-3618_	36" x 18"
RF44-3624_	36" x 24"
RF44-3627_	36" x 27"

PRODUCT NO.	W x D
RF44-4824_	48" x 24"
RF44-4827_	48" x 27"
RF44-5424_	54" x 24"
RF44-5427_	54" x 27"
RF44-6024_	60" x 24"
RF44-6027_	60" x 27"

HEAVY-DUTY FRONT ACCESS ROLL-OUT SHELF



RF40



- 400lb. load capacity, 100% extension
- Heavy-duty construction
- Easy to install
- Painted steel with 3"H edges on the sides and back
- Total height: 6"
- Full access to contents
- To order: Specify the type of lock-in mechanism required, e.g., RF40-3624A

PRODUCT NO.	W x D
RF40-2421_	24" x 21"
RF40-2427_	24" x 27"
RF40-3021_	30" x 21"
RF40-3027_	30" x 27"
RF40-3618_	36" x 18"
RF40-3624_	36" x 24"
RF40-3627_	36" x 27"

PRODUCT NO.	W x D
RF40-4824_	48" x 24"
RF40-4827_	48" x 27"
RF40-5424_	54" x 24"
RF40-5427_	54" x 27"
RF40-6024_	60" x 24"
RF40-6027_	60" x 27"

INTEGRATED LOCK-IN MECHANISM

A



- Automatically activated when lifting the handle up
- The drawer or roll-out shelf can be opened with one hand only
- Closes with a simple push
- Stops drawer or roll-out shelf from opening on their own
- Easy to retrofit
- To order: Add **A** to the product number for the drawer, preconfigured compartment layout or roll-out shelf, e.g., RF31-362406A
- For replacement parts or to retrofit this mechanism, order an RY08-WWA

PRODUCT NO.
A

ECONO LOCK-IN MECHANISM

B



- Activated with the right hand by sliding the mechanism with thumb
- The drawer or roll-out shelf closes without having to reactivate the slide mechanism
- Stops drawer or roll-out shelf from opening on their own
- Easy to retrofit
- To order: Add **B** to the product number for the drawer, preconfigured compartment layout or roll-out shelf, e.g., RF31-362406B
- For replacement parts or to retrofit this mechanism, order an RY01-B

PRODUCT NO.
B

DRAWER LOCK

L3



- Compatible with all drawer dimensions
- Does not reduce the drawer's storage space
- To order: Add **L3** to the product number for the drawer or preconfigured compartment layout, e.g., RF31-362406**L3**
- For replacement parts or to retrofit this mechanism, order an **RY01-L3**



352

PRODUCT NO. _____
L3 _____

LOCK-OUT MECHANISM

RF85

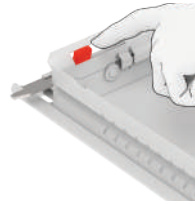

- For both drawers and roll-out shelves
- Locks drawers and roll-out shelves in an open position
- Activated manually, only when required
- Compatible with all drawer accessories

PRODUCT NO. _____
RF85 _____

NOTE: Plastic bins in the back row may make it more difficult to activate the mechanism

SHELF

RB20 / RB21



- For storage of bulky items
- The back and side edges prevent objects from falling to the bottom of the cabinet
- Height can be adjusted in 1" increments c/c
- Up to 400lb. load capacity, evenly distributed
- Includes perforations on the top spaced 3" apart c/c for inserting SH52 Partial Dividers. Allow 3" vertical clearance for installation, [see page 14](#)

PRODUCT NO.	W × D	LOAD CAPACITY (LB.)
RB20-2421	24" × 21"	200
RB20-2427	24" × 27"	200
RB21-3021	30" × 21"	400
RB21-3027	30" × 27"	400
RB21-3618	36" × 18"	400
RB21-3624	36" × 24"	400
RB21-4824	48" × 24"	400
RB21-4827	48" × 27"	400
RB21-5424	54" × 24"	400
RB21-5427	54" × 27"	400
RB21-6024	60" × 24"	400
RB21-6027	60" × 27"	400

NOTE: Actual usable space is 2" c/c less than the height, 2 1/4" c/c less than the width and 4" c/c less than the depth.

DRAWER ACCESSORIES

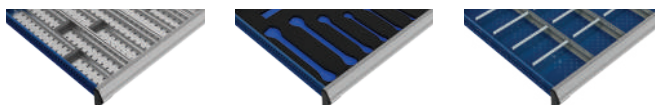

We offer a wide variety of drawer accessories that integrate with each other to help you organize and locate small parts. They are ideal for high-density storage and ensure you retain space for growth.

ACCESSORIES	PRODUCT NO.	CATALOG PAGE
Front to back partition	RG00	p. 294
Side to side partition	RG01	p. 294
Divider	RG10	p. 295
Plastic bins	RG20	p. 297
Divider for plastic bins	RG22 / RG24	p. 297
Conductive plastic bins	RG21	p. 297
Conductive divider for plastic bins	RG23 / RG25	p. 297
Groove tray	RG35	p. 298
Divider for groove trays	RG39	p. 298
Tool foam	RG42	p. 297

COMPONENTS

MOBILITY

CASTERS

RB81 / RB84 / RB8E



- Sold in pairs
- Three types of casters available: rigid, swivel and swivel with total-lock brake (on wheel and swivel)
- Dark gray, non-marking polyurethane tread
- Superior industrial quality

PRODUCT NO.	CASTER TYPE	CAPACITY	HEIGHT	
			WHEEL	TOTAL
RB81-01	Rigid	440 lb	4"	5 1/8"
RB81-02	Swivel	440 lb	4"	5 1/8"
RB81-03	Swivel with total-lock brake	440 lb	4"	5 1/8"
RB84-01	Rigid	1100 lb	6"	7 1/2"
RB84-02	Swivel	1100 lb	6"	7 1/2"
RB84-03	Swivel with total-lock brake	1100 lb	6"	7 1/2"
RB8E-02	Swivel caster directional locking kit for swivel casters (x2)			

NOTES: The casters install directly under an R cabinet (without base).
Not compatible with 18"W R cabinets.

QUIET CASTERS

RB8C / RB8D



- Sold in pairs
- Smooth and quieter rolling
- Two types of casters available: rigid and swivel with total-lock brake (on wheel and swivel)
- Blue, hard-wearing polyurethane tread for quiet and easy maneuvering
- Superior industrial quality

PRODUCT NO.	CASTER TYPE	CAPACITY	HEIGHT	
			WHEEL	TOTAL
RB8C-01	Quiet, rigid	660 lb	4"	5 1/8"
RB8C-03	Quiet, swivel with total-lock brake	660 lb	4"	5 1/8"
RB8D-01	Quiet, rigid	1100 lb	6"	7 1/2"
RB8D-03	Quiet, swivel with total-lock brake	1100 lb	6"	7 1/2"

NOTES: The casters install directly under an R cabinet (without base).
Not compatible with 18"W R cabinets.

EXTENDED BASE FOR CASTERS

RB88



- Provides stability when the cabinet has fewer than four drawers and/or when the load is not evenly distributed (e.g., One drawer supporting 400lb. and the other three supporting 50lb.)
- Moves the casters 5" forward (adds 5" to the unit depth).
- Compatible with 4" and 6" casters

PRODUCT NO.	DEPTH
RB88-18-05	18"
RB88-21-05	21"
RB88-24-05	24"
RB88-27-05	27"

SIDE HANDLE

RB90



- Installs on the side of single or double cabinets. Specify which side when ordering (left or right)
- Anodized aluminum with heavy-duty plastic end caps
- Wide-grip handle for easier cabinet handling

PRODUCT NO.	HANDLE WIDTH	FOR CABINET
RB90-18	15"	18"D
RB90-21	18"	21"D
RB90-24	21"	24"D
RB90-27	24"	27"D

FRONT HANDLES

RB92



- Sold in pairs
- Installs on the front of 24"W and 30"W single cabinets
- Black resistant plastic

PRODUCT NO.
RB92-01

NOTES: Not compatible with the L50 digital lock and the L100 smart lock.
Not compatible with 18"W R cabinets.



L COMPACT MOBILE CABINET

The innovative L Compact Mobile Cabinet is 18" wide and comes in two depths (21" and 27") and five heights (24", 28", 30", 34" and 40"). It adapts perfectly to your needs and easily integrates into your workspace. Whether you want a single, double or triple unit, it comes mounted on 4" or 6" premium-quality casters, which ensures years of satisfaction from this robust and reliable work equipment.

The L compact drawer has a load capacity of 100lb. and boasts 100% extension in both cabinet depths. There is also a wide range of accessories available for it. The lock-in mechanism allows users to move the cabinet safely, while the central locking mechanism locks all drawers at the same time for secure storage of the drawer contents.

With its intelligent construction and design, the L Compact Mobile Cabinet is versatile, modular and truly ingenious. It is an excellent alternative to the R heavy-duty version.



L3BBD-2803L3B

THE ROUSSEAU DIFFERENCE



100% extension for both drawer depths, 100lb. load capacity per drawer, six drawer heights available: 3", 4", 5", 6", 8" and 12".

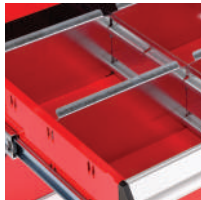

Wide variety of drawer accessories available: full-depth partitions, dividers, plastic bins, hanging file holders, protective foam, etc.



Central locking on the cabinet housing.



The lock-in mechanism stops drawers from opening on their own.



Polyurethane casters for excellent maneuverability without marking floors.



LIFETIME WARRANTY
The Rousseau drawer rolling mechanism is covered by a lifetime warranty.

PRECONFIGURED MODELS

HERE ARE SOME OF OUR MOST POPULAR PRECONFIGURED MODELS OF L COMPACT MOBILE CABINETS

- All preconfigured models are factory assembled and ready to use
- The preconfigured models in this section have 4" casters, including two rigid and two swivel casters with total-lock brakes
- To add a top, [see page 61](#)
- To order a key lock on the housing, add **L3** to the end of the product number
- To add a LP safety hasp, an L50 digital lock or a L100 smart lock to a door or to your L mobile cabinet, [see page 58](#)
- A lock-in mechanism stops drawers from opening on their own when moving the cabinet and when the central locking is not activated
- To order a lock-in mechanism, add **B** to the product number, e.g., L3BBD-2401L3 **B** for an 18"W x 21"D x 29 1/4"H cabinet, with three drawers, central lock and lock-in mechanism



IMPORTANT

Drawer compartments are included in all models. See the table for the number of compartments

To order drawers without compartments, replace the last two digits of the model number with the next even number up.

e.g., L3BBD-2401 with L3BBD-2402 without



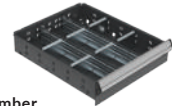

NUMBER OF COMPARTMENTS (LAYOUT CODE)		
DRAWER DIMENSION	18"W x 21"D	18"W x 27"D
3"H to 5"H	9 (0206)	9 (0206)
6"H and 8"H	6 (0104)	6 (0104)
12"H	4 (0102)	4 (0102)



A security mechanism B on the drawer and/or L3 on the housing is required for all mobile applications.

18" WIDE (W x D x H)

Each model includes two front handles

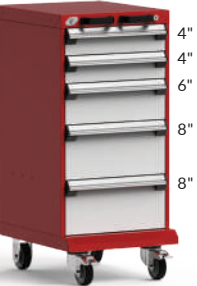
 <p>4" 4" 12"</p>	 <p>6" 6" 8"</p>	 <p>3" 4" 5" 12"</p>	 <p>5" 5" 6" 8"</p>	 <p>3" 3" 5" 5" 5" 5"</p>
3 DRAWERS L3BBD-2401__ 18" x 21" x 29 1/4" L3BGG-2401__ 18" x 27" x 29 1/4"	3 DRAWERS L3BBD-2403__ 18" x 21" x 29 1/4" L3BGG-2403__ 18" x 27" x 29 1/4"	4 DRAWERS L3BBD-2801__ 18" x 21" x 33 1/2" L3BGG-2801__ 18" x 27" x 33 1/2"	4 DRAWERS L3BBD-2803__ 18" x 21" x 33 1/2" L3BGG-2803__ 18" x 27" x 33 1/2"	6 DRAWERS L3BBD-3001__ 18" x 21" x 35 1/8" L3BGG-3001__ 18" x 27" x 35 1/8"
 <p>3" 3" 4" 6" 6" 8"</p>	 <p>30"</p>	 <p>6" 6" 6" 6" 6" 6"</p>	 <p>4" 4" 6" 8" 8"</p>	 <p>6" 6" 6" 6" 12"</p>
6 DRAWERS L3BBD-3401__ 18" x 21" x 39 1/2" L3BGG-3401__ 18" x 27" x 39 1/2"	1 DOOR / 1 SHELF L3BBD-3412__ 18" x 21" x 39 1/2" L3BGG-3412__ 18" x 27" x 39 1/2"	5 DRAWERS L3BBD-3413__ 18" x 21" x 39 1/2" L3BGG-3413__ 18" x 27" x 39 1/2"	5 DRAWERS L3BBD-3415__ 18" x 21" x 39 1/2" L3BGG-3415__ 18" x 27" x 39 1/2"	4 DRAWERS L3BBD-3417__ 18" x 21" x 39 1/2" L3BGG-3417__ 18" x 27" x 39 1/2"
 <p>5" 5" 8" 12"</p>	 <p>3" 4" 5" 6" 6" 12"</p>	 <p>3" 4" 4" 5" 6" 6" 6" 8"</p>	 <p>4" 6" 6" 8" 12"</p>	 <p>3" 3" 3" 8" 8" 8"</p>
4 DRAWERS L3BBD-3403__ 18" x 21" x 39 1/2" L3BGG-3403__ 18" x 27" x 39 1/2"	6 DRAWERS L3BBD-4001__ 18" x 21" x 45 1/2" L3BGG-4001__ 18" x 27" x 45 1/2"	7 DRAWERS L3BBD-4003__ 18" x 21" x 45 1/2" L3BGG-4003__ 18" x 27" x 45 1/2"	5 DRAWERS L3BBD-4007__ 18" x 21" x 45 1/2" L3BGG-4007__ 18" x 27" x 45 1/2"	7 DRAWERS L3BBD-4009__ 18" x 21" x 45 1/2" L3BGG-4009__ 18" x 27" x 45 1/2"

36" WIDE (W x D x H)

Each model includes one side handle



9 DRAWERS
L3BED-2401__ 36" x 21" x 29 1/8"
L3BEG-2401__ 36" x 27" x 29 1/8"



11 DRAWERS
L3BED-2801__ 36" x 21" x 33 1/8"
L3BEG-2801__ 36" x 27" x 33 1/8"



4 DRAWERS / 1 DOOR / 1 SHELF
L3BED-2823__ 36" x 21" x 33 1/8"
L3BEG-2823__ 36" x 27" x 33 1/8"



10 DRAWERS
L3BED-3431__ 36" x 21" x 39 1/8"
L3BEG-3431__ 36" x 27" x 39 1/8"



9 DRAWERS
L3BED-3433__ 36" x 21" x 39 1/8"
L3BEG-3433__ 36" x 27" x 39 1/8"

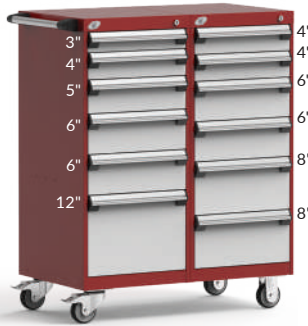

12 DRAWERS
L3BED-4001__ 36" x 21" x 45 1/8"
L3BEG-4001__ 36" x 27" x 45 1/8"



15 DRAWERS
L3BED-4003__ 36" x 21" x 45 1/8"
L3BEG-4003__ 36" x 27" x 45 1/8"



4 DRAWERS / 2 DOORS / 2 SHELVES
L3BED-4033__ 36" x 21" x 45 1/8"
L3BEG-4033__ 36" x 27" x 45 1/8"

54" WIDE (W x D x H)

Each model includes one side handle



12 DRAWERS
L3BJD-2801__ 54" x 21" x 33 1/8"
L3BJG-2801__ 54" x 27" x 33 1/8"



13 DRAWERS
L3BJD-3001__ 54" x 21" x 35 1/8"
L3BJG-3001__ 54" x 27" x 35 1/8"



16 DRAWERS
L3BJD-3403__ 54" x 21" x 39 1/8"
L3BJG-3403__ 54" x 27" x 39 1/8"



15 DRAWERS
L3BJD-3401__ 54" x 21" x 39 1/8"
L3BJG-3401__ 54" x 27" x 39 1/8"



18 DRAWERS
L3BJD-4001__ 54" x 21" x 45 1/8"
L3BJG-4001__ 54" x 27" x 45 1/8"



8 DRAWERS / 2 DOORS / 2 SHELVES
L3BJD-4003__ 54" x 21" x 45 1/8"
L3BJG-4003__ 54" x 27" x 45 1/8"

ACCESSORIES

SECURITY MECHANISMS

KEY LOCK / SAFETY HASP FOR CABINET L3 / LP



352-353

- Locks all drawers in the cabinet at the same time
- Easy to retrofit
- The drawer layout can be changed without touching the locking mechanism
- To order a lock, add L3 to the cabinet housing or preconfigured model number e.g., LA30-182134L3
- To order a safety hasp, add LP to the cabinet housing product number e.g., LA30-182134LP
- For replacement parts or to retrofit this mechanism, [see pages 352-353](#)

PRODUCT NO.

L3	Key lock
LP	Safety hasp

DIGITAL LOCK FOR CABINET L50



354

- Electronically locks all drawers in the cabinet at the same time
- No key required
- Up to 20 different users can be programmed
- 4-8 digit access codes
- Simplifies access management to drawers
- To order a lock, add L50 to the cabinet housing or preconfigured model number e.g., LA30-182134L50
- For replacement parts or to retrofit this mechanism, [see page 354](#)

PRODUCT NO.

L50

SMART LOCK FOR CABINET L100



355

- Handy unlocking via a transponder or smartphone
- User-friendly and intuitive
- No key required
- Easy and comprehensive management
- To order a lock, add L100 to the cabinet housing e.g., LA30-182134L100
- For replacement parts or to retrofit this mechanism, [see page 356](#)

PRODUCT NO.

L100

NOTE: NFC transponders are not included with the lock, they must be ordered separately (pack of 5). [See page 356.](#)

KEY LOCK / SAFETY HASP FOR DOORS L3/LP



352-353

- Two keys provided with each lock
- To order a key lock, add L3 to the door product number e.g., LB30-1812L3
- To order a safety hasp, add LP to the door product number e.g., LB30-1812LP
- For replacement parts or to retrofit this mechanism, [see pages 352-353](#)

PRODUCT NO.

L3	Key lock
LP	Safety hasp

NOTE: An LF91 security panel must be ordered to block access between two doors and if two different user access rights are required.

DIGITAL LOCK FOR DOORS L50



354

- Electronically locks a cabinet door
- No key required
- Up to 20 different users can be programmed
- 4-8 digit access codes
- To order: Add L50 to the door product code, e.g. LB30-1812L50

PRODUCT NO.

L50

NOTE: Cannot be retrofitted.

SMART LOCK FOR DOORS L100



355

- Handy unlocking via a transponder or smartphone
- User-friendly and intuitive
- No key required
- Easy and comprehensive management
- To order: Add L100 to the door product code, e.g. LB30-1812L100

PRODUCT NO.

L100

NOTES: Cannot be retrofitted.

NFC transponders are not included with the lock, they must be ordered separately (pack of 5). [See page 356.](#)

DRAWER LOCK

L3



352

- Two keys provided with each lock
- Compatible with all drawer dimensions
- The mechanism (covered by a galvanized steel box) requires 3"W×1"D space inside the drawer
- To order: Add L3 to the product number for the drawer or preconfigured compartment layout e.g., LF31-182106L3
- For replacement parts or to retrofit this mechanism, [see page 352](#)

PRODUCT NO.

L3

NOTE: An LF91 security panel must be ordered to block access between two drawers and if two different user access rights are required.

LOCK-IN MECHANISM

B



- Activated with the right hand by sliding the mechanism with thumb
- The drawer closes without having to reactivate the sliding mechanism
- Stops drawers from opening on their own
- Easy to retrofit
- To order: Add B to the product number for the drawer or preconfigured compartment layout e.g., LF31-182106B
- For replacement parts or to retrofit this mechanism, order an LY01 and a LY02

PRODUCT NO.

B

VERTICAL SECURITY BAR

LB10



352-353

- Locks all drawers in a cabinet with a key or padlock
- The key or safety hasp is located at the top of the bar to facilitate access
- Covers a bank of drawers from 20" to 36" high
- Easy to assemble
- Installs on the right-hand side
- To order: Specify the type of lock required, LP for a safety hasp or L3 for a standard key lock

PRODUCT NO.	CABINET HEIGHT	VERTICAL SECURITY BAR HEIGHT
LB10-24__A	24"	20"
LB10-28__A	28"	24"
LB10-30__A	30"	26"
LB10-34__A	34"	30"
LB10-40__A	40"	36"

SECURITY PANEL

LF91

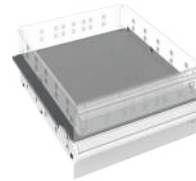

- Divides the cabinet up for use by more than one user
- Adjustable in 1" increments c/c
- Must be ordered to:
 - Block access between doors
 - Block access when a door with lock is installed under a drawer
 - Block the space left when a door is installed above a drawer
- Two security panel versions available for housings with or without a central locking mechanism
- Galvanized steel
- To order: Specify the housing depth, 21" or 27"

PRODUCT NO. FOR LA30

LF91-18__01 With L3/LP/L50 on the housing

LF91-18__02 Without L3/LP/L50 on the housing

DRAWER AND HANDLE ACCESSORIES

HANDLE PROTECTOR

LF70



- Clips onto the drawer handle
- Made of transparent plastic
- Protects identification labels from dust, grease and dirt
- Easy to remove

PRODUCT NO.

LF70-18

HANDLE LABELS

LF71



- Labels to be attached to handles under the handle protector (LF70)
- 30 labels per page (10 pages)
- Print your own labels
- Download the electronic template (MS Word) from the rousseau.com website under the "Resources" tab to create labels or scan this QR code.

PRODUCT NO.

LF71-425075



ACCESSORIES

HANGING FILE BARS LG31



- For storing hanging files
- Fits both letter and legal sizes
- For 12"H drawers

PRODUCT NO.
LG31-18

TOOL FOAM LG42



- Oil resistant and non-absorbent
- Includes one piece of ¼"-thick blue foam
- Includes one piece of ½"-thick black foam
- Sold without cut-outs. Can be cut with a utility knife

PRODUCT NO.	FOR DRAWER
LG42-1821-01	18"W × 21"D
LG42-1827-01	18"W × 27"D

PVC DRAWER LINER LG40



- Protects stored objects
- Non-skid surface
- Can be installed under partitions and dividers
- Thickness: 3/32"

PRODUCT NO.	FOR DRAWER
LG40-1821-01	18"W × 21"D
LG40-1827-01	18"W × 27"D

PROTECTIVE FOAM LG41

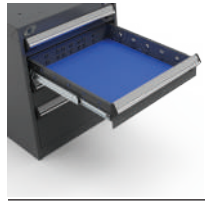

- Protects items stored in the drawer
- Includes one piece of ¼"-thick blue foam

PRODUCT NO.	FOR DRAWER
LG41-1821-01	18"W × 21"D
LG41-1827-01	18"W × 27"D

NOTE: Partitions and dividers cannot be installed in the same drawer as this foam.

FRONT TO BACK PARTITION LG02



- Divides the drawer along its depth
- Clip system locks dividers in place
- Galvanized steel
- Compatible with RG10 dividers, which can be used to make smaller compartments between each partition
- Compatible with plastic bins and PVC drawer liners

NOMINAL DRAWER HEIGHT (ACTUAL)	NOMINAL DRAWER DEPTH (ACTUAL)	
	21" (18")	27" (24")
3" (1 1/8"H)	LG02-2103	LG02-2703
4" (2 5/8"H)	LG02-2104	LG02-2704
5" (3 3/8"H)	LG02-2105	LG02-2705
6" (4 3/8"H)	LG02-2106	LG02-2706
8" (6 3/8"H)	LG02-2108	LG02-2708
12" (8 3/8"H)	LG02-2110	LG02-2710

PLASTIC BIN RG20



- For easier storing, moving and managing of small parts
- Lightweight and durable
- For 3"H and 4"H drawers
- 45° angled rim for easy identification of bin contents and removal of bins
- Compatible with partitions and dividers
- 6" plastic bins can be subdivided

DIMENSIONS			PRODUCT NO.		
W	D	H	BIN	PARTITION	DIVIDER
3"	3"	2"	RG20-030302	-	-
4"	3"	2"	RG20-040302	-	-
6"	3"	2"	RG20-060302	RG22-0302	-
6"	6"	2"	RG20-060602	RG22-0602	RG24-0602
3"	3"	3"	RG20-030303	-	-
4"	3"	3"	RG20-040303	-	-
6"	3"	3"	RG20-060303	RG22-0303	-
6"	6"	3"	RG20-060603	RG22-0603	RG24-0603

NOTE: 2"H bins = 1 1/2" actual height
3"H bins = 2 1/2" actual height

DRAWER DIVIDER RG10



- Dividers clip in place
- 45° angled edge for easy identification of compartment contents
- Adjustable in 3" increments (c/c)

NOMINAL DIVIDER WIDTH	NOMINAL DRAWER HEIGHT (ACTUAL)					
	3" (1 1/8"H)	4" (2 5/8"H)	5" (3 3/8"H)	6" (4 3/8"H)	8" (6 3/8"H)	12" (8 3/8"H)
3"	RG10-03003	RG10-03004	RG10-03005	RG10-03006	RG10-03008	RG10-03010
5"	RG10-05003	RG10-05004	RG10-05005	RG10-05006	RG10-05008	RG10-05010
6"	RG10-06003	RG10-06004	RG10-06005	RG10-06006	RG10-06008	RG10-06010
7 1/2"	RG10-07503	RG10-07504	RG10-07505	RG10-07506	RG10-07508	RG10-07510
9"	RG10-09003	RG10-09004	RG10-09005	RG10-09006	RG10-09008	RG10-09010
10"	RG10-10003	RG10-10004	RG10-10005	RG10-10006	RG10-10008	RG10-10010
12"	RG10-12003	RG10-12004	RG10-12005	RG10-12006	RG10-12008	RG10-12010
15"	RG10-15003	RG10-15004	RG10-15005	RG10-15006	RG10-15008	RG10-15010

CABINET TOPS

RESISTANT ACRYLIC/PVC PLASTIC LAMINATED TOP WS08



- Ideal for assembly stations or for applications using solvents, oils or other chemical products
- Color: gray
- Featuring softened edges, with 1/8" PVC edge banding around the entire perimeter for a clean and durable finish
- Premium-quality laminated top
- Excellent chemical resistance (can be in prolonged contact with a substance)
- Superior abrasion resistance compared with standard laminated tops
- Superior impact resistance compared with standard laminated tops
- Attractive appearance
- Thickness: 1 1/2"

STEEL TOP WITH RUBBER MAT RC32



- Non-slip rubber surface
- Includes edges on the sides and back
- Height: 1"

STAINLESS STEEL TOP RC35



- Acts as a work surface and protects the cabinet from impacts
- Particle board top with stainless steel cover (#4 brushed finish)
- Excellent corrosion and chemical resistance
- Top complies with CARB regulations on formaldehyde emissions
- Includes welded corners for an attractive appearance
- Thickness: 1 3/4"

LAMINATED HARDWOOD TOP WS14



- Top for general industrial applications
- Made from varnished hardwood slats
- Includes a 90° radius front edge for extra comfort
- High impact resistance
- Attractive appearance
- Thickness: 1 3/4"

PAINTED STEEL TOP RC37



- Acts as a work surface and protects the cabinet from impacts
- Particle board top with painted steel cover
- Top complies with CARB regulations on formaldehyde emissions
- Includes welded corners for an attractive appearance
- Thickness: 1 3/4"

PLASTIC LAMINATED TOP WS16



- Top for general use. Ideal for assembly stations, quality control and packaging
- Colors: Default is white. For another color, add "-BA" for black or "-GB" for gray to the end of the product number, e.g., WS16-6024A-BA for a black top
- Featuring softened edges, with 1/8" PVC edge banding around the entire perimeter for a clean and durable finish
- Attractive appearance
- Easy to clean
- Thickness: 1 1/2"



DISSIPATIVE TOP WS17



- Top for electronics tasks. Ideal for electronics inspection or assembly stations
- Color: white
- Featuring softened edges, with 1/8" PVC edge banding around the entire perimeter for a clean and durable finish
- Attractive appearance
- Easy to clean
- Dissipates electrical charges that can damage electronic components
- The resistance point to point and point to ground is between 10⁶ and 10⁹Ω
- In accordance with the standard ESD-S4 1-1997
- Thickness: 1 1/2"

NOTE: Grounding accessories are sold separately, see page 35.

DIMENSIONS		CABINET TOPS						
W	D	ACRYLIC/PVC PLASTIC LAMINATED	LAMINATED HARDWOOD	PLASTIC LAMINATED	DISSIPATIVE	STEEL WITH RUBBER MAT	STAINLESS STEEL	PAINTED STEEL
18"	21"		WS14-1821A	WS16-1821-__		RC32-1821-01	RC35-1821	RC37-1821
	27"		WS14-1827A	WS16-1827-__		RC32-1827-01	RC35-1827	RC37-1827
36"	21"	WS08-3621	WS14-3621A	WS16-3621-__	WS17-3621	RC32-3621-01	RC35-3621	RC37-3621
	27"	WS08-3627	WS14-3627A	WS16-3627-__	WS17-3627	RC32-3627-01	RC35-3627	RC37-3627
54"	21"	WS08-5421	WS14-5421A	WS16-5421-__	WS17-5421	RC32-5421-01	RC35-5421	RC37-5421
	27"	WS08-5427	WS14-5427A	WS16-5427-__	WS17-5427	RC32-5427-01	RC35-5427	RC37-5427

ACCESSORIES

TOP ACCESSORIES

FOLDAWAY SHELF

RC00



- Load capacity: 50lb. (evenly distributed)
- Includes a protective rubber surface
- Compatible with optional RC01 side and back stops for foldaway shelf

PRODUCT NO.	W×D
RC00-152101	15"×21"
RC00-152701	15"×27"

SIDE AND BACK STOPS FOR FOLDAWAY SHELF

RC01



- Use the 15" stop for front or back of shelf
- Use the 21" or 27" stop for the sides
- Height: 1"

PRODUCT NO.	WIDTH
RC01-15	15"
RC01-21	21"
RC01-27	27"



HOUSING AND DOORS

L COMPACT CABINET HOUSING

LA30



352-356

- Create a customized workspace with a wide range of possibilities
- Drawers, shelves and doors can be installed in the housing
- The housing units include knockouts:
 - On the top: for stacking an LD75 Housing for Drawer Unit
 - On the sides: for assembling cabinets side to side
- Requires an LB93 Cart for Single Cabinet for a single mobile cabinet or an LB96 Base for Casters for a double or triple cabinet
- Four types of lock available: L3 for a key lock, LP for a safety hasp, L50 for an digital lock or L100 for a smart lock

PRODUCT NO.	W × D × H
LA30-182124__	18" × 21" × 24"
LA30-182128__	18" × 21" × 28"
LA30-182130__	18" × 21" × 30"
LA30-182134__	18" × 21" × 34"
LA30-182140__	18" × 21" × 40"
LA30-182724__	18" × 27" × 24"
LA30-182728__	18" × 27" × 28"
LA30-182730__	18" × 27" × 30"
LA30-182734__	18" × 27" × 34"
LA30-182740__	18" × 27" × 40"

NOTE: NFC transponders are not included with the smart lock, they must be ordered separately (pack of 5). See page 356.

INTEGRATED DOOR

LB30



352-356

- Black plastic recessed handle
- The doors are factory installed with hinges on the left. They can be installed on the right upon request
- An LB24 Adjustable Shelf must be ordered as a storage surface for doors installed above a drawer or another door
- Four types of lock available: L3 for a key lock, LP for a safety hasp, L50 for an digital lock or L100 for a smart lock

PRODUCT NO.	W × H
LB30-1812__	18" × 12"
LB30-1818__	18" × 18"
LB30-1820__	18" × 20"
LB30-1824__	18" × 24"
LB30-1826__	18" × 26"
LB30-1830__	18" × 30"
LB30-1836__	18" × 36"

NOTE: NFC transponders are not included with the smart lock, they must be ordered separately (pack of 5). See page 356.

L COMPACT DRAWER

LF31



A security mechanism **B** on the drawer and/or **L3** on the housing is required for all mobile applications.



352

- 100 lb. load capacity, 100% extension
- Vast choice of accessories available to customize the drawer to your storage needs
- Precision ball bearing drawer slides included
- Easy hook-on assembly
- For preconfigured drawer compartment layouts, see pages 29-30
- Drawer heights available: 03", 04", 05", 06", 08" and 12"
- To order: Add the drawer height required to the product number, e.g., LF31-182106
- To order a drawer key lock, add L3 to the drawer product number. The mechanism (covered by a galvanized steel box) requires 3"W × 1"D space inside the drawer e.g., LF31-182704L3
- To order a drawer lock-in mechanism, add **B** to the drawer product number, e.g., LF31-182103B

PRODUCT NO.	W × D	INSIDE DIM.
LF31-1821__	18" × 21"	15" × 18"
LF31-1827__	18" × 27"	15" × 24"

SHELF

LB24



- For storage of bulky items
- Includes side and back edges
- Height can be adjusted in 1" increments c/c
- Up to 100lb. load capacity, evenly distributed
- Two shelf versions available for housings with or without a central locking mechanism
- Galvanized steel
- To order: Specify the housing depth, 21" or 27"

PRODUCT NO.	FOR LA30
LB24-18__01	With L3/LP on the housing
LB24-18__02	Without L3/LP on the housing



MOBILITY

CASTERS

LB81 / LB84 / RB8E



LB81-03

LB84-03

RB8E-02

- Sold in pairs
- Three types of casters available: rigid, swivel and swivel with total-lock brake (on wheel and swivel)
- Dark gray, non-marking polyurethane tread
- Superior industrial quality

PRODUCT NO.	CASTER TYPE	CAPACITY	HEIGHT	
			WHEEL	TOTAL
LB81-01	Rigid	440 lb	4"	5 1/8"
LB81-02	Swivel	440 lb	4"	5 1/8"
LB81-03	Swivel with total-lock brake	440 lb	4"	5 1/8"
LB84-01	Rigid	1100 lb	6"	7 1/2"
LB84-02	Swivel	1100 lb	6"	7 1/2"
LB84-03	Swivel with total-lock brake	1100 lb	6"	7 1/2"
RB8E-02	Swivel caster directional locking kit for swivel casters (x2)			

NOTE: LB93 Cart for Single Cabinet or LB96 Base for Casters is required for use with an L compact cabinet, [see page 65](#).

QUIET CASTERS

LB8C / LB8D



LB8C-03

LB8D-03

- Sold in pairs
- Smooth and quieter rolling
- Two types of casters available: rigid and swivel with total-lock brake (on wheel and swivel)
- Blue, hard-wearing polyurethane tread for quiet and easy maneuvering
- Superior industrial quality

PRODUCT NO.	CASTER TYPE	CAPACITY	HEIGHT	
			WHEEL	TOTAL
LB8C-01	Quiet, rigid	660 lb	4"	5 1/8"
LB8C-03	Quiet, swivel with total-lock brake	660 lb	4"	5 1/8"
LB8D-01	Quiet, rigid	1100 lb	6"	7 1/2"
LB8D-03	Quiet, swivel with total-lock brake	1100 lb	6"	7 1/2"

NOTE: LB93 Cart for Single Cabinet or LB96 Base for Casters is required for use with an L compact cabinet, [see page 65](#).

CART FOR SINGLE CABINET

LB93



- Required for installing casters under a single cabinet
- Installs under cabinets without a base
- Compatible with 4" and 6" casters (sold separately)

PRODUCT NO.	W×D
LB93-1821	18"×21"
LB93-1827	18"×27"

BASE FOR CASTERS

LB96

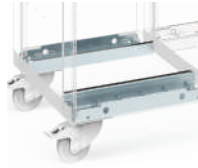

- Required for installing casters under double or triple cabinets
- A base includes two brackets (one front and one rear). Order two bases for a double cabinet and three bases for a triple cabinet
- Installs under cabinets without a base
- Compatible with 4" and 6" casters (sold separately)

PRODUCT NO.
LB96-18



Mobile cabinets must be loaded uniformly to eliminate the risk of tipping when a drawer is opened.

SIDE HANDLE

RB90



- Installs on the side of double or triple cabinets. Specify which side when ordering (left or right)
- Anodized aluminum with heavy-duty plastic end caps
- Wide-grip handle for easier cabinet handling

PRODUCT NO.	ACTUAL DEPTH	FOR CABINET
RB90-21	18"	21"D
RB90-27	24"	27"D

FRONT HANDLES

RB92



- Sold in pairs
- Installs on the front of 18"W single cabinets
- Black resistant plastic

PRODUCT NO.
RB92-01

NOTE: Not compatible with the L50 digital lock and the L100 smart lock.

