

supermaxi
pipe bevelers

724

416



 **G.B.C.**[®]
Industrial Tools S.p.A.

supermaxi 7²

Range Ø 180-504 mm (7,08" – 19,84")

Unità utilizzata per il piping e in officine di saldature per lavorazioni di condutture, caldaie, impianti complessi.

The unit is designed for piping industries and welding workshops for processing pipelines, boilers and fittings.

CAMPI DI APPLICAZIONE

- Tornitura
- Rastrematura interna ed esterna
- Smussatura interna ed esterna delle estremità di tubo in acciaio, leghe speciali e metalliche

APPLICATION FIELDS

- *Milling processes*
- *External and Internal Tapering*
- *External and Internal Beveling of steel pipes and special metallic alloys*



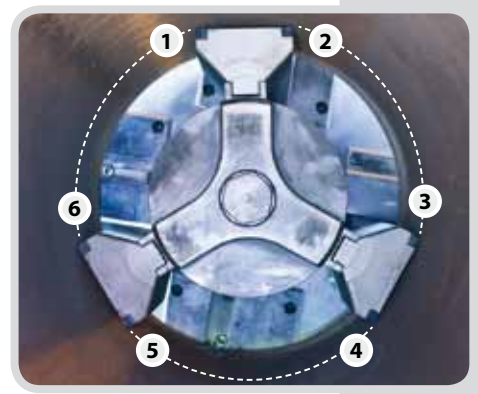
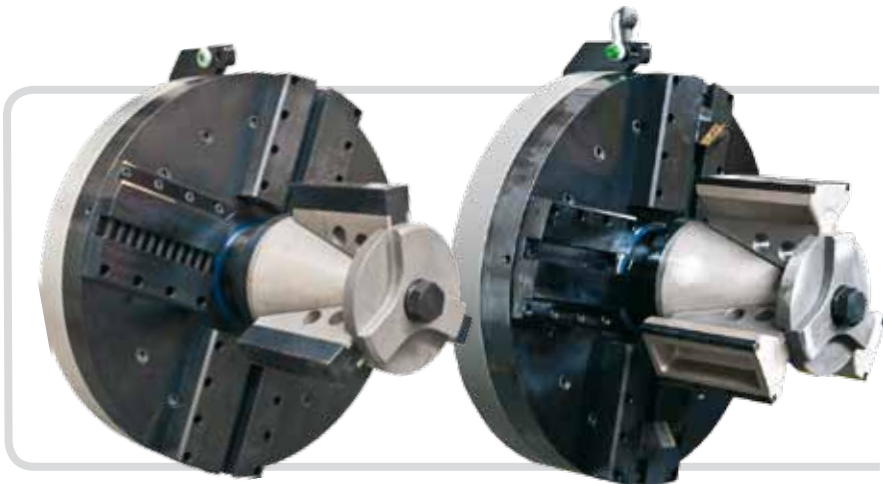

- **Macchina di nuova generazione equipaggiata con innovativo sistema di bloccaggio a sei punti di contatto per garantire stabilità nella lavorazione e assenza di vibrazioni.**
- *New generation machine equipped with an innovative 6 points of contact locking system able to grant stability and absence of vibrations during the operations.*
- **Massima facilità di installazione e centraggio estremamente preciso e funzionale.**
- *The installation and centering are extremely easy, precise and functional.*

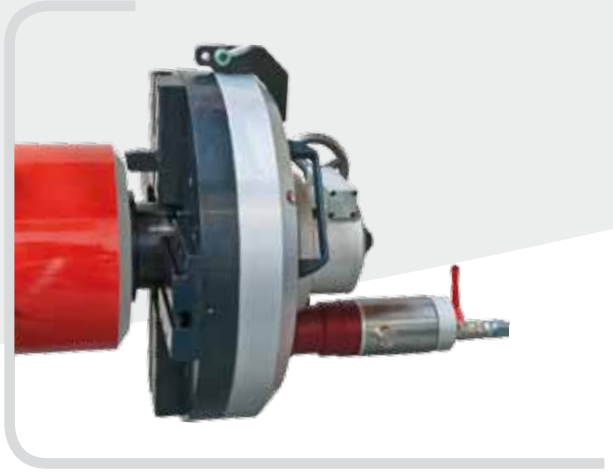

- **L'uniformità della passata è garantita da un nuovo sistema di avanzamento e da nuove motorizzazioni che consentono una velocità radiale costante e una rugosità minima.**
- *The uniformity of every single step is granted by a new feeding system and by new motorizations which deliver a constant radial speed for perfect and uniform bevels.*
- **Il nuovo lay-out della macchina consente lo scarico trucioli sicuro e senza ripercussioni sulle successive passate.**
- *The new machine layout is designed so that the chips of the previous pass will not affect the following passes.*

supermaxi 7²

Range Ø 180-504 mm (7,08" – 19,84")

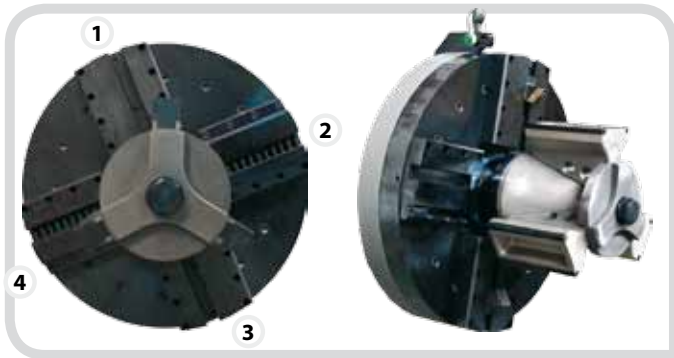

■ Mandrino di nuova concezione che grazie ad un sistema innovativo di fissaggio consente l'utilizzo sia di utensili standard sia di utensili con placchetta intercambiabile.

■ *The new mandrel has been designed to be used with standard solid body tools and with wedge locking tools with interchangeable inserts.*

◀ standard configuration



■ Range di lavorazione da 7" a 20" (180-504 mm) in configurazione standard e fino a 24" (590 mm) con l'applicazione del kit estensione opzionale.

■ *Working range from 7" to 20" (180-504mm) in standard configuration and up to 24" (590mm) with the optional extension kit.*

◀ with optional "extension kit"

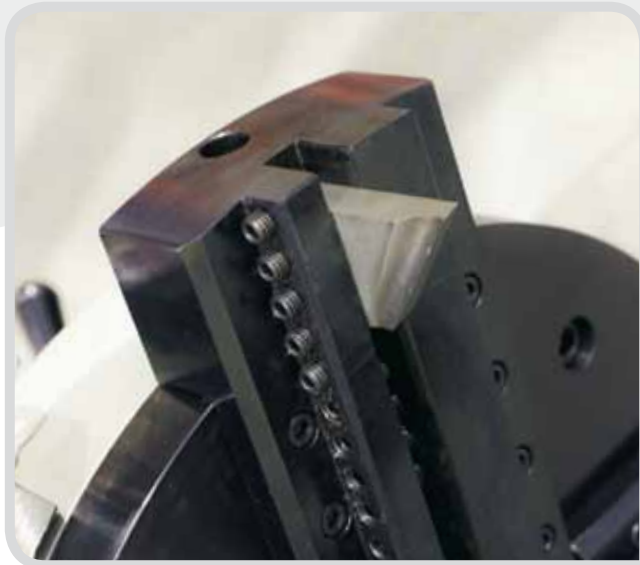

L'unità può utilizzare utensili facilmente intercambiabili per la realizzazione di smussi di qualsiasi forma e angolazione. In relazione al materiale da lavorare sono disponibili in diverse tipologie:

- 8% cobalto
- rivestiti al titanio
- placchetta in metallo duro

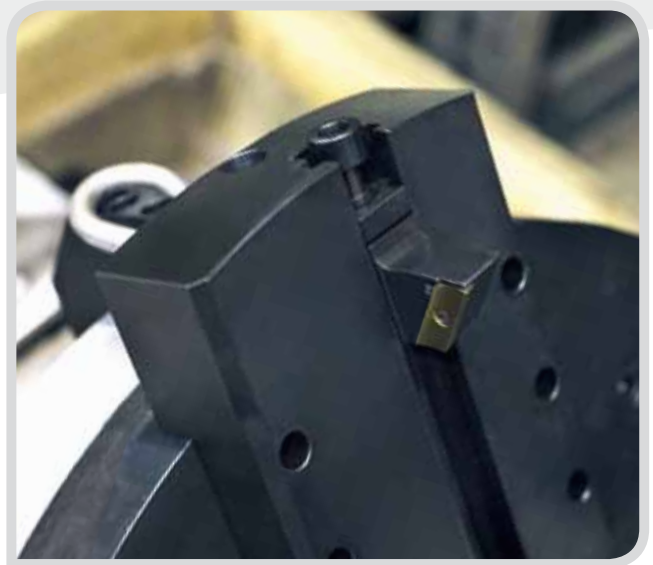

The unit is equipped with easily interchangeable tools for any angle of bevel which come in various hardness scales in relation to the material typology:

- 8% cobalt
- titanium coated
- tip of hard metal

standard - regular

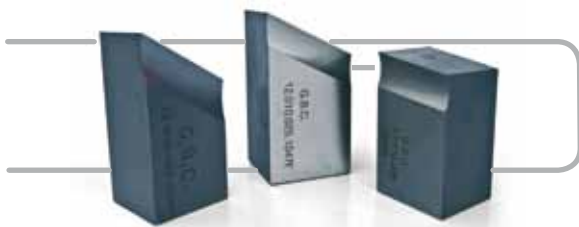

speciali - special

Esempio di Performance Ottenibile Example of Performance Obtainable

smusso per tubo fino a 20mm
bevel for pipes up to 20mm wall thickness

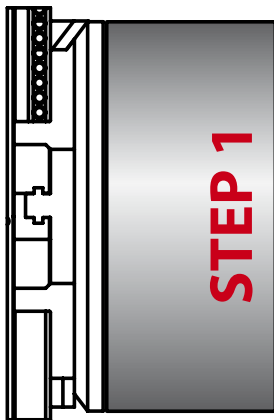

smusso per tubo fino a 40mm
bevel for pipes up to 40mm wall thickness

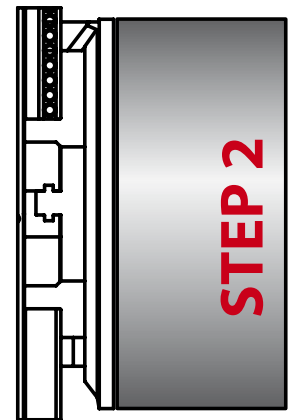
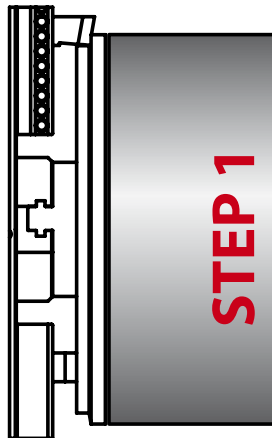

smusso per tubo fino a 60mm
bevel for pipes up to 60mm wall thickness

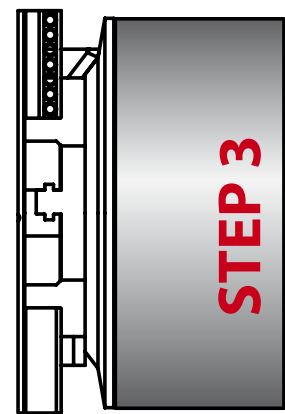
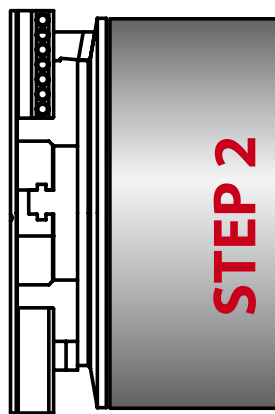
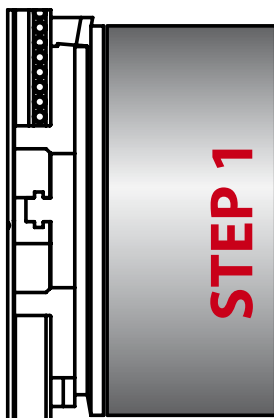

La simulazione sopra riportata rappresenta la macchina operante in condizioni ottimali su acciaio al carbonio. Le performance della macchina possono variare conseguentemente all'abilità dell'operatore, ai materiali, alle condizioni degli utensili e alla qualità dell'aria dell'impianto in caso di macchina pneumatica.

The above simulation represents the machine operating in optimal conditions, on mild carbon steel. The performance of the machine may vary depending on the skill of the operator, the materials, the conditions of the tools and the purity of the air of the system in case of pneumatic unit.

PNEUMATICA
PNEUMATIC
IDRAULICA
HYDRAULIC
ELETTRICA
ELECTRIC

capacità di bloccaggio ø interno <i>locking Range</i>	mm <i>inches</i>	180-504 7,08-19,84	180-504 7,08-19,84	180-504 7,08-19,84
velocità a vuoto <i>idle speed</i>	gg/min <i>rpm</i>	11	15	18
avanzamento assiale <i>axial stroke</i>	mm <i>inches</i>	50 1,96	50 1,96	50 1,96
potenza motore pneumatico <i>pneumatic motor power</i>	hp <i>w</i>	4 2940	-	-
consumo aria <i>air consumption</i>	l/min <i>cfm</i>	2690 95	-	-
pressione aria <i>air pressure</i>	bar <i>psi</i>	6 90	-	-
connessione attacco aria <i>air hose connection</i>	pollici <i>inches</i>	3/4"	-	-
potenza motore idraulico <i>hydraulic motor power</i>	hp <i>w</i>	-	6,8 5000	-
pressione max utilizzo <i>max oil pressure</i>	bar <i>psi</i>	-	100 1450	-
erogazione olio <i>oil flow rate</i>	l/min <i>gpm</i>	-	30 7,8	-
potenza motore elettrico <i>electric motor power</i>	hp <i>w</i>	-	-	3,2 2400
tensione <i>tension</i>	volt	-	-	110 / 220
frequenza <i>frequency</i>	hz	-	-	50 / 60
emissione acustica max <i>max acoustic emission</i>	db	75	75	75
peso macchina <i>machine weight</i>	kgs	245	245	245
ø macchina "A" <i>machine "A" ø</i>	mm <i>inches</i>	550 (630opt) 21,65 (24,80opt)	550 (630opt) 21,65 (24,80opt)	550 (630opt) 21,65 (24,80opt)
lunghezza macchina "B" <i>machine "B" Length</i>	mm <i>inches</i>	880 34,64	830 32,68	800 31,5

Garantiamo al cliente di aver superato con successo le prove di sicurezza elettrica e di immunità, collaudo interno e di conformità alle vigenti norme europee

We guarantee we have successfully passed the electric and immunity safety test, internal tests, and to be compliant with the European Norms in force.

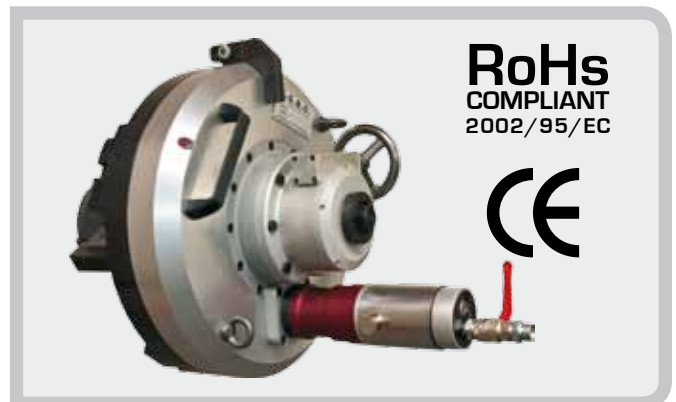
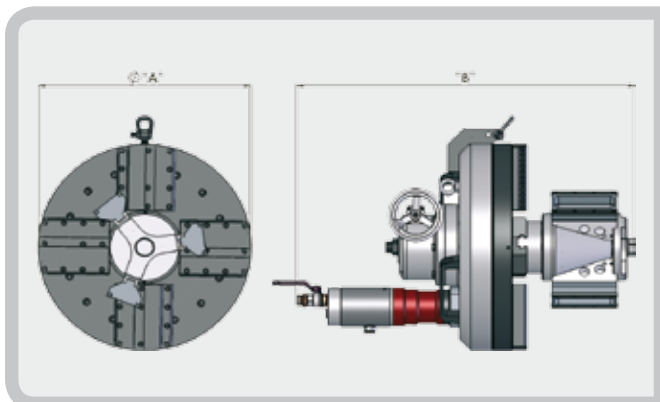

supermaxi 4¹⁶

Range Ø 94,5- 318,5mm (3,7"-12,5")

Unità utilizzata per il piping e in officine di saldature per lavorazioni di condutture, caldaie, impianti complessi.

The unit is designed for piping industries and welding workshops for processing pipelines, boilers and fittings.

CAMPI DI APPLICAZIONE

- Tornitura
- Rastrematura interna ed esterna
- Smussatura interna ed esterna delle estremità di tubo in acciaio, leghe speciali e metalliche

APPLICATION FIELDS

- *Milling processes*
- *External and Internal Tapering*
- *External and Internal Beveling of steel pipes and special metallic alloys*

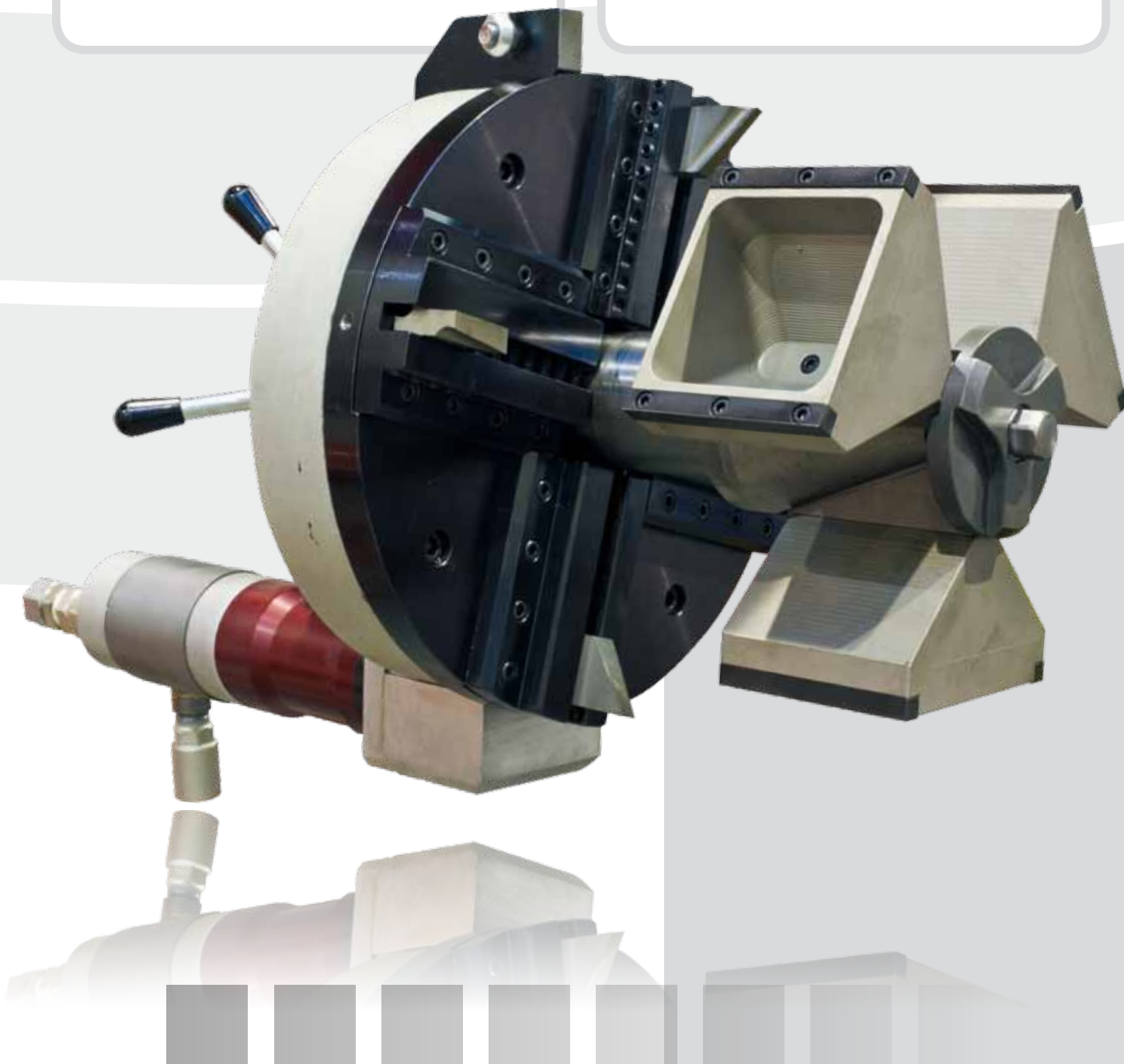

supermaxi 4⁹

Range Ø 94,5– 318,5mm (3,7"-12,5")



- Macchina di nuova generazione equipaggiata con innovativo sistema di bloccaggio a sei punti di contatto per garantire stabilità nella lavorazione e assenza di vibrazioni.
- *New generation machine equipped with an innovative 6 points of contact locking system able to grant stability and absence of vibrations during the operations.*
- Massima facilità di installazione e centraggio estremamente preciso e funzionale.
- *The installation and centering are extremely easy, precise and functional.*

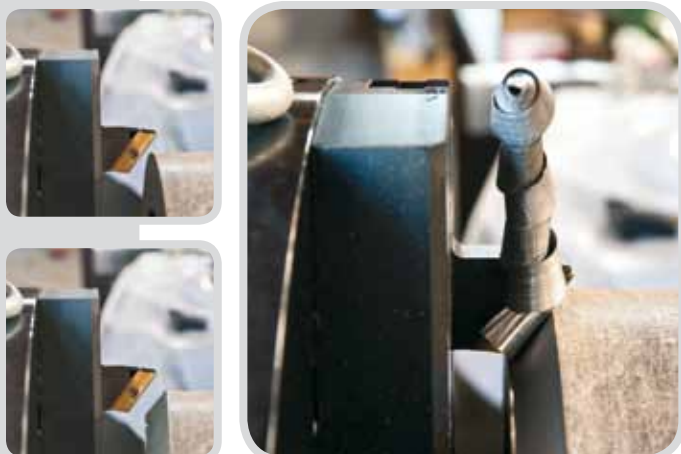

- L'uniformità della passata è garantita da un nuovo sistema di avanzamento e da nuove motorizzazioni che consentono una velocità radiale costante e una rugosità minima.
- *The uniformity of every single step is granted by a new feeding system and by new motorizations which deliver a constant radial speed for perfect and uniform bevels.*
- Il nuovo lay-out della macchina consente lo scarico trucioli sicuro e senza ripercussioni sulle successive passate.
- *The new machine layout is designed so that the chips of the previous pass will not affect the following passes.*

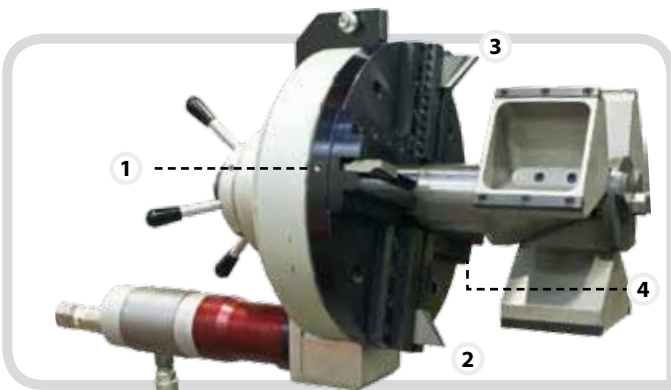

■ Mandrino di nuova generazione che grazie ad un design innovativo consente l'utilizzo sia di utensili standard sia con placchetta intercambiabile.

■ *The new mandrel has been designed to be used with standard solid body tools and with wedge locking tools with interchangeable inserts.*

◀ standard

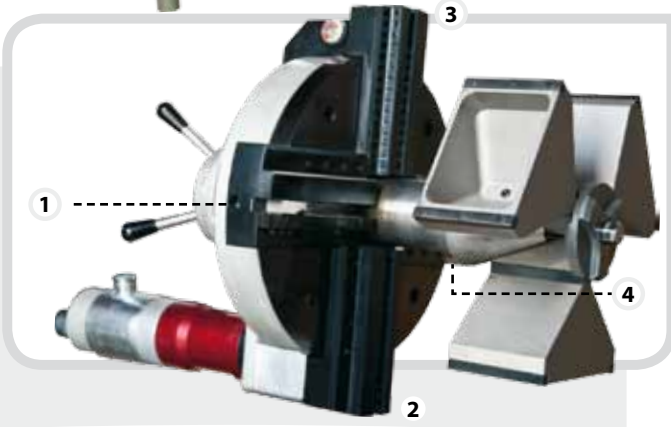

■ Range di lavorazione da 3,7" a 12,5" (94,5-318,5mm) con la configurazione standard e fino a 16,45" (418mm) con l'applicazione del kit estensione opzionale.

■ *Working range from 3,7" to 12,5" (94,5-318,5mm) in standard configuration and up to 16,45" (418mm) with the optional extension kit.*

◀ optional "extension kit"



L'unità può utilizzare utensili facilmente intercambiabili per la realizzazione di smussi di qualsiasi forma e angolazione. In relazione al materiale da lavorare sono disponibili in diverse tipologie:

- 8% cobalto
- rivestiti al titanio
- placchetta in metallo duro



The unit is equipped with easily interchangeable tools for any angle of bevel which come in various hardness scales in relation to the material typology:

- 8% cobalt
- titanium coated
- tip of hard metal

standard - regular

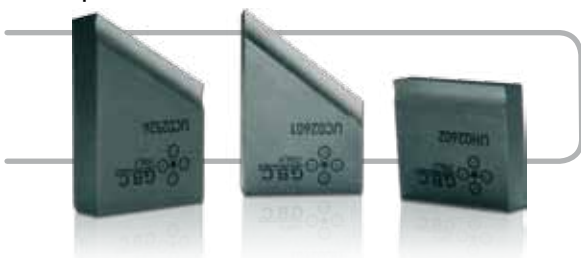

speciali - special

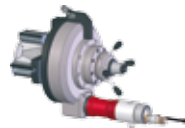

		PNEUMATICA <i>PNEUMATIC</i>	IDRAULICA <i>HYDRAULIC</i>	ELETTRICA <i>ELECTRIC</i>
range di bloccaggio <i>locking range</i>	mm <i>inches</i>	94,5 - 318,5 3,72 - 12,54	94,5 - 318,5 3,72 - 12,54	94,5 - 318,5 3,72 - 12,54
velocità a vuoto <i>no-load speed</i>	gg/min <i>rpm</i>	19	18	17
avanzamento assiale <i>axial stroke</i>	mm <i>inches</i>	50 1,97	50 1,97	50 1,97
potenza motore pneumatico <i>pneumatic motor power</i>	hp w	3 2200	-	-
consumo aria <i>air consumption</i>	l/min <i>cfm</i>	1800 63,56	-	-
pressione aria <i>air pressure</i>	bar <i>psi</i>	6 87,02	-	-
connessione attacco aria <i>air connection</i>	pollici <i>inches</i>	3/4"	-	-
potenza motore idraulico <i>hydraulic motor power</i>	hp w	-	6,8 5000	-
pressione max di utilizzo <i>max operating pressure</i>	bar <i>psi</i>	-	100 1450	-
erogazione olio <i>erogation oil</i>	l/min <i>cfm</i>	-	30 1,06	-
potenza motore elettrico <i>electric motor power</i>	hp w	-	-	2,95 2200
tensione/ <i>tension</i>	volt	-	-	110/220
frequenza/ <i>frequency</i>	hz	-	-	50
emissione acustica max <i>max acoustic emission</i>	db	75	75	75
peso macchina <i>machine weight</i>	Kg pound	80 176,37	80 176,37	80 176,37
ø macchina "A" <i>machine "A" ø</i>	mm <i>inches</i>	330 (426 opt) 12,99 (16,77 opt)	330 (426 opt) 12,99 (16,77 opt)	330 (426 opt) 12,99 (16,77 opt)
ø macchina "B" <i>machine "B" ø</i>	mm <i>inches</i>	365 (475opt) 14,37 (18,70opt)	365 (475opt) 14,37 (18,70opt)	365 (475opt) 14,37 (18,70opt)
lunghezza macchina "C" <i>machine "C" Length</i>	mm <i>inches</i>	750 29,53	610 24,02	630 24,80

Garantiamo al cliente di aver superato con successo le prove di sicurezza elettrica e di immunità, collaudo interno e di conformità alle vigenti norme europee.

We guarantee we have successfully passed the electric and immunity safety test, internal tests, and to be compliant with the European Norms in force.

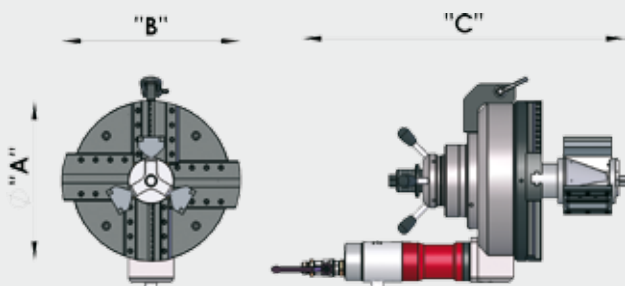

RoHs
COMPLIANT
2002/95/EC



Macchine estremamente versatili e facilmente convertibili da alimentazione pneumatica, ad alimentazione idraulica o elettrica

The machines are extremely versatile and easily convertible from pneumatic feeding to electric or hydraulic feeding

PNEUMATICA - PNEUMATIC

IDRAULICA - HYDRAULIC

ELETTRICA - ELECTRIC

7²⁴

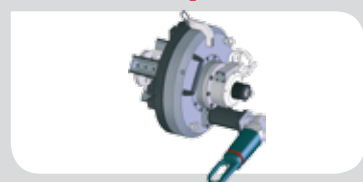
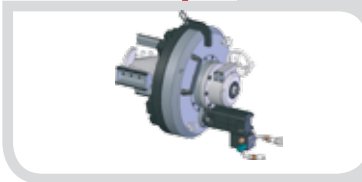
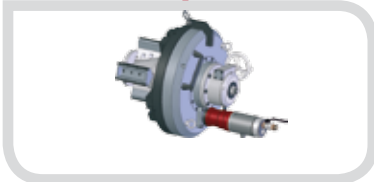

4¹⁶

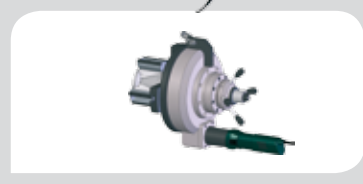
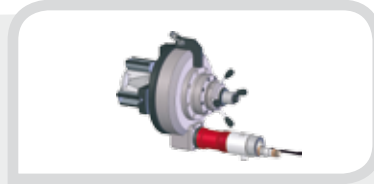

CENTRALINE OLEODINAMICHE - HYDRAULIC UNIT

A completamento della configurazione idraulica possiamo fornire una centralina oleodinamica studiata ad hoc al fine di ottimizzare le prestazioni dell'unità.

As complement of the hydraulic configuration we can supply an hydraulic power pack designed ad hoc to optimize the performance of the unit.

dati tecnici

- capacità serbatoio 60 lt
- portata max 30 lt/min
- pressione di esercizio 100bar
- potenza motore 5,5 Kw
- comando a distanza
- sistema di raffreddamento con sessioni di lavoro ininterrotte

technical features

- Tank capacity : 60 lt
- Max flow : 30lt/min
- Working pressure : 100 bar
- Motor power : 5,5 Kw
- Remote control
- No-Stop Cooling System (No need to stop the unit)





- **Portable Pipe Cold Beveling Machines**
- Portable Pipe Cold Cutting and Beveling Machines
- Plate Cold Beveling Machines
- Flange Facing Machines
- Orbital Pipe Cutting Machines
- Back Gauging and Grinding Systems
- Pipe Alignment Clamps and Stands



IT

QR
code

EN

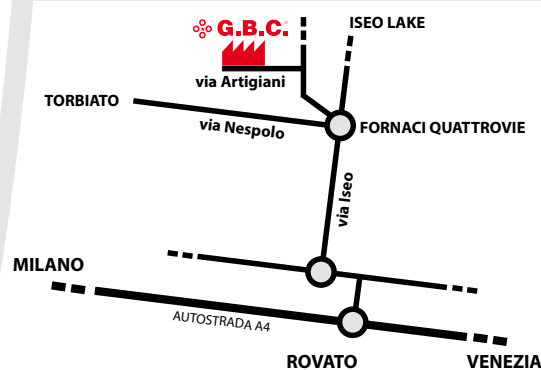

GBC Industrial Tools si riserva il diritto di apportare in qualsiasi momento modifiche costruttive e funzionali.
GBC Industrial Tools has the right to modify its product at any time.

 **G.B.C.**[®]
Industrial Tools S.p.A.

G.B.C. Industrial Tools S.p.a.

Via Artigiani, 17 - 25030 - Torbiato di Adro (BS) - Italia
phone: +39 (0)30 745.11.54 - fax +39 (0)30 735.66.29
www.gbcspa.com - mailto: sales@gbcspa.com

