

RAPTOR RACKS - RIGS

ONE STEP AHEAD IN GYM CREATION
WWW.STRIDEEUROPE.COM

STRIDE



STRIDE
GYM CREATION | STRIDEEUROPE.COM

STRIDE RAPTOR POWER UP YOUR PERFORMANCE.

At STRIDE, we value individual needs. All of our RAPTOR rigs and racks are therefore modular, which means they all consist of parts that can be combined or interchanged to create the design that fits your space optimally.





STRIDE RAPTOR SERIES

WALL-MOUNTED RIGS

P. 100-101



FREE-STANDING RIGS

P. 100-101



WALL-MOUNTED RIGS

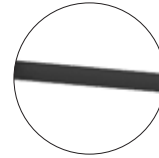

HORIZONTAL PULL-UP BAR

For horizontal pull-ups bars you can choose between the **short type (110 cm)** and the **long type (180 cm)**. In some cases, horizontal pull-ups can be replaced with storage shelves. The same lengths apply.

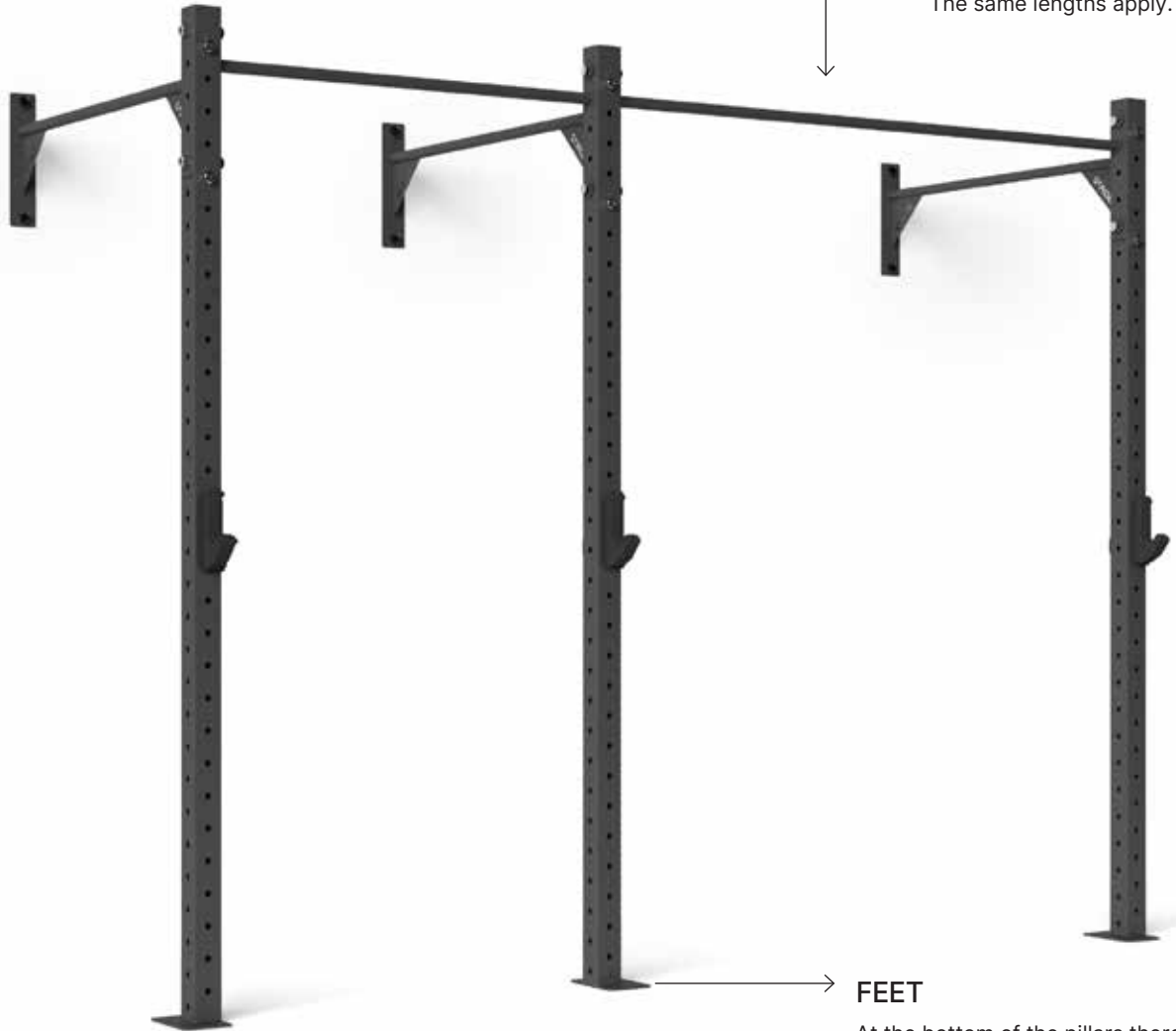

FEET

At the bottom of the pillars there are feet for extra stability. To measure the outer dimensions of your rack, you need to take these feet into account, and **add 6,25 cm on each end.**

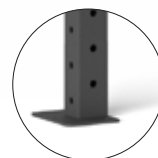

RACKS

P. 100-101

**STORAGE SOLUTIONS**

P. 100-101

**ATTACHMENTS**

P. 100-101

**HORIZONTAL BEAM**

For horizontal beams you can choose between the **short type (110 cm)** and the **long type (180 cm)**. In some cases, horizontal beams can be replaced with storage shelves. The same lengths apply.

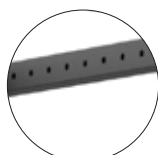
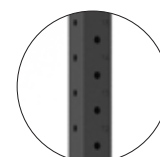
**STAND ALONE RIGS****VERTICAL PILLARS
ALSO CALLED UPRIGHTS**

All pillars have a **standard height of 240 cm** (but can be customized upon request) and are 7,5 cm wide in both directions.

WALL-MOUNTED





WALL-MOUNTED RIGS Solid Wall Solutions.

Our high-end steel wall-mounted rigs are modular, ultra-durable, and designed to seamlessly fit the needs of any fitness club.

WALL-MOUNTED RIGS

TECHNICAL SHEET

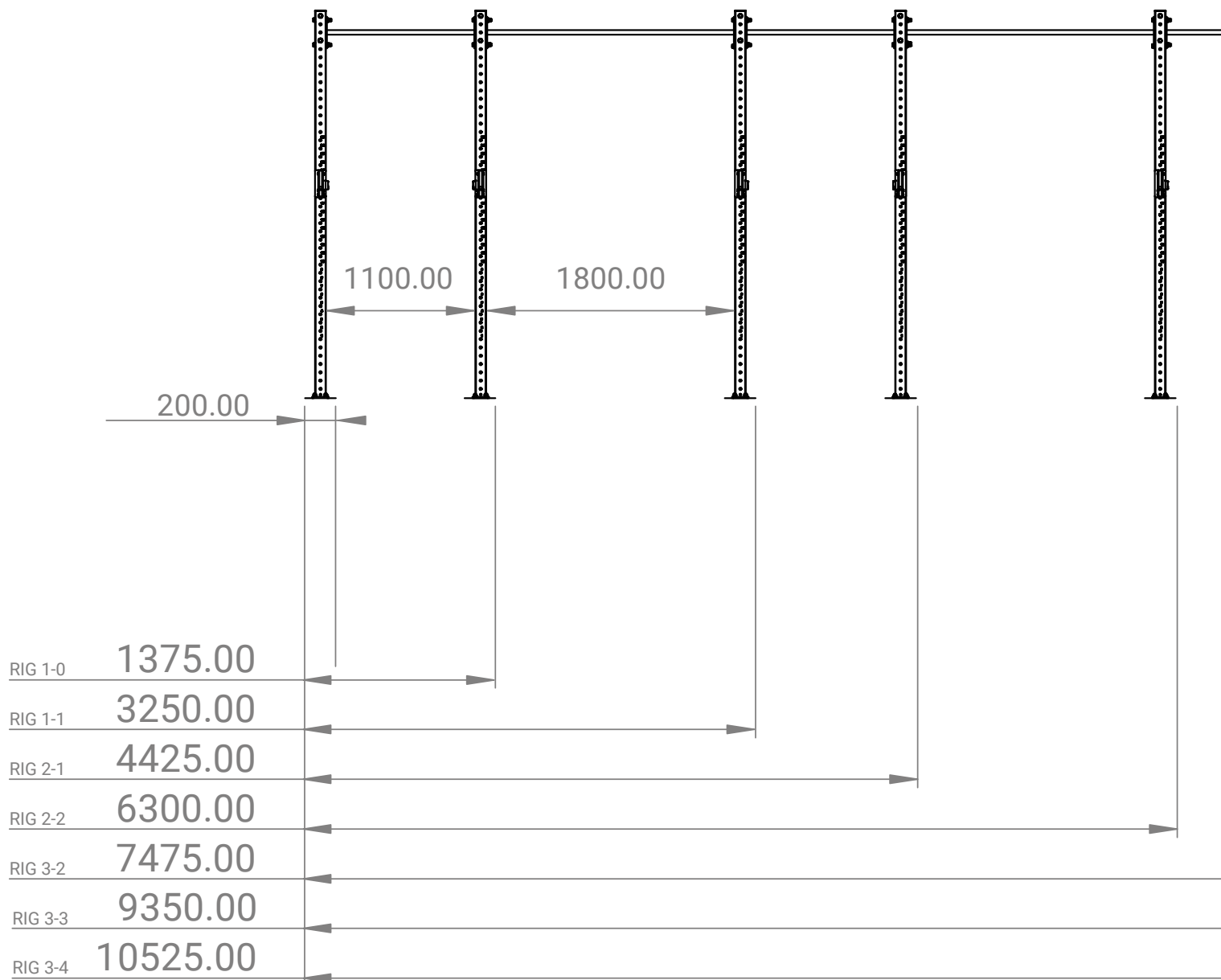



- All pillars have a standard height of 240cm and can be extended up to 340cm when needed.
- Width of squat station is 110cm or 180cm.
- Upright pillars 7,5cm x 7,5cm.
- Connected to wall with 110cm or 180cm pull-up bars.
- At the bottom of the pillars there are feet for extra stability. To measure the outer dimensions of your rack, you need to take these feet into account, and add 6,25cm on each end.

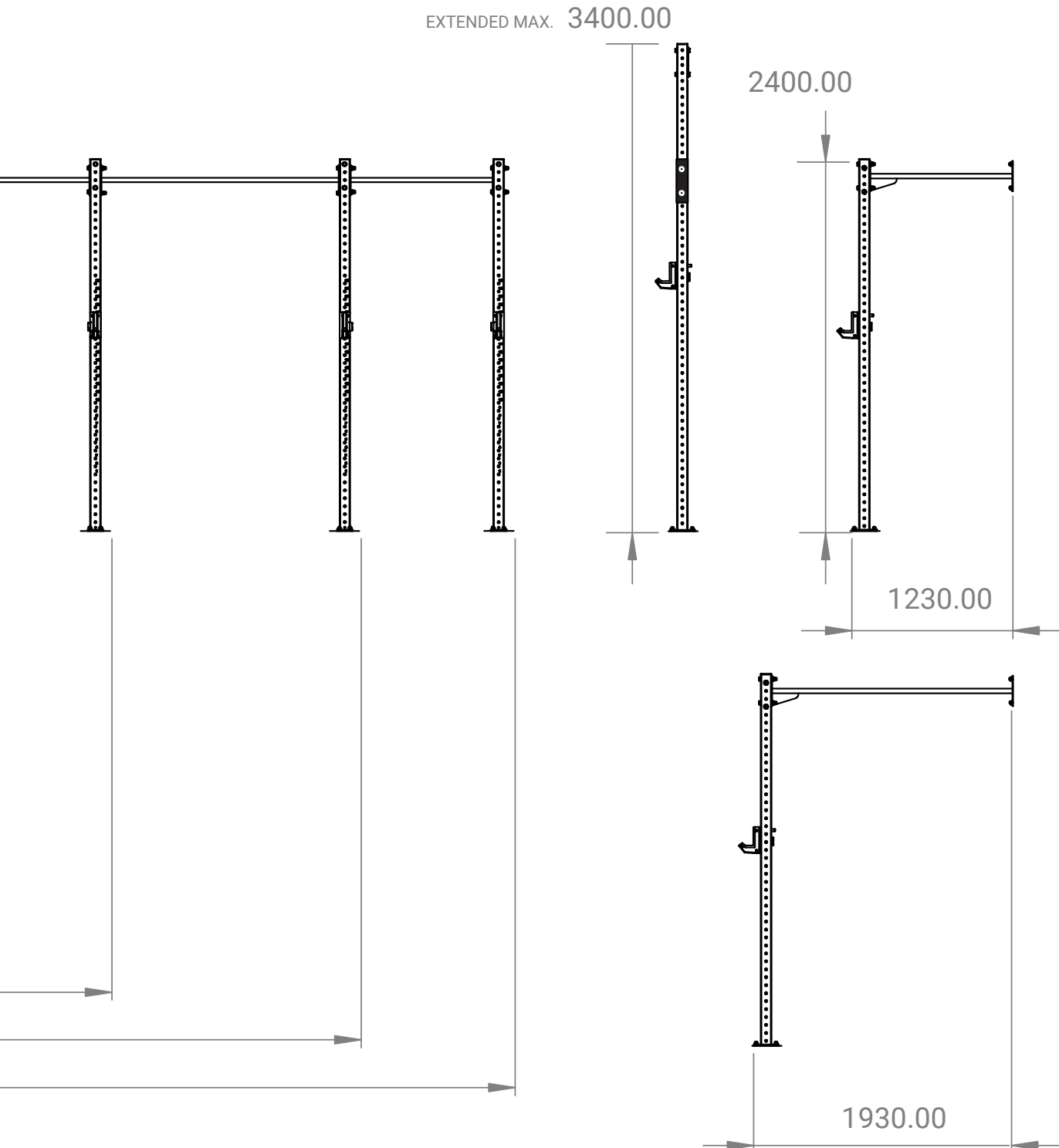

SCAN QR CODE
TO SEE PRICES
AND WHAT IS
CURRENTLY IN STOCK.



WALL-MOUNT TRAINING RIG 1-0

Art. Nr.	Item	Price
RAP-180WALMNT1-0	RAPTOR Wall-Mount Training Rig 1-0	



CHECK OUT OUR SPEC SHEET
ON THE PREVIOUS PAGE
FOR ALL DIMENSIONS

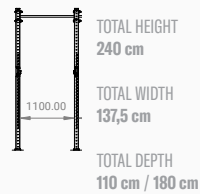

WALL-MOUNT TRAINING RIG 1-1

Art. Nr.	Item	Price
RAP-180WALMNT1-1	RAPTOR Wall-Mount Training Rig 1-1	



CHECK OUT OUR SPEC SHEET
FOR ALL DIMENSIONS

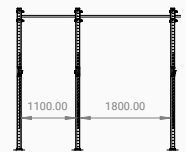

WALL-MOUNT TRAINING RIG 2-1

Art. Nr.	Item	Price
RAP-180WALMNT2-1	RAPTOR Wall-Mount Training Rig 2-1	



CHECK OUT OUR SPEC SHEET
FOR ALL DIMENSIONS

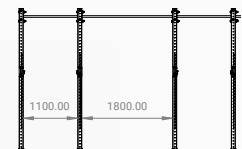

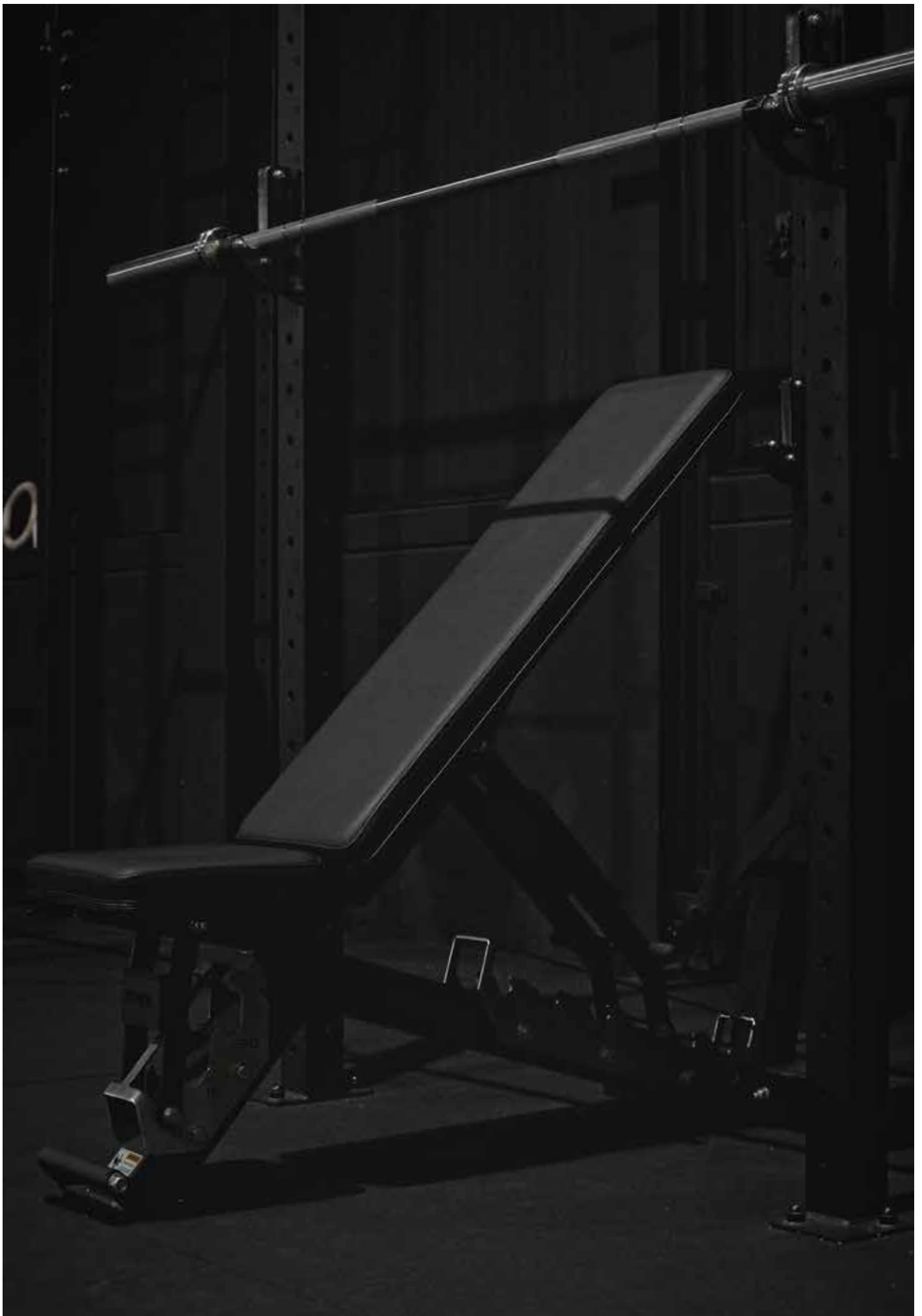

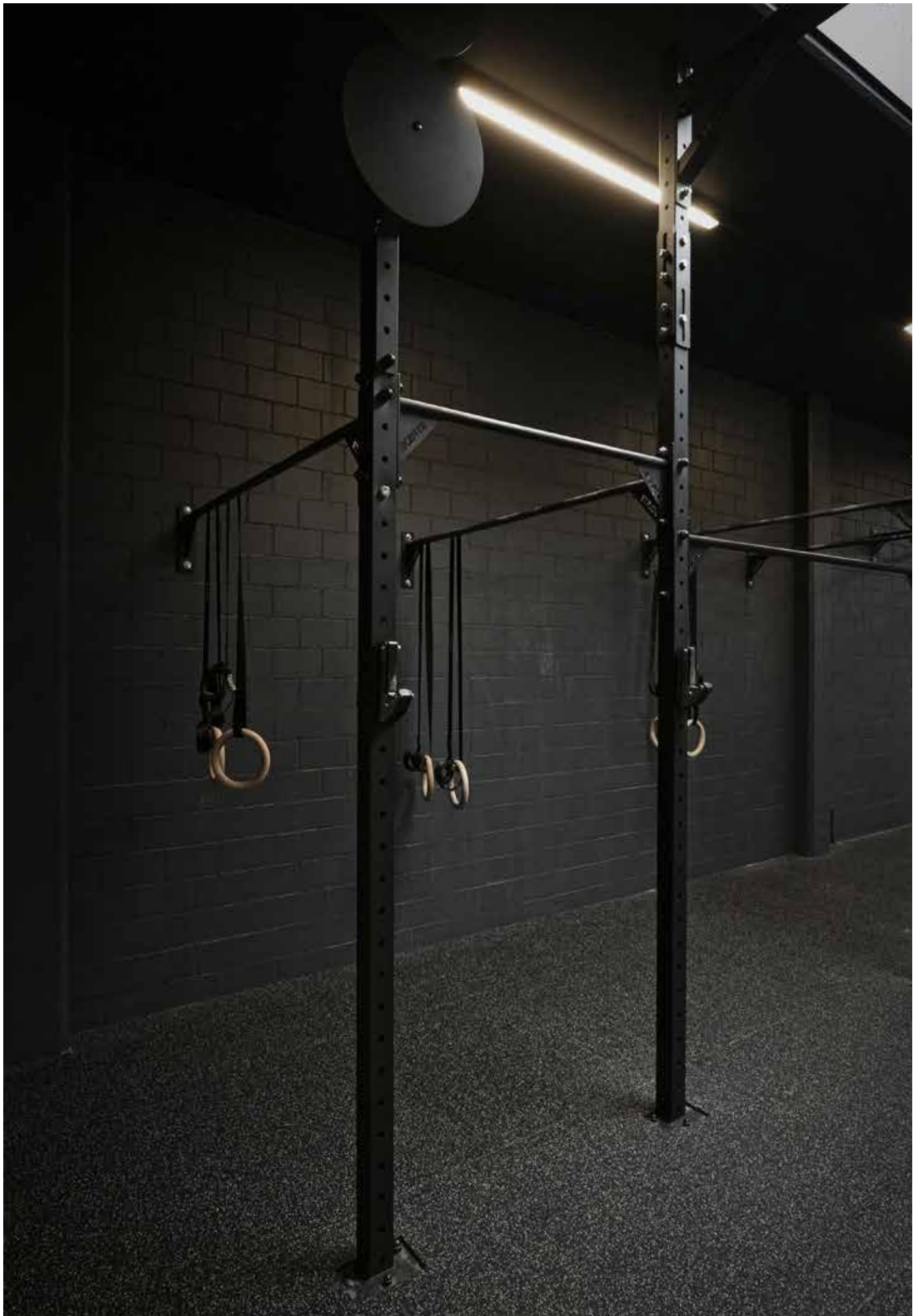

WALL-MOUNT TRAINING RIG 3-2

Art. Nr.	Item	Price
RAP-180WALMNT3-2	RAPTOR Wall-Mount Training Rig 3-2	

CHECK OUT OUR SPEC SHEET
FOR ALL DIMENSIONS

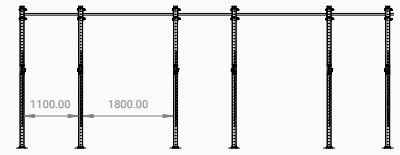

HEIGHT
240 cm

WIDTH
747,5 cm

DEPTH
110 cm / 180 cm



WALL-MOUNT TRAINING RIG 4-3

Art. Nr.	Item	Price
RAP-180WALMNT4-3	RAPTOR Wall-Mount Training Rig 4-3	

CHECK OUT OUR SPEC SHEET
FOR ALL DIMENSIONS

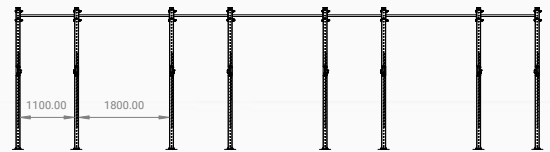

HEIGHT
240 cm

WIDTH
1052,5 cm

DEPTH
110 cm / 180 cm



FREE STANDING



FREE STANDING RIGS
Strength in Structure.



Our steel free-standing rigs are modular, robust, and adaptable to every sports environment—perfect for both indoor and outdoor setups.

FREE STANDING RIGS

TECHNICAL SHEET

IMPORTANT

we recommend you leave at least 1 meter of space next to the rack so you can perform decent barbell exercises.

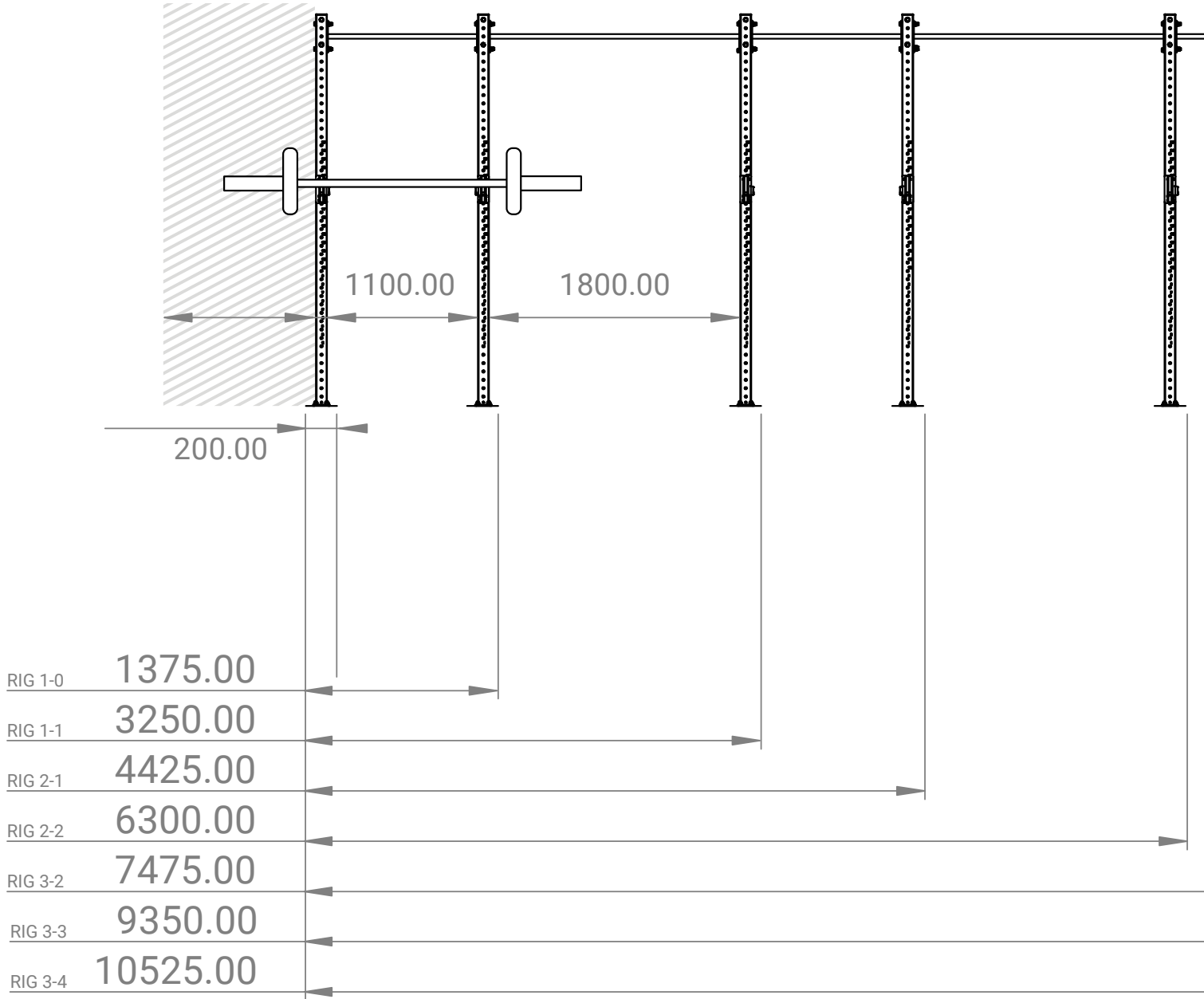



- All pillars have a standard height of 240cm and can be extended up to 340cm when needed.
- Width of squat station is 110cm or 180cm.
- Upright pillars 7,5cm x 7,5cm.
- Connected to wall with 110cm or 180cm pull-up bars.
- At the bottom of the pillars there are feet for extra stability. To measure the outer dimensions of your rack, you need to take these feet into account, and add 6,25cm on each end.

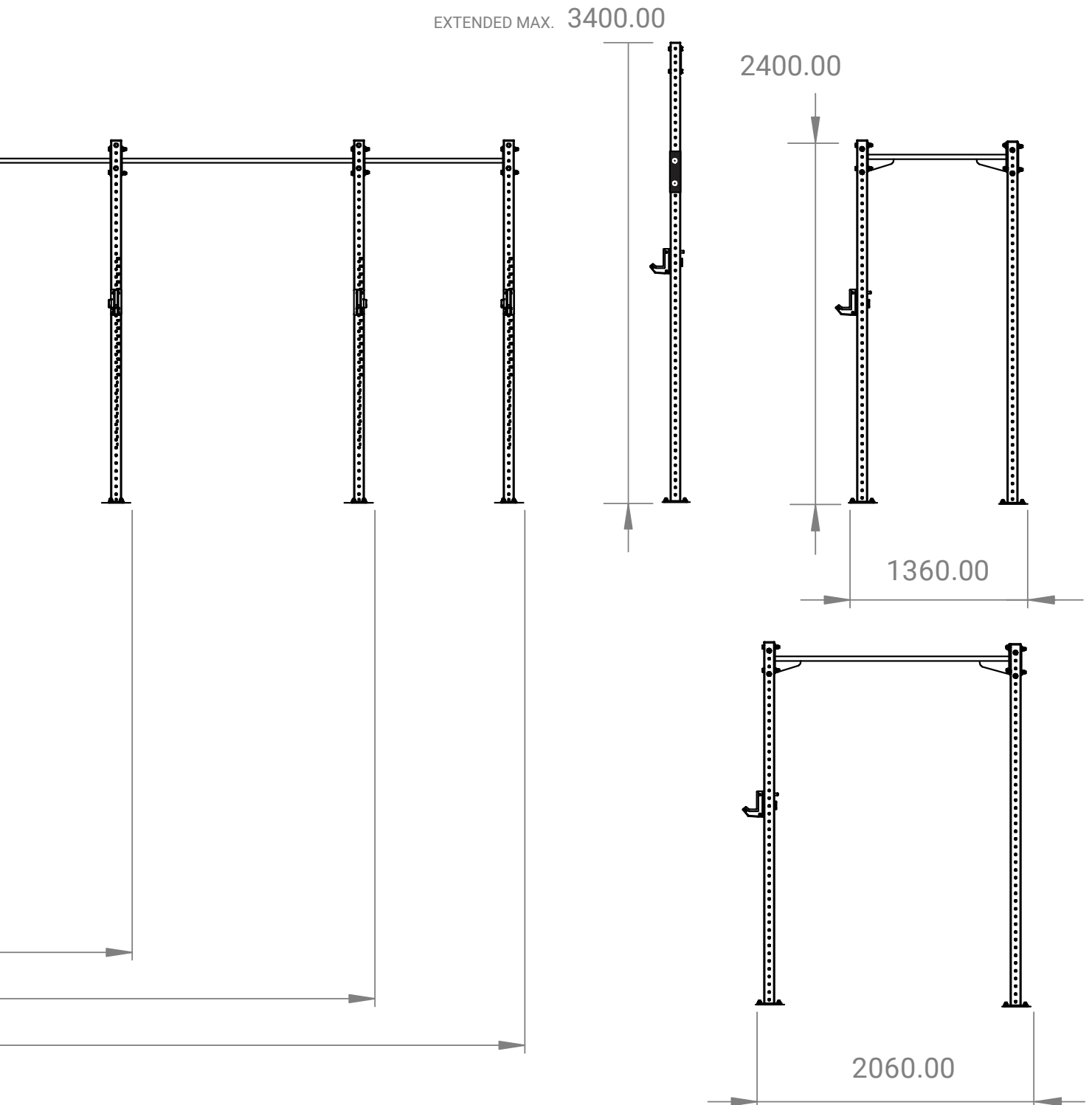

FREE STANDING RIGS

SCAN QR CODE
TO SEE PRICES
AND WHAT IS
CURRENTLY IN STOCK.



FREE STANDING TRAINING RIG 1-0

Art. Nr.	Item	Price
RAP-FREESTND1-0	RAPTOR Free Standing Training Rig 1-0	



FREE STANDING TRAINING RIG 1-0 EXT.

Art. Nr.	Item	Price
RAP-FREESTND1-OE	RAPTOR Free Standing Training Rig 1-0 Extended	



FREE STANDING TRAINING RIG 1-1

Art. Nr.	Item	Price
RAP-FREESTND1-1	RAPTOR Free Standing Training Rig 1-1	



FREE STANDING TRAINING RIG 2-1

Art. Nr.	Item	Price
RAP-FREESTND2-1	RAPTOR Free Standing Training Rig 2-1	



FREE STANDING TRAINING RIG 3-2

Art. Nr.	Item	Price
RAP-FREESTND3-2	RAPTOR Free Standing Training Rig 3-2	

CHECK OUT OUR SPEC SHEET ON PAGE 100 FOR ALL DIMENSIONS

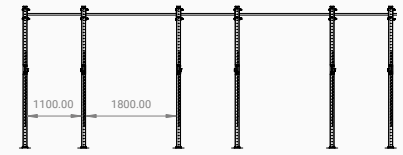

TOTAL HEIGHT
240 cm

TOTAL WIDTH
747,5 cm

TOTAL DEPTH
110 cm / 180 cm

FREE STANDING TRAINING RIG 4-3

Art. Nr.	Item	Price
RAP-FREESTND4-3	RAPTOR Free Standing Training Rig 4-3	

CHECK OUT OUR SPEC SHEET ON PAGE 100 FOR ALL DIMENSIONS

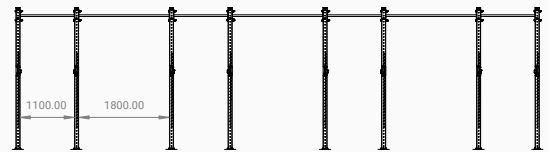

TOTAL HEIGHT
240 cm

TOTAL WIDTH
1052,5 cm

TOTAL DEPTH
110 cm / 180 cm

RACKS

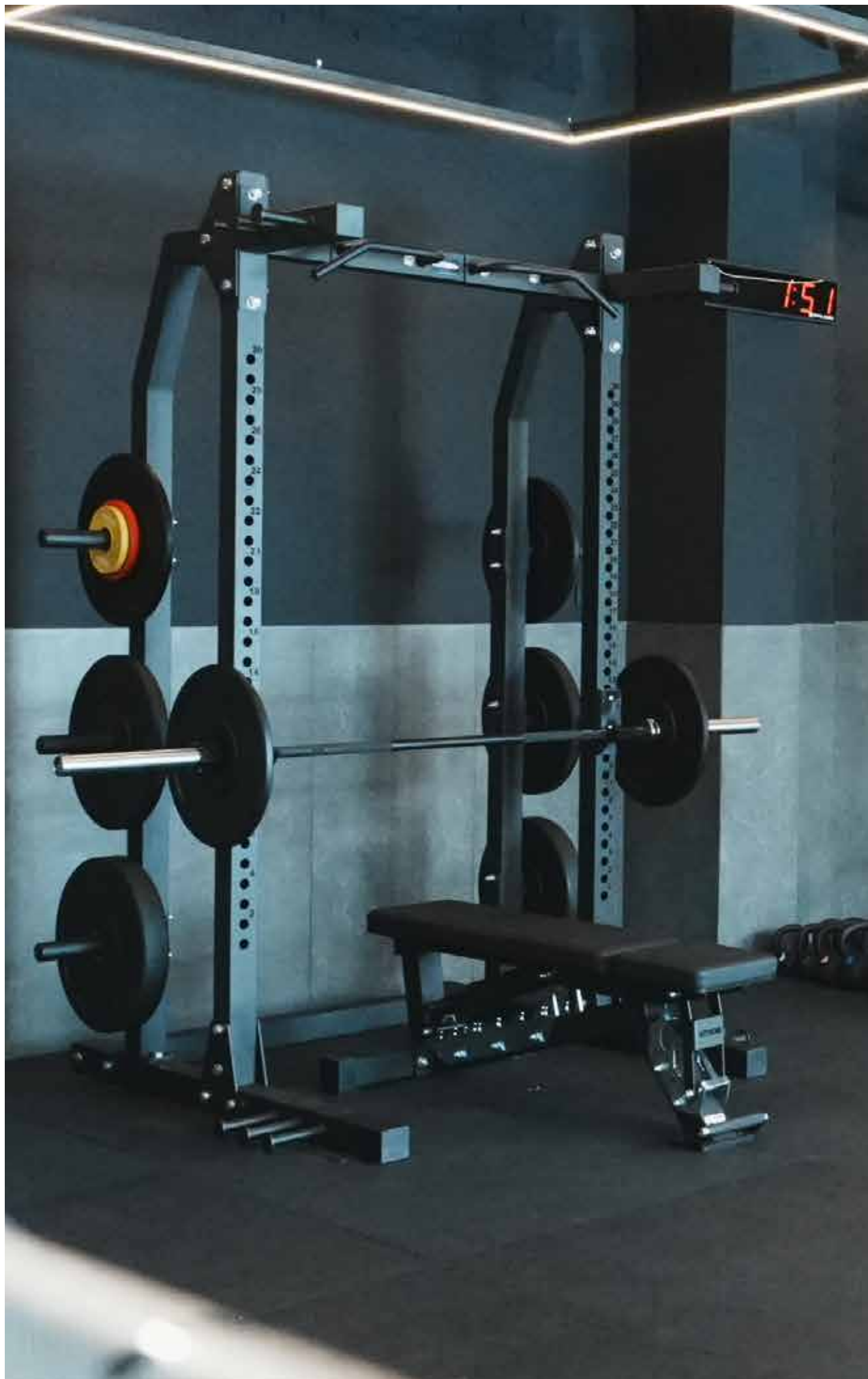



RAPTOR RACKS

Form. Function. Power.

Precision-engineered for maximum safety and durability, these racks are built to handle the most demanding workouts.

HALF / POWER / PERFORMANCE / CABLE RACKS

TECHNICAL SHEET

IMPORTANT

we recommend you leave at least 1 meter of space next to the rack so you can perform decent barbell exercises.

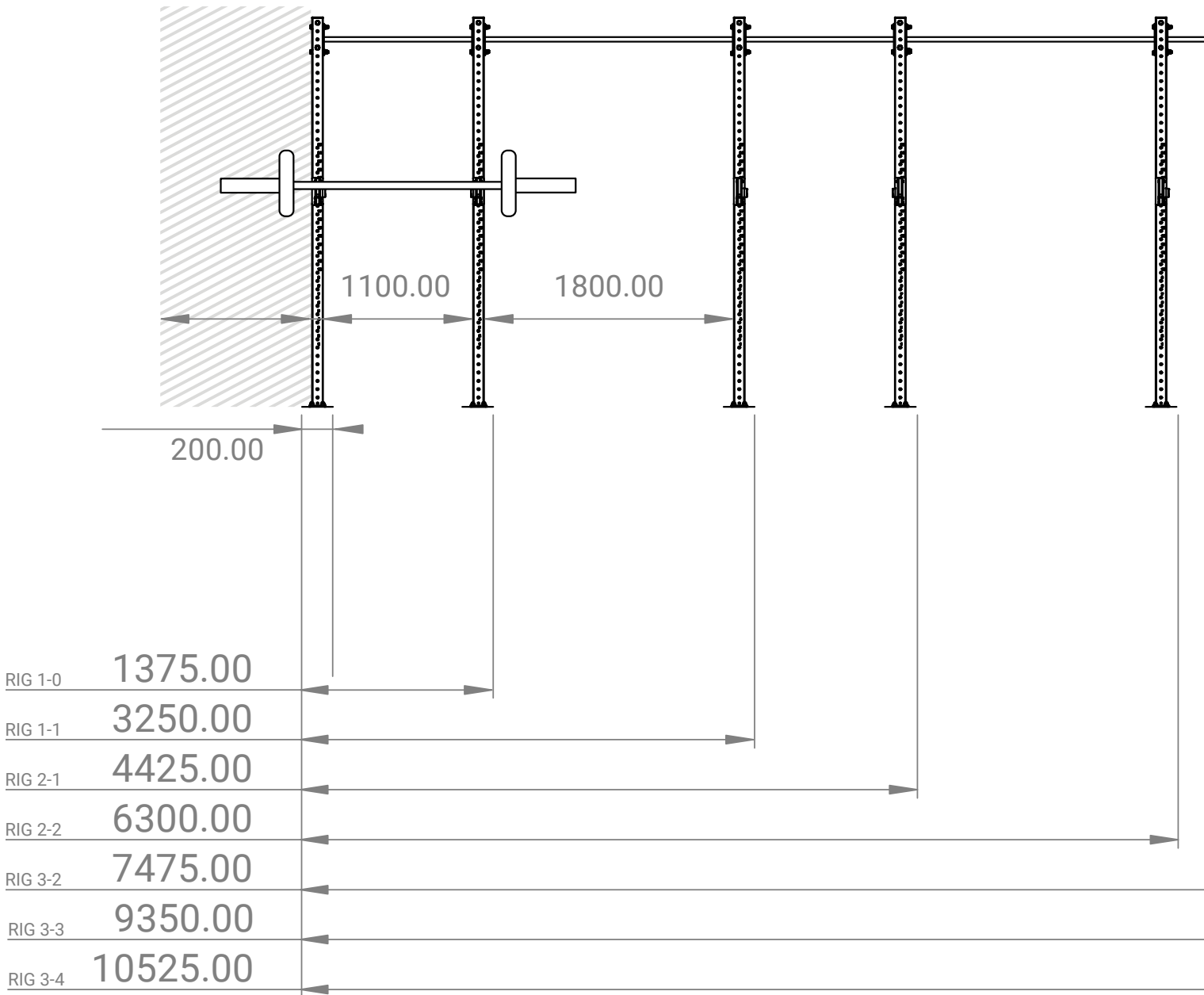



- All pillars have a standard height of 240cm and can be extended up to 340cm when needed.
- Width of squat station is 110cm or 180cm.
- Upright pillars 7,5cm x 7,5cm.
- Connected to wall with 110cm or 180cm pull-up bars.
- At the bottom of the pillars there are feet for extra stability. To measure the outer dimensions of your rack, you need to take these feet into account, and add 6,25cm on each end.

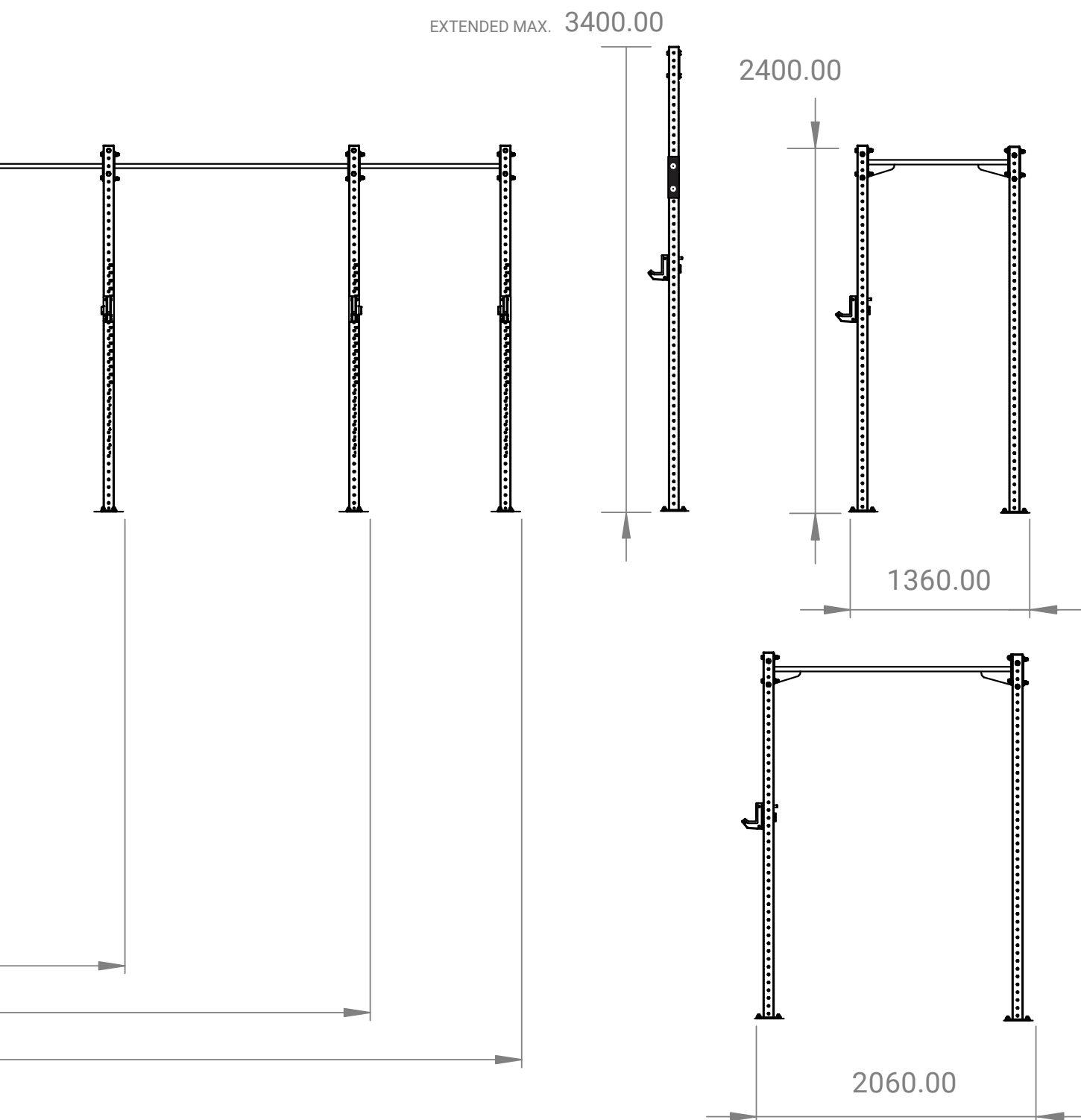

HALF RACKS

SCAN QR CODE
TO SEE PRICES
AND WHAT IS
CURRENTLY IN STOCK.



BASIC HALF RACK

Art. Nr.	Item	Price
----------	------	-------

STR-HALFRACK	STRIDE Basic Half Rack	
--------------	------------------------	--

Dimensions: L 177 cm x W 170 cm x H 234 cm



**BUDGET MODEL:
RAPTOR
ATTACHMENTS NOT
SUPPORTED.**

RAPTOR HALF RACK

Art. Nr.	Item	Price
----------	------	-------

RAP-HALFRACK	RAPTOR Half Rack	
--------------	------------------	--

Dimensions: L 109 cm x W 181 cm x H 248 cm
170 kg



RAPTOR HALF RACK 2

CHECK OUT OUR SPEC SHEET ON PAGE 100 FOR ALL DIMENSIONS

Art. Nr.	Item	Price
RAP-HALFRACK2	RAPTOR Half Rack 2	

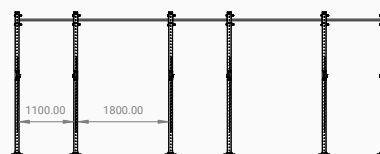

TOTAL HEIGHT
240 cm

TOTAL WIDTH
747,5 cm

TOTAL DEPTH
110 cm / 180 cm

RAPTOR HALF RACK 3

CHECK OUT OUR SPEC SHEET ON PAGE 100 FOR ALL DIMENSIONS

Art. Nr.	Item	Price
RAP-HALFRACK3	RAPTOR Half Rack 3	

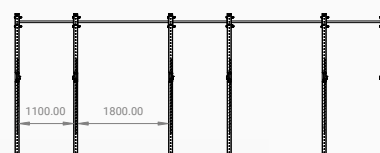

TOTAL HEIGHT
240 cm

TOTAL WIDTH
747,5 cm

TOTAL DEPTH
110 cm / 180 cm

POWER RACKS

SCAN QR CODE
TO SEE PRICES
AND WHAT IS
CURRENTLY IN STOCK.



POWER RACK STANDARD

Art. Nr.	Item	Price
RAP-POWRAC	RAPTOR Power Rack Standard	



CHECK OUT OUR SPEC SHEET
ON THE PREVIOUS PAGE
FOR ALL DIMENSIONS

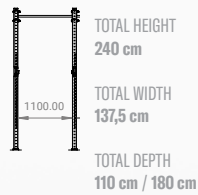

POWER RACK EXTENDED

Art. Nr.	Item	Price
RAP-POWRACE	RAPTOR Power Rack Extended	



CHECK OUT OUR SPEC SHEET
ON THE PREVIOUS PAGE
FOR ALL DIMENSIONS

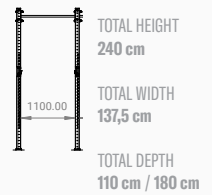

POWER RACK WITH SHELVES 1-1

Art. Nr.	Item	Price
RAP-POWRACS1-1	RAPTOR Power Rack with Shelves 1-1	



CHECK OUT OUR SPEC SHEET
ON THE PREVIOUS PAGE
FOR ALL DIMENSIONS

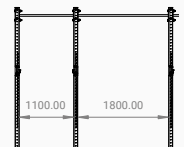

POWER RACK WITH SHELVES 2-1

Art. Nr.	Item	Price
RAP-POWRACS2-1	RAPTOR Power Rack with Shelves 2-1	



CHECK OUT OUR SPEC SHEET ON THE PREVIOUS PAGE FOR ALL DIMENSIONS

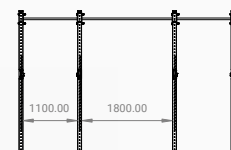

TOTAL HEIGHT
240 cm

TOTAL WIDTH
442,5 cm

TOTAL DEPTH
110 cm / 180 cm



POWER RACK WITH SHELVES 3-2

Art. Nr.	Item	Price
RAP-POWRACS3-2	RAPTOR Power Rack with Shelves 3-2	



CHECK OUT OUR SPEC SHEET ON PAGE 100 FOR ALL DIMENSIONS

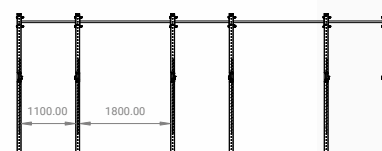

TOTAL HEIGHT
240 cm

TOTAL WIDTH
747,5 cm

TOTAL DEPTH
110 cm / 180 cm



PERFORMANCE RACKS

SCAN QR CODE
TO SEE PRICES
AND WHAT IS
CURRENTLY IN STOCK.



PRO PERFORMANCE RACK

Art. Nr.	Item	Price
RAP-PROPERFRAC	RAPTOR Pro Performance Rack	



CHECK OUT OUR SPEC SHEET
ON THE PREVIOUS PAGE
FOR ALL DIMENSIONS

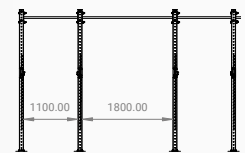

TOTAL HEIGHT
240 cm

TOTAL WIDTH
442,5 cm

TOTAL DEPTH
110 cm / 180 cm



PRO PERFORMANCE RACK (WITHOUT LADDER)

Art. Nr. Item Price

RAP-PROPERFRACNOLA RAPTOR Pro Performance Rack (without ladder)



CHECK OUT OUR SPEC SHEET
ON THE PREVIOUS PAGE
FOR ALL DIMENSIONS

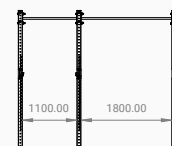

TOTAL HEIGHT
240 cm

TOTAL WIDTH
325 cm

TOTAL DEPTH
110 cm / 180 cm

PRO PERFORMANCE RACK (WITHOUT SHELVES)

Art. Nr. Item Price

RAP-PROPERFRACNOSH RAPTOR Pro Performance Rack (without shelves)



CHECK OUT OUR SPEC SHEET
ON THE PREVIOUS PAGE
FOR ALL DIMENSIONS

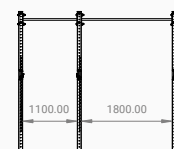

TOTAL HEIGHT
240 cm

TOTAL WIDTH
325 cm

TOTAL DEPTH
110 cm / 180 cm

DOUBLE CABLE POWER RACKS

SCAN QR CODE
TO SEE PRICES
AND WHAT IS
CURRENTLY IN STOCK.

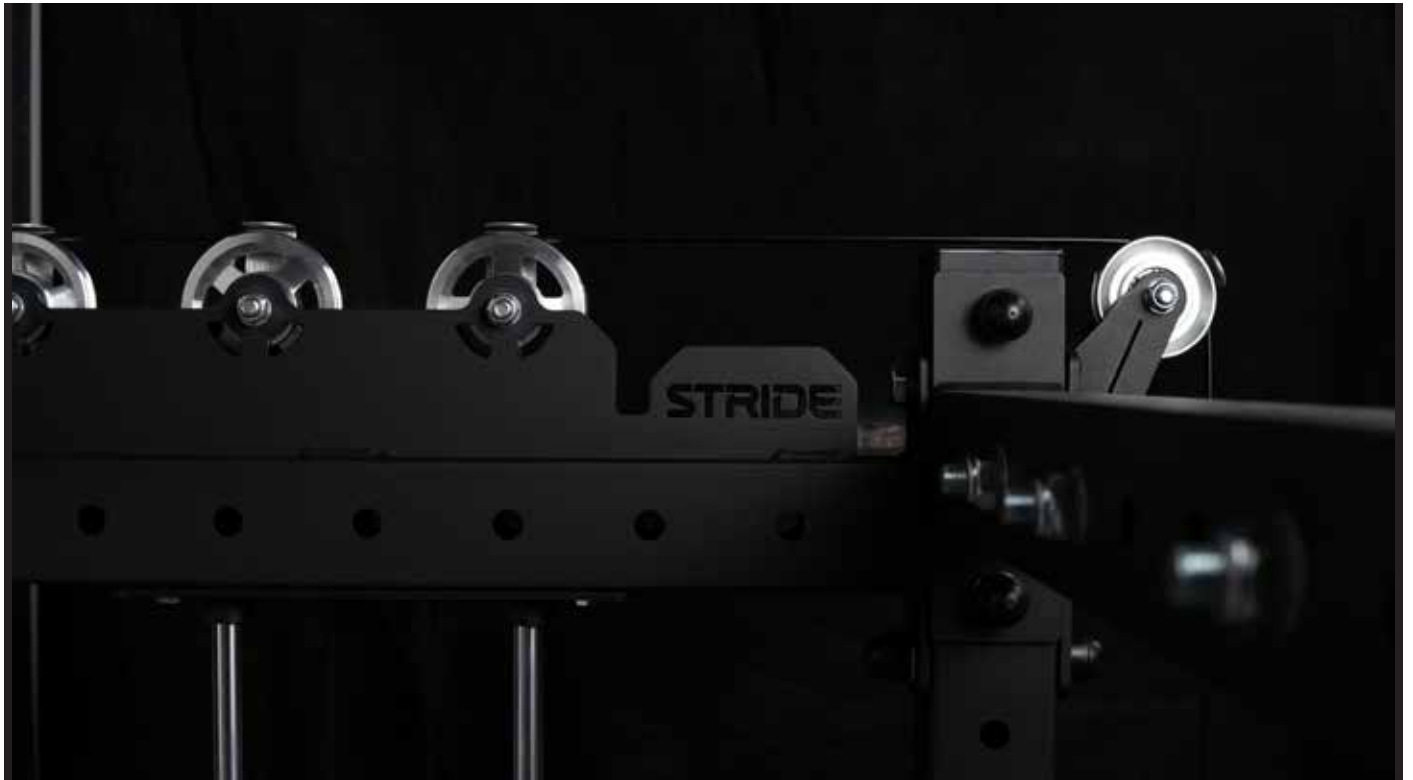

DOUBLE CABLE POWER RACK

Art. Nr.	Item	Price
----------	------	-------

RAP-DOUBLECABLEPOWRACK	RAPTOR double cable power rack	
------------------------	--------------------------------	--



CHECK OUT OUR SPEC SHEET
ON THE PREVIOUS PAGE
FOR ALL DIMENSIONS

TOTAL HEIGHT
240 cm

TOTAL WIDTH
137,5 cm

TOTAL DEPTH
110 cm / 180 cm

EXTENDED DOUBLE CABLE POWER RACK

Art. Nr.	Item	Price
----------	------	-------

RAP-EXTDOUBLECABLPOWRACK	RAPTOR Extended double cable power rack	
--------------------------	-----------------------------------------	--



CHECK OUT OUR SPEC SHEET
ON THE PREVIOUS PAGE
FOR ALL DIMENSIONS

TOTAL HEIGHT
240 cm

TOTAL WIDTH
137,5 cm

TOTAL DEPTH
110 cm / 180 cm





DOUBLE CABLE POWER RACK WITH SHELVES

Art. Nr.	Item	Price
	RAPTOR double cable power rack with shelves	
		



CHECK OUT OUR SPEC SHEET ON THE PREVIOUS PAGE FOR ALL DIMENSIONS

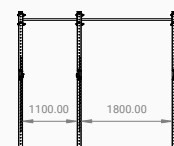

TOTAL HEIGHT
240 cm

TOTAL WIDTH
325 cm

TOTAL DEPTH
110 cm / 180 cm

PRO PERFORMANCE DOUBLE CABLE WITH SHELVES

Art. Nr.	Item	Price
RAP-2-1DOUBLECABLEPOWRACK	RAPTOR Pro Performance double cable with shelves	
		



CHECK OUT OUR SPEC SHEET ON THE PREVIOUS PAGE FOR ALL DIMENSIONS

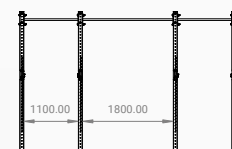

TOTAL HEIGHT
240 cm

TOTAL WIDTH
442,5 cm

TOTAL DEPTH
110 cm / 180 cm

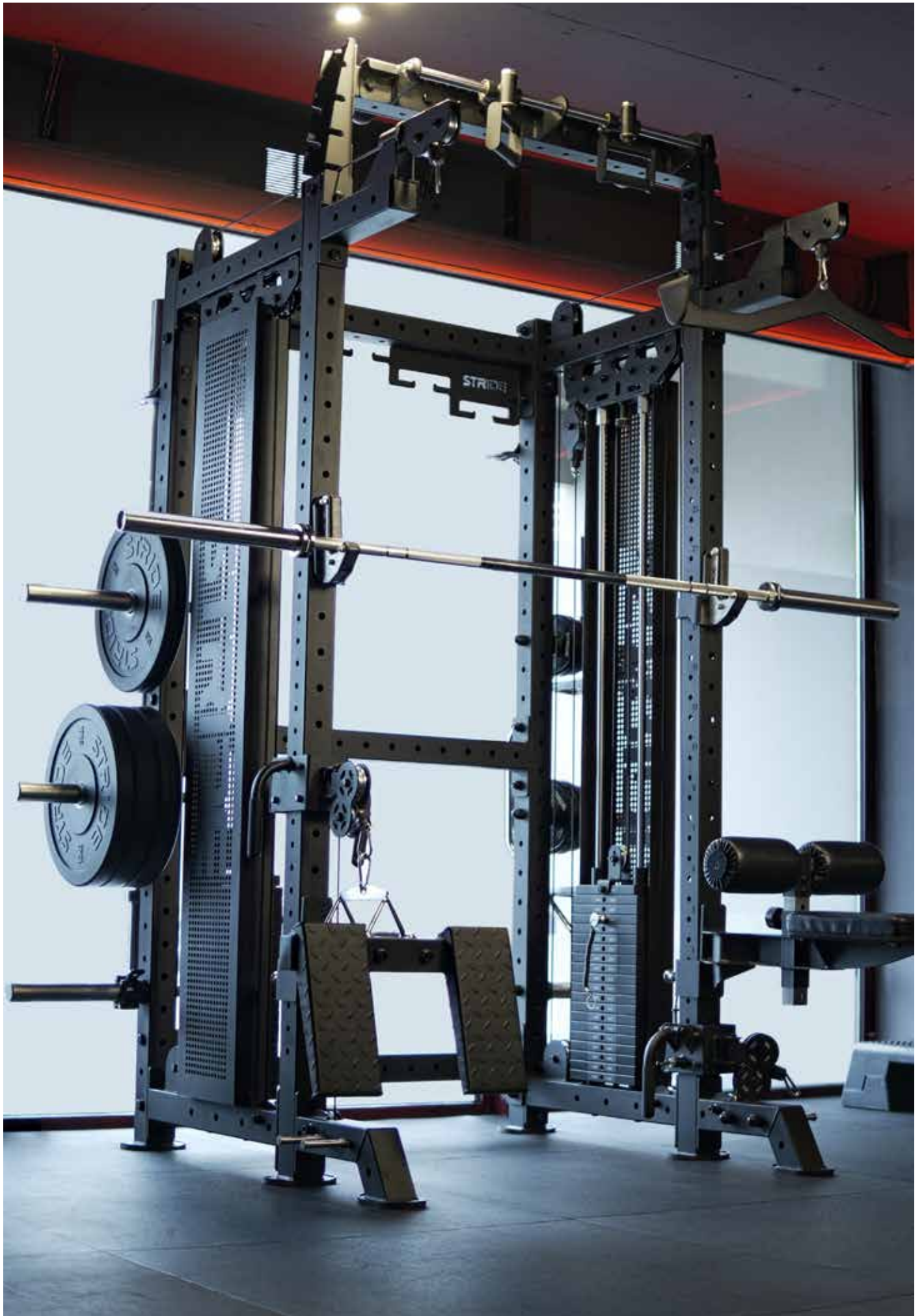

RAPTOR MULTIFUNCTIONAL POWER RACK

Item	Price
RAP-POWERRACKWS-TACK Raptor multifunctional power rack (weight stack)	

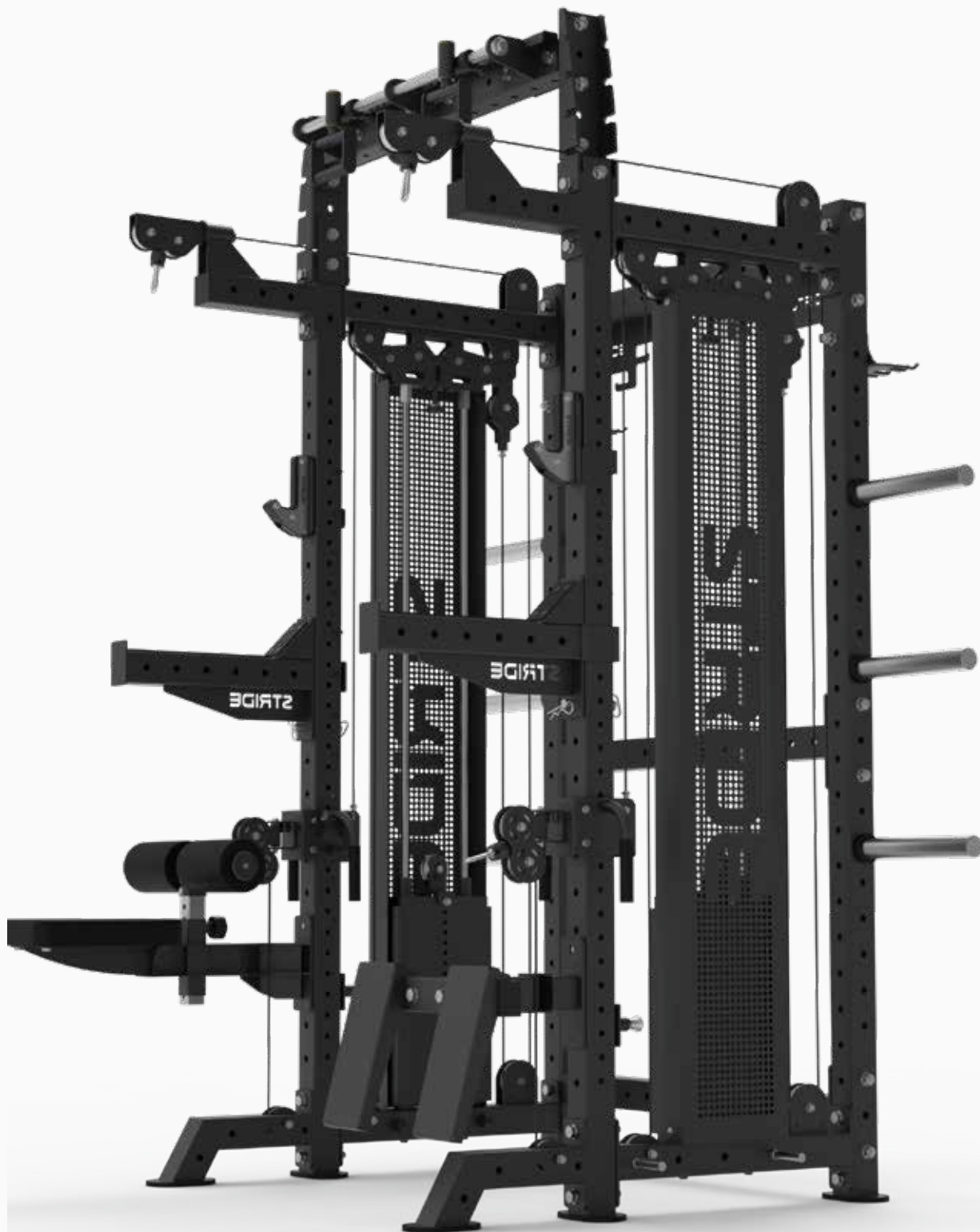

STORAGE SOLUTIONS

STORAGE SOLUTIONS
Minimal Space.
Maximum Efficiency.

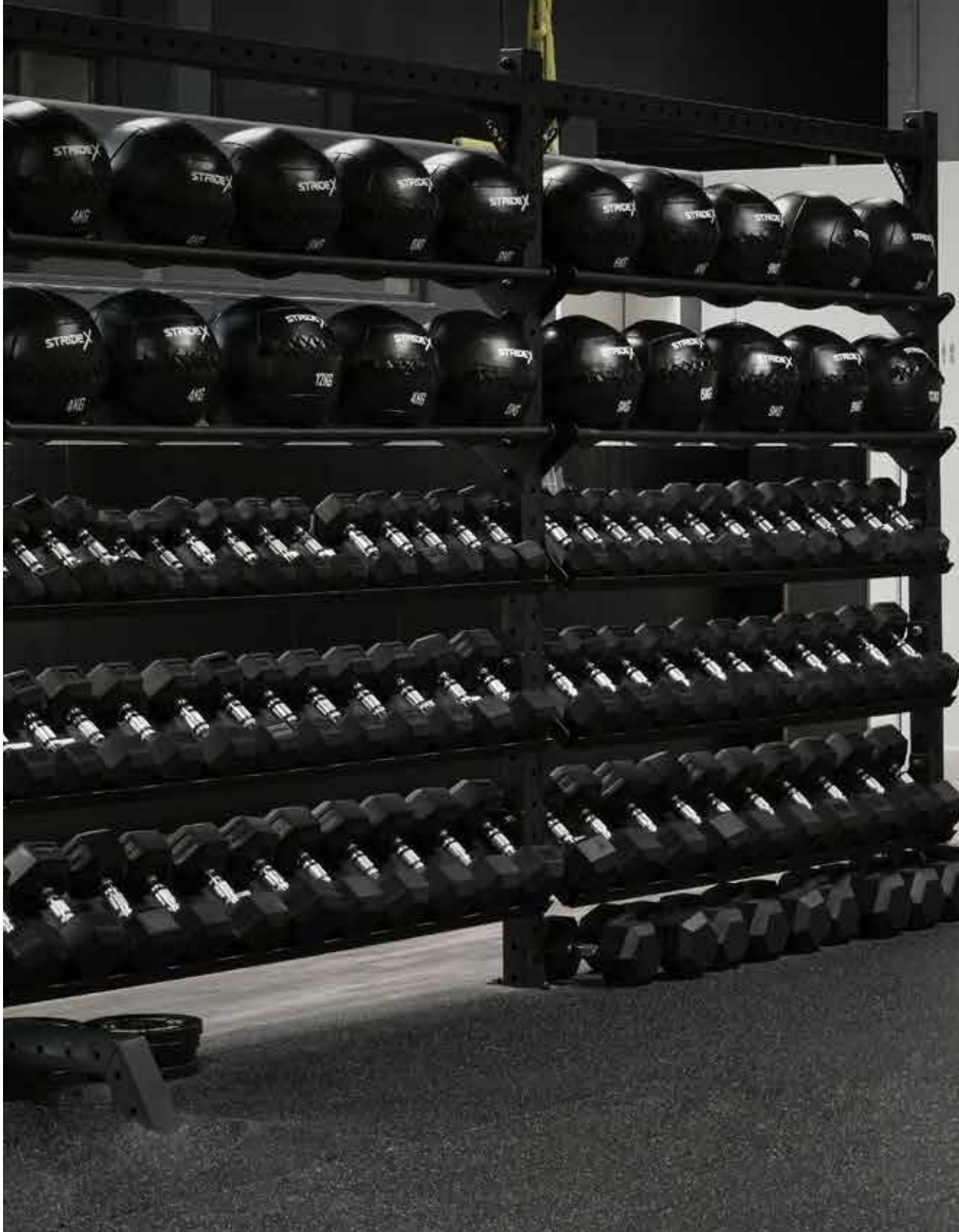



Our modular steel wall racks feature four versatile shelf types, designed to organize any training space efficiently.

STORAGE SOLUTIONS

TECHNICAL SHEET

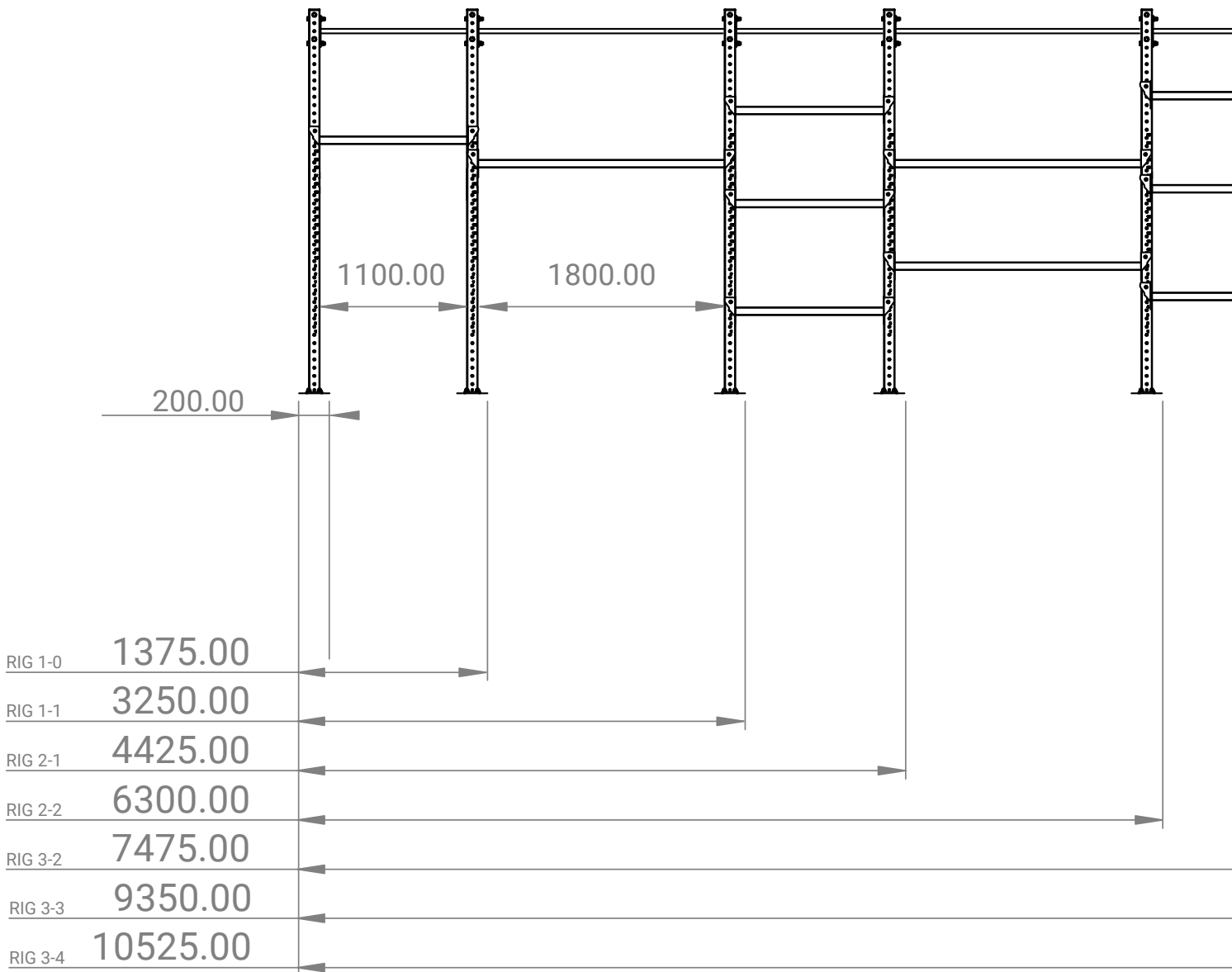



- All pillars have a standard height of 240cm and can be extended up to 340cm when needed.
- Width of squat station is 110cm or 180cm.
- Upright pillars 7,5cm x 7,5cm.
- Connected to wall with 110cm or 180cm pull-up bars.
- At the bottom of the pillars there are feet for extra stability. To measure the outer dimensions of your rack, you need to take these feet into account, and add 6,25cm on each end.

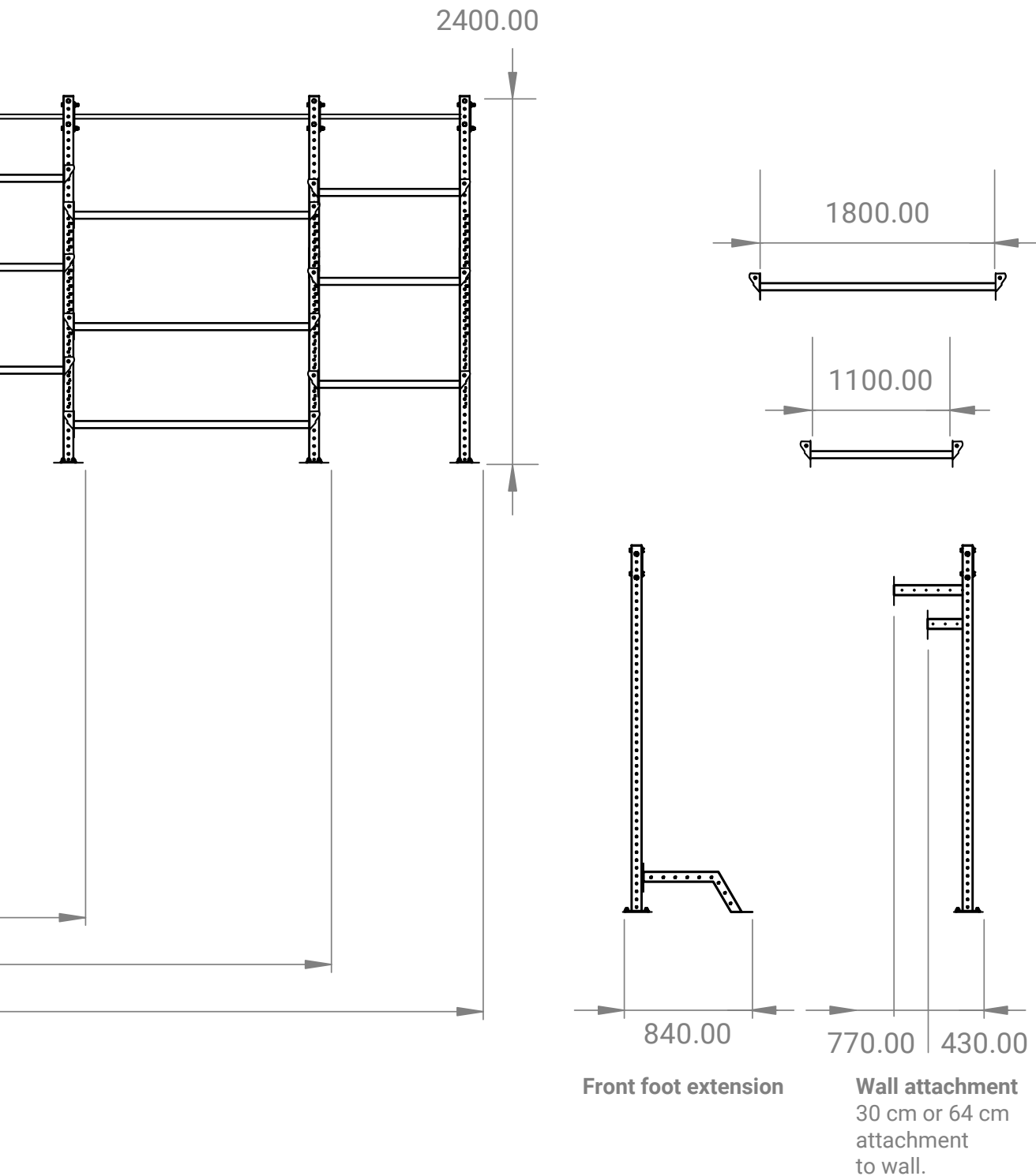

STORAGE SOLUTIONS

SCAN QR CODE
TO SEE PRICES
AND WHAT IS
CURRENTLY IN STOCK.



WALL 1

Art. Nr.	Item	Price
RAP-180STOWAL1	RAPTOR Storage Wall	



CHECK OUT OUR SPEC SHEET
ON THE PREVIOUS PAGE
FOR ALL DIMENSIONS

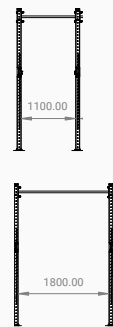

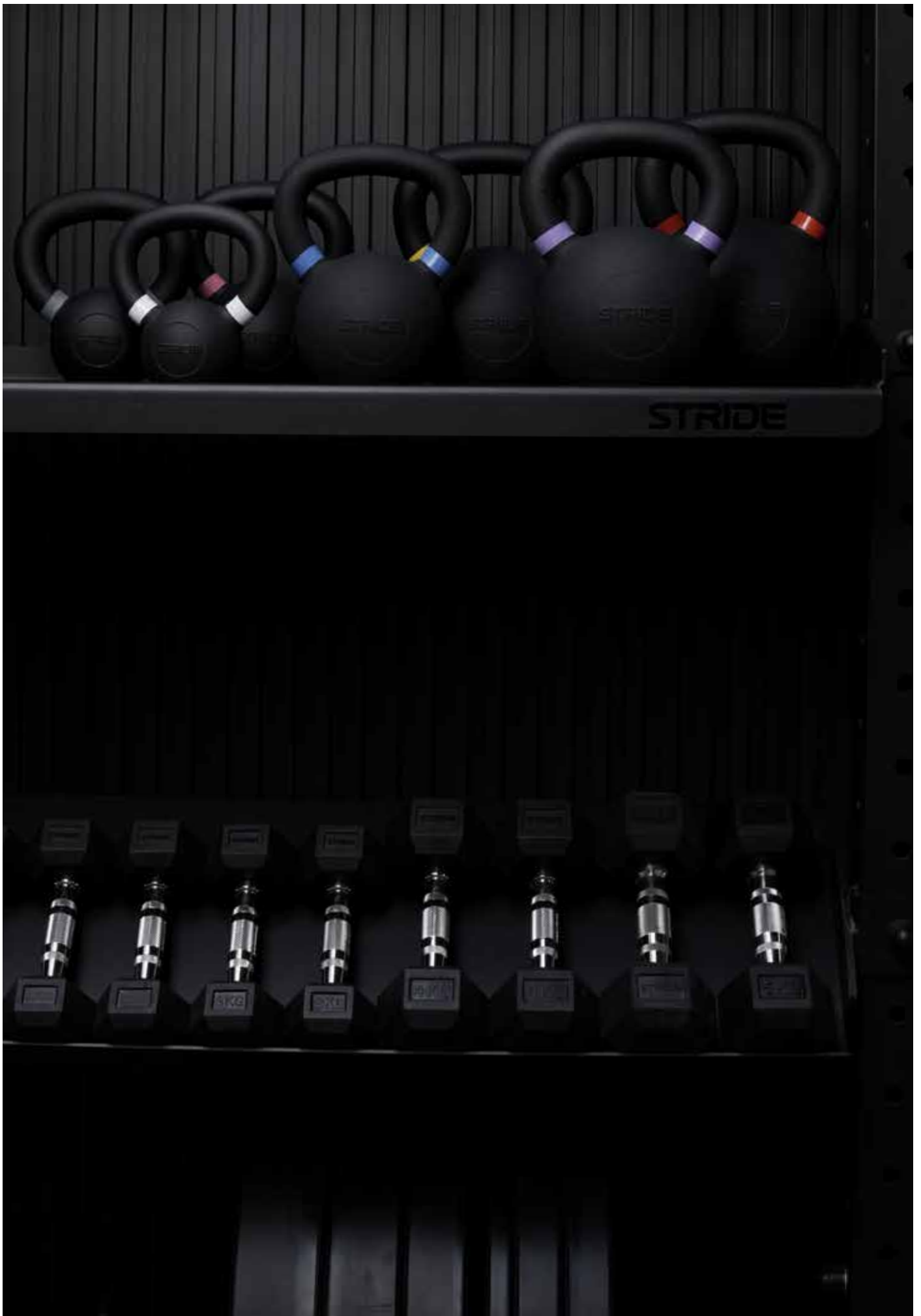

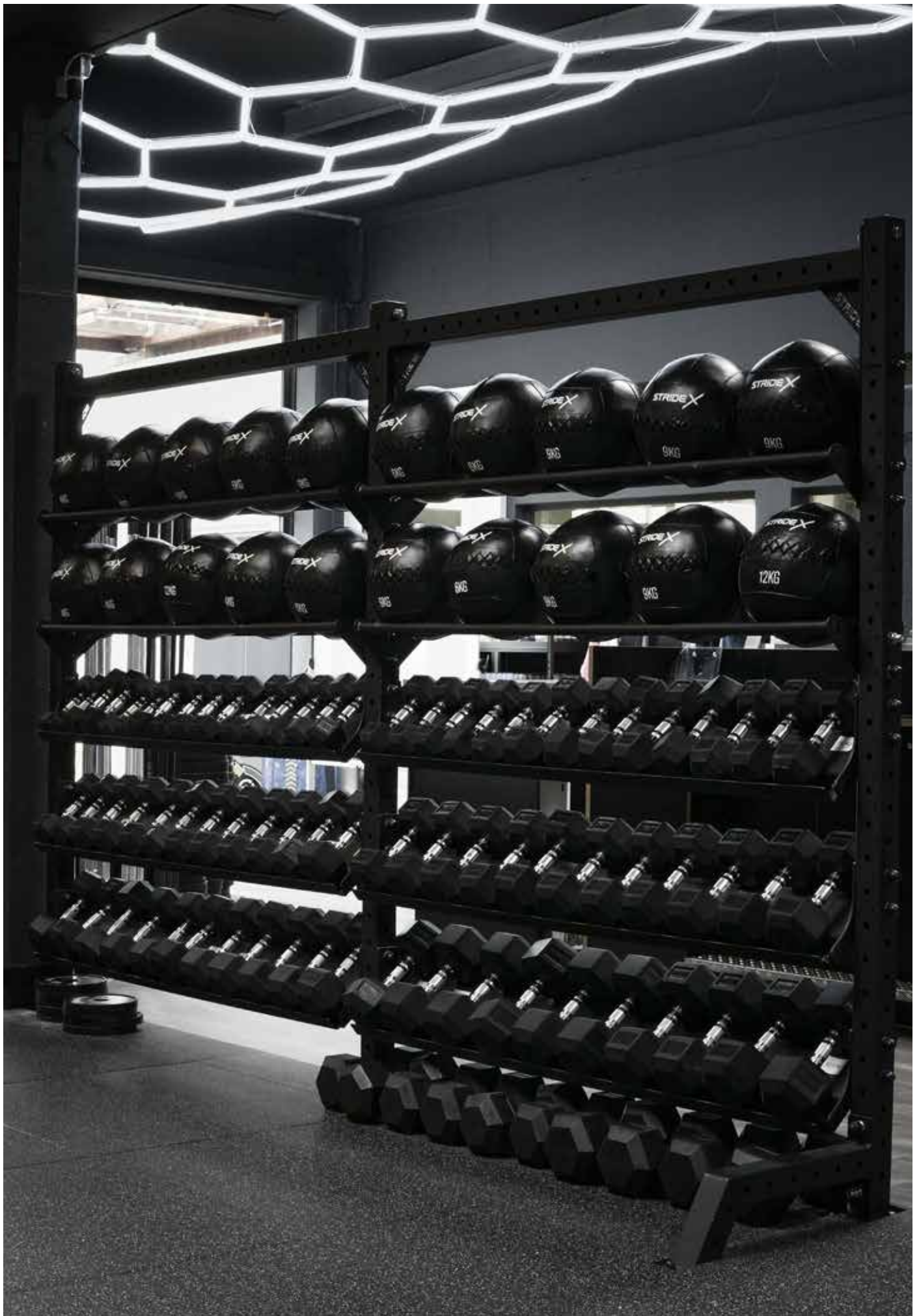

WALL 2

Art. Nr.	Item	Price
RAP-180STOWAL2	RAPTOR Storage Wall 2	



CHECK OUT OUR SPEC SHEET
ON THE PREVIOUS PAGE
FOR ALL DIMENSIONS

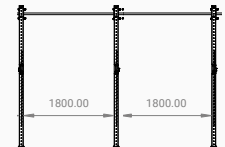

TOTAL HEIGHT
240 cm

WIDTH
110 cm / 180 cm

WALL 3

Art. Nr.	Item	Price
RAP-180STOWAL3	RAPTOR Storage Wall 3	



CHECK OUT OUR SPEC SHEET
ON THE PREVIOUS PAGE
FOR ALL DIMENSIONS

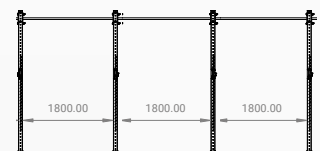

TOTAL HEIGHT
240 cm

WIDTH
110 cm / 180 cm

STORAGE ATTACHMENTS

SCAN QR CODE TO SEE PRICES AND WHAT IS CURRENTLY IN STOCK.



FRONT FOOT EXTENSION

Art. Nr.	Item	Price
RAP-FOOEXT	Raptor Front Foot Extension	



1.10M PLATE RACK

Art. Nr.	Item	Price
RAP-110PLRACK	Raptor 1.10m Plate rack	



1.80M PLATE RACK

Art. Nr.	Item	Price
RAP-180PLRACK	Raptor 1.80m Plate rack	



1.10M FLAT SHELF

Art. Nr.	Item	Price
RAP-110FLATSH	Raptor 1.10m flat shelf	



1.80M FLAT SHELF

Art. Nr.	Item	Price
RAP-180FLATSH	Raptor 1.80m flat shelf	

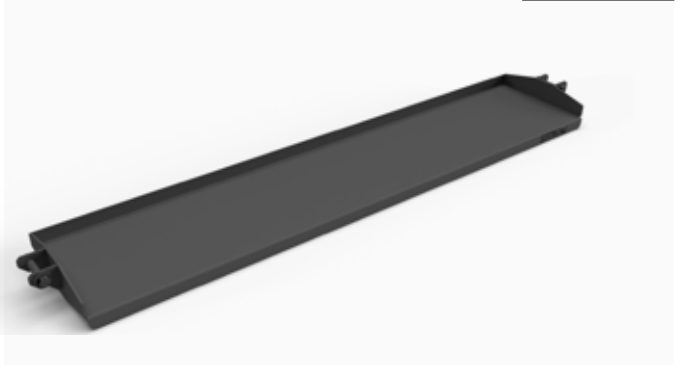

1.10M DUMBBELL SHELF

Art. Nr.	Item	Price
RAP-110DBRACK	Raptor 1.10m Dumbbell shelf	



SPECS

Length: 110cm
Width: 28cm
Weight: 15kg



1.80M DUMBBELL SHELF

Art. Nr.	Item	Price
RAP-180DBRACK	Raptor 1.80m Dumbbell shelf	



SPECS

Length: 110cm
Width: 28cm
Weight: 15kg

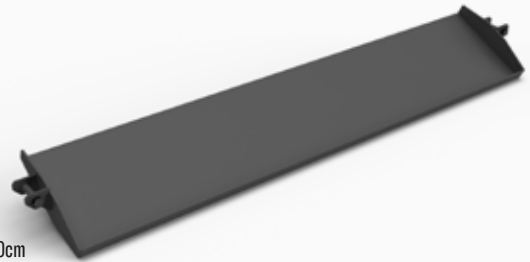

1.10M BALL RAIL

Art. Nr.	Item	Price
RAP-110BALLRAIL	Raptor 1.10m Ball Rail	



1.80M BALL RAIL

Art. Nr.	Item	Price
RAP-180BALLRAIL	Raptor 1.80m Ball Rail	



1.10M LOGO PLATE CROSSBEAM

Art. Nr.	Item	Price
RAP-110CROSSLOGO	Raptor 1.10m logo plate crossbeam	



1.80M LOGO PLATE CROSSBEAM

Art. Nr.	Item	Price
RAP-180CROSSLOGO	Raptor 1.80m logo plate crossbeam	



FUNCTIONAL TRAINING ATTACHMENTS



DIP STATION

Art. Nr.	Item	Price
RAP-DIPSTAT	Raptor dip station	



J-CUPS

Art. Nr.	Item	Price
RAP-JCUPS	Raptor J-cups	

SOLD PER PAIR



PLATE PIN SET (2)

Art. Nr.	Item	Price
RAP-PLATEPINSET	RAPTOR Plate Pin Set (2)	



SINGLE BARBELL HOLDER

Art. Nr.	Item	Price
RAP-SINGBARHOLD	Raptor Single barbell holder (rack attachment)	



CLIMBING ROPE (4,5M; HEMP)

Art. Nr.	Item	Price
RAP-CLIMBROPE	Raptor climbing rope (4,5m; hemp)	



OUTBOARD ATTACHMENT

Art. Nr.	Item	Price
RAP-OUTBOARD	Raptor outboard attachment	



BAND PEGS PACK (4PCS)

Art. Nr.	Item	Price
RAP-BANDPEGS	Raptor Band Pegs Pack (4pcs)	



WOODEN LADDER

Art. Nr.	Item	Price
RAP-WOODLAD	Raptor wooden ladder	



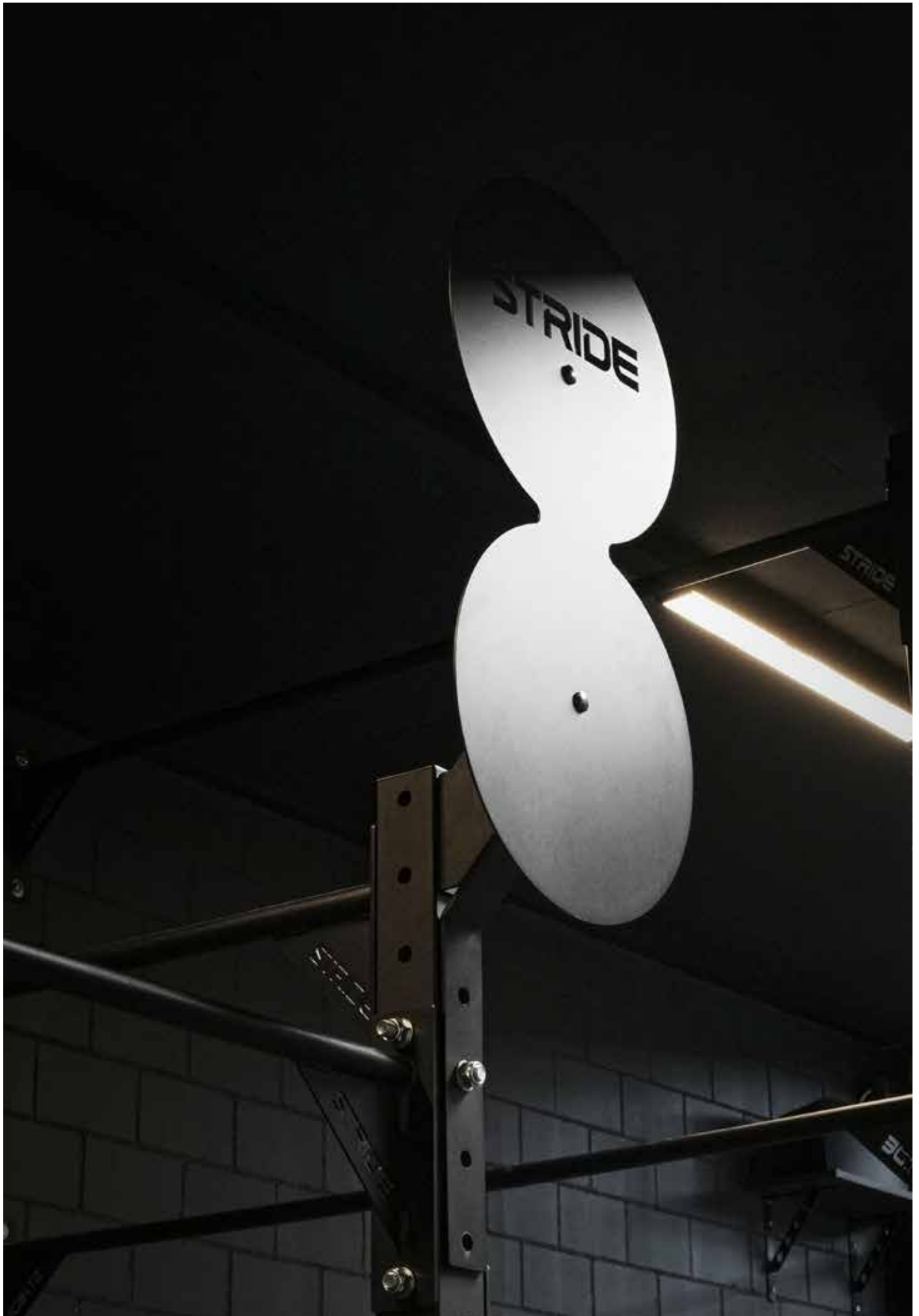

LANDMINE (RACK ATTACHMENT)

Art. Nr.	Item	Price
----------	------	-------

RAP-LANDMINE	Raptor Landmine (rack attachment)	
--------------	-----------------------------------	--



SAFETY SPOTTERS

Art. Nr.	Item	Price
----------	------	-------

RAP-SAFSPOT	Raptor safety spotters	
-------------	------------------------	--

SOLD PER PAIR



WALL BALL TARGET

Art. Nr.	Item	Price
----------	------	-------

RAP-WBTARG	Raptor wall ball target	
------------	-------------------------	--



DOUBLE WALL BALL TARGET

Art. Nr.	Item	Price
----------	------	-------

RAP-WBTARG2	Raptor double wall ball target	
-------------	--------------------------------	--



UNIVERSAL ANCHOR

Art. Nr.	Item	Price
----------	------	-------

RAP-ANCH	Raptor universal anchor	
----------	-------------------------	--



LEG CURL/EXTENSION

Art. Nr.	Item	Price
----------	------	-------

RAP-LEGEXT	Raptor Leg curl/extension (rack attachment)	
------------	---------------------------------------------	--



RAPTOR 1.10M DIRTY SOUTH BAR

Art. Nr.	Item	Price
RAP-110DIRTSTHBAR	Raptor 1.10m Dirty south bar	



RAPTOR 1.80M DIRTY SOUTH BAR

Art. Nr.	Item	Price
RAP-180DIRTSTHBAR	Raptor 1.80m Dirty south bar	

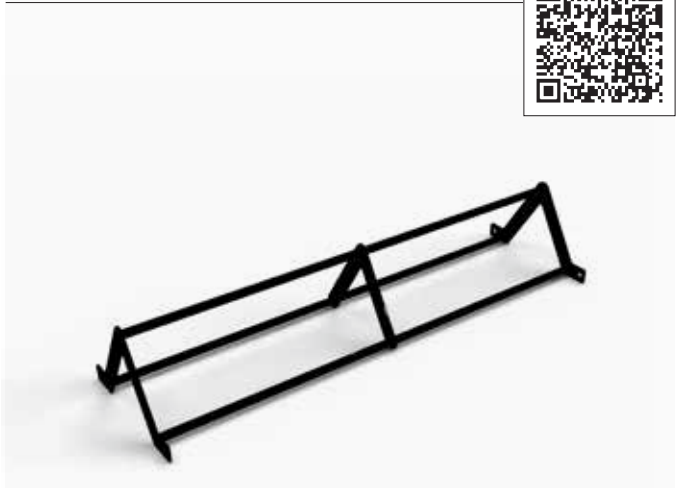

CHIN UP BAR

Art. Nr.	Item	Price
RAP-CHINBAR	Raptor Chin up bar	



ON-BEAM GLOBE PULL UP BAR

Art. Nr.	Item	Price
RAP-PUGLOBE	Raptor on-beam globe pull up bar	



ADJUSTABLE PULL-UP BAR

Art. Nr.	Item	Price
RAP-110ADJPU	Raptor 1.10m Adjustable Pull-Up Bar	
RAP-180ADJPU	Raptor 1.80m Adjustable Pull-Up Bar	



FLYING PULL-UP BAR

Art. Nr.	Item	Price
RAP-110FLYPU	Raptor 1.10m Flying Pull-up bar	
RAP-180FLYPU	Raptor 1.80m Flying Pull-up bar	





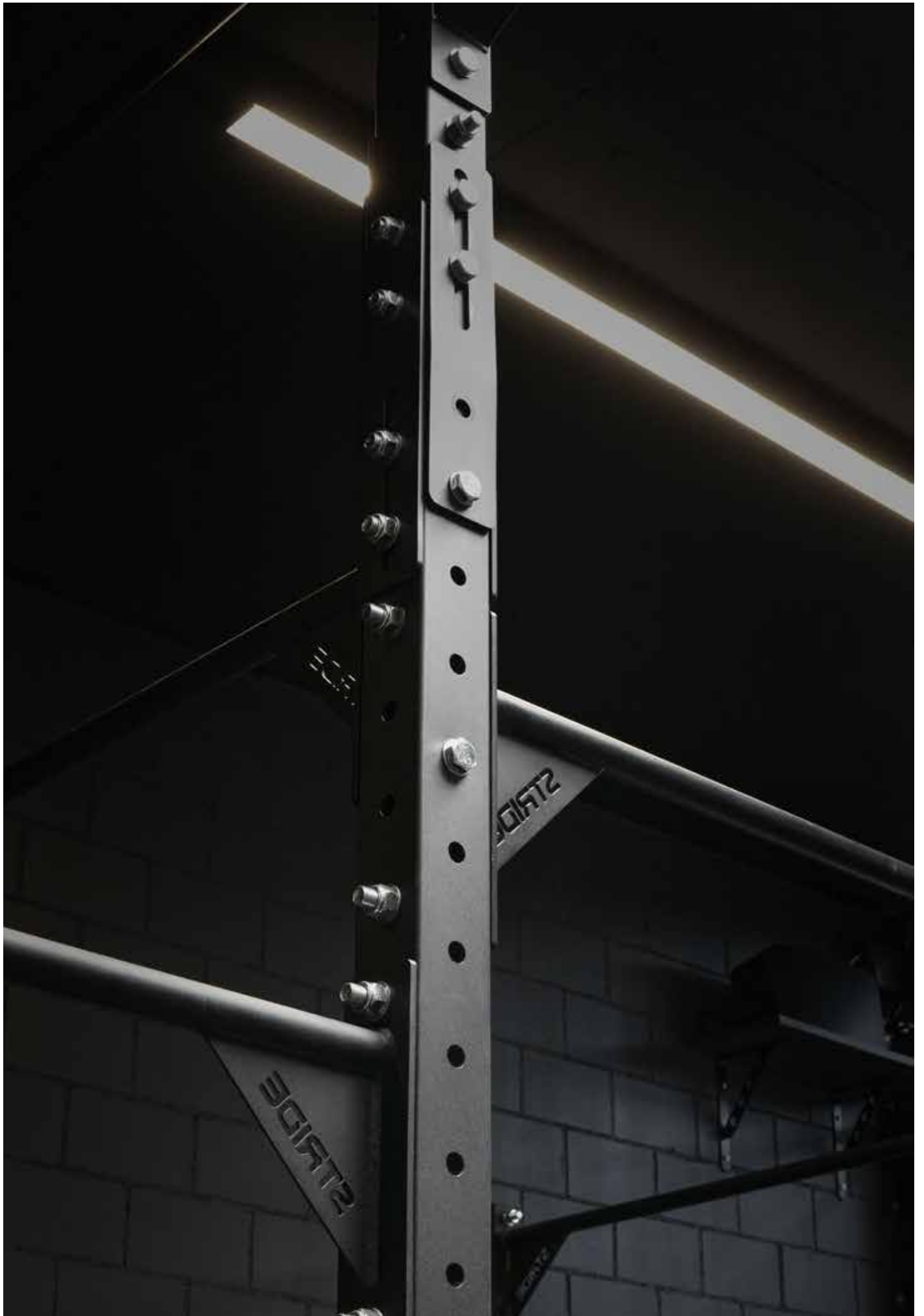

SINGLE ROPE GRIP

Art. Nr.	Item	Price
RT-SROPE	STRIDE-Single Rope Grip	



DOUBLE ROPE GRIP

Art. Nr.	Item	Price
STR-DBLROPEGRIP	STRIDE-Double rope grip	



WIDE GRIP

Art. Nr.	Item	Price
RT-WIDEGRIP	RAPTOR Wide shoulder grip	



DOUBLE HAND GRIP

Art. Nr.	Item	Price
STR-DBLHANDGRIP	STRIDE Double hand grip	



WEBBING SAFETY STRAPS

Art. Nr.	Item	Price
RAP-SAFSTRAPS	RAPTOR Webbing Safety Straps	



HIP THRUST ATTACHMENT

Art. Nr.	Item	Price
RAP-PLATEPINSET	RAPTOR Plate Pin Set (2)	





WEIGHT STACK CABLE ATTACHMENT

Art. Nr.	Item	Price
RAP-CABLEATTACH	RAPTOR weight stack cable attachment	



OUTDOOR TRAINING

SCAN QR CODE
TO SEE PRICES
AND WHAT IS
CURRENTLY IN STOCK.



STRIDE CONTAINER (10 FT OR 20 FT)

Art. Nr.	Item	Price
STRIDE-CONTAINER	STRIDE CONTAINER	

RAPTOR
ATTACHMENTS NOT
SUPPORTED.



CUSTOM DESIGN POSSIBILITIES

LET'S DESIGN A CUSTOM RIG TOGETHER.
CONTACT US FOR MORE.

RAPTOR
ATTACHMENTS NOT
SUPPORTED.







STRIDE RAPTOR RACKS

Built to Hold. Engineered to Last.

STRIDE SALES TEAM



**THIBAUT
POULET**

Account Manager
Belgium
thibault
@strideeurope.com
+32 494 20 29 72



**VINCENT
GINNEBERGE**

Account Manager
Belgium
vincent
@strideeurope.com
+32 474 07 19 24



**CELINE
DE COSTER**

Account Manager
Belgium
celine
@strideeurope.com
+32 494 69 62 70



**SANDER
KAMPHUIS**

Account Manager
The Netherlands
sander
@strideeurope.com
+31 6 23 790 343



**MIKE
GRIEPINK**

Account Manager
The Netherlands
mike
@strideeurope.com
+31 6 44 215 966



**OLIVIER
DE COSTER**

Country Manager
France
olivier
@stridefrance.fr
+33 6 33 61 17 64



**WANNES
VANDELDELDE**

Country Manager
France
wannes
@strideeurope.com
+32 498 65 53 72



**AN-SOFIE
DE VISSCHER**

Country Manager
Spain
ansofie
@strideeurope.com
+32 498 42 52 82



**ANTHONY
BOTTA**

Country Manager
Spain
anthony
@strideeurope.com



**TOMASZ
WÓJCIK**

Country Manager
Poland
tomasz
@strideeurope.com
+48 737 50 98 87



**MATTHIAS
ALTHOFF**

Country Manager
Germany
germany
@strideeurope.com
+49 176 705 965 26



**BRODI
CASULL**

Country Manager
Germany
germany
@strideeurope.com
+49 173 651 90 40



**ÖZKAN
ARAS**

Country Manager
Germany
germany
@strideeurope.com
+49 151 500 000 37



**SIMONE
GAMIN**

Country Manager
Italy
stride-italy
@strideeurope.com
+39 6 334 310 3317



**MATTEO
CENCIG**

Country Manager
Italy
stride-italy
@strideeurope.com
+39 333 224 3529



**MILI
SKOKO**

Country Manager
South-East Europe
south-east
@strideeurope.com
+385 98 4220 55



**DAMIR
LAŠTRE**

Country Manager
South-East Europe
south-east
@strideeurope.com
+385 99 3243 587



**IGOR
OGNJENOVIC**

Country Manager
South-East Europe
south-east
@strideeurope.com
+382 67 285 921



**MICHEL
KOCH**

Country Manager
Switzerland
michel
@strideeurope.com
+41 78 805 06 84



**LEANDER
VERBRAEKEN**

Key Account
Manager / CEO
leander
@strideeurope.com

STRIDE
ONE STEP AHEAD IN GYM CREATION