



**evolabel**<sup>®</sup>

Simplicity through technology



**CODE IT**<sup>®</sup>

# Print & Apply EVOLVED

**Simplicity  
every step  
of the way**

PAGES 3-4

**Solutions  
that meet  
your needs**

PAGES 6-13

**Discover  
our smart  
products**

PAGES 14-25

## Table of Contents

- 3 About Evolabel
- 5 Evolabel X CodeIT
- 6 Product News Coldstore Range
- 8 Complete Solutions
- 12 Products Modular System
- 13 Products Effortless Integration
- 14 Printers
- 16 Applicators
- 23 Applicator Pads
- 25 Accessories
- 26 Partners
- 28 Contact



# Simplicity every step of the way

Evolabel develops, manufactures and supplies innovative and intuitive machines for automatic labeling in production or warehousing around the globe.

## Mission

To provide the greatest **Print & Apply** solution in the industry.

## What we do

We take complex challenges and turn them into simple and intelligent solutions. ***Simplicity through technology*** is our philosophy, every step of the way.

## How we do it

**Innovation** is at the heart of what we do. It is what drives us. We focus on attracting the right people to join our family and giving them the right tools to innovate.



 **MADE**  
 **IN**  
 **SWEDEN**

With the user in focus, the Evolabel Print & Apply range is developed, designed and manufactured in Sweden.

# Intelligent Print Modules

**Produced as one system with a built-in print function.**

Evolabel manufactures Print & Apply machines for automatic labeling in automated production and warehouse operations. Typical applications are manufacturing where product labels are applied with information like a barcode, best before date, table of contents, batch number, weight, etc. In applications where uptime and quality is essential, Evolabel does the job.



Change label roll within 20 seconds

## Installation

The compact and clean design, together with stable & flexible brackets and holders make mechanical installation easy.

## Integration

The open and defined Evolabel API allows external software programs to fully control the Evolabel Print & Apply system.

## Robust and Safe

The solid aluminum chassis is in one piece for perfect alignment of label and transfer rollers, printhead, etc.

## User-friendly

The user is alerted before the label roll needs replacing. The clean and open design makes changing the paper roll straightforward and simple.

## Maintenance

The ribbon and label roll are fast and easy to replace. Cleaning the printhead is quick and easy – no tools needed, no need to turn off the machine.

Change printhead or print roller within 1 minute



# Evolabel X CodeIT

Connected to the full production reality. Most production environments are built over time, with different machines, technologies and systems working side by side. Creating efficiency requires more than standalone equipment. It requires everything to work together.

This is where CodeIT creates value. We connect production equipment and marking systems with surrounding business systems into one structured and traceable production flow.

Our strength lies in making different technologies integrate seamlessly, without locking customers into one specific setup or equipment. Within Print & Apply, Evolabel is CodeIT's dedicated hardware partner.

Their reliable technology performs well in complex production environments and integrates naturally into the solutions we build.

For manufacturers, this means less manual handling, stronger traceability and greater flexibility to grow, replace equipment or adapt production without starting over.

For further information and inquiries, please contact:

## **Norway**

Phone: (+47) 22 107 380

Email: [post@codeit.no](mailto:post@codeit.no)

## **Sweden**

Phone: (+46) 31 351 99 50

Email: [info@codeitab.se](mailto:info@codeitab.se)

## **Support**

Phone: (+46) 20 42 42 16

Email: [support@codeit.no](mailto:support@codeit.no)



“Our role is to connect the full production reality, from business systems to equipment on the production floor. Within Print & Apply, Evolabel is our hardware partner of choice.”

— Christian Öhrn, CEO, CodeIT Group



# Print & Apply in freezing conditions — Even at $-30^{\circ}\text{C}$ ( $-22^{\circ}\text{F}$ )



Scan to explore our Coldstore Range



FlexWipe® Motorized  
Stand XL Coldstore  
Pallet Labeling System

eTamp Coldstore  
Applicator

# Coldstore Range

Evolabel's new Coldstore Range is designed, engineered, manufactured, tested, and verified in Sweden to deliver unmatched Print & Apply performance in freezing conditions down to  $-30^{\circ}\text{C}$  /  $-22^{\circ}\text{F}$  — redefining what's possible for automated labeling in cold and freezing conditions. Developed in close collaboration with our most demanding customers, this innovative product range performs even in the most challenging applications.



## Unmatched reliability at $-30^{\circ}\text{C}$ / $-22^{\circ}\text{F}$

Ensuring precise labeling in extreme conditions from  $-30^{\circ}\text{C}$  to  $+40^{\circ}\text{C}$  ( $-22^{\circ}\text{F}$  to  $104^{\circ}\text{F}$ ) in pharmaceuticals, food production, or cold chain logistics.



## Up to 50% smaller footprint

Space-saving, compact solution eliminating bulky, expensive, and slow heating cabinets or enclosures.

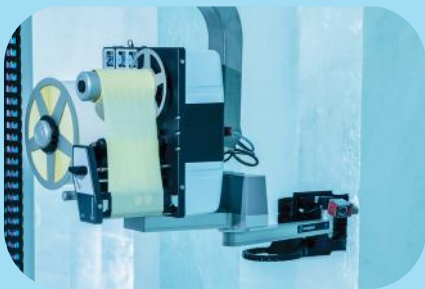

## Advanced software for optimal performance

Coldstore's intelligent software automatically adjusts to ambient conditions, ensuring optimal performance at all times.



## Built with safety in mind

Like all Evolabel solutions, Coldstore meets strict safety standards and delivers reliable labeling when others fail, offering peace of mind.

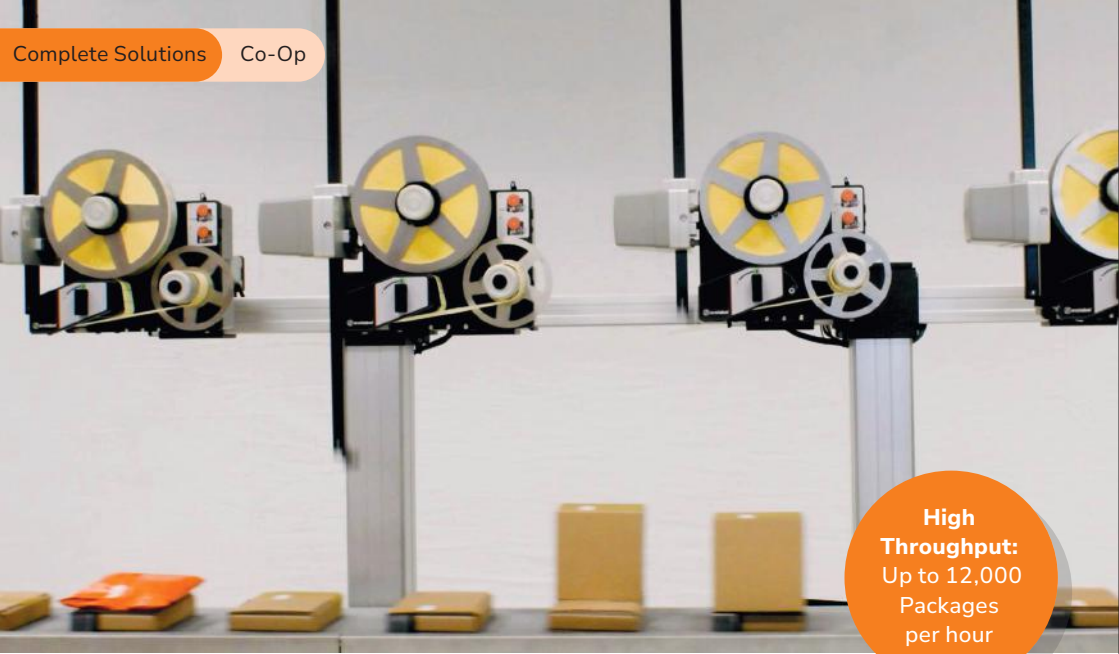

# Co-Op Solution

The core of the solution is the principle of collaboration.

## Scalable Capacity & Full Redundancy

A unique concept where a group of up to four printers communicate and work together for scalable capacity and redundancy. The printers in a Co-Op group communicate with each other and schedule each print job, in real time, to the printer that is most suited for the task. The solution offers simplified integration without the need to distribute jobs to multiple printers or implement control logic for handover.

## Easy operation and maintenance to ensure uptime

With shared workload across the printers, operator time for label changes and maintenance is minimized,

maintaining the required throughput even if one printer is offline. The result is a scalable solution that reduces operator stress. Label rolls can be replaced in 20 seconds and printheads or rollers in just a minute.

All Evolabel printers are developed with **Safety in Focus** and with a very **small Footprint** allowing operators to efficiently manage their production line.

For inquiries and more product specifications, please contact:

[info@codeitab.se](mailto:info@codeitab.se) (Sweden)  
[support@codeit.no](mailto:support@codeit.no) (Norway)

**Co-Op** is an excellent match for logistics applications with different package heights, package types, and unique label information.



The **innovative software** adapts to the host control system, not the other way around. No extra hardware or software is needed. It allows for a new Print & Apply solution, perfect for any application that requires high capacity.

Co-Op Controller



Co-Op Member



Co-Op Member



Co-Op Member



Co-Op Member

Built-in  
Software  
Solution

One control  
system,  
seamlessly  
managing up  
to 4 printers



Safety  
in Focus

# FlexWipe<sup>®</sup>

## Pallet Labeling System

**Enhancing safety, maximizing throughput, ensuring traceability and enabling flexibility.**

A flexible pallet labeling solution, designed with safety in focus, that maximizes throughput, ensures traceability and offers a small footprint.

All Evolabel products are developed with operators' safety and ergonomics in mind. The design reduces crushing hazards and trap points.

It features a **high capacity of up to 5 pallets/minute** with a label roll change in less than 20 seconds. Flexwipe ensures a seamless high-capacity production line.

You can maximize your flow by swiftly labeling double-stacked pallets and increase the pallet count per hour by doubling it, ensuring an effective and problem-free production. It gives you a rapid label application, with a scan function ensuring they are readable.

- Labels virtually any surface
- Easily applies labels on three sides
- Reduces investment costs
- Small footprint
- One machine handles it all

# A Giant Leap for Pallet Labeling



## Motorized Stand XL

Automatically label on varying heights with an adjustable range of up to 1.6 m (5'3")

## Evolabel 15" GUI

Touch Display for Printer operation.

## Connection Cabinet



## Flexible Cables

## Status Beacon

## Printer

T63 G2  
SE or PE

## Safety in Focus

Stepper motors with feedback STOP movement automatically

## Applicator

The patented design of the Multi Side, FlexWipe® Applicator turns 360° in any direction

Automatic Portrait or Landscape Mode

## Floor Stand Plate Pallet

# Modular System

Compact and intelligent building blocks provide the optimal solution for your specific Print & Apply requirements, even in very narrow spaces.

The modules are designed to function seamlessly as a complete system, ensuring optimal functionality and user-friendliness. They can be mounted in virtually any direction (exception: reels cannot point down). This enables label application on any side of your product and service from your preferred direction.

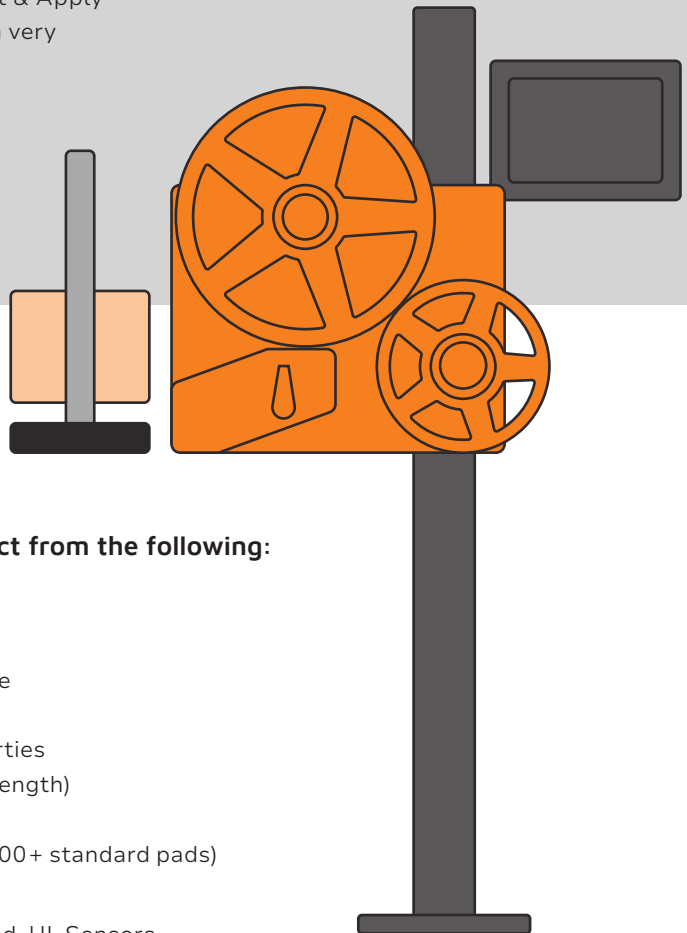

## Configure and select from the following:

- 1 Printer Module
- 2 Applicator Module
- 3 Applicator Properties (e.g., stroke/arm length)
- 4 Applicator Pad (100+ standard pads)
- 5 Accessories (Stand, UI, Sensors, Status Beacon, etc.)

# Effortless Integration

Evolabel's standardized computer platform ensures seamless integration. It offers everything from standalone functionality with built-in label design software and product list to the JSON-RPC API, which fully utilizes Evolabel software features.

Other well-known standard interfaces such as ZPL, PDF, Modbus, digital I/O, provide an easy way to leverage layouts created for Zebra™ printers, and XML, which populate layouts in the Evolabel printer with data from your ERP system.

Also as stand alone

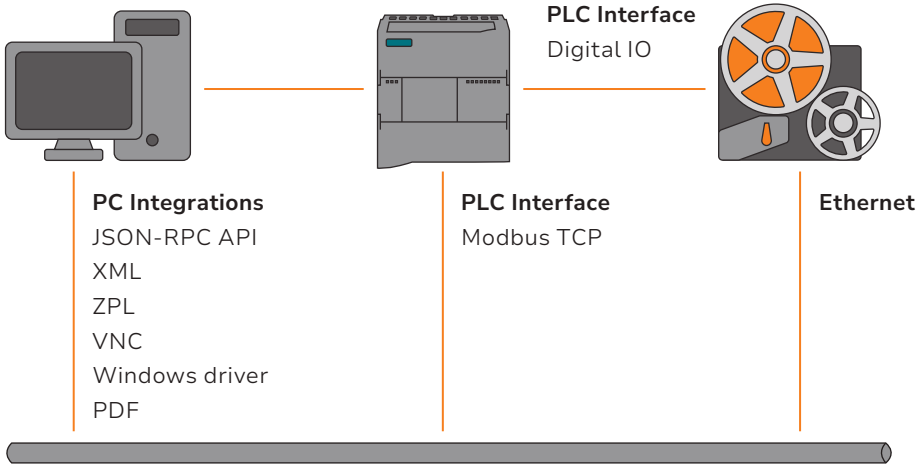

## Windows Driver

Download the NiceLabel™ Evolabel – Windows printer driver, and you can print from a Windows application (such as NiceLabel Designer Pro).

Test your system without hardware

## Virtual Printer

We offer a virtual printer for Mac, Windows and Linux, so developers can test their systems without the need for physical hardware.

## Layout View2

An online viewer that allows developers to validate both their 203dpi and 300dpi ZPL layouts without the need for an Evolabel Printer.

# Our Printers

We offer two sizes, 4" and 6", matching printhead width, with several options that provide flexibility for handling a wide range of labels. The compact D43 integrates easily into production lines using Direct Thermal Labels. T43 and T63 support both Thermal Transfer and Direct Thermal, while the D63 shares the T63 footprint but supports only Direct Thermal.

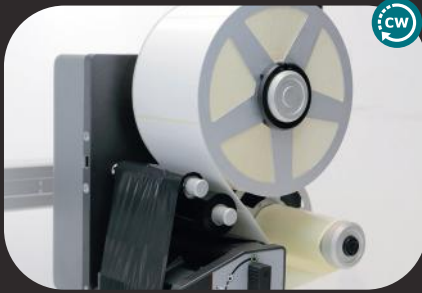

### T63 Printer

Thermal Transfer Technology  
6 inch print width  
300 dpi resolution



### T43 Printer

Thermal Transfer Technology  
4 inch print width  
300 dpi resolution



### D63 Printer

Direct Thermal Technology  
6 inch print width  
300 dpi resolution



### D43 Printer

Direct Thermal Technology  
4 inch print width  
300 dpi resolution



Clockwise Print & Apply = a mirrored version of the products is available to provide more flexibility and additional solutions for installations.



### Direct Thermal Technology

Direct Thermal Labels are widely used in the **food** and **logistics industries**, as well as in applications that do not require long-term storage.

Direct Thermal Technology requires only one media type, making it the easiest technology to use.

# Labeling Techniques

### Thermal Transfer Technology

The Thermal Transfer Technology is often used in applications where the labeled product has a long lifespan, is stored for long periods of time, or is exposed to tough handling. Examples are industries like **pharmaceutical**, **consumer goods**, **construction materials**, **auto industries** and other **non-food production**.

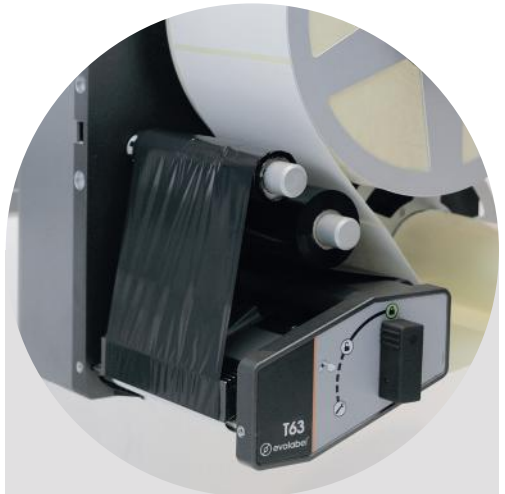



# Wide range of Applicators

For optimal functionality, user friendliness and safety, Evolabel designs the Printers and Applicators as one system.

For example, all Applicators are automatically moved away from the printhead and label path when the printhead is moved to its service position. This gives very good access when changing labels or cleaning the

printhead. The patented Applicator Pads with integrated vacuum ejectors ensure precise and consistent label position.

We offer a wide range of Applicator Modules within three categories:

- **Linear Applicators**
- **Rotary Applicators**
- **Contact-free Applicators**

# Have a look at our **Applicators**



**Tamp**



**eTamp**



**QuickTamp®**



**QuickTamp® Vac**



**QuickTamp® Airless**



**Wipe90  
& Wipe**



**BlowVac**



**Belt**



Available as  
clockwise.

# Linear Applicators

Achieve seamless label application with our Linear Label Applicators, perfect for top, bottom, and side applications. Available in various stroke lengths and properties for your needs.

## Tamp

The Tamp Applicator is designed for Print & Apply applications with high performance demands and accurate label positioning. It features a stroke length of 70 mm (2.75”).



Fast and simple pneumatic Applicator



With optional scanner for pallet labeling

## eTamp

Designed for stationary objects, the system offers a safety focused and lightweight design with high labeling precision. Adjustable stroke lengths ranging from 150 mm (5.9”) to 850 mm (33.5”) allow flexible adaptation to different product types and sizes, reaching products both near and far, regardless of which side you label on. With its extended stroke length and precise stepper motor control, the eTamp handles side, top, and pallet labeling with ease.



## Want to know more about our Applicators?

Scan for more information, or contact us to find the Applicators that best suit your industry.

### QuickTamp®

A fast and user-friendly logistics labeling system, excellent for e-Commerce, applying shipping labels on top of boxes and eliminating the overall bottleneck in production lines. The QuickTamp® handles random height variations of 1 meter (3'3") and conveyor speeds up to 80m/min (260 fpm). With our built-in Co-Op function, double or triple the capacity without changing your own software system.



Handles various product heights



Long reach with small labels

### QuickTamp® Vac

QuickTamp® Vac handles small labels reliably down to 20x20 mm (0.79"x0.79"), thanks to the vacuum in the pad during the application cycle.

Our optional height sensor makes handling height variations effortless (valid for all QuickTamp® models).



# NEW QuickTamp® Airless

Fully Electric  
Print & Apply  
Solution

**Fully electric Print & Apply solution that delivers high speed and exceptional reliability.**

Evolabel QuickTamp® Airless is designed with sustainability in mind, eliminating the need for compressed air. It is ideal for high-throughput applications such as logistics centers, warehouses, and e-commerce operations, as well as any installation where compressed air is unavailable.

This new solution features a retrofittable design, allowing you to reuse an existing Evolabel QuickTamp® Applicator for new applications.



# Rotary Applicators

Our Rotary Applicators apply labels with a rotary motion, perfect for multiple label applications, uneven surfaces, and diverse needs. Customize with various stroke lengths and properties to meet your specific requirements.

## Wipe90 & Wipe

**One module – multiple choices with variable reach.**

Flexible, fast and safe stepper motor driven applicator for front, side, rear, top, corner wrap, adjacent sides, and two-sided label applications.

The light 3D printed arm gives fast and precise labeling without sacrificing safety. The unique tactile arm detects not only the product for perfect label application, but also obstacles in its way – which enhances both safety and reliability. This enables fast and precise labeling, even on very light products. The Wipe system’s rotating movement is aligned with the print direction, allowing long labels, over 300 mm (12”), to be applied smoothly onto the product.

The Wipe90 system features a fast, rotating movement positioned 90 degrees to the print direction, making it ideal for applying wide, short labels with high speed and accuracy.



Corner wrap labeling

Labeling on 2 adjacent sides



# Applicator Pads

Explore our wide range of Applicator Pads seamlessly integrated into our flexible Modular System.

Our innovative Applicator Pads leverage 3D printing technology in plastic, offering a compact and lightweight design. Their user-friendly design ensures easy replacement and is available for a wide range of label sizes. While our standard range covers most label sizes, our 3D printing capability allows us to create pads tailored to your specific requirements, such as one pad for multiple label sizes.



Contact us if  
you want to  
know more!

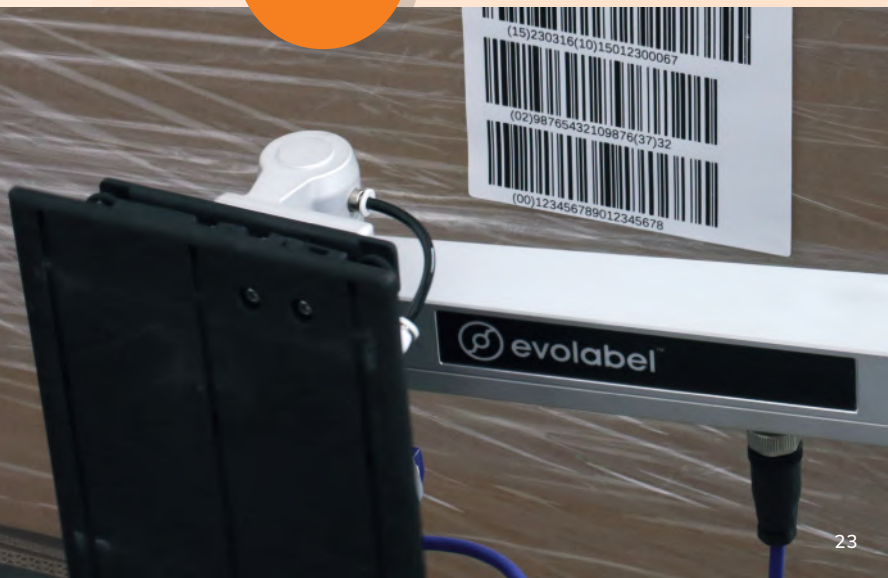



# NEW SoftPads

Evolabel Applicator Pads, **SoftPads**, enhance precision on uneven surfaces and effectively manage packages or products of different materials or shapes.

The exceptional flexibility of SoftPads is ideal for challenging applications, including **curved surfaces** like drain-pipes, shrink wrapped products, beer kegs or pooling systems crates for the food industry. The SoftPads apply with perfect precision **on concave and convex surfaces**.

Evolabel SoftPads stand out due to their unique design and functionality, delivering unparalleled precision, flexibility, and efficiency in Print & Apply applications. Their capability to handle various package types within the same workflow makes them a valuable tool for industries seeking advanced labeling solutions.

**Available** as an option for Evolabel's existing Print & Apply products; **eTamp, QuickTamp® Vac and Wipe**



### Mounting Parts

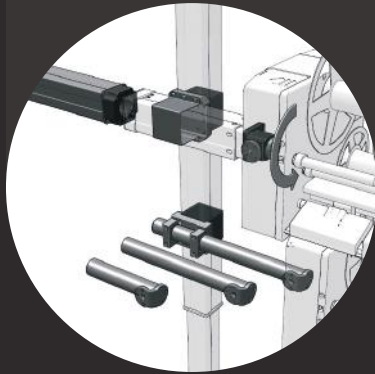

### Sensors, Scanners and Relay Box



# Our Accessories

Optimize your operational efficiency with our anodized aluminum stands, providing flexibility in floor-mounting or mobile stand placement, complete with optional motorized height adjustment. The intuitive touch screen interface empowers operators to effortlessly change products and settings, while

the Status Beacon allows convenient monitoring of machine status from a distance.

Discover all the vital components for a complete Print & Apply solution, including various barcode options for accurate validation of 1 or 2D codes.



### Printer Accessories



### User Interface

# Our Partners



Our mission is to remain focused on innovation while our trusted Partners handle service and support. Professional, skilled Partners provide local service and expertise. Our professional Partners are found on every continent and our network continues to grow, ensuring worldwide coverage.





Developed,  
designed and  
manufactured  
in Sweden

# Join the EVOLUTION

Distributed and supported by:



[www.codeitworldwide.com](http://www.codeitworldwide.com)

**Norway**

(+47) 22 107 380

[post@codeit.no](mailto:post@codeit.no)

**Sweden**

(+46) 31 351 99 50

[info@codeitab.se](mailto:info@codeitab.se)



Simplicity through technology

Evolabel AB | Johannefredsgatan 9 | SE-431 53 Mölndal, Sweden

[info@evolabel.com](mailto:info@evolabel.com) | +46 (0) 31-38 156 00

[www.evolabel.com](http://www.evolabel.com)