

2023/2024 PRODUCT RANGE



£ LOW PRICES

FAST 
UK DELIVERY

HUGE
RANGE FROM STOCK

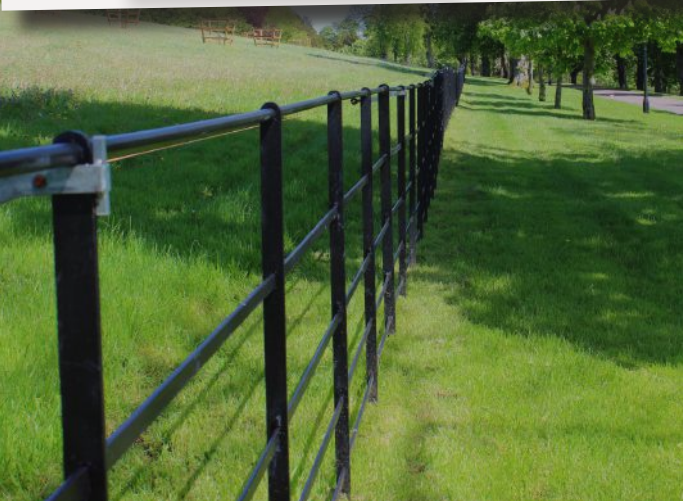

- Access Ladders
- Armco Barrier
- Bollards & Guards
- Gates & Springs
- GRP Flooring
- Handrail Systems
- Key Clamp
- Kickplate & Toeboard
- Step Overs
- Steel Flooring
- Steel Tube & Bars
- Working at Height
- And More...

DEAR CUSTOMER

Welcome to our latest product brochure!

This last year we've been working hard behind the scenes to bring you exciting new products as well as working towards UKAS accreditations in ISO 9001 and ISO 14001. This ensures our products are top quality & at leading UK prices.



We service customers from independent roofing contractors through to fencing contractors and large organisations such as Network Rail, Port Authorities, Highways agencies and much more.

With over 20 years of experience within our industry, we can offer our expertise and assist with your requirements.

We ship all over the UK with next day deliveries available. All despatches are made from our 52,000 sq. ft warehouse and manufacturing base in Eastbourne, East Sussex. Collections from our distribution centre can be made by prior appointment only, which will ensure quick and seamless loading/despatching of materials.

As well as offering our large range of stock products, we are able to offer other services such as quotations based on layout drawings, cutting services and bespoke metalwork items to your design.

We hope you find our product range and services of use and we look forward to your next order with us.

Best wishes,
from all of us at Lockinex UK Ltd.



TRADING HOURS:

Monday:	8:00am-5:00pm	Friday:	8:00am-5:00pm
Tuesday:	8:00am-5:00pm	Saturday:	Closed
Wednesday:	8:00am-5:00pm	Sunday:	Closed
Thursday:	8:00am-5:00pm		



Shop Online With Us!

Leading UK Prices at Competitive Rates!

- 24/7 Online Quotes
- Technical Information
- Blog Posts & Video Guides
- Next Day Delivery



www.lockinex-store.com

How To Find Us:

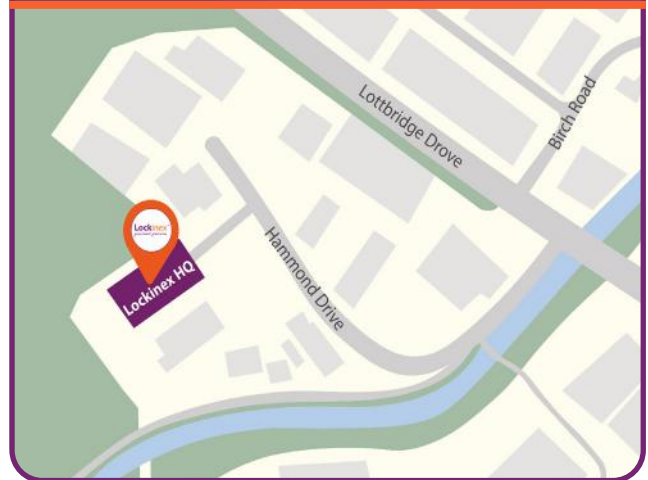

Lockinex Works, Hammonds Drive, Eastbourne,
East Sussex, BN23 6PW



CONTENTS

- **Our Services.....page 04**
 - Powder Coating
 - GRP Cutting and Punching
 - Tube Cutting
 - Bespoke Pre Assembled Posts
 - Quotes from Drawings
- **New Products.....page 05-11**
 - Estate Fencing.....page 05
 - Key Clamp Kits.....page 06-07
 - Composite Decking.....page 08,10
 - Composite Fencing.....page 09-10
 - Scaffold Fittings.....page 11
- **Access Ladders.....page 12-15**
 - Galvanised Ladders.....page 12
 - Stainless Steel Ladders.....page 12
 - Aluminium Ladders.....page 13
 - Ladder Components.....page 14-15
- **Armco Crash Barrier.....page 16-19**
 - Barrier Beams.....page 16
 - Posts & Attachments.....page 17
 - Ends & Corners.....page 18
 - Components & Fixings.....page 19
- **Bollards & Guards.....page 20-22**
 - Bollards/Posts.....page 20
 - Corner, Pipe & Column.....page 21
 - Guards
 - Speed Bumps & Safety.....page 22
 - Mirrors
- **Fixings, Fastenings,.....page 23-24**
Studs & Shims
- **Gate Systems.....page 25-29**
& Springs
 - Self Closing Safety Gates..page 25
 - Mezzanine Pallet Gates...page 26
 - Sliding Gate Kits.....page 27-29
- **GRP Flooring.....page 30-32**
 - Anti-Slip GRP Grating.....page 30-31
 - Fixing Clips.....page 31
 - GRP Flat Sheets.....page 32
- **GRP Pultruded Profiles.....page 33**
- **Handrail/Guardrail.....page 34-45**
Systems
 - Ball Standards.....page 34-35
 - DDA Handrail.....page 36-37
 - GRP Handrail.....page 38
 - Highway Pedestrian.....page 39
 - Guardrail
 - Stainless Steel Handrail.....page 40-41
 - Mesh Panels & Clips.....page 42-43
 - Handrail Tube &.....page 44-45
 - Connectors
- **Kickplates & Brackets.....page 46-47**
- **Key Clamp.....page 48-57**
 - Galvanised Steel.....page 48-55
 - Ready Made Posts Steel.....page 56
 - GRP.....page 57
 - Ready Made Posts GRP.....page 57
- **PPE Workwear.....page 58-59**
- **Roof Guardrail Systems.....page 60-65**
 - BS 13700:2021. Rubber.....page 60-61
 - Counter Weighted System
 - BS EN 13374:2013 Rubber....page 62-63
 - Counter Weighted System
 - Fixed System For Metal.....page 64
 - Clad Roofs
- **Equipment Support Feet.. page 65**
- **Steel Flooring & Stair.....page 66-69**
Treads
 - Open Steel Flooring.....page 66
 - Stair Treads.....page 67-68
 - Stair Nosings & Covers.....page 69
- **Step Over Platforms.....page 70-71**
- **Steel Sections.....page 72-73**
- **Welding Discs, Elbows.....page 74-77**
Plates & Caps
- **Customer Testimonials.....page 78-81**
& Case Studies
- **Index.....page 82-84**



OUR SERVICES

Our team is committed to supporting you. We supply a large range of products at leading UK prices and offer useful services so you can get the job done.

BESPOKE PRE-ASSEMBLED POST

We can cut and assemble any handrail post design you require utilising components from the Lockinex DDA handrail and Lockinex key clamp range. This ensures fast installation times on site and reduced labour costs.

CUTTING AND HOLE PUNCHING

We are able to offer cutting and shaping services for a number of our products in house. Want your GRP grating panels to be professionally cut to size and re-sealed before delivery? We can do that. Need your galvanised tube cut to certain lengths for quick install on site? We can do that too.

POWDER COATING

We offer high quality powder coating to your choice of colour and cutting of top and/or mid horizontal tubular rails to accommodate your requirements for quick install on site.

QUOTES FROM DRAWINGS

We can examine your drawings and provide you with a competitive quote based on the products we are able to provide for you to complete the project.

RAPID DELIVERY

We ship all over the UK with next day deliveries available and run our own fleet of delivery vehicles alongside renowned couriers. So you can rest assured that your order will be with you as soon as possible.

For more information [email](mailto:sales@lockinex.com) or [call us](tel:01323737626) to speak to a member of our sales team



sales@lockinex.com 01323 737 626



NEW PRODUCTS

We are excited to show you our new product range. These products have been carefully selected to suit our customers. If there is a product you would like us to stock, let us know by getting in touch via sales@lockinex.com.

ESTATE FENCING

Estate fencing offers a strong, stable and protective structure that can enhance the surrounding environment while also signifying boundaries of the land.

Our estate fencing is designed to be installed by either being driven into the ground or by being concreted in. This offers a variety of options of where to place the structure.

Lockinex estate fencing posts and rails come as natural steel that can be painted after installation or left to rust over time, giving it a rustic look.



Round Lower Rail Posts



ROUND

To accept 20mm round top rail & 4 x 16mm round lower rails

Length
2000mm

● EST-01

Flat Lower Rail Posts



FLAT

To accept 20mm round top rail & 4 x 25x8mm flat lower rails

Length
2000mm

● EST-03

25x8mm Flat Bar



Use as lower rails

Length
3000mm

● FB258-3

16mm Solid Round Bar



Use as lower rails

Length
3000mm

● SRB16-3

20mm Solid Round Bar

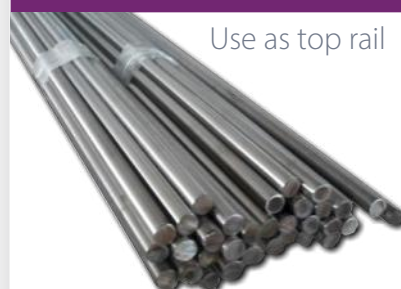

Use as top rail

Length
3000mm

● SRB20-3

NEW PRODUCTS

We are excited to show you our new product range. These products have been carefully selected to suit our customers. If there is a product you would like us to stock, let us know by getting in touch via sales@lockinex.com.

KEY CLAMP KITS:

FRUIT & VEG CAGE

Made with galvanised Lockinex key clamp fittings and galvanised steel tube this fruit cage comes with **heavy-duty bird netting** to protect fruits, vegetables, foliage and flowers from being damaged by birds.

Perfect for private or community allotments and gardens with a minimum **service life of 20 years** for the steel frame due to the galvanised finish to industrial British Standards.

Due to the kit design, the fruit cage is **easy to assemble** with only the need for an Allen key to secure and tighten grub screws, a hammer to secure foundation poles and a step stool to reach and place the netting.



● CAGE-5



Email or call us to speak
to our sales team:
sales@lockinex.com
01323 737 626



Visit our Youtube Channel to see a step by step video on how to put this together!

NEW PRODUCTS

We are excited to show you our new product range. These products have been carefully selected to suit our customers. If there is a product you would like us to stock, let us know by getting in touch via sales@lockinex.com.

PULL UP & DIP BAR:

Made out of Lockinex key clamp and galvanised steel tube. **Quick and easy** to assemble with only an Allen key needed to tighten grub screws.

With an **adjustable** dip bar that can swivel up to 45 degrees and alter the width between each bar. The Pull Up Bar itself can also be adjusted to **different heights** with the maximum height for the Pull-Up Bar being 2.1m.

The kit is suitable for a variety of different calisthenic exercises such as **Pull-ups, Dips, Chin-ups, Sit ups and much more.**

As a freestanding structure, the weight limitation is 130kg.

However, the structure can also be **bolted down** into grass, concrete or other flooring if preferred for even further **stability.**

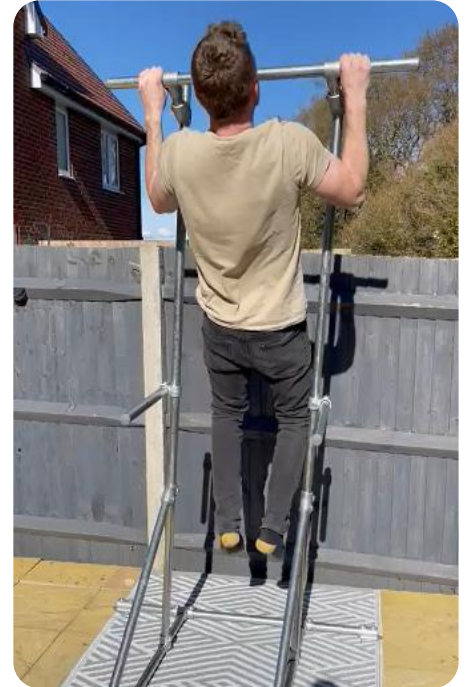

● GYM-01



Visit our Youtube Channel to see a step by step video on how to put this together!

NEW PRODUCTS

We are excited to show you our new product range. These products have been carefully selected to suit our customers. If there is a product you would like us to stock, let us know by getting in touch via sales@lockinex.com.

COMPOSITE DECKING

Lockinex composite decking range is all made from **100% recycled** woods and plastics.

Composite products offer a **longer-lasting, lower maintenance** alternative to conventional timber structures and offer a modern look in various colours.

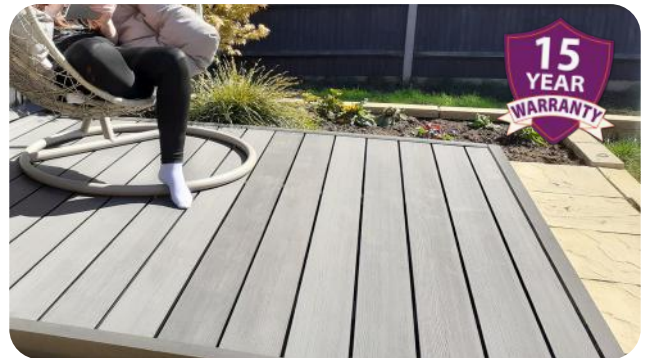

Composite offers **high levels of UV resistance** which minimises the fading/colour change that occurs over time. **Moisture resistance, low expansion/shrinkage** in hot and cold climates (operational temperatures of -40°C to 60°C), **termite resistance, corrosion resistance, distortion resistance & impact resistance**.

Lockinex composite decking boards offer a **wood effect** on one side and a **grooved effect** on the other, allowing a choice of surface style.

All composite products have an expected **minimum life span of 15 years** with **minimal maintenance** required.

Charcoal Decking



• WPC-DECK-02

Light Ash Decking



• WPC-DECK-03

Coffee Brown Decking



• WPC-DECK-01

Charcoal Decking Joist



• WPC-JOIST-01

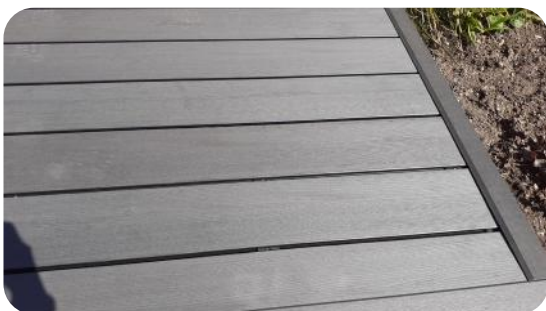

Visit our Youtube Channel to see a demonstration video on how to put this together!

NEW PRODUCTS

We are excited to show you our new product range. These products have been carefully selected to suit our customers. If there is a product you would like us to stock, let us know by getting in touch via sales@lockinex.com.

COMPOSITE FENCING

Lockinex composite fencing range is all made from **100% recycled** woods and plastics.

Composite products offer a **longer-lasting, lower maintenance** alternative to conventional timber structures and offer a modern look in various colours.

Composite offers **high levels of UV resistance** which minimises the fading/colour change that occurs over time. **Moisture resistance, low expansion/shrinkage** in hot and cold climates (operational temperatures of -40°C to 60°C), **termite resistance, corrosion resistance, distortion resistance & impact resistance**.

Lockinex composite fencing boards have a contemporary brushed/sanded surface finish to offer a neutral, yet eye-catching finished structure. Fencing posts have **pre-cut channels** ready to slot panels in place, resulting in an easy installation process. All composite products have an expected **minimum life span of 15 years** with **minimal maintenance** required.



Charcoal Fence Panels

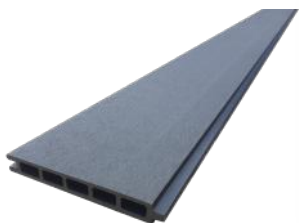

• WPC-FENCEPANEL-02

Light Ash Fence Panels

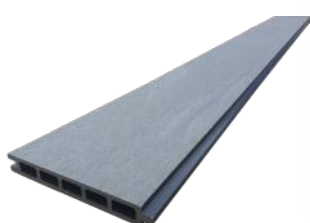

• WPC-FENCEPANEL-03

Coffee Brown Fence Panels



• WPC-FENCEPANEL-01

Charcoal Fence Post



• WPC-FENCEPOST-02

Light Ash Fence Post



• WPC-FENCEPOST-03

Coffee Brown Fence Post



• WPC-FENCEPOST-01

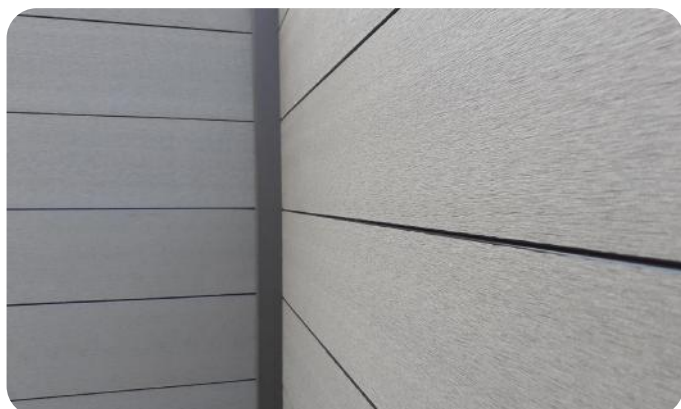

Visit our Youtube Channel to see a demonstration video on how to put this together!

NEW PRODUCTS

We are excited to show you our new product range. These products have been carefully selected to suit our customers. If there is a product you would like us to stock, let us know by getting in touch via sales@lockinex.com.

COMPOSITE FIXINGS & ACCESSORIES



Fencing Cap



• WPC-POSTCAP

Charcoal Fascia Board



• WPC-SKIRTRIM-02

Light Ash Fascia Board



• WPC-SKIRTRIM-03

Coffee Brown Fascia Board



• WPC-SKIRTRIM-01

Charcoal Corner Capping



• WPC-CORNERTRIM-02

Light Ash Corner Capping



• WPC-CORNERTRIM-03

Coffee Brown Corner Capping



• WPC-CORNERTRIM-01



Lockinex Charcoal Decking installed with Charcoal Corner Capping

Decking Clips
Bag of 100



• WPC-CLIP-01

Starter Clips
Bag of 100



• WPC-CLIP-02

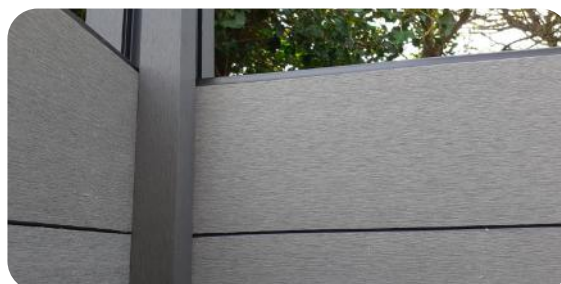

Email or call us to speak to our sales team:
sales@lockinex.com
01323 737 626

NEW PRODUCTS

We are excited to show you our new product range. These products have been carefully selected to suit our customers. If there is a product you would like us to stock, let us know by getting in touch via sales@lockinex.com.

SCAFFOLD FITTINGS

All of our scaffold fittings are manufactured to EN74-1 and galvanised for corrosion resistance.

Our fittings are to suit 48.3mm scaffold tube.

Swivel fittings rotate a full 360 degrees to accommodate any required angle.



External Sleeve Scaffold Fitting



• SCAFF-05

Swivel Angle Scaffold Fitting



Angle
360 Degrees

• SCAFF-03

Fixed 90 Degree Scaffold Fitting



• SCAFF-01

Scaffold Board



Length
13ft

• SCAFF-BOARD



Email or call us to speak
to our sales team:
sales@lockinex.com
01323 737 626

ACCESS LADDER KITS

Lockinex Access Ladders are manufactured and distributed in "Kit" form. Comprising of all the necessary components to construct an Access Ladder, safely, quickly and economically. Individual components are available in Mild Steel Galvanised.

GALVANISED STEEL LADDER KITS

Designed and manufactured by Lockinex to **BS 4211:2005** for permanently fixed ladders, our Galvanised Access Ladder range offers the solution you may require to safe access at height.

All kits & components are galvanised to **BS EN ISO 1461:2009** for corrosion resistance and long service life.



Climb Height (mm)

Code

1885/2635

GLS - 2500

2635/3135

GLS - 3000

3135/3885

GLS - 3500

3885/4385

GLS - 4000

4385/5135

GLS - 4500

5135/5635

GLS - 5500

5635/6385

GLS - 6000

Climb Height (mm)

Code

6385/6885

GLS - 6500

6885/7635

GLS - 7000

7635/8135

GLS - 8000

8135/8885

GLS - 8500

8885/9385

GLS - 9000

9385/10135

GLS - 9500

STAINLESS STEEL LADDER KITS

Our stainless steel Access Ladder kits are designed and manufactured by Lockinex to **BS 4211:2005** & **A1:2008** for permanently fixed ladders. The stainless steel is manufactured in a mill finish to **316 grade** standard. It offers the solution you may require to safe access at height.



Climb Height (mm)

Code

2000/2300

SLS - 2000

2400/2700

SLS - 2500

2800/3200

SLS - 3000

3300/3800

SLS - 3500

Climb Height (mm)

Code

3900/4300

SLS - 2000

4400/5200

SLS - 2500

5300/6000

SLS - 3000

ACCESS LADDER KITS

Lockinex Access Ladders are manufactured and distributed in "Kit" form. Comprising of all the necessary components to construct an Access Ladder, safely, quickly and economically. Individual components are available in Mild Steel Galvanised.



ALUMINIUM ACCESS LADDERS

Our aluminium Access Ladder kits are designed and manufactured by Lockinex to BS 4211:2005 & A1:2008 for permanently fixed ladders. The aluminium alloy is manufactured in a mill finish and may offer the solution you require to safe access at height.

Climb Height (mm)	Code
2000/2300	ALS - 2000
2400/2700	ALS - 2500
2800/3200	ALS - 3000
3300/3800	ALS - 3500
3900/4300	ALS - 4000
4400/5200	ALS - 4500
5300/6000	ALS - 5500



Our Aluminium Access Ladders, can also be manufactured to order. Please send us floor to floor dimensions for a competitive quote.



Email or call us to speak to our sales team:
sales@lockinex.com
01323 737 626

MAINTENANCE AND ASSEMBLY

All of our ladder kits have a minimum service life of 25 years due to the hot dip galvanising process. All ladder kits come with assembly guidelines included for quick and easy installation on site, saving time and labour costs.



ACCESS LADDER COMPONENTS

Lockinex Access Ladders are manufactured and distributed in "Kit" form. Comprising of all the necessary components to construct an Access Ladder, safely, quickly and economically. Individual components are available in Mild Steel Galvanised.

GALVANISED STEEL LADDER COMPONENTS

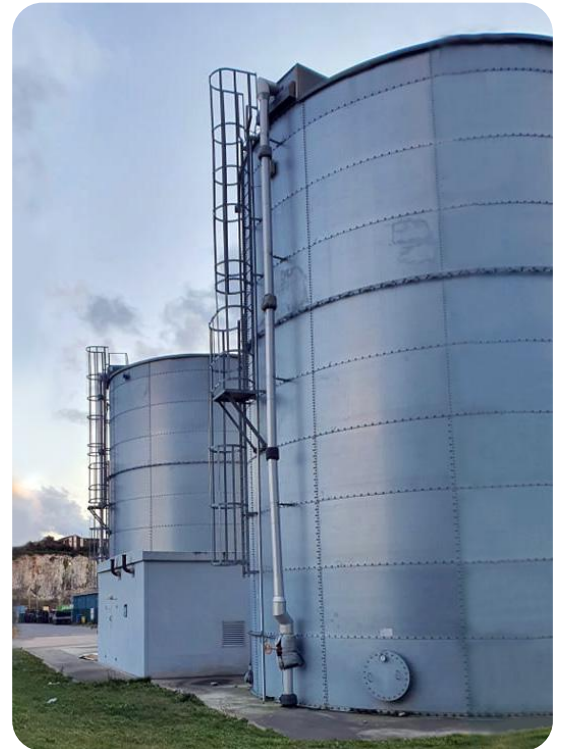
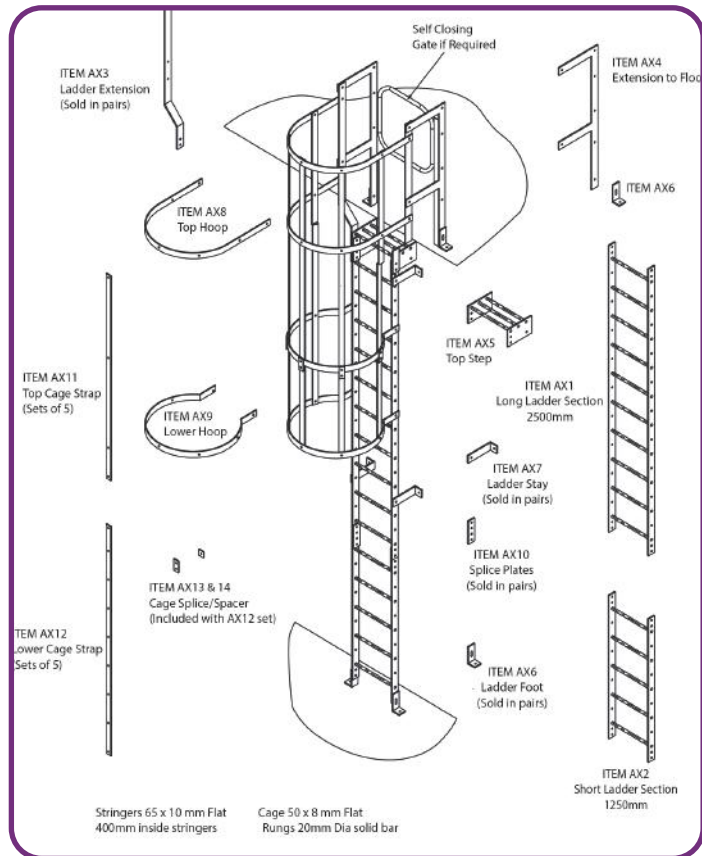

Lockinex ladder components installed at a storage facility.

All ladder components are designed and manufactured by Lockinex to BS:4211:2005 for permanently fixed ladders & galvanised to BS EN ISO 1461:2009 for corrosion resistance and long service life.

½ Height Self Closing Ladder Gate

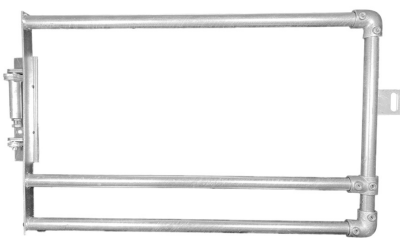

● GLS-HALFGATE

Full Height Self Closing Ladder Gate



● GLS-FULLGATE

Climb Restriction Door



● GLS-CLIMBREstriction

For more info on our Self Closing Gate Kits see [page 25](#)

ACCESS LADDER COMPONENTS

Lockinex Access Ladders are manufactured and distributed in "Kit" form. Comprising of all the necessary components to construct an Access Ladder, safely, quickly and economically. Individual components are available in Mild Steel Galvanised.

Ladder Sections



Length
1250 mm 2500mm

- GLS-AX2
- GLS-AX1

Extended Stringer

PAIR

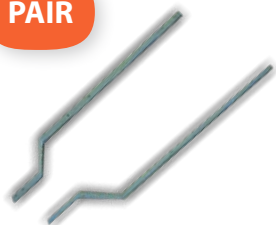

- GLS-AX3

Platform F Rails

PAIR

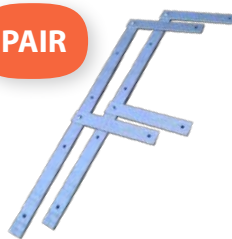

- GLS-AX4

Ladder Top Step



- GLS-AX5

Ladder Feet

PAIR



- GLS-AX6

Ladder Stays

PAIR



Length
272 mm

- GLS-AX7

Top Ladder Hoops



- GLS-AX8-GALV
- GLS-AX8-SELF COLOUR

Lower Ladder Hoops



- GLS-AX9-GALV
- GLS-AX9-SELF COLOUR

Joint Plates

PAIR



- GLS-AX10

Upper Cage Straps

SET OF 5



- GLS-AX11

Lower Cage Straps

SET OF 5



- GLS-AX12

Domed Connection Bolts



- M12X35
- M12X50

Ladder Rung Non Slip Cover



Length
2000 mm

- GRIPATEX-RUNGCOVER



Lockinex ladder components installed with Lockinex free standing roof guardrail for fall protection.



Email or call us to speak to our sales team:
sales@lockinex.com
01323 737 626

See page 60-65 for Roof Guardrail

ARMCO CRASH BARRIER BEAMS

Armco crash barrier is ideal for off highway applications such as traffic segregation, protection of pedestrians & protection of buildings/assets from moving and commercial vehicles.

ARMCO BARRIER BEAMS

Our range of Armco safety barrier beams are all suitable for heavy-duty applications. Various lengths are available and all beams are galvanised to **BS EN ISO 1461:2009** which ensures corrosion resistance and long service life.

2 PEAK ARMCO BEAM



Length (m)	Coverage	Thickness (mm)	Code
3.5	3.2	3	VC01
3.5	3.2	2	VC500-LITE
1.8	1.5	3	VC02
1.0	0.7	3	VC03

2 PEAK RADIUS ARMCO BEAM

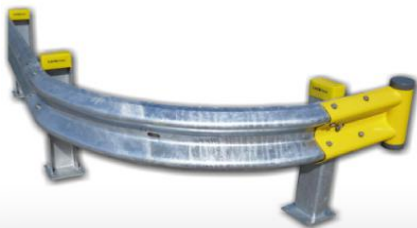

Radius	Angle	Code
2320	90	VB-RAD-2320

Our Radius Armco Barrier Beams can also be manufactured to customised measurements. Contact us for more information.



Email or call us to speak to our sales team:
sales@lockinex.com
 01323 737 626



3 PEAK ARMCO BEAM



Length (m)	Coverage	Thickness (mm)	Code
1.8	1.5	3	VC05

We are one of the only suppliers in the UK!

3-2 PEAK ARMCO BEAM

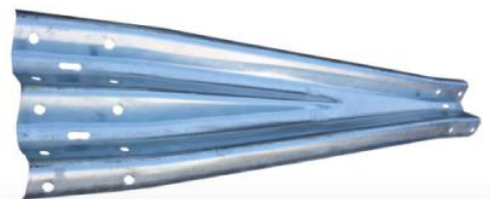

Length (m)	Coverage	Thickness (mm)	Code
2.3	2.0	3	VC30



ARMCO CRASH BARRIER POSTS

Armco crash barrier is ideal for off highway applications such as traffic segregation, protection of pedestrians & protection of buildings/assets from moving and commercial vehicles.

ARMCO POSTS & ATTACHMENTS

A range of RSJ, U channel and bump type posts with bolt down and concrete in options are available along with hi-vis post caps. Various posts are available from stock in hi-vis powder-coated yellow.

All posts galvanised to **BS EN ISO 1461:2009** for corrosion resistance and long service life.

All handrail attachments are galvanised to **BS EN ISO 1461:2009** for corrosion resistance and long service life.

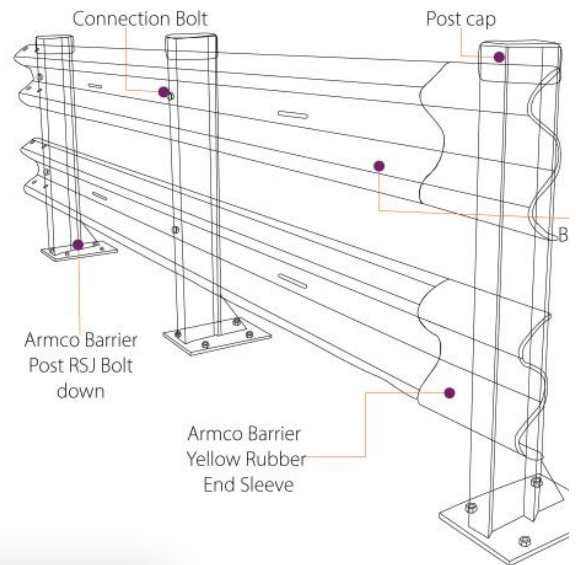

Armco Crash Barrier

RSJ Bolt Down Post



Height
610mm 760mm 1100mm

• VB09 • VB10 • VB12

RSJ Concrete In Post



Length
1.2m 2.0m

• VB11 • VB13

C Shape Bolt Down Post



Height
610mm 760mm

• VB20 • VB21

C Shape Concrete In Post



Length
1.2m

• VB22

Floor Bump Post



• VB70

Wall Bump Post



• VB72

Rolled Handrail



• DDA-RolledEnd

Handrail Ball Post



• VB77

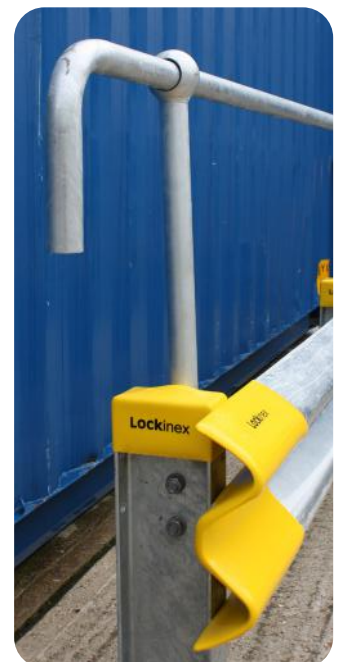

ARMCO CRASH BARRIER ENDS & CORNERS

Armco crash barrier is ideal for off highway applications such as traffic segregation, protection of pedestrians & protection of buildings/assets from moving and commercial vehicles.

ARMCO END TERMINALS AND CORNERS

A range of internal and external corners along with Armco end terminals and connection bolts. Various corners and end terminals are available from stock with a powder-coated yellow finish. Alternatively, we also offer polymer ends with high visibility reflectors integrated into their surface.

All galvanised corners and end terminals are galvanised to [BS EN ISO 1461:2009](#) for corrosion resistance and long service life.



Fish Tail End



• VB06

3 Peak Fish Tail End



• VB40

Pedestrian Friendly End



• VB15

Flexible Corner



• VB04-FLEXY

Internal/External Corners



Internal

External

• VB04-INT • VB04-EXT

3 Peak Internal/External Corners



Internal

External

• VB44-INT • VB44-EXT

Polymer Ends



• VB109Y

• VB101Y

Hi Vis Rubber Sleeve



Length

300mm

125mm

• VB08

• VB08 BUDGET

Polymer Wing End



• VB105Y



Lockinex Armco beams, posts, flexy corner & polymer pedestrian friendly ends.

ARMCO CRASH BARRIER COMPONENTS

Armco crash barrier is ideal for off highway applications such as traffic segregation, protection of pedestrians & protection of buildings/assets from moving and commercial vehicles.

ARMCO COMPONENTS & FIXINGS

Bolt On Reflectors



Red & White

• VB90

Armco Post Cap



• VB28

Pedestrian Friendly End Cap



• VB31

Tube Plug



42.4mm
Grey Black

• A68-7Grey • A68-7BLACK

Connection Bolt



M16x35mm M16x50mm

• VB35 • VB50

Through Bolt M20x160mm



• F-M20x160

Threaded Stud M20x260mm



• F-M20x260Stud

Trouser Shims

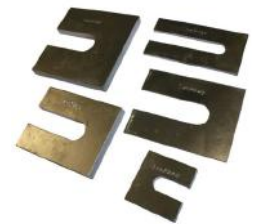

See page 24

OPEN BOX BEAM CRASH BARRIER

Open Box Beam Barrier



• VB01

Post Clip



• VB07

End Cap



• VB14A

Joint Plates



• VB03



We also supply Yellow powder coated posts, beams & ends as well as black adhesive banding.

Need a more bespoke product? We can provide a powder coating service to chosen RAL colours.



For more information [email](#) or [call us](#) to speak to a member of our sales team



BOLLARDS & GUARDS

Protecting Building Curtilage, Assets & Personnel the Lockinex range of Bollards & Guards are used throughout industry and the public sector. Assisting in guiding vehicles and preventing damage to structures and plants.

PARKING/LOADING BOLLARDS

Lockinex bollards are robust, solid structures that limit vehicular access to an area such as loading bays preventing damages from heavy machinery such as forklifts, trucks or other vehicles. As well as marking boundaries and guiding vehicles by instructing them to certain sections within the area.

Our bollards come either in mild steel with a hot dip galvanised finish with options for powder coating and black adhesive banding or bendy plastic with high visibility reflective stripes for a budget friendly option.

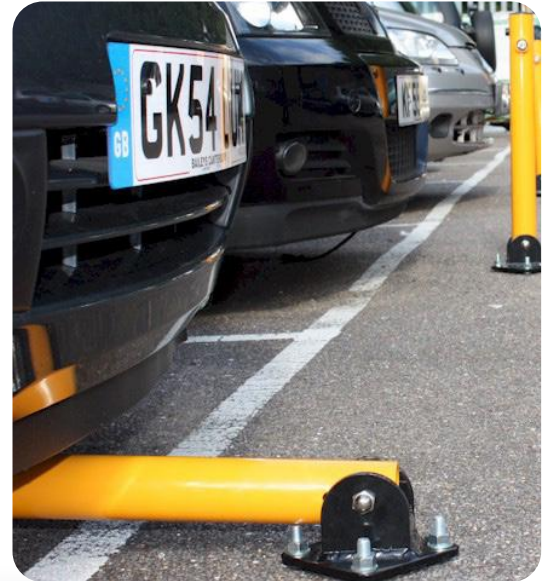

Plastic Bendy Reflective Bollard

Diameter (mm)
Length (m)

D 80mm	L 7.50m
--------	---------

• BOLLARD05

Bolt Down Bollard

Diameter (mm)
Length (m)

D 140mm	D 140mm
L 1.0m	L 2.0m

• BOLLARD06 • BOLLARD07

Concrete In Bollard

Diameter (mm)
Length (m)

D 140mm	D 140mm
L 1.5m	L 3.0m

• BOLLARD03 • BOLLARD04

Bolt Down Bollard Yellow/Black

Diameter (mm)
Length (m)

D 140mm	D 140mm
L 1.0m	L 2.0m

• BOLLARD08 • BOLLARD09

Concrete In Bollard Yellow/Black

Diameter (mm)
Length (m)

D 140mm	D 140mm
L 1.5m	L 3.0m

• BOLLARD11 • BOLLARD13

Bollard Cap

• VB29



See [page 23](#) for fixings to use with Lockinex bollards & more



Lockinex concrete in yellow powder coated bollard with rubber bollard cap

BOLLARDS & GUARDS

Protecting Building Curtilage, Assets & Personnel the Lockinex range of Bollards & Guards are used throughout industry and the public sector. Assisting in guiding vehicles and preventing damage to structures and plants.

CORNER, PIPE & COLUMN GUARDS

Our collection of guards for protecting cables, columns, water pipes and corners from impact by forklifts, cars, lorries and other vehicles.

All of our pipe and corner guards are made of mild steel with yellow powder coating for high visibility. Our corner guards also have the option to fix bolt on reflectors for enhanced visibility.

Column & Pole Guard



Height 800mm
Diameter 700mm

• CG-800H

Rubber Corner Guard



Height 1200mm
Height 800mm

• CG-02 • CG-03

Short Pipe/Cable Guard



Height 500mm

• DWG500-200-YELLOW



Lockinex short pipe guard in use

Tall Pipe/Cable Guard



Height 1000mm

• DWG1000-200-YELLOW

Hi-Vis Bolt Down Corner Guard



Height 800mm

• CG22-800H

Rubber Wheel Stop

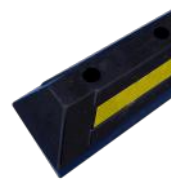

Height 105mm
Length 560mm

• WS-560

Bolt On Reflectors



Red & White

• VB90

Safety Guard/Barrier



Height 1000mm
Width 1250mm

• BARRIER-NO-14



Lockinex Rubber Wheel Stop with reflective strip in use



Lockinex Column Guard in use at a parking bay

SPEED BUMPS & SAFETY MIRRORS

A range of speed bumps and safety mirrors, ideal for use around indoor and outdoor work areas and car parks.

Speed Bumps & Safety Mirrors

UNBREAKABLE SAFETY MIRRORS

Mirrors assist with road safety and can help eliminate blind spots at corners, concealed entrances and exits, car parks and junctions. Lockinex mirrors are designed to be unbreakable for up to 3 years and come with all fixings and brackets. Our mirrors can either be installed on walls or on posts from 60mm to 90mm in diameter.

Circular Black & Yellow Mirror



Frame
750mm

Mirror
600mm

● MIRROR-586

Rectangular Black & Yellow Mirror



Frame
680x500mm

Mirror
600x400mm

● MIRROR-584

Rectangular White & Red Mirror



Frame
950x750mm

Mirror
800x600

● MIRROR-556



Lockinex unbreakable safety mirrors installed in multiple warehouses and facilities



Email or call us to speak to our sales team:
sales@lockinex.com
 01323 737 626

SPEED BUMPS

High-quality speed bumps for 5-10 mph speed range. Built-in cat eyes provide high visibility in the dark. 50mm height provides a safe yet noticeable "Bump".

Middle Section With Cat Eyes Black

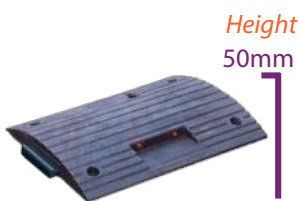

Height
50mm

Length
250mm

Width
400mm

● SH-01

Middle Section With Cat Eyes Yellow



Height
50mm

Length
250mm

Width
400mm

● SH-02

Pair of Speed Bump Ends

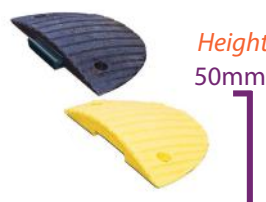

Height
50mm

Length
250mm

Width
400mm

● SH-04



FIXINGS, FASTENINGS, STUDS & SHIMS

Through-bolts & Studs for anchoring structural members to concrete. High Grade Connection bolts are used for joining steel work & connection of Guardrail posts to steel work. Many other items such as U Bolts & shims can be used in various applications.

FIXINGS, FASTENINGS, STUDS & SHIMS

Range of Fixings & Fastenings with galvanised finishes. Structural Grade connection bolts and Holding Down bolts are designed to provide proven structural joints and anchoring points.



THROUGH BOLT

Length (mm)	Model	Code
95	M10	F-M10X95TB
100	M12	F-M12X100TB
140	M16	F-M16X140TB
160	M20	F-M20X160TB

THREADED STUD

Length (mm)	Model	Code
160	M12	F-M12X160STUD
260	M20	F-M20X260STUD



TARMAC BOLT

Length (mm)	Model	Code
100	M12	F-M12TARMAC

CONNECTION BOLT

Length (mm)	Model	Code
35	M16	VB35
50	M16	VB50



CONNECTION BOLT

Length (mm)	Model	Code
35	M12	M12X35
50	M12	M12X50

LONG THREADED BOLT

Length (mm)	Model	Code
170	M10	M10X170



COACH SCREW

Model	Code
M10	F-M10-Coach-Screw

U-BOLT

Tube Dia. (mm)	Model	Code
42.4	M10	UBOLT-42.4
48.3	M10	UBOLT-48.3
60.3	M10	UBOLT-60.3



FIXINGS, FASTENINGS & SHIMS

Through-bolts & Studs for anchoring structural members to concrete. High Grade Connection bolts are used for joining steel work & connection of Guardrail posts to steel work. Many other items such as U Bolts & shims can be used in various applications.

TROUSER SHIMS

Hot Dip Galvanised shims for complete protection with no raw steel edges. Lockinex shims come in a variety of different sizes and thicknesses.

1MM THICKNESS

Slot	Length	Width	Code
14mm	50mm	50mm	TS-1145050
14mm	100mm	50mm	TS-11410050
22mm	100mm	75mm	TS-12210075
25mm	100mm	100mm	TS-125100100

3MM THICKNESS

Slot	Length	Width	Code
14mm	50mm	50mm	TS-3145050
14mm	100mm	50mm	TS-31410050
22mm	100mm	75mm	TS-3220075
25mm	100mm	100mm	TS-325100100

5MM THICKNESS

Slot	Length	Width	Code
14mm	50mm	50mm	TS-5145050
14mm	100mm	50mm	TS-51410050
22mm	100mm	75mm	TS-52210075
25mm	100mm	100mm	TS-525100100

10MM THICKNESS

Slot	Length	Width	Code
14mm	50mm	50mm	TS-10145050
14mm	100mm	50mm	TS-101410050
22mm	100mm	75mm	TS-102210075
25mm	100mm	100mm	TS-1025100100

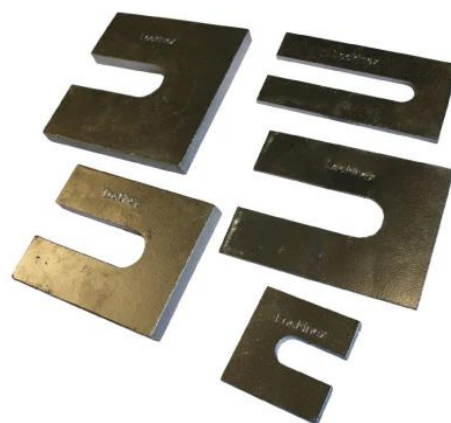

SELF CLOSING SAFETY GATES

Lockinex range of half-height & full height self-closing gates. All gates are galvanised to BS EN 1461:2009 for corrosion resistance and long service life. Individual gate spring sets are also available from stock in a range of styles and finishes for the fabricator/engineer to use in their own projects.

SELF CLOSING SAFETY GATE KIT

Lockinex safety gates are self closing and comply with **BS EN ISO 14122-3:2016**. They come in kit form for quick and easy assembly.

The gate can swing through 180 degrees in either direction due to the included **tension spring** that can swing in either a clockwise or anti-clockwise direction and hung either for left or right handed.

Gate frames may be easily cut down to suit the required opening but are provided from stock to suit 1200mm openings.

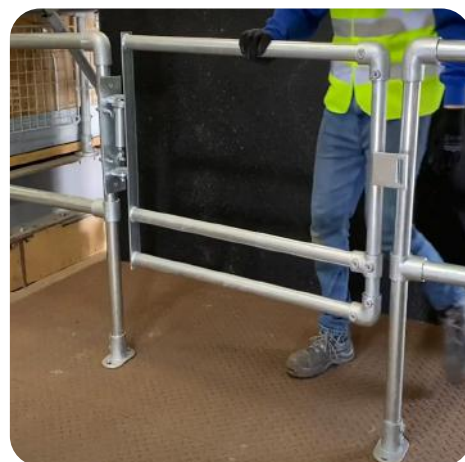

Half Height Gate Kit



Width
1200mm

• GATE-21

Full Height Gate Kit



Width
1200mm

• GATE-23

Roof Edge Guardrail Self Closing Gate Kit



Width
700mm

• FSR-GATE-KIT

Roof Edge Guardrail Self Closing Gate Kit



Width
700mm

• NFSR-GATE-KIT

GATE SPRINGS & LATCHES

Open Spring & Lower Hinge



Self Colour Galvanised

• GLS-GATE SPRINGBLACK • GLS-GATE SPRING

Enclosed Spring & Lower Hinge



Flat lugs (weld to flat section) Curved lugs (weld to tube)

• GS01 • GS02

Gate Latch & Striking Pin



Comes as a set

• GL-01

Gate Latch Fixing Bracket



Two required per latch

• GL36



MEZZANINE PALLET GATES

Pallet gate kits designed by lockinex for safe access for workers when loading and unloading pallets. Application includes factories, workshops and warehouses. Lockinex pallet gates come in three sizes small, medium and large.

PALLET GATES

Supplied in kit form ready for quick assembly. Pallet gates consist of Lockinex galvanised key clamps, 48.3mm diameter galvanised tube and galvanised kickplate. The cantilevered design makes gates easily operable by one person. All gate designs comply with [BS EN 14122-3](#) loadings and requirements.

Kits are supplied with components ready to assemble and install. The horizontal rails etc. can simply be cut down on-site to create desired dimensions if needed.

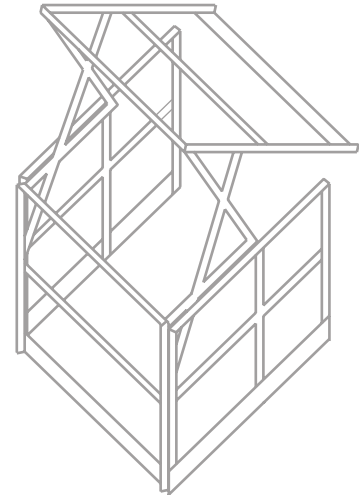

Small Pallet Gate



Height (mm)	Width (mm)	Depth (mm)
1800	1500	1500

• MEZ-1

Medium Pallet Gate



Height (mm)	Width (mm)	Depth (mm)
1800	2000	1500

• MEZ-3

Large Pallet Gate



Height (mm)	Width (mm)	Depth (mm)
1800	3000	1500

• MEZ-5



See [page 42](#)
Integrate our custom mesh infill panels and clips to create a more protective structure.



Powder coating to a choice of RAL colour is also available.

For more information [email](#) or [call us](#) to speak to a member of our sales team



SLIDING CANTILEVERED GATES

Sliding gates can be installed on private and commercial property to enhance security and property value. Lockinex offer a range of high quality kits and components.

SLIDING GATE KITS

Lockinex sliding gates come as a kit form composed of channels, double bearings wheels, an end stop and wheel gate end guides. The kit comes in three difference sizes differentiating by weight. Our double bearing wheel system produces minimal noise and results in a smoother, quieter operation.

500kg Sliding Gate Kit



- [Sliding-Gate-Kit-500kg](#)

2 x Sets of 8 Wheeled Carriers
2 x 3mtr Lengths of Channel
1 x Gate end Stop
1 x Gate end guide wheel
16 x Levelling Shims.
4 x M16x190mm studs, nuts and washers

1000kg Sliding Gate Kit



- [Sliding-Gate-Kit-1000kg](#)

2 x Sets of 8 Wheeled Carriers
2 x 3mtr Lengths of Channel
1 x Gate end Stop
1 x Gate end guide wheel
16 x Levelling Shims.
12 x M16x190mm studs, nuts and washers

1500kg Sliding Gate Kit



- [Sliding-Gate-Kit-1500kg](#)

2 x Sets of 8 Wheeled Carriers
2 x 3mtr Lengths of Channel
1 x Gate end Stop
1 x Gate end guide wheel
4 x Suitable Resin Studs
16 x Packing Shims.
12 x M16x190mm studs, nuts and washers



SLIDING GATE COMPONENTS

Sliding gates can be installed on private and commercial property to enhance security and property value. Lockinex offer a range of high quality kits and components.



FOR UP TO 500KG GATES

Wheel Channel



Length
3m

• SLGHW 07

8 Wheel Carrier



Wheel Diameter
50mm

• SLGHW 13

Channel End Wheel



• SLGHW 20

Gate Stop



• SLGHW 26

FOR UP TO 1000KG GATES

Wheel Channel



Length
3m

• SLGHW 09

8 Wheel Carrier



Wheel Diameter
70mm

• SLGHW 15

Wheel Channel



Length
3m

• SLGHW 11

8 Wheel Carrier



Wheel Diameter
110mm

• SLGHW 17

Channel End Wheel



• SLGHW 22

Gate Stop



• SLGHW 28

Channel End Wheel



• SLGHW 24

Gate Stop



• SLGHW 30

SLIDING GATE HARDWARE

Sliding gates can be installed on private and commercial property to enhance security and property value. Lockinex offer a range of high quality kits and components.

WHEELS

All of the wheels shown are fitted with double bearings, producing a stable and free running wheel. All wheels are for use with Lockinex tracks, having a 20mm (Nominal) Running rail.

Wheel & Bracket



Wheel Diameter
100mm 120mm

- SLGHW 40
- SLGHW 42

Wheel & Cage



Wheel Diameter
100mm 120mm

- SLGHW 50
- SLGHW 52

Wheel



Wheel Diameter mm
100mm 120mm

- SLGHW 60
- SLGHW 62

DRIVE TRACKS

Fixings For Welding/Bolting



500KG
2m Length

- SLGHW 70

Fixings For Welding/Bolting



1000KG
2m Length

- SLGHW 72

Fixings For Welding/Bolting



1500KG
2m Length

- SLGHW 74

RUNNING RAILS

Floor Track Fixed



Length
3m

- SLGHW 01

Concrete In Floor Track



Wheel Diameter
50mm

- SLGHW 03



Email or call us to speak
to our sales team:
sales@lockinex.com
01323 737 626



ANTI SLIP GRP GRATING

Lockinex GRP gratings are used to construct suitable non-slip flooring in areas such as risers, roof walkways, platforms and much more. Offering higher levels of corrosion resistance over steel products they are suited to high corrosion environments. The non-conductive properties of GRP also mean they are commonly used in the rail and electrical power industries.

GRP GRATING

All of Lockinex GRP Gratings are tested and comply with **BS 4592-0:2006** loadings as well as falling into the highest non slip rating specified with a **coefficient of friction greater than 0.6**. Our gratings come in either green, yellow or grey colour and a variety of different sizes and apertures to suit requirements.



GREEN

Thickness (mm)	Sheet Size (mtr)	Aperture (mm)	Code
25	2.4x1	32x32	GRP-05
25	3.66x1	32x32	GRP-25
38	2.4x1	32x32	GRP-13
38	3.66x1	32x32	GRP-31
38	3.66x1.22	32x32	GRP-30
38	2.4x1	12.7x12.7	GRP-51
38	3.66x1	12.7x12.7	GRP-53
38	2.4x1	SOLID TOP	GRP-47
38	3.66x1	SOLID TOP	GRP-49
50	2.4x1	42x42	GRP-21
50	3.66x1.22	42x42	GRP-17
50	2.4x1.22	42x42	GRP-65

GREY

Thickness (mm)	Sheet Size (mtr)	Aperture (mm)	Code
25	2.4x1	32x32	GRP-07
25	3.66x1	32x32	GRP-29
38	2.4x1	32x32	GRP-15
38	3.66x1	32x32	GRP-35
38	3.66x1.22	32x32	GRP-36
38	2.4x1	12.7x12.7	GRP-59
38	3.66x1	12.7x12.7	GRP-61
38	2.4x1	SOLID TOP	GRP-55
38	3.66x1	SOLID TOP	GRP-57
50	2.4x1.22	32x32	GRP-37
50	2.4x1	42x42	GRP-23
50	3.66x1.22	42x42	GRP-19
50	2.4x1.22	42x42	GRP-67

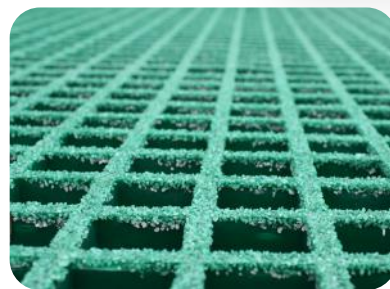
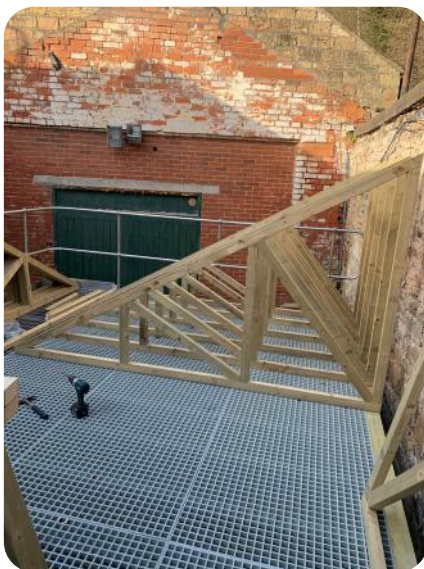

NEED A MORE BESPOKE PRODUCT?



Email or call us to speak to our sales team:
sales@lockinex.com
 01323 737 626

We also offer a GRP Cutting and Sealing service. This can help to save time and money when installing on site.

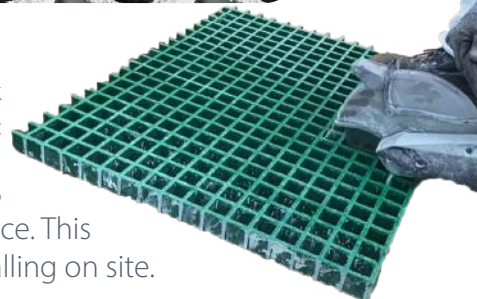

ANTI SLIP GRP GRATING

Lockinex GRP gratings are used to construct suitable non-slip flooring in areas such as risers, roof walkways, platforms and much more. Offering higher levels of corrosion resistance over steel products they are suited to high corrosion environments. The non-conductive properties of GRP also mean they are commonly used in the rail and electrical power industries.

YELLOW

Thickness (mm)	Sheet Size (mtr)	Aperture (mm)	Code
25	2.4x1.22	32x32	GRP-06
25	3.66x1	32x32	GRP-27
38	2.4x1.22	32x32	GRP-32
38	3.66x1	32x32	GRP-33
38	3.66x1.22	32x32	GRP-63
38	2.4x1	12.7x12.7	GRP-43
38	3.66x1	12.7x12.7	GRP-45
38	2.4x1	SOLID TOP	GRP-39
38	3.66x1	SOLID TOP	GRP-41

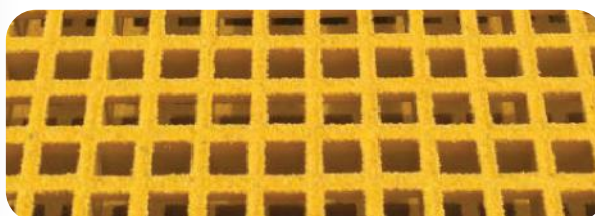

FIXING CLIPS



M CLIP & BOLT

Thickness (mm)	Aperture (mm)	Code
25	32	ClipM2532
38	32	ClipM3832
50	42	ClipM5042
50	32	ClipM5032
38	12.7	ClipM3812



M CLIP & CLAW

Thickness (mm)	Aperture (mm)	Code
38	32	ClipMBC3832
50	32	ClipMBC5032
50	42	ClipMBC5042



C CLIP

Thickness (mm)	Aperture (mm)	Code
25	32	ClipC2532
38	32	ClipC3832
50	32/42	ClipC5032
38	12.7	ClipC3812



DOME CLIP & CLAW

Thickness (mm)	Aperture (mm)	Code
25	32	ClipDBC253832
38/50	32	ClipDBC503832
50	42	ClipDBC503842



DOME & BOLT

Thickness (mm)	Aperture (mm)	Code
25 & 38	32	ClipDB2532
50	42	ClipDB5042

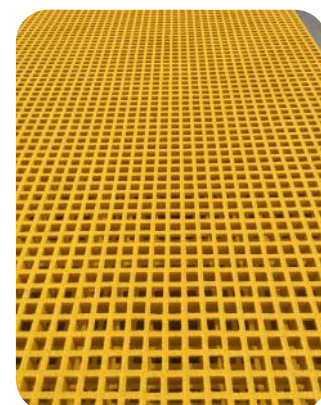

GRP NON SLIP FLOORING

Lockinex GRP flooring sheets are used to cover existing surface and create a suitable non-slip flooring. Offering higher levels of corrosion resistance over steel products they are suited to high corrosion environments. The non-conductive properties of GRP also mean they are commonly used in the rail and electrical power industries.

GRP FLAT SHEETS

Lockinex supplies a variety of different sizes and colours of GRP flat sheets. GRP flat sheets are versatile, durable and provide anti-slip properties, corrosion resistance and are non-conductive. Some Application includes flooring for water treatment and electrical facilities, walkways, factories and warehouses.



Black Flat Sheet
1200 x 1200mm



• ST302

Yellow Flat Sheet
1200 x 1200mm



• ST304

Black Flat Sheet
2400 x 1200mm

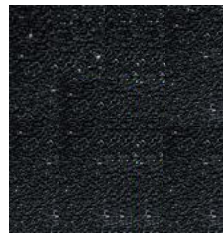

• ST301

Yellow Flat Sheet
2400 x 1200mm



• ST303

GRP Flooring

GRP STAIR NOSINGS

Hi Vis Nosing

55mm wide



Length (mm)

600 800

• ST206 • ST207

Hi Vis Nosing

55mm wide



Length (mm)

1200 1830

• ST208 • ST209

Hi Vis Nosing

55mm wide



Length (mm)

2400 3000

• ST210 • ST211

Hi Vis Nosing

55mm wide



Length (mm)

3660

• ST212

GRP STAIR COVERS

Stair Tread Cover



Length (mm)

600 800 1200

• ST106 • ST107 • ST108

Stair Tread Cover



Length (mm)

1800 2400

• ST109 • ST110

Stair Tread Cover



Length (mm)

3000 3660

• ST111 • ST112

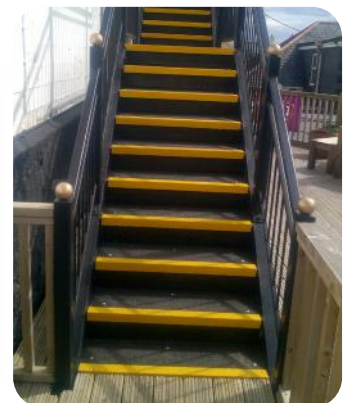

🔍 See page 67-68 for steel stair treads

GRP PULTRUDED PROFILES

Lockinex GRP profiles are used to construct various structures such as GRP stepovers, platforms, supports, frames etc. They offer higher levels of corrosion resistance over steel products & are suited to marine, food processing, water treatment & other high corrosion environments. They are commonly used in the rail & electrical power industry due to non-conductive properties.

Box



• GRP BOX

Embedment Angle



• GRP EMBEDMENT ANGLE

Flat



• GRP FLAT

I Beam



• GRP I BEAM

Tube



• GRP TUBE

U Channel



• GRP U CHANNEL

GRP Angle
51x51x6.35mm

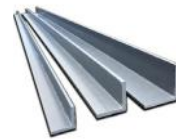

3m Length

• GRP-ANGLE-05

GRP Angle
75x75x10mm

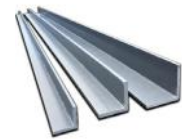

3m Length

• GRP-ANGLE-03

GRP Angle
100x100x8mm

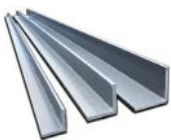

3m Length

• GRP-ANGLE-01



See [page 72-73](#) for our range of steel section beams, angles & more

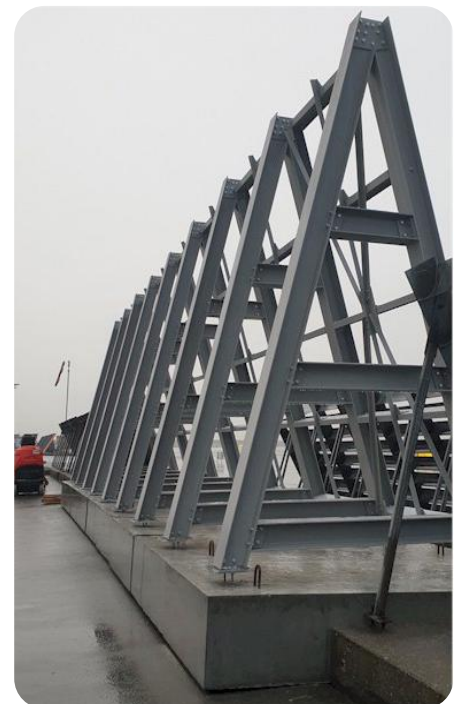

BALL STANDARDS

Ball standards are ideal to create secure guardrail systems for industrial walkways, marine walkways, maintenance platforms and much more. Lockinex ball standards are from galvanised steel tube, weldable balls and variations of base plates for fixing to handrail tube.

Lockinex Ball Standards are hot dip galvanised to **BS EN 1461:2009**.

Due to the hot dip galvanised finish, they offer a **long service life** and are **corrosion resistant** which makes the system popular within the marine and water treatment industries.

We stock a variety of different ball standard types such as side mounted and flat bases, galvanised or self colour finishes and we also offer angled ball standards to suit various stairways.

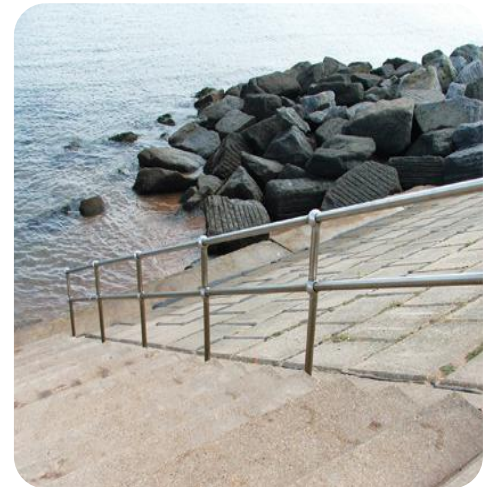

FLAT BASE BALL STANDARDS 1100MM TALL

Rail Diameter	Post Diameter	Ball Centres	Code
33.7	33.7	550	HS1-6
33.7	42.4	500	HS1-7X6
42.4	42.4	550	HS1-7
42.4	42.4	500	HS1-7-500
42.4	48.3	550	HS1-8X7
48.3	48.3	550	HS1-8

SIDE MOUNTED BALL STANDARDS 1200MM TALL

Rail Diameter	Post Diameter	Ball Centres	Code
33.7	33.7	550	HS2-6
33.7	33.7	500	HS2-6-500
33.7	42.4	500	HS2-7X6
42.4	42.4	550	HS2-7
42.4	42.4	500	HS2-7-500
48.3	48.3	550	HS2-8

Handrail/Guardrail Systems

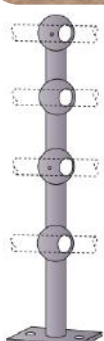
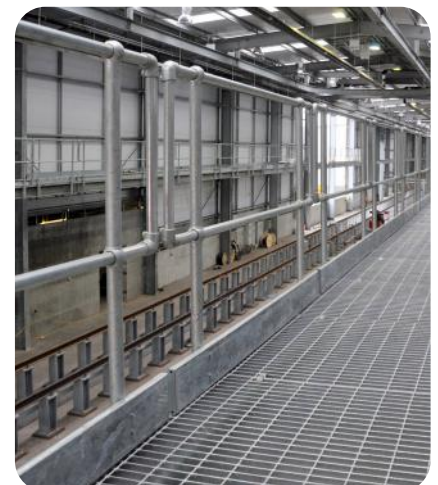

NEED A MORE BESPOKE PRODUCT?

We also manufacture **bespoke** ball standards and offer many ball, base plate and handrail configurations, plus a powder coating service to chosen RAL colour.



Email or call us to speak to our sales team:
sales@lockinex.com
01323 737 626

BALL STANDARDS

Ball standards are ideal to create secure guardrail systems for industrial walkways, marine walkways, maintenance platforms and much more. Lockinex ball standards are from galvanised steel tube, weldable balls and variations of base plates for fixing to handrail tube.

LEFT HAND ANGLED SIDE MOUNTED (AS ASCENDING)

1000MM TALL

Rail Diameter	Post Diameter	Ball Centres	Angle	Code
33.7	33.7	450	34	HS56G34LH
33.7	33.7	450	37	HS56G37LH
33.7	33.7	450	41	HS56G41LH
42.4	42.4	450	37	HS57G37LH
42.4	42.4	450	41	HS57G41LH
48.3	48.3	450	37	HS58G37LH

RIGHT HAND ANGLED SIDE MOUNTED (AS ASCENDING)

1000MM TALL

Rail Diameter	Post Diameter	Ball Centres	Angle	Code
33.7	33.7	450	37	HS56G37RH
33.7	33.7	450	41	HS56G41RH
42.4	42.4	450	37	HS57G37RH
42.4	42.4	450	41	HS57G41RH
48.3	48.3	450	37	HS58G37RH

SELF COLOUR BALL STANDARDS 1250MM TALL

Rail Diameter	Post Diameter	Ball Centres	Code
33.7	33.7	550	HS36B
33.7	33.7	500	HS36B-500
42.4	42.4	550	HS37B
42.4	42.4	500	HS37B-500
48.3	48.3	550	HS38B

ANGLED SELF COLOUR BALL STANDARDS 1150MM TALL

Rail Diameter	Post Diameter	Ball Centres	Angle	Code
33.7	33.7	450	34	HS6-6-B-34
33.7	33.7	450	37	HS6-6-B-37
33.7	33.7	450	41	HS6-6-B-41
42.4	42.4	450	34	HS6-7-B-34
42.4	42.4	450	37	HS6-7-B-37
42.4	42.4	450	41	HS6-7-B-41



DDA HANDRAIL

DDA handrail is a legal requirement where disability access ramps and/or stairways are present into public and commercial buildings such as schools, GP practices, hospitals & community centres. We stock a variety of DDA products that all adhere to The Equality Act 2010 & Building Regulations Part M. Application includes public domain areas such as museums, parks, transport stations, hospitals and care homes.

Lockinex DDA handrail systems are hot dip galvanised and offer **long service life** with minimal maintenance needed. The components are easy to install and can be mixed and matched to suit the project needs.

Our DDA handrail is fully compliant with **The Equality Act 2010** and adheres to **Building Regulations Part M 2015**. Offering a wide range of style and finishes as well as powder coating services to your chosen colour creating a fully bespoke product.



External Tube Connector



• A08-7

Internal Tube Connector With Collar



• HC-7TX

Internal Tube Connector



• A09-7

Single Screw Splice Locks



• SL-7

Double Screw Splice Locks



• SL-7D

Straight Permanent Tube Connector



• HC-7

Variable Connector



• DDA-09

90 Degree Corner



• DDA-05

Rolled Handrail End



1750x250mm

• DDA-ROLLED-END

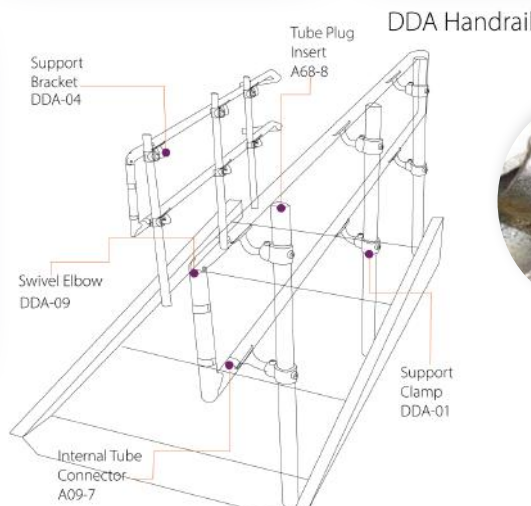

See **page 45** for the full size range of our handrail connectors

DDA HANDRAIL

DDA handrail is a legal requirement where disability access ramps and/or stairways are present into public and commercial buildings such as schools, GP practices, hospitals & community centres . We stock a variety of DDA products that all adhere to The Equality Act 2010 & Building Regulations Part M. Application includes public domain areas such as museums, parks, transport stations, hospitals and care homes.

Handrail Termination Plate



• DDA-10

Handrail Support Clamp



• DDA-01

Handrail Support Bracket



• DDA-04

Handrail Support Bracket



• DDA-03

Welding Handrail Support Bracket



• HB-5

Heavy Duty Handrail Bracket



• HB-11



Handrail Support Cover Plate



• CP-03

Handrail Support Cover Plate



• CP-02

Radiused Saddle Handrail Support



75mm Stand Off

• HB3RS

Flat Saddle Handrail Support



75mm Stand Off

• HB3FS



GRP HANDRAIL

GRP Handrail is a perfect alternative to mild steel handrail systems and is popular within the railway engineering industry due to its non conductive properties. It is also lightweight and easy to install.

GRP PROFILE HANDRAIL



GRP Handrail Square Tube

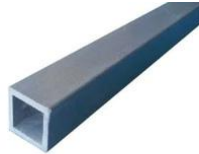

• GRIPATEX-HR50

GRP Handrail Circular Tube



• GRIPATEX-HR38

GRP Handrail Yellow Tube



• GRIPATEX-KC50

GRP Handrail Capping



• GRIPATEX-HR75

GRP Handrail Base Plate



• GRIPATEX-HR12

GRP Yellow Kickplate/Toeboard



• GRIPATEX-KICKPLATE



GRP READY MADE POSTS

Lockinex manufactures ready made GRP Handrail posts which come with all clamps fixed to upright posts. The posts are **quick and easy** to install helping reduce labour time on site resulting in **cost savings**.

GRP Middle Post



1100mm tall
Rails available at 500 OR 550mm centres

Rail Diameter (mm)
50

- GRIPATEX-RM-MID-500
- GRIPATEX-RM-MID-550

GRP Corner Post



1100mm tall
Rails available at 500 OR 550mm centres

Rail Diameter (mm)
50

- GRIPATEX-RM-CORNER-500
- GRIPATEX-RM-CORNER-550

GRP End Post



1100mm tall
Rails available at 500 OR 550mm centres

Rail Diameter (mm)
50

- GRIPATEX-RM-END-500
- GRIPATEX-RM-END-550



We also manufacture **bespoke** ready made posts to specifications.



Email or call us to speak to our sales team:

sales@lockinex.com

01323 737 626

HIGHWAY PEDESTRIAN GUARDRAIL

Highway pedestrian guardrail helps to protect people and property and are a vital part of road and highway safety protection. Lockinex offers various types of pedestrian guardrail staggered, inline and with a gap. Our rails with gaps offer a viewing panel making it easier to see people or vehicles and our staggered or inline offer enhanced visibility for drivers to see pedestrians.

HIGHWAY PEDESTRIAN GUARDRAIL

Galvanised to [BS EN 1461:2009](#) and adhering to UK highway regulations, our pedestrian guardrail offers an effective roadside barrier for pedestrians from drivers and cyclists.

Our guardrails are [designed with optional visibility](#) gaps in mind to give an enhanced view for drivers, cyclists and pedestrians. All guardrails have 12mm infill bars, 1372mm total height and are installed by concreting in.



Pedestrian Rail Staggered With Gap



1mtr long

• PG-2-1.0MTR

Pedestrian Rail Staggered With Gap



2mtr long

• PG-2-2.0MTR

Pedestrian Rail Inline With Gap



1mtr long

• PG-4-1.0MTR

Pedestrian Rail Inline With Gap



2mtr long

• PG-4-2.0MTR

Pedestrian Rail Staggered Without Gap



1mtr long

• PG-1-1.0MTR

Pedestrian Rail Staggered Without Gap



2mtr long

• PG-1-2.0MTR

Pedestrian Rail Inline Without Gap



1mtr long

• PG-3-1.0MTR

Pedestrian Rail Inline Without Gap



2mtr long

• PG-3-2.0MTR



Staggered pedestrian rail without gap



See [page 56](#) for our ready made pedestrian guardrail posts & panels
(Not for highway use)

STAINLESS STEEL HANDRAIL

Stainless steel handrail is an alternative option to standard or galvanised steel handrail that can offer a high class look and feel to the surrounding environment and its users. Applications include ramps, hotels, restaurants, office buildings and more.

Lockinex Stainless Steel Handrail is manufactured using **grade 304** stainless steel with a **satín finish** applied to each item for a luxury look and feel.

Application for this product includes use within both the commercial and public sector such as restaurants, offices, showrooms, poolside and domestic property.

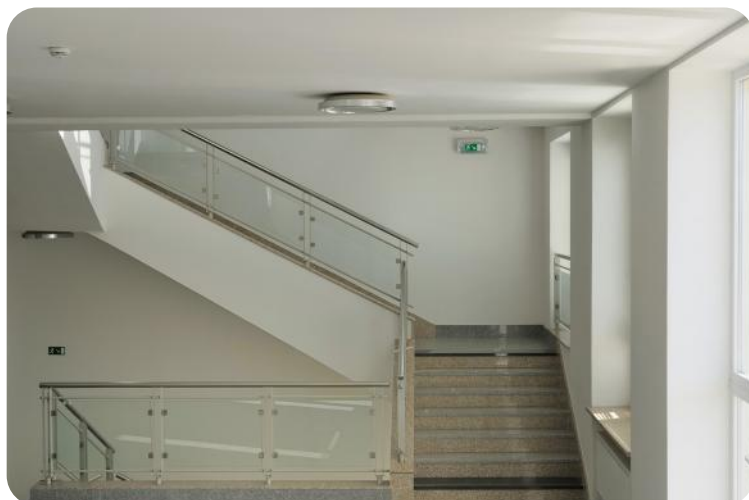

Lockinex stainless steel handrail is supplied in separate components, making it **easy to transport and assemble**, as well as offering flexibility in the overall design of the system.

Swivel Tube Connector



• Inox-535

Internal Tube Connector



• Inox-538

90 Degree Tube Connector

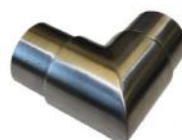

• Inox-541

Tee Tube Connector



• Inox-544

Multi Angle Tube Connector



• Inox-547

3 Way Tube Connector



• Inox-553

4 Way Cross Tube Connector



• Inox-550

Mechanical 90 Degree Connector



• Inox-555

STAINLESS STEEL HANDRAIL

Stainless steel handrail is an alternative option to standard or galvanised steel handrail that can offer a high class look and feel to the surrounding environment and its users. Application include ramps, hotels, restaurants, office buildings and more.

Stainless Steel Handrail Bracket



• Inox-503

Weldable Stainless Steel Rail Bracket



• Inox-509

Tube Mounted Handrail Bracket



• Inox-506

Tube Mounted Handrail Bracket



• Inox-512

Offset Tube Mounted Handrail Bracket



• Inox-515

Flat Connector Glass Clamp



• Inox-523

Fixed To Tube Glass Clamp



• Inox-521

Heavy Duty Base Plate



• Inox-527

Side Mounted Base Plate



• Inox-532

Weldable Base Plate



• Inox-529

Base /Wall Plate



• Inox-525

Base Wall/ Plate Cover



• Inox-906

Base Wall/ Plate Cover



• Inox-908



Email or call us to speak
to our sales team:
sales@lockinex.com
01323 737 626

MESH PANELS

Mesh panels can be used to create a secure handrail system utilising key clamp, handrail tube and the mesh panels. Our stock self colour panels can also be used by fabricators and engineers to create their own bespoke mesh structures.

MESH PANELS

Lockinex manufactures mesh panels and supplies panels from stock. Offering both **hot dip galvanised** panels and **self colour** panels for welding. We stock a variety of different sizes and apertures with 50mm being the most common. We offer panels **specially** for handrail systems as well as more **versatile** mesh flat sheets that can be used in warehouse storage facilities and for mezzanine gates etc.



HANDRAIL MESH INFILL PANELS

Size mm	Mesh mm	Frame mm	Wire Thickness	Code
1363x418	50	8	3mm	MSH-1363X418
1363x836	50	8	3mm	MSH-1363X836
1363x972	50	8	3mm	MSH-1363X972

MESH FLAT SHEETS 25x25mm

Finish	Size	Wire Thickness	Aperture	Code
Galv	2.4mtr x 1.2mtr	3mm	25mm	MSH-25-2
Self Colour	2.4mtr x 1.2mtr	3 mm	25mm	MSH-25-1



MESH FLAT SHEETS 50x50mm

Finish	Size	Wire Thickness	Aperture	Code
Galv	2.4mtr x 1.2mtr	3mm	50mm	MSH-50-2



We also manufacture **bespoke** mesh panels to specifications.

Email or call us to speak to our sales team:



sales@lockinex.com
01323 737 626

MESH INFILL PANEL CLIPS

Mesh panels can be used to create a secure handrail system utilising key clamp, handrail tube and the mesh panels. Our stock self colour panels can also be used by fabricators and engineers to create their own bespoke mesh structures.

MESH PANEL CLIPS

Single Mesh
Clip 26.9mm



• A70-5

Single Mesh
Clip 33.7mm



• A70-6

Single Mesh
Clip 42.4mm



• A70-7

Single Mesh
Clip 48.3mm



• A70-8

Single Mesh
Clip 60.3mm



• A70-9

Double Mesh
Clip 26.9mm



• A72-5

Double Mesh
Clip 33.7mm



• A72-6

Double Mesh
Clip 42.4mm



• A72-7

Double Mesh
Clip 48.3mm



• A72-8

Double Mesh
Clip 60.3mm



• A72-9

Floor Mounted
Clip



• A73



Lockinex Mesh Infill Panel with galvanised tube, key clamp fittings and Single mesh panel clips in use as guardrail systems.



HANDRAIL TUBE

Lockinex stocks and offers a variety of tube for use in handrail systems. Our galvanised tube is manufactured to EN 10255:2004 and galvanised to BS EN 10240:1998. We also stock GRP handrail and yellow powder coated tube. For a more bespoke product we offer powder coating to chosen RAL colours and tube cutting services.

GALVANISED STEEL TUBE

Tube Diameter	Wall Thickness	Tube Length	Code
26.9mm	2.9mm	3.2 mtr	T5-3.2mtr
26.9mm	2.9mm	6.0/6.4 mtr	T5-6.0/6.4mtr
33.7mm	3.2mm	3.2 mtr	T6-3.2mtr
33.7mm	3.2mm	6.0/6.4 mtr	T6-6.0/6.4mtr
42.4mm	3.2mm	3.2 mtr	T7-3.2mtr
42.4mm	3.2mm	6.0/6.4 mtr	T7-6.0/6.4mtr
48.3mm	3.2mm	3.2 mtr	T8-3.2mtr
48.3mm	3.2mm	6.0/6.4 mtr	T8-6.0/6.4mtr
60.3mm	3.6mm	3.2 mtr	T9-3.2mtr
60.3mm	3.6mm	6.0/6.4 mtr	T9-6.0/6.4mtr

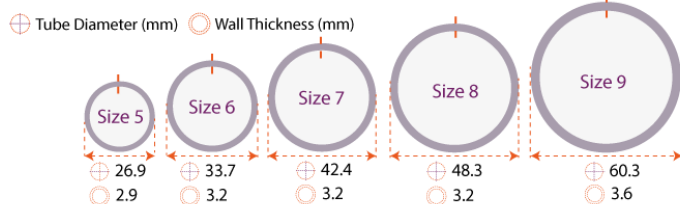

POWDER COATED STEEL TUBE

Tube Diameter	Wall Thickness	Tube Length	Code
42.4mm	3.2mm	1060mm	T7-1060-PPC
48.3mm	3.2mm	1060mm	T8-1060-PPC
42.4mm	3.2mm	1600mm	T7-1600-PPC
48.3mm	3.2mm	1600mm	T8-1600-PPC
42.4mm	3.2mm	3200mm	T7-3200-PPC
48.3mm	3.2mm	3200mm	T8-3200-PPC

GRP Handrail Tube 5 Meter



• Gripatex-KC50

GRP Handrail Square Tube 6 Mtr

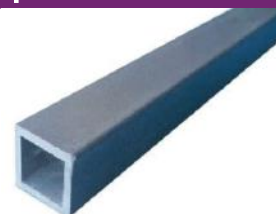

• Gripatex-HR50



Did You Know?

We also offer tube cutting services. For more information [email](mailto:sales@lockinex.com) or [call us](tel:01323737626) to speak to a member of our sales team.

HANDRAIL CONNECTORS

Used as joints for handrail and guardrail installations, we stock a variety of handrail connectors to suit your requirements. Lockinex also stocks a variety of splice locks with either a stainless steel or bright zinc plate steel.

SPLICE LOCKS

Material	Tube Dia. (mm)	Type	Code
Stainless Steel	42.4	Single Screw	SL-7Stainless
BZP Steel	42.4	Single Screw	SL-7
BZP Steel	42.4	Double Screw	SL-7D
BZP Steel	48.3	Single Screw	SL-8
BZP Steel	48.3	Double Screw	SL-8D
BZP Steel	60.3	Single Screw	SL-9
BZP Steel	60.3	Double Screw	SL-9D



PERMANENT CONNECTOR



To Suite Tube Diameter (mm)	Tube Wall Thickness	Code
33.7	3.2mm	HC- 6
42.4	3.2mm	HC- 7
48.3	3.2mm	HC- 8



Email or call us to speak to our sales team:
sales@lockinex.com
 01323 737 626

Handrail Connectors

SPRING-LOADED INTERNAL CONNECTOR

To Suite Tube Diameter (mm)	Tube Wall Thickness	Code
33.7	3.2mm	HC- 6TX
42.4	3.2mm	HC- 7TX
48.3	3.2mm	HC- 8TX



CAST INTERNAL TUBE CONNECTOR

To Suite Tube Diameter (mm)	Tube Wall Thickness	Code
33.7	3.2mm	A09-6
42.4	3.2mm	A09-7
48.3	3.2mm	A09-8

KICKPLATES & BRACKETS

Utilised to prevent small items being knocked over walking areas and causing accidents, kickplates and brackets are vital to complying with British Standards. All of Lockinex's steel kickplates are hot dip galvanised to BS EN 1461:2009.

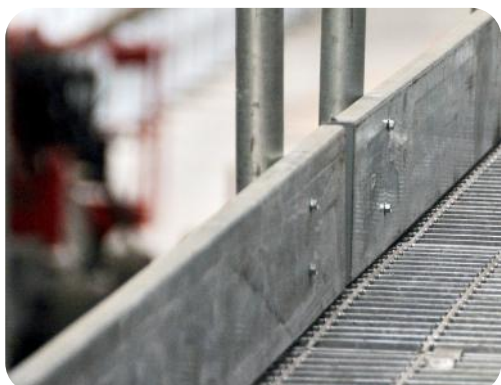

C CHANNEL GALVANISED STEEL KICKPLATE

Height (mm)	Length (mm)	Code
150	2980	Forginex11A



135° Kickplate Connection



Use with Forginex11A
• FORGINEX44

Straight Kickplate Connection



Use with Forginex11A
• FORGINEX40

90° Kickplate Connection



Use with Forginex11A
• FORGINEX42



90° BEND GALVANISED STEEL KICKPLATE

Height (mm)	Length (mtr)	Thickness (mm)	Code
150	3	2.5	CF2

FLAT GALVANISED STEEL KICKPLATE

Height (mm)	Length (mtr)	Thickness (mm)	Code
150	3	6	KP11

GRP KICKPLATE

Height (mm)	Length (m)	Code
150	6	Gripatex-Kickplate-Toeboard-Yellow



Lockinex GRP kickplate is used in our Step Over Platform Kits.

See [page 70](#) for step over kits

Kickplates & Brackets



Used with our GRP key clamp & tube, the GRP kickplate is perfect for creating a durable metal-free handrail system compliant with BS EN 14122-3.

See [page 57](#) for GRP Key Clamp

KICKPLATES & BRACKETS

Utilised to prevent small items being knocked over walking areas and causing accidents, kickplates and brackets are vital to complying with British Standards. All of Lockinex's steel kickplates are hot dip galvanised to BS EN 1461:2009.



KICKPLATE RETAINING BRACKET

To Suit Tube Diameter (mm)	Code
33.7	KP-01
42.4	KP-02
48.3	KP-02



Lockinex KP02 retaining brackets used with Forginex11A C channel Toeboard.

KICKPLATE RETAINING BRACKET

To Suit Tube Diameter (mm)	Code
42.4 & 48.3	KP-05



KICKPLATE BRACKET CONNECTOR

Type	Code
90°	KP-07
Straight	KP-08

Use with KP11

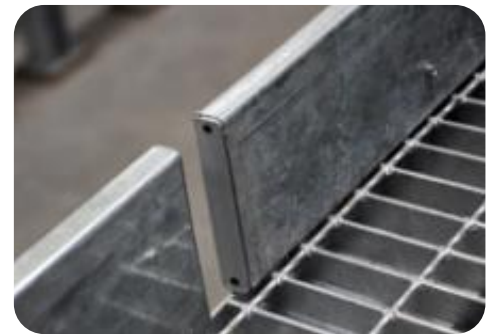

Lockinex kickplates, end plugs & open steel flooring installed at a railworks as part of an industrial walkway.



C CHANNEL CONNECTION BRACKET

Hole Diameter (mm)	Code
18	Lockinex-02



Lockinex-02 can be drilled through and bolted to the kickplate, or use self tapping screws to retain.

C SECTION MULTI ANGLE CONNECTOR

Angle	Length (mm)	Code
15° -180°	120	Lockinex-07



KEY CLAMP - GALVANISED STEEL

Lockinex stocks a huge variety of high quality key clamp fittings. Key Clamp is known for its diversity and applications which include guardrail, handrail, storage & racking and much more. Lockinex Key Clamp is manufactured and hot dip galvanised to British Standards and is quick and easy to assemble with only an allen key needed to install.

Lockinex Key Clamps are malleable iron castings, streamlined in appearance and providing **versatility** in their application. Used with Lockinex Tubing, they create **robust and durable** installations, which are aesthetically pleasing.

A wide range of rigid modular structures are possible with standard clamps. They are **easily and quickly assembled** without the need of special skills or tools. All Clamps are manufactured **BS EN 1562:2012** and hot-dip galvanising to **BS EN ISO 1461:2009**



Key Clamp

<p>A01 Acute Elbow</p>  <p>Diameter (mm) 42.4 48.3</p> <p>• A01-7 • A01-8</p>	<p>A02 Short Tee</p>  <p>Diameter (mm) 26.9 33.7 42.4</p> <p>• A02-5 • A02-6 • A02-7</p>	<p>A02 Short Tee</p>  <p>Diameter (mm) 48.3 - 33.7 48.3 - 42.4</p> <p>• A02-8/6 • A02-8/7</p>	<p>A02 Short Tee</p>  <p>Diameter (mm) 60.3</p> <p>• A02-9</p>
<p>A02 Retro Short Tee</p>  <p>Diameter (mm) 42.4 48.3</p> <p>• A02-7 RETRO • A02-8 RETRO</p>	<p>A03 Angle Incline</p> <p>30-60 degree incline</p>  <p>Diameter (mm) 33.7 42.4 48.3</p> <p>• A03-6 • A03-7 • A03-8</p>	<p>A04 Long Tee</p>  <p>Diameter (mm) 26.9 33.7</p> <p>• A04-5 • A04-6</p>	<p>A04 Long Tee</p>  <p>Diameter (mm) 42.4 48.3 60.3</p> <p>• A04-7 • A04-8 • A04-9</p>



KEY CLAMP - GALVANISED STEEL

Lockinex stocks a huge variety of high quality key clamp fittings. Key Clamp is known for its diversity and applications which include guardrails, handrail, storage & racking and much more. Lockinex Key Clamp is manufactured and hot dip galvanised to British Standards and is quick and easy to assemble with only an allen key needed to install.

A05 Swivel Elbow



Diameter (mm)
42.4 48.3

- A05-7
- A05-8

A06 90 Degree Elbow



Diameter (mm)
26.9 33.7 42.4

- A06-5
- A06-6
- A06-7

A06 90 Degree Elbow



Diameter (mm)
48.3 60.3

- A06-8
- A06-9

A07 Variable Angled Elbow



Diameter (mm)
33.7 42.4 48.3

- A07-6
- A07-7
- A07-8

A08 External Straight Connector



Diameter (mm)
26.9 33.7

- A08-5
- A08-6

A08 External Straight Connector



Diameter (mm)
42.4 48.3 60.3

- A08-7
- A08-8
- A08-9

A09 Internal Tube Connector



Diameter (mm)
33.7 42.4 48.3

- A09-6
- A09-7
- A09-8

A10 Wall End Termination



Diameter (mm)
26.9 33.7

- A10-5
- A10-6

A10 Wall End Termination



Diameter (mm)
42.4 48.3 60.3

- A10-7
- A10-8
- A10-9

A12 Base Plate



Diameter (mm)
26.9 33.7

- A12-5
- A12-6

A12 Base Plate



Diameter (mm)
42.4 48.3 60.3

- A12-7
- A12-8
- A12-9

A13 Base Plate



Diameter (mm)
42.4 48.3

- A13-7
- A13-8

A14 Side Mount Base Plate



Diameter (mm)
33.7 42.4 48.3

- A14-6
- A14-7
- A14-8

A15 Side Mount Triangular Base Plate



Diameter (mm)
33.7 42.4 48.3

- A15-6
- A15-7
- A15-8

A16 Side Mount Base Plate



Diameter (mm)
33.7 42.4 48.3

- A16-6
- A16-7
- A16-8

A16FM Heavy Duty Side Mount Base Plate



Diameter (mm)
33.7 42.4 48.3

- A16-6FM
- A16-7FM
- A16-8FM

KEY CLAMP - GALVANISED STEEL

Lockinex stocks a huge variety of high quality key clamp fittings. Key Clamp is known for its diversity and applications which include guardrail, handrail, storage & racking and much more. Lockinex Key Clamp is manufactured and hot dip galvanised to British Standards and is quick and easy to assemble with only an allen key needed to install.

A17 Ground Socket



Diameter (mm)

33.7 42.4 48.3

• A17-6 • A17-7 • A17-8

A18 3 Way Corner



Diameter (mm)

26.9 33.7

• A18-5 • A18-6

A18 3 Way Corner



Diameter (mm)

42.4 48.3 60.3

• A18-7 • A18-8 • A18-9

A20 4 Way Corner



Diameter (mm)

26.9 33.7

• A20-5 • A20-6

A20 4 Way Corner



Diameter (mm)

42.4 48.3 60.3

• A20-7 • A20-8 • A20-9

A20 4 Way Retro Fit Corner



Diameter (mm)

48.3

• A20-Retro-8

A21 Corner Swivel Tee



Pair shown. Sold in singles.

Diameter (mm)

33.7 42.4 48.3

• A21-6 • A21-7 • A21-8

A22 Middle Cross



Diameter (mm)

26.9 33.7

• A22-5 • A22-6

A22 Middle Cross



Diameter (mm)

42.4 48.3 60.3

• A22-7 • A22-8 • A22-9

A22 Retro Fit Middle Cross



Diameter (mm)

48.3

• A22-RETRO-8

A23 Angled Middle Slope

30-45 degree incline



Diameter (mm)

33.7 42.4 48.3

• A23-6 • A23-7 • A23-8

A24 Retro Fit Side Outlet Tee



Diameter (mm)

48.3

• A24-RETRO-8

A24 Side Way Corner



Diameter (mm)

26.9 33.7

• A24-5 • A24-6

A24 Side Way Corner



Diameter (mm)

42.4 48.3 60.3

• A24-7 • A24-8 • A24-9

A25 Elbow Swivel



Diameter (mm)

48.3

• A25-8

A26 5 Way Outlet



Diameter (mm)

26.9 33.7

• A26-5 • A26-6

KEY CLAMP - GALVANISED STEEL

Lockinex stocks a huge variety of high quality key clamp fittings. Key Clamp is known for its diversity and applications which include guardrail, handrail, storage & racking and much more. Lockinex Key Clamp is manufactured and hot dip galvanised to British Standards and is quick and easy to assemble with only an allen key needed to install.

A26 5 Way Outlet



Diameter (mm)
42.4 48.3

- A26-7
- A26-8

A26 Retro 5 Way Outlet



Diameter (mm)
48.3

- A26-RETRO-8

A27 Swivel Short Tee



Diameter (mm)
48.3

- A27-8

A28 Short Cross Over Tee



Diameter (mm)
26.9 33.7

- A28-5
- A28-6

A28 Short Cross Over Tee



Diameter (mm)
42.4 48.3 60.3

- A28-7
- A28-8
- A28-8

A28 Short Cross Over Tee Alternate



Diameter (mm)
33.7 42.4 48.3

- A29-6
- A29-7
- A29-8

A28 Retro Short Cross Over Tee



Diameter (mm)
48.3

- A28-RETRO-8

A29 45 Degree Tee



Diameter (mm)
33.7 42.4 48.3

- A29-6
- A29-7
- A29-8

A30 Crossover Middle Cross



Diameter (mm)
26.9 33.7

- A30-5
- A30-6

A30 Crossover Middle Cross



Diameter (mm)
42.4 48.3 60.3

- A30-7
- A30-8
- A30-9

A31 Internal Offset Swivel Tee



Diameter (mm)
33.7 42.4 48.3

- A31-6
- A31-7
- A31-8

A32 Clamp On Short Tee



Diameter (mm)
26.9 33.7

- A32-5
- A32-6

A32 Clamp On Short Tee



Diameter (mm)
42.4 48.3 60.3

- A32-7
- A32-8
- A32-9

A34 Handrail Support



Diameter (mm)
26.9 33.7

- A34-5
- A34-6

A34 Handrail Support



Diameter (mm)
42.4 48.3

- A34-7
- A34-8

A35 Double Lug



Diameter (mm)
26.9 33.7

- A35-5
- A35-6

KEY CLAMP - GALVANISED STEEL

Lockinex stocks a huge variety of high quality key clamp fittings. Key Clamp is known for its diversity and applications which include guardrail, handrail, storage & racking and much more. Lockinex Key Clamp is manufactured and hot dip galvanised to British Standards and is quick and easy to assemble with only an allen key needed to install.

A35 Double Lug



Diameter (mm)
42.4 48.3

- A35-7
- A35-8

A36 Single Lug Collar



Diameter (mm)
26.9 33.7

- A36-5
- A36-6

A36 Single Lug Collar



Diameter (mm)
42.4 48.3 60.3

- A36-7
- A36-8
- A36-9

A37 Single Lug Collar



Diameter (mm)
26.9 33.7

- A37-5
- A37-6

A37 Single Lug Collar



Diameter (mm)
42.4 48.3

- A37-7
- A37-8

A38 Double Lug Collar



Diameter (mm)
26.9 33.7

- A38-5
- A38-6

A38 Double Lug Collar



Diameter (mm)
42.4 48.3 60.3

- A38-7
- A38-8
- A38-9

A40 90 Degree Double Lug Collar



Diameter (mm)
33.7 42.4 48.3

- A40-6
- A40-7
- A40-8

A41 Single Lug Cup



Diameter (mm)
33.7 42.4 48.3

- A41-6
- A41-7
- A41-8

A42 Double Lug Cup



Diameter (mm)
26.9 33.7

- A42-5
- A42-6

A42 Double Lug Cup



Diameter (mm)
42.4 48.3 60.3

- A42-7
- A42-8
- A42-9

A44 Single Swivel



Diameter (mm)
26.9 33.7

- A44-5
- A44-6

A44 Single Swivel



Diameter (mm)
42.4 48.3 60.3

- A44-7
- A44-8
- A44-9

A46 Double Swivel



Diameter (mm)
26.9 33.7

- A46-5
- A46-6

A46 Double Swivel



Diameter (mm)
42.4 48.3 60.3

- A46-7
- A46-8
- A46-9

A48 90 Degree Double Swivel



Diameter (mm)
33.7 42.4 48.3

- A48-6
- A48-7
- A48-8

KEY CLAMP - GALVANISED STEEL

Lockinex stocks a huge variety of high quality key clamp fittings. Key Clamp is known for its diversity and applications which include guardrail, handrail, storage & racking and much more. Lockinex Key Clamp is manufactured and hot dip galvanised to British Standards and is quick and easy to assemble with only an allen key needed to install.

A50 Lug Plate



Nominal Weight (g)
0.40

• A50

A52 Swivel Plate



Diameter (mm)
26.9 33.7

• A52-5 • A52-6

A52 Swivel Plate



Diameter (mm)
42.4 48.3 60.3

• A52-7 • A52-8 • A52-9

A54 Roof Apex Eave



Diameter (mm)
48.3

• A54-8

A56 Roof Apex Eave



Diameter (mm)
48.3

• A56-8

A58 Collar



Diameter (mm)
26.9 33.7 42.4 48.3

• A58-5 • A58-6 • A58-7 • A58-8

A60 Collar



Diameter (mm)
26.9 33.7

• A60-5 • A60-6

A60 Collar



Diameter (mm)
42.4 48.3

• A60-7 • A60-8

A62 Collar With Pin



Diameter (mm)
26.9 33.7

• A62-5 • A62-6

A62 Collar With Pin



Diameter (mm)
42.4 48.3

• A62-7 • A62-8

A64 Hook Collar



Diameter (mm)
26.9 33.7

• A64-5 • A64-6

A64 Hook Collar



Diameter (mm)
42.4 48.3

• A64-7 • A64-8

A66 Cross Over



Diameter (mm)
33.7 42.4 48.3

• A66-6 • A66-7 • A66-8

A67 Base Plate Shield



Diameter (mm)
33.7 42.4 48.3

• A67-6 • A67-7 • A67-8

A68 Tube Plug



Available in black or grey

Diameter (mm)
26.9 33.7

• A68-5 • A68-6

A68 Tube Plug



Available in black or grey

Diameter (mm)
42.4 48.3 60.3

• A68-7 • A68-8 • A68-9

KEY CLAMP - GRADIENT GALVANISED STEEL

Lockinex stocks a huge variety of high quality key clamp fittings. Key Clamp is known for its diversity and applications which include guardrail, handrail, storage & racking and much more. Lockinex Key Clamp is manufactured and hot dip galvanised to British Standards and is quick and easy to assemble with only an allen key needed to install.

A74 Socket With Hex Key



Diameter (mm)
6 8

- A74-6
- A74-8

J Clamp



Diameter (mm)
48.3

- J-99

G01 30-60 Degree Angled Tee



Diameter (mm)
33.7 42.4 48.3

- G01-6
- G01-7
- G01-8

G02 0-11 Degree Short Angled Tee



Diameter (mm)
33.7 42.4 48.3

- G02-6
- G02-7
- G02-8

G03 11-30 Degree Short Angled Tee



Diameter (mm)
42.4 48.3

- G03-7
- G03-8

G04 0-11 Degree Angled Long Tee



Diameter (mm)
33.7 42.4 48.3

- G04-6
- G04-7
- G04-8

G05 11-30 Degree Angled Long Tee



Diameter (mm)
42.4 48.3

- G05-7
- G05-8

G06 0-11 Degree Elbow Incline



Diameter (mm)
33.7 42.4 48.3

- G06-6
- G06-7
- G06-8

G07 30-45 Degree Angled Long Tee



Diameter (mm)
42.4 48.3

- G07-7
- G07-8

G08 11-30 Degree Incline



Diameter (mm)
42.4 48.3

- G08-7
- G08-8

G09 30-45 Degree Incline



Diameter (mm)
42.4 48.3

- G09-7
- G09-8

G10 15-60 Degree Incline



Diameter (mm)
33.7 42.4 48.3

- G10-6
- G10-7
- G10-8

G11 11-30 Degree Incline



Diameter (mm)
42.4 48.3

- G11-7
- G11-8

G12 0-11 Degree Incline



Diameter (mm)
33.7 42.4 48.3

- G12-6
- G12-7
- G12-8

G13 11-30 Degree Incline



Diameter (mm)
42.4 48.3

- G13-7
- G13-8

G14 30-45 Degree Incline



Diameter (mm)
42.4 48.3

- G14-7
- G14-8

Key Clamp

KEY CLAMP - GRADIENT GALVANISED STEEL

Lockinex stocks a huge variety of high quality key clamp fittings. Key Clamp is known for its diversity and applications which include guardrail, handrail, storage & racking and much more. Lockinex Key Clamp is manufactured and hot dip galvanised to British Standards and is quick and easy to assemble with only an allen key needed to install.

G15 11-30 Degree Incline



Diameter (mm)
42.4 48.3

- G15-7 • G15-8

G22 0-11 Degree Incline



Diameter (mm)
33.7 42.4 48.3

- G22-6 • G22-7 • G22-8

G23 11-30 Degree Incline



Diameter (mm)
33.7 42.4 48.3

- G23-6 • G23-7 • G23-8

G24 30-45 Degree Incline



Diameter (mm)
33.7 42.4 48.3

- G24-6 • G24-7 • G24-8

G26 Corner 30-45 Degree Outlet



Diameter (mm)
42.4 48.3

- G26-7 • G26-8

G28 Corner 30-45 Degree Outlet



Diameter (mm)
42.4 48.3

- G28-7 • G28-8

G30 Corner 30-45 Degree Outlet



Diameter (mm)
42.4 48.3

- G30-7 • G30-8

G32 30-45 Degree Outlet



Diameter (mm)
42.4 48.3

- G32-7 • G32-8

G34 30-45 Degree Outlet Tee



Diameter (mm)
42.4 48.3

- G34-7 • G34-8

G36 30-45 Degree Outlet Tee



Diameter (mm)
42.4 48.3

- G36-7 • G36-8

G38 30-45 Degree Outlet



Diameter (mm)
42.4 48.3

- G38-7 • G38-8

A73 Floor Mesh Infill Panel Clip



- A73

Single Mesh Clip



Diameter (mm)
26.9 33.7

- A70-5 • A70-6

Single Mesh Clip



Diameter (mm)
42.4 48.3 60.2

- A70-7 • A70-8 • A70-9

Double Mesh Clip



Diameter (mm)
26.9 33.7

- A72-5 • A72-6

Double Mesh Clip



Diameter (mm)
42.4 48.3 60.2

- A72-7 • A72-8 • A72-9

Key Clamp

KEY CLAMP - STEEL READY MADE POSTS

Lockinex manufactures ready made handrail posts which come with all clamps fixed to upright posts and includes all needed fixings. The posts are quick and easy to install, helping reduce labour time on site, resulting in cost savings.

GALVANISED READY MADE POSTS

Galvanised Middle Post



1100mm tall
550mm rail centres

Rail/Post Diameter

42.4 48.3

• RM-MID-2-7 • RM-MID-2-8

Galvanised Corner Post



1100mm tall
550mm rail centres

Rail/Post Diameter

42.4 48.3

• RM-CORNER-2-7
• RM-CORNER-2-8

Galvanised End Post



1100mm tall
550mm rail centres

Rail/Post Diameter

42.4 48.3

• RM-END-2-7 • RM-END-2-8



KEY CLAMP PEDESTRIAN GUARDRAIL INFILL PANELS

Pedestrian Guardrail Panel



Fence Width (mm)

900 1200

• PGKC-900 • PGKC-1200

Pedestrian Guardrail Corner Post



1100mm tall

Rail/Post Diameter

48.3mm

• PGKC-CORNER

Pedestrian Guardrail End Post



1100mm tall

Rail/Post Diameter

48.3mm

• PGKC-END

Pedestrian Guardrail Middle Post



1100mm tall

Rail/Post Diameter

48.3mm

• PGKC-MIDDLE



KEY CLAMP - GRP & READY MADE POSTS

Gripatex GRP Hi-Vis yellow key clamp provides a non-conductive alternative to galvanised powder-coated steel. Years of rust-free, low maintenance use. This product can withstand all weather types, is UV resistant and requires no paint.



KC02 GRP Short Tee

• GRIPATEX-KC02



KC03 Angled Short Tee

• GRIPATEX-KC03



KC04 GRP Long Tee

• GRIPATEX-KC04



KC06 GRP Elbow

• GRIPATEX-KC06



KC10 GRP Wall Plate

• GRIPATEX-KC10



KC12 GRP Base Plate

• GRIPATEX-KC12



KC14 GRP Side Base

• GRIPATEX-KC14



KC18 GRP Corner

• GRIPATEX-KC18



KC20 GRP Corner

• GRIPATEX-KC20



KC22 GRP Cross

• GRIPATEX-KC22



KC23 GRP Angled Cross

• GRIPATEX-KC23



KC44 GRP Single Swivel

• GRIPATEX-KC44



KC45 Top Rail Connector

• GRIPATEX-KC45

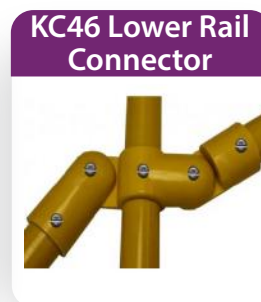

KC46 Lower Rail Connector

• GRIPATEX-KC46



KC50 GRP Handrail Tube

5m lengths

• GRIPATEX-KC50



KC-Spigot GRP Handrail Joint

• KC-SPIGOT



GRP Middle Post

1100mm tall
550mm OR
500mm rail
centres

• GRIPATEX-RM-MID-500
• GRIPATEX-RM-MID-550



GRP Corner Post

1100mm tall
550mm OR
500mm rail
centres

• GRIPATEX-RM-CORNER-500
• GRIPATEX-RM-CORNER-550



GRP End Post

1100mm tall
550mm OR
500mm rail
centres

• GRIPATEX-RM-END-500
• GRIPATEX-RM-END-550



GRP Key Clamp



We also manufacture *bespoke* ready made posts to specifications.



Email or call us to speak to our sales team:
sales@lockinex.com

01323 737 626

PPE CLOTHING & WORKWEAR

Compliant with BS EN 471 Class 2 visibility requirements. All coats and trousers are fully waterproofed to BS EN 343 with taped seams. Our coats and trousers have durable Oxford fabric with PU waterproof coating to BS EN 343 and our vests are long-lasting durable polyester fabric compliant with BS EN 471 Class 2.

L (39-43 inch chest)
 XL (43-46 inch chest)
 XXL (46-50 inch chest)

- Compliant with **BS EN 471** Class 2 visibility requirements.
- Available in Orange & Lime.
- Durable Polyester fabric for **long-lasting use**.
- Velcro closure.

Large Hi-Vis Vest Orange



• PPE-VO-01L

Large Hi-Vis Vest Yellow



• PPE-VL-01L

Extra Large Hi-Vis Vest Orange



• PPE-VO-03XL

Extra Large Hi-Vis Vest Yellow



• PPE-VL-03XL

XXL Hi-Vis Vest Orange



• PPE-VO-05XXL

XXL Hi-Vis Vest Yellow



• PPE-VL-05XXL

L (39-43 inch chest)
 XL (43-46 inch chest)
 XXL (46-50 inch chest)

Large Hi-Vis Coat Orange



• PPE-JO-03L

Large Hi-Vis Coat Yellow



• PPE-JL-03L

- Durable Oxford fabric with PU waterproof coating to **BS EN 343**
- Compliant with **BS EN 471** Class 2 visibility requirements.
- Padded quilt lining.
- Adjustable fold away hood in collar.
- Fully taped seams ensure **waterproof protection**.
- Two way zip and snap button closure.
- Two large **easy access outer pockets** with flap, one large inner chest Velcro pocket & one large inner chest zip pocket (within zip overlap).
- Available in Orange & Lime.

Extra Large Hi-Vis Coat Orange



• PPE-JO-01XL

Extra Large Hi-Vis Coat Yellow



• PPE-JL-01XL

XXL Hi-Vis Coat Orange



• PPE-JO-05XXL

XXL Hi-Vis Coat Yellow



• PPE-JL-05XXL

PPE CLOTHING & WORKWEAR

Compliant with BS EN 471 Class 2 visibility requirements. All coats and trousers are fully waterproofed to BS EN 343 with taped seams. Our coats and trousers have durable Oxford fabric with PU waterproof coating to BS EN 343 and our vests are long-lasting durable polyester fabric compliant with BS EN 471 Class 2

Large Hi-Vis Trousers Orange



• PPE-TO-01L

Large Hi-Vis Trousers Yellow



• PPE-TL-01L

L (38-42 inch waist)
XL (42-44 inch waist)
XXL (44-58 inch waist)

- Durable Oxford fabric with PU waterproof coating to **BS EN 343**.
- Compliant with **BS EN 471** Class 2 visibility requirements.
- Fully taped seams ensure **waterproof protection**.
- Elasticated waist.
- Available in Orange & Lime.
- Two access side pockets.

Extra Large Hi-Vis Trousers Orange



• PPE-TO-03XL

Extra Large Hi-Vis Trousers Yellow



• PPE-TL-03XL

XXL Hi-Vis Trousers Orange



• PPE-TO-05XXL

XXL Hi-Vis Trousers Yellow



• PPE-TL-05XXL



BS 13700:2021 RUBBER GUARDRAIL SYSTEM

Roof guardrail system designed and tested to British Standard 13700:2021. Lockinex Roof Guardrail provides a safe working environment for personnel who may frequent roof areas. A safe working area is constructed, enabling maintenance of equipment such as air conditioning units, telecoms, water tanks, communication services or general maintenance to the roof.

Fully compliant to the latest **British Standard 13700:2021** for permanent counterweight guardrail systems. Lockinex rubber counterweighted guardrail includes **built in handles** designed to make pickup of weights quicker, easier and safer. The system is **compact** in its design making it **easier to install** as well as saving space on rooftops. The guardrail is **stackable** making shipping more efficient and results in **lower transport costs**.

All of our posts are **hot dip galvanised** to provide long lasting protection against corrosion and all of our guardrail comes with stainless steel post screws for **quick fastening** of horizontal rails.

This product and all its components have a **service life of 20+ years**.



Roof Edge Guardrail Post For Use With Counterweight



● FSR-405-X

Roof Edge Guardrail Post No Counterweight



● FSR-401-X

Roof Edge Guardrail 20kg Counterweight



● FSR-407-X

BS 13700:2021 RUBBER GUARDRAIL SYSTEM

Roof guardrail system designed and tested to British Standard 13700:2021. Lockinex Roof Guardrail provides a safe working environment for personnel who may frequent roof areas. A safe working area is constructed, enabling maintenance of equipment such as air conditioning units, telecoms, water tanks, communication services or general maintenance to the roof.

Roof Edge Guardrail 2.5m Galvanised Tube



● FSR-409

Roof Edge Guardrail Double Connection



● FSR-415

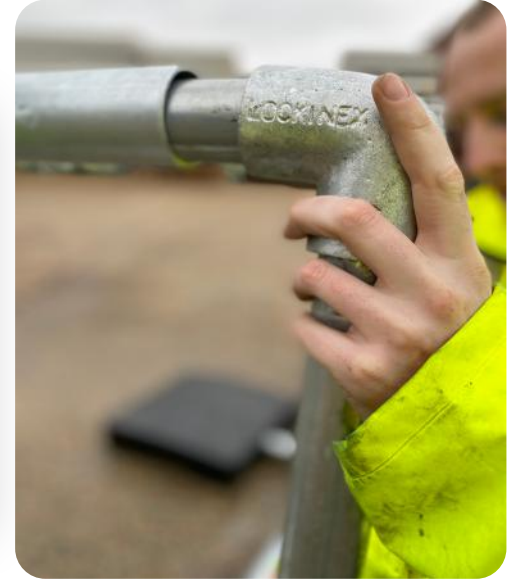

Roof Edge Guardrail Triple Connection



● FSR-420

1200mm Self Closing Gate Kit



● FSR-GATE-KIT

Galvanised Steel Kickplate - 2.5mm



● CF2

A06 90 Degree Elbow



Diameter (mm)
48.3

● A06-8

A10 Wall End Termination



Diameter (mm)
48.3

● A10-8

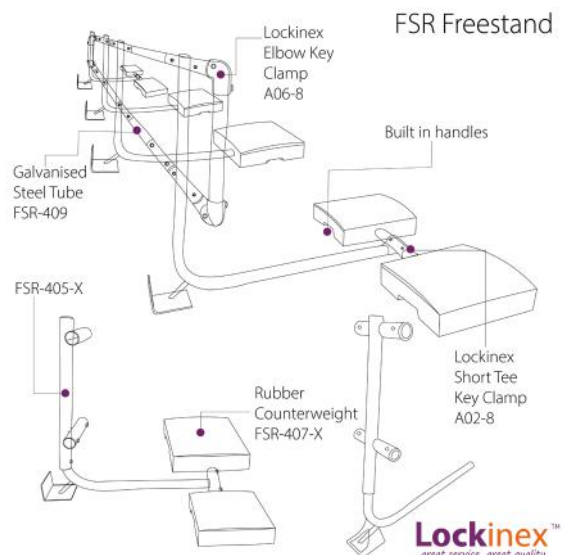

RUBBER GUARDRAIL SYSTEM

Lockinex Roof Guardrail provides a safe working environment for personnel who may frequent roof areas. A safe working area is constructed, enabling maintenance of equipment such as air conditioning units, telecoms, water tanks, communication services or general maintenance to the roof.

Designed with easy assembly in mind, Lockinex Rubber Counterweighted Roof Guardrail system is designed and tested to comply with **BS EN 13374 Class A**.

It may also comply with **BS EN 14122:3** with the use of a toe-board and if a parapet wall is present.

This product range offers a complete collective fall protection guardrail giving safe access to **roof areas at any time**.



We supply whole systems as well as components for use as replacements or improvements to previous installed systems. A collapsible version of this system is also available upon request.

This product and all its components have a **service life of 20+ years**

Roof Edge Guardrail Post For Use With Counterweight



● **FSR-405**

Roof Edge Guardrail Post No Counterweight



● **FSR-401**

Roof Edge Guardrail 20kg Counterweight



● **FSR-407**



RUBBER GUARDRAIL SYSTEM

Lockinex Roof Guardrail provides a safe working environment for personnel who may frequent roof areas. A safe working area is constructed, enabling maintenance of equipment such as air conditioning units, telecoms, water tanks, communication services or general maintenance to the roof.

Roof Edge Guardrail 2.5m Galvanised Tube



● FSR-409

Roof Edge Guardrail Double Connection



● FSR-415

Roof Edge Guardrail "D" End Termination



● FSR-413

Roof Edge Guardrail Triple Connection



● FSR-420

Roof Edge Guardrail Triple Connection



● FSR-411

Galvanised Steel Kickplate - 2.5mm



● CF2

Roof Edge Guardrail Gate Kit



● FSR-GATE-KIT



Visit our Youtube Channel to see a step by step video on how to install our roof guardrail counterweighted system!

FIXED SYSTEM FOR METAL CLAD ROOFS

Lockinex Roof Guardrail provides a safe working environment for personnel who may frequent roof areas. A safe working area is constructed, enabling maintenance of equipment such as air conditioning units, telecoms, water tanks, communication services or general maintenance to the roof.

Designed for use on profiled roofs, Lockinex Fixed Roof Guardrail system is designed and tested to comply with **BS EN 13374 Class A**.

It may also comply with **BS EN 14122:3** with the use of a toe-board or if a parapet wall is present.

This product range offers a complete collective fall protection guardrail, giving safe access to **roof areas at any time**.

Key features include heavy-duty fixing plates for strength and durability, fully galvanised posts and tube for corrosion resistance, compatibility with Lockinex key clamp allowing easy creation of bends and ends.

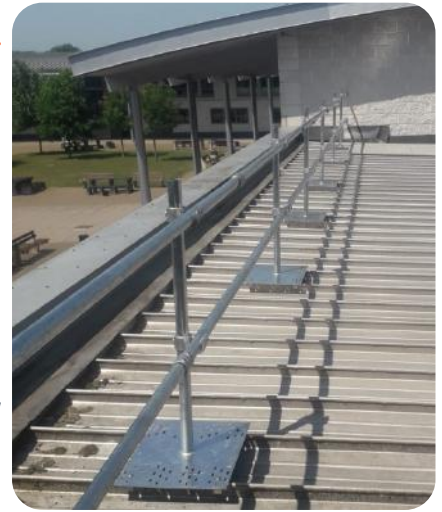

This product and all its components have a **service life of 20+ years**.

GALVANISED STEEL TUBE

Tube Diameter	Wall Thickness	Tube Length	Code
48.3mm	3.2mm	3.2 mtr	T8-3.2mtr
48.3mm	3.2mm	6.0/6.4 mtr	T8-6.0/6.4mtr



Fixed Roof Edge Guardrail Post



• CF5

Fixed Roof Edge Guardrail Post Raked



• CF5-RAKED

Butyl Sealing Strip 9.6 Meter Roll



• Butyl-Strip

Galvanised 48.3mm J Clamp



• J-99

90 Degree Elbow



• A06-8

Wall End Termination



• A10-8

Roof Guardrail

EQUIPMENT SUPPORT FEET

Lockinex Roof Support Equipment offers solutions for supporting various structures on rooftops and other areas. The products rubber construction ensures no damage to the roof membrane whilst offering substantial load bearing capabilities.

Lockinex support feet have been designed to provide a **stable and non penetrating** load bearing base for roof structures. Each foot supports a maximum recommended load of 200kg.

Positioned onto flat roofs, an optional rubber mat is also available for **added protection** of the roof membrane. Suitable frameworks can then be attached to the foot using the threaded spigot to make the connection. Ideal for supporting Air conditioning units, access ladders, step-overs and more.



Roof Support Foot



• GIANT-01

Roof Rubber Under Mat



• GIANT-03

Roof Support Spigot



• GIANT-05



Email or call us to speak
to our sales team:
sales@lockinex.com
01323 737 626

OPEN STEEL FLOORING

Lockinex offers a variety of self colour open steel flooring with different sizes and apertures. Lockinex open steel flooring is designed with bearer bars and twisted crossbars to allow small debris and rain/liquid to fall through preventing slips and trips whilst also preventing larger objects to fall through and cause damage.



OPEN STEEL FLOORING WITH TWISTED BARS

Bearing Bars (mm)	Apertures (mm)	Sheet Size (mtr)	Code
25x5	41x100	3x1	FORGINEX-01
25x3	41x100	3x1	FORGINEX-03
25x5	30x100	3x1	FORGINEX-05
25x3	30x100	3x1	FORGINEX-07

Multi Fit Grating Flooring Clip

Hot dip galv & Nyloc nut



• Lockinex-01

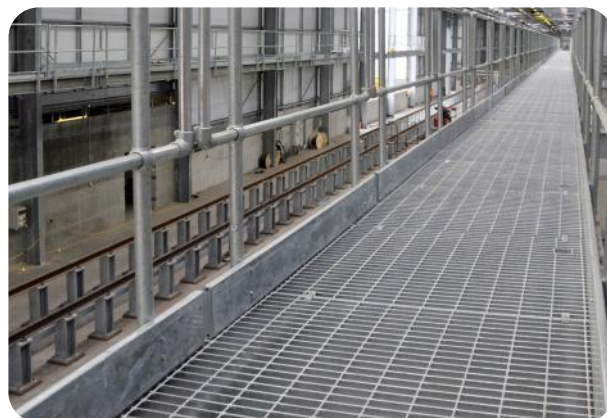

SELF COLOUR STEEL STAIR TREADS

Utilised to form industrial walkways, stairways and stair cases, steel stair treads offer a safe effective solution for climbing up and accessing areas. Durbar nosings offer extra grip and open steel treads prevent slips and trips. Lockinex self colour treads can be welded or cut to desired specifications.

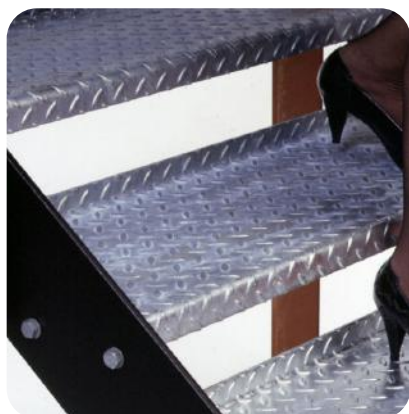

SELF-COLOUR DURBAR TREADS

Turn Up/ Down (mm)	Tread Size (mm)	Thickness (mm)	Code
50x50	800x265	4.5	DBST-02
50x50	1000x265	4.5	DBST-03
50x50	1250x265	4.5	DBST-05
145x50	800x265	4.5	DBST-04
145x50	1000x265	4.5	DBST-09
50x145	1250x265	6.0	DBST-11

Durbar Tread Support Cleats



Self Colour

2x Slot

50x50x200mm

• CLEAT-20

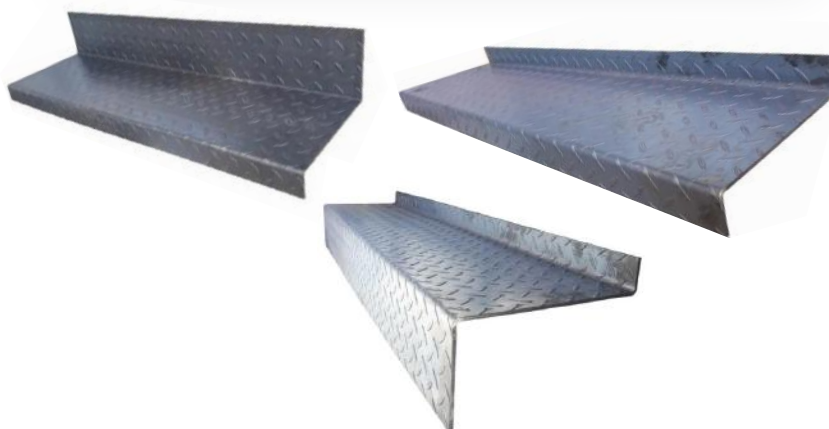

SELF-COLOUR OPEN STEEL TREADS WITH DURBAR NOSING

Bearing Bars (mm)	Tread Size (mm)	Openings (mm)	Code
25x5	1000x288	30x100	OSST-23
30x5	1200x318	30x100	OSST-33



SELF-COLOUR OPEN STEEL TREADS WITH PERFORATED NOSING

Bearing Bars (mm)	Tread Size (mm)	Openings (mm)	Code
25x5	1000x283	41x100	TREAD-1000X283-LOOSE-PLATE
30x5	1200x333	41x100	TREAD-1200X333-LOOSE-PLATE

GALVANISED STEEL STAIR TREADS

Utilised to form industrial walkways, stairways and stair cases, steel stair treads offer a safe effective solution for climbing up and accessing areas. Durbar nosings offer extra grip and open steel treads prevent slips and trips. All of Lockinex's galvanised stair treads are hot dip galvanised to BS EN 1461:2009.



GALVANISED OPEN STEEL TREADS WITH DURBAR NOSING

Bearing Bars (mm)	Tread Size (mm)	Openings (mm)	Code
25x5	800x288	30x100	OSST-11
25x5	1000x288	30x100	OSST-21
30x5	1200x318	30x100	OSST-31
25x5	600x108	30x100	OSST-03

GALVANISED OPEN STEEL TREADS WITH PERFORATED NOSING

Bearing Bars (mm)	Tread Size (mm)	Openings (mm)	Code
25x5	800x242	41x100	PERFORATED NOSING TREADS
25x5	1000x283	41x100	PERFORATED NOSING TREADS



TIGER GALVANISED PERFORATED TREADS

Holes Up (mm)	Holes Down (mm)	Tread Size (mm)	Openings (mm)	Code
12	07	800x250x42	41x100	Tiger-03

Clip for Perforated Treads



To Suite Tiger-03

• CLIP-45



STAIR TREAD NOSINGS & COVERS

A selection of hard wearing gritted GRP stair tread covers and nosings for installation on various styles of step such as concrete, wood and steel. All Lockinex stair nosings and covers offer high visibility and year round grip, helping to protect users from slips and trips and can be fixed using suitable adhesives or mechanical fixings.

GRP STAIR TREAD HI-VIS NOSING

Length (mm)	Width (mm)	Code
55	600	ST206-600mm
55	800	ST207-800mm
55	1200	ST208-120mm
55	1800	ST209-1800mm
55	2400	ST210-2400mm
55	3000	ST211-3000mm
55	3600	ST112-3600mm

GRP STAIR TREAD HI-VIS COVER

Length (mm)	Width (mm)	Code
55	600	ST106-600mm
55	800	ST107-800mm
55	1200	ST108-120mm
55	1800	ST109-1800mm
55	3660	ST212-3600mm

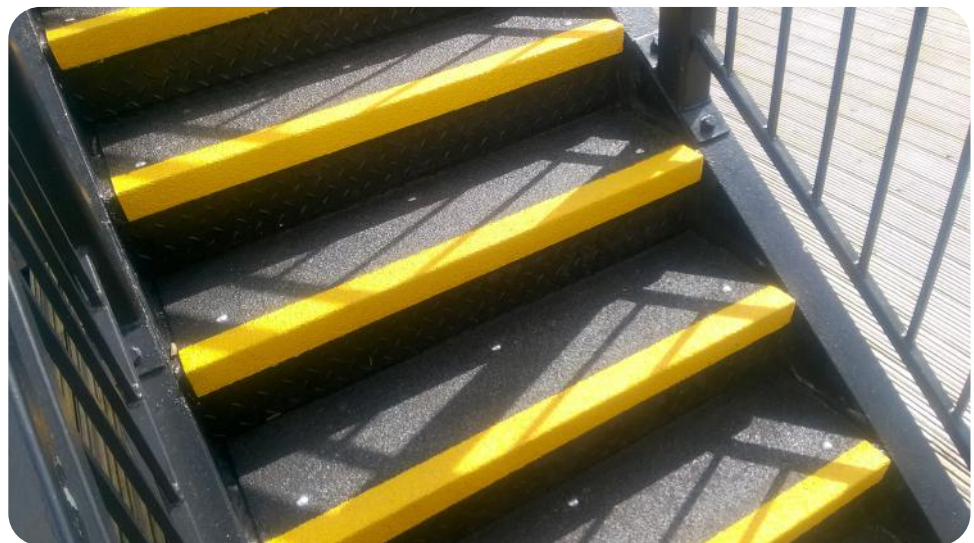

Email or call us to speak to our sales team:



sales@lockinex.com

01323 737 626

STEP OVER PLATFORMS

A range of off the shelf Stepover kits for fixing down to concrete or freestanding for rooftops. Designed and manufactured by Lockinex to BS EN ISO 14122-3:2016 (Permanent means of Access to Machinery, Stairs, Step Ladders & Guardrails).

FREE STANDING STEP OVER PLATFORM

Step overs **ensure safety** when navigating over hazards such as pipes, wall boundaries or a network of cables. They shield the user from the object and **prevent users from stepping, kicking or tripping on the object.**

Freestanding step over platforms are a heavy duty permanent structure ideally suited to rooftop areas where the roof membrane cannot be penetrated by fixings. All step overs are supplied in kit/component form, ready for **easy assembly on site.**



Underside Clearance	No. Of Treads	Platform Length	Platform Width	Code
145mm	1	*1.0 or 1.5mtr	800mm	SO-RF1-1
325mm	2	*1.0 or 1.5mtr	800mm	SO-RF2-1
505mm	3	*1.0 or 1.5mtr	800mm	SO-RF3-1
685mm	4	*1.0 or 1.5mtr	800mm	SO-RF4-1
865mm	5	*1.0 or 1.5mtr	800mm	SO-RF5-1
1045mm	6	*1.0 or 1.5mtr	800mm	SO-RF6-1
1225mm	7	*1.0 or 1.5mtr	800mm	SO-RF7-1
1405mm	8	*1.0 or 1.5mtr	800mm	SO-RF8-1
1585mm	9	*1.0 or 1.5mtr	800mm	SO-RF9-1



Email or call us to speak to our sales team:
sales@lockinex.com
 01323 737 626

*Platforms are supplied in 1.0 or 1.5mtr sections. Multiple sections can be bolted together to obtain overall needed platform length.



STEP OVER PLATFORMS

A range of off the shelf Steptover kits for fixing down to concrete or freestanding for rooftops. Designed and manufactured by Lockinex to BS EN ISO 14122-3:2016 (Permanent means of Access to Machinery, Stairs, Step Ladders & Guardrails).

FIXED STEP OVER PLATFORM

Step overs **ensure safety** when navigating over hazards such as pipes, wall boundaries or a network of cables. They shield the user from the object and **prevent users from stepping, kicking or tripping on the object.**

Fixed platforms are a heavy duty permanent structure which is bolted down into the ground using provided fixings. All Lockinex Fixed step over platforms come in kit form for **easy assembly on site.**



Underside Clearance	No. Of Treads	Platform Length	Platform Width	Code
145mm	1	*1.0 or 1.5mtr	800mm	SO-FB1-1
325mm	2	*1.0 or 1.5mtr	800mm	SO-FB2-1
505mm	3	*1.0 or 1.5mtr	800mm	SO-FB3-1
685mm	4	*1.0 or 1.5mtr	800mm	SO-FB4-1
865mm	5	*1.0 or 1.5mtr	800mm	SO-FB5-1
1045mm	6	*1.0 or 1.5mtr	800mm	SO-FB6-1
1225mm	7	*1.0 or 1.5mtr	800mm	SO-FB7-1
1405mm	8	*1.0 or 1.5mtr	800mm	SO-FB8-1
1585mm	9	*1.0 or 1.5mtr	800mm	SO-FB9-1

*Platforms are supplied in 1.0 or 1.5mtr sections. Multiple sections can be bolted together to obtain overall needed platform length.

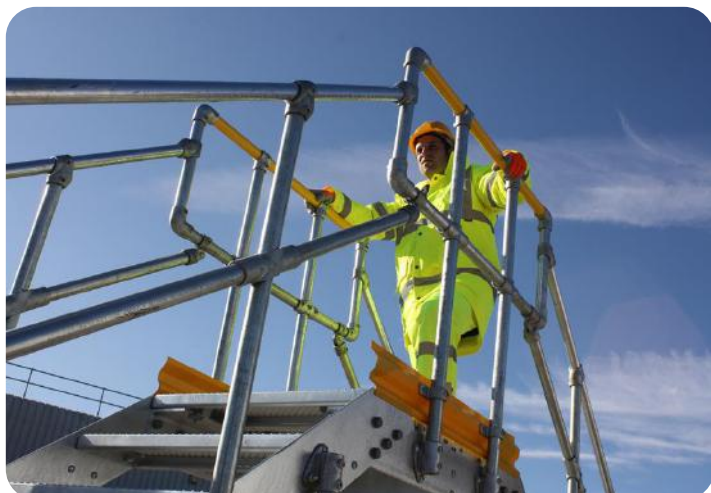

STEEL SECTIONS

A range of steel sections that can be used for a number of projects. Lockinex stocks round, square, flat bars or tubes with a choice of either a galvanised finish or a self colour finish ready for welding.

ANGLE IRON

Height & Width (mm)	Length	Thickness	Galvanised Code	Self Colour Code
25x25	3mtr	3mm	GAi25253-3	Ai25253-3
25x25	6mtr	3mm	GAi25253-6	Ai25253-6
40x40	3mtr	3mm	GAi40403-3	Ai40403-3
40x40	6mtr	3mm	GAi40403-6	Ai40403-6
50x50	3mtr	3mm	GAi50503-3	Ai50503-3
50x50	6mtr	3mm	GAi50503-6	Ai50503-6
75x75	3mtr	6mm	GAi75756-3	Ai75756-3
75x75	6mtr	6mm	GAi75756-6	Ai75756-6
100x100	3mtr	8mm	GAi1001008-3	Ai1001008-3
100x100	6mtr	8mm	GAi1001008-6	Ai1001008-6



SOLID FLAT BAR

Width (mm)	Thickness (mm)	Length	Galvanised Code	Self Colour Code
50	8	3mtr	GFB508-3	FB508-3
50	8	6mtr	GFB508-6	FB508-6
65	10	3mtr	GFB6510-3	FB6510-3
65	10	6mtr	GFB6510-6	FB6510-6
150	8	3mtr	GFB1508-3	FB1508-3
150	8	6mtr	GFB1508-6	FB1508-6
150	10	3mtr	GFB15010-3	FB15010-3
150	10	6mtr	GFB15010-6	FB15010-6



HOLLOW SECTION 3.75MTR LENGTH

Width (mm)	Height (mm)	Thickness (mm)	Galvanised Code	Self Colour Code
50	25	3	GRHS50253	RHS50253
60	40	3	GRHS60403	RHS60403
80	40	3	GRHS80403	RHS80403
100	50	3	GRHS100503	RHS100503
120	60	3	GRHS120603	RHS120603



STEEL SECTIONS

A range of steel sections that can be used for a number of projects. Lockinex stocks round, square, flat bars or tubes with a choice of either a galvanised finish or a self colour finish ready for welding.



SQUARE SECTION 3.75MTR LENGTH

Width (mm)	Height (mm)	Thickness (mm)	Galvanised Code	Self Colour Code
25	25	3	GSHS25253	SHS25253
30	30	3	GSHS30303	SHS30303
40	40	3	GSHS40403	SHS40403
50	50	3	GSHS50503	SHS50503
70	70	3	GSHS70703	SHS70703
90	90	3	GSHS90902	SHS90903
100	100	4	GSHS1001004	SHS1001004
120	120	5	GSHS1201205	SHS1201205

SELF COLOUR TUBE 3.75MTR LENGTH

Diameter (mm)	Thickness (mm)	Code
33.7	3	SHS25253
42.4	3	SHS30303
48.3	3	SHS40403
60.3	3	SHS50503
76.1	3	SHS70703
88.9	3	SHS90903



Steel Sections

SQUARE STEEL BAR



Height & Width (mm)	Length	Galvanised Code	Self Colour Code
20x20	3mtr	GSB2020-3	SB2020-3
20x20	6mtr	GSB2020-6	SB2020-6
40x40	3mtr	GSB4040-3	SB4040-3
40x40	6mtr	GSB4040-6	SB4040-6
50x50	3mtr	GSB5050-3	SB5050-3

WELDING DISCS, ELBOWS & CAPS

Lockinex Offers a range of self colour discs, elbows and caps for the engineer and fabricator. Ideal for welding onto tubular structures to create bends and neatly close off the ends of tube to give a smooth, streamlined finish.

WELDABLE ELBOWS

Lockinex welding elbows for handrails and balustrades are ideally suited for tubular constructions where aesthetics are of prime importance. The use of these welding elbows enables tight bends and curves to be obtained even on large diameter tubes and resolves the problem of either sharp mitred edges or distortion, which occurs on tubes when radiused.

They provide a neat safe joint which is permanent and strong. The engineer will benefit from the highest quality of manufacture giving dimensional accuracy. If required Lockinex welding elbows can be trimmed back to obtain any type of angle. After fabrication all kinds of finish can be applied to the material.

Lockinex welding elbows are available to suit a large range of tube sizes. Typical uses are for handrail, street furniture, protection barriers and all types of tubular constructions.



90 DEGREE WELDABLE ELBOWS

Diameter (mm)	Code
26.9	Weld-Elbow-26.9mm
33.7	Weld-Elbow-33.7mm
42.4	Weld-Elbow-42.4mm
48.3	Weld-Elbow-48.3mm
60.3	Weld-Elbow-60.3mm
76.1	Weld-Elbow-76.1mm
88.9	Weld-Elbow-88.9mm
114.3	Weld-Elbow-114.3mm
139.7	Weld-Elbow-139.7mm

45 DEGREE WELDABLE ELBOWS

Diameter (mm)	Code
42.4	Weld-Elbow-42.5mm-45
48.3	Weld-Elbow-48.3mm-45



Email or call us to speak
to our sales team:
sales@lockinex.com
01323 737 626

WELDING DISCS, ELBOWS & CAPS

Lockinex Offers a range of self colour discs, elbows and caps for the engineer and fabricator. Ideal for welding onto tubular structures to create bends and neatly close off the ends of tube to give a smooth, streamlined finish.

WELDABLE DISCS

Lockinex welding discs can be used by fabricators and welders to cap off handrail tube in conjunction with our weldable elbows or steel tubing.

An alternative to our tube plugs, Lockinex weldable discs provide a neat closer to many metal tubings. We offer a variety of discs with different diameters and thicknesses to suit the required tube cap.

The discs can also be used as base plating for handrail and our ball standards on multiple surfaces.



WELD DISC MILD STEEL

Diameter (mm)	Thickness (mm)	Code
32	3	D32-3mm
38	3	D38-3mm
38	6	D38-6mm
47	5	D47-5mm
60	5	D60-5mm
75	6	D75-6mm
89	6	D89-6mm

Diameter (mm)	Thickness (mm)	Code
100	3	D100-3mm
100	6	D100-6mm
127	5	D127-5mm
127	10	D127-10mm
150	5	D150-5mm



WELDING DISCS, ELBOWS & CAPS

Lockinex Offers a range of self colour discs, elbows and caps for the engineer and fabricator. Ideal for welding onto tubular structures to create bends and neatly close off the ends of tube to give a smooth, streamlined finish.

WELDABLE DOME CAPS

Lockinex welding dome caps can be used by fabricators and welders to cap off handrail tube and seal upright handrail.

An alternative to our tube plugs, Lockinex weldable discs provide a domed finish to many metal tubings.

It seals off tube resulting in a softer look and feel to handrailing systems, removing any sharp edges.



WELD DOME CAPS

To Suit Diameter (mm)	Diameter (A) (mm)	Code
26.9	15	WC-05
42.4	28	WC-07
60.3	35	WC-09

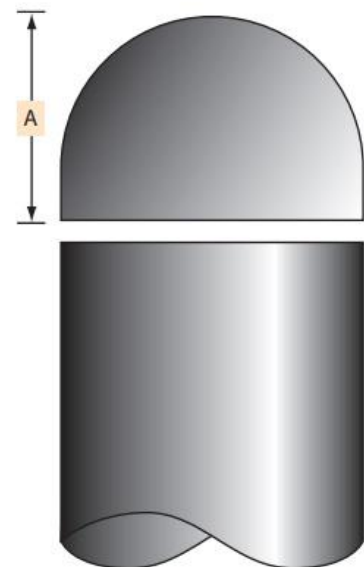

WELDABLE BASE PLATES

Lockinex Offers a range of self colour weldable base plates for use with our ball standard range or for use on your own bespoke projects. Various styles are available to suit your requirements.

WELDABLE BASE PLATES

Lockinex self colour weldable base plates designed to use in conjunction with our Ball standards handrail systems or for your own bespoke post designs.

We supply various shapes and sizes with different hole placements to suit your needs. Bespoke made to order base plates for large quantities are also available. Contact us for further information and pricing.



TRIANGULAR BASE PLATE 150 X 150

Holes Spacing (mm)	Thickness (mm)	Code
150	12	BP-04

RECTANGULAR BASE PLATE 200 x 65MM

Holes Spacing (mm)	Thickness (mm)	Code
100	12	BP-01
150	12	BP-02

CUSTOMER TESTIMONIALS

Don't just take our word for it read some of the numerous five star reviews we have gotten from previous customers!

“ Used Lockinex for many years and always been happy with the service. Fast replies to queries, always competitive costs and quick delivery times. Would recommend. ”



“ Fantastic company to deal with, knowledgeable, helpful and good value, highly recommend. ”



“ We have been buying Barrier products for 30 years, we find Lockinex provide the best prices with a high level of service. ”



CUSTOMER TESTIMONIALS

Don't just take our word for it read some of the numerous five star reviews we have gotten from previous customers!

“ Over the years, we have used Key Clamps from Lockinex for many projects ranging from workbenches and guard railing to custom built storage racking. The product has always performed to our expectations and the service has been first class. ”



“ Great range of stocked products, well mannered staff and prompt deliveries. Overall a very pleasant company to deal with, will keep using! ”



“ We always purchase our weld elbows from Lockinex and always receive a quick delivery service. Good stock levels and accurate paperwork. Would Highly recommend! ”



CASE STUDIES

Take a look at our case studies showcasing some of the projects we have worked on with clients at industrial and commercial sites

Guardrail for Newhaven Port & Harbour

We were first contacted to complete a site survey for our client working on a project at Newhaven port, revolving around creating and supplying a guardrail system designed for use by cyclists and pedestrians.

The guardrail was to be installed within the Newhaven dock area to separate cyclists and pedestrians from a busy road where heavy goods vehicles frequently drive.

Once the site survey was completed by our team, we supplied our Lockinex branded key clamp and galvanised tube to our client at Newhaven port where it was then installed.



Step Over Access Platform Newhaven Port & Harbour

A site survey was first completed at the docks for our client to acquire safe and secure access for ship crew members to manoeuvre over large sea walls and gain access to crew only areas.

It was agreed that our Step Overs were suitable to allow easy and safe access over the concrete walls for crew members when disembarking.

We supplied numerous Step Overs designed and manufactured by Lockinex which were then installed by a local construction company.

GRP Cutting & Sealing

We were contacted by our client (a steel fabrication company) who were working on a project at an industrial factory to install brand new service platforms for machine maintenance.

The client requested custom cut GRP grating and suitable clips which we produced in house, ready for delivery and quick installation on site.



CASE STUDIES

Take a look at our case studies showcasing some of the projects we have worked on with clients at industrial and commercial sites



Step Over Platforms For a Prestigious University

29 Step over units were supplied to one of our customers to install at a prestigious university in London. These were required to be installed on a large rooftop area to allow safe access over various ducts, pipes and electrical cables.

We manufactured these 29 stepovers in house along with layout drawings and installation instructions for a smooth installation process for our customer.

Armco Crash Barrier at Dover Docks

Lockinex have provided Dover docks with various orders of armco crash barrier used to help protect and segregate pedestrians and traffic and to help protect certain buildings and assets.

Hi-vis yellow powder coated armco beams with attached handrail system along with standard galvanised finish armco barrier have all been used to provide the desired level of protection.

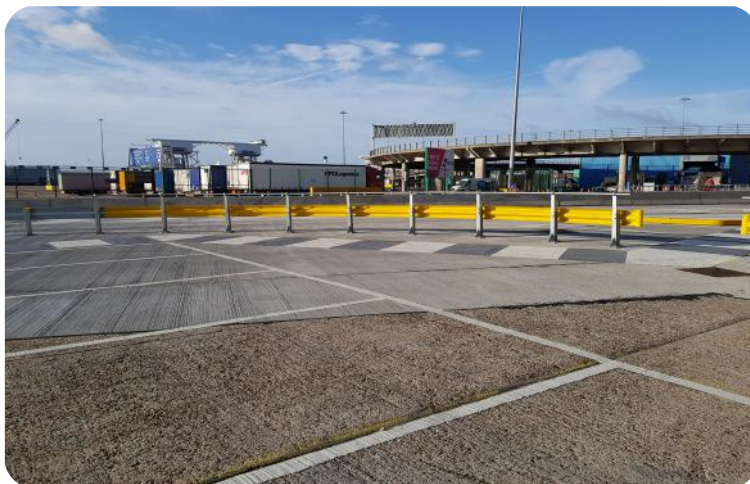

INDEX

Easily locate and search for Lockinex products using this handy index of familiar & relatable known product names that are listed throughout this brochure & its sections.

- A**
- Access Ladders 12-15
 - Anti Slip - GRP 30-32, 69
 - Armco Barrier 16-19
- B**
- Ball Type Guardrail Posts 34-35
 - Balustrades Systems 34-35
 - Bolts - Fixing Down 23
 - Bollards - Parking 20
 - Bollards - Plastic 20
 - Bollards - Steel 20
 - Box Beam Barrier 19
 - Bump Stop Rubber 21
- C**
- Cantilever Gate Kit 27-29
 - Caps - For Welding 76
 - Car Park Barrier 16-19, 20
 - CAT Ladders 12-15
 - Column Guards - Steel 21
 - Composite Decking 08, 10
 - Composite Fencing 09-10
 - Corner Guards Rubber 21
 - Crash Barrier 16-19
- D**
- DDA - Non Slip Products 32, 69
 - DDA Compliant Handrail ... 36, 37
 - Decking Boards 08
 - Discs - For Welding 75
 - Dome Caps - For Welding ... 76
 - Durbar Stair Treads 67
- E**
- Edge Protection Systems
 - For Roofs..... 60-64
 - Elbows - For Welding 74
 - Estate Fencing 05
 - Equipment Support Feet 65
- F**
- Fencing - Composite 09-10
 - Fencing - Estate 05
 - Fixings & Fastenings 19, 23
 - Flooring - GRP 30-32
 - Flooring Clips For GRP Grating 31
 - Flooring Clips For Steel Flooring 66, 68
 - Fixed Roof Guardrail 64
 - Freestanding Roof Guardrail..... 60-63
 - Fruit Cage 06
- G**
- Galvanised Tube 44
 - Gate Springs & Hinges 25
 - Gate Systems 25-29
 - GRP Handrail 38, 44, 57
 - GRP Key Clamp 38, 57
 - GRP Mesh Flooring/Grating ... 30-31
 - GRP Stair Nosing & Covers 32, 69
 - GRP Profiles 33
 - Guardrail - GRP 38, 44, 57
 - Guardrails - Highways 39
 - Guardrails - Key Clamp 38, 48-57
 - Guardrails - Pedestrian 39, 56
 - Guardrails - Quick Kits 38, 56-57
 - Guardrails - Ready Made Kits ... 38, 56-57
 - Guardrails - Roof Edge 38, 56-57

INDEX

Easily locate and search for Lockinex products using this handy index of familiar & relatable known product names that are listed throughout this brochure & its sections.

H

Handrails For Ramps	36-37
Handrail Support Brackets	36-37
Handrail Brackets	36-37, 41
Handrail Tube Connectors	36, 45
Handrail Ball Type Posts	34-35
Handrail DDA Compliant.....	36-37
Handrail - GRP	38, 44, 57
Handrail - Key Clamp	38, 48-57
Handrail Stainless Steel	40-41
Handrail Tube	44
Highway Guardrails	39
Hoop Ladders	12-15
Hi vis workwear	58-59

K

Key Clamp - Fast Kits	38, 56-57
Key Clamp - GRP	57
Key Clamp - Kits	06-07
Key Clamp - Mesh Infill Panels	42-43
Key Clamp - Quick Kits	38, 56-57
Key Clamp - Ready Made Kits	38, 56-57
Key Clamp - Steel	48-56
Kick Plate Brackets.....	46-47
Kickplates - GRP	38, 46
Kickplates - Steel	46

L

Ladders - Access/CAT/Hoop	12-15
---------------------------------	-------

M

Mesh Clips - For Infill Panels	43, 55
Mesh Flooring - GRP	30-31
Mesh Infill Panels - Guardrails	42-43
Mezzanine Pallet Gates.....	26
Mirrors Safety	22

N

Non Slip Stair Nosings - GRP ...	32, 69
Non Slip Gratings - GRP	30-31
Non Slip Sheet - GRP	32
Non Slip Stair Covers - GRP	32, 69

O

Open Box Beam Barrier	19
Open Steel Stair Treads.....	67-68
Open Steel Flooring.....	66

P

Pallet Gates	26
Parking Bollards	20
Pedestrian Guardrails	39, 56
Pillar Guards	21
Plastic Bollards	20
Posts - Armco	17
PPE - Hi vis workwear	58-59
Profiles - GRP	33
Profiles Steel	72-73

Q

Quick Kits - Key Clamp	38, 56-57
------------------------------	-----------

R

Ramp Handrail	36-37
Ready Made Key Clamp	38, 56-57
Roof Access Ladders	12-15
Roof Edge Guardrail Systems ..	60-64
Rubber Corner Guards	21

INDEX

Easily locate and search for Lockinex products using this handy index of familiar & relatable known product names that are listed throughout this brochure & its sections.

S

Safety Gates	14, 25-26
Safety Mirrors	22
Scaffold Boards	11
Scaffold Fittings	11
Self-Closing Gates	14, 25
Shims -Trouser	24
Sliding Gate Kits	27-29
Speed Bumps	22
Splice Locks	36, 45
Spring Units For Gates	25
Stair Tread Nosing - GRP	32, 69
Stair Treads Steel	67-68
Stainless Steel Handrail	40-41
Steel Flooring.....	66
Steel Tube	44, 73
Step Over Platforms	70-71
Steel Sections	72-73

T

Tarmac Fixings	23
Toe Board - Brackets	46-47
Toe Board - GRP	38, 46
Toe Board - Steel	46-47
Trouser Shims	24
Tube Connectors	36, 45
Tube Clamps	48-57
Tube - GRP	38, 44, 57
Tube - Steel	44, 73

U

U-Bolts	23
---------------	----

V

Vehicle Barrier	16-19, 20
-----------------------	-----------

W

Warehouse Barriers ...	14, 16, 19, 21, 25
Weldable Caps	76
Weldable Discs	75
Weldable Elbows	74
Wheel Stops	21
Working At Height ...	12-15, 26, 60-64, 70-71

NOTES

A large rectangular area with a thin black border, containing 18 horizontal dotted lines for writing notes.



Lockinex
great service, great quality



📞 01323 737 626

✉ sales@lockinex.com

🌐 www.lockinex-store.com