

# SOCIAL NORMS WILL BE CHALLENGED



Prepared by: Marie Linsenhoff  
SM15

# God's bondage



Censored Freedom

Mad fighter

Challenging Oppression



# G O D ' S B O N D A G E

**Freddie Mercury's music video of "Living on my own" inspired me, it was filmed at his 49th birthday and banned until 2019, because of potentially disturbing content for society. My skirt collection is a message of freedom and a fight against oppression, after the saying be bold, be you, be free.**

God's Bondage - refers to not owning your own body, due to not expressing it in the way you want, because of social norms or religious oppression or many more.



Polarising Chique

# **DESIGN DEVELOPMENT**

# “I WANT TO BREAK FREE” SKIRT

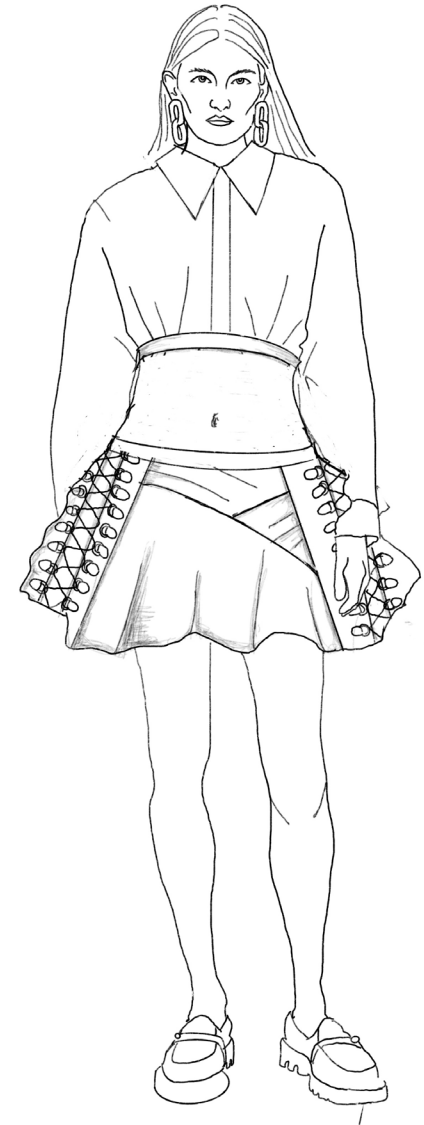
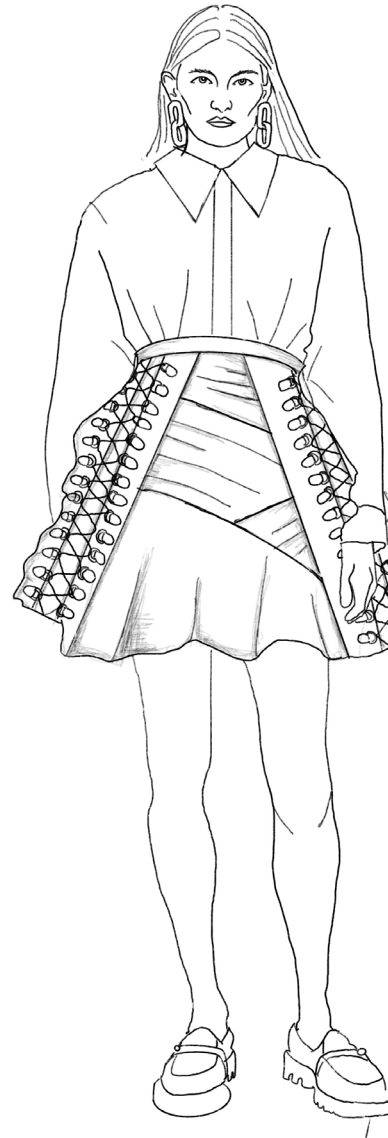

Window 1

# "I WANT TO BREAK FREE" SKIRT 1

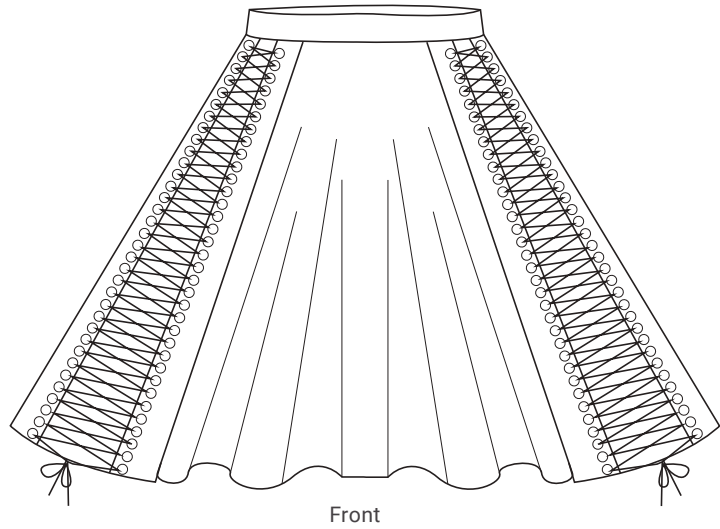

# "I WANT TO BREAK FREE" SKIRT 2

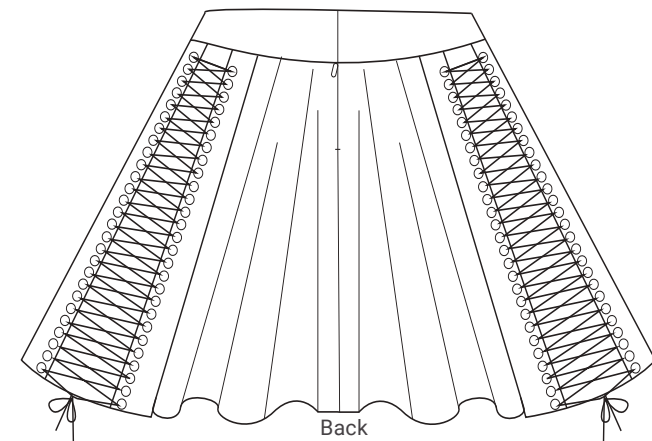
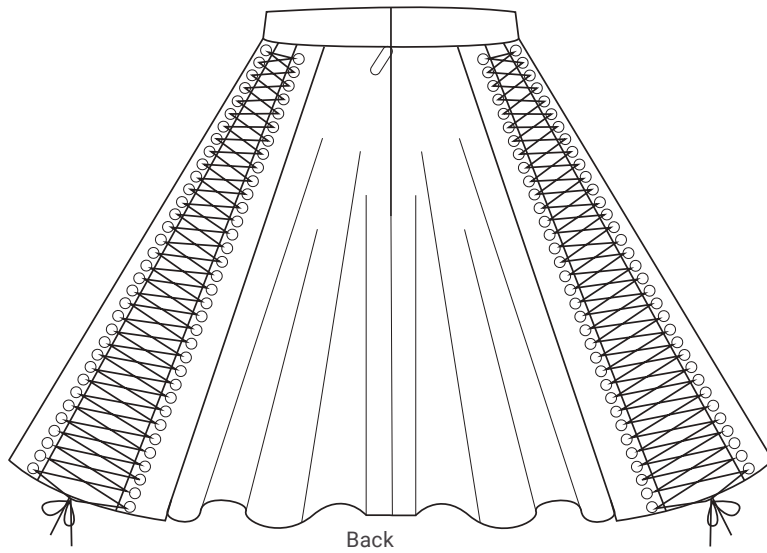
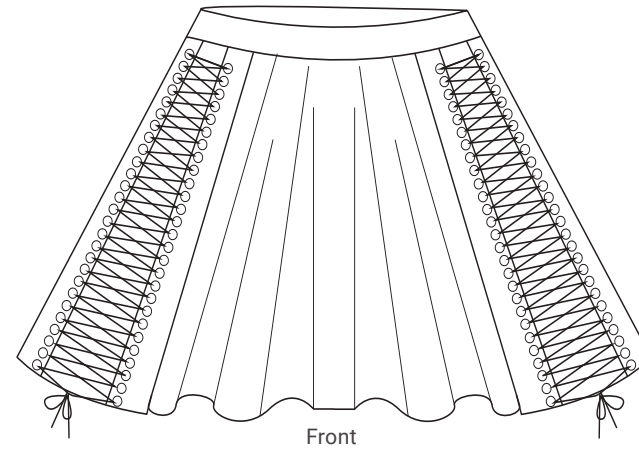

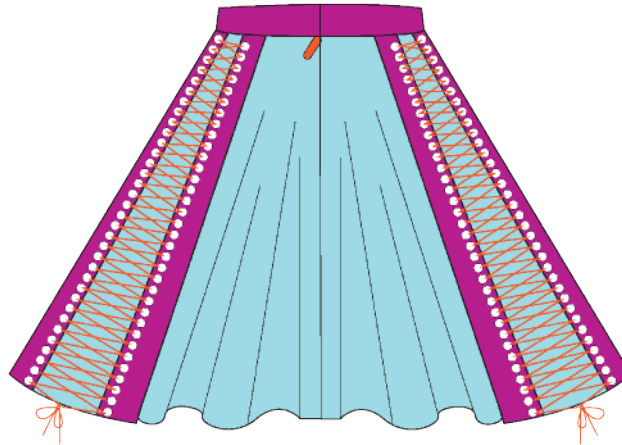
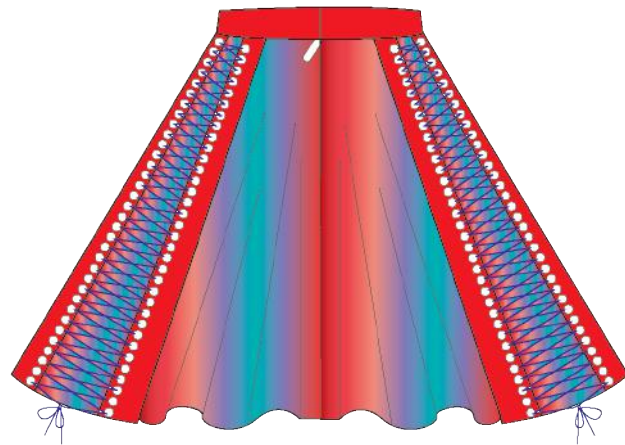
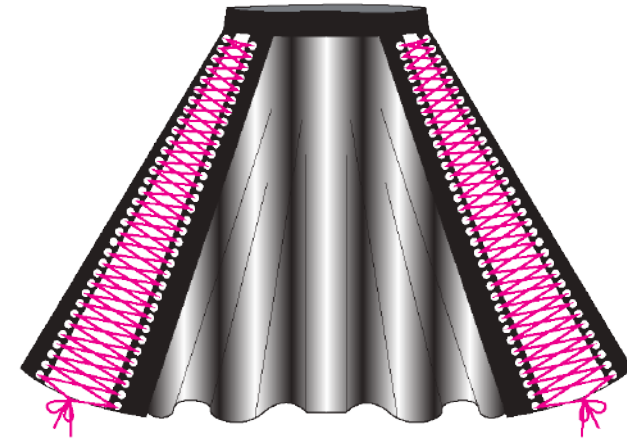
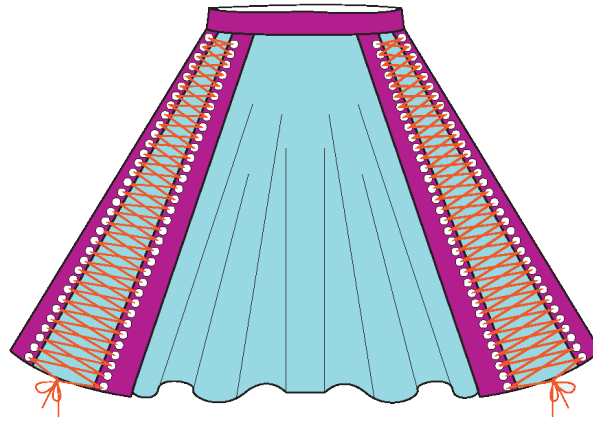
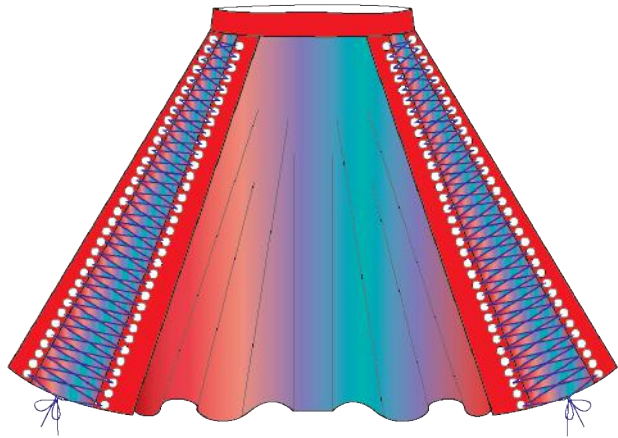

COLOR OPTIONS



JANE

Art.: U1-76-32-69 /NS 100

Comp.: %100 COTT Weight: 148 +- %2

Width: 170 +- %5



SETTEBELLO

Art: Noppa Real Lux

Comp: %100 Leather

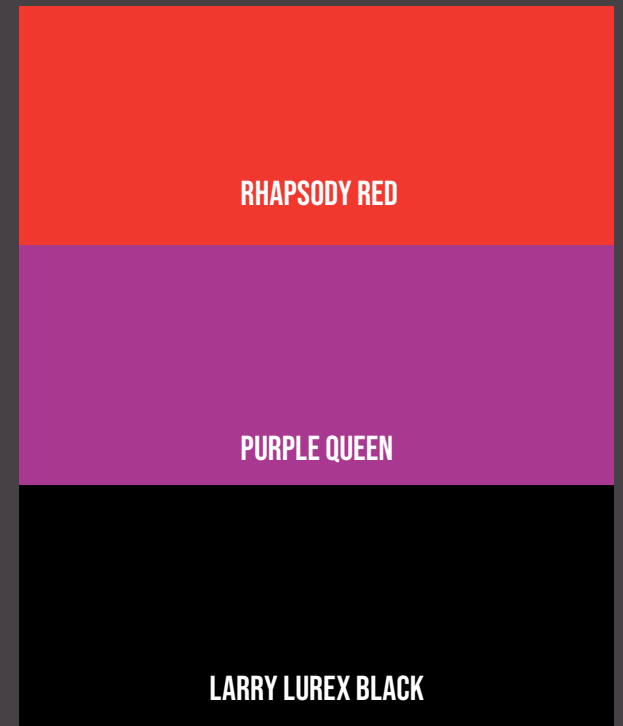

# ZANZIBAR SKIRT



Window 2

# ZANZIBAR SKIRT 1

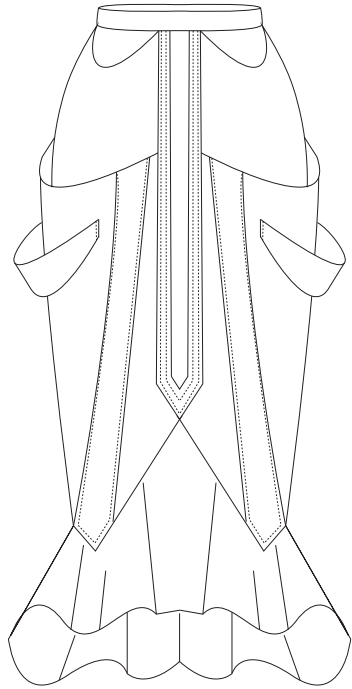

Front

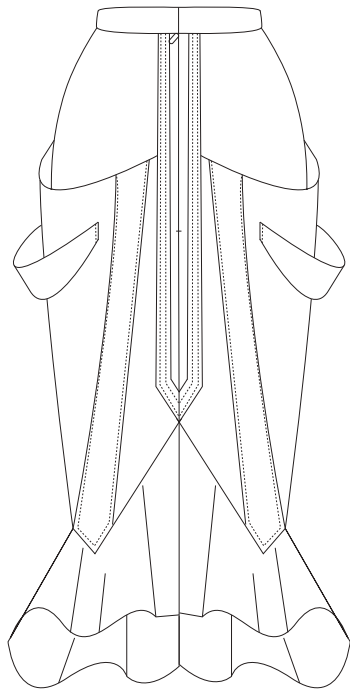

Back

# ZANZIBAR SKIRT 2

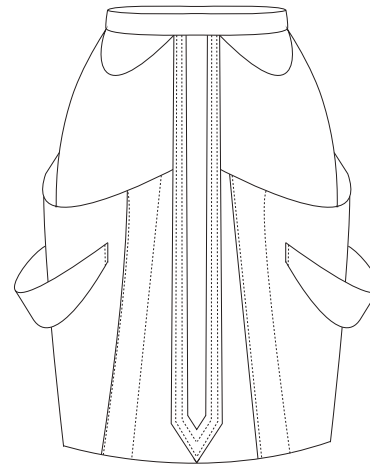

Front

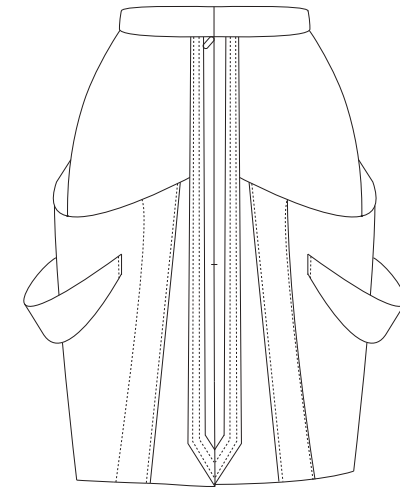

Back

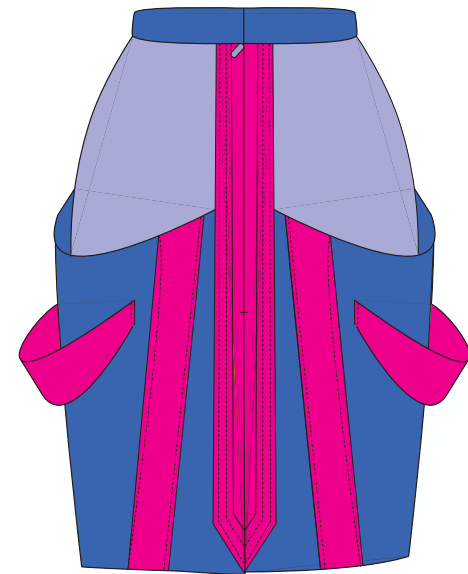
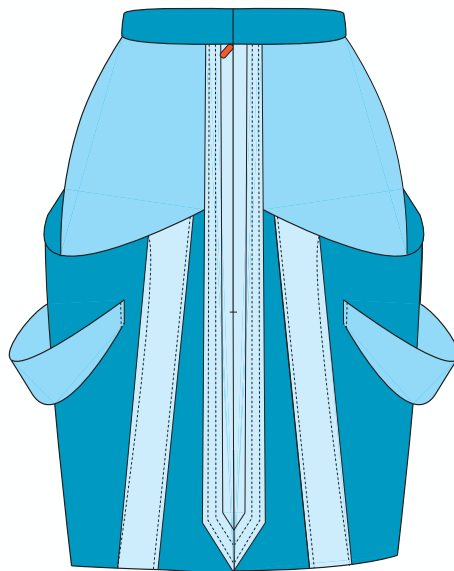
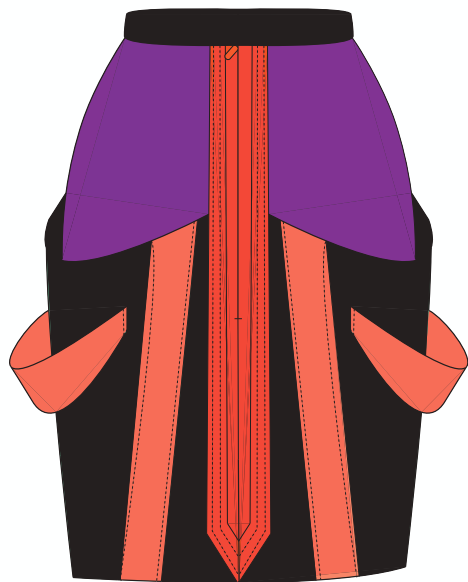
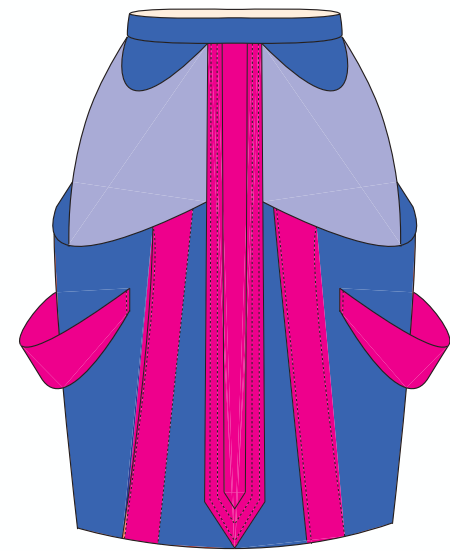
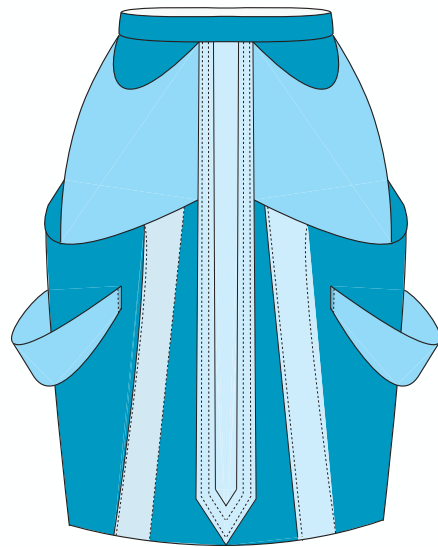
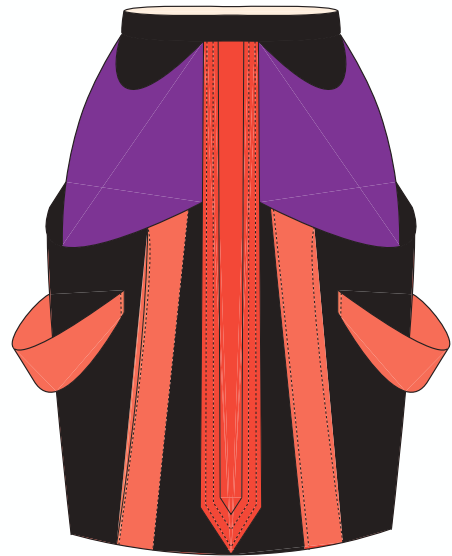

COLOR OPTIONS

WHISPER

Art.: 53214/00002 Comp.: %33 PA - 67% CO

Alt: 140 cm Paso: 0386 Gr/mtl



ROANNE

Art.: U1-77-9/NS2131 Comp.: %97 COTT %3 EA

Weight: 200 +- %5 Width: 150 +- %2

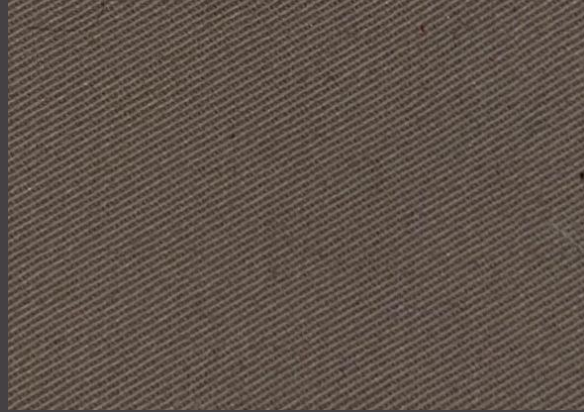

DULCE3.F10100

H.TOT.CM: 153+/-3% GR/MT SQ. 300

LIN. 459 STAB.ORDITO: -3%/+2 STAB.TRAMA: -4% +2



LARRY LUREX BLACK

LOVER BOY BLUE

MELANCHOLY BLUE

KILLER QUEEN PURPLE

COOL CAT BLUE

DELILAH GREY

SLIGHTLY MAD ORANGE

FAIRY KING BLUE

POWER PINK

# MARY AUSTIN SKIRT

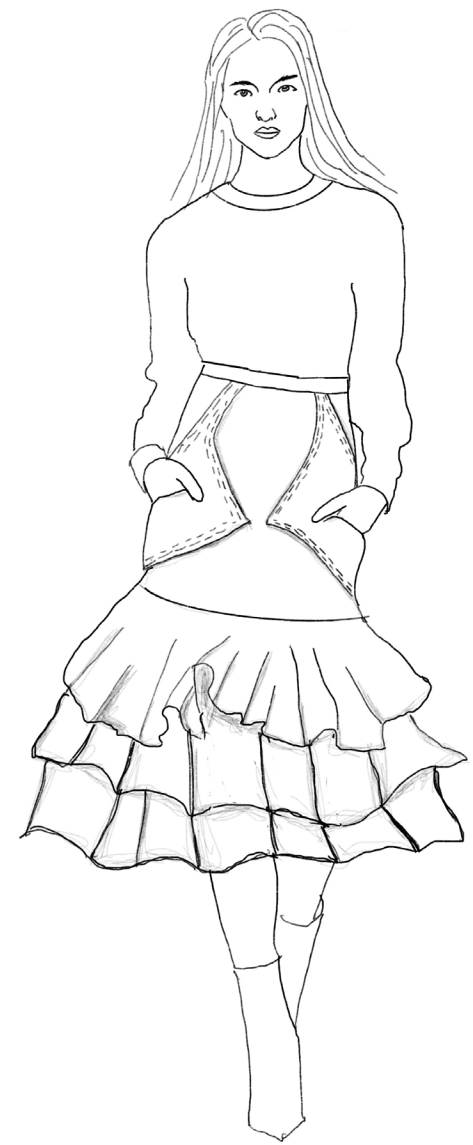

Window 3

# MARY AUSTIN SKIRT 1

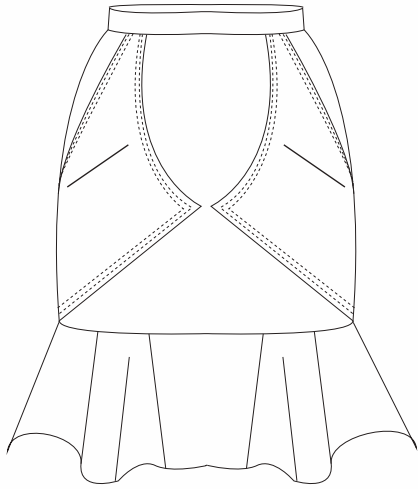

Front

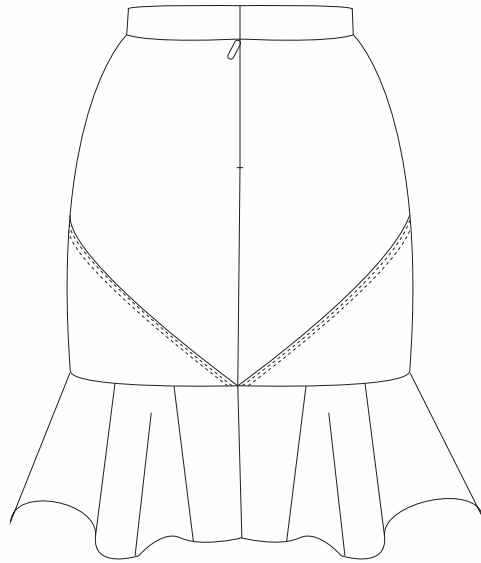

Back

# MARY AUSTIN SKIRT 2

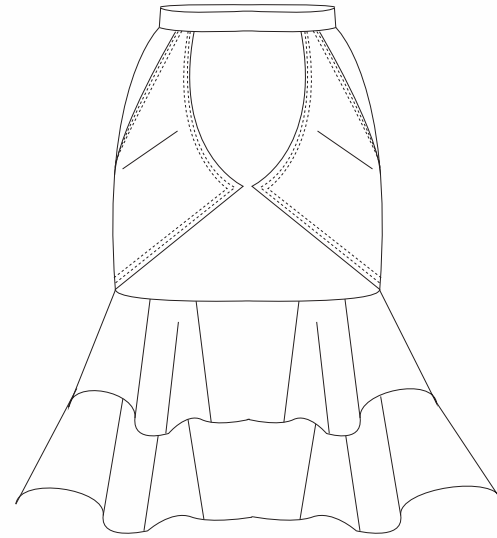

Front

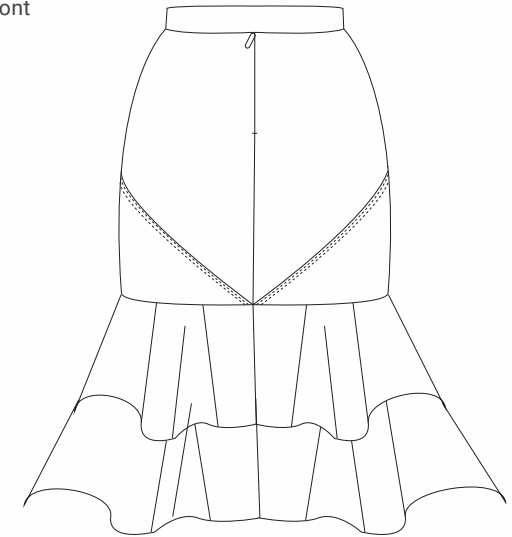

Back

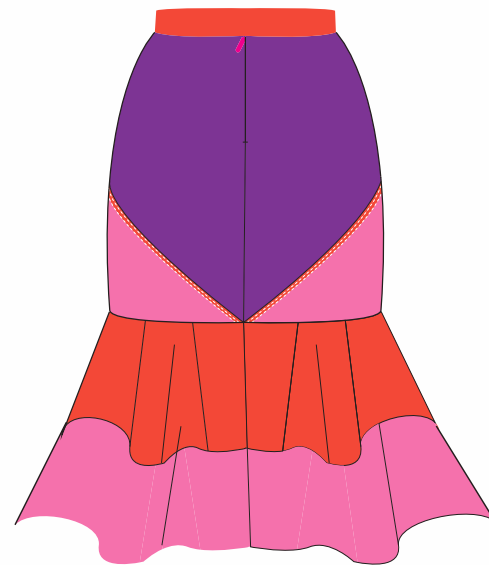
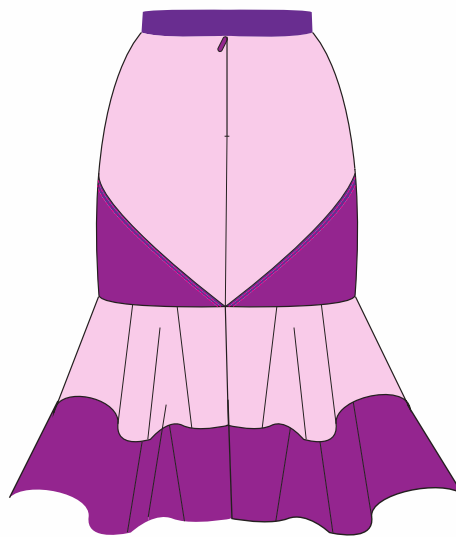
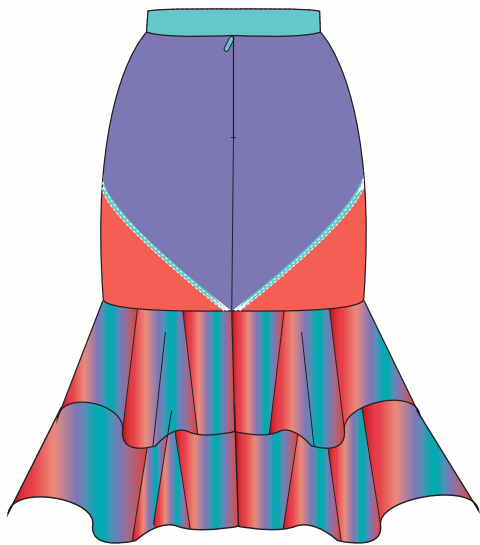
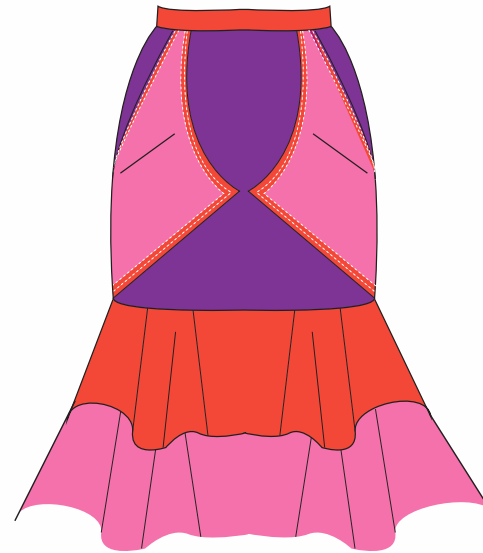
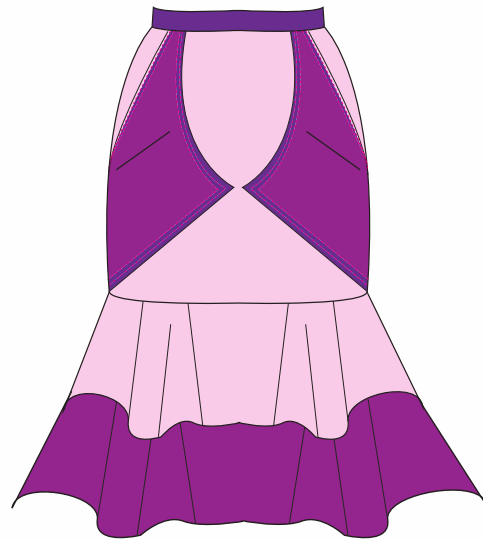
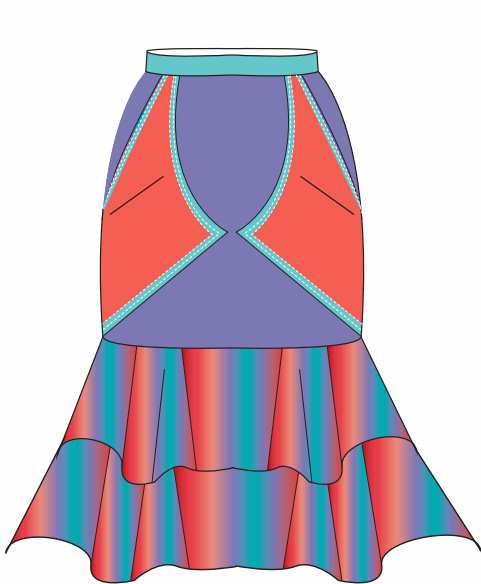

**COLOR OPTIONS**



WHISPER

Art.: 53214/00002 Comp.: %33 PA - 67% CO

Alt: 140 cm Paso: 0386 Gr/mtl



WHISPER

Art.: 53214/00002 Comp.: %33 PA - 67% CO

Alt: 140 cm Paso: 0386 Gr/mtl



ROANNE

Art.: U1-77-9/NS2131 Comp.: %97 COTT %3 EA

Weight: 200 +- %5 Width: 150 +- %2

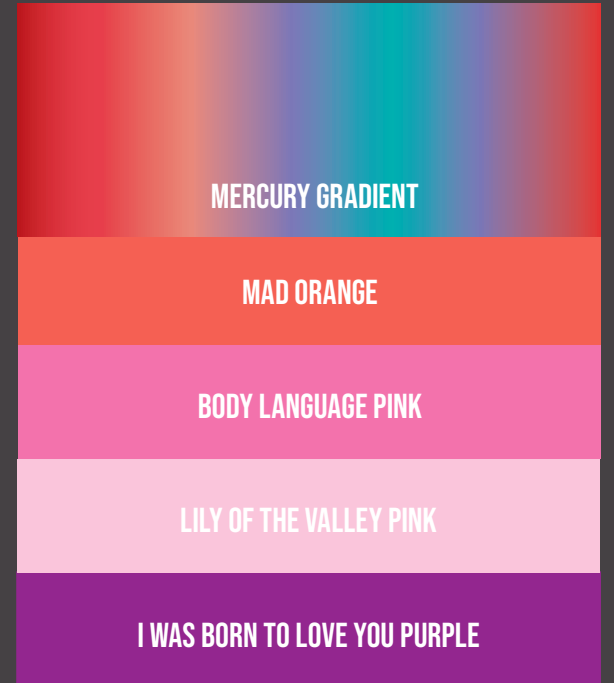
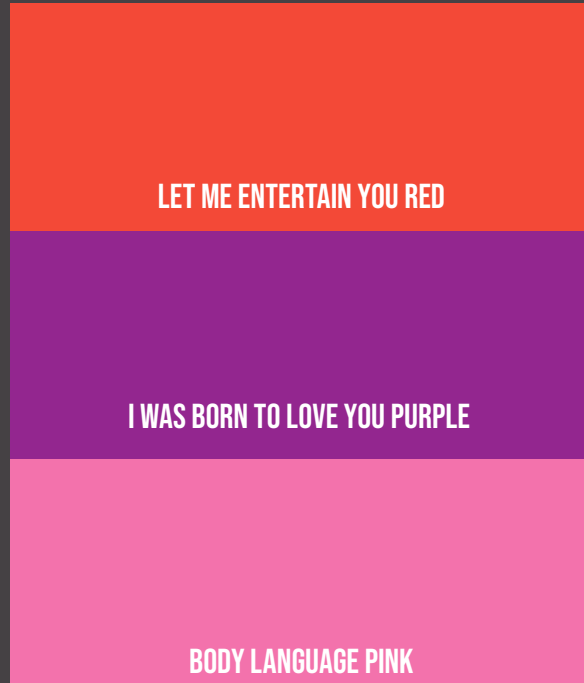
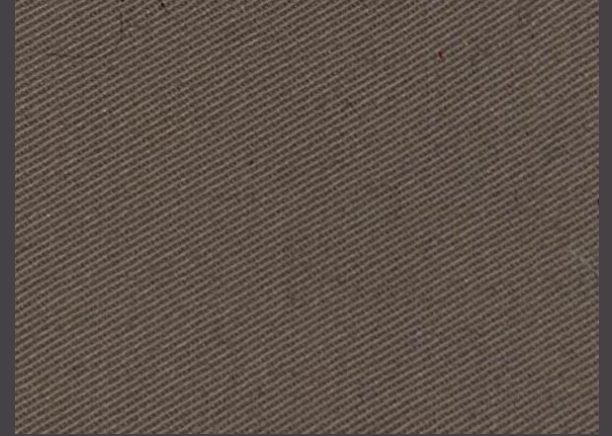

# BARCELONA SKIRT

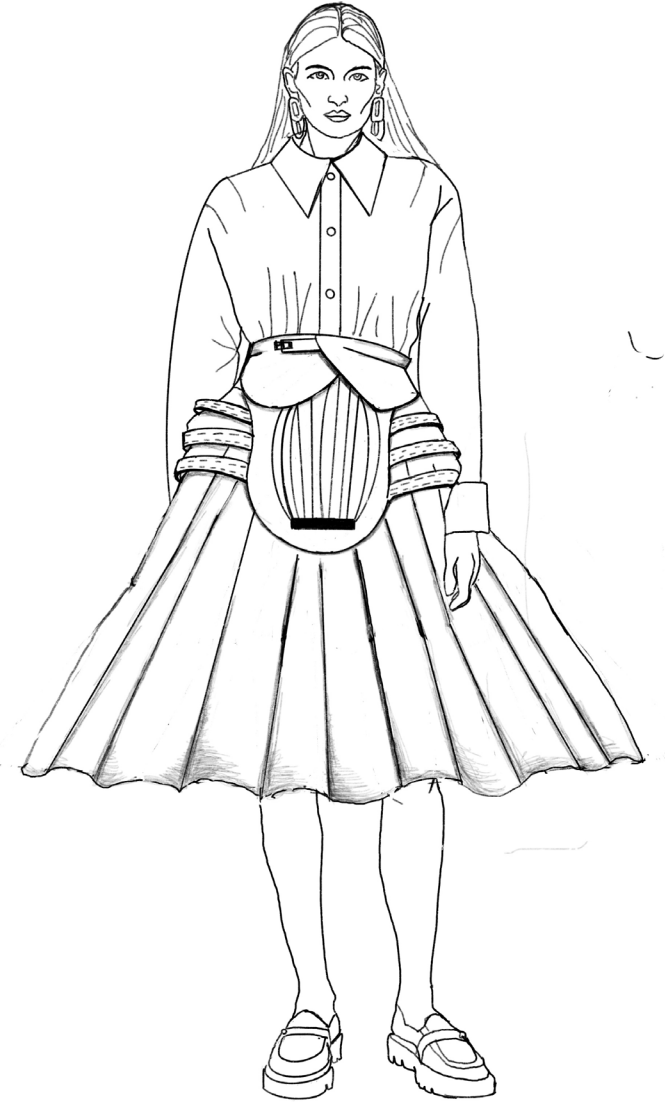
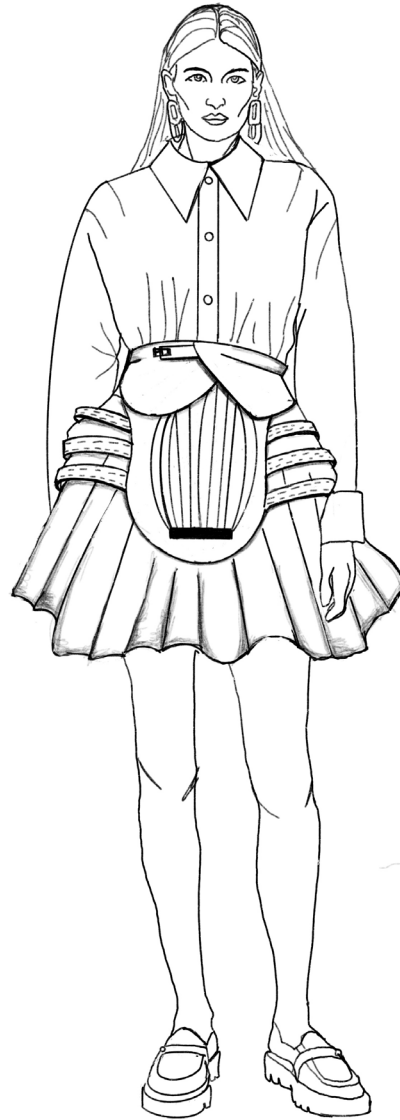

Window 4

# BARCELONA SKIRT 1

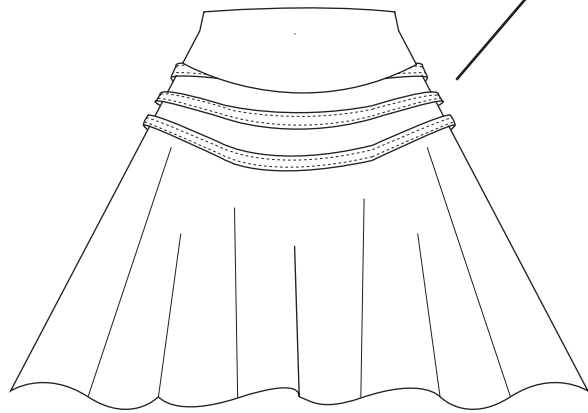

Back

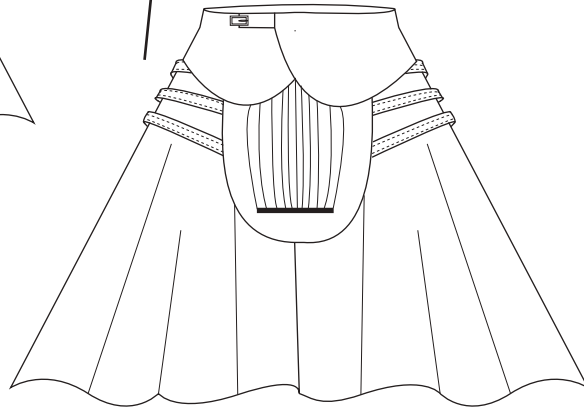
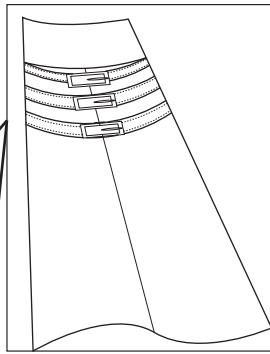

Front

# BARCELONA SKIRT 2

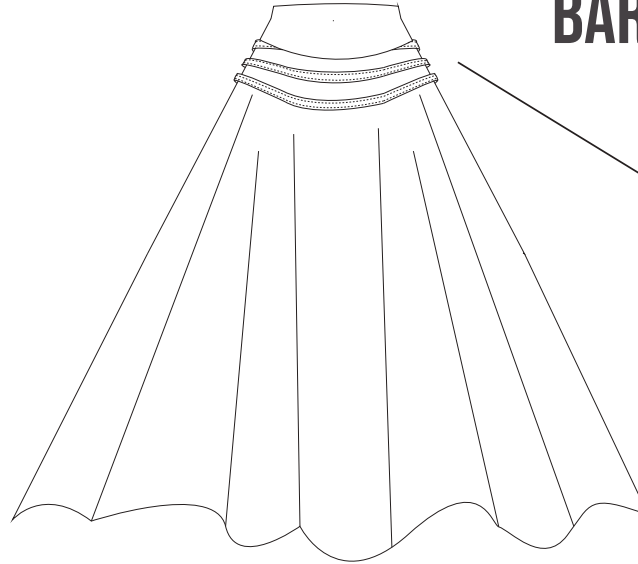

Back

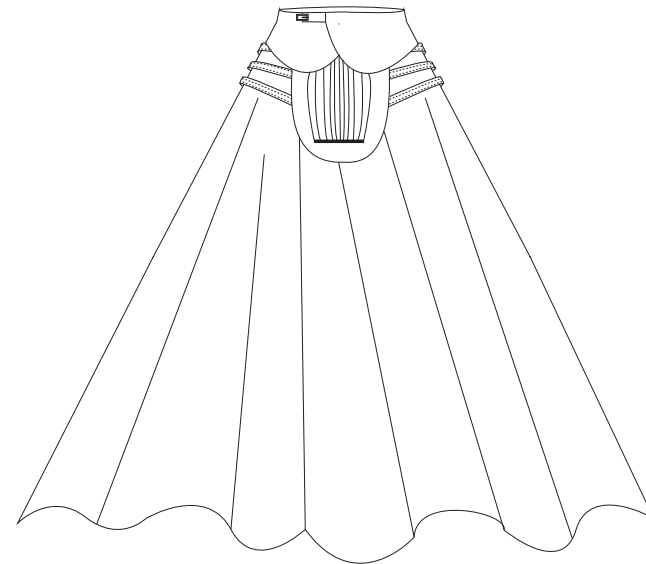
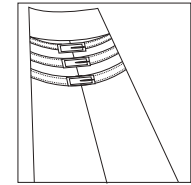

Front

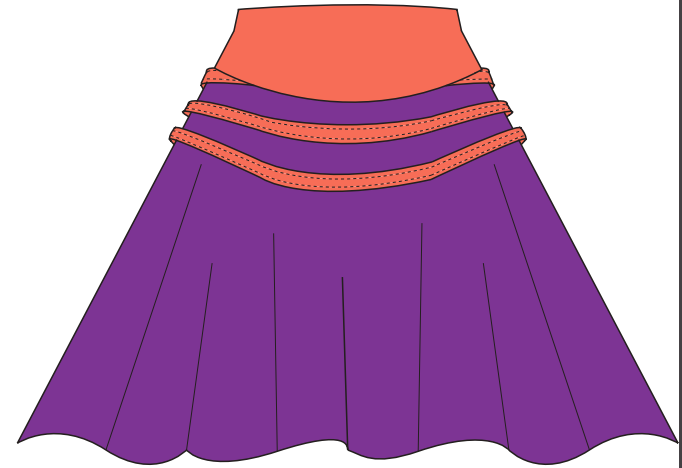
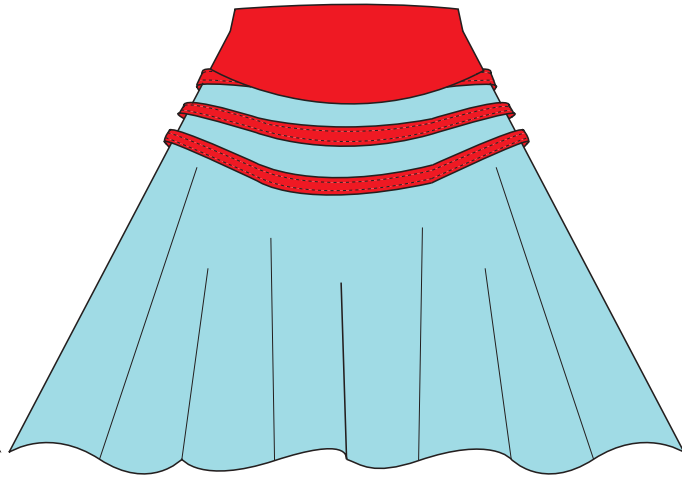
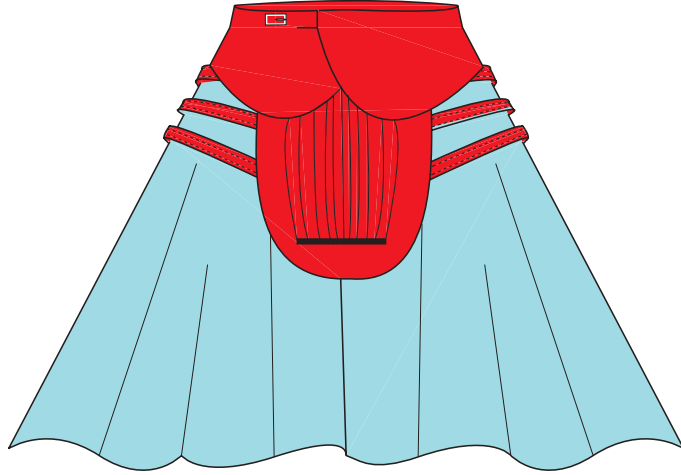

**COLOR OPTIONS**

JANE

Art.: U1-76-32-69 /NS 100

Comp.: %100 COTT Weight: 148 +- %2 Width: 170 +- %5



DUATE CERF

Comp.: %100 Leather Thickness: 14/16

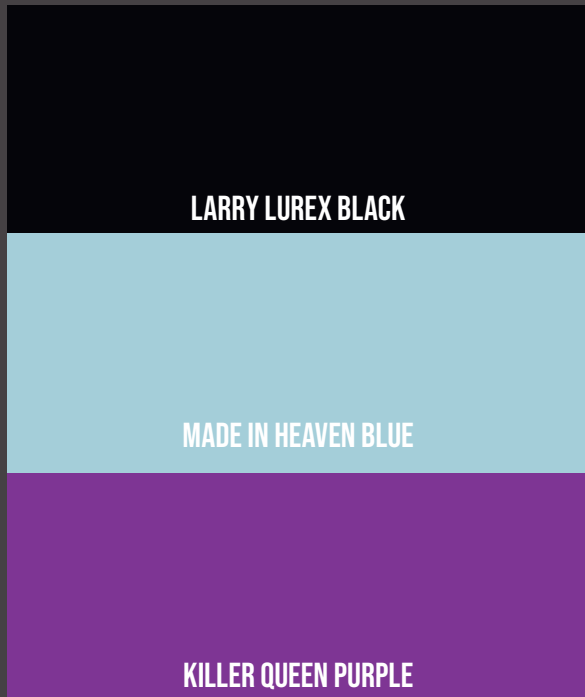

# BREASTS OF LIBERTY SKIRT

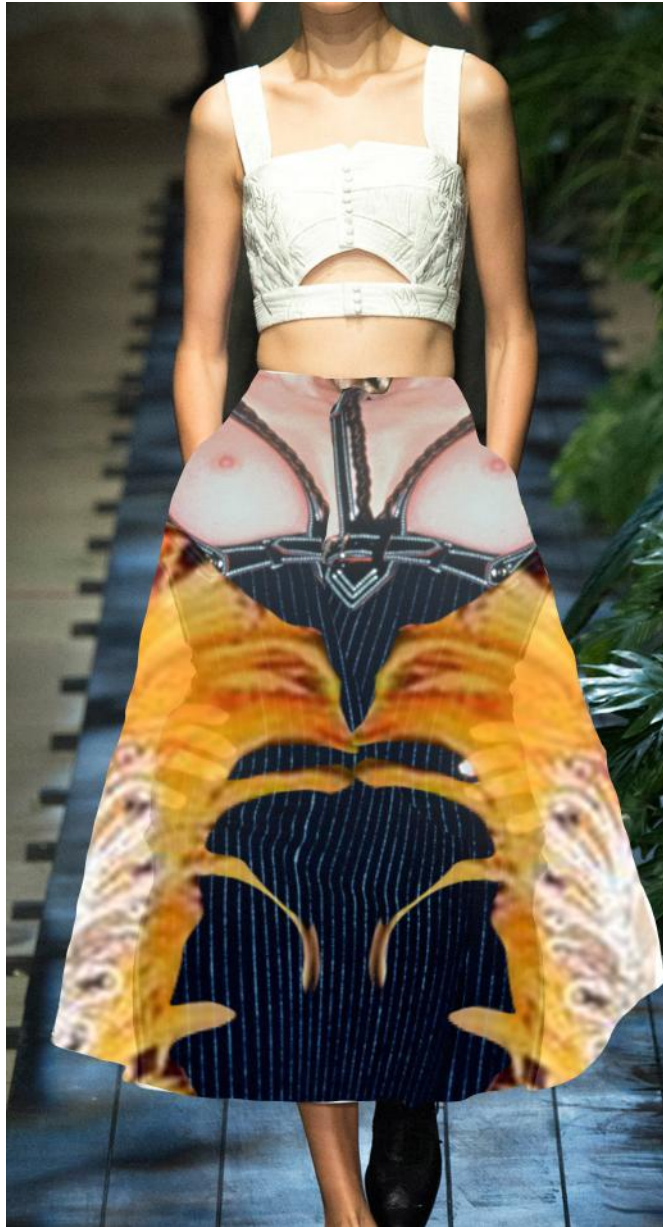

Window 5

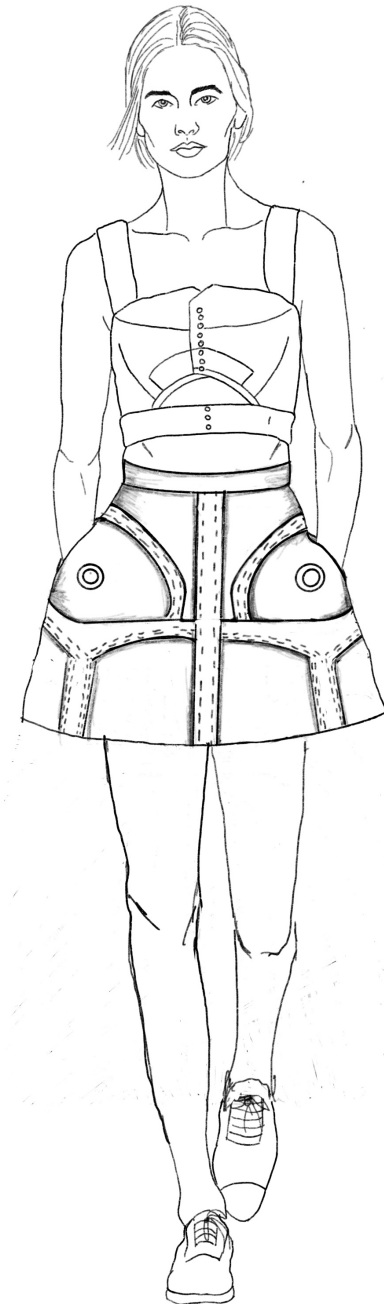
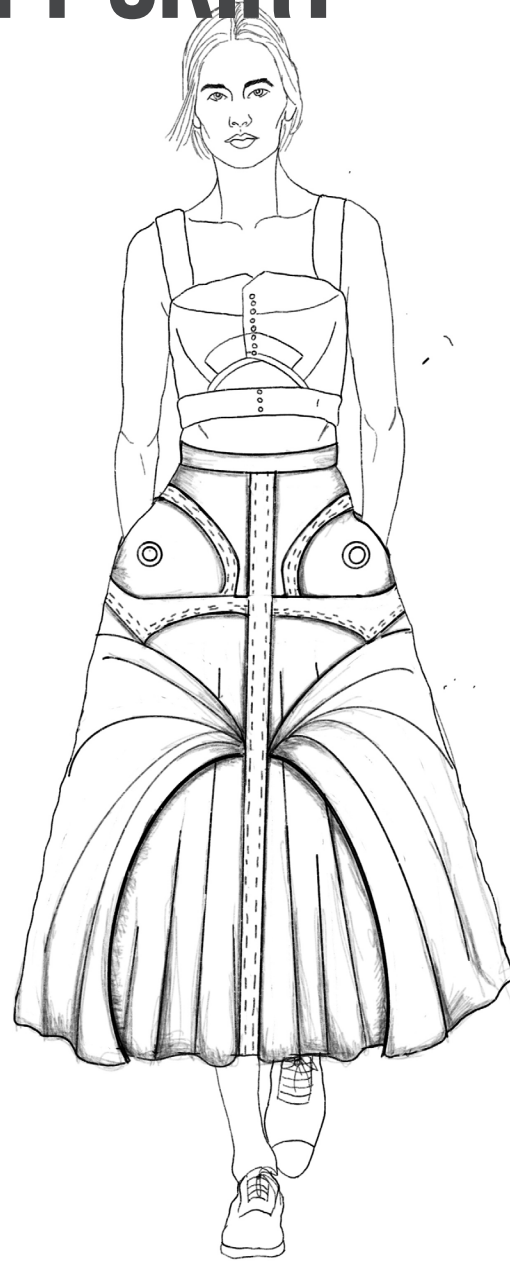

# BREASTS OF LIBERTY SKIRT 1

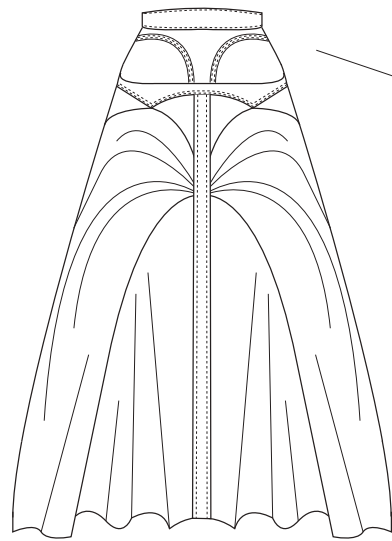

Back

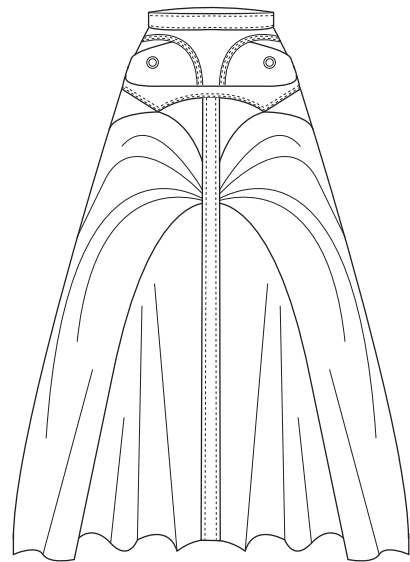
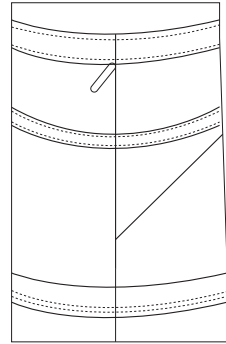

Front

# BREASTS OF LIBERTY SKIRT 2

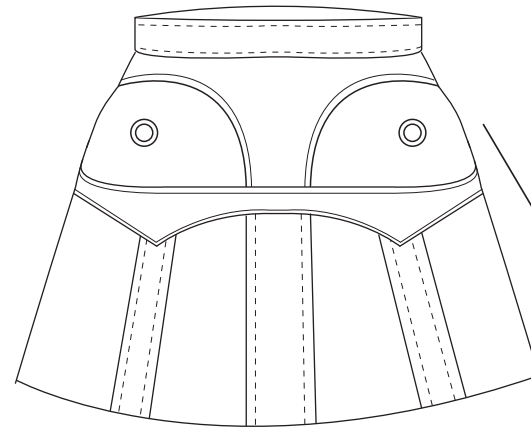

Front

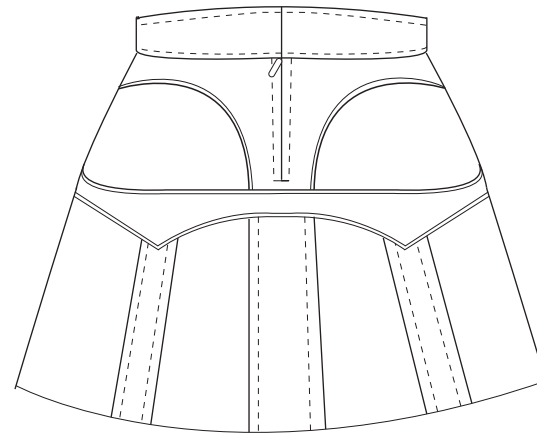
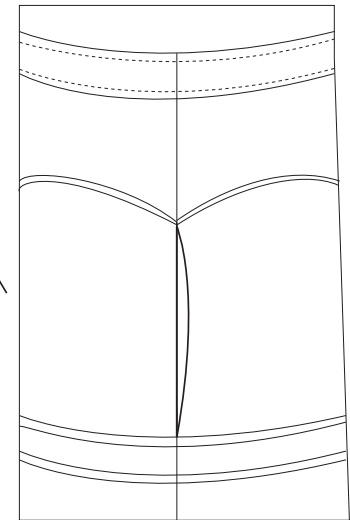

Back



**COLOR OPTIONS**



ROANNE

Art.: U1-77-9/NS2131 Comp.: %97 COTT %3 EA

Weight: 200 +- %5 Width: 150 +- %2

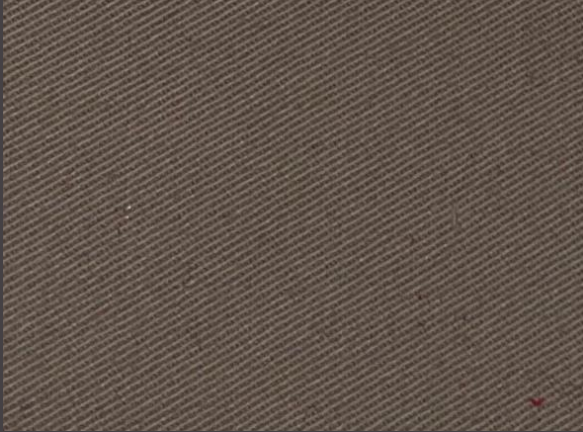

ROANNE

Art.: U1-77-9/NS2131 Comp.: %97 COTT %3 EA

Weight: 200 +- %5 Width: 150 +- %2

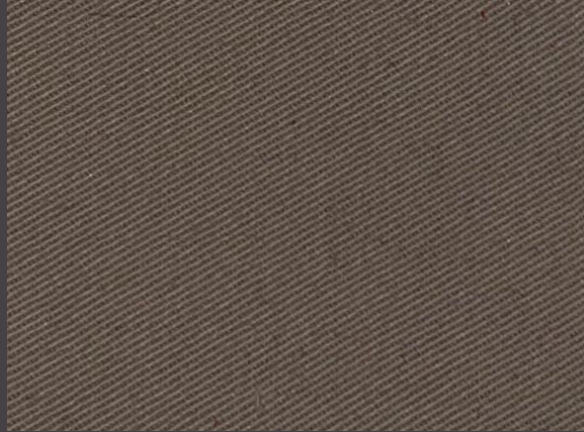

DULCE3.F10100

H.TOT.CM: 153+/-3% GR/MT SQ. 300

LIN. 459 STAB.ORDITO: -3%/+2 STAB.TRAMA: -4% +2



LARRY LUREX BLACK

PURPLE QUEEN

MOTHER LOVE BLUE

LARRY LUREX BLACK

PURPLE QUEEN

PLEASURE BLUE

"DON'T STOP ME NOW" PINK

MAKE LOVE ORANGE

LET ME ENTERTAIN YOU RED

# THE FINAL SKIRT

## ANALYSIS

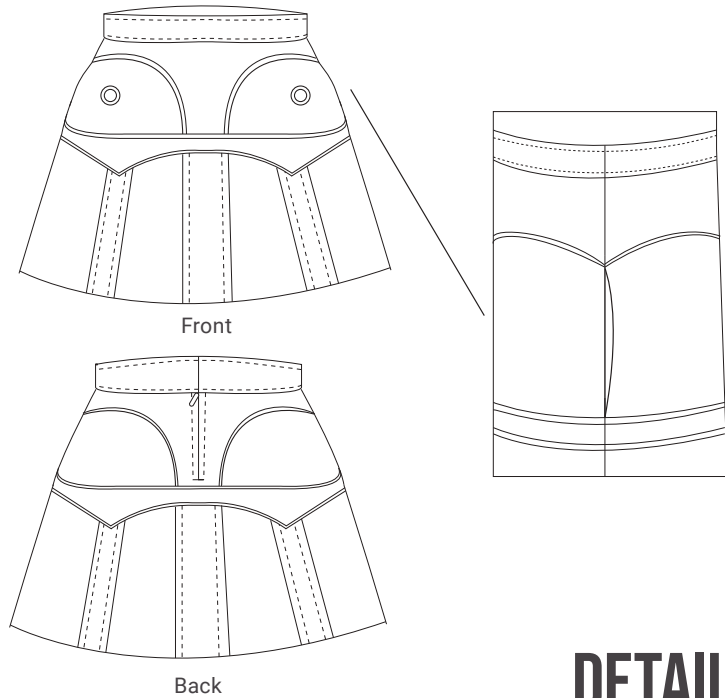

**Style:** High-waisted, flaired, mini skirt

**Front:** top and bottom topstitched waistband, v-shaped yoke at the top with pipping, 2 pockets in the side seam with buttons at the center, 1 horizontal patch with pipping, 1 vertical patch at the center front and 2 vertical stripes on the side of it, all with topstitching on both sides.

**Back:** Edge to Edge zipper at center back with topstitching, 1 horizontal patch with pipping, 1 vertical patch at the center back and 2 vertical stripes on the side of it, all with topstitching on both sides.

## DETAILS

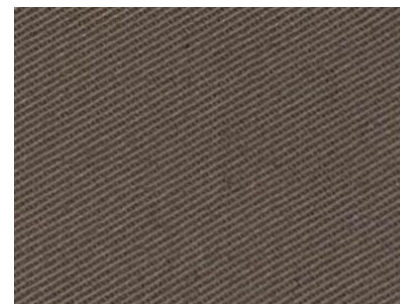

ROANNE

Art.: U1-77-9/NS2131 Comp.: %97 COTT %3 EA

Weight: 200 +- %5 Width: 150 +- %2

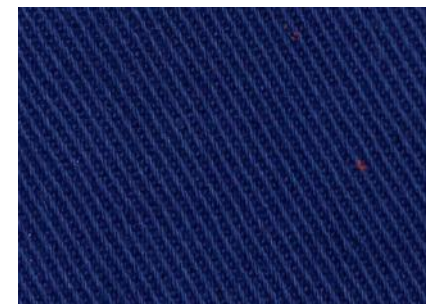

DULCE3.F10100

H.TOT.CM: 153+/-3% GR/MT SQ. 300

LIN. 459 STAB.ORDITO: -3%/+2 STAB.TRAMA: -4% +2

PURPLE QUEEN

MAKE LOVE ORANGE

**FIND MY HEAD IS ALWAYS UP  
IN THE CLOUDS IN A DREAM-  
WORLD**

- Freddie Mercury