



PLAY FOR ALL

**AN
INCLUSIVE
APPROACH**

Jambette.com

PLAY FOR ALL

At Jambette, we like to believe that we bring people together, that we make the playground a meeting place for all, young and old alike, active or not so much.

By being wildly creative, seeking to renew recreation again and again, with installations that are original, colourful and welcoming, we are transforming public parks and redefining play to make it a sensory, physical and social experience.





TABLE OF CONTENTS

4

Close-up of the inclusive park

14

Inclusion explained

16

Three layouts that speak volumes

20

Large selection of inclusive products

35

Large selection of models

43

Warranties and terms of sale





CLOSE-UP OF THE INCLUSIVE PARK





While the playground was long considered a place strictly for children, it has now become a public space for all. The inclusive approach now put forward by many specialists and organizations dedicated to the development of families and individuals now recommended access for all... for everyone together.

The inclusive approach brings everyone's needs together, regardless of individual physical or intellectual conditions and regardless of socioeconomic situation, place of origin, gender, age, culture or religion.

An inclusive playground is a space that fosters access and interaction between people, a space where everyone feels welcome.



At Jambette, we are convinced that public parks must offer a true play experience to everyone, young and old alike. With an inclusive approach that encourages creativity and free play, we are making play democratic, so it is accessible and open to everyone.

Structures that combine aesthetics and safety, solutions that allow spaces to be developed in perfect harmony with the environment, a touch of boldness and imagination...

Jambette signature parks welcome, charm and amuse young and old alike for hours.



ZONES

- 1 - Welcome
- 2 - Training
- 3 - Calm play
- 4 - Creation
- 5 - Physical play



3 CALM
PLAY
ZONE

4 CREATION
ZONE

2 TRAINING
ZONE

1 WELCOME
ZONE

5 PHYSICAL
PLAY
ZONE

1 WELCOME ZONE

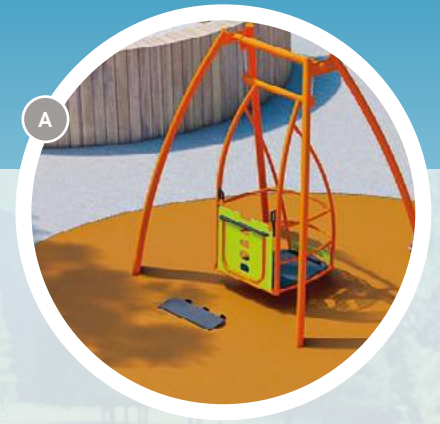

- A L-19086**
Wheelchair swing set
- B H-14000**
Bench with back
- C H-14002**
Backless bench
- D H-13019**
Bike racks
- E H-13034**
Waste management containers
- F H-16002**
Accessible table



2 TRAINING ZONE



- A** Z-13004 Adductor pro
- B** Z-13005 Recumbent bike
- C** Z-13007 Leg lift/ body lift



3 CALM PLAY ZONE



- A L-16022-A**
Town house
- B C-16002**
Self-serve storage box
- C C-18000**
Log tunnel
- D LA-20000**
Accessible craft table
- E L-19079**
Rocking nest
- F L-19080**
Suspended nest
- G G-16004**
Working ant on the ground
- H S-2871/2888/2874**
Shade sail canvas



4 CREATION ZONE

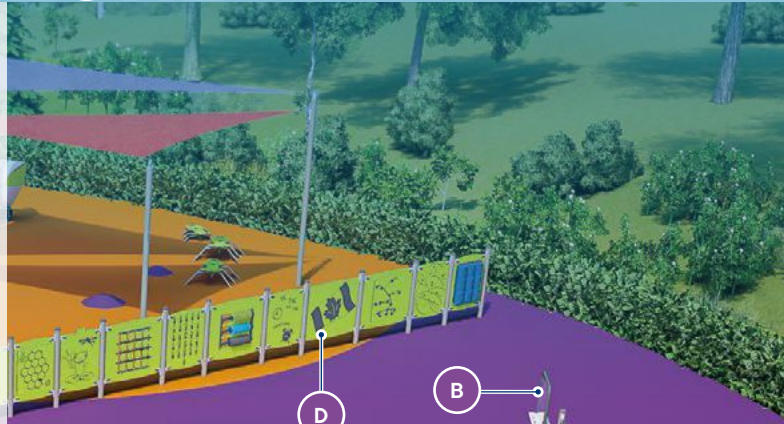

- A C-18001**
Sensory mushroom
- B L-0038**
Paint panel
- C L-17013-A**
Chalk board panel
- D CL-19000-A**
Panel fence
- E L-16032-A**
Creative space
- F L-15011**
Accessible sand digger
- G L-15020**
Baby dino fossil
- H L-13017**
Sea lion sand station

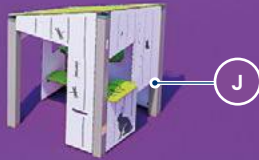
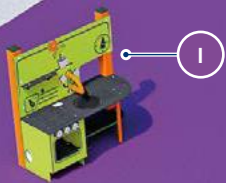

- I A-18000**
Kitchenette
- J A-17000**
Forest Villa
- K G-15005**
Oscilla-sound podium
- L L-18031**
Bongos
- M L-15046-B**
Percu-sound
- N L-18033-B**
Xylophone
- O C-17000**
Self-serve storage box
- P L-15010**
Sand digger
- Q L-16021**
Accessible sand table



5 PHYSICAL PLAY ZONE

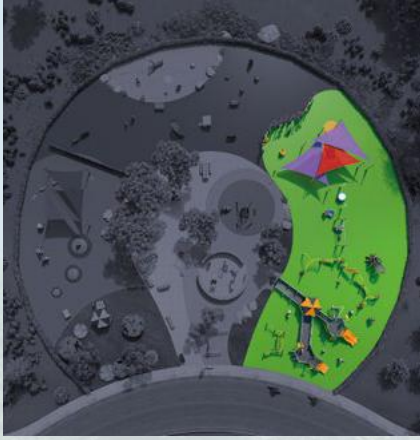

- A** G-15007 AND G-15008
Yellow birch trees (2)
- B** J3-19171-5HA
Play structure
- C** GX-07069
Etna Trapp swing
- D** L-06016
Arched swing, with 1 adaptive swing seat S-18000 and 1 seat S-047
- E** SRI000
Inclusive scooter roundabout
- F** L-09001
Standing spinner Xyrä-35
- G** L-18043
Spinning chair



J

B

- H** S-2871/2888/2874
Shade sail canvas
- I** J2-18004-5B
Psychomotor course
- J** J2-17113-5HB
Accessible psychomotor course
- K** G-15002
Bug





INCLUSION EXPLAINED



A TOOL TO HELP YOU

Our product design takes into account three fundamental aspects of children’s development: the physical, intellectual and sensory aspects.

Fully supporting this approach, Jambette uses symbols throughout this catalogue to indicate each of its products that take into account these three aspects.



To verify product certification, visit www.ipema.org



To verify product certification, visit www.ipema.org



INTELLECTUAL ASPECTS

Imagine



Learn



SENSORY ASPECTS

Socialize



See



Hear



Touch



PHYSICAL ASPECTS

Climb



Hang



Balance



Slide



Crawl



Spin



CAN/CSA-Z614 STANDARD AND ASTM F1487

Brought into effect several years ago, the Canadian and American standards on playgrounds contain sections and benchmarks on accessibility for children with reduced mobility. This primarily involves Appendix H of the CAN/CSA-Z614 standard and the Americans with Disabilities Act Accessibility Guidelines (ADAAG).



This logo, which you will find throughout this catalogue, means that the products are “accessible” within the meaning of these safety standards.



1-2-3 LAYOUTS THAT SPEAK VOLUMES



1 AT THE HEART OF THE OCEAN

Navigate the high seas among the cetaceans and deep-sea beauties. The play structure sits at the centre of the layout and offers a wide range of activities with rewarding challenges for all children, regardless of their physical or neurological condition. The surrounding climbers, whether the Whale, the Iris or the Manta, allow play to be experienced to the full!



- A** J3-15304-HA
Play structure
- B** GX-07070
Etna Trapp swing (2)
- C** L-06014
Arched swing
- D** G-14006
Whale Iris
- E** J6-16004-5B
Manta climber
- F** L-13003
Xyrä teeter totter
- G** LA-16009
Fish spring rider
- H** LA-15002-D
Lobster spring rider



2 URBAN DREAM

A magical and stimulating universe, with its larger than life insects and plants! Discover dozens of products and play elements arranged to offer creative zones, active play zones and calm play zones simultaneously.

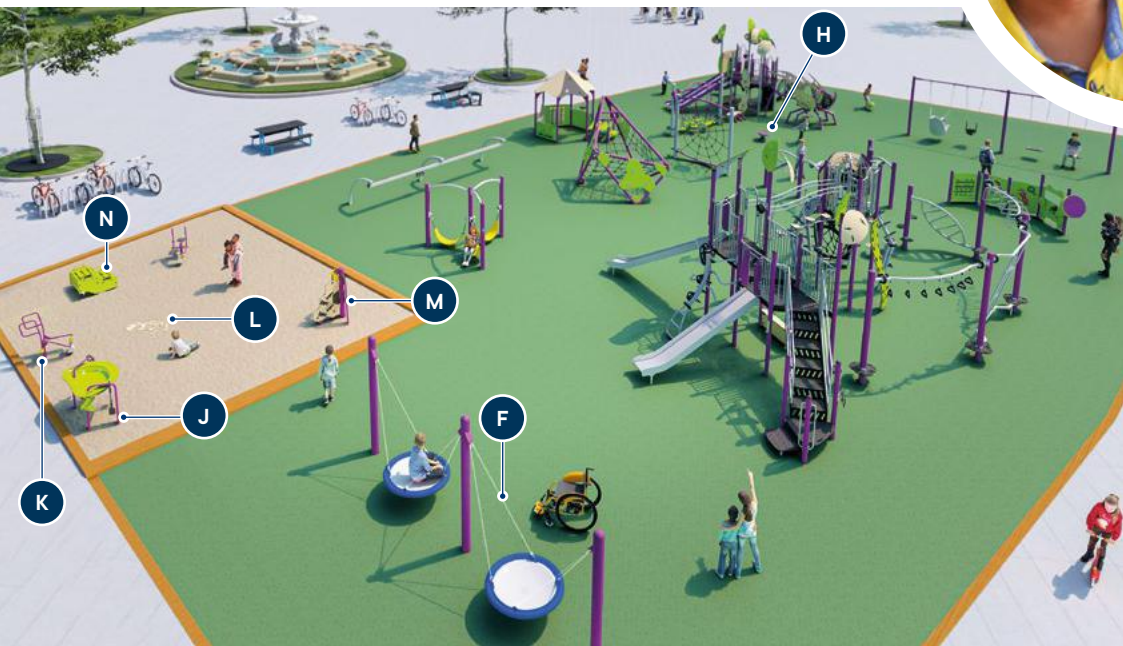

- A** M-17107-HA5B
Recreational space
- B** G-9731
Track ride
- C** G-19008
Iceberg
- D** L-17056-A
Creative space
- E** M-19107-HA5B
Recreational space
- F** GX-07070
Etna Trapp swing (2)
- G** L-07012
Steel swing
- H** L-09002
Seated spinner Xyrä-40
- I** L-09001
Standing spinner Xyrä-35
- J** L-16021
Accessible sand table
- K** L-15011
Accessible sand digger
- L** L-15020
Baby dino fossil digger
- M** L-14008
Honeycomb sand cascade
- N** D-19000
Transfer system

3

NATURE IN THE CITY

A play structure equipped with slides, climbers, a roof and several other individual pieces of equipment such as musical instruments, interactive panels, rest areas... everyone will be interested in this park that is both compact and complete!



- A** J3-19362-HA
Play structure
- B** L-17038-A
Abacus panel
- C** L-15046-B
Percu-sound
- D** L-18043
Spinning chair
- E** L-14032-A
Cockpit panel
- F** L-19004-B
Creative space



LARGE SELECTION OF INCLUSIVE PRODUCTS





The rocking nest L-19079

- Experiencing the spinning motion helps develop the inner ear and sense of balance.
- Some children need to isolate themselves from their environment.



The suspended nest L-19080

- Experiencing the spinning motion helps develop the inner ear and sense of balance.
- Some children need to isolate themselves from their environment.



The wheelchair accessible swing set L-19086

- The experience of swinging without having to get out of their wheelchair is a unique and uncommon experience.
- Experiencing the swinging motion helps develop the inner ear and sense of balance.
- A self-propulsion system that users can use themselves helps with developing independence.





The adaptive swing seat* S-18000

- Regular and repetitive swinging helps develop calmness in users.
 - A full harness provides freedom of movement with maximum safety.
- * In the illustration, the adapted seat is installed on swing set L-0325.



The rain stick L-15045-B

- The rain stick emits a soft sound when set in motion.



The xylophone L-18033-B

- The xylophone plays all the notes on the scale.



The firefighter bell panel L-15047-A

- The single-sound bell is easy to use and has a reliable mechanism without a clapper.



The sensory mushroom C-18001



- The opportunity to touch many different textures and shapes develops the sense of touch.
- A half-spherical shape that allows one to lay on their stomach helps develop the muscles that support the head.



The bongos L-18031

- A musical instrument stimulates auditory abilities.
- Playing music helps develop coordination of movements and rhythm.



Details on page 15





The spinning chair L-18043

- The pivoting motion stimulates the development of balance and spatial organization.



The xylophone panel L-13009-A

- A musical instrument stimulates auditory abilities.
- Playing music helps develop coordination of movements and rhythm.
- Well-placed equipment at a specific height from the ground provides ideal access for a wheelchair.



The accessible sand digger* L-15011

- Working the levers to capture the sand with the bucket is a coordination challenge.
- Helps develop observation and spatial organization.
- A piece of equipment such as this without an integrated seat allows it to be used from a wheelchair.

* Model with integrated seat also available L-15010.



The echo seat S-19001

- Being able to swing face to face with your child is definitely an eloquent expression of an enriching, inclusive activity.
- The fact of not losing the gaze of your child increases the safety aspect of the activity.

The accessible mobile platform*



- Regular and repetitive swinging helps develop calmness in users.
- The experience of spinning without having to leave their wheelchair is a unique and uncommon experience.
- This type of motion helps develop the inner ear and sense of balance.
- A platform that accommodates several children at once fosters inclusion, interaction with others and socializing.

* Installation directly on a play structure.





The control panel

L-13012-A

- The small parts to be operated develop dexterity and fine motor skills.
- Resembling a vehicle dashboard, it is easy to see how the use of imagination and role-playing will be involved.



The manipulating gear panel

L-17045-B

- The small parts and levers to be operated develop dexterity and fine motor skills.
- A set of gears that interlock and work together helps develop logic and interest in mechanical techniques.

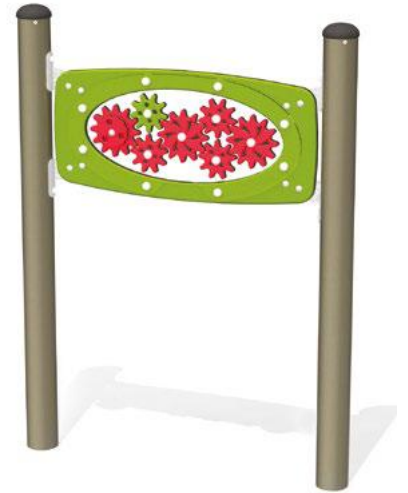

The manipulating marble panel

L-17048-B

- Sets with moving parts provide entertainment and intrigue.
- A set of small, moving balls simulate the movement of fluids and introduce certain laws of physics.

Discontinued

~~The inclusive scooter roundabout~~

SRI000

- Experiencing a rotating motion helps develop the inner ear and sense of balance.
- A small platform with a handle that acts as a scooter helps propel the large platform.
- A platform installed flush with the ground provides an ideal access for a wheelchair.
- A platform that accommodates several children at once fosters inclusion, interaction with others and socializing.



Details on page 15





The monkey bar with 2 rings
J2-15008-5B

- A set of overhead rings fosters the development of the upper limbs.
- Placed at an appropriate height, this type of equipment allows for wheelchair access.



The curved overhead loop ladder
J2-17103-5HB

- A set of overhead bars fosters the development of the upper limbs.
- Placed at an appropriate height, this type of equipment allows for wheelchair access.



The reel
J2-15031-5B

- The stirring motion helps develop the upper limbs.
- Placed at an appropriate height, this type of equipment allows for wheelchair access.



The stainless steel slide*
L-15029-B

- Sliding produces a positive effect on the inner ear and fosters the development of balance.
- Various slides made of plastic and stainless-steel materials do not present problems for children wearing cochlear implants.
- Speed is a positive experience that provides pleasure and sensation.

* Available in various sizes.



The hill slide*
L-16052-B

- A semi-cylindrical shape helps provide proper positioning throughout the descent.
- Sliding produces a positive effect on the inner ear and fosters the development of balance.
- Speed is a positive experience that provides pleasure and sensation.

* Available in various sizes.



The treehouse slide*
L-13002

- A set of elements representing a theme stimulates the imagination.
- A concentration of fun offerings accommodates several children at once, promoting inclusion, interaction with others and socializing.

* Other themes are available: elephant L-0501, dream catcher L-15000, mushroom L-13001, treasure island L-13005.





The oscilla-sound podium G-15005

- Dance and listen!
- The subtlety in the sounds develops auditory acuity.



The sound of the river podium G-16002

- Dance and listen!
- The subtlety in the sounds develops auditory acuity.



The percu-sound* L-15046-B

- A musical instrument stimulates auditory abilities.
- Playing music helps develop coordination of movements and rhythm.

* A model in Indigenous colours is also available. Ask for L-16018-B.



The cow bell panel* L-15002-A

- The subtlety in the sounds develops auditory acuity.
- The single-sound bell is easy to use and has a reliable mechanism without a clapper.
- * A "firefighter" model is also available, see page 22 or ask for L-15047-A.





The braille panel

L-18004-B

- The light textures help develop the sense of touch.
- Learning the writing used by the vision impaired is an asset that fosters inclusion.

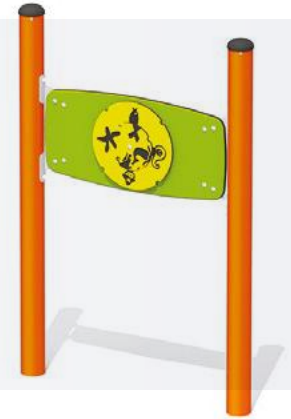

The characters panel

L-13011-A

- Seeking to make fun associations generates laughter and pleasure.
- Manipulation sets foster dexterity and fine motor skills.



The sign language panel

L-17032-A

- The light textures help develop the sense of touch.
- Learning the writing used by the deaf-mute is an asset that fosters inclusion.



The paint panel

L-0038

- Creating and encouraging creativity is a strong stimulant and encourages the development of artistic talents.
- Painting develops dexterity and fine motor skills.
- Contact with gouache develops touch.



The cockpit panel

L-14032-A

- The small parts and levers to be operated develop dexterity and fine motor skills.
- Resembling the cockpit of a flying machine, it is easy to see how using the imagination and role-playing will be involved.



Details on page 15



All products on this page are accessible. Details on page 15

JAMBETTE.COM



The covered sandbox

C-15001

- Contact with the sand develops touch.
- Creating and encouraging creativity is a strong stimulant and encourages the development of artistic talents.
- The sandy surface accommodates several children at once, promoting inclusion, interaction with others and socializing.



The baby dino fossil

L-15020

- Digging in the sand and discovering various shapes hones curiosity and fosters the development of the sense of touch.



The honeycomb sand cascade

L-14008

- Pouring the sand in a set of cascades hones curiosity and fosters the development of the sense of touch.

The self-serve storage box*

C-17000

- Useful for storing accessories, toys, balls, etc.
- * A smaller model is also available.





The seated spinner Xyrä-40

L-09002

- Experiencing the rotating motion helps develop the inner ear and sense of balance.
- A shape that allows one to lay on their stomach helps develop the muscles that support the head.



The standing spinner Xyrä-35

L-09001

- Experiencing the rotating motion helps develop the inner ear and sense of balance.



The aerial spinner Xyrä-30

L-09000

- Experiencing the rotating motion helps develop the inner ear and sense of balance.
- A set of overhead handles fosters the development of the upper limbs.
- A large-diameter roundabout accommodates several children at once and fosters inclusion, interaction with others and socializing.



The wading bird Iris*

G-14004

- Handles with multiple grips allow children to hang and crawl upside down.
- A set of handles placed at regular intervals fosters the development of the lower and upper limbs.
- A climber that accommodates several children at once fosters inclusion, interaction with others and socializing.

* Other themes are also available: whale G-14006, astronaut G-14007, dragon G-17005, wolf G-18000, goaltender G-18004 or basic G-13002.



Details on page 15

JAMBETTE.COM



The track ride

G-9731

- Moving at a moderate speed provides a unique and exhilarating experience.
- Hanging from an overhead handle fosters the development of the upper limbs.



The Etna Trapp swing*

GX-07069

- The large welcoming saucer accommodates several children at once and fosters inclusion, interaction with others and socializing.
- Regular and repetitive swinging helps develop calmness in users.

* A model with two saucers is also available. Ask for GX-07070.



The beastie

G-18003

- The large horizontal net installed near the ground accommodates several children at once and fosters inclusion, interaction with others and socializing.
- A product that represents a theme stimulates the imagination.



The tree*

G-18013

- Moderate climbing opportunities offer children with reduced mobility a unique experience.
- A product that represents a theme stimulates the imagination.
- The opportunity to touch several different textures and shapes fosters the sense of touch.

* Available in three heights:
3' (0.9 m) G-18012, 4' (1.2 m) G-18013 and 5' (1.5 m) G-18014.





The wading bird mini-climber*

G-14000

- Moderate climbing opportunities offer children with reduced mobility a unique experience.
- A product that represents a theme stimulates the imagination.
- * Other themes are available: astronaut G-14002, firefighter G-14003 and whale G-14008.



The duetto teeter totter

L-16004

- Regular and repetitive swinging helps develop calmness in users.



The quattro spring rider

LA-16004

- Regular and repetitive swinging helps develop calmness in users.



The mini quattro spring rider

LA-16005

- Regular and repetitive swinging helps develop calmness in users.



Details on page 15



The hammock

L-16020-B

- Experiencing the spinning motion fosters calmness and reverie.
- This type of motion helps develop the inner ear and sense of balance.



The banana bench

SC-BAN2-035-U-44

- A comfortable place to hang out, play, dream.



The newtonian telescope

L-16001-B

- A telescope inevitably incites curiosity... who wouldn't want to take a look?



The allo-phone™*

AO-TEL2-000-U-50

- Listen! Respond! The subtlety in the sounds develops auditory acuity.
- * Installation on a play structure.



The scale

L-15048-B

- Contact with the various materials to be weighed fosters the development of the sense of touch.
- Use of a set of weigh scales helps develop logic and interest in mechanical techniques.



The working ant on the ground

G-16004

- A shape that allows one to lay on their stomach helps develop the muscles that support the head.
- A large, welcoming platform accommodates several children at once and fosters inclusion, interaction with others and socializing.



Details on page 15



The snowmobile spring rider

LA-9205-D



- Experiencing the spinning motion helps develop the inner ear and sense of balance.
- A configuration where access to the seat is open facilitates loading and unloading.



The fish spring rider

LA-16009



- Experiencing the spinning motion helps develop the inner ear and sense of balance.



The eco-mobile spring rider

LA-16006



- Experiencing the spinning motion helps develop the inner ear and sense of balance.
- A two-seater model fosters inclusion, interaction with others and socializing.



The tern oscillating podium

G-14009



- Experiencing the spinning motion helps develop the inner ear and sense of balance.



The footbridge

G-13010-D



- A product accommodating several children fosters inclusion, interaction with others and socializing.



The trawler spring rider

LA-14006-D

- Experiencing the spinning motion helps develop the inner ear and sense of balance.
- A product accommodating several children fosters inclusion, interaction with others and socializing.
- The seafaring theme is sure to stimulate the imagination.

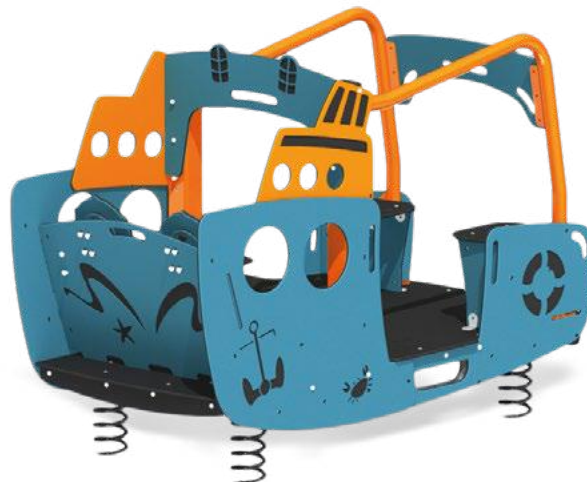

The starfish stepping stone

G-12032

- A comfortable place to hang out, play, dream.



Details on page 15



All products on this page are accessible. Details on page 15

JAMBETTE.COM

33



The discovery tipi*

A-15000

- The tipi theme is sure to stimulate the imagination.
- A product accommodating several children fosters inclusion, interaction with others and socializing.
- Some children need to isolate themselves from their environment.

* A "tipi climber" is also available. Ask for G-15000.



The kitchenette

A-18000

- Imitating adults is sure to stimulate the imagination.
- A product accommodating several children fosters inclusion, interaction with others and socializing.



The villa*

A-16000



- Creating the image of a "cabin" is sure to stimulate the imagination.
- A product accommodating several children fosters inclusion, interaction with others and socializing.
- Some children need to isolate themselves from their environment.

* A "forest villa" is also available. Ask for A-17000.



The accessible craft table

LA-20000

- A product accommodating several children fosters inclusion, interaction with others and socializing.



The log tunnel

C-18000



- Walking on all fours is a body movement that develops the entire body.
- The opportunity to touch several different textures and forms fosters the sense of touch.
- Some children need to isolate themselves from their environment.



Details on page 15





LARGE SELECTION OF MODULES



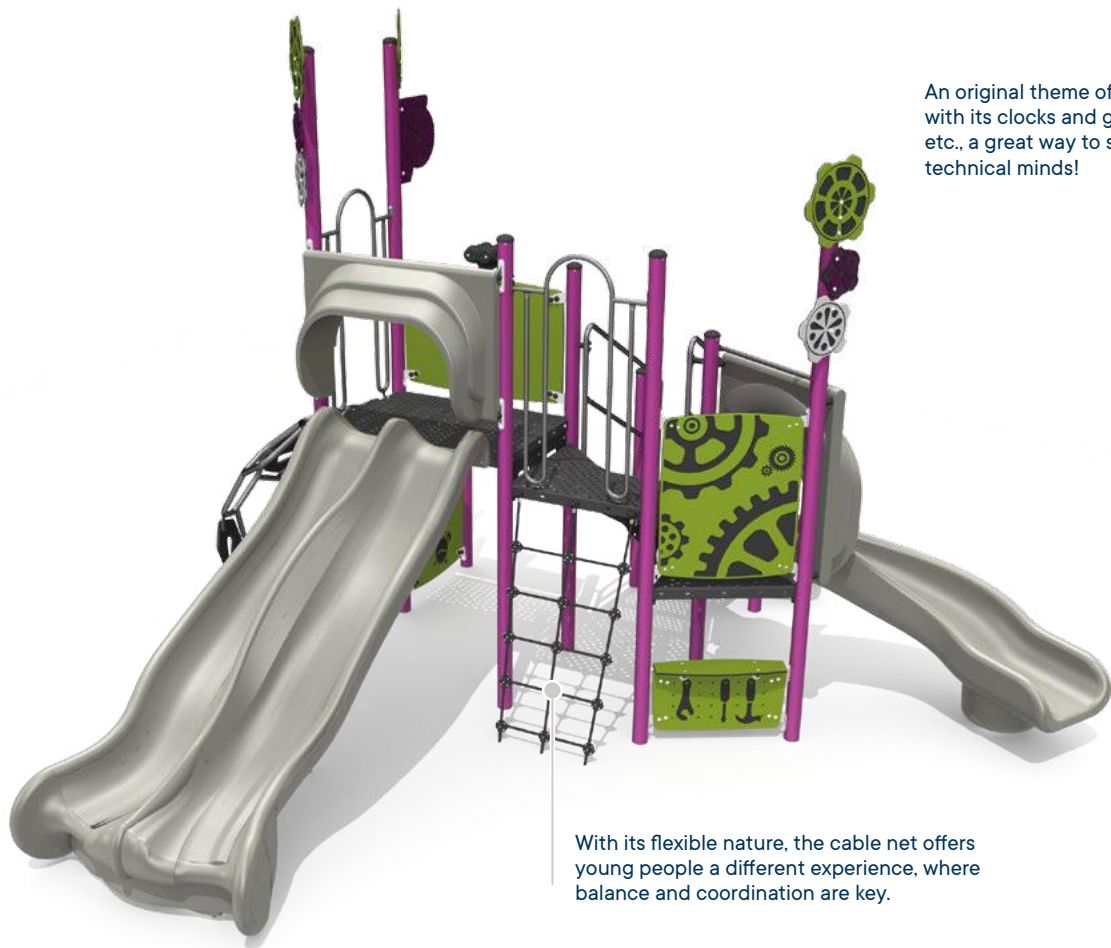

An original theme of "time" with its clocks and gears, etc., a great way to stimulate technical minds!

With its flexible nature, the cable net offers young people a different experience, where balance and coordination are key.



The wavy slide provides an additional element for developing balance and the inner ear.

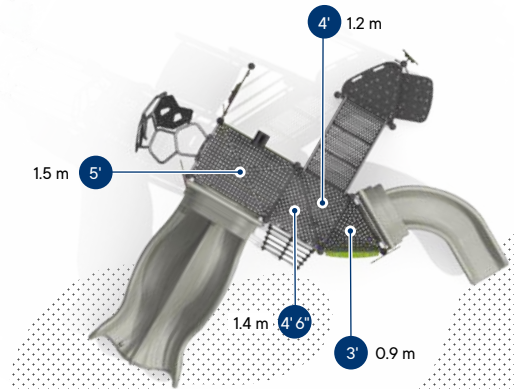

J3-19075-HA play structure

AGE GROUP	CHILD CAPACITY	REQUIRED SURFACE	CSA FALL HEIGHT	ASTM FALL HEIGHT
18 months - 5 years old	28 children	33' x 32' / 10 m x 9.7 m	98" / 2.5 m	60" / 1.5 m

! Based on the CAN/CSA-Z614 and ASTM F1487 standards, installation on a cushioning surface and compliance with clearance distances are required during installation.



Details on page 15



The panel representing a house is very attractive and creates a magical ambiance.

The game table is a key element of the ground-level play area with several elements that foster socialization, conversation, etc.



The transfer station provides access to the highest part of the module, even for children with limited mobility.

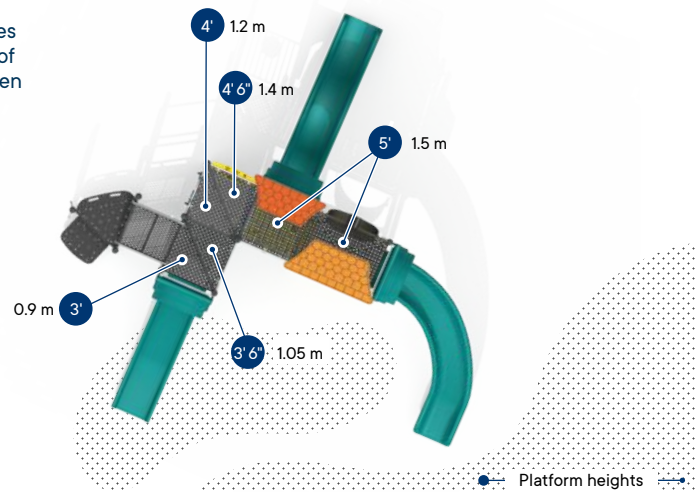

J3-19124-HA play structure

AGE GROUP	CHILD CAPACITY	REQUIRED SURFACE	CSA FALL HEIGHT	ASTM FALL HEIGHT
18 months - 5 years old	39 children	37' x 36' / 11.3 m x 11 m	98" / 2.5 m	60" / 1.5 m

! Based on the CAN/CSA-Z614 and ASTM F1487 standards, installation on a cushioning surface and compliance with clearance distances are required during installation.



Details on page 15



The "south sea" theme stimulates imagination and creativity.

A slide provides a unique experience of the forces associated with acceleration and speed.

The transfert station provides access for children with reduced mobility to the upper part of the module, including the slide.

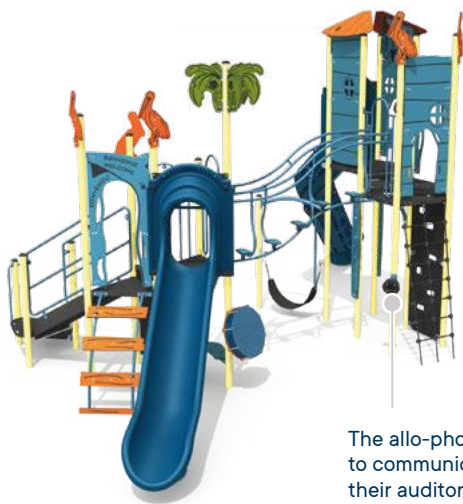

The allo-phone™ allows children to communicate and develop their auditory acuity.

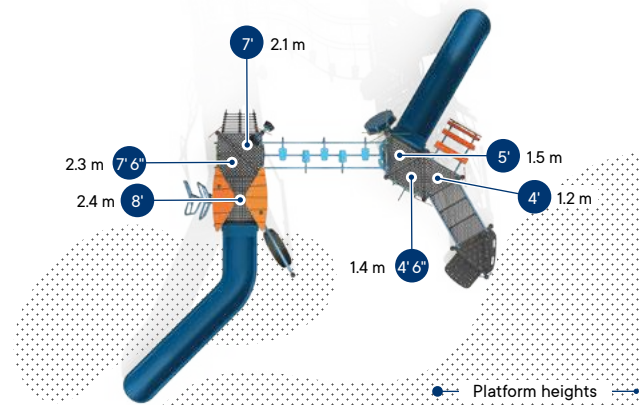

J3-18212-HB play structure

AGE GROUP	CHILD CAPACITY	REQUIRED SURFACE	CSA FALL HEIGHT	ASTM FALL HEIGHT
5-12 years old	51 children	42' x 41' / 12.8 m x 12.5 m	134" / 3.4 m	102" / 2.6 m

! Based on the CAN/CSA-Z614 and ASTM F1487 standards, installation on a cushioning surface and compliance with clearance distances are required during installation.



Details on page 15

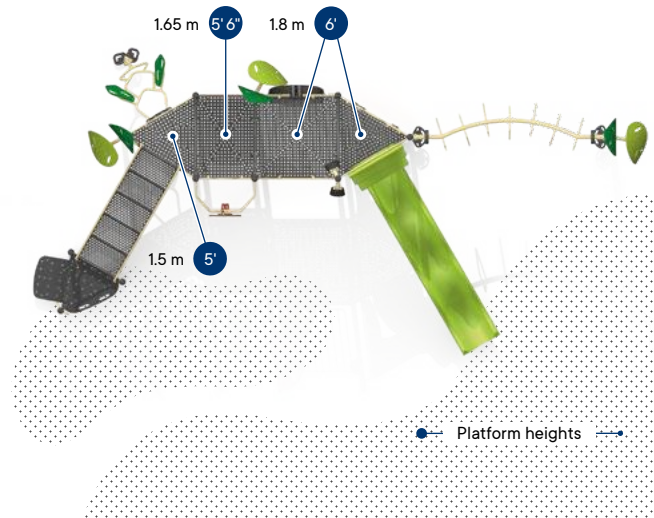

J3-19092-HA play structure

AGE GROUP	CHILD CAPACITY	REQUIRED SURFACE	CSA FALL HEIGHT	ASTM FALL HEIGHT
5-12 years old	37 children	44' x 30' / 13.4 m x 9.1 m	110" / 2.8 m	89" / 2.3 m

! Based on the CAN/CSA-Z614 and ASTM F1487 standards, installation on a cushioning surface and compliance with clearance distances are required during installation.



Details on page 15



The telescope, although it has no lens, encourages the development of visual acuity and curiosity.

The banana benches and the hands-on sets create a space under the platforms that is good for interacting with others, playing and chatting.

The marbles manipulation accessory provides a fun and stimulating auditory and visual experience.



The transfer station provides access to the highest part of the module, even for children with limited mobility.

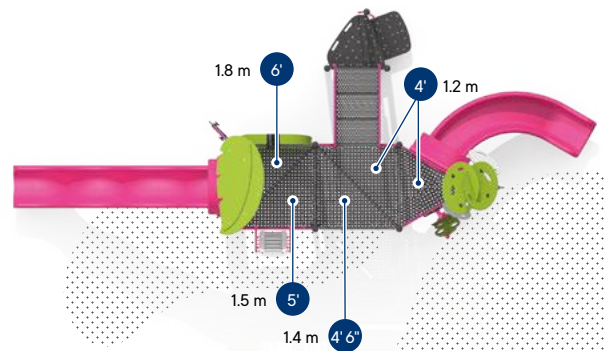

Platform heights

J3-18423-HA play structure

AGE GROUP	CHILD CAPACITY	REQUIRED SURFACE	CSA FALL HEIGHT	ASTM FALL HEIGHT
18 months - 12 years old	34 children	43' x 26' / 13.12 m x 7.9 m	110" / 2.8 m	72" / 1.8 m

! Based on the CAN/CSA-Z614 and ASTM F1487 standards, installation on a cushioning surface and compliance with clearance distances are required during installation.



Details on page 15

The rain stick produces a pleasant, non-aggressive sound.



The play structure is equipped with several climbers offering a diversity of movements and grips for the hands and feet, etc.

The curved shapes of the slides ensure stability, support and safety.

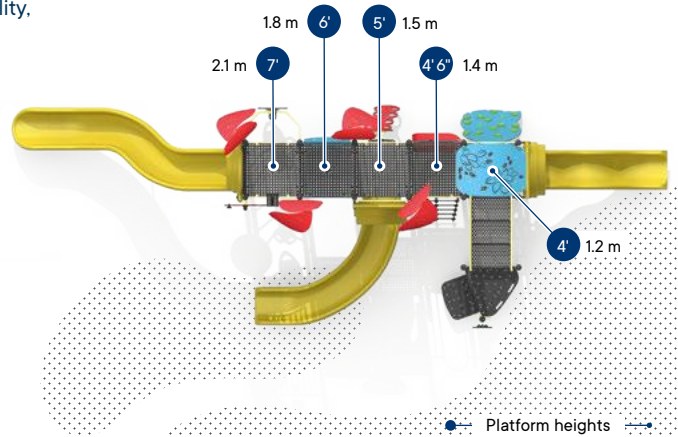

J3-19139-HB play structure

AGE GROUP	CHILD CAPACITY	REQUIRED SURFACE	CSA FALL HEIGHT	ASTM FALL HEIGHT
18 months - 12 years old	43 children	49' x 26' / 14.9 m x 7.9 m	122" / 3 m	123" / 3.1 m

! Based on the CAN/CSA-Z614 and ASTM F1487 standards, installation on a cushioning surface and compliance with clearance distances are required during installation.



Details on page 15

The large roof provides protection against strong UV rays.

The wide access ramp allows a wheelchair to access the play platforms.



The triangular play platforms include lower steps that make them easier to use.

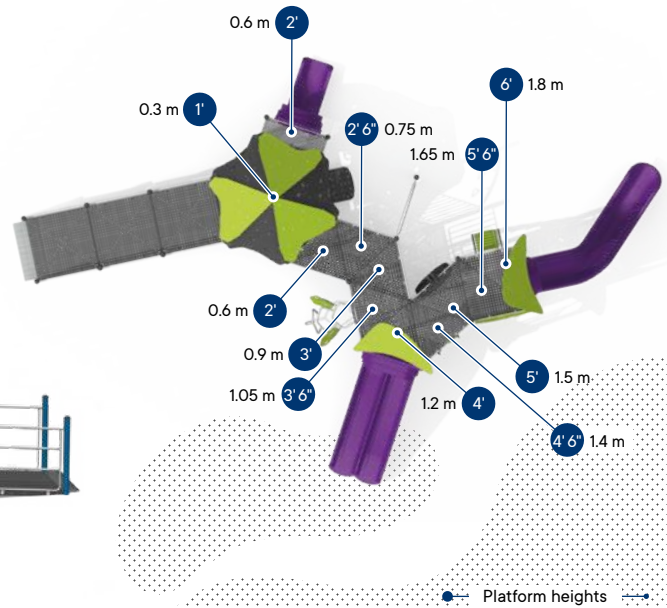

J3-19172-HA play structure

AGE GROUP	CHILD CAPACITY	REQUIRED SURFACE	CSA FALL HEIGHT	ASTM FALL HEIGHT
18 months - 12 years old	56 children	48' x 42' / 14.6 m x 12.8 m	110" / 2.8 m	72" / 1.8 m

! Based on the CAN/CSA-Z614 and ASTM F1487 standards, installation on a cushioning surface and compliance with clearance distances are required during installation.



Details on page 15

THE MOST COMPREHENSIVE WARRANTIES ON THE MARKET



JAMBETTE WARRANTY*

Aluminum parts Hardware	LIFETIME
Swing hangers Steel parts	15 YEARS
Polyethylene parts Recycled plastic parts Plastisol parts	10 YEARS
Steel/polyurethane cables Steel/polyurethane cable nets	7 YEARS
Labour Polycarbonate parts Swing seats	5 YEARS
Other parts Spring rider springs	2 YEARS
Concrete products	1 YEAR

SUTCLIFF INCLUSIVE SCOOTER ROUNDABOUT WARRANTY* PAGE 24

Metal frames	25 YEARS
Plastic parts	10 YEARS
Joints	2 YEARS

ETNA SWING WARRANTY* PAGE 30

Aluminum and stainless-steel posts Cast aluminum	100 YEARS
Tubular steel components Cable joints Coating and plastisol finishes Rubber seats and harnesses	15 YEARS
Trampoline-type surfaces Nylon joining parts and rollers	
Nylon bearings for Etna seats Rubber bumpers for Etna seats Watertightness of nylon cables	5 YEARS



JAMBETTE PLAYGROUND EQUIPMENT INC. TERMS OF SALE:

The payment term is 30 days net after the billing date. The opening of an account may be required at the request of JAMBETTE PLAYGROUND EQUIPMENT INC. to grant this payment term of 30 days net. Any outstanding balance will be charged interest at a rate of 2% per month (24% per year). Any return of merchandise must first be approved by our representative. The merchandise must be returned within 10 days and in perfect condition. The client agrees to pay the administration and handling fees of 20% of the value of said merchandise. In addition, all work and costs related to disassembly, land restoration, packing and transportation are the client's responsibility and at the client's expense. Personalized products, installation and landscaping work are non-refundable. The client must produce their bill upon request. The client acknowledges that JAMBETTE PLAYGROUND EQUIPMENT INC. will not be held liable for circumstances beyond its control and that its liability is limited to the price paid by the client for the merchandise in question. The parties agree that this agreement shall be interpreted under the laws of the Province of Quebec and that the parties elect domicile in the judicial district of Québec, Province of Quebec, Canada. If the account is sent to a collection agency or a lawyer due to default on payment by the client, the client agrees to pay, in addition to the balance due, collection fees equivalent to 20% of the balance due in capital and interest.

*Details and terms of the warranties available upon request.

JAMBETTE .COM



Jambette.COM

700, rue des Calfats
Lévis, Québec
G6Y 9E6
Canada

Tel: 418-837-8246
Toll-free: 1-877-363-2687
Fax: 418-837-2916

jambette.com

We reserve the right to change, without notice, the design and features of our products as well as the details of our services and warranties.

RBQ LICENSE: 8330-7280-51

 **MADE IN CANADA**

 The logo identifies the products that are accessible by wheelchair in accordance with Appendix H of the CAN/CSA-Z614 standards and the Americans with Disabilities Act Accessibility Guidelines (ADAAG).



To verify product certification, visit www.ipema.org



To verify product certification, visit www.ipema.org



bisscomm.com

The International Play Equipment Manufacturers Association (IPEMA) provides a third-party certification to ensure product conformance to specific ASTM and/or CSA standards. Each product promoted here, if certified by IPEMA, includes the name and model number for you to search the IPEMA website for verification. To verify product certification, visit www.ipema.org and conduct a search.