



ALLIANCE[®]
OUTDOOR LIGHTING

LANDSCAPE & ARCHITECTURAL LIGHTING

PRODUCT CATALOG

DESIGNER SERIES

PICTORIAL INDEX OF FIXTURES

ACCENT/UPLIGHT



AREA & PATH

HAT/STEM COMBO SECTION



WALL WASH



DOWN LIGHTS



ALL AGED BRASS FIXTURES AVAILABLE IN PREMIUM BLACK OVERCOAT (EXCEPT FOR UNDERWATER)

IN-GROUND



WL100
PG 37



WL200
PG 38



WL300
PG 39



CGWL01
PG 40



CGWL02
PG 41



WL495-LED
PG 42

BLUETOOTH®
AVAILABLE



WL400-BT
PG 43



GL100
PG 46



GL150
PG 46



GL160
PG 46



GL170
PG 47



GL180
PG 47



GL190
PG 47

bt

BLUETOOTH®
AVAILABLE



GL300
PG 48



GL310
PG 48



GL350
PG 48



GL360
PG 49



GL370
PG 49



GL380
PG 49



GL390
PG 49

bt

HARDSCAPE



SL100
PG 52



SL150
PG 53



POST50
PG 54



POST100
PG 55



SL65-LED
PG 57



SL75-LED
PG 58



SL85-LED
PG 59



SL26-LED
PG 60



SL36-LED
PG 61



TAPE-LED
PG 65

BLUETOOTH®
AVAILABLE



SL25-LED
PG 62



SL35-LED
PG 63



SL70
PG 64



SL60-BT
PG 66



SL80-BT
PG 67



WS350-BT
PG 68

bt

SPECIALTY



**TIKI
ALSTEM60**
PG 81



ML15-LED
PG 82



ML25-LED
PG 83



ML35-LED
PG 84



ML65
PG 85



ML45-LED
PG 86



ML55-LED
PG 87



UL395-LED
PG 88



GOLF100
PG 89

BLUETOOTH®
AVAILABLE



UL100
PG 90



GOLF50-BT
PG 91

bt

MORE

Power and Control
PG 92-97

bt System
PG 98 - 103

Installation Accessories
PG 104 - 105

Lamps
PG 106 - 109

Demo Kit
PG 110

Warranty info
PG 111

To see a pictorial index of only **bt** fixtures, see page 102

The Alliance Advantages

DESIGNER SERIES

Lighting built for the real world.

You've got jobs to finish, deadlines to meet, and customers to keep happy. Our fixtures are built with that in mind—designed to save you time, cut down on hassle, and hold up on every install. This is lighting that works as hard as you do.

Faster Installs, Less Hassle.

No extra splices. No wasted time. Our double wire lead—25' and 18"—gives you options and flexibility. Fewer connections means faster installs, lower labor costs, and cleaner jobs.

DOUBLE
WIRE
LEAD



Built to Last (and Look Good Doing It).

Every fixture is made from solid brass. That means serious durability and long-term value. We offer both Aged Brass and our Premium Black Overcoat finish—so you've got choices that look sharp in any style or setting.

SOLID
BRASS



Transformers Contractors Actually Like.

We build our transformers to handle the real conditions you deal with—heat, cold, moisture, whatever. No gimmicks, no fragile parts. Just reliable power that keeps your systems running.

No-Nonsense Smart Systems.

Our Bluetooth® fixtures don't require Wi-Fi, bridges, or guesswork. Just plug them in, open the app, and take control. Setup is quick, connection is solid, and the system just works.

EASY APP
CONTROLS



Work Smarter, Not Harder.

If you're still installing brands that fight you at every step, ask yourself: Why are you working harder than you have to?

**Switch to Alliance Designer Series fixtures—
and see how much smoother your installs can be.**

What do you get with
Alliance Outdoor Lighting
that you just don't get
with *the other guys?*



Lighting isn't just what we do —
it's who we are.

We are your lighting people. When you choose Alliance, you choose an industry leader that is with you every step of the way. From design and manufacturing, to product training and customer support, we stand behind our products because we do the hard work ourselves - we don't outsource, we don't take shortcuts. We take pride in our work so you can take pride in yours.

ALLIANCE
OUTDOOR LIGHTING



OUR STORY

ALLIANCE[®]

OUTDOOR LIGHTING

We're your lighting people

Let's take a look behind the scenes to see the life of our fixtures, from design and manufacturing, to distribution and installation.



DESIGN + MANUFACTURING

Owned and operated by Alliance Outdoor Lighting, our factories ensure top-quality products through full control of the manufacturing process, allowing us to offer quick solutions for our partners.



WAREHOUSE & SHIPPING

With warehouses located on the East and West coasts, and a rapid turnaround, we make sure you have enough inventory to keep shelves stocked and projects moving.

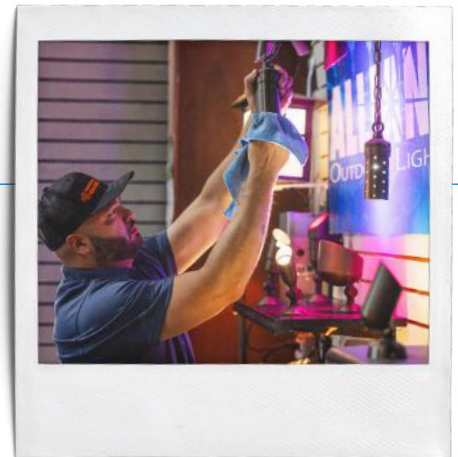

DEDICATED SALES TEAM

Our distributor partnerships ensure that the Alliance sales team is dedicated to serving your stores and contractors in each market. From branch visits to ride-alongs with your sales team, we make you feel like part of the Alliance family.



INNOVATIVE SOLUTIONS

With innovation and simplicity driving our product development, we ensure you have the tools to unlock your creativity for every project. Choose from a wide range of fixtures, lamps, and transformers to complete your masterpiece.



TRAINING AND SUPPORT

We prioritize your training and education with in-person seminars, online video libraries, and the "Do You Know" program, ensuring you have all the information needed to deliver the best customer experience.

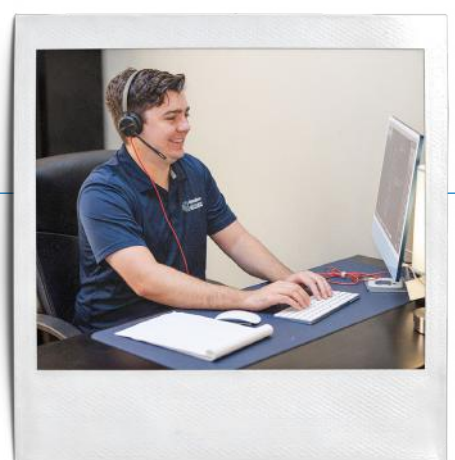

CUSTOMER SERVICE

Our dedicated customer and tech support teams ensure your questions are answered and solutions provided. Call or email us, and we'll get you the support you need.



TABLE OF CONTENTS

Accent/Uplight	9	Specialty	80
Area & Path	20	Power & Control	92
In-Ground	36	bt System	98
Hardscape	50	Accessories	104
Wall Wash	70	Lamps	106
Down Lights	74	Demo Kit	110



ACCENT & UPLIGHTS

Create dramatic
lighting effects with
precise aiming

ACCENT & UPLIGHT



Aged Brass
BL50



Premium Black Overcoat
BL50-BLK

Extra small accent light that is easy to conceal, yet packs a strong lighting punch.

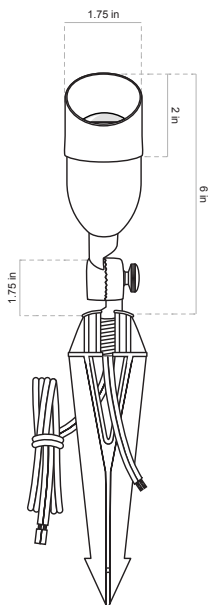

DIMENSIONS

HEIGHT 1.75"
LENGTH/DEPTH 6"
WIDTH 1.75"

PRODUCT SPECS

MOUNTING/INSTALLATION

- Wire Lead** Double 18AWG wire leads (option to daisy chain), first 25', second 18".
- Mounting** Slotted 8" ground stake (standard), Options: surface mount, gutter mount, Permapost heavy-duty stake, fixed solid brass risers. See page 104-105 for details.

MATERIAL

- Housing** Solid cast brass.
- Knuckle** Solid cast brass, knob for angle adjustment.
- Socket** Spring-loaded ceramic bi-pin MR-11, with Dual contacts & lamp clips.
- Shroud & Lens** Solid cast brass, with o-ring seal, with convex tempered, shock-resistant glass lens.

ORDERING INFORMATION



LIGHT SOURCE OPTIONS

- Choose from:
- Drop-in MR-11 LED lamp below
 - Also available without lamp.

DROP-IN MR11 LAMP OPTION

ADD-SUFFIX	WATTAGE	BEAM ANGLE	DELIVERED LUMENS	COLOR TEMPERATURE
-LED	4	45	175	2900K

HOW TO SPECIFY

FIXTURE	FINISH OPTION	CHOOSE LIGHT SOURCE	ORDER ACCESSORIES
BL50	- BLK for black overcoat (blank for aged brass finish)	- LED Add suffix for lamp (see above chart) (blank for no lamp)	Mounting (see page 104) Risers (see page 105)

Example: BL50-BLK-LED

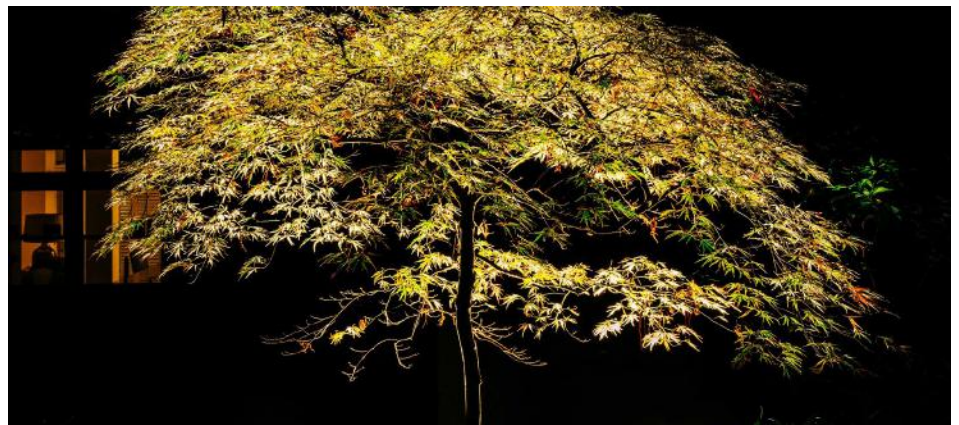

PRODUCT SPECS

MOUNTING/INSTALLATION

- Wire Lead** Double 18AWG wire leads (option to daisy chain), first 25'; second 18".
- Mounting** Slotted 8" ground stake (standard), Options: surface mount, gutter mount, Permapost heavy-duty stake, fixed solid brass risers. See page 104-105 for details.

MATERIAL

- Housing** Solid cast brass.
- Knuckle** Solid cast brass, knob for angle adjustment.
- Socket** Spring-loaded ceramic bi-pin MR16, with Dual contacts & lamp clips.
- Shroud & Lens** Solid cast brass, with Dual o-ring seal, with convex tempered, shock-resistant glass lens.
- Optional Lenses** Frosted lens, hex louver.

ORDERING INFORMATION

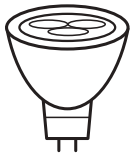

LIGHT SOURCE OPTIONS

- Choose from:
- Drop-in MR-16 LED lamp below
 - Also available without lamp.

DROP-IN MR16 LAMP OPTION

ADD-SUFFIX	WATTAGE	BEAM ANGLE	DELIVERED LUMENS	COLOR TEMPERATURE	BASE COLOR CODE
-LED4W-NS	4	15	250	2900K	BLACK
-LED4W	4	45	250	2900K	BLACK
-LED4W-WF	4	60	250	2900K	BLACK
-LED5W-NS	5	15	310	2900K	WHITE
-LED5W	5	45	310	2900K	WHITE
-LED5W-WF	5	60	310	2900K	WHITE
-LED6W	6	45	400	2900K	BLUE

HOW TO SPECIFY

FIXTURE	FINISH OPTION	CHOOSE LIGHT SOURCE	ORDER ACCESSORIES
BL110	-BLK for black overcoat (blank for aged brass finish)	-LED Add suffix for lamp (see above chart) (blank for no lamp)	Mounting (see page 104) Risers (see page 105) Lenses (see page 109)

Example: BL110-BLK-LED5W



Aged Brass
BL110



Premium Black Overcoat
BL110-BLK

Sleek linear design. A highly versatile workhorse fixture.

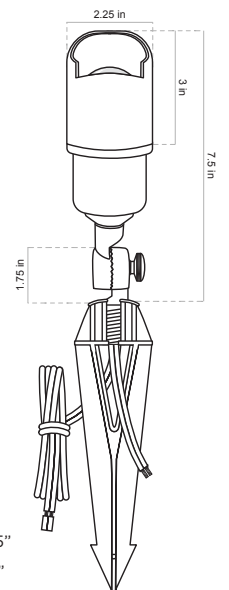

DIMENSIONS

- HEIGHT** 1.75"
- LENGTH/DEPTH** 7.5"
- WIDTH** 2.25"

ACCENT & UPLIGHT



Aged Brass
BL300



Premium
Black Overcoat
BL300-BLK

Maximum impact powerful directional lighting from a PAR36 lamp with a mounting option and numerous options for lamps.

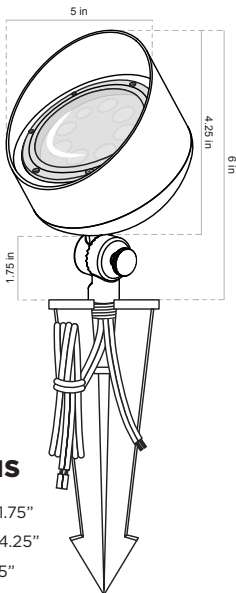

DIMENSIONS

- HEIGHT 1.75"
- LENGTH/DEPTH 4.25"
- WIDTH 5"

PRODUCT SPECS

MOUNTING / INSTALLATION

- Wire Lead** Double 18AWG wire leads (option to daisy chain), first 25', second 18".
- Mounting** Slotted 8.5" large ground stake (standard), Options: surface mount, gutter mount, Permapost heavy-duty stake, fixed solid brass risers. See page 104-105 for details.

MATERIAL

- Housing** Solid brass.
- Knuckle** Solid cast brass, knob for angle adjustment.
- Socket** Spade connectors for LPAR36 lamps.
- Shroud** Solid cast brass, with turn-to-lock fitting.

ORDERING INFORMATION

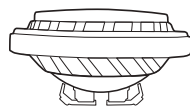

LIGHT SOURCE OPTIONS

CHOOSE FROM:

- Drop-in PAR-36 lamp (see page 107 for details) below
- Also available without lamp.

DROP-IN PAR36 LAMP OPTION

ADD-SUFFIX	WATTAGE	BEAM ANGLE	DELIVERED LUMENS	COLOR TEMPERATURE	COLOR CODE
-LED4W-F	4	20	250	2800K	GRAY
-LED4W	4	40	250	2800K	GRAY
-LED8W-F	8	20	300	2800K	BLACK
-LED8W	8	40	300	2800K	BLACK
-LED10W-F	10	30	400	2800K	BLUE
-LED10W	10	45	400	2800K	BLUE

HOW TO SPECIFY

FIXTURE	FINISH OPTION	CHOOSE LIGHT SOURCE	ORDER ACCESSORIES
BL300	-BLK for black overcoat (blank for aged brass finish)	-LED Add suffix for lamp (see above) (blank for no lamp)	Mounting (see page 104) Risers (see page 105) Lenses (see page 109)

Example: BL300-BLK-LED10W



PRODUCT SPECS

MOUNTING / INSTALLATION

- Wire Lead** Double 18AWG wire leads (option to daisy chain), first 25', second 18".
- Mounting** Slotted 8.5" large ground stake (standard), Options: surface mount, gutter mount, Permapost heavy-duty stake, fixed solid brass risers. See page 104-105 for details.

MATERIAL

- Housing** Solid cast brass.
- Knuckle** Solid cast brass, knob for angle adjustment.
- Shroud** Solid cast brass, with turn-to-lock fitting.

ORDERING INFORMATION

LIGHT SOURCE

INTEGRATED LED

- 11 watts
- 1200 lumens
- 40 degree flood
- 3000K

HOW TO SPECIFY

FIXTURE	FINISH OPTION	ORDER ACCESSORIES
BL395-LED	-BLK for black overcoat (blank for aged brass finish)	Mounting (see page 104) Risers (see page 105)

Example: BL395-LED-BLK



Aged Brass

BL395-LED



Premium
Black Overcoat

BL395-LED-BLK

HIGH LUMEN OUTPUT

Powerful integrated LED fixture for maximum impact directional accent lighting.

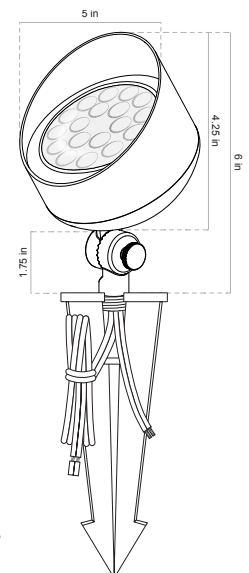

DIMENSIONS

- HEIGHT** 1.75"
- LENGTH/DEPTH** 4.25"
- WIDTH** 5"

ACCENT & UPLIGHT



Aged Brass
BL200



Premium Black Overcoat
BL200-BLK

Our most versatile and popular **uplight**, with numerous options for lamps, mounting options and optional color-tunable, dimmable Bluetooth® LED module.

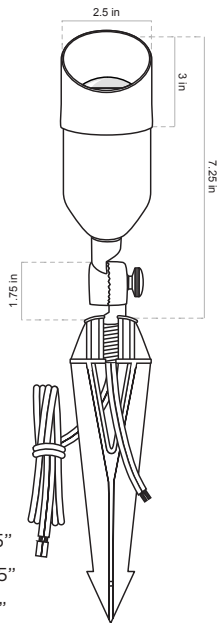

DIMENSIONS

HEIGHT 1.75"
LENGTH/DEPTH 7.25"
WIDTH 2.5"

PRODUCT SPECS

MOUNTING / INSTALLATION

Wire Lead Double 18AWG wire leads (option to daisy chain), first 25', second 18".
Mounting Slotted 8" ground stake (standard), Options: surface mount, gutter mount, Permapost heavy-duty stake, fixed solid brass risers. See page 104-105 for details.

MATERIAL

Housing Solid cast brass.
Knuckle Solid cast brass, knob for angle adjustment.
Socket Spring-loaded ceramic bi-pin MR16, with Dual contacts & lamp clips.
Shroud & Lens Solid cast brass, with Dual o-ring seal, with convex tempered, shock-resistant glass lens.
Optional Lenses Frosted lens, hex louver.

ORDERING INFORMATION

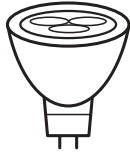

LIGHT SOURCE OPTIONS

CHOOSE FROM:

- Drop-in MR-16 LED lamp below
- Factory-installed Bluetooth® module.
- Also available without lamp.

DROP-IN MR16 LAMP OPTIONS

ADD-SUFFIX	WATTAGE	BEAM ANGLE	DELIVERED LUMENS	COLOR TEMPERATURE	BASE COLOR CODE
-LED4W-NS	4	15	250	2900K	BLACK
-LED4W	4	45	250	2900K	BLACK
-LED4W-WF	4	60	250	2900K	BLACK
-LED5W	5	15	310	2900K	WHITE
-LED5W-F	5	45	310	2900K	WHITE
-LED5W-WF	5	60	310	2900K	WHITE
-LED6W	6	45	400	2900K	BLUE

FACTORY-INSTALLED RGBW LED BLUETOOTH® MODULE

Wattage	2w - 4w
Lumen Output	10lm - 430lm
Beam Spread	40°
CCT Options	Adjustable from 2700K-5000K
RGBW Options	Unlimited color wheel, quick presets for red, green, blue, amber & purple
Dimming	0-100% dimming option available for every color choice

HOW TO SPECIFY

	FIXTURE	FINISH OPTION	FACTORY INSTALLED LED	ORDER ACCESSORIES
WITH bt	BL200-BT	-BLK for black overcoat (blank for aged brass finish)		Mounting (page 104) Risers (page 105) Lenses (page 109)
WITHOUT bt	BL200		-LED Add suffix for lamp (see above) (blank for no lamp)	

Example: BL200-BT-BLK

PRODUCT SPECS

MOUNTING / INSTALLATION

- Wire Lead** Double 18AWG wire leads (option to daisy chain), first 25', second 18".
- Mounting** Slotted 8" ground stake (standard), Options: surface mount, gutter mount, Permapost heavy-duty stake, fixed solid brass risers. See page 104-105 for details.

MATERIAL

- Housing** Solid cast brass.
- Knuckle** Solid cast brass, knob for angle adjustment.
- Socket** Spring-loaded ceramic bi-pin MR16, with Dual contacts & lamp clips.
- Shroud & Lens** Solid cast brass, with convex tempered, shock-resistant glass lens.
- Optional Lenses** Frosted lens, hex louver.

ORDERING INFORMATION

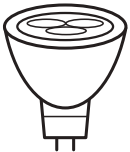

LIGHT SOURCE OPTIONS

CHOOSE FROM:

- Drop-in MR-16 LED lamp below
- Factory-installed Bluetooth® module.
- Also available without lamp.



ADJUSTABLE SHROUD ALLOWS BEAM AND GLARE CONTROL.

DROP-IN MR16 LAMP OPTIONS

ADD-SUFFIX	WATTAGE	BEAM ANGLE	DELIVERED LUMENS	COLOR TEMPERATURE	BASE COLOR CODE
-LED4W-NS	4	15	250	2900K	BLACK
-LED4W	4	45	250	2900K	BLACK
-LED4W-WF	4	60	250	2900K	BLACK
-LED5W-NS	5	15	310	2900K	WHITE
-LED5W	5	45	310	2900K	WHITE
-LED5W-WF	5	60	310	2900K	WHITE
-LED6W	6	45	400	2900K	BLUE

FACTORY-INSTALLED RGBW LED BLUETOOTH® MODULE

Wattage	2w - 4w
Lumen Output	10lm - 430lm
Beam Spread	40°
CCT Options	Adjustable from 2700K-5000K
RGBW Options	Unlimited color wheel, quick presets for red, green, blue, amber & purple
Dimming	0-100% dimming option available for every color choice

HOW TO SPECIFY	FIXTURE	FINISH OPTION	FACTORY INSTALLED LED	ORDER ACCESSORIES
WITH bt  Bluetooth® RGBW LED Module	BL900-BT	-BLK for black overcoat (blank for aged brass finish)		Mounting (page 104) Risers (page 105) Lenses (page 109)
WITHOUT bt	BL900		-LED Add suffix for lamp (see above) (blank for no lamp)	

Example: BL900-BT-BLK



Aged Brass
BL900



Premium Black Overcoat
BL900-BLK

A fully-adjustable shroud adds versatility to this sleek, heavy-duty fixture with numerous options and an optional color-tunable, dimmable Bluetooth® LED module.

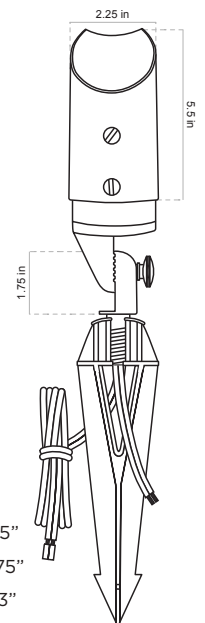

DIMENSIONS

- SHROUD HEIGHT** 5.5"
HEIGHT 1.75"
LENGTH/DEPTH 7.3"
WIDTH 2.25"

ACCENT & UPLIGHT



Aged Brass

BL400-BT



Premium
Black Overcoat

BL400-BT-BLK

Powerful integrated bt fixture for maximum impact directional accent lighting.

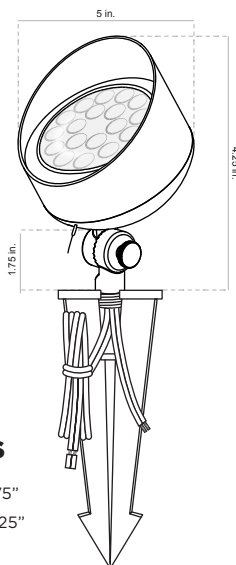

DIMENSIONS

HEIGHT 1.75"
LENGTH/DEPTH 4.25"
WIDTH 5"

PRODUCT SPECS

MOUNTING / INSTALLATION

Wire Lead Double 18AWG wire leads (option to daisy chain), first 25', second 18".

Mounting Slotted 8.5" large ground stake (standard), Options: surface mount, gutter mount, Permapost heavy-duty stake, fixed solid brass risers. See page 104-105 for details.

MATERIAL

Housing Solid cast brass.

Knuckle Solid cast brass, knob for angle adjustment.

Shroud Solid cast brass, with turn-to-lock fitting.

ORDERING INFORMATION



LIGHT SOURCE

INTEGRATED BLUETOOTH® RGBW MODULE

Wattage	4w - 11w
Lumen Output	15lm - 900lm
Beam Spread	40°
CCT Options	Adjustable from 2700K-5000K
RGBW Options	Unlimited color wheel, quick presets for red, green, blue, amber & purple
Dimming	0-100% dimming option available for every color choice

HOW TO SPECIFY

FIXTURE	FINISH OPTION	ORDER ACCESSORIES
BL400-BT	-BLK for black overcoat (blank for aged brass finish)	Mounting (see page 104) Risers (see page 105)

Example: BL400-BT-BLK



PRODUCT SPECS

MOUNTING / INSTALLATION

- Wire Lead** 25' 18AWG wire lead.
Mounting Cast bronze ground stake (standard).

MATERIAL

- Housing** Solid bronze, with solid bronze shroud.
Knuckle Bronze, adjustable for precision aiming.
Socket Spring-loaded ceramic bi-pin MR16, with Dual contacts & lamp clips.
Shroud & Lens Solid bronze, with o-ring seal, with convex tempered, shock-resistant glass lens.
Optional Lenses Frosted lens, hex louver.

ORDERING INFORMATION

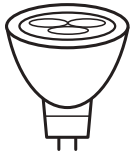

LIGHT SOURCE OPTIONS

CHOOSE FROM:

- Drop-in MR-16 lamp below
- Also available without lamp.

DROP-IN MR16 LAMP OPTION

ADD-SUFFIX	WATTAGE	BEAM ANGLE	DELIVERED LUMENS	COLOR TEMPERATURE	BASE COLOR CODE
-LED4W-NS	4	15	250	2900K	BLACK
-LED4W	4	45	250	2900K	BLACK
-LED4W-WF	4	60	250	2900K	BLACK
-LED5W-NS	5	15	310	2900K	WHITE
-LED5W	5	45	310	2900K	WHITE
-LED5W-WF	5	60	310	2900K	WHITE
-LED6W	6	45	400	2900K	BLUE

HOW TO SPECIFY

FIXTURE	CHOOSE LIGHT SOURCE	ORDER ACCESSORIES
HSC-BL1	-LED Add suffix for lamp (see above) (blank for no lamp)	Lenses (see page 109)

EXAMPLE: HSC-BL1-LED5W



Includes sand-cast bronze stake



Sand-Cast Bronze

HSC-BL1



For applications where the client desires the chunky, thick appearance of a sand-cast bronze fixture, our HSC series is a superior choice. This HSC bullet light is a medium size option that uses an MR-16 lamp.

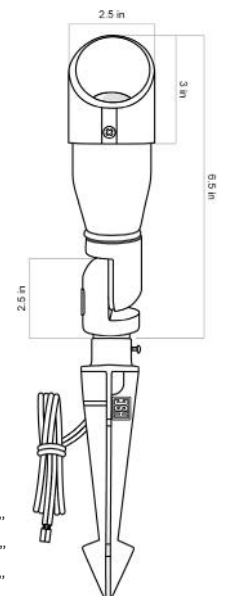

DIMENSIONS

- HEIGHT** 2.5"
LENGTH/DEPTH 6.5"
WIDTH 2.5"

ACCENT & UPLIGHT



Sand-Cast Bronze
HSC-BL2

For applications where the client desires the chunky, thick appearance of a sand-cast bronze fixture, our HSC series is a superior choice. This HSC bullet light is a smaller option that uses an MR-11 lamp.

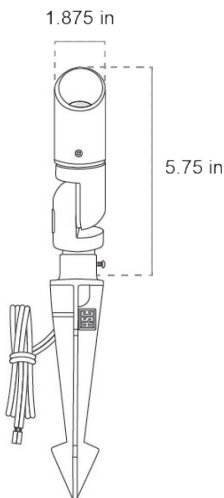

DIMENSIONS

HEIGHT 5.75"
DIAMETER 1.875"

PRODUCT SPECS

MOUNTING / INSTALLATION

Wire Lead 25' 18AWG wire lead.
Mounting Cast bronze ground stake (standard).

MATERIAL

Housing Solid bronze, with solid bronze shroud.
Knuckle Bronze, adjustable for precision aiming.
Socket Spring-loaded ceramic bi-pin MR11, with Dual contacts & lamp clips.
Shroud & Lens Solid bronze, with o-ring seal, with convex tempered, shock-resistant glass lens.

ORDERING INFORMATION



LIGHT SOURCE OPTIONS

CHOOSE FROM:

- Drop-in MR-11 lamp below
- Also available without lamp.

DROP-IN MR11 LAMP OPTION

ADD-SUFFIX	WATTAGE	BEAM ANGLE	DELIVERED LUMENS	COLOR TEMPERATURE
-LED	4	45	175	2900K

HOW TO SPECIFY

FIXTURE	CHOOSE LIGHT SOURCE
HSC-BL2	-LED Add suffix for lamp (see above) (blank for no lamp)

EXAMPLE: HSC-BL2-LED



Includes sand-cast bronze stake

PRODUCT SPECS

MOUNTING / INSTALLATION

- Wire Lead** 25' 18AWG wire lead.
- Mounting** Cast bronze ground stake (standard).

MATERIAL

- Housing** Solid bronze, with solid bronze shroud.
- Knuckle** Bronze, adjustable for precision aiming.
- Shroud & Lens** Solid bronze, with o-ring seal, with convex tempered, shock-resistant glass lens.

ORDERING INFORMATION

bt LIGHT SOURCE
INTEGRATED BLUETOOTH® RGBW MODULE

FACTORY-INSTALLED RGBW LED BLUETOOTH® MODULE

Wattage	2w - 4w
Lumen Output	10lm - 430lm
Beam Spread	40°
CCT Options	Adjustable from 2700K-5000K
RGBW Options	Unlimited color wheel, quick presets for red, green, blue, amber & purple
Dimming	0-100% dimming option available for every color choice

HOW TO SPECIFY

FIXTURE	ORDER ACCESSORIES
HSC-BL3-BT	Lenses (see page 109)

EXAMPLE: HSC-BL3-BT



Includes sand-cast bronze stake



Sand-Cast Bronze
HSC-BL3-BT

For applications where the client desires the chunky, thick appearance of a sand-cast bronze fixture, our HSC series is a superior choice. This HSC bullet light is an integrated bt fixture.

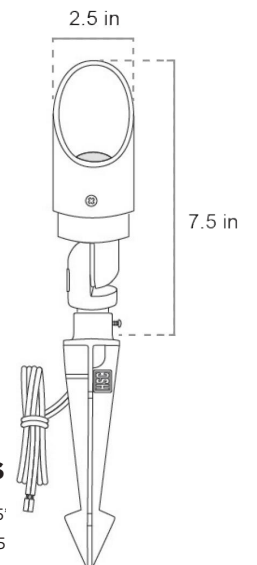

DIMENSIONS

- HEIGHT** 7.5'
- DIAMETER** 2.5



AREA & PATH

Allow safe passage after dark while enhancing the landscape

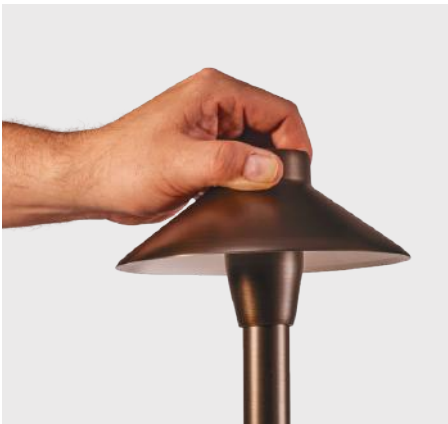

CUSTOMIZE YOUR HAT & STEM COMBO

Designed for easy inventory and mix-and-match design flexibility, our area lights are ordered in two steps:

1 CHOOSE YOUR HAT STYLE

On the following pages, choose from these hat styles: AL100, AL150, AL250, AL400, AL300, AL500, AL550, AL700, AL750, AL800, AL850.

2 CHOOSE YOUR STEM SIZE & LIGHT SOURCE

On the following pages, choose from the 12" stem, 18" stem, or 24" stem. All sizes can be purchased with drop-in LED lamp or without a lamp. The 12" and 18" stems are available with integrated Bluetooth® RGBW module.

At Alliance, we let you mix and match our stems and hats so you can create the coverage you need in the styles you desire. Get precise lighting with a shorter stem and smaller hat, or opt for a taller stem with a larger hat for more coverage. We make it easy to customize your path lights, so you can have more control over your lighting designs.



SHORTER STEMS AND SMALLER HATS ARE GREAT FOR
SMALLER AREAS | PRECISE PATH LIGHTING

- focused light spread
- subtle appearance
- minimized glare



LONGER STEMS AND LARGER HATS ARE GREAT FOR
LARGER AREAS | WIDE PATHS

- wider coverage
- dramatic visual impact
- enhanced visibility

AREA & PATH

We recommend pairing the hats on this page with a **12"** or **18"** stem

Choose from the minimalist style of the AL150, the art deco style of the AL300, the precise light spread of the small AL550, or the traditional look of the AL500.



↙ SMALLER HATS AND SHORTER STEMS ARE GREAT FOR FOCUSED LIGHT SPREAD



We recommend pairing the hats on this page with a **18"** or **24"** stem

Choose from the traditional style of the AL100, the sleek and modern AL250 or the beautifully decorative AL400 hat.



Aged Brass
AL100

Premium Black Overcoat
AL100-BLK

HEIGHT: 2.5"
WIDTH: 6.75"



Aged Brass
AL250

Premium Black Overcoat
AL250-BLK

HEIGHT: 2"
WIDTH: 7.75"

Aged Brass
AL400

Premium Black Overcoat
AL400-BLK

HEIGHT: 4.75"
WIDTH: 7.5"

MID-SIZE HATS AND MEDIUM HEIGHT STEMS GIVE A BALANCED SPREAD



We recommend pairing the hats on this page with a **18"** or **24"** stem

THESE WILL NOT FIT THE 12" OR 18" ALSTEM-BT BLUETOOTH® STEMS.

Choose from the bold look of the AL700, the wide light spread of the AL800, the contemporary two-toned AL750, or the mushroom cap style of AL850.



LARGER HATS AND TALLER STEMS MAKE FOR WIDER BEAM SPREADS ↷



2 CHOOSE YOUR STEM SIZE (AND LIGHT SOURCE!)

12" stems are perfect for

- focused illumination
- small plants and features
- narrow walkways

18" stems are perfect for

- balanced illumination
- mid-height plants and features
- wide range of designs

24" stems are perfect for

- wide paths and driveways
- dramatic visual impact
- enhanced safety and visibility



bt
OPTION
AVAILABLE

Aged Brass
ALSTEM12

bt
OPTION
AVAILABLE

Premium
Black Overcoat
ALSTEM12-BLK

bt
OPTION
AVAILABLE

Aged Brass
ALSTEM18

bt
OPTION
AVAILABLE

Premium
Black Overcoat
ALSTEM18-BLK

Aged Brass
ALSTEM24

Premium
Black Overcoat
ALSTEM24-BLK

PRODUCT SPECS

MOUNTING/INSTALLATION

- Wire Lead** Double 18AWG wire leads (option to daisy chain), first 25', second 18"
- Mounting** Slotted 8.5" large ground stake (standard). Optional surface mount or Permapost heavy-duty stake. See page 104 for details.

MATERIAL

- Hat and Stem** Solid cast brass
- Lens** Polycarbonate lens with rubber gasket. Clear and frosted lenses included, except AL750, AL800, and AL850, which include a frosted lens permanently sealed into the collar.
- Socket** G4 Bi-Pin, Spring-loaded ceramic, with Dual contacts
- Adjustable Beam** Stem incorporates adjustable collar for light spread and glare control

ORDERING INFORMATION

STANDARD LED OR NO LAMP STEM OPTIONS

PART NUMBER	HEIGHT	LED LAMP INSTALLED
ALSTEM12-LED	12"	LBIPIN-LED-200LM 2.5 WATT 2700K
ALSTEM18-LED	18"	LBIPIN-LED-200LM 2.5 WATT 2700K
ALSTEM24-LED	24"	LBIPIN-LED-200LM 2.5 WATT 2700K
ALSTEM12	12"	NO LAMP
ALSTEM18	18"	NO LAMP
ALSTEM24	24"	NO LAMP

RGBW LED BLUETOOTH® MODULE STEM OPTIONS

PART NUMBER	HEIGHT	LED LAMP INSTALLED
ALSTEM12-BT	12"	bt System LED module
ALSTEM18-BT	18"	bt System LED module
Wattage	2w - 6w	
Lumen Output	10lm - 350lm	
CCT Options	Adjustable from 2700K-5000K	
RGBW Options	Unlimited color wheel, quick presets for red, green, blue, amber and purple	
Dimming	0-100% dimming option for every color choice	

HOW TO SPECIFY

HAT	STEM	FINISH OPTIONS
<i>Example:</i> AL300	<i>Example:</i> ALSTEM18-BT (use the charts above to determine which stem you need)	-BLK for black overcoat (blank for aged brass finish)

Example: AL300-BLK, ALSTEM18-BT-BLK

AREA & PATH



Bold lighted directional bollard equally suitable for estate-type residential, commercial and institutional pedestrian spaces. Low voltage design easily retrofits to existing landscapes to visually guide visitors without the expense of new line-voltage electrical circuits.

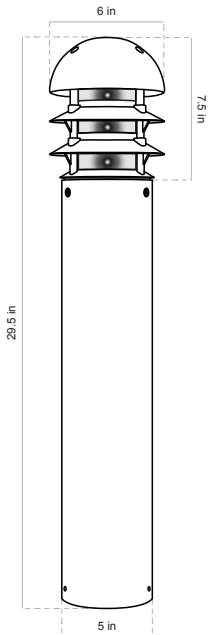

DIMENSIONS

- BASE HEIGHT** 29.5"
- BASE WIDTH** 5"
- TOP HEIGHT** 7.5"
- TOP WIDTH** 6"

PRODUCT SPECS

MOUNTING / INSTALLATION

- Wire Lead** 36" 18AWG wire lead.
- Mounting** Stainless steel mounting base with three anchor L-bolts for installation into a poured concrete footing. For best results, footing should be higher than finished grade to protect fixture base from trimmers in lawn areas.

MATERIAL

- Cover & louvers** Solid brass 3-tier cover and louvers.
- Post** Stainless steel post with aged brass finish.
- Lens** Frosted polycarbonate lens recommended and provided. Clear lens also provided.
- Lamp Socket** G4 Bi-Pin, Spring-loaded ceramic, with Dual contacts.

ORDERING INFORMATION

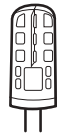

LIGHT SOURCE OPTIONS

CHOOSE FROM:

- Drop-in LBIPIN-LED-350lm 3.5W 2700K
- Also available without lamp.

HOW TO SPECIFY

MODEL	FINISH OPTIONS	CHOOSE LIGHT SOURCE
BOLLARD100	-BLK for black overcoat (blank for aged brass finish)	- LED for LBIPIN-LED-350lm 3.5 watt 2700K lamp

Example: BOLLARD100-BLK-LED



PRODUCT SPECS

MOUNTING / INSTALLATION

- Wire Lead** Double 18AWG wire leads (option to daisy chain), first 25', second 18".
- Mounting** Slotted 14" giant ground stake (standard)

CONSTRUCTION

- Material** Solid brass
- Lens** Frosted polycarbonate lens installed

ORDERING INFORMATION

LIGHT SOURCE

INTEGRATED LED MODULE

- 3 watts • 300 lumens • 3000K

HOW TO SPECIFY

MODEL	FINISH OPTIONS
PL600-LED	-BLK for black overcoat (blank for aged brass finish)

Example: PL600-LED-BLK

Giant 14" ground stake pre-installed for maximum stability.



Aged Brass
PL600-LED

Premium
Black Overcoat
PL600-LED-BLK

Modernist path-light with bold angular appearance for both residential and commercial appeal. Taller height provides wider spread of light and visually punctuates the path.

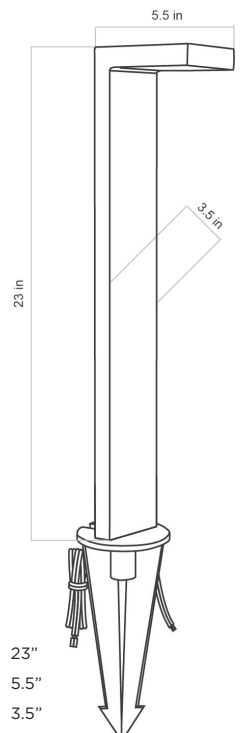
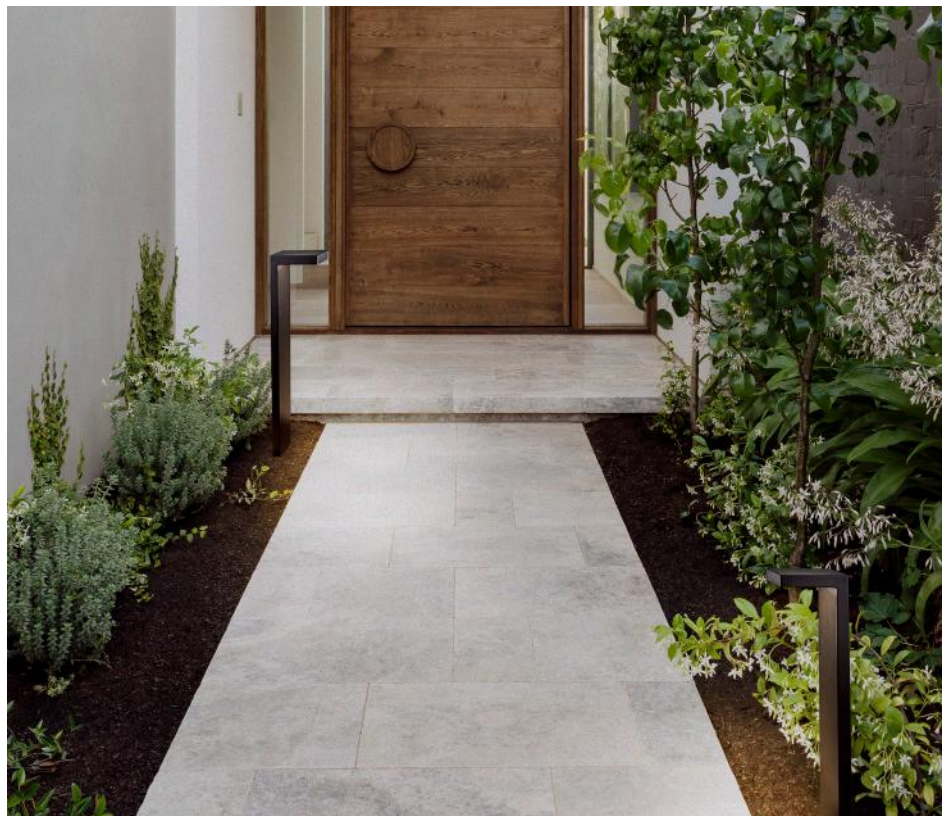

DIMENSIONS

- HEIGHT** 23"
- WIDTH** 5.5"
- STEM THICKNESS** 3.5"

AREA & PATH



Featuring a fully-adjustable stem, this fixture allows you to control the light spread precisely from large spread to focused pools of light.

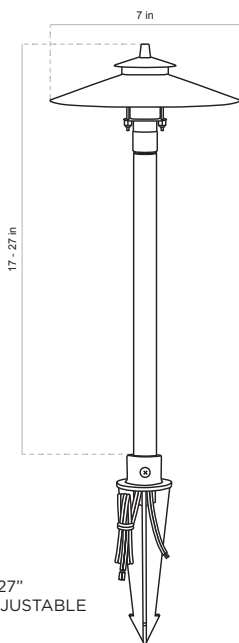

DIMENSIONS

HEIGHT 17-27"
ADJUSTABLE
HAT DIAMETER 7"

PRODUCT SPECS

MOUNTING / INSTALLATION

Wire Lead Double 18AWG wire leads (option to daisy chain), first 25', second 18".
Mounting Solid brass ground stake (standard).

CONSTRUCTION

Adjustability Telescoping stem allows height adjustment between 17" and 27" for light spread control.
Material Solid cast brass (hat and stem).
Lens Clear, shock-resistant glass
Socket G4 Bi-Pin, Spring-loaded ceramic, with Dual contacts.

ORDERING INFORMATION

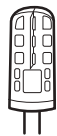

LIGHT SOURCE OPTIONS

CHOOSE FROM:

- LBIPIN-LED-200lm 2.5 watt 2700K drop-in lamp.
- Also available without lamp.

HOW TO SPECIFY

MODEL	FINISH OPTIONS	CHOOSE LIGHT SOURCE
PL200	-BLK for black overcoat (blank for aged brass finish)	- LED for LBIPIN-LED-200lm 2.5 watt 2700K lamp

Example: PL200-BLK-LED



Solid brass ground stake comes standard with both PL200 and PL250



PRODUCT SPECS

MOUNTING / INSTALLATION

- Wire Lead** Double 18AWG wire leads (option to daisy chain), first 25', second 18".
- Mounting** Solid brass ground stake (standard).

CONSTRUCTION

- Adjustability** Telescoping stem allows height adjustment between 17" and 27" for light spread control.
- Material** Solid cast brass (hat and stem).
- Lens** Clear, shock-resistant glass
- Socket** G4 Bi-Pin, Spring-loaded ceramic, with Dual contacts.

ORDERING INFORMATION

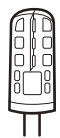

LIGHT SOURCE OPTIONS

CHOOSE FROM:

- LBIPIN-LED-200lm 2.5 watt 2700K drop-in lamp.
- Also available without lamp.

HOW TO SPECIFY

MODEL	FINISH OPTIONS	CHOOSE LIGHT SOURCE
PL250	-BLK for black overcoat (blank for aged brass finish)	- LED for LBIPIN-LED-200lm 2.5 watt 2700K lamp

Example: PL250-BLK-LED

ADJUST THE STEM HEIGHT TO MATCH THE GROWTH OF YOUR LANDSCAPE

Adjustable stem permits precise light and control for both PL200 and PL250

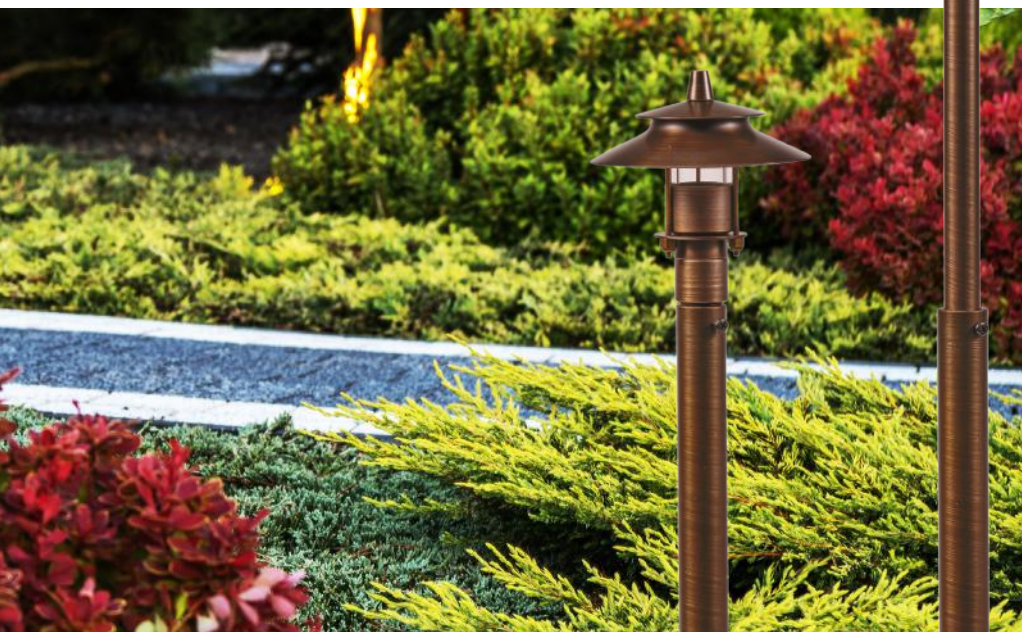

Aged Brass
PL250



Premium
Black Overcoat
PL250-BLK

This fixture is the mini hat version of the PL200. Featuring a fully-adjustable stem, this fixtures allows you to control the light spread precisely from large spread to focused pools of light.

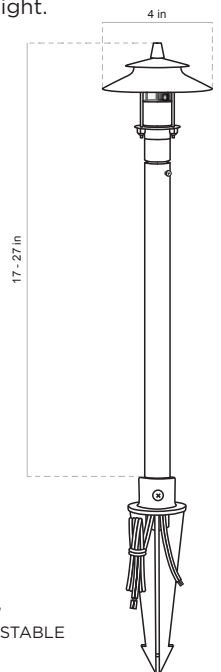

DIMENSIONS

- HEIGHT** 17-27" ADJUSTABLE
- HAT DIAMETER** 4"

AREA & PATH



Aged Brass
PL100



Premium
Black Overcoat
PL100-BLK

Elegant curved stem path fixture provides visual interest as well as the ultimate in aiming. The fixture hat can be pivoted to control light beam and reduce glare.



DIMENSIONS

- HEIGHT 19"
- WIDTH 10"
- HAT HEIGHT 4.2"
- HAT DIAMETER 5.2"

PRODUCT SPECS

MOUNTING / INSTALLATION

- Wire Lead** Double 18AWG wire leads (option to daisy chain), first 25', second 18".
- Mounting** Slotted 8.5" large ground stake (standard), Optional surface mount or Permapost heavy-duty stake. See page 104 for details.

CONSTRUCTION

- Adjustability** Hat incorporates dual adjustments, brass thumb screw for vertical adjustments, brass stem nut for horizontal adjustments.
- Material** Solid brass (hat and stem).
- Lens** Frosted polycarbonate bubble lens.
- Socket** G4 Bi-Pin, Spring-loaded ceramic, with Dual contacts.



FULLY ADJUSTABLE HAT

ORDERING INFORMATION

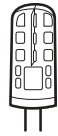

LIGHT SOURCE OPTIONS

CHOOSE FROM:

- Drop-in LBIPIN-LED-200lm 2.5 watt 2700K
- Factory-installed Bluetooth® module.
- Also available without lamp.

FACTORY-INSTALLED RGBW LED BLUETOOTH® MODULE

Wattage	2w - 6w
Lumen Output	10lm - 350lm
CCT Options	Adjustable from 2700K-5000K
RGBW Options	Unlimited color wheel, quick presets for red, green, blue, amber & purple
Dimming	0-100% dimming option available for every color choice

HOW TO SPECIFY

	FIXTURE	FINISH OPTION	FACTORY INSTALLED LED	ORDER ACCESSORIES
WITH bt	PL100-BT	-BLK for black overcoat (blank for aged brass finish)		Mounting (page 104)
WITHOUT bt	PL100		-LED for LBIPIN-LED-200lm 2.5 watt 2700K (blank for no lamp)	

Example: PL100-BT-BLK

PRODUCT SPECS

MOUNTING / INSTALLATION

- Wire Lead** Double 18AWG wire leads (option to daisy chain), first 25', second 18".
- Mounting** Slotted 8.5" large ground stake (standard), Optional surface mount or Permapost heavy-duty stake. See page 104 for details.

CONSTRUCTION

- Material** Solid brass.
- Lens** Frosted polycarbonate lens installed. Clear lens provided for drop-in fixture.
- Lamp Socket** G4 Bi-Pin, Spring-loaded ceramic, with Dual contacts.

ORDERING INFORMATION

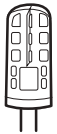

LIGHT SOURCE OPTIONS

CHOOSE FROM:

- Drop-in LBIPIN-LED-200lm 2.5 watt 2700K
- Factory-installed Bluetooth® module.
- Also available without lamp.

FACTORY-INSTALLED RGBW LED BLUETOOTH® MODULE

Wattage	2w - 6w
Lumen Output	10lm - 350lm
CCT Options	Adjustable from 2700K-5000K
RGBW Options	Unlimited color wheel, quick presets for red, green, blue, amber & purple
Dimming	0-100% dimming option available for every color choice

HOW TO SPECIFY

	FIXTURE	FINISH OPTION	FACTORY INSTALLED LED	ORDER ACCESSORIES
WITH bt Bluetooth® RGBW LED Module	PL300-BT	-BLK for black overcoat (blank for aged brass finish)		Mounting (page 104)
WITHOUT bt	PL300		-LED for LBIPIN-LED-200lm 2.5 watt 2700K (blank for no lamp)	

Example: PL300-BT-BLK



Aged Brass
PL300



Premium
Black Overcoat
PL300-BLK



Designed to harmonize with minimalist landscapes or modern architecture, this fixture provides outstanding area lighting without drawing attention to itself.

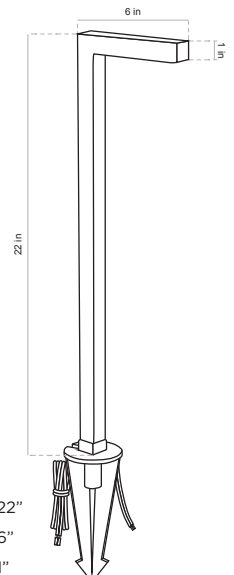

DIMENSIONS

- HEIGHT** 22"
- WIDTH** 6"
- STEM THICKNESS** 1"

AREA & PATH



For applications where a path light with a thicker, chunkier appearance is desired, this sand-cast bronze version provides all of the rugged performance of the Alliance line. The hat, collar, and stake are sand-cast bronze and the stem is thick copper.

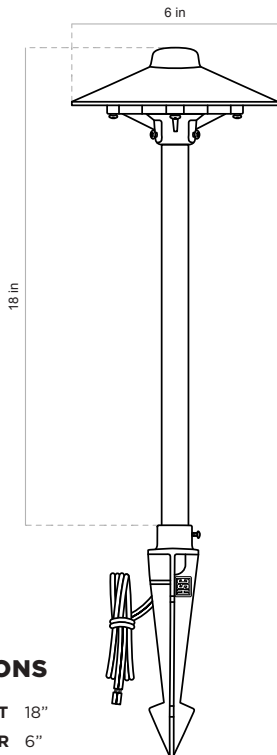

DIMENSIONS

HEIGHT 18"
HAT DIAMETER 6"

PRODUCT SPECS

MOUNTING / INSTALLATION

Wire Lead 25' 18AWG wire leads.
Mounting Cast bronze ground stake (standard).

CONSTRUCTION

Material Solid sand-cast bronze hat. Thick copper stem.
Lamp Socket G4 Bi-Pin, Spring-loaded ceramic, with Dual contacts.

ORDERING INFORMATION

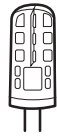

LIGHT SOURCE OPTIONS

CHOOSE FROM:

- Drop-in LBIPIN-LED-200lm 2.5 watt 2700K
- Also available without lamp.

Includes sand-cast bronze stake



HOW TO SPECIFY

FIXTURE	CHOOSE LIGHT SOURCE
HSC-PL1	-LED for LBIPIN-LED-200lm 2.5 watt 2700K lamp (blank for no lamp)

Example: HSC-PL1-LED



PRODUCT SPECS

MOUNTING / INSTALLATION

- Wire Lead** 25' 18AWG wire leads.
- Mounting** Cast bronze ground stake (standard).

CONSTRUCTION

- Material** Solid sand-cast bronze hat and collar. Thick copper stem.
- Lamp Socket** G4 Bi-Pin, Spring-loaded ceramic, with Dual contacts.

ORDERING INFORMATION

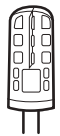

LIGHT SOURCE OPTIONS

CHOOSE FROM:

- Drop-in LBIPIN-LED-200lm 2.5 watt 2700K
- Also available without lamp.

Includes sand-cast bronze stake



HOW TO SPECIFY

FIXTURE	CHOOSE LIGHT SOURCE
HSC-PL2	-LED for LBIPIN-LED-200lm 2.5 watt 2700K lamp (blank for no lamp)

Example: HSC-PL2-LED



Sand-Cast Bronze

HSC-PL2

Path light with patterned cutouts for light bleed. For applications where a thicker, chunkier appearance is desired, this sand-cast bronze version provides all of the rugged performance of the Alliance line. The hat, collar, and stake are sand-cast bronze and the stem is thick copper.



DID YOU KNOW?

Sand-casting bronze is a time-sensitive process requiring skilled artisans. Components are produced in small batches and hand-finished before being assembled into complete fixtures. Sand-cast bronze ages naturally, for a fixture that blends well in outdoor environments.

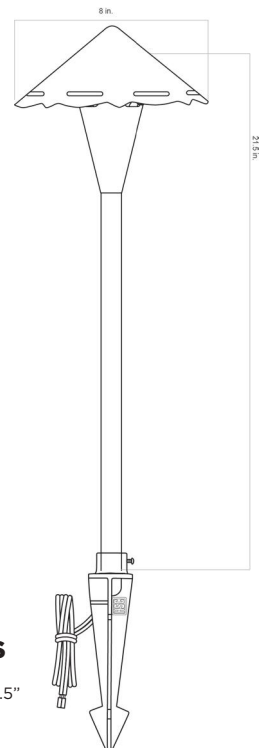

DIMENSIONS

- HEIGHT** 21.5"
- HAT DIAMETER** 8"

AREA & PATH



Sand-Cast
Bronze

HSC-PL3

For applications where a path light with a thicker, chunkier appearance is desired, this sand-cast bronze version provides all of the rugged performance of the Alliance line. The hat, collar, and stake are sand-cast bronze and the stem is thick copper.

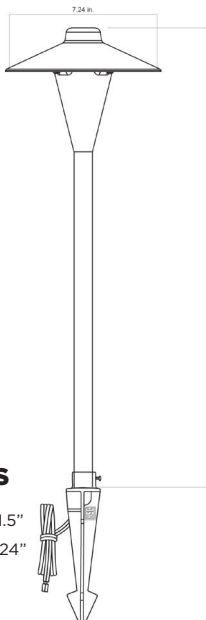

DIMENSIONS

HEIGHT 21.5"
HAT DIAMETER 7.24"

PRODUCT SPECS

MOUNTING / INSTALLATION

Wire Lead 25' 18AWG wire leads.
Mounting Cast bronze ground stake (standard).

CONSTRUCTION

Material Solid sand-cast bronze hat and collar. Thick copper stem.
Lamp Socket G4 Bi-Pin, Spring-loaded ceramic, with Dual contacts.

ORDERING INFORMATION

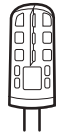

LIGHT SOURCE OPTIONS

CHOOSE FROM:

- Drop-in LBIPIN-LED-200lm 2.5 watt 2700K
- Also available without lamp.

Includes sand-cast
bronze stake



HOW TO SPECIFY

FIXTURE	CHOOSE LIGHT SOURCE
HSC-PL3	-LED for LBIPIN-LED-200lm 2.5 watt 2700K lamp (blank for no lamp)

Example: HSC-PL3-LED

PRODUCT SPECS

MOUNTING / INSTALLATION

- Wire Lead** 25' 18AWG wire leads.
- Mounting** Cast bronze ground stake (standard).

CONSTRUCTION

- Material** Solid sand-cast bronze hat. Thick copper stem.
- Lamp Socket** G4 Bi-Pin, Spring-loaded ceramic, with Dual contacts.

ORDERING INFORMATION

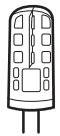

LIGHT SOURCE OPTIONS

CHOOSE FROM:

- Drop-in LBIPIN-LED-200lm 2.5 watt 2700K
- Also available without lamp.

HOW TO SPECIFY

FIXTURE	CHOOSE LIGHT SOURCE
HSC-PL4	-LED for LBIPIN-LED-200lm 2.5 watt 2700K lamp (blank for no lamp)

Example: HSC-PL4-LED

Includes sand-cast bronze stake



Sand-Cast Bronze

HSC-PL4



Path light with a square based pyramid shaped hat. For applications where a thicker, chunkier appearance is desired, this sand-cast bronze version provides all of the rugged performance of the Alliance line. The hat and stake are sand-cast bronze and the stem is thick copper.

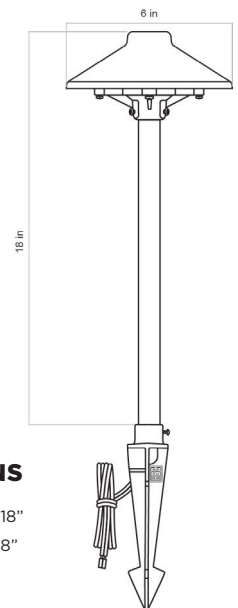

DIMENSIONS

- HEIGHT** 18"
- HAT DIAMETER** 8"



IN-GROUND LIGHTS

Concealed by day, these lights reveal themselves at night with dramatic, controlled effects

PRODUCT SPECS

INSTALLATION

Wire Lead Double 18AWG wire leads (option to daisy chain), first 25', second 18".

CONSTRUCTION

Housing ABS plastic can, stainless steel lamp retainer ring.

Lid Black ABS grated lid

Socket Spade connectors for LPAR36 lamp

Accessories Hex louver

ORDERING INFORMATION

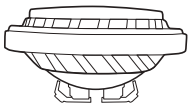

LIGHT SOURCE OPTIONS

CHOOSE FROM:

- Drop-in PAR-36 lamp (see page 107 for details)
- Also available without lamp.

DROP-IN PAR36 LAMP OPTIONS

ADD-SUFFIX	WATTAGE	BEAM ANGLE	DELIVERED LUMENS	COLOR TEMP	COLOR CODE
-LED4W-F	4	20	250	2800K	GRAY
-LED4W	4	40	250	2800K	GRAY
-LED8W-F	8	20	300	2800K	BLACK
-LED8W	8	40	300	2800K	BLACK
-LED10W-F	10	30	400	2800K	BLUE
-LED10W	10	45	400	2800K	BLUE

HOW TO SPECIFY

FIXTURE	CHOOSE LIGHT SOURCE
WL100	- LED Add suffix for lamp (see above) (blank for no lamp)

Example: WL100-LED8W



Black ABS
WL100

Black ABS grated lid, PAR36 lamp. Installing in grassy areas with foot and light lawn equipment traffic is acceptable.

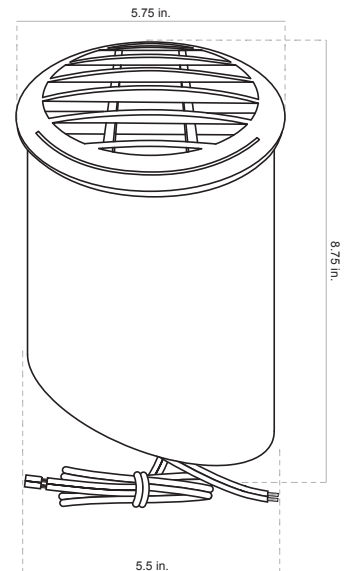

DIMENSIONS

LID EXPOSED DIAMETER	5.75"
BURIED FIXTURE DEPTH	8.75"
CAN DIAMETER	5.5"

IN-GROUND LIGHTS



Aged Brass
WL200



Premium
Black Overcoat
WL200-BLK

Well light with cast brass lid with open glass lens. Installing in areas with high foot or lawn equipment traffic is not recommended.

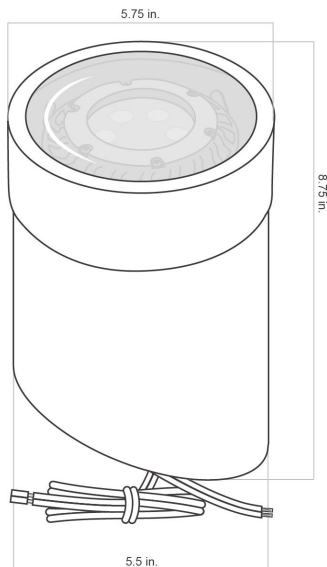

DIMENSIONS

LID DIAMETER	5.75"
BURIED FIXTURE DEPTH	8.75"
CAN DIAMETER	5.5"

PRODUCT SPECS

INSTALLATION

Wire Lead Double 18AWG wire leads (option to daisy chain), first 25', second 18".

CONSTRUCTION

Housing ABS plastic can, stainless steel lamp retainer ring.

Lid Cast brass, clear glass lens

Socket Spade connectors for LPAR36 lamp

Accessories Hex louver

ORDERING INFORMATION

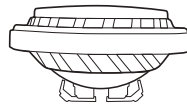

LIGHT SOURCE OPTIONS

CHOOSE FROM:

- Drop-in PAR-36 lamp (see page 107 for details)
- Also available without lamp.

DROP-IN PAR36 LAMP OPTIONS

ADD-SUFFIX	WATTAGE	BEAM ANGLE	DELIVERED LUMENS	COLOR TEMP	COLOR CODE
-LED4W-F	4	20	250	2800K	GRAY
-LED4W	4	40	250	2800K	GRAY
-LED8W-F	8	20	300	2800K	BLACK
-LED8W	8	40	300	2800K	BLACK
-LED10W-F	10	30	400	2800K	BLUE
-LED10W	10	45	400	2800K	BLUE

HOW TO SPECIFY

FIXTURE	FINISH OPTIONS	CHOOSE LIGHT SOURCE
WL200	- BLK for black overcoat (blank for aged brass finish)	- LED Add suffix for lamp (see above) (blank for no lamp)

Example: WL200-BLK-LED8W

IN-GROUND LIGHTS

PRODUCT SPECS

INSTALLATION

- Aiming** Lamp height adjustable on a brass track (grooves to lock settings) and a swivel mount for directional aiming of beam.
- Wire Lead** Double 18AWG wire leads (option to daisy chain), first 25', second 18"

MATERIAL

- Housing** ABS plastic can.
- Lid** Cast brass, attached with color-matched stainless steel screws.
- Socket** Spring-loaded ceramic bi-pin MR16, w/Dual contacts & lamp clips.
- Optional Lenses** Frosted lens, hex louver available.

ORDERING INFORMATION

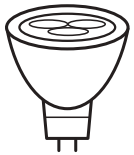

LIGHT SOURCE OPTIONS

CHOOSE FROM:

- Drop-in MR-16 lamp below
- Also available without lamp.

DROP-IN MR16 LAMP OPTIONS

ADD-SUFFIX	WATTAGE	BEAM ANGLE	DELIVERED LUMENS	COLOR TEMP	BASE COLOR CODE
-LED4W-NS	4	15	250	2900K	BLACK
-LED4W	4	45	250	2900K	BLACK
-LED4W-WF	4	60	250	2900K	BLACK
-LED5W-NS	5	15	310	2900K	WHITE
-LED5W	5	45	310	2900K	WHITE
-LED5W-WF	5	60	310	2900K	WHITE
-LED6W	6	45	400	2900K	BLUE

HOW TO SPECIFY

FIXTURE	FINISH OPTIONS	CHOOSE LIGHT SOURCE
WL300	-BLK for black overcoat (blank for aged brass finish)	-LED Add suffix for lamp (see above) (blank for no lamp)

Example: WL300-LED4W



Adjustable and aimable lamp assembly.



Aged Brass
WL300



Premium
Black Overcoat
WL300-BLK

Precisely aimable and adjustable MR16 well light for ultimate in light control. Provides the best of both worlds: flush mounting for lawn or hardscape areas and beam control. Installing in areas with high foot traffic is acceptable.

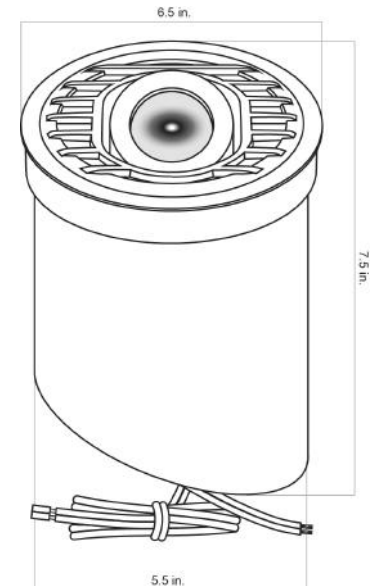

DIMENSIONS

- LID EXPOSED DIAMETER 6.5"
- BURIED FIXTURE DEPTH 7.5"
- CAN DIAMETER 5.5"

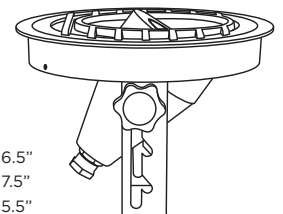

IN-GROUND LIGHTS



Aged Brass
CGWL01



Premium
Black Overcoat
CGWL01-BLK

Heavy duty brass grated lid, convex tempered glass lens, PAR36 lamp. Installing in areas with high foot traffic and light lawn equipment is acceptable.

PRODUCT SPECS

INSTALLATION

Wire Lead Double 18AWG wire leads (option to daisy chain), first 25', second 18".

CONSTRUCTION

Housing ABS plastic can, stainless steel lamp retainer ring.

Lid Cast brass, convex clear lens

Socket Spade connectors for LPAR36 lamp

Accessories Hex louver

ORDERING INFORMATION

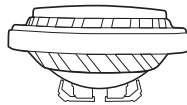

LIGHT SOURCE OPTIONS

CHOOSE FROM:

- Drop-in PAR-36 lamp (see page 107 for details)
- Also available without lamp.

DROP-IN PAR36 LAMP OPTIONS

ADD-SUFFIX	WATTAGE	BEAM ANGLE	DELIVERED LUMENS	COLOR TEMP	COLOR CODE
-LED4W-F	4	20	250	2800K	GRAY
-LED4W	4	40	250	2800K	GRAY
-LED8W-F	8	20	300	2800K	BLACK
-LED8W	8	40	300	2800K	BLACK
-LED10W-F	10	30	400	2800K	BLUE
-LED10W	10	45	400	2800K	BLUE

HOW TO SPECIFY

FIXTURE	FINISH OPTIONS	CHOOSE LIGHT SOURCE
CGWL01	-BLK for black overcoat (blank for aged brass finish)	-LED Add suffix for lamp (see above) (blank for no lamp)

Example: CGWL01-BLK-LED10W

DIMENSIONS

LID EXPOSED DIAMETER 6"
BURIED FIXTURE DEPTH 8.75"
CAN DIAMETER 5.5"

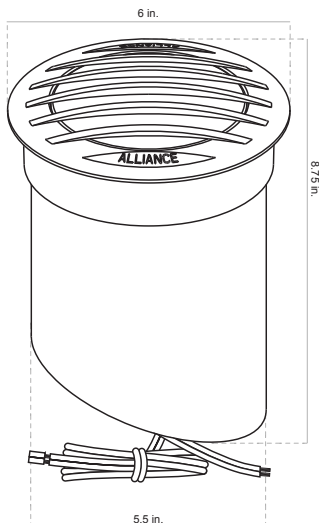

IN-GROUND LIGHTS

PRODUCT SPECS

INSTALLATION

Wire Lead Double 18AWG wire leads (option to daisy chain), first 25', second 18".

CONSTRUCTION

Housing ABS plastic can, stainless steel lamp retainer ring.

Lid Cast brass, clear lens

Socket Spade connectors for LPAR36 lamp

Accessories Hex louver

ORDERING INFORMATION

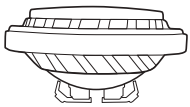

LIGHT SOURCE OPTIONS

CHOOSE FROM:

- Drop-in PAR-36 lamp (see page 107 for details)
- Also available without lamp.

DROP-IN PAR36 LAMP OPTIONS

ADD-SUFFIX	WATTAGE	BEAM ANGLE	DELIVERED LUMENS	COLOR TEMP	COLOR CODE
-LED4W-F	4	20	250	2800K	GRAY
-LED4W	4	40	250	2800K	GRAY
-LED8W-F	8	20	300	2800K	BLACK
-LED8W	8	40	300	2800K	BLACK
-LED10W-F	10	30	400	2800K	BLUE
-LED10W	10	45	400	2800K	BLUE

HOW TO SPECIFY

FIXTURE	FINISH OPTIONS	CHOOSE LIGHT SOURCE
CGWL02	-BLK for black overcoat (blank for aged brass finish)	- LED Add suffix for lamp (see above) (blank for no lamp)

Example: CGWL02-BLK-LED4W



Aged Brass
CGWL02



Premium
Black Overcoat
CGWL02-BLK

Cast brass lid with open glass lens, PAR36 lamp. Installing in areas with high foot traffic is acceptable. Lens is not drive-over rated.

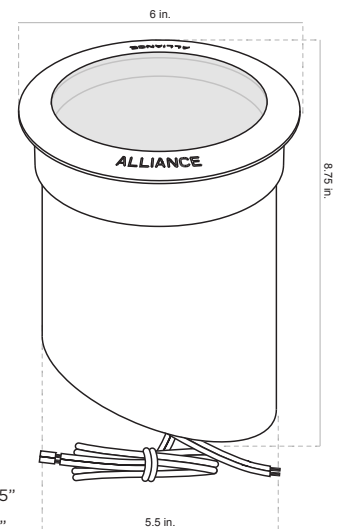

DIMENSIONS

LID DIAMETER 6"
BURIED
FIXTURE
DEPTH 8.75"
CAN DIAMETER 5.5"

IN-GROUND LIGHTS



Aged Brass
WL495-LED



Premium
Black Overcoat
WL495-LED-BLK

HIGH LUMEN OUTPUT

Cast brass lid with open glass lens. Includes integrated high lumen LED module. Installing in areas with high foot traffic is acceptable. Lens is not drive-over rated.

DIMENSIONS

LID DIAMETER 6"
BURIED
FIXTURE
DEPTH 8.75"
CAN DIAMETER 5.5"

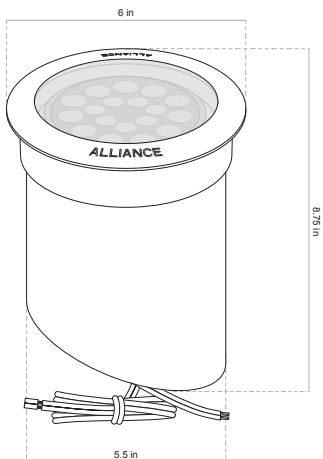

PRODUCT SPECS

INSTALLATION

Wire Lead Double 18AWG wire leads (option to daisy chain), first 25', second 18".

CONSTRUCTION

Housing ABS plastic can, stainless steel lamp retainer ring.

Lid Cast brass, clear lens

Accessories Hex louver

ORDERING INFORMATION

LIGHT SOURCE

INTEGRATED LED

- 11 watts
- 1200 lumens
- 40 degree flood
- 3000K

HOW TO SPECIFY

FIXTURE	FINISH OPTIONS
WL495-LED	-BLK for black overcoat (blank for aged brass finish)

Example: WL495-LED-BLK



PRODUCT SPECS

INSTALLATION

Wire Lead Double 18AWG wire leads (option to daisy chain), first 25', second 18".

CONSTRUCTION

Housing ABS plastic can, stainless steel lamp retainer ring.

Lid Cast brass, clear glass lens

Accessories Hex louver

ORDERING INFORMATION

bt **LIGHT SOURCE**
INTEGRATED BLUETOOTH® RGBW MODULE

FACTORY-INSTALLED RGBW LED BLUETOOTH® MODULE

Wattage	2w - 6w
Lumen Output	10lm - 900lm
Beam Spread	40°
CCT Options	Adjustable from 2700K-5000K
RGBW Options	Unlimited color wheel, quick presets for red, green, blue, amber & purple
Dimming	0-100% dimming option available for every color choice

HOW TO SPECIFY

FIXTURE	FINISH OPTIONS
WL400-BT	-BLK for black overcoat (blank for aged brass finish)

Example: WL400-BT-BLK



IN-GROUND LIGHTS



Aged Brass
WL400-BT



Premium
Black Overcoat
WL400-BT-BLK



Cast brass lid with open glass lens. Includes integrated Bluetooth® module. Installing in areas with high foot traffic is acceptable. Lens is not drive-over rated.

DIMENSIONS

LID DIAMETER 6"
**BURIED
FIXTURE
DEPTH** 8.75"
CAN DIAMETER 5.5"

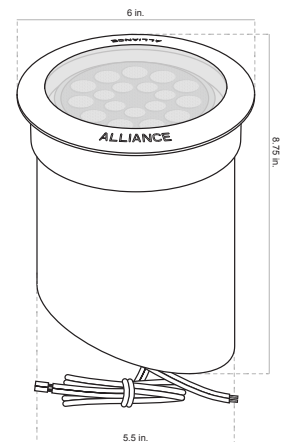

IN-GROUND LIGHTS



CHOOSING THE RIGHT IN-GROUND LIGHT

Different applications call for different lighting solutions. When we designed our GL100 and GL300 series, we simplified the process by giving you all the lid styles you need to create the lighting effects that you want.



GL100 SERIES



- Cast brass housing
- Double wire lead (25', 18")
- Smaller profile
- 3.5" lid diameter
- 6 lid styles available

Choose the GL100 series if you value a full brass construction for maximum durability and stability, need the extended wire length for flexible placement, and prefer a more compact, discreet fixture.



GL300 SERIES



- Non-corrosive ABS housing
- Single wire lead (60")
- Adjustable beam (drop-in)
- 4.75" lid diameter
- 7 lid styles available

Choose the GL300 series if you want a broader light spread with a larger brass top, are working within a budget, and don't mind the ABS base being less heavy, especially if cost savings and ease of installation are important.

On the following pages, we'll walk you through the different lid styles, so you can pick the right fixtures for your project. We have 6 lid styles in the GL100 series, and 7 lid styles available for the GL300 series - each one designed to give you more control over your lighting.

IN-GROUND LIGHTS



bt
OPTION
AVAILABLE

GL100 SERIES

A complete family of in-grade lighting solutions in a design that incorporates a cast brass body and lid. Select from models for uplighting, wall-washing and ground washing in one fixture series. Small exposed diameter hides easily. Ground washing models are a good alternative to path lights in areas where an exposed fixture is objectionable. OK for foot traffic, but not suitable for areas where they may be driven over by vehicles.



GREAT FOR:
**UPLIGHTING
WALL WASHING**

GL100 LID STYLE

Shrouded open convex lens, for wall washing, directional uplighting.



Aged
Brass
GL100



Premium
Black
Overcoat
GL100-BLK



GREAT FOR:
**UPLIGHTING
WALL WASHING**

GL150 LID STYLE

Clear convex lens, for uplighting.



Aged
Brass
GL150



Premium
Black
Overcoat
GL150-BLK

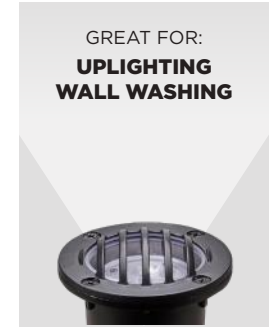

GREAT FOR:
**UPLIGHTING
WALL WASHING**

GL160 LID STYLE

Grate-protected convex lens, for uplighting.



Aged
Brass
GL160



Premium
Black
Overcoat
GL160-BLK

PRODUCT SPECS

INSTALLATION

Wire Lead Double 18AWG wire leads (option to daisy chain), first 25', second 18".

CONSTRUCTION

Housing Cast brass.

Lid Cast brass with clear lens, attached with 4 color-matched stainless steel screws

Socket Spring-loaded ceramic bi-pin MR16 with Dual contacts and lamp clips

ORDERING INFORMATION



LIGHT SOURCE OPTIONS

CHOOSE FROM:

- Drop-in MR-16 LED lamp from chart to the right
- Factory-installed Bluetooth® module.
- Also available without lamp for field installation

IN-GROUND LIGHTS



GREAT FOR:
GROUND WASHING

GL170 LID STYLE

Ground wash, opposing sides.



Aged Brass

GL170



Premium Black Overcoat

GL170-BLK



GREAT FOR:
GROUND WASHING

GL180 LID STYLE

Ground wash, 180 pattern, often for pavement lighting.



Aged Brass

GL180



Premium Black Overcoat

GL180-BLK



GREAT FOR:
GROUND WASHING

GL190 LID STYLE

Ground wash, 360 pattern.



Aged Brass

GL190



Premium Black Overcoat

GL190-BLK

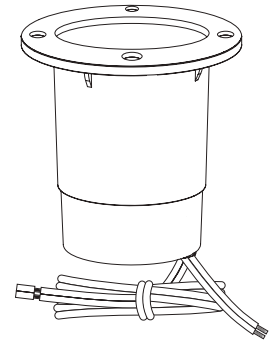
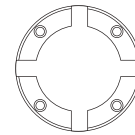
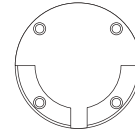
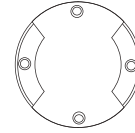
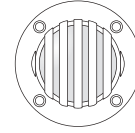
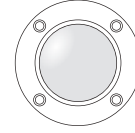
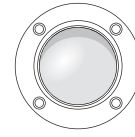

DIMENSIONS

LID DIAMETER 3.5"

BURIED
FIXTURE
DEPTH 3.5"

LID THICKNESS GL100: 1.5"
GL150: 0.5"
GL160: 0.5"
GL170: 0.5"
GL180: 0.5"
GL190: 0.5"

DROP-IN MR16 LAMP OPTIONS

ADD-SUFFIX	WATTAGE	BEAM ANGLE	DELIVERED LUMENS	COLOR TEMP	COLOR CODE
-LED4W-NS	4	15	250	2900K	BLACK
-LED4W	4	45	250	2900K	BLACK
-LED4W-WF	4	60	250	2900K	BLACK
-LED5W-NS	5	15	310	2900K	WHITE
-LED5W	5	45	310	2900K	WHITE
-LED5W-WF	5	60	310	2900K	WHITE
-LED6W	6	45	400	2900K	BLUE

FACTORY-INSTALLED RGBW LED BLUETOOTH® MODULE

Wattage	2w - 4w
Lumen Output	10lm - 430lm
Beam Spread	40°
CCT Options	Adjustable from 2700K-5000K
RGBW Options	Unlimited color wheel, quick presets for red, green, blue, amber & purple
Dimming	0-100% dimming option available for every color choice

HOW TO SPECIFY

WITH bt
Bluetooth®
RGBW LED
Module



WITHOUT bt

SELECT LID STYLE	Example: GL160-BT	Example: GL160
FINISH OPTIONS	-BLK for black overcoat (blank for aged brass finish)	
CHOOSE LIGHT SOURCE		-LED Add suffix for lamp (see MR16 lamp option chart)

Example: GL160-BLK-LED4W

IN-GROUND LIGHTS



GL300 SERIES

A complete family of in-grade lighting solutions for a variety of lighting applications. Combines a rugged brass lid with a non-corrosive polymer housing for long life. OK for foot traffic, but not suitable for areas where they may be driven over by vehicles.

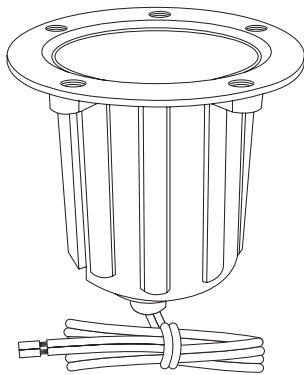

DIMENSIONS

LID DIAMETER	4.87"
BURIED FIXTURE DEPTH	4.75"
LID THICKNESS	GL300: 0.5" GL310: 2" GL350: 1.75" GL360: 1" GL370: 1" GL380: 1" GL390: 1"



GREAT FOR:
**UPLIGHTING
WALL WASHING**

GL300 LID STYLE

Clear flat lens, for uplighting.



Aged Brass
GL300



Premium Black Overcoat
GL300-BLK

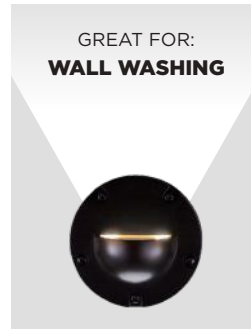

GREAT FOR:
WALL WASHING

GL310 LID STYLE

Domed half lid, for wall washing or directional lighting.



Aged Brass
GL310



Premium Black Overcoat
GL310-BLK



GREAT FOR:
**UPLIGHTING
WALL WASHING**

GL350 LID STYLE

Shrouded open convex lens, for wall washing, directional uplighting.



Aged Brass
GL350



Premium Black Overcoat
GL350-BLK

PRODUCT SPECS

INSTALLATION

Lead Wire 60" 18AWG wire lead.

CONSTRUCTION

Housing Non-corrosive polymer.

Lid Cast brass, attached with 5 color-matched stainless steel screws

Socket Spring-loaded ceramic bi-pin MR16, with Dual contacts and lamp clips

ORDERING INFORMATION



LIGHT SOURCE OPTIONS

CHOOSE FROM:

- Drop-in MR-16 LED lamp from chart to the right
- Factory-installed Bluetooth® module.
- Also available without lamp for field installation

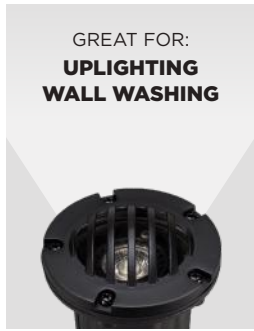

GL360 LID STYLE

Grate-protected flat lens light fixture, for uplighting.

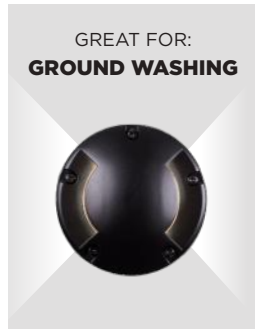

GL370 LID STYLE

Ground wash, opposing sides.



GL380 LID STYLE

Ground wash, 180 degree pattern, often for pavement lighting.



GL390 LID STYLE

Ground wash, 360 degree pattern.

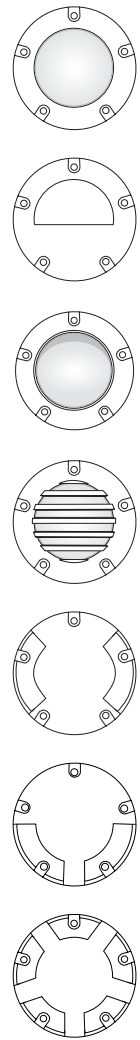

DROP-IN MR16 LAMP OPTIONS

ADD-SUFFIX	WATTAGE	BEAM ANGLE	DELIVERED LUMENS	COLOR TEMP	COLOR CODE
-LED4W-NS	4	15	250	2900K	BLACK
-LED4W	4	45	250	2900K	BLACK
-LED4W-WF	4	60	250	2900K	BLACK
-LED5W-NS	5	15	310	2900K	WHITE
-LED5W	5	45	310	2900K	WHITE
-LED5W-WF	5	60	310	2900K	WHITE
-LED6W	6	45	400	2900K	BLUE

FACTORY-INSTALLED RGBW LED BLUETOOTH® MODULE

Wattage	2w - 6w
Lumen Output	15lm - 450lm
Beam Spread	40°
CCT Options	Adjustable from 2700K-5000K
RGBW Options	Unlimited color wheel, quick presets for red, green, blue, amber & purple
Dimming	0-100% dimming option available for every color choice

HOW TO SPECIFY	WITH bt Bluetooth® RGBW LED Module	WITHOUT bt
SELECT LID STYLE	Example: GL360-BT	Example: GL360
FINISH OPTIONS	-BLK for black overcoat (blank for aged brass finish)	
CHOOSE LIGHT SOURCE		-LED Add suffix for lamp (see MR16 lamp option chart)

Example: GL360-BLK-LED4W



HARDSCAPE

Bring light to your
outdoor living areas

ILLUMINATE YOUR OUTDOOR LIFESTYLE

Entertain guests into the night with our hardscape fixtures. Light up a BBQ island, retaining wall, fence post, or increase safety with step lights. We have everything you need to make an outdoor space inviting and safe, well into the evening.



HARDSCAPE



Aged Brass
SL100



Premium Black Overcoat
SL100-BLK

Versatile surface-mounted fixture commonly used on fence posts, steps and walls to provide low-level illumination for safe passage.

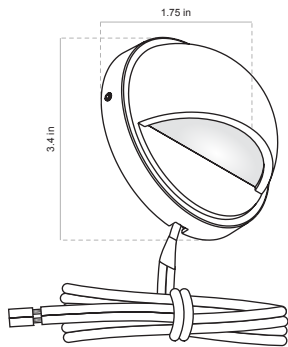

DIMENSIONS

DIAMETER 3.4"
DEPTH 1.75"

PRODUCT SPECS

MOUNTING/INSTALLATION

Wire Lead 25' 18AWG wire lead.

Mounting Concealed mounting base plate and fasteners with adjustable mounting guides. SL100 fixture face attaches to mounting base with inconspicuous allen hex screws. Mounting template provided to guide in mounting and concealing wiring. Splices are made remotely from fixture, not in base plate.

MATERIAL

Housing Solid cast brass.

Lens Frosted lens.

Socket G4 Bi-pin, spring-loaded ceramic, with Dual contacts.

ORDERING INFORMATION



LIGHT SOURCE OPTIONS

Choose from:

- Drop-in LBIPIN-LED-200lm 2.5 watt 2700K.
- Also available without lamp.

DROP-IN LAMP OPTION

ADD-SUFFIX	WATTAGE	DELIVERED LUMENS	COLOR TEMP
-LED	2.5	200	2700K

HOW TO SPECIFY

FIXTURE	FINISH OPTION	CHOOSE LIGHT SOURCE
SL100	-BLK for black overcoat (blank for aged brass finish)	-LED for LBIPIN-LED-200lm 2.5 watt 2700K lamp (blank for no lamp)

Example: SL100-BLK-LED



PRODUCT SPECS

MOUNTING/INSTALLATION

- Wire Lead** 25' 18AWG wire lead.
- Mounting** Built-in teardrop-style mounting system for clean, secure installation. Screws mount directly to the surface, and the fixture slides down to lock into place. No separate base plate or visible fasteners—everything is integrated into the fixture housing.

MATERIAL

- Housing** Solid cast brass.
- Socket** G4 Bi-pin, spring-loaded ceramic, with Dual contacts.

ORDERING INFORMATION

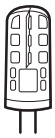

LIGHT SOURCE OPTIONS

- Choose from:
- Drop-in LBIPIN-LED-200lm 2.5 watt 2700K.
 - Also available without lamp.

DROP-IN LAMP OPTION

ADD-SUFFIX	WATTAGE	DELIVERED LUMENS	COLOR TEMP
-LED	2.5	200	2700K

HOW TO SPECIFY

FIXTURE	FINISH OPTION	CHOOSE LIGHT SOURCE
SL150	-BLK for black overcoat (blank for aged brass finish)	-LED for LBIPIN-LED-200lm 2.5 watt 2700K lamp (blank for no lamp)

Example: SL150-BLK-LED



Aged Brass
SL150



Premium
Black
Overcoat
SL150-BLK

Bell-shaped fixture has a decorative appearance, providing versatility for mid-wall and low-level installations.

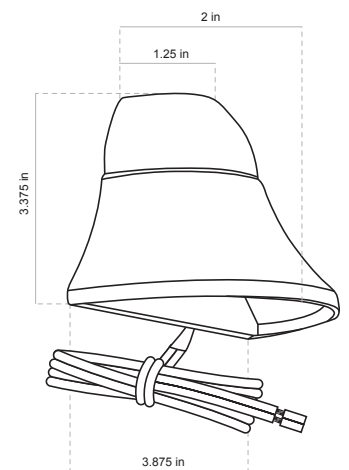

DIMENSIONS

- WIDTH** 3.875"
HEIGHT 3.375"
DEPTH 2"

HARDSCAPE



Aged Brass

POST50



Premium
Black
Overcoat

POST50-BLK

Craftsman / prairie-style post or column fixture with alluring daytime appearance and guiding night-time glow. 3.5" square footprint, 7" overall height and 5.25" hat width.

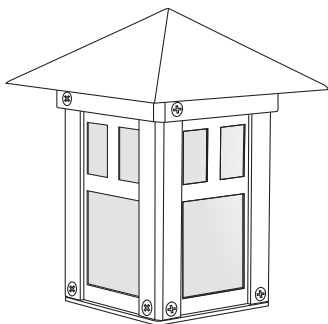

DIMENSIONS

BASE 3.5" SQUARE
HEIGHT 7"
HAT WIDTH 5.25"

PRODUCT SPECS

MOUNTING/INSTALLATION

Wire Lead 25' 18AWG wire lead.

Mounting Concealed mounting base plate. Fixture face attaches to mounting base with color-matched phillips screws. Splices are made remotely from fixture, not in base plate.

CONSTRUCTION

Material Brass fixture (hat, body, base).

Lens Opaque polycarbonate lenses.

Socket G4 Bi-Pin, ceramic, spring-loaded Dual contacts

ORDERING INFORMATION

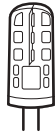

LIGHT SOURCE OPTIONS

Choose from:

- Drop-in LBIPIN-LED-200lm 2.5 watt 2700K.
- Also available without lamp.

DROP-IN LAMP OPTION

ADD-SUFFIX	WATTAGE	DELIVERED LUMENS	COLOR TEMP
-LED	2.5	200	2700K

HOW TO SPECIFY

FIXTURE	FINISH OPTION	CHOOSE LIGHT SOURCE
POST50	-BLK for black overcoat (blank for aged brass finish)	-LED for LBIPIN-LED-200lm 2.5 watt 2700K lamp (blank for no lamp. 250lm and 350lm LBIPIN drop-in lamp options sold separately - see page 108)

Example: POST50-BLK-LED

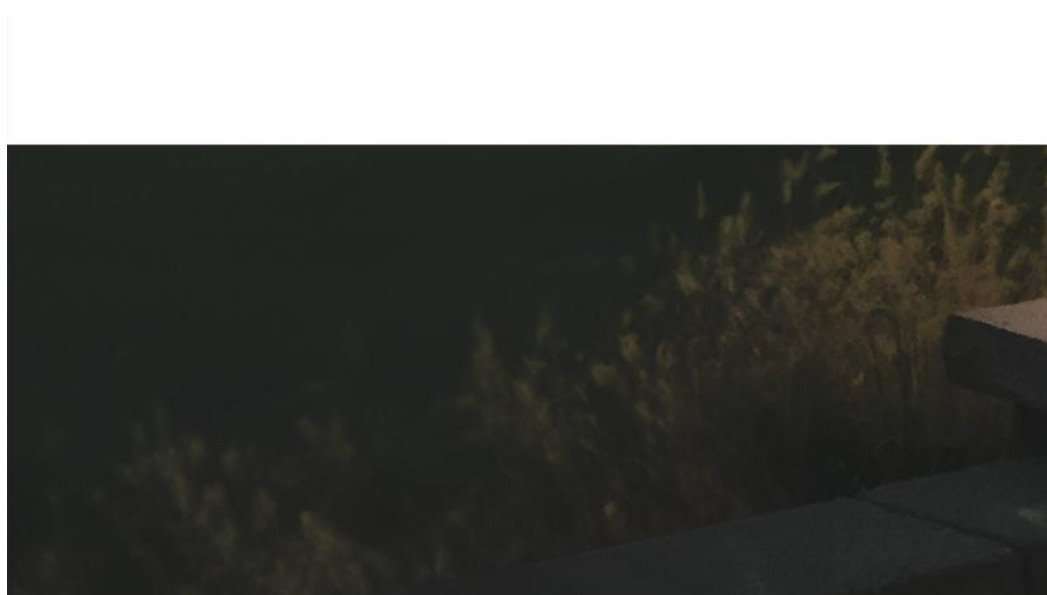

PRODUCT SPECS

MOUNTING/INSTALLATION

Wire Lead 25' 18AWG wire lead.

Mounting Concealed mounting base plate. Fixture face attaches to mounting base with color-matched phillips screws. Splices are made remotely from fixture, not in base plate.

CONSTRUCTION

Material Brass fixture (hat, body, base).

Lens Opaque polycarbonate lenses.

Socket MR16 bi-pin, ceramic, spring loaded Dual contacts

ORDERING INFORMATION

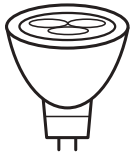

LIGHT SOURCE OPTIONS

CHOOSE FROM:

- Drop-in MR-16 LED lamp below
- Also available without lamp.

DROP-IN MR16 LAMP OPTIONS

ADD-SUFFIX	WATTAGE	BEAM ANGLE	DELIVERED LUMENS	COLOR TEMP	COLOR CODE
-LED4W	4	45	250	2900K	BLACK
-LED5W	5	45	310	2900K	WHITE
-LED6W	6	45	400	2900K	BLUE

HOW TO SPECIFY

FIXTURE	FINISH OPTION	CHOOSE LIGHT SOURCE
POST100	-BLK for black overcoat (blank for aged brass finish)	-LED Add suffix for lamp (see above) (blank for no lamp)

Example: POST100-BLK-LED4W



Aged Brass

POST100



Premium
Black Overcoat

POST100-BLK

Larger format craftsman post fixture with 7.75" square footprint and 12" overall height. Hat width is 11". Impressive appearance perfect for stone or masonry columns.

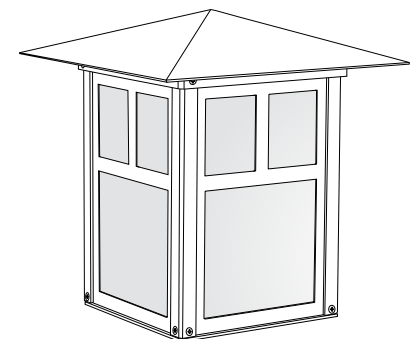

DIMENSIONS

BASE 7.75" SQUARE
HEIGHT 12"
HAT WIDTH 11"



REMOVEABLE MOUNTING PLATE- MORE OPTIONS FOR INSTALLATION

SL65-LED, SL75-LED and SL85-LED fixtures all come with a removable mounting plate. The mounting plate is ideal for use in new construction, in cases where you are building a retaining wall or perimeter wall, and can mount the ledge fixture before adding the wall cap. You can also add it to an existing retaining wall if you're able to remove the wall cap.



Alternatively, you can remove the mounting plate and install using the surface mount. This is great for use on existing structures, on railings, decks and fences.



PRODUCT SPECS

MOUNTING/INSTALLATION

Wire Lead 10' 18AWG wire lead

CONSTRUCTION

Material Fixture housing cast brass. Removable mounting plate stainless steel. Includes optional cast brass glare shield. Optional polycarbonate frosted lens.

ORDERING INFORMATION

LIGHT SOURCE

INTEGRATED LED MODULE

- 2 watts
- 110 lumens
- 2700K

SPECIAL FEATURES



Optional glare shield included.



Optional frosted lens included.



HOW TO SPECIFY

FIXTURE	FINISH OPTION
SL65-LED	-BLK for black overcoat (blank for aged brass finish)

Example: SL65-LED-BLK



Aged Brass

SL65-LED



Premium
Black Overcoat

SL65-LED-BLK

This 4" wide ledge fixture is ideal for tight areas and columns. Retaining walls, perimeter walls (use mounting plate); can also surface mount to railings, decks.

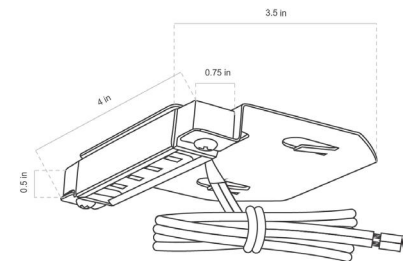

DIMENSIONS

LENGTH	4"
BRACKET DEPTH	3.5"
HOUSING HEIGHT	0.5"
HOUSING DEPTH	0.75"

HARDSCAPE



Aged Brass

SL75-LED



Premium
Black Overcoat

SL75-LED-BLK

Popular 7" wide fixture for all applications. Retaining walls, perimeter walls (use mounting plate); can also surface mount to railings, decks.

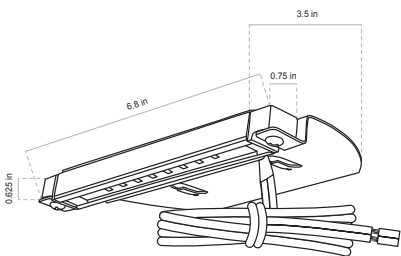

DIMENSIONS

LENGTH	6.8"
BRACKET DEPTH	3.5"
HOUSING HEIGHT	0.625"
HOUSING DEPTH	0.75"

PRODUCT SPECS

MOUNTING/INSTALLATION

Wire Lead 10' 18AWG wire lead

CONSTRUCTION

Material Fixture housing cast brass. Removable mounting plate stainless steel. Includes optional cast brass glare shield. Optional polycarbonate frosted lens.

ORDERING INFORMATION

LIGHT SOURCE

INTEGRATED LED MODULE

• 3 watts • 300 lumens • 2700K

SPECIAL FEATURES



Optional glare shield included.



Optional frosted lens included.

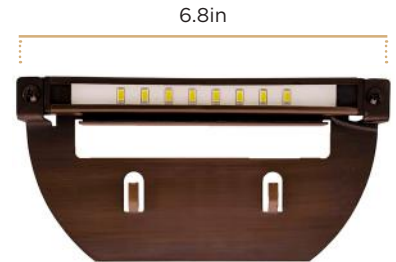

HOW TO SPECIFY

FIXTURE	FINISH OPTION
SL75-LED	-BLK for black overcoat (blank for aged brass finish)

Example: SL75-LED-BLK



PRODUCT SPECS

MOUNTING/INSTALLATION

Wire Lead 10' 18AWG wire lead

CONSTRUCTION

Material Fixture housing cast brass. Removable mounting plate stainless steel. Includes optional cast brass glare shield. Optional polycarbonate frosted lens.

ORDERING INFORMATION

LIGHT SOURCE

INTEGRATED LED MODULE

• 4 watts • 380 lumens • 2700K

SPECIAL FEATURES



Optional glare shield included.



Optional frosted lens included.

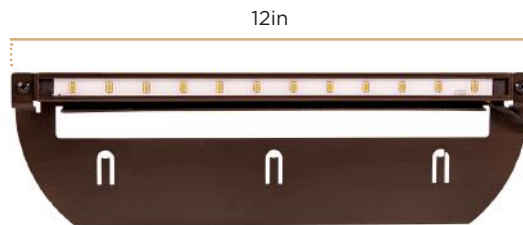

HOW TO SPECIFY

FIXTURE	FINISH OPTION
SL85-LED	- BLK for black overcoat (blank for aged brass finish)

Example: SL85-LED-BLK



Aged Brass

SL85-LED



Premium
Black Overcoat

SL85-LED-BLK

Extended 12" wide ledge fixture for taller walls and wider spread. Retaining walls, perimeter walls (use mounting plate); can also surface mount to railings, decks.

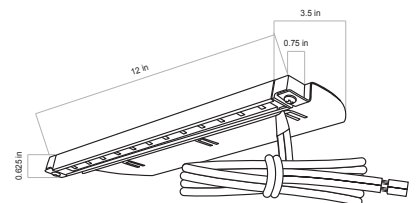

DIMENSIONS

LENGTH	12"
BRACKET DEPTH	3.5"
HOUSING HEIGHT	0.625"
HOUSING DEPTH	0.75"

HARDSCAPE



Aged Brass

SL26-LED



Premium Black Overcoat

SL26-LED-BLK

Convenient surface-mounted (backless), does not have/require a junction box. Frosted open lens face.

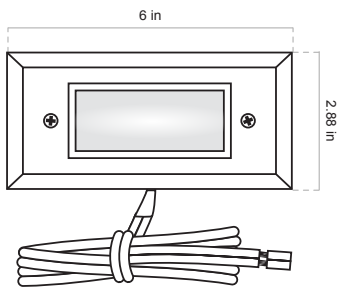

DIMENSIONS

WIDTH 6"
HEIGHT 2.88"
DEPTH 0.5"

PRODUCT SPECS

MOUNTING/INSTALLATION

Wire Lead 25' 18AWG wire lead.

CONSTRUCTION

Material Brass construction. Polycarbonate lens

ORDERING INFORMATION

LIGHT SOURCE

INTEGRATED LED MODULE

• 7 watts • 570 lumens • 2700K

HOW TO SPECIFY

FIXTURE	FINISH OPTION
SL26-LED	-BLK for black overcoat (blank for aged brass finish)

Example: SL26-LED-BLK

FAST, CONVENIENT INSTALLATION

Thin style fixture allows surface mounting to any surface. No junction box needed or provided. Wood screw anchors provided. Choose other anchors to affix to masonry if desired.

PRODUCT SPECS

MOUNTING/INSTALLATION

Wire Lead 25' 18AWG wire lead.

CONSTRUCTION

Material Brass construction. Polycarbonate lens

ORDERING INFORMATION

LIGHT SOURCE

INTEGRATED LED MODULE

• 13 watts • 1000 lumens • 2700K

HOW TO SPECIFY

FIXTURE	FINISH OPTION
SL36-LED	-BLK for black overcoat (blank for aged brass finish)

Example: SL36-LED-BLK

FAST, CONVENIENT INSTALLATION

Thin style fixture allows surface mounting to any surface. No junction box needed or provided. Wood screw anchors provided. Choose other anchors to affix to masonry if desired.



Aged Brass

SL36-LED



Premium Black Overcoat

SL36-LED-BLK

Convenient surface-mounted (backless), does not have/require a junction box. Frosted open lens face.

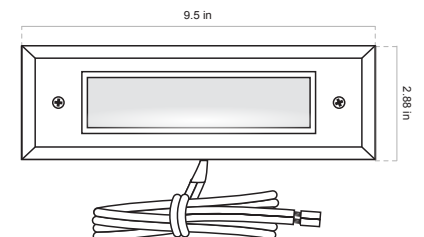

DIMENSIONS

WIDTH 9.5"

HEIGHT 2.88"

DEPTH 0.5"

HARDSCAPE



Aged Brass

SL25-LED



Premium
Black Overcoat

SL25-LED-BLK

Convenient surface-mounted (backless), does not have/require a junction box. Louvered face.

FAST, CONVENIENT INSTALLATION

Thin style fixture allows surface mounting to any surface. No junction box needed or provided. Wood screw anchors provided. Choose other anchors to affix to masonry if desired.

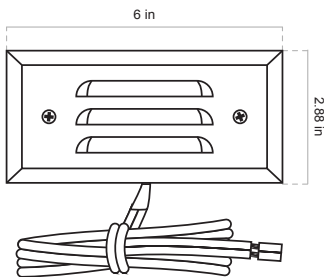

DIMENSIONS

WIDTH 6"
HEIGHT 2.88"
DEPTH 0.5"

PRODUCT SPECS

MOUNTING/INSTALLATION

Wire Lead 25' 18AWG wire lead.

CONSTRUCTION

Material Brass construction. Polycarbonate lens

ORDERING INFORMATION

LIGHT SOURCE

INTEGRATED LED MODULE

- 7 watts • 570 lumens • 2700K
- Optional factory-installed RGBW Bluetooth module.

Please note that heavy shielding of louvered cover reduces lumen output significantly.

FACTORY-INSTALLED RGBW LED BLUETOOTH® MODULE

Wattage	1w - 4w
Lumen Output	15lm - 200lm
CCT Options	Adjustable from 2700K-5000K
RGBW Options	Unlimited color wheel, quick presets for red, green, blue, amber & purple
Dimming	0-100% dimming option available for every color choice

HOW TO SPECIFY

FIXTURE	CHOOSE LIGHT SOURCE	FINISH OPTIONS
SL25	-LED Integrated LED module -BT for RGBW Bluetooth® module	-BLK for black overcoat (blank for aged brass finish)

Example: SL25-LED-BLK



PRODUCT SPECS

MOUNTING/INSTALLATION

Wire Lead 25' 18AWG wire lead.

CONSTRUCTION

Material Brass construction. Polycarbonate lens

ORDERING INFORMATION

LIGHT SOURCE

INTEGRATED LED MODULE

- 13 watts • 1000 lumens • 2700K
- Optional factory-installed RGBW Bluetooth module.

Please note that heavy shielding of louvered cover reduces lumen output significantly.

FACTORY-INSTALLED RGBW LED BLUETOOTH® MODULE

Wattage	2w - 5w
Lumen Output	15lm - 300lm
CCT Options	Adjustable from 2700K-5000K
RGBW Options	Unlimited color wheel, quick presets for red, green, blue, amber & purple
Dimming	0-100% dimming option available for every color choice

HOW TO SPECIFY

FIXTURE	CHOOSE LIGHT SOURCE	FINISH OPTIONS
SL35	-LED Integrated LED module -BT for RGBW Bluetooth® module	-BLK for black overcoat (blank for aged brass finish)

Example: SL35-LED-BLK



bt
OPTION
AVAILABLE

Aged Brass

SL35-LED



bt
OPTION
AVAILABLE

Premium Black Overcoat

SL35-LED-BLK

Convenient surface-mounted (backless), does not have/require a junction box. Louvered face.

FAST, CONVENIENT INSTALLATION

Thin style fixture allows surface mounting to any surface. No junction box needed or provided. Wood screw anchors provided. Choose other anchors to affix to masonry if desired.

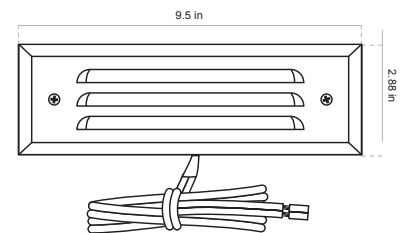

DIMENSIONS

WIDTH 9.5"
HEIGHT 2.88"
DEPTH 0.5"

HARDSCAPE



bt
OPTION AVAILABLE
Aged Brass
SL70



bt
OPTION AVAILABLE
Premium Black Overcoat
SL70-BLK

Bracket-mounted ledge light fixtures with optional on-board integrated RGBW LED Bluetooth® module

PRODUCT SPECS

MOUNTING/INSTALLATION

- Wire Lead** 25' 18AWG wire lead.
Mounting Integrated mounting plate for easy attachment in masonry walls or under cap stones.

CONSTRUCTION

- Material** Brass body. Brass flange
Lens Frosted polycarbonate lens.

ORDERING INFORMATION



LIGHT SOURCE OPTIONS

- Choose from:
- Drop-in LBIPIN-LED-200lm 2.5 watt 2700K
 - Factory-installed Bluetooth® module.
 - Also available without lamp.

DROP-IN LAMP OPTION

ADD-SUFFIX	WATTAGE	DELIVERED LUMENS	COLOR TEMP
-LED	2.5	200	2700K

FACTORY-INSTALLED RGBW LED BLUETOOTH® MODULE

Wattage	1w - 3w
Lumen Output	15lm - 200lm
CCT Options	Adjustable from 2700K-5000K
RGBW Options	Unlimited color wheel, quick presets for red, green, blue, amber & purple
Dimming	0-100% dimming option available for every color choice

HOW TO SPECIFY

	FIXTURE	FINISH OPTION	DROP-IN LED
WITH bt Bluetooth® RGBW LED Module	SL70-BT	-BLK for black overcoat (blank for aged brass finish)	
WITHOUT bt	SL70		-LED integrated LED module (blank for no lamp)

Example: SL70-BLK-LED

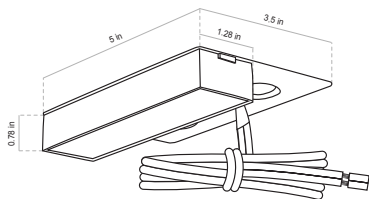

DIMENSIONS

- WIDTH:** 5"
BRACKET DEPTH: 3.5"
HOUSING HEIGHT: 0.75 IN.
HOUSING DEPTH: 1.28 IN.



PRODUCT SPECS

MOUNTING/INSTALLATION

- Wire Lead** 10' 18AWG wire attached to the end of the rolled light strip.
- Mounting** Directly to surface or in channel, trim to length needed. Optional mounting: aluminum tape sleeve (3' section) **TAPE-SLV3**

CONSTRUCTION

- Material** Flexible silicone sleeve

ORDERING INFORMATION

LIGHT SOURCE

INTEGRATED LED MODULE

- 120° degrees flood, soft white 2900K.
- CRI Ra>80. Rated hours 30,000.
- See How to Specify for watts and lumens.

HOW TO SPECIFY

FIXTURE	ADD FOR TAPE LENGTH	MOUNTING
TAPE-LED	-5FT 5' length, 9W, 750lm -15FT 15' length, 23W, 1500lm -30FT 30' length, 46W, 2900lm	For optional aluminum tape sleeve (available in 3' sections) order TAPE-SLV3

Example: TAPE-LED-30FT



TAPE-LED

Continuous strip of LED emitters available in 5', 15' or 30' lengths that can be trimmed (Scrap tape cannot be re-used). Can be affixed directly to surfaces. Includes an integrated frosted diffusing lens. Typically installed facing down on railings, step risers, toe-kicks, under cabinets, etc.

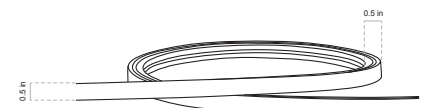

DIMENSIONS

- TAPE WIDTH** 0.5"
- TAPE HEIGHT** 0.5"

HARDSCAPE



Aged Brass
SL60-BT



Premium Black Overcoat
SL60-BT-BLK

Surface mounted ledge light fixtures with integrated RGBW LED Bluetooth® module.

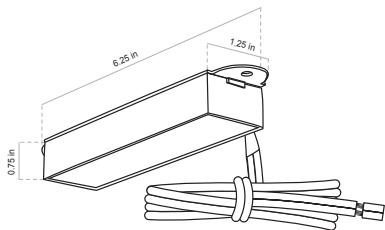

DIMENSIONS

MOUNTING PLATE

WIDTH: 6.25"

FIXTURE WIDTH: 5"

HOUSING HEIGHT: 0.75 IN.

HOUSING DEPTH: 1.25 IN.

PRODUCT SPECS

MOUNTING/INSTALLATION

Wire Lead 25' 18AWG wire lead.

Mounting Designed for surface mounting to rails, decks, etc.

CONSTRUCTION

Material Brass body.

Lens Frosted polycarbonate lens.

ORDERING INFORMATION



LIGHT SOURCE

INTEGRATED BLUETOOTH® RGBW MODULE

Wattage	1w - 3w
Lumen Output	15lm - 200lm
CCT Options	Adjustable from 2700K-5000K
RGBW Options	Unlimited color wheel, quick presets for red, green, blue, amber & purple
Dimming	0-100% dimming option available for every color choice

HOW TO SPECIFY

FIXTURE	FINISH OPTIONS
SL60-BT	-BLK for black overcoat (blank for aged brass finish)

Example: SL60-BT-BLK

PRODUCT SPECS

MOUNTING/INSTALLATION

- Wire Lead** 25' 18AWG wire lead.
- Mounting** Designed for surface mounting to rails, decks, etc

CONSTRUCTION

- Material** Brass body.
- Lens** Frosted polycarbonate lens.

ORDERING INFORMATION

bt **LIGHT SOURCE**
INTEGRATED BLUETOOTH® RGBW MODULE

Wattage	2w - 6w
Lumen Output	15lm - 650lm
CCT Options	Adjustable from 2700K-5000K
RGBW Options	Unlimited color wheel, quick presets for red, green, blue, amber & purple
Dimming	0-100% dimming option available for every color choice

HOW TO SPECIFY

FIXTURE	FINISH OPTIONS
SL80-BT	-BLK for black overcoat (blank for aged brass finish)

Example: SL80-BT-BLK



bt Aged Brass
SL80-BT



bt Premium Black Overcoat
SL80-BT-BLK

Large surface mounted ledge light fixtures with an integrated RGBW LED Bluetooth® module.

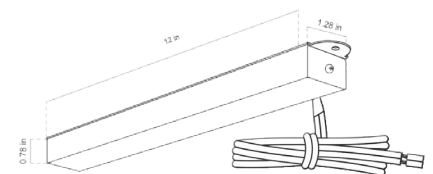

DIMENSIONS

- WIDTH:** 12"
- HOUSING HEIGHT:** 0.78 IN.
- HOUSING DEPTH:** 1.28 IN.

HARDSCAPE



Aged Brass
WS350-BT



Premium
Black Overcoat
WS350-BT-BLK



Premium
White Overcoat
WS350-BT-WHT

Classic cylindrical up/down fixture with dual Bluetooth® controlled RGBW light sources for creative wall lighting options.

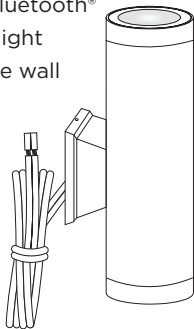

DIMENSIONS

WIDTH: 8"
HOUSING HEIGHT: 2.5"
HOUSING DEPTH: 4."

PRODUCT SPECS

MOUNTING/INSTALLATION

Wire Lead 25' wire lead, 18AWG.
Mounting Stainless steel concealed mounting plate. Fixture attaches to mounting plate with color-matched phillips screws.

CONSTRUCTION

Housing Solid cast brass.
Lens Clear shock-resistant glass lens.

ORDERING INFORMATION



LIGHT SOURCE
INTEGRATED BLUETOOTH® RGBW MODULE

Wattage	4-8W
Lumen Output	10lm - 430lm per module
CCT Options	Adjustable from 2700K-5000K
RGBW Options	Unlimited color wheel, quick presets for red, green, blue, amber & purple
Dimming	0-100% dimming option available for every color choice

HOW TO SPECIFY

FIXTURE	FINISH OPTIONS
WS350-BT	- BLK for premium black overcoat - WHT for premium white overcoat (blank for aged brass finish)

Example: WS350-BT-WHT

WS350-BT FIXTURES ARE OFTEN USED IN SWIMMING POOL SCREENED ENCLOSURES. THEY ARE EASILY ADDED TO VERTICAL SUPPORTS.







LOOKING FOR MORE HARDSCAPE OPTIONS?

Check out our mini lights - they're in the Specialty section on pages 82- 87. With surface mountable options, you can find creative solutions for your unusual lighting opportunities. These are great for small spaces and hidden niches.

mini SERIES

 <p>ML15-LED PAGE 82</p>	 <p>ML25-LED PAGE 83</p>
 <p>ML35-LED PAGE 84</p>	 <p>ML65 PAGE 85</p>
 <p>ML45-LED PAGE 86</p>	 <p>ML55-LED PAGE 87</p>

WALL WASH

Flood your space with light, define boundaries, and create dramatic shadows



PRODUCT SPECS

MOUNTING/INSTALLATION

- Wire Lead** Double 18AWG wire leads (option to daisy chain), first 25', second 18".
- Mounting** Slotted 8" ground stake (standard), Options: surface mount, gutter mount, Permapost heavy-duty stake, fixed solid brass risers. See page 104 for details.

CONSTRUCTION

- Material** Solid cast brass body and faceplate. Rubber faceplate gasket. Solid cast brass knuckle with knob for angle adjustment.
- Lens** Faceplate with clear lens factory-installed. Optional frosted faceplate sold separately for field installation.
- Socket** G4 Bi-Pin, Spring-loaded, ceramic, with Dual contacts. .

ORDERING INFORMATION

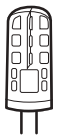

LIGHT SOURCE OPTIONS

- Choose from:
- Drop-in LBIPIN-LED-200lm 2.5 watt 2700K
 - Also available without lamp.

DROP-IN LAMP OPTION

ADD-SUFFIX	WATTAGE	DELIVERED LUMENS	COLOR TEMP
-LED	2.5	200	2700K

HOW TO SPECIFY

FIXTURE	FINISH OPTION	CHOOSE LIGHT SOURCE	ORDER ACCESSORIES
FL100	-BLK for black overcoat (blank for aged brass finish)	-LED for LBIPIN-LED-200lm 2.5 watt 2700K lamp (blank for no lamp)	-FFP Frosted face plate Mounting (see page 104) Risers (see page 105)

Example: FL100-BLK-LED



Aged Brass
FL100



Premium
Black Overcoat
FL100-BLK

Mid-size wall flood and wall-washing fixture for floodlighting architecture, boundary walls or signage.

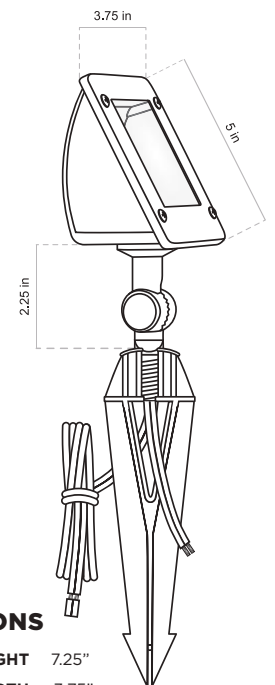

DIMENSIONS

HEIGHT	7.25"
WIDTH	3.75"
FACEPLATE HEIGHT	5"

WALL WASH



Compact wall wash fixture that provides broad beam of light at low intensity to avoid reflected hot spots. Ideal for wall washing, signage and more.

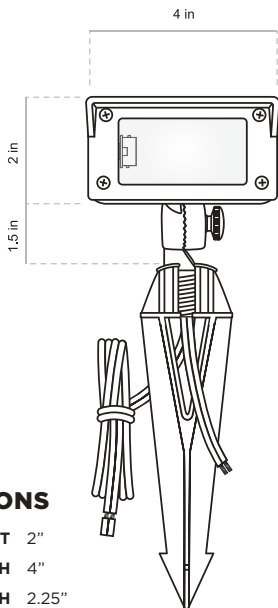

DIMENSIONS

HEIGHT 2"
WIDTH 4"
DEPTH 2.25"

PRODUCT SPECS

MOUNTING/INSTALLATION

Wire Lead Double 18AWG wire leads (option to daisy chain), first 25', second 18".
Mounting Slotted 8" ground stake (standard), optional surface mount or Permapost heavy-duty stake. Optional risers. See page 104 for details.

CONSTRUCTION

Material Solid cast brass body and faceplate. Rubber faceplate gasket. Solid cast brass knuckle with knob for angle adjustment.
Lens Faceplate with clear lens factory-installed. Optional frosted faceplate (pictured) available at no additional cost (model FL50-FFP).
Socket G4 Bi-Pin, spring-loaded, ceramic, with Dual contacts

ORDERING INFORMATION

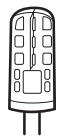

LIGHT SOURCE OPTIONS

- Choose from:
- Drop-in LBIPIN-LED-200lm 2.5 watt 2700K
 - Factory-installed Bluetooth® module
 - Also available without lamp.

DROP-IN LAMP OPTION

ADD-SUFFIX	WATTAGE	DELIVERED LUMENS	COLOR TEMP
-LED	2.5	200	2700K

FACTORY-INSTALLED RGBW LED BLUETOOTH® MODULE

Wattage	2w - 6w
Lumen Output	10lm - 350lm
CCT Options	Adjustable from 2700K-5000K
RGBW Options	Unlimited color wheel, quick presets for red, green, blue, amber & purple
Dimming	0-100% dimming option available for every color choice

HOW TO SPECIFY

	FIXTURE	FINISH OPTION	FACTORY INSTALLED LED	ORDER ACCESSORIES
WITH bt  Bluetooth® RGBW LED Module	FL50-BT	-BLK for black overcoat (blank for aged brass finish)		-FFP Frosted face plate Mounting (see page 104) Risers (see page 105)
WITHOUT bt	FL50		-LED integrated LED module (blank for no lamp)	

Example: FL50-BLK-LED-FFP



PRODUCT SPECS

MOUNTING/INSTALLATION

- Wire Lead** Double 18AWG wire leads (option to daisy chain), first 25', second 18".
- Mounting** Slotted 8.5" ground stake (standard), Options: surface mount, gutter mount, Permapost heavy-duty stake, fixed solid brass risers. See page 104 for details.

MATERIAL

- Housing** Solid cast brass.
- Knuckle** Solid cast brass, knob for angle adjustment.
- Socket** Spring-loaded ceramic bi-pin MR16, with Dual contacts and lamp clips.
- Lens** Solid cast brass, Faceplate with clear lens factory-installed.
Optional frosted faceplate included in box.

ORDERING INFORMATION

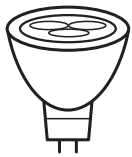

LIGHT SOURCE OPTIONS

- Choose from:
- Drop-in MR16 LED lamp below
 - Factory-installed Bluetooth® module
 - Also available without lamp.

DROP-IN MR16 LAMP OPTIONS

ADD-SUFFIX	WATTAGE	BEAM ANGLE	DELIVERED LUMENS	COLOR TEMPERATURE	BASE COLOR CODE
-LED4W-NS	4	15	250	2900K	BLACK
-LED4W	4	45	250	2900K	BLACK
-LED4W-WF	4	60	250	2900K	BLACK
-LED5W-NS	5	15	310	2900K	WHITE
-LED5W	5	45	310	2900K	WHITE
-LED5W-WF	5	60	310	2900K	WHITE
-LED6W	6	45	400	2900K	BLUE

FACTORY-INSTALLED RGBW LED BLUETOOTH® MODULE

Wattage	4w - 11w
Lumen Output	10lm - 900lm
CCT Options	Adjustable from 2700K-5000K
RGBW Options	Unlimited color wheel, quick presets for red, green, blue, amber & purple
Dimming	0-100% dimming option available for every color choice

HOW TO SPECIFY

	FIXTURE	FINISH OPTION	FACTORY INSTALLED LED	ORDER ACCESSORIES
WITH bt  Bluetooth® RGBW LED Module	FL200-BT	-BLK for black overcoat (blank for aged brass finish)		Mounting (see page 104) Risers (see page 105)
WITHOUT bt	FL200		-LED Add suffix for lamp (see above) (blank for no lamp)	

Example: FL200-BLK-LED4W



Aged Brass
FL200



Premium
Black Overcoat
FL200-BLK



Versatile, wide format wall washer and floodlight with numerous options for lamps, mounting options and optional color-tunable, dimmable Bluetooth® LED module.

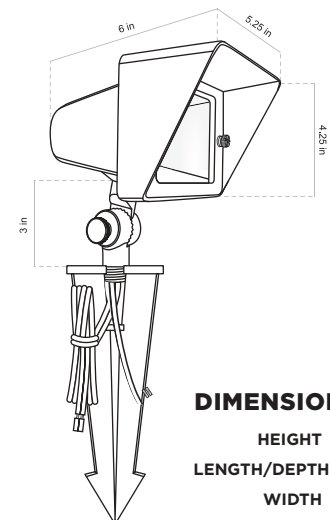

DIMENSIONS
HEIGHT 4.25"
LENGTH/DEPTH 6"
WIDTH 5.25"



DOWN LIGHTS

Accent specific features or emulate the silvery glow of moonlight

DOWN LIGHTS

PRODUCT SPECS

MOUNTING / INSTALLATION

- Wire Lead** 25' wire lead, 18AWG
Mounting Round mounting base with three color-matched screws.

MATERIAL

- Housing** Solid cast brass.
Knuckle Solid cast brass, knob for angle adjustment.
Socket Spring-loaded ceramic bi-pin MR-11, with Dual contacts and lamp clips.
Shroud Solid cast brass, with o-ring seal.

ORDERING INFORMATION



LIGHT SOURCE OPTIONS

CHOOSE FROM:

- Drop-in MR-11 lamp below
- Also available without lamp.

DROP-IN MR11 LAMP OPTION

ADD-SUFFIX	WATTAGE	BEAM ANGLE	DELIVERED LUMENS	COLOR TEMP
-LED	4	45	175	2900K

HOW TO SPECIFY

FIXTURE	FINISH OPTION	CHOOSE LIGHT SOURCE	ORDER ACCESSORIES
DL50	-BLK for black overcoat (blank for aged brass finish)	-LED Add suffix for lamp (see above) (blank for no lamp)	Lenses (see page 109)

Example: DL50-BLK-LED

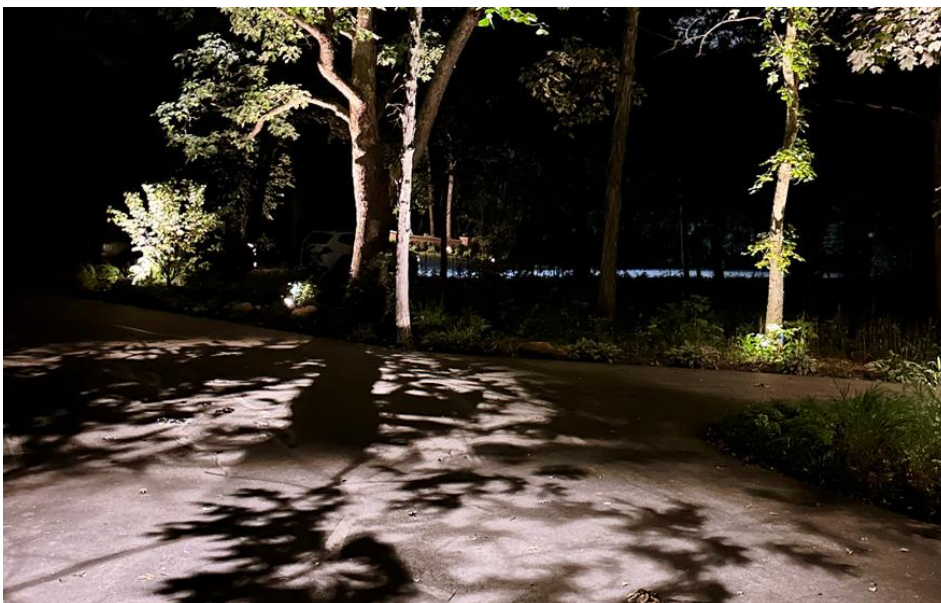

Aged Brass

DL50



Premium Black Overcoat

DL50-BLK

Easy to conceal downlight with precise aiming can be hidden under eaves, in trees or other overhead locations.

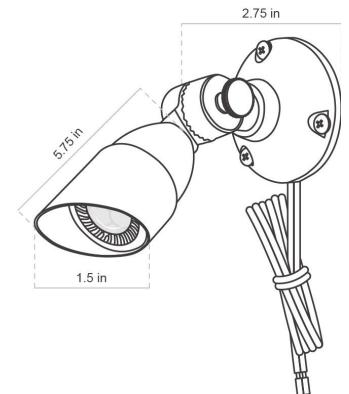

DIMENSIONS

- HEIGHT** 5.75"
BASE HEIGHT 2.75"
WIDTH 1.5"
BASE WIDTH 1.75"

DOWN LIGHTS



Aged Brass
DL100



Premium Black Overcoat
DL100-BLK

Mid-sized downlight available with a wide-range of LED lamps. Tree mounting bracket standard.

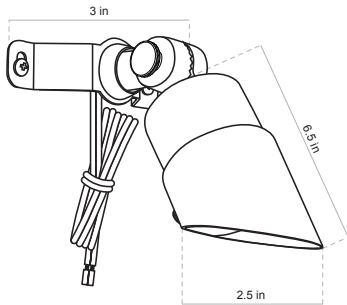

DIMENSIONS

HEIGHT	6.5"
BASE HEIGHT	3"
WIDTH	2.5"
BASE WIDTH	4.5"

PRODUCT SPECS

MOUNTING / INSTALLATION

- Wire Lead** 25' wire lead, 18AWG.
- Mounting** Brass tree-mounting bracket and brass nut. Supplied with stainless steel screws with adjustable stand-offs to accommodate tree growth. Fixture can also be attached to our tree mounting box (See page 104) if desired.

MATERIAL

- Housing** Solid cast brass.
- Knuckle** Solid cast brass, knob for angle adjustment.
- Socket** Spring-loaded ceramic bi-pin MR16, with Dual contacts and lamp clips.
- Shroud** Solid cast brass, with Dual o-ring seal

ORDERING INFORMATION

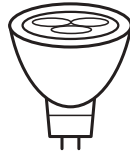

LIGHT SOURCE OPTIONS

CHOOSE FROM:

- Drop-in MR16 lamp below
- Also available without lamp.

DROP-IN MR16 LAMP OPTIONS

ADD-SUFFIX	WATTAGE	BEAM ANGLE	DELIVERED LUMENS	COLOR TEMP	BASE COLOR CODE
-LMR16-LED-4W-250LM	4	45	250	2900K	BLACK
-LMR16-LED-5W-310LM*	4	45	250	2900K	WHITE
-LMR16-LED-6W-F	4	45	250	2900K	BLUE
-LMR16-LED-6W-2700K	5	45	310	2900K	BLUE

* = standard light source option

HOW TO SPECIFY

FIXTURE	FINISH OPTION	CHOOSE LIGHT SOURCE	ORDER ACCESSORIES
DL100	-BLK for black overcoat (blank for aged brass finish)	-LED Add suffix for lamp (see above) (blank for no lamp)	Mounting (see page 104) Lenses (see page 109)

Example: DL100-BLK-LED4W



ANOTHER MOUNTING OPTION: THE TREE MOUNTING BOX

See page 104 for details

PRODUCT SPECS

MOUNTING / INSTALLATION

- Wire Lead** 25' wire lead, 18AWG, brown color.
- Mounting** Brass tree-mounting bracket and brass nut. Supplied with stainless steel screws with adjustable stand-offs to accommodate tree growth. Fixture can also be attached to our tree mounting box (See page 104) if desired.

MATERIAL

- Housing** Solid cast brass.
- Knuckle** Solid cast brass, knob for angle adjustment.
- Socket** Spring-loaded ceramic bi-pin MR16, with Dual contacts and lamp clips.
- Shroud** Solid cast brass, with Dual o-ring seal

ORDERING INFORMATION

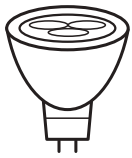

LIGHT SOURCE OPTIONS

CHOOSE FROM:

- Drop-in MR16 lamp below
- Factory-installed Bluetooth® module
- Also available without lamp.

DROP-IN MR16 LAMP OPTIONS

ADD-SUFFIX	WATTAGE	BEAM ANGLE	DELIVERED LUMENS	COLOR TEMP	BASE COLOR CODE
-LMR16-LED-4W-250LM	4	45	250	2900K	BLACK
-LMR16-LED-5W-310LM*	4	45	250	2900K	WHITE
-LMR16-LED-6W-F	4	45	250	2900K	BLUE
-LMR16-LED-6W-2700K	5	45	310	2900K	BLUE

* = standard light source option

FACTORY-INSTALLED RGBW LED BLUETOOTH® MODULE

Wattage	2w - 4w
Lumen Output	10lm - 430lm
Beam Spread	40°
CCT Options	Adjustable from 2700K-5000K
RGBW Options	Unlimited color wheel, quick presets for red, green, blue, amber & purple
Dimming	0-100% dimming option available for every color choice

HOW TO SPECIFY

FIXTURE	FINISH OPTION	FACTORY INSTALLED LED	ORDER ACCESSORIES
WITH bt  Bluetooth® RGBW LED Module	DL200-BT	-BLK for black overcoat (blank for aged brass finish)	Mounting (see page 104) Risers (see page 105)
WITHOUT bt	DL200	-LED Add suffix for lamp (see above) (blank for no lamp)	

Example: DL200-BLK-LED4W



Aged Brass

DL200



Premium Black Overcoat

DL200-BLK

Our most versatile and popular downlight, with numerous options for lamps and optional color-tunable, dimmable Bluetooth® LED module. This fixture's long adjustable shroud aids in aiming and glare control.

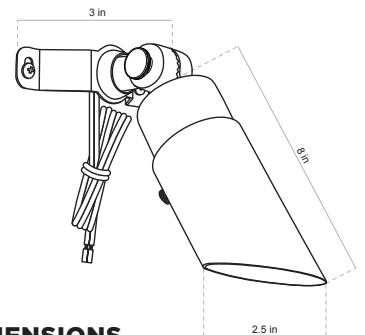

DIMENSIONS

- HEIGHT** 8"
- BASE HEIGHT** 3"
- WIDTH** 2.5"
- BASE WIDTH** 4.5"

DOWN LIGHTS



Aged Brass
HL100



Premium
Black Overcoat
HL100-BLK

An all-purpose hanging downlight with adjustable extendable shroud. Supplied with 18" mounting chain.

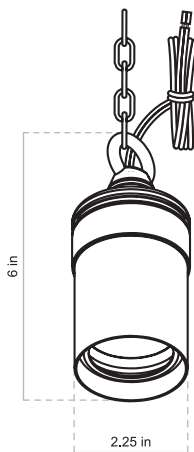

DIMENSIONS

HEIGHT 6"
WIDTH 2.25"
CHAIN LENGTH 18"

PRODUCT SPECS

MOUNTING / INSTALLATION

Wire Lead 25' wire lead, 18AWG.
Mounting 18" hanging chain supplied. Loop on top of fixture can also be attached with guy wire, etc.

MATERIAL

Housing Solid cast brass.
Socket Spring-loaded ceramic bi-pin MR16, with Dual contacts and lamp clips.
Shroud Solid cast brass adjustable and extendable.

ORDERING INFORMATION

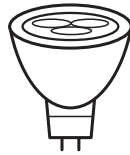

LIGHT SOURCE OPTIONS

Choose from:

- Drop-in MR16 LED lamp below
- Factory-installed Bluetooth® module
- Also available without lamp.

DROP-IN MR16 LAMP OPTIONS

ADD-SUFFIX	WATTAGE	BEAM ANGLE	DELIVERED LUMENS	COLOR TEMP	BASE COLOR CODE
-LMR16-LED-4W-250LM	4	45	250	2900K	BLACK
-LMR16-LED-5W-310LM*	4	45	250	2900K	WHITE
-LMR16-LED-6W-F	4	45	250	2900K	BLUE
-LMR16-LED-6W-2700K	5	45	310	2900K	BLUE

* = standard light source option

FACTORY-INSTALLED RGBW LED BLUETOOTH® MODULE

Wattage	2w - 4w
Lumen Output	10lm - 350lm
Beam Spread	40°
CCT Options	Adjustable from 2700K-5000K
RGBW Options	Unlimited color wheel, quick presets for red, green, blue, amber & purple
Dimming	0-100% dimming option available for every color choice

HOW TO SPECIFY

	FIXTURE	FINISH OPTION	FACTORY INSTALLED LED
WITH bt	HL100-BT	-BLK for black overcoat (blank for aged brass finish)	
WITHOUT bt	HL100		-LED Add suffix for lamp (see above) (blank for no lamp)

Example: HL100-BLK-LED4W

PRODUCT SPECS

MOUNTING / INSTALLATION

- Wire Lead** 25' wire lead, 18AWG.
- Mounting** 18" hanging chain supplied. Loop on top of fixture can also be attached with guy wire, etc.

MATERIAL

- Housing** Solid cast brass.
- Socket** Spring-loaded ceramic G4 Bi-Pin, with Dual contacts and lamp clips.
- Shroud & Lens** Solid cast brass, with star-lighting perforations, frosted lens.

ORDERING INFORMATION

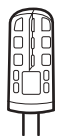

LIGHT SOURCE OPTIONS

- Choose from:
- Drop-in LBIPIN-LED-200lm 2.5 watt 2700K
 - Factory-installed Bluetooth® module
 - Also available without lamp.

DROP-IN LAMP OPTION

ADD-SUFFIX	WATTAGE	DELIVERED LUMENS	COLOR TEMP
-LED	2.5	200	2700K

FACTORY-INSTALLED RGBW LED BLUETOOTH® MODULE

Wattage	2w - 8w
Lumen Output	10lm - 350lm
Beam Spread	40°
CCT Options	Adjustable from 2700K-5000K
RGBW Options	Unlimited color wheel, quick presets for red, green, blue, amber & purple
Dimming	0-100% dimming option available for every color choice

HOW TO SPECIFY

HOW TO SPECIFY	FIXTURE	FINISH OPTION	FACTORY INSTALLED LED
WITH bt  Bluetooth® RGBW LED Module	HL200-BT	-BLK for black overcoat (blank for aged brass finish)	
WITHOUT bt	HL200		-LED Add suffix for lamp (see above) (blank for no lamp)

Example: HL200-BLK-LED



Aged Brass

HL200



Premium Black Overcoat

HL200-BLK

Perforated hanging lamp provides eye-catching effects without glare. Appears to twinkle in the breeze.

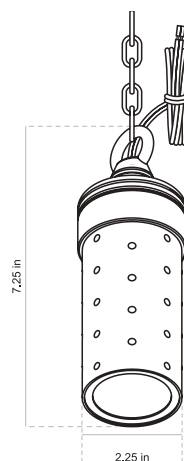

DIMENSIONS

- HEIGHT** 7.25"
- WIDTH** 2.25"
- CHAIN LENGTH** 18"



SPECIALTY LIGHTS

Solutions for
unusual lighting
opportunities

PRODUCT SPECS

MOUNTING / INSTALLATION

- Wire Lead** ALSTEM60, Double 18AWG wire leads (option to daisy chain), first 25', second 18".
- Mounting** Hat and stem sold separately. Recommended for use with ALSTEM60 60" brass stem with Permapost stake included. See page 104 for details.

CONSTRUCTION

- Material** Brass body, metal wick snuffer/protector, metal chain. Braided wick.
- Lamp socket** ALSTEM60, G4 bi-pin, spring-loaded ceramic, with Dual contacts.
- Shroud** Solid cast brass, with turn-to-lock fitting.
- Collar** Solid brass collar
- Wick** Braided wick with brass holder

ORDERING INFORMATION

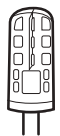

LIGHT SOURCE OPTIONS

- Choose from:
- Drop-in LBIPIN-LED-200lm 2.5 watt 2700K
 - Also available without lamp.

ADD-SUFFIX	WATTAGE	DELIVERED LUMENS	COLOR TEMP
-LED	2.5W	200	2700K

HOW TO SPECIFY

HAT	FINISH OPTIONS	STEM	FINISH OPTIONS	ADD FOR LIGHT SOURCE
TIKI	-BLK for black overcoat (blank for aged brass finish)	ALSTEM60	-BLK for black overcoat (blank for aged brass finish)	-LED for LBIPIN-LED-200lm 2.5 watt 2700k lamp

Example: TIKI-BLK, ALSTEM60-BLK-LED



Aged Brass
TIKI ALSTEM60

Premium Black Overcoat
TIKI-BLK ALSTEM60-BLK

Brass hat holds a citronella or kerosene torch, adding a tropical touch to outdoor spaces. Paired with the ALSTEM60, it throws wide, even light—perfect for patios, walkways, and pool decks. Style and function in one simple setup.

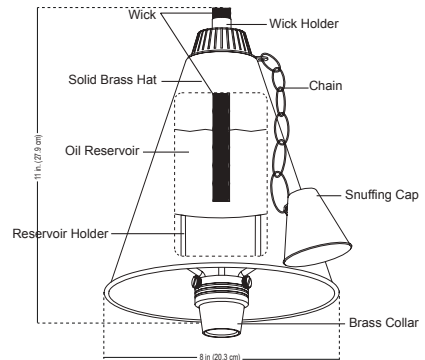

DIMENSIONS

- RECOMMENDED**
- STEM HEIGHT** 60"
 - HAT HEIGHT** 11"
 - HAT WIDTH** 8"

SPECIALTY



Aged Brass
ML15-LED



Premium
Black Overcoat
ML15-LED-BLK

mini

A compact integrated LED fixture that allows light to be added to unusual and creative places. Illuminate stone lanterns, rock niches, and under steps. (Illustration includes stainless steel stake and optional glare shield).

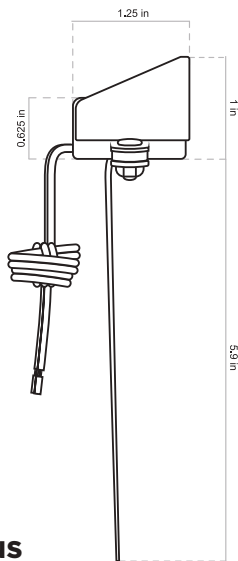

DIMENSIONS

- HEIGHT 1.25"
- WIDTH 0.75"
- DEPTH 0.625"
- WIDTH AT EARS 1.56"

PRODUCT SPECS

MOUNTING/INSTALLATION

- Wire Lead** 10' 18AWG lead pre-attached to fixture.
- Mounting** ML15 has attachment ears and optional stake

CONSTRUCTION

- Material** Brass fixture. Brass glare shield and stainless steel stake
- Lens** Clear lens
- Light Source** Integrated LED 1.3 watts 135 lumens. Warm white 2900K CRI > 80. Rated life 30,000 hours.

ORDERING INFORMATION

LIGHT SOURCE

INTEGRATED LED MODULE

- 1.3 watts • 135 lumens • 2900K

ADD-SUFFIX	WATTAGE	DELIVERED LUMENS	COLOR TEMP
-LED	1.3	135	2900K

HOW TO SPECIFY

FIXTURE	FINISH OPTION
ML15-LED	-BLK for black overcoat (blank for aged brass finish)

Example: ML15-LED-BLK



Ground stake
(provided)



With glare
shield installed



PRODUCT SPECS

MOUNTING/INSTALLATION

Wire Lead 10' 18AWG lead pre-attached to fixture.

CONSTRUCTION

Material Brass fixture

Lens Frosted lens

Light Source Integrated LED 1.3 watts 135 lumens. Warm white 2900K CRI > 80. Rated life 30,000 hours.

ORDERING INFORMATION

LIGHT SOURCE

INTEGRATED LED MODULE

• 1.2 watts • 120 lumens • 2900K

ADD-SUFFIX	WATTAGE	DELIVERED LUMENS	COLOR TEMP
-LED	1.2	120	2900K

HOW TO SPECIFY

FIXTURE	FINISH OPTION
ML25-LED	-BLK for black overcoat (blank for aged brass finish)

Example: ML25-LED-BLK



Aged Brass

ML25-LED



Premium Black Overcoat

ML25-LED-BLK

mini

Disc-shaped miniature lighting fixture works as an up-light, downlight or can be installed vertically. The possibilities are endless.

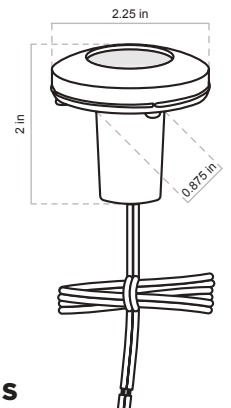

DIMENSIONS

- TOP WIDTH 2.25"
- LENGTH/DEPTH 2"
- BASE WIDTH 0.875"

SPECIALTY



Aged Brass
ML35-LED



Premium
Black Overcoat
ML35-LED-BLK

mini

A discreet integrated LED fixture for fences, deck posts, wood retaining walls and other perimeter lighting applications.

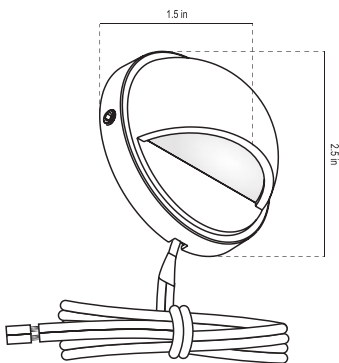

DIMENSIONS

DEPTH 1.5"
HEIGHT 2.5"

PRODUCT SPECS

MOUNTING/INSTALLATION

Wire Lead 10' 18AWG wire lead.

Mounting Wall plate, fixture attached with allen screws.

CONSTRUCTION

Material Brass construction. Frosted lens.

ORDERING INFORMATION

LIGHT SOURCE

INTEGRATED LED MODULE

• 1.3 watts • 130 lumens • 2900K

ADD-SUFFIX	WATTAGE	DELIVERED LUMENS	COLOR TEMP
-LED	1.3	130	2900K

HOW TO SPECIFY

FIXTURE	FINISH OPTION
ML35-LED	-BLK for black overcoat (blank for aged brass finish)

Example: ML35-LED-BLK



PRODUCT SPECS

MOUNTING/INSTALLATION

- Wire Lead** 10' 18AWG wire lead.
- Mounting** Optional 1.5" PVC installation sleeve.

CONSTRUCTION

- Material** Brass construction. Glass lens
- Lens** Clear flat lens.

ORDERING INFORMATION



LIGHT SOURCE OPTIONS

CHOOSE FROM:

- Drop-in LMR8-LED-150lm 2 watt 2900K
- Also available without lamp.

DROP-IN MR8 LAMP OPTION

ADD-SUFFIX	WATTAGE	BEAM ANGLE	DELIVERED LUMENS	COLOR TEMP
-LED	2	45	150	2900K

HOW TO SPECIFY

FIXTURE	FINISH OPTION	CHOOSE LIGHT SOURCE
ML65	-BLK for black overcoat (blank for aged brass finish)	-LED for MR-8 lamp (see above) (blank for no lamp)

Example: ML65-BLK-LED



Aged Brass
ML65



Premium
Black Overcoat
ML65-BLK

mini

A discreet domed directional half lid fixture for hardscapes. Can be installed vertically (for step or beacon lighting). Or can be installed horizontally to mark the edge of hardscaped spaces. The potential is boundless.

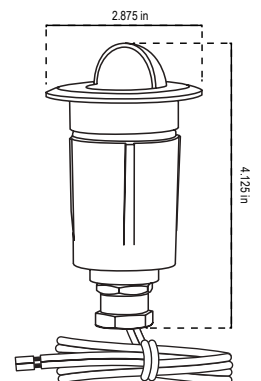

DIMENSIONS

- WIDTH** 2.875"
- LENGTH/DEPTH** 4.125"

SPECIALTY



ML45-LED

mini

A discreet integrated LED fixture for fences, wood retaining walls, deck posts, and other perimeter lighting applications. Serves as a marking light for the surface it is installed into.

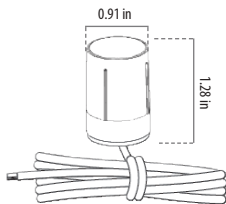

DIMENSIONS

DIAMETER 0.91"
DEPTH 1.28"

PRODUCT SPECS

MOUNTING/INSTALLATION

Wire Lead 10' 18AWG wire lead.

CONSTRUCTION

Material Polycarbonate.

Lens Clear lens.

ORDERING INFORMATION

LIGHT SOURCE

INTEGRATED LED MODULE

• 0.64 watt • 33.8 lumens • 2700K

ADD-SUFFIX	WATTAGE	DELIVERED LUMENS	COLOR TEMP
-LED	0.64	33.8	2700K

HOW TO SPECIFY

FIXTURE	FINISH OPTION
ML45-LED	

Example: ML45-LED



PRODUCT SPECS

MOUNTING/INSTALLATION

Wire Lead 10' 18AWG wire lead.

CONSTRUCTION

Material Brass ring, polycarbonate body.

ORDERING INFORMATION

LIGHT SOURCE

INTEGRATED LED MODULE

• 0.19 watt • 11.6 lumens • 2700K

ADD-SUFFIX	WATTAGE	DELIVERED LUMENS	COLOR TEMP
-LED	0.19	11.6	2700K

HOW TO SPECIFY

FIXTURE	FINISH OPTION
ML55-LED	-BLK for black overcoat (blank for aged brass finish)

Example: ML55-LED-BLK



Aged Brass

ML55-LED



Premium
Black Overcoat

ML55-LED-BLK

mini

A discreet integrated LED fixture for fences, deck posts, wood retaining walls, and other perimeter lighting applications. Serves as a marking light for the surface it is installed into. Brass ring narrows amount of light that shines through for a more discreet appearance.

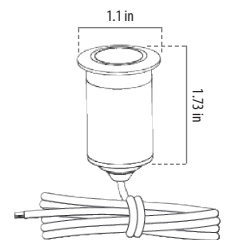

DIMENSIONS

DIAMETER 1.1"
DEPTH 1.73"

SPECIALTY



Aged Brass
UL395-LED

HIGH LUMEN OUTPUT

High-lumen output integrated LED underwater fixture. Solid brass construction for outstanding durability and longevity. Ideal for larger water features, waterfalls and cascades, or multi-tier fountains. Completely submersible or install in water splash areas.

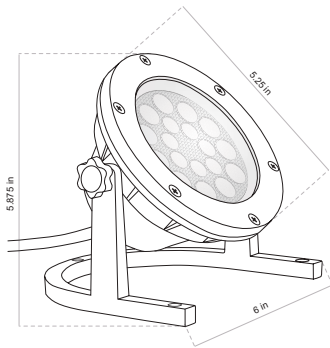

DIMENSIONS

TOP DIAMETER	5.25"
BASE WIDTH	6"
FIXTURE HEIGHT	5.875"

PRODUCT SPECS

MOUNTING/INSTALLATION

Wire Lead 25' waterproof wire lead standard and pre-connected to fixture. Make wire splices outside of the water feature.

Mounting Includes heavy brass base for stability.

MATERIAL

Housing Solid cast brass.

Faceplate Solid cast brass, with dual rubber seals, stainless screws.

Lens Clear flat lens.

Aiming Dual knobs tighten to hold angle adjustment and aiming.

Light Source Integrated LED Module: 11 watts, 1200 lumens, 40 degree flood, soft white 3000K.

ORDERING INFORMATION

LIGHT SOURCE

INTEGRATED LED MODULE

• 11 watts • 1200 lumens • 3000K

FACTORY-INSTALLED LAMP OPTION

ADD-SUFFIX	WATTAGE	DELIVERED LUMENS	COLOR TEMP
-LED	11	1200	3000K

HOW TO SPECIFY

FIXTURE

UL395-LED

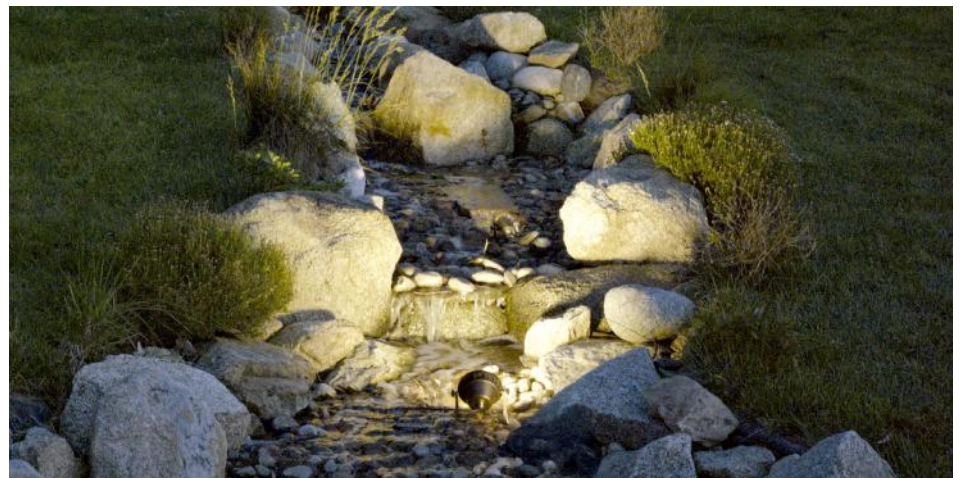

PRODUCT SPECS

MOUNTING / INSTALLATION

- Wire Lead** 25' 18AWG wire lead
- Mounting** Slotted 8.5" large ground stake (standard).

CONSTRUCTION

- Adjustability** Head incorporates locking knuckle with thumb screw for precise aiming and adjustments.
- Material** Solid brass (hat and stem).
- Lens** Clear lens.
- Socket** G4 Bi-Pin, Spring-loaded ceramic, with Dual contacts.

ORDERING INFORMATION

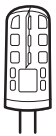

LIGHT SOURCE OPTIONS

- Choose from:
- Drop-in LBIPIN-LED-200lm 2.5 watt 2700K
 - Also available without lamp.

DROP-IN LAMP OPTION

ADD-SUFFIX	WATTAGE	DELIVERED LUMENS	COLOR TEMP
-LED	2.5	200	2700K

HOW TO SPECIFY

FIXTURE	FINISH OPTION	CHOOSE LIGHT SOURCE
GOLF100	-BLK for black overcoat (blank for aged brass finish)	-LED for LBIPIN-LED-200lm 2.5 watt 2700K (blank for no lamp)

Example: GOLF100-BLK



Aged Brass

GOLF100



Premium Black Overcoat

GOLF100-BLK

Special fixture for wide, glare-free lighting of putting greens, tee boxes, sports courts, paved areas and displays.

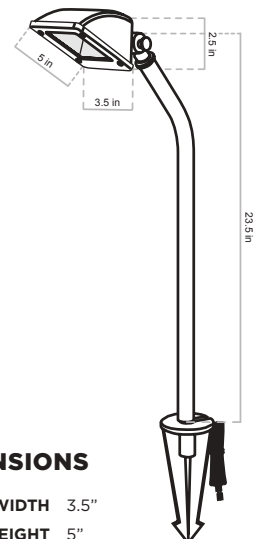

DIMENSIONS

- HEAD WIDTH** 3.5"
- HEAD HEIGHT** 5"
- LENGTH/DEPTH** 23.5"

SPECIALTY



bt
OPTION
AVAILABLE
Aged Brass
UL100

Solid brass underwater lamp built for outstanding durability and longevity for fountains, cascades, waterfalls. Submersible or install in waterfall splash areas.

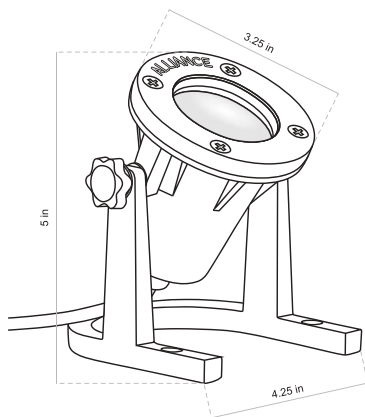

DIMENSIONS

TOP DIAMETER	3.25"
BASE WIDTH	4.25"
FIXTURE HEIGHT	5"

PRODUCT SPECS

MOUNTING/INSTALLATION

Wire Lead 25' waterproof wire lead standard and pre-connected to fixture. Optional 50' lead available by special order. Make wire splices outside of the water feature. bt model includes power and signal combination cable.

Mounting Includes heavy brass base. Bluetooth® model includes remote antenna which must be installed outside of water feature on ground stake supplied.

MATERIAL

Housing Solid cast brass.

Aiming Knob for angle adjustment.

Socket Spring-loaded ceramic bi-pin MR16, with Dual contacts and lamp clips.

Faceplate Solid cast brass, with rubber seal, with clear tempered, shock-resistant glass lens.

ORDERING INFORMATION



LIGHT SOURCE OPTIONS

CHOOSE FROM:

- Drop-in MR16 lamp below
- Factory-installed Bluetooth® module
- Also available without lamp.

DROP-IN MR16 LAMP OPTIONS

ADD-SUFFIX	WATTAGE	BEAM ANGLE	DELIVERED LUMENS	COLOR TEMPERATURE	BASE COLOR CODE
-LED4W	4	45	250	2900K	BLACK
-LED4W-WF	4	60	250	2900K	BLACK
-LED5W	5	45	310	2900K	WHITE
-LED5W-WF	5	60	310	2900K	WHITE
-LED6W-F	6	45	400	2900K	BLUE

FACTORY-INSTALLED RGBW LED BLUETOOTH® MODULE

Wattage	2w - 4w
Lumen Output	10lm - 430lm
Beam Spread	40°
CCT Options	Adjustable from 2700K-5000K
RGBW Options	Unlimited color wheel, quick presets for red, green, blue, amber & purple
Dimming	0-100% dimming option available for every color choice

HOW TO SPECIFY

FIXTURE	CHOOSE LIGHT SOURCE	INSTALLATION ACCESSORY
UL100	-LED Add suffix for lamp (see above) -BT for Bluetooth® RGBW LED Module (blank for no lamp)	Junction box available for grouping (2) UL100-BT fixtures together (see page 105)

Example: UL100-LED5W

PRODUCT SPECS

MOUNTING / INSTALLATION

- Wire Lead** 25' 18AWG wire lead
- Mounting** Slotted 8.5" large ground stake (standard),

CONSTRUCTION

- Adjustability** Head incorporates locking knuckle with thumb screw for precise aiming and adjustments.
- Material** Solid brass (hat and stem).
- Lens** Clear lens.

ORDERING INFORMATION

bt **LIGHT SOURCE**
INTEGRATED BLUETOOTH® RGBW MODULE

Wattage	2-4w
Lumen Output	10lm - 350lm
CCT Options	Adjustable from 2700K-5000K
RGBW Options	Unlimited color wheel, quick presets for red, green, blue, amber & purple
Dimming	0-100% dimming option available for every color choice

HOW TO SPECIFY

FIXTURE	FINISH OPTION
GOLF50-BT	- BLK for black overcoat (blank for aged brass finish)

Example: GOLF50-BT-BLK



bt
Aged Brass
GOLF50-BT



bt
Premium
Black Overcoat
GOLF50-BT-BLK

Special fixture for wide, glare-free lighting of putting greens, tee boxes, sports courts, paved areas and displays.

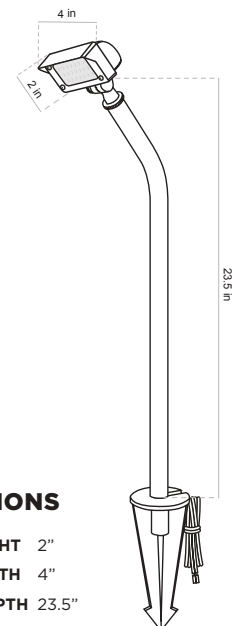

DIMENSIONS
HEAD HEIGHT 2"
HEAD WIDTH 4"
LENGTH/DEPTH 23.5"

POWER & CONTROL

We offer a wide range of transformers and controls that are reliable and easy to install



PRODUCT SPECS

KEY FEATURES

- App-controlled for on/off remote control and scheduling
- Up to 3 individually-scheduled zones for maximum lighting control (example: facade, landscape, walkway)
- Astronomic timing (sunrise/sunset adjusted automatically), plus clock-based on/off
- Settings saved to the cloud in case of power interruption
- Maximum control range. Discreet integrated external antenna plus dual control with Bluetooth® or WiFi. (WiFi is optional, not required)
- Digital power meter (in app) displays real-time power consumption and history
- Angled terminal strip for easy wire connections, eliminates blind spots
- Removable bottom panel, multiple knockouts for wire connections
- Heavy-duty stainless-steel cabinet with integrated mounting bar, lockable
- Integrated short circuit and overload protection
- Includes 5' grounded heavy-gauge power cord
- ETL tested, in conformance to ANSI/UL 1838
- Magnetic core for A/C systems

CONTROL UP TO 3 DIFFERENT ZONES



Example of Zoning for greater control:

1. Welcome Home lights for curb appeal
2. Perimeter lights for all-night security
3. Backyard lights for entertaining and evening use.

ELECTRICAL SPECS

it2-150 has three 14-volt taps

it2-300 has three 14-volt taps

Use any combination of terminal lugs but do not exceed transformer's rated wattage on any lug



CONNECT WITH ALEXA

Connect your itPRO account with your Amazon® Alexa app to enable voice commands and add to your routines

ORDERING INFORMATION

HOW TO SPECIFY

CHOOSE MODEL
IT2-150
IT2-300



IT2 INTELLIGENT TRANSFORMERS

- 150 Watt **IT2-150**
- 300 Watt **IT2-300**

Intelligent transformer and app-driven control system in a single easy-to-install package. Controlled with the Alliance itPro app through Bluetooth® or WiFi for remote on/off control and set-up of lighting schedules. Ability to manage up to 3 different independently-scheduled lighting zones in a single transformer for maximum flexibility and energy savings.

IT2-150 DIMENSIONS

HEIGHT ON WALL	14.37"
WIDTH	5"
DEPTH	5.5"

IT2-300 DIMENSIONS

HEIGHT ON WALL	16"
WIDTH	7.25"
DEPTH	5.25"

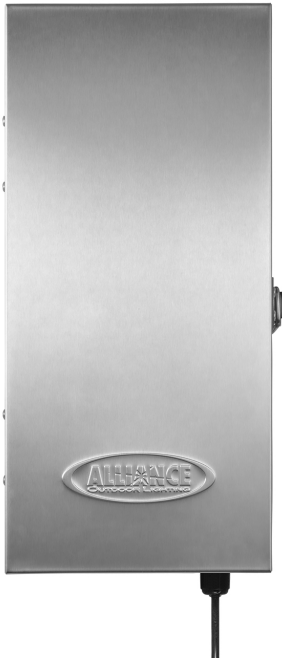

XF SERIES TRANSFORMERS

150 Watt **XF150** 300 Watt **XF300** 600 Watt **XF600**

The heart of a low-voltage outdoor lighting system is the transformer. Our rugged professional-grade multi-tap transformer sets the standard for ease of installation and adaptability to standard and app-based controls.

XF150 DIMENSIONS

HEIGHT ON WALL 14.37"
 WIDTH 4.25"
 DEPTH 5.12"

XF300/XF600 DIMENSIONS

HEIGHT ON WALL 16"
 WIDTH 7.25"
 DEPTH 5.12"

PRODUCT SPECS

KEY FEATURES

- Magnetic core for A/C systems
- Fully-potted, insulated, single-core transformer
- Easy on/off, secondary breaker switches on each common tap
- Two common lug terminals
- Amp loop to check the primary amperage on the transformer
- Accepts plug-in-timers, has direct photocell connection
- Angled terminal strip for easy wire connections, eliminates blind spots
- Heavy-duty stainless-steel cabinet with integrated mounting bar, lockable
- Removable bottom panel, 5 knockouts for wire connections
- Integrated short circuit and overload protection
- Includes 5' grounded heavy-gauge power cord
- ETL tested, in conformance to ANSI/UL 1838

ELECTRICAL SPECS

XF150 has 4 taps: 12, 13, 14, 15 volts

XF300 watt model has 4 taps: 12, 13, 14, 15 volts

XF600 watt model has 7 taps: 12, 13, 14, 15, 16, 17, 18 volts

Use any combination of terminal lugs but do not exceed transformer's rated wattage on any lug



ORDERING INFORMATION

HOW TO SPECIFY

CHOOSE MODEL	ORDER CONTROLS SEPARATELY
XF150	iTimerPRO app-based control (see pg. 95)
XF300	TIMER2 mechanical timer (see pg. 97)
XF600	PC plug-in photocell (see pg. 97)

PRODUCT SPECS

KEY FEATURES

- Convenient, app-based programming and control of lighting with Alliance app
- Set, change, & view schedules on mobile device or tablet. Activate lights remotely on mobile device
- Automatic astronomic (sunrise/ sunset) adjustment (no photocell needed)
- Bluetooth® based control. No need to access customer’s WiFi (ITIMERPRO-2 has wifi capabilities)
- Outstanding range from external antenna, control/program from indoors
- Upgrade existing transformers to app control
- Includes 32” grounded heavy-gauge power cord
- Wall-mounts separately from transformer with convenient attachment tabs
- Rated 120 volt, 15A

ORDERING INFORMATION

HOW TO SPECIFY

CHOOSE MODEL

ITIMERPRO

ITIMERPRO-2

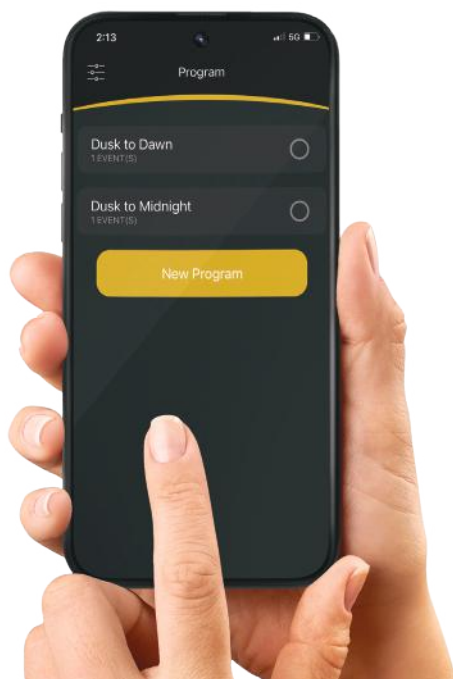

ITIMERPRO APP-BASED CONTROL

1 Output with Bluetooth® connectivity
ITIMERPRO

1 Output with Bluetooth® and wifi connectivity
ITIMERPRO-2



Today’s lighting users want more convenience. iTimerPRO and iTimerPRO-2 make it easy to offer a full suite of digital features with a standard transformer, including app-based remote control and on-screen programming. It is also a popular way to quickly upgrade existing transformers to app-based controls. It is compatible with a wide range of existing transformer brands. Simply unplug the existing mechanical timer and connect iTimerPRO.

DIMENSIONS

- HEIGHT** 5"
- WIDTH** 3"
- DEPTH** 2"
- ANTENNA** 5"



150 Watt
TF150



200 Watt
TF200

300 Watt
TF300

TF SERIES TRANSFORMERS

Offers an outstanding value with a stainless steel cabinet or plastic housing, easy wire connections, and built-in photocell and timer.

TF150 DIMENSIONS

HEIGHT ON WALL 6.75"
WIDTH 4.25"
DEPTH 3.25"

TF200/TF300 DIMENSIONS

HEIGHT ON WALL 9.25"
WIDTH 5.75"
DEPTH 3.25"

PRODUCT SPECS

TF150 KEY FEATURES

- Magnetic core for A/C systems
- Plastic housing
- Includes on-board photocell and digital timer
- DOE and CEC compliant
- ETL listed
- 12 volt tap only

TF200/TF300 KEY FEATURES

- Magnetic core for A/C systems
- Toroidal transformer
- Stainless steel cabinet
- Includes on-board photocell and digital timer
- 300 watt model has multiple taps (12, 15 volts)
- 200 watt model has 12 volt tap only
- 5' heavy-gauge power cord with grounded plug
- DOE and CEC compliant
- ETL listed

ORDERING INFORMATION

HOW TO SPECIFY

CHOOSE MODEL

TF150

TF200

TF300



CONTROL AND WIRING ACCESSORIES



PC

Photocell mounts to side of Alliance XF transformers to provide automatic dusk-to-dawn control. Plugs directly into the photocell connector inside for fast set-up.



TIMER2

Mechanical timer, plugs into outlet inside the XF series transformer.



CS100

Buried connection point for central point wiring. Includes two brass connectors with set screws and plastic lug caps in PVC housing. When installed: 2.5" diameter x 9.15" depth. For direct-burial, outdoor applications. Do not use underwater.



Bluetooth® Signal



bt Range Extender
Communication

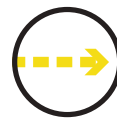

bt Range Extender
to Fixture Signal

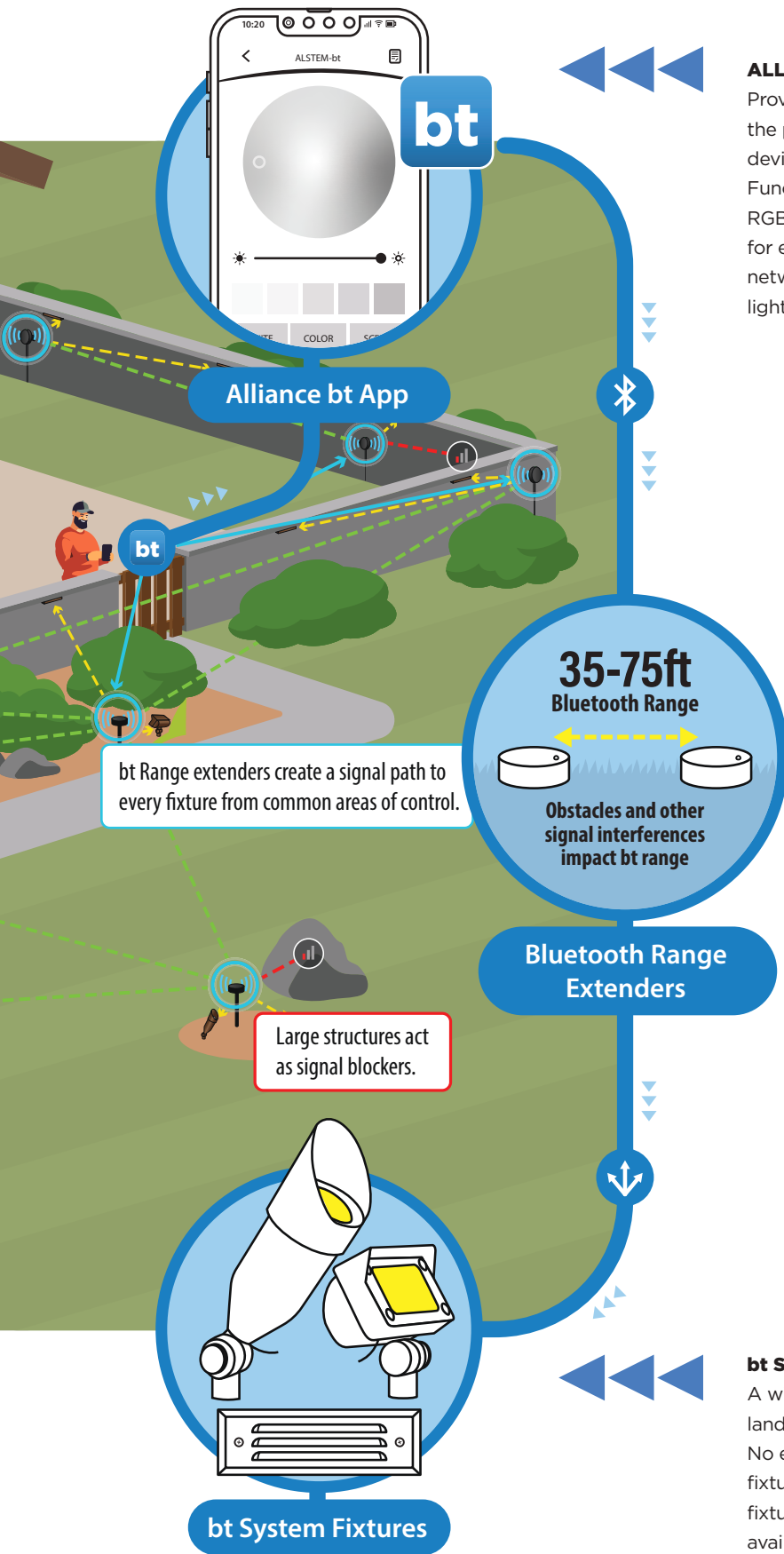

ALLIANCE bt APP

Provides ultimate convenience and customization from the palm of your hand. Controls a BT system from any mobile device (phone, tablet) with both iOS and Android compatibility. Functions as a remote control for dimming, color temperatures, RGBW colors and more. Fixtures can be grouped within the app for easy application of lighting scenes. Allows creation of a secure network for the site, so only those with permission can control the lights. Complete features, see page 100.

BLUETOOTH® RANGE EXTENDERS

Installed throughout a property to repeat bt signals to assure reliable communication to all fixtures. These are essential and mandatory to compensate for distance, obstructions, elevation changes and other factors that diminish signal strength. Indoor plug-in units (BTRE-PLUGIN) allow indoor use of the app, helping the signal exit the structure. BTRE range extenders are placed throughout the landscape and hardscape. Ground stake models and surface mount models are available and wire into the same cable supplying the bt fixtures. See page 101 for model details, page 103 for system requirements.

bt SYSTEM FIXTURES

A wide selection of Alliance fixtures covering every possible landscape lighting need are available with onboard bt modules. No elaborate programming or codes are needed to pair these fixtures to a bt system to access the full bt benefits. For existing fixtures, use bt Ally drop-in lamps. For a complete list of fixtures available with bt modules, see page 100.



JOIN THE bt REVOLUTION – CREATE THE ULTIMATE LIGHTING EXPERIENCE

Advance your landscape lighting designs to the next level with the full capabilities of the Alliance bt System. Move to advanced capabilities that put a landscape into a whole new light.

Alliance's bt system brings a wide suite of capabilities in a system that is easy and economical to install. It does not require a specific controller or transformer, and can be adapted to sites, including those with existing low-voltage landscape lighting.



DOWNLOAD THE FREE BT APP



KEY bt CAPABILITIES AND BENEFITS:

Dimming – control individual fixture intensity from 1% to 100% to dramatically change the appearance and make overall lighting more pleasing.

Color temperature control – tune individual fixture output infinitely from warm 2700K to silvery moonlight 4000K. Amplify architectural colors and tones. Invigorate vegetation. Emulate moonlight.

RGBW color control – paint a landscape with rich, colorful light. Choose from up to 30,000 different custom colors, plus easy pre-set colors.

Scene creation – create custom lighting schemes to suit specific times of day, activities, moods or events. Adjust fixture color and dimming to create romantic, festive or relaxing scenes. Celebrate family events, holidays, sporting events with customized color.

EXPERIMENT WITH LIGHT!

Expand the quality of your lighting designs and increase your customers' enjoyment of their lighting investment with the bt system. Here are some themes to try:

- Softer lighting with a touch of color can be relaxing or romantic.
- Bright saturated colors are festive and celebratory, perfect for sports night or pool night
- Dimming and color together particularly effective for outdoor gatherings, as it can help bring focus to seating and task areas while using muted colored lighting for perimeter ambiance.
- Holiday themes: Christmas, Hanukkah, Halloween, Valentines Day, Independence Day, etc.

bt RANGE EXTENDERS

Range extenders are a MUST for every bt System to operate reliably. They repeat and strengthen the communication between all system components, operating as a **“mesh network”**.

Communication signal strength can be reduced by physical obstructions (buildings, landscape features, etc.), intermittent communication interference (competing signals, static, signal noise, magnetic fields, etc.), weather and more.

You want a reliable installation! Avoid parts of your bt system network going off-line by creating a strong network of range extenders (RE).

Range extenders are assigned to a specific network. If you have multiple networks on a property, separate range extender groups will be needed for each network.

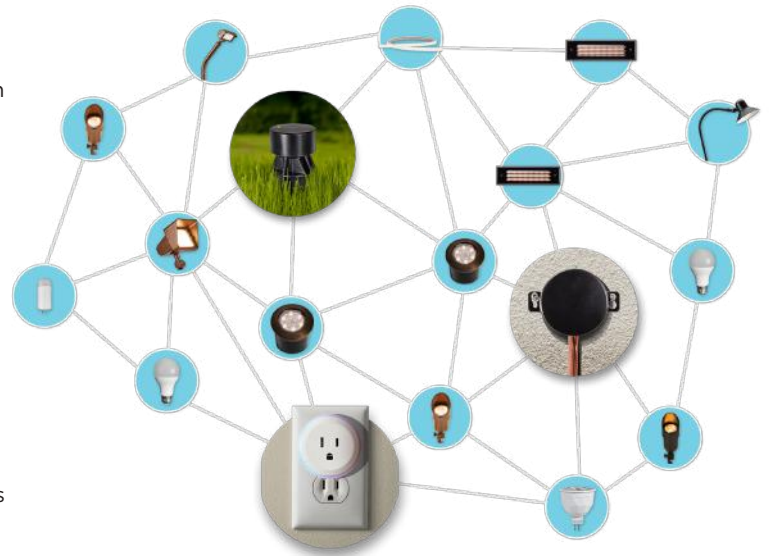

the “mesh network”



BTRE

Stake mounted range extender installs in the landscape along your wire cable path. Installed where spacing between fixtures is significant, where elevation or obstructions might interrupt signal and simply to strengthen the overall network. Nestle among landscape foliage, do not place behind physical obstructions like walls, stones, etc.

- 8” slotted ground stake
- 5’ wire lead
- Option to add height with risers of various lengths, see page 104
- 5 dB, 2.4 GHz
- Indicator light displays green when RE is active in a network.
- 1 watt



BTRE-SM

Surface mounted range extender ideal for use in hardscape areas or on the exterior walls of structures. Installed where spacing between fixtures is significant, where elevation or obstructions might interrupt signal and simply to strengthen the overall network.

- Mounting ears for attachment to vertical surfaces
- 5’ wire lead
- Add removable ½” threaded base to attach to RMB mount or another base.
- Indicator light displays green when RE is active in a network.
- 1 watt



BTRE-PLUGIN

Indoor range extender plugs into a standard 120V grounded receptacle. Intended to help carry signal from indoors to the landscape. (For example, when adjusting lighting on a cold winter night). A must for residential installations.

- Allows outlet to continue to be used for other purposes (10A limit).
- LED indicator light displays blue when RE is active in network

bt SYSTEM - FIXTURES



Alliance offers a wide selection of fixtures with onboard bt modules. Here are all our bt fixtures in one place, so you can easily find what you're looking for. Specification information for each is located on the specific fixture page.

bt ACCENT/UPLIGHT



BL200-BT PG 14
BL900-BT PG 15
BL400-BT PG 16

HEAVY SAND
CAST BRONZE



HSC-BL3-BT PG 19

bt WALL WASH



FL50-BT PG 72
FL200-BT PG 73

bt DOWN LIGHTS



DL200-BT PG 77
HL100-BT PG 78
HL200-BT PG 79

bt AREA & PATH



AL100 PG 23
AL150 PG 22
AL250 PG 23
AL300 PG 22
AL400 PG 23
AL500 PG 22
AL550 PG 22
ALSTEM12-BT PG 25
ALSTEM18-BT PG 25
PL100-BT PG 30
PL300-BT PG 31

bt IN-GROUND



WL400-BT PG 43
GL100-BT PG 46
GL150-BT PG 46
GL160-BT PG 46
GL170-BT PG 47
GL180-BT PG 47
GL190-BT PG 47



GL300-BT PG 48
GL310-BT PG 48
GL350-BT PG 48
GL360-BT PG 49
GL370-BT PG 49
GL380-BT PG 49
GL390-BT PG 49

bt HARDSCAPE



SL25-BT PG 62
SL35-BT PG 63
SL70-BT PG 64
SL60-BT PG 66
SL80-BT PG 67
WS350-BT PG 68

bt LAMPS



BT-ALLY-MR16 PG 106
BT-ALLY-G4 PG 106
BT-ALLY-PAR36 PG 106
BT-ALLY-A19 PG 106

bt SPECIALTY



UL100-BT PG 90
GOLF50-BT PG 91

bt RANGE EXTENDERS



BTRE PG 101
BTRE-SM PG 101
BTRE-PLUGIN PG 101

bt SYSTEM INSTALLATION REQUIREMENTS AND TIPS

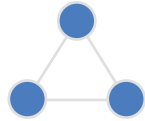

1) Triangulate bt range extenders so that each has a line of sight to at least 2 other range extenders. This strengthens the Bluetooth® mesh network and increases communication to the bt fixtures in range.



2) Signal strength is aided by elevation. Where possible, install range extenders in trees, on hilltops, on fences, roofs, etc. For ground-stake models use a RISER for height.



3) Set up secured network(s). Secured networks help to block those without permission from accessing the bt system, and separate fixtures. You can create multiple secured networks for a property, if desired. (e.g. front yard and back yard). Range extenders are assigned to a specific secure network, and cannot be shared across different secure networks.

4) Review system operation with the property owner. Use their device to test the app from key locations (indoors, outdoor seating, entrances, garages) to ensure reliable control and avoid callbacks. Leave a copy of the bt How-To Guide covering app features, scene setup, secure access, and signal tips.



5) Communication Distances.

- bt fixtures: 5-20 ft Bluetooth® range
- bt Range Extenders: 35-75 ft range
- Smartphones: 10-30 ft range

Actual range can vary due to elevation, rocks, foliage, buildings, patio covers, and interference from electrical or wireless devices like pool equipment.

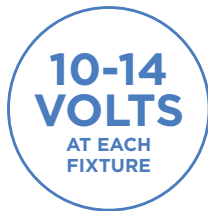

6) bt Fixtures Require Between 10-14 Volts to Communicate. Over 14 volts will damage the components of a bt module. Place no more than 8 bt fixtures on a wire run.

7) The bt System does Not Require a Special Transformer. The bt System works with any transformer that outputs 10-14 volts at the fixture.



VISIT OUR WEBSITE TO DOWNLOAD OUR bt SYSTEM HOW-TO GUIDE



FIXTURE INSTALLATION ACCESSORIES



ROUND SURFACE MOUNTING BASE

Low-profile brass base for mounting any standard ½" threaded fixture to flat surfaces like decks, walls, or wide rails. Built-in wire notch for a clean run. Includes 3 wood screws, or use your own fasteners as needed. Just ½" tall for a low-profile install.

RMB

3" round mounting base, aged brass

RMB-BLK

3" round mounting base, black overcoat



TREE-MOUNTING BOX

Cast aluminum box mounts to a tree or post with adjustable lag screws and holds any fixture with ½" MPT threads. Designed to allow for natural tree growth over time. Splices stay protected inside the waterproof housing—only one cable run needed up the trunk.

Model: **TREEMOUNT**



GUTTERMOUNT

Installs discreetly inside a standard metal gutter to support ½" threaded fixtures—ideal for dormer or façade lighting. Keeps the fixture secure without disturbing the roofline. 3.3" length. (Fixture sold separately.)

Model: **GUTTERMOUNT**
GUTTERMOUNT-BLK



T-ADAPTER

Use with riser of your choice to create dual-head accent fixtures for special applications that require precise aiming and light control. Recommended with BL50 (pictured).

Model: **T-ADAPTER**
T-ADAPTER-BLK



L-ADAPTER

Pair with the riser of your choice to create an aimable area light. Popular solution for lighting inclined driveways where wide dispersal and glare control is required. Recommended with BL50, BL100 or BL200 (pictured).

Model: **L-ADAPTER**
L-ADAPTER-BLK



SLOTTED PLASTIC GROUND STAKES

Standard with most ground-mounted fixtures. Brown for aged brass and black for black overcoat fixtures.

STAKE-P1 8" standard stake
STAKE-P2 8.5" large stake
STAKE-P3 14" giant stake



PERMAPOST GROUND STAKES

Provides deep anchoring for fixtures in high traffic areas. Helps maintain fixture position and aiming when bumped by pedestrians and maintenance equipment. Included with ALSTEM60 60" stem. 18.5" depth x 3" diameter. Brass locking nut and cap. PVC body. Plastic stabilizing fins.

Model: **PERMAPOST**
PERMAPOST-BLK



UNDERWATER JUNCTION BOX

IP68 rated underwater junction box that allows for (2) UL100-BT's to be connected to a single external antenna. Includes 10' of power and signal combination cable.



Example of UL100-BT-JXN connected

Model: **UL100-BT-JXN**



A-LOC LOCKING WATERPROOF SPLICES WITH CRIMP SLEEVE

Secure: Each connector uses a brass crimp sleeve for the splice, then seals the connection inside a silicone gel-filled housing. A locking bolt clamps down on the wire jacket—not the copper—for a tight, reliable hold.

Easy installation: Strip wires, twist together, crimp, insert into splice, tighten “bolt”.

Clean, organized installation: Interlocking sides click together for a secure, low profile fit.

Weatherproof: Suitable for direct-burial, outdoor applications. Do not use underwater.

Model: **A-LOC-50** Container of 50 pieces (25 pairs)



RISER6
AGED BRASS

RISER6-BLK
PREMIUM BLACK OVERCOAT

RISER12
AGED BRASS

RISER12-BLK
PREMIUM BLACK OVERCOAT

RISER18
AGED BRASS

RISER18-BLK
PREMIUM BLACK OVERCOAT

EXTENSION RISERS

Provides additional height to raise fixture out of plantings, to respond to changes in terrain or to aid in aiming for wall washing or signage illumination. Can also tune fixture height on existing installations to accommodate plant growth. Male end attaches to mounting, female end to fixture.

- RISER6** 6" fixed riser, aged brass
- RISER6-BLK** 6" fixed riser, premium black overcoat
- RISER12** 12" fixed riser, aged brass
- RISER12-BLK** 12" fixed riser, premium black overcoat
- RISER18** 18" fixed riser, aged brass
- RISER18-BLK** 18" fixed riser, premium black overcoat



BT-ALLY-MR16



BT-ALLY-G4



BT-ALLY-PAR36



BT-ALLY-A19
(120V LAMP)



APP-CONTROLLED COLOR-CHANGING LAMPS

EASILY RETROFIT EXISTING FIXTURES BY SWAPPING TO BT-ALLY LAMPS

Add the control capabilities of Alliance's bt System to existing lighting fixtures with bt Ally drop-in lamps. Like bt fixtures, these lamps offer app controls, RGBW color adjustability, tunable white and dimming capability.

PRODUCT SPECS

- Operates with Alliance bt app from any mobile device (phone, tablet) with either iOS or Android
- Operating Voltage: 10-14 volts
- CRI: Ra>80
- Rated hours: 30,000
- Ambient operating temperature: < 160F

Remote Control

Control lamps (on/off) individually with the bt app.

Dimming Control

Control individual lamps intensity from 1% to 100%



Color Temperature Control

Tune individual lamps output infinitely from warm 2700K to silvery moonlight 4000K.



RGBW Color Control

Paint a landscape with rich, colorful light. Choose from up to 30,000 different custom colors, plus easy preset colors.



Scene/Theme Creation

Create custom lighting schemes to suit specific times of night, activities, moods or events.

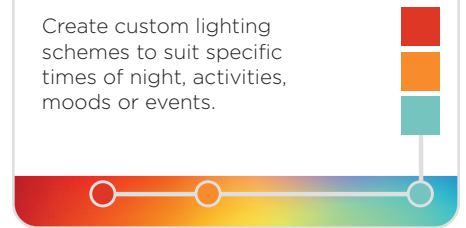

ALLIANCE BT-ALLY LAMPS

MODEL	WATTAGE	BEAM SPREAD	DELIVERED LUMENS	COLOR TEMP.
BT-ALLY-MR16	Adjustable 2-4W	40° Flood	10-430	Adjustable 2700K-5000K
BT-ALLY-G4	Adjustable 1-2.5W	360° spread	10-250	Adjustable 2700K-5000K
BT-ALLY-PAR36	Adjustable 2-7W	45° Flood	15-460	Adjustable 2700K-5000K
BT-ALLY-A19 120v lamp for integrating line-voltage fixtures into a bt system	8W	220° wide angle	10-800	Adjustable 2700K-5000K

IMPORTANT NOTE:

BT-ALLY-G4 (Dimensions: 2.8125" Height x 0.9375" Diameter)

DOES NOT FIT THESE FIXTURES:

HSC-PL1, HSC-PL4, PL200, PL250, PL300, SL150, SL70, PAL705
PL200-BLK, PL250-BLK, PL300-BLK, SL150-BLK, SL70-BLK, PAL705-BLK

BT-ALLY-MR16 (Dimensions: 1.875" Height x 2" Diameter)

DOES NOT FIT THESE FIXTURES: GL170, GL180, GL190, UL100, BL900

ALLIANCE MR-16 LED LAMPS

MODEL	WATTAGE	BEAM ANGLE	DELIVERED LUMENS	COLOR TEMP.	BASE COLOR
LMR16-LED-4W-NS	4	15° NARROW SPOT	250	2900K	BLACK
LMR16-LED-4W-F	4	45° FLOOD	250	2900K	BLACK
LMR16-LED-4W-WF	4	60° WIDE FLOOD	250	2900K	BLACK
LMR16-LED-5W-NS	5	15° NARROW SPOT	310	2900K	WHITE
LMR16-LED-5W-F	5	45° FLOOD	310	2900K	WHITE
LMR16-LED-5W-WF	5	60° WIDE FLOOD	310	2900K	WHITE
LMR16-LED-6W-F	6	45° FLOOD	400	2900K	BLUE

Note:

4 watt models are approximately equivalent output to halogen 20 watt
 5 watt models are approximately equivalent output to halogen 35 watt
 6 watt model is approximately equivalent output to halogen 50 watt



LMR16-LED-4W-NS



LMR16-LED-6W-F

ALLIANCE MR-11 & MR-8 LED LAMPS

MODEL	WATTAGE	BEAM ANGLE	DELIVERED LUMENS	COLOR TEMP.	BASE COLOR
LMR11-LED-4W-F	4	45° FLOOD	175	2900K	WHITE
LMR8-LED-150LM	2	45° FLOOD	150	2900K	WHITE



LMR11-LED-4W-F



LMR8-LED-150LM

ALLIANCE PAR36 LED LAMPS

MODEL	WATTAGE	BEAM ANGLE	DELIVERED LUMENS	COLOR TEMP.	BASE COLOR
LPAR36-LED-4W-F	4	20° FLOOD	250	2800K	GRAY
LPAR36-LED-4W-WF	4	40° WIDE FLOOD	250	2800K	GRAY
LPAR36-LED-8W-F	8	20° FLOOD	300	2800K	BLACK
LPAR36-LED-8W-WF	8	40° WIDE FLOOD	300	2800K	BLACK
LPAR36-LED-10W-F	10	30° FLOOD	400	2800K	BLUE
LPAR36-LED-10W-WF	10	45° WIDE FLOOD	400	2800K	BLUE

Note:

4 watt models are approximately equivalent output to halogen 20 watt
 8 watt models are approximately equivalent output to halogen 35 watt
 10 watt model is approximately equivalent output to halogen 50 watt





ALLIANCE G4 BIPIN LED LAMPS

MODEL	WATTAGE	DELIVERED LUMENS	COLOR TEMP.
LBIPIN-LED-200lm	2.5	200	2700K
LBIPIN-LED-250lm	3	250	2700K
LBIPIN-LED-350lm	3.5	350	2700K



ALLIANCE 3156 WEDGE BASE LED LAMPS

MODEL	WATTAGE	DELIVERED LUMENS	COLOR TEMP.
L3156-LED-200lm	2.5	200	2700K
L3156-LED-250lm	3	250	2700K



ALLIANCE SINGLE CONTACT BAYONET LED LAMPS

MODEL	WATTAGE	DELIVERED LUMENS	COLOR TEMP.
LBA15S-LED-200lm	2.5	200	2700K



ALLIANCE DUAL CONTACT BAYONET LED LAMPS

MODEL	WATTAGE	DELIVERED LUMENS	COLOR TEMP.
LBA15D-LED-200lm	2.5	200	2700K



ALLIANCE T5 WEDGE BASE LED LAMPS

MODEL	WATTAGE	DELIVERED LUMENS	COLOR TEMP.
L921T5-LED-200lm	2.5	200	2700K

HEX LOUVERS

Used to diffuse and reduce sideways glare that the fixture shroud alone may not block. Architectural lamps like PAR and MR types often emit spill light beyond the lamp face—adding a hex louver softens that output for a more controlled, comfortable look.

HEXLOUVER-MR16

MR-16 size, fits Alliance fixtures using a MR16 lamp.



HEXLOUVER-PAR36

PAR-36 size, fits Alliance fixtures using a PAR36 lamp.



FROSTED LENSES

Frosted lenses create a more diffuse spread of light and reduce scallop effects. Preserves the output of the beam while removing striation and halation. Particularly effective in sign lighting and wall-washing.

MR16LENS-FROSTED

MR-16 size, fits Alliance fixtures using a MR16 lamp.



PAR36LENS-FROSTED

PAR-36 size, fits Alliance fixtures using a PAR36 lamp.



INTERCHANGEABLE LIDS FOR WELL LIGHTS

Field install a different color or style lid to update our traditional CGWL01 well lights to your project's requirements.



CGWL01-GRATE



CGWL02-TOP



CGWL01-GRATE-BLK



CGWL02-TOP-BLK



DEMO KITS

DEMOKIT8-BT - bt Demonstration Kit

DEMOKIT8 - LED Demonstration Kit

THE SECRET TO CLOSING MORE JOBS

Alliance demo kits let you showcase lighting effects in real time—right on the customer’s property. Quick to set up, easy to adjust, and built to help you close the job.



DEMO KIT FEATURES:

- Our industry first double wire leads: fixtures with two 18AWG (UL Listed) brown wire leads pre-connected to the fixture, one 18” and one 25’ in length.
- Quick connecting adapters at each wire end make connections fast and easy (not intended for in ground burial)
- TF series transformer with an 18” wire lead pre-connected with quick connect adapter
- Compact storage case making the kit easy to store and transport
- Extra quick connectors

bt DEMOKIT8-BT INCLUDES:

- (6) BL200-bt
- (2) ALSTEM12-bt
- (2) AL100 Hats
- (1) TF Series Transformer
- (2) Wire Splitters
- (12) Extra Connectors
- Storage Case
- (1) bt-RE

DEMOKIT8 INCLUDES:

- (6) BL200-LED4W
- (2) ALSTEM12-LED
- (2) AL100 Area Light Hats
- (1) TF Series Transformer
- (2) Wire Splitters
- (12) Extra Connectors
- Storage Case



Alliance Outdoor Lighting warrants its products against defects in material and workmanship. Without charge, Alliance Outdoor Lighting will either repair or replace (Alliance Outdoor Lighting reserves the right to decide between repair or replacement) any properly installed Alliance Outdoor Lighting product that fails under normal operating conditions within the specified warranty period. Damage due to acts of nature, such as, but not limited to, lightning, flooding, explosions and earthquakes, are not covered.

PRODUCT WARRANTY DETAILS

BRASS, COPPER & BRONZE FIXTURES:

All have a lifetime warranty for all castings and housings.

IT2 SERIES TRANSFORMERS:

All IT2 series transformers carry a lifetime warranty on enclosures. All transformer windings carry a lifetime warranty.

XF SERIES TRANSFORMERS:

All XF series transformers carry a lifetime warranty on enclosures. All transformer windings carry a lifetime warranty.

TF SERIES TRANSFORMERS:

2 year warranty.

bt AND INTEGRATED LED FIXTURES

All Alliance LED integrated fixtures carry a 10 year warranty.

bt AND LED LAMPS:

10 year warranty.

ITIMERPRO:

10 year warranty.

TIMERS AND PHOTOCELLS:

Do not carry a warranty.

All products are warranted from the date of invoice, provided it is returned to the Alliance Outdoor Lighting distributor from where it was purchased. Our factory inspection determines it to be defective under the terms of the warranty. This warranty covers only equipment manufactured by Alliance Outdoor Lighting and does not extend to transportation, installation, labor compensation, or replacement charges, nor does it apply to any equipment of another manufacturer used in conjunction with Alliance Outdoor Lighting equipment.

NOTE: All Alliance Outdoor Lighting products are designed to be repaired in the field by a qualified lighting installer. All service parts are readily available and we encourage field repairs as a significant cost and labor savings which can be realized by the installer. All warranted components, as stated in the above warranty, which are installed in the field, will be honored.

YOUR LIGHTING PEOPLE ↘

ALLIANCE[®]

OUTDOOR LIGHTING

West Coast Hub: Temecula, CA
East Coast Hub: Sanford, FL



Copyright © 2026 Alliance Outdoor Lighting. All Rights Reserved.

www.allianceoutdoorlighting.com

MKT_CAT2026
rev. December 2025