

Pren

BISLEY

Contents

03	Introduction	26	Accessories
05	Why choose us?	29	Locking technology
09	Workspace essentials	30	Finishes
	A perfect combination		
	Purpose beyond storage		
	A systems approach to storage		
	Storage meets style		
	Good to know		
20	Range overview	32	Our commitments
	Two-door cupboards		
	Wardrobes		
	Lockers	32	Contact us

Introducing Pren, a collection of freestanding lockers, wardrobes, and cupboards that make specifying your entire storage system refreshingly simple.

Pren, which is the Welsh word for wood, tells the story of how proud we are of our heritage and of our independence, having been based in South Wales since 1988.

With purpose beyond storage, Pren's freestanding units act as zone dividers throughout the office, creating defined neighbourhoods wherever you need. Contra-facing units are available at multiple heights, maximising storage throughout, and additional including planter tops and sleek over-sailing panels add mood-boosting biophilia, or create an extended standing height work bench

Spanning warm wood-effect tones and solid colour finishes, Pren is available in a variety of laminates, matching LockerWall's broad palette, creating symmetry for your storage. And almost entirely made in-house, the lead times remain significantly shorter than average.

Pren's storage is designed to be entirely secure with a range of locking options. From smart, contactless RFID locking solutions, to the classic key or combination locks, you can relax and continue with your day, knowing your belongings are safely stored.

Pren - loceri a cypyrddau annibynnol.
freestanding lockers, cupboards, and wardrobes.





Why choose us?

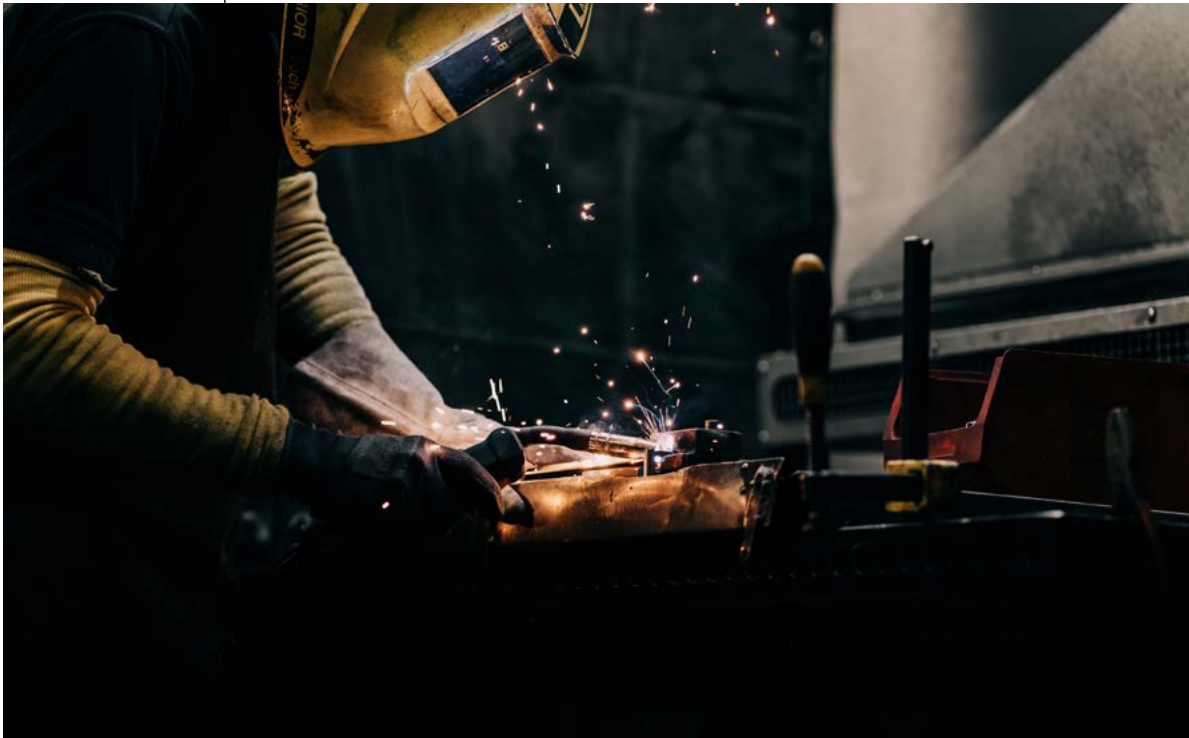

A greener Bisley

View the Bisley Green Guide to learn about our sustainability achievements and commitments.

Manufacturing excellence

We're proud to be a full manufacturer - we manufacture all our products in our South Wales factory and our UK distribution centres.

We practice Lean Manufacturing and have invested over £2m in machinery to enhance our production processes and technology to create better products and designs.



Over 80 years of
award-winning
design expertise

Europe's leading
manufacturer of steel
storage with a state-
of-the-art wood plant

15,000 products leave
our South Wales
factory every week

ence that's engineered around you.

ll manufacturer that really is Made in Britain
our own steel and wooden furniture in our
and export worldwide.

ufacturing, and have recently invested over
nsure we are using the latest manufacturing
ologies, continually seeking to improve our

Our knowledge and expertise is unrivalled and continues to grow. Our team is here to guide you through all the options – from dimensions and finishes, to putting together a precise design specification. Whatever the project requirement, we're on hand to ensure you achieve exactly what you want.

We create furniture that lasts a lifetime for our customers; made from the highest quality materials, using the latest innovative technologies and processes with minimum impact on our environment.

Workspace essentials





A perfect combination

Inspired by and designed to suite with our premium LockerWall range, Pren allows you to build upon your existing LockerWall installation, or complement it, without excess alterations and additional finishing panels.

You can even design your office space combining both Pren and LockerWall from the outset. Entirely freestanding, with a breadth of options, finishing touches and lock choices, Pren becomes an extension of LockerWall, integrating it throughout the office as space division, isolated storage zones and additional standing height work surfaces.

Both ranges share a laminate colour palette, with a choice of wood effect and neutral solid colours to bring warmth to your space. The palette has been designed to not only work seamlessly across Pren and LockerWall, but also offers contrasting finishes that work well together.

Pren works perfectly with LockerWall to maximise your space and storage requirements.



Download images

Purpose beyond storage

Create zones and wayfinding throughout your office with Pren. The contra-facing design allows for dual-sided access, maximising usable storage space, while oversailing decorative tops keep joint lines to a minimum.

The lower height units are perfect for space division and give open-plan workplaces defined neighbourhoods. Separate focussed working zones from collaborative or break-out areas with Pren's additional fixtures – wooden planters which incorporate mood boosting biophilia, and sleek tops that double up as standing height worktops.

Wherever placed in the office, Pren fulfils your storage requirements while shaping dedicated working zones, maximising productivity within your workspace.









A systems approach to storage

Pren makes specifying an entire floorplate surprisingly simple. The extensive range covers all aspects of workplace storage; from personal storage lockers and drawers, cupboards for filing and technology, or a place to hang your coat.

Your storage can support multiple possibilities in the workplace - the various height options are perfectly suited to form subtle space division in open plan environments.

Blending desirable workplace aesthetics with practical storage, Pren's clean design means there is no need to specify extra finishing panels; you can achieve an entire, uncomplicated, storage system, without compromising on cost.

All Pren units are 500mm deep, meaning any combination can be placed side-by-side or contra-facing. And with a variety of locking options available, your workforce can rest assured that their personal belongings are safely stowed throughout the working day.

Storage meets style

Perfect your boardroom or meeting room with a contemporary credenza to create a focal point, with a place to store technology or guests' belongings.

Pair lower height cupboards and lockers and opt for an oversailing top to create a luxurious addition to a meeting space. Pren cupboards feature round, solid wood handles for a smart, subtle design.

The palette of soft wood effect textures and modern neutrals available for Pren complement any colour scheme, and will blend beautifully with your brand colours, whether you are designing a new space or simply upgrading your storage.



Extra information

- The entire Pren range shares the same 500mm depth, so lockers, wardrobes and cupboards can be neatly combined.
- Each unit includes full height finishing panels and a plinth meaning there's no need to specify additional materials. This also means that reconfiguration is easy should you choose to refresh your workspace, providing excellent value and longevity.
- Internal accessories, such as shelves with under shelf filing* and coat rails are included. Additional accessories are available to order separately if you require them.
- Manufactured almost entirely at our factory in South Wales, keeping lead times to a minimum.
- The Pren range has a five-year guarantee.

*available in cupboard units.





Range overview

Two-door cupboards

All cupboards are 462mm (18.2") deep.

715mm (28.1")

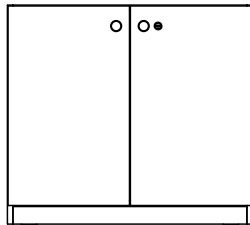

Internal measurements
H 617mm (24.3")
D 462mm (18.2")

Includes 1 adjustable shelf

Available with no lock and standard AB & M3

1018mm (40")

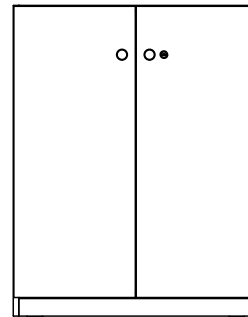

Internal measurements
H 920mm (36.2")
D 462mm (18.2")

Includes 2 adjustable shelves

Available with no lock and standard AB & M3

1210mm (47.62")



Available in 800mm (31.5") wide.

Internal widths: 764mm (30")

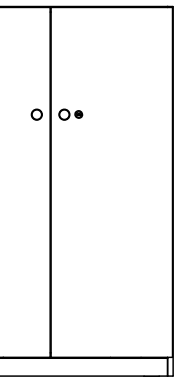

Internal measurements
H 1112mm (43.8")
D 462mm (18.2")

Includes 2 adjustable
shelves

Available with no lock
and standard AB & M3

1590mm (62.6")

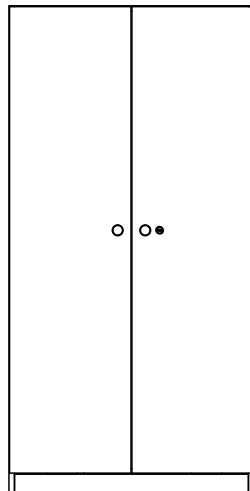

Internal measurements
H 1492mm (58.7")
D 462mm (18.2")

Includes 3 adjustable
shelves

Available with no lock
and standard AB & M3

1970mm (77.5")

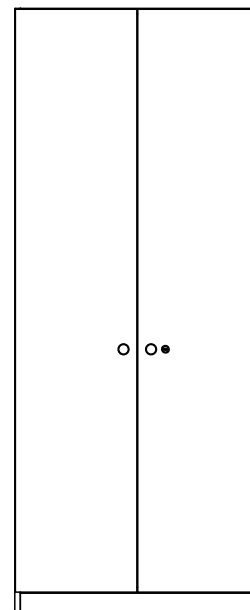

Internal measurements
H 1872mm (73.7")
D 462mm (18.2")

Includes 4 adjustable
shelves

Available with no lock
and standard AB & M3

Available in two widths: 800mm (31.5") & 1000mm (39.4")

Internal widths: 764mm (30") & 964mm (37.9")

Line drawings are for illustrative purposes only.

Wardrobes

All wardrobes are 500mm (19.7") deep.

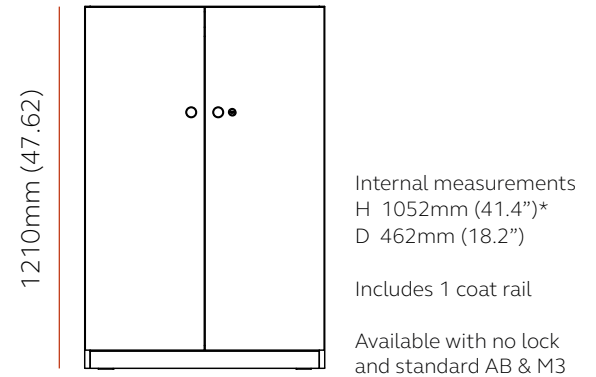
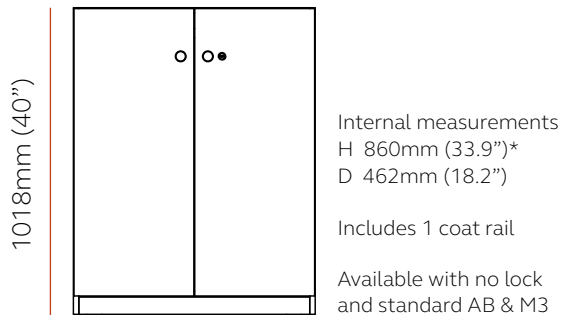

Available in two widths: 800mm (31.5")

Internal widths: 764mm (30") & 960mm (37.8")

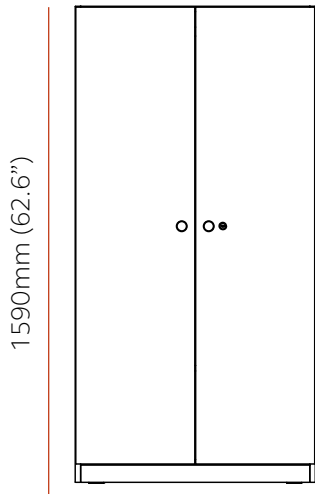

Internal measurements
 H 1154mm (45.4")*
 D 462mm (18.2")

Below bottom shelf
 H 260mm (10.2")

Includes 1 coat rail and
 1 fixed shelf

Available with no lock
 and standard AB & M3

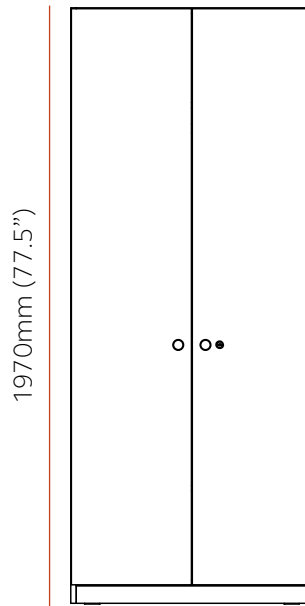

Internal measurements
 H 1186mm (46.7")*
 D 462mm (18.2")

Above top shelf H 330mm (13")	Below bottom shelf H 260mm (10.2")
----------------------------------	---------------------------------------

Includes 1 coat rail and
 2 fixed shelves

Available with no lock
 and standard AB & M3

) & 1000mm (39.4")
 54mm (38")

*From coat rail to bottom shelf.
 Line drawings are for illustrative purposes only.

Lockers - 1018mm (40") high

All lockers are 500mm (19.7") deep.

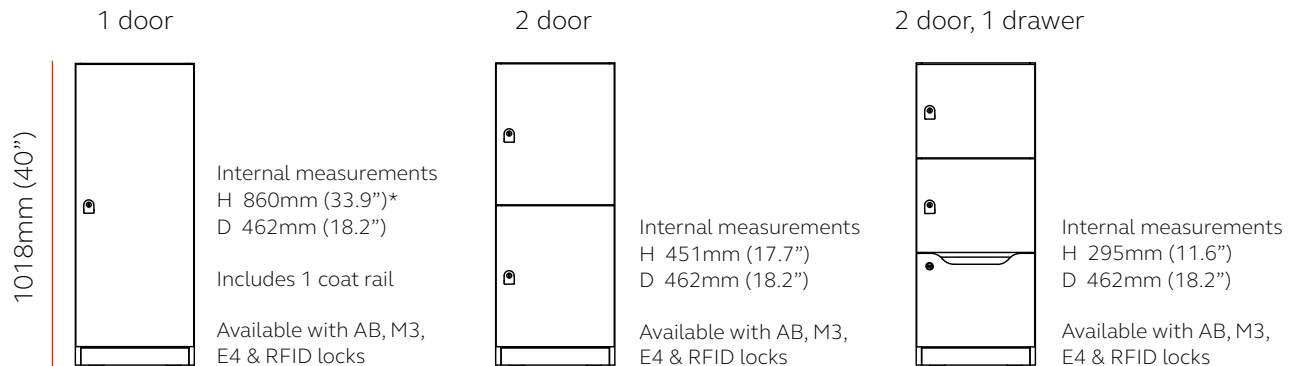

Available in 400mm (15.7") wide.

Internal width: 364mm (14.3") per compartment

2 door

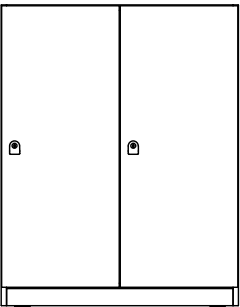

Internal measurements
H 860mm (33.8")*
D 462mm (18.2")

Includes 1 coat rail

Available with AB, M3,
E4 & RFID locks

4 door

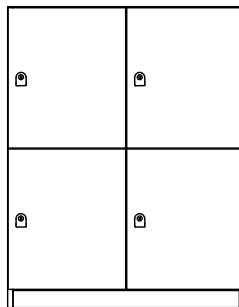

Internal measurements
H 451mm (17.7")
D 462mm (18.2")

Available with AB, M3,
E4 & RFID locks

4 door, 2 drawers

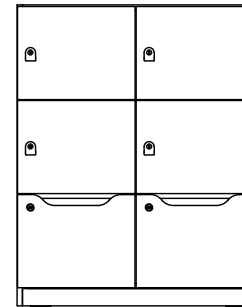

Internal measurements
H 295mm (11.6")
D 462mm (18.2")

Available with AB, M3,
E4 & RFID locks

Available in 800mm (31.5") wide.
Internal width: 364mm (14.3") per compartment

*From coat rail to bottom shelf.
Line drawings are for illustrative purposes only.

Lockers - 1970mm (77.5") high

All lockers are 500mm (19.7") deep.

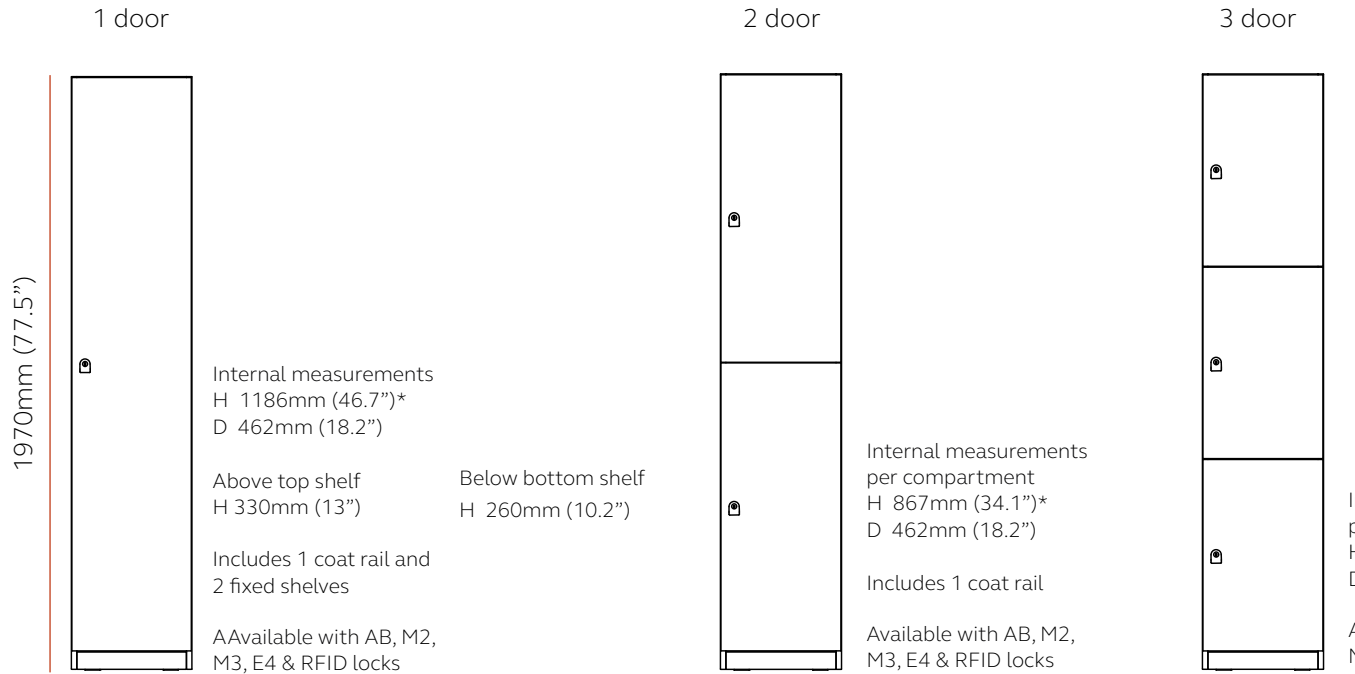

Available in 40
 Internal width: 364mm

4 door

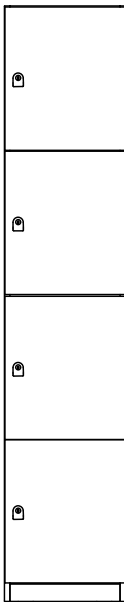

Internal measurements
per compartment
H 455mm (17.9")
D 462mm (18.2")

Available with AB, M2 &
M3 locks

4 door, 1 drawer

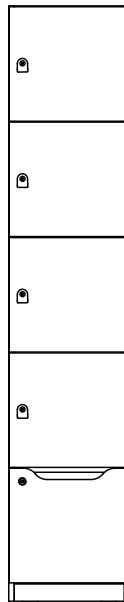

Internal measurements
per compartment
H 360mm (14.2")
D 462mm (18.2")

Available with AB, M2 &
M3 locks

5 door, 1 drawer

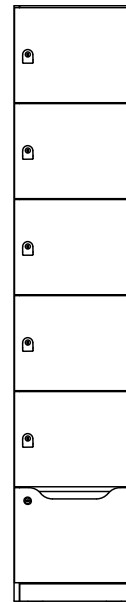

Internal measurements
per compartment
H 297mm (11.7")
D 462mm (18.2")

Available with AB, M2 &
M3 locks

Internal measurements
per compartment
H 613mm (24.1")
D 462mm (18.2")

Available with AB, M2,
M3, E4 & RFID locks

0mm (15.7") wide.
h (14.3") per compartment

*From coat rail to base of Locker.
Line drawings are for illustrative purposes only.

Lockers - 1970mm (77.5") high

All lockers are 500mm (19.7") deep.

2 door

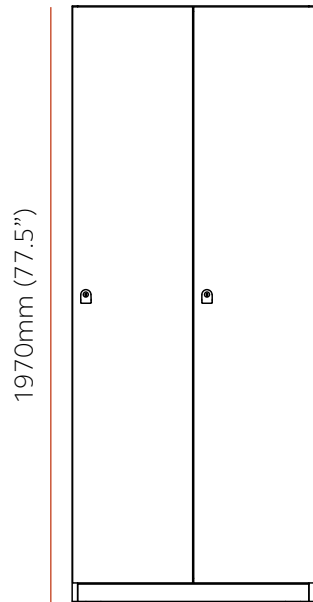

Internal measurements
H 1186mm (46.7")*
D 462mm (18.2")

Above top shelf
H 330mm (13")

Below bottom shelf
H 260mm (10.2")

Includes 1 coat rail and
2 fixed shelves

Available with AB, M2,
M3, E4 & RFID locks

4 door

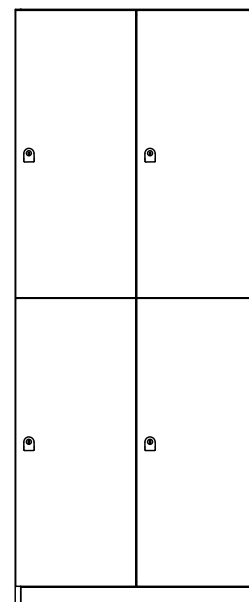

Internal measurements
per compartment
H 867mm (34.1")*
D 462mm (18.2")

Includes 1 coat rail

Available with AB, M2,
M3, E4 & RFID locks

Available in 800mm (31.5")
Internal width: 364mm (14.3")

6 door

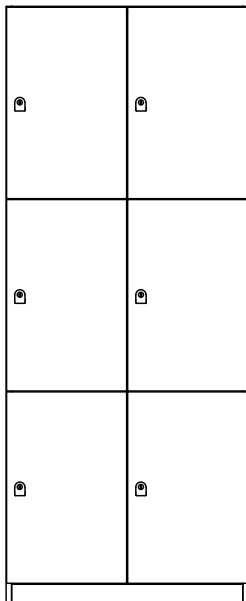

Internal measurements
per compartment
H 613mm (24.1")
D 462mm (18.2")

Available with AB, M2,
M3, E4 & RFID locks

8 door

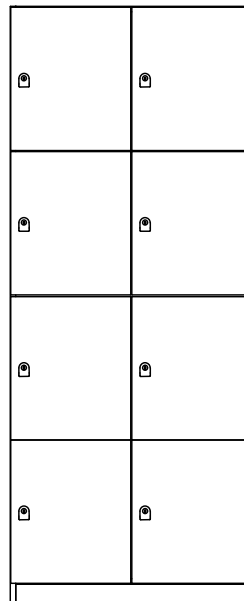

Internal measurements
per compartment
H 455mm (17.9")
D 462mm (18.2")

Available with AB, M2 &
M3 locks

11.5") wide.
per compartment

*From coat rail to base of Locker.
Line drawings are for illustrative purposes only.

Lockers - 1970mm (77.5") high

All lockers are 500mm (19.7") deep.

8 door, 2 drawers

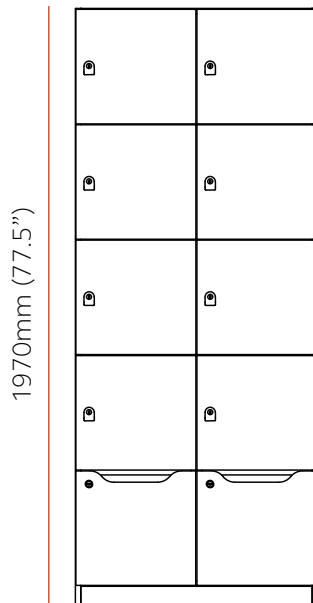

Internal measurements
per compartment
H 360mm (14.2")
D 462mm (18.2")

Available with AB, M2 &
M3 locks

10 door, 2 drawers

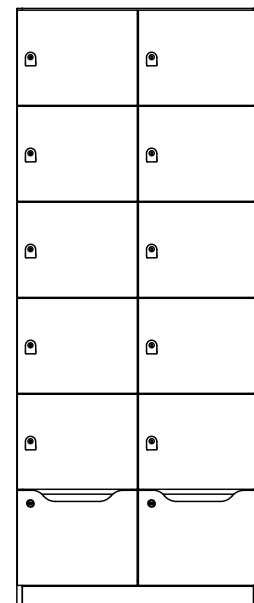

Internal measurements
per compartment
H 297mm (11.7")
D 462mm (18.2")

Available with AB, M2 &
M3 locks

Available in 800mm (31.5") wide.
Internal width: 364mm (14.3") per compartment

Line drawings are for illustrative purposes only

Download images 



Accessories

Additional laminate planters can be added to lower height units to introduce greenery and to subtly border different working zones. And oversailing tops can be applied to banks of units positioned together, minimising joint lines, while creating extra standing-height workspace.

Internal shelves

MCF shelves for two-door cupboards are available in two widths: 362mm (14.3”) & 371mm (14.6”)

MFC Decorative Tops - 500mm (19.7”)

Available in 7 widths: 400mm (15.7”), 800mm (31.5”), 1200mm (47.2”), 1600mm (63”) 2000mm (78.7”) & 2400mm (94.5”)

Planters

All planters are 145mm (5.7”) high and 50mm (2”) deep. They are available in four width: 400mm (15.7”), 800mm (31.5”), 1000mm (39.4”) & 1200mm (47.2”)

Steel shelves for Locker units are available in two widths: 800mm (31.5") & 1000mm (39.4")

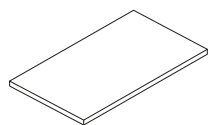

) & 1000mm (39.4") deep.

mm (31.5"), 1000mm (39.4"),
n (78.7") & 2400mm (94.5")

00mm (19.7") deep.

15.7"), 800mm (31.5"),

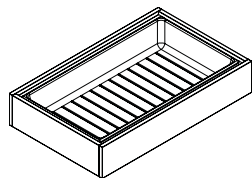





Locking technology

AB Lock

AB locks are a great, cost-effective option if you are looking for a straightforward, secure solution with user keys, ideal for both assigned and shared lockers.

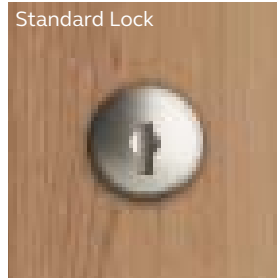

Combination locks

Combination locks seamlessly integrate with our products while providing enhanced protection. With both shared and assigned combination locks are a reliable, cost-effective solution for personal storage.

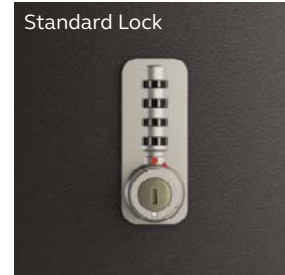

 LEHMANN®



 LE



Digilock

te with many of
ed security and
ned user options,
effective solution

RFID locks

As personal storage solutions advance, the security element is following suit, and touch free, RFID locks are becoming increasingly popular for workspace installs as well as leisure and hospitality environments. Trading in lock and key entry for hassle free RFID access brings control and peace of mind to flexible workforces.



HMANN®



Digilock®

We design and manufacture the highest quality storage solutions, but we also have the knowledge and expertise on hand to advise you on the best lock choice.

Our standard range of secure locking options for Pren gives all employees – whether permanent, mobile, or nomadic – a sense of peace of mind while in the office.

Whether you opt for a traditional key lock or a more advanced mechanical lock that can be programmed depending on the user, we work with a variety of the most trusted lock providers to meet even the most challenging privacy and security requirements of the modern workplace.

Specifying Pren alongside a LockerWall installation?

Rest assured your lock choice can be integrated across both products, meaning your entire storage solution can operate under one secure locking solution.

Finishes

Pren gives you the scope to create an efficient, multipurpose storage system for your entire workspace. It can be specified in a variety of beautiful laminate finishes to bring warmth and softness to your office, and match seamlessly with your LockerWall installation and brand aesthetic.

MFC finishes

Palette one

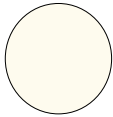

Platinum
White
562
W980 ST7



Light Grey
554
U708 ST9



Sand Beige
899
U156 ST9



Pearl Grey
634
U763 ST9



Graphite
U9



Carbon Grey
635
U968 ST9



Rusty Red
058
U335 ST9

Palette two

*A surcharge may apply, please contact your Bisley representative.



Antique Rose
200
U325 ST9



Stone Green
047
U665 ST9



Dark Brown
059
U818 ST9



Petrol
641
244 SU



Nutmeg
H3

Palette three

*A surcharge may apply, please contact your Bisley representative.



White
Halifax Oak
751
H1176 ST37



Brown
Orleans Oak
061
H1379 ST36



Marone
Casella Oak
062
H1369 ST40



Alpine
W1

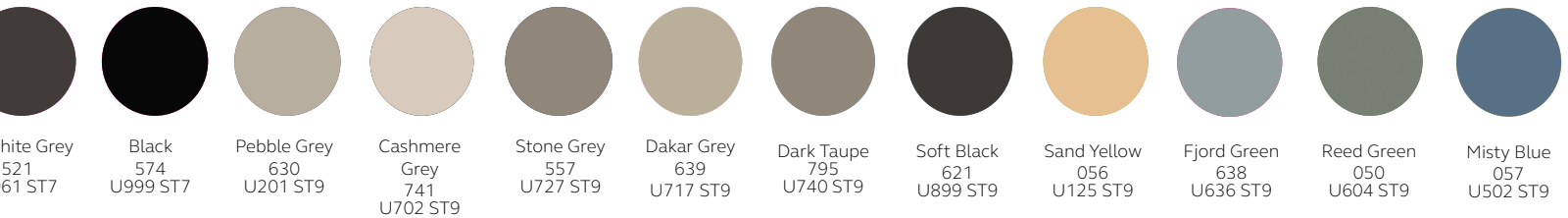

ect sense

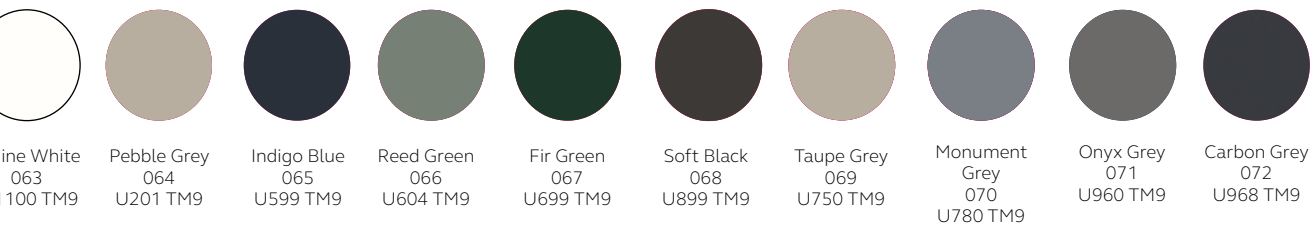

Handle finishes

Choose from 3 wooden handle finishes



Light
847



Medium
807



Dark
808

*Only available on two-door cupboards
and wardrobes.

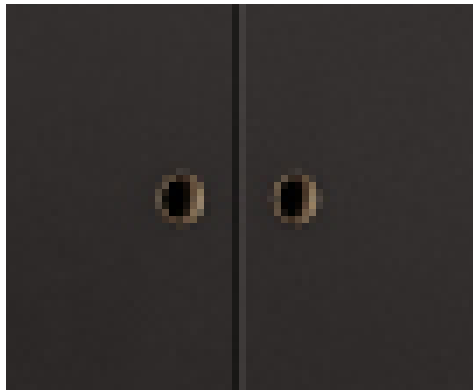

Carcase

Optional finishing accessories
e.g. decorative tops (shown)
or planters. See page 26.

Back Panel

Door and drawer fronts

Our commitments

100%

of wood materials used in manufacturing is FSC and PEFC compliant from sustainably managed sources.





As a proud British manufacturer, we take our responsibilities towards the environment very seriously, ensuring that sustainability runs through everything we do. Our dedicated sustainability team ensures that our facilities are as environmental as possible, while ensuring our products last and are sustainably sourced.

Bisley products are designed for functionality, durability, and a long service life. They are all tested rigorously to British and European harmonised standards for safety, strength and stability.

As for electricity, we source all of the electricity that powers our manufacturing activities through renewable energy tariff. We also participate in the Energy Savings Opportunity Scheme (ESOS), which has led to substantial investment in procurement and installation of energy efficient machinery and equipment.

Visit [bisley.com](https://www.bisley.com) to find out more, or contact your Bisley representative for more information on Pren.

Get in touch
www.bisley.com/get-in-touch

Head Office

Caswell Way,
Reevesland Ind Est,
Newport, South Wales
NP19 4PW

+44 (0)1633 637 383

London

32 Dallington Street,
London,
EC1V 0BB

+44 (0)203 952 4000

Manchester

Calico Building,
55 Mosely Street,
Manchester,
M2 3HQ

+44 (0)161 543 0850

Bray

Bisley House
IDA Bray Business Park,
Southern Cross Road,
Bray,
Co. Wicklow,
Ireland

00353 1 2769100

Dublin

Bridgewater Business
Centre, Bridgewater Quay,
Islandbridge,
D08 T9NH



BISLEY

France

Immeuble le Corosa
1-3 rue Eugène
et Armand Peugeot
92500 Rueil Malmaison

+33 (0)1 41 39 97 20

North America

1140 Broadway
Suite 902, New York
New York
10001

1-212-675-3055

Germany

Hauptsitz und Showroom
Wiesenstraße 70 A3
40549 Düsseldorf

+49 (0)211 87541 600

Dubai

Office 4501
U-Bora Tower
Marasi Drive
Business Bay
Dubai
United Arab Emirates

00971 (4) 450 3747

Netherlands

Burg. Stekelenburgplein
199
Unit 2.4
5041 SC
Tilburg

+31 (0)13 590 10 03

carebisley



Bisley Storage

BISLEY