

# MIKRON

---

**KATALOG**  
rezervnih delova  
2024





Mikron je porodična firma u privatnom vlasništvu, osnovana 1995. godine. Osnivač, Branko Krivokuća, inženjer organizacije rada sa višegodišnjim iskustvom vođen ličnim vrednostima - integritetom, poštenjem, ambicijom i profesionalnošću, pokreće poslovanje u sferi poljoprivredne mehanizacije specijalizovano za kardane.

Danas Mikron, deo kompanije PI Grupe, stoji iza dugogodišnjeg uspešnog rada u oblasti trgovine delovima za poljoprivredne i komunalne mašine, i servisa kardana. Naš cilj je da vrhunskim kvalitetom usluga i proizvoda koje nudimo, omogućimo kontinuirani rast i razvoj poljoprivrednicima, kompanijama, ali i našem društvu kroz posvećenost, čovečnost i efikasnost. Verujemo da svaki mikro segment čini sistem i teđimo da budemo motor razvoja našeg društva i regiona.

## Šta obezbeđujemo poljoprivrednicima?

Dostupnost kvalitetnih proizvoda i rešenja našim kupcima je ono čemu smo posvećeni i da bi obezbedili najraznovrsniju ponudu naš asortiman nudi: delove za priključne mašine, za traktore, kombajne, kardane i delove kardana, delove za komunalne mašine, za mašine za stočarstvo, filtere, motorna ulja i maziva, lance, ležajeve i semeringe, bogat program za svetlosnu signalizaciju, alate, hidrauliku i opremu; a od usluga bi izdvojili jedan od najkvalitetnijih servisa kardana u regionu.

Pratimo trendove i potrebe naših korisnika da bi pravovremeno obezbedili proizvode i usluge za optimizaciju efikasnosti i profitabilnosti, a istovremeno se trudimo da pratimo zahteve za sigurnost, zaštitu zdravlja korisnika naših proizvoda i usluga, kao i za zaštitu životne sredine.

Saradnja sa nama je laka. Profesionalni i stručni pristup naših zaposlenih Vam obezbeđuje kvalitetno iskustvo i naša ambicija za rastom, kako za nas, tako i za naše klijente, obezbeđuje najbolje rezultate.

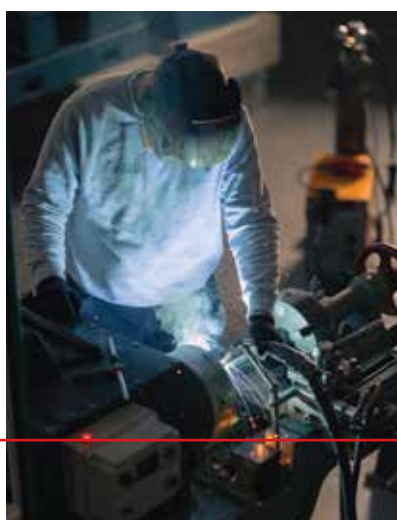

# DELOVI ZA SETVOSPREMAČE



# S OPRUGE

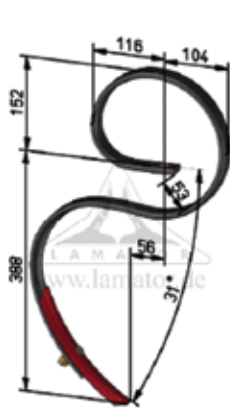

32 x 10 x 560



32 x 12 x 500  
*Doublet Record*

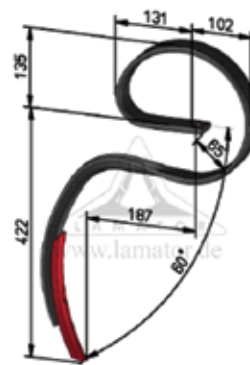

45 x 10  
*Väderstad Agrilla Cobra*

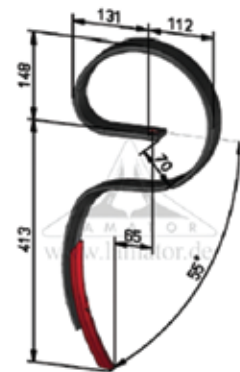

45 x 10 x 500  
*Kverneland KK300500*

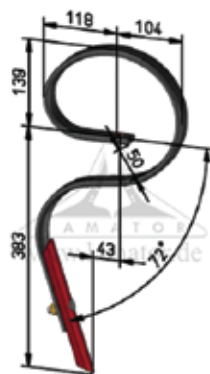

32 x 10  
*EH 380*



32 x 12  
*Kverneland KW111099002 EH 450*

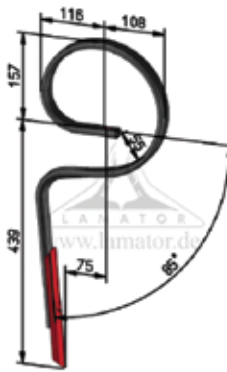

32 x 12 x 525  
*Jack Pot*



45 x 12 x 560  
*Solbjerg*



32 x 12  
*Optiflex*



32 x 10  
*Germinator*

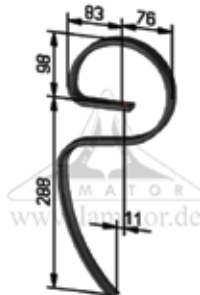

25 x 8 L



25 x 8 GL



40 x 10



32 x 10

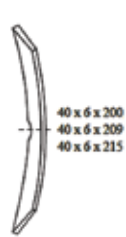

40 x 6 x 200  
40 x 6 x 209  
40 x 6 x 215

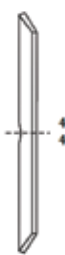

40 x 6 x 135  
40 x 6 x 215

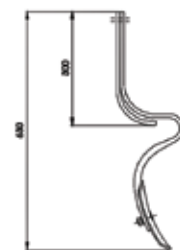

32 x 10

Više na: [www.lamator.de](http://www.lamator.de)

# DELOVI ZA SEJALICE

## Točkovi



## Gume za točkove



## PVC creva za sejalice

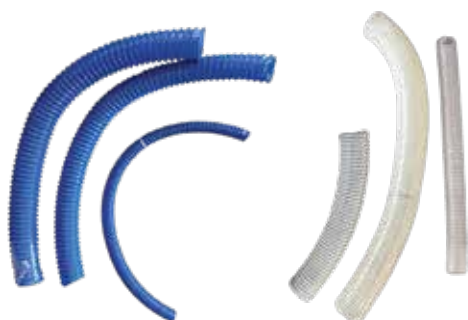

## Raoni ulagači semena



## Diskosni ulagači semena



# DELOVI ZA PRSKALICE I ATOMIZERE



## Injektorske dizne sa jednim mlazom



Arag ASJ tehnologija obezbeđuje smanjenje drifta do 95%

## Injektorske dizne sa dva mlaza



## TurboDrop TD-ADF dizne



## High speed dizne sa keramičkim uloškom



## Dizne sa vrtložnim kupastim mlazom



# DELOVI ZA PRSKALICE I ATOMIZERE



## Fitinzi



## Miks posude za sipanje pesticida



## Filteri



## Hidraulični mešaći za rezervoar protiv penušanja sa bočnim usisom



## Veliki filter



## Nosači dizni



# DELOVI ZA PRSKALICE I ATOMIZERE



## Komandne grupe



## Računari i upravljačke jedinice



## Manometri



## Protokomeri





# DELOVI ZA ŠPARTAČE

**INDUSTRIEHOF**   
SCHERENBOSTEL

## Motike



Širina:

110 mm

150 mm

175 mm

190 mm

240 mm



## FLEDBAG®

Dozator za  
džambo vreće



40°

25°

## S opruge



# INDUSTRIEHOF

## Klinovi za rotodrljače



## Motičice za freze



## Noževi za poljoprivredne i komunalne mašine

**INDUSTRIEHOF**   
SCHERENBÖSTEL



# SILAŽA

Jedan od najvećih problema u proizvodnji silaže je oksidacija bilnog materijala u periodu između kosidbe i formiranja silosa, pri čemu rastvorljivi ugljeni hidrati podležu oksidaciji tj. truljenju. Prisustvo vazduha u silaži omogućava razvoj aerobnih bakterija koje daju podlogu za rast plesni i kvarenje silaže.

Pravilnim načinom skladištenja možemo doprineti unapređenju kvaliteta silaže, a UV stabilna folija otporna na sunčeve zrake je jedna od bitnih stavki kada birate foliju.

## Podfolija

- Podfolija se postavlja prva na silomasu, a direktno ispod silofolije. Ona je 40 mikrona debljine i idealno prijanja na silažu čime smanjuje prodor vazduha do silaže. Pri neznatnim oštećenjima silofolije, podfolija sprečava stvaranje vazdušnih komora i time pruža dodatnu zaštitu. Upotreba ove folije je jednokratna.

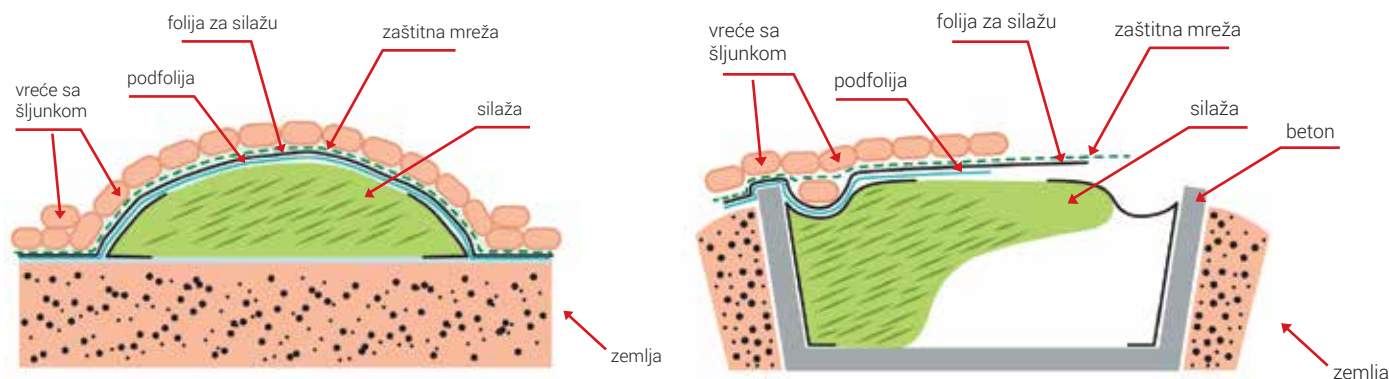

## Silofolija

- Preko podfolije se celom dužinom i širinom silosa postavlja gornja UV silofolija. Silofolija je crno-bele boje i prilikom postavljanja treba obratiti pažnju da bela boja bude okrenuta ka nebu. Ona je 150 mikrona debljine, UV je stabilna, ima zadatak da spreči prodiranje atmosfere vode u silažu i da zaštiti podfoliju od oštećenja.

Kupcima su na raspolaganju silo- i podfolije širine od 6 m do 20 m, a sve rolne su dužine 50 m. Maksimalni rok eksploatacije je do 3 godine nakon toga postepeno gubi svojstvo UV stabilnosti. Njen rok eksploatacije takođe zavisi od načina manipulacije i skladištenja. Nakon njene upotrebe za pokrivanje se može koristiti kao bočna folija.

**rkw** WHEN EXCELLENCE MATTERS



### ✓ PREDNOSTI PROIZVODA:

- *Optimalni rezultati silaže*
- *UV stabilnost*
- *Otpornost na vremenske uslove*

# SILAŽA

Način skladištenja silaže je veoma važan, imajući u vidu da kvalitet silaže direktno utiče na zdravlje preživara, na količinu i kvalitet mleka. Stručnjaci savetuju da se pridržavamo sledećeg postupka pokrivanja silažne mase u cilju smanjenja rizika od kvarenja dela silaže.

- 1 Pre početka punjenja silosa, preko betonskih zidova postaviti bočnu foliju debljine 0,15 mm da bi se zaštitio zid od kiseline koja nastaje u toku fermentacije. Produžiti prekrivanje po podu, folija treba da leži na podu silosa dužinom 0,5 m i treba da je viša od zida silosa od 0,5 m do 1 m. Za ovu radnju se koristi obična providna folija.
- 2 Nakon gaženja silaže, bočnu foliju koja je iznad betonskog zida, odnosno iznad silaže, treba presaviti na siliranu masu.
- 3 Na silo masu po celoj širini i dužini postaviti podfoliju.
- 4 Na podfoliju direktno postaviti silofoliju po celoj širini i dužini.
- 5 Na silofoliju postaviti silo zaštitnu mrežu i džakove.

Cilj u postupku pravilne pripreme silaže je hraniti stoku ispravnom i zdravom silažom tokom cele godine.

## Silo zaštitne mreže i džakovi

- Moderna tehnika tkanja i stroge kontrole u proizvodnji naših dobavljača obezbeđuju ravnomerno tkanje, maksimalnu UV stabilnost i veliku čvrstinu silo zaštitnih mreža i džakova. Ovi proizvodi se takođe izdvajaju po ekstremno dugom veku trajanja. Silo zaštitne mreže i džakovi se prave od najkvalitetnijih i najpostojanijih sirovina. Rok trajanja džaka je 10 godina, 5 godina je okrenut na jednu stranu (linija na džaku okrenuta ka nebu), a drugih 5 godina je okrenut na drugu stranu.



### ✓ PREDNOSTI PROIZVODA:

- *Potpuna zaštita od ptica, sitnih životinja i grada*
- *Pokrivanje bez gume i peska čime se izbegava zadržavanje vode i komaraca i kidanje folije prilikom skidanja peska*
- *Veoma otporne na cepanje i gaženje*

## Tuneli za silažu

RKW je razvio e7 novu tehnologiju koja savršeno odgovara savremenim potrebama skladištenja u stočarstvu. RKW tuneli obezbeđuju kvalitetnu silažu i bolju konzervaciju semena, održavaju visoku nutritivnu vrednost i smanjuju gubitak koji može nastati tokom procesa oksidacije i fermentacije.

### ✓ **BITNE KARAKTERISTIKE PROIZVODA:**

- TUNEL ZA SILAŽU 2,0x60m; 200μ; 6.5ft
- TUNEL ZA SILAŽU 2,4x60m; 212μ; 8ft
- TUNEL ZA SILAŽU 2,4x75m; 212μ; 8ft
- TUNEL ZA SILAŽU 2,7x60m; 230μ; 9ft
- TUNEL ZA SILAŽU 2,7x75m; 230μ; 9ft
- TUNEL ZA SILAŽU 3,0x75m; 230μ; 10ft



**rkw** WHEN EXCELLENCE MATTERS

## Veživa i mreže za baliranje

Dobar odabir kvalitetnih veživa i mreža za baliranje može uticati na ostvarivanje većih ušteda. Čvrsta veživa i mreže pomažu u sprečavanju rasipanja i olakšavaju manipulaciju bala prilikom transporta i skladištenja. Mreže dodatni štite od spoljašnjih faktora, kao što su kiša, sunčeva svetlost i vetar i pomažu u održavanju oblika bala.

### ✓ **PREDNOSTI PROIZVODA:**

- UV stabilnost
- Sastav 100% polipropilen
- Konstantna debljina
- Izuzetna čvrstoća
- Minimalno habanje delova prese
- Specijalna tehnika namotavanja mreže na rolnu koja sprečava paranje



Dimenzije veživa:	Dimenzije mreža:
Veživo tip 130	Mreža 123 cm x 2000 m
Veživo tip 130 MASTER	Mreža 123 cm x 3000 m
Veživo tip 130 EXTREM	Mreža 125 cm x 2000 m
Veživo tip 400	Mreža 125 cm x 3000 m
Veživo tip 500	Mreža 130 cm x 3000 m
Veživo tip 750	Mreža 125 cm x 3600 m

**JUTA**

## Folije za umotavanje bala

Poljoprivrednici se u više od 50 zemalja oslanjaju na brend Triowrap, svetskog lidera na tržištu folija za umotavanje.

### ✓ BITNE KARAKTERISTIKE PROIZVODA:

- Održavaju konstantan kvalitet pod ekstremnim uslovima poput visokih temperatura, vlažnosti i vetrovitih i prašnjavih sredina
- Odlična rastegljivost i elastičnost, kao i znatno veća otpornost na probijanje u odnosu na standardne folije, za hermetički zatvorene bale sa trajnom zaštitom
- Prilikom rada folija može da se istegne do 70% od svoje početne dužine, što omogućava veći broj umotanih bala po rolni i satu
- Mogu se koristiti na svim tipovima mašina za omotavanje
- Visoka UV zaštita tokom 12 meseci
- Sedmoslojna folija čiji prvi sloj omogućava izvanredno prijanjanje, poslednji sloj smanjuje trenje a međuslojevi obezbeđuju snagu, rastegljivost, UV stabilnost i otpornost na mehanička opterećenja



Trioworld

### Glavne funkcionalnosti višeslojne folije



## Zaštitne pokrivke za seno i slamu

Zaštitne pokrivke pouzdano štite bale od uticaja sunca i kiše i obezbeđuju efikasno provetravanje bala. Sprečavaju da se vlaga kondenzuje ispod površine pokrivke i samim tim se sprečava pojava buđi. Pokrivke omogućuju da se sačuva visok kvalitet slame od obimnih padavina tokom godine.

### ✓ BITNE KARAKTERISTIKE PROIZVODA:

- Propustljivi za vazduh i isparenja (sprečavaju stvaranje buđi)
- Omogućavaju slivanje vode niz kamaru (nagib >45°)
- Visoka zatezna čvrstoća i otpornost na cepanje (izdržavaju jake vetrove)
- Postojana UV zaštita (životni vek najmanje 3 godine)



TENCATE

# PRAVILAN POSTUPAK POKRIVANJA BALA

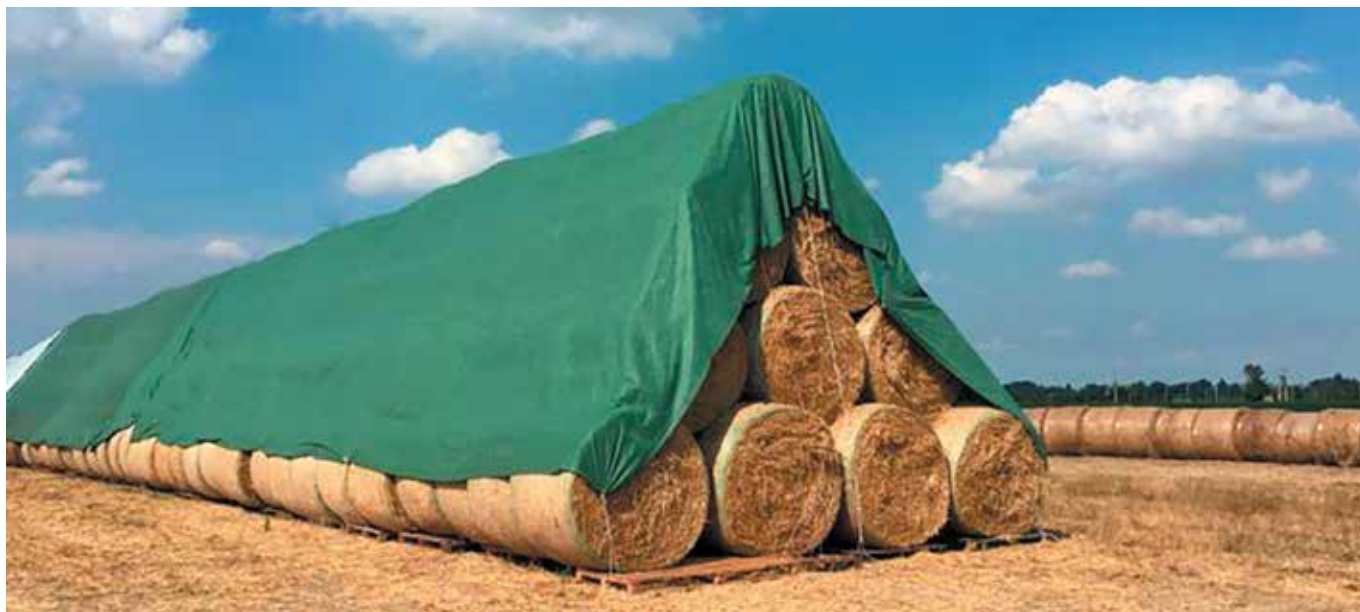

- 1 Okrenite kamaru i pokrivku duž glavnog pravca duvanja vetra

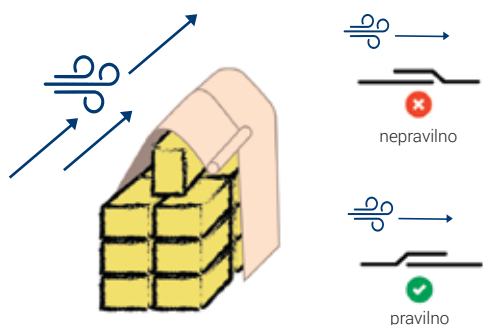

- 2 Pokrivanje kamare izvršiti tako da se na vrhu ostvari minimalan nagib od 45° (što veći nagib to bolje), kako bi se omogućilo što bolje slivanje vode sa površine pokrivke. Pokrivku treba dobro zategnuti da se dobije efekat krova.

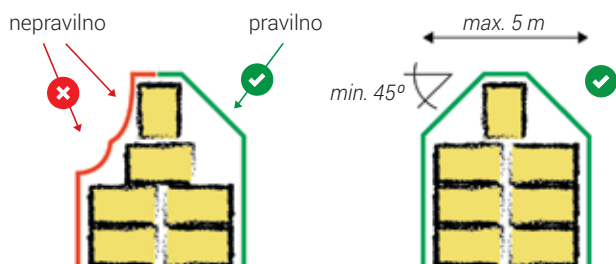

\*Ugao nagiba min 45°, maksimalana širina stoga 5 m ili 2 kvadratne bale.

- 3 Zatezanje pokrivke treba izvršiti ručno. Obezbeđivanje zategnutosti pokrivke izvršiti čičak trakama na koje se kači teret do 5 kg.
- 4 Paziti na pravac postavljanja spojeva. Spojevi treba da budu postavljeni uspravno na osu kamare ili duž vrha „krova”. Ukoliko se spojevi postavje u pravcu kamare, voda bi mogla da se nakupi i prodre u slamu.



**TENCATE**

**Dimenzije za pokrivke:**

Pokrivka 9,8 m x 25 m

Pokrivka 9,8 m x 12,5 m

Pokrivka 12 m x 25 m

Pokrivka 15,6 m x 25 m

# DELOVI ZA MAŠINE U STOČARSTVU

## Noževi za silo kombajne



## Noževi za rotacione kosačice



## Noževi za miks prikolice



## Šiljci i čaure za utovarivače bala



## Kardani



Kardani za miks prikolice i prese



Kardani za rotacione kosačice



Kardani za telehendere

## Lanci za prese i podmazivanje



## Delovi za prikolice za rasturanje stajnjaka

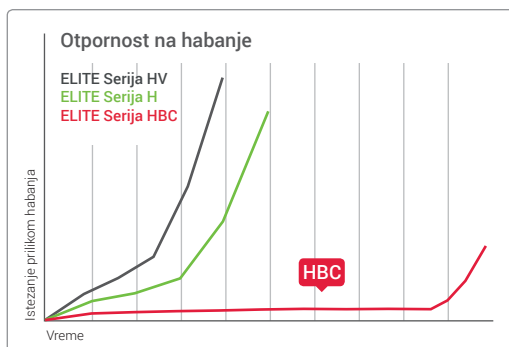



# DELOVI ZA KOMBAJNE



SCHUMACHER.plus  
HARVESTING SOLUTION PARTNER

## Noževi za kose



## Sekcione kose

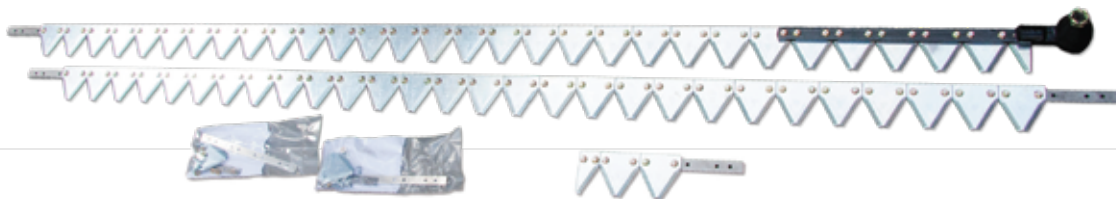

## Glave kose



## Opruge vitla



## Vođice pikap prsta, pritiskači i podloške



## Pikap prsti



## Dupli prsti



## Podizači polegla mase



# DELOVI ZA KOMBAJNE



SCHUMACHER.plus  
HARVESTING SOLUTION PARTNER

## Letve bubnja



## Drveni ležajevi



## Ležajevi



## Lančanci uvlačnog grla, elevatora



## Silen blokovi



## Letve uvlačnog grla



## Noževi sečke i čaure



# DELOVI ZA KUKURUZNE ADAPTERE



Specijalno nanesen  
sloj volfram karbida

# LANCI ZA POLJOPRIVREDNE MAŠINE

**iwis**  
antriebssysteme  
wir bewegen die welt

**100**  
*godina*  
**ISKUSTVA**

Kompanija IWIS osnovana 1916. godine u Minhenu, predstavlja savršen spoj tradicije i iskustva. Stogodišnje iskustvo u kombinaciji sa najsavremenijim tehnologijama za izradu lanaca, omogućuju kompaniji IWIS da tržištu ponudi vrhunski kvalitet lanaca koji može odgovoriti izazovima i u najtežim uslovima rada, kao što poljoprivreda i zahteva.

Kao rezultat kvaliteta, lanci firme IWIS se nalaze u prvoj ugradnji kod mnogih proizvođača poljoprivredne mehanizacije kao što su: CNH (Case, New Holland, Steyr), Class, John Deere, Capello, Geringhoff i dr.



# DELOVI ZA TANJIRAČE



Profil tvrdoće:

- od 48 do 50 HRC
- od 50 do 55 HRC
- od 55 do 558HRC



Prečnik:	Osovina:	Profil:
ø660	41 x 41	Glatki
ø660	41 x 41	Nazubljeni
ø610	41 x 41	Glatki
ø610	41 x 41	Nazubljeni
ø560	41 x 41	Glatki
ø560	41 x 41	Nazubljeni
ø560	36 x 36	Glatki
ø560	36 x 36	Nazubljeni



AMAZONE Catros



LEMKEN Rubin



HORSCH Joker, Pronto



VADERSTAD Carrier



TUPANJAC Tanjirača



NIAUX 200



Komplet kučište



Čistač diska



Nosaač diska



Kučište



Osovina sa krajevima



Ležajna jedinica FKL

# LEŽAJEVI

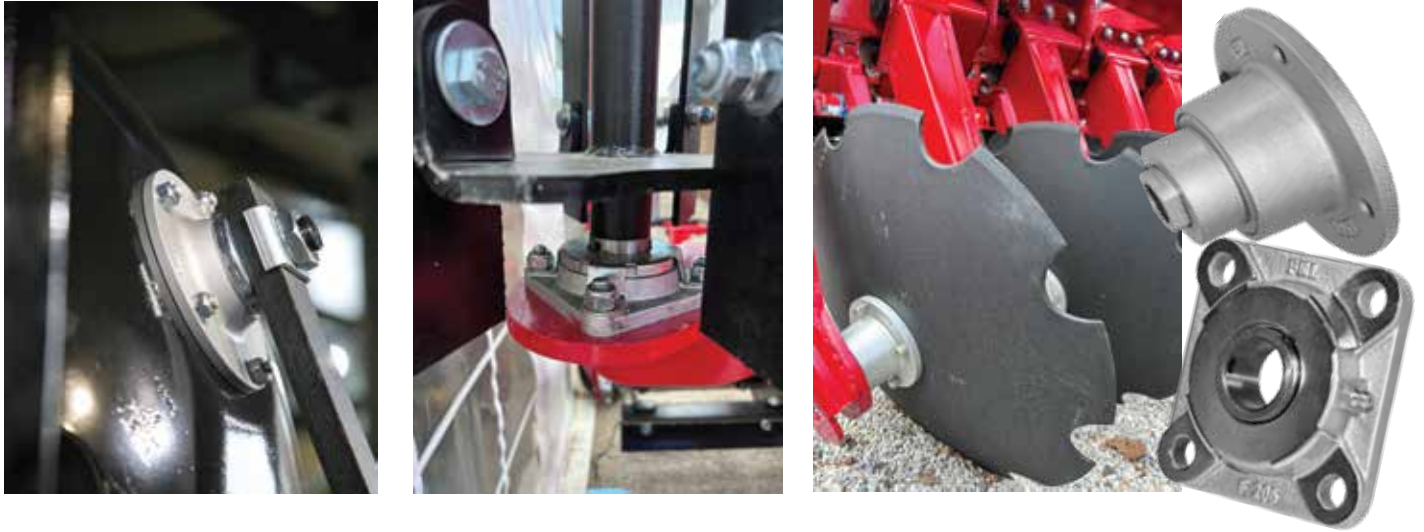

Nudeći širok spektar FKL ležajnih jedinica prilagođenih za ugradnju u tanjiračama, drljačama, kombajnama, sejalicama, balirkama i drugim poljoprivrednim mašinama, kao i za prvu ugradnju na domaćim priključnim mašinama, Mikron već decenijama predstavlja pouzdanog partnera za poljoprivrednike i proizvođače priključnih mašina

Kvalitet ležaja zavisi od kvaliteta svih njegovih delova, ali mislimo da je za procese u poljoprivredi koji se odvijaju uglavnom uz prisustvo prašine, blata i raznih mehaničkih nečistoća najvažniji deo jednog ležaja kvalitet zaptivke koja sprečava ulazak prašine u unutrašnjost ležaja i sprečava da se kuglice i prstenovi brzo pohabaju. Zato FKL sve svoje ležajeve proizvodi sa minimalno 2F zaptivkom koja se sastoji od zaštitnog lima i jednousne zaptivke. Ovakva zaptivka obezbeđuje duplo veću zaštitu od standardne 2S zaptivke koja se sastoji samo od lima sa 1 gumenom zaptivkom.

FKL je jedini evropski proizvođač ležajeva koji svoju Y seriju podesivih ležajnih jedinica proizvodi u Evropi i zadržao je visok kvalitet izrade.

Iz izbora zaptivki, Mikron preporučuje korišćenje ležajeva sa trousnom zaptivkom 2T, jer ovakvi ležajevi dolaze na svim novim Zapadnim kombajnama. Razlika u zaptivkama nije vidljiva na prvi pogled okom ali se razlikuju oznake ležajeva:

## LES 205-100 2F.X

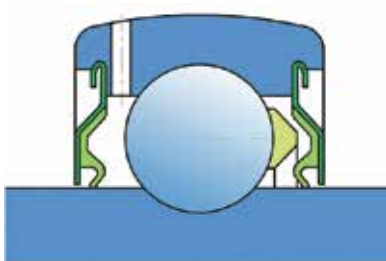

Zaptivka 2S

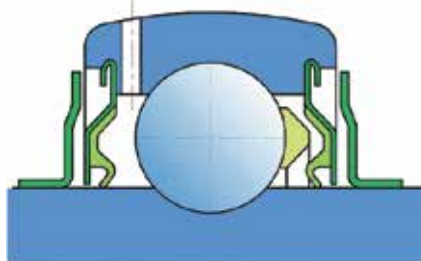

Zaptivka 2F

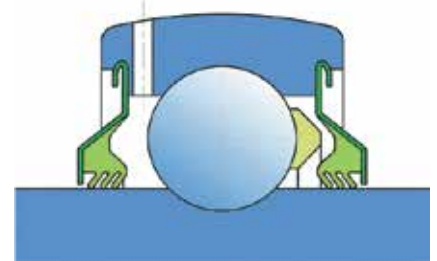

Zaptivka 2T

# LEŽAJEVI

## ARMOR serija (LEFG XXX TDT)

- Specijalno kućište od nodularnog liva, sa 3 puta većom zateznom čvrstoćom, zaštićena mazalica i specijalna kasetna zaptivka. Odličan za sve vrste rotara na priključnim mašinama. Namenjen za najteže uslove rada.



LEFG

## Specijalni ležajevi sa limenom zaštitom

- Serija napravljena za zemljišta sa tvrdom zemljom, ili primesama kamena. Limena zaštita sprečava oštećivanje zaptivke samog ležaja u koliko ležaj nije sakriven unutar rotora. Specijalno dizajnirana trousna zaptivka osigurava da prašina neće prodrti u unutrašnjost ležaja.

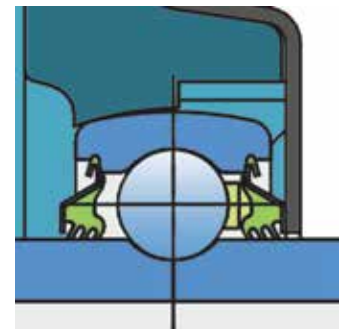

## Specijalne izvedbe

- Ležajevi koji su napravljeni po uzorku na različite OEM proizvođače i mogu se modifikovati po ugradbenim merama i kvalitetu.



LSGR 205 FS  
Lemken Kompaktor



LSGR 207 TBS  
Lemken Kompaktor,  
Smaragd, Rubin



LESQFS 212 TDT.H  
Horsch Terrano



## Specijalne izvedbe



LSQFR 308 2TD.H.T  
Amazone Catros



Tupanjac Drljače



ZGKU 309 2S Gapsardo



## Ležajevi za sejalice



## TESTIRANO NA VAŠIM MAŠINAMA

Pored različitih specijalnih izvedbi ležajnih jedinica, u FKL programu se nalazi i proizvodni program jednorednih kugličnih ležajeva serije 6. Za ležajeve koji nisu u proizvodnom programu FKL-a, Mikron vam nudi FAG, SNR, Timken i druge svetske poznate brendove.



# DELOVI ZA PLUGOVE



# DELOVI ZA PLUGOVE



# DELOVI ZA PLUGOVE



# DELOVI ZA PLUGOVE



# DELOVI ZA PLUGOVE

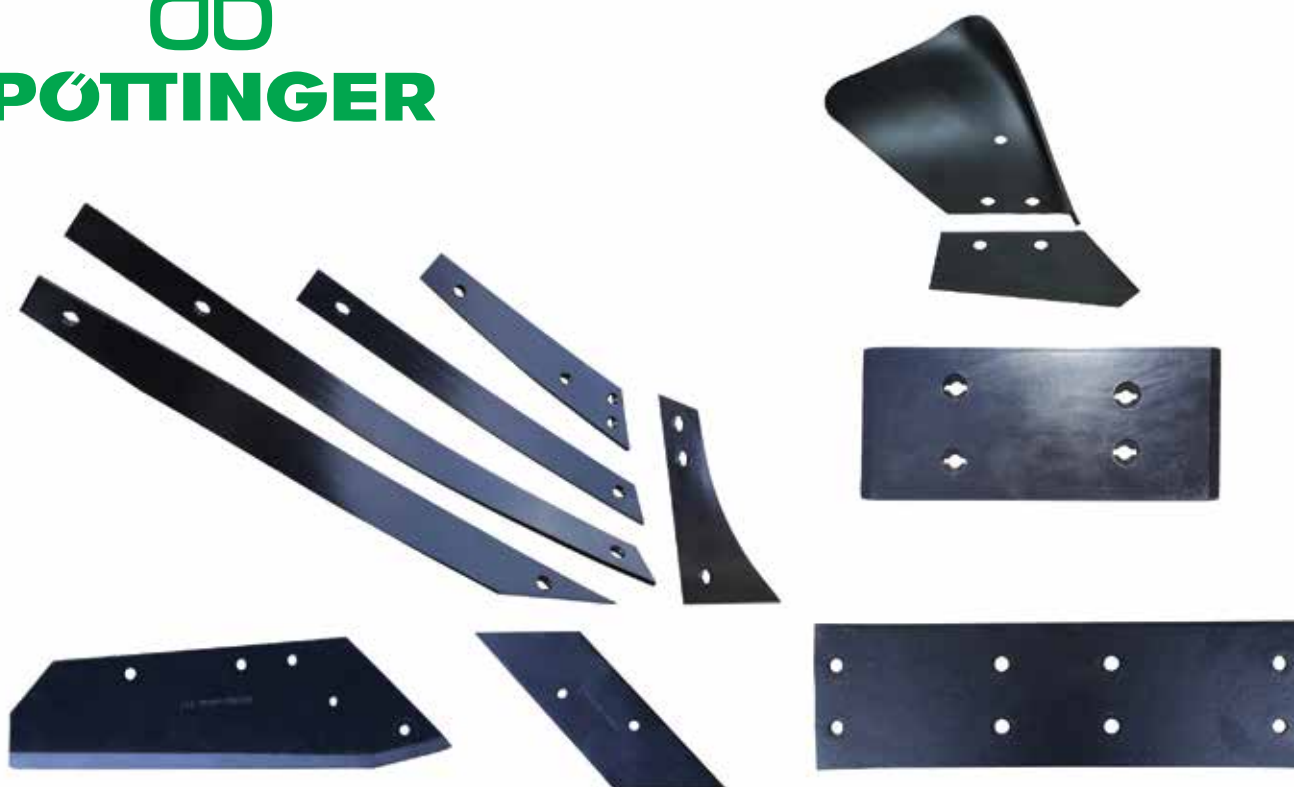
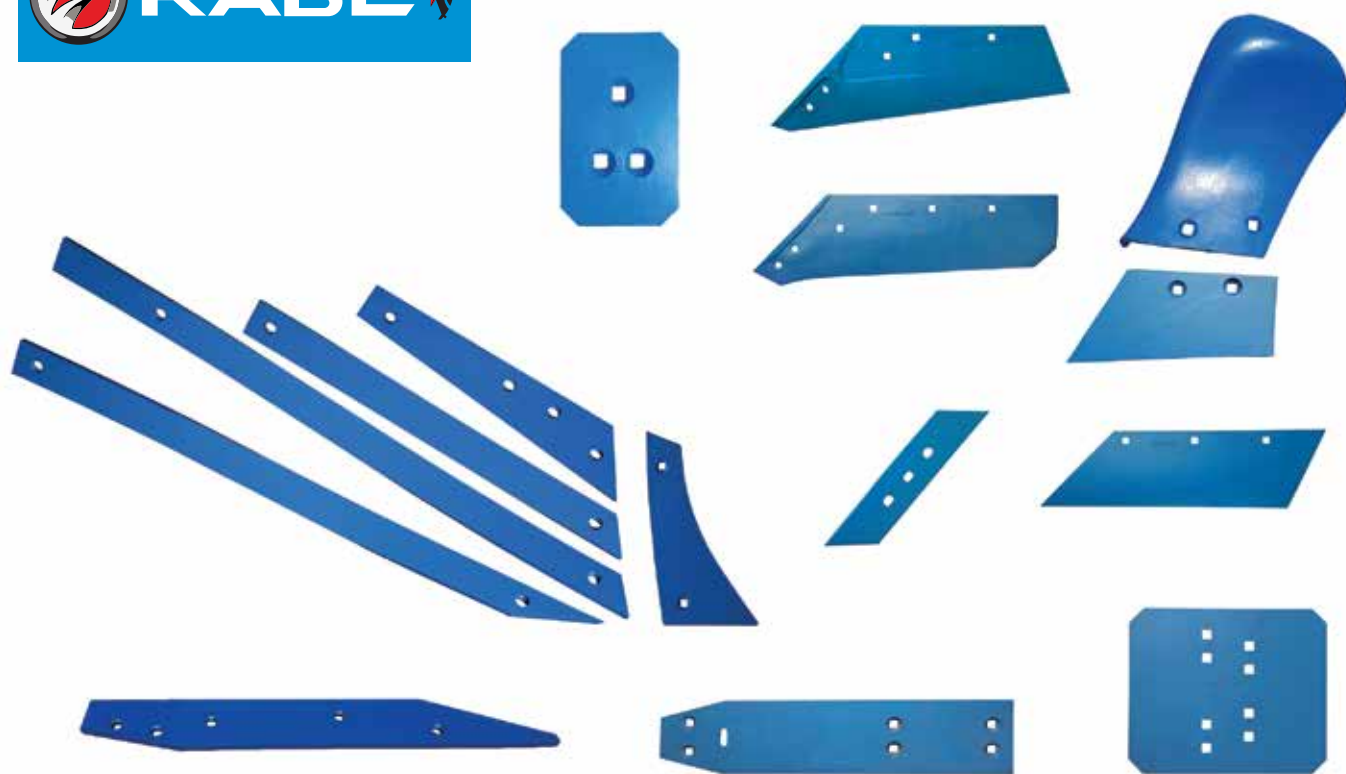

# DELOVI ZA GRUBERE

 **LEMKEN**

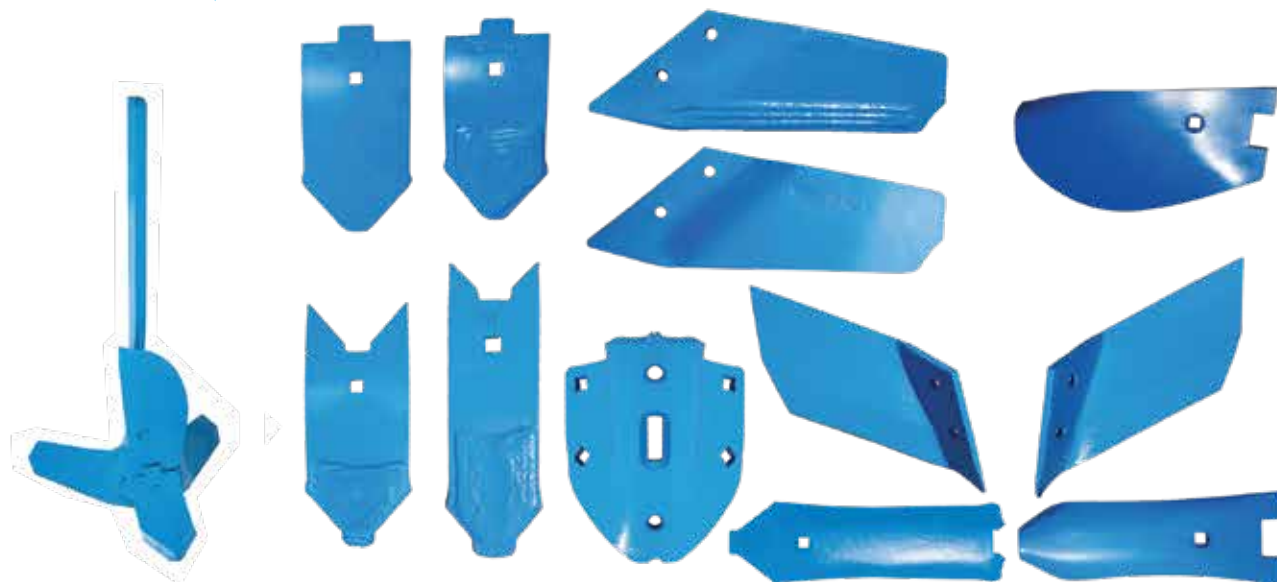

**HORSCH**



 **AMAZONE**



# AUTOMATSKO KAČENJE PRIKLJUČNIH MAŠINA

**WALTERSCHEID**



Odgovara za BELARUS  
820.2 920.2 952.3 1025.3



## Kugle za donje poluge

	katgorija	katgorija	D	d	d1	
	traktora	mašine				
<b>Kugla FANGPROFIL</b>	2	2	44	22.4	12	305 209
	2	2	56	28.7	12	099 032
	3	2	64	28.7	12	099 035
	3	3	64	37.3	12	099 034
	3	3	64	37.3	17	099 033
<b>Reducir otvora za fangprofil</b>			D	d	a	
	2	1/2	28	22.4	63	082 651
	3	2/3	37	28.7	62	305 281
<b>Kugla KHU</b>	1	1	44	22.4	35	305 051
	2	2	56	28.7	45	308 800
	3	2	64	28.7	45	309 246
	3	3	64	37.3	45	308 801
	3	3	64	37.3	45	202 332*
	4	3	85	37.3	57	200 049
	4	4	85	51.0	57	306 330
<b>Reducir otvora za KHU-RHU</b>			D	d	a	
	2	1/2	28	22.4	45	305 279
	3	2/3	37	28.7	45	305 280



## Kugle za toplink

		2	D=50 d=25.4 B=51	099042	
		3-2	D=60 d=25.4 B=51	099044	
		3	D=60 d=32 B=51	099043	
		3	D=60 d=32 B=51	202484 tvrda	
	<b>Redukcija otvora RHO</b>	2-1	D= 25 d=19.4 L=44	082649	
		3-2	D=32 d=25.7 L=51	305278	
		3-2	Clinch on	083269	

# POTEZNICE

WALTERSCHEID



SAUERMAN

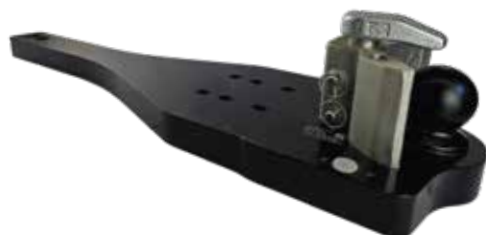



# HIDRAULIČNE BRZE SPOJKE

**manuli**<sup>®</sup>  
HYDRAULICS



**KENNFIXX**<sup>®</sup>



**MIKRON**

# AMORTIZERI

## STABILUS

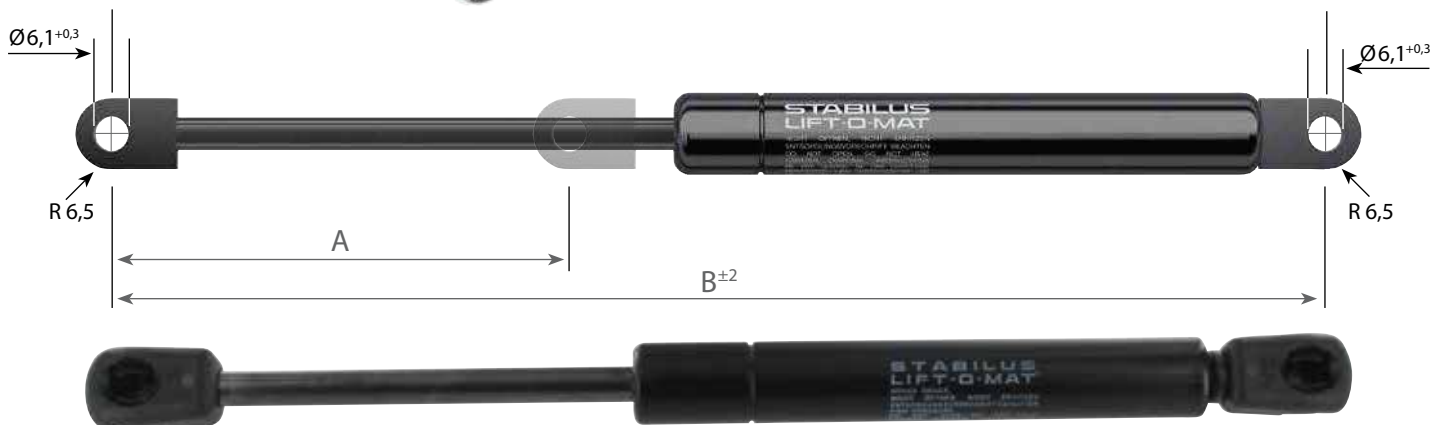

# FILTERI

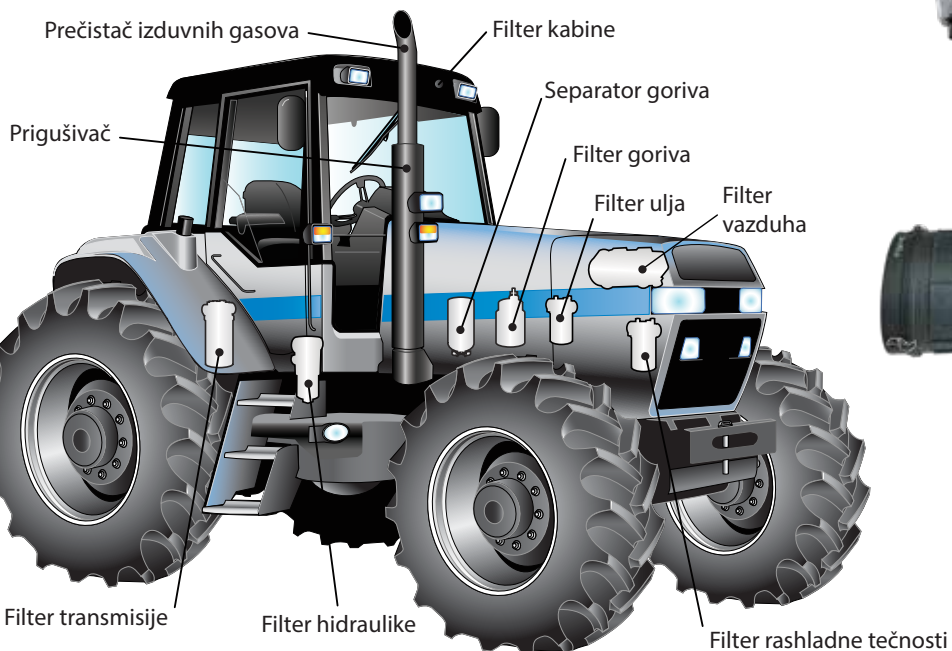

Više na: [www.donaldson.com](http://www.donaldson.com)



# UREĐAJI ZA TOČENJE I PODMAZIVANJE



SEPAR  
FILTER

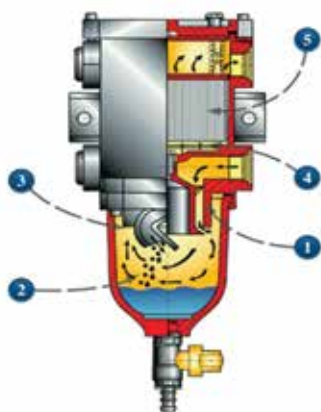

Pneumatsko crevo



Merači protoka



Separator za vodu



Kolica

Ručna mazalica

Pumpa za gorivo



Istakalica za ulje



AdBlue

# SVETLOSNA SIGNALIZACIJA ZA POLJOPRIVREDNE MAŠINE

## Rotaciona svetla



Led rotacija



Halogena rotacija



Led rotacija



Led rotacija



Led rotacija

## Radna svetla



Led radno svetlo



Led svetla za prskalice



Led radno svetlo



Led radno svetlo



Led radno svetlo



Led radno svetlo



Led radno svetlo



Led radno svetlo



Led radno svetlo



Halogen uložak za far



Led radno svetlo



Led rol bar

# SVETLOSNA SIGNALIZACIJA ZA POLJOPRIVREDNE MAŠINE

## Bežični magnetni set



## Utičnice



## Prekidači



## Uređaji za obeležavanje mašine



Led stop svetlo



Halogen svetlo



Led stop svetlo



Led stop svetlo



Led stop svetlo



Led stop svetlo

# SERVIS KARDANA

Servis poljoprivrednih kardanskih vratila je osnovna delatnost našeg servisa. Imajući u vidu činjenicu da do kvarova i lomova dolazi onda kada su mašine najuposlenije i da je od velike važnosti u što kraćem roku mašinu vratiti u pogon, naši stručnjaci u servisu popravci pristupaju odmah po detektovanju kvara i isporučuju popravljen kardan u najkraćem mogućem roku.

Firma Mikron više od 20 godina distribuira proizvode kompanije Walterscheid, rešenje svetskog lidera u proizvodnji kardanskih vratila. Različite izvedbe kardana ovog proizvođača nezamenljive su na mestima sa ekstremnim

opterećenjima i uslovima eksploatacije. Ukoliko kardan treba popraviti ili prilagoditi Vašoj novoj mašini, u Mikronu možete pronaći najširi asortiman kompletnih kardanskih vratila i njihovih delova.

Mikronov servis je specijalizovan za remont oštećenih i pohabanih kardana, kao i za proizvodnju novih. U ponudi su kardani svetski poznatih imena. Pored Walterscheid-a tu su Benzi i Di Terlizzi.



## Pružamo usluge remonta jednodelnih i višedelnih kardana za:

- Program komercijalnih vozila
- Program građevinskih pogonskih mašina
- Program poljoprivrednih pogonskih mašina



## Proces servisiranja

### 1 Potrebne informacije:

Prilikom predaje kardana servisu treba obezbediti sledeće podatke:

- marka, model i godište vozila sa kog je kardan skinut
- problemi koji se javljaju tokom rada mašine

### 2 Defektaža

Na osnovu predatih podataka serviser:

- tačno definiše vrstu kardana
- vrši defektažu kardana
- priprema ponudu za remont kardana

### 3 Remont kardana

U zavisnosti od rezultata defektaže vrši se:

- zamena krstaka
- zamena klznog sklopa
- zamena pribubnica
- zamena centralnih ležajeva
- zamena oštećenih cevi
- balansiranje - na zahtev se štampa izveštaj o balansiranju
- farbanje



# SERVIS KARDANA



Kardansko vratilo se koristi u industriji, na vozilima i u svim vrstama pogona, gde je potreban prenos snage i obrtnog momenta između dve osovine koje nisu saosne. Delovi kardana su precizne izrade, proizvedeni po strogim DIN i SAE standardima, i moraju biti redovno održavani, kako bi svoju funkciju vršili bez prekida i na način propisan od proizvođača.

Kardani koji se okreću obrtajima većim od 1000 o/min. moraju biti balansirani zbog velikih inercijalnih sila. Delovi koji su istrošeni ili oštećeni, zahtevaju zamenu i pravovremeno servisiranje.

## Program komercijalnih vozila



IVECO



SCANIA



# SERVIS KARDANA

## Program građevinskih pogonskih mašina



Za servis i proizvodnju kardana građevinskih pogonskih mašina koristimo kvalitetne i sigurne zamenske i originalne proizvode za brendove kao što su CAT, DOOSAN, JCB, Komatsu, Volvo i drugi.



## Program poljoprivrednih pogonskih mašina

Za servis i proizvodnju kardana poljoprivrednih pogonskih mašina koristimo renomirane zamenske i originalne proizvode za proizvođače mašina kao što su Claas, Fendt, John Deere, Manitou i drugi.



# KARDANI I DELOVI KARDANA

**WALTERSCHEID**

## SERIJA W-P-E

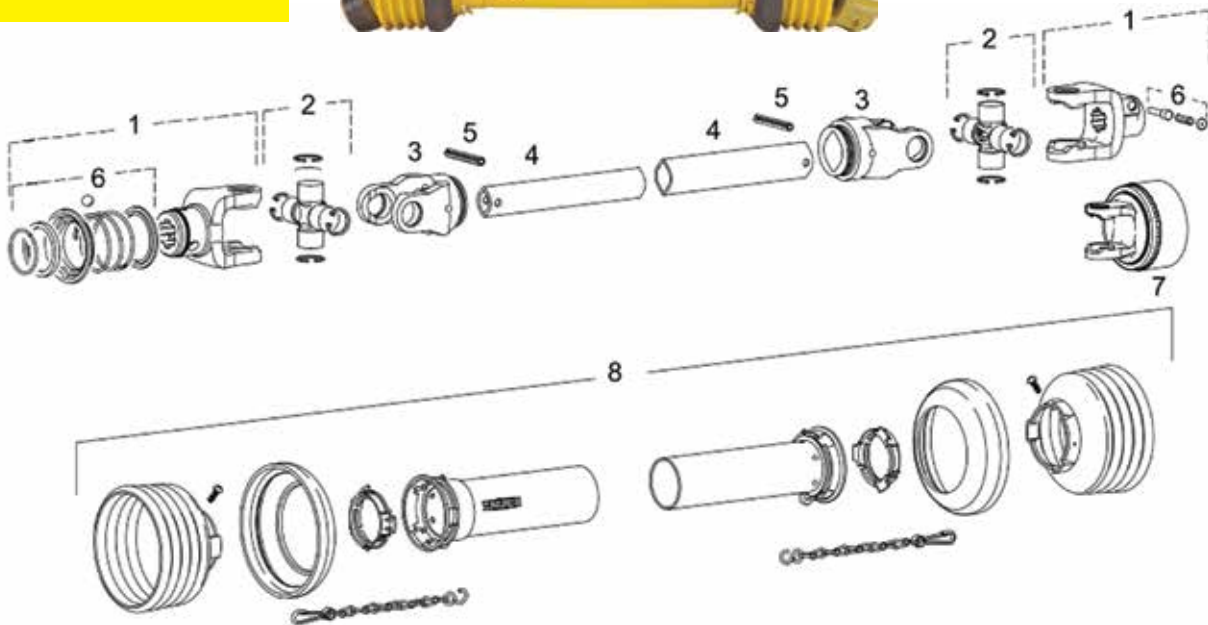

## SERIJE WWE - WWZ

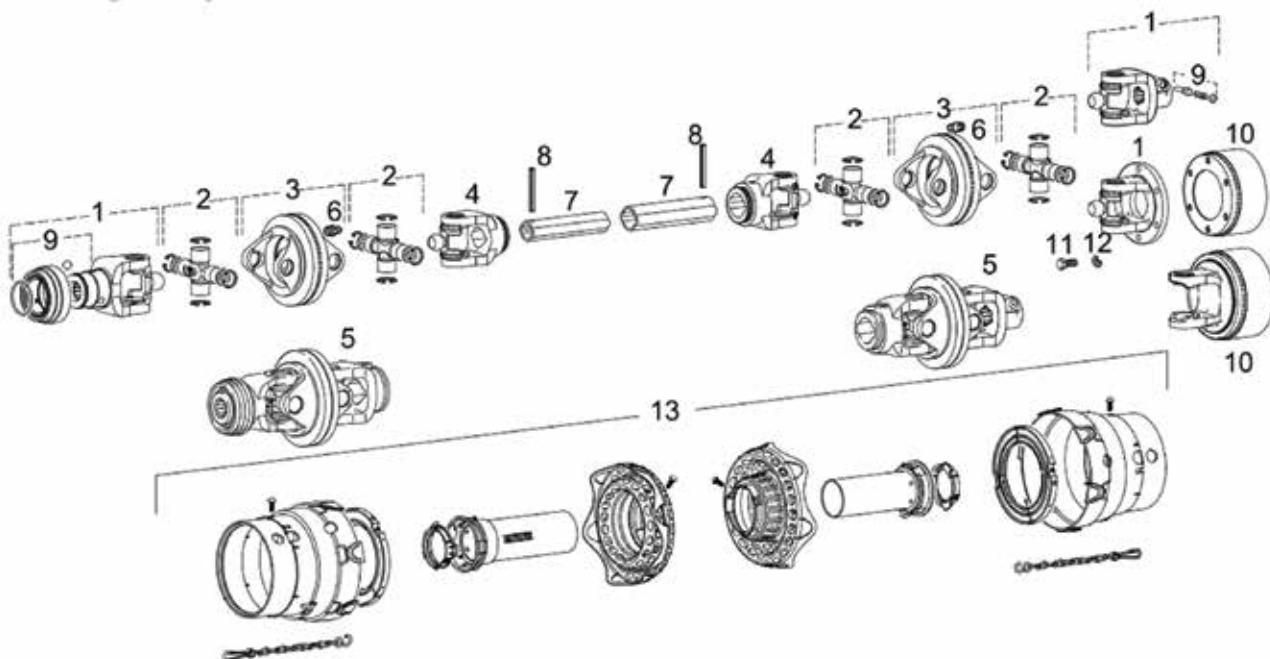

Više na: [www.walterscheid.com](http://www.walterscheid.com)

# KARDANI I DELOVI KARDANA

**WALTERSCHEID**



2100					
2200					
2300					
2400					
2500					
2600					
2700					
2280					
2380					
P480					
2480					
P580					
2580					



# KARDANI I DELOVI KARDANA

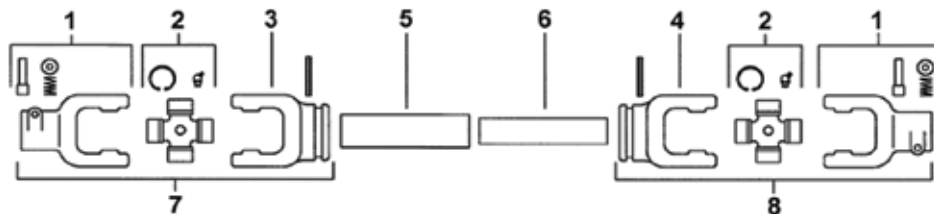

## Seriya L

		1	2	3	4	* 5	* 6	7	8
		1.3/8"-6				A B S	A B S		
L 01		010110	020140	50120L	50130L	30 X 39 X 2,8	23,5 X 31 X 3,6	70120L	70130L
L 13		010110	020140	51320L	51330L	41 X 48 X 3	34,5 X 40 X 4	71320L	71330L
L 02		010210	020240	50220L	50230L	30 X 39 X 2,8	23,5 X 31 X 3,6	70220L	70230L
L 23		010210	020240	52320L	52330L	41 X 48 X 3	34,5 X 40 X 4	72320L	72330L
L 04		010410	020440	50420L	50430L	41 X 48 X 3	34,5 X 40 X 4	70420L	70430L
L 46		010410	020440	54620L	54630L	48 X 57,5 X 4	39,5 X 49 X 4,5	74620L	74630L
L 05		010510	020540	50520L	50530L	48 X 57,5 X 4	39,5 X 49 X 4,5	70520L	70530L
L 67		016710	026740	56720L	56730L	48 X 57,5 X 4	39,5 X 49 X 4,5	76720L	76730L

## Seriya T

		1	2	3	4	** 5	** 6	7	8
		1.3/8"-6				A B S	A B S		
T 05		010510	020540	50520T	50530T	61 X 47 X 4,5	51 X 37 -	70520T	70530T
T 67		016710	026740	56720T	56730T	61 X 47 X 4,5	51 X 37 -	76720T	76730T
T 89		010910	020940	58920T	58930T	61 X 47 X 4,5	51 X 37 -	78920T	78930T
T 09		010910	020940	50920T	50930T	71,5 X 57,5 X 5	61 X 47 X 4,5	70920T	70930T

Više na: [www.benzi.it](http://www.benzi.it)

# KARDANI I DELOVI KARDANA

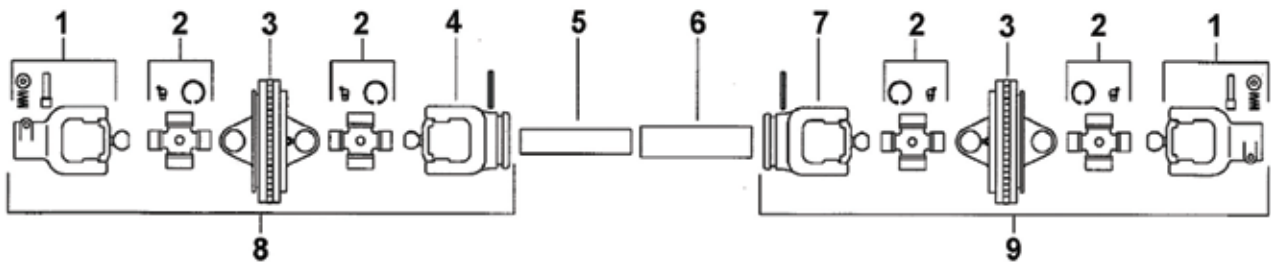

	A B C D				1	2	3	4	* 5			** 6			7	8	9
	A	B	C	D					A	B	S	A	B	S			
<b>W 23</b>					1.3/8"-6					34,5 X 40 X 4	41 X 48 X 3						
<b>W 27</b>	23,8	61,3	22	80	012310W	022340W	502W	52330W	60230L....FR	60220L3	52320W	72330W	72320W				
<b>W 40</b>									34,5 X 40 X 4	41 X 48 X 3							
<b>W 42</b>	27	74,6	23,8	95	010410W	020440W	504W	50430W	60230L....FR	60220L3	50420W	70430W	70420W				
<b>W 46</b>									39,5 X 49 X 4,5	48 X 57,5 X 4							
<b>W 48</b>	27	74,6	23,8	95	010410W	020440W	504W	54630W	60430L....FR	60320L3	54620W	74630W	74620W				
<b>W 50</b>									39,5 X 49 X 4,5	48 X 57,5 X 4							
<b>W 52</b>	32	76	27	98	010510W	020540W	505W	50530W	60430L....FR	60320L3	50520W	70530W	70520W				
<b>W 60</b>									39,5 X 49 X 4,5	48 X 57,5 X 4							
<b>W 62</b>	36	89	32	110	016510W	026740W	506W	56030W	60430L....FR	60320L3	56020W	76030W	76020W				

	A B C D				1	2	3	4	* 5		** 6			7	8	9
	A	B	C	D					A	B	A	B	S			
<b>W 55</b>					1.3/8"-6				51 X 37	61 X 47 X 4,5						
<b>W 57</b>	32	76	27	98	010510W	020540W	505W	55530W	60130T....FR	60120T3	55520W	75530W	75520W			
<b>W 65</b>									51 X 37	61 X 47 X 4,5						
<b>W 67</b>	36	89	32	110	016510W	026740W	506W	56530W	60130T....FR	60120T3	56520W	76530W	76520W			

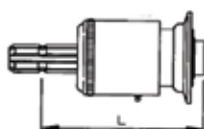
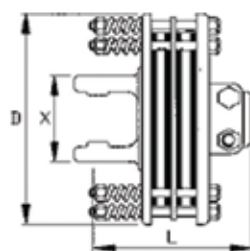
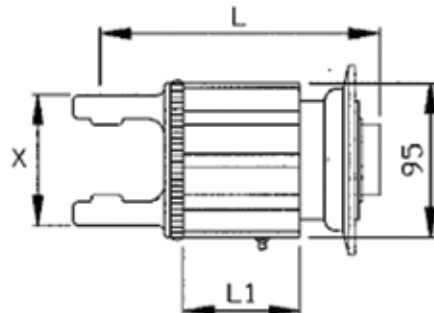
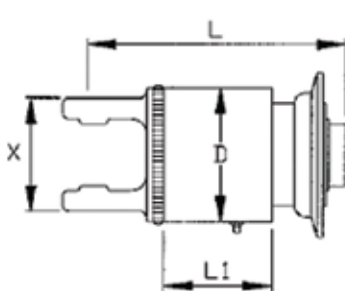

# KARDANI I DELOVI KARDANA

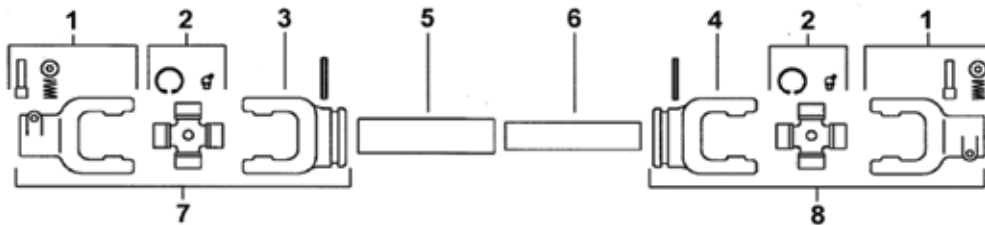

## Serijs B

	1	2	3	4	* 5	* 6	7	8	
	1.3/8"-6				S A	S A			
<b>B 01</b>		10110	20140	50120B	50130B	60120B3	60130B3	70120B	70130B
<b>B 02</b>		10210	20240	50220B	50230B	60250B3	60230B3	70220B	70230B
<b>B 03</b>		10310	20340	50320B	50330B	60320B3	60250B3	70320B	70330B
<b>B 04</b>		10410	20440	50420B	50430B	60320B3	60330B3	70420B	70430B
<b>B 05</b>		10510	20540	50520B	50530B	60420B3	60430B3	70520B	70530B
<b>B 06</b>		10610	20640	50620B	50630B	60550B3	60430B3	70620B	70630B
<b>B 07</b>		10710	20740	50720B	50730B	60550B3	60530B3	70720B	70730B
<b>B 08</b>		10810	20840	50820B	50830B	60620B3	60550B3	70820B	70830B
<b>B 09</b>		10910	20940	50920B	50930B	60620B3	60630B3	70920B	70930B
<b>B 10</b>		11010	21040	51020B	51030B	60720B3	60730B3	71020B	71030B

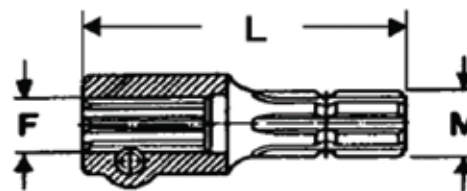
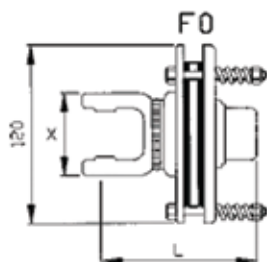

Više na: [www.benzi.it](http://www.benzi.it)

# MIKRON

## MIKRON doo

🏠 JNA 47, 21214 Sirig

☎ +381 21 849-650

✉ office@mikrondoo.rs

🌐 www.mikron-doo.rs

🌐 mikrondoo

📘 Mikron doo

📷 mikrondoo

📺 mikrondoosirig

