

**UNICORN
DenMart**  [®]
Behind The Best Indian Dentists



Introducing The All New

MAGNIFI 3D

DIGITAL MICROSCOPE

Eyepiece-Free 3D

30x Magnification

4K Precision

Scan for Website



Engineered for Modern Microsurgery

Built for clinicians who demand more than magnification.

Precision Technology Backed by Advanced Engineering

- ✓ Superior visualization for predictable outcomes
- ✓ Seamless digital documentation
- ✓ Real-time collaboration and teaching
- ✓ Long-term operational reliability

Next-Generation Digital Visualization

- ✓ Up to 30x Digital Magnification
- ✓ 4K Ultra-HD Imaging
- ✓ Large Depth of Field
- ✓ Naked-Eye 3D Viewing
- ✓ Electro-Controlled Zoom & Tilt



SEE BEYOND MAGNIFICATION

Operate With Lens from Zeiss

The Magnifi 3D Digital Microscope transforms how clinicians visualize, diagnose, and operate – delivering ultra-clear 4K imaging, naked-eye 3D depth perception, and electro-controlled movement for uninterrupted procedural flow.

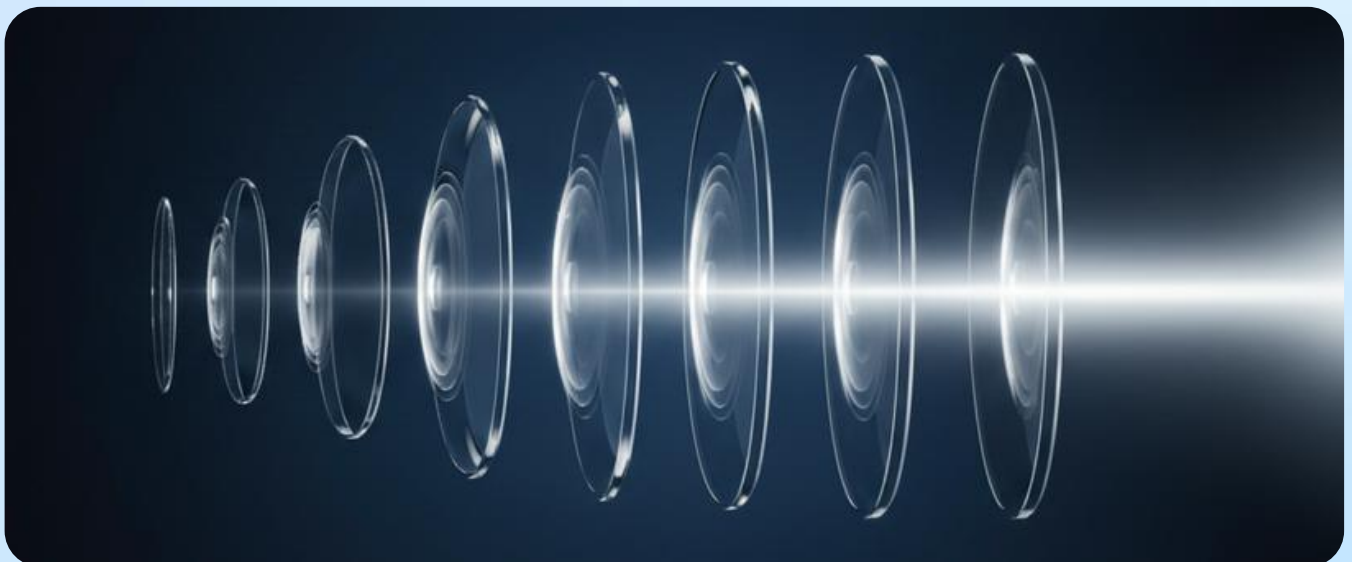

Precision Begins With Perfect Visualization

Clinical precision begins with exceptional clarity. The Magnifi 3D transforms light into ultra-high-definition visualization, empowering clinicians to see finer details, operate accurately, and perform with confidence.

Unmatched Visual Clarity

Enhanced Depth Perception

Digital-First Imaging

The Intelligence Behind Every Image



The Magnifi 3D Digital Optical System redefines surgical visualization by combining naked-eye 3D viewing with intelligent zoom and focus control. Designed to expand the clinician's field of vision while simplifying operation, it enables smoother workflows, enhanced posture, and precision-driven performance across procedures.

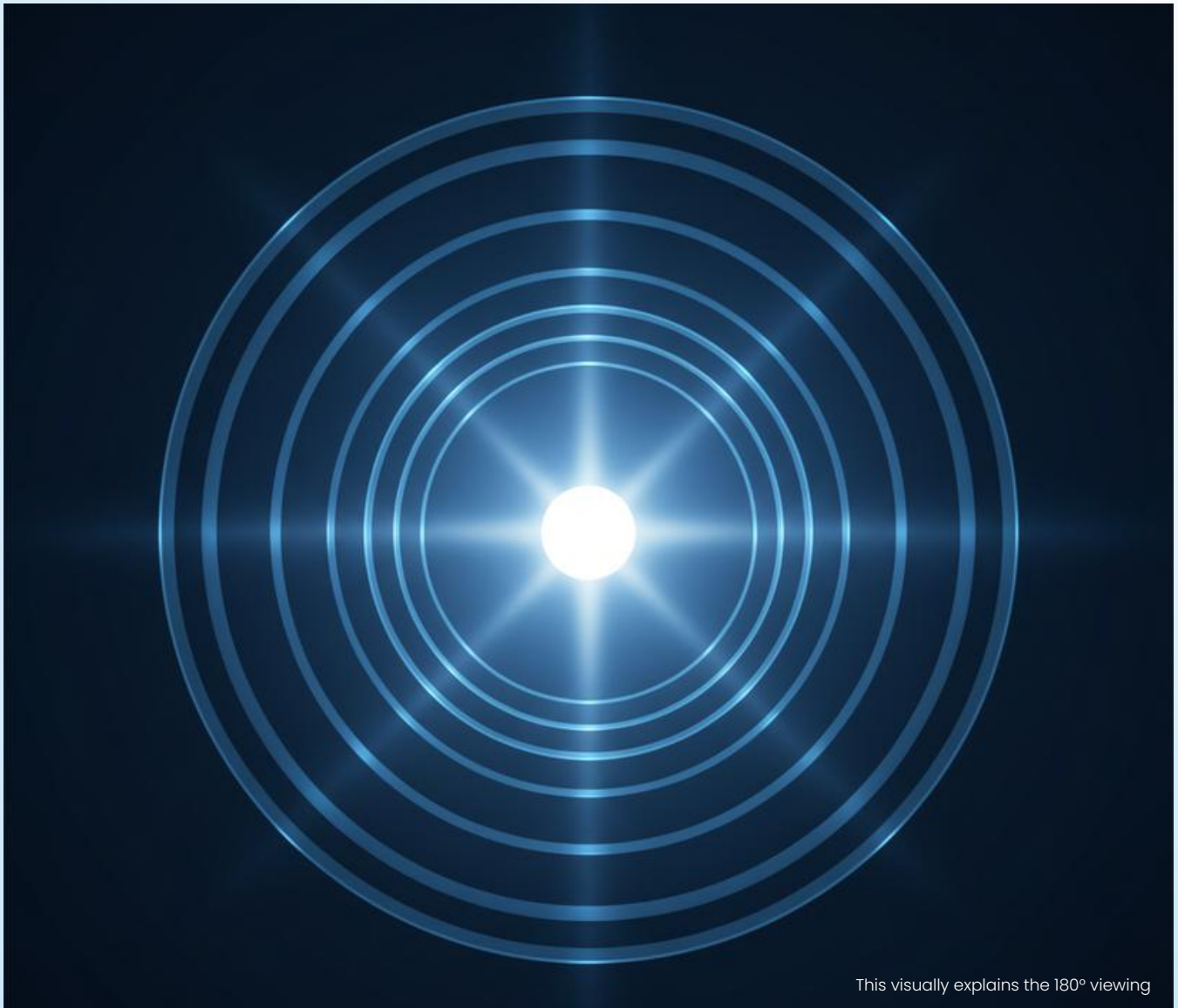

This visually explains the 180° viewing

180° Naked-Eye Viewing Freedom

Intelligent Continuous Zoom

One-Touch Auto Focus

Extended Working Distance

Why Digital Visualization Matters

- Improves procedural accuracy
- Enhances operator posture
- Reduces visual fatigue
- Supports teaching & collaboration
- Enables better documentation

Designed Around the Surgeon

Long procedures demand more than visual clarity – they demand physical comfort. The Magnifi 3D Digital Microscope is designed to support a natural working posture through naked-eye 3D viewing and flexible tilt control. By eliminating eyepiece dependency, it reduces neck, shoulder, and back strain, allowing clinicians to operate longer with greater focus and less fatigue.

Natural Upright Posture

Reduced Neck & Back Strain

Fatigue-Free Operations

Steady Precision Over Time

Comfort for the surgeon. Precision for the patient.



See Tissue, Shade, and Detail Exactly as They Are

Accurate diagnosis begins with accurate visualization. The Magnifi 3D Illumination system delivers true-color lighting and adjustable intensity to reveal fine treatment details with clarity. Designed to minimize glare and visual fatigue, it enhances tissue differentiation while maintaining a comfortable clinical environment.

True-Color
Illumination

Adjustable
Lighting Control

Reduced Glare
& Reflection

Comfort for Long
Procedures



White, Green & Orange Filter Modes:



White light source mode:
High color rendering
index, more color lifelike.



Green light source mode:
See clearly in the surgical
environment tiny nerve
blood vessels.



Orange light source mode:
Resin material can be
retarded during time.

4K Ultra-HD Photo
& Video Capture

Real-Time Large
Screen Projection

Electro-Controlled
Zoom & Tilt

Teaching &
Training Ready

Visualize. Document. Educate.

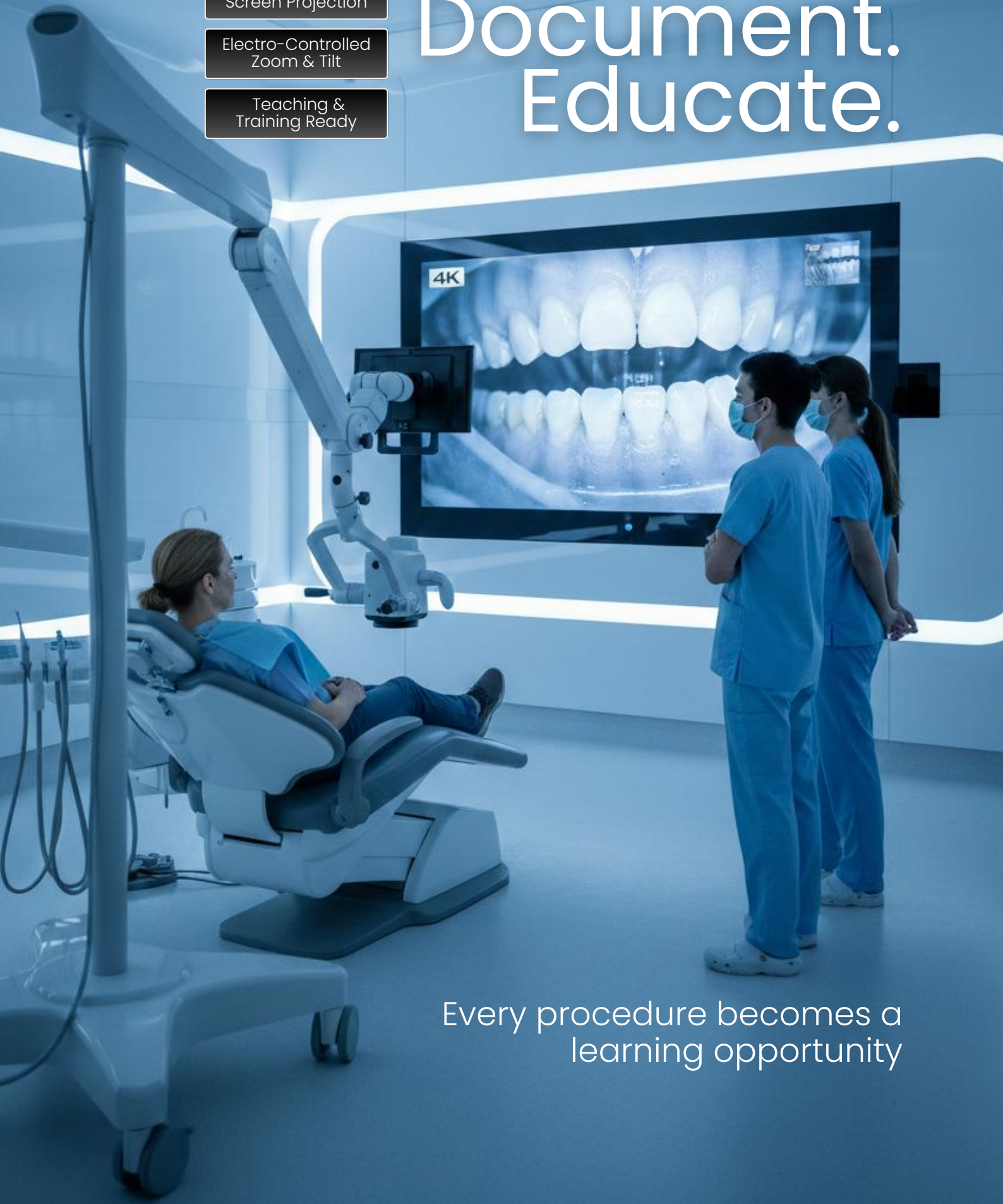

Every procedure becomes a
learning opportunity

1 Pendulum System

Operating Instruction

6 Left Control Handle

5 Right Control Handle

4 Large Zoom Objective Lens

2 Camera Handle

7 Inner Ring Light Knob

3 Endoscope Body with Large-Angle Tilt Design (Front and Rear)









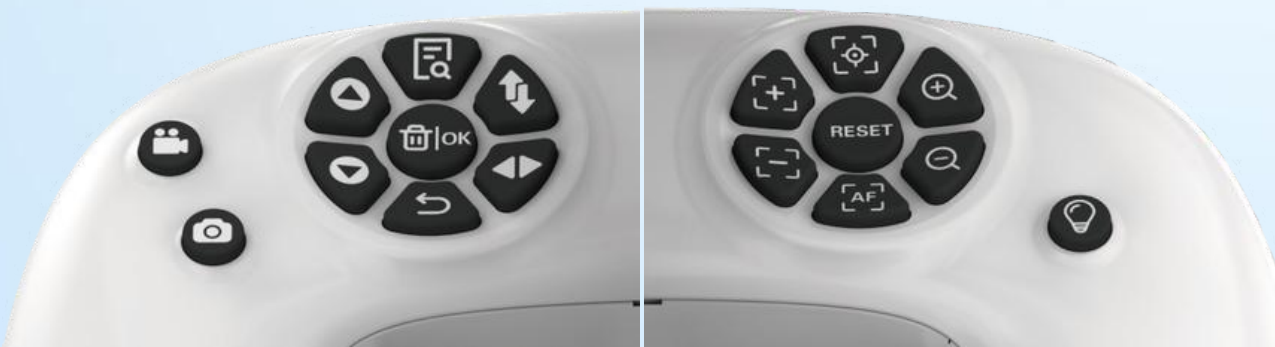







8 Outer Ring Light Knob



Serial No.	Name	Function
1	Pendulum System	When the endoscope body tilts left or right by 45°, the field of view remains unchanged during observation at different positions.
2	Camera Handle	Ergonomically designed grip for easy operation.
3	Endoscope Body with Large-Angle Tilt Design (Front and Rear)	The endoscope body can tilt forward by 45° and backward by 90°, adapting to various special treatment positions and hard-to-observe working angles.
4	Large Zoom Objective Lens	A large zoom objective lens suitable for surgery, dentistry, and orthopedics. Its focusing range covers the entire depth of the oral cavity, and the large working distance achieved by large zoom enables easy zoom and focus adjustment.
5	Right Control Handle	Main operational functions: Manual Focus, One-Click Focus, Auto Focus, ZOOM continuous magnification system adjustment, and function buttons such as lighting control.

Serial No.	Name	Function
6	Left Control Handle	Main operating functions include four-directional flip (up, down, left, right) for microscopic viewing preview and a return button, meeting the needs of treatment at different angles.
7	Inner Ring Light Knob	<ul style="list-style-type: none"> • Press the button: Toggle the current inner ring light on or off. • Rotate the knob: Increase or decrease the light brightness.
8	Outer Ring Light Knob	<ul style="list-style-type: none"> • Press the button: Toggle the current outer ring light on or off. • Rotate the knob: Increase or decrease the light brightness. • The outer ring light has a total of five lighting modes, which cycle as follows: • OFF → Orange Light → Green Light → Weak White Light → White Light → OFF.



Left Handle Button	Function	Right Handle Button	Function
	Menu		Focus Lock
	Upside Down		Zoom In
	Left-Right Reverse		Zoom Out
	Return		One-Click Focus
	Page Up		Manual Focus
	Page Down		Manual Focus
	Delete / Confirm		One-Click Reset
	Record		Three-Color Lighting
	Photography		

Technical Specifications

Dimension and Weight	<ul style="list-style-type: none"> Machine Head Size: 240mm × 240mm × 280mm Bracket Size: 170cm × 85cm × 85cm Weight (Main Unit + Camera Handle): 4.25 kg
Power Supply	<ul style="list-style-type: none"> Power Input: AC 100–240V~, Single-phase, 50Hz/60Hz Input Power: 90VA Fuse: F2AL250V
Software Release Version	<ul style="list-style-type: none"> V1.0
Digital Optical System	<ul style="list-style-type: none"> 180° naked-eye wide field of view with stereoscopic image transmission for a larger viewing range, freeing doctors' eyes with simple operation. Zoom mode: continuous zoom system with manual and automatic continuous adjustment, including one-click auto-focus. Total magnification: 3.30X–30X, continuously adjustable Ultra-large zoom objective system Working distance (WD) zoom range: 160–450mm
Lighting System	<ul style="list-style-type: none"> Built-in high-reliability medical-grade LED light source with continuously adjustable brightness Minimum illuminance on object surface (at f=250mm): >50,000 lux Lighting spot diameter: >100mm Lighting color temperature: 5000K–5700K, with stepless dimming for realistic color reproduction Three color filtering modes: Orange: Prevents premature curing of resin materials Green: Facilitates clear visualization of tiny blood vessels and nerves in surgical blood environments White: For general illumination
Bracket System	<ul style="list-style-type: none"> Maximum Boom Length: 1550mm Cross Arm Swing Radius: 770mm (360° rotation) Spring Arm Swing Radius: 600mm (+100° rotation) Spring Arm Vertical Movement Range: +300mm
Built-in Ultra-HD Video Recording and Photography System	<ul style="list-style-type: none"> Camera: Imported HD camera Video resolution: 3840 × 2160 (4K) Video frame rate: 60fps @ 4K Storage medium: External USB flash drive Playback function: Photos viewed via left handle button menu Videos viewed by inserting USB flash drive into a computer
Digital Imaging Module	<ul style="list-style-type: none"> Video resolution: 4K (3840 × 2160) Frame rate: 60fps with 4K image storage Control methods: Supports mouse, buttons, and touch screen Output interface: HDMI Image Sensor: CMOS 4K sensor Mirror function: Supports vertical and horizontal flip

Traditional Microscope Vs Digital Microscope

Vision & Eye Comfort (Biggest Daily Impact)

Traditional Microscope

- Constant eyepiece use
- Diopter adjustment for each eye
- Neck flexion, Eye strain, Headaches



Digital Microscope

- No eyepieces, No diopters
- Large 3D / 4K Screen
- Natural Posture, Relaxed Vision

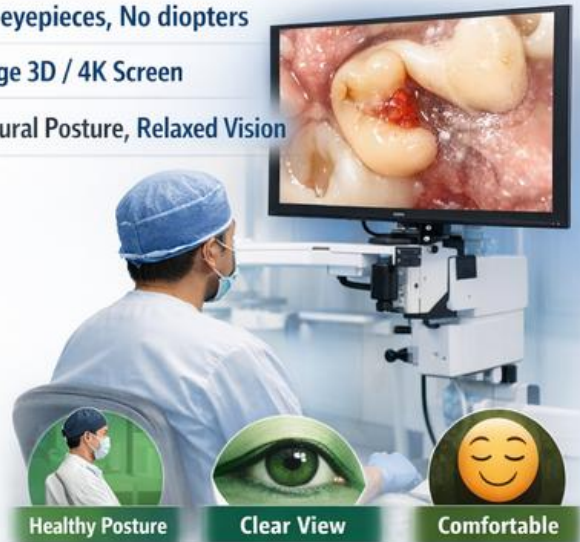

Clinical Benefit: Work Longer, Calmer & More Precisely Without Physical Exhaustion.

Ergonomics & Posture (Career-Saving Advantage)

Traditional

- Operator must align head, eyes, and body to microscope
- Fixed posture → chronic neck, shoulder & spine issues



Digital

- Surgeon looks straight at the screen
- Free head movement, upright posture
- Ideal for long endo, microsurgery, implant cases



Clinical Benefit: Reduces musculoskeletal disorders — a major cause of early burnout in dentists.

Traditional Microscope Vs Digital Microscope

Learning Curve & Daily Workflow

Traditional

- Steep learning curve
- Hand-eye coordination through eyepieces takes time
- Assistants cannot see what the doctor sees



Hard to Learn

Slow Process

No Team Visibility

Digital

- Intuitive, screen-based workflow (like using a monitor)
- Assistant, nurse, student see exact same field live
- Faster adoption even for non-microscope users



Easy to Use

Shared View

Clinical Benefit: Better team coordination, faster procedures, fewer errors.

Magnification & Field Awareness

Traditional

- Optical magnification is excellent
- But narrow field of view at high magnification
- Constant **refocusing** needed



Narrow Field of View

Constantly Refocus

Digital

- High digital magnification with larger depth of field
- Better situational awareness
- Easier transitions between macro → micro



Wide Field of View

Macro to Micro

Clinical Benefit: More control during canal negotiation, perforation repair, micro-suturing.

Traditional Microscope Vs Digital Microscope

Documentation, Teaching & Case Acceptance

Traditional

- Requires add-on cameras
- Sharing visuals is limited
- Patients can't understand what doctor sees



External Camera

Limited Sharing

Patient Unaware

Digital

- Built-in photo & video recording
- Live display for patients, staff, students
- Easy case documentation



Auto Recording

Live Teaching

File Updates

Clinical Benefit: Higher patient trust • Better case acceptance • Strong medico-legal

Multi-User & Multi-Purpose Use

Traditional

- Mostly single-operator tool
- Teaching requires external monitors



Single Operator

External Monitor

Digital

- Perfect for:
- Teaching
- Live demonstrations
- Team discussions
- Case reviews



Teaching

Live discussions

Case reviews

Clinical Benefit: One device serves treatment + education + marketing.

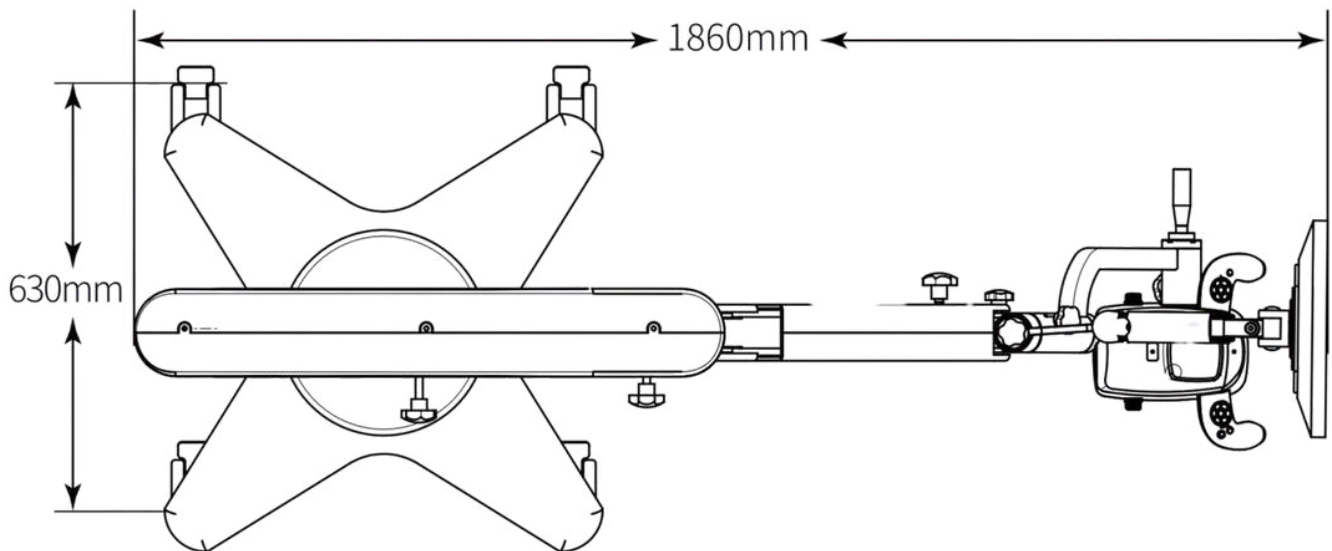
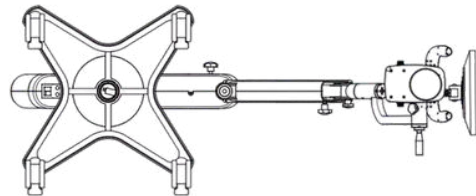
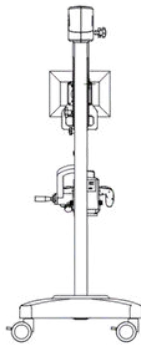
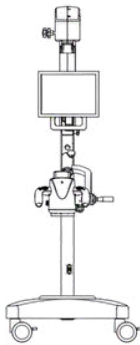
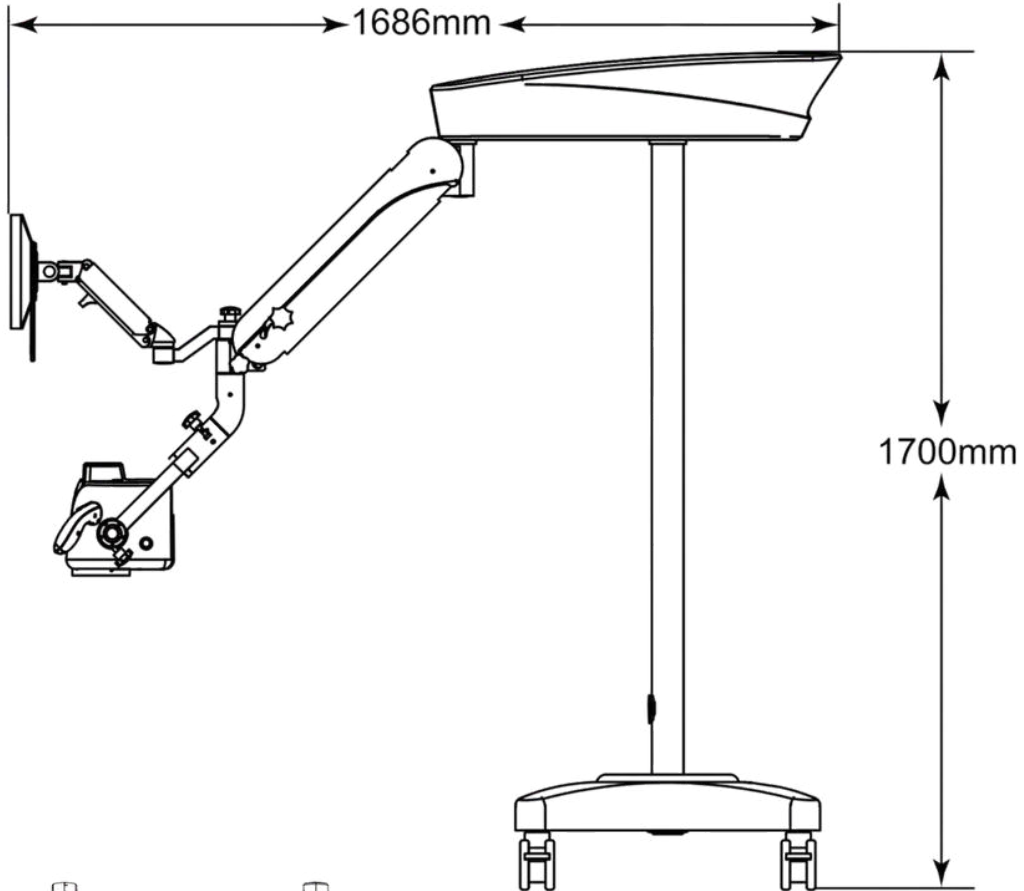





WHERE TRUST COMES FIRST



Warranty Ke Saath Bhi
Warranty Ke Baad Bhi

For any Sales & Support

 9821184441, 8448398852

 sales@unicorndenmart.com

Customer Care

Register Your Complaint with A Missed Call: **7065-558-558**

 011-45551250, 51, 55  9717012081, 95994 48518

 care@unicorndenmart.com | care1@unicorndenmart.com

Connect With



Unicorn DenMart



Corporate Office: 3 Local Shopping Centre, MOR Land, Near J Block DDA Market,
New Rajender Nagar, New Delhi – 110060



Accessories shown may not be a part of standard equipment. Specifications are subject to change without notice.