

Bluegrass

EDUCATIONAL TECHNOLOGIES, LLC



Learning Solutions for Engineering & Technology

Table of Contents

Our Partners.....	1
About Us.....	2
BET Contacts.....	3
STEM.....	4
Industrial Maintenance.....	6
Hydraulics & Pneumatics.....	10
Electricity & Electronics.....	12
Electric Power & Alternative Energy.....	14
E-Learning.....	17
HVAC & Refrigeration.....	18
Instrumentation & Process Control.....	20
CNC Machining & Woodworking.....	22
Automotive and Diesel.....	24
Mechatronics & Advanced 4.0 Manufacturing.....	26
PLCs.....	28
Robotics & Automation.....	30
Welding Technology.....	32
Telecommunications.....	33
Makerspaces & Innovation Labs.....	34
Furniture.....	36
Semiconductors.....	38
AR/VR.....	39
Industry Recognized Credentials.....	40
Proudly Supporting.....	43

FESTO

LABXTECH

PHabLAB

Carbide 3D

GLOBAL INDUSTRIAL

SIEMENS

Allen-Bradley

KINOVA

SIMUMATIK

SPECTRUM INDUSTRIES INC.

FABLICATOR

JAR SYSTEMS

ABB

EMCO

Hoffmann Group

ZIGMI
Greene Manufacturing, Inc.

zSpace

Techno CNC Systems

ROOTS

TENSTAR
simulation

ROBOLINK

WLKATA

Future Tek Inc.



About Us

Bluegrass Educational Technologies is a leading provider of high-quality training materials and equipment for both traditional and emerging technology programs. Headquartered in the heart of beautiful Lexington, Kentucky, we proudly serve secondary and post-secondary institutions across Kentucky, Maryland, Delaware, Washington D.C., Virginia, West Virginia and Florida — delivering curriculum, training systems, and services from the industry’s top manufacturers.

With strong partnerships spanning more than 20 industrial manufacturers — each with dedicated educational divisions—**Bluegrass Educational Technologies** is uniquely positioned to support a wide range of programs in advanced automation, mechanical systems, robotics, and engineering. Our solutions ensure educators are equipping students with industry-standard technology while providing access to stackable, industry-recognized credentials.

At **Bluegrass Educational Technologies**, customer service is at the core of everything we do. We understand the challenge instructors face in staying up to date with industry advancements while delivering quality education. That’s why we offer comprehensive support, including in-depth consultations during the planning phase; on-site, virtual, and hybrid training for new or updated products; and ongoing professional development through webinars, workshops, and seminars focused on emerging technologies.

Our mission is to deliver **Simple Solutions for Powerful Programs**, to help bridge the skills gap from education to workforce. With Educational Program Consultants located throughout our service regions, we’re ready and excited to support the development and enhancement of your career and technical education programs.



771 Corporate Drive
Suite 750
Lexington, Kentucky 40503
866.276.6457



Nathan Hicks
Vice President of Operations
Cell 270.874.0441
Email nhicks@bluegrasset.com
[in](#)



Meredith Howard
Kentucky & West Virginia
Post-Secondary Program Consultant
Cell 859.893.4957
Email mhoward@bluegrasset.com



Miles Baird
Kentucky
Secondary Program Consultant
Cell 662.295.1975
Email mbaird@bluegrasset.com
[in](#)



Steve Cercone
Florida
Program Consultant
Cell 813.413.7836
Email steve@bluegrasset.com
[in](#)



Daniel Edwards
Virginia, West Virginia, Maryland, & Delaware
Program Consultant
Cell 540.393.0514
Email dedwards@bluegrasset.com
[in](#)

Connect with us:



bluegrasset.com

STEM

The “learning cluster” approach is inherently flexible and allows a STEM classroom to consist of modules from all clusters, specific clusters, or a variety of such.

Advanced Manufacturing

- Aerodynamics
- CNC Mill & Lathe
- Computer-Aided Design with 3D Printing
- Engineering and Stress Analysis
- Exploring Electricity
- Fiber Optics and Lasers
- Introduction to Process Engineering
- Plastics

Mechatronics

- Automation and Robotics
- Exploring Mechanisms
- Exploratory Electronics
- Exploring Mechatronics
- Plastics

Environmental Discovery

- Environmental Technology
- Alternative Energy

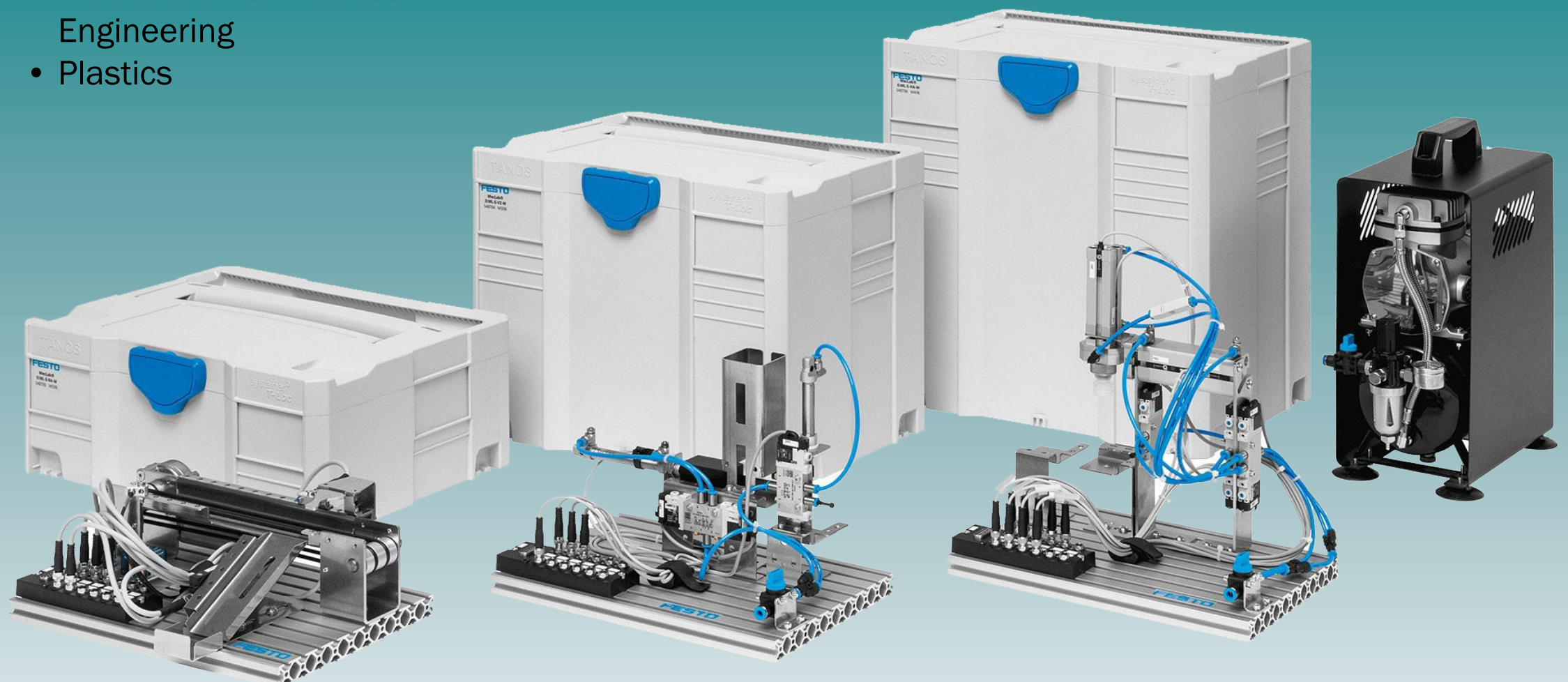



Bionics4Education Kit

One Bionics Kit... Three bionics projects!
 The Bionics Kit contains the materials and components required for three different bionics projects: The Bionic Fish, The Bionic Chameleon Gripper, and The Bionic Elephant's Trunk, an adaptive gripper with Fin Ray Effect.



FESTO

Bionic Flower

The Bionic Flower is a construction kit inspired by the plant world. It opens and closes its petals in response to external influences such as approach or light.

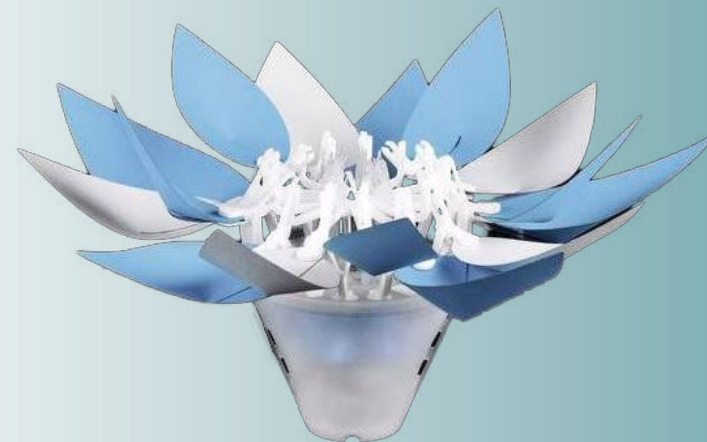

FESTO

CoDrone EDU

The CoDrone EDU is a programmable drone, meant for learning in the classroom. Code it in Python or start from the basics with block based coding. With a durable and safe frame, programmable lights, and access to seven sensors, it is a great way to learn coding and Engineering skills.



codrone EDU



Pumps System

- Single Pump Systems
- Multiple Pump Systems
- Variable Frequency Drives
- Pump Installation
- Basic Pumping Circuits
- Centrifugal Pumps



Rigging System

- Ropes & Slings
- Wedge Sockets
- Dollies & Rollers
- Gantry Cranes & Hoists
- Machine Installation
- Lifting Objects



Industrial Motor Controls System

- Basic controls
- PLC
- Motor Drives
- Sensors
- Troubleshooting
- Symbols & Schematics



Industrial Motor Controls Simulation Software

- Industrial Components
- Full Schematics
- True Simulated Models
- Stand Alone Access
- Online Access
- Site License



Industrial Wiring System

- Interpret Industrial drawings
- Punching, Deburring, and cleaning procedures
- Wire Connection
- Prepare and Install
- Commission, Troubleshoot, & Maintain Installations



Conventional Fire Alarm Trainer

- Wiring and Schematics
- End-Of-Line Resistor
- Remote Zone Indicators
- Control Panels
- Commercial-Grade
- Compact

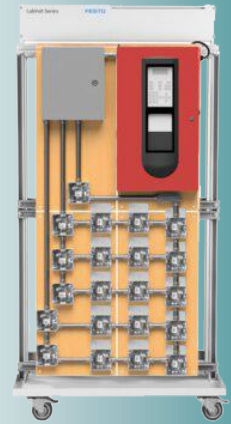

Mechanical Drives System

- Belt Drives
- Chain Drives
- Gear Drives
- Bearings & Seals
- Shaft Alignment
- Couplings



AC/DC Learning System

- Electricity Basics
- Circuits Principles
- Electromagnetism
- Ohm's Law
- Kirchhoff's Law
- Troubleshooting
- Common Components
- Portable Design
- Practical Training



Process Control System

- Pressure, Flow, and Level using Differential-Pressure Transmitters
- Create circuits to mimic industry-specific controls
- Learn Tune Control
- PID and Cascade Process Control



Basic Motor Control System

- Lockout / Tagout
- Symbols & Schematics
- Troubleshooting
- Control & Pilot Devices
- Protection Devices
- Manual Starters



Piping Training System

- Pipe Fittings
- Hangers
- Circuit Layout
- Calculations
- Cutting & Threading
- Installation & Assembly



Variable-Frequency Drive Training System

- Motor Drives
- Motor Characteristics
- VFD Characteristics
- VFD Control Circuits
- VFD Load Types
- VFD Installation



Industrial Maintenance

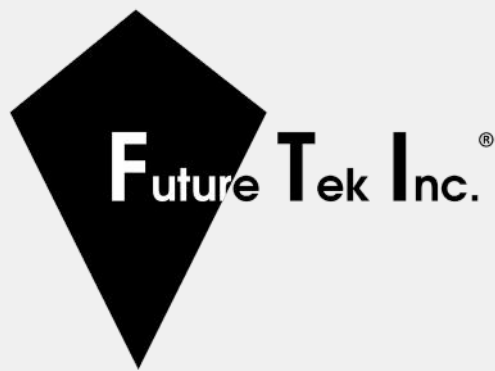

"Real-World Trainers for "Real-World" Jobs

Chain Drive Trainer

- Identify Belt and Chain Drive Components
- Install and Adjust Belt and Chain Drives
- Calculate Drive Ratio and Sprocket Size
- Hands-on "Real World"
- Job Sheets

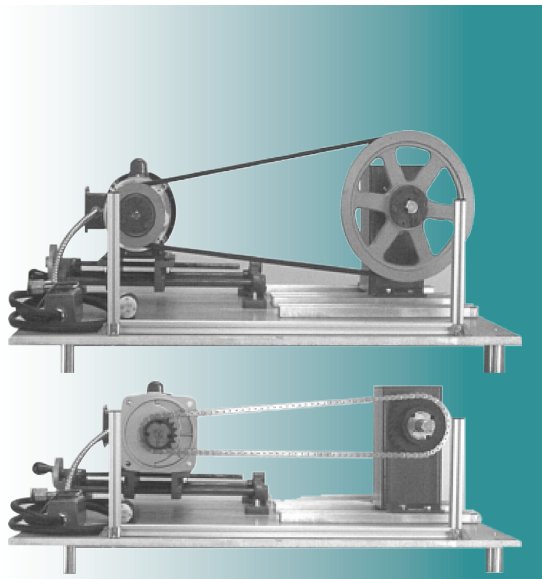

Shaft / Coupling Alignment

- Measure/Correct a Soft Foot Condition
- Measure for Shaft Run out
- Determine Bar Sag
- Use Straight Edges, Feeler Gauges, and Two Dial Indicator to Perform an Alignment

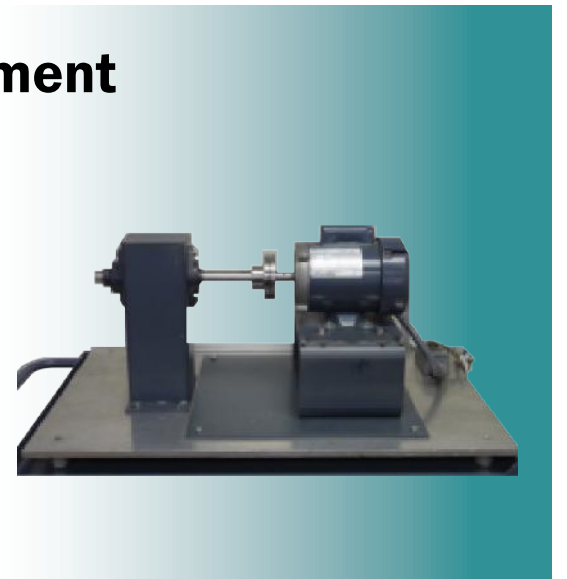

Bearing Maintenance Trainer

- Bearing Identification and Mounting
- Bearing Lubrication
- Reduction or Internal Clearance Exercises
- Use of Mounting and Dismounting Sleeves



Pump Maintenance Trainer

- Pump Overview
- Disassembly
- Liquid End Disassembly/Reassembly
- Coupling End Frame Disassembly/Reassembly
- Impeller Adjustment

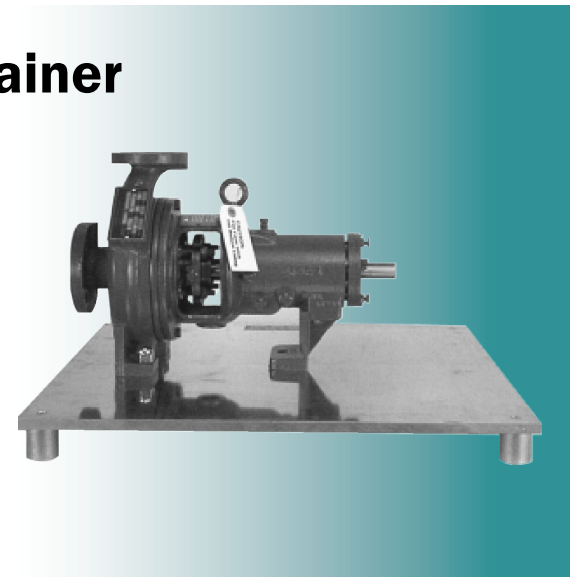

Pump Drive Trainer

- Cavitation
- Centrifugal and Positive Displacement Pumps
- Sheave and Bushing Alignment
- Mounting and Removing QD Bushings and Sheaves



Pneumatic Clutch and Break

- Teaches basic air controlled industrial clutch application and simple braking load

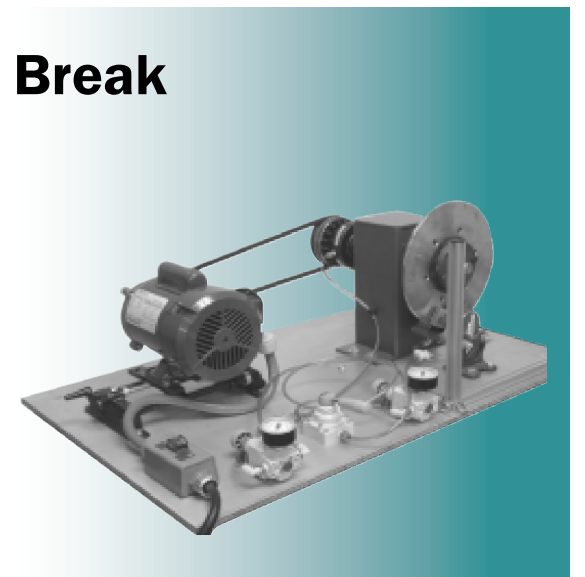

Pneumatics Trainer

- Trainer Varieties
- Portable Models
- Suitcase Models
- PLC Option
- Pneumatics Training
- Onboard Pumps
- Lab Manuals

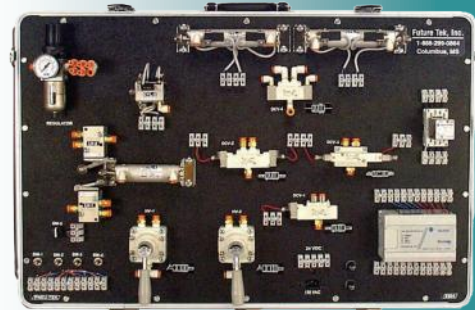

Programmable Logic Control (PLC)

- Allen Bradley Processor
- Inputs & Outputs to external equipment
- Motor Training
- PowerFlex Drives
- Operator Interface
- Network Capabilities



Motor Controls

- Model Options
- Industrial Training
- Lab Manuals
- VOM Usage
- Wiring Diagrams
- Schematics Application
- Complete Packages



Troubleshooting Trainers

- Fault Insertion
- Instructor Control
- Data Recording
- Component Replacement
- Performance Report
- PLC Integration
- Session Tracking



Hydraulics Trainer

- Portable Models
- Suitcase Models
- PLC Option
- Onboard Pumps
- Lab Manuals

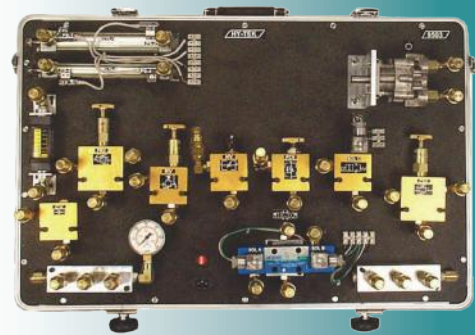

Residential Wiring Workstation

- Desktop Rack
- Service Entrance Module
- SP-3W-4W Switches
- GFCI Protection Module
- Bath & Light Modules
- Alarm Module



Conveyor System

- Programming Practice
- Pneumatic Robot
- Pick and Place
- Automation Integration
- Motor Applications
- System Wiring

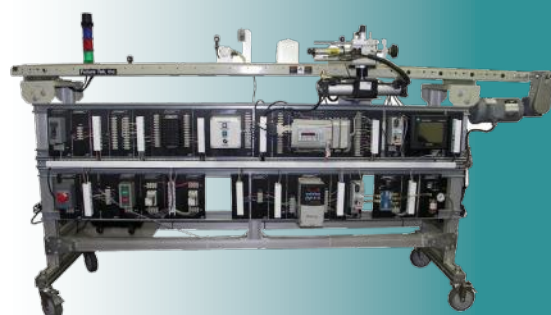

Residential Wiring Trainer

- 100A Meter Base
- Easy Storage
- Multiple Users
- Lockout/Tagout
- 100A Meter Base
- Circuit Breaker Panel



Hydraulics & Pneumatics



Low Cost Electropneumatics Training System

- Design Circuits
- Direct and Indirect Actuation
- Logic Operations
- End-Position Monitoring
- Pneumatics Proximity
- Industrial Wiring

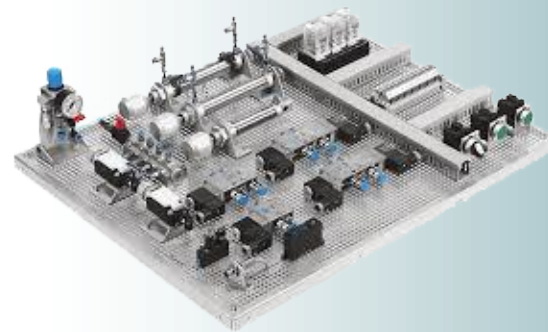

FESTO

Suitcase Hydraulic Training Systems

- Designed for Safe Operation
- Accumulator
- Motor Circuits
- Basic Hydraulics
- Optional External PLC
- Optional Built in PLC



Future Tek Inc.

Suitcase Pneumatic Training Systems

- Manual Control
- Pilot Operation
- Electric Control
- Basic Pneumatics
- Optional External PLC
- Optional Built in PLC

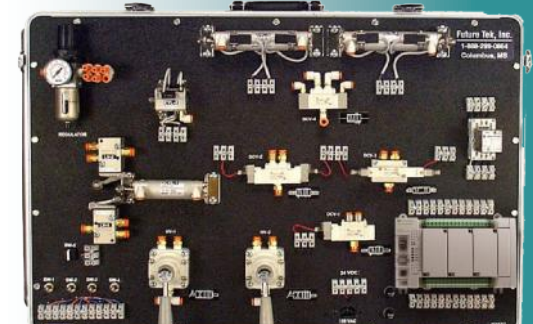

Future Tek Inc.

Pneumatics Training System

- Industry Components
- Basic Physical Concepts
- Controls of Cylinders
- Pneumatic Motor Circuits
- Air Conditioning
- High Level of Inherent Safety

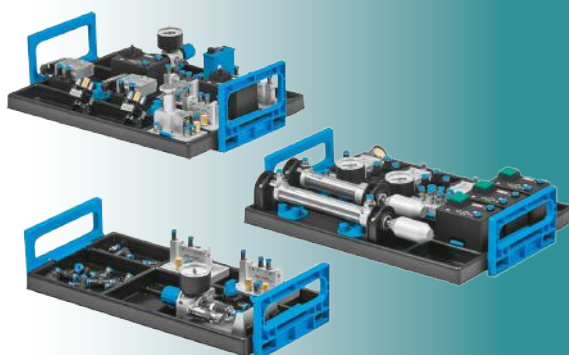

FESTO

Hydraulics Training System

- Introduction to BFP
- Pressure Measurements
- Prevention Principles
- Spill-Resistant Vacuum Breaker
- Reduced Pressure Zone Assembly
- Test Procedures

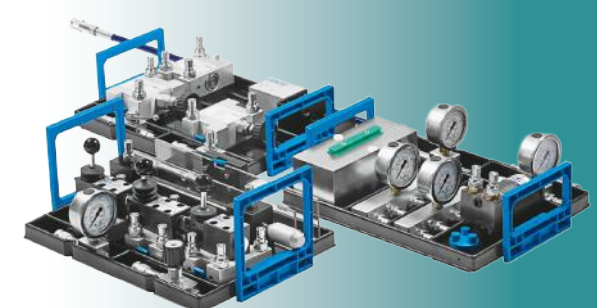

FESTO

Hydraulic Dual Circuit Break System

- Hydraulic Circuit controls Drum and Disc Brake
- Familiarization with Operational Hydraulic Function
- Drum Brake section highlights internal parts function



Hydraulic Brake Chassis Trainer

- Skills training for Operation, Installation, Maintenance, and Repair of Hydraulic Break Systems
- Integrated Floor Stand
- Color Schematic Chart
- Self Contained Unit



Series And Parallel Pump Set

- Two Independent sets of Centrifugal Pumps and Sump Tank
- Polypropylene Piping with Pressure Gauges and Flow Meters
- Plotting and Calculating Flow Rate



Hydraulics Trainers

- Fluid Power Physics
- Controls, Directional and Pressure Controls
- Basic Design and Schematics
- Pumps, Check Valves, Actuators, Connectors and Conditioning



Pneumatics Trainers

- Physics of Pneumatic Systems
- Flow and Directional Controls
- Air Preparation and Distribution
- Valves, Vacuum, Compressors, Air Dryers, Actuators, Connectors, and Conductors



Solenoid Valves

- Optimized Operational Efficiency
- Enhanced Cycle Times
- Robust VUVS Performance
- Compact VUVG versatility
- Pneumatic/Electric Compatibility

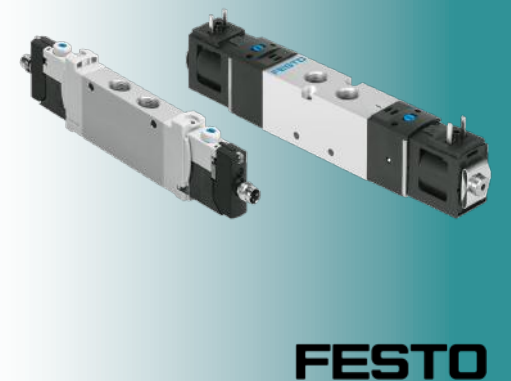

Pneumatic Valve

- Reliable Flow Control
- Compact Valve Design
- Durable Industrial Construction
- Efficient Pneumatic Performance
- Fast Switching Response



Hydraulic Power Pack with LS Variable and Constant Displacement Pump Combination

- Mobile Hydraulic Suitability
- Load-sensing Capability
- Multiple Voltage Variants
- Fixed-pump Delivery
- Adjustable Operating Pressure
- Over-load Protected Motor



Electricity & Electronics



AC/DC Training System

- Basic Concepts
- Ohm's Law
- Kirchhoff's Law
- Using Measuring Instruments
- Electromagnetism
- Troubleshooting



FESTO

Fundamentals of Electrical/Electronics Engineering

- Direct Current
- Alternating Current
- Semiconductors
- Basic Circuits
- Expandable
- Realistic Projects

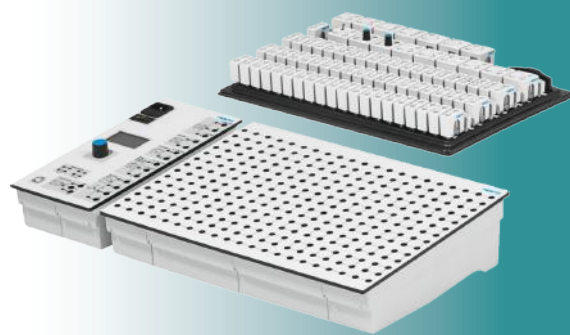

FESTO

Exploring Electricity

- Electric Circuits
- Electromechanical Relays
- Ohm's Law
- Logic Circuits
- Comprehensive Curriculum
- Safe Tabletop System



FESTO

Facet Electronics Training System

- Student-Controlled
- 30 Topics
- 4 Areas of Study
- Industrial Grade
- Fault-Insertion
- Minimal Wiring

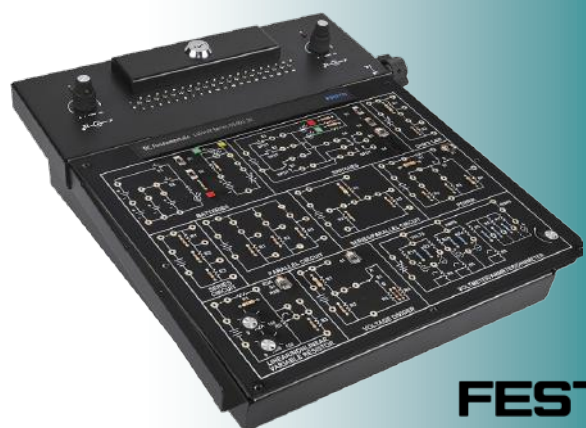

FESTO

Sensors for Object Detection

- Basic Principles
- Configuration of Logic Circuits
- Switching Characteristics
- Binary Output Signals
- Tabletop
- Easy Setup

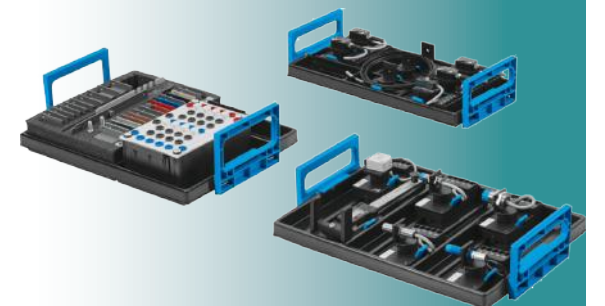

FESTO

PIC Microcontroller

- Simulation and debugging
- Modular hardware platform
- Expandable learning boards
- Flowcode IDE support
- Beginner-friendly programming
- Industry-relevant skills



Smart Sensors

- Industry 4.0
- Data Monitoring
- IO-Link Communication
- Different Manufacturing Communication Layers
- Predictive Maintenance
- Troubleshooting



Basics of Electricity Trainer

- Modular Electricity Fundamentals
- Starter Grounding Course
- Ideal Introductory Training
- Globally Accepted Manual
- Industry-recommended Program
- Comprehensive 57 experiments



Basic Electricity Trainer PCB Modular

- Basic Electrical Engineering
- Electricity & Electromagnetics
- Modular Experiment Boards
- AC & DC Circuits
- Training Manual



Circuit Based Training Series

- Topic-specific Boards
- Hands-on circuit exercises
- PCB Modules Included
- Base Station Compatible
- Silk-screened Schematics



Industrial Electronics Trainer

- Industrial Electronics Fundamentals
- Power Electronics Devices
- Three-phase System Applications
- Modular Experiment Training
- EIA-supported Courseware



Sensor and Transducer Trainer

- Transducer and Sensors
- Signal Conditioning Methods
- Instrumentation Amplifier Use
- Signal Processing Applications
- Electronic Meter Integration
- Circuit Troubleshooting Skills



CCTV and Security System Trainer

- Domestic Commercial Applications
- Wiring Operation
- Troubleshooting
- Panel-mounted Components
- Unauthorized Personnel Detection



Electric Power & Alternative Energy



Electric Power Technology Training System

- AC/DC Power Circuits
- Power Transformers
- Rotating Machines
- Transmission Lines
- Industrial Controls
- Power Electronics

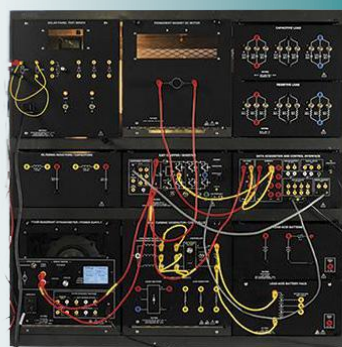

FESTO

Numerical Protective Relays Training System

- Siemens SUPROTEC 5 Series
- DIGSI 5 Programming
- Over current/Overload Protection
- Directional Protection
- Differential Protection
- Distance Protection



FESTO

Dissectible Machines Training System

- DC Machine Assembly
- Split-Phase Capacitor-Start
- Capacitor-Run
- Two Value Capacitor
- Universal Motor
- 3PH Wound-Rotor Induction



FESTO

2kW Electromechanical Training System

- Four Designs Available
- Modularized
- Power Circuits
- DC Machines
- Transformers & AC Machines
- High Inertia



FESTO

Nacelle - Wind Power Generation System

- Mobile
- Yaw System
- Hub and Low-Speed Shaft
- Alignment
- Hydraulic Breaks
- Weather Sensors



FESTO

EMS Electromechanical Simulation Software

- Polarity and Terminal Markings
- Single-Phase Leads
- Single-Phase Paralleling
- 3PH Banking Configurations
- Thermal Magnetic Protection
- Eight Trainer Faults



FESTO

Motor Winding Kit Training System

- 3 Types of Rotors
- Split-Phase Capacitor-Start
- Three-Phase Squirrel Cage Induction
- Three-Phase Wound-Rotor Induction
- Synchronous Machine
- High-Quality Components



Distribution Transformer Trainer

- Polarity and Terminal Markings
- Single-Phase Leads
- Single-Phase Paralleling
- 3PH Banking Configurations
- Thermal Magnetic Protection
- Eight Trainer Faults



Emergency Generator/ATS Training System

- Installation and Testing
- LNG Generator
- Voltage Measurement
- Simulation
- Progress Reports
- Troubleshooting

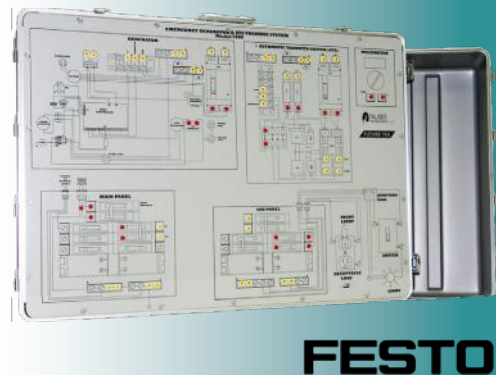

Home Energy Production Training System

- Voltage, Current, and Ohm's Law
- Equivalent Resistance
- Power in DC Circuits
- Series and Parallel Circuits
- Battery Fundamentals
- Discharge Characteristics



Solar Wind Energy Training System

- Energy Fundamentals
- Safety
- Solar Module
- Wind Turbine
- Solar/Wind Systems
- Real-World Component



Solar Thermal Energy Training System

- Basic Principles
- Hot Water System
- Radiant Heat
- Hydronic Floor Heating
- Multi-Loop Systems
- Measure Different Parameters



Electrical Installation Safety System

- AC Voltage Measurement
- DC Battery Voltage
- Phase Rotation Test
- Earth Resistance Test
- Insulation Resistance Test
- Leakage Breaker Test

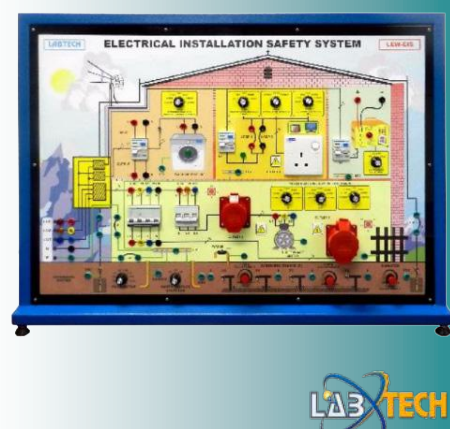

Training System for DIREC Digital Control BMS System

- Honeywell Setup Programming
- DDC System Control
- Building/Industrial Applications
- Analog & Digital I/O
- Damper & Fan Control



Electric Power & Alternative Energy

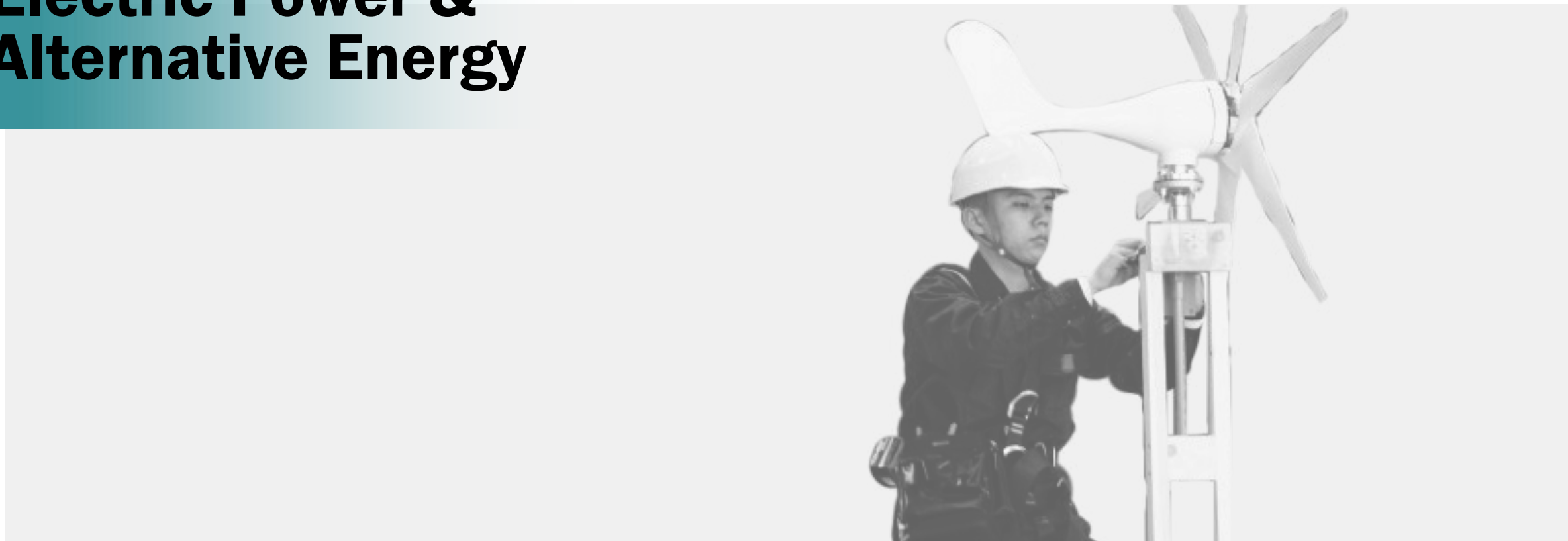

MagTran Training System

- Faraday's Law
- Magnetic Coupling
- Transformers
- Eddy Currents
- Flux Measurement
- Hysteresis Loop



Power Line Series Compensation Demonstrator

- Power Transfer Capability
- Effects on System Stability
- Regulation of Receiver Voltage
- Transmission Losses
- Simulates 735 kV 3PH Lines
- Integrated Mobile Console



Electric Pitch Hub Training System

- Human-Machine Interface
- Programmable Logic Controller
- Introduction to SCADA
- Blade-Angle Optimization
- Electric Pitch Control Operation
- Troubleshooting



Hydraulic Pitch Hub Training System

- Human-Machine Interface
- Programmable Logic Controller
- Introduction to SCADA
- Blade-Angle Optimization
- Hydraulic Pitch Control Operation
- Troubleshooting



Geothermal Training Systems

- Ground Loops
- Refrigeration Cycle
- COP and Energy Efficiency Ratio
- Heat Pump System
- Analyze and Compare
- Insertable Faults



Wind Farm Simulation Software

- Structure of a Wind Farm
- WDS WT and WFS SCADA
- Physics of a Wind Turbine
- Wind Farm Operations
- Common Connection Point
- Operational Curve



E - Learning

Our affordable e-learning systems provide on-demand instruction and a self-paced curriculum that enhance and reinforce hands-on learning. Fully customizable to meet a wide range of student needs and learning styles, these solutions are designed to boost engagement and support positive educational outcomes.



Features

- Individual Learning
- Learning Analytics
- Learner Management
- LX Creator
- Equipment Management
- Competency Management
- Connected Learning
- Mobile Learning
- Evaluation
- Micro Learning
- Comment and Rate
- Powerful Search
- Notification Center
- Learning Library

- 1. Create a Course**
- 2. Assign the Course**
- 3. Start Learning**
- 4. Monitor Progress and Support**
- 5. Assessment and Success**



HVAC & Refrigeration



Refrigeration Capstone Project

- Mobile, Safe and Small
- Fabrication
- Turnkey Solution
- Pressure-Testing
- Essential Skills
- Meets World skills Requirement



FESTO

Building HVAC Controls Learning System

- Direct Digital Controls (DDC)
- BACnet MS/TP
- Variable Air Volume (VAV)
- Constant Air Volume (CAV)
- Web-Based Monitoring
- Building HVAC Layout

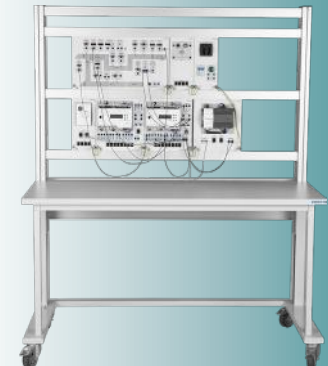

FESTO

Heat Pump Technology Troubleshooting Trainer

- Portable Design
- Low & High Voltage Electrical
- Detailed Reporting
- 5 Levels of Complexity
- Tutorial Mode
- Troubleshooting Mode

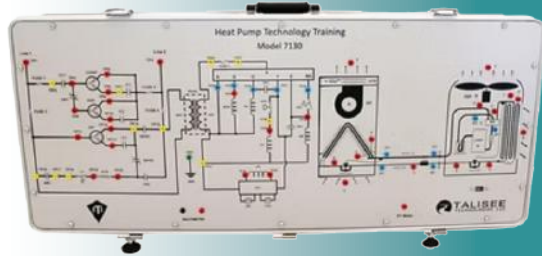

Future Tek Inc.

HVAC Electrical Troubleshooting Trainer

- Real-World Components
- Comprehensive Labs
- Portable Design
- Low Cost
- No Consumables
- 16 Concealed Faults

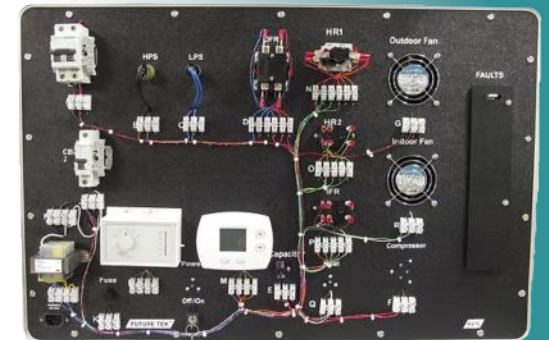

Future Tek Inc.

zSpace HVAC Simulation

- Residential / Commercial
- Formative Assessments
- Working Principles
- Exploded Views
- Technical Simulation
- Multiple Modules



FESTO

Refrigeration Training System

- Data Acquisition
- Pressure-Temperature Relationship
- LVHVAC Software
- Electrical Measurements
- Troubleshoot Faults
- Determine COP and NRE



FESTO

Refrigeration Laboratory Unit

- VCC Varied Conditions
- Refrigeration Energy Balance
- Coding Condensing Temps
- Power Basis Comparison
- Condenser Coil & Heat Transfer Coefficient



Commercial Air Conditioning Trainer

- Water Chiller Components
- Condenser Outlet Temps
- Sub-cooling Calculations
- Heat Rejection Function
- Filter Drier & Moisture
- Pressure Control Function
- Capacity Calculations



Multipurpose Heat Pump Trainer

- P, T, Flow, Electrical Measurements
- TXV & Capillary Performance
- Evaporator, Heat Pump, Compressor, Refrigeration Capacity
- P-H Charting



Centrifugal Fan & Air Ducting Trainer

- AHU Components & Assembly
- Duct Pressure Losses
- Fan Pressure & Flow Characteristics
- Airflow Measurement Methods & Balancing Control
- Branch Investigation



Ventilation System Trainer

- Air Duct Components
- Manometer- Installation & Calibration
- Air Velocity Measurement
- Fan Speed & Pressure effects
- Filters Velocity Characteristics



Central Air Conditioner Training System

- AHU Safety Systems and Components
- Chiller Components
- System Checking
- Troubleshooting & Fault Finding
- System Logs



Industrial Air Conditioner Trainer

- Background Theory
- Open Loop Analysis
- Closed Loop Exploration
- Air Mixing Observed
- Psychometric Charts
- Air Velocity



Refrigeration Laboratory Unit

- Energy Balance Calculation
- Fridge Duty Variation
- Heat Transfer Coefficient
- Expansion Valve Performance
- Power Input Analysis



Instrumentation & Process Control



EduKit PA Process Engineering

- Energy Efficiency
- Closed-Loop Control
- FluidLab PA Software
- LabVIEW Compatible
- Pneumatic Pitch Valve
- Modular Concept



Process Control Training System

- Pressure, Flow, and Level
- PID Controller
- Temperature
- pH Control
- Process Dynamics
- Troubleshooting



Process Control PFL Training System

- Temperature
- Pressure, Flow, and Level
- Air Pressure and Flow
- pH and Conductivity
- Smart Transmitters
- Faults

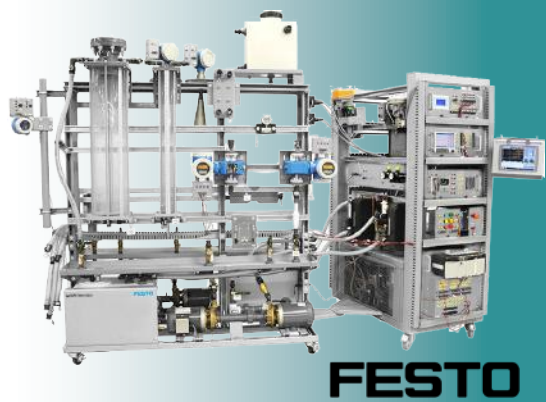

PlantPax DCS Process Control Demonstrator

- Rockwell Automation
- Smart Transmitters
- Hart Protocol
- Foundation Fieldbus
- Profibus PA
- Ethernet/IP



Three-Phase Separator Learning System

- Oil Separation
- Basic Pneumatics
- Smart Instrumentation
- Effects of Gravity
- Effects of Layer Thickness
- Oil/Water/Gas Ratio



Process pH and Conductivity Training System

- Conductivity Measurements
- Water Organization
- Batch pH Process
- Chemical Solutions
- Titration
- Troubleshooting



Air Pressure/Flow Process Learning Systems

- Industrial PID
- Digital Positioners
- Valve Theory
- SCADA / DCS Software
- Tuning and Control
- Pressure Loss



Process Control/Instrumentation

- Level, Flow, Pressure
- Temperature
- PID Controllers
- Onboard PLC & HMI
- Gear Pumps
- Proportional Flow Control



PA Process Automation Applications

- Filtering Station
- Mixing Station
- Reactor Station
- Battling Station
- Unlimited Possibilities
- Environmental Discovery



Temperature Process Control Trainer

- PID Controller Tuning
- Disturbance Response Investigation
- Parameter Influence Analysis
- Cascade Control Application
- DAQ Variable Processing
- SCADA-based Monitoring
- Open and Closed Loop Implementation



Cooling Tower Trainer

- Psychrometric Chart Plotting
- Heat Transfer
- Air Velocity Approach Effect
- Water Circulation Cooling Range
- Water/Air Ratio Coefficient



Level Process Control Trainer

- Familiarization with Controllers, Transducers, Actuators
- Process Variables using Data Acquisition



Multi Process Control Trainer: Level, Flow, Temperature and Pressure

- Multi-process Calibration
- Level, Temperature & Flow Sensor Elements
- Heat Radiator Exchange
- Water Float Switch
- PID Control



Process Control Trainer, PH

- Calibration Process Control Elements
- Demonstrating Open & Closed Loop Control
- Tuning of PID
- Process of pH Control System



CNC Machining & Woodworking



Venus Plasma Cutter

- 20" X 30" Process Area
- Precision Ball Screw On All Three Axes
- Hypertherm Torch
- Brushless Micro Stepper
- Water Tray with Vertical Grid
- Electro Torch Breakaway



Compact Concept Mill

- Up to 9 Controls
- Adjustable Main Drive
- Automatic 8 Station Tool Turret
- High-Resolution Axis Motors
- Electromechanical Tailstock
- Robotic Interface

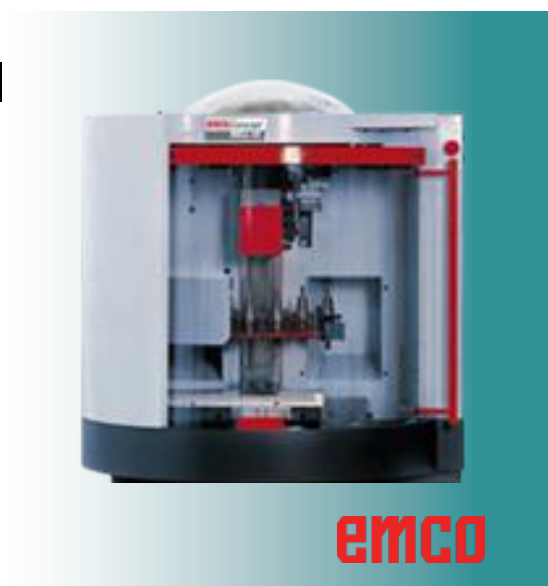

CT60 Concept Turn

- Interchangeable Control
- Linear Rail Guides
- 16 mm Spindle Bar
- High Resolution Axis Motors
- Tool Turret
- 4200 rpm Spindle

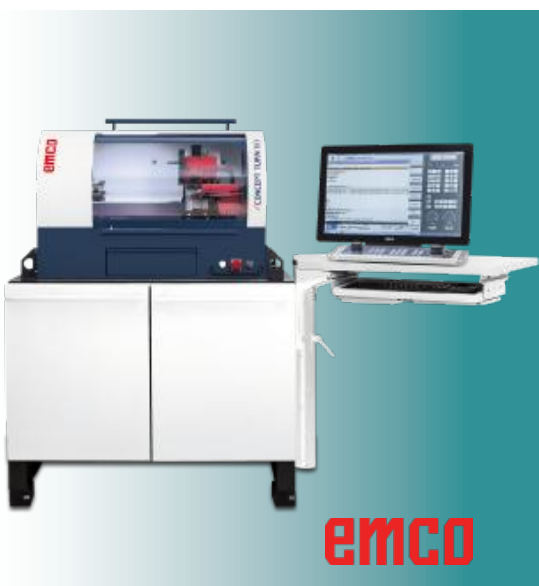

WINNC Interchangeable Control Software

- Interchangeable Controls
- PC Simulation
- G-Code Compatibility
- Tool Offsets
- Virtual Panel
- Real Emulation
- Rapid Switching



BT 1212 Table Top Router

- 3 Axis Precision Ball Screws
- Brushless Micro Stepper Motor Control System
- Compatible G & M code
- Hand Held Controller
- 800 Watt (1HP) Variable Speed Spindle 8,000-24,000 RPM



HDS Dual Bed CNC Router

- Maintenance Free Brushless AC Servo Motors & Drives
- 4Zone Vacuum T-Slot Table
- Pneumatic Operated Dust Collector
- Easy Sheet Alignment
- PC with Monitor & Accessories



CM55 Concept Mill

- Interchangeable Control
- Automatic Reference Points
- Variable Main Drive
- Large Safety Glass Window
- Tool Changer
- Cast-Iron Construction



Nomad 3 - Desktop CNC Mill

- Cuts all types of wood
- Cuts most types of plastic
- Cuts Aluminum, Brass, & Copper
- 8" x 8" x 3" Cutting area
- 17.5" x 19" x 17" Footprint



WIN3D-View

- Realistic Construction
- Collision Control
- Scaling
- Sectional View
- Integrated Tool Library
- Tool Graphics

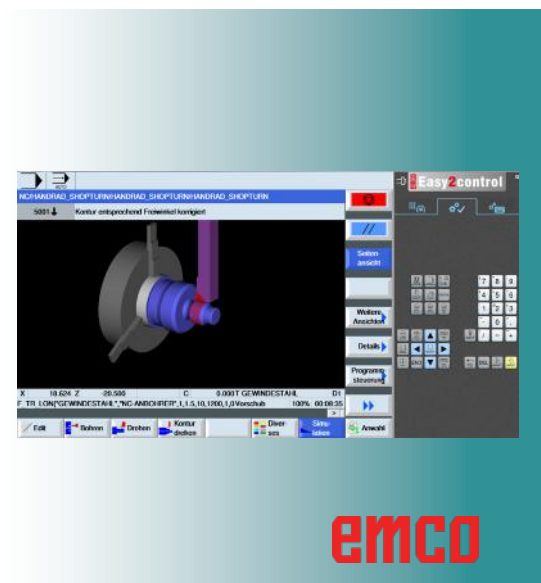

HD II Tabletop CNC Router

- 20" x 30" Process Area
- Precision Ball Screws
- High Frequency Collet Spindle
- Linear Rails and Bearings
- Vacuum T-Slot Table
- Handheld Controller



Shapeoko 4 CNC Router

- Rigid aluminum frame
- Powerful trim router
- Easy assembly setup
- Precision motion control
- Expandable work area
- User-friendly software

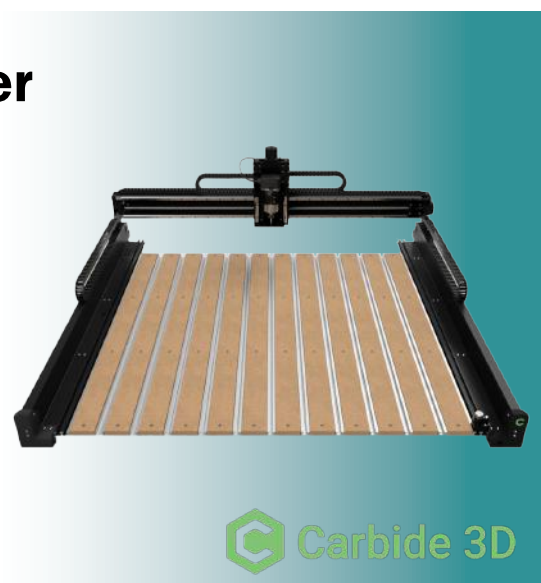

Atlas CNC Wood Router

- Console Work Station
- High-Frequency Collet Spindle
- Maintenance Free Brushless Drive Motors
- Handheld Controller
- Open Architecture



Iconic CNC Wood Router

- Extruded Aluminum Frame
- Integrated MDF Spoil Board
- Auto Tool Touch-Off
- Precision Ball Screws
- 1HP Electro Spindle
- RichAuto 811 CNC Controller



Elite CNC Wood Router

- Servo Driven Performance
- 3HP ER-20 Electro Spindle
- Liquid Cooling System
- Precision Ball Screws
- Prismatic Guide
- Industrial 4 Axis Controller



Automotive & Diesel

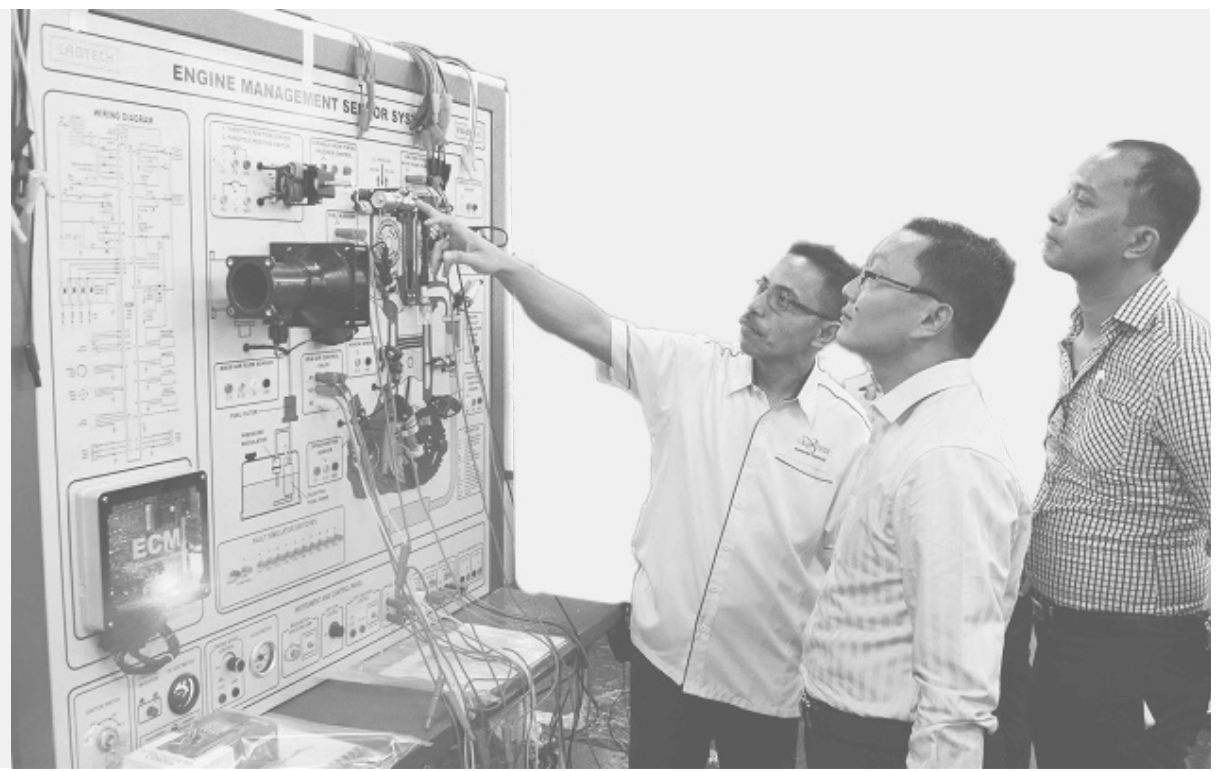

Crane and Lifting Simulation Systems

- Forklift
- Tower Crane
- Mobile Crane
- Crawler Crane
- Boom Truck
- Realistic Equipment



Traffic Simulation Training Systems

- Car
- Long-Hauler
- Truck with Trailer
- Bus
- Van



Front Wheel Alignment Trainer

- Pre-Alignment Check Procedures
- Study of Caster
- Study of Chamber
- Steering Axis Inclination
- Alignment of Steering Gear
- Track Alignment
- Study of Set Back



Earthmoving Simulation Training Systems

- Backhoe
- Dozer
- Excavator
- Motor Grader
- Wheel Loader
- Realistic Environments



Sectioned Front Suspension Steering Unit Wishbone Type

- Steering Suspension Demonstration
- Stabilizer Function Exposure
- Steering Linkage Function
- Suspension System Study
- Break System Operation
- Functional Steering
- Shock Absorber Operation



Shock Absorber and Test Stand

- Shock Positioning
- Chassis Lean Simulation
- Axle Lean Simulation
- Variable Road Conditions
- Friction Effect Observation
- Hand Break Testing
- Data Acquisition Analysis
- Suspension Performance Recording



Antilock Breaking System ABS Trainer

- Automotive Electrical Components
- Acceleration and Deceleration
- Wheel Slip Effects
- Hydraulic Circuit Function
- Solenoid Valve Control
- Electrical Fault Diagnosis



Automotive Air Conditioning & Heat System Trainer

- Clutch System Cycling
- Heating and Air Distribution Control
- Filtration System Operation
- Coolant Recovery Systems
- Coolant Leakage Checks
- Electrical Control Failures
- Climate Control Services



Automotive Engine Control Management Trainer

- ECM Fault Management
- Sensor and Transducers
- Mechanical Actuator Control
- Fuel System Electronics
- Emission Control Components
- ECM Parameter Overview



Can Bus Automotive Electrical System Trainer

- CAN Bus Operation
- Vehicle Wiring Systems
- Short and Open Circuit Detection
- Breakout Terminal Testing
- Component Failure Identification
- Engine Management



Engine Management Principles Trainer

- ECU Voltage References
- Crank/Cam Sensor Functions
- Coolant Sensor Operation
- Flash-to_OBD Conversion
- Temperature-Injection Influence
- Air-Fuel Ratio
- Turbo System Principles



Vehicle Display Principles Trainer

- Coil and Bimetal Gauges
- Speed and PIP Sensors
- Speed Sensor Observation
- Warning Indicator Principles
- Airbag System Diagnosis
- SRS Impact Sensor
- ECU Sensor Connection
- Oscilloscope Signal Observation



Automotive Lighting Circuit Trainer

- Vanity Light Investigation and Troubleshooting
- Door-Contact Troubleshooting
- Reversing Light, High/Low Beam, Hazard Light, and Turn Signal Troubleshooting
- Vehicle Lighting System
- Headlamp Relay Circuit



Suspension and Shock Absorber Trainer

- Electronic Power Management
- Shock Absorber Actuator
- LED Damping Display
- Road Surface Simulation
- Suspension Simulation Model
- Brake Control Potentiometer
- Diagnostic Test Points



Mechatronics & Advanced I4.0 Manufacturing

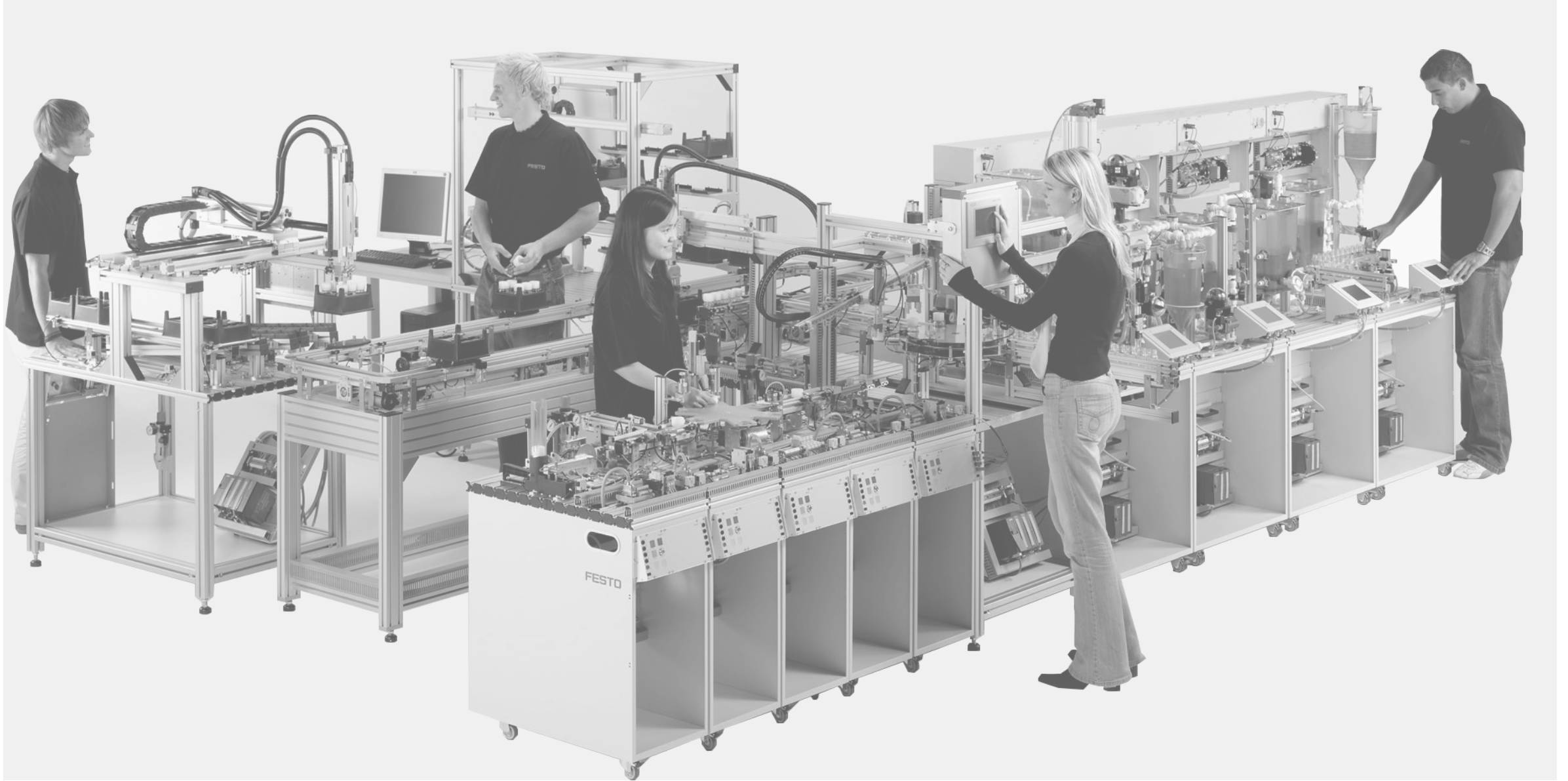

MPS 403-1 Advanced I4.0 Training System

- IoT Retrofitting
- Network-Based Protocols
- Customized Products
- RFID Technology
- IO-Link-Based Sensors
- Human/Machine Interfaces



Compact Cyber Physical Lab 400 Series

- Industry 4.0 Training
- Compact Design
- Modular System
- Industrial Components
- Plug-and-Produce
- Expandable Ecosystem



Cyber Physical Factory

- Modularity
- IT/OT Integration
- IoT Connectivity
- Automation
- Data Analytics
- Collaboration
- Scalability

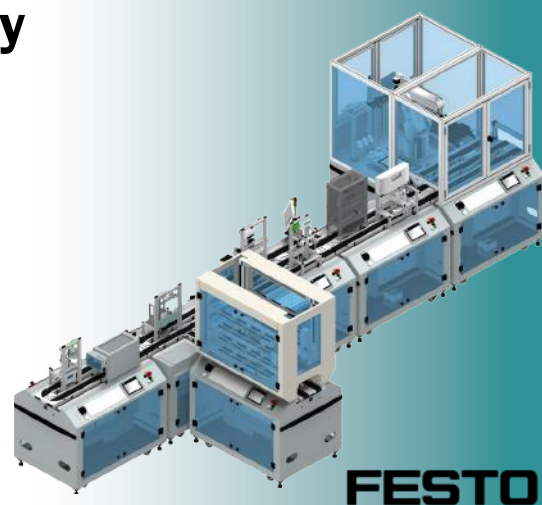

MecLab System

- Stacking Station
- Conveyor Station
- Handling Station
- Fundamentals of Pneumatics
- Modular and Flexible
- Expandable

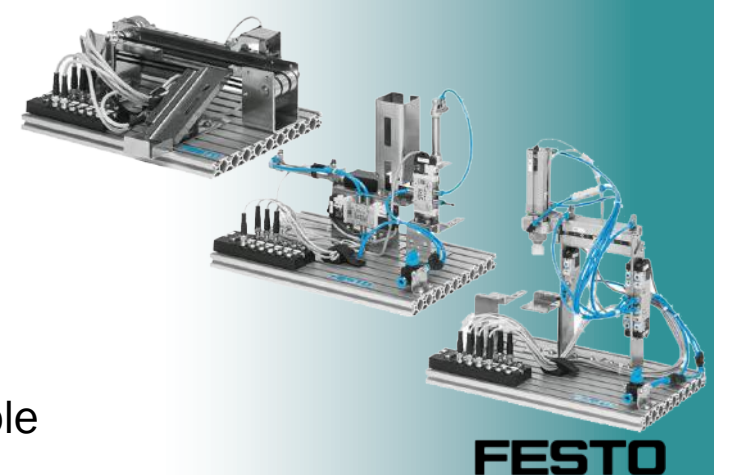



MPS Modular Production System Series

- Manufacturing and Assembly
- Multiple Applications
- Robot-Supported Assembly
- Expandable
- Safety Modules
- Choice of PLC



FESTO

CIROS Automation Simulation Software

- PLC Integration
- Multiple Control Platforms
- Safe Commissioning
- Simulated Sequences without Hardware
- Realistic Environments
- Custom Process Models

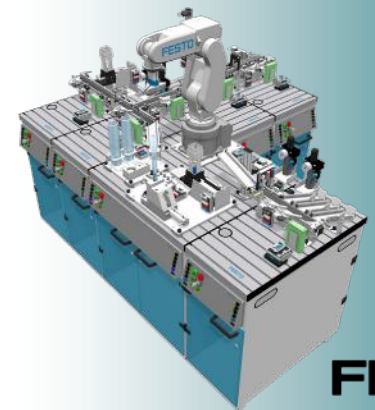

FESTO

MES Manufacturing Execution Software

- Graphical System Configurator
- Work Schedule Editor
- Production Control
- TCP/IP or OPC UA Communication
- Order Management

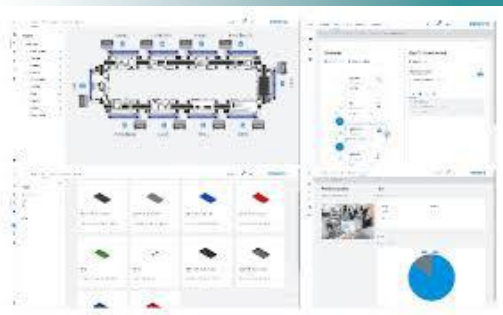

FESTO

FluidSIM ML MecLab Simulation Software

- Universal PC Interface
- Pneumatic Circuits
- Electrical Circuits
- Create and Control
- Integrated PLC
- Symbols



FESTO

PLCs

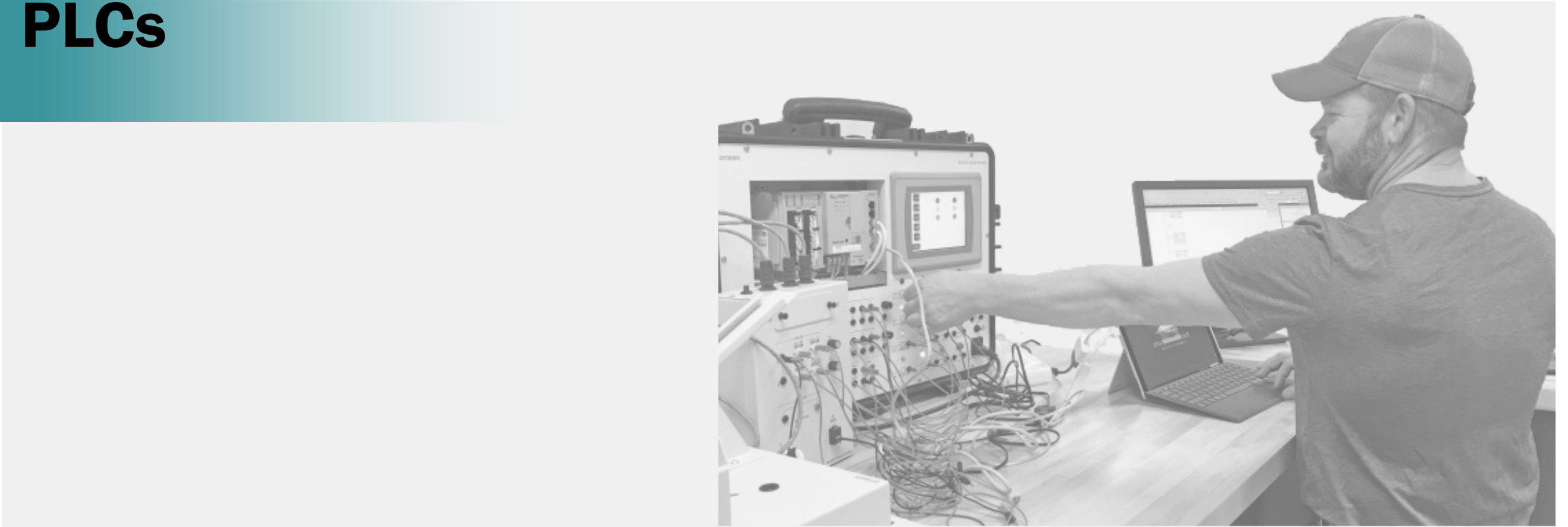

Allen-Bradley MicroLogix 1100

- 14 Digital Inputs (24VDC)
- 10 Relay Outputs
- Twelve Fault Switches
- PID Control
- Rackless I/O Expansion
- 3 Push Buttons & 4 Toggle Switches



Future Tek Inc.

Siemens ET200S

- 24V Built-in Power Supply
- 8 Inputs (24VDC)
- 12 relay outputs (24VDC)
- Eight Fault Switches
- PID Control
- Rackless I/O Expansion
- 4 Toggle Switches & Push-Buttons



Future Tek Inc.

Omron CPM1A

- Compact Design
- 12 Digital Inputs
- 8 Relay Outputs
- Hydraulic/Pneumatic Work Surfaces
- Compatible with 8036
- Includes Curriculum



FESTO

Moeller EASY512

- 8 Digital Inputs
- 4 Relay Outputs
- LCD Display
- 2 Configurable Analog Inputs
- EASY-SOFT Basic Software



FESTO

Programmable Logic Controller Trainers

- Human Machine Interface
- Ladder Programming
- Mnemonic Code
- Logical Continuity
- I/O Devices
- Counters, Sequencers, Shift Registers
- Comparison Instructions



LAB TECH

Motor Control and Protection Trainer PLC

- Motor Controls Basic Trainings
- PLC for Motor Operation Control
- DC and AC Drives
- Photoelectric and Proximity Switches



LAB TECH

Flexible Manufacturing System

- Simulates Production Line
- Modular Design
- Multiple Sensors
- Pneumatic Devices
- Servo Control
- Operator Panel
- Fault Insertion
- Wiring Skills



Traffic Light System

- Classic Trainer
- Traffic Control and Pedestrian Crossing
- Expandable System
- Sensors and Light Sync
- Fault Insertion
- Long Life LEDs
- 10 Inputs
- Job Sheets



Controller CECC

- Compact PLC
- CODESY Programming
- 12 Digital Inputs
- 8 Digital Outputs
- 2 High Speed Counters
- USB Data Transfer
- IO-Link Master



Electro-Pneumatic System

- Two Double-Acting Cylinders
- Reed & Mechanical Limit Switches
- Perforated Work Surface
- Solenoid Valve Station
- Stamping, Punch, Filling
- Fault Insertion
- 3 Control Signals (24VDC)



Electro-Mechanical System (DC Motor)

- Drives & Lead Screw
- 1800 RPM, 90VDC motor
- Magnetic Limit Switches
- Bi-directional DC Drive
- Perforated Base
- Fault Insertion
- 100 ppr Encoder
- 3 Control Signals



Wind Turbine System

- Nacelle & Wind Generator
- Small Air Blower
- DC Motor with Clutch
- Two Limit Switches
- Analog Wind Direction Sensor
- Wind Speed Pulse Signal
- 2 Control Signals



Level Process Control System

- Submersible Variable-Speed Pump
- Level Process Column
- Electronic Level Interface
- Float, Capacitive, & Magnetic Switches
- Solenoid & Manual Valves
- Self-regulation Process
- Batch & PID Control



Bottling Process System

- Canister Capping Process
- Pneumatic & Motion Control
- 2 Stepper Motors
- Dual Motor Drive
- Inductive & Mechanical Switches
- Solenoid Valve
- Double-Acting Cylinder
- Liquid Filling

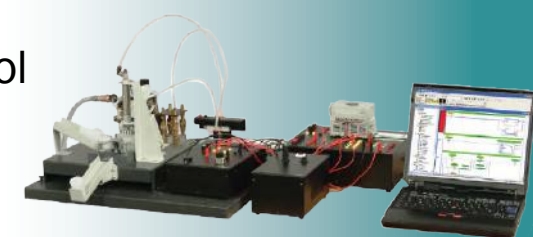

Robotics & Automation

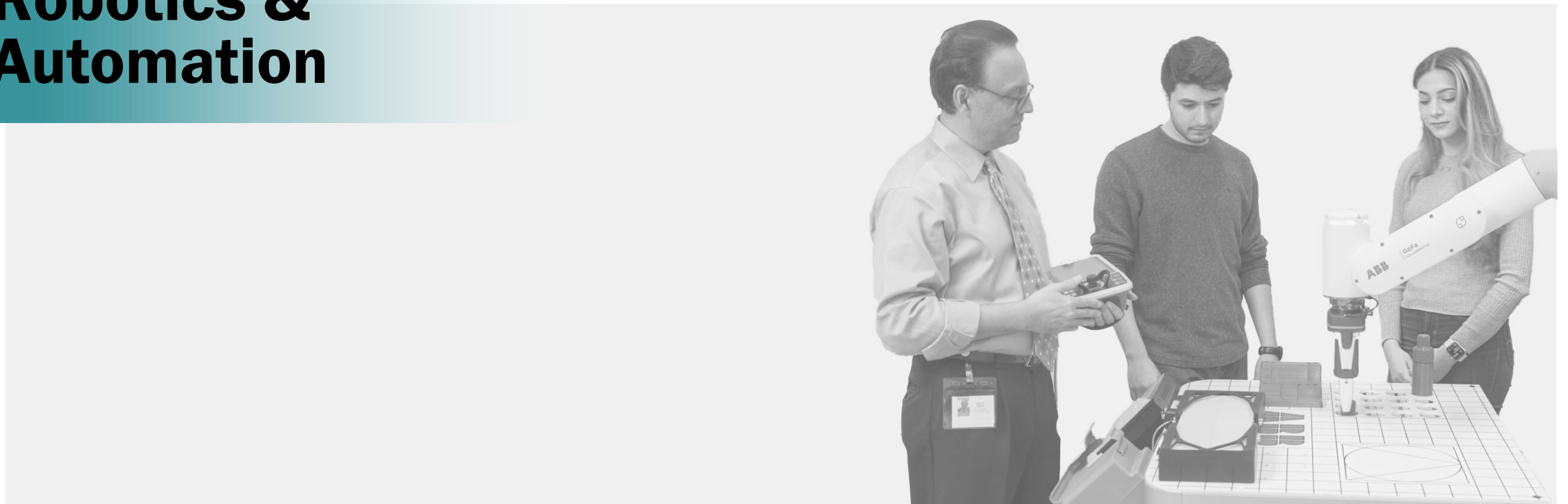

ROOTS FTM Board

- Modular Robotics Training
- Mechatronics System
- Industry Relevant Training
- Flexible Training Platform
- Practical Technical Education
- Automation Skills Practice
- Progressive Competency

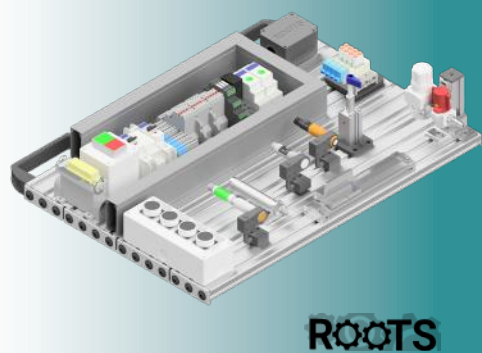

ROOTS

Robotic Arm Trainer, 6 Axis

- Portable
- Lightweight
- Plug and Play
- User Friendly
- Power Efficient
- Corresponding Curriculum



LAB TECH

Mirobot Desktop Robotic Arm

- 6-Axis Robotic Arm
- Open Source Platform
- End-Effectors and Accessories
- Extender Box
- Remote Controller
- Compact



WLKATA

Gen 3 Lite Robotic Arm

- Portable
- Lightweight
- Plug and Play
- User Friendly
- Power Efficient
- Corresponding Curriculum



KINOVA

Link 6 Collaborative Robot

- 6-Axis Cobot
- Compact Controller
- Machine Tending
- Small Parts Assembly
- Quality Control and Assurance
- Corresponding Curriculum



KINOVA

STEM Flextrainer

- Collaborative Robot
- Tabletop Workspace
- Material Handling
- Machine Tending
- Assembly
- Picking and Packaging



ABB

ABB Fenceless FlexTrainer Robot Training System

- Compact Training Setup
- Safe Collaborative Design
- Flexible Robot Simulation
- Easy Operator Instruction
- Portable Learning Platform



ROOTS Robotic Rise Cell

- Conveyor Tracking
- Advanced Pick & Place
- Automated Palletizing & Sorting
- External Device Control
- Robotic Languages, Vision Systems, and Calibration
- Robotic Integration Technician

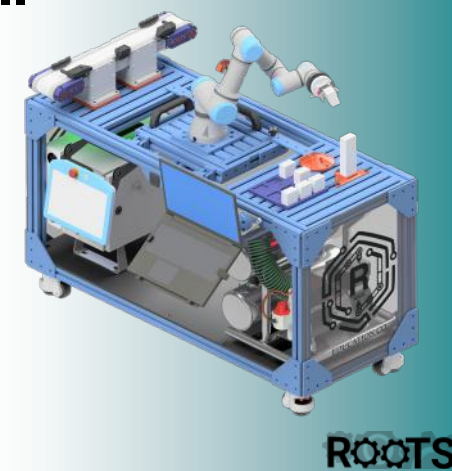

ROOTS Care Medical Robot Cell

- Innovative Healthcare Technology
- Hands-On Experience
- Interdisciplinary Learning
- Ethical Consideration
- Career Pathways
- Diverse Patient Needs
- Skills Training



GoFa Material Handling

- Integrated Vision
- Conveyor
- Electric Gripper
- STEM Activity Tabletop
- HMI Interface
- Courseware and Education Kits
- OmniCore Controller



GoFa - 5 Lincoln Electric Education Package

- Adaptive Arc Welding Robot Arm
- Cooper TM App
- R450 Power Source
- 4R100 Wire Feeder
- PRO Air-Cooled Robotic Torch
- Welding Cart and Tooling Table



Dobot MG400

- Compact Design
- High Repeat Accuracy
- User-Friendly Interface
- Lightweight Industrial Design
- Flexible Programming Options
- Safe Collaboration
- Versatile Tasks



MT4 Metal 4 Axis Robotic Arm

- High Precision Repeatability
- Durable Metal Construction
- Four-Axis Flexibility
- ROS2 Compatible Platform
- Arduino Rebuildable System
- Education-Focused Design



Haro 380 6 Axis Mini Robot Arm

- Compact Six-Axis Design
- High Precision Motion
- Versatile Training Platform
- Durable Metal Build
- Smooth Servo Control
- Classroom Friendly Footprint
- Easy Software Integration
- Reliable Performance



Welding Technology



Phoenix CNC Plasma Cutter

- Large Capacity
- Multiple Torch Option
- Water Table Tray
- Gantry Uprights
- Brushless Drive Motors
- Electronic Torch Breakaway



Techno
CNC
Systems

Venus Tabletop Series CNC Plasma Cutter

- Electronic Torch Breakaway
- Controller
- Fully Enclosed
- Water Table
- 20" x 30" Process Area
- Precision Ball Screws



Techno
CNC
Systems

Welding Booth & Equipment

- Robust Booth Construction
- Superior Spark Protection
- Durable Welding Curtains
- Modular Booth Design
- Heavy-Duty Frames
- Reliable Ventilation Options
- Easy Set Up



ZIGMI
Greene Manufacturing, Inc.

zSpace Welding Simulation Software

- Realistic Gestures
- Train Long Workpieces
- In-Depth Tracking
- Environmentally Friendly
- Track and Adapt
- Student Learning Path
- Safe Experience



zSpace

ABB GoFa Cobots Welding Package

- High Precision Welding
- User-friendly Programming
- Fast Development Setup
- Consistent Weld Quality
- Smooth Torch Control
- Safe Collaboration
- Compact Robotic Cell
- Consistent Weld Quality



ABB



Cellular Mobile Phone Trainer

- Operation, Theory, Programming, Servicing, Problem Diagnosis, and Repair of Cellular Mobile Phones
- Specially Modified for Training Purposes
- Telephone Display, GSM, Microphone Programming
- Courseware



LAB TECH

Telephony Training System

- Analog Access
- Central Office Operation
- Digital PABX
- PABX Analog Trunk
- Digital Trunk
- Fault-Insertion



FESTO

Communication Technologies Training System

- Pulse Modulation
- Digital Modulation
- Data Transmission
- Phase Shift Keying
- Amplitude Modulation
- Asymmetric Digital Subscriber Line



FESTO

Radar Training System

- Synthetic-Aperture Radar
- Principles of Radar Systems
- Analog MTI Processing
- Fault-Insertion Capability
- Digital Analysis
- Digital MTD Processing



LAB TECH

Antenna Training and Measuring System

- Antenna Measurements
- Circular Polarization
- Microstrip & Array Antennas
- Radiation Pattern
- Microstrip Technology
- Half Wave Folded Dipole



LAB TECH

Makerspaces and Innovation Labs



Cobot MDAC1 3D Printing STEM Education Package

- Beginner-Friendly Robotics
- Integrated 3D Printing
- Modular STEM Toolkit
- Classroom-Ready Setup
- Hands-On Learning
- Safe Student Operation
- Interactive Coding Exercises
- Engaging Project Workflow

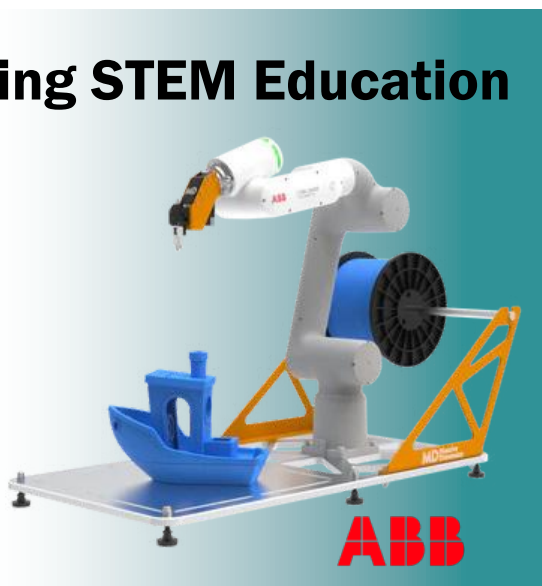

MDAC2 - 6 Axis Robot Pellet Printer

- Six-Axis Pellet Printing
- High-flow Extrusion
- Advanced Motion Control
- Industrial-grade Precision
- Versatile Material Capability
- Robust Training Platform
- Easy Maintenance Design
- Efficient Production Flow

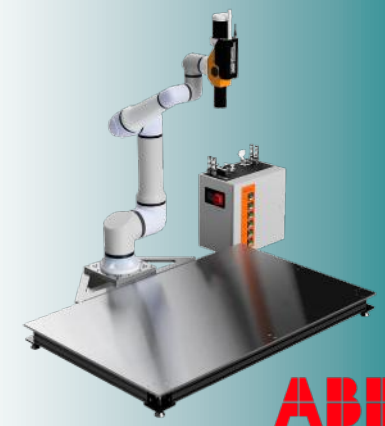

Bambu Lab H2C

- High-Speed Performance
- CoreXY Precision Motion
- Dual-material Capability
- Advanced Thermal Management
- Intelligent Print Automation
- Durable Modular Design



Bambu Lab A1 3D Printer

- Fast Printing Speeds
- Precise Motion Control
- Multi-Material Ready
- Quiet Operation Mode
- User-friendly Interface
- Reliable Build Quality
- Smart Calibration Routines
- Vibrant Touchscreen Controls

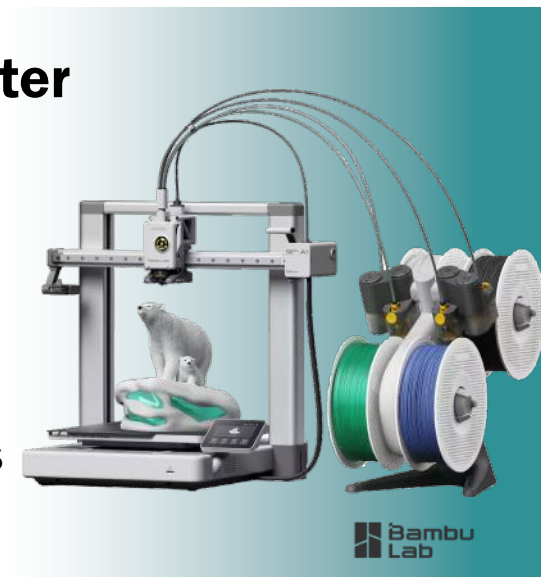

Bambu Lab P2S

- High-speed Printing
- Enclosed Chamber Design
- Multi-material Capability
- Advanced Cooling System
- Precision Motion Control
- Reliable Automation Features



Bambu Lab P1P 3D Printer

- Fast Printing Performance
- Open-Frame Design
- Reliable CoreXY Motion
- Easy Upgrade Platform
- Consistent Print Quality
- User-friendly Setup
- Stable Layer Adhesion
- Lightweight Compact Footprint

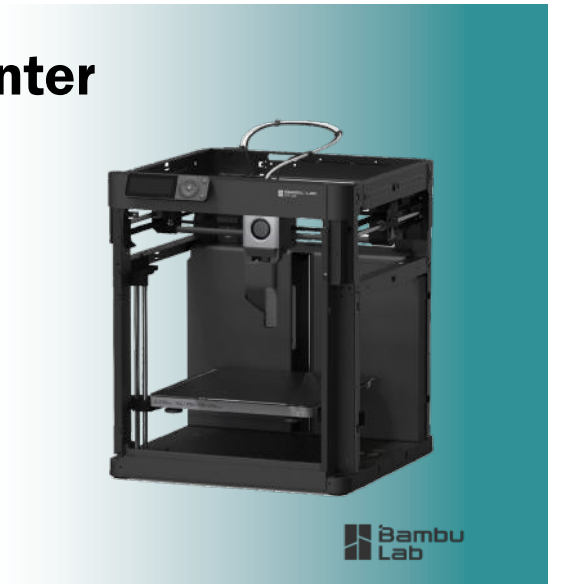

FM1

- Compact Desktop Printer
- High-precision Extrusion
- User-friendly Interface
- Reliable Print Performance
- Durable Build Platform
- Versatile Filament Compatibility

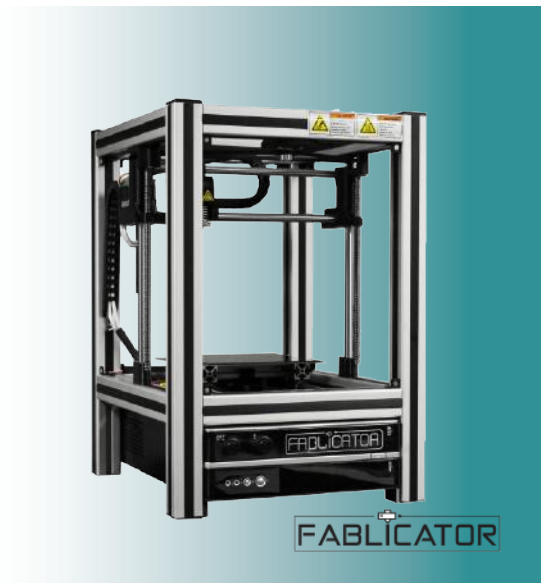

Bambu Lab H2D

- High-Speed Printing
- Dual-Extrusion Capability
- Precision Motion System
- Advanced Cooling Performance
- Intelligent Automation Features
- Reliable Build Quality



MX

- Large-format Printing
- Multi-material Capability
- High-precision Motion
- Industrial-grade Durability
- Advanced Temperature Control
- Reliable Automated Printing

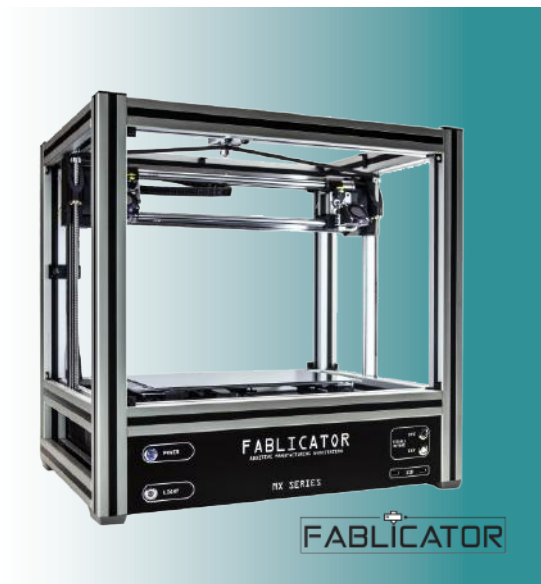

SX

- Dual-extruder System
- High-speed Printing
- Precision Layer Control
- Robust Metal Frame
- Versatile Material Support
- User Friendly Touchscreen
- Consistent Quality Output

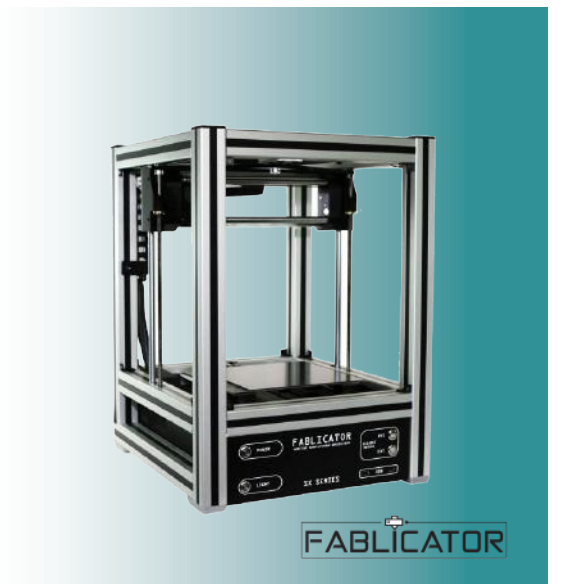

3D Print-Pro Fume Extractor

- Powerful Fume Extraction
- Quiet Operation Mode
- Adjustable Suction Control
- HEPA Filter System
- Compact Desktop Design
- Long Filter Lifespan
- Continuous Duty Cycle
- Flexible Hose Attachment



C02 CNC Laser Cutter

- Easy-to-use Control
- Downdraft Fume Evacuation
- Precision Linear Rails
- Micro Stepper Controller
- All-Steel Construction
- Lifetime Technical Support



Furniture & Charging Carts



Rally Tables

- Three Heights
- Sit, stand, learn, make, or collaborate
- Two seat variations
- Choose your top style, frame, and other customizable features



Esports Gaming Chairs

- Adjustable heights
- Customizable features
- Vast selections



Getzen Metal Tables

- Picnic Tables
- Round and Square
- Pedestal Tables
- Customizable Features



LC36 Lower Storage Cabinet

- Large Storage Capacity
- Adjustable Shelves
- Easy Cord Access
- Locking, Acrylic-Panel Doors
- Color Choices
- Optional Work surfaces



Portable Mobile Room Divider

- High Quality Partition
- Noise Reducing Surface
- Infinite Configuration
- 360 Hinges
- Versatile Environments



Evaluate USB-C Charging Cart EDU

- Screens up to 15
- Up to 32 devices
- Hassle free
- Color Options



Modular Drawer Cabinet with Locks

- 200lbs Capacity Per Drawer
- All Welded Steel Construction with Powder Coat Finish
- Single Key Cylinder Locks for All Drawers



Immersion XR Cart 2.0

- Pull Out Drawers
- Universal Fit Foam
- Dual Bolt Key Lock
- Ventilated Panels
- Mobility



Adjustable Height Workbench 60 x 30"

- Kiln Dried Hardwood
- Hard Wired Outlet
- Optional Plug-In Outlet
- Scratch Resistant Steel
- Adjustable Legs



Immersion XR Case

- Includes Mobility Handle and Wheels
- Large Charging Capacity
- Removable Frame and Trays
- Watertight Construction



InVision Element Table

- Dynamic Workspace
- Customizable Features
- Self Levels
- Clean Cord and Wire Channels
- Display Stand
- Scratch Resistant



Connect 10 Locker

- Includes Mobility Handle and Wheels
- Large Charging Capacity
- Removable Frame and Trays
- Watertight Construction



Semiconductors



Festo's student semiconductors showcase the thoughtful creativity and technical curiosity of emerging engineers. Developed with careful attention to performance and reliability, these student-led designs reflect a fresh perspective on modern semiconductor innovation. Their work brings a quiet but confident sense of progress—promising new ideas, steady advancement, and a bright future for intelligent technology.

FESTO

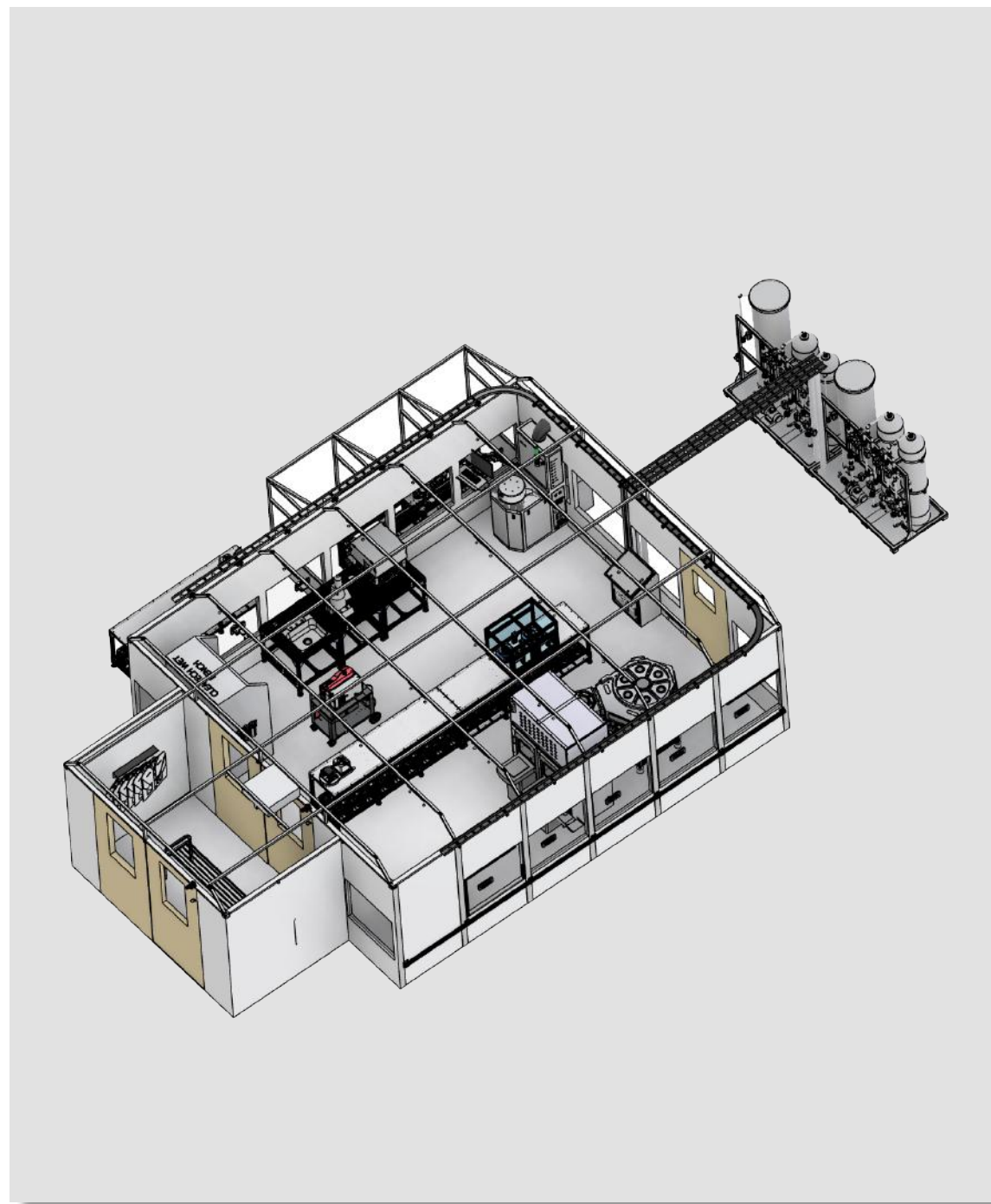

ROOTS' semiconductor trainers combine practical learning with hands-on innovation, giving students the tools to explore and understand modern chip technology. Designed to inspire curiosity while building real technical skills, these trainers reflect a thoughtful approach to education and development. They offer a steady, engaging pathway for the next generation of engineers to experiment, learn, and grow with confidence.

ROOTS

VIVED Life Sciences Simulation AR/VR Software

- Astronomy
- Botany
- Earth Sciences
- Human Anatomy
- Microbiology
- Zoology



Virtual ECG Simulation AR/VR Software

- Electrocardiography (ECG)
Electrode Placement
- Heart Lead Regions
- Heart Conditions



3D Modeling Simulation AR/VR Software

- Sculpt
- Paint
- 3D Print Your Designs



Human Anatomy Simulation AR/VR Software

- Models of Human Body
- Muscular Movement
Animations
- Self-Assessment



3D Mechanical Simulation AR/VR Software

- Perform Processes
- Inspect 3D Prototypes
- Build Problem Solving
Skills
- Improved Dexterity
- Reduced Training
Costs



Dental Simulation AR/VR Software

- Virtual Living Body
Structures
- Relationships Between
Various Organs
- Dental Problems
- Oral Diseases
- Dental Procedures



Hydraulic & Pneumatics AR/VR Software

- Multiple Components
- Working Principles
- Exploded Views
- Realistic Flow
- Build Circuits





Industry-recognized credentials are more valuable than ever—and they can set candidates apart in a competitive job market. Employers actively seek individuals who bring proven expertise, practical skills, and the confidence to excel from day one. Our stackable technical credentials in maintenance, manufacturing, and automation empower learners to quickly build in-demand skills through flexible, short-term courses. Whether starting a new career or leveling up, learners can chart a clear pathway to advancement and unlock new opportunities with credentials employers trust. Instructors attend Train-the-Trainer sessions to become certified to teach the curriculum to their students. Their students are then able to earn industry recognized certifications at no cost.

Level 1 Certifications: Fundamentals

- Electricity - AC & DC
- Fluid Power - Pneumatics & Hydraulics
- Industry 4.0
- Mechanical Systems
- Sensor Technology
- PLCs - Allen Bradley & Siemens
- Robotics
- Industrial Wiring
- Certified Industry 4.0 Associate

Level 2 Certifications: Applied

- Industrial Motor Controls
- Fluid Power
- Mechanical Systems
- Principles of Smart Sensors
- PLC Technology II: Allen Bradley & Siemens
- Robotics
- Industry 4.0
- Product ID Fundamentals
- Certified Industry 4.0 Technician

Level 3 Certifications: Advanced

- Industrial Communications
- PLC Technology
- Smart Maintenance
- Industry 4.0
- Product I.D
- Robotics



| LEARNING THAT WORKS. SM

Industry Recognized Credentials

The logo for Siemens, featuring the word "SIEMENS" in a bold, teal, sans-serif font.

Siemens Mechatronic Systems Certification Program



German American
Chambers of Commerce
Deutsch-Amerikanische
Handelskammern

German AHK Mechatronics Exam Certification



NIMS Industrial Maintenance Technician



NATIONAL CENTER
FOR CONSTRUCTION
EDUCATION AND RESEARCH

National Center for Construction Education & Research



National Occupational Competency Testing Institute



ABB Globally Recognized STEM Certification Program



Festo Industry 4.0 Certification Program



Packaging Machinery Manufacturers Institute

