



**AUTOMOTIVE STORAGE EQUIPMENT
FOR YOUR CAR DEALERSHIP**



PARTS & SERVICE 2026-2027

**SINCE
1950**

ROUSSEAU EXPERTISE

ROUSSEAU IS THE GLOBAL LEADER IN THE DESIGN AND MANUFACTURE OF FLEXIBLE AND HIGH-QUALITY STORAGE SOLUTIONS!

ROUSSEAU: SERVING INDUSTRIES THROUGH EXPERTISE AND INNOVATION

Rousseau designs and manufactures shelving, drawer and workstation systems for professional use. Known for their industry-leading durability, quality and innovations, our products are sold through a network of specialized partners who work in a wide range of sectors.



THE ROUSSEAU DIFFERENCE IS...

Flexible and customized solutions, modular and scalable design, unrivaled quality and durability. And above all, it means choosing a manufacturer and distribution partners who always put customers first.

MEANING OF THE ICONS



New Product



Improved



New Model



Design Patent



Design Patent Pending



New Dimensions



5S Storage



This product can be made mobile



Patented



Patent Pending



Registered Trademark



Idea

To learn more about patented products, registered industrial designs, and trademarks, visit the website rousseau.com

TABLE OF CONTENTS

DESIGNED, DEVELOPED AND MANUFACTURED IN NORTH AMERICA

We invest heavily in product development, modernization of our facilities, new technologies and our employees to offer premium-quality products, from design to manufacturing to end product.

Our goal is to understand your requirements so we can create tailored solutions that meet your expectations and needs in terms of your environment (new construction or existing construction) and priorities.

SERVICE DEPARTMENT

INTRODUCTION	
INTRODUCTION TO THE SERVICE DEPARTMENT	2-3

WORKBENCHES AND WORKSTATIONS

ERGONOMIC WORKBENCHES AND WORKSTATIONS	
FACTORS TO CONSIDER	4
Frequency of use	4
Importance of quick identification	4
Size and weight	4
Purpose and category	4
STORING AND ORGANIZING ITEMS	5
CREATE YOUR OWN WORKCENTER	
5 easy steps	6
How to create your own workcenter	7
Step 1 - Type of work surface	8
Step 2 - Under the work surface	9-10
Step 3 - Above the work surface	11-14
Step 4 - Center	15-18
Step 5 - Sides of bays	19

WORKCENTERS	
DOUBLE WORKCENTERS	20-27
12'W (144"W) work surface	20-21
10'W (120"W) work surface	22-23
8'W (96"W) work surface	24-25
7'W (84"W) work surface	26-27
SINGLE WORKCENTERS	28-33
6'W (72"W) work surface	28-29
5'W (60"W) work surface	30-31
4'W (48") work surface	32-33

R WORKSTATIONS

CORNER WROKSTATIONS	34-39
Introduction	34
Corner workstations - 0030	35
Corner workstations - 0630	36
Corner workstations - 1230	37
Corner workstations - 1830	38
Accessories	39
TEKZONE WORKSTATIONS HUTCH	40-43
Introduction	40
4 easy steps	40
Step 1 - Dimensions and panel types	41
Step 2 - Power feed panel	41
Step 3 - Type of surface	41
Step 4 - Accessories	42-43
TOOLBOXES	44-54
Introduction	44
Stationary toolboxes under the worksurface	45
Stationary toolboxes sides of bays	46-48
Mobiles toolboxes	49-51
Accessories	52-54
R2V VERTICAL STORAGE	55-60
Introduction	55
Height combinations	56-58
Accessories	59-60
CABINET FOR TWO USERS	61-62
REEL CABINETS	63-66

STORAGE UNITS	
STORAGE UNITS	67-70
STORAGE UNITS AND LOCKERS	71-72

MULTITEK	
MULTITEK CART	73-79
Introduction	73
Fits in storage units and under work surfaces	74-75
Next to the work surface	76-77
Accessories	78-79

SPECIALIZED UNITS	
SPECIALIZED UNITS	80-83
BASIC WORKBENCHES	84-86
SERVICE ADVISOR DESKS	87-93
Models	90-92
Accessories	93
PERSONALIZED PANELS	94

PARTS DEPARTMENT

INTRODUCTION	
INTRODUCTION TO THE PARTS DEPARTMENT	95-97

SPECIALIZED PARTS STORAGE

PARTS STORAGE	
SMALL AND MEDIUM-SIZED PARTS STORAGE	98-105
Shelving	98
Shelving with drawers	99
Banks of drawers for shelving	100
Cabinets with drawers	101
Shelving accessories	102-105
SPECIALIZED STORAGE	106-109
LARGE PARTS STORAGE	110-111
Stationary mini-racking for large parts	110
Mobile mini-racking for large parts	111
MULTI-LEVEL SHELVING SYSTEM	112-113
WORKSTATIONS	
MULTITEK CART - MATERIAL HANDLING	114
WORKBENCHES AND WORKSTATIONS	115
SERVICE COUNTERS	116-117

5S STORAGE	
5S STORAGE	118-121

CABINETS	
CABINETS FOR SPECIALIZED TOOLS	122

DRAWER ACCESSORIES	
DRAWER ACCESSORIES	123-124

CASE STUDIES

SHOWCASE

NOTES

STANDARD COLORS



SERVICE DEPARTMENT

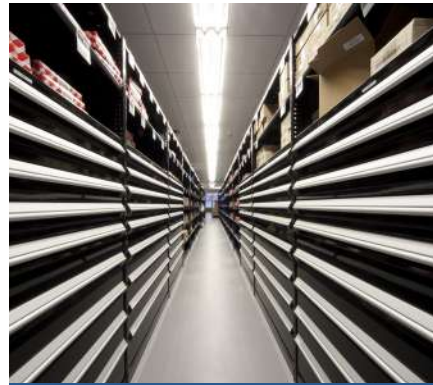

PARTS DEPARTMENT

SERVICE DEPARTMENT

A SERVICE DEPARTMENT IN YOUR OWN IMAGE

Rousseau's workcenters for technicians are the most complete and versatile solutions on the market. Our specialists will help you find a custom configuration that meets your unique requirements and reflects the professional image of your company.



Mercedes-Benz Winnipeg (MB)

A COMPLETE SOLUTION

We have the perfect solution, whether you are looking for basic workstations with a little or a lot of storage, or a more comprehensive workcenter with integrated lift motor control, computer systems, reels and much more.

We have a wide range of additional options, including MultiTek Carts for technicians, waste containers, utility panels and power feed panels, so you can add everything you need to your workstation.

A PERSONALIZED SOLUTION

Rousseau designs and manufactures its workstations with a height of 36" to ensure they are as ergonomic as possible. This is the perfect height to work standing up in a service department for the vast majority of people. However, if your team members need extra height, 40"H work surfaces are also available.

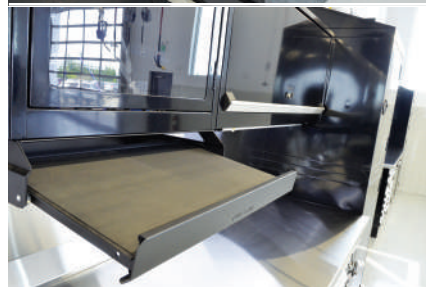
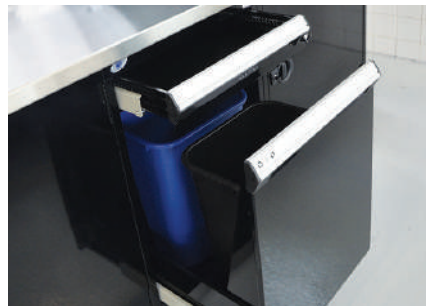

TRY OUT OUR BAY DESIGN TOOL!

Do you have an idea what kind of workcenter you need? If you do and would like a quick preview of what your ideal workcenter would look like, be sure to try out our Bay Design tool on MyModel-r.com.

In just a few easy steps, you can configure your very own workcenter. If you can't find exactly what you're looking for with our Bay Design tool, don't worry. The tool only shows the most popular dimensions, options and accessories, but others are available. For a personalized solution, our team of specialists will suggest options and help you find a configuration that meets your requirements.

The Bay Design tool offers a way for you to create and preview a custom layout in just a few easy steps. When you're happy with your design, you can save it or request a quote with your desired specifications.

Give it a try!



SCAN THE QR CODE TO SET UP YOUR WORKSTATION TO SUIT YOUR NEEDS.

OPTIMIZING WORKSPACES FOR ELECTRIC VEHICLE MAINTENANCE

With the growing popularity of electric vehicles (EVs), adapting workspaces for their specific maintenance is crucial. While the layout of workbenches and toolboxes is similar for servicing any vehicle, certain elements can make a difference when customizing a workstation for EVs.

An ideal approach is to maintain a versatile workspace that provides a tailored work surface as needed and has dedicated locations for EV-specific tools.

Essential tools to consider for effective EV maintenance include insulated tools, personal protective equipment, safety signage, a high-voltage rescue hook, a shutdown key, fire blankets, and a car charger.

Effective identification methods, such as color-coded drawers, and doors containing tools specific to EVs can help provide an efficient and secure workspace.



GT-C1044X

NEED INSPIRATION?

Take a look at our Portfolio on www.rousseau.com/industries/automotive

ROUSSEAU EXPERTISE

DESIGNED, DEVELOPED AND MANUFACTURED IN NORTH AMERICA

We invest heavily in product development, modernization of our facilities, new technologies and our employees to offer premium-quality products, from design to manufacturing to end product. Our goal is to understand your requirements so we can create tailored solutions that meet your expectations and needs in terms

of your environment (new construction or existing construction) and priorities.



SERVICE DEPARTMENT		2-3
Ergonomic Workstation		4-5
Create Your Own Workcenter		6-17
Double Workcenters		18-25
Single Workcenters		26-31
Corner Workstations		32-37
TekZone Hutch		38-41
Toolboxes		42-52
R2V Vertical Storage		53-58
Cabinet for two users		59-60



SCAN THE QR CODE TO DISCOVER THE PROJECTS COMPLETED BY ROUSSEAU

ERGONOMIC WORKSTATION

FACTORS TO CONSIDER

The first step in creating an optimal storage solution is to list all the tools and items to be stored. You can't store all these items in the same cabinet, drawer or shelf, so you need to categorize them.

To do this, there are four factors and four reach zones to consider when organizing your storage solution.



1- FREQUENCY OF USE

It's important to know how often your tools are used. This generally determines the location of your equipment. We can divide frequency of use into four categories: frequent, average, occasional and specific. We recommend storing frequently used items in easy-to-reach zones (green and yellow).

2- IMPORTANCE OF QUICK IDENTIFICATION

We recommend using the 5S methodology for organizing your tools. Items that need to be found or used quickly should be placed in easy-to-reach zones.

3- SIZE AND WEIGHT

The weight of items handled is an other important factor to take into account. By considering this in conjunction with frequency of use, it's easier to determine the best storage location. A heavy item used frequently should always be stored where the risk of injury is lowest. This will rule out zones that are too high or too low. However, a less ergonomic location is suitable if the heavy item is not used frequently. We should only be retrieving light items in high-reach zones.

4- PURPOSE AND CATEGORY

In some situations, you might want to group several items together according to type or how they are used. For example, you may want to group all screwdrivers together in the same drawer, even if you don't use all sizes with the same frequency.

STORING AND ORGANIZING ITEMS

Place your items in the storage solution according to these four factors within the four zones shown here. In this illustration, we have used a person of average height. We recommend using a 50th percentile adult when more than one person works in the same space. See technical guide R69 for ergonomic designs for taller or smaller people.

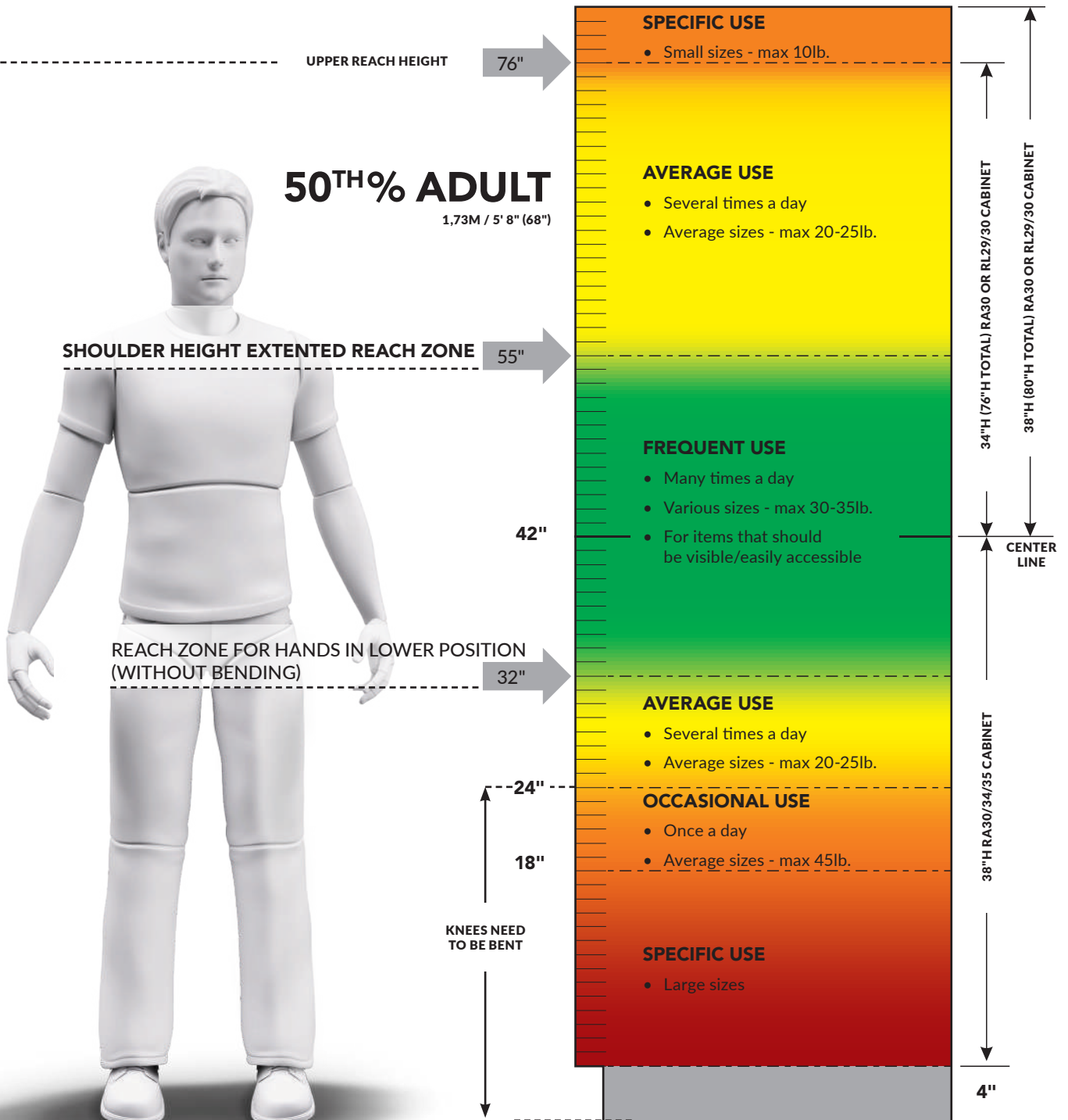

CREATE YOUR OWN WORKCENTER

5 EASY STEPS

Our specialists will work with you to evaluate the best configurations for your situation. They will take into consideration many different factors by asking various questions:

- What is the total amount of space available?
- Is computer access required?
- How much space is needed for tools?
- Where do the reels come from (air, electricity, oil, etc.)?

- How much space is needed for storage of bulky items?
- What type of lift do you use (integrated or posts, what brand)?
- Do you need task lighting?
- Etc.

In just five steps, we can help you create your own layout quickly and easily. The following pages take you through these steps.

SEE THE DIFFERENCE...



HOW TO CREATE YOUR OWN WORKCENTER

Following the steps below, you can create a custom layout by choosing models from those suggested on [pages 20-33](#) (144"W, 120"W, 96"W, 84"W, 72"W, 60"W and 48"W models).

To order, complete the product numbers as shown in the steps below.

1 TYPE OF WORK SURFACE

Widths: **48", 60", 72", 84", 96", 120"** and **144"** (2 × 72")

Type of work surface: 16ga painted or stainless steel

Rubber mat available: Mats are 26" deep to accommodate tech uprights, cover panels and power feed panels.

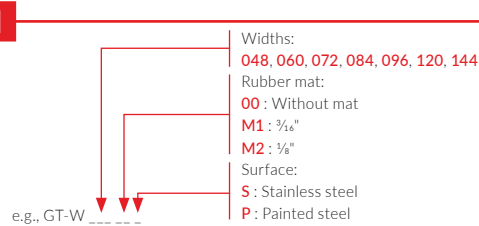

2 UNDER THE WORK SURFACE

The suggested models are some of the most popular. Simply add **S** to the end of the model number for a stainless steel base, or **P** for a painted steel base.

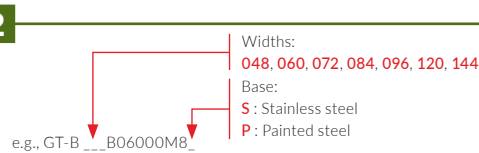

3 ABOVE THE WORK SURFACE

Widths: **48", 60", 72", 84", 96", 120"** and **144"** (2 × 72")

Includes: storage cabinet, computer cabinet, power feed panel, cover panel, tech uprights and panel support

Panel: painted or stainless steel

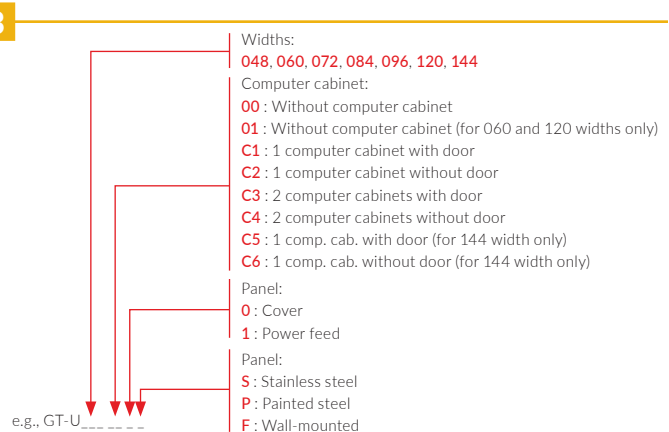

4 CENTER

WITH CABINETS (ABOVE THE WORK SURFACE)

Widths: **48", 60", 72", 84", 96", 120"** and **144"** (2 × 72")

Includes: finishing panel, utility panel and plastic bin panel

Finishing and utility panel: painted or stainless steel

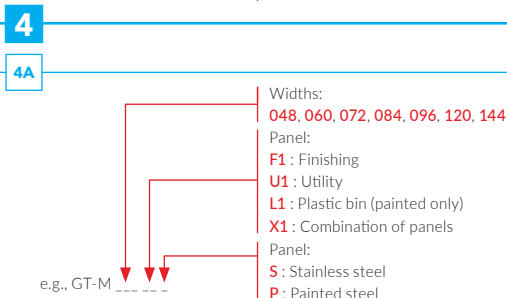

WITHOUT CABINETS (ABOVE THE WORK SURFACE)

Widths: **48", 60", 72", 84", 96", 120"** and **144"** (2 × 72")

Includes: finishing panel, tech uprights, panel support, cover panel and power feed panel

Panel: painted or stainless steel

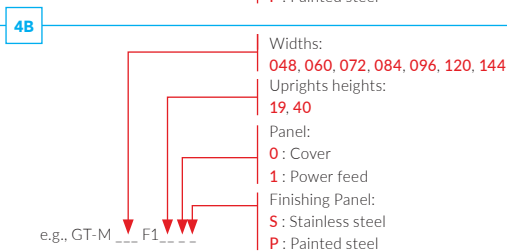

WITHOUT TECH UPRIGHTS (ABOVE THE WORK SURFACE)

Widths: **48", 60", 72", 84", 96", 120"** and **144"** (2 × 72")

Includes: finishing panel for computer arm, cover panel and power feed panel without tech uprights, monitor mount

Finishing panel: painted steel or stainless steel

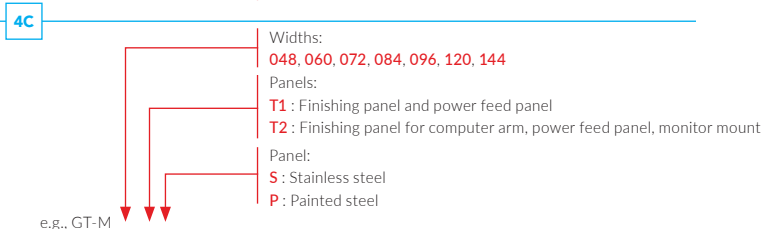

5 SIDES OF BAYS

See page 19

1 TYPE OF WORK SURFACE

NOTE: THE WIDTH OF THE WORK SURFACE DETERMINES THE WIDTH FOR STEPS **2**, **3** AND **4**.

STAINLESS STEEL TOP



- Acts as a work surface and protects the top of the cabinet from impacts
- Particle board top with stainless steel cover (#4 brushed finish)
- Excellent chemical resistance
- Excellent corrosion resistance
- Welded corners for an attractive appearance
- Available in 12ga or 16ga steel (12ga steel top provides better impact resistance)
- 12ga top thickness: 1³/₁₆"
- 16ga top thickness: 1³/₄"

PRODUCT NO.	W × D
RC35-4830-__	48" × 30"
RC35-6030-__	60" × 30"
RC35-7230-__	72" × 30"
RC35-8430-__	84" × 30"
RC35-9630-__	96" × 30"
RC35-12030-__	120" × 30"

NOTES: Add **12** to the product number for a 12ga steel top.
For a 144"W workstation, order two 72"W tops.

MARINE EDGE STAINLESS STEEL TOP



- The edge stops hardware and liquids from falling off
- Acts as a work surface and protects the top of the cabinet from impacts
- Particle board top with stainless steel cover (#4 brushed finish)
- Excellent chemical resistance
- Excellent corrosion resistance
- Welded corners for an attractive appearance
- Available in 12ga or 16ga steel (12ga steel top provides better impact resistance)
- 12ga top thickness: 1³/₁₆" and 2" edge
- 16ga top thickness: 1³/₄" and 1⁵/₁₆" edge

PRODUCT NO.	W × D
RC35-4830-__M	48" × 30"
RC35-6030-__M	60" × 30"
RC35-7230-__M	72" × 30"
RC35-8430-__M	84" × 30"
RC35-9630-__M	96" × 30"
RC35-12030-__M	120" × 30"

NOTES: Add **12** to the product number for a 12ga steel top, or **16** for a 16ga steel top.
For a 144"W workstation, order two 72"W tops.

PAINTED STEEL TOP



- Acts as a work surface and protects the top of the cabinet from impacts
- Particle board top with painted steel cover
- Welded corners for an attractive appearance
- Thickness: 1³/₄"

PRODUCT NO.	W × D
RC37-4830	48" × 30"
RC37-6030	60" × 30"
RC37-7230	72" × 30"
RC37-8430	84" × 30"
RC37-9630	96" × 30"
RC37-12030	120" × 30"

NOTE: For a 144"W workstation, order two 72"W tops.

NEOPRENE RUBBER MAT



- Neoprene mat for protecting the work surface
- Thickness: 1/8"
- Order a 26"D mat for use with tech uprights, or 30"D for use without tech uprights.

WIDTH	DEPTH	
	26"	30"
48"	RG45-4826	RG45-4830
60"	RG45-6026	RG45-6030
72"	RG45-7226	RG45-7230
84"	RG45-8426	RG45-8430
96"	RG45-9626	RG45-9630
120"	RG45-12026	RG45-12030
144"	RG45-14426	RG45-14430

NOTE: Not compatible with the marine edge stainless steel top.

NITRILE RUBBER MAT



- Nitrile mat with excellent hydrocarbon and shock resistance
- Thickness: 3/16"
- Order a 26"D mat for use with tech uprights, or 30"D for use without tech uprights.

WIDTH	DEPTH	
	26"	30"
48"	RG48-4826	RG48-4830
60"	RG48-6026	RG48-6030
72"	RG48-7226	RG48-7230
84"	RG48-8426	RG48-8430
96"	RG48-9626	RG48-9630
120"	RG48-12026	RG48-12030
144"	RG48-14426	RG48-14430

NOTE: Not compatible with the marine edge stainless steel top.

2 UNDER THE WORK SURFACE

SLIDING LIFT MOTOR UNIT FOR ROTARY SHOCKWAVE™



- Quick and easy access to the lift control by sliding the unit out
- Easy access to the lift control on both sides
- Unit includes housing and a removable front
- 4"H base: painted or stainless steel
- Compatible with 120V only
- Optional leveling glides: RA75-01

PRODUCT NO.	TYPE OF BASE	W×D×H
RC05-18273401	Painted steel	18"×27"×34"
RC06-18273401	Stainless steel	18"×27"×34"
RC05-18273801	Painted steel	18"×27"×38"
RC06-18273801	Stainless steel	18"×27"×38"

STRUCTURAL CLOSED LEG



- Available for ends or middle of workstation
- Provides adequate support for integrating non-structural elements under the work surface (for over 18"W). Leg is 3" wide
- The middle leg can be used to create workstations wider than 72" without needing another structural element for support
- Two options available: Two 15A power outlets, or one 15A power outlet with two USB ports
- Use a stringer (RC77) for applications that only use legs
- Two base types available (4"H): recessed or full depth
- The base is available in painted or stainless steel
- Includes leveling glides
- An inside finishing panel (RC74) is also available for a more finished look

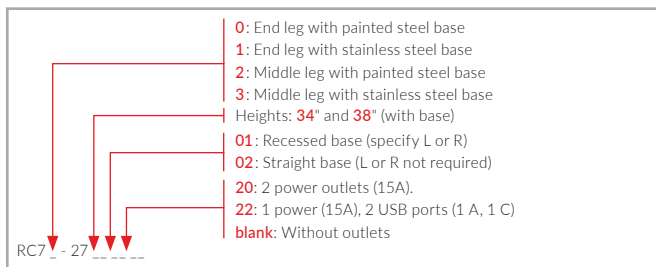

CROSSMEMBER



- Supports closed legs when used at the end of the workstation
- Connects the leg to another structural element on the workstation to provide extra rigidity at the bottom
- Stainless steel

PRODUCT NO.
RC78-__

NOTE: Complete the product number with the width required: 18", 21", 24", 27", 30", 36", 42" or 48".

SLIDING LIFT MOTOR UNIT



- Quick and easy access to the lift control by sliding the unit out
- Easy access to the lift control on both sides
- Available for Rotary Mechanical, Rotary inground SmartLift®, Challenger with BMC and Challenger EnviroLift®
- Includes housing
- 4"H base: painted or stainless steel
- Compatible with 220 V only
- Optional leveling glides: RA75-01

PRODUCT NO.	TYPE OF LIFT
RC__-1227__01	Challenger with BMC (controls on the workstation)
RC__-1227__05	Rotary inground SmartLift® (2007 version to present)
RC__-1227__07	Rotary Mechanical (conventional controls, September 2010 to present)
RC__-1227__08	Challenger EnviroLift® without BMC before 2015
RC__-1227__09	Challenger with BMC (controls integrated into sliding lift motor unit)
RC__-1227__10	Challenger EnviroLift® without BMC after 2015

NOTES: Add 20 to the RC__ product number for a painted steel base, or 21 for a stainless steel base.
 Add 34 to the product number for a 36"H workstation, or 38 for a 40"H workstation.

HIDEAWAY DOOR



- Designed to conceal waste containers (RK06), MultiTek Carts and L Mobile Cabinets under the work surface
- Includes a handle to easily open the door
- Available with or without a lock

PRODUCT NO.	W×H	NOMINAL HEIGHT
RB52-1834__	18"×34"	30"
RB52-2134__	21"×34"	30"
RB52-2434__	24"×34"	30"
RB52-2734__	27"×34"	30"
RB52-1838__	18"×38"	34"
RB52-2138__	21"×38"	34"
RB52-2438__	24"×38"	34"
RB52-2738__	27"×38"	34"

NOTES: Add L3 to the end of the product number to order a hideaway door with L3 key lock.
 Add L to the end of the product number to have the hinges on the left or R for the hinges on the right.
 Order a 21"W or 24"W hideaway door to fit an L Mobile Cabinet.

DOOR EXTENSION



- Compatible with RB52 Hideaway Door
- Provides an immaculate finish
- Available in painted steel or stainless steel
- Compatible with a 23"W MultiTek Cart

PRODUCT NO.	W×H
RB__-180401	18"×4"
RB__-210401	21"×4"
RB__-240401	24"×4"
RB__-270401	27"×4"

NOTE: Add 59 to the product number for a painted steel extension or 60 for a stainless steel extension.

2 UNDER THE WORK SURFACE

WASTE & RECYCLING DOOR



- Designed to seamlessly integrate waste and recycling containers (RK08/RK09) under the work surface without affecting the usable surface area
- Includes a stainless steel flipper door for discarding waste without needing to open the panel
- A panel support (RB57) must be ordered for units installed at the end of a bay
- A base (RA59/RA60) must be ordered for seamless integration under the work surface

PRODUCT NO.	HINGE	HEIGHT
RB53-2434L	Left	34"
RB53-2434R	Right	34"
RB53-2438L	Left	38"
RB53-2438R	Right	38"

WASTE & RECYCLING DRAWER



- Used for sorting waste and items for recycling
- Logos on the side to facilitate sorting
- Drawer heights available: 17", 26" and 30"
- Holds two containers (one black and one blue) with a divider that secures the containers and allows items to be stored behind

PRODUCT NO.	W × D × H	CONTAINER SIZE
R51CG-X1701	24" × 27" × 17"	Small (7 gallons/26.5 liters)
R51DG-X1701	30" × 27" × 17"	Small (7 gallons/26.5 liters)
R51CG-X2601	24" × 27" × 26"	Large (10 gallons/39 liters)
R51DG-X2601	30" × 27" × 26"	Large (10 gallons/39 liters)
R51CG-X3001	24" × 27" × 30"	Large (10 gallons/39 liters)
R51DG-X3001	30" × 27" × 30"	Large (10 gallons/39 liters)

WASTE & RECYCLING CABINET



- Can be used as a standalone unit, as part of a cabinet configuration or integrated underneath the work surface
- Used for sorting waste and items for recycling
- The 30"H unit includes a 26"H drawer with labeled handle to facilitate sorting; the 34"H unit also includes a 4"H drawer
- Includes two 15 ¼"W × 11"D × 20"H containers: a black one for waste (RK09-02) and a blue one for recycling (RK09-01)
- The drawer includes a divider which secures the containers and also allows items to be stored behind
- Optional leveling glides: RA74-01

PRODUCT NO.	W × D × H	WORKSTATION HEIGHT
GT-5ACG30050_	24" × 27" × 34"	36"
GT-5ACG34050_	24" × 27" × 38"	40"
GT-5ADG30050_	30" × 27" × 34"	36"
GT-5ADG34050_	30" × 27" × 38"	40"

NOTE: Add **S** to the end of the product number for a stainless steel base or **P** for a painted steel base.

WASTE & RECYCLING DOORS



- Hide RK10 Waste & Recycling Containers under the work surface
- The doors are not full height so users can dispose of waste without opening the door
- Include hinges for opening door when emptying containers
- Include magnets to keep the door closed
- Include self-adhesive labels attached to the doors to identify the waste and recycling sides

PRODUCT NO.		WIDTH
RB58-24_-01L	Recycling	24"
RB58-24_-02R	Waste	24"
RB58-30_-01L	Recycling	30"
RB58-30_-02R	Waste	30"

NOTES: 17"H panels are recommended for 36"H workstations; 21"H panels are recommended for 40"H workstations. Complete the product number with the height required: **17"** or **21"**.

By default, the recycling door is on the left and the waste door is on the right.

WASTE CONTAINER



- Capacity: 28 gallons (the square bin has 14% greater capacity than the round bin)
- Rounded corners for easier cleaning
- Dimensions: 21 ½"W (25"W with handles) × 21 ½"D × 22 ½"H
- Optional door is available for seamless integration under the work surface (RB52)
- Mobile pedestal also available (RK07)

PRODUCT NO.	INCLUDES
RK06-01	Waste container
RK07-01	Mobile pedestal

WASTE AND RECYCLING CONTAINERS



- Used for sorting waste and items for recycling
- 3 sizes:
 - **Small** (14 ¾"W × 10 ¼"D × 15"H) for a 17"H Waste & Recycling Drawer (R51CG-X1701 and R51DG-X1701)
 - **Large** (15 ¼"W × 11"D × 20"H) for use with an RB53 Waste & Recycling Drawer or a 26"H Waste & Recycling Drawer (R51CG-X2601) and R51DG-X2601)
 - **Extra large** (18 ¾"W × 23 ½"D × 16 ½"H) recommended for RB58 Waste & Recycling Doors

PRODUCT NO.	SIZE	COLOR
RK08-01	Small (7 gallons/26.5 liters)	Blue
RK08-02	Small (7 gallons/26.5 liters)	Black
RK09-01	Large (10 gallons/39 liters)	Blue
RK09-02	Large (10 gallons/39 liters)	Black
RK10-01	Extra large (18 gallons/68 liters)	Blue
RK10-02	Extra large (18 gallons/68 liters)	Gray

HEIGHT-ADJUSTABLE ARTICULATING ARM

All models featured here have the following characteristics:

- Installs on the work surface with an RC68 or RC69 cover panel for electronics mounts, does not install directly on the housing
- Compatible with the following work surfaces: RC35, RC37 and WS14
- Includes an 18"H pole
- The work surface must extend beyond the rear by 1½"
- Optimum ergonomics

WITHOUT UPRIGHTS

EASY CABLE MANAGEMENT



MONITOR ARM



- Compatible with most monitors (max. 21") on the market
- Complies with VESA 75 and 100 monitor mounting standards
- Includes a height adjustable articulating arm(s) with two joints
- The articulating arm with two joints provides extra adjustment options
- Screen can be rotated and tilted
- Single and dual arm versions are available
- Arm includes a channel for cable management
- Height can be adjusted tool free
- Capacity: 20 lb
- Color: Black

PRODUCT NO.	FOR
RC59-03	Single Monitor
RC59-04	Two Monitors

LAPTOP ARM



- Holds a laptop, electronic device or any other object
- Tray's usable area: 19"W x 14"D
- Includes a height adjustable articulating arm with two joints
- The articulating arm with two joints provides extra adjustment options
- Includes ½"H edges on the sides and back
- Tray can be rotated and tilted
- Arm includes a channel for cable management
- Height can be adjusted tool free
- Capacity: 20 lb
- Color: Black

PRODUCT NO.
RC59-42

MONITOR MOUNT AND KEYBOARD AND MOUSE ARM



- Holds a computer monitor, keyboard and mouse
- Compatible with most monitors (max. 21") on the market
- Complies with VESA 75 and 100 monitor mounting standards
- Keyboard tray's usable area: 23½"W x 8½"D
- Includes a height adjustable articulating arm with one joint
- Screen and tray can be rotated and tilted
- Arm includes a channel for cable management
- Height can be adjusted tool free
- Capacity: 14 lb
- Color: Black

PRODUCT NO.
RC59-21

TABLET ARM



- Compatible with most tablets on the market
- The clamps and mount have a non-slip surface to keep the tablet stable
- Compatible tablet sizes:
 - Small: 7¾"W to 10"W
 - Large: 9¾"W to 12¼"W
- Includes a height adjustable articulating arm with or two joints
- The articulating arm with two joints provides extra adjustment options
- Height can be adjusted tool free
- Tablet can be rotated and tilted
- Arm includes a channel for cable management
- Capacity: 14 lb
- Color: Black

PRODUCT NO.	FOR
RC59-62-01	Small tablet
RC59-62-02	Large Tablet

3 ABOVE THE WORK SURFACE

POWER FEED PANEL WITHOUT UPRIGHTS



- Includes a power bar with three 15A outlets for a 15A circuit
- Additional versions available: with a knockout for a pneumatic connection and a perforation (with a cover plate) for a telephone / Ethernet jack; or with two USB ports; or with knockout, perforation and two USB ports
- Installs on RC35 and RC37 tops
- Available in painted steel or stainless steel

4: Without uprights, painted steel
 5: Without uprights, stainless steel
 Widths:
 30", 36", 42", 48", 54", 60" and 72"
 10: 3 power outlets (15A)
 11: 3 power outlets (15A), perforations
 12: 3 power outlets (15A), 2 USB ports (1 A, 1 C)
 13: 3 power outlets (15A), 2 USB ports (1 A, 1 C), knockout and perforation
 01: Without back panel
 02: With back panel (only available for applications without uprights)

RC6 _ _ _ _

e.g., RC64-361201 for a 36"W painted steel power feed panel with power outlet strip with 3 power outlets (15A), 2 USB ports, and without a back panel.



GC-C11675

COVER PANEL FOR COMPUTER MOUNTS

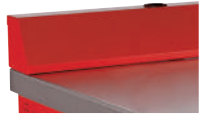

- Provides a more aesthetic finish when installing computer mounts (RC59-03/RC59-04/RC59-21/RC59-42/RC59-62-01/02)
- Can be combined with a power feed panel (RC64/RC65) or cover panel (RC66/RC67) if required
- Available in painted steel or stainless steel
- Width: 24"

8: Painted steel
 9: Stainless steel
 01: Without back panel
 02: With back panel

RC6 _-24 _ _

COVER PANEL WITHOUT UPRIGHTS



- Can be combined with a power feed panel when necessary, or used on its own for a perfect finish
- Available in stainless or painted steel

6: Without uprights, painted steel
 7: Without uprights, stainless steel
 Widths:
 24", 30", 36", 42", 48", 54", 60" and 72"
 01: Without back panel
 02: With back panel (available for applications without uprights only)

RC6 _ _ _ _

e.g., RC66-3001 for a painted steel cover panel, 30" wide, without back panel.

TECH UPRIGHTS



- For installation of a storage cabinet (RD02), computer cabinet (R5MCA), panel support (RC47), power feed panels (RC60/RC61) and cover panels (RC62/RC63)
- Allows height of cabinets to be adjusted in 4" increments
- Anchors securely to the work surface

PRODUCT NO.	HEIGHT
RD44-19	19"
RD44-40	40"

PANEL SUPPORT



- Supports finishing panels (RC41/RC42), plastic bin panels (RC45), utility panels (RC93/RC94) and finishing panels for computer arm (RC81/RC82)
- Enables a combination of different panel types to be installed

PRODUCT NO.	WIDTH
RC47-24 _ _	24"
RC47-30 _ _	30"
RC47-36 _ _	36"
RC47-42 _ _	42"
RC47-48 _ _	48"
RC47-60 _ _	60"

NOTES: For 19" RD44 uprights, add 03 to the number.

For 40" RD44 uprights, add 01 to the number for the lower section and 02 for the upper section.

SLOPED TOP FOR STORAGE CABINET AND COMPUTER CABINET



- Keeps the workspace clean and safe while reducing clutter
- Fits perfectly into the "5S" storage method
- 35° sloped top for computer cabinet and storage cabinet
- The top for computer cabinets includes a fan
- Height: 8"

PRODUCT NO.	FOR	W × D
RD42-241408	Storage cabinet	24" × 14"
RD42-301408	Storage cabinet	30" × 14"
RD42-361408	Storage cabinet	36" × 14"
RD42-421408	Storage cabinet	42" × 14"
RD42-481408	Storage cabinet	48" × 14"
RD42-601408	Storage cabinet	60" × 14"
RD43-241408	Computer cabinet	24" × 14"

FLIPPER DOOR STORAGE CABINET



- Can be wall mounted or installed on RD44 tech uprights
- The back is removable when wall mounted allowing easy access to electrical components (power outlets)
- The flipper door has a large handle for a comfortable grip (RD20)
- Optional lamp produces optimized lighting (RD45)

PRODUCT NO.	W × D × H
R5MCB-2111	24" × 14" × 21"
R5MDB-2111	30" × 14" × 21"
R5MEB-2111	36" × 14" × 21"
R5MHB-2111	42" × 14" × 21"
R5MGB-2111	48" × 14" × 21"
R5MKB-2111	60" × 14" × 21"

NOTE: Flipper door storage cabinets include an L3 key lock. For an L50 digital lock or an L100 smart lock, please contact Customer Service.

SLIDING DOOR STORAGE CABINET



- Can be wall mounted or installed on RD44 tech uprights
- The back is removable when wall mounted allowing easy access to electrical components (power outlets)
- Integrated door provides maximum clearance for handling items stored in the cabinet
- Polycarbonate door provides excellent impact resistance

PRODUCT NO.	W × D × H
R5MEB-21__	36" × 14" × 21"
R5MHB-21__	42" × 14" × 21"
R5MGB-21__	48" × 14" × 21"
R5MKB-21__	60" × 14" × 21"

NOTE: Add **07** to the product number for a solid integrated door or **08** for a polycarbonate integrated door.

COMPUTER CABINET



- Includes a monitor mount to create room for a CPU and monitor
- Available with fan (for standalone use) or without fan (for use with sloped top)
- Includes a power outlet strip
- The keyboard tray (optional) can be tucked away under the cabinet when not in use
- Width: 24"

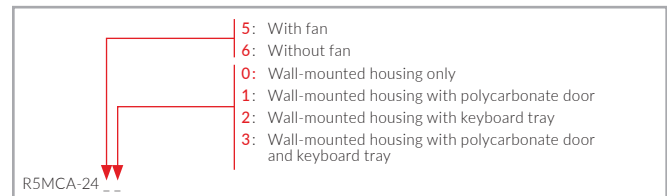

LAPTOP, KEYBOARD & MOUSE TRAY



- Allows a laptop or keyboard and mouse to be used under a cabinet. Maximum laptop screen size: 15"
- Tucks away under the cabinet when not in use
- Tilts 17° when pulled out
- Includes a neoprene mat for better grip underneath the laptop or keyboard and mouse
- Opens easily and smoothly

PRODUCT NO.	FOR
RD47-2414	

STORAGE UNIT



- Installs underneath a storage cabinet with or without an RD47 Laptop, Keyboard & Mouse Tray
- Can be installed underneath a computer cabinet with or without an RD47 Laptop, Keyboard & Mouse Tray
- Provides extra storage space
- Allows Laptop, Keyboard & Mouse Tray to be lowered by 4"
- Width: 24"

PRODUCT NO.	FOR
RD48-24140401	Computer cabinet and storage cabinet (24"W)
RD48-24140403	Storage cabinet over 24"W

3 ABOVE THE WORK SURFACE

LED LIGHT



- Brighter and more energy efficient than a fluorescent tube
- Brightens shaded areas under cabinets
- Can be installed under RD00/ RD02 cabinets
- Color temperature: 5000-6000K (day white)
- Includes a galvanized steel adapter
- Includes a 10' power cord
- The recommended operating temperature for our LED lights is between 5 and 40 °C (41 to 104 °F)
- An optional motion sensor can be added

PRODUCT NO.	STORAGE CABINET WIDTH	LIGHT WIDTH
RD45-1814__	24"	15"
RD45-2414__	30", 36"	21"
RD45-3614__	42", 48", 24"+ 24"	33"
RD45-4814__	60", 30" + 30"	45"
RD45-6014__	36" + 36"	57"

NOTES: To order an LED light with motion sensor, add **MS** to the product number.
Not compatible with computer cabinets.

CONNECTING CABLE



- Up to 7 lights can be connected in series
- Each light is independent and controlled by its own switch

PRODUCT NO.	CABLE LENGTH
70001108	8"
70001112	12"
70001124	24"

PLASTIC WRAP ROLL HOLDER



- Ideal for rolls of protective plastic for car seats
- Installs under an RD02 storage cabinet
- Total load capacity: 50lb.

PRODUCT NO.	WIDTH
RD46-4814	48"
RD46-6014	60"

NOTE: Not compatible with LED light.

POWER FEED PANEL WITH UPRIGHTS



- Includes a power bar with three 15A outlets for a 15A circuit
- Additional versions available: with a knockout for a pneumatic connection and a perforation (with a cover plate) for a telephone/Ethernet jack; or with two USB ports; or with knockout, perforation and two USB ports
- Installs on RC35 and RC37 tops
- Designed for use with tech uprights (RD44)
- Available in painted steel or stainless steel

	0: With uprights, painted steel
	1: With uprights, stainless steel
Widths:	
30", 36", 42", 48" and 60"	
10: 3 power outlets (15A)	
11: 3 power outlets (15A), perforations	
12: 3 power outlets (15A), 2 USB ports (1 A, 1 C)	
13: 3 power outlets (15A), 2 USB ports (1 A, 1 C), knockout and perforation	

e.g., RC61-361201 for a 36"W stainless steel power feed panel with uprights, with a power outlet strip with 3 power outlets (15A) and 2 USB ports.



10: 3 power outlets (15A)



11: 3 power outlets (15A), a knockout for a pneumatic connection and a perforation (with cover plate) for installing a telephone or network jack

COVER PANEL WITH UPRIGHTS



- Can be combined with a power feed panel or used on its own to cover the feet of tech uprights for an immaculate finish
- Designed for use with tech uprights (RD44);
- Available in painted steel or stainless steel

	2: With uprights, painted steel
	3: With uprights, stainless steel
Widths:	
24", 30", 36", 42", 48" and 60"	

e.g., RC62-3001 for a 30"W painted steel cover panel with uprights.



12: 3 power outlets (15A) and 2 USB ports



13: 3 power outlets (15A), 2 USB ports, a knockout for a pneumatic connection and a perforation (with cover plate) for installing a telephone or network jack

UTILITY PANEL

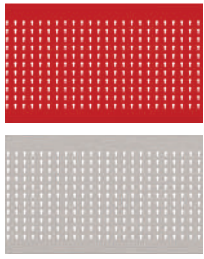

- Includes perforations spaced 1" apart c/c and is compatible with all WM9_ hooks and holders (see page 119)

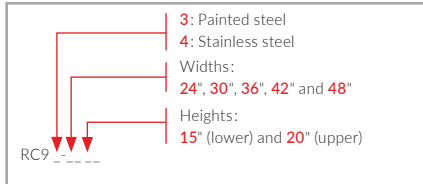

NOTE: Not compatible with the WM21 Tilttable Shelf for Utility Panel.

FINISHING PANEL

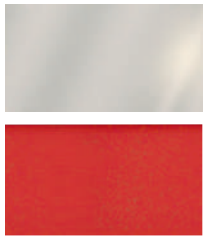

- Provides an immaculate finish
- Available in painted and stainless steel
- Can be used with or without a cabinet on top
- Two panels can be stacked (15"H + 20"H) to create a full height wall, which can hold accessories as needed
- Panels are compatible with the following accessories: multi-purpose holders (RC51), monitor mounts (RC52), keyboard & mouse tray (RC53), multi-purpose supports (RC54)

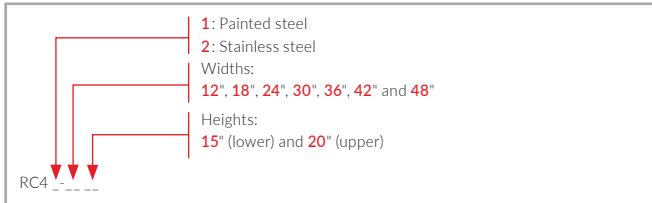

PLASTIC BIN PANEL



- Compatible with RG20 plastic bins (see page 121) and all brands of plastic bins with hanging lip on the market

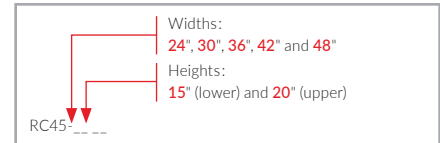

FINISHING PANEL FOR COMPUTER ARM



- Available in painted and stainless steel
- Can be used with or without a cabinet on top
- Two panels can be stacked (15" + 20")
- Panels are compatible with the following accessories: RC58-03/RC58-21/RC58-42/RC58-62
- Includes perforation for running cables through
- Width: 12"

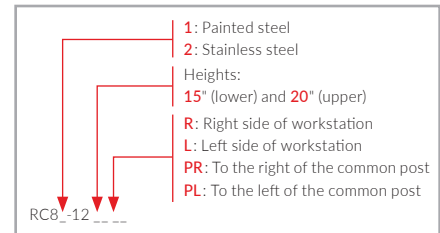

NOTE: Determine where the panel will be placed on the workstation and order the appropriate part (R, L, PR, PL). The panel cannot be installed anywhere other than the designated location.



MULTI-PURPOSE HOLDER



- Holds up to 4 aerosol cans
- Also compatible with drinks cans
- Hooks securely onto RC41/RC42/RC93/RC94/RC45 panels
- Can be installed anywhere across the width of the bay

PRODUCT NO.	COMBINATION
RC51-120303	Panels only
RC51-120312	Panels and storage cabinets



PHONE AND DOCUMENT HOLDER

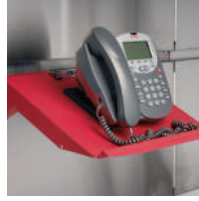

- Usable surface area: 14"W x 12"D
- Includes a clip to keep documents in place
- Hooks securely onto RC41/RC42/RC93/RC94/RC45 panels
- Can be installed anywhere across the width of the bay

PRODUCT NO.	COMBINATION
RC54-1412	Panels only
RC54-141202	Panels and storage cabinets



GT-C2047S

HEIGHT-ADJUSTABLE ARTICULATING ARM

All models featured here have the following characteristics:

- Installs on finishing panel for computer arm
- Easy cable management
- Optimum ergonomics

EASY CABLE MANAGEMENT

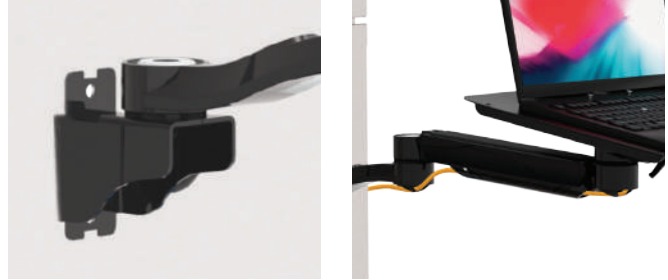

MONITOR ARM



- Compatible with most monitors (max. 21") on the market
- Complies with VESA 75 and 100 monitor mounting standards
- Includes an articulating arm with two joints
- The articulating arm with two joints provides extra adjustment options
- Monitor can be rotated and tilted
- Installs on a lower (15") finishing panel for computer arm (RC81/RC82)

PRODUCT NO.
RC58-03

LAPTOP ARM



- Holds a laptop, electronic device or any other object
- Tray's usable area: 14"W x 12"D
- Includes an articulating arm with two joints
- The articulating arm with two joints provides extra adjustment options
- Tray can be rotated and tilted
- Installs on a lower (15") finishing panel for computer arm (RC81/RC82)

PRODUCT NO.
RC58-42

MONITOR MOUNT AND KEYBOARD & MOUSE ARM



- Holds a computer monitor, keyboard and mouse
- Keyboard tray's usable area: 23 5/8"W x 8 1/2"D
- Includes an articulating arm with a single joint
- Compatible with most monitors (max. 21") on the market
- Complies with VESA 75 and 100 monitor mounting standards
- Monitor and tray can be rotated and tilted
- Installs on a lower (15) and upper (20) finishing panel for computer arm (RC81/RC82)

PRODUCT NO.
RC58-21

TABLET ARM



- Compatible with most tablets on the market
- The clamps and mount have a non-slip surface to keep the tablet stable
- Includes an articulating arm with two joints
- The articulating arm with two joints provides extra adjustment options
- Tablet can be rotated and tilted
- Installs on a lower (15") finishing panel for computer arm (RC81/RC82)
- Compatible tablet sizes:
 - Small: 7 5/8"W to 10"W
 - Large: 9 7/8"W to 12 1/4"W

PRODUCT NO.	FOR
RC58-62-01	Small
RC58-62-02	Large



4 CENTER

KEYBOARD & MOUSE TRAY



- Usable surface area: 24"W x 12"D for a keyboard and mouse
- Includes a series of bends at the front (3/4" surface) that act as a palm rest
- Hooks securely onto RC41/RC42/RC93/RC94/RC45 panels
- Can be installed anywhere across the width of the bay

PRODUCT NO.	COMBINATION
RC53-2412	Panels only
RC53-241202	Panels and storage cabinets

LAPTOP TRAY



- Supports laptops of up to 14"W x 12"D
- Hooks securely onto RC41/RC42/RC93/RC94/RC45 panels
- Includes a series of bends at the front (3/4" surface) that act as a palm rest
- Can be installed anywhere across the width of the bay

PRODUCT NO.
RC54-1412

MONITOR MOUNT



- Supports monitors and RC41/RC42/RC93/RC94/RC45 panels
- Complies with VESA 75 and 100 monitor mounting standards
- Includes a central cutout for cable management from the rear of the mount
- Two positions: vertical or angled 10° forward to reduce reflections

PRODUCT NO.
RC52-20



GT-C1034S



GT-C1069S

5 SIDES OF BAYS



5A TOOLBOXES - PAGES 44-54

- Toolboxes can be ordered on their own or as components of a workcenter as featured on [pages 20-33](#)
- 10 drawer heights and 7 toolbox heights available for a wide range of custom combinations
- Drawer lock-in mechanisms available for all models
- Stationary and mobile versions available

5B R2V VERTICAL STORAGE - PAGES 55-60

- This vertical storage system provides easy access to stored items, increases storage density and reclaims floor space
- Compatible with a wide variety of 5S accessories for simple and efficient inventory management
- Drawer lock-in mechanism included with all models
- Optional One-Drawer-at-a-Time System available
- Installs on standard widths of Rousseau R cabinets
- To ensure unit stability, the unit must be anchored to a cabinet

5C REEL CABINETS - PAGES 63-66

- A range of reel cabinets available that vary according to number of reels required and layout
- Cabinets include a door and/or panel for easy access and maintenance
- Removable drip tray included

5D STORAGE UNITS - PAGES 67-70

- Unit provides secure storage for technicians' personal belongings and for an oil waste container or MultiTek Cart
- Heights available: 48", 76" and 80". Can be used in a workcenter or as a standalone unit
- To ensure unit stability, the unit must be anchored to a workstation, toolbox, storage cabinet or the wall
- Several configurations available: with or without storage for a MultiTek Cart, L Compact Mobile Cabinet or oil waste container

5E STORAGE UNITS AND LOCKERS - PAGES 71-72

- Unit provides secure storage for technicians' personal belongings
- Heights available: 48", 76" and 80". Can be used in a workcenter or as a standalone unit
- To ensure unit stability, the unit must be anchored to a workstation, toolbox, storage cabinet or the wall
- Several configurations possible: 1 door or 2 doors with or without ventilation holes

PRECONFIGURED MODELS - DOUBLE WORKCENTERS

12'W (144"W) WORK SURFACE



Customizing a technicians workcenter has never been easier. Simply follow the steps below to configure your bays.

FOR HELP COMPLETING
PRODUCT NUMBERS, **SEE PAGE 7**

The complete GT-C2153S unit to the left includes the following products:

- | | |
|---------------------------|-------------------------|
| 1 GT-W144M1S | AA GT-M144F2S |
| 2 GT-B144B01AC1K1S | SC GT-RDG720401S |
| 3 GT-U144C31S | |

1 TYPE OF SURFACE



Our stainless steel and painted steel tops have a particle board core for excellent impact resistance.

- The stainless steel top adds stylish aesthetics
- The rubber mat is oil resistant and protects the work surface (available for painted and stainless steel tops)

2 UNDER THE WORKSURFACE

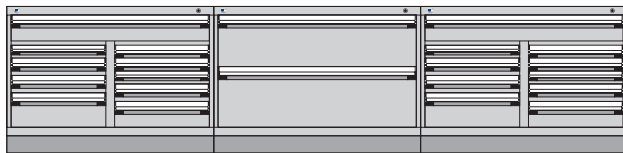

3 Toolboxes

GT-B144001000X3_

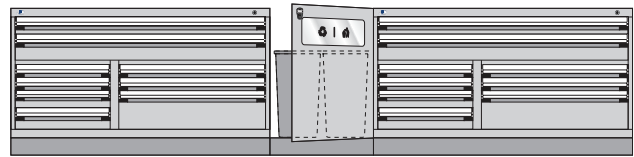

2 Toolboxes - Waste & Recycling Door and Containers

GT-B144B06000K8_

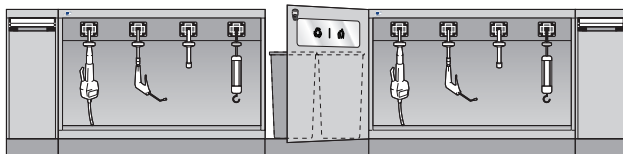

2 Reel Cabinets - Waste & Recycling Door and Containers 2 Lift Control Units

GT-B144A14CR400_



4 Toolboxes

GT-B144001000X2_

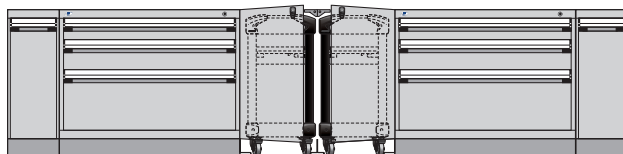

2 Toolboxes - 2 Hideaway Doors - 2 Lift Control Units 2 MultiTek Carts

GT-B144B07AR4A9_



2 Toolboxes - 2 Lift Control Units

GT-B144B01AR4K9_

PRECONFIGURED MODELS - DOUBLE WORKCENTERS

3 OVER THE WORKSURFACE

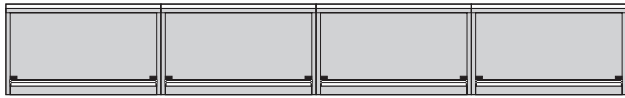

4 Storage Cabinets (wall-mounted)

GT-U14400F

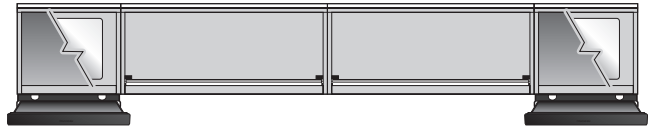

2 Storage Cabinets - 2 Computer Cabinets with Fan (wall-mounted)

GT-U144C_OF

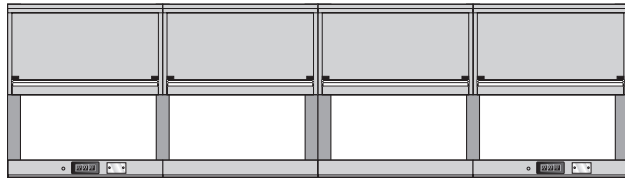

4 Storage Cabinets - Tech Uprights - Panels

GT-U14400_

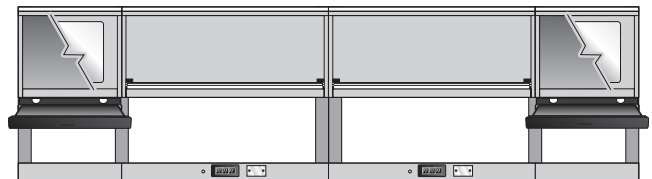

2 Storage Cabinets - 2 Computer Cabinets with Fan - Tech Uprights - Panels

GT-U144C_

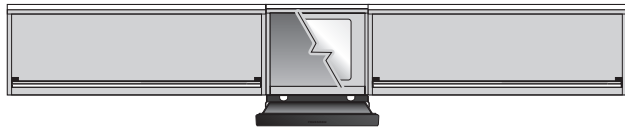

2 Storage Cabinets - Computer Cabinet with Fan (wall-mounted)

GT-U144C_OF

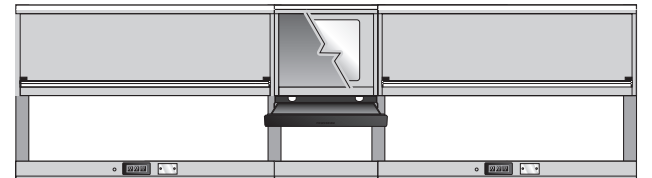

2 Storage Cabinets - Computer Cabinet with Fan - Tech Uprights - Panels

GT-U144C_

4 CENTER

4A CENTER - WITH CABINETS



Finishing Panels

GT-M144F1_



Utility Panels

GT-M144U1_

4B CENTER - WITHOUT CABINETS



Finishing Panels - 19"H Tech Uprights - Panels

GT-M144F119_

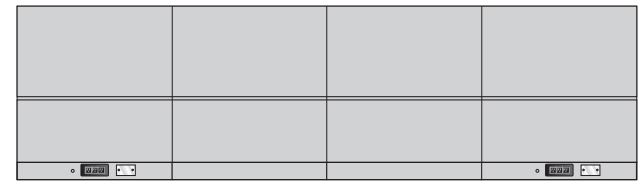

Finishing Panels - 40"H Tech Uprights - Panels

GT-M144F140_

4C CENTER - WITHOUT TECH UPRIGHTS



Power Feed Panels

GT-M144T1_

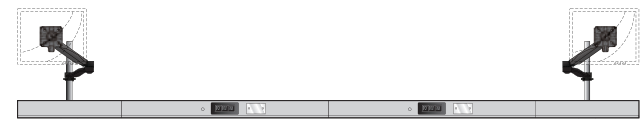

Finishing and Power Feed Panels - Monitor Arms

GT-M144T2_

5 SIDES OF BAYS

5A

TOOLBOXES
PAGES 44-54

5B

R2V VERTICAL STORAGE
PAGES 55-60

5C

REEL CABINETS
PAGES 63-66

5D

STORAGE UNITS
PAGES 67-70

5E

STORAGE UNITS
AND LOCKERS
PAGES 71-72



Not sure what solution you need? Our specialists will help you find a customized solution for your specific needs. Contact us.

PRECONFIGURED MODELS - DOUBLE WORKCENTERS

10'W (120"W) WORK SURFACE

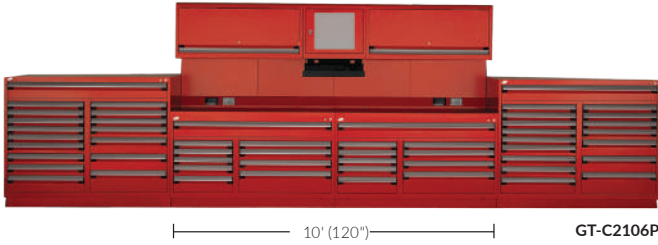

Customizing a technicians workcenter has never been easier. Simply follow the steps below to configure your bays.

FOR HELP COMPLETING
PRODUCT NUMBERS, **SEE PAGE 7**

The complete GT-C2106P unit to the left includes the following products:

- | | |
|---------------------------|------------------------------|
| 1 GT-W120M1P | 4A GT-M120F1P |
| 2 GT-B120001000K2P | 5A GT-5KKG44004P (2x) |
| 3 GT-U120C11P | |

1 TYPE OF SURFACE



GT-W12000P



GT-W12000S



GT-W120M1_



GT-W120M2_

Our stainless steel and painted steel tops have a particle board core for excellent impact resistance.

- The stainless steel top adds stylish aesthetics
- The rubber mat is oil resistant and protects the work surface (available for painted and stainless steel tops)

2 UNDER THE WORKSURFACE

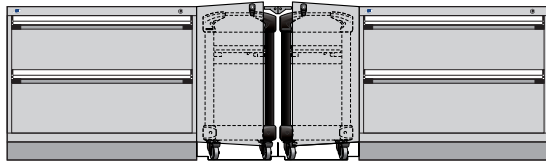

2 Toolboxes - 2 Hideaway Doors - 2 MultiTek Carts

GT-B120001000A8_

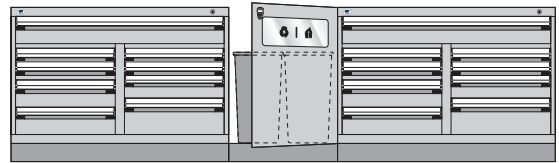

2 Toolboxes - Waste & Recycling Door and Containers

GT-B120B02000K9_

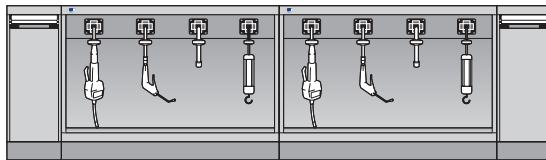

2 Reel Cabinets - 2 Lift Control Units

GT-B120A01CR400_

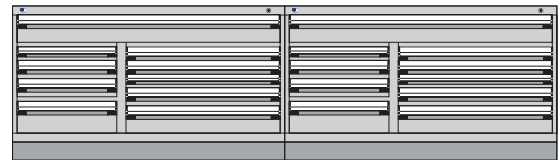

2 Toolboxes

GT-B120001000K2_

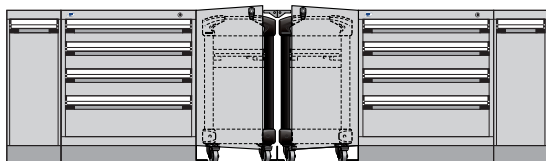

2 Toolboxes - 2 Hideaway Doors - 2 Lift Control Units - 2 MultiTek Carts

GT-B120B03AR4C2_

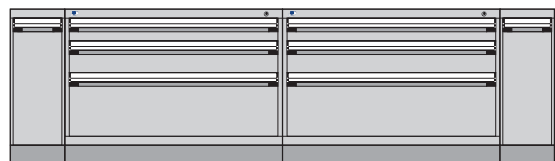

2 Toolboxes - 2 Lift Control Units

GT-B120B01CR4A9_

PRECONFIGURED MODELS - DOUBLE WORKCENTERS

3 OVER THE WORKSURFACE



2 Storage Cabinets (wall-mounted)

GT-U120010F

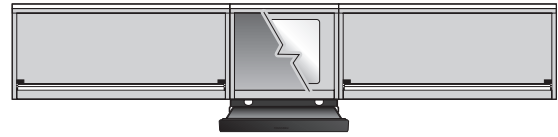

2 Storage Cabinets - Computer Cabinet with Fan (wall-mounted)

GT-U120C_0F

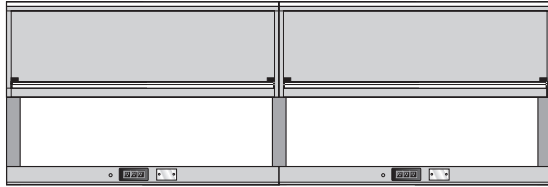

2 Storage Cabinets - Tech Uprights - Panels

GT-U12001_

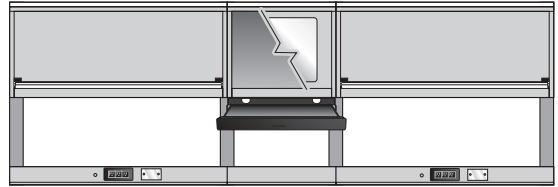

2 Storage Cabinets - Computer Cabinet with Fan - Tech Uprights - Panels

GT-U120C_

4 CENTER

4A CENTER - WITH CABINETS



Finishing Panels

GT-M120F1_

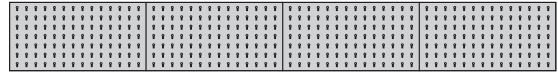

Utility Panels

GT-M120U1_

4B CENTER - WITHOUT CABINETS



Finishing Panels - 19"H Tech Uprights - Panels

GT-M120F119_



Finishing Panels - 40"H Tech Uprights - Panels

GT-M120F140_

4C CENTER - WITHOUT TECH UPRIGHTS



Power Feed Panels

GT-M120T1_



Finishing and Power Feed Panels - Monitor Arms

GT-M120T2_

5 SIDES OF BAYS

5A

TOOLBOXES
PAGES 44-54

5B

R2V VERTICAL STORAGE
PAGES 55-60

5C

REEL CABINETS
PAGES 63-66

5D

STORAGE UNITS
PAGES 67-70

5E

STORAGE UNITS
AND LOCKERS
PAGES 71-72



GT-C2020P



GT-C2048S



Not sure what solution you need? Our specialists will help you find a customized solution for your specific needs. Contact us.

PRECONFIGURED MODELS - DOUBLE WORKCENTERS

8'W (96" W) WORK SURFACE

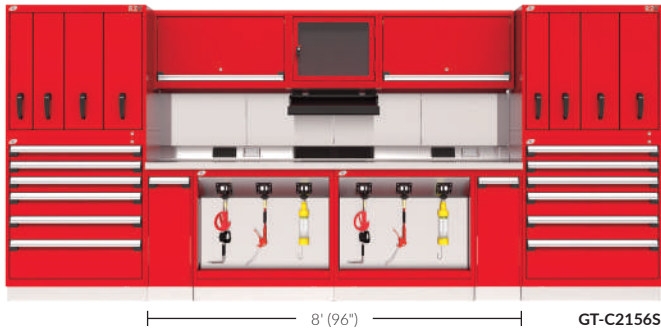

Customizing a technicians workcenter has never been easier. Simply follow the steps below to configure your bays.

FOR HELP COMPLETING
PRODUCT NUMBERS, **SEE PAGE 7**

The complete GT-C2156S unit to the left includes the following products:

- | | |
|---------------------------|------------------------------|
| 1 GT-W09600S | AA GT-M096F1S |
| 2 GT-B096A03CR400S | SB GT-5KKG44004P (2x) |
| 3 GT-U096C11S | |

1 TYPE OF SURFACE



GT-W09600P



GT-W09600S



GT-W096M1_



GT-W096M2_

Our stainless steel and painted steel tops have a particle board core for excellent impact resistance.

- The stainless steel top adds stylish aesthetics
- The rubber mat is oil resistant and protects the work surface (available for painted and stainless steel tops)

2 UNDER THE WORKSURFACE

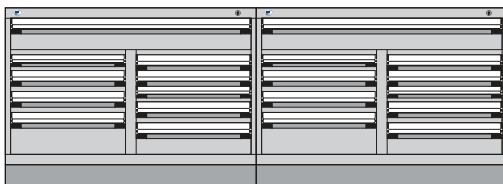

2 Toolboxes

GT-B096001000K2_

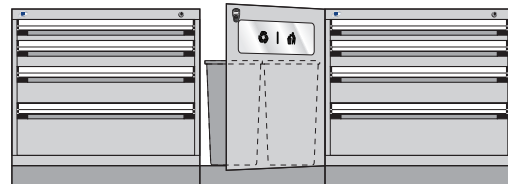

2 Toolboxes - Waste & Recycling Door and Containers

GT-B096B03000A7_

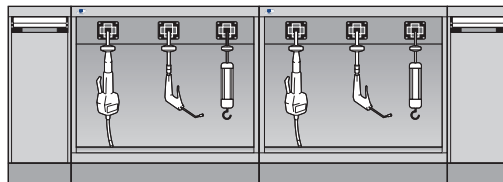

2 Reel Cabinets - 2 Lift Control Units

GT-B096A03CR400_



4 Toolboxes

GT-B096001000X1_

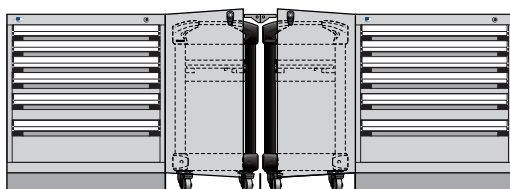

2 Toolboxes - 2 Hideaway Doors - 2 MultiTek Carts

GT-B096B01000A1_

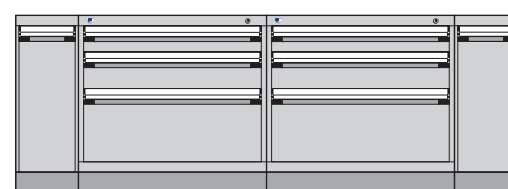

2 Toolboxes - 2 Lift Control Units

GT-B096B01AR4A9_

PRECONFIGURED MODELS - DOUBLE WORKCENTERS

3 OVER THE WORKSURFACE

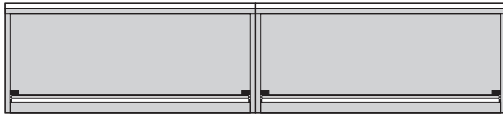

2 Storage Cabinets (wall-mounted)

GT-U09600F

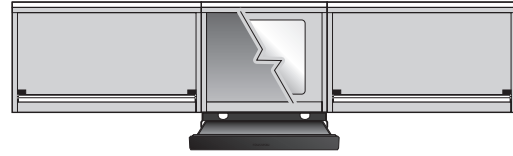

2 Storage Cabinets - Computer Cabinet with Fan (wall-mounted)

GT-U096C_OF

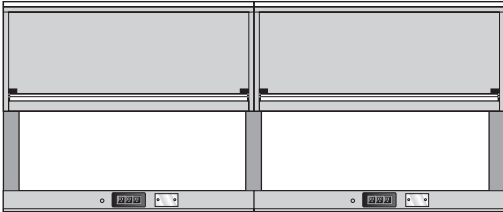

2 Storage Cabinets - Tech Uprights - Panels

GT-U09600_

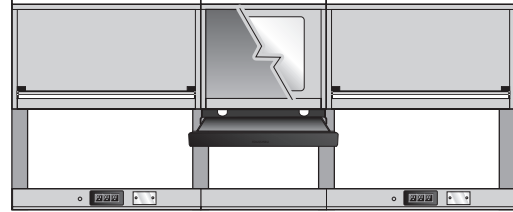

2 Storage Cabinets - Computer Cabinet with Fan - Tech Uprights - Panels

GT-U096C_

4 CENTER

4A CENTER - WITH CABINETS



Finishing Panels

GT-M096F1_

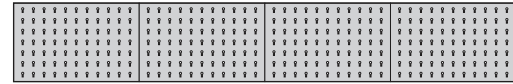

Utility Panels

GT-M096U1_

4B CENTER - WITHOUT CABINETS

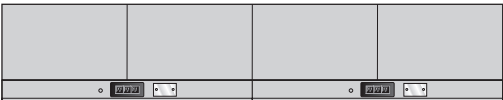

Finishing Panels - 19"H Tech Uprights - Panels

GT-M096F119_



Finishing Panels - 40"H Tech Uprights - Panels

GT-M096F140_

4C CENTER - WITHOUT TECH UPRIGHTS



Power Feed Panels

GT-M096T1_



Finishing and Power Feed Panels - Monitor Arms

GT-M096T2_

5 SIDES OF BAYS

5A

TOOLBOXES
PAGES 44-54

5B

R2V VERTICAL STORAGE
PAGES 55-60

5C

REEL CABINETS
PAGES 63-66

5D

STORAGE UNITS
PAGES 67-70

5E

STORAGE UNITS
AND LOCKERS
PAGES 71-72



GT-C2101P



GT-C2036S



Not sure what solution you need? Our specialists will help you find a customized solution for your specific needs. Contact us.

PRECONFIGURED MODELS - DOUBLE WORKCENTERS

7'W (84"W) WORK SURFACE



Customizing a technicians workcenter has never been easier. Simply follow the steps below to configure your bays.

FOR HELP COMPLETING
PRODUCT NUMBERS, [SEE PAGE 7](#)

The complete GT-C2044S unit to the left includes the following products:

- | | |
|---------------------------|-------------------------------|
| 1 GT-W08400S | 4B GT-M084F1402S |
| 2 GT-B084001000A8S | 5A GT-5GHG34502PS (2x) |

1 TYPE OF SURFACE



GT-W08400P



GT-W08400S



GT-W084M1_



GT-W084M2_

Our stainless steel and painted steel tops have a particle board core for excellent impact resistance.

- The stainless steel top adds stylish aesthetics
- The rubber mat is oil resistant and protects the work surface (available for painted and stainless steel tops)

2 UNDER THE WORKSURFACE

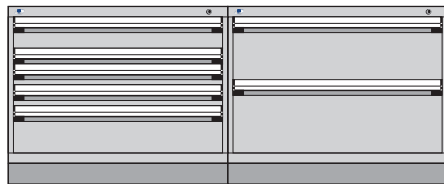

2 Toolboxes

GT-B084001000X2_

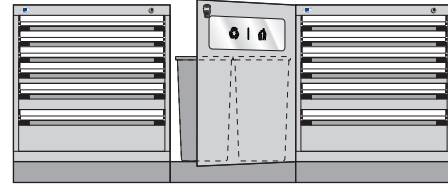

2 Toolboxes - Waste & Recycling Door and Containers

GT-B084B01000A1_

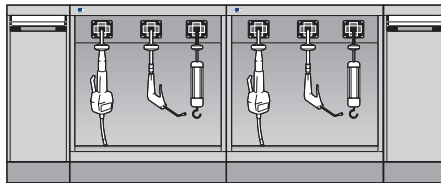

2 Reel Cabinets - 2 Lift Control Units

GT-B084A01CR400_

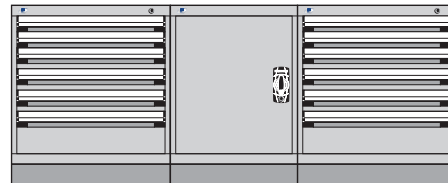

3 Toolboxes

GT-B084001000X1_

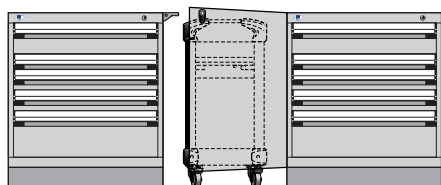

2 Toolboxes - Hideaway Door - MultiTek Cart

GT-B084B02000C3_

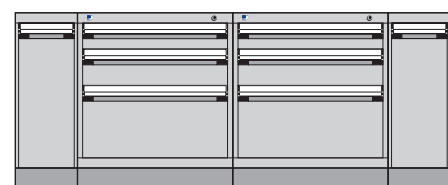

2 Toolboxes - 2 Lift Control Units

GT-B084B01AR4A9_

PRECONFIGURED MODELS - DOUBLE WORKCENTERS

3 OVER THE WORKSURFACE

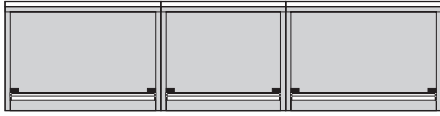

3 Storage Cabinets (wall-mounted)

GT-U08400F

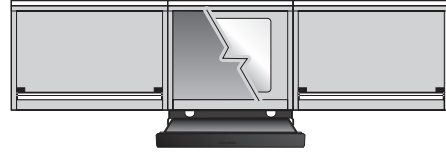

2 Storage Cabinets - Computer Cabinet with Fan (wall-mounted)

GT-U084C_OF

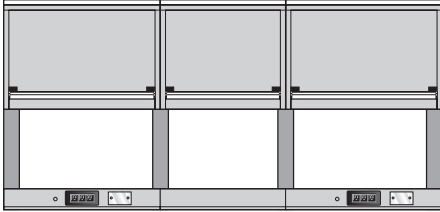

3 Storage Cabinets - Tech Uprights - Panels

GT-U08400_

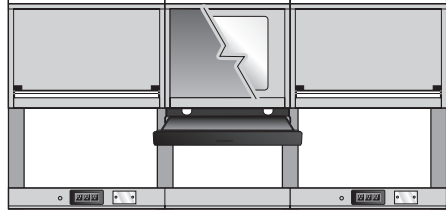

2 Storage Cabinets - Computer Cabinet with Fan - Tech Uprights - Panels

GT-U084C_

4 CENTER

4A CENTER - WITH CABINETS



Finishing Panels

GT-M084F1_

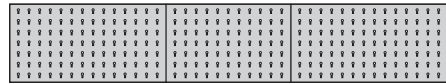

Utility Panels

GT-M084U1_

4B CENTER - WITHOUT CABINETS

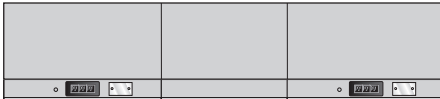

Finishing Panels - 19"H Tech Uprights - Panels

GT-M084F119_



Finishing Panels - 40"H Tech Uprights - Panels

GT-M084F140_

4C CENTER - WITHOUT TECH UPRIGHTS



Power Feed Panels

GT-M084T1_



Finishing and Power Feed Panels - Monitor Arms

GT-M084T2_

5 SIDES OF BAYS

5A

TOOLBOXES
PAGES 44-54

5B

R2V VERTICAL STORAGE
PAGES 55-60

5C

REEL CABINETS
PAGES 63-66

5D

STORAGE UNITS
PAGES 67-70

5E

STORAGE UNITS
AND LOCKERS
PAGES 71-72



GT-C2139S



GT-C2038S



Not sure what solution you need? Our specialists will help you find a customized solution for your specific needs. Contact us.

PRECONFIGURED MODELS - SINGLE WORKCENTERS

6'W (72"W) WORK SURFACE



Customizing a technicians workcenter has never been easier. Simply follow the steps below to configure your bays.

FOR HELP COMPLETING PRODUCT NUMBERS, [SEE PAGE 7](#)

The complete GT-C1111S unit to the left includes the following products:

- | | |
|---------------------------|-------------------------|
| 1 GT-W072M1S | 4A GT-M072F1S |
| 2 GT-B072B01AC1K1S | 5A GT-5KKG44002S |
| 3 GT-U072C11S | |

1 TYPE OF SURFACE



Our stainless steel and painted steel tops have a particle board core for excellent impact resistance.

- The stainless steel top adds stylish aesthetics
- The rubber mat is oil resistant and protects the work surface (available for painted and stainless steel tops)

2 UNDER THE WORKSURFACE

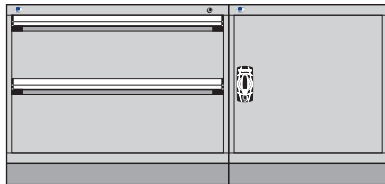

2 Toolboxes

GT-B072001000X1_

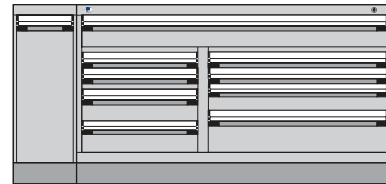

Toolbox - Lift Control Unit

GT-B072B01AR4K9_

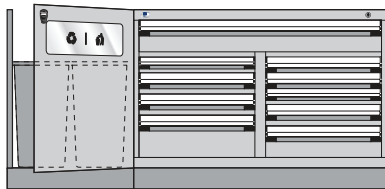

Toolbox - Waste & Recycling Door and Containers

GT-B072B01000K2_

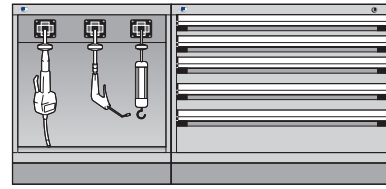

Toolbox - Reel Cabinet

GT-B072A12000A4_

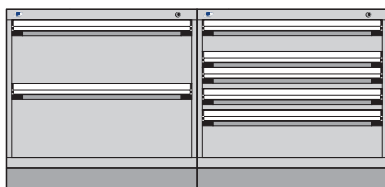

2 Toolboxes

GT-B072001000X3_

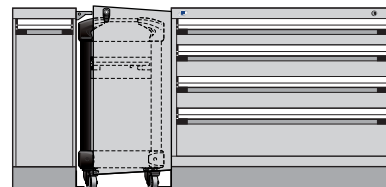

Toolbox - Hideaway Door - Lift Control Unit MultiTek Cart

GT-B072B02AR4C2_

PRECONFIGURED MODELS - SINGLE WORKCENTERS

3 OVER THE WORKSURFACE



2 Storage Cabinets (wall-mounted)
GT-U072000F

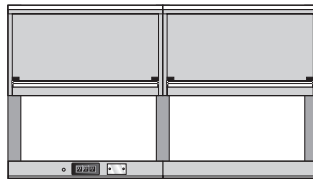

2 Storage Cabinets
Tech Uprights - Panels
GT-U07200 _ _

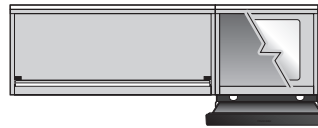

Storage Cabinet - Computer Cabinet
with Fan (wall-mounted)
GT-U072C_OF

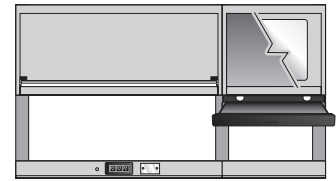

Storage Cabinet - Computer Cabinet
with Fan - Tech Uprights - Panels
GT-U072C _ _ _

4 CENTER

4A CENTER - WITH CABINETS



Finishing Panels
GT-M072F1_

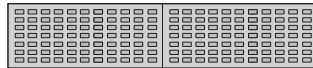

Plastic Bin Panels
GT-M072L1P

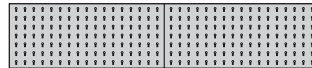

Utility Panels
GT-M072U1 _

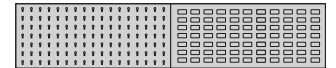

Plastic Bin and Utility Panels
GT-M072X1P

4B CENTER - WITHOUT CABINETS



Finishing Panels - 19"H Tech Uprights - Panels
GT-M072F119_ _



Finishing Panels - 40"H Tech Uprights - Panels
GT-M072F140_ _

4C CENTER - WITHOUT TECH UPRIGHTS



Power Feed Panel
GT-M072T1_



Cover Panel and Power Feed Panel Monitor Arm
GT-M072T2_

5 SIDES OF BAYS

5A

TOOLBOXES
PAGES 44-54

5B

R2V VERTICAL STORAGE
PAGES 55-60

5C

REEL CABINETS
PAGES 63-66

5D

STORAGE UNITS
PAGES 67-70

5E

STORAGE UNITS
AND LOCKERS
PAGES 71-72



GT-C1103P



GT-C1110P



GT-C1004P



Not sure what solution you need? Our specialists will help you find a customized solution for your specific needs. Contact us.

PRECONFIGURED MODELS - SINGLE WORKCENTERS

5'W (60"W) WORK SURFACE

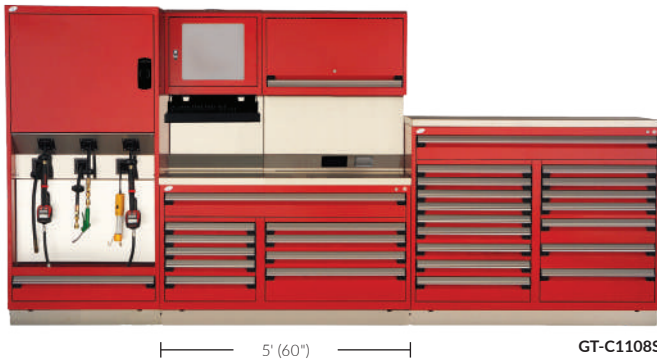

Customizing a technicians workcenter has never been easier. Simply follow the steps below to configure your bays.

FOR HELP COMPLETING PRODUCT NUMBERS, **SEE PAGE 7**

The complete GT-C1108S unit to the left includes the following products:

- | | |
|---------------------------|-------------------------|
| 1 GT-W060M1S | 4A GT-M060F2S |
| 2 GT-B060001000K2S | 5A GT-5KKG44004S |
| 3 GT-U060C11S | 5C GT-REG720601S |

1 TYPE OF SURFACE



GT-W06000P



GT-W06000S



GT-W060M1_



GT-W060M2_

Our stainless steel and painted steel tops have a particle board core for excellent impact resistance.

- The stainless steel top adds stylish aesthetics
- The rubber mat is oil resistant and protects the work surface (available for painted and stainless steel tops)

2 UNDER THE WORKSURFACE

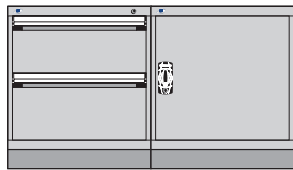

2 Toolboxes

GT-B060001000X1_

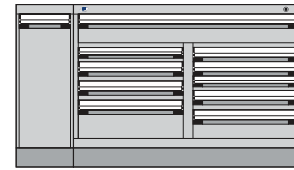

Toolbox - Lift Control Unit

GT-B060B01AR4K2_

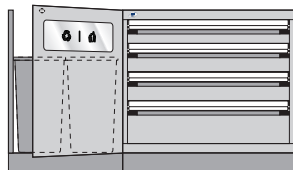

Toolbox - Waste & Recycling - Door and Containers

GT-B060B01000C2_

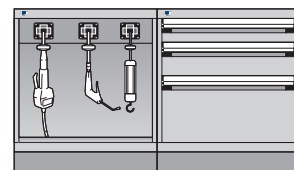

Toolbox - Reel Cabinet

GT-B060A10000A9_

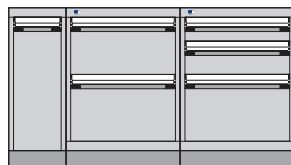

2 Toolboxes - Lift Control Unit

GT-B060B01AR4X1_

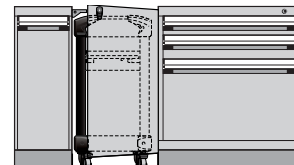

Toolbox - Hideaway Door - Lift Control Unit - MultiTek Cart

GT-B060B03AR4C1_

PRECONFIGURED MODELS - SINGLE WORKCENTERS

3 OVER THE WORKSURFACE



Storage Cabinet (wall-mounted)
GT-U060010F



Storage Cabinet - Tech Uprights - Panel
GT-U06001_

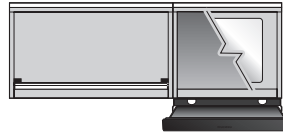

Storage Cabinet - Computer Cabinet
with Fan (wall-mounted)
GT-U060C_0F

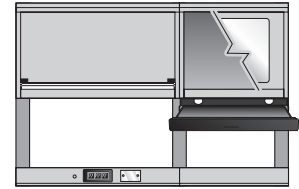

Storage Cabinet - Computer Cabinet
with Fan - Tech Uprights - Panels
GT-U060C_ _ _

4 CENTER

4A CENTER - WITH CABINETS



Finishing Panels
GT-M060F1_



Finishing Panels
GT-M060F2_

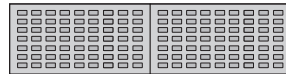

Plastic Bin Panels
GT-M060L1P



Utility Panels
GT-M060U1_

4B CENTER - WITHOUT CABINETS



Finishing Panels - 19\"/>

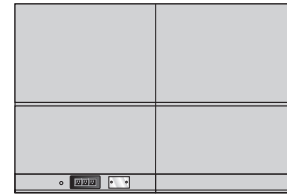

Finishing Panels - 40\"/>

4C CENTER - WITHOUT TECH UPRIGHTS



Power Feed Panel
GT-M060T1_

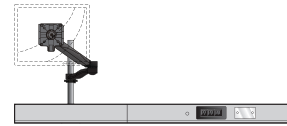

Cover Panel and Power Feed Panel - Monitor Arm
GT-M060T2_

5 SIDES OF BAYS

5A

TOOLBOXES
PAGES 44-54

5B

R2V VERTICAL STORAGE
PAGES 55-60

5C

REEL CABINETS
PAGES 63-66

5D

STORAGE UNITS
PAGES 67-70

5E

STORAGE UNITS
AND LOCKERS
PAGES 71-72



GT-C1020P



GT-C1163S



GT-C1034S



Not sure what solution you need? Our specialists will help you find a customized solution for your specific needs. Contact us.

PRECONFIGURED MODELS - SINGLE WORKCENTERS

4'W (48"W) WORK SURFACE



Customizing a technicians workcenter has never been easier. Simply follow the steps below to configure your bays.

FOR HELP COMPLETING
PRODUCT NUMBERS, **SEE PAGE 7**

The complete GT-C1053S unit to the left includes the following products:

- | | |
|---------------------------|-------------------------|
| 1 GT-W04800S | 4A GT-M048F1S |
| 2 GT-B048B04000A7S | 5A GT-5ADG44506S |
| 3 GT-U048000S | |

1 TYPE OF SURFACE



GT-W04800P



GT-W04800S



GT-W048M1_



GT-W048M2_

Our stainless steel and painted steel tops have a particle board core for excellent impact resistance.

- The stainless steel top adds stylish aesthetics
- The rubber mat is oil resistant and protects the work surface (available for painted and stainless steel tops)

2 UNDER THE WORKSURFACE

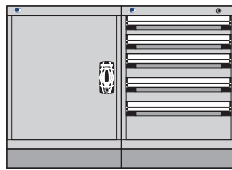

2 Toolboxes

GT-B048001000X3_

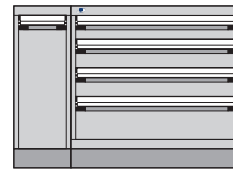

Toolbox - Lift Control Unit

GT-B048B01AR4C2_

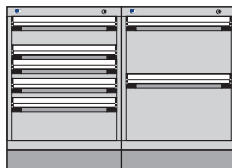

2 Toolboxes

GT-B048001000X4_

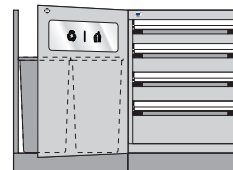

Toolbox - Waste & Recycling Door and Containers

GT-B048B03000C2_

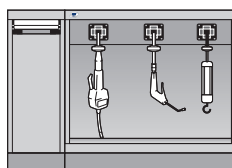

Reel Cabinet - Lift Control Unit

GT-B048A03CR400_

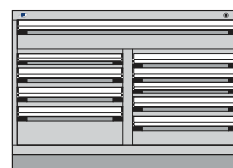

Toolbox

GT-B048001000K2_

PRECONFIGURED MODELS - SINGLE WORKCENTERS

3 OVER THE WORKSURFACE



Storage Cabinet (wall-mounted)
GT-U04800F

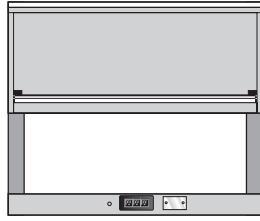

Storage Cabinet - Tech Uprights - Panel
GT-U04800_ _

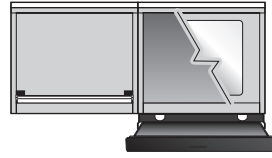

Storage Cabinet - Computer Cabinet
with Fan (wall-mounted)
GT-U048C_0F

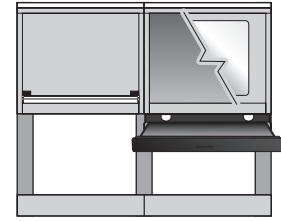

Storage Cabinet - Computer Cabinet
with Fan - Tech Uprights - Panels
GT-U048C_0_ _

4 CENTER

4A CENTER - WITH CABINETS



Finishing Panels
GT-M048F1_ _

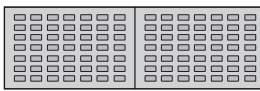

Plastic Bin Panels
GT-M048L1P

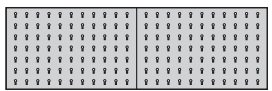

Utility Panels
GT-M048U1_ _

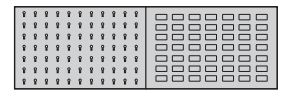

Plastic Bin and Utility Panels
GT-M048X1P

4B CENTER - WITHOUT CABINETS



Finishing Panels - 19\"/>

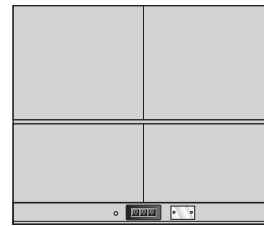

Finishing Panels - 40\"/>

4C CENTER - WITHOUT TECH UPRIGHTS



Power Feed Panel
GT-M048T1_ _

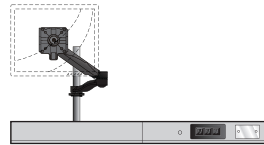

Cover Panel and Power Feed Panel - Monitor Arm
GT-M048T2_ _

5 SIDES OF BAYS

5A

TOOLBOXES
PAGES 44-54

5B

R2V VERTICAL STORAGE
PAGES 55-60

5C

REEL CABINETS
PAGES 63-66

5D

STORAGE UNITS
PAGES 67-70

5E

STORAGE UNITS
AND LOCKERS
PAGES 71-72



GT-C1044S



GT-C1142S



GT-C1101P



Not sure what solution you need? Our specialists will help you find a customized solution for your specific needs. Contact us.

CORNER WORKSTATIONS

MAXIMIZE SPACE FOR WORK AND STORAGE



Ferrari Lake Forest (IL)

Corner workstations allow for a more complete and integrated layout. They also make use of all available space for work and storage.

- Ergonomic 36" or 40" work surface height
- Standard 30" work surface depth
- Choice of two configurations: with or without cabinet under the work surface
- Leveling glides included in each model for a stable and level workstation
- Designed to be placed against a wall or back to back
- Must be anchored to two cabinets of the same height and depth, one on each side (RA30 or RA35)

To order, choose "WITH" or "WITHOUT" cabinet under the work surface.

Then configure your workstation. Options vary depending on the configuration chosen.

WITHOUT CABINET UNDER THE WORK SURFACE

0030

Right-angled corner
(2"W finishing panel)

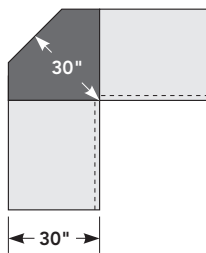

0630

9"W finishing panel

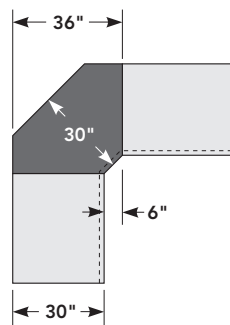

WITH CABINET UNDER THE WORK SURFACE

1230

L cabinet

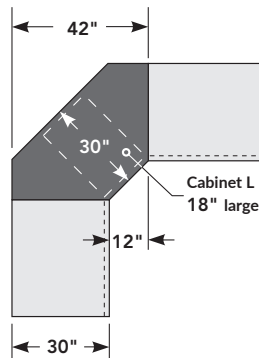

1830

R cabinet

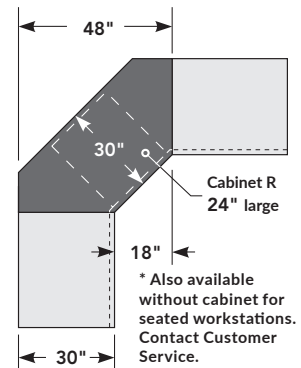

RS-C084X



RS-C002X



RS-C080S



RS-C008X

CORNER WORKSTATIONS - 0030

1 TYPE OF SURFACE

Choose your work surface

For a neoprene or nitrile rubber mat, choose the desired finish: painted steel (P) or stainless steel (S).



Painted Steel
RS-W003001P



Stainless Steel
RS-W003001S



Nitrile Mat - 3/16"
RS-W0030M3



Neoprene Mat - 1/8"
RS-W0030M4_

2 UNDER THE WORKSURFACE

Choose your workstation height and a finish for the base.

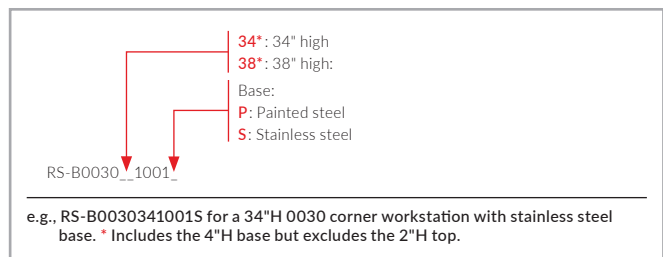
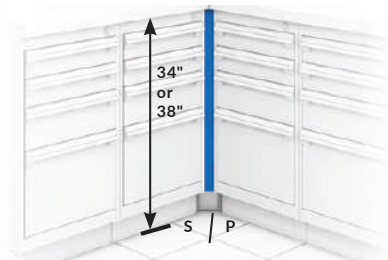

3 OVER THE WORKSURFACE

Choose from the following models

Choose a finish for the power feed and finishing panel: painted steel (P) or stainless steel (S).

A

Upper finishing panels + power feed panel*

RS-U0030F14_

For this model, the power feed panel determines the panel finish, P or S.



Finishing panels + monitor arm and keyboard & mouse tray + power feed panel*

RS-M0030S1404_

For this model, the power feed panel determines the panel finish, P or S.

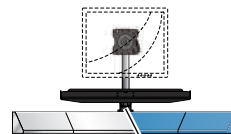

Cover panel + monitor arm and keyboard & mouse tray

RS-M0030T3_



Power feed panel*

RS-M0030T4_

NOTE: * Includes three 15A power outlets

4 CENTER - LOWER PANELS

Choose your panels for model **A** and finish: painted steel (P) or stainless steel (S)



Finishing panels
RS-M0030F1_



Utility panels
RS-M0030U1_



Plastic bin panels
RS-M0030L1P



Finishing panels + tablet arm
RS-M0030S2_

CORNER WORKSTATIONS - 0630



RS-J06303404P

1 TYPE OF SURFACE

Choose your work surface

For a neoprene or nitrile rubber mat, choose the desired finish: painted steel (P) or stainless steel (S).



Painted Steel

RS-W063001P



Stainless Steel

RS-W063001S



Nitrile Mat - 3/16"

RS-W0630M3



Neoprene Mat - 1/8"

RS-W0630M4_

2 UNDER THE WORKSURFACE

Choose your workstation height and a finish for the base.

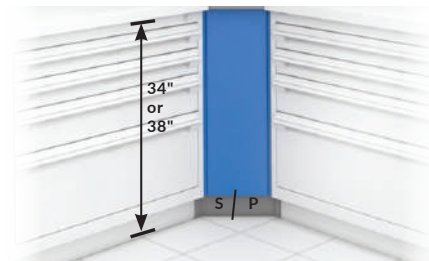

34*: 34" high
38*: 38" high
Base:
P: Painted steel
S: Stainless steel

RS-B0630__1001_

e.g., RS-B0630341001S for a 34"H 0630 corner workstation with stainless steel base. * Includes the 4"H base but excludes the 2"H top.

3 OVER THE WORKSURFACE

Choose from the following models

Choose a finish for the power feed and finishing panel: painted steel (P) or stainless steel (S).

A

Storage cabinet with flipper door + power feed panel²
RS-U0630R01_

B

Computer cabinet + cover panel
RS-U0630C10_

C

Upper finishing panels + power feed panel²
RS-U0630F11_

For this model, the power feed panel determines the panel finish, P or S.



Finishing panels + monitor arm and keyboard & mouse tray + power feed panel^{1 2}

RS-M0630S1401_

In this model the power feed panel determines the panel finish, P or S.

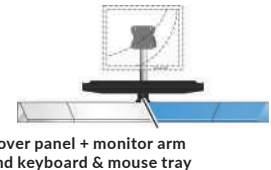

Cover panel + monitor arm and keyboard & mouse tray

RS-M0630T3_



Power feed panel²

RS-M0630T1_

NOTES: ¹The computer mount is positioned on the right by default in this model.

²Includes three 15A power outlets, a knockout for a pneumatic connection and a perforation for installing a telephone or Ethernet jack.

4 CENTER - LOWER PANELS

Choose your panels for models **A**, **B** and **C** and finish: painted steel (P) or stainless steel (S).



Finishing panels

RS-M0630F1_



Utility panels

RS-M0630U1_

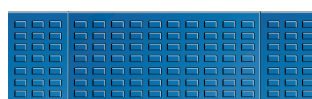

Plastic bin panels

RS-M0630L1P



Finishing panels + tablet arm³

RS-M0630S2_

NOTE: ³The tablet arm is positioned on the right by default in this model.

CORNER WORKSTATIONS - 1230

1 TYPE OF SURFACE

Choose your work surface

For a neoprene or nitrile rubber mat, choose the desired finish: painted steel (P) or stainless steel (S).



RS-J12303402X



Painted Steel
RS-W123001P



Stainless Steel
RS-W123001S



Nitrile Mat - 3/16"
RS-W1230M3



Neoprene Mat - 1/8"
RS-W1230M4_

2 UNDER THE WORKSURFACE

Choose your workstation and cabinet height and a finish for the base.

Cabinet models include a key lock (L3), attachments bars under the surface and finishing panels. Cabinet dimensions are 18"W x 27"D x 34"H/38"H.

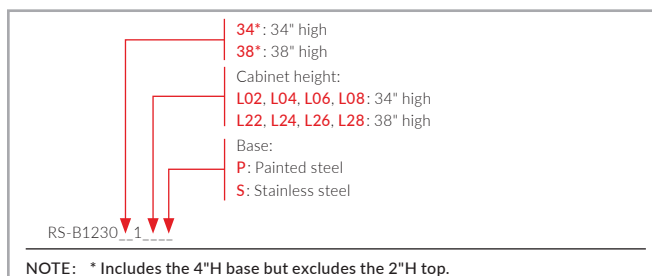
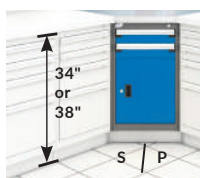

34" H CABINETS



38" H CABINETS



3 OVER THE WORKSURFACE

Choose from the following models

Choose a finish for the power feed and finishing panel: painted steel (P) or stainless steel (S).

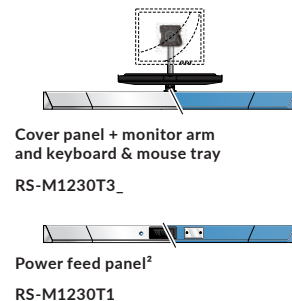
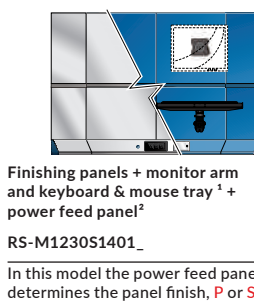
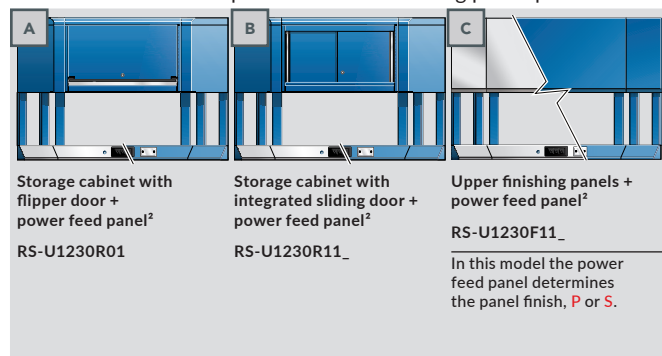

NOTES: ¹The computer mount is positioned on the right by default in this model.
²Includes three 15A power outlets, a knockout for a pneumatic connection and a perforation for installing a telephone or Ethernet jack.

4 CENTER - LOWER PANELS

Choose your panels for models A, B and C and panel finish: painted steel (P) or stainless steel (S).

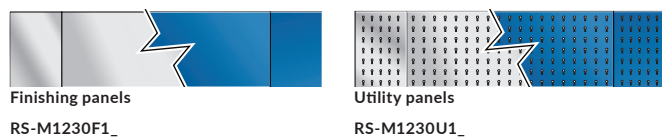

NOTE: ³The tablet arm is positioned on the right by default in this model.

CORNER WORKSTATIONS - 1830

1 TYPE OF SURFACE

Choose your work surface

For a neoprene or nitrile rubber mat, choose the desired finish: painted steel (P) or stainless steel (S).



Painted Steel
RS-W183001P

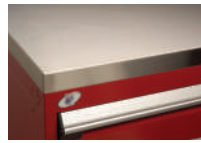

Stainless Steel
RS-W183001S



Nitrile Mat - 3/16"
RS-W1830M3



Neoprene Mat - 1/8"
RS-W1830M4_



2 UNDER THE WORKSURFACE

Choose your workstation and cabinet height and a finish for the base.

Cabinet models include a key lock (L3), attachments bars under the surface and finishing panels. Cabinet dimensions are 24"W x 27"D x 34"H/38"H.

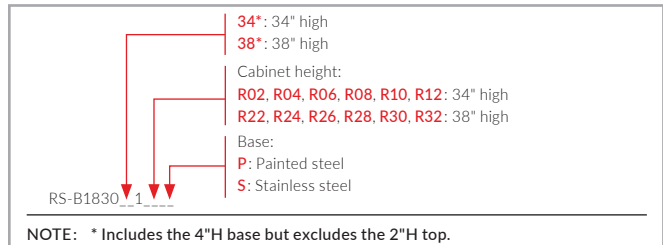

34" H CABINETS

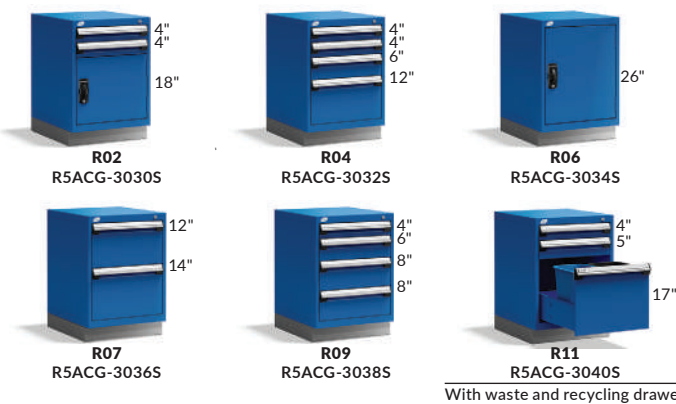

38" H CABINETS

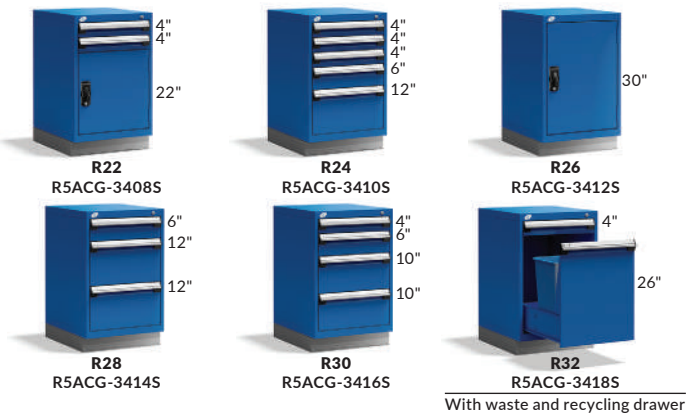

3 OVER THE WORKSURFACE

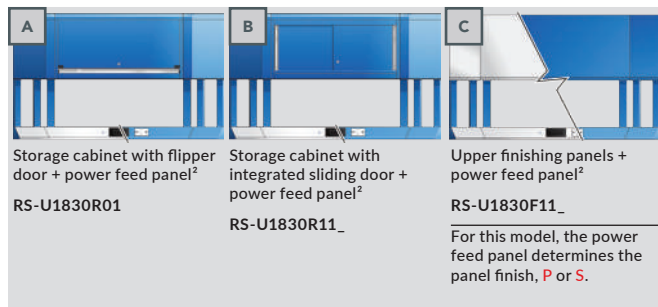

Finishing panels + monitor arm and keyboard & mouse¹ + power feed panel²
RS-M1830S1401_

In this model the power feed panel determines the panel finish, P or S.



Cover panel + monitor arm and keyboard & mouse tray
RS-M1830T3_



Power feed panel²
RS-M1830T1_

NOTE: For ordering guidelines, (P), (S) and notes 1 & 2, please see page 36.

4 CENTER - LOWER PANELS

Choose your panels for models A, B or C and panel finish: painted steel (P) or stainless steel (S).



Finishing panels
RS-M1830F1_

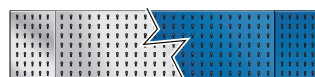

Utility panels
RS-M1830U1_



Plastic bin panels
RS-M1830L1P



Finishing panels + tablet arm³
RS-M1830S2_

NOTE: ³ The tablet arm is positioned on the right by default in this model.

LED LIGHT



- Brighter and more energy efficient than a fluorescent tube
- Brightens shaded areas under cabinets
- Color temperature: 5000-6000K (day white)
- Includes a galvanized steel fitting
- Includes a 10' power cord
- The recommended operating temperature for our LED lights is between 5 and 40 °C (41 to 104 °F)
- An optional motion sensor can be added

PRODUCT NO.	CONFIGURATION	LED WIDTH
RD45-2416__	0630 and 1230	21"
RD45-3616__	1830	33"

NOTES To order an LED light with motion sensor, add **MS** to the product number.
Not compatible with computer cabinets.

MULTI-PURPOSE HOLDER



- Holds up to four aerosol cans
- Also compatible with drinks cans

PRODUCT NO.	FOR
RC51-120312	With or without top cabinet
RC51-120303	With panel configurations only

TOOL HOLDERS

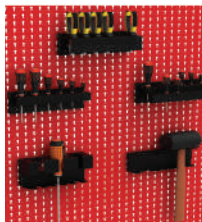

- Variety of hooks and holders available for hanging items and tools. Here are our most popular products:

PRODUCT NO.	
WM9N-01	Single Screwdriver Holder
WM9H-05	Double Back Single Hook
WM9M-01	Pliers Holder
WM9G-200	2" dia. Single Loop Hook

MULTI-PURPOSE SUPPORT



- Includes a clip to keep documents in place

PRODUCT NO.	FOR
RC54-141202	With or without top cabinet
RC54-1412	With panel configurations only

SLOPED TOP



- Keeps the workspace clean and safe while reducing clutter
- The top for computer cabinets includes a fan

PRODUCT NO.	CONFIGURATION	FOR
RS31-063008	0630	Storage cabinet
RS31-123008	1230	Storage cabinet
RS31-183008	1830	Storage cabinet
RS32-063008	0630	Computer cabinet

TABLET ARM



- Compatible with most tablets on the market
- Installs on a lower (15") finishing panel for computer arm (RS81/RS82)
- Compatible tablet sizes:
 - Small: 7 $\frac{1}{8}$ "W to 10"W
 - Large: 9 $\frac{1}{4}$ "W to 12 $\frac{1}{4}$ "W

PRODUCT NO.	FOR
RC58-62-01	Small
RC58-62-02	Large



TEKZONE WORKSTATION HUTCH

SECURITY – FLEXIBILITY – EFFICIENCY



With the TekZone Workstation Hutch, you can create a personalized and organized workspace.

- The work area it provides is spacious and well lit. Each TekZone Hutch is equipped with an LED light with motion sensor so the workspace lights up as soon as you open the door
- A wide range of accessories helps you to stay tidy by freeing up the work surface, while keeping your essential tools close at hand
- The ingenious door mechanism allows you to open and close the hutch easily, smoothly and safely. With the full-width handle, you can open the door with any hand position. The door is fitted with a lock to secure the contents of the hutch
- An L3 key lock is included with the hutch. For an L50 digital lock or an L100 smart lock, please contact Customer Service

OPEN/CLOSED VIEW



TZ-C044S



4 EASY STEPS

In just four steps, we can help you configure your own layout quickly and easily.

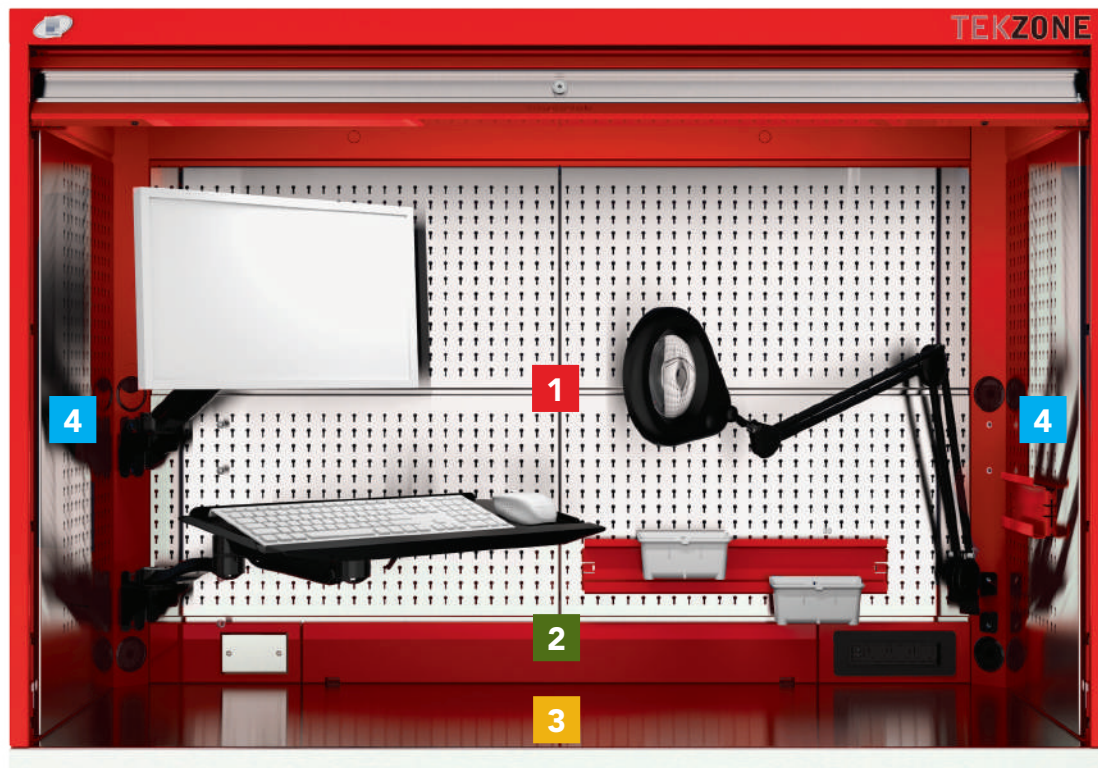

TEKZONE WORKSTATION HUTCH

1 DIMENSIONS AND PANEL TYPES

UTILITY PANELS

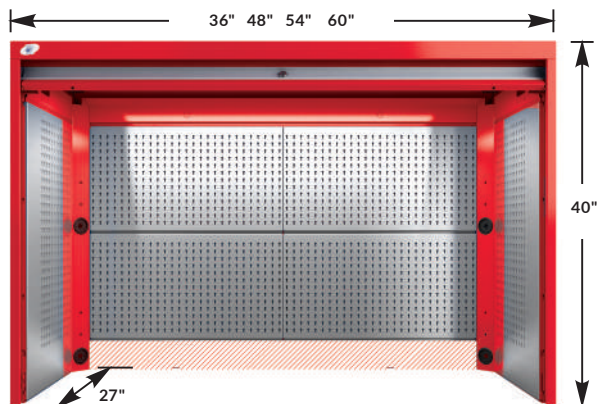

Width:
E: 36"; **G:** 42"; **H:** 48"; **J:** 54"; **K:** 60"
 Panel types:
P: Painted steel
S: Stainless steel

TZ-U_G40U002_L3

UTILITY AND PLASTIC BINS PANELS

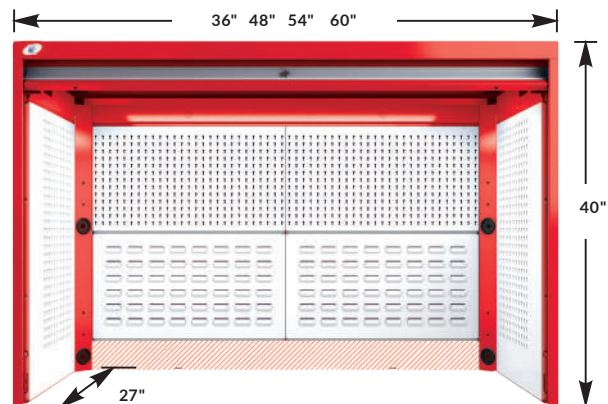

Width:
E: 36"; **G:** 42"; **H:** 48"; **J:** 54"; **K:** 60"
 Panel types:
P: Painted steel

TZ-U_G40X002PL3

2 POWER FEED PANEL

3 Power Outlets (15A)
 TZ-M0_ _ T4_

3 Power Outlets (15A), 2 USB Ports
 TZ-M0_ _ T2_

Widths:
36", 42", 48", 54" and 60"
 Panel types:
P: Painted steel
S: Stainless steel

TZ-M0_ _ T4_

3 Power Outlets (15A), Knockout and Perforation
 TZ-M0_ _ T1_

3 Power Outlets (15A), 2 USB Ports, Knockout and Perforation
 TZ-M0_ _ T3_

Cover Panel
 TZ-M0_ _ 00_

3 TYPE OF SURFACE

Slim Painted Steel Top
 RH10- _ _27 For R cabinets

Slim Stainless Steel Top
 RH11- _ _27 For R cabinets

1 3/4" Painted Steel Top
 RC37- _ _ _-02 For R cabinets or GT workstations

1 3/4" Stainless Steel Top
 RC35- _ _ _-02 For R cabinets or GT workstations

Resistant Rubber Mat (Top must be ordered separately)
 RH90- _ _ _ 3/4" oil-resistant nitrile
 RH91- _ _ _ 1/2" neoprene

Widths:
36", 42", 48", 54" and 60"
 Depths:
27" and 30"

RH90- _ _ _

TEKZONE WORKSTATION HUTCH

4 ACCESSORIES

TABLET ARM



- Compatible with most tablets on the market
- The clamps and mount have a non-slip surface to keep the tablet stable
- Includes an articulating arm with two joints
- The articulating arm with two joints provides extra adjustment options
- Tablet can be rotated and tilted
- Compatible tablet sizes:
 - Small: 7 $\frac{3}{8}$ "W to 10"W
 - Large: 9 $\frac{7}{8}$ "W to 12 $\frac{1}{4}$ "W

PRODUCT NO.	FOR
EA64-62-01	Small
EA64-62-02	Large

LAPTOP ARM



- Holds a laptop, electronic device or any other object
- Tray's usable area: 14"W x 12"D
- Includes an articulating arm with two joints
- The articulating arm with two joints provides extra adjustment options
- Tray can be rotated and tilted

PRODUCT NO.
EA64-42

LAMP WITH MAGNIFIER AND LED LIGHT

RH50



- Diopter: 5 (2.25x magnification)

PRODUCT NO.	USE
RH50-02	Support and Lamp with magnifier and LED light

WIRE SPOOL AND ROLL HOLDERS

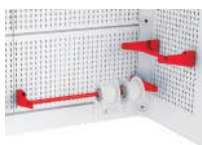

- Hooks onto utility panels at the desired height
- Ideal for wire spools or paper towel rolls
- Tube diameter: $\frac{3}{4}$ "
- Load capacity: 50lb.

PRODUCT NO.	WIDTH	USE
WM9P-1201	12"	For 27"D side panels
WM9P-2001	20"	For half-width back panels on a 48"W hutch
WM9P-2301	23"	For half-width back panels on a 54"W hutch
WM9P-2601	26"	For half-width back panels on a 60"W hutch For back panels on a 36"W and 42"W hutch

MONITOR MOUNT AND KEYBOARD & MOUSE ARM



- Holds a computer monitor, keyboard and mouse
- Keyboard tray's usable area: 23 $\frac{3}{8}$ "W x 8 $\frac{1}{2}$ "D
- Includes an articulating arm with a single joint and an articulating arm with two joints
- The articulating arm with two joints provides extra adjustment options
- Compatible with most monitors (max. 21") on the market
- Complies with VESA 75 and 100 monitor mounting standards
- Monitor and tray can be rotated and tilted

PRODUCT NO.	USE
EA64-02	Articulating arm for monitor
EA64-32	Articulated arm for keyboard and mouse

MONITOR MOUNT



- Supports a monitor compliant with the VESA 75 and 100 standards
- Includes a central cutout for cable management from the rear of the mount
- Two positions: vertical or angled 10° forward to reduce reflections

PRODUCT NO.
RH52-15

KEYBOARD TRAY



- Hooks onto back utility panels at the desired height
- Unique and heavy-duty design with palm rests
- 25"W to accommodate a keyboard and mouse
- Includes a non-slip protective mat

PRODUCT NO.
RH53-25

PLASTIC BIN RAIL

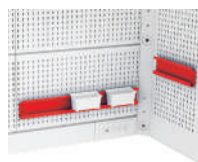

- Hooks onto utility panels at the desired height
- Plastic bins hook onto the rail for efficient storage of small parts
- Compatible with RG20 plastic bins (sold separately)

PRODUCT NO.	WIDTH	USE
WM9C-12	12"	For 27"D side panels
WM9C-20	20"	For half-width back panels on a 48"W hutch
WM9C-23	23"	For half-width back panels on a 54"W hutch
WM9C-26	26"	For half-width back panels on a 60"W hutch For back panels on a 36"W and 42"W hutch

TEKZONE WORKSTATION HUTCH

4 ACCESSORIES

SLOPED TOP



- Keeps the workspace clean and safe while reducing clutter
- Height: 8"

PRODUCT NO.	W x D
RH89-362708	36" x 27"
RH89-422708	42" x 27"
RH89-482708	48" x 27"
RH89-542708	54" x 27"
RH89-602708	60" x 27"

CAN HOLDER

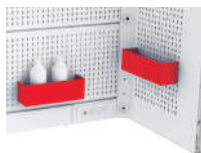

- Hooks onto utility panels at the desired height
- Ideal for storing cans and other containers of different sizes
- Compatible with side and back panels

PRODUCT NO.	W x D x H
WM9D-12	12" x 3" x 4"

SHELF AND DIVIDERS

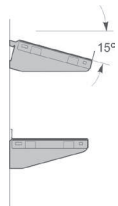

- Hooks onto back utility panels at the desired height
- Can be installed at a right angle or angled 15°
- The shelf is reversible and its edge can act as a back stop for plastic bins and ring binders
- Load capacity: 100lb. (evenly distributed)
- Compatible with SH52-1206 dividers in 2" increments c/c
- Width compatibility:
36" and 42" hutches: full-width shelf
48", 54" and 60" hutches: half-width shelf

PRODUCT NO.	WIDTH	COMPATIBILITY
RH60-24__	20"	½ shelf for 48"W hutch
RH60-27__	23"	½ shelf for 54"W hutch
RH60-30__	26"	½ shelf for 60"W hutch
RH61-36__	29"	Shelf for 36"W hutch
RH61-42__	35"	Shelf for 42"W hutch
SH52-1206		Divider

NOTE: Add 08 to the product number for an 8"D shelf and 12 for a 12"D shelf.

MIDDLE SHELF AND BOTTOM SHELF

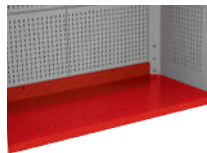
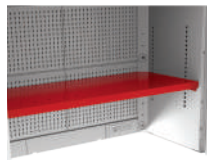

- Full-length and full-depth shelf
- Load capacity: 200lb. (evenly distributed)
- Compatible with SH52-2106 dividers in 3" increments c/c
- Compatible with RH20 and RH21 back utility panels (the panel area right next to the shelf will be unusable)
- Not compatible with RH22/RH23 back plastic bin panels
- RH64 Middle Shelf:**
 - Attaches to RH35 side panels only
 - To add to a preconfigured TZ model, replace the side panels with RH35 side panels
 - Not compatible with the following side panels: RH32 plastic bin panels, RH30/RH31 utility panels and RH28/RH29 finishing panels
- RH65 Bottom Shelf:**
 - A top (see page 41) is required for joining the hutch to the cabinet underneath

PRODUCT NO.	WIDTH	ACTUAL DEPTH
RH__-3627	36"	20 7/16"
RH__-4227	42"	20 7/16"
RH__-4827	48"	20 7/16"
RH__-5457	54"	20 7/16"
RH__-6027	60"	20 7/16"

NOTES: Add 64 to the product number for a middle shelf and 65 for a bottom shelf. RH40/41 power feed panels, RH38/39 cover panels and RH36/37 cable management modules cannot be used with the bottom shelf.

BATTERY CHARGER SHELF

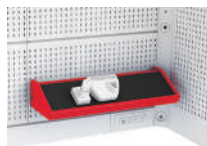

- Hooks onto back utility panels at the desired height
- 25" usable width accommodates several chargers at once
- Includes a non-slip protective mat
- Includes a built-in power strip with six power outlets (15A/120V, with switch, circuit breaker and 15' power cord)
- Includes storage space for cable management

PRODUCT NO.	WIDTH
RH54-26	26"

TEKZONE: KEEPING YOUR WORKSPACE ORGANIZED AND YOUR TOOLS SECURE



TOOLBOXES

QUALITY - DURABILITY - VERSATILITY



Richmond Hill Toyota (ON)

Forget everything you think you know about toolboxes because Rousseau toolboxes are in a different league. Those who try them never look back!

You will love their distinctive looks and impressive versatility.

Whether you need just one unit or one hundred, our specialists will help you build your ideal configuration.

ROUSSEAU: A VAST RANGE OF SOLUTIONS

Many different dimensions available

- Different work surface options
- A choice of 20 standard colors
- Duotone available
- A wide variety of accessories
- An L3 key lock is included on all preconfigured toolbox models. For an L50 digital lock or an L100 smart lock, please contact Customer Service.



ROUSSEAU TOOLBOXES ARE DESIGNED, DEVELOPED AND MANUFACTURED IN NORTH AMERICA

Choose one of our preconfigured models or build your own.

UNDER THE WORK SURFACE - PAGES 45-47



SIDE - PAGE 48



MOBILE - PAGES 49-51



TOOLBOX ACCESSORIES - PAGES 52-54



DRAWER ACCESSORIES - PAGES 123-124



2 UNDER THE WORKSURFACE

Toolboxes can be ordered on their own or as components of workcenters (2 "Under the Work Surface") as featured on pages 20-33.

- Multi-drawer cabinets include stabilizing bars to provide extra rigidity to the housing
- An L3 key lock is included on all preconfigured toolbox models. For an L50 digital lock or an L100 smart lock, please contact Customer Service
- A range of optional accessories are also available, see pages 52-54 and pages 123-124



SOME OF OUR MOST POPULAR MODELS ARE SHOWN BELOW:

Widths: 1 bank of drawers: 24" (C); 30" (D); 36" (E); 42" (G); 48" (H); 54" (J); 60" (K);
 3 banks of drawers: 48" (H); 54" (J); 60" (K);
 4 banks of drawers: 72" (L); 84" (U); 96" (R);

Depth: 27"

Heights: 34", 38" (including the 4"H base)

NOTE	WIDTH
1	Available in 48"W, 54"W and 60"W
2	H (48"W) 1 bank 48"W, 2 banks 24"W
	J (54"W) 1 bank 54"W, 1 bank 24"W, 1 bank 30"W
	K (60"W) 1 bank 60"W, 2 banks 30"W
3	H (48"W) 1 bank 48"W, 2 banks 24"W
	J (54"W) 1 bank 54"W, 1 bank 18"W, 1 bank 36"W
4	K (60"W) 1 bank 60"W, 1 bank 24"W, 1 bank 36"W
	24"W Single integrated swing door
5	30"W+ Double integrated swing doors
	Only available in 24"W and 30"W

NOTE: The 18"W and 24"W banks of drawers are always installed on the left side of a 54"W and 60"W housing.



34"H

<p>6 Drawers GT-5A_G30002_</p>	<p>7 Drawers GT-5A_G30004_</p>	<p>6 Drawers GT-5A_G30006_</p>	<p>5 Drawers GT-5A_G30008_</p>
<p>7 Drawers GT-5A_G30010_</p>	<p>4 Drawers GT-5A_G30020_</p>	<p>4 Drawers GT-5A_G30032_</p>	<p>2 Drawers GT-5A_G30042_</p>

TOOLBOXES

2 UNDER THE WORKSURFACE

34"H



3 Drawers
GT-5A_G30044_



2 Drawers - 1 Waste & Recycling Drawer
GT-5A_G30046_ (Note 5)



4 Drawers
GT-5A_G30048_



Integrated Swing Doors - 2 Shelves
GT-5A_G30012_ (Note 4)

NOTE: See page 10 for more details on the Waste & Recycling Drawer.



Integrated Sliding Doors - 2 Shelves
GT-5A_G30014_ (Note 1)



11 Drawers
GT-5K_G30002_ (Note 2)



10 Drawers
GT-5K_G30004_ (Note 3)



7 Drawers
GT-5K_G30010_ (Note 2)



7 Drawers
GT-5K_G30008_ (Note 2)



7 Drawers
GT-5K_G30016_ (Note 2)



9 Drawers
GT-5K_G30018_ (Note 3)



9 Drawers
GT-5K_G30020_ (Note 3)



9 Drawers
GT-5K_G30024_ (Note 2)

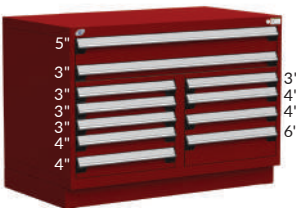

11 Drawers
GT-5K_G30026_ (Note 2)



14 Drawers
GT-5KUG30004_

NOTE: Width: 84"

2 UNDER THE WORKSURFACE

38" H



5 Drawers

GT-5A_G34006_



5 Drawers

GT-5A_G34008_



3 Drawers

GT-5A_G34010_



4 Drawers

GT-5A_G34012_



10 Drawers

GT-5K_G34002_ (Note 2)



8 Drawers

GT-5K_G34004_ (Note 2)



8 Drawers

GT-5K_G34006_ (Note 2)



9 Drawers

GT-5K_G34008_ (Note 3)



Integrated Swing Doors - 2 Shelves

GT-5A_G34014_ (Note 4)



Integrated Sliding Doors - 2 Shelves

GT-5A_G34018_ (Note 1)



10 Drawers

GT-5K_G34010_ (Note 3)

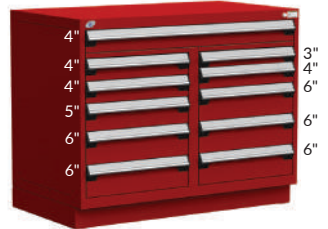

11 Drawers

GT-5K_G34012_ (Note 3)



14 Drawers

GT-5KLG34002_

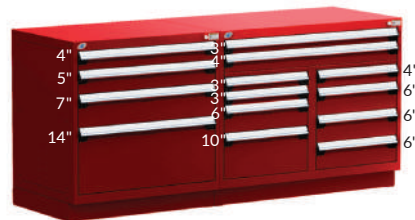

14 Drawers

GT-5KUG34002_



14 Drawers

GT-5KRG34002_

NOTE: Width: 72"

NOTE: Width: 84"

NOTE: Width: 96"

TOOLBOXES

5A SIDES OF BAYS

Toolboxes can be ordered on their own or as components of a workcenter as featured on [pages 20-33](#).

- Multi-drawer cabinets include stabilizing bars to provide extra rigidity to the housing
- An L3 key lock is included on all preconfigured toolbox models. For an L50 digital lock or an L100 smart lock, please contact Customer Service
- A range of optional accessories are also available, see [pages 49-52](#) and [pages 119-120](#)



SOME OF OUR MOST POPULAR MODELS ARE SHOWN BELOW:

Widths: 1 bank of drawers: 24" (C); 30" (D); 36" (E); 42" (G); 48" (H); 54" (J); 60" (K);
 3 banks of drawers: 48" (H); 54" (J); 60" (K);
 4 banks of drawers: 96" (R);

Depth: 27"

Heights: 42", 48", 62" (including the 4"H base)



NOTE	WIDTH	
	H (48"W)	1 bank 48"W, 2 banks 24"W
1	J (54"W)	1 bank 54"W, 1 bank 18"W, 1 bank 36"W
	K (60"W)	1 bank 60"W, 2 banks 30"W

NOTE: The 18"W and 24"W banks of drawers are always installed on the left side of a 54"W or 60"W housing.

42" H



12 Drawers
GT-5K_G38002_(Note 1)

48" H



9 Drawers
GT-5A_G44010_



15 Drawers
GT-5K_G44010_(Note 1)



17 Drawers
GT-5K_G44004_(Note 1)

48" H



16 Drawers
GT-5K_G44008_(Note 1)



8 Drawers
GT-5A_G44008_

62" H



15 Drawers
GT-5K_G58004_(Note 1)



14 Drawers
GT-5K_G58006_(Note 1)

Toolboxes can be ordered on their own or as components of a workcenter as featured on [pages 20-33](#).

- An L3 key lock is included on all preconfigured toolbox models. For an L50 digital lock or an L100 smart lock, please contact Customer Service
- Preconfigured models include 6" polyurethane casters (total height: 7 1/2"), including two rigid and two swivel casters with total-lock brakes. 4" polyurethane casters are also available
- A range of optional accessories are also available, see [pages 52-54](#) and [pages 123-124](#)



SOME OF OUR MOST POPULAR MODELS ARE SHOWN BELOW:

Widths: 1 bank of drawers: 30" (D); 36" (E); 48" (H); 54" (J); 60" (K);
 3 banks of drawers: 48" (H); 54" (J); 60" (K);
 4 banks of drawers: 72" (L); 78" (V); 84" (U); 96" (R); 108" (S);

Depth: 27"
 Heights: 37 1/2", 41 1/2", 45 1/2" (including casters)



NOTE	WIDTH	
1	H (48")	1 bank 48"W, 2 banks 24"W
	J (54")	1 bank 54"W, 1 bank 18"W, 1 bank 36"W
	K (60")	1 bank 60"W, 1 bank 24"W, 1 bank 36"W

NOTE: The 18"W and 24"W banks of drawers are always installed on the left side of a 54"W or 60"W housing.

37 1/2" H



6 Drawers

GT-5B_G30002P_



5 Drawers

GT-5B_G30004P_



4 Drawers

GT-5B_G30008P_



10 Drawers

GT-5G_G30006P_ (Note 1)

41 1/2" H



7 Drawers

GT-5G_G34006P_ (Note 1)



10 Drawers

GT-5G_G34004P_ (Note 1)

45 1/2" H



12 Drawers

GT-5G_G38010P_ (Note 1)



16 Drawers

GT-5G_G38002P_ (Note 1)

TOOLBOXES

MOBILE

37 1/2" H



6 Drawers
GT-5G_G30010P_(Note 1)

41 1/2" H



9 Drawers
GT-5G_G34008P_(Note 1)

45 1/2" H



9 Drawers
GT-5G_G38012P_(Note 1)



11 Drawers
GT-5G_G38014P_(Note 1)

37 1/2" H



12 Drawers
GT-5GLG30002P_

NOTE: Width: 72"



13 Drawers
GT-5GUG30002P_

NOTE: Width: 84"



13 Drawers
GT-5GRG30002P_

NOTE: Width: 96"

41 1/2" H



14 Drawers
GT-5GVG34002P_

NOTE: Width: 78"



14 Drawers
GT-5GLG34002P_

NOTE: Width: 72"



13 Drawers
GT-5GRG34002P_

NOTE: Width: 96"

45 1/2" H



15 Drawers
GT-5GVG38002P_

NOTE: Width: 78"



13 Drawers
GT-5GRG38002P_

NOTE: Width: 96"



16 Drawers
GT-5GSG38002P_

NOTE: Width: 108"

HANGING SIDE CABINET - SIDE ACCESS



- For additional storage space in your mobile toolbox, consider our hanging side cabinets.
- Adjustable shelves in 1" increments c/c
- Available with bottom and adjustable shelves
- Both shelf types are compatible with SH52 dividers
- For 27"D toolboxes
- Load capacity: 600lb. per cabinet
- Choice of door. Complete the product number as follows:
 - **01**: Solid door
 - **02**: Polycarbonate door

W x D x H	PRODUCT NO.	NO. OF ADJUSTABLE SHELVES (RD05)
27" x 14" x 24"	R5QPA-24__	-
27" x 14" x 28"	R5QPA-28__	1
27" x 14" x 30"	R5QPA-30__	1
27" x 14" x 34"	R5QPA-34__	1
27" x 14" x 38"	R5QPA-38__	2

POLYURETHANE CASTERS



- Polyurethane casters provide ultra-quiet and excellent maneuverability without marking floors
- 4" and 6" casters available in rigid, swivel and swivel with total-lock brake, with 440lb. and 1,100lb. load capacity per wheel respectively
- An optional directional locking pedal is available for swivel casters (4" and 6") for better control over long distances

PRODUCT NO.	CASTER TYPE	HEIGHT	ACTUAL HEIGHT
RB81-01	Rigid	4 "	5 1/8"
RB81-02	Swivel	4 "	5 1/8"
RB81-03	Swivel with total-lock brake	4 "	5 1/8"
RB84-01	Rigid	6 "	7 1/2"
RB84-02	Swivel	6 "	7 1/2"
RB84-03	Swivel with total-lock brake	6 "	7 1/2"
RB8E-02	Swivel caster directional locking kit		

NOTE: Directional locking pedals are sold in pairs.

SIDE HANDLE



- Wide-grip handle for easier toolbox handling

PRODUCT NO.	ACTUAL DEPTH OF HANDLE
RB90-27	24"

LOCK-IN MECHANISM



Activates when handle is lifted



Closes with a simple push

- Each drawer includes a lock-In mechanism that automatically activates when the drawer is opened
- Stops drawer from opening on its own

PRODUCT NO.
A

FOLDAWAY SHELF



- Provides an additional work surface
- Folds easily to the side when not in use
- Includes a protective neoprene surface

PRODUCT NO.	W x D
RC00-152701	15" x 27"

SIDE AND BACK STOP FOR FOLDAWAY SHELF



- Prevents parts and tools from falling
- Height: 1"

PRODUCT NO.	WIDTH
RC01-15	15"
RC01-27	27"



Troy High School (IL)

TOOLBOXES

TOOLBOX ACCESSORIES



STAINLESS STEEL TOP



- Acts as a work surface and protects the top of the cabinet from impacts
- Particle board top with stainless steel cover (#4 brushed finish)
- Excellent chemical resistance
- Excellent corrosion resistance
- Welded corners for an attractive appearance
- Available in 12ga or 16ga steel (12ga steel top provides better impact resistance)
- 12ga top thickness: 1¹³/₁₆"
- 16ga top thickness: 1³/₄"

PRODUCT NO.	W × D
RC35-2427-__	24" × 27"
RC35-3027-__	30" × 27"
RC35-3627-__	36" × 27"
RC35-4227-__	42" × 27"
RC35-4827-__	48" × 27"
RC35-5427-__	54" × 27"
RC35-6027-__	60" × 27"

NOTE: Complete number with **12** for a 12-gauge steel top.

MARINE EDGE STAINLESS STEEL TOP

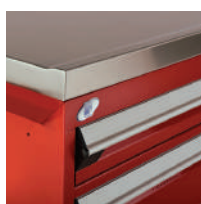

- The edge stops hardware and liquids from falling off
- Acts as a work surface and protects the top of the cabinet from impacts
- Particle board top with stainless steel cover (#4 brushed finish)
- Excellent chemical resistance
- Excellent corrosion resistance
- Welded corners for an attractive appearance
- Available in 12ga or 16ga steel (12ga steel top provides better impact resistance)
- 12ga top thickness: 1¹³/₁₆" and 2" edge
- 16ga top thickness: 1³/₄" and 1¹³/₁₆" edge

PRODUCT NO.	W × D
RC35-2427-__M	24" × 27"
RC35-3027-__M	30" × 27"
RC35-3627-__M	36" × 27"
RC35-4227-__M	42" × 27"
RC35-4827-__M	48" × 27"
RC35-5427-__M	54" × 27"
RC35-6027-__M	60" × 27"

NOTES: Add **12** to the product number for a 12ga steel top, or **16** for a 16ga steel top.
Not compatible with the nitrile or neoprene rubber mat

We have a wide range of accessories so you can gain maximum benefit from your toolbox. Take a look at our selection of tops, doors, stacking cabinets, and other useful add-ons.

PAINTED STEEL TOP

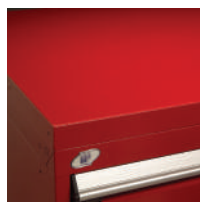

- Acts as a work surface and protects the top of the cabinet from impacts
- Particle board top with painted steel cover
- Welded corners for an attractive appearance
- Thickness: 1³/₄"

PRODUCT NO.	W × D
RC37-2427	24" × 27"
RC37-3027	30" × 27"
RC37-3627	36" × 27"
RC37-4227	42" × 27"
RC37-4827	48" × 27"
RC37-5427	54" × 27"
RC37-6027	60" × 27"

PAINTED STEEL COVER

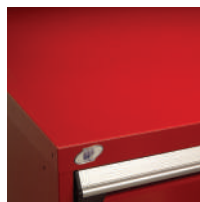

- Adds a protective work surface to the top of the toolbox
- Welded corners for an attractive appearance
- Compatible with the toolbox lock

PRODUCT NO.	W × D
RC38-2427L	24" × 27"
RC38-3027L	30" × 27"
RC38-3627L	36" × 27"
RC38-4227L	42" × 27"
RC38-4827L	48" × 27"
RC38-5427L	54" × 27"
RC38-6027L	60" × 27"

STAINLESS STEEL COVER

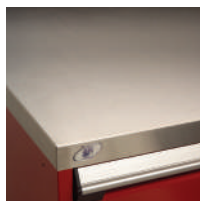

- Adds a protective work surface to the top of the toolbox
- Stainless steel adds stylish aesthetics
- Excellent chemical resistance
- Excellent corrosion resistance
- Welded corners for an attractive appearance
- Compatible with the toolbox lock

PRODUCT NO.	W × D
RC39-2427L	24" × 27"
RC39-3027L	30" × 27"
RC39-3627L	36" × 27"
RC39-4227L	42" × 27"
RC39-4827L	48" × 27"
RC39-5427L	54" × 27"
RC39-6027L	60" × 27"

NITRILE RUBBER MAT



- Nitrile mat with excellent hydrocarbon and shock resistance
- Thickness: 3/16"

PRODUCT NO.	W×D
RG48-2427	24"×27"
RG48-3027	30"×27"
RG48-3627	36"×27"
RG48-4227	42"×27"
RG48-4827	48"×27"
RG48-5427	54"×27"
RG48-6027	60"×27"

NOTE: Not compatible with the marine edge stainless steel top.

NEOPRENE RUBBER MAT



- Neoprene mat for protecting the work surface
- Thickness: 1/8"

PRODUCT NO.	W×D
RG45-2427	24"×27"
RG45-3027	30"×27"
RG45-3627	36"×27"
RG45-4227	42"×27"
RG45-4827	48"×27"
RG45-5427	54"×27"
RG45-6027	60"×27"

NOTE: Not compatible with marine edge stainless steel top.

ADJUSTABLE KICK PLATE FOR LEVELING GLIDES



- Provides an immaculate finish
- Prevents dust from entering
- Available in stainless steel only
- Please contact your customer service representative for more details

LEVELING GLIDES



- For easy height adjustment and leveling of toolbox without removing drawers (1 1/2" to 2" from the ground)
- Compatible with toolbox bases
- Sold in packs of 4

PRODUCT NO.
RA74-01

SIDE UTILITY PANEL



- Maximizes toolbox storage space
- Installs on the sides of toolboxes
- Compatible with all WM9_ hooks and holders, [see page 119](#)

PRODUCT NO.	DEPTH
RC02-27_	27"

NOTES: Complete the product number with the housing height required: 28", 30", 34", 38", 44", 58".

Full height installation only.

Not compatible with RC00 foldaway shelves.

BUMPERS FOR TOOLBOXES



- Protects toolboxes from bumps and damage
- Protection kit for all four corners of toolboxes
- Vertical bumpers and endcaps made from resistant soft PVC
- Quick and easy installation with double-sided adhesive tape
- Tool-free installation

PRODUCT NO.	COMPATIBLE WITH
RB9J-_ 01	RA30/RA35 toolbox
RB9J-_ 02	RA30/RA35 toolbox and RD01 side cabinet
RB9J-_ 03	RA30/RA35 toolbox and 1 RC02/RC04 side panel
RB9J-_ 04	RA30/RA35 toolbox and 2 RC02/RC04 side panels

NOTES: Complete the product number with the housing height required: 28", 30", 34", 38", 44", 58".

Not compatible with RC00 foldaway shelves.

SIDE PLASTIC BIN PANEL



- Maximizes toolbox storage space
- Holds RG20 plastic bins, [see page 121](#)
- Installs on the sides of toolboxes
- Compatible with all commercially available brands of plastic bins with a hanging lip

PRODUCT NO.	DEPTH
RC04-27_	27"

NOTES: Complete the product number with the housing height required: 28", 30", 34", 38", 44", 58".

Full height installation only.

Not compatible with RC00 foldaway shelves.



TOOLBOXES

TOOLBOX ACCESSORIES

STACKING CABINET



- For storage of large and bulky items, choose a stacking cabinet.
- Shelves are height adjustable in 1" increments c/c and include an edge that prevents items from falling
- Housing heights available: 24" and 30"
- Available with or without doors (solid steel or polycarbonate)
- A range of dimensions available

PRODUCT NO.	W × D
R5HDG-___	30" × 27"
R5HEG-___	36" × 27"
R5HHG-___	48" × 27"
R5HJG-___	54" × 27"
R5HKG-___	60" × 27"

DOOR TYPE	CABINET WIDTHS				
	30"	36"	48"	54"	60"
00 Without door	X	X	X	X	X
01 Single integrated door	X	X			
02 Single integrated polycarbonate door	X	X			
03 Double integrated doors	X	X	X	X	X
04 Double integrated polycarbonate doors	X	X	X	X	X
05 Double doors with frame	X	X	X	X	X
06 Double polycarbonate doors with frame	X	X	X	X	X
07 Integrated sliding doors			X	X	X
08 Integrated sliding polycarbonate doors			X	X	X
09 Sliding doors with frame			X	X	X
10 Sliding polycarbonate doors with frame			X	X	X

NOTE: When ordering, specify the housing height and type of door required: e.g., R5HEG-24 03 for a 36"W × 27"D × 24"H cabinet with double integrated doors.

SLOPED TOP



- Keeps the workspace clean and tidy while reducing clutter
- 16° slope angle
- Height: 8"

PRODUCT NO.	W × D
RC31-362708	36" × 27"
RC31-422708	42" × 27"
RC31-482708	48" × 27"
RC31-542708	54" × 27"
RC31-602708	60" × 27"

DRAWER WITH STAINLESS STEEL FRONT



- Adds stylish aesthetics to workstations and toolboxes
- Excellent chemical and corrosion resistance
- #4 brushed finish

Drawer widths:	18", 24", 30", 36", 42", 48", 54", 60"
Drawer heights:	03", 04", 05", 06", 07", 08", 09", 10", 12", 14"

RF35-___27"

NOTE: Order an RA30 or RA35 housing and RF35 drawers with stainless steel fronts.

DOORS



- Doors are ideal for secure and discrete storage.
- Available in the following combinations: single or double (double door can be sliding), polycarbonate or solid steel
- All door models include an L3 key lock
- The L50 digital lock option or the L100 smart lock is compatible with swing doors. Please contact our customer service.

PRODUCT NO.	TYPE	SURFACE
RB62	Single integrated	Steel
RB67	Double integrated	Steel
RB75	Double with frame	Steel
RB50	Integrated sliding	Steel
RB55	Sliding with frame	Steel
RB61	Single integrated	Polycarbonate
RB66	Double integrated	Polycarbonate
RB76	Double with frame	Polycarbonate
RB51	Integrated sliding	Polycarbonate
RB56	Sliding with frame	Polycarbonate

L50 DIGITAL LOCK



- Simple, fast and easy to use
- No key required
- Up to 20 different users
- 4-to 8-digit access codes
- Retrofits on existing Rousseau R or L cabinets with drawers
- Simplifies access management to drawers
- Can be used in all configurations of cabinets with drawers
- Compatible with RC35 and RC37 tops

PRODUCT NO.	FOR
RB00-DDHHL50	RA30 (R Cabinet)
RB01-WWDDHHL50	RA35 (Multi-Drawer Cabinet)
LB00-DDHHL50	LA30 (L Cabinet)

NOTE: Not compatible with RC38 and RC39 tops.

L100 SMART LOCK



- Intuitive use
- No key required
- Simple and complete management
- Handy unlocking via a transponder or smartphone
- Retrofits on existing Rousseau R or L cabinets with drawers
- Can be used in all configurations of cabinets with drawers
- Compatible with RC35 and RC37 tops

PRODUCT NO.	FOR
RB00-DDHHL100	RA30 (R Cabinet)
RB01-WWDDHHL100	RA35 (Multi-Drawer Cabinet)
LB00-DDHHL100	LA30 (L Cabinet)

NOTE: Not compatible with RC38 and RC39 tops.



The R2V Vertical Storage System is the only product of its type on the market. Stacked above an R cabinet (sold separately), it is ideal for storing more tools and equipment while keeping them within easy reach. By using all vertical space available, you can free up floor space and stay perfectly organized.

The drawers – which are fitted with a lock-in mechanism – open to full extension and boast a load capacity of 200lb. They provide high-density and tidy storage, which helps boost your productivity and efficiency.

- Widths: 24", 30", 36", 42", 48", 54" and 60"
- Depth: 27"
- Heights: 34" and 38"
- Drawer widths: 6", 7", 8", 9", 10", 11" and 12"



DISTINCTIVE FEATURES

DRAWER INTERIOR

Pale-gray 071 interior for better visibility



ERGONOMIC HANDLE

Comfort-grip handle with integrated drawer lock-in mechanism



ORGANIZATION

Front and rear panels with perforations for hanging tools. Optional utility panels and 5S accessories also available



LOCKS

Key lock included on all models. Optional electronic locks and two-user lock also available

100% EXTENSION

Quick and easy access and identification of tools

HEIGHT COMBINATIONS

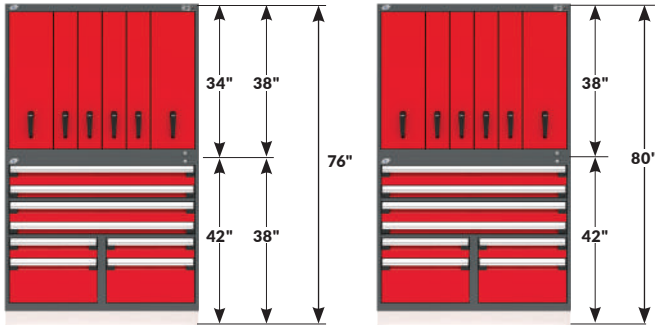

DRAWER SUBDIVISION

To subdivide your drawers, see the layouts and accessories on [pages 59 and 60](#).

OPTIONS UNDERNEATH

TOOLBOXES
SEE PAGES 44-48

REEL CABINET
SEE PAGE 63-66

CABINET WITH WASTE AND RECYCLING DRAWER
SEE PAGE 10

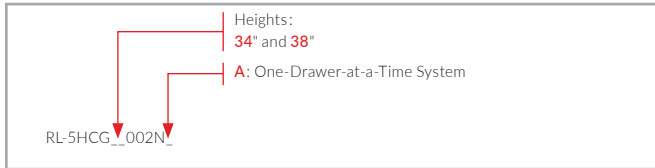

NOTES: The R2V Vertical Storage System must be installed on top of an R cabinet of the same width. It cannot be installed directly on the ground.

For stability reasons, the stacked cabinet must be anchored to the R cabinet underneath.

For compatibility with RD86 / 87 storage unit, contact Customer Service.



There is no mobile version of this product available.

24" W



3 drawers

RL-5HCG_002N_



3 drawers

RL-5HCG_004N_



2 drawers

RL-5HCG_006N_

30" W



3 drawers

RL-5HDG_002N_



4 drawers

RL-5HDG_004N_



3 drawers

RL-5HDG_006N_

36" W



4 drawers

RL-5HEG__002N_



4 drawers

RL-5HEG__004N_



3 drawers

RL-5HEG__006N_

42" W



4 drawers

RL-5HGG__002N_



5 drawers

RL-5HGG__004N_



4 drawers

RL-5HGG__006N_

48" W



6 drawers

RL-5HHG__002N_



6 drawers

RL-5HHG__004N_



4 drawers

RL-5HHG__006N_

54" W



5 drawers
RL-5HJG__002N_



6 drawers
RL-5HJG__004N_



5 drawers
RL-5HJG__006N_



5 drawers
RL-5HJG__008N_

60" W



8 drawers
RL-5HKG__002N_



6 drawers
RL-5HKG__004N_



5 drawers
RL-5HKG__006N_



6 drawers
RL-5HKG__008N_



You have a project? Our specialists will help you find a customized solution. Contact us.

Choose the interior layout of each drawer using the preconfigured suggestions on this page. Complete your layouts with the accessories on [page 60](#) or [118-121](#) in the 5S section as needed.

- NOTES: 1: Hook perforations on both sides of the panel. Panel position is adjustable across the shelf width.
 2: Not available for 7"W drawers.
 3: Available for 10"W drawers and over.
 4: Panel position is adjustable across the shelf width.

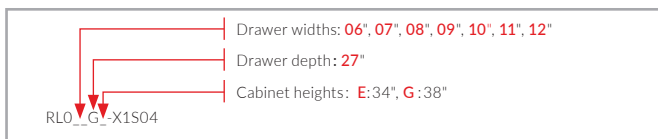



Refer to technical guide R68 for details on accessories compatibility.



Tray, 8 magnetic dividers

RLO_G_T1001

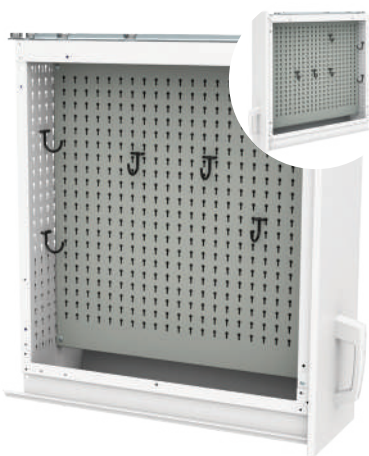

Adjustable utility panel¹, 20 hooks

RLO_G_U0C02



Side utility panel, 20 hooks, plastic bins²

RLO_G_U0S03



2 trays, 12 magnetic dividers

RLO_G_T2001

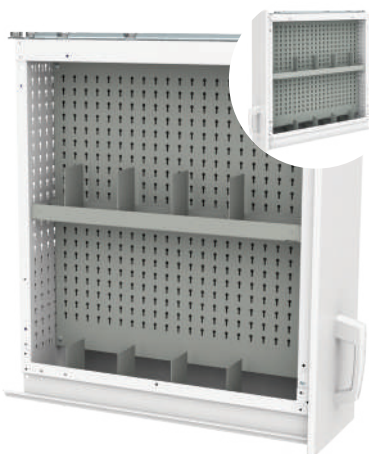

Adjustable utility panel¹, 2 trays, 16 magnetic dividers³

RLO_G_X2C01



Side utility panel, 1 tray, 4 magnetic dividers, plastic bins²

RLO_G_X1S04



RL-XCG76S002NS



RL-XEG76S002NS



RL-XHG76S002NS



RL-XKG76S002NS

SIDE UTILITY PANEL



- For locating tools quickly and easily
- Full-height and full-depth panel
- Installs on the far right of the drawer but can be easily repositioned on the left
- Color: light gray 071

PRODUCT NO.	CABINET HEIGHT
RL40-2734	34"
RL40-2738	38"

ADJUSTABLE TRAY



- Ideal for storing assorted products and tools (cans, bottles, etc.)
- Tool-free installation and adjustment
- Includes edges to prevent objects from falling to the bottom of the drawer
- Height adjustable in 1" increments (c/c)
- Compatible with side utility panels. For compatibility with adjustable utility panels, refer to technical guide R68
- Color: light gray 071

PRODUCT NO.
RL21-__27

NOTE: Complete the product number with the drawer width: 06", 07", 08", 09", 10", 11" and 12".

NON-SLIP DRAWER/TRAY LINER



- Protects tools stored in the drawer or on a tray
- Thick 3/32"

PRODUCT NO.	DEPTH
RL49-__24	24"
RL49-__27	27"

NOTES: Complete the product number with the drawer width: 06", 07", 08", 09", 10", 11" and 12".
Not compatible with magnetic dividers.

LABEL HOLDER



- For 7/8"H paper labels
- Label holder height: 15/16"
- Widths available: 6" and 9"

PRODUCT NO.	
RL81-__	Self-adhesive
RL82-__	Magnetic

NOTE: Complete the product number with the desired width: 06", 09".

ADJUSTABLE UTILITY PANEL



- For locating tools quickly and easily
- Full-height and full-depth panel
- Tools can be hung on each side of the panel without obstructing the drawer
- Width adjustable in 1/2" increments c/c
- Color: light gray 071

PRODUCT NO.	CABINET HEIGHT
RL43-2734	34"
RL43-2738	38"

MAGNETIC DIVIDER



- Installs on drawer bottoms and adjustable trays
- Includes a magnetic strip for easy repositioning
- Divider height: 4"
- Color: light gray 071

PRODUCT NO.	DIVIDER
RL60-2704	Depth
RL61-__04	Width

NOTES: Complete the RL61 number with the drawer width: 06", 07", 08", 09", 10", 11" and 12".
Not compatible with non-slip drawer/tray liners.

ONE-DRAWER-AT-A-TIME SYSTEM



- Prevents more than one drawer from opening at the same time for greater stability
- To order: Add "A" to the model numbers on [pages 56-58](#)

L50 DIGITAL LOCK



- Simple, fast and easy to use
- No key required
- Up to 20 different users
- 4- to 8-digit access codes

PRODUCT NO.
RL00-__27L50

NOTE: Complete the product number with the cabinet width: 24", 30", 36", 42", 48", 54" and 60".

L100 SMART LOCK



- Intuitive use
- No key required
- Simple and complete management
- Handy unlocking via a transponder or smartphone

PRODUCT NO.
RL00-__27L100

NOTE: Complete the product number with the cabinet width: 24", 30", 36", 42", 48", 54" and 60".

CABINET FOR TWO USERS



Sharing toolboxes between two users is now easy with two-user access. Available for multi-drawer toolboxes and the R2V Vertical Storage System, two-user access allows each technician to lock their own bank of drawers individually. This solution is ideal when two employees share the same workstation and floor space is a challenge. Furthermore, by stacking R2V storage over an R toolbox, you can increase the number of tools stored without using any extra floor space.

- Widths available: 48" and 60"
- Two locks and two distinct locking mechanisms for each housing
- L3 key lock, LP safety hasp, L50 digital lock or L100 smart lock available
- Drawer banks split in two equal parts, from left to right

SAME WORK SHIFT

Each user has their own workstation while sharing the toolbox (R + R2V)

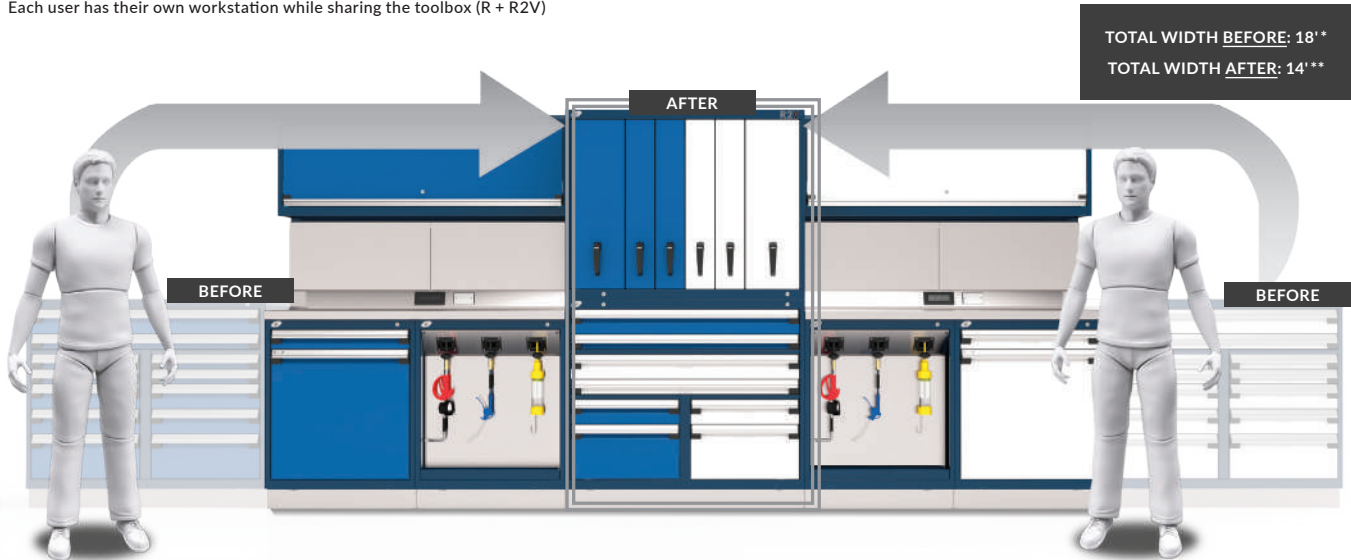

DIFFERENT WORK SHIFT

Users share the workstation space and the toolbox (R + R2V).

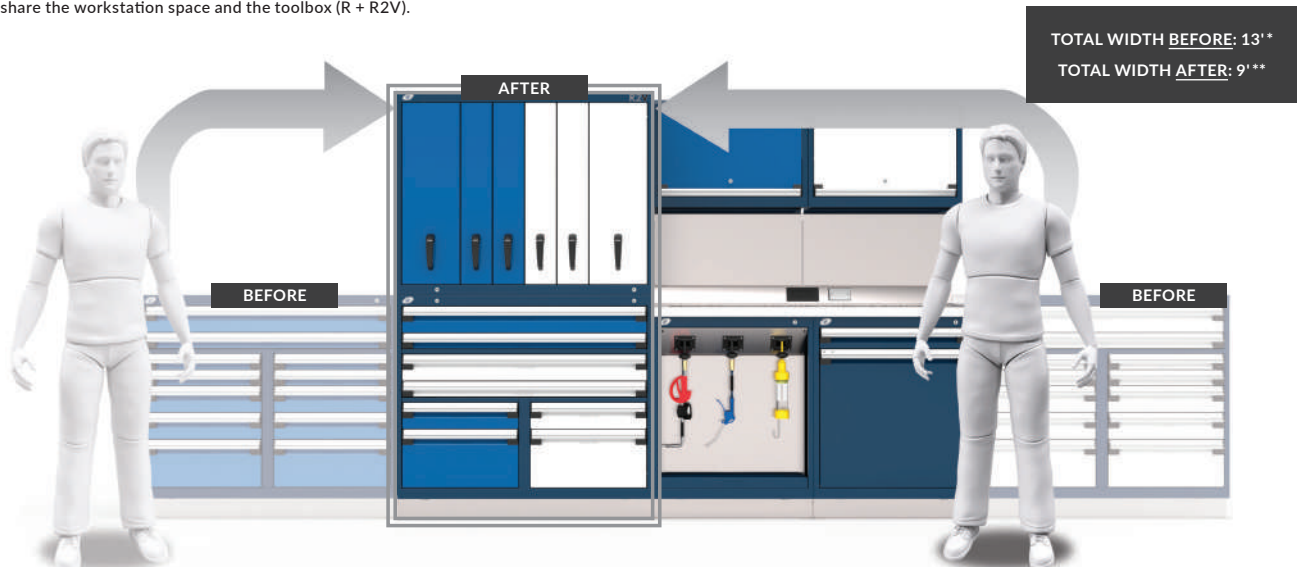

NOTES: * WITHOUT two-user access ** WITH two-user access

Different colors are only shown to help visualize the access and shared space for two different users.

CABINET FOR TWO USERS

INDIVIDUAL LOCK FOR USER 1 AND 2



L3 LOCK



L50 DIGITAL LOCK



LP SAFETY LOCK



L100 SMART LOCK

ONE-DRAWER-AT-A-TIME SYSTEM (OPTIONAL)

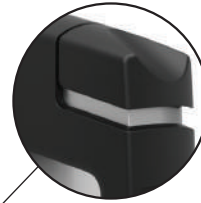
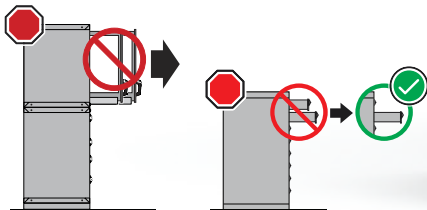

LOCK-IN MECHANISM

Each vertical drawer includes a mechanism to stop the drawer from opening on its own



SECURITY PANELS

Blocks access between two banks of drawers



RL91



RF91



RF92

HERE ARE SOME PRECONFIGURED MODELS



W×D×H

48"×27"×42"

R6KHG-3802S



W×D×H

48"×27"×76"

RL-XHG76D002NS



W×D×H

48"×27"×76"

RL-XHG76D004NS

FOR CUSTOMIZED MODELS:

R2V VERTICAL HOUSING



- An RL91 security panel must be ordered to separate the drawers

PRODUCT NO.	W×D
RL29-4827__-L3_	48"×27"
RL29-6027__-L3_	60"×27"

NOTES: Complete the product number with the cabinet height: **34"** or **38"**.

For an digital lock, replace L3 with **L50**.

For a smart lock, replace L3 with **L100**.

For a One-Drawer-at-a-Time mechanism, add **A** to the end of product number.

MULTI-DRAWER HOUSING



- RF91 and RF92 security panels must be ordered to separate full-width drawers and banks of drawers

PRODUCT NO.	W×D
RA34-4827__-L3_	48"×27"
RA34-6027__-L3_	60"×27"

NOTES: Complete the product number with the cabinet height: **28"**, **30"**, **34"**, **38"**, **44"** or **58"**. The height excludes the 4"H base.

An RA45 partition and RA46 cross tie must be ordered.

For an digital lock, replace L3 with **L50**.

For a smart lock, replace L3 with **L100**.

For a One-Drawer-at-a-Time mechanism, add **A** to the end of product number.

NOTES: Only the housing needs to be ordered for two users; the drawers and other accessories are the same as single-user access.

Two-user access cannot be added to an RA30, RA35 or RL30 cabinet.

For the ideal height combination to reach 76" or 80" high, [see page 56](#).

SC REEL CABINETS

DISTINCTIVE SOLUTIONS



Ferrari Maserati Québec (QC)

We know every dealership is unique, which is why we offer a range of reel cabinets that vary according to the number of reels required and where they are placed.

- All our cabinets include a door and/or front panel for easy access and maintenance (optional lock available)
- Removable drip tray included
- Widths: 24", 30", 36" and 48"
- Heights: 30", 38" and 72" (without base)
- 4"H base and quick access panel: painted or stainless steel

CONSIDERATIONS

Placement of service reels is a very important consideration to achieve the optimal configuration for a technician's workcenter. When reels are to be integrated into the workcenter, we help you determine the best place to store them.

After analyzing technicians' movements between the workcenter and vehicle, we have the following recommendations:

- Place toolboxes near to the technician, under the work surface
- Place reel cabinets in direct line with the automobile, beside the work surface. The reels will therefore not block access to the work surface
- If many different tools are used, we recommend storing the most frequently used tools below the work surface and others in toolboxes at the sides of the work surface

The technician's overall efficiency is increased when there is fast and easy access to tools, and direct and safe access to service reels.

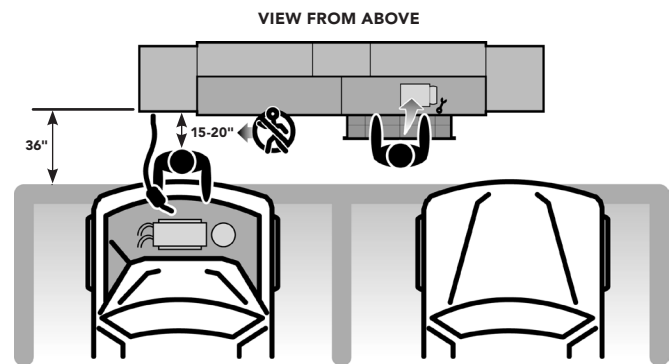

GT-RCG720401S

NOTES: It is your responsibility to check if there are any regulations regarding reel locations in your region.
Reels are not available from Rousseau.

5C REEL CABINETS



GT-REG720601S

Widths available: 24", 30" and 36". The cabinet can store up to six reels.

- Includes a 6"H drawer for meters or other storage and a removable drip tray above the drawer
- Height: 76" (including the 4"H base)
- Can be used in a workcenter or as a standalone unit

GT-RCG720401 _ 4" base and quick access panel:
 S: Stainless steel
 P: Painted steel

NOTE: For a workcenter with a 40"H work surface that includes storage cabinets and finishing panels, we recommend combining the 42"H (including base) reel cabinet with a 38"H toolbox to obtain the same height as the workcenter (80"H).

76" H CABINET



24"W - 4 openings

GT-RCG720401 _



30"W - 4 openings

GT-RDG720401 _



30"W - 6 openings

GT-RDG720601 _



36"W - 6 openings

GT-REG720601 _



GT-C1105P

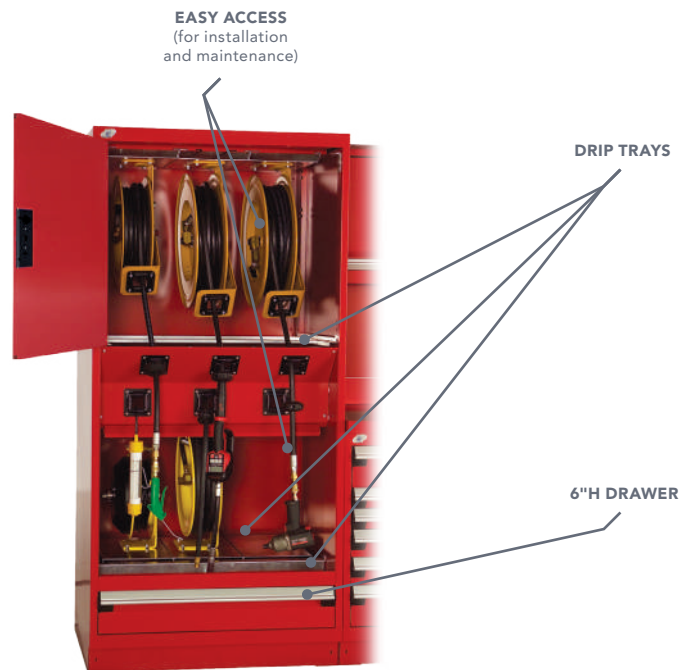



GT-5XEG1001P

Widths available: 24", 30" and 48". The cabinet can store up to six reels.

- The reel cabinet can be stacked on a toolbox (ordered separately). It can also be used in a workcenter or as a standalone unit
- Heights: 38" (without base) and 42" (with base)
- Includes a removable drip tray

Quick access panel:
S: Stainless steel
P: Painted steel

Base:
blank: without base
S: Stainless steel
P: Painted steel

GT-RCG380201 __

NOTE: For a workcenter with a 40"H work surface that includes storage cabinets and finishing panels, we recommend combining the 42"H (including base) reel cabinet with a 38"H toolbox to obtain the same height as the workcenter (80"H).

38"H AND 42"H CABINETS



24"W - 2 openings

GT-RCG380201 __



30"W - 2 openings

GT-RDG380201 __



30"W - 3 openings

GT-RDG380301 __



36"W - 3 openings

GT-REG380301 __



48"W - 4 openings

GT-RHG380401 __



48"W - 5 openings

GT-RHG380501 __



GT-C1020P



EASY ACCESS
(for installation
and maintenance)

DRIP TRAY

5C REEL CABINETS



GT-RHG300401P

Widths available: 24", 30" and 48". The cabinet can store up to five reels.

- Installs under the work surface
- Height: 34" (including the 4"H base)
- Includes a removable drip tray

GT-RCG300201 _

4" base and quick access panel:
 S: Stainless steel
 P: Painted steel

34" H CABINET



24"W - 2 openings

GT-RCG300201 _



30"W - 2 openings

GT-RDG300201 _



30"W - 3 openings

GT-RDG300301 _



36"W - 3 openings

GT-REG300301 _



48"W - 4 openings

GT-RHG300401 _



48"W - 5 openings

GT-RHG300501 _



GT-C1130S



EASY ACCESS
(for installation
and maintenance)

DRIP TRAY

TRUE VERSATILITY AND FUNCTIONALITY



Ferrari Lake Forest (IL)

This is a great solution for your technicians: a unit that can safely store personal belongings as well as an oil barrel, a MultiTek Cart or an L Compact Mobile Cabinet.

- Heights available: 48", 76" and 80".
Can be used in a workcenter or as a standalone unit
- Two widths available for storage of different items. The 24"W unit can be combined with a MultiTek Cart or L Compact Mobile Cabinet. The 30"W unit can be combined with a MultiTek Cart, oil barrel or L Compact Mobile Cabinet
- Depth: 27"
- An L3 key lock is included with storage units and lockers.
For an L50 digital lock or an L100 smart lock, please contact Customer Service.
- Leveling glides available, order RA76-03 (pack of 4)

SOME OF OUR MOST POPULAR MODELS ARE SHOWN BELOW:

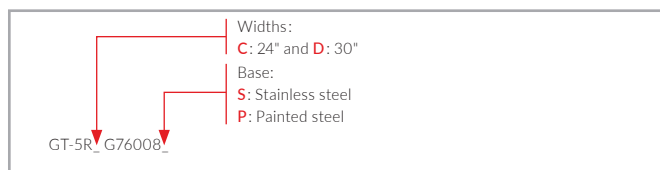

48" H

SLOPED TOP



- Keeps the workspace clean and tidy while reducing clutter
- Fits perfectly into the 5S storage method
- 16° slope angle
- Height: 8"

PRODUCT NO.	W x D
RC31-242708	24" x 27"
RC31-302708	30" x 27"

DOOR EXTENSION



- Compatible with RD86/RD87 storage cabinet doors
- Provides an immaculate finish
- Available in painted or stainless steel

PRODUCT NO.	W x H
RD__-2404	24" x 4"
RD__-3004	30" x 4"

NOTE: Add 81 to the product number for a painted steel extension, or 82 for a stainless steel extension.



Door

GT-5R_G48002_ (Note 1)



Roll-Out Shelf, Door

GT-5R_G48004_ (Note 1)



Door

GT-5R_G48002_ (Note 2)



Clothes Hanging Rail, Door

GT-5R_G48001_ (Note 3)

NOTE #

- MultiTek Carts and L Compact Mobile Cabinets must be ordered separately. The photos on pages 67-69 feature the 37"H MultiTek Cart.
- Oil barrels are not available from Rousseau. They are only compatible with 30"W cabinets.
- For storage cabinets with clothes hanging rails, the height of the MultiTek Cart is 33". The MultiTek Cart must be ordered separately.



Heavy-duty drawers and roll-out shelves are not compatible with these storage units.
To ensure unit stability, the unit must be anchored to a workstation, toolbox, storage cabinet or the wall.

76" H



2 Shelves, Clothes Hanging Rail, Door

GT-5R_G76004_



2 Shelves, 2 Doors

GT-5R_G76006_(Note1)



2 Shelves, Door

GT-5R_G76007_(Note 1)



5 Shelves, Door

GT-5R_G76003_



Shelf, 2 Doors

GT-5R_G76002_(Note 2)



2 Shelves, Clothes Hanging Rail, 2 Doors

GT-5R_G76008_(Note 3)



Ferrari Maserati Québec (QC)



Valley Lexus (CA)

76" H



Shelf, 2 Half-Shelves, Half Clothes Hanging Rail, 2 Doors
GT-5R_G76014_ (Note 1)



2 Shelves, 3 Half-Shelves, Half Clothes
Hanging Rail, Door

GT-5R_G76009_



Shelf, 2 Half-Shelves, 2 Half Clothes Hanging Rails, Door

GT-5R_G76011_



2 Shelves, 6 Half-Shelves, Door

GT-5R_G76010_



2 Roll-Out Shelves, Door

GT-5R_G76019_ (Note 1)



Shelf, 3 Half-Shelves (2 × 12" W, 1 × 18" W), 2 Doors

GT-5R_G76013_ (Note 1)



Roll-Out Shelf, Door

GT-5R_G76020_ (Note 2)



5 Roll-Out Shelves, Door

GT-5R_G76021_



2 Shelves, Clothes Hanging Rail, Door

GT-5R_G76022_ (Note 3)

80" H



Shelf, 3 Half-Shelves, 2 Doors
GT-5X_G80002_(Note 1)



3 Shelves, Clothes Hanging Rail, 2 Doors
GT-5X_G80004_



Shelf, 4 Half-Shelves, 2 Doors
GT-5X_G80006_



2 Shelves, 2 Doors
GT-5X_G80008_(Note 2)



Shelf, 2 Half-Shelves, Clothes Hanging Rail,
Roll-Out Shelf, 2 Doors
GT-5X_G80010_



Shelf, 2 Half-Shelves, 2 Doors
GT-5X_G80012_(Note 2)

NOTE #

- | | |
|---|--|
| 1 | MultiTek Carts and L Compact Mobile Cabinets must be ordered separately. The photos on pages 67-69 feature the 37"H MultiTek Cart. |
| 2 | Oil barrels are not available from Rousseau. They are only compatible with 30"W cabinets. |
| 3 | For storage cabinets with clothes hanging rails, the height of the MultiTek Cart is 33". The MultiTek Cart must be ordered separately. |



Prémont Harley-Davidson (QC)



Complexe Volkswagen 440 (QC)

Storage units and lockers are an ideal solution for secure storage of technicians' personal belongings or to provide additional storage space for a neat and organized workspace. They also integrate seamlessly with your workstations.

A wide selection of dimensions and options are available to meet your needs:

- Standard widths: 12", 15" and 18" (15"W and 18"W models will store a motorcycle helmet)
- Depth: 27"
- Heights: 48", 76" and 80" (including the 4"H base)
- Includes hanging zones for installing hooks inside the door
- An L3 key lock is included with storage units and lockers. For an L50 digital lock or an L100 smart lock, please contact Customer Service
- Optional accessories include: leveling glides, shelf dividers, hooks and sloped tops

SOME OF OUR MOST POPULAR MODELS ARE SHOWN BELOW:

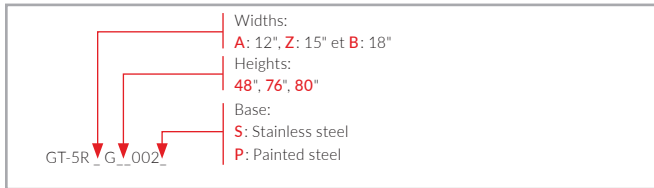

STORAGE CABINETS

DISTINCTIVE FEATURES



48\"H Storage Cabinet,
2 Adjustable Shelves, Solid Door

GT-5R_G48001_



76\"H or 80\"H Storage Cabinet,
4 Adjustable Shelves, Solid Door

GT-5R_G__002_



Heavy-duty and ergonomic handle



Vented door for lockers



Compatible with light-duty hooks



Pale-gray interior for better visibility



Storage cabinets and lockers are sold unassembled.
To ensure unit stability, the unit must be anchored to a workstation, toolbox, storage cabinet or the wall.

LOCKERS



48"H Locker, 2 Hooks, Clothes Hanging Rail, Vented Door

GT-5R_G48003_



76"H or 80"H Locker, Adjustable Shelf, 2 Hooks, Clothes Hanging Rail, Vented Door

GT-5R_G__004_



76"H or 80"H Locker, 4 Hooks, 2 Clothes Hanging Rails, Middle Shelf, 2 Vented Doors

GT-5R _ G__005_

ACCESSORIES

SLOPED TOP



- Keeps the workspace clean and safe while reducing clutter
- 16° slope angle
- Height: 8"

PRODUCT NO.	W x D
RK90-122708	12" x 27"
RK90-152708	15" x 27"
RK90-182708	18" x 27"

ADJUSTABLE SHELF



- For storage of equipment
- Height can be adjusted in 1" increments c/c
- Load capacity: up to 100lb.

PRODUCT NO.	W x D
RK93-1227	12" x 27"
RK93-1527	15" x 27"
RK93-1827	18" x 27"

HOOK



- Attaches under the shelf or top
- Load capacity: 10lb. per hook
- Sold individually

PRODUCT NO.	
RK94-01	1 Hook

PARTIAL DIVIDER



- Unique concept facilitates position changes
- Height: 5 1/2"
- Easy tool-free installation

PRODUCT NO.
SH52-2406

LEVELING GLIDES



- Adjusts your storage unit or locker to make it level

PRODUCT NO.	
RA75-01	Pack of 4

ADJUSTABLE KICK PLATE FOR LEVELING GLIDES



- Provides an immaculate finish
- Prevents dust from entering
- Only available in stainless steel
- Please contact your customer service representative for more details

A COMPLETE AND INTEGRATED SOLUTION



Honda Queensway (ON)

To perform vehicle repairs and maintenance, technicians need a variety of tools and replacement parts near the vehicle and within easy reach. Every technician has their own way of working, and the requirements of each task can vary considerably between vehicles and between dealerships. The MultiTek Cart's design allows for a high level of personalization based on different work habits and requirements.

- Minimizes trips back and forth
- Transports tools, original parts and spare parts
- Ensures important tools are within easy reach
- Ergonomic working height
- 36"W x 24"D and 48"W x 24"D models are available on [page 114](#) in the Parts Department section

DISTINCTIVE FEATURES



LOCKABLE SECURITY COVER

Opens 90° for unrestricted access to the work surface. The cover features strategically placed gas springs to allow access to the top shelf when open. It is also equipped with a lock to secure the contents when closed.



COMFORTABLE AND ERGONOMIC HANDLES

ROLL-OUT SHELF

Expand your work surface area with a roll-out shelf.



FRONT OR SIDE DRAWERS

Transport tools safely and securely. 4"H drawers feature a lock-in mechanism to keep them closed. 50lb. load capacity per drawer.

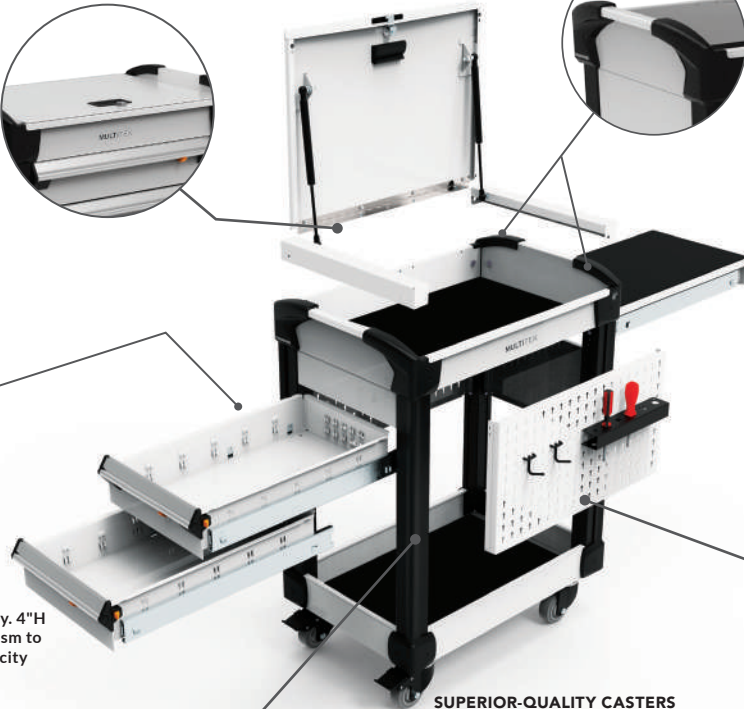

FINISHING PANELS, UTILITY PANELS OR PLASTIC BIN PANELS

Add accessories to ensure everything you need is always within reach.

SUPERIOR-QUALITY CASTERS

UPRIGHT BUMPERS

Protect vehicles from accidental bumps.



Whether you need just one unit or one hundred, our specialists will help you build your ideal configuration.

MULTITEK CART

FITS IN STORAGE UNITS AND UNDER WORK SURFACES

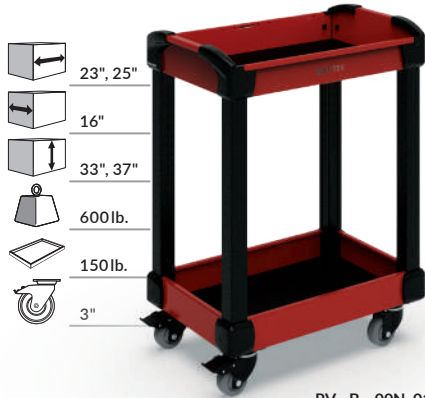

RV-_B__00N_01

The 16\"D MultiTek Cart is designed to fit underneath the work surface, behind a hideaway door or inside a side storage unit.

- The 33\"H MultiTek Cart is compatible with a 36\"H workstation; the 37\"H cart is compatible with a 40\"H workstation and a 24\"W or 30\"W storage unit
- For a storage cabinet with clothes hanging rail, the 33\"H MultiTek Cart must be used
- Only the 23\"W version is compatible with RB59/60 and RD81/82 door extensions
- Each shelf can be lined with a rubber mat and has a 150lb. load capacity
- The side roll-out shelf is lined with a rubber mat, has a 15lb. load capacity and provides an extra work surface

	<p>Widths: D: 23" G: 25"</p> <p>Heights: 33", 37"</p> <p>Rubber mat on each shelf: 0: with 1: without L3: Drawer lock</p>
--	--

RV-_B__A1F_04__B

NOTES: 1: For this model without a rubber mat, replace the letter C with **L**.
 2: See page 119 for compatible hooks.



Front drawer

RV-_B__A1F_04__B



2 front drawers

RV-_B__A2F_04__B



Front drawer, side roll-out shelf



RV-_B__A1F_02__B



2 front drawers, side roll-out shelf

RV-_B__A2F_02__B



Front drawer, cover, utility panel

RV-_B__A1UC10__B (Note 1 and 2)



2 front drawers, cover, utility panel, upright bumpers

RV-_B__A2UC12__B (Note 1 and 2)



MULTITEK CART



Side drawer



RV_B__S1F_04__B



2 side drawers



RV_B__S2F_04__B



2 side drawers, side roll-out shelf



RV_B__S2F_06__B



2 side drawers, side roll-out shelf,
cover, utility panels, upright bumpers

RV_B__S2X_02__B (Note 2)



Side drawer, side roll-out shelf



RV_B__S1F_06__B



Side roll-out shelf



RV_B__00F_01

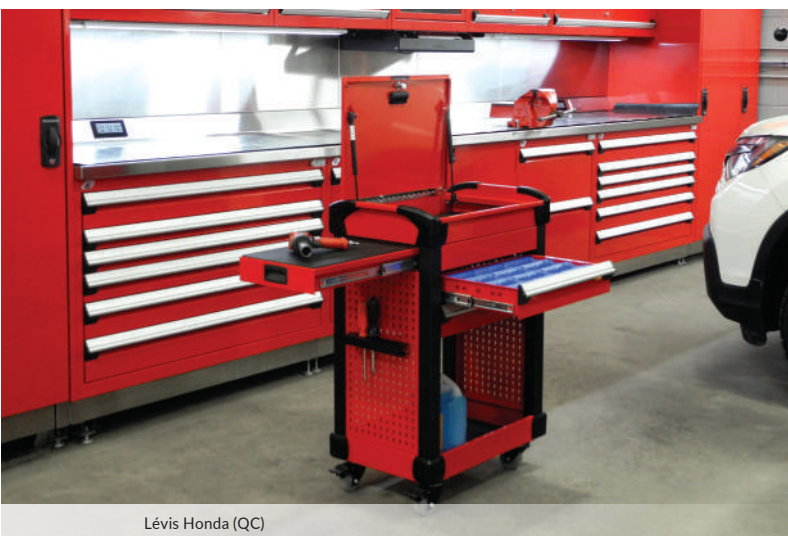

Lévis Honda (QC)



Budds' Imported Cars (ON)

MULTITEK CART

INCREDIBLY PRACTICAL AND VERSATILE – NEXT TO THE WORK SURFACE

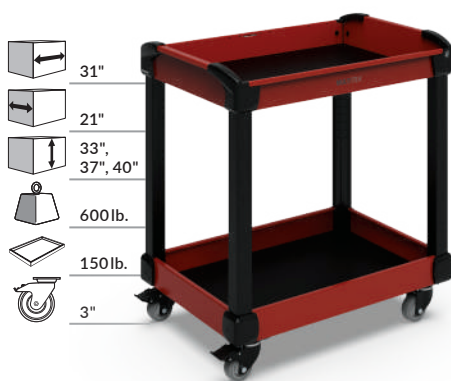

RV-NH__00K_01 (Note 3)

The 31"W×21"D MultiTek cart is ideal as a freestanding unit. It offers plenty of storage space and multiple configurations. With this size, you can have roll-out half-shelves or half-drawers on both sides of the MultiTek Cart.

- Each shelf can be lined with a rubber mat and has a 150lb. load capacity
- The side roll-out shelf is lined with a rubber mat, has a 15lb. load capacity and provides an extra work surface

Heights:
33", **37"**
 Rubber mat on each shelf:
0: with
1: without
L3: Drawer lock

RV-NH__S1F_04__B

NOTES: 1: For this model without a rubber mat, replace the letter C with L.
 2: See pages 119-121 for compatible hooks and plastic bins.
 3: Sold unassembled.



Side drawer

RV-NH__S1F_04__B



2 side drawers

RV-NH__S2F_04__B



3 side drawers

RV-NH__S3F_04__B



3 front drawers, cover, plastic bins panels, upright bumpers

RV-NH__A3X_02__B (Note 2)



3 front drawers, cover, utility panel, upright bumpers

RV-NH__A3UC16__B (Note 1 and 2)



Side roll-out shelf

RV-NH__00F_01



Front drawer, 2 side roll-out half-shelves

RV-NH__A1F_06__B



2 front drawers, 2 side roll-out half-shelves

RV-NH__A2F_06__B



2 front drawers, 2 side roll-out half-shelves, cover, utility panels

RV-NH__A2UC06__B (Note 1 and 2)



2 side half-drawers

RV-NH__B2F_02__B



Front drawer, 2 side half-drawers

RV-NH__M3F_02__B



2 side roll-out half-shelves

RV-NH__00F_02



3 shelves

RV-NH__00K_07 (Note 3)



3 shelves, utility panels

RV-NH__00U_07 (Note 2)



2 front drawers, cover, utility and plastic bin panels

RV-NH__A2X_08__B (Note 2)

ACCESSORIES

NON-SLIP PVC LINER FOR SHELF



- Non-slip PVC protects items stored on shelves
- Thickness: ¼"

PRODUCT NO.	W × D
RV__-2316-01	23" × 16"
RV__-2516-01	25" × 16"
RV__-3121-01	31" × 21"
RV__-3624-01	36" × 24"
RV__-4824-01	48" × 24"

NOTES: To order a PVC liner for a top or bottom shelf, add **44** to the product number.
To order a PVC liner for a middle shelf, add **74** to the product number.

PROTECTIVE FOAM FOR SHELF



- Oil-resistant and non-absorbent foam protects items stored on shelves
- ¼" blue foam

PRODUCT NO.	W × D
RV__-2316-01	23" × 16"
RV__-2516-01	25" × 16"
RV__-3121-01	31" × 21"
RV__-3624-01	36" × 24"
RV__-4824-01	48" × 24"

NOTES: To order protective foam for a top or bottom shelf, add **46** to the product number.
To order protective foam for a middle shelf, add **76** to the product number.

TOOL FOAM FOR SHELF



- Missing tools can be spotted quickly with this oil-resistant and non-absorbent foam on shelves
- The blue foam is ¼" thick and the black self-adhesive foam is ½" thick

PRODUCT NO.	W × D
RV__-2316-01	23" × 16"
RV__-2516-01	25" × 16"
RV__-3121-01	31" × 21"
RV__-3624-01	36" × 24"
RV__-4824-01	48" × 24"

NOTES: To order tool foam for a top or bottom shelf, add **47** to the product number.
To order tool foam for a middle shelf, add **77** to the product number.
Sold without cut-outs.

NON-SLIP PVC LINER FOR DRAWER



- Non-slip PVC protects items stored in drawers
- Thickness: ¼"

PRODUCT NO.	DRAWER	CART WIDTH
RV49-1623-01S	Side	23"
RV49-1625-01S	Side	25"
RV49-2131-01S	Side	31"
RV49-2131-01S2	Side half	31"
RV49-2316-01F	Front	23"
RV49-2516-01F	Front	25"
RV49-3121-01F	Front	31"

NOTE: Not compatible with partitions and dividers.

PROTECTIVE FOAM FOR DRAWER

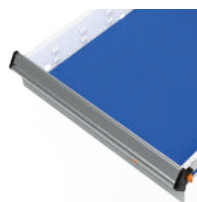

- Oil-resistant and non-absorbent foam protects items stored in drawers
- ¼" blue foam

PRODUCT NO.	DRAWER	CART WIDTH
RV41-1623-01S	Side	23"
RV41-1625-01S	Side	25"
RV41-2131-01S	Side	31"
RV41-2131-01S2	Side half	31"
RV41-2316-01F	Front	23"
RV41-2516-01F	Front	25"
RV41-3121-01F	Front	31"

TOOL FOAM FOR DRAWER

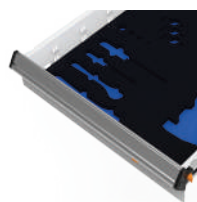

- Missing tools can be spotted quickly with this oil-resistant and non-absorbent foam in drawers
- The blue foam is ¼" thick and the black self-adhesive foam is ½" thick

PRODUCT NO.	DRAWER	CART WIDTH
RV42-1623-01S	Side	23"
RV42-1625-01S	Side	25"
RV42-2131-01S	Side	31"
RV42-2131-01S2	Side half	31"
RV42-2316-01F	Front	23"
RV42-2516-01F	Front	25"
RV42-3121-01F	Front	31"

NOTE: Sold without cut-outs.

DRAWER LOCK



- Drawer can be locked with the same key used for other products (MultiTek Cart cover, toolboxes, storage cabinets, etc.)
- To order: Add **L3** to the product number

NOTE: 36"W × 24"D and 48"W × 24"D models are available in the parts department section on page 114.

MIDDLE SHELF



- Load capacity: 150lb. per shelf, 600lb. max. per cart
- One or two shelves can be added to the cart
- Compatible with finishing panels, utility panels and plastic bin panels
- Thickness: 2"

PRODUCT NO.	W × D
RV25-2316	23" × 16"
RV25-2516	25" × 16"
RV25-3121	31" × 21"
RV25-3624	36" × 24"
RV25-4824	48" × 24"

LONG TOOL HOLDER



- For storing long tools, e.g., pry bars
- Easy to install
- Holds up to three long tools
- Space available for two smaller tools, e.g., screwdrivers

PRODUCT NO.	W × D × H
WM9Q-08	8" × 2" × 4"

STORAGE UNIT



- A storage unit is perfect for storing MultiTek Carts and L Compact Mobile Cabinets as well as providing enough storage space for personal belongings and other items.
- Available in different heights and configurations, [see pages 67-70](#)
- Optional door extension available
- Accessories available: fixed shelf, roll-out shelf, clothes hanging rail

PRODUCT NO.	TYPE OF BASE
RD86	Painted Steel Base
RD87	Stainless Steel Base

HIDEAWAY DOOR



- Integrates a MultiTek Cart into the workcenter
- Includes a handle to easily open the door
- Optional door extension available

PRODUCT NO.	W × H	MULTITEK HEIGHT
RB52-1834_ _ _	18" × 34"	33"
RB52-2134_ _ _	21" × 34"	33"
RB52-2434_ _ _	24" × 34"	33"
RB52-2734_ _ _	27" × 34"	33"
RB52-1838_ _ _	18" × 38"	37"
RB52-2138_ _ _	21" × 38"	37"
RB52-2438_ _ _	24" × 38"	37"
RB52-2738_ _ _	27" × 38"	37"

NOTES: Add **L3** to the end of the product number to order a hideaway door with lock.
Add **L** to the end of the product number to have the hinges on the left or **R** for the hinges on the right.

UPRIGHT BUMPERS



- Kit of four protective bumpers
- Protects vehicles, surrounding objects and the MultiTek Cart itself
- Made from soft PVC

PRODUCT NO.	MULTITEK CART (W × D)		
	23 × 16	31 × 21	36 × 24
RV63-29	33"H	33"H	35"H
RV63-33	37"H	37"H	39"H
RV63-36		40"H	42"H
RV63-42			48"H

CASTERS



- Available in two heights: 3" and 5"
- Sold in pairs
- Three types of casters available: fixed, swivel, swivel with brake
- Ultra-quiet casters
- Good chemical resistance to many products found in a vehicle garage (oils, hydrocarbons, water with de-icing salts, antifreeze, lubricants, etc.)

PRODUCT NO.	TYPE	HEIGHT	ACTUAL
RV82-01	Rigid	3"	4¼"
RV82-02	Swivel	3"	4¼"
RV82-03	Swivel with brake	3"	4¼"
RV83-01	Rigid	5"	6"
RV83-02	Swivel	5"	6"
RV83-03	Swivel with brake	5"	6"

NOTES: 23"W × 16"D, 25"W × 16"D and 31"W × 21"D MultiTek Carts include 3" casters by default.
36"W × 24"D and 48"W × 24"D MultiTek models include 5" wheels by default (see page 114)

SPECIALIZED UNITS

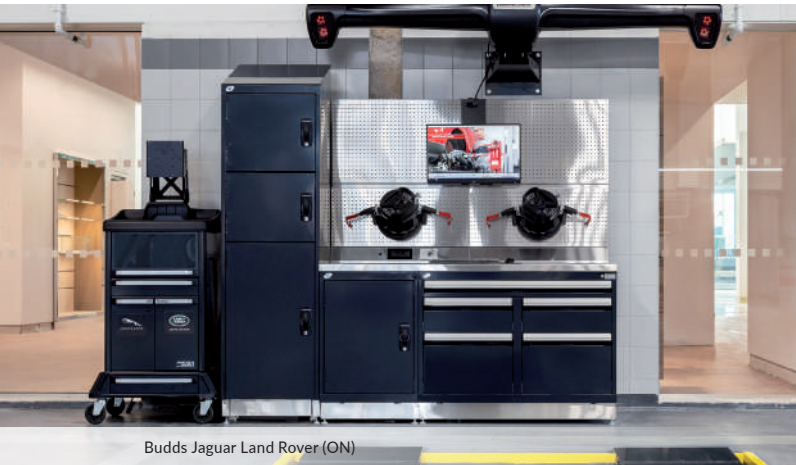

Budds Jaguar Land Rover (ON)

Bays are often dedicated to specific functions, such as changing tires or express lube.

This means that different accessories may be required to create compact units that are tailored to the task being performed. This section features various suggestions for specialized workspaces.

S: Stainless steel
P: Painted steel

To complete the product numbers, specify the type of finish for the base, top and power feed panel

e.g.: GT-C1025_

OIL CHANGE



MOBILE EXPRESS LUBE UNIT

- Keeps all the lube equipment you need within easy reach
- 8 sloped shelves with edge for damage-free transportation
- Includes containers for disposing of waste wherever you are

W × D × H	PRODUCT NO.
32" × 27" × 60"	EMA2072



BASIC OIL CHANGE STATION

- Organized and secure storage for oil change equipment (oil cans, towels, small tools, etc.)
- Power feed panel for constant access to power

W × D × H	PRODUCT NO.
48" × 30" × 36"	GT-C1072_
60" × 30" × 36"	GT-C1075_



QUICK OIL CHANGE STATION

- Multiple storage compartments for tools and equipment of assorted sizes
- Includes a waste & recycling door to keep the work surface clear and tidy
- Power feed panel for constant access to power

W × D × H	PRODUCT NO.
48" × 30" × 36"	GT-C1073_
60" × 30" × 36"	GT-C1076_



ILLUMINATED OIL CHANGE STATION

- Complete solution with drawer cabinet, waste & recycling door and top storage cabinet for even more storage
- LED light provides a well-lit work surface
- Power feed panel for constant access to power

W x D x H	PRODUCT NO.
48" x 30" x 76"	GT-C1074_
60" x 30" x 76"	GT-C1077_



COMPLETE OIL CHANGE STATION

- Reel cabinet with two openings and a removable drip tray for easy cleaning
- Top cabinet for taller items, such as bottles and cans
- Power feed panel for constant access to power
- Drawers of varying heights for flexible storage options

W x D x H	PRODUCT NO.
48" x 30" x 76"	GT-C1025_



OIL CHANGE STATION WITH COMPUTER CABINET

- Perform oil changes, book appointments and complete your invoicing all at the same workstation
- Reel cabinet with four openings and a removable drip tray for easy cleaning
- The hydraulic hoses are neatly hidden behind a door
- Drawers of varying heights for flexible storage options

W x D x H	PRODUCT NO.
48" x 30" x 76"	GT-C1019_

SPECIALIZED UNITS

TIRE CHANGE



TIRE CHANGE STATION

- This compact workstation installs near tire changer machines to cut down on unnecessary trips back and forth
- Includes many plastic bins for well-organized storage of small parts
- Power feed panel for constant access to power
- Lots of storage for items of different sizes

W×D×H	PRODUCT NO.
36"×30"×76"	GT-C1071_

NOTE: The plastic bin panel is only available in painted steel.

VEHICLE PREPARATION



VEHICLE PREPARATION STATION

- Shelf for discreet storage of protective sheets for floor mats while keeping them within easy reach
- Includes a roll holder for car seat protective plastic wrap
- Waste & recycling doors for concealing the containers behind
- Top storage cabinet for keeping finishing equipment within easy reach

W×D×H	PRODUCT NO.
48"×30"×76"	GT-C1078_
60"×30"×76"	GT-C1079_

WHEEL ALIGNMENT



ALIGNMENT STATION

- Easily keep an eye on the screen while performing tire tests
- Install wheel alignment tools on the utility panel for quick access
- Power feed panel for constant access to power

W×D×H	PRODUCT NO.
96"×30"×76"	GT-C1170_

CAR DETAILING



WALL-MOUNTED CLEANING STATION



- Workspace designed to facilitate car detailing tasks
- Two storage cabinets for storing equipment after use
- Includes shelves to keep cleaning products within easy reach at all times

W × D × H	PRODUCT NO.
60" × 14" × 72"	EMC1000



WALL-MOUNTED DETAILING STATION

- Ideal for keeping the floor clear while cleaning or to prevent clutter accumulating under the work surface
- All detailing equipment can be stored in the wall-mounted cabinets

W × D	PAINTED STEEL	STAINLESS STEEL
60" × 30"	R5WH5-1010	R5WH5-6010

HAND WASHING



SINK STATION

- Provides a sink for technicians to wash their hands when needed
- Extra storage for towels and equipment
- Waste and recycling drawer for keeping the surface clean and tidy at all times

W × D × H	PRODUCT NO.
48" × 30" × 36"	GT-XHG0026S

NOTES : Work surface cutting is not provided by Rousseau.
Sink not included.



Can't find what you're looking for? Our specialists will help you find a customized solution. Contact us.

BASIC WORKBENCHES

A SOLUTION FOR EVERY NEED



Whether you need a basic workbench consisting of two legs and a top, or a more specialized table for mobile or stationary applications, we have a solution for every use case.

Our painted and stainless steel work surfaces are available in a wide range of dimensions, so you can have a single or double workbench tailored to your requirements.

Our solutions also provide unlimited layout possibilities, both above and below the work surface.



OPEN WORKBENCH – STATIONARY OR MOBILE



- With its sturdy construction and stylish aesthetics, this workbench fits in with almost any environment
- Height: stationary = 34"; mobile = 35"
- To order: Add **A** to the product number for the stationary version and **W** for the mobile version (includes a pair of 4" rigid casters and a pair of 4" swivel casters with total-lock brake system)
- Available with a painted steel or stainless steel top

W×D	PAINTED STEEL	STAINLESS STEEL
60"×30"	WS_1031	WS_6031
72"×30"	WS_1035	WS_6035
72"×36"	WS_1039	WS_6039



MOBILE WORKBENCH WITH STORAGE UNIT



- The ideal combination of a work surface, storage unit and mobility
- Includes a back edge to prevent your tools and parts from falling
- Available with a painted steel or stainless steel top

W×D×H	PAINTED STEEL	STAINLESS STEEL
60"×30"×39"	LJ1013	LJ6013



CLOSED WORKBENCH WITH SLIDING DOORS AND CLOSED LEGS

- Provides secure and neat storage of various items with enclosed shelves underneath
- Includes two shelf levels (1 single and 1 double)
- Available with a painted steel or stainless steel top

W×D×H	PAINTED STEEL	STAINLESS STEEL
60"×30"×34"	WSA1170	WSA6170
72"×30"×34"	WSA1171	WSA6171
72"×36"×34"	WSA1172	WSA6172

BASIC WORKBENCHES

TEARDOWN BENCH - STATIONARY OR MOBILE



WSA7000

- This workbench has been specially designed to allow liquids to drain cleanly and effectively when repairing transmissions
- The top includes a rim (back and sides) to prevent spills while oil is draining
- The steel surface includes a 2" dia. threaded drain for connecting a drainage pipe
- Stainless steel top

W×D	28"H LEG	32"H LEG	34"H LEG
48"×30"	WS_7000	WS_7010	WS_7020
48"×36"	WS_7001	WS_7011	WS_7021
60"×30"	WS_7002	WS_7012	WS_7022
60"×36"	WS_7003	WS_7013	WS_7023



WSW7000

WS_7000	A: stationary
	W: with 4" casters: 2 rigid and 2 swivel with total-lock brake
	P: with 4" casters: 2 swivel and 2 swivel with total-lock brake



LD75-3201

DRAWER UNIT WITH 6" H DRAWER

UNIT DEPTH	PRODUCT NO.
21"	LD75-3201__
27"	LD75-4201__

NOTE: Add L3 to the end of the product number to order a drawer lock.



WSC01-01

DRIP TRAY

PRODUCT NO.	W×D×H
WSC01-01	16"×9"×6"

BASIC WORKBENCHES

WORKBENCH WITH L COMPACT CABINET - STATIONARY OR MOBILE



- An L Compact Cabinet is ideal for storing small items and office supplies. With its painted or stainless steel top, this workbench is a great choice as part of a complete storage solution
- Add **G** to the product number for a 21"D cabinet, **H** for a 27"D cabinet and **J** for the mobile version (includes a pair of 4" rigid casters and a pair of 4" swivel casters with total-lock brake)
- Height: stationary = 34"; mobile = 35"
- A range of drawer accessories are also available

W x D	PAINTED STEEL	STAINLESS STEEL
60" x 30"	L_8131L3C	L_7131L3C
72" x 30"	L_8132L3C	L_7132L3C
72" x 36"	LH8133L3C	LH7133L3C

OPEN DOUBLE WORKBENCH



- With its sturdy construction and stylish aesthetics, this workbench fits in with almost any environment.
- It can be adapted to your requirements by simply adding accessories
- Includes one shelf level
- Available with a painted steel or stainless steel top

W x D x H	PAINTED STEEL	STAINLESS STEEL
96" x 30" x 34"	WSA1902	WSA6902
120" x 30" x 34"	WSA1904	WSA6904
144" x 30" x 34"	WSA1906	WSA6906

WORKBENCH WITH SLIDING DOORS



- Provides secure and neat storage of various items
- Two toolboxes: 2 x 60"W with two integrated sliding doors
- Includes two shelf levels
- Available with a painted steel or stainless steel top

W x D x H	PAINTED STEEL	STAINLESS STEEL
120" x 30" x 34"	R5XWG-3002	R5XWG-3004



SERVICE ADVISOR DESKS

WELCOMING - PROFESSIONAL - MODERN



Oxford Dodge Chrysler (ON)

Rousseau's service advisor desks create a dedicated space for greeting customers. As well as its welcoming and contemporary looks, it has been designed to facilitate all tasks performed by a service advisor.

This includes initial greeting, delivery of keys, explanation of work to be performed, work order planning, car preparation and payment. For all this and more, the service advisor desk excels and impresses both visitors and advisors.

- Spacious work surface including a cable grommet to keep the surface clear
- Work surface and riser shelf have rounded fronts for a distinctive and welcoming look
- Choice of models with or without cabinet (18"W x 27"D x 38"H) to meet the advisor's needs
- Work surface and riser shelf options: stainless steel, gray laminate and wood
- No visible cables
- Sold assembled



LAYOUT OPTIONS

Choose one or more stationary or mobile desks to meet the needs of your dealership. You can join stationary desks together in either a side-by-side or offset configuration. With a wide range of accessories available, you can build a truly personalized service advisor desk.

MOBILE



STATIONARY (SINGLE)



SIDE BY SIDE



OFFSET



SERVICE ADVISOR DESKS

METICULOUSLY DESIGNED TO PROVIDE AN ORGANIZED WORKSPACE

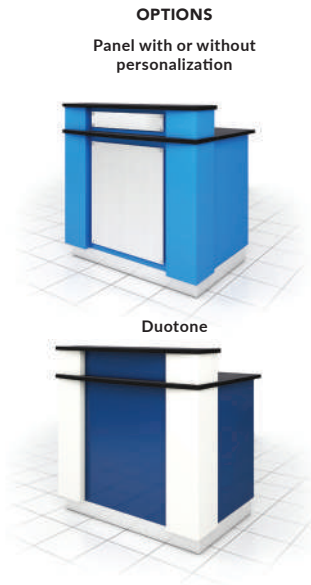
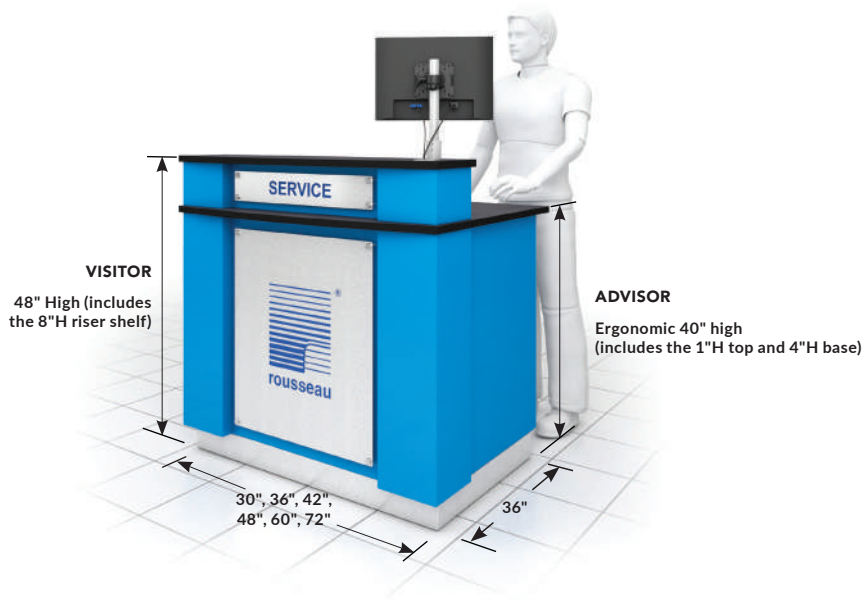

DESKTOP:

- monitor mount
- Multiple top and riser shelf options

UNDER THE WORK SURFACE:

- Fixed shelf
- Waste and recycling containers
- Printer shelf
- Adjustable shelf
- Door with lock to secure personal belongings

UNDER THE RISER SHELF:

- Power outlets and USB ports
- LED light

WITH OR WITHOUT CABINET:

- Multiple drawer heights available
- 12"H drawer for file storage
- The drawer has a 100lb. load capacity and the total load capacity of the cabinet is 250lb.

STATIONARY AND MOBILE VERSIONS AVAILABLE

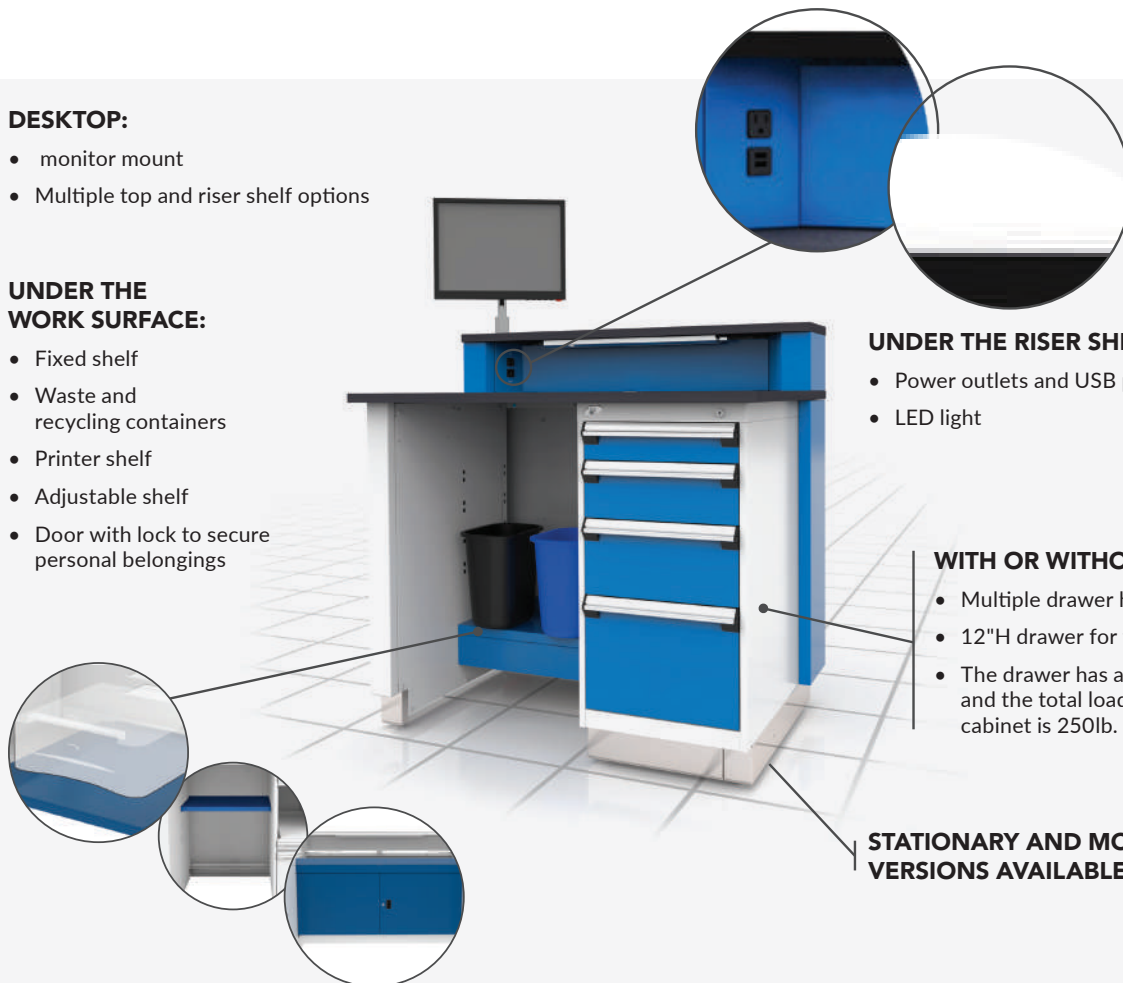

NOTE: To add accessories to preconfigured models, please contact Customer Service.

SERVICE ADVISOR DESKS

BUILD YOUR OWN

Follow the steps below to order your own customized service advisor desk. By choosing the various options available, you can build a desk that fulfills your requirements and matches your brand image. You can choose the top, finishing panels, and six different widths for both mobile and stationary desks.

1 B: Mobile
D: Stationary

2 Widths:
D: 30", E: 36", G: 42", H: 48", K: 60", L: 72"

3 Top:
5: Laminate, O: Stainless Steel, 2: Wood

4 Panel:
S: Stainless Steel, P: Painted Steel

RP-J38_0020S

Complete the model number on pages 90-92 with the options below.

1 TOPS



MOBILE (B)

- Includes 2" casters for moving the desk easily when required
- Four casters are included for desks with two legs
- Six casters are included for models with one leg and a cabinet

NOTE: Side-by-side desks and offset desks cannot be mobile.



STATIONARY (D)

- The stainless steel bases include leveling glides for easy leveling
- Includes four leveling glides, except the 60"W and 72"W versions with cabinet, which include five
- Side-by-side and offset configurations are possible by adding desk joining kit RP-K001S

2 WIDTHS

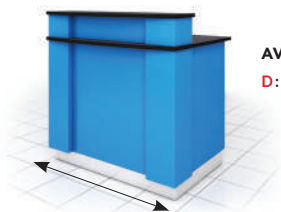

AVAILABLE WIDTHS:

D: 30", E: 36", G: 42", H: 48", K: 60", L: 72"

3 TOPS

Tops and riser shelves have rounded corners (visitor side).

STAINLESS STEEL (O)



GRAY LAMINATE (5)



WOOD (2)



4 PANEL CHOICE AND COLORS

NO PANEL

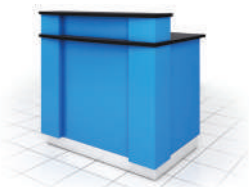

NOTE: No code to add. Base models come without a panel.

WITH PAINTED (P) OR STAINLESS (S) STEEL PANEL



With this option, you can personalize your desk by adding a logo or name, see page 94.

NOTE: Not available for the 30"W version.

FOR DUOTONE



Simply specify your chosen colors when ordering. There is no code to add.

5 ACCESSORIES

See page 93

To join two or more service advisor desks together, side by side or offset, please order desk joining kit RP-K001S, see page 92.

NOTE: Side-by-side desks and offset desks cannot be mobile.



SERVICE ADVISOR DESKS

FRONT VIEW FOR PRECONFIGURED MODELS

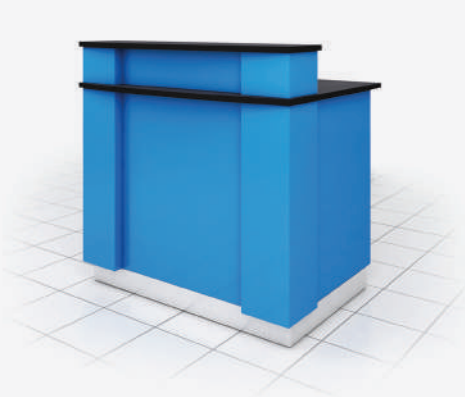

1 B: Mobile
 D: Stationary
2 Widths:
 D: 30", E: 36", G: 42", H: 48", K: 60", L: 72"
3 Top:
 5: Laminate, O: Stainless Steel, 2: Wood
4 Panel:
 S: Stainless Steel, P: Painted Steel

RP-__J38_0020S_

Complete the model number on pages 90-92 with the options below.

NOTE

1	Only available for 42, 48"W, 60"W and 72"W desks.
2	The shelf width varies according to the desk width. 24"W for a 48"W desk; 36"W for a 60"W desk; 48"W for a 72"W desk.
3	48"W desk = 24"W double doors; 60"W desk = 36"W double doors; 72"W desk = 48"W double doors.
4	Available in 30"W only.
5	Desks with doors cannot be mobile.

REAR VIEW

BASIC DESK



- Riser shelf

PRODUCT NO.

RP-__J38_0020S_

BASIC DESK WITH MONITOR MOUNT



- Riser shelf with 1 power outlet and 2 USB ports
- monitor mount
- LED light
- Full-width shelf
- Waste and recycling containers

PRODUCT NO.

RP-__J38_0040S_

DESK WITH CABINET



- Riser shelf
- 18"W cabinet with 4 drawers

PRODUCT NO.

RP-__J38_002RS_ (Note 1)

DESK WITH CABINET AND MONITOR MOUNT



- Riser shelf with 1 power outlet and 2 USB ports
- monitor mount
- LED light
- 18"W cabinet with 4 drawers
- Shelf
- Waste and recycling containers

PRODUCT NO.

RP-__J38_004RS_ (Note 1 and 2)

SERVICE ADVISOR DESKS

DESK WITH CABINET



- Riser shelf
- 18"W cabinet with 2 drawers and 1 roll-out shelf

PRODUCT NO.
RP-_J38_006RS_ (Note 1)

DESK WITH CABINET AND MONITOR MOUNT



- Riser shelf with 1 power outlet and 2 USB ports
- monitor mount
- LED light
- 18"W cabinet with 2 drawers and 1 roll-out shelf
- Shelf
- Waste and recycling containers

PRODUCT NO.
RP-_J38_008RS_ (Note 1 and 2)

DESK WITH CABINET, MONITOR MOUNT AND SECURE STORAGE UNDER THE WORK SURFACE

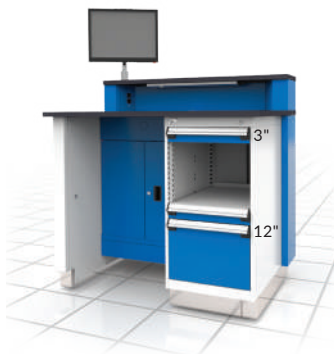

- Riser shelf with 1 power outlet and 2 USB ports
- monitor mount
- LED light
- 18"W cabinet with 2 drawers and 1 roll-out shelf
- Adjustable shelf
- Shelf
- Door with lock to secure personal belongings

PRODUCT NO.
RP-D_J38_012RS_ (Note 1, 2, 3 and 5)

DESK WITH CABINET AND SECURE STORAGE UNDER THE WORK SURFACE



- Riser shelf with 1 power outlet and 2 USB ports
- LED light
- 18"W cabinet with 4 drawers
- Adjustable shelf
- Shelf
- Door with lock to secure personal belongings

PRODUCT NO.
RP-D_J38_010RS_ (Note 1, 2, 3 and 5)

DESK WITH PRINTER SHELF



- Riser shelf with 1 power outlet and 2 USB ports
- Power feed panel under the work surface
- Printer shelf
- LED light

PRODUCT NO.
RP-_DJ38_0060S (Note 4)



Grimsby Ford (ON)

SERVICE ADVISOR DESKS

DOUBLE SERVICE ADVISOR DESKS



DESKS WITH CABINETS AND MONITOR MOUNTS

- Gray laminate tops
- 2 riser shelves with 1 power outlet and 2 USB ports each
- 2 monitor mounts
- 2 LED lights
- 2 cabinets (18"W) with 4 drawers each
- 2 shelves (24"W)
- Waste and recycling containers
- Stainless steel finishing panels

PRODUCT NO.	WIDTH
RP-C252004SS	96"

NOTE: This model number is effectively 2 × model RP-DHJ385004RS on [page 90](#), plus desk joining kit RP-K001S.



DESK WITH CABINET AND MONITOR MOUNT COMBINED WITH DESK WITH PRINTER SHELF

- Wood tops
- 2 riser shelves with 1 power outlet and 2 USB ports each
- monitor mount
- 2 LED lights
- 18"W cabinet with 4 drawers
- 24"W shelf
- Waste and recycling containers
- Printer shelf
- Power feed panel under the work surface
- Stainless steel finishing panels

PRODUCT NO.	WIDTH
RP-C221002SS	78"

NOTE: This model number is effectively model RP-DHJ382004RSS and RP-DDJ3820060S on [pages 90-91](#), plus desk joining kit RP-K001S.

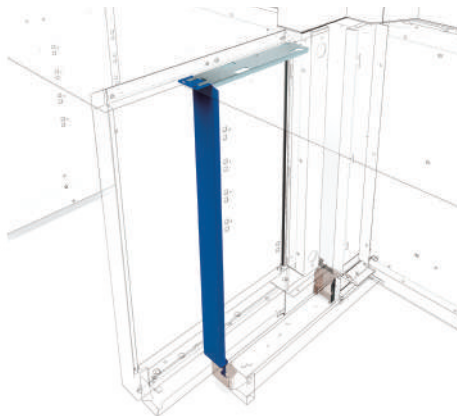

DESK JOINING KIT

- For joining two or more stationary service advisor desks together
- Suitable for side-by-side (linear) and offset configurations
- In offset configurations, the offset distance between desks is 8"
- One kit required per additional desk
- Includes finishing strips and attachment bars

PRODUCT NO.
RP-K001S

NOTE: Side-by-side desks and offset desks cannot be mobile.

SERVICE ADVISOR DESKS

ACCESSORIES



WASTE AND RECYCLING CONTAINERS

PRODUCT NO.	
RP46-01	Recycling Container
RP46-02	Waste Container



DOOR WITH LOCK TO SECURE PERSONAL BELONGINGS

PRODUCT NO.
RP48



ADJUSTABLE SHELF

PRODUCT NO.
RP41



PRINTER SHELF

PRODUCT NO.
RP43-2121



POWER FEED PANEL UNDER THE WORK SURFACE

PRODUCT NO.
RP95

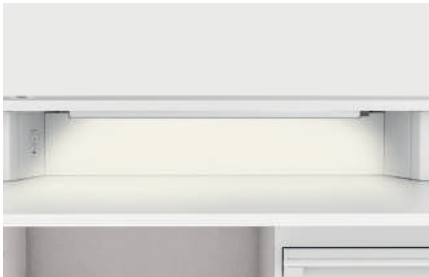

LED LIGHT

PRODUCT NO.
RP89



PHONE AND NETWORK CABLE KIT

PRODUCT NO.
RP95-01



CABLE MANAGEMENT KIT

PRODUCT NO.
RP95-02



10 ADHESIVES CABLE TIES MOUNTING KIT

PRODUCT NO.
RP95-03

NOTE: To add accessories to preconfigured models, please contact Customer Service.

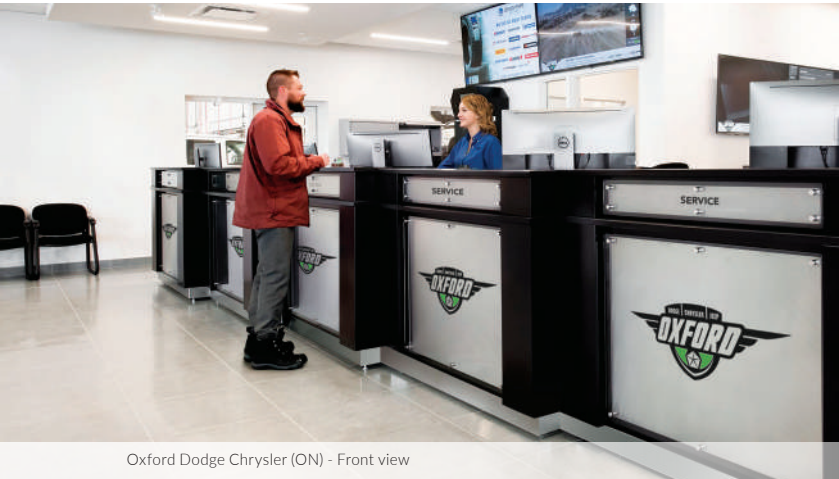

Oxford Dodge Chrysler (ON) - Front view

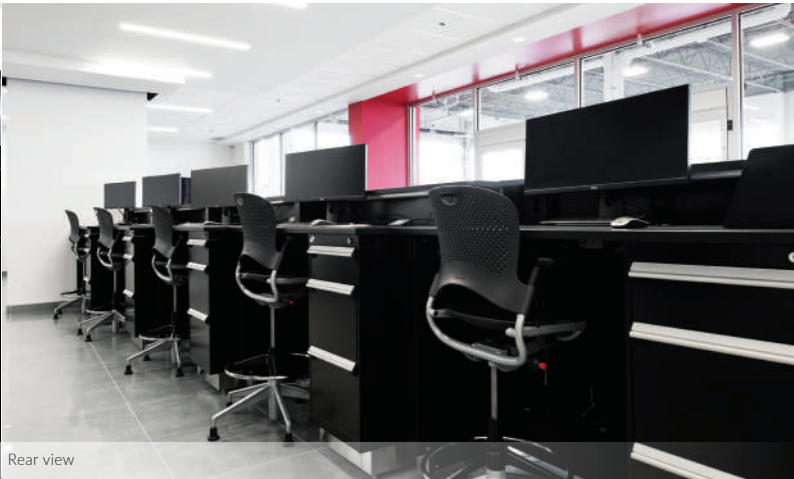

Rear view

PERSONALIZED PANELS

STAND OUT FROM THE COMPETITION!



Oxford Dodge Chrysler (ON)

Rousseau offers a personalization service for painted or stainless steel panels installed on GT workstations, service advisor desks and corner service counters.

Panels can be personalized with a logo, a name or even a slogan. Personalization is performed using digital printing with UV ink. It is a highly durable process that creates an immaculate finish and is easy to clean.

- Endless color possibilities
- For maximum impact, the design is always centered (vertically and horizontally)
- Existing panels can be replaced with new personalized panels

SEVERAL OPTIONS AVAILABLE



Digital printing with UV ink



Mirror finish to simulate a chrome finish

AVAILABLE FOR:

GT WORKSTATIONS



Order:
Stainless: RC42 + RZ99-43
Painted: RC41 + RZ99-43

CORNER WORKSTATIONS



Order:
Stainless: RS83 + RZ99-43
Painted: RS87 + RZ99-43

SERVICE ADVISOR DESKS



Order:
Stainless: RP96 + RZ99-43
Painted: RP99 + RZ99-43

SERVICE COUNTERS



Order:
Stainless: RS96 + RZ99-43
Painted: RS99 + RZ99-43

PARTS DEPARTMENT

A COMPLETE SOLUTION



We have been the experts in workspace storage and organization for over 75 years. In this time we have developed industry-leading expertise in parts department installations. You can therefore rest assured that all our products fulfill the strictest requirements for any dealership. All our products are designed, manufactured and rigorously tested in North America to meet the highest standards of engineering and quality.

The strength of our system is that it adapts to your environment and evolves with your needs. With the wide range of sizes and accessories available, you can create your own layouts and configurations to complement the installations you already have in place.

SERVICE COUNTERS

With our service counters, you can provide rapid, efficient and secure service to your customers. These workspaces can be fully personalized to ensure your most used items are always within easy reach. Placed exactly where you need it, your service counter will be an indispensable addition to your parts department.

Our products are customized to integrate into your unique environment and the space you have available. From corner workstations to counter cabinets, our scalable service counters offer the perfect blend of aesthetics and ergonomics, [see pages 116-117](#).



SPECIALIZED STORAGE

With our storage solutions, your parts are stored to make them easy to handle and completely secure. With racks available for any requirement, there's dedicated storage for every part: moldings, bumpers, exhaust pipes, tires, etc. Our specialists will also support you throughout the process, so you can take full advantage of everything our specialized storage has to offer.

By choosing our solutions, you ensure your parts department is optimally organized, and your inventory management is as efficient as possible, [see pages 106-109](#).

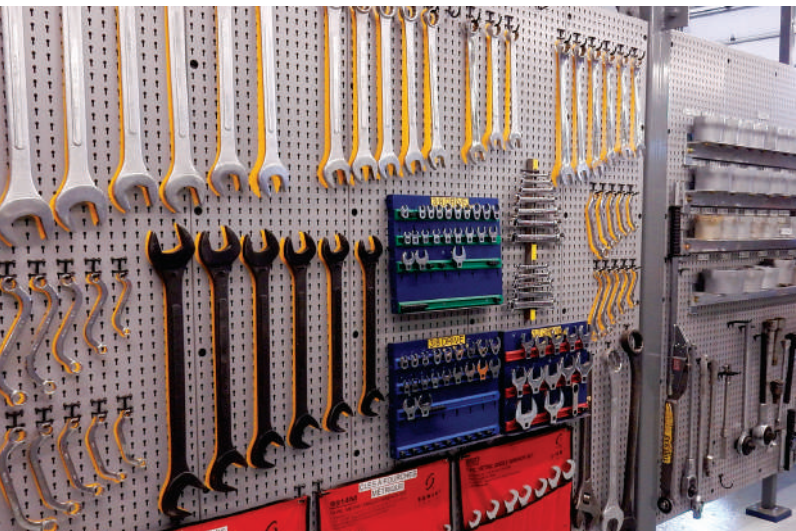

5S STORAGE

Rousseau's various storage solutions can be used to apply the Japanese 5S method. We have a range of products specially designed to optimize organization of your work area by assigning a specific place for each item. From hooks to tool holders to adhesive identification labels, everything has been designed to create a safe environment that facilitates inventory management and helps your staff to move around and work efficiently, [see pages 118-121](#).



MULTITEK CART

When parts are located far away from the service counter, the MultiTek Cart is your best friend. It offers a safe and secure way to rapidly transport parts of different sizes from A to B.

Built for heavy-duty tasks, the premium-quality MultiTek Cart is available in various dimensions and can be equipped with a range of accessories, which makes it incredibly versatile and perfectly adapted to automotive dealership environments. And by adding shelves with a 150lb. load capacity, you can transport more items in one go, saving you precious time and energy, [see page 114](#).



DRAWERS FOR SHELVING

By adding drawers to your shelving, you can recover 50% to 70% of your floor space. This can help you reduce the size of your parts department, leaving more room available for money-making departments like the service department or showroom. And with our drawer subdividing and labeling accessories, it's also much easier and quicker to locate the parts you need, saving you time and effort. Great savings that will surpass your expectations!

MAIN BENEFITS:

- More parts stored in the same space
- Less time spent searching for parts
- Less time spent by your mechanics waiting at the service counter
- More time for vehicle maintenance
- More time for your customers

Rousseau drawers add value to your existing equipment. They can be installed in more than 35 brands of shelving on the market, [see page 100](#).

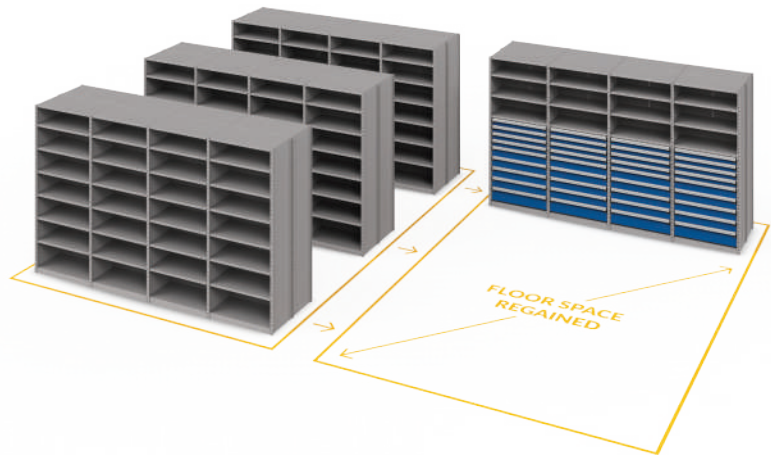
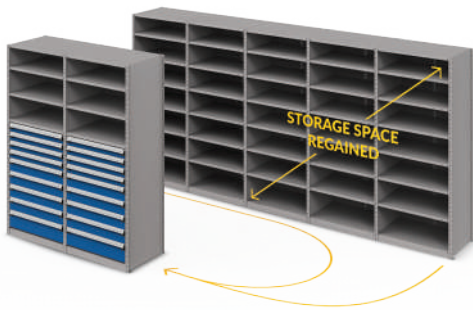

CURRENT SITUATION

- 1 Top and bottom shelves are not properly filled and hard to access
- 2 Backs of shelves are poorly lit
- 3 Shelves obstruct line of sight for stored items
- 4 Huge amount of unused space between shelves

RESULT

An inefficient system that makes finding items and managing inventory a laborious task

STANDARD SHELVING

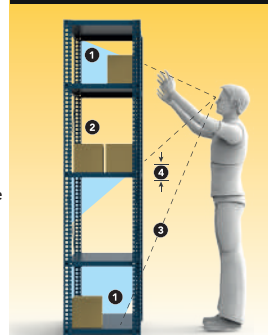

SHELVING WITH DRAWERS

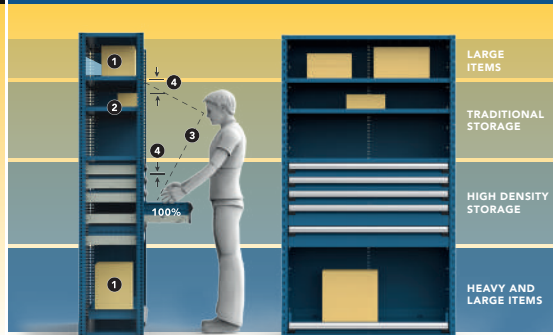

OUR RECOMMENDATIONS

- 1 Widely spaced shelves for storage of larger items
- 2 Close-set shelves positioned at eye level
- 3 Drawers that open to full extension for easily locating objects
- 4 Optimized use of space based on the size of stored items

RESULT

An organized and efficient storage system that enables easier inventory management

SMALL AND MEDIUM-SIZED PARTS STORAGE

MUCH MORE THAN A SIMPLE SHELVING UNIT



Our Spider® Shelving system is perfect for day-to-day parts, special orders and parts you need to keep in stock for warranties. It's the most versatile and complete solution of its type on the market! Thanks to its unique design, it is extremely easy to configure and add accessories.

- The only system that allows you to alternate shelves (medium-sized parts) and steel decking (large parts)
- Our common post reduces the number of posts needed by 25%, leaving more space for storage
- When planning tomorrow's needs today, make Spider® Shelving the heart of your multi-level shelving system, [see pages 112-113](#)



SHELVING FOR MEDIUM-SIZED PARTS

- Add drawers to combine storage of small and large items, [see page 100](#)
- BOX shelves are adjustable in 1" increments c/c



SRP0142



SRP0144

W×D×H	NO. OF SHELVES	OPEN	CLOSED
36"×18"×75"	7	SRP0101	SRP0103
36"×24"×75"	7	SRP0102	SRP0104
36"×18"×87"	8	SRP0111	SRP0113
36"×24"×87"	8	SRP0112	SRP0114
36"×18"×99"	9	SRP0121	SRP0123
36"×24"×99"	9	SRP0122	SRP0124
48"×18"×75"	7	SRP0131	SRP0133
48"×24"×75"	7	SRP0132	SRP0134
48"×18"×87"	8	SRP0141	SRP0143
48"×24"×87"	8	SRP0142	SRP0144
48"×18"×99"	9	SRP0151	SRP0153
48"×24"×99"	9	SRP0152	SRP0154

SHELVING WITH SLOPED SHELVES

- The 15-degree angle provides excellent visibility of stored items and is ideal for gravity flow storage
- Includes a heavy-duty front edge to keep stored items in place
- Sloped shelves and non-sloped SH20 BOX shelves can be combined in the same unit

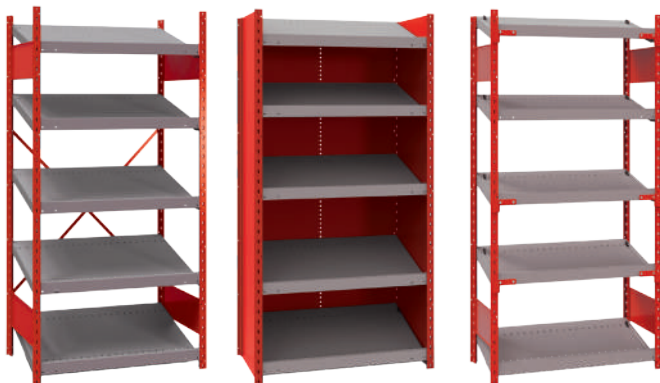

Open
SRE1T-EE750501

Closed
SRE2T-EE750501

Fifo
SRK1F-EE750501

W×D×H	NO. OF SHELVES	OPEN	CLOSED	FIFO
36"×18"×75"	5	SRE1T-EC750501	SRE2T-EC750501	SRK1F-EC750501
36"×24"×75"	5	SRE1T-EE750501	SRE2T-EE750501	SRK1F-EE750501
36"×18"×87"	6	SRE1T-EC870601	SRE2T-EC870601	SRK1F-EC870601
36"×24"×87"	6	SRE1T-EE870601	SRE2T-EE870601	SRK1F-EE870601
36"×18"×99"	6	SRE1T-EC990601	SRE2T-EC990601	SRK1F-EC990601
36"×24"×99"	6	SRE1T-EE990601	SRE2T-EE990601	SRK1F-EE990601
48"×18"×75"	5	SRE1T-HC750501	SRE2T-HC750501	SRK1F-HC750501
48"×24"×75"	5	SRE1T-HE750501	SRE2T-HE750501	SRK1F-HE750501
48"×18"×87"	6	SRE1T-HC870601	SRE2T-HC870601	SRK1F-HC870601
48"×24"×87"	6	SRE1T-HE870601	SRE2T-HE870601	SRK1F-HE870601
48"×18"×99"	6	SRE1T-HC990601	SRE2T-HC990601	SRK1F-HC990601
48"×24"×99"	6	SRE1T-HE990601	SRE2T-HE990601	SRK1F-HE990601

SMALL AND MEDIUM-SIZED PARTS STORAGE

SHELVING WITH DRAWERS



10 DRAWERS

W×D	HEIGHT/NO. OF USABLE SHELVES			NO. OF COMPART.	
	75" / 3	87" / 4	99" / 5	Total	Per Drawer
36"×18"	R5SEC-754851_	R5SEC-874851_	R5SEC-994851_	200	20
36"×24"	R5SEE-754851_	R5SEE-874851_	R5SEE-994851_	250	25
48"×18"	R5SHC-754851_	R5SHC-874851_	R5SHC-994851_	240	24
48"×24"	R5SHE-754851_	R5SHE-874851_	R5SHE-994851_	300	30

NOTE: To order an add-on unit, add **A** to the product number.



**8 DRAWERS,
1 ROLL-OUT SHELF**

W×D	HEIGHT/NO. OF USABLE SHELVES			NO. OF COMPART.	
	75" / 3	87" / 4	99" / 5	Total	Per Drawer
36"×18"	R5SEC-754857_	R5SEC-874857_	R5SEC-994857_	160	20
36"×24"	R5SEE-754857_	R5SEE-874857_	R5SEE-994857_	200	25
48"×18"	R5SHC-754857_	R5SHC-874857_	R5SHC-994857_	192	24
48"×24"	R5SHE-754857_	R5SHE-874857_	R5SHE-994857_	240	30

NOTE: To order an add-on unit, add **A** to the product number.



9 DRAWERS

W×D	HEIGHT/NO. OF USABLE SHELVES			NO. OF COMPART.	
	75" / 3	87" / 4	99" / 5	Total	Per Drawer
36"×18"	R5SEC-754853_	R5SEC-874853_	R5SEC-994853_	180	20
36"×24"	R5SEE-754853_	R5SEE-874853_	R5SEE-994853_	225	25
48"×18"	R5SHC-754853_	R5SHC-874853_	R5SHC-994853_	216	24
48"×24"	R5SHE-754853_	R5SHE-874853_	R5SHE-994853_	270	30

NOTE: To order an add-on unit, add **A** to the product number.



**7 DRAWERS,
1 ROLL-OUT SHELF**

W×D	HEIGHT/NO. OF USABLE SHELVES			NO. OF COMPART.	
	75" / 3	87" / 4	99" / 5	Total	Per Drawer
36"×18"	R5SEC-754855_	R5SEC-874855_	R5SEC-994855_	140	20
36"×24"	R5SEE-754855_	R5SEE-874855_	R5SEE-994855_	175	25
48"×18"	R5SHC-754855_	R5SHC-874855_	R5SHC-994855_	168	24
48"×24"	R5SHE-754855_	R5SHE-874855_	R5SHE-994855_	210	30

NOTE: To order an add-on unit, add **A** to the product number.



42"W shelving with drawers is also available. Contact us for more information.
Shelving with drawers must be anchored to the floor.

SMALL AND MEDIUM-SIZED PARTS STORAGE

BANKS OF DRAWERS FOR SHELVING

Rousseau drawers can be installed in over 35 shelving brands available on the market. You can therefore keep your existing installations and still make significant space saving gains.



4 DRAWERS - 18" H

PRODUCT NO.	W x D	NO. OF COMPART.
R5LEC-1801	36" x 18"	80
R5LEE-1801	36" x 24"	102
R5LGC-1801	42" x 18"	66
R5LGE-1801	42" x 24"	102
R5LHC-1801	48" x 18"	106
R5LHE-1801	48" x 24"	135



5 DRAWERS - 24" H

PRODUCT NO.	W x D	NO. OF COMPART.
R5LEC-2401	36" x 18"	88
R5LEE-2401	36" x 24"	114
R5LGC-2401	42" x 18"	78
R5LGE-2401	42" x 24"	114
R5LHC-2401	48" x 18"	116
R5LHE-2401	48" x 24"	150



7 DRAWERS - 36" H

PRODUCT NO.	W x D	NO. OF COMPART.
R5LEC-3601	36" x 18"	104
R5LEE-3601	36" x 24"	138
R5LGC-3601	42" x 18"	102
R5LGE-3601	42" x 24"	138
R5LHC-3601	48" x 18"	136
R5LHE-3601	48" x 24"	180



7 DRAWERS - 36" H

PRODUCT NO.	W x D	NO. OF COMPART.
R5LEC-3603	36" x 18"	120
R5LEE-3603	36" x 24"	156
R5LGC-3603	42" x 18"	108
R5LGE-3603	42" x 24"	156
R5LHC-3603	48" x 18"	158
R5LHE-3603	48" x 24"	205



8 DRAWERS - 48" H

PRODUCT NO.	W x D	NO. OF COMPART.
R5LEC-4801	36" x 18"	64
R5LEE-4801	36" x 24"	96
R5LGC-4801	42" x 18"	96
R5LGE-4801	42" x 24"	96
R5LHC-4801	48" x 18"	80
R5LHE-4801	48" x 24"	120



**7 DRAWERS,
1 ROLL-OUT SHELF - 48" H**

PRODUCT NO.	W x D	NO. OF COMPART.
R5LEC-4809	36" x 18"	136
R5LEE-4809	36" x 24"	174
R5LGC-4809	42" x 18"	114
R5LGE-4809	42" x 24"	174
R5LHC-4809	48" x 18"	180
R5LHE-4809	48" x 24"	230



Shelving units must be ordered separately.
Shelving with drawers must be anchored to the floor.

SMALL AND MEDIUM-SIZED PARTS STORAGE

CABINETS WITH DRAWERS



DO YOU NEED MAXIMUM FLEXIBILITY?

Are you constantly rearranging your parts department or planning a remodel in the future? No problem! Choose a solution that makes the job easier: cabinets with drawers. With our selection of forklift bases, you can rest assured that moving them is fast, efficient and safe.

STACKING CABINETS



- Stacking cabinets allow you to add storage for medium-sized parts above your small parts storage
- Includes one adjustable shelf (adjustable in 1" increments c/c) and one bottom shelf
- Available with or without door (lock included on every door)

W×D×H	WITHOUT DOOR	WITH DOUBLE INTEGRATED DOORS
36"×18"×24"	R5HEC-2400	R5HEC-2403
36"×18"×30"	R5HEC-3000	R5HEC-3003
36"×24"×24"	R5HEE-2400	R5HEE-2403
36"×24"×30"	R5HEE-3000	R5HEE-3003
48"×24"×24"	R5HHE-2400	R5HHE-2403
48"×24"×30"	R5HHE-3000	R5HHE-3003
48"×27"×24"	R5HHG-2400	R5HHG-2403
48"×27"×30"	R5HHG-3000	R5HHG-3003

CABINETS WITH DRAWERS

8 DRAWERS

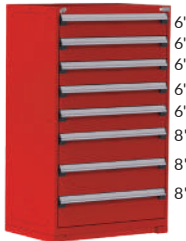

W×D×H	PRODUCT NO.	NO. OF COMPARTMENTS
36"×18"×60"	R5AEC-5835	64
36"×24"×60"	R5AEE-5835	96
48"×24"×60"	R5AHE-5815	120
48"×27"×60"	R5AHG-5815	120

10 DRAWERS

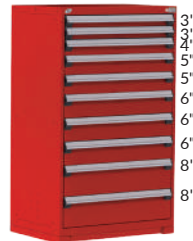

W×D	PRODUCT NO.	NO. OF COMPARTMENTS
36"×18"×60"	R5AEC-5837	160
36"×24"×60"	R5AEE-5837	210
48"×24"×60"	R5AHE-5817	275
48"×27"×60"	R5AHG-5817	235

11 DRAWERS

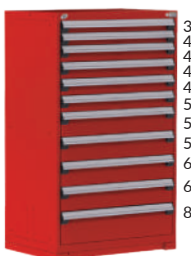

W×D×H	PRODUCT NO.	NO. OF COMPARTMENTS
36"×18"×60"	R5AEC-5839	216
36"×24"×60"	R5AEE-5839	276
48"×24"×60"	R5AHE-5819	365
48"×27"×60"	R5AHG-5819	301

NOTES: Other dimensions available. Please contact us.
Key lock (L3) included on each cabinet.



SMALL AND MEDIUM-SIZED PARTS STORAGE

SHELVING ACCESSORIES



With our shelving accessories, you can make use of all available space while resolving your storage challenges. The unique shape of the Spider® post is a Rousseau Metal Inc. trademark.

Cut back on wasted time and materials. Each item is stored in its proper place, clearly labeled and easy to locate.

See pages 118-121 for a range of Rousseau accessories that help you integrate the 5S methodology into the storage solution of your dealership's parts department.

UTILITY PANELS FEATURES



- Compatible with light-duty and heavy-duty hooks (WM9F/WM9G/WM9H/WM9J/WM9A and WM9B)
- Compatible with plastic bin rails (WM9C), can holders (WM9D), tool holders (WM9L/WM9N/WM9M/WM9Q) and tiltable shelves (WM21)
- The holes are spaced 1" apart c/c, which provides many options for hook placement



FULL HEIGHT UTILITY PANEL



- With the side utility panel you can make the most of unused space at the end of aisles.

PRODUCT NO.	D × H
SH69-1875	18" × 75"
SH69-1887	18" × 87"
SH69-2475	24" × 75"
SH69-2487	24" × 87"



BACK UTILITY PANEL

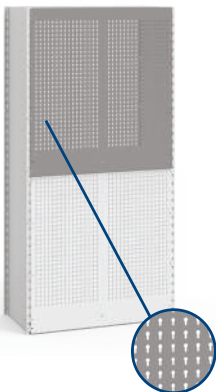

- Use the space on the back of shelving units with this panel.
- Two versions available: retrofit (SR79) or structural (SH79)

PRODUCT NO.	W × H
S_79-3639	36" × 39"
S_79-3651	36" × 51"
S_79-4839	48" × 39"
S_79-4851	48" × 51"

FINISHING PANEL

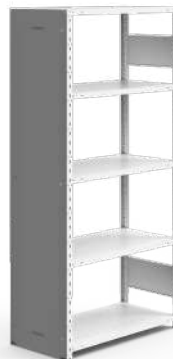

- Finishing panel for end-of-aisle shelving units
- Quick and easy hook-on assembly
- Creates a neater appearance
- Compatible with certain multi-level shelving applications. Contact Customer Service for more information

PRODUCT NO.	HEIGHT
SH37-__075	75"
SH37-__087	87"

NOTE: Add R to the product number for retrofit or H for structural.

NOTE: Complete the product number with the depth required: 18" or 24".

SMALL AND MEDIUM-SIZED PARTS STORAGE

BACK OR SIDE PLASTIC BIN PANEL



- Make the most of the space available on the sides or inside of your shelving to store small parts close by
- Compatible with RG20 plastic bins and all brands of plastic bins with hanging lip on the market

PRODUCT NO.	TYPE	W × H
SH65-3614	Back	36" × 14"
SH65-3620	Back	36" × 20"
SH65-3632	Back	36" × 32"
SH65-4814	Back	48" × 14"
SH65-4820	Back	48" × 20"
SH65-4832	Back	48" × 32"

PRODUCT NO.	TYPE	D × H
SH66-1814	Side	18" × 14"
SH66-1820	Side	18" × 20"
SH66-1832	Side	18" × 32"
SH66-2414	Side	24" × 14"
SH66-2420	Side	24" × 20"
SH66-2432	Side	24" × 32"

BACK OR SIDE UTILITY PANEL



- Make the most of the space available on the sides or inside of your shelving to store frequently used parts and tools close by

PRODUCT NO.	TYPE	W × H
SH67-3614	Back	36" × 14"
SH67-3620	Back	36" × 20"
SH67-3632	Back	36" × 32"
SH67-4814	Back	48" × 14"
SH67-4820	Back	48" × 20"
SH67-4832	Back	48" × 32"

PRODUCT NO.	TYPE	D × H
SH68-1814	Side	18" × 14"
SH68-1820	Side	18" × 20"
SH68-1832	Side	18" × 32"
SH68-2414	Side	24" × 14"
SH68-2420	Side	24" × 20"
SH68-2432	Side	24" × 32"

SLIDING UTILITY PANEL

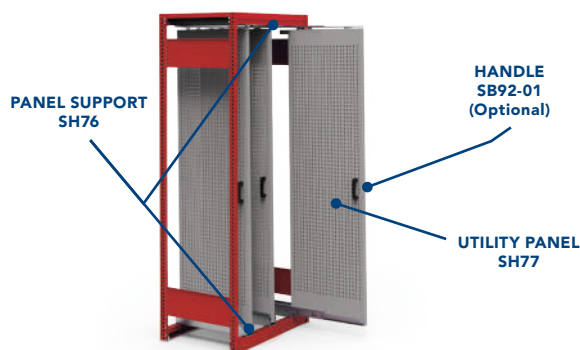

- For storing a wide range of items: tools, straps, cables, pipes, gaskets, etc.
- Load capacity: 300lb. per panel (evenly distributed)
- Refer to technical guide S84 for spacing between panels
- Compatible with open and closed shelving
- A SH76 Sliding Panel Support is required. Order based on the shelving width: Add 30", 36", 42" or 48" to the product number
- Optional handles (SB92)

PRODUCT NO.	D × H
SH77-1863	18" × 63"
SH77-2463	24" × 63"
SH77-1875	18" × 75"
SH77-2475	24" × 75"
SH77-1887	18" × 87"
SH77-2487	24" × 87"
SH76-__	Panel support
SB92-01	Handles



The panel support must be anchored to the ground to ensure stability

LED LIGHT FOR SPIDER® SHELVE



- Brightens shaded areas under shelves
- Can be installed under shelves
- Brighter and more energy efficient than a fluorescent tube

PRODUCT NO.	FOR	LIGHT WIDTH
SH95-01	30"W or 36"W shelves	21"
SH95-02	42"W or 48"W shelves	33"

SHELF DIVIDER



- Shelf dividers are used to subdivide shelves and support stored items
- Tool-free installation and easily reconfigured

PRODUCT NO.	TYPE	D × H
SH50-1809	Full height	18" × 9"
SH50-1815	Full height	18" × 15"
SH50-2409	Full height	24" × 9"
SH50-2415	Full height	24" × 15"
SH52-1806	Partial divider	13 1/2"D for 18"D shelves
SH52-2406	Partial divider	19 1/2"D for 24"D shelves

SPOOL HOLDER



- Designed so the bar can be pivoted to help with changing spools.
- Each bar has a 50lb. load capacity and a diameter of 3/4" (compatible with most spools on the market)

PRODUCT NO.	NO. OF RAILS	W × D
SH72-3618-01	1	36" × 18"
SH72-3618-02	2	36" × 18"
SH72-3624-01	1	36" × 24"
SH72-3624-02	2	36" × 24"
SH72-4818-01	1	48" × 18"
SH72-4818-02	2	48" × 18"
SH72-4824-01	1	48" × 24"
SH72-4824-02	2	48" × 24"

SMALL AND MEDIUM-SIZED PARTS STORAGE

LEVELING GLIDE KIT



- Adjusts the height of Spider® Shelving units from 1¼" to 2½" on uneven surfaces
- Load capacity: maximum 750lb. per glide
- Restrictions:
 - Only compatible with 99"H shelving or shorter
 - Only compatible with SR uprights and posts
 - Not compatible with modular drawers (RF32/RF36), roll-out shelves (RF41/RF45), SH28 bases, or SH uprights and posts
- Sold in pairs

PRODUCT NO.

SR49-01

FLIPPER DOOR FOR SPIDER® SHELVING



- Ideal for safe storage of small amounts of equipment and confidential files
- 14"H door for folder storage
- 16"H door for binder storage

PRODUCT NO.	W × D
SH85-3618_	36" × 18"
SH85-3624_	36" × 24"
SH85-4818_	48" × 18"
SH85-4824_	48" × 24"

NOTES: Complete the product number with the height required: 14", 16", 17" or 18".
Complete L3 for a key lock, L50 for an digital lock or L100 for a smart lock.

LABEL HOLDER FOR SHELF



- Self-adhesive and magnetic versions are available. The wide surface makes it adhere well to the shelf.

PRODUCT NO.	TYPE	W × H
SH82-600	Magnetic Label Holder	6" × 1"
SH81-36	Self-Adhesive Label Holder	36" × 1"
SH81-48	Self-Adhesive Label Holder	48" × 1"

NOTE: Labels (RG53) are available in packs of 200.

MOBILE SHELVING



- Preconfigured models include open shelving uprights, braces, BOX shelves, a mobile base for Spider® shelving and four 4" casters (2 swivel casters with total-lock brake system and 2 rigid casters)
- Load capacity: 1000lb. per base
- All preconfigured models are quick and easy to assemble and can be disassembled when not in use

W × D × H	OPEN
36" × 18" × 63"	SRE4001M
36" × 24" × 63"	SRE4002M
36" × 24" × 75"	SRE4003M
48" × 18" × 63"	SRE4007M
48" × 24" × 63"	SRE4008M
48" × 24" × 75"	SRE4009M

NOTE: Preconfigured models have six usable shelves.

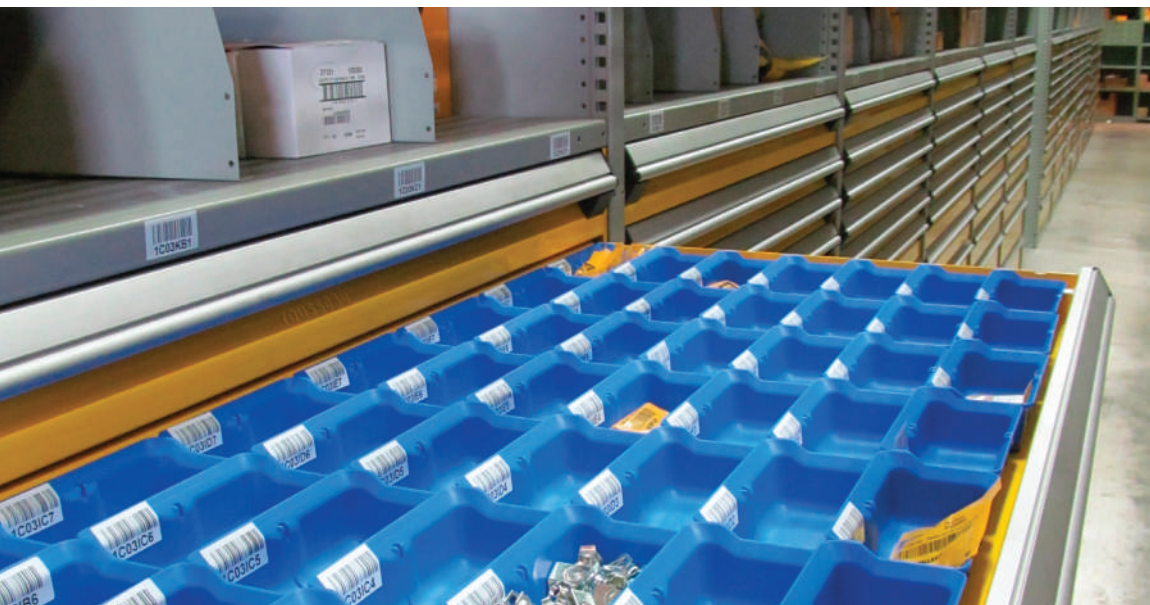

SMALL AND MEDIUM-SIZED PARTS STORAGE

SOLID DOORS WITH FRAME



SRE3205

- Designed for shelving with or without drawers, Rousseau doors store equipment safely and protect it from dirt
- Ideal for expensive parts, such as car radios
- Doors open 180° with a locking mechanism integrated into the handle

POLYCARBONATE DOORS WITH FRAME



SRE3204

- Designed for shelving with or without drawers, Rousseau doors store equipment safely and protect it from dirt
- Ideal for expensive parts, such as promotional items
- Polycarbonate panels ensure contents are visible
- Excellent impact resistance
- Doors open 180° with a locking mechanism integrated into the handle

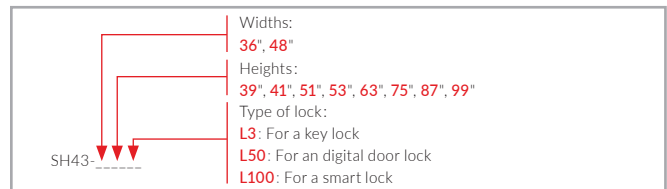
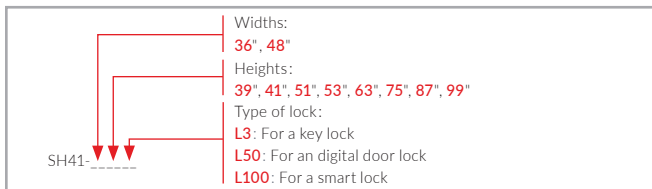

STACKED SOLID DOORS WITH FRAME



R5SEE-871813

- These doors install in the top part of Spider® Shelving over a bank of drawers without obstructing them
- Ideal for storage and keeping work areas tidy
- Ideal for storing expensive parts or slow-moving inventory
- Doors open fully on 180° hinges, allowing shelving contents to be visible and easily accessible
- The sturdy handle includes a lock
- See technical guide S64 for all available dimensions

STACKED POLYCARBONATE DOORS WITH FRAME



R5SEE-871815

- These doors install in the top part of Spider® Shelving over a bank of drawers without obstructing them
- Ideal for storage and keeping work areas tidy
- The polycarbonate panels ensure shelving contents are visible and have excellent impact resistance
- Ideal for storing expensive parts or slow-moving inventory
- Doors open fully on 180° hinges, allowing shelving contents to be visible and easily accessible
- The sturdy handle includes a lock
- See technical guide S64 for all available dimensions



Refer to technical guide S64 Spider® Shelving Doors - Layouts and Dimensions for recommended configurations and all possible combinations.

DISTINCTIVE FEATURES



Door opens by turning handle to the left or right.



Door closes with a simple push.



L50 Digital Lock and L100 Smart Lock: easier management of door access permissions.



R5SEE-871807



R5SEE-871811

SPECIALIZED STORAGE

A SOLUTION FOR EVERY NEED



What's the best way to store mufflers, bumpers, bodywork parts, batteries, tires and other items with unique shapes and sizes? The solution is simple: Rousseau specialized storage racks. These racks are the perfect way to make your parts department both efficient and tidy.

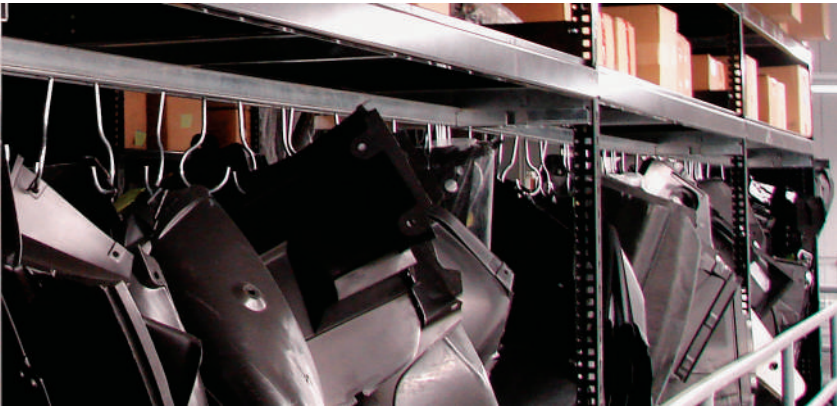

HANGING RACK FOR ASSORTED PARTS



SRP0404

- These racks are ideal for hanging exhaust pipes and any other item
- Available with one or two rails and includes hooks
- Three steel decking levels for storing large parts
- Extra hook (SR63-02)

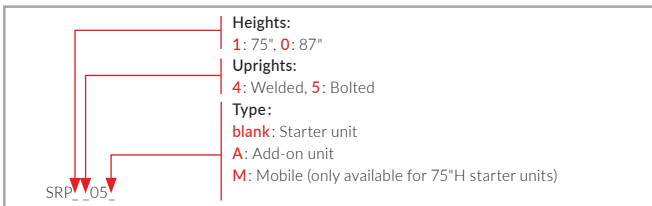

W x D	NO. OF RAILS (HOOKS)	PRODUCT NO.
60" x 36"	1 (15)	SRP_05_
60" x 36"	2 (30)	SRP_06_
72" x 36"	1 (15)	SRP_03_
72" x 36"	2 (30)	SRP_04_
96" x 36"	1 (25)	SRP_07_
96" x 36"	2 (45)	SRP_08_

NOTE: The mobile version offers a capacity of 1000 lbs per base

DOUBLE HANGING RACK FOR ASSORTED PARTS



SRP2404

- Easily find what you are looking for!
- This two-level hanging rack can be used to store many items of different shapes and sizes
- Available with two or four rails and includes hooks
- Three steel decking levels for storing large parts
- Extra hook (SR63-02)

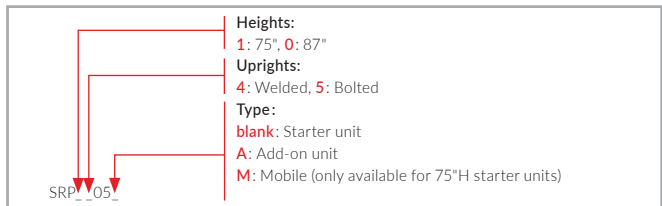

W x D	NO. OF RAILS (HOOKS)	PRODUCT NO.
60" x 36"	2 (30)	SRP_05_
60" x 36"	4 (60)	SRP_06_
72" x 36"	2 (30)	SRP_03_
72" x 36"	4 (60)	SRP_04_
96" x 36"	2 (50)	SRP_07_
96" x 36"	4 (90)	SRP_08_

NOTE: The mobile version offers a capacity of 1000 lbs per base

SINGLE MAT RACK



SRP0473

- Designed for hanging mats on one level
- Available with one or two rails
- Three steel decking levels for storing large parts

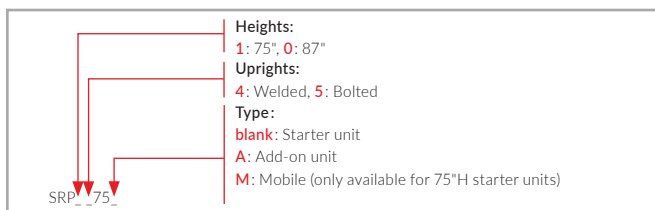

W × D	NO. OF RAILS	PRODUCT NO.
60" × 36"	1	SRP_75_
60" × 36"	2	SRP_76_
72" × 36"	1	SRP_73_
72" × 36"	2	SRP_74_
96" × 36"	1	SRP_77_
96" × 36"	2	SRP_78_

NOTE: The mobile version offers a capacity of 1000 lbs per base.

DOUBLE MAT RACK



SRP2473

- Designed for hanging mats on two levels
- Available with two or four rails
- Three steel decking levels for storing large parts

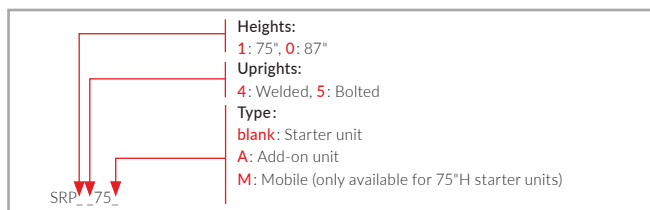

W × D	NO. OF RAILS	PRODUCT NO.
60" × 36"	2	SRP_75_
60" × 36"	4	SRP_76_
72" × 36"	2	SRP_73_
72" × 36"	4	SRP_74_
96" × 36"	2	SRP_77_
96" × 36"	4	SRP_78_

NOTE: The mobile version offers a capacity of 1000 lbs per base.

BUMPER AND PIPE RACK



SRP0420

- For storage of pipes and bumpers with space on top for other items
- Includes dividers to separate parts resting on the bottom of the unit
- The divider can be adjusted laterally without tools
- Extra single divider (SR61-2401)



W × D × H	NO. OF DIVIDERS	PRODUCT NO.
60" × 36" × 75"	4	SRP1421_
60" × 48" × 75"	4	SRP2421_
60" × 36" × 87"	4	SRP0421_
60" × 48" × 87"	4	SRP3421_
72" × 36" × 75"	4	SRP1420_
72" × 48" × 75"	4	SRP2420_
72" × 36" × 87"	4	SRP0420_
72" × 48" × 87"	4	SRP3420_
96" × 36" × 75"	6	SRP1422_
96" × 48" × 75"	6	SRP2422_
96" × 36" × 87"	6	SRP0422_
96" × 48" × 87"	6	SRP3422_

NOTES: Mobile version only available for 75"H starter units.

For an add-on unit, add **A** to the product number. For a mobile rack, add **M** to the product number.

The mobile version offers a capacity of 1000 lbs per base.

SHEET METAL RACK



SRP0430

- Divides parts and boxes stored vertically in the unit
- The divider can be adjusted laterally without tools
- Extra double divider (SR60-2415)



W × D × H	NO. OF DIVIDERS	PRODUCT NO.
60" × 36" × 75"	2	SRP1431_
60" × 48" × 75"	2	SRP2431_
60" × 36" × 87"	2	SRP0431_
60" × 48" × 87"	2	SRP3431_
72" × 36" × 75"	2	SRP1430_
72" × 48" × 75"	2	SRP2430_
72" × 36" × 87"	2	SRP0430_
72" × 48" × 87"	2	SRP3430_
96" × 36" × 75"	3	SRP1432_
96" × 48" × 75"	3	SRP2432_
96" × 36" × 87"	3	SRP0432_
96" × 48" × 87"	3	SRP3432_

NOTES: Mobile version only available for 75"H starter units.

For an add-on unit, add **A** to the product number. For a mobile rack, add **M** to the product number.

The mobile version offers a capacity of 1000 lbs per base.

SPECIALIZED STORAGE

WINDSHIELD RACK



SRP0481

- This rack provides secure storage for windshields and includes dividing rods.
- Includes a steel shelf at the top for extra storage space
- Includes stainless steel dividing rods

W×D×H	NO. OF USABLE SPACES	PRODUCT NO.
72"×48"×87"	7	SRP0481_
96"×48"×87"	7	SRP0480_

NOTE: To order an add-on unit, add **A** to the product number.

MOLDING RACK

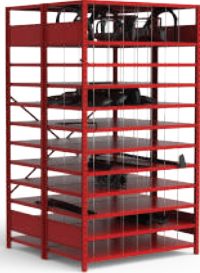

SRP0410

- The dividing rods are designed to provide efficient storage for most molding sizes available.
- Includes stainless steel dividing rods

W×D×H	NO. OF SPACES	NO. OF SHELVES	PRODUCT NO.
36"×48"×75"	54	9	SRP0413_
36"×48"×87"	66	11	SRP0411_
48"×48"×75"	72	9	SRP0412_
48"×48"×87"	88	11	SRP0410_

NOTE: To order an add-on unit, add **A** to the product number.

DOUBLE BUMPER RACK

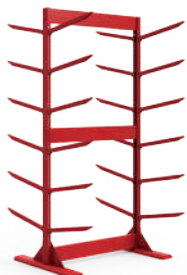

EMA3510

- Double racks can hold up to 12 bumpers. Several models are available, including stationary and mobile versions.
- The support arms are easily reconfigured, removed and stored as needed without tools

W×D×H	VERSION	PRODUCT NO.
45"×42"×85 1/2"	Standard version	EMA3510
45"×42"×87"	With leveling glide kit	EMA3511
45"×42"×91"	With 4" casters: 2 rigid and 2 swivel with total-lock brake	EMA3512
45"×42"×91"	With 4" casters: 2 swivel and 2 swivel with total-lock brake	EMA3513

HOOD RACK



SRP0450

- This rack is designed to hold heavy boxes. There is no bottom shelf so heavy items can slide in without being lifted.
- Includes two steel shelves at the top for extra storage space

W×D×H	PRODUCT NO.
48"×48"×75"	SRP2450_
48"×48"×87"	SRP0450_
60"×48"×75"	SRP2451_
60"×48"×87"	SRP0451_



To order an add-on unit, add **A** to the product number.
Hood racks must be anchored to the floor (anchoring kit included).

HIGH-DENSITY MAT RACK



- This unit stores a large number of mats and includes dividing rods.
- Includes three steel shelves for storing mats vertically
- Includes one steel shelf at the top for extra storage space
- Includes stainless steel dividing rods

W×D×H	PRODUCT NO.
60"×36"×87"	SRP0482_

NOTE: To order an add-on unit, add **A** to the product number.

WALL-MOUNTED BUMPER RACK



- Wall-mounted racks can hold up to six bumpers.
- The support arms are easily reconfigured, removed and stored as needed without tools
- Load capacity: 300lb. (if wall and wall anchoring are of sufficient strength)

W×D×H	PRODUCT NO.
45"×23"×72"	EMP1000

TIRE RACK



SRP0442

- With Rousseau tire racks, you can efficiently store, quickly identify and easily access all your tires.
- The angled beams provide excellent support for your tires
- The rack can also be used to store rims and wheels
- The single row version includes a wall spacer, while the double row version includes a unit spacer

W×D×H	VERSION	PRODUCT NO.
60"×15"×87"	Single	SRP0443_
60"×48"×87"	Double	SRP0444_
72"×15"×87"	Single	SRP0441_
72"×48"×87"	Double	SRP0442_

NOTE: To order an add-on unit, add **A** to the product number. The mobile version offers a capacity of 1000 lbs per base.

SLIDING PANEL SYSTEM

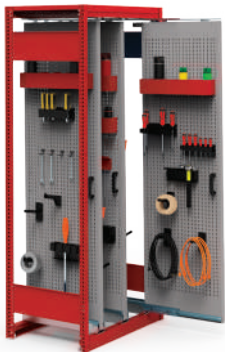

SHE1C-EE870103

- For storing a wide range of items: tools, straps, cables, pipes, gaskets, etc.
- Load capacity: 300lb. per panel (evenly distributed)
- SB92 Handles included
- 5S accessories not included, see pages 118-121
- Refer to technical guide S84 for spacing between panels

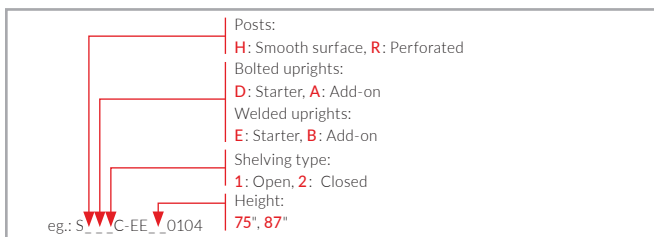

W×D	NUMBER OF PANELS	PRODUCT NO.
30"×18"	2	S__C-DC_0102
30"×24"	2	S__C-DE_0102
36"×18"	3	S__C-EC_0103
36"×24"	3	S__C-EE_0103
42"×18"	4	S__C-GC_0104
42"×24"	4	S__C-GE_0104
48"×18"	5	S__C-HC_0105
48"×24"	5	S__C-HE_0105



The panel support must be anchored to the ground to ensure stability

BATTERY RACK



SRP0490



- The battery shelves are sloped 10° for easier battery rotation (first in, first out)
- Slick black polyester paint helps the batteries to slide smoothly. The paint is also resistant to sulfuric acid
- Each level has a stop at the front and two guides on the sides to prevent batteries from falling accidentally
- The stopper plate makes it easier to grip batteries by creating more room for fingers. Adjustment possible to cater to batteries of different widths (motorcycle, car, heavy truck, etc.)
- 87"H models also include one steel decking level

W×D×H	NO. OF SHELVES	PRODUCT NO.
36"×36"×39"	2	SRP0494_
36"×36"×51"	3	SRP0495_
48"×36"×75"	4	SRP0490_
48"×48"×75"	4	SRP0491_
48"×36"×87"	4	SRP0492_
48"×48"×87"	4	SRP0493_

NOTE: For an add-on unit, add **A** to the product number. For a mobile rack, add **M** to the product number. The mobile version offers a capacity of 3300 lbs per base.

KEY CUTTING STATION



- This unit makes cutting keys easy by ensuring everything is within easy reach.
- 1 roll-out shelf, 100% extension to accommodate the cutting machine
- 2 drawers (3"H) for storing keys and small parts
- 4 steel shelves for storing larger items

W×D×H	PRODUCT NO.
36"×24"×87"	R5SEE-871202

RECORD STORAGE SYSTEM



- Save between 10% and 15% of shelving space compared to similar products on the market.
- Designed to accommodate all popular sizes of record storage boxes
- Capacity: up to 80 boxes
- Shelving and Mini-Racking units are available in many dimensions. Contact our specialists for more information

LARGE PARTS STORAGE

MINI-RACKING FOR LARGE PARTS



SRP0286

Mini-Racking is designed for storing large and heavy parts. With a wide choice of dimensions and decks, you can configure the units to fully meet your specific requirements.

There are three options available: steel decking, wire-mesh decking and wood decking.

MINI-RACKING WITH CHOICE OF DECKING

STEEL

To order a unit with steel decking, add **S** to the product number.

SRB5127S SRE5127S

WIRE MESH

To order a unit with wire-mesh shelves, add **W** to the product number. Available for 48"W, 60"W, 72"W and 96"W units and 24"D, 36"D and 48"D.

SRB5127W SRE5127W

WOOD

To order a unit without decking (e.g., for use with wood decking), leave the product number as is.

SRB5127 SRE5127

HOW TO ORDER

When ordering, model numbers must be completed as follows:

Uprights	Starter unit	Add-on unit
Bolted	D	A
Welded	E	B

e.g., SR_5001_

Type:
S: Steel decking
W: Wire-mesh decking
blank: Without decking

e.g., SRD5001S

For a starter unit (48"W x 18"D x 75"H) with bolted uprights and steel decking

NOTES: Steel decking has a greater load capacity than wood.
 Wire-mesh decking reduces fire risk.
 Wood panels are not available from Rousseau.

MINI-RACKING WITH MEDIUM-DUTY AND HEAVY-DUTY BEAMS

MEDIUM-DUTY BEAMS					HEAVY-DUTY BEAMS				
DIMENSIONS			NO. OF DECKING LEVELS		DIMENSIONS			NO. OF DECKING LEVELS	
W	D	H	3	4	W	D	H	3	4
48"	18"	75"	SR_5001_	SR_5021_	72"	18"	75"	SR_5151_	SR_5171_
	24"		SR_5002_	SR_5022_		24"		SR_5152_	SR_5172_
	36"		SR_5003_	SR_5023_		36"		SR_5153_	SR_5173_
	48"	SR_5004_	SR_5024_	48"		SR_5154_	SR_5174_		
	18"	87"	SR_5005_	SR_5025_		18"	87"	SR_5155_	SR_5175_
	24"		SR_5006_	SR_5026_		24"		SR_5156_	SR_5176_
	36"		SR_5007_	SR_5027_		36"		SR_5157_	SR_5177_
	48"		SR_5008_	SR_5028_		48"		SR_5158_	SR_5178_
24"	75"		SR_5051_	SR_5071_	24"	99"		-	SR_5180_
36"		SR_5052_	SR_5072_	36"	SR_5181_				
48"		SR_5053_	SR_5073_	48"	SR_5182_				
60"	18"	87"	SR_5054_	SR_5074_	96"	18"	75"	SR_5201_	SR_5221_
	24"		SR_5055_	SR_5075_		24"		SR_5202_	SR_5222_
	36"		SR_5056_	SR_5076_		36"		SR_5203_	SR_5223_
	48"		SR_5057_	SR_5077_		48"		SR_5204_	SR_5224_
	48"		SR_5058_	SR_5078_		18"		SR_5205_	SR_5225_
	24"	99"	-	SR_5080_		24"	87"	SR_5206_	SR_5226_
	36"		-	SR_5081_		36"		SR_5207_	SR_5227_
	48"		-	SR_5082_		48"		SR_5208_	SR_5228_
72"	18"	75"	SR_5101_	SR_5121_	24"	99"	-	SR_5230_	
	24"		SR_5102_	SR_5122_	36"		SR_5231_		
	36"		SR_5103_	SR_5123_	48"		SR_5232_		
	48"	SR_5104_	SR_5124_	18"	87"	SR_5105_	SR_5125_		
	18"	SR_5105_	SR_5125_	24"		SR_5106_	SR_5126_		
	24"	SR_5106_	SR_5126_	36"		SR_5107_	SR_5127_		
	36"	SR_5107_	SR_5127_	48"		SR_5108_	SR_5128_		
	48"	SR_5108_	SR_5128_	24"		-	SR_5130_		
24"	99"	-	SR_5130_	36"	-	SR_5131_			
36"		-	SR_5131_	48"	-	SR_5132_			
48"		-	SR_5132_						

NOTE: * Mini-Racking units in these sizes can be joined to back-to-back shelving units of the same depth.

LARGE PARTS STORAGE

MOBILE MINI-RACKING FOR LARGE PARTS



SRE4545SM

Mobile Mini-Racking is designed to moving parts, tools, and other large and heavy items.

There are three options available: steel decking, wire-mesh decking and no decking.

- The preconfigured models in this section include a mobile base for Mini Racking and four 4" casters, including two swivel casters with total-lock brakes and two rigid casters
- Models with a 36"D or 48"D base include a mobile Mini-Racking handle
- Load capacity: 1000lb. per base
- All preconfigured models are quick and easy to assemble and can be disassembled when not in use

MOBILE MINI-RACKING WITH CHOICE OF DECKING

STEEL

To order a unit with steel decking, add **S** to the product number.



SRE4515SM

WIRE MESH

To order a unit with wire mesh decking, add **W** to the product number.

Not compatible with 18"D units.



SRE4515WM

WOOD

To order a unit without decking (e.g., for use with wood decking), leave the product number as is.



SRE4515M

HOW TO ORDER

When ordering, model numbers must be completed as follows:

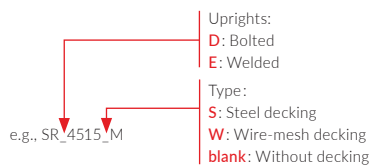

e.g., SRE4515SM

For a 36"D x 75"H unit with welded uprights, steel decking, and a 60"W x 36"D mobile base with 4" casters

NOTES: Steel decking has a greater load capacity than wood.

Wire-mesh decking reduces fire risk.

Wood panels are not available from Rousseau.

MOBILE MINI-RACKING WITH MEDIUM-DUTY AND HEAVY-DUTY BEAMS

MEDIUM-DUTY BEAMS

W	DIMENSIONS		NO. OF DECKING LEVELS
	D	H	
48"	18"	63"	SR_4507_M
	24"	75"	SR_4509_M
60"	36"	75"	SR_4515_M
	48"	75"	SR_4517_M
72"	36"	75"	SR_4531_M
	48"	75"	SR_4533_M

HEAVY-DUTY BEAMS

W	DIMENSIONS		NO. OF DECKING LEVELS
	D	H	
96"	36"	75"	SR_4539_M
	48"	75"	SR_4541_M

MULTI-LEVEL SHELVING SYSTEM

NOT ENOUGH SPACE?

BEFORE YOU EMBARK ON AN EXPANSION PROJECT, CONSIDER ROUSSEAU MULTI-LEVEL SHELVING

Our specialists will suggest solutions to work around all your building's obstacles: beams, columns, doors, air ducts, building structure, sprinklers, etc.

Our system maximizes your storage potential by combining shelving (with or without drawers), Mini Racking and specialized storage (tire racks, battery racks, etc.).

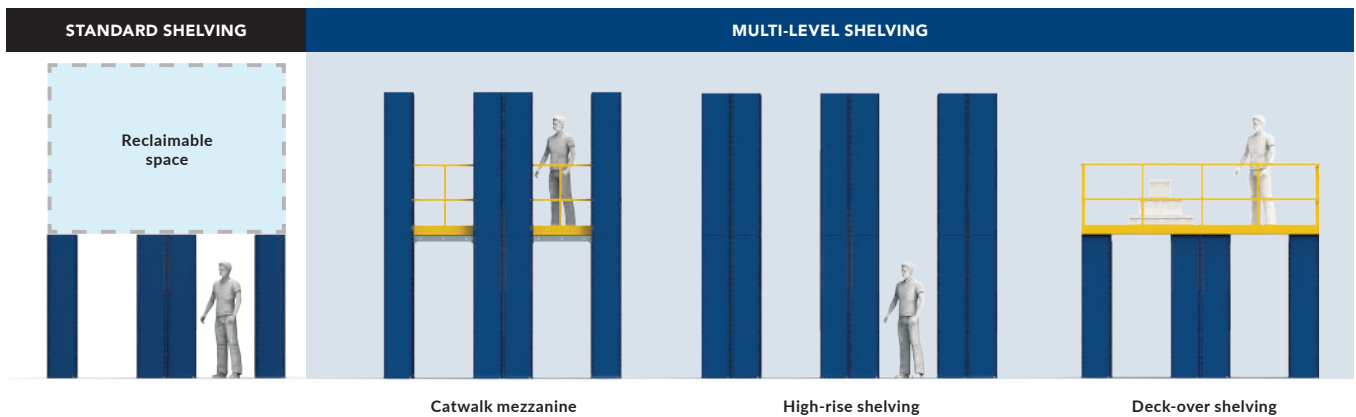

MULTI-LEVEL SHELVING SYSTEM

EXPERTISE THAT LEAVES NOTHING TO CHANCE

Multi-level shelving systems are subject to standards and recommendations in earthquake-prone regions.

The Rousseau team is available to help you work out what shelving and sway bracing you need to complete your multi-level shelving project.

Call us to speak with our experts. They will evaluate your requirements and suggest a system that meets your needs.

USE THE SECOND LEVEL TO STORE LARGER PARTS AND SPECIALIZED PARTS, [SEE PAGES 106-111](#).



OUR ACCESSORIES ARE PERFECT FOR STORING SMALL AND MEDIUM-SIZED PARTS, [SEE PAGES 98-105](#) AND [PAGES 119-121](#).



MULTITEK CART – MATERIAL HANDLING

ERGONOMIC AND VERSATILE



The MultiTek Cart is ideal for transporting large parts. You will find it quickly becomes indispensable in your parts department.

- Each shelf can be lined with a rubber mat
- Each shelf has a load capacity of 150lb. for a maximum of 600lb. per cart

You can find other preconfigured models (dimensions and accessories), [see pages 73-79](#).

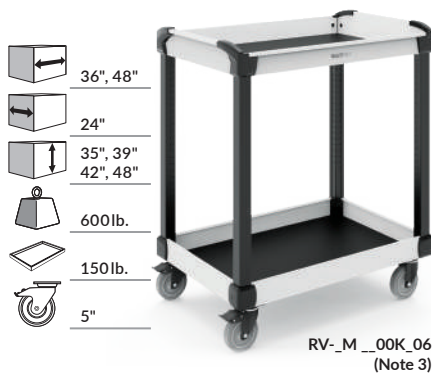
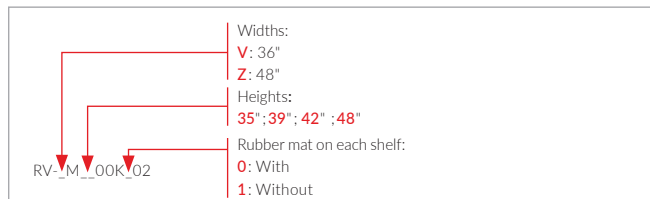

NOTES 1: For compatible hooks, [see page 119](#).
 2: Only available for 42"H and 48"H carts.
 3: Sold unassembled.



3 shelves

RV-M__00K_08 (Note 3)



4 shelves

RV-M__00K_09 (Note 2 and 3)



Utility panels

RV-M__00U_06 (Note 1)



Utility panels, 3 shelves

RV-M__00U_08 (Note 1)



Utility panels, 4 shelves

RV-M__00U_09 (Note 1 and 2)

OPTIMIZE YOUR WORKSPACE



To help you optimize your work area, Rousseau offers workstations tailored to your needs. Whether you are looking for a basic workbench or more extensive storage options over and under the work surface, we have many options available. And with a wide range of accessories to choose from, there is a near limitless number of layouts and configurations possible.

Heavy duty and meticulously designed, our workstations meet the strictest standards of quality and functionality. You will love their versatility and the value they add for specific tasks, including computer work, key copying, packaging, shipping, and much more.



BASIC WORKBENCH



- A high-quality bench available in multiple dimensions and with a choice of work tops

TYPE OF TOP	W x D x H		
	60" x 30" x 34"	72" x 30" x 34"	72" x 36" x 34"
Painted Steel	WS_1031	WS_1035	WS_1039
Laminated Wood	WS_2031	WS_2035	WS_2039
Plastic Laminated	WS_3031	WS_3035	WS_3039
Acrylic/PVC	WS_9031	WS_9035	WS_9039

NOTES: For a stationary table, complete with an A.
For a mobile table, complete with a W.



PACKING AND SHIPPING WORKSTATION



- For efficient preparation of orders to be shipped
- The spool support under the bench keeps your workspace clear

W x D x H	PRODUCT NO.
60" x 30" x 80"	WEM0006



WORKBENCH WITH STORAGE

- Ideal for storing tools, office supplies and other frequently used items
- Stationary workbench with 27"D cabinet on a 2"H recessed base

TYPE OF TOP	W x D x H		
	60" x 30" x 34"	72" x 30" x 34"	72" x 36" x 34"
Stainless Steel	R5WH5-2021	R5WH5-2031	R5WH5-2041
Painted Steel	R5WH5-2022	R5WH5-2032	R5WH5-2042
Laminated Wood	R5WH5-2023	R5WH5-2033	R5WH5-2043
Plastic Laminated	R5WH5-2024	R5WH5-2034	R5WH5-2044
Acrylic/PVC	R5WH5-2025	R5WH5-2035	R5WH5-2045



RECEIVING WORKSTATION AND INVENTORY CONTROL

- For efficient inspection of merchandise upon arrival
- Includes a steel shelf under the work surface
- The riser shelf includes one standard support and one support with three 15A power outlets and two USB ports

W x D x H	PRODUCT NO.
60" x 30" x 50"	WSA2006

SERVICE COUNTERS

OPTIMIZE YOUR SERVICE



To provide rapid and efficient service to your internal and external customers, make sure you have high-turnover parts to hand, i.e., directly at the service counter!

Adding drawers under the work surface provides high-density storage. This means you can access more parts without having to move. We also recommend combining shelves and drawers to maximize storage efficiency of parts with a high turnover.

Rousseau service counters have been designed to be welcoming for your customers while also providing an efficient and ergonomic workspace. You will love the distinctive look of our new corner service counters. With an attractive finish and the option to personalize stainless steel front panels, you can proudly display your logo and highlight your brand image. See [page 94](#) for more details.

CORNER SERVICE COUNTER, CONFIGURATION 1830: 15 DRAWERS

This counter allows you to keep high-turnover parts within arm's reach. With a 24"W leg space, it's easy to work at the counter or store a chair underneath as needed.

- Left bank (24"W)
- Middle bank (24"W)
- Right bank (2 × 36"W)

	STAINLESS STEEL	PAINTED STEEL
30" × 36"	RS-C096S	RS-C096P

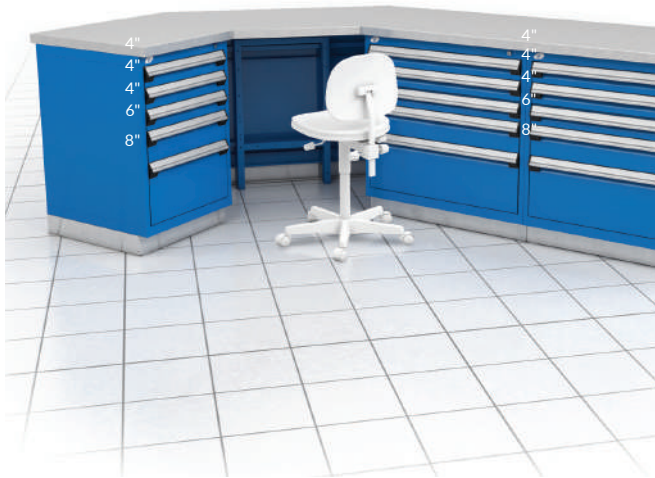

MIDDLE SECTION ONLY, INCLUDING THE CORNER TOP

	STAINLESS STEEL	PAINTED STEEL
	RS-J18303420S	RS-J18303420P



CORNER SERVICE COUNTER, CONFIGURATION 1830: 17 DRAWERS, 1 SHELF

With multiple drawers of different dimensions and a secure storage space with door, you can store high-demand parts whatever their size and shape.

- Left bank (24"W)
- Middle bank (24"W)
- Right bank (2 × 36"W)

	STAINLESS STEEL	PAINTED STEEL
30" × 36"	RS-C094S	RS-C094P

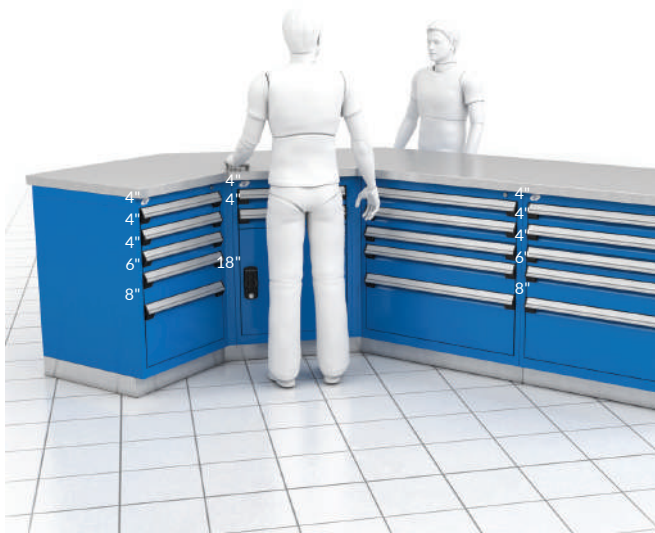

MIDDLE SECTION ONLY, INCLUDING THE CORNER TOP

	STAINLESS STEEL	PAINTED STEEL
	RS-J18303418S	RS-J18303418P



NOTES: The corner workstation must be anchored to two cabinets of the same height and depth, one on each side (RA30 or RA35).

Our corner service counters are available in configurations 0030, 0630, 1230 and 1830. Please contact Customer Service for more details.

5S STORAGE

EFFICIENT WORKSPACE ORGANIZATION

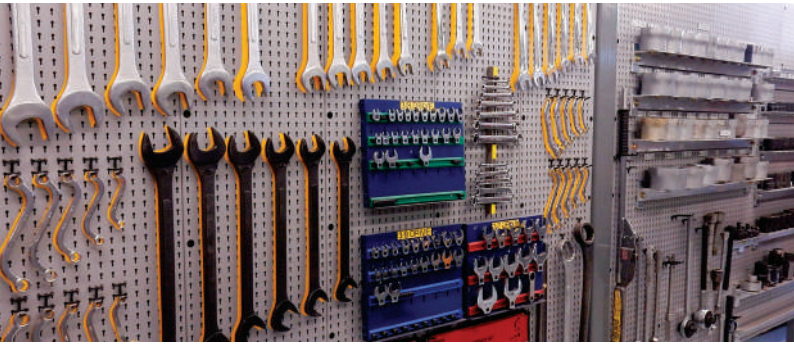

The Japanese 5S method focuses on sorting, straightening or setting in order, sweeping or shining, standardizing and sustaining the practice. This method ensures that the various tools and parts are stored according to their purpose and the frequency with which they are used, in a manner that is clear and well identified. Each item has its place, which reduces wasted time and lost items. With this method, the work environment is standardized so as to ensure the best organization possible while enhancing working conditions and team morale. Moreover, this means that less time and money are wasted. Here are several Rousseau accessories that will enable you to integrate the 5S method for lean manufacturing in the storage solution for the parts department of your automobile dealership.

WALL-MOUNTED UTILITY PANEL

WM57 / WM5B

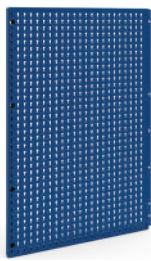

- Painted steel utility panel: WM57
- Stainless steel utility panel: WM5B
- For storing small- and medium-sized tools with visual identification close to the user or in a store
- Completely flat surface for easy visual identification with photos, P-touch, stickers or WM91 vinyl decals
- The panels overlap to anchor in the same anchoring zones
- Two widths available: 16" (16 holes) and 24" (24 holes)
- The installation hardware is between two panels for easy assembly
- 16"W: Vertical installation and conforms with architectural standards with uprights spaced 16" c/c
- Compatible with WM9F, WM9G, WM9H, WM9J and WM9L light-duty hooks, and WM9A and WM9B heavy-duty hooks
- Compatible with WM9C bin rails, WM9D can holders, WM9M and WM9N hooks, WM9Q tool holders, WM9P spool and roll holders, WM9R hammers support, WM9S document holder, and EA28 and WM21 shelves, [see page 119](#)
- To order: Specify the height required: 18", 24", 36", 48" or 72"

PRODUCT NO.	FINISH	WIDTH
WM57-16_	Painted Steel	16"
WM57-24_	Painted Steel	24"
WM5B-16_	Stainless Steel	16"
WM5B-24_	Stainless Steel	24"

WALL-MOUNTED PLASTIC BIN PANEL

WM5C

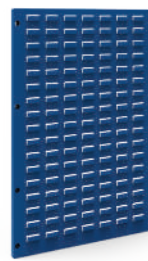

- Holds RG20 plastic bins, [see page 121](#)
- Compatible with all commercially available brands of plastic bins with a hanging lip
- Quick and easy installation
- The panels overlap to anchor in the same anchoring zones
- Two widths available: 16" and 24"
- 16"W: Vertical installation and conforms with architectural standards with uprights spaced 16" c/c
- To order: Specify the height required: 18", 24", 36", 48" or 72"

PRODUCT NO.	WIDTH
WM5C-16_	16"
WM5C-24_	24"

FINISHING PANEL

WM58 / WM5D



- Painted steel panel: WM58
- Stainless steel panel: WM5D
- Finishing panel for the end of a wall panel layout
- Quick and easy installation
- Creates a neater appearance
- To order: Specify the type of steel required, e.g., WM58-36

PRODUCT NO.	HEIGHT
WM_-18	18"
WM_-24	24"
WM_-36	36"
WM_-48	48"
WM_-72	72"

NOTE: Compatible with a wall panel of the same height, e.g., WM58-36 is only compatible with WM57-1636.

VINYL RUB-ON IDENTIFICATION DECAL

WM91

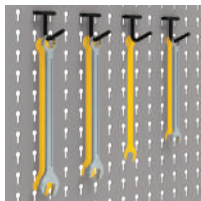

- For easy identification of where tools should be stored on utility panels
- Contrasting color so it is easy to notice when a tool is missing and what kind of tool it is
- Ideal for 5S method tool management
- Sold in rolls of 2'W x 8'L

PRODUCT NO.
WM91-01J

MAGNETIC DIVIDER



- Supports and separates items stored in can holders
- Includes a magnetic strip for easy repositioning

PRODUCT NO.	HEIGHT
WM9T-01	4"

LIGHT-DUTY HOOKS

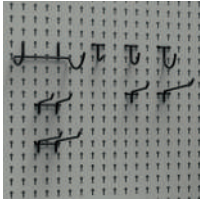

- Our hooks can be used to store many different parts, tools and accessories
- They are compatible with Rousseau utility panels as well as other panels currently available on the market (1/4" dia. holes)
- Also compatible with the wall-mounted panel system
- Color: black

PRODUCT NO.	TYPE (QTY)	DIMENSIONS
WM9F-150	Straight Arm Hooks (20)	1 1/2"D
WM9G-150	Single Loop Hooks (20)	1 1/2" dia.
WM9G-200	Single Loop Hooks (20)	2" dia.
WM9H-03	Double Back Single Hooks (10)	3"D
WM9H-05	Double Back Single Hooks (10)	5"D
WM9J-03	Double Back Double Hooks (10)	3"D
WM9J-05	Double Back Double Hooks (10)	5"D
WM9L-01	Drill Holder (1)	5"W x 3 1/2"D
WM9N-01	Screwdriver Holder (1)	9"W x 1 1/2"D x 2"H
WM9N-02	Screwdriver Holder (1)	9"W x 3 3/8"D x 2"H
WM9M-01	Pliers Holder (1)	9"W x 2 1/2"D x 2"H

HEAVY-DUTY HOOKS

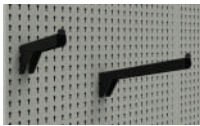

- Our hooks can be used to store many different parts and tools
- Load capacity: 50lb.
- Square and round versions available
- Color: black

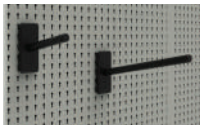

PRODUCT NO.	TYPE OF HOOK
WM9A-__	Square
WM9B-__	Round

NOTE: To order, specify the required length: **03"**, **06"**, **09"**.

WIRE SPOOL AND ROLL HOLDER

WM9P

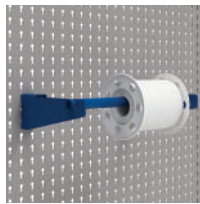

- Hooks onto utility panels (WM57, WM5B, SH67, SH68, SH69, SH77, SH79, SR79, RC02, RC93 and RC94)
- Ideal for wire spools or paper towel rolls
- Tube diameter: 3/4"
- Load capacity: 50lb.

PRODUCT NO.	WIDTH	NO. OF HOLES
WM9P-0901	9"	10
WM9P-1201	12"	13
WM9P-1501	15"	16
WM9P-2001	20"	21
WM9P-2301	23"	24
WM9P-2601	26"	27

CAN HOLDER

WM9D

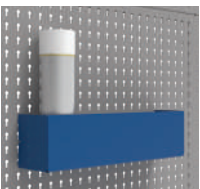

- Hooks onto utility panels WM57, WM5B, SH67, SH68, SH69, SH77, SH79, SR79, RC02, RC93, RC94 and EP12
- Ideal for storing various items of different sizes, such as aerosol cans
- Hook-on installation
- Includes side notches for extra stability
- Widths available: 6" (7 holes), 9" (10 holes), 12" (13 holes), 14" (15 holes), 15" (16 holes) and 20" (21 holes)
- To order: specify the width required

PRODUCT NO.	D x H
WM9D-__	3" x 4"

LIGHTWEIGHT SHELF

 EA28

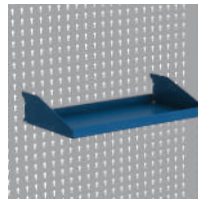

- Hooks onto utility panels WM57, WM5B, SH67, SH68, SH69, SH77, SH79, SR79, RC02, RC93, RC94 and EP12
- Allows the storage of small items
- Equipped with 1" front and rear edges to prevent items from falling
- Capacity: 10 lb

PRODUCT NO.	W x D
EA28-1508	15" x 8"

DOCUMENT HOLDER

WM9S

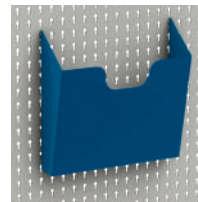

- Hooks onto utility panels WM57, WM5B, SH67, SH68, SH69, SH77, SH79, SR79, RC02, RC93, RC94 and EP12
- 10° angle on the front face compared to vertical
- Front face lower than back to assist in identifying documents
- Designed for both letter and legal sized papers

PRODUCT NO.	W x D x H
WM9S-01	12 1/4" x 3 3/4" x 10 1/2"

PLASTIC BIN RAIL

WM9C

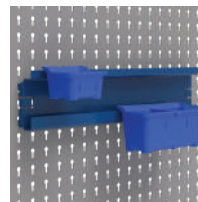

- Hooks onto utility panels WM57, WM5B, SH67, SH68, SH69, SH77, SH79, SR79, RC02, RC93, RC94 and EP12
- Plastic bins hook onto the rail for efficient storage of small parts
- Hook-on installation
- Includes side notches for extra stability
- Compatible with all brands of plastic bins with hanging lip on the market
- Compatible with RG20 plastic bins, **see page 121**
- Bins sold separately
- Widths available: 6" (7 holes), 9" (10 holes), 12" (13 holes), 15" (16 holes), 20" (21 holes), 23" (24 holes) and 26" (27 holes)
- To order: specify the width required

PRODUCT NO.	HEIGHT
WM9C-__	3"

5S STORAGE

LONG TOOL HOLDER

WM9Q

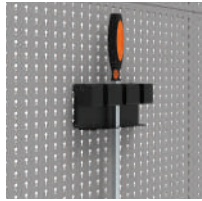

- Hooks onto utility panels WM57, WM5B, SH67, SH68, SH69, SH77, SH79, SR79, RC02, RC93, RC94 and EP12
- Holds up to three long tools
- Easy to install
- Color: black

PRODUCT NO.	W x D x H
WM9Q-08	8" x 3" x 4"

SCREWDRIVER HOLDER

WM9N

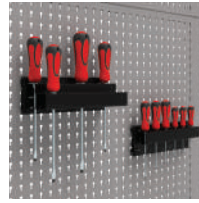

- Hooks onto utility panels WM57, WM5B, SH67, SH68, SH69, SH77, SH79, SR79, RC02, RC93, RC94 and EP12
- Holds 6-12 screwdrivers
- Color: black

PRODUCT NO.	VERSION	W x D x H
WM9N-01	Single	9" x 1" 1/2 x 2"
WM9N-02	Double	9" x 3" 1/4 x 2"

HAMMER SUPPORT

WM9R

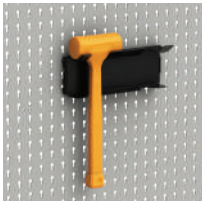

- Hooks onto utility panels WM57, WM5B, SH67, SH68, SH69, SH77, SH79, SR79, RC02, RC93, RC94 and EP12
- Holds up to 2 hammers
- Easy to install
- Designed for most plastic or rubber hammers and rubber mallets
- Color: black

NO DE PRODUIT	W x D x H
WM9R-09	9 1/16" x 2 1/16" x 5 3/16"

PLIERS HOLDER

WM9M

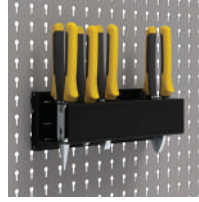

- Hooks onto utility panels WM57, WM5B, SH67, SH68, SH69, SH77, SH79, SR79, RC02, RC93, RC94 and EP12
- Holds up to six pliers
- Color: black

PRODUCT NO.	W x D x H
WM9M-01	9" x 2" 1/2 x 2"

5S IDENTIFICATION



With a wide selection of identification accessories, you can organize your workspace more efficiently. Easy identification of parts, tools and accessories boosts your team's efficiency, facilitates stock taking, increases productivity and prevents expensive tools from being misplaced or lost. Taking the time to organize things well can save you time and money.

ACCESSORIES	PRODUCT NO.	CATALOG PAGE
1"H label holders	RG51	p. 124
1"H label holders with adhesive	RG52	p. 124
1 3/4"H label holders	RG54	p. 124
1 3/4"H label holders with adhesive	RG55	p. 124
Handle protector	RF70	p. 124
Handle labels	RF71	p. 124
Vinyl rub-on identification decal	WM91-01J	p. 118

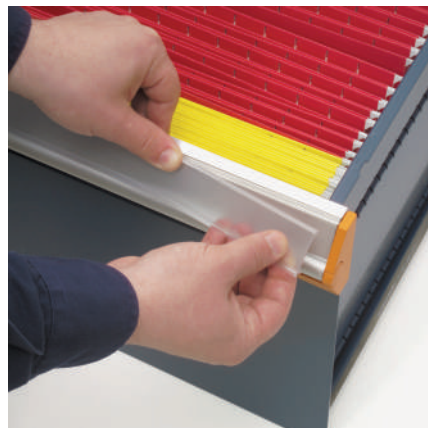

DRAWER ACCESSORIES

PLASTIC BIN

RG20



- For easier storing, moving and managing of small parts Lightweight and durable
- 45° angled rim for easy identification of bin contents and removal of bins
- Compatible with SH65, SH66, WM5C, RC04 and EP14 plastic bin panels, and EA32 / WM9C plastic bin rails
- 6" plastic bins can be subdivided

DIMENSIONS			PRODUCT NO.		
W	D	H	BIN	PARTITION	DIVIDER
3"	3"	2"	RG20-030302	-	-
4"	3"	2"	RG20-040302	-	-
6"	3"	2"	RG20-060302	RG22-0302	-
6"	6"	2"	RG20-060602	RG22-0602	RG24-0602
3"	3"	3"	RG20-030303	-	-
4"	3"	3"	RG20-040303	-	-
6"	3"	3"	RG20-060303	RG22-0303	-
6"	6"	3"	RG20-060603	RG22-0603	RG24-0603

NOTE: Height 2" = 1½" real
Height 3" = 2½" real



CABINETS FOR SPECIALIZED TOOLS

UNEQUALED FLEXIBILITY



We understand how valuable specialized tools are and that they must be carefully protected and completely secure. Our drawer accessories have been designed to protect your precious tools, regardless of their shape or size, and to make it easy to locate them.

We provide a turnkey service to help you create a cabinet that meets your exact and personal requirements.



YOUR OWN COMPLETELY ACCESSORIZED AND READY-TO-USE PRODUCT

Create fully personalized storage space with drawer accessories (PVC drawer liners, tool foam, plastic bins, subdivided compartment system)

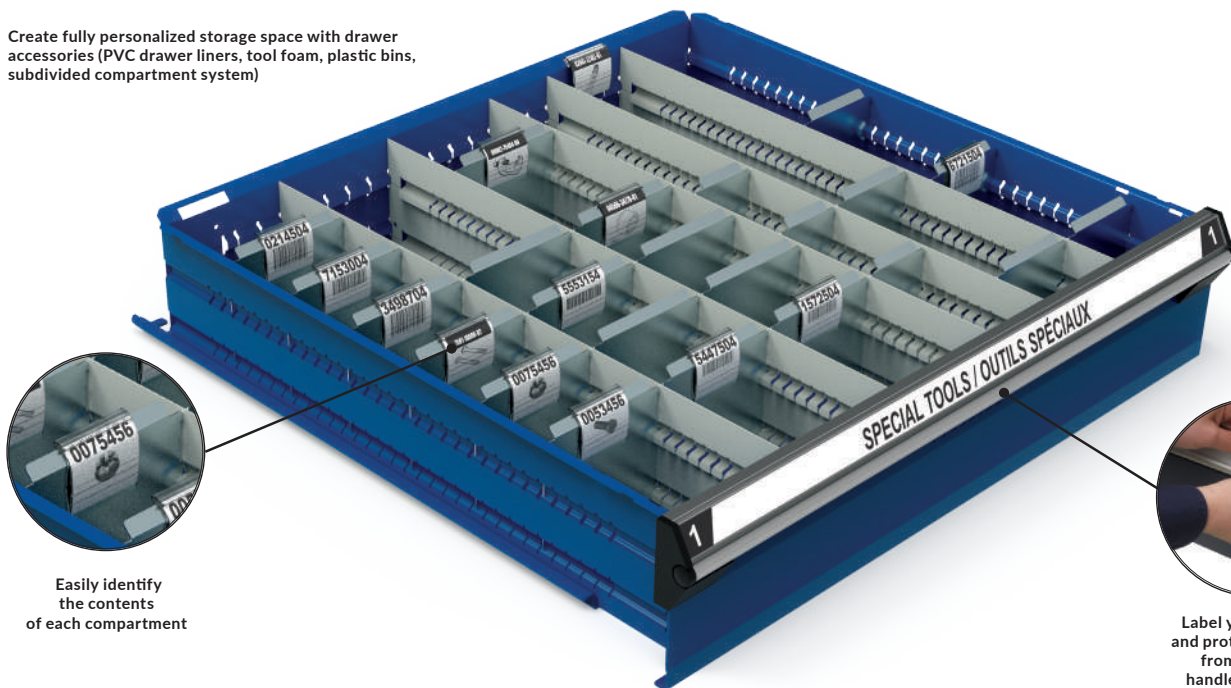

Easily identify the contents of each compartment

Label your drawers and protect the labels from dirt with handle protectors

DRAWER ACCESSORIES



Our wide range of drawer accessories are compatible with each other to help you keep your tools organized and easy to find. No matter what shape or size of item you need to store, we have the accessory you need.

The unique design of the R drawer is a trademark of Rousseau Metal Inc. The drawer is also protected by a registered industrial design. To view various preconfigured models, visit the Modular Drawers & Compartments section on our website.

NON-SLIP PVC DRAWER LINER (RG49)

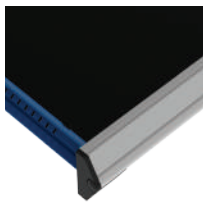

- Non-slip surface protects items stored in drawers
- Thickness: 3/32"
- Sold in sizes to fit drawer dimensions or in 27"W x 50"L rolls

NOTES: Not compatible with partitions and dividers.
To order a 27" x 50' roll: RG49-RR27-01.

PVC DRAWER LINER (RG40)

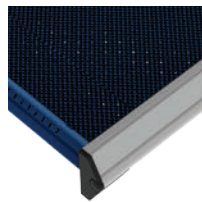

- Thickness: 3/32"
- Sold in sizes to fit drawer dimensions or in 7'W x 100'L
- Compatible with partitions and dividers

NOTE: To order a 7' x 100' roll: RG40-RR84-01.

TOOL FOAM (RG42)

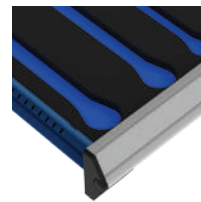

- Helps to easily identify stored items
- Oil resistant and non-absorbent
- The blue foam is 1/4" thick and the black self-adhesive foam is 1/2" thick

NOTE: Sold without cut-outs.

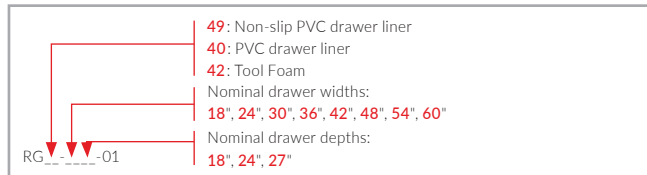

PARTITIONS AND DIVIDERS

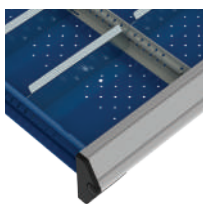

- Front to back and left to right partitions available
- Our tool-free "clip-in" subdividing system keeps the dividers firmly in place and reduces noise caused by vibrations

FRONT TO BACK PARTITIONS

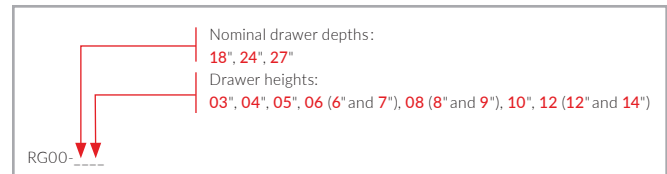

DRAWER DIVIDER

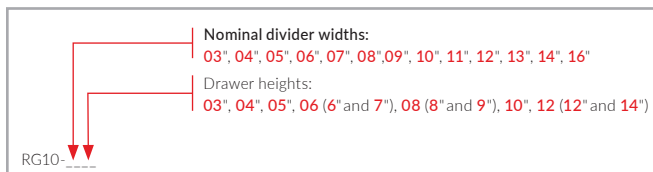

LEFT TO RIGHT PARTITIONS

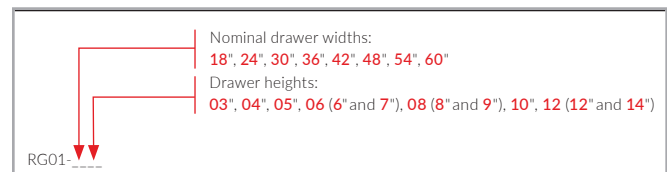

NOTE: Drawer accessories are available in other dimensions. Please contact your customer service representative for more details.

DRAWER ACCESSORIES

PLASTIC BINS

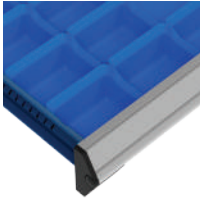

- Ideal for easier storage, handling and management of small parts
- 45° angled rim for easy identification of bin contents and removal of bins
- Designed for 3"H and 4"H drawers

PRODUCT NO.	W x D x H
RG20-040302	4" x 3" x 2"
RG20-040303	4" x 3" x 3"
RG20-060302	6" x 3" x 2"
RG20-060303	6" x 3" x 3"
RG20-060602	6" x 6" x 2"
RG20-060603	6" x 6" x 3"

NOTE: Partitions and dividers are also available (RG22/RG24).

LOCK-IN MECHANISM



- Stops drawer from opening on its own
- Designed so you can open and close the drawer with one hand only

PRODUCT NO.
A

LABEL HOLDER



- For dividers and plastic bins
- Once installed, the label holders remain in place when removing objects
- Contents of each compartment can be easily identified

PRODUCT NO.	TYPE	W x H
RG51-200	1"H Label Holder	2" x 1"
RG52-200	1"H Label Holder with Adhesive Strip for Plastic Bins	2" x 1"
RG54-200	1 3/4"H Label Holder	2" x 1 3/4"
RG54-400	1 3/4"H Label Holder	4" x 1 3/4"
RG55-200	1 3/4"H Label Holder with Adhesive Strip	2" x 1 3/4"
RG55-400	1 3/4"H Label Holder with Adhesive Strip	4" x 1 3/4"

NOTE: Labels (RG53) are available in packs of 200.

LABELS

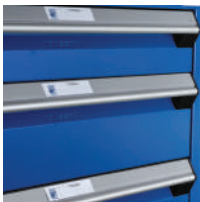

- Labels that attach to toolbox handles under the handle protector (RF70)
- 22 labels per page (10 pages)
- Print your own labels
- Download the electronic template (MS Word) from the rousseau.com website under the "Resources" tab to create labels or scan this QR code.



PRODUCT NO.	W x H
RF71-425100	4 3/4" x 1"

GROOVE TRAY

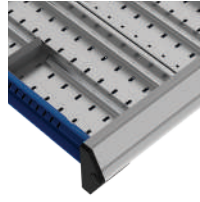

- For storing and protecting long objects
- Made of durable aluminum
- Gray plastic divider with 3/8" angled labeling area (to be ordered separately)
- Specially designed for 3"H and 4"H drawers

PRODUCT NO.		FRONT TO BACK	LEFT TO RIGHT	DIVIDER NO.
RG35-03DD	RG36-03WW			
RG35-04DD	RG36-04WW			
RG35-06DD	RG36-06WW			

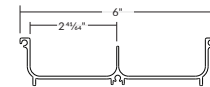
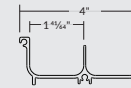
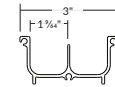

NOTE: Complete the product number with the depth required: 18", 24", 27", or the width required 18", 24", 30", 36", 42", 48", 54", 60".

DRAWER LOCK



- Locks a single drawer
- Compatible with all drawer dimensions

PRODUCT NO.
L3

HANDLE PROTECTOR



- Protects identification labels from dust, grease and dirt
- Made of transparent, matte plastic that eliminates glare and makes labels easy to read
- Clips onto the handle of the drawer or roll-out shelf

PRODUCT NO.	WIDTH
RF70-18	18"
RF70-24	24"
RF70-30	30"
RF70-36	36"
RF70-42	42"
RF70-48	48"
RF70-54	54"
RF70-60	60"

"OUR PARTS DEPARTMENT HAD A PROBLEM WITH LACK OF SPACE"

Derek Copeland, BMW Mississauga



CHALLENGE

Find the ideal solution to maximize the space in the parts department at BMW Mississauga, and by doing so, assemble the entire inventory in one place.

OBJECTIVE

Create a storage solution that would allow the client to solve the problem of having little space in the parts department, using Spider® Shelving Systems and Rousseau drawers.

ROUSSEAU SOLUTION

BMW Mississauga is a prestigious car dealership which serves a huge client base in the Greater Toronto Area, in Canada. This very busy garage was looking for a solution for their lack of space in the existing parts department.

When Derek Copeland, Parts Manager at BMW Mississauga, came to the conclusion that the parts department needed to be renovated, he had already made his decision on which option to go with. The owner of this high end dealership owns several other dealerships, among them a Ferrari dealership where he had selected Rousseau Storage Solutions in the past. He was so satisfied with the results that he knew right away he would use Rousseau systems for his BMW parts department to get the customized solution he needed.

"He was always available to talk to us. He asked questions about our needs and he presented us with his proposal. I liked their solution very much." This is what Mr. Copeland had to say about our automotive specialist Mike de Prinse. He loved his

experience! After a week of working on the project, our distributor was successful in presenting the client with a customized solution, adapted to their specific needs. Quality, modularity, flexibility and efficiency were all combined to provide a personalized solution. The excellent team work between Mr. Copeland and Mr. de Prinse was the key to the success of this project!

"Our parts department had a problem with lack of space. It is impressive to see how the layout of the shelving, drawers and accessories in the parts department has made storing all of our materials in a limited space possible, while also maximizing the work environment and storage. The productivity in the parts department has significantly increased since installing these solutions!"

FINAL COMMENTS FROM DEREK COPELAND

Here is what Mr. Copeland noticed most about Rousseau Storage Systems: "Durability and quality are what best describe Rousseau. Their modular storage materials allow you to create infinite configurations".



CASE STUDIES

"WHAT GRABBED OUR ATTENTION WAS THE DESIGN AND FLEXIBILITY OF THE PRODUCTS AND HOW HEAVY-DUTY THEY WERE"

Lorenzo D'Alessandro, Queensway Honda



CHALLENGE

The new dealership had to look professional and include technicians workstations, toolboxes, reel cabinets and computer stations

OBJECTIVE

Create a comprehensive solution that combined high-quality products, professional aesthetics and efficient workflow

ROUSSEAU SOLUTION

For over 50 years, Marino's Auto Group's promise to its customers has always been to exceed expectations. This business in the greater Toronto area specializes in five vehicle brands: Honda, Subaru, Volvo, Jaguar and Land Rover. Each customer is given a family-style welcome by passionate employees. Their driving force is to provide the best customer service possible. Although the business was thriving for this respected company, it did not want to sit back and rely on its good reputation. Recognizing that the market was evolving, and customers had new expectations, the owners wanted to relocate three of its dealerships to a new location. As a result, the group moved Lakeshore Honda to a building built for the new Queensway Honda.

Located in Etobicoke in Ontario, the new building needed to cater to current needs as well as growth in the medium and long term. This meant choosing a storage system that

was flexible enough to scale over time. The group heard about Rousseau at the annual NADA trade show and at the Automotive Conference Expo (ACE). The managers were immediately impressed by the quality of the products on show: "What grabbed our attention most of all was the design and flexibility of the products and, of course, how heavy-duty they were," said Partner Lorenzo D'Alessandro. "We also liked the fact that the products were made entirely in North America."

The group was in the early stages of their relocation project and meeting with the Rousseau team was a turning point. The Rousseau product specialist at Metric Storage Systems, was soon involved in the project. As Mr. D'Alessandro said, "It has been great to work with Rousseau

products expert from Metric Automotive – he listened to our needs and presented us with recommendations based on our requirements as well as innovative storage solutions for our parts department. The initial need was for a high-quality workbench solution with a professional appearance, but as we had a more in-depth look at our requirements, we had to find a solution for multiple technician shifts, as well as a way to integrate everything from toolboxes and air and oil reels to computer stations."

Everything was considered in this project. From technicians workstations to alignment stations and oil changes, every detail was included in the creation of workspaces that met the specific needs of the tasks to be performed. The Honda dealership now



has stylish and distinctive aesthetics and is a pleasant environment for employees to work in. Mr. D'Alessandro maintains that the quality of the installations is also important for hiring and retaining high-performing employees. "Their design aesthetic makes an impactful statement by presenting a professional appearance not only to our customers but equally as important – to our employees." The work environment's design and functionality of the custom workstations will most likely help recruit top talent in the coming years.

The end result is down to teamwork from start to finish. This project proves that establishing a partnership between passionate people with a common goal – to offer customers the best experience – leads to an end result that exceeds expectations. Our Rousseau specialist agrees. He believes that a project of this scale is particularly rewarding: "It's great to work on a project of this size. We installed a total of 24 workstations and a complete parts department. We took the time to listen to our client and advise them. When you look at the result, and when the client is happy, you know you've done a good job."

Although they didn't know at the start of the project that the three dealerships would turn to Rousseau for their parts and service departments, they were left in no doubt after the Queensway Honda project was completed: Rousseau had the solution. Mr. D'Alessandro summed it up, "Rousseau products have greatly contributed to increased productivity and given the business a more professional look." A few months after completing the Honda Queensway installation, Marino's Auto Group once again called on Rousseau for Marino's Fine Cars Subaru and Jaguar Land Rover Metro West.



Jaguar Land Rover Metro West



Marino's Fine Cars Subaru

SHOWCASE – SERVICE DEPARTMENTS

TAILOR-MADE FOR EVERY CUSTOMER

FERRARI LAKE FOREST (IL)



SHOWCASE – SERVICE DEPARTMENTS

LANCASTER TOYOTA (PA)



SHOWCASE – SERVICE DEPARTMENTS

BUDDS JAGUAR LAND ROVER (ON)



SHOWCASE – SERVICE DEPARTMENTS

COMPLEXE VOLKSWAGEN 440 (QC)



SHOWCASE – OFFICES



SHOWCASE – PARTS DEPARTMENTS

SPECIALIZED STORAGE

For many years we have worked on solutions to help you achieve maximum efficiency in your parts stores. You can count on us no matter your store size or what obstacles you are faced with. We have the solution you need!



SHOWCASE – PARTS DEPARTMENTS

MULTI-LEVEL SHELVING



SHOWCASE – PARTS DEPARTMENTS

SMALL, MEDIUM AND LARGE PARTS STORAGE



SHOWCASE – PARTS DEPARTMENTS

SERVICE COUNTERS AND SERVICE ADVISOR DESKS



STANDARD COLORS

HAVING THE ABILITY TO CUSTOMIZE YOUR ROUSSEAU PRODUCT WITH ANY OF OUR 20 STANDARD COLORS IS ALSO DISTINCTIVELY ROUSSEAU!



Everest Blue
051



Classic Blue
052



Avalanche Blue
055



Midnight Blue
057



Glossy Sapphire Blue
560

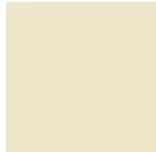

Beige
041

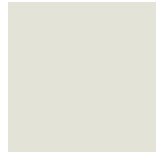

Frost White
061



Light Gray
071



Modern Gray
745



Charcoal Gray
072



Glossy Carbon Black
741



White
616



Glossy EverGreen
1025



Glossy Yellow
208



Sienna Orange
085



Flame Red
081



Glossy Carmine Red
806



Glossy Cranberry Red
815



Black
091



Glossy Black
902

FOR PRODUCTS THAT REALLY POP, YOU CAN EVEN COMBINE COLORS. HERE ARE SOME EXAMPLES:



Flame Red/
Black
081/091



Glossy Yellow/
Charcoal Gray
208/072



Charcoal Gray/
Black
072/091



Modern Gray/
Charcoal Gray
745/072



Frost White/
Black
061/091



Glossy Carmine
Red / Charcoal Gray
806/072

HANDLE END CAPS:



Black
031



Orange
021



Ocean Blue
011

**CAN'T FIND
THE COLOR YOU WANT?**

CONTACT OUR CUSTOMER SERVICE.

*Colors may differ slightly from those shown.



QUICK ACCESS

Scan the QR codes to visit our different platforms.



WEBSITE
rousseau.com



CONFIGURATOR
MyModel-r.com



VIDEOS
youtube.com























DISTRIBUTORS ACCESS
e-rousseau.com



STANDARD COLORS

Colors may vary slightly from those shown.

						
Avalanche Blue 055	Everest Blue 051	Classic Blue 052	Midnight Blue 057	Glossy Sapphire Blue 560	Glossy EverGreen 1025	Black 091
						
Beige 041	Frost White 061	Light Gray 071	Modern Gray 745	Charcoal Gray 072	Glossy Carbon Black 741	White 616
						
Sienna Orange 085	Flame Red 081	Glossy Carmine Red 806	Glossy Cranberry Red 815	Glossy Yellow 208	Glossy Black 902	

Rousseau is continuously improving its products and reserves the right to make any modifications judged necessary.

ROUSSEAU METAL INC.

105, avenue de Gaspé Ouest
Saint-Jean-Port-Joli (Québec)
G0R 3G0 CANADA

WEBSITE
rousseau.com

DISTRIBUTORS
1.800.463.4271

DISTRIBUTORS ACCESS
e-rousseau.com

END USERS
1.866.463.4270

CONFIGURATOR
MyModel-r.com

EMAIL
info@rousseau.com



Printed in Canada