



FURNISYS
Functional Furniture Systems

Manufacturing Industry

Work Station, Workbench,
Cabinet, Cart, Trolley, Flow Rack
Application Brochure

CONTENTS

01

03

05

09

19

23

36

Our Story

Our Value Chain

Unique Value Proposition

Products

Services

Application

Clientele



EAG TECH INDIA

Our Story

Our journey began as **furnace**, crafting custom furniture for laboratories, education, and manufacturing. Evolving into **Furnisys**, we now deliver industry-agnostic furniture systems designed for seamless configuration, adapting to diverse industry applications and driving greater value.

Value Investment

Agile Workforce

Research Driven

Systemic Design

Lean Thinking Integrated

Concepts Application

Technology Backed

Collaborative Approach

Our Value chain

Engineering Design

Individual Engineering, PDM, DFM

Project Operations

Consistency, Time-Sensitive

Product Management

PLM, Value Engineering

Sales & Marketing

Solution Advocacy, Engagement

Manufacturing Infrastructure:

Furnisys is supported by multiple self-owned factories located in over 25,000 sq.ft. in Navi Mumbai. Manufacturing all products in-house provides us with the opportunity to control 100% of the product quality and ability to facilitate projects of all sizes while maintaining competitive pricing and outstanding lead times. All of the factories feature the latest machinery and technology available to use.

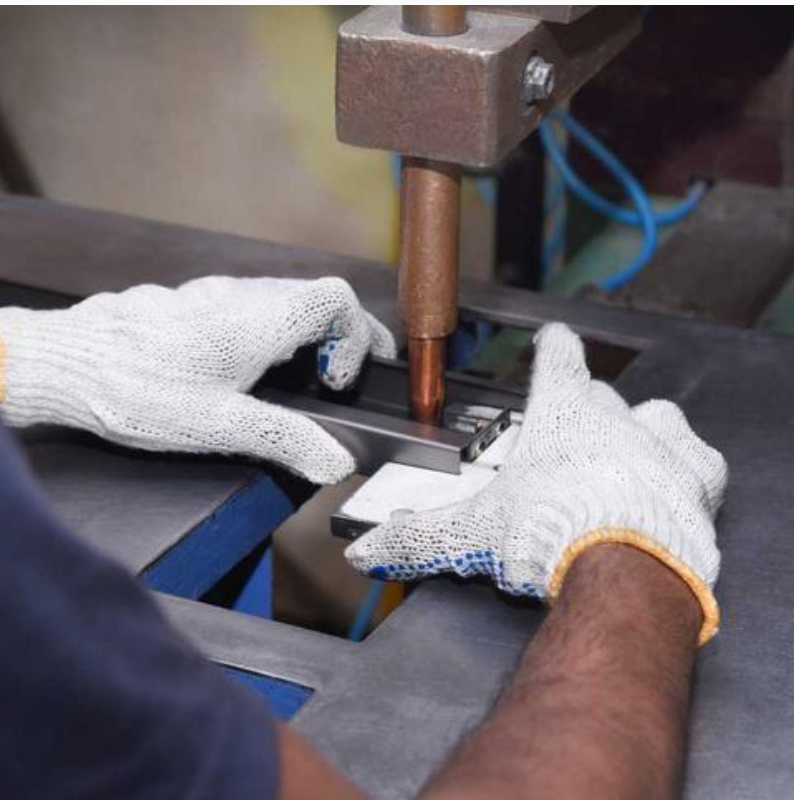

Unique Value Proposition

Furnisys offers integrated systems that go beyond standalone products, empowering manufacturers to optimize resources, improve workflows, and create scalable work environments.

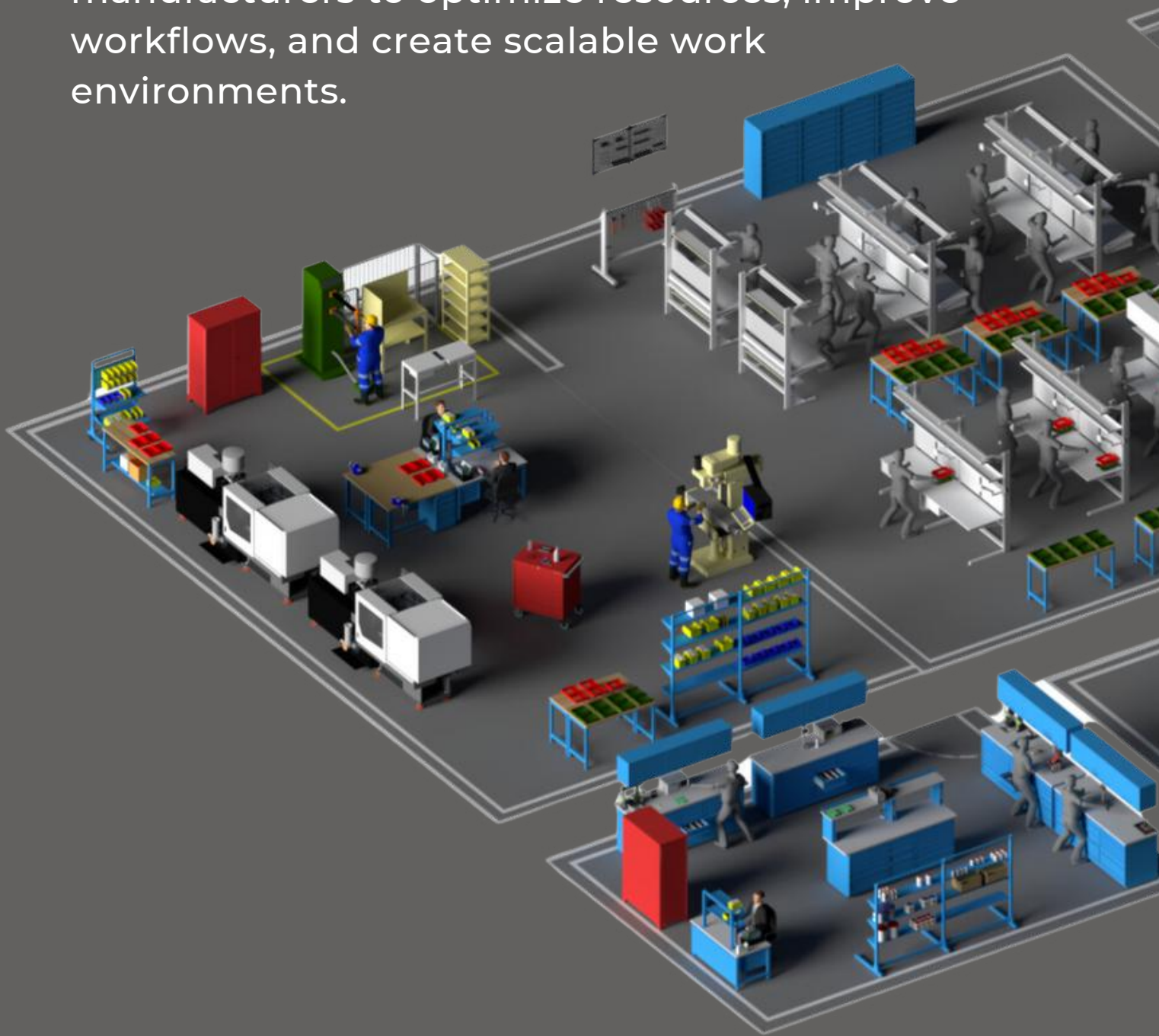

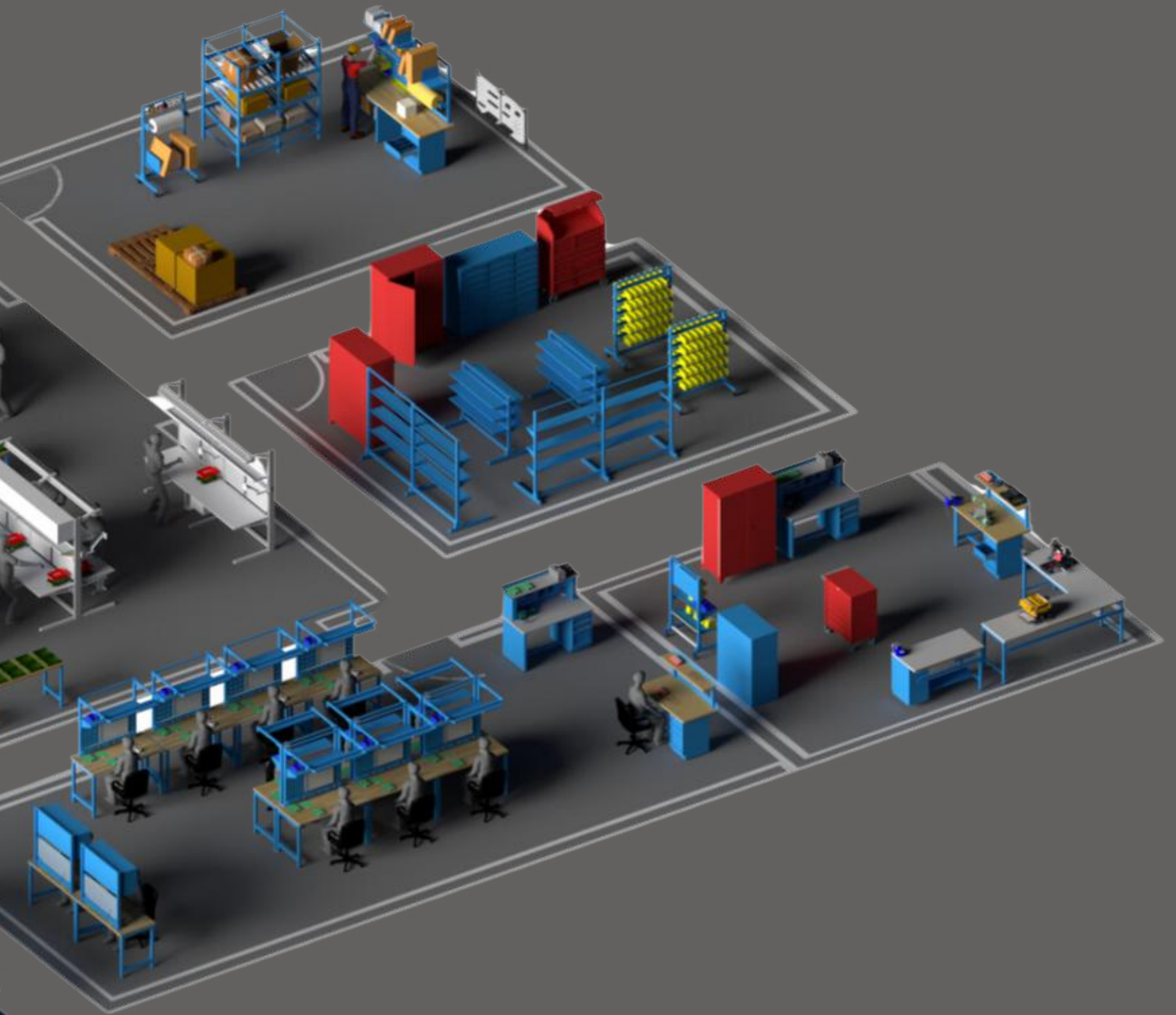

With Furnisys, you're not investing in products—you're investing in smarter, cohesive workspace solutions.

Our Systems Advantage:

At Furnisys, we specialize in delivering integrated systems designed to redefine manufacturing workspaces. Unlike standalone products, our systems are built from versatile components that work together seamlessly to create cohesive solutions. This approach ensures greater efficiency, adaptability, and long-term value.



Integration and Cohesion

Furnisys systems provide seamless integration of workspace, storage, and mobility, eliminating inefficiencies often caused by mismatched standalone products.

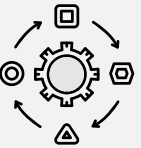

Flexibility and Adaptability

Our modular systems evolve with your production lines, allowing you to reconfigure setups as your needs change without requiring replacements.

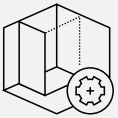

Space Optimization

Designed with efficient layouts and integrated storage, our systems maximize floor space, reducing clutter and improving accessibility.



Workflow Efficiency

By connecting workbenches, trolleys, flow racks, and cabinets, our systems streamline processes and minimize material handling time.



Alignment with Lean Principles

Furnisys systems support lean manufacturing by reducing waste, enhancing flow, and enabling continuous improvement (kaizen).



Cost Effectiveness

Unlike static product setups, our systems are scalable, minimizing costs over time by adapting to evolving operational demands.



Ergonomics and Operator Productivity

With user-friendly designs that enhance comfort and safety, our systems boost operator efficiency and reduce fatigue.



Durability and Longevity

Built with robust components, Furnisys systems ensure consistent performance in demanding manufacturing environments.



Aesthetic Uniformity

Our systems maintain a cohesive, professional appearance, enhancing the overall look of your facility.



Future-Ready Design

Furnisys systems adapt to new technologies and workflows, providing a workspace solution that grows with your business.



PRODUCTS

**WORK
SYSTEM**

Workbenches
Link System
Flexi System

11

**STORAGE
SYSTEM**

Base Cabinet
Tall Cabinet
Mobile Cabinet

17

WORKBENCHES

Furnisys offers a diverse range of workbenches designed to bring a perfect balance amongst environmental and operational within a manufacturing workspace. Each of these workbenches can be expanded and converted into a Work Station using the Link Uprighter System.

Base Series

All purpose workbench series designed to functionally serve your basic workspace needs.

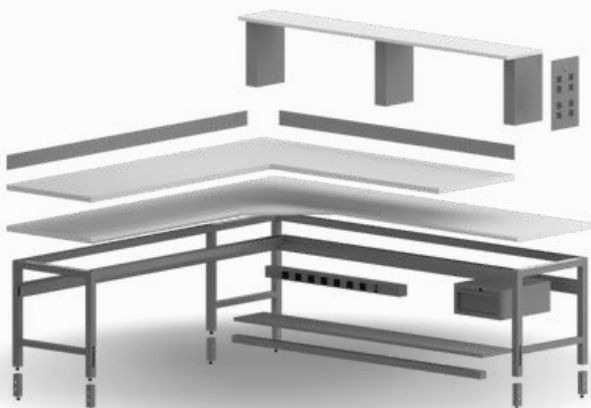

Scitec Series

An adaptable workbench series designed for diverse technical environment.

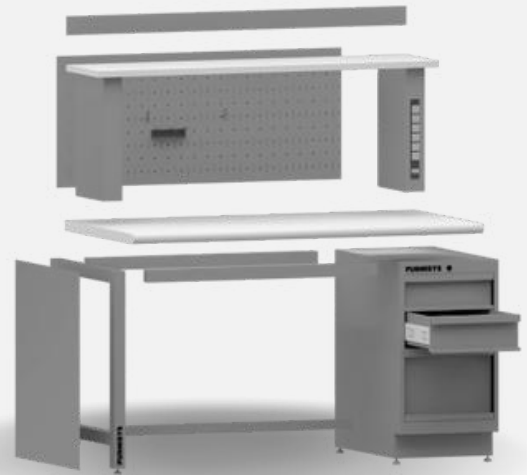

Pro Series

An industrial grade workbench series designed to withstand rough work environments.



LINK SYSTEM

A functional system consisting of uprighters, auxiliary workstands, ancillary trolleys, and flow racks. The uprighters are designed to integrate seamlessly with the Base, Pro, Scitec, and Pack Workbench Series, as well as any existing workbench at the buyer's end. The auxiliary stands, ancillary trolleys, and flow racks can be utilized independently or integrated with each other, providing enhanced flexibility and support for diverse operational needs.

Uprighter

Enhance the efficiency of any of our workbenches by integrating the link uprighter system with it. Link Uprighter can also be independently used by fixing it to a wall.

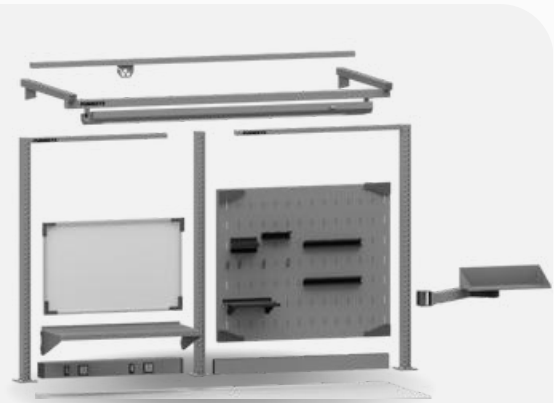

Work Stand

Seamlessly integrate it into your production, assembly, or repair workspace. It's the ideal solution for securely holding or transporting all your Work-in-Progress (WIP) inventory, including parts, tools, and equipment.

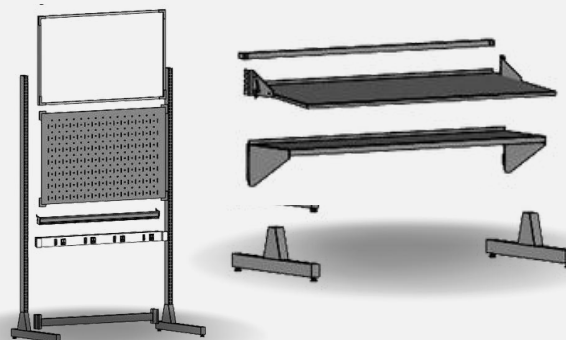

Trolley

A space-saving, cost-effective solution for efficient material transport. Its self-sufficient frame accommodates various accessories and a functional worksurface, maximizing utility while minimizing footprint.

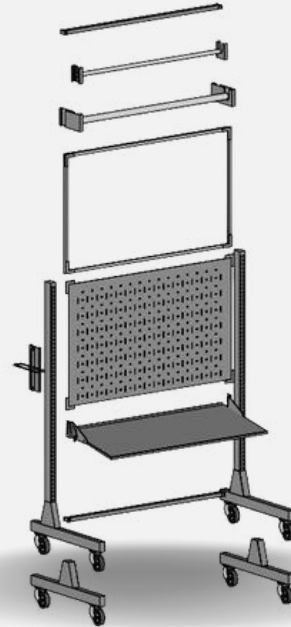
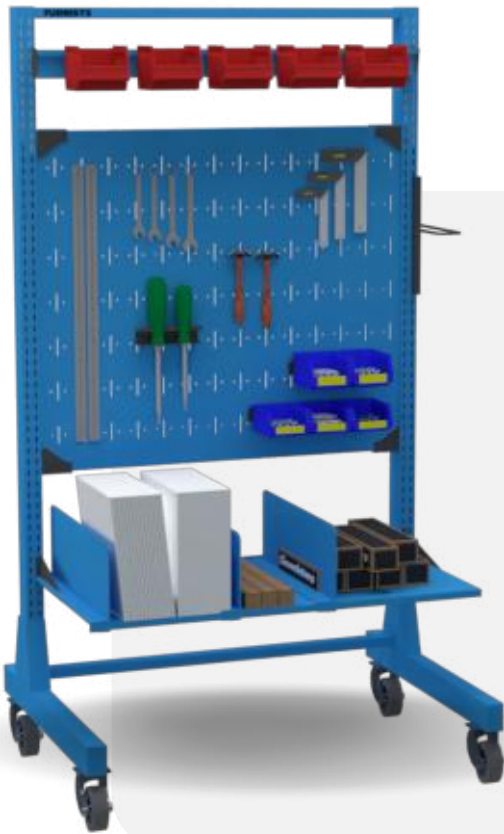

Flow Rack

Link Flow Racks is a functional material handling solution to feed parts for picking, kitting and assembly operations. Having a gravity based part feeding mechanism helps reduce the need for helpers.

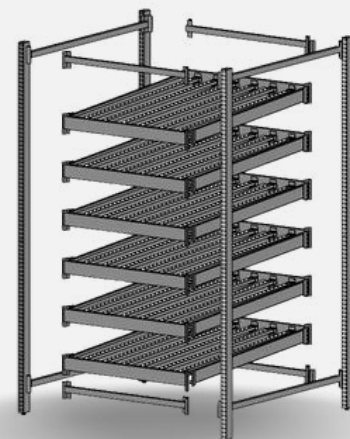

FLEXI SYSTEM

The most flexible independent work system, designed to seamlessly transition into various product ranges from Workbench, Carts to Flow Racks. Its unique micro and macro slot system enables maximum configurations and eases cross-product integration within its ecosystem.

Work Station

Flexi Workstations is our most flexible workstation series which can not only easily adapt to a user's present needs but also reconfigure to cater the user's future needs. The flexibility behind these workstations can help achieve the maximum productivity per square foot.

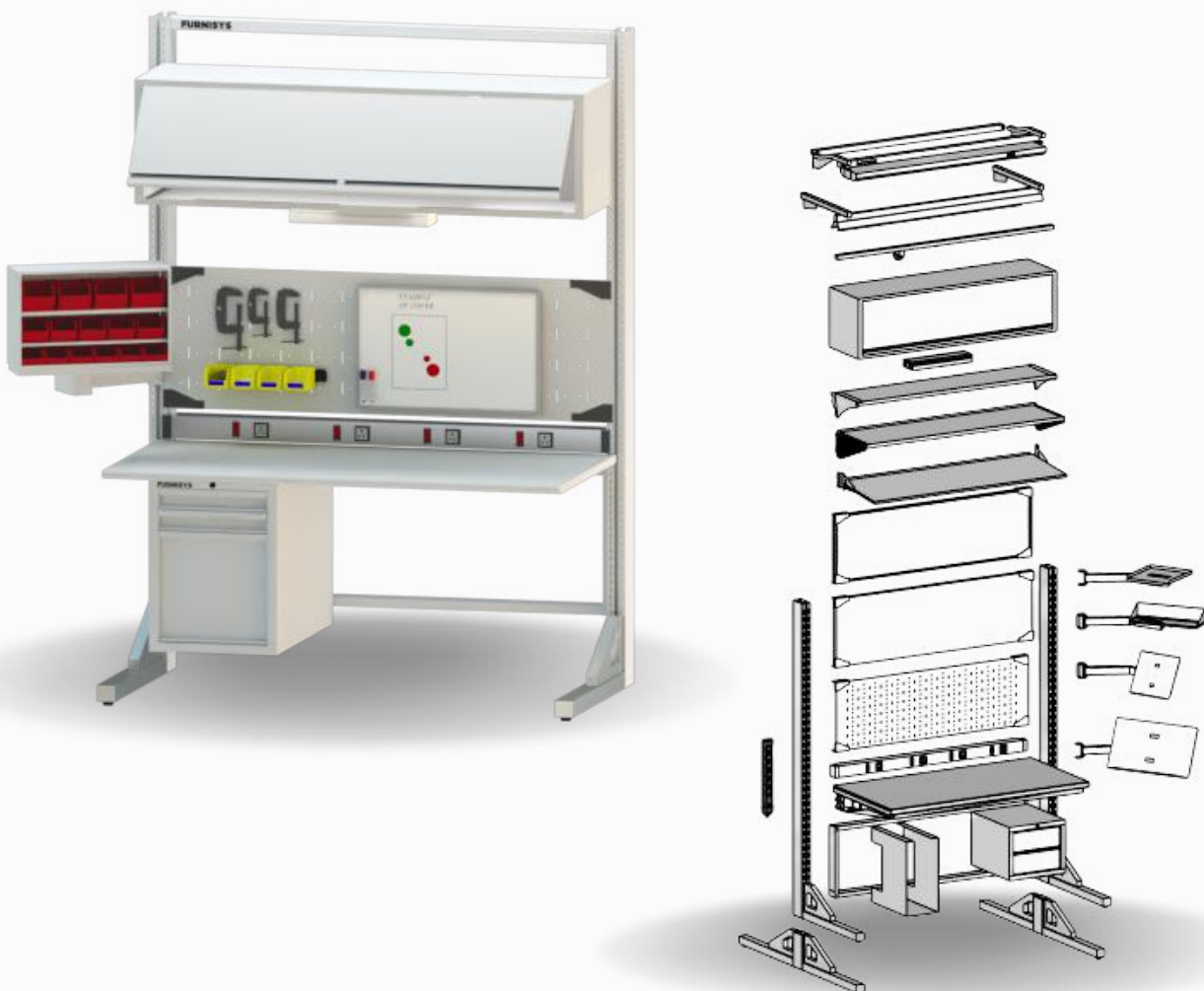

Universal Cart

Flexi Universal Cart flexible can be used for organizing, storing and moving part, tools and equipment around various departments. All of the accessories on the flexi workstations can be interchangeable with Flexi Universal Cart.



Flow Rack

Flow racks can be used to stage and deliver parts utilizing gravity, reducing material handling time and costs. Bins or totes are loaded on flow rack frames from the rear, and as operators remove one from the front, a new bin glides forward on rollers.



STORAGE SYSTEM

Furnisys cabinet range is designed to achieve complete organization of parts, tools and equipment. Our extensive range enables maximised use of the cubic capacity of the space.

Base Cabinet

Furnisys offers an extensive range of cabinets with multiple size and drawer options. Its heavy duty construction enables them to withstand heavy storage needs.

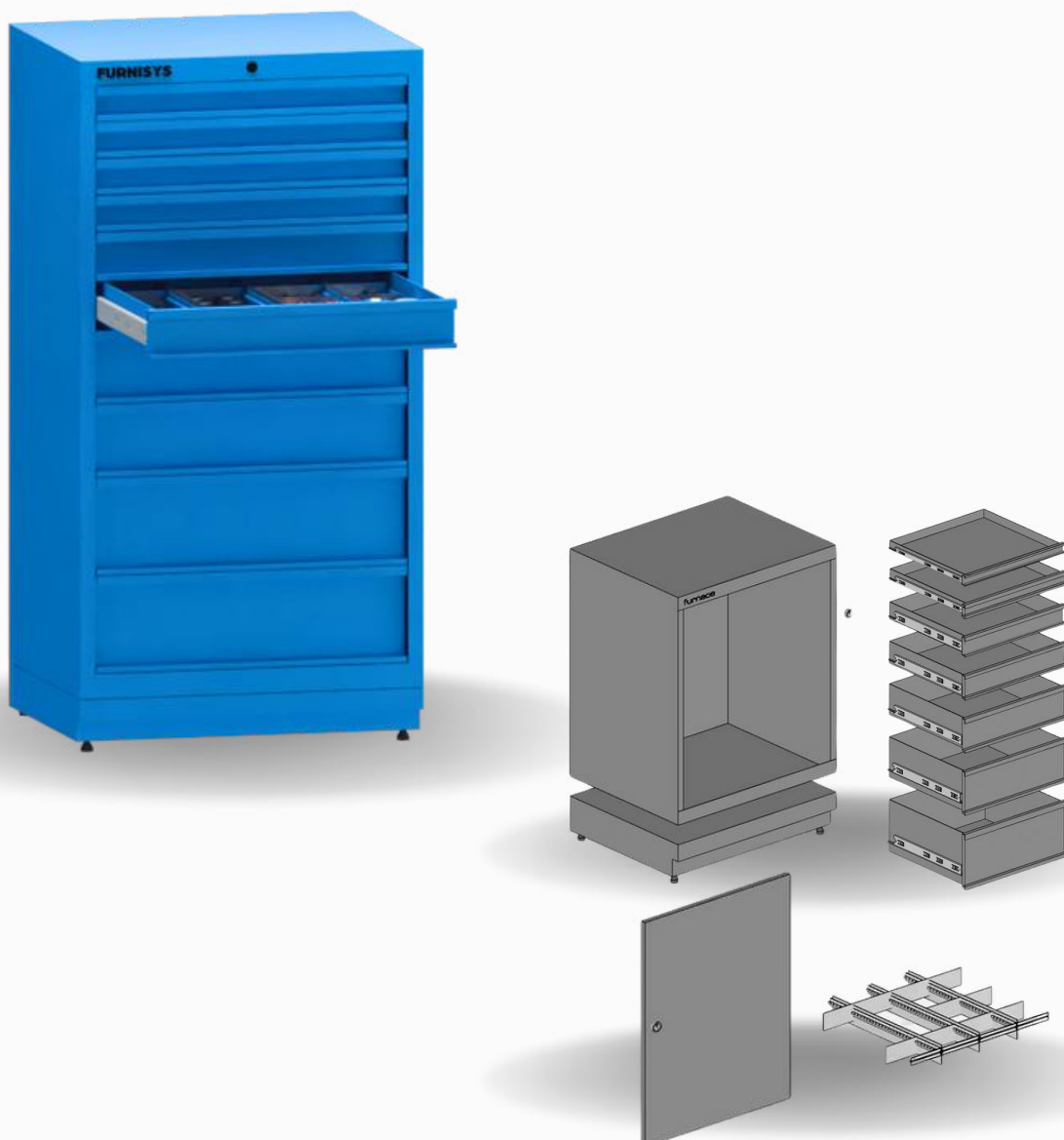



Tall Cabinet

Furnisys Tall Cabinet's robust welded construction and its versatile design are built to withstand rugged workspace demands.

Mobile Cabinet

Furnisys mobile cabinets can be used in cases when a workflow would require storage plus mobility.

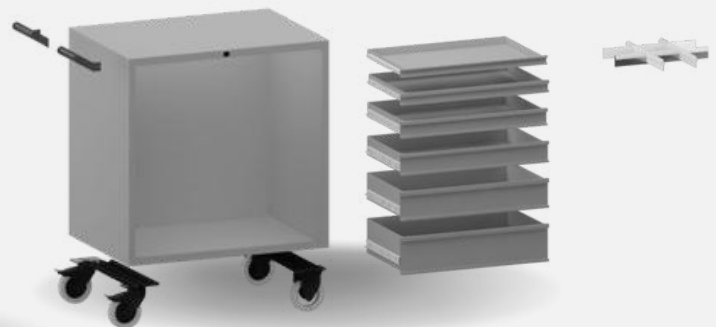

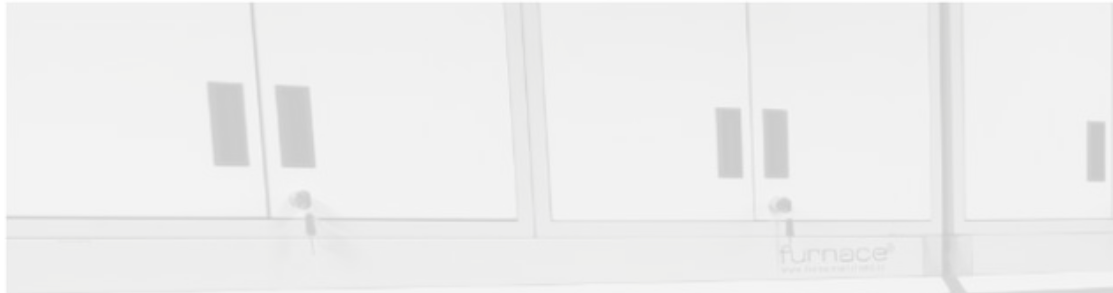

SERVICES







Consultation, Planning, and Visualization

Is your project complex or expansive? At Furnisys, we provide personalized consultations to understand your unique requirements. We analyze your operational needs and visualize your workspace solution using advanced planning tools, ensuring a tailored and efficient furniture system.



Installation

Furnisys solutions are installed on-site by skilled professionals. Our team ensures seamless assembly and can provide training to your employees if needed, guaranteeing smooth integration into your operations and long-term success in using our systems.



Post-Installation Support

Our commitment extends beyond installation. Furnisys provides continuous support to ensure your systems operate at their best. Whether it's troubleshooting, guidance, or advice, our experienced staff is always available to assist.



Spare Parts

Maintain the longevity of your Furnisys systems with original, high-quality replacement parts. We ensure easy access to spare components to keep your operations running smoothly.



Customer Support

For technical queries or operational advice, our dedicated customer support team is ready to help. Whether remotely or on-site, we provide expert assistance to ensure your workspace operates without disruptions.

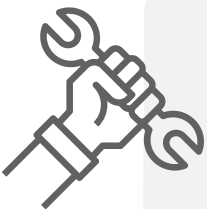

Repairs

If a repair is needed, Furnisys ensures your systems are back in operation quickly and efficiently. Our experts handle repairs with the utmost care to minimize downtime and maintain your workflow.



Resources

Furnisys empowers your team with a comprehensive range of resources, including brochures, catalogs, manuals, and guides. These tools provide detailed insights into our systems, helping you optimize their use and fully integrate them into your operations.



APPLICATION

INDUSTRIES

Electronic & Circuit Board
Assembly
Labs
Medical Manufacturing
Maintenance & Repair
Machining & Fabrication
Warehouses
Aerospace & Aviation

SPACE

Production
Assembly
Packaging
Maintenance
Store
QC & QA
R&D

CONCEPTS

Lean Thinking
Space Utilization
Ergonomics



Electronic Equipment

Application

PCB testing area for IoT-based Water Monitoring Solutions.

Problem Statement

The challenge was to create compact, modular workstations configured for an in-line layout to perform pre-test inspection, voltage testing, MSP and ADC testing, token generation, and real-time current testing of PCBs used in smart flow meters, while being easy to assemble and reconfigure as needed.

Solution

- Furnisys provided 5 Link Workstands, each with adjustable shelves, pegboards, ESD-protected work surfaces and accessories, and vertical power strips, tailored for PCB testing steps, from pre-test inspection to real-time current testing.
- The modular design allowed for easy assembly, space-efficient storage, and ergonomic optimization.
- This setup maximized workspace, reduced clutter, and ensured comfort during long testing hours, offering a cost-effective solution compared to pre-built systems.



Oil & Gas Equipment & Services

Application

Research & Development Laboratory -

- Rubber and metal testing area PCB Testing Area.

Problem Statement

- Need for durable, stable workstations for heavy equipment (ovens, UTM machines), ergonomic layouts for safety and efficiency, ample storage, and specialized surfaces for testing.
- ESD-safe workstations to protect sensitive PCBs and versatile setups for varied testing tools.

Solution

- Rubber & Metal Testing Area:

Pro Workbenches with HPL and SSW Worktops were provided for equipment like FTIR spectrometer, DSC, UTM, and TGA, complemented by integrated storage units for organization. Double-sided Flexi Workstations to enable team collaboration and documentation.

- PCB Testing Area:

Scitec Workstations with ESD accessories and custom setups for furnaces, climate chambers, and soldering tools ensured electrostatic protection and versatility.



Automotive Components

Application

The client required five task-specific workstations for their R&D lab to organize tire samples, handle electronic components safely, and prepare sections for testing, with modular, ergonomic, and efficient setups.

Problem Statement

- Tire samples (~1 kg, 6" width) required secure hanging and inspection.
- ESD-safe stations were critical for handling electronic components.
- Workstations needed task-specific functionality, space efficiency, and adaptability.

Solution

- Tire Inspection: Pegboards with hooks, magnifying lamps, and digital calipers for secure hanging and precise dimensional analysis.
- Material Testing: Integrated FTIR, DSC, and TGA systems for analyzing rubber properties with organized storage for tools and consumables.
- Section Preparation: Heavy-duty tools like rotary cutters, impact wrenches, and bench vises for efficient tire sectioning.
- Dimensional Analysis: Digital gauges, barcode systems, and monitors for detailed measurements and streamlined documentation.

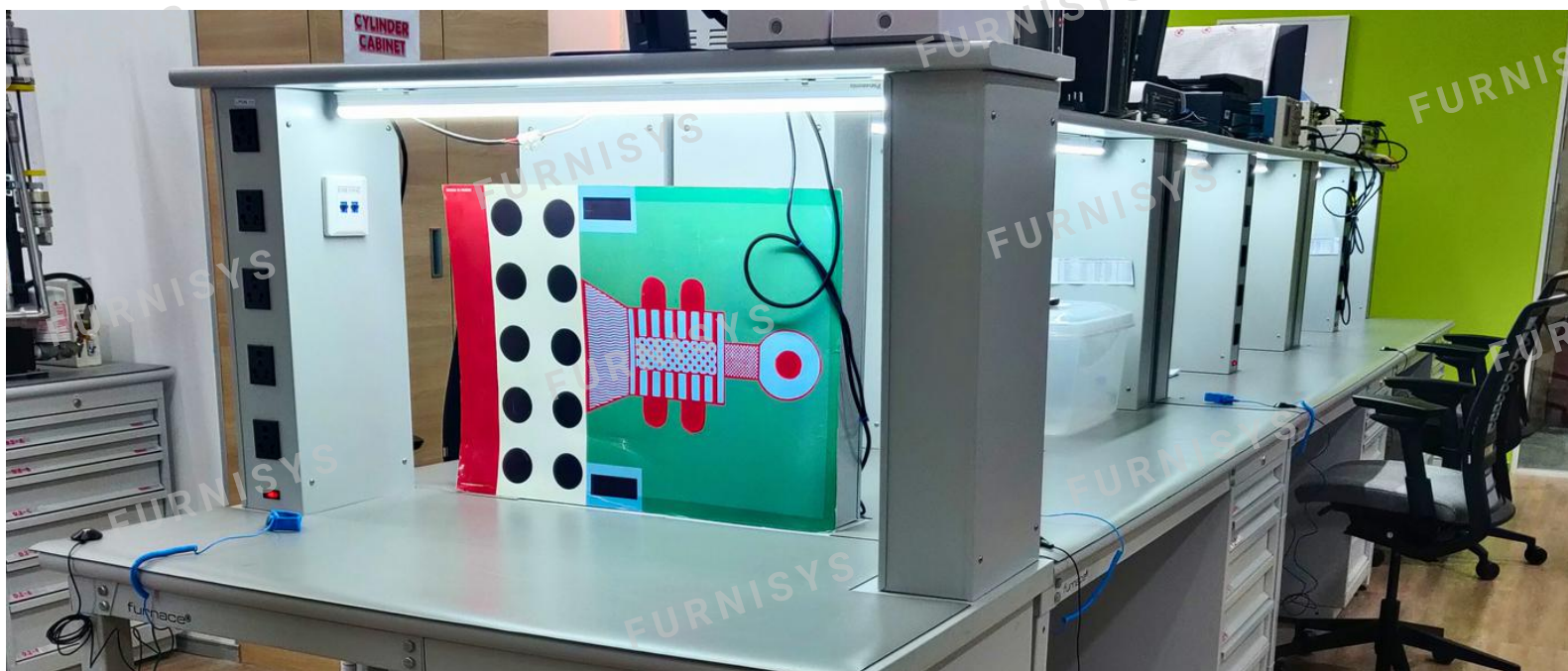

Healthcare

Application

Testing high-value medical devices like joint replacement systems, arthroscopy tools, and advanced wound care equipment in a controlled lab environment.

Problem Statement

The client required ESD-safe furniture adhering to international standards to support high-value medical equipment testing, while ensuring an optimized layout for workflow efficiency and seamless integration within spatial constraints..

Solution

- Scitec Workstations (7 units): Equipped with instrument riser shelves, ESD protection, base cabinets, and power supplies for efficient testing of imaging systems and circuit boards.
- Scitec Workbenches (4 units): Tailored for hydraulic testing, inspection, and assembly, featuring robust surfaces, organized storage, and adaptable configurations for seamless workflow.



Industrial Machinery & Equipments

Application

Repair & Maintenance in the RAC manufacturing plant.

Problem Statement

The challenge was to design a cabinet that could accommodate diverse tools while ensuring mobility, ergonomic handling, and quick accessibility during critical maintenance tasks.

Solution

Furnisys delivered a custom-configured MS mobile cabinet with:

- 7-drawer layout: Tailored for specific tool types, accommodating hand tools, diagnostic equipment, and bulky items.
- Optimized organization: Categorized storage with dividers for neat and efficient access.
- Ergonomic mobility: Balanced design for easy movement and tool retrieval.



Food & Beverages

Application

modular workstation for packaging and billing tasks, with an adaptable layout to optimize workspace efficiency and support future scaling.

Problem Statement

- Needed organized storage for tools, consumables, and electronic devices.
- Required a flexible design to accommodate varied workflows and future growth.
- Prioritized ergonomic and efficient packaging and billing operations.

Solution

Furnisys provided a custom Flexi Workstation tailored for efficient packaging and billing. Key features:

- Organized Storage: Adjustable shelves, trays, and utility bins for tea packets, tools, and consumables.
- Integrated Tools: Power rail, weighing scale, barcode scanner, and printer for seamless operations.
- Flexible Design: Modular layout options (U-shaped, in-line) with easy future scalability.



Automotive Components

Application

Streamlined packaging operations for bearings and power transmission products, involving tasks like weighing, sealing, and organizing materials such as cartons, stretch film, and labeling accessories.

Problem Statement

The client faced challenges in selecting the right workstation configuration during a warehouse expansion. They needed an efficient, scalable solution to support increased packaging operations while maintaining lean manufacturing principles.

Solution

- Scitec Workbench with GI+Wood Worktop: Sturdy surface for tasks like weighing and sealing.
- Organized Storage: Under-worktop shelves with dividers for cartons and packaging materials.
- Link Uprighter Accessories:
 - Whiteboard for SOPs, Adjustable Shelf for tools like scissors and tape dispensers.
 - Power Rail for packaging equipment, Lighting for better visibility.
- Pallets: For stacking packaged boxes.

The setup of 8 workstations boosted efficiency, scalability, and lean manufacturing adherence.



Automotive Components (Mechatronics)

Application

Efficient storage of small yet critical components such as sensors, PCBs, actuators, wiring, and switches in the client's manufacturing facility.

Problem Statement

The client faced high transportation costs and delays with their existing storage vendor located far away. They required a tailored, cost-effective solution to organize and protect delicate components while allowing easy access and scalability.

Solution

We delivered a 9-drawer modular base cabinet with:

- 50 Adjustable Compartments: For organized storage and future scalability.
- Custom Partitions: Segregating diverse components for easy identification.
- Robust Build: Ensuring safe storage and protection of sensitive parts.



Electrical Equipment Manufacturing

Application

Supporting assembly, testing, and quality control in an electric vehicle charging station R&D lab for 12 users.

Problem Statement

The client required adaptable, modular furniture with integrated storage and ESD features to optimize the R&D lab while maintaining safety and functionality.

Solution

- Flexi Workstations: Modular back-to-back configuration for 12 users, with starter-adder setup.
- ESD Protection: ESD mats, wrist straps, and grounding blocks to safeguard sensitive electronics.
- Storage & Organization: Hanging drawers for tools, pegboard for accessories, and adjustable shelves for testing equipment.
- Power & Lighting: Fixed tube light and horizontal power rail for visibility and easy access to electricity.
- Workstation Features: Whiteboard for instructions and collaboration, organized storage for tools, testers, and fasteners.

This setup enabled efficient use of space, flexibility for future expansion, and enhanced safety for delicate electronic components.



Industrial Equipment & safety system Manufacturing

Application

Supporting hands-on training for assembly, testing, and quality control of Flame Arresters and Breather Valves in a new Sales Office and Training Academy.

Problem Statement

The client sought adaptable, high-quality, and aesthetically pleasing assembly tables that would support dynamic training sessions, offering both functionality and design appeal.

Solution

- Scitec Workstation: Modular setup with a Link Uprighter, pegboard, adjustable shelf, and task light for efficient tool organization.
- Mobile Cabinets: Two cabinets for flexible storage of tools, spare parts, and training materials.
- Power & Lighting: Integrated power rail and lighting for smooth operations.
- This setup optimized space, improved organization, and enhanced hands-on training efficiency.



Textile & Apparel

Application

Optimizing the storage and kitting process for raw materials in a lean workspace, supporting efficient operations in departments for casual, formal, and kitting/issuing workflows.

Problem Statement

Inefficient raw material supply due to unorganized storage areas led to time-consuming and labor-intensive operations, making material location difficult despite departmental segregation.

Solution

- Flow Racks (FIFO): Streamlined storage for fabrics, buttons, collar bones, and labels, ensuring easy access and organization.
- Link Workstations: Centralized kitting and issuing operations with features like laminated wood tops, bin rails, and integrated lighting.
- Starter-Adder System: Modular racks enabled cost-effective storage and easy scalability for future needs.
- Space Planning: Optimized layouts with 3D visualizations for lean workspace transformation.
- This tailored solution simplified workflows, saved time, and improved operational efficiency, creating a well-organized storage and kitting area.



Jeweler

Application

Efficient assembly, packaging, and storage of jewelry and watch accessories such as necklaces, bracelets, rings, earrings, and charms.

Problem Statement

The client needed to expand their facility to meet growing jewelry demand. They required scalable furniture for jewelry assembly, packaging, and efficient material storage. The solution needed to support multiple employees working collaboratively while optimizing space for kitting and future workforce growth.

Solution

- Flexi Workstations (2 Units)
Integrated whiteboard for task tracking, tool shelves, overhead storage for packaging, and an inline layout for streamlined workflow and collaboration.
- Flexi Universal Carts (3 Units)
Adjustable shelves organized materials, with a worktop cart for sorting, assembly, and quality checks.
- Scalable Reconfiguration
Adapted existing Flexi Workstations into a back-to-back layout to accommodate 10 employees. Achieved scalability with minimal investment using the existing setup.



Textile

Application

Repair and maintenance operations for jute machinery and production equipment.

Problem Statement

The client needed durable, high-quality tool cabinets to enhance organization and accessibility of tools and components. Existing cabinets lacked the required flexibility and storage efficiency for diverse mechanical and electrical tasks.

Solution

We provided custom tool cabinets with:

- Compartmentalized Drawers: For tools like spanners, Allen keys, screwdrivers, and wrenches.
- Precision Tools: Storage for calipers and micrometers.
- Electrical Tools: Space for multimeters and insulation testers.
- Consumables Storage: Dedicated compartments for lubricants, spare parts, and cleaning materials.

This optimized setup streamlined repair operations, improved workspace efficiency, and met diverse maintenance requirements.

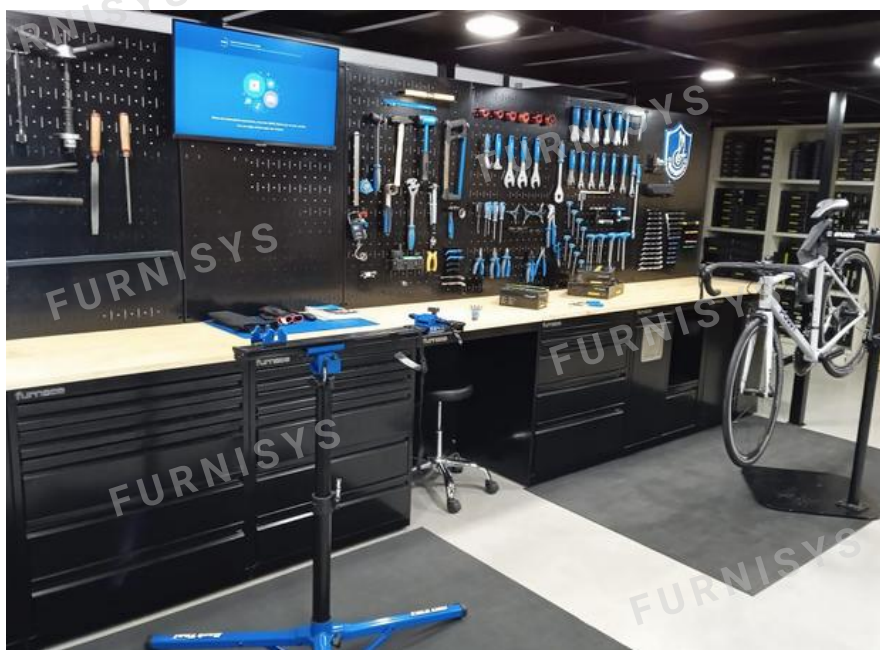

Bicycle

Application

Assembly, repair, and maintenance of premium bicycles, accessories, and spare parts.

Problem Statement

The client needed durable workbenches for bicycle assembly and repair but faced challenges with overseas vendors' long lead times and poor servicing. Local vendors failed to meet quality and service expectations, prompting the search for a reliable, efficient solution.

Solution

- Assembly Area: Pro Workstations with Base Cabinets and Link Uprighters were provided for tool organization, efficient storage of bike parts, and streamlined workflows.
- Repair Area: Workstations with essential tools and ample storage for spare parts and consumables enabled quick and organized bicycle maintenance.
- This setup improved operational efficiency and ensured a professional, well-organized workspace.



E-waste Recycling

Application

Disassembly area for electronic waste recycling.

Problem Statement

Micro-entrepreneurs in e-waste recycling lacked access to professional workspaces, adequate resources, and scalable furniture solutions. The Client sought a partner capable of delivering high-quality, configurable furniture tailored to their vision but faced challenges with unprofessional and unsatisfactory local vendors.

Solution

- Furnisys provided 32 Base Workbenches and Link Workstands with shelves, horizontal power rails, and integrated tools like screwdrivers, pliers, and safety gear. This setup ensured efficient dismantling of electronics and organized storage of components.
- The solution aligned with the Client's vision, empowering micro-entrepreneurs, promoting sustainability, and advancing the circular economy.

CLIENTELE

adani™



Smith+Nephew

SHIMANO®



LIEBHERR



KOHLER®



Dräger



KOHLI





Fabtech India, EL-21 TTC Industrial

Area, Mahape,

Navi Mumbai - 400 710

+ 91 7045763012

enquiry@furnisys.co

www.furnisys.co

FURNISYS /   

