





ARMATURDETALJER  
MÄSSING

.01

3-FAS SKENOR	<b>04</b>
3-FAS SKENOR MED DALI	<b>10</b>
TILLBEHÖR	<b>20</b>
ADAPTRAR FÖR ARMATURER	<b>26</b>
TEKNISKA SPECIFIKATIONER	<b>40</b>

Is a strong global brand in tailor made lighting track systems and universal adapters for the professional lighting market. Powergear offers a high quality 3 circuit (3-phase) lighting track system which is fully compatible with 3-phase adapters of all major brands. The comprehensive range of innovative accessories – like the twisted L and T connectors – gives the designer maximum freedom to create the ultimate track plan. To guarantee cost-effectiveness and flexibility, we make use of our own manufacturing facilities with our products being produced under certified ISO9001 and ISO14001 regulations and ENEC, CE and UL labels which are relevant for the European and/ or US market.

**Customer service**

From our European head office for sales, service and distribution we offer swift and efficient deliveries and strive to provide the highest level of customer service possible. The growing Powergear distribution centre network ensures availability throughout all European countries, making Powergear the winning brand in Lighting Track.

**Flexible solutions**

Due to our strong customer focus, Powergear is willing and able to offer flexible opportunities to fulfill the specific needs of a customer. From a fully customized product to our standard product and every step in between is part of the Powergear offer and service. This means that Powergear can offer a solution in own Förpackning or label of the customer, but also a complete private label concept. In general it means that we walk the extra mile to satisfy our customer.



*Maximum freedom to create  
your ultimate trackplan*

## 3-CIRCUIT TRACK SYSTEM

Powergear's high quality 3-circuit track system for the professional lighting market is suitable for track lights with 3-circuit adapters of all major brands.

A comprehensive range of innovative accessories give designers maximum freedom to create unique track plans. For both surface mounted and recessed 3-circuit track the same accessories can be used. The unique Powergear Twisted L and T connectors enable a quick and easy installation with less items to take care of.

Powergear track can be easily shortened and is immediately ready to install as there is no need to adjust wires. The "EZCLICK" mounting features make the track system quick and easy to install.

A new, innovative and competitive range of Powergear Ultimate adapters is at your disposal. As the LED driver is concealed in the adapter you can continue to miniaturize your track lights.

To make your 3-circuit system Bluetooth controllable, Powergear offers Ultimate adapters with Casambi technology.



SURFACE MOUNTED

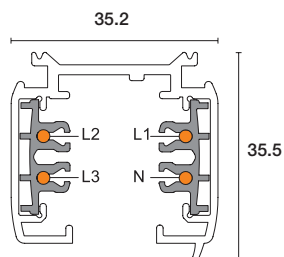

RECESSED

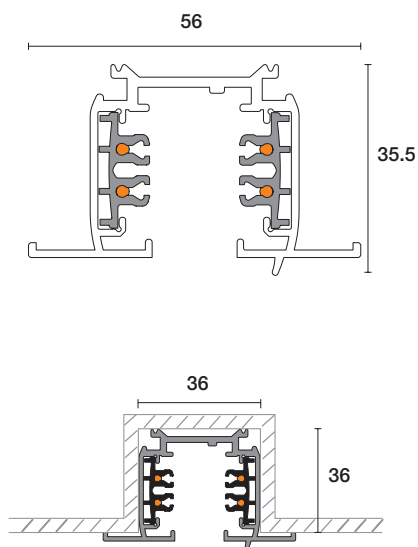

### 3-FAS SKENA - UTANPÅLIGGANDE

Artikelnummer	Längd	Färg	Förpackning
26-20001	1000mm	□ Vit	1 / 6
26-20002	1000mm	■ Grå	1 / 6
26-20003	1000mm	■ Skena	1 / 6
26-20004	2000mm	□ Vit	1 / 6
26-20005	2000mm	■ Grå	1 / 6
26-20006	2000mm	■ Skena	1 / 6
26-20007	3000mm	□ Vit	1 / 6
26-20008	3000mm	■ Grå	1 / 6
26-20009	3000mm	■ Skena	1 / 6

### 3-FAS SKENA INFÄLLD

Artikelnummer	Längd	Färg	Förpackning
26-20010	1000mm	□ Vit	1 / 4
26-20011	1000mm	■ Grå	1 / 4
26-20012	1000mm	■ Skena	1 / 4
26-20013	2000mm	□ Vit	1 / 4
26-20014	2000mm	■ Grå	1 / 4
26-20015	2000mm	■ Skena	1 / 4
26-20016	3000mm	□ Vit	1 / 4
26-20017	3000mm	■ Grå	1 / 4
26-20018	3000mm	■ Skena	1 / 4

NÄTANSLUTNING VÄNSTER



Artikelnummer	Färg
PRO-0431 L-W	<input type="checkbox"/> Vit
PRO-0431 L-S	<input checked="" type="checkbox"/> Grå
PRO-0431 L-B	<input checked="" type="checkbox"/> Skena



NÄTANSLUTNING HÖGER



Artikelnummer	Färg
PRO-0431 R-W	<input type="checkbox"/> Vit
PRO-0431 R-S	<input checked="" type="checkbox"/> Grå
PRO-0431 R-B	<input checked="" type="checkbox"/> Skena



RAKSKARV



Artikelnummer	Färg
PRO-0433-W	<input type="checkbox"/> Vit
PRO-0433-S	<input checked="" type="checkbox"/> Grå
PRO-0433-B	<input checked="" type="checkbox"/> Skena



RAKSKARV (MEKANISK)



Artikelnummer	Färg
PRO-0433A-W	<input type="checkbox"/> Vit
PRO-0433A-S	<input checked="" type="checkbox"/> Grå
PRO-0433A-B	<input checked="" type="checkbox"/> Skena



MITTANSLUTNING



Artikelnummer	Färg
PRO-0434-W	<input type="checkbox"/> Vit
PRO-0434-S	<input checked="" type="checkbox"/> Grå
PRO-0434-B	<input checked="" type="checkbox"/> Skena



ÄNDSTYCKE



Artikelnummer	Färg
PRO-0432-W	<input type="checkbox"/> Vit
PRO-0432-S	<input checked="" type="checkbox"/> Grå
PRO-0432-B	<input checked="" type="checkbox"/> Skena



FLEX-SKARV



Artikelnummer	Färg
PRO-0439-W	<input type="checkbox"/> Vit
PRO-0439-S	<input checked="" type="checkbox"/> Grå
PRO-0439-B	<input checked="" type="checkbox"/> Skena



VRID-SKARV



Artikelnummer	Färg
PRO-M435-W	<input type="checkbox"/> Vit
PRO-M435-S	<input checked="" type="checkbox"/> Grå
PRO-M435-B	<input checked="" type="checkbox"/> Skena



X-SKARV



Artikelnummer	Färg
PRO-0437-W	<input type="checkbox"/> Vit
PRO-0437-S	<input checked="" type="checkbox"/> Grå
PRO-0437-B	<input checked="" type="checkbox"/> Skena





# TWISTED T AND L CONNECTORS

Powergear Twisted T (and L) connectors enable maximum flexibility to create the ultimate trackplan with less connectors to use. And give the installer the freedom to change on the work spot. Simply unscrew the cover plate and change L1 into L2 or R1 into R2.

## TWISTED T CONNECTOR

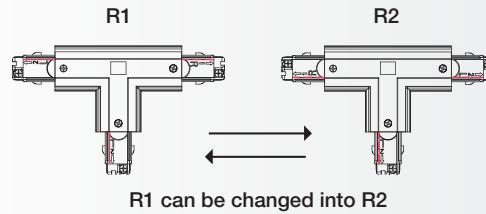
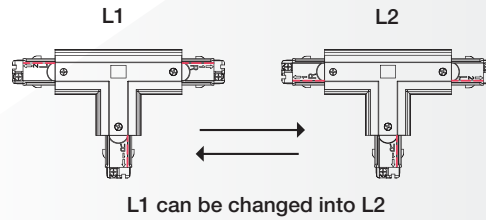
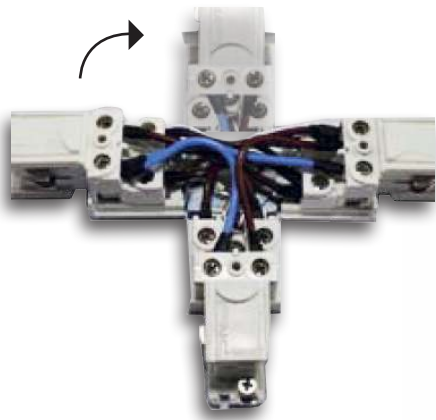

## TWISTED L CONNECTOR

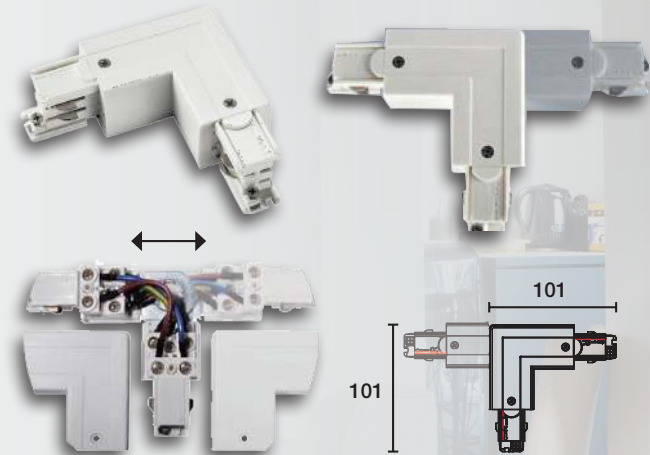

### TWISTED L CONNECTOR (L AND R)

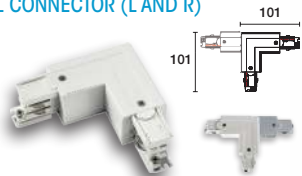

Artikelnummer	EAN	Färg	Förpackning
PRO-M438-W	8719747930663	Vit	18 / 108
PRO-M438-S	8719747930670	Grå	18 / 108
PRO-M438-B	8719747930687	Skena	18 / 108



### TWISTED T CONNECTOR L1 -> L2

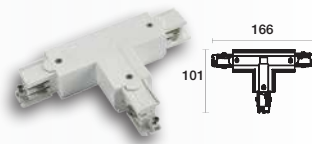

Artikelnummer	EAN	Färg	Förpackning
PRO-M436L-W	8719747930694	Vit	12 / 72
PRO-M436L-S	8719747930700	Grå	12 / 72
PRO-M436L-B	8719747930717	Skena	12 / 72



### TWISTED T CONNECTOR R1 -> R2

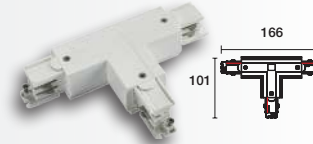

Artikelnummer	EAN	Färg	Förpackning
PRO-M436R-W	871974790724	Vit	12 / 72
PRO-M436R-S	871974790731	Grå	12 / 72
PRO-M436R-B	871974790748	Skena	12 / 72



## L CONNECTOR LEFT



Artikelnummer	EAN	Färg	Förpackning
PRO-0435 L-W	8719747930397	Vit	18 / 108
PRO-0435 L-S	8719747930403	Grå	18 / 108
PRO-0435 L-B	8719747930410	Skena	18 / 108



## L CONNECTOR RIGHT



Artikelnummer	EAN	Färg	Förpackning
PRO-0435 R-W	8719747930427	Vit	8 / 160
PRO-0435 R-S	8719747930434	Grå	8 / 160
PRO-0435 R-B	8719747930441	Skena	8 / 160



## T CONNECTOR LEFT1

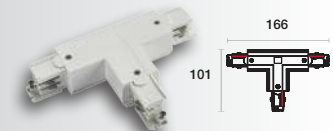

Artikelnummer	EAN	Färg	Förpackning
PRO-0436 L1-W	8719747930458	Vit	12 / 72
PRO-0436 L1-S	8719747930465	Grå	12 / 72
PRO-0436 L1-B	8719747930472	Skena	12 / 72



## T CONNECTOR LEFT2



Artikelnummer	EAN	Färg	Förpackning
PRO-0436 L2-W	8719747930489	Vit	12 / 72
PRO-0436 L2-S	8719747930496	Grå	12 / 72
PRO-0436 L2-B	8719747930502	Skena	12 / 72



## T CONNECTOR RIGHT1



Artikelnummer	EAN	Färg	Förpackning
PRO-0436 R1-W	8719747930519	Vit	12 / 72
PRO-0436 R1-S	8719747930526	Grå	12 / 72
PRO-0436 R1-B	8719747930533	Skena	12 / 72



## T CONNECTOR RIGHT2



Artikelnummer	EAN	Färg	Förpackning
PRO-0436 R2-W	8719747930540	Vit	12 / 72
PRO-0436 R2-S	8719747930557	Grå	12 / 72
PRO-0436 R2-B	8719747930564	Skena	12 / 72



## X CONNECTOR COVER



Artikelnummer	EAN	Färg	Förpackning
PRO-R437-W	8719747931226	Vit	80 / 480
PRO-R437-S	8719747931233	Grå	80 / 480
PRO-R437-B	8719747931240	Skena	80 / 480



## MIDDLE CONNECTOR COVER



Artikelnummer	EAN	Färg	Förpackning
PRO-R434-W	8719747931134	Vit	40 / 480
PRO-R434-S	8719747931141	Grå	40 / 480
PRO-R434-B	8719747931158	Skena	40 / 480



## L CONNECTOR COVER



Artikelnummer	EAN	Färg	Förpackning
PRO-R435-W	8719747931165	Vit	25 / 500
PRO-R435-S	8719747931172	Grå	25 / 500
PRO-R435-B	8719747931189	Skena	25 / 500



## CONNECTOR COVER



Artikelnummer	EAN	Färg	Förpackning
PRO-R431-W	8719747931103	Vit	25 / 500
PRO-R431-S	8719747931110	Grå	25 / 500
PRO-R431-B	8719747931127	Skena	25 / 500



## T CONNECTOR COVER



Artikelnummer	EAN	Färg	Förpackning
PRO-R436-W	8719747931196	Vit	30 / 360
PRO-R436-S	8719747931202	Grå	30 / 360
PRO-R436-B	8719747931219	Skena	30 / 360



*Make your Powergear lighting track  
a smart Dali system*







# SMART 3-CIRCUIT DALI TRACK SYSTEM

Powergear's high quality DALI 3-circuit track system for the professional lighting market is suitable for track lights with Powergear 3-circuit DALI adapters.

A comprehensive range of innovative DALI accessories give designers maximum freedom to create unique and smart track plans. The DALI accessories can be used for both surface mounted and recessed 3-phase DALI track.

Powergear DALI track can be easily shortened and is immediately ready to install as there is no need to adjust wires. The "EZCLICK" mounting features make the track system quick and easy to install.

A new, innovative and competitive range of Powergear Ultimate DALI adapters is at your disposal. As the DALI LED driver is concealed in the adapter you can continue to miniaturize your track lights.

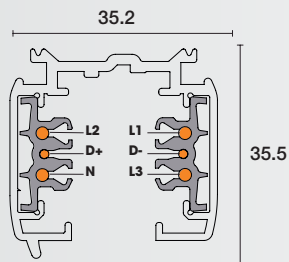

SURFACE MOUNTED

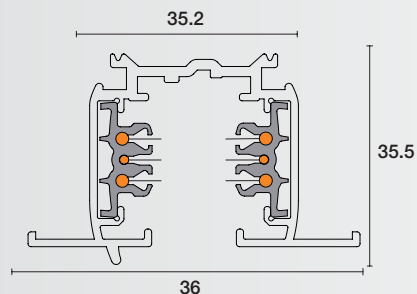

RECESSED

More technical details on page 41.

## 3-CIRCUIT DALI SURFACE MOUNTED TRACK SYSTEM

Artikelnummer	EAN	Beskrivning	Färg	Förpackning
PRO-0610-W	8719747931257	1 M DALI track (1000mm)	□ Vit	1 / 6
PRO-0610-S	8719747931264	1 M DALI track (1000mm)	■ Grå	1 / 6
PRO-0610-B	8719747931271	1 M DALI track (1000mm)	■ Skena	1 / 6
PRO-0620-W	8719747931288	2 M DALI track (2000mm)	□ Vit	1 / 6
PRO-0620-S	8719747931295	2 M DALI track (2000mm)	■ Grå	1 / 6
PRO-0620-B	8719747931301	2 M DALI track (2000mm)	■ Skena	1 / 6
PRO-0630-W	8719747931318	3 M DALI track (3000mm)	□ Vit	1 / 6
PRO-0630-S	8719747931325	3 M DALI track (3000mm)	■ Grå	1 / 6
PRO-0630-B	8719747931332	3 M DALI track (3000mm)	■ Skena	1 / 6
PRO-0640-W	on request	4 M DALI track (4000mm)	□ Vit	1 / 6
PRO-0640-S	on request	4 M DALI track (4000mm)	■ Grå	1 / 6
PRO-0640-B	on request	4 M DALI track (4000mm)	■ Skena	1 / 6

## 3-CIRCUIT DALI RECESSED TRACK SYSTEM

Artikelnummer	EAN	Beskrivning	Färg	Förpackning
PRO-R610-W	8719747931738	1 M DALI track (1000mm) recessed	□ Vit	1 / 4
PRO-R610-S	8719747931745	1 M DALI track (1000mm) recessed	■ Grå	1 / 4
PRO-R610-B	8719747931752	1 M DALI track (1000mm) recessed	■ Skena	1 / 4
PRO-R620-W	8719747931769	2 M DALI track (2000mm) recessed	□ Vit	1 / 4
PRO-R620-S	8719747931776	2 M DALI track (2000mm) recessed	■ Grå	1 / 4
PRO-R620-B	8719747931783	2 M DALI track (2000mm) recessed	■ Skena	1 / 4
PRO-R630-W	8719747931790	3 M DALI track (3000mm) recessed	□ Vit	1 / 4
PRO-R630-S	8719747931806	3 M DALI track (3000mm) recessed	■ Grå	1 / 4
PRO-R630-B	8719747931813	3 M DALI track (3000mm) recessed	■ Skena	1 / 4
PRO-R640-W	on request	4 M DALI track (4000mm)	□ Vit	1 / 4
PRO-R640-S	on request	4 M DALI track (4000mm)	■ Grå	1 / 6
PRO-R640-B	on request	4 M DALI track (4000mm)	■ Skena	1 / 6

CONNECTOR LEFT DALI 3-CIRCUIT



Artikelnummer	EAN	Färg	Förpackning
PRO-D631 L-W	8719747931370	□ Vit	10 / 120
PRO-D631 L-S	8719747931387	■ Grå	10 / 120
PRO-D631 L-B	8719747931394	■ Skenå	10 / 120



CONNECTOR RIGHT DALI 3-CIRCUIT



Artikelnummer	EAN	Färg	Förpackning
PRO-D631 R-W	8719747931400	□ Vit	10 / 120
PRO-D631 R-S	8719747931417	■ Grå	10 / 120
PRO-D631 R-B	8719747931424	■ Skenå	10 / 120



COUPLER DALI 3-CIRCUIT

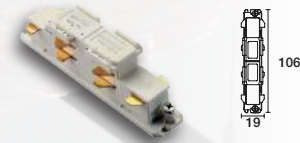

Artikelnummer	EAN	Färg	Förpackning
PRO-D633-W	8719747931431	□ Vit	10 / 180
PRO-D633-S	8719747931448	■ Grå	10 / 180
PRO-D633-B	8719747931455	■ Skenå	10 / 180



MIDDLE CONNECTOR DALI 3-CIRCUIT



Artikelnummer	EAN	Färg	Förpackning
PRO-D634-W	8719747931462	□ Vit	10 / 120
PRO-D634-S	8719747931479	■ Grå	10 / 120
PRO-D634-B	8719747931486	■ Skenå	10 / 120



END CAP

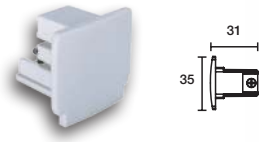

Artikelnummer	EAN	Färg	Förpackning
PRO-0432-W	8719747930274	□ Vit	15 / 300
PRO-0432-S	8719747930281	■ Grå	15 / 300
PRO-0432-B	8719747930298	■ Skenå	15 / 300



FLEXIBLE CONNECTOR DALI 3-CIRCUIT



Artikelnummer	EAN	Färg	Förpackning
PRO-D639-W	8719747931554	□ Vit	12 / 60
PRO-D639-S	8719747931561	■ Grå	12 / 60
PRO-D639-B	8719747931578	■ Skenå	12 / 60



X CONNECTOR DALI 3-CIRCUIT

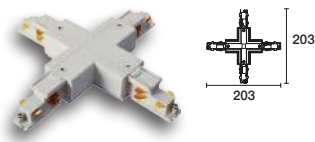

Artikelnummer	EAN	Färg	Förpackning
PRO-D637-W	8719747931585	□ Vit	2 / 24
PRO-D637-S	8719747931592	■ Grå	2 / 24
PRO-D637-B	8719747931608	■ Skenå	2 / 24



L CONNECTOR DALI LEFT 3-CIRCUIT



Artikelnummer	EAN	Färg	Förpackning
PRO-D635 L-W	8719747931493	□ Vit	12 / 60
PRO-D635 L-S	8719747931509	■ Grå	12 / 60
PRO-D635 L-B	8719747931516	■ Skenå	12 / 60



L CONNECTOR DALI RIGHT 3-CIRCUIT



Artikelnummer	EAN	Färg	Förpackning
PRO-D635 R-W	8719747931523	□ Vit	12 / 60
PRO-D635 R-S	8719747931530	■ Grå	12 / 60
PRO-D635 R-B	8719747931547	■ Skenå	12 / 60



## T CONNECTOR DALI LEFT1 3-CIRCUIT



Artikelnummer	EAN	Färg	Förpackning
PRO-D636 L1-W	8719747931646	□ Vit	9 / 54
PRO-D636 L1-S	8719747931653	■ Grå	9 / 54
PRO-D636 L1-B	8719747931660	■ Skena	9 / 54



## T CONNECTOR DALI LEFT2 3-CIRCUIT



Artikelnummer	EAN	Färg	Förpackning
PRO-D636 L2-W	8719747931677	□ Vit	9 / 54
PRO-D636 L2-S	8719747931684	■ Grå	9 / 54
PRO-D636 L2-B	8719747931691	■ Skena	9 / 54



## T CONNECTOR DALI RIGHT1 3-CIRCUIT



Artikelnummer	EAN	Färg	Förpackning
PRO-D636 R1-W	8719747931707	□ Vit	9 / 54
PRO-D636 R1-S	8719747931714	■ Grå	9 / 54
PRO-D636 R1-B	8719747931721	■ Skena	9 / 54



## T CONNECTOR DALI RIGHT2 3-CIRCUIT



Artikelnummer	EAN	Färg	Förpackning
PRO-D636 R2-W	8719747931615	□ Vit	9 / 54
PRO-D636 R2-S	8719747931622	■ Grå	9 / 54
PRO-D636 R2-B	8719747931639	■ Skena	9 / 54



## CONNECTOR COVER

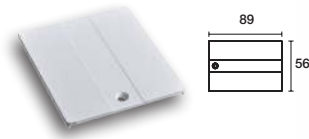

Artikelnummer	EAN	Färg	Förpackning
PRO-R631-W	8719747931820	□ Vit	40 / 480
PRO-R631-S	8719747931837	■ Grå	40 / 480
PRO-R631-B	8719747931844	■ Skena	40 / 480



## T CONNECTOR COVER



Artikelnummer	EAN	Färg	Förpackning
PRO-R436-W	8719747931196	□ Vit	30 / 360
PRO-R436-S	8719747931202	■ Grå	30 / 360
PRO-R436-B	8719747931219	■ Skena	30 / 360



## L CONNECTOR COVER



Artikelnummer	EAN	Färg	Förpackning
PRO-R435-W	8719747931165	□ Vit	25 / 500
PRO-R435-S	8719747931172	■ Grå	25 / 500
PRO-R435-B	8719747931189	■ Skena	25 / 500



## X CONNECTOR COVER



Artikelnummer	EAN	Färg	Förpackning
PRO-R437-W	8719747931226	□ Vit	80 / 480
PRO-R437-S	8719747931233	■ Grå	80 / 480
PRO-R437-B	8719747931240	■ Skena	80 / 480



## MIDDLE CONNECTOR COVER



Artikelnummer	EAN	Färg	Förpackning
PRO-R434-W	8719747931134	□ Vit	40 / 480
PRO-R434-S	8719747931141	■ Grå	40 / 480
PRO-R434-B	8719747931158	■ Skena	40 / 480











*Track system design  
made flexible and versatile*

# TRACK SUSPENSION & GENERAL ACCESSORIES

The Powergear track suspension accessories make the track system quick and easy to install. Suspension kits wire lengths can be customized. Track plans can be easily extended via fixed or DALI monopoints. And for an additional power outlet simply use the Powergear Schuko adapter



**SUSPENSION CONNECTION CLAMP**

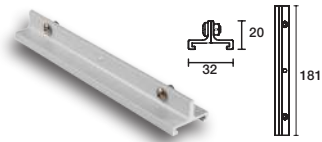

Artikelnummer	EAN	Färg	Förpackning
PRO-0418SK-W	8719747930847	<input type="checkbox"/> Vit	6 / 180
PRO-0418SK-S	8719747930854	<input checked="" type="checkbox"/> Grå	6 / 180
PRO-0418SK-B	8719747930861	<input checked="" type="checkbox"/> Skena	6 / 180



**ROD SUSPENSION EZCLICK**  
*suspension kit with 1m rod*



Artikelnummer	EAN	Färg	Förpackning
PRO-EZ0447-W	8719747930755	<input type="checkbox"/> Vit	1 / 30
PRO-EZ0447-S	8719747930762	<input checked="" type="checkbox"/> Grå	1 / 30
PRO-EZ0447-B	8719747930779	<input checked="" type="checkbox"/> Skena	1 / 30



**WIRE SUSPENSION EZCLICK 5M**  
*suspension kit with 5m steel wire*

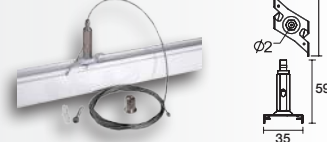

Artikelnummer	EAN	Färg	Förpackning
PRO-EZ0449-W	8719747932483	<input type="checkbox"/> Vit	8 / 96
PRO-EZ0449-S	8719747932490	<input checked="" type="checkbox"/> Grå	8 / 96
PRO-EZ0449-B	8719747932506	<input checked="" type="checkbox"/> Skena	8 / 96



**WIRE SUSPENSION EZCLICK 5M**  
*suspension kit with 5m steel wire*



Artikelnummer	EAN	Färg	Förpackning
PRO-EZ0448-W	8719747930786	<input type="checkbox"/> Vit	8 / 96
PRO-EZ0448-S	8719747930793	<input checked="" type="checkbox"/> Grå	8 / 96
PRO-EZ0448-B	8719747930809	<input checked="" type="checkbox"/> Skena	8 / 96



**T-BAR EZCLICK**

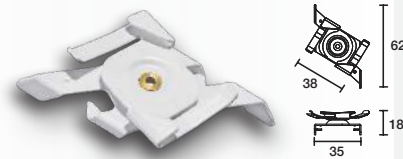

Artikelnummer	EAN	Färg	Förpackning
PRO-M146T-W	8719747930816	<input type="checkbox"/> Vit	25 / 500
PRO-M146T-S	8719747930823	<input checked="" type="checkbox"/> Grå	25 / 500
PRO-M146T-B	8719747930830	<input checked="" type="checkbox"/> Skena	25 / 500



**REINFORCEMENT PLATE**  
*reinforcement plate with 5m steel suspension wire*



Artikelnummer	EAN	Färg	Förpackning
PRO-M147-W	8719747932643	<input type="checkbox"/> Vit	4 / 48
PRO-M147-S	8719747932650	<input checked="" type="checkbox"/> Grå	4 / 48
PRO-M147-B	8719747932667	<input checked="" type="checkbox"/> Skena	4 / 48



**MOUNTING CLAMP**

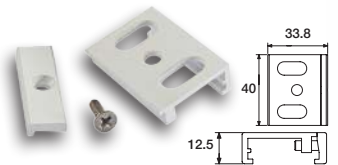

Artikelnummer	EAN	Färg	Förpackning
PRO-04SK-W	8719747930939	<input type="checkbox"/> Vit	30 / 600
PRO-04SK-S	8719747930946	<input checked="" type="checkbox"/> Grå	30 / 600
PRO-04SK-B	8719747930953	<input checked="" type="checkbox"/> Skena	30 / 600



**SUSPENSION HOOK**



Artikelnummer	EAN	Färg	Förpackning
PRO-M142-W	8719747930878	<input type="checkbox"/> Vit	20 / 400
PRO-M142-S	8719747930885	<input checked="" type="checkbox"/> Grå	20 / 400
PRO-M142-B	8719747930892	<input checked="" type="checkbox"/> Skena	20 / 400



**TRACK COVER STRIP 3M**

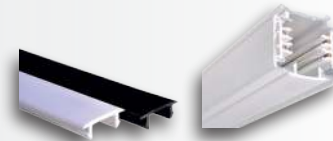

Artikelnummer	EAN	Färg	Förpackning
PRO-CS04300-W	8719747932438	<input type="checkbox"/> Vit	1 / 150
PRO-CS04300-B	8719747932445	<input checked="" type="checkbox"/> Skena	1 / 150



**FIXED MONOPOINT FOR TRACK ADAPTER**

*universal*



Artikelnummer	EAN	Färg	Förpackning
PRO-C100-W	8719747930960	□ Vit	1 / 50
PRO-C100-S	8719747930977	■ Grå	1 / 50
PRO-C100-B	8719747930984	■ Skenå	1 / 50



**FIXED MONOPOINT FOR DALI TRACK ADAPTER**



Artikelnummer	EAN	Färg	Förpackning
PRO-C150-W	8719747933213	□ Vit	1 / 40
PRO-C150-S	8719747933220	■ Grå	1 / 40
PRO-C150-B	8719747933237	■ Skenå	1 / 40



**SCHUKO ADAPTER**



Artikelnummer	EAN	Färg	Förpackning
PRO-4230V-W	8719747930991	□ Vit	1 / 50
PRO-4230V-B	8719747931004	■ Skenå	1 / 50







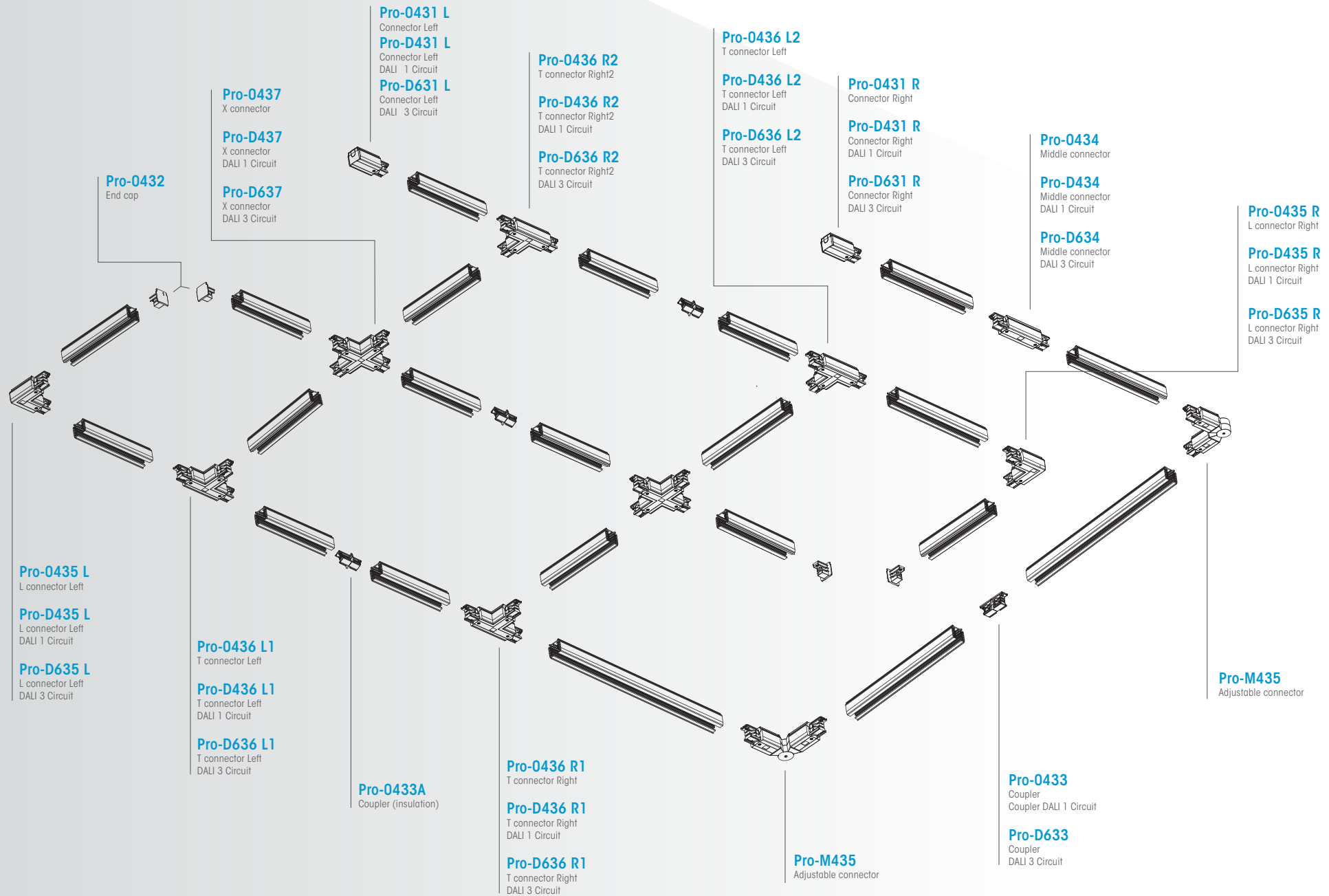

**Pro-0432**  
End cap

**Pro-0437**  
X connector

**Pro-D437**  
X connector  
DALI 1 Circuit

**Pro-D637**  
X connector  
DALI 3 Circuit

**Pro-0431 L**  
Connector Left  
**Pro-D431 L**  
Connector Left  
DALI 1 Circuit  
**Pro-D631 L**  
Connector Left  
DALI 3 Circuit

**Pro-0436 R2**  
T connector Right2

**Pro-D436 R2**  
T connector Right2  
DALI 1 Circuit

**Pro-D636 R2**  
T connector Right2  
DALI 3 Circuit

**Pro-0436 L2**  
T connector Left

**Pro-D436 L2**  
T connector Left  
DALI 1 Circuit

**Pro-D636 L2**  
T connector Left  
DALI 3 Circuit

**Pro-0431 R**  
Connector Right

**Pro-D431 R**  
Connector Right  
DALI 1 Circuit

**Pro-D631 R**  
Connector Right  
DALI 3 Circuit

**Pro-0434**  
Middle connector

**Pro-D434**  
Middle connector  
DALI 1 Circuit

**Pro-D634**  
Middle connector  
DALI 3 Circuit

**Pro-0435 R**  
L connector Right

**Pro-D435 R**  
L connector Right  
DALI 1 Circuit

**Pro-D635 R**  
L connector Right  
DALI 3 Circuit

**Pro-0435 L**  
L connector Left

**Pro-D435 L**  
L connector Left  
DALI 1 Circuit

**Pro-D635 L**  
L connector Left  
DALI 3 Circuit

**Pro-0436 L1**  
T connector Left

**Pro-D436 L1**  
T connector Left  
DALI 1 Circuit

**Pro-D636 L1**  
T connector Left  
DALI 3 Circuit

**Pro-0433A**  
Coupler (insulation)

**Pro-0436 R1**  
T connector Right

**Pro-D436 R1**  
T connector Right  
DALI 1 Circuit

**Pro-D636 R1**  
T connector Right  
DALI 3 Circuit

**Pro-M435**  
Adjustable connector

**Pro-M435**  
Adjustable connector

**Pro-0433**  
Coupler  
Coupler DALI 1 Circuit

**Pro-D633**  
Coupler  
DALI 3 Circuit

*Versatile, innovative  
and highly compatible*





# ADAPTER SOLUTIONS

Powergear offers a wide range of 3 circuit and 3 circuit DALI adapters for the OEM market.

Powergear adapters are highly compatible to all major lighting track systems. The innovative range of intrack adapters enable new opportunities for minimalistic design in track lights. A multi current LED driver is concealed in the adapter. To make your 3-circuit system Bluetooth controllable, Powergear offers an Ultimate adapter with Casambi technology.



SMART 3-CIRCUIT ADAPTER



Artikelnummer	EAN	Färg	Förpackning
PRO-0222-W	8719747930182	<input type="checkbox"/> Vit	1 / 150
PRO-0222-S	8719747930199	<input type="checkbox"/> Grå	1 / 150
PRO-0222-B	8719747930205	<input type="checkbox"/> Skena	1 / 150

FMax: 50N



CLASSIC 3-CIRCUIT ADAPTER

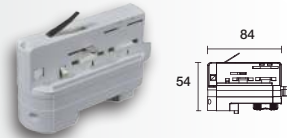

Artikelnummer	EAN	Färg	Förpackning
PRO-0440-W	8719747932346	<input type="checkbox"/> Vit	1 / 150
PRO-0440-S	8719747932353	<input type="checkbox"/> Grå	1 / 150
PRO-0440-B	8719747932360	<input type="checkbox"/> Skena	1 / 150

FMax: 100N



DALI 3-CIRCUIT ADAPTER



Artikelnummer	EAN	Färg	Förpackning
PRO-D680-W	8719747931349	<input type="checkbox"/> Vit	1 / 150
PRO-D680-S	8719747931356	<input type="checkbox"/> Grå	1 / 150
PRO-D680-B	8719747931363	<input type="checkbox"/> Skena	1 / 150

FMax: 100N

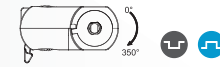

DALI 1-CIRCUIT ADAPTER

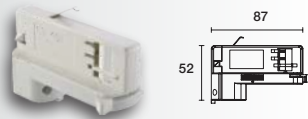

Artikelnummer	EAN	Färg	Förpackning
PRO-D480-W	8719747931851	<input type="checkbox"/> Vit	1 / 150
PRO-D480-S	8719747931868	<input type="checkbox"/> Grå	1 / 150
PRO-D480-B	8719747931875	<input type="checkbox"/> Skena	1 / 150

FMax: 100N



NIPPLE M10X8

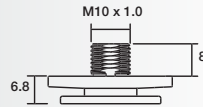

Artikelnummer	EAN	Färg	Förpackning
PRO-M10-008-02	8719747932315	<input type="checkbox"/> Alu	100
PRO-M10-008-02-W	8719747932513	<input type="checkbox"/> Vit	100
PRO-M10-008-02-S	8719747932674	<input type="checkbox"/> Grå	100
PRO-M10-008-02-B	8719747932520	<input type="checkbox"/> Skena	100

NIPPLE M10X12

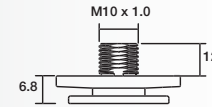

Artikelnummer	EAN	Färg	Förpackning
PRO-M10-012-02	8719747932322	<input type="checkbox"/> Alu	100
PRO-M10-012-02-W	8719747932537	<input type="checkbox"/> Vit	100
PRO-M10-012-02-S	8719747932681	<input type="checkbox"/> Grå	100
PRO-M10-012-02-B	8719747932544	<input type="checkbox"/> Skena	100

PVC STRAIN RELIEF

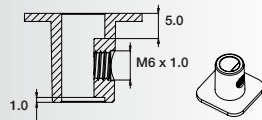

Artikelnummer	EAN	Färg	Förpackning
PRO-M510-W	8719747933244	<input type="checkbox"/> Vit	100
PRO-M510-S	8719747933251	<input type="checkbox"/> Grå	100
PRO-M510-B	8719747933268	<input type="checkbox"/> Skena	100

PVC NIPPLE STRAIN RELIEF M10

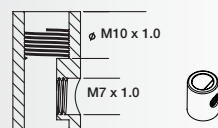

Artikelnummer	EAN	Färg	Förpackning
PRO-M10-008-PVC-W	8719747933152	<input type="checkbox"/> Vit	100
PRO-M10-008-PVC-S	8719747933169	<input type="checkbox"/> Grå	100
PRO-M10-008-PVC-B	8719747933176	<input type="checkbox"/> Skena	100

TOOL FOR WIRING



Artikelnummer	EAN	Färg	Förpackning
PRO-0222-001-04	8719747932308		1

ULTIMATE ADAPTER

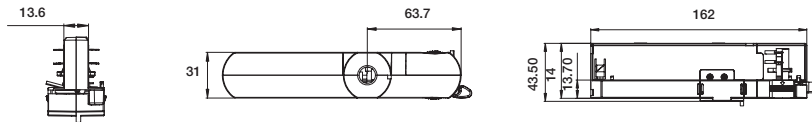

**Specifications**  
 Flicker Free, Ripple Free  
 Input: 220-240Vac, 50/60Hz  
 Output: 25-42Vdc  
 Current output dc/mA: Pro-UA420 / 250-500mA 11-21W  
 Pro-UA430 / 600-800mA 25-34W  
 Pro-UA440 / 850-1050mA 36-44W  
 Dip-switches for easy output current selection  
 Lifetime: 50,000 hours  
 Fmax: 50N  
 Certificate: ENEC/CE/CCC

Artikelnummer	EAN	Färg	Förpackning
PRO-UA420-W	8719747933985	<input type="checkbox"/> Vit	1 / 50
PRO-UA420-S	8719747933992	<input checked="" type="checkbox"/> Grå	1 / 50
PRO-UA420-B	8719747934005	<input checked="" type="checkbox"/> Skena	1 / 50
PRO-UA430-W	8719747934012	<input type="checkbox"/> Vit	1 / 50
PRO-UA430-S	8719747934029	<input checked="" type="checkbox"/> Grå	1 / 50
PRO-UA430-B	8719747934036	<input checked="" type="checkbox"/> Skena	1 / 50
PRO-UA440-W	8719747934043	<input type="checkbox"/> Vit	1 / 50
PRO-UA440-S	8719747934050	<input checked="" type="checkbox"/> Grå	1 / 50
PRO-UA440-B	8719747934067	<input checked="" type="checkbox"/> Skena	1 / 50

ULTIMATE ADAPTER



**Specifications**  
 Flicker Free  
 Input: 220-240Vac, 50/60Hz  
 Output: 5-44Vdc, 59Vdc Max.  
 Current output dc/mA: Pro-T6700 / 325-700mA 14-31W  
 Pro-T61050 / 675-1050mA 28-40W  
 PF>0.9, THD<15%  
 ta: 0°C - 35°C, tc: 85°C  
 Fmax: 50N  
 Unloaded protection, Short-circuit Protection,  
 Overvoltage Protection  
 Certificate: ENEC/CE/CCC

Artikelnummer	EAN	Färg	Förpackning
PRO-T6700-W	8719747932612	<input type="checkbox"/> Vit	1 / 50
PRO-T6700-S	8719747932629	<input checked="" type="checkbox"/> Grå	1 / 50
PRO-T6700-B	8719747932636	<input checked="" type="checkbox"/> Skena	1 / 50
PRO-T61050-W	8719747934104	<input type="checkbox"/> Vit	1 / 50
PRO-T61050-S	8719747934111	<input checked="" type="checkbox"/> Grå	1 / 50
PRO-T61050-B	8719747934128	<input checked="" type="checkbox"/> Skena	1 / 50

ULTIMATE ADAPTER

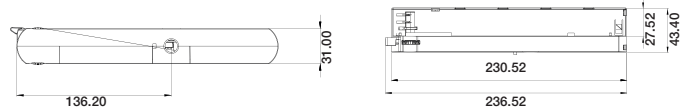

**Specifications**  
 Flicker Free  
 Input: 220-240Vac, 50/60Hz  
 Output: 5-42Vdc, 59Vdc Max.  
 Current output dc/mA: 325-700mA 14-31W  
 PF>0.9, THD<15%  
 ta: 0°C - 35°C, tc: 90°C  
 Fmax: 50N  
 Unloaded protection, Short-circuit Protection,  
 Overvoltage Protection  
 Certificate: ENEC/CE/CCC

Artikelnummer	EAN	Färg	Förpackning
PRO-4700CB-W	8719747934074	<input type="checkbox"/> Vit	1 / 50
PRO-4700CB-S	8719747934081	<input checked="" type="checkbox"/> Grå	1 / 50
PRO-4700CB-B	8719747934098	<input checked="" type="checkbox"/> Skena	1 / 50

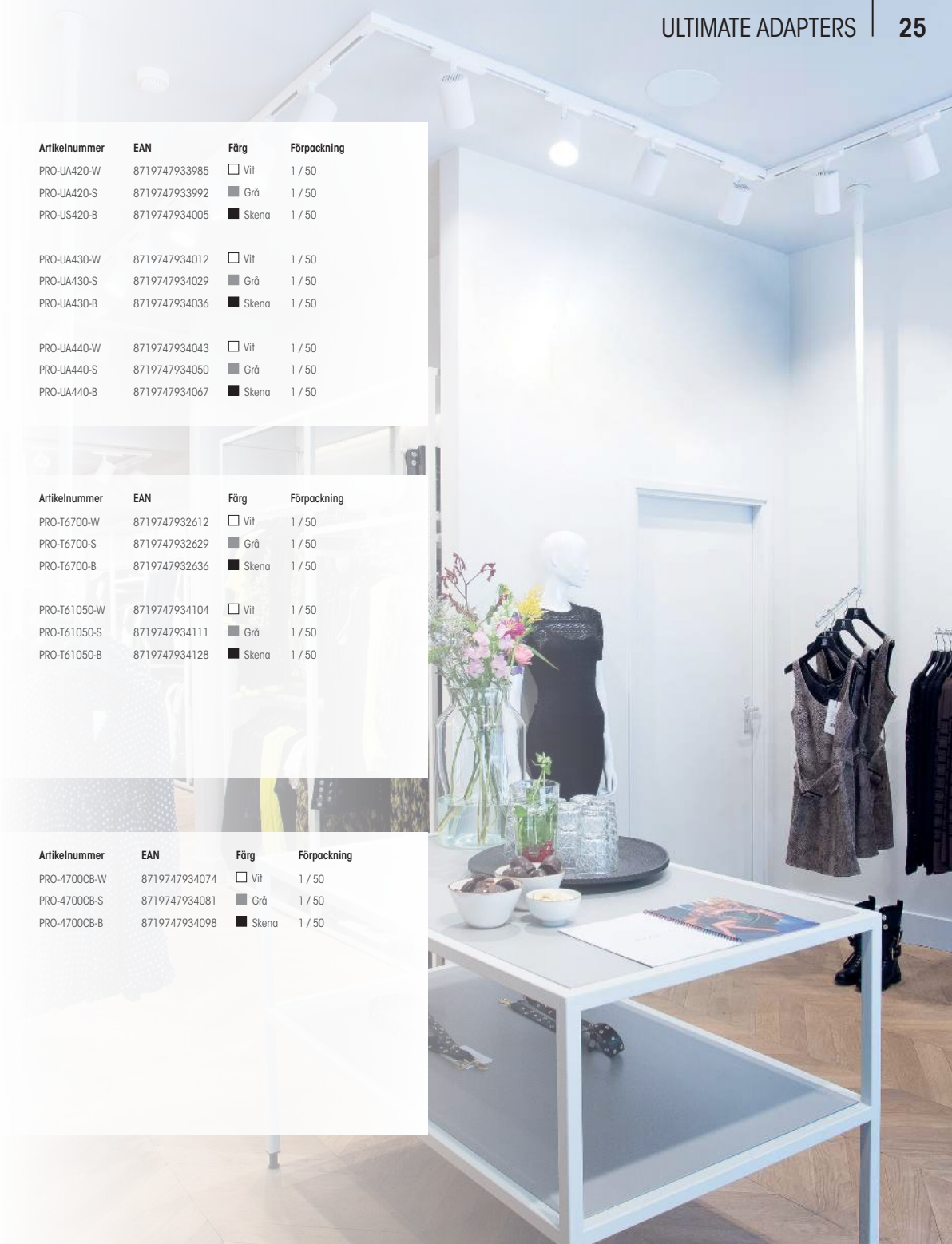

## ULTIMATE ADAPTER WIDE OPERATING VOLTAGE



DIP Switch

**Specifications**

Input: 220-240Vac, 50/60Hz  
 Output: 5-42Vdc, 59Vdc Max.  
 Current output dc/mA: 675-1050mA 28-40W  
 PF>0.9, THD<15%  
 ta: 0°C - 35°C, tc: 90°C  
 Fmax: 50N  
 Unloaded protection, Short-circuit Protection,  
 Overvoltage Protection  
 Certificate: ENEC/CE/CCC

**Artikelnummer**

PRO-41050-W

**EAN**

8719747932582

**Färg** Vit**Förpackning**

5 / 50

PRO-41050-S

8719747932599

 Grå

5 / 50

PRO-41050-B

8719747932605

 Skenå

5 / 50

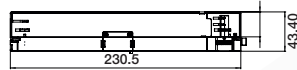
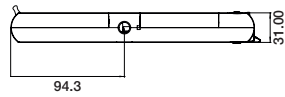

## ULTIMATE ADAPTER TRIAC DIMMABLE

**Specifications**

Input: 220-240Vac, 50/60Hz  
 Output: 25-40Vdc  
 Current output dc/mA: 350mA, 500mA, 750mA  
 Fmax: 50N  
 Certificate: ENEC/CE/CCC

**RELEASE IN 2021  
 PLEASE CHECK WEBSITE**

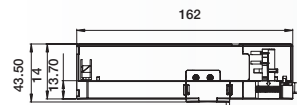
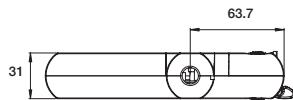





MECHANICAL LOAD DIAGRAM

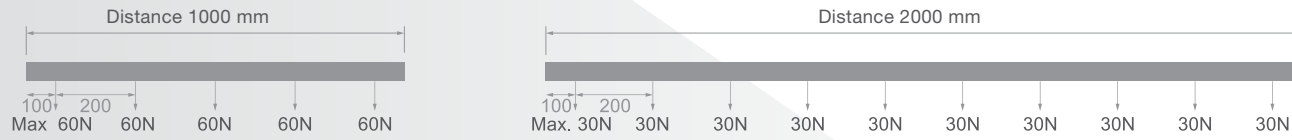

FIXING POINT DIMENSIONS

L / mm	a / mm	b / mm	c / mm	d / mm
1000	125			
2000	125	998		
3000	125		914	1167

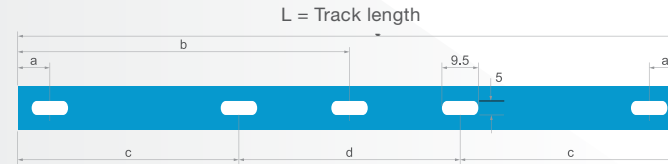

It is recommended to fasten the track at every hole with a screw or suspension kit.

CONNECTING DIAGRAM

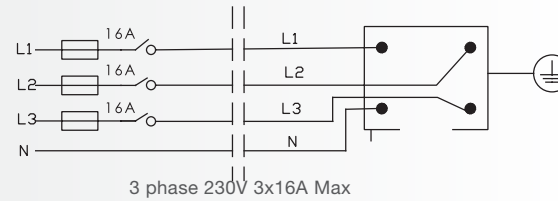
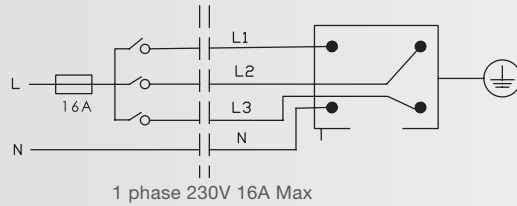

CONNECTING DIAGRAM (RED LINE INDICATES THE POLARITY RIDGE.)

FLOOR VIEW

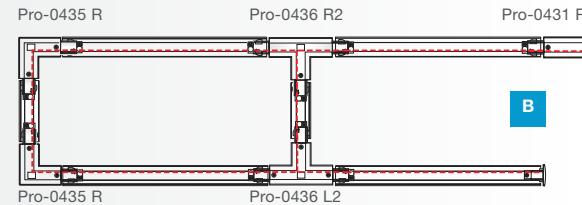
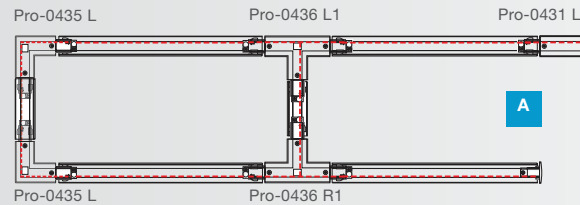

### MECHANICAL LOAD DIAGRAM

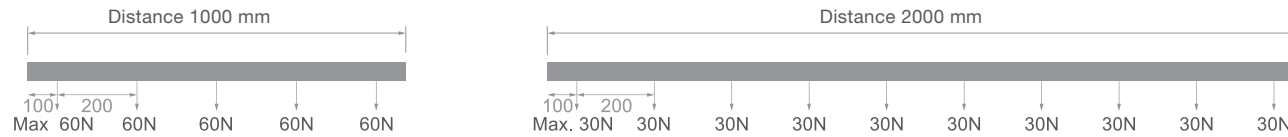

### FIXING POINT DIMENSIONS

L / mm	a / mm	b / mm	c / mm	d / mm
1000	125			
2000	125	998		
3000	125		914	1167

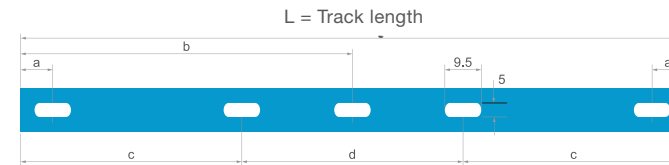

It is recommended to fasten the track at every hole with a screw or suspension kit.

### CONNECTING DIAGRAM

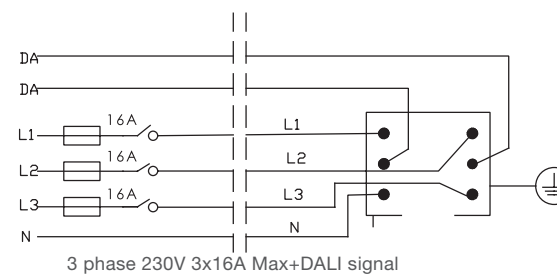
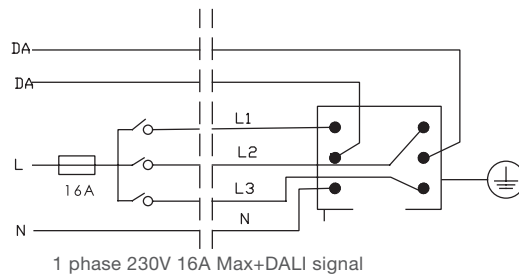

### CONNECTING DIAGRAM (RED LINE INDICATES THE POLARITY RIDGE.)

FLOOR VIEW

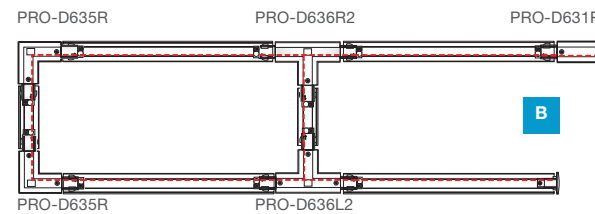
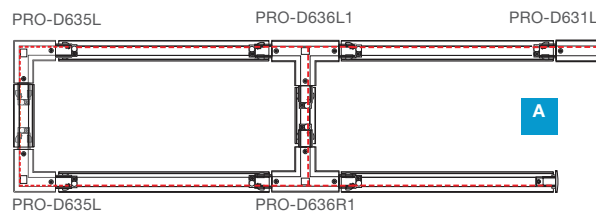

Low Voltage 2 Circuits



48V 2\*15A Max.

Low Voltage Single Circuit DALI



48V 15A Max.

T-BAR EZCLICK

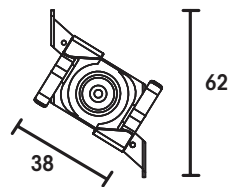

Artikelnummer	EAN	Färg	Förpackning
PRO-M146T-W	8719747930816	□ Vit	25 / 500
PRO-M146T-S	8719747930823	■ Grå	25 / 500
PRO-M146T-B	8719747930830	■ Skena	25 / 500

T-BAR EZCLICK MOUNTING INSTRUCTION



1 Adjust the EZCLICK Mounting Kit's direction, put it vertically on to the T-Bar ceiling, and then rotate right and fix (as picture shows).

2 Adjust the EZCLICK Mounting Kit's direction, put the track vertically into the EZCLICK Mounting Kit, rotate left and fix (as picture shows)

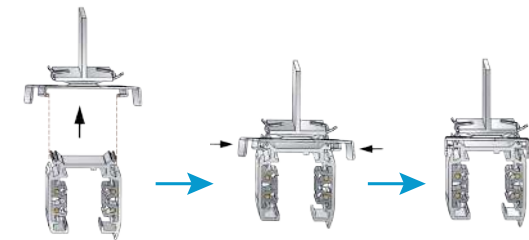
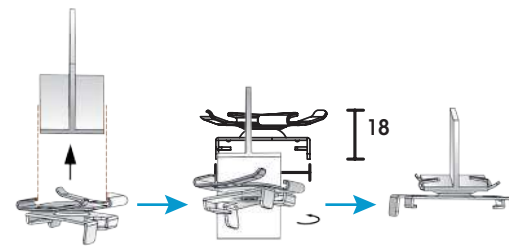

REINFORCEMENT PLATE  
REINFORCEMENT PLATE WITH 5M STEEL SUSPENSION WIRE

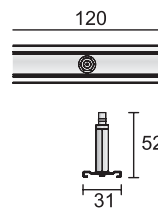

Artikelnummer	EAN	Färg	Förpackning
PRO-M147-W	8719747932643	□ Vit	4 / 48
PRO-M147-S	8719747932650	■ Grå	4 / 48
PRO-M147-B	8719747932667	■ Skena	4 / 48

REINFORCEMENT PLATE MOUNTING INSTRUCTION



1 Put the track into the reinforcement plate parallel (as picture shows)

2 Release the start valve, press and get the wire through the EZCLICK mounting kit, rotate tight the start valve and lock the wirerope (as picture shows)

