

CaterMarket

FOOD SERVICE EQUIPMENT

CATERING EQUIPMENT CATALOGUE

2022-24

EDITION #2



QUICK NAVIGATION

FOOD PREPARATION	4-21
PACKAGING	22-27
COOKING EQUIPMENT	28-93
BEVERAGE	94-107
WASHING & HARDWARE	108-125
BUFFET WARE	126-137
REFRIGERATION	138-163
DISPLAY & RETAIL	164-181
HOLDING & DISTRIBUTION	182-193
STORAGE & HANDLING SOLUTIONS	194-203

WHAT DOES IT MEAN?



Baking trays per deck



Gas equipment



Pizza bases per deck



Electric equipment



Packed weight & dimensions

 ***BakeMark***



SmartBlend

Smoothies
Cocktails
Shakes
Soups
Puree



VORTEX_{SC}



VORTEX



STORM

SECTION INDEX

Blenders	8
Bowl cutters	7
Burger patty presses	12
Cake mixers	14-16
Chip cutters	9
Cold meat slicers	10-11
Dough divider & rounder	19
Dough mixers	17-18
Dough rollers	20
Dough sheeters	21
Fry cutters	9
Hamburger press	12
Kitchen assistant	14-15
Meat slicers	10-11
Mixers	14-18
Pastry sheeters	21
Patty press	12
Pizza dough rollers	20
Planetary mixers	14-16
Polony slicers	10-11
Potato chippers	9
Slicers	10-11
Smoothie makers	8
Spiral dough mixers	17-18
Spiral potato cutter	9
Tomato slicer	7
Vegetable preparation machines	6



FEATURES

- Aluminium and magnesium alloy body
- Fitted with a safety micro switch to stop operation when cover is opened
- Ventilated motor, allowing continuous operation
- Motor thermal protection against over heating
- Removable hinged lid equipped with a large half moon mouth or cylindrical mouth
- Rounded edges for easy cleaning
- Feeder stick and cleaning brush included
- Fitted with (4x) non-slip rubber feet



SPECIFICATIONS

MODEL	SmartChef HLC-300
ELECTRICITY	0.55kW, 220V, Single Phase
DIMENSIONS	200 x 490 x 500mm high
WEIGHT	23kg
SPEED	375rpm - Single speed
FEEDER	Half moon 58mm Ø
BLADES INCLUDED	2mm slicer 4mm slicer 2mm grater 3mm grater 7mm grater

ORDER CODE

VPS0001



**HALF-MOON
FEEDER MOUTH**



SPECIFICATIONS

MODEL	SmartChef HLC-300AL
ELECTRICITY	0.55kW, 220V, Single Phase
DIMENSIONS	310 x 540 x 550mm high
WEIGHT	23kg
SPEED	375rpm - Single speed
FEEDER	Round 190mm Ø
BLADES INCLUDED	2mm slicer 4mm slicer 3mm grater 5mm grater 7mm grater

ORDER CODE

VPS0002



**LARGE, ROUND
FEEDER MOUTH**

OPTIONAL BLADES

GRATING BLADES

- 3mm VPS1003
- 7mm VPS1007
- 4mm VPS1004

SLICING BLADES

- 2mm VPS2002
- 8mm VPS2008
- 14mm VPS2014
- 4mm VPS2004
- 10mm VPS2010

CURVED SLICING BLADES

- 1mm VPS3001
- 5mm VPS3005
- 2mm VPS3002

CHIPPING BLADES

must be used with a slicing disk

- 8mm VPS4008
- 10mm VPS4010

JULIENNE BLADES

- 2.5mm VPS5025
- 8mm VPS5008
- 4mm VPS5004
- 10mm VPS5010

DICING BLADES

must be used with a slicing disk

- 8mm VPS6008
- 12mm VPS6012
- 10mm VPS6010
- 20mm VPS6020

PARMESAN BLADES

ORDER CODE VPS7001

EJECTOR PLATE

ORDER CODE VPS9000



BOWL CUTTERS

SmartChef



FEATURES

- Robust stainless steel body and bowl
- Transparent cover for easy viewing of product
- Lid is fitted with a large dosing cup to easily add liquid
- Easy removable cutting bowl and blades
- Fitted with a safety switch
- Fitted with (4x) non-slip feet

MODEL	SmartChef HR-9
ELECTRICITY	1.8kW, 220V, Single Phase
DIMENSIONS	520 x 317 x 445mm high
WEIGHT	20kg
CAPACITY	9Lt
REVOLUTION	1000 ~2500 rpm

ORDER CODE **BCS0009**



TOMATO SLICERS

SmartChef



FEATURES

- Robust stainless steel construction
- Smooth sliding action
- Easy to operate and clean
- Fitted with (4x) suction-cup feet

MODEL	SmartChef HT-4
DIMENSIONS	430 x 200 x 210mm high
WEIGHT	5kg
SLICE THICKNESS	4mm

ORDER CODE **TSS0004**



BLADE SET
ORDER CODE

XTSS0004-POS2



FEATURES

- Modern design ABS housing with an "unbreakable" food grade Polycarbonate jar
- Various speed control, time and pulse action
- Removable dosing cup and stir bar included
- Industrial grade, heavy duty motor with pure copper coil
- VORTEX SC fitted with a Polycarbonate soundproof cover as standard (Optional extra for the VORTEX)
- Fitted with a stainless steel blade assembly
- Fitted with an over-heat, auto shut-off safety function
- Housing fitted with non-slip feet



VORTEX SC (WITH SOUND COVER)

SPECIFICATIONS

MODEL	SmartBlend VORTEX SC 1680C
ELECTRICITY	1.68kW, 220V, Single Phase
DIMENSIONS	230 x 250 x 540mm high (closed) 230 x 250 x 790mm high (open)
WEIGHT	9kg
SPEED	32 000rpm - Touch control
JAR CAPACITY	2Lt
ORDER CODE	BSB1680C/C



VORTEX

SPECIFICATIONS

MODEL	SmartBlend VORTEX 1680
ELECTRICITY	1.68kW, 220V, Single Phase
DIMENSIONS	230 x 250 x 520mm high
WEIGHT	6kg
SPEED	32 000rpm - Analog control
JAR CAPACITY	2Lt
ORDER CODE	BSB1680



STORM

SPECIFICATIONS

MODEL	SmartBlend STORM 112
ELECTRICITY	1.1kW, 220V, Single Phase
DIMENSIONS	225 x 210 x 490mm high
WEIGHT	4kg
SPEED	26 000rpm - Analog control
JAR CAPACITY	2Lt
ORDER CODE	BSB0112

OPTIONAL EXTRAS



SOUND COVER

Compatible with VORTEX SC 1680C
VORTEX 1680

ORDER CODE **BSB1680-S/COVER**



2Lt JAR & TAMPER

Compatible with VORTEX SC 1680C
VORTEX 1680

ORDER CODE **BSB1680-JAR2L**

2Lt JAR & TAMPER

Compatible with STORM 112

ORDER CODE **BSB0112-JAR2L**



FRY CUTTER

SPECIFICATIONS

MODEL	SmartChef HC-02
DIMENSIONS	430 x 220 x 330mm high
CUT SIZE	8/10/12mm
WEIGHT	3.5kg
ORDER CODE	FCS0009



OPTIONAL WALL BRACKET

ORDER CODE **WBS0000**

FEATURES

- Heavy-duty, cast aluminum frame and handle
- Clean and durable stainless steel "V" trough for smooth operation
- Sure grip handle
- Screw holes on base of legs for permanent mounting to table or wall
- Supplied with 8, 10 and 12mm interchangeable blade sets
- Optional wall bracket available for ease of operation



CHIPPERS

SPECIFICATIONS

DIMENSIONS	330 x 140 x 640mm high
WEIGHT	4kg

6 HOLE

MODEL	SmartChef HC-01/6
CUT HOLES & SIZE	6 x 6 / 14mm
ORDER CODE	CHS0006

7 HOLE

MODEL	SmartChef HC-01/7
CUT HOLES & SIZE	7 x 7 / 12mm
ORDER CODE	CHS0007



FEATURES

- Heavy-duty, cast aluminum frame and handle
- Fitted with a heavy-duty spring
- Easy interchangeable block and blade
- Easy to operate
- Maximum potato size - 150mm

OPTIONAL CHIPPER BRIDGE

ORDER CODE **CBS0000**



SPIRAL POTATO CUTTER

SPECIFICATIONS

MODEL	SmartChef HSP-01
DIMENSIONS	340 x 130 x 140mm high
WEIGHT	1kg

ORDER CODE **SPC0001**



FEATURES

- Manufactured from stainless steel
- Replaceable stainless steel blade
- Fixed shaft with hole for the skewer
- Easy to operate
- Fitted with (4x) non-slip rubber feet





FEATURES

- The slicer is built with polished cast aluminum
- Easy to use and clean with little maintenance
- Double ball bearing blade support
- Double stone sharpening accessory included
- Strong fan silenced with professional motor
- Very sturdy design
- The blade is made from non-sticking steel
- Sliding carriage on Teflon bushings with a heavy duty food holder
- Two button on-off switch
- Fitted with 4 non-slip feet



220mm BLADE

SPECIFICATIONS

MODEL	Celme FY220
ELECTRICITY	0.16kW, 220V, Single Phase
DIMENSIONS	440 x 360 x 330mm high
WEIGHT	10kg
BLADE DIAMETER	220mm
SLICE THICKNESS	0.2 to 16mm
USEFUL CUT	220 x 165mm

ORDER CODE

MSC0220



275mm BLADE

SPECIFICATIONS

MODEL	Celme Family 275
ELECTRICITY	0.16kW, 220V, Single Phase
DIMENSIONS	530 x 420 x 390mm high
WEIGHT	15kg
BLADE DIAMETER	275mm
SLICE THICKNESS	0.2 to 16mm
USEFUL CUT	230 x 180mm

ORDER CODE

MSC0275



300mm BLADE

SPECIFICATIONS

MODEL	Celme Family 300
ELECTRICITY	0.22kW, 220V, Single Phase
DIMENSIONS	580 x 470 x 420mm high
WEIGHT	21kg
BLADE DIAMETER	300mm
SLICE THICKNESS	0.2 to 16mm
USEFUL CUT	245 x 195mm

ORDER CODE

MSC0300



FEATURES

- Body manufactured from polished cast aluminium
- Stainless Steel blade
- Waterproof emergency shut-off switch
- Adjustable slice thickness
- Belt drive
- Integrated blade sharpener
- Perspex protector guard
- Fitted with non-slip feet



195mm BLADE

SPECIFICATIONS

MODEL SmartChef HBS-195JS
 ELECTRICITY 0.12kW, 220V, Single Phase
 DIMENSIONS 420 x 380 x 315mm high
 WEIGHT 12kg
 BLADE DIAMETER 195mm
 SLICE THICKNESS 0.2 to 12mm
 MAX SLICE WIDTH 150mm

ORDER CODE **MSS0195**



220mm BLADE

SPECIFICATIONS

MODEL SmartChef HBS-220
 ELECTRICITY 0.12kW, 220V, Single Phase
 DIMENSIONS 480 x 395 x 360mm high
 WEIGHT 15kg
 BLADE DIAMETER 220mm
 SLICE THICKNESS 0.2 to 12mm
 MAX SLICE WIDTH 160mm

ORDER CODE **MSS0220**



250mm BLADE

SPECIFICATIONS

MODEL SmartChef HBS-250
 ELECTRICITY 0.15kW, 220V, Single Phase
 DIMENSIONS 540 x 490 x 420mm high
 WEIGHT 16kg
 BLADE DIAMETER 250mm
 SLICE THICKNESS 0.2 to 12mm
 MAX SLICE WIDTH 180mm

ORDER CODE **MSS0250**



300mm BLADE

SPECIFICATIONS

MODEL SmartChef HBS-300
 ELECTRICITY 0.25kW, 220V, Single Phase
 DIMENSIONS 577 x 493 x 436mm high
 WEIGHT 22kg
 BLADE DIAMETER 300mm
 SLICE THICKNESS 0.2 to 15mm
 MAX SLICE WIDTH 200mm

ORDER CODE **MSS0300**



FEATURES

- The body is manufactured from heavy-duty aluminum alloy
- The machine is operated by hand, without electric power
- Fitted with a convenient paper holder
- The food tray is made of food grade stainless steel
- Fitted with quick release button for food tray
- Easy to clean



100mm

SPECIFICATIONS

MODEL SmartChef HF-100
 DIMENSIONS 210 x 275 x 290mm high
 WEIGHT 5kg
 PATTY DIAMETER 100mm Ø

ORDER CODE HPS0100



130mm

SPECIFICATIONS

MODEL SmartChef HF-130
 DIMENSIONS 210 x 275 x 290mm high
 WEIGHT 5.5kg
 PATTY DIAMETER 130mm Ø

ORDER CODE HPS0130



*Smart***Chef**

PATTY PRESS



PRESS, PATTY, PERFECT.
YOUR SHORTCUT TO SAVOURY SATISFACTION



SUPPLIED WITH

- 7Lt stainless steel beater bowl
- Polyethylene bowl cover
- Dough scraper & spatula
- 3.5Lt clear plastic beater bowl
- Dough roller
- Balloon whisk
- Dough hook
- Cookie beater

FEATURES

- Cast aluminum body
- The open bowl makes it easy to add ingredients and see the dough
- The bowl spins on the assistant base
- The weighted base bottom creates stability
- Multi functional - more than 16 different functions
- Fitted with 12 minute timer
- Variable speed control

SPECIFICATIONS

MODEL	Ankarsrum Assistant Original
ELECTRICITY	1.5kW, 220V, Single Phase
DIMENSIONS	270 x 360 x 370mm high
WEIGHT	9kg
DRY FLOUR CAPACITY	3kg
CAPACITY	7Lt / 5kg
PLANETARY SPEED	45 ~ 130rpm

ORDER CODE

AKM6230



OPTIONAL EXTRAS



DELUXE PACKAGE INCLUDES

- 3 Sausage horns 10 / 20 / 25mm
- Feeder tray & feeder plug
- 4 x hole discs plates 2.5 / 4.5 / 6 / 8mm
- Mincer
- Grater
- Cookie attachment
- Citrus press
- Strainer
- Pasta discs
- Blender jug
- Splash guard for mincer

ORDER CODE

AKM920900067

INDIVIDUAL ATTACHMENTS



Meat mincer & sausage horn 10 / 20 / 25mm
AKM920900057



Hole discs for mincer 2,5 / 4,5 / 6 / 8mm
AKM920900052/3/4/5



Grater attachment for mincer
AKM920900034



Strainer attachment for mincer
AKM920900033



Cookie attachment for mincer
AKM920900035



Pasta discs for mincer
AKM920900036



1.5Lt Blender jug
AKM920900066



1.2Lt Citrus press
AKM920900026



Vegetable cutter
AKM920900043



Extra grating drums
AKM920900044



Pasta roller - Lasagne
AKM920900063



Pasta cutter - Fettuccine
AKM920900064



Pasta cutter - Spaghetti
AKM920900065



Flour and coffee grinder
AKM920900045



Flake mill
AKM920900046

COLOUR OPTIONS



BLACK
AKM6230B



BLACK DIAMOND
AKM6230BD



BLACK CHROME
AKM6230BC



JUBILEE SILVER
AKM6230JS



MINERAL WHITE
AKM6230MW



HARMONY BEIGE
AKM6230HB



CREME
AKM6230C



OCEAN BLUE
AKM6230OB



OLIVE GREEN
AKM6230OG



SUNBEAM YELLOW
AKM6230OSY



RED
AKM6230R



CORAL CRUSH
AKM6230CC



FEATURES

- All metal construction with enamel coating
- Bowl can be lifted and lowered with the wheel action lifting mechanism
- Fitted with safety guard
- 3 Speed options
- Supplied with 3 attachments:
 - Whisk for stirring liquids and beating eggs
 - Flat beater for mixing soft batter
 - Dough hook for mixing soft dough batter

SUPPLIED ATTACHMENTS



DOUGH HOOK



FLAT BEATER



WIRE WHISK

10 LITRE

SPECIFICATIONS

MODEL	BakeMark B10-BL
ELECTRICITY	0.37kW, 220V, Single Phase
DIMENSIONS	444 x 360 x 650mm high
WEIGHT	50kg
DRY FLOUR CAPACITY	1kg
SPEED	110 / 220 / 420rpm
DRIVE METHOD	Gear

ORDER CODE

PMB0010



20 LITRE

SPECIFICATIONS

MODEL	BakeMark B20-BL
ELECTRICITY	1.1kW, 220V, Single Phase
DIMENSIONS	513 x 405 x 762mm high
WEIGHT	65kg
DRY FLOUR CAPACITY	3kg
SPEED	110 / 220 / 420rpm
DRIVE METHOD	Gear

ORDER CODE

PMB0020



30 LITRE

SPECIFICATIONS

MODEL	BakeMark B30-B
ELECTRICITY	1.5kW, 220V, Single Phase
DIMENSIONS	545 x 440 x 882mm high
WEIGHT	82kg
DRY FLOUR CAPACITY	6kg
SPEED	110 / 220 / 420rpm
DRIVE METHOD	Gear

ORDER CODE

PMB0030



40 LITRE

SPECIFICATIONS

MODEL	BakeMark B40-B
ELECTRICITY	2kW, 220V, Single Phase
DIMENSIONS	620 x 630 x 1011mm high
WEIGHT	150kg
DRY FLOUR CAPACITY	8kg
SPEED	65 / 102 / 296rpm
DRIVE METHOD	Belt

ORDER CODE

PMB0040



SPIRAL DOUGH MIXERS FLOOR STANDING



FEATURES

- Robust construction
- The particular shape of the spiral allows for a perfectly mixed dough
- Bowl, spiral, central column and protection grid is made from stainless steel
- Oil bath gear motor provides a particular silent transmission system
- Fitted with protection grid for increased safety
- Two speed motor is available on request on 3 Phase models
- Fitted with a 60 minute timer
- Fitted with an Emergency Stop switch
- Fitted with non-slip feet

10 LITRE

SPECIFICATIONS

MODEL	BakeMark HS10
ELECTRICITY	0.75kW, 220V, Single Phase
DIMENSIONS	540 x 315 x 770mm high
WEIGHT	60kg
DOUGH WEIGHT	7kg
SHAFT SPEED	250 rpm
BOWL SPEED	25 rpm

ORDER CODE **DMB0010**



20 LITRE

SPECIFICATIONS

MODEL	BakeMark BHS20A
ELECTRICITY	1.5kW, 220V, Single Phase
DIMENSIONS	700 x 500 x 770mm high
WEIGHT	75kg
DOUGH WEIGHT	16kg
SHAFT SPEED	125 / 250 rpm
BOWL SPEED	12.5 / 25 rpm

ORDER CODE **DMB0020**



30 LITRE

SPECIFICATIONS

MODEL	BakeMark BHS30A
ELECTRICITY	2kW, 220V, Single Phase
DIMENSIONS	770 x 550 x 850mm high
WEIGHT	114kg
DOUGH WEIGHT	25kg
SHAFT SPEED	125 / 250 rpm
BOWL SPEED	12.5 / 25 rpm

ORDER CODE **DMB0030**



50 LITRE

SPECIFICATIONS

MODEL	BakeMark HS50
ELECTRICITY	2.2kW, 380V, 3 Phase + N
DIMENSIONS	770 x 550 x 850mm high
WEIGHT	160kg
DOUGH WEIGHT	42kg
SHAFT SPEED	125 / 250 rpm
BOWL SPEED	12.5 / 25 rpm

ORDER CODE **DMB0050**





FEATURES

- Robust construction
- The particular shape of the spiral allows for a perfectly mixed dough
- Bowl, spiral, central column and protection grid is made from stainless steel
- Oil bath gear motor provides a particular silent transmission system
- Fitted with protection grid for increased safety
- Two speed motor is available on request on 3 Phase models
- Fitted with a 30 minute timer
- Fitted with castors for ease of movement and cleaning

20 LITRE

SPECIFICATIONS

MODEL	Prismafood IBM 20
ELECTRICITY	0.75kW, 220V, Single Phase
DIMENSIONS	430 x 740 x 860mm high
WEIGHT	62kg
DOUGH WEIGHT	17kg
BOWL DIAMETER	360mm
OUTPUT	Up to 56kg per hour

ORDER CODE

DMP1020



30 LITRE

SPECIFICATIONS

DIMENSIONS	440 x 770 x 770mm high
WEIGHT	87kg
DOUGH WEIGHT	25kg
BOWL DIAMETER	400mm
OUTPUT	Up to 88kg per hour

MODEL

Prismafood IBM 30

ELECTRICITY

1.1kW, 220V, Single Phase

ORDER CODE

DMP1030

MODEL

Prismafood IBT 30

ELECTRICITY

1.1kW, 380V, 3 Phase + N

ORDER CODE

DMP3030



50 LITRE

SPECIFICATIONS

MODEL	Prismafood IBT 50
ELECTRICITY	1.5kW, 380V, 3 Phase + N
DIMENSIONS	480 x 790 x 820mm high
WEIGHT	98kg
DOUGH WEIGHT	42kg
BOWL DIAMETER	450mm
OUTPUT	Up to 128kg per hour

ORDER CODE

DMP3050



DOUGH DIVIDER & ROUNDER SEMI-AUTOMATIC



FEATURES

- Heavy duty rigid cast iron construction
- Heat treated enamel finish resists rust, scratches and dents
- Dual stage, semi-automatic operation
- Stainless steel cutting knives, divides dough into 30 equal pieces
- Self-lubricating, enclosed motor for food safety and low maintenance
- The weight of the dough pieces can be adjusted between 30 and 100g
- Includes two divider rounder plates

SPECIFICATIONS

MODEL	BakeMark HLM-30S
ELECTRICITY	0.75kW, 220V, Single Phase
DIMENSIONS	550 x 720 x 1350mm high
WEIGHT	290kg
OUTPUT	30pcs
DOUGH WEIGHT	30 ~ 100g per piece
PROCESSING TIME	10 ~ 13 seconds

ORDER CODE

DDR-HLM-30S



FEATURES

- Machine body manufactured from stainless steel
- Fitted with exclusive, patented automatic "Touch and Go" system. Sensors automatically switch the machine on when the operator puts dough onto the slope
- The working time can be set from 10 - 35 seconds
- Thickness adjustment knob on rollers
- Rollers are protected in transparent plexiglass for maximum safety with optimal visibility
- Easy to operate
- DMA 500/1 - Supplied with an electric foot pedal
- Can be mounted onto a table for increased stability



DOUBLE ROLLER TILTED

SPECIFICATIONS

MODEL	Prismafood DSA 420 T.G.O
ELECTRICITY	0.25kW, 220V, Single Phase
DIMENSIONS	585 x 330 x 790mm high
WEIGHT	36kg
PIZZA BASE DIAMETER	260 ~ 400mm
BASE THICKNESS	1 ~ 5mm
DOUGH WEIGHT	210 ~ 700gr

ORDER CODE

PRP0040



- Tilted upper roller
- Ideal for round pizza thanks to the presence of the central sling bar



DOUBLE ROLLER PARALLEL

SPECIFICATIONS

MODEL	Prismafood DSA 420 RP T.G.O
ELECTRICITY	0.25kW, 220V, Single Phase
DIMENSIONS	585 x 330 x 790mm high
WEIGHT	36kg
PIZZA BASE DIAMETER	260 ~ 400mm
BASE THICKNESS	1 ~ 5mm
DOUGH WEIGHT	210 ~ 700g

ORDER CODE

PRP0041



- Parallel rollers
- Ideal for pizza on tray (rectangular shape)



SINGLE ROLLER

SPECIFICATIONS

MODEL	Prismafood DMA 500/1
ELECTRICITY	0.25kW, 220V, Single Phase
DIMENSIONS	650 x 345 x 430mm high
WEIGHT	27kg
PIZZA BASE DIAMETER	260 ~ 450mm
BASE THICKNESS	1 ~ 5mm
DOUGH WEIGHT	210 ~ 700g

ORDER CODE

PRP0050





FEATURES

- Machine body manufactured from stainless steel
- Overload protection and open-phase protection function
- Fitted with an emergency stop button
- Adjustable dough thickness
- Collapsable for space saving purposes
- Fitted with (4x) casters, 2 lockable



630mm BELT SPECIFICATIONS

MODEL	BakeMark QS-630B
ELECTRICITY	1.1kW, 220V, Single Phase
EXPANDED DIMENSIONS	1000 x 3100 x 1100mm high
STOWED DIMENSIONS	1000 x 720 x 1700mm high
WEIGHT	268kg
MAX. DOUGH CAPACITY	6.5kg
BELT SIZE	630 x 2400mm
ROLLER ADJUSTABLE GAP	1 ~ 40mm

ORDER CODE

PSB-QS-630B



400mm BELT SPECIFICATIONS

MODEL	BakeMark QS-400B
ELECTRICITY	0.4kW, 220V, Single Phase
EXPANDED DIMENSIONS	760 x 2000 x 1040mm high
STOWED DIMENSIONS	760 x 620 x 1310mm high
WEIGHT	160kg
MAX. DOUGH CAPACITY	4kg
BELT SIZE	400 x 1600mm
ROLLER ADJUSTABLE GAP	1 ~ 35mm

ORDER CODE

PSB-QS-400B





SmartVac

SECTION INDEX

Continuous sealers	26
Double chamber vacuum sealers	24
Hand-press impulse sealers	27
Heat sealing machines	27
Horizontal continuous sealers	26
Impulse sealers	27
Single chamber vacuum sealers	24-25
Vacuum sealers	24-25
Vertical continuous sealers	26
Wrapping machines	27





FEATURES

- External structure and chamber made from stainless steel
- Double alternating chambers increases productivity
- Spring loaded lid stabilising arms for easy operation
- Fitted with stainless steel lid handles
- High density lid gasket for superior sealing during routine work
- Waterproof digital control panel
- Automatic vacuum extraction and sealing
- Can seal multiple types of materials
- Fitted with (4x) castors

DOUBLE CHAMBERS

- Work in turns
- Increased efficiency
- More convenience



500mm SEALING BAR WITH GAS FLUSH

SPECIFICATIONS

MODEL	SmartVac DZ-500/2SB
ELECTRICITY	220V, Single Phase
PUMP / SEAL POWER	2kW / 0.8kW
DIMENSIONS	1250 x 600 x 970mm high
CHAMBER SIZE	(2x) 550 x 470 x 150mm deep
SEALING BAR	(4x) 500 x 10mm
WEIGHT	186kg

ORDER CODE

VPS0500FS-GF



VACUUM SEALERS SINGLE CHAMBER (FLOOR STANDING MODELS)



VPS0600



VPS0400

FEATURES

- External structure and chamber made from stainless steel
- Clear Plexiglas domed-lid allows for full view of process
- Wide lid opening for easy operation
- High density lid gasket for superior sealing during routine work
- Waterproof digital control panel
- Fitted with (4x) castors

600mm SEALING BAR

SPECIFICATIONS

ELECTRICITY	220V, Single Phase
PUMP / SEAL POWER	0.9kW / 1.5kW
DIMENSIONS	680 x 730 x 955mm high
CHAMBER SIZE	620 x 620 x 95mm deep
SEALING BAR	(2x) 600 x 10mm
WEIGHT	152kg

WITHOUT GAS FLUSH

MODEL	SmartVac DZ-600
ORDER CODE	VPS0600

WITH GAS FLUSH

MODEL	SmartVac DZ-600G
ORDER CODE	VPS0600FS-GF



400mm SEALING BAR

SPECIFICATIONS

ELECTRICITY	220V, Single Phase
PUMP / SEAL POWER	0.9kW / 0.8kW
DIMENSIONS	490 x 530 x 880mm high
CHAMBER SIZE	400 x 420 x 80mm deep
SEALING BAR	(2x) 400 x 10mm
WEIGHT	62kg

WITHOUT GAS FLUSH

MODEL	SmartVac DZ-400
ORDER CODE	VPS0400

WITH GAS FLUSH

MODEL	SmartVac DZ-400G
ORDER CODE	VPS0400FS-GF



VACUUM SEALERS SINGLE CHAMBER (TABLE MODELS)

SmartVac

FEATURES

- External structure and chamber made from stainless steel
- Wide lid opening for easy operation
- Waterproof digital control panel
- Clear Plexiglas domed-lid allows for full view of process
- High density lid gasket for superior sealing during routine work
- Fitted with (4x) non-slip feet



VPS0400T



VPS0300



VPS0240

450mm SEALING BAR WITH GAS FLUSH

SPECIFICATIONS

MODEL	SmartVac DZ-450
ELECTRICITY	220V, Single Phase
PUMP / SEAL POWER	0.9kW / 0.8kW
DIMENSIONS	530 x 570 x 500mm high
CHAMBER SIZE	460 x 450 x 170mm deep
SEALING BAR	450 x 10mm
WEIGHT	65kg
ORDER CODE	VPS0450T-GF



300mm SEALING BAR

SPECIFICATIONS

ELECTRICITY	220V, Single Phase
PUMP / SEAL POWER	0.3kW / 0.7kW
DIMENSIONS	370 x 500 x 375mm high
CHAMBER SIZE	320 x 380 x 75mm deep
SEALING BAR	300 x 8mm
WEIGHT	38kg



WITHOUT GAS FLUSH

MODEL	SmartVac DZ-300
ORDER CODE	VPS0300

WITH GAS FLUSH

MODEL	SmartVac DZ-300G
ORDER CODE	VPS0300-GF

400mm SEALING BAR

SPECIFICATIONS

MODEL	SmartVac DZ-400T
ELECTRICITY	220V, Single Phase
PUMP / SEAL POWER	0.75kW / 0.8kW
DIMENSIONS	490 x 535 x 500mm high
CHAMBER SIZE	400 x 420 x 80mm deep
SEALING BAR	(2x) 400 x 10mm
WEIGHT	64kg
ORDER CODE	VPS0400T



260mm SEALING BAR

SPECIFICATIONS

MODEL	SmartVac DZ-260C
ELECTRICITY	220V, Single Phase
PUMP / SEAL POWER	0.12kW / 0.4kW
DIMENSIONS	420 x 310 x 350mm high
CHAMBER SIZE	270 x 320 x 60mm deep
SEALING BAR	260 x 8mm
WEIGHT	27kg
ORDER CODE	VPS0260



240mm SEALING BAR

SPECIFICATIONS

MODEL	SmartVac DZ-240B
ELECTRICITY	220V, Single Phase
PUMP / SEAL POWER	0.18kW / 0.4kW
DIMENSIONS	500 x 480 x 230mm high
CHAMBER SIZE	250 x 320 x 50mm deep
SEALING BAR	240 x 6mm
WEIGHT	25kg
ORDER CODE	VPS0240

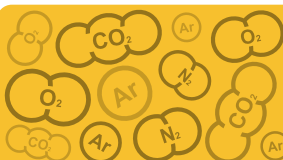

GAS FLUSHING

Injecting a gas increases the product's shelf life, it offers extra protection and it prevents the product from colouring. Usually, a mixture of nitrogen (N₂) and carbon dioxide (CO₂) is used. Dioxygen (O₂) can also be added to this combination. The use of argon (Ar) has been increasing, as this contains the same properties as nitrogen (N₂).

FEATURES

- This product finishes continuous carrying, sealing and printing in one operation
- Fitted with an electronic constant temperature control system
- Fitted with a stepless speed adjusting transmission mechanism
- Pure aluminum turbine box, polyoxymethylene gear and a high-power 80W copper core motor ensures high power, stable performance, low noise and high efficiency
- Fitted with an emergency stop switch to stop quickly in case of emergency
- Fitted with a pure copper heating block - evenly heated and durable
- The machine is supplied with an embossing wheel and a printing wheel as standard
- The sealing width is 6-12mm, which can be adjusted manually
- Fitted with non-slip feet
- The Vertical continuous sealer allows you to package and seal liquids as well



VERTICAL SPECIFICATIONS

MODEL	SmartVac FR-880-LW
ELECTRICITY	0.85kW, 220V, Single Phase
DIMENSIONS	860 x 420 x 350mm high
WEIGHT	20kg
SEAL WIDTH	6 ~ 12mm
OUTPUT	0 ~ 12m/min
TEMPERATURE RANGE	0 ~ 300°C
MAX LOAD	5kg



ORDER CODE **SMS0880-LW**

HORIZONTAL SPECIFICATIONS

MODEL	SmartVac FR-880
ELECTRICITY	0.85kW, 220V, Single Phase
DIMENSIONS	860 x 420 x 350mm high
WEIGHT	19kg
SEAL WIDTH	6 ~ 12mm
OUTPUT	0 ~ 12m/min
TEMPERATURE RANGE	0 ~ 300°C
MAX LOAD	5kg



ORDER CODE **SMS0880**



VERTICAL SEALER
IDEAL FOR SEALING LIQUIDS



HORIZONTAL SEALER
IDEAL FOR SEALING DRY FOODS

HAND PRESS IMPULSE SEALERS



FEATURES

- Body is manufactured from heavy duty painted steel
- Fitted with a timer control and a LED indicator light
- No pre-heating required
- Seals a variety of materials
- Light weight and portable
- Fitted with (4x) non-slip feet

400mm SEALING BAR

SPECIFICATIONS

MODEL SmartVac PFS-400i
 ELECTRICITY 0.6kW, 220V, Single Phase
 DIMENSIONS 550 x 85 x 180mm high
 WEIGHT 2.8kg
 SEALING BAR 400mm
 HEATING TIME 0.2 ~ 1.5sec

ORDER CODE

HSM1400



300mm SEALING BAR

SPECIFICATIONS

MODEL SmartVac PFS-300i
 ELECTRICITY 0.4kW, 220V, Single Phase
 DIMENSIONS 450 x 85 x 180mm high
 WEIGHT 2.5kg
 SEALING BAR 300mm
 HEATING TIME 0.2 ~ 1.5sec

ORDER CODE

HSM1300



200mm SEALING BAR

SPECIFICATIONS

MODEL SmartVac PFS-200i
 ELECTRICITY 0.3W, 220V, Single Phase
 DIMENSIONS 320 x 80 x 150mm high
 WEIGHT 1.8kg
 SEALING BAR 200mm
 HEATING TIME 0.2 ~ 1.5sec

ORDER CODE

HSM1200



WRAPPING MACHINES



FEATURES

- Body is manufactured from stainless steel
- Light weight and portable
- Fitted with (4x) non-slip feet

430mm

SPECIFICATIONS

MODEL SmartVac HWM-430
 ELECTRICITY 0.75kW, 220V, Single Phase
 DIMENSIONS 430 x 660 x 155mm high
 WEIGHT 5kg
 MAX ROLL SIZE 380mm

ORDER CODE

WMS0430



550mm

SPECIFICATIONS

MODEL SmartVac HWM-550
 ELECTRICITY 0.75kW, 220V, Single Phase
 DIMENSIONS 550 x 660 x 155mm high
 WEIGHT 7kg
 MAX ROLL SIZE 500mm

ORDER CODE

WMS0550



SmartChef

PRESSURE FRYERS



COOKING EQUIPMENT

SECTION INDEX

Boiling tables (Gas)	31
Brat pans	40-41
Char grillers (Gas)	32
Charcoal ovens	80-81
Chef bases	35
Chip dumps	49
Combi steam ovens	
• Electric	60-63, 65, 67
• Gas	64, 66
Cone bakers	57
Contact grills	50
Convection ovens	68, 70-71, 78
Conveyor toasters	52
Cooking ranges	
• Electric (Full)	38-39
• Gas (Full)	30
• Gas (Electric oven)	36-37
Corn dog bakers	58
Crepe makers	58
Deck ovens	
• Electric	82, 88-90
• Gas	91-92
Dough proofers	79
Flat top griddles	
• Electric	50
• Gas	33
Fryers	
• Electric (Floor standing)	44
• Electric (Table model)	48
• Gas (Floor standing)	45-46
• Pressure	47-48

Induction cookers	42
Microwave ovens	53
Oil filter cart	46
Oven grids & pans	72, 93
Ovens	
• Charcoal ovens	80-81
• Convection ovens	66, 68-69, 74
• Combi steam ovens	60-67, 69
• Deck ovens	82, 88-92
• Pizza ovens	82-86
Packing stations	49
Pizza ovens	82-86
Proofers	79
Radiant grillers (Gas)	32
Rice cookers	54
Salamanders	53
Sandwich toasters	51
Sous-vide cookers	54
Tilting pans	40-41
Toasters	
• Contact grills	50
• Conveyor	52
• Manual lift	52
• Sandwich	51
Waffle bakers	
• Belgian	55
• Cone bakers	57
• Lolly (Waffle on a stick)	55
• Round	56
Water filtration system	77



FEATURES

- Exterior body manufactured from Stainless steel
- Drip tray provided under burners to catch grease drippings
- Oven pilot with 100% safety shut off
- (1x) chrome oven rack per oven
- 3/4" NPT rear gas connection and regulator provided
- Enamel interior for easy cleaning
- Standing pilot for open top burners
- Multiple position oven rack guides
- Available in Natural and LPG models

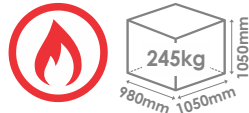

6 BURNER WITH OVEN

SPECIFICATIONS

MODEL	CookRite ATO-6B
BURNER BTU	(6x) 23 000
OVEN BTU	27 000
TOTAL BTU	165 000
DIMENSIONS	915 x 815 x 910mm high (+ 51.5mm splashback)
WEIGHT	185kg
GRATE DIM	(6x) 300 x 300mm
OVEN INTERNAL DIM	670 x 660 x 355mm high
OVEN GRID SUPPLIED	(1x) 665 x 642mm
RUNNER SPACING	40mm
TEMP RANGE	80 to 280°C

ORDER CODE CR/ATO-6B

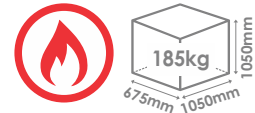

4 BURNER WITH OVEN

SPECIFICATIONS

MODEL	CookRite ATO-4B
BURNER BTU	(4x) 23 000
OVEN BTU	24 000
TOTAL BTU	116 000
DIMENSIONS	610 x 815 x 910mm high (+ 51.5mm splashback)
WEIGHT	137kg
GRATE DIM	(4x) 300 x 300mm
OVEN INTERNAL DIM	510 x 660 x 355mm high
OVEN GRID SUPPLIED	(1x) 500 x 642mm
RUNNER SPACING	40mm
TEMP RANGE	80 to 280°C

ORDER CODE CR/ATO-4B

ADDITIONAL OVEN GRIDS

DIMENSIONS	665 x 642mm
ORDER CODE	CR/GRID-6B

DIMENSIONS	500 x 642mm
ORDER CODE	CR/GRID-4B

BOILING TABLES

TABLE MODEL

FEATURES

- Robust stainless steel exterior and interior
- Heavy duty burners with a standing pilot for open top burners
- Fitted with (4x) device levelling legs
- Fitted with a stainless steel full width drip tray
- Heavy duty cast iron top grates



6 BURNER SPECIFICATIONS

MODEL CookRite ATHP-36-6
 BURNER BTU RATING (6x) 25 000
 TOTAL BTU RATING 150 000
 DIMENSIONS 915 x 700 x 390mm high
 WEIGHT 65kg
 GRATE DIMENSIONS (6x) 300 x 300mm

ORDER CODE **CR/ATHP-36-6**

OPTIONAL STAND

DIMENSIONS 915 x 710 x 650mm high
 ORDER CODE **CR/ATSE-2836**



4 BURNER SPECIFICATIONS

MODEL CookRite ATHP-24-4
 BURNER BTU RATING (4x) 25 000
 TOTAL BTU RATING 100 000
 DIMENSIONS 610 x 700 x 390mm high
 WEIGHT 45kg
 GRATE DIMENSIONS (4x) 300 x 300mm

ORDER CODE **CR/ATHP-24-4**

OPTIONAL STAND

DIMENSIONS 610 x 710 x 650mm high
 ORDER CODE **CR/ATSE-2824**



2 BURNER SPECIFICATIONS

MODEL CookRite ATHP-12-2
 BURNER BTU RATING (2x) 25 000
 TOTAL BTU RATING 50 000
 DIMENSIONS 305 x 700 x 390mm high
 WEIGHT 25kg
 GRATE DIMENSIONS (2x) 300 x 300mm

ORDER CODE **CR/ATHP-12-2**

RADIANT / CHAR GRILLERS

TABLE MODEL

FEATURES

- Robust stainless steel exterior and interior
- Supplied with a stainless steel drip tray
- Fitted with (4x) device levelling legs
- Heavy duty, reversible cast-iron grates
- Top grates are multilevel / adjustable



OPTIONAL STAND

DIMENSIONS 915 x 710 x 650mm high
 ORDER CODE CR/ATSE-2836



900mm

SPECIFICATIONS

BURNER BTU RATING (3x) 35 000
 TOTAL BTU RATING 105 000
 DIMENSIONS 915 x 700 x 390mm high
 WEIGHT 85kg
 COOKING SURFACE 0.63m²

CHAR GRILLER

MODEL CookRite ATCB-36
 ORDER CODE CR/ATCB-36

RADIANT GRILLER

MODEL CookRite ATRC-36
 ORDER CODE CR/ATRC-36



OPTIONAL STAND

DIMENSIONS 610 x 710 x 650mm high
 ORDER CODE CR/ATSE-2824



600mm

SPECIFICATIONS

BURNER BTU RATING (2x) 35 000
 TOTAL BTU RATING 70 000
 DIMENSIONS 610 x 700 x 390mm high
 WEIGHT 65kg
 COOKING SURFACE 0.41m²

CHAR GRILLER

MODEL CookRite ATCB-24
 ORDER CODE CR/ATCB-24

RADIANT GRILLER

MODEL CookRite ATRC-24
 ORDER CODE CR/ATRC-24

STONES FOR CHAR GRILLERS

20kg GRILLING STONES
 ORDER CODE GSB0001

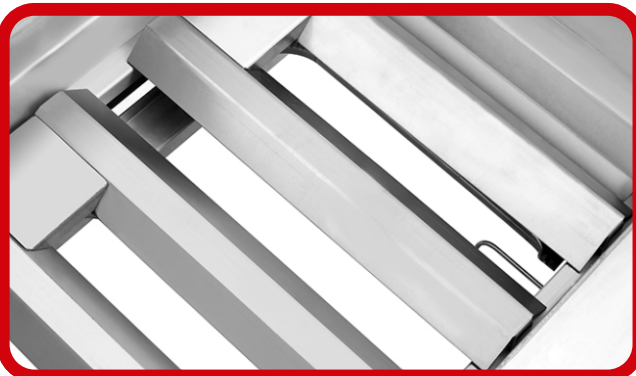

FLAT TOP GRIDDLES

TABLE MODEL

FEATURES

- Robust stainless steel exterior and interior
- Heavy duty, 12mm thick polished griddle plate
- Supplied with a stainless steel drip tray
- Fitted with (4x) device levelling legs



900mm

SPECIFICATIONS

MODEL	CookRite ATMG-36
BURNER BTU RATING	(3x) 30 000
TOTAL BTU RATING	90 000
DIMENSIONS	915 x 700 x 390mm high
WEIGHT	105kg
COOKING SURFACE	0.63m ²

ORDER CODE

CR/ATMG-36

OPTIONAL STAND

DIMENSIONS

915 x 710 x 650mm high

ORDER CODE

CR/ATSE-2836



600mm

SPECIFICATIONS

MODEL	CookRite ATMG-24
BURNER BTU RATING	(2x) 30 000
TOTAL BTU RATING	60 000
DIMENSIONS	610 x 700 x 390mm high
WEIGHT	73kg
COOKING SURFACE	0.41m ²

ORDER CODE

CR/ATMG-24

OPTIONAL STAND

DIMENSIONS

610 x 710 x 650mm high

ORDER CODE

CR/ATSE-2824



FEATURES

- Sturdy, stainless steel top surface and under shelf
- Safety hemmed edge around the sides and back to keep equipment and other content from sliding off
- Added "H-shape" reinforced rib underneath the top surface makes it able to support more evenly distributed weight
- Adjustable under shelf and bullet feet provide additional storage space, as well as optimum stability
- Ships flat-packed
- Tools are included for easy assembly



1220mm SPECIFICATIONS

MODEL	CookRite ATSE-2848
DIMENSIONS	1220 x 710 x 650mm high
WEIGHT	29kg
ORDER CODE	CR/ATSE-2848



915mm SPECIFICATIONS

MODEL	CookRite ATSE-2836
DIMENSIONS	915 x 710 x 650mm high
WEIGHT	24kg
ORDER CODE	CR/ATSE-2836



610mm SPECIFICATIONS

MODEL	CookRite ATSE-2824
DIMENSIONS	610 x 710 x 650mm high
WEIGHT	18kg
ORDER CODE	CR/ATSE-2824



EASY TO ASSEMBLE



ADJUSTABLE FEET



DURABLE STAINLESS STEEL

FEATURES

- Stainless steel exterior and interior
- Carel digital controller
- Gravity fed self closing drawers
- Magnetic drawer gaskets
- Stainless steel inserts included
- One-Piece heavy duty reinforced stainless steel top
- Recessed door handles
- Heavy Duty stainless steel drawer slides and rollers
- Pre-installed casters



1800mm

SPECIFICATIONS

MODEL CookRite MGF8453GR
 ELECTRICITY 0.3kW, 230V, Single Phase
 DIMENSIONS 1840 x 814 x 675mm high
 WEIGHT 136kg
 NUMBER OF DRAWERS 4
 PANS PER DRAWER (2x) 1/1GN
 TEMP RANGE 2 to 5°C
 REFRIGERANT GAS R290

ORDER CODE

CR/MGF8453GR



1200mm

SPECIFICATIONS

MODEL CookRite MGF8450GR
 ELECTRICITY 0.3kW, 230V, Single Phase
 DIMENSIONS 1230 x 814 x 675mm high
 WEIGHT 117kg
 NUMBER OF DRAWERS 2
 PANS PER DRAWER (2x) 1/1GN
 TEMP RANGE 2 to 5°C
 REFRIGERANT GAS R290

ORDER CODE

CR/MGF8450GR

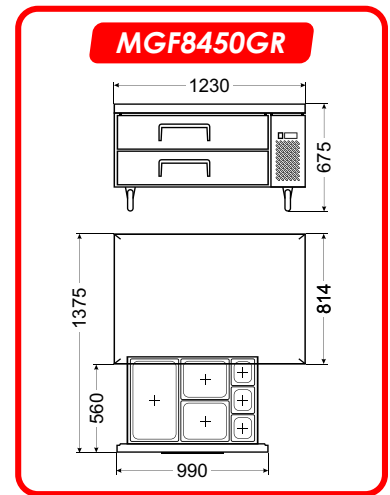
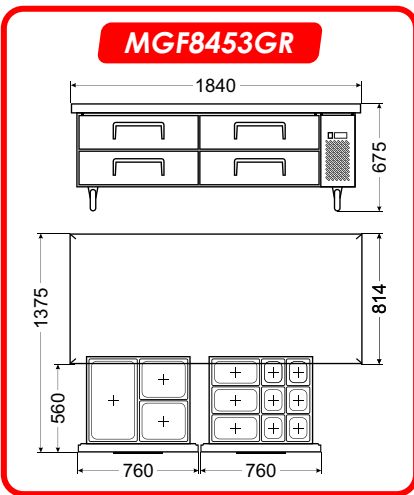

GAS COOKING RANGES

700 SERIES

arisco®

FEATURES

- Body and panelling manufactured of stainless steel
- Top grids manufactured from cast iron
- Each burner operates independently from each other providing heat economy
- Automatic "Flame out" safety switch (If the flame goes out, gas valve is cut off)
- Fitted with (4x) devise leveling legs
- Supplied with (1x) 1/1 GN oven grid



6 BURNER

WITH 1/1GN ELECTRIC CONVECTION OVEN & CABINET

SPECIFICATIONS

MODEL	Arisco GR732E/EO722/D711
BTU RATING	36 000
ELECTRICITY	3kW, 240V, Single Phase
DIMENSIONS	1200 x 700 x 920mm high
WEIGHT	110kg
INTERNAL OVEN DIM	610 x 405 x 302mm high
RUNNER SPACING	48mm - 4 levels
INTERNAL CABINET DIM	355 x 537 x 425mm high
OVEN TEMP RANGE	50 to 300°C

ORDER CODE

ARI/6BG-EOC/700



4 BURNER

WITH 1/1GN ELECTRIC CONVECTION OVEN

SPECIFICATIONS

MODEL	Arisco GR721S/EO722
BTU RATING	24 000
ELECTRICITY	3kW, 240V, Single Phase
DIMENSIONS	800 x 700 x 920mm high
WEIGHT	97kg
INTERNAL OVEN DIM	610 x 405 x 302mm high
RUNNER SPACING	48mm - 4 levels
OVEN TEMP RANGE	50 to 300°C

ORDER CODE

ARI/4BG-EOC/700



ADDITIONAL OVEN GRIDS 530 x 325mm

ORDER CODE OGS0011



GAS COOKING RANGES 900 SERIES



FEATURES

- Body and panelling manufactured of stainless steel
- Top grids manufactured from cast iron
- Each burner operates independently from each other providing heat economy
- Automatic "Flame out" safety switch (*If the flame goes out, gas valve is cut off*)
- Fitted with (4x) devise leveling legs
- Supplied with (1x) 2/1 GN oven grid



4 BURNER WITH 2/1GN ELECTRIC CONVECTION OVEN

SPECIFICATIONS

MODEL	Arisco GR922E
BTU RATING	(4x) 27 000
ELECTRICITY	7.5kW, 380V, 3 Phase + N
DIMENSIONS	850 x 900 x 900mm high
WEIGHT	158kg
INTERNAL OVEN DIM	610 x 700 x 280mm high
RUNNER SPACING	48mm - 4 levels
OVEN TEMP RANGE	50 to 300°C

ORDER CODE **ARI/GR922E**



FEATURES

- Body and panelling manufactured of stainless steel
- Cooking top manufactured from cast iron
- Automatic "Flame out" safety switch (*If the flame goes out, gas valve is cut off*)
- Allows you to sauté, simmer, and warm food all at the same time, without having to fiddle with the knobs of your burners
- Fitted with (4x) devise leveling legs



FRENCH TOP WITH OPEN CABINET

SPECIFICATIONS

MODEL	Arisco GR921P
BTU RATING	48 000
DIMENSIONS	850 x 900 x 900mm high
WEIGHT	160kg
INTERNAL CABINET DIM	825 x 790 x 425mm high

ORDER CODE **ARI/GR921P**



4 BURNER WITH 2/1GN GAS OVEN

SPECIFICATIONS

MODEL	Arisco GR922
BTU RATING	(4x) 27 000 + 25 000
DIMENSIONS	850 x 900 x 900mm high
WEIGHT	158kg
INTERNAL OVEN DIM	610 x 700 x 280mm high
RUNNER SPACING	48mm - 4 levels
OVEN TEMP RANGE	50 to 300°C

ORDER CODE **ARI/GR922**



ADDITIONAL OVEN GRIDS

DIMENSIONS **650 x 530mm**
ORDER CODE **OGS0021**

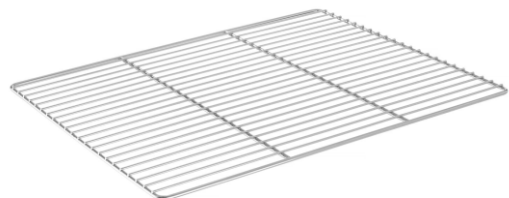

ELECTRIC COOKING RANGES 700 SERIES

arisco®

FEATURES

- Body and panelling manufactured of stainless steel
- Fitted with (4x) 220mm round plates
- Each plate operates independently from each other providing heat economy
- Fitted with a 1/1 GN electric convection oven
- Controlled by thermostats against overheating
- Fitted with (4x) devise leveling legs
- Supplied with (1x) 1/1 GN oven grid



4 PLATE WITH 1/1GN CONVECTION OVEN

SPECIFICATIONS

MODEL	Arisco ER722
ELECTRICITY	13.4kW, 380V, 3 Phase + N
DIMENSIONS	800 x 700 x 900mm high
WEIGHT	88kg
INTERNAL OVEN DIM	610 x 405 x 302mm high
RUNNER SPACING	48mm - 4 levels
OVEN TEMP RANGE	50 to 300°C

ORDER CODE **ARI/ER722**



FEATURES

- Body and panelling manufactured of stainless steel
- Fitted with (4x) 220mm round plates
- Each plate operates independently from each other providing heat economy
- Controlled by thermostats against overheating
- Fitted with a stainless steel neutral cabinet
- Fitted with (4x) devise leveling legs



4 PLATE WITH NEUTRAL CABINET

SPECIFICATIONS

MODEL	Arisco ER721-S/D721
ELECTRICITY	10.4kW, 380V, 3 Phase + N
DIMENSIONS	800 x 700 x 900mm high
WEIGHT	53kg
INTERNAL CABINET DIM	710 x 537 x 425mm high

ORDER CODE **ARI/ER721S/D721**



ADDITIONAL OVEN GRIDS 530 x 325mm **ORDER CODE** OGS0011



ELECTRIC COOKING RANGES 900 SERIES

arisco®

FEATURES

- Body and panelling manufactured of stainless steel
- Fitted with (4x) 300 x 300mm square plates
- Each plate operates independently from each other providing heat economy
- Fitted with a 2/1 GN electric convection oven
- Controlled by thermostats against overheating
- Fitted with (4x) devise leveling legs
- Supplied with (1x) 2/1 GN oven grid



4 PLATE WITH 2/1GN CONVECTION OVEN

SPECIFICATIONS

MODEL	Arisco ER922
ELECTRICITY	22kW, 380V, 3 Phase + N
DIMENSIONS	850 x 900 x 900mm high
WEIGHT	149kg
INTERNAL OVEN DIM	610 x 615 x 302mm high
RUNNER SPACING	48mm - 4 levels
OVEN TEMP RANGE	50 to 300°C

ORDER CODE

ARI/ER922



FEATURES

- Body and panelling manufactured of stainless steel
- Fitted with (4x) 300 x 300mm square plates
- Each plate operates independently from each other providing heat economy
- Controlled by thermostats against overheating
- Fitted on a stainless steel neutral cabinet
- Fitted with (4x) devise leveling legs



4 PLATE WITH NEUTRAL CABINET

SPECIFICATIONS

MODEL	Arisco ER921
ELECTRICITY	16kW, 380V, 3 Phase + N
DIMENSIONS	850 x 900 x 900mm high
WEIGHT	108kg
INTERNAL CABINET DIM	825 x 790 x 425mm high

ORDER CODE

ARI/ER921



ADDITIONAL OVEN GRIDS 650 x 530mm **ORDER CODE** OGS0021

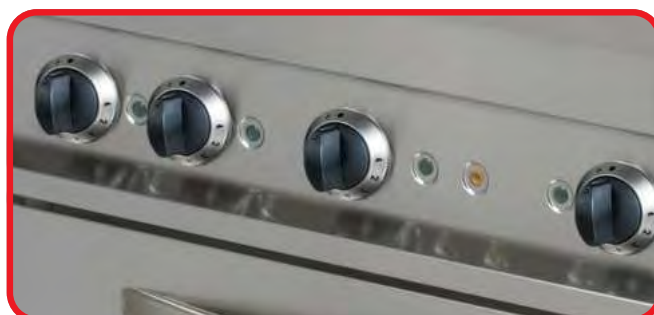

TILTING / BRAT PANS ELECTRIC & GAS

arisco®

FEATURES

- 304 stainless steel tank for easy cleaning
- Safety cutout switch - when tank is lifted burners/elements shut off
- Precise thermostatic temperature control
- Gas models are fitted with stainless steel burners and pilot light
- Fitted with (4x) devise leveling legs
- 10mm, 316-L stainless steel base plate
- Easy to use analogue controls
- Fitted with water fill tap
- Manual tank lift mechanism
- Fitted with counterbalanced hinged lid



95 LITRE ELECTRIC

SPECIFICATIONS

MODEL	Arisco EP922
ELECTRICITY	12kW, 380V, 3 Phase + N
DIMENSIONS	1000 x 900 x 900mm high
WEIGHT	163kg
CAPACITY	95Lt
COOKING SURFACE	915 x 605mm - 0.55m ²
TEMP RANGE	50 to 300°C

ORDER CODE **ARI/EP922**



95 LITRE GAS

SPECIFICATIONS

MODEL	Arisco GP922
BTU RATING	71 655
DIMENSIONS	1000 x 900 x 900mm high
WEIGHT	163kg
CAPACITY	95Lt
COOKING SURFACE	915 x 605mm - 0.55m ²
TEMP RANGE	100 to 300°C

ORDER CODE **ARI/GP922**



TILTING / BRAT PANS ELECTRIC

Kromet[®]



FEATURES

- Robust stainless steel construction
- Pan tilt with manual tilting mechanism/wheel
- Manual lift lid
- Lid designed to prevent dripping
- Extremely durable and reliable product
- Fitted with (4x) device levelling plastic foot pieces

40 LITRE *ELECTRIC*

SPECIFICATIONS

MODEL	Kromet 000.PE-025P
ELECTRICITY	5.4kW, 380V, 3 Phase + N
DIMENSIONS	700 x 600 x 850mm high
WEIGHT	72kg
CAPACITY	40Lt
COOKING SURFACE	0.25m ²
TEMP RANGE	50 to 250°C

ORDER CODE

TPK0040



INDUCTION COOKERS TABLE MODEL

SmartChef-i

FEATURES

- Stainless steel body
- LED display
- 10 temperature settings
- Black crystal glass hob
- Timer (0 - 180min) on single plate only
- Electronic overheating protection
- Touch control
- 10 power levels (500 - 3500W)

*Ferromagnetic compatible cookware only



SINGLE SPECIFICATIONS

MODEL SmartChef-i BT-350K6-E
ELECTRICITY 3.5kW, 230V, Single Phase
DIMENSIONS 330 x 425 x 105mm high
WEIGHT 5kg
TEMP RANGE 60 to 240°C

ORDER CODE **ISC-BT-350K6-E**



DOUBLE SPECIFICATIONS

MODEL SmartChef-i BT-700D3(T)
ELECTRICITY (2x) 3.5kW, 230V, Single Phase
DIMENSIONS 390 x 710 x 125mm high
WEIGHT 14kg
TEMP RANGE 60 to 240°C

ORDER CODE **ISC-BT-700D3(T)**



WOK COOKER SPECIFICATIONS

MODEL SmartChef-i BT-350KCT-2-A
ELECTRICITY 3.5kW, 230V, Single Phase
DIMENSIONS 425 x 330 x 135mm high
WEIGHT 6kg
TEMP RANGE 60 to 240°C

ORDER CODE **ISC-BT-350KCT2A**



WOK PAN SPECIFICATIONS

MODEL SmartChef-i SSWOK
DIAMETER 360mm
WEIGHT 3kg

ORDER CODE **ISC-SSWOK**

Induction cooking operates on a simple yet ingenious principle of **electromagnetic induction**, transforming the way we prepare meals in the kitchen. Beneath the sleek surface of an induction cooktop lies a coil of copper wire through which a high-frequency alternating current passes. When a compatible ferromagnetic pot or pan is placed on the cooktop, the **magnetic field** induces an electric current within the cookware, generating heat directly within the vessel. This direct heating method eliminates the need for an intermediary surface to transfer heat, resulting in **rapid and precise** temperature control. As a result, induction cooking offers an **efficient and responsive** cooking experience, reducing both cooking times and energy consumption.

One of the most significant benefits of induction cooking is its **remarkable efficiency**. By heating the cookware directly, rather than relying on radiant heat or gas flames, induction cooktops waste **minimal energy**. This efficiency not only saves on electricity bills but also **reduces the environmental footprint** of cooking. Furthermore, the precise temperature control of induction cooking allows for more **consistent and uniform results**, whether you're simmering delicate sauces or searing meats to perfection. Additionally, the **instantaneous response** of induction cooktops to changes in temperature settings provides a level of precision unmatched by conventional cooking methods, empowering chefs to exercise **greater control** over their culinary creations.

Beyond efficiency and precision, induction cooking offers a range of practical benefits that **enhance safety** and convenience in the kitchen. Because induction cooktops only generate heat within the cookware itself, the surrounding surface remains relatively **cool to the touch**, reducing the risk of burns and making them safer for households with children. Furthermore, induction cooktops are **easier to clean** than traditional stoves, as spills are less likely to bake onto the surface. With its blend of efficiency, precision, and safety, induction cooking has emerged as a **modern solution** for both home cooks and professional chefs, revolutionizing the way we approach culinary endeavors.



INDUCTION COOKING

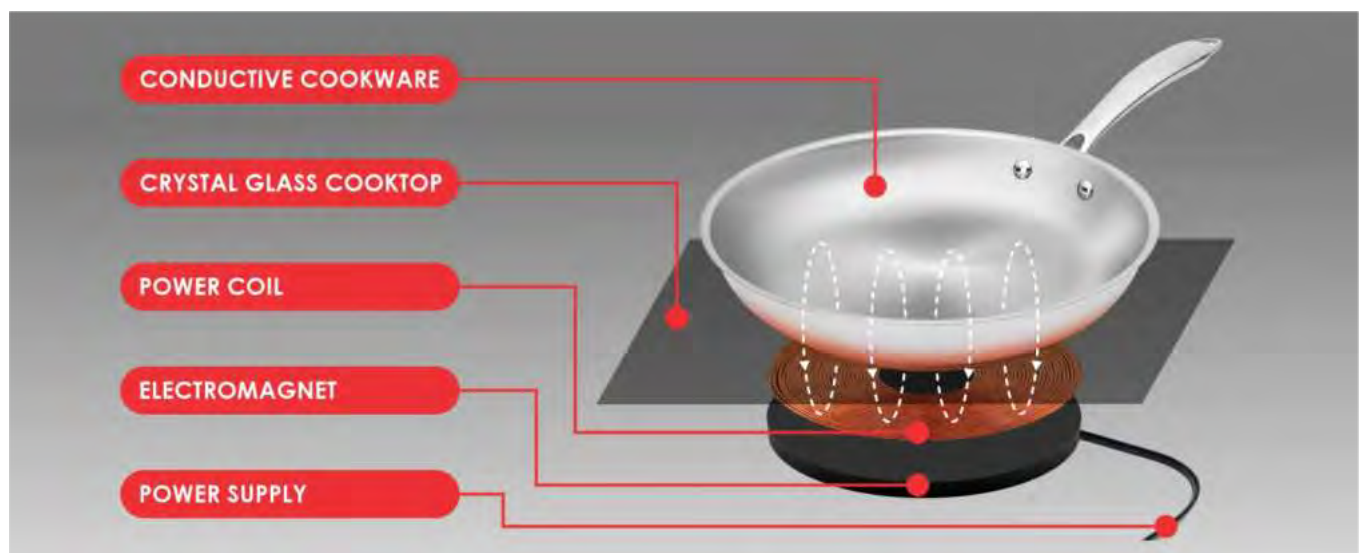



FEATURES

- High quality stainless steel body
- High power for fast heating and recovery
- Replaceable individual heating elements
- Supplied with night covers
- Fitted with control and safety thermostat
- Even heat distribution
- Supplied with chrome plated wire baskets with insulated plastic grips
- Fitted with (4x) 150mm, height adjustable, device leveling legs



2 x 30L BINS

SPECIFICATIONS

MODEL SmartChef E-DZ-800G
ELECTRICITY 36kW, 380V, 3 Phase + N
DIMENSIONS 800 x 825 x 900mm high
(+260 mm splashback)
WEIGHT 85kg
TEMP RANGE 50 to 190°C
CAPACITY 2 x 30L
BASKETS INCLUDED (4x) 160 x 335 x 150mm deep
BASKET CAPACITY 7.5L

ORDER CODE KB/E-DZ-800G

4 x 15L BINS

SPECIFICATIONS

MODEL SmartChef E-DZ-800G-4
ELECTRICITY 36kW, 380V, 3 Phase + N
DIMENSIONS 800 x 825 x 900mm high
(+260 mm splashback)
WEIGHT 85kg
TEMP RANGE 50 to 190°C
CAPACITY 4 x 15L
BASKETS INCLUDED (4x) 160 x 335 x 150mm deep
BASKET CAPACITY 7.5L

ORDER CODE KB/E-DZ-800G-4

1 x 30L BIN

SPECIFICATIONS

MODEL SmartChef E-DZ-400G
ELECTRICITY 18kW, 380V, 3 Phase + N
DIMENSIONS 400 x 825 x 900mm high
(+260 mm splashback)
WEIGHT 48kg
TEMP RANGE 50 to 190°C
CAPACITY 30L
BASKETS INCLUDED (2x) 160 x 335 x 150mm deep
BASKET CAPACITY 7.5L

ORDER CODE KB/E-DZ-400G

2 x 15L BINS

SPECIFICATIONS

MODEL SmartChef E-DZ-400G-2
ELECTRICITY 18kW, 380V, 3 Phase + N
DIMENSIONS 400 x 825 x 900mm high
(+260 mm splashback)
WEIGHT 48kg
TEMP RANGE 50 to 190°C
CAPACITY 2 x 15L
BASKETS INCLUDED (2x) 160 x 335 x 150mm deep
BASKET CAPACITY 7.5L

ORDER CODE KB/E-DZ-400G-2



ADDITIONAL EXTRAS

FRYER BASKET

FBS0075

OIL FILTER CART

KB/E-LYC-1



FEATURES

- Stainless steel exterior and interior
- Welded stainless steel tank
- Heavy duty burners with a standing flame and standby pilots
- Oil cooling zone in the bottom of the tank captures food particles and extends oil life
- Safety valve with an automatic gas stabilizing function
- Self-reset high temperature limiting device
- Supplied with 2 nickel plated baskets with coated handles
- Supplied with wire mesh crumb screen and basket hanger
- Fitted with (4x) 150mm, height adjustable, device leveling legs



35L BIN

SPECIFICATIONS

MODEL	CookRite ATFS-75
BTU RATING	150 000
DIMENSIONS	536 x 765 x 920mm high (+210 mm splashback)
WEIGHT	76kg
TEMP RANGE	93 to 200°C
CAPACITY	35Lt
BASKETS INCLUDED	(2x) 235 x 335 x 150mm deep
BASKET CAPACITY	12Lt

ORDER CODE CR/ATFS-75

ADDITIONAL BASKETS

DIMENSIONS	235 x 335 x 150mm deep
ORDER CODE	FBS0012



20L BIN

SPECIFICATIONS

MODEL	CookRite ATFS-40
BTU RATING	90 000
DIMENSIONS	400 x 765 x 920mm high (+210 mm splashback)
WEIGHT	60kg
TEMP RANGE	93 to 200°C
CAPACITY	20Lt
BASKETS INCLUDED	(2x) 160 x 335 x 150mm deep
BASKET CAPACITY	7.5Lt

ORDER CODE CR/ATFS-40

ADDITIONAL BASKETS

DIMENSIONS	160 x 335 x 150mm deep
ORDER CODE	FTS0075

OPTIONAL EXTRAS OIL FILTER CART KB/E-LYC-1



FEATURES

- Stainless steel exterior and interior
- Welded stainless steel tank
- Heavy duty burners with a standing flame and standby pilots
- Oil cooling zone in the bottom of the tank captures food particles and extends oil life
- Supplied with chrome plated wire baskets with insulated plastic grips
- Fitted with device leveling legs

20Lt BIN

SPECIFICATIONS

MODEL	SmartChef DCF3-LPG
BTU RATING	90 000
CAPACITY	20Lt
DIMENSIONS	380 x 835 x 1145mm high
WEIGHT	75kg
TEMP RANGE	90 to 200°C

ORDER CODE

FSG0040



ADDITIONAL BASKETS

ORDER CODE **FBS0075**

OIL FILTER CART

FEATURES

- Manufactured from Stainless steel
- High efficiency filtration prolongs the use cycle of oil, reducing cost and increasing profit
- Fitted with universal casters for easy mobility (two lockable)



SPECIFICATIONS

MODEL	SmartChef E-LYC-1
ELECTRICITY	0.55kW, 220V, Single Phase
DIMENSIONS	440 x 755 x 620mm
WEIGHT	25kg
CAPACITY	40Lt

ORDER CODE

KB/E-LYC-1



ADDITIONAL OIL FILTER BAGS

ORDER CODE **OFB0050**



FEATURES

- Body manufactured from 304 Stainless steel
- Built-in filtration system makes oil recycling easy and energy efficient
- Fitted with a pressure gauge
- Functions: electronic timing / automatic temperature and pressure control / exhausting and over-pressure protection
- Electronic control panel with 10 pre-programmed cooking functions
- Supplied with a cleaning kit
- Supplied with (1x) fryer baskets (3 Layer)
- Fitted with (4x) castors (2 lockable)

25 LITRE ELECTRIC 

SPECIFICATIONS

MODEL	SmartChef YXD-25D
ELECTRICITY	13.5kW, 380V, 3 Phase + N
DIMENSIONS	470 x 920 x 1180mm high
WEIGHT	135kg
TEMP RANGE	60 to 200°C
OPERATING PRESSURE	12psi
CAPACITY	25Lt
BASKETS INCLUDED	(1x) 3 Layer basket 250 x 340 x 195mm deep
BASKET CAPACITY	16.5Lt Chicken ± 24-30 pc

ORDER CODE

PFS-YXD-25D



3 PIECE CLEANING KIT INCLUDED AS STANDARD



- (1x) Straight brush
- (1x) L-Shape brush
- (1x) Long handle brush

25 LITRE GAS 

SPECIFICATIONS

MODEL	SmartChef YXY-25D
ELECTRICITY	0.65kW, 220V, Single Phase
BTU RATING	45 000
DIMENSIONS	500 x 1030 x 1180mm high
WEIGHT	165kg
TEMP RANGE	60 to 200°C
OPERATING PRESSURE	12psi
CAPACITY	25Lt
BASKETS INCLUDED	(1x) 3 Layer basket 250 x 340 x 195mm deep
BASKET CAPACITY	16.5Lt Chicken ± 24-30 pc

ORDER CODE

PFS-YXY-25D



3 LAYER BASKET



- Maximize space and streamline food preparation processes
- Layer spacing 70mm

OPTIONAL EXTRAS

REGULAR BASKET
5 PIECE CLEANING KIT

**PFS-YXD-BO
CKF0005**

3 LAYER BASKET
2 PIECE CLEANING KIT

**PFS-YXD-B3
CKF0002**

FILTER PAPER 100 PACK

FPS0100

FEATURES

- Body manufactured from 304 Stainless steel
- Aluminum lid, rugged and lightweight, easy to open and close
- Manual temperature control and timer
- Quadruple explosion protection: Vent valve; pressure valve; silicone sealing ring; elastic beam
- Fitted with a pressure gauge
- Fitted with an oil drainage tap with a safety locking mechanism
- Supplied with fryer basket
- Fitted with non-slip feet



16 LITRE - TABLE MODEL

SPECIFICATIONS

MODEL	SmartChef YXDT-16
ELECTRICITY	3kW, 230V, Single Phase
DIMENSIONS	440 x 570 x 520mm high
WEIGHT	21kg
TEMP RANGE	60 to 200°C
OPERATING PRESSURE	8psi
CAPACITY	16Lt
BASKETS INCLUDED	(1x) 738 Ø x 195mm deep
BASKET CAPACITY	8.5Lt

ORDER CODE

PFS-YXDT-16



ADDITIONAL BASKETS

738 Ø x 195mm

PFS-YXDT-B

ELECTRIC FRYERS TABLE MODEL

FEATURES

- Removable element box
- Supplied with night cover and baskets
- Fitted with safety thermostat
- 3kW element per pan for fast recovery
- Removable oil tank with special handles
- Fitted with (4x) non-slip rubber feet



2 x 6Lt BINS

SPECIFICATIONS

MODEL	SmartChef E-DZ-6L-2
ELECTRICITY	(2x) 230V, 2.5kW, Single Phase
CAPACITY	(2x) 6Lt
DIMENSIONS	540 x 410 x 285mm high
WEIGHT	6kg
TEMP RANGE	60 to 200°C
BASKETS INCLUDED	(2x) 200 x 215 x 100mm deep
BASKETS CAPACITY	4.3Lt

ORDER CODE

KB/E-DZ-6L-2



1 x 6Lt BIN

SPECIFICATIONS

MODEL	SmartChef E-DZ-6L
ELECTRICITY	230V, 2.5kW, Single Phase
CAPACITY	6Lt
DIMENSIONS	260 x 410 x 285mm high
WEIGHT	4kg
TEMP RANGE	60 to 200°C
BASKETS INCLUDED	(1x) 200 x 215 x 100mm deep
BASKETS CAPACITY	4.3Lt

ORDER CODE

KB/E-DZ-6L

ADDITIONAL BASKETS ORDER CODE FBS0043

FEATURES

- Manufactured from stainless steel
- Heating element provides even heat distribution
- Ideal for keeping chips warm
- Fitted with (4x) non-slip rubber feet



SPECIFICATIONS

MODEL SmartChef HCW-620
 ELECTRICITY 1kW, 230V, Single Phase
 DIMENSIONS 345 x 605 x 550mm high
 WEIGHT 7kg
 TEMP RANGE 30 to 85°C

ORDER CODE

CDS1000



FEATURES

- Manufactured from heavy-duty stainless steel
- Fitted with a removable drainboard and oil collecting pan to drain and collect excess oil
- Fitted with a multi-slot packaging shelf
- Infrared heating tubes provide heat to keep your fried foods hot, crisp, and ready to serve at all times
- Two warm light bulbs attached to the top illuminates the food station for improved display
- Separate switches provide simplified operation for controlling the heat and lights individually
- Fitted with 4 non-slip feet



SPECIFICATIONS

MODEL SmartChef HCW-8
 ELECTRICITY 0.64kW, 220V, Single Phase
 DIMENSIONS 800 x 700 x 650mm high
 WEIGHT 31kg
 TEMP RANGE 30 to 85°C

ORDER CODE

CDS2000

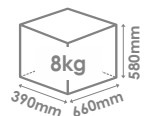

FLAT TOP GRIDDLES TABLE MODEL

SmartChef



730mm

SPECIFICATIONS

MODEL SmartChef HEG-820
ELECTRICITY 4.4kW, 230V, Single Phase
DIMENSIONS 730 x 470 x 240mm high
WEIGHT 34kg
COOKING SURFACE 728 x 400mm
TEMP RANGE 50 to 300°C

ORDER CODE

FTS0730



FEATURES

- Strong stainless steel body with splash guard
- Large output capacity
- Thick steel plate for even heat distribution and heat retention
- Fat drainage drawer for convenience
- Thermostat controller
- Energy efficient
- Easy to use and clean-up
- Fitted with (4x) non-slip feet

550mm

SPECIFICATIONS

MODEL SmartChef HEG-818
ELECTRICITY 3kW, 230V, Single Phase
DIMENSIONS 550 x 430 x 240mm high
WEIGHT 19kg
COOKING SURFACE 548 x 350mm
TEMP RANGE 50 to 300°C

ORDER CODE

FTS0550



CONTACT GRILLS

SmartChef

FEATURES

- Adjustable top plate for a variety of product thickness
- Heat resistant handle
- Available in full flat and full ribbed non-stick surface models
- Drip tray to catch excess fat
- Robust construction
- Fitted with (4x) non-slip feet



NON-STICK FLAT PLATES

SPECIFICATIONS

MODEL SmartChef HEG-811EB
ELECTRICITY 2.2kW, 230V, Single Phase
DIMENSIONS 435 x 410 x 210mm high
WEIGHT 19kg
COOKING SURFACE 345 x 235mm
TEMP RANGE 50 to 300°C

ORDER CODE

CGS0002



NON-STICK RIBBED PLATES

SPECIFICATIONS

MODEL SmartChef HEG-811E
ELECTRICITY 2.2kW, 230V, Single Phase
DIMENSIONS 435 x 410 x 210mm high
WEIGHT 19kg
COOKING SURFACE 345 x 235mm
TEMP RANGE 50 to 300°C

ORDER CODE

CGS1002



FEATURES

- Robust construction
- Drip tray to catch excess fat
- Fitted with a heat resistant handle
- Adjustable top plate for a variety of product thickness
- Available in standard & non-stick plate models
- Fitted with (4x) non-slip feet



STANDARD PLATES

SPECIFICATIONS

MODEL	SmartChef HT-01
ELECTRICITY	2.2kW, 230V, Single Phase
DIMENSIONS	540 x 400 x 290mm high
WEIGHT	8kg
COOKING SURFACE	353 x 330mm
TEMP RANGE	50 to 300°C

ORDER CODE STS0009



NON-STICK PLATES

SPECIFICATIONS

MODEL	SmartChef HT-01
ELECTRICITY	2.2kW, 230V, Single Phase
DIMENSIONS	540 x 400 x 290mm high
WEIGHT	8kg
COOKING SURFACE	353 x 330mm
TEMP RANGE	50 to 300°C

ORDER CODE STS1009

OPTIONAL EXTRAS

Teflon cover

TCT0001



FEATURES

- Stainless steel construction
- Standby / bread / roll settings available
- Perfect for self-service application
- Fitted with (4x) device leveling legs
- Various conveyor speed settings
- Can be set to pass through or return to front operation
- Individual heat controls for top and bottom elements



450 SLICE WIDE BELT

SPECIFICATIONS

MODEL	SmartChef TT-450
ELECTRICITY	2.6kW, 230V, Single Phase
DIMENSIONS	470 x 420 x 400mm high
WEIGHT	18kg
CAPACITY	450 to 500 slices per hour

ORDER CODE CTS0450



300 SLICE

SPECIFICATIONS

MODEL	SmartChef TT-300
ELECTRICITY	1.94kW, 230V, Single Phase
DIMENSIONS	350 x 420 x 400mm high
WEIGHT	14kg
CAPACITY	300 to 350 slices per hour

ORDER CODE CTS0300

6 SLICE TOASTERS



FEATURES

- Stainless steel construction
- Fitted with a timer
- 3 or 6 slot operation can be chosen
- Fitted with (4x) non-slip feet

SPECIFICATIONS

MODEL	SmartChef HET-6
ELECTRICITY	3.2kW, 230V, Single Phase
DIMENSIONS	460 x 210 x 225mm high
WEIGHT	7kg
CAPACITY	3/6 slices

ORDER CODE TLS0006



FEATURES

- Inner and outer casing manufactured from stainless steel
- The salamander can be used to toast, heat and grill
- 4 pre-set positions for removable grid
- Fitted with 4 non-slip feet



SPECIFICATIONS

MODEL	SmartChef SA936
ELECTRICITY	2kW ,220V, Single Phase
DIMENSIONS	610 x 340 x 280mm high
WEIGHT	13.5kg
TEMP RANGE	50 to 250°C
ORDER CODE	SES0936

SALAMANDERS GAS

FEATURES

- High quality stainless steel structure
- 4 Position adjustable shelf
- Thermostat controller
- Thick steel plate for even heat distribution and heat retention
- Fat drainage drawer for convenience
- (2x) 21 500 BTU high efficiency ceramic burners and standby pilots



SPECIFICATIONS

MODEL	CookRite ATSB-36
TOTAL BTU RATING	43 000
DIMENSIONS	914 x 457 x 440mm high
WEIGHT	65kg
RUNNER SPACING	95mm
SHELF DIMENSIONS	710 x 356mm
ORDER CODE	CR/ATSB-36

MICROWAVE OVEN

FEATURES

- All stainless steel exterior and interior
- Includes interior light
- Digital touch pad controls
- LED display
- Audible alarm when timed cycle is complete
- Large easy to grip polished handle with durable interlock system
- Reinforced flexible door latch to reduce breakage
- 3 stage cooking capabilities



SPECIFICATIONS

MODEL	SmartWave EM025
ELECTRICITY	1kW, 220V, Single Phase
DIMENSIONS	510 x 430 x 310mm high
WEIGHT	17kg
CAPACITY	25Lt
ORDER CODE	MWS2510



ELECTRIC RICE COOKERS

SmartChef



FEATURES

- Painted steel exterior pot fitted with cool-touch plastic handles
- Removable interior cooking pot manufactured from high quality aluminium
- Stainless steel lid with cool-touch plastic handle
- Keep-warm function keeps food fresh before serving
- Cooking and keep-warm indicator lights
- Fitted with (3x) plastic feet
- Supplied with a food grade plastic rice spoon

SPECIFICATIONS

MODEL	SmartChef ERC-10L
ELECTRICITY	1.6kW, 220V, Single Phase
DIMENSIONS	710 Ø x 325mm high
WEIGHT	5kg
CAPACITY	4.6Lt

ORDER CODE

RCS0010



SOUS-VIDE COOKERS

SmartChef



FEATURES

- AISI 304 stainless steel structure
- Temperature sensor
- Accuracy +/- 0.1°C
- 5 minutes to 99 hours digital timer
- For low temperature vacuum cooking

SPECIFICATIONS

MODEL	SmartChef SV130
ELECTRICITY	1.5kW, 220V, Single Phase
DIMENSIONS	70 x 145 x 340mm high
WEIGHT	1.3kg
TEMP RANGE	5 to 90°C
HEATING CAPACITY	20Lt to 30Lt

ORDER CODE

SVS0130



FEATURES

- Machine body manufactured from stainless steel
- The handles are manufactured from heat-resistant material
- Fitted with a timer
- A removable tray around the bottom of the work surface is used to collect excess dough for easy cleaning
- Cast aluminium baking plates with non-stick coating
- Thermostat controlled
- Fitted with (4x) non-slip feet



BELGIAN - SINGLE

SPECIFICATIONS

MODEL	SmartChef HWB-1S
ELECTRICITY	1.6kW, 230V, Single Phase
DIMENSIONS	290 x 330 x 250mm high
WEIGHT	7.5kg
BAKING SURFACE	220 x 220mm
TEMP RANGE	50 to 300°C

ORDER CODE **WBS0001**



BELGIAN - DOUBLE

SPECIFICATIONS

MODEL	SmartChef HWB-2S
ELECTRICITY	3.2kW, 230V, Single Phase
DIMENSIONS	570 x 380 x 250mm high
WEIGHT	15kg
BAKING SURFACE	(2x) 220 x 220mm
TEMP RANGE	50 to 300°C

ORDER CODE **WBS0002**



WAFFLE LOLLY WAFFLE ON A STICK

SPECIFICATIONS

MODEL	SmartChef HX-2208
ELECTRICITY	1.7kW, 230V, Single Phase
DIMENSIONS	330 x 365 x 235mm high
WEIGHT	10kg
CAPACITY	4 Rows
SINGLE WAFFLE SIZE	225 x 60 x 15mm
TEMP RANGE	50 to 300°C

ORDER CODE **WBS2001**



ROUND WAFFLE BAKERS SNACK



FEATURES

- Machine body manufactured from stainless steel
- Fitted with heat-insulated handles
- Fitted with a timer
- Fitted with (4x) non-slip feet
- Cast aluminium baking plates with non-stick coating
- Thermostat controlled
- A removable tray around the bottom of the work surface is used to collect excess dough for easy cleaning



SINGLE

SPECIFICATIONS

MODEL SmartChef HWB-1
 ELECTRICITY 1kW, 230V, Single Phase
 DIMENSIONS 250 x 350 x 260mm high
 WEIGHT 6kg
 BAKING SURFACE 170mm Ø
 TEMP RANGE 50 to 300°C

ORDER CODE WBS1001



DOUBLE

SPECIFICATIONS

MODEL SmartChef HWB-2
 ELECTRICITY 2kW, 230V, Single Phase
 DIMENSIONS 500 x 350 x 260mm high
 WEIGHT 11kg
 BAKING SURFACE (2x) 170mm Ø
 TEMP RANGE 50 to 300°C

ORDER CODE WBS1002



FEATURES

- Machine body manufactured from stainless steel
- Fitted with a timer
- Easy to clean
- Fitted with (4x) non-slip feet
- Cast aluminium baking plates with non-stick coating
- Thermostat controlled
- Spiral metal handles. Isolated to prevent burning
- Cone roller moulds included



SINGLE PLATE SPECIFICATIONS

MODEL SmartChef HCB-1
ELECTRICITY 1.2kW, 230V, Single Phase
DIMENSIONS 250 x 360 x 270mm high
WEIGHT 6.4kg
BAKING SURFACE 210mm Ø
TEMP RANGE 50 to 300°C

ORDER CODE CBS1001



DOUBLE PLATE SPECIFICATIONS

MODEL SmartChef HCB-2
ELECTRICITY 2.4kW, 230V, Single Phase
DIMENSIONS 500 x 360 x 270mm high
WEIGHT 11kg
BAKING SURFACE (2x) 210mm Ø
TEMP RANGE 50 to 300°C

ORDER CODE CBS1002



CREPE MAKERS

SmartChef



FEATURES

- Body manufactured from stainless steel
- Cooking surface manufactured from cast aluminium with non-stick coating
- Stainless steel heating element
- Easy to clean
- Wooden batter spreader included

SPECIFICATIONS

MODEL	SmartChef FYA-1
ELECTRICITY	3kW, 220V, Single Phase
DIMENSIONS	450 x 455 x 235mm high
WEIGHT	16kg
BAKING SURFACE	400mm Ø
TEMP RANGE	50 to 300°C

ORDER CODE

CMS0001



CORN DOG BAKERS

SmartChef



FEATURES

- Body manufactured from stainless steel
- Baking plates manufactured from cast aluminium with non-stick coating
- The handles are manufactured from heat-resistant material
- Thermostat controlled
- Fitted with a timer
- Fitted with (4x) non-slip feet

SPECIFICATIONS

MODEL	SmartChef HX-216
ELECTRICITY	1.5kW, 220V, Single Phase
DIMENSIONS	335 x 300 x 245mm high
WEIGHT	8kg
TEMP RANGE	50 to 300°C
CAPACITY	6 Corn dogs
CORN DOG SIZE	140mm x 40mm Ø

ORDER CODE

WBS2002





COMBI STEAMERS & CONVECTION OVENS





FEATURES

- Patented fan guard system *Airflowlogic™*
 - Patented system for direct steam *Humilogic™*
 - Patented system for cooking chamber drying *Drylogic™*
 - Outer casing manufactured from AISI 304 stainless steel
 - Cooking chamber is manufactured from 1mm - thick, moulded, AISI 304 18/10 stainless steel with fully rounded edges
 - Cooking chamber lighting via LED Bar fitted into the door
 - Door is right hand hinged with adjustable door hinges and handle catch
 - 10 Levels of direct steam controlled by a touch control panel situated on the right hand side of the door
 - Fitted with quick selection knob for the touch screen
 - The side supports and drip tray can easily be removed for cleaning
 - Fitted with 4 bidirectional fan motors for even heat distribution
 - 500 Programmable recipes
 - Delayed start function up to 23 hours and 59 minutes
 - Supplied with multipoint core probe
 - Trays and grids not included
- IPX5 protection rating against water
 - 42 Language settings for the control panel
 - Humidity management software installed
 - Automatic washing system integrated
 - Chemicals not included

** It is recommend that all combi steamers be installed with water treatment system



20 PAN GASTRONOMY

SPECIFICATIONS

MODEL	EKA MKF 2011 TS
ELECTRICITY	31kW, 380V, 3 Phase + N
DIMENSIONS	930 x 1035 x 1900mm high
WEIGHT	247kg
CHAMBER DIMENSIONS	710 x 551 x 1440mm high
TEMP RANGE	30 to 270°C
NUMBER OF PROGRAMS	500
PROGRAMMABLE COOKING STEPS	10
PRE-HEATING TEMPERATURE	180°C

ORDER CODE

MKF2011TS



Supplied with 20 pan gastronomy trolley with handle

CAPACITY	(20x) 1/1GN Pans
RUNNER SPACING	66mm
ORDER CODE	EKF-EKCR20TC

Convert your oven to a 16 tray baking oven by changing trolleys

CAPACITY	(16x) 600 x 400 baking trays
RUNNER SPACING	80mm
ORDER CODE	EKF-EKCR16TC



STANDARD WITH BUILT-IN SELF CLEAN SYSTEM

OPTIONAL EXTRAS (FULL SPECS • PAGE 72 - 73)

INSERTS

- 1/1 GN PAN - 55mm
- 1/1 GN PAN - 55mm (perforated)
- 1/1 GN PAN - 40mm
- 1/1 GN PAN - 40mm (perforated)

- GNF8055**
- GNF8055.P**
- GNF8040**
- GNF8040.P**

GRIDS

- 1/1 GN GRID

OGS0011

BAKING TRAYS

- 600 x 400 x 30mm

BTA0064

CLEANING

- CLEANING DETERGENT

MKF-MKDET



FEATURES

- Outer casing manufactured from AISI 304 stainless steel
- Cooking chamber is manufactured from 1mm - thick, moulded, AISI 304 18/10 stainless steel with fully rounded edges
- Cooking chamber lighting via LED Bar fitted into the door
- Door is right hand hinged with adjustable door hinges and handle catch
- The side supports and drip tray can easily be removed for cleaning
- Manual hand spray/wash can be fitted
- 5 Levels of direct steam controlled by a manual control panel situated on the right hand side of the door
- Fitted with a condensate collection bowl, with drain on door
- Fitted with 4 bidirectional fan motors for even heat distribution
- IPX4 protection rating against water
- Timer for cooking from 10 to 120 minutes / infinity
- Supplied without stand
- Supplied without trays and grids
- Supplied without chemicals

** It is recommend that all combi steamers be installed with water treatment system



20 PAN GASTRONOMY

SPECIFICATIONS

MODEL	EKA MKF 2011 S
ELECTRICITY	31kW, 380V, 3 Phase + N
DIMENSIONS	930 x 1041 x 1900mm high
WEIGHT	247kg
CHAMBER DIMENSIONS	710 x 551 x 1440mm high
TEMP RANGE	100 to 270°C
PRE-HEATING TEMPERATURE	180°C

ORDER CODE

MKF2011S



Supplied with 20 pan gastronomy trolley with handle

CAPACITY	(20x) 1/1GN Pans
RUNNER SPACING	66mm
ORDER CODE	EKF-EKCR20TC

Convert your oven to a 16 tray baking oven by changing trolleys

CAPACITY	(16x) 600 x 400 baking trays
RUNNER SPACING	80mm
ORDER CODE	EKF-EKCR16TC

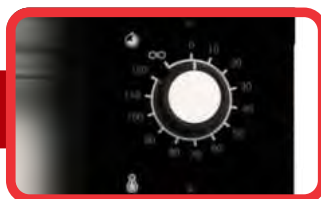
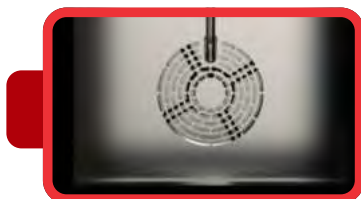

OPTIONAL EXTRAS (FULL SPECS • PAGE 72 - 73)

INSERTS

- 1/1 GN PAN - 55mm
- 1/1 GN PAN - 55mm (perforated)
- 1/1 GN PAN - 40mm
- 1/1 GN PAN - 40mm (perforated)

- GNF8055**
- GNF8055.P**
- GNF8040**
- GNF8040.P**

GRIDS

- 1/1 GN GRID

OGS0011

BAKING TRAYS

- 600 x 400 x 30mm

BTA0064

CLEANING

- MANUAL SPAY KIT

EKF-EKKD



FEATURES

- Patented technology *Airflowlogic™* / *Humilogic™* / *Drylogic™*
- Outer casing manufactured from AISI 304 stainless steel
- Cooking chamber is manufactured from 1mm - thick, moulded, AISI 304 18/10 stainless steel with fully rounded edges
- Cooking chamber lighting via LED Bar fitted into the door
- Door is right hand hinged with adjustable door hinges and handle catch
- The side supports and drip tray can easily be removed for cleaning
- 10 Levels of direct steam controlled by a touch control panel situated on the right hand side of the door
- IPX5 protection rating against water
- 42 Language settings for the control panel
- Humidity management software installed
- Automatic washing system integrated
- Stand, trays and grids NOT supplied
- Fitted with quick selection knob for the touch screen
- 500 Programmable recipes
- Fitted with a Wi-fi communication system
- Delayed start function up to 23 hours and 59 minutes
- Multipoint core probe included

** It is recommend that all combi steamers be installed with water treatment system



11 PAN GASTRONOMY

SPECIFICATIONS

MODEL	EKA MKF 1111 TS
ELECTRICITY	15.4kW, 380V, 3 Phase + N
DIMENSIONS	730 x 850 x 1130mm high
WEIGHT	114kg
CAPACITY	(11x) 1/1 GN pans
RUNNER SPACING	68mm
NUMBER OF FANS	(2x) bidirectional
TEMP RANGE	30 to 270°C
NO. OF PROGRAMS	500
PROG. COOKING STEPS	10
PRE-HEAT TEMPERATURE	180°C



ORDER CODE MKF1111TS

7 PAN GASTRONOMY

SPECIFICATIONS

MODEL	EKA MKF 711 TS
ELECTRICITY	11.4kW, 380V, 3 Phase + N
DIMENSIONS	730 x 850 x 850mm high
WEIGHT	96kg
CAPACITY	(7x) 1/1 GN pans
RUNNER SPACING	68mm
NUMBER OF FANS	(2x) bidirectional
TEMP RANGE	30 to 270°C
NO. OF PROGRAMS	500
PROG. COOKING STEPS	10
PRE-HEAT TEMPERATURE	180°C



ORDER CODE MKF711TS



STANDARD WITH BUILT-IN SELF CLEAN SYSTEM

OPTIONAL EXTRAS (FULL SPECS • PAGE 72 - 73)

INSERTS

1/1 GN PAN - 55mm	GNF8055
1/1 GN PAN - 55mm (perforated)	GNF8055.P
1/1 GN PAN - 40mm	GNF8040
1/1 GN PAN - 40mm (perforated)	GNF8040.P

GRIDS

1/1 GN GRID	OGS0011
-------------	----------------

STANDS

Stand for MKF1111TS	MKF-MKTS1111-L
Stand for MKF711TS	MKF-MKTS711-L

CLEANING

CLEANING DETERGENT	MKF-MKDET
--------------------	------------------



FEATURES

- Outer casing manufactured from stainless steel
- Cooking chamber is manufactured from 1mm - thick, moulded, AISI 304 18/10 stainless steel with fully rounded edges
- Cooking chamber lighting via LED Bar fitted into the door
- Door is right hand hinged with adjustable door hinges and handle catch
- The side supports and drip tray can easily be removed for cleaning
- Manual hand spray/wash can be fitted
- 5 Levels of direct steam controlled by a manual control panel situated on the right hand side of the door
- IPX4 protection rating against water
- Timer for cooking from 10 to 120 minutes / infinity
- Supplied without trays and grids
- Fitted with a condensate collection bowl, with drain on door
- Supplied without stand
- Fitted with 2 bidirectional fan motors for even heat distribution

** It is recommend that all combi steamers be installed with water treatment system



11 PAN GASTRONOMY

SPECIFICATIONS

MODEL	EKA MKF 1111 S
ELECTRICITY	15.4kW, 380V, 3 Phase + N
DIMENSIONS	730 x 855 x 1130mm high
WEIGHT	114kg
CAPACITY	(11x) 1/1 GN pans
RUNNER SPACING	68mm
NUMBER OF FANS	(2x) bidirectional
TEMP RANGE	100 to 270 °C

ORDER CODE MKF1111S



7 PAN GASTRONOMY

SPECIFICATIONS

MODEL	EKA MKF 711 S
ELECTRICITY	10.4kW, 380V, 3 Phase + N
DIMENSIONS	730 x 855 x 850mm high
WEIGHT	96kg
CAPACITY	(7x) 1/1 GN pans
RUNNER SPACING	68mm
NUMBER OF FANS	(2x) bidirectional
TEMP RANGE	100 to 270 °C

ORDER CODE MKF711S



OPTIONAL EXTRAS (FULL SPECS • PAGE 72 - 73)

INSERTS

1/1 GN PAN - 55mm	GNF8055
1/1 GN PAN - 55mm (perforated)	GNF8055.P
1/1 GN PAN - 40mm	GNF8040
1/1 GN PAN - 40mm (perforated)	GNF8040.P

GRIDS

1/1 GN GRID	OGS0011
-------------	----------------

STANDS

Stand for MKF1111TS	MKF-MKTS1111-L
Stand for MKF711TS	MKF-MKTS711-L

CLEANING

MANUAL SPRAY KIT	EKF-EKGD
------------------	-----------------



FEATURES

- Outer casing manufactured from stainless steel
- Cooking chamber is manufactured from 1mm - thick, moulded, AISI 304 18/10 stainless steel with fully rounded edges
- Cooking chamber lighting via LED Bar fitted into the door
- Door is right hand hinged with adjustable door hinges and handle catch
- The side supports and drip tray can easily be removed for cleaning
- Manual hand spray/wash can be fitted
- 5 Levels of direct steam controlled by a manual control panel situated on the right hand side of the door
- Fitted with a condensate collection bowl, with drain on door
- Timer for cooking from 10 to 120 minutes / infinity
- Supplied without trays and grids
- IPX4 protection rating against water
- Supplied without stand
- Fitted with bidirectional fan motors for even heat distribution

** It is recommend that all combi steamers be installed with water treatment system



11 PAN GASTRONOMY

SPECIFICATIONS

MODEL	EKA MKF 1111 GS
BTU RATING	60 000
ELECTRICITY	0.7kW, 220V, Single Phase
DIMENSIONS	730 x 855 x 1231mm high
WEIGHT	141kg
CAPACITY	(11x) 1/1 GN pans
RUNNER SPACING	68mm
NUMBER OF FANS	(3x) bidirectional
TEMP RANGE	100 to 270 °C

ORDER CODE

MKF1111GS



7 PAN GASTRONOMY

SPECIFICATIONS

MODEL	EKA MKF 711 GS
BTU RATING	46 000
ELECTRICITY	0.5kW, 220V, Single Phase
DIMENSIONS	730 x 855 x 850mm high
WEIGHT	109kg
CAPACITY	(7x) 1/1 GN pans
RUNNER SPACING	68mm
NUMBER OF FANS	(2x) bidirectional
TEMP RANGE	100 to 270 °C

ORDER CODE

MKF711GS



OPTIONAL EXTRAS (FULL SPECS • PAGE 72 - 73)

INSERTS

1/1 GN PAN - 55mm	GNF8055
1/1 GN PAN - 55mm (perforated)	GNF8055.P
1/1 GN PAN - 40mm	GNF8040
1/1 GN PAN - 40mm (perforated)	GNF8040.P

GRIDS

1/1 GN GRID	OGS0011
-------------	----------------

STANDS

Stand for MKF1111GS	MKF-MKTS1111-L
Stand for MKF711GS	MKF-MKTS711-L

CLEANING

MANUAL SPRAY KIT	EKF-EKKD
------------------	-----------------



FEATURES

- Outer casing manufactured from stainless steel
- Cooking chamber is manufactured from 1mm - thick, moulded, AISI 304 18/10 stainless steel with fully rounded edges
- Cooking chamber lighting via LED Bar fitted into the door
- Door is right hand hinged with adjustable door hinges and handle catch
- The side supports and drip tray can easily be removed for cleaning
- Manual hand spray/wash can be fitted
- 5 Levels of direct steam controlled by a manual control panel situated on the right hand side of the door
 - IPX4 protection rating against water
 - Supplied without stand
 - Fitted with bidirectional fan motors for even heat distribution
- Fitted with a condensate collection bowl, with drain on door
- Timer for cooking from 10 to 120 minutes / infinity
- Supplied without trays and grids

** It is recommend that all combi steamers be installed with water treatment system



10 TRAY BAKERY

SPECIFICATIONS

MODEL	EKA MKF 1064 S
ELECTRICITY	15.4kW, 380V, 3 Phase + N
DIMENSIONS	850 x 1041 x 1130mm high
WEIGHT	140kg
CAPACITY	(10x) 600 x 400mm trays
RUNNER SPACING	80mm
NUMBER OF FANS	(3x) bidirectional
TEMP RANGE	100 to 270 °C

ORDER CODE MKF1064S



6 TRAY BAKERY

SPECIFICATIONS

MODEL	EKA MKF 664 S
ELECTRICITY	10.4kW, 380V, 3 Phase + N
DIMENSIONS	850 x 1041 x 850mm high
WEIGHT	108kg
CAPACITY	(6x) 600 x 400mm trays
RUNNER SPACING	80mm
NUMBER OF FANS	(2x) bidirectional
TEMP RANGE	100 to 270 °C

ORDER CODE MKF664S



OPTIONAL EXTRAS (FULL SPECS • PAGE 72 - 73)

BAKING TRAYS

600 x 400 x 30mm **BTA0064**

GRIDS

600 x 400mm Grid **OGS0064**

STANDS

Stand for MKF1064S **MKF-MKTS1064-L**
Stand for MKF664S **MKF-MKTS664-L**

CLEANING

MANUAL SPRAY KIT **EKF-EKKD**



FEATURES

- Outer casing manufactured from stainless steel
- Cooking chamber is manufactured from 1mm - thick, moulded, AISI 304 18/10 stainless steel with fully rounded edges
- Cooking chamber lighting via LED Bar fitted into the door
- Door is right hand hinged with adjustable door hinges and handle catch
- The side supports and drip tray can easily be removed for cleaning
- Manual hand spray/wash can be fitted
- 5 Levels of direct steam controlled by a manual control panel situated on the right hand side of the door
- Fitted with a condensate collection bowl, with drain on door
- Timer for cooking from 10 to 120 minutes / infinity
- Supplied without trays and grids
- IPX4 protection rating against water
- Supplied without stand
- Fitted with bidirectional fan motors for even heat distribution

** It is recommend that all combi steamers be installed with water treatment system



10 TRAY BAKERY

SPECIFICATIONS

MODEL	EKA MKF 1064 GS
BTU RATING	61 000
ELECTRICITY	0.7kW, 220V, Single Phase
DIMENSIONS	850 x 1041 x 1231mm high
WEIGHT	158kg
CAPACITY	(10x) 600 x 400mm pans
RUNNER SPACING	80mm
NUMBER OF FANS	(3x) bidirectional
TEMP RANGE	100 to 270 °C

ORDER CODE

MKF1064GS



6 TRAY BAKERY

SPECIFICATIONS

MODEL	EKA MKF 664 GS
BTU RATING	46 000
ELECTRICITY	0.5kW, 220V, Single Phase
DIMENSIONS	850 x 1041 x 850mm high
WEIGHT	123kg
CAPACITY	(6x) 600 x 400mm trays
RUNNER SPACING	80mm
NUMBER OF FANS	(2x) bidirectional
TEMP RANGE	100 to 270 °C

ORDER CODE

MKF664GS



OPTIONAL EXTRAS (FULL SPECS • PAGE 72 - 73)

BAKING TRAYS

600 x 400 x 30mm

BTA0064

GRIDS

600 x 400mm Grid

OGS0064

STANDS

Stand for MKF1064S
Stand for MKF664S

MKF-MKTS1064-L
MKF-MKTS664-L

CLEANING

MANUAL SPRAY KIT

EKF-EKGD



FEATURES

- Outer casing manufactured from stainless steel
- Cooking chamber is manufactured AISI 304 stainless steel
- Door is right hand hinged with adjustable door hinges and handle catch
- The side supports and drip tray can easily be removed for cleaning
- Direct steam levels manually controlled (0 to 100%)
- IPX4 protection rating against water
- Timer for cooking from 10 to 120 minutes / infinity
- 100 Programmable recipes
- Fitted with a bidirectional fan motor for even heat distribution
- Supplied without stand
- Supplied without trays and grids

*** It is recommend that all combi steamers be installed with water treatment system*



TOUCH CONTROL

SPECIFICATIONS

MODEL	EKA 523 NTUD
ELECTRICITY	3.2kW, 230V, Single Phase
DIMENSIONS	550 x 755 x 662mm high
CHAMBER DIMENSIONS	350 x 390 x 450mm high
WEIGHT	42kg
CAPACITY	(5x) 2/3 GN
RUNNER SPACING	80mm
TEMP RANGE	30 to 270°C
NO. OF PROGRAMS	100
PROG. COOKING STEPS	5
PRE-HEAT TEMPERATURE	180°C

ORDER CODE

EKF523NTUD



FEATURES

- Outer casing manufactured from stainless steel
- Cooking chamber is manufactured AISI 304 stainless steel
- Door is right hand hinged with adjustable door hinges and handle catch
- The side supports and drip tray can easily be removed for cleaning
- 5 Levels of direct steam levels manually controlled
- IPX4 protection rating against water
- Timer for cooking from 10 to 120 minutes / infinity
- Fitted with a bidirectional fan motor for even heat distribution
- Supplied without stand
- Supplied without trays and grids

*** It is recommend that all combi steamers be installed with water treatment system*



MANUAL CONTROL

SPECIFICATIONS

MODEL	EKA 523NUD
ELECTRICITY	3.2kW, 230V, Single Phase
DIMENSIONS	550 x 755 x 665mm high
WEIGHT	41kg
CAPACITY	(5x) 2/3 GN
CHAMBER DIMENSIONS	350 x 390 x 450mm high
RUNNER SPACING	80mm
TEMP RANGE	100 to 270°C

ORDER CODE

EKF523NUD



OPTIONAL EXTRAS (FULL SPECS • PAGE 72 - 73)

INSERTS

- 2/3 GN PAN - 20mm
- 2/3 GN PAN - 65mm
- 2/3 GN PAN - 40mm (Perforated)
- 1/3 GN PAN - 40mm
- 1/3 GN PAN - 65mm

GN2T8020
GN2T8065
GN2T8040.P
GNT8040
GNT8065

STANDS

Stand for EKF523N Ovens

SOE0423

CLEANING

MANUAL SPRAY KIT

EKF-EKKD



FEATURES

- Outer casing manufactured from stainless steel
- Cooking chamber is manufactured from 1mm - thick, moulded, AISI 304 18/10 stainless steel with fully rounded edges
- Cooking chamber lighting via LED Bar fitted into the door
- Manual control panel situated on the right hand side of the door
- Door is right hand hinged with adjustable door hinges and handle catch
- The side supports and drip tray can easily be removed for cleaning
- Manual hand spray/wash can be fitted
- Fitted with a condensate collection bowl, with drain on door
- Timer for cooking from 10 to 120 minutes / infinity
- Supplied without trays and grids
- IPX3 protection rating against water
- Supplied without stand
- Fitted with bidirectional fan motors for even heat distribution



6 TRAY

SPECIFICATIONS

MODEL	EKA MKF 664 SP
ELECTRICITY	10.4kW, 380V, 3 Phase + N
DIMENSIONS	850 x 1041 x 850mm high
WEIGHT	108kg
CAPACITY	(6x) 600 x 400mm pans
RUNNER SPACING	80mm
NUMBER OF FANS	(2x) bidirectional
TEMP RANGE	100 to 270 °C

ORDER CODE

MKF664SP



OPTIONAL EXTRAS (FULL SPECS • PAGE 72 - 73)

BAKING TRAYS

600 x 400 x 30mm

BTA0064

GRIDS

600 x 400mm Grid

OGS0064

STAND

Stand for MKF664SP

MKF-MKTS664-L



FEATURES

- Outer casing manufactured from stainless steel
- Cooking chamber is manufactured from 1mm thick, moulded, AISI 304 18/10 stainless steel with fully rounded edges
- 2 halogen lights inside the cooking chamber
- The side supports and drip tray can easily be removed for cleaning
- 10 Levels of direct steam controlled by a digital control panel situated below the door
- Fitted with 2 bidirectional fan motors for even heat distribution
- IPX3 protection rating against water
- Bottom hinged door
- Supplied without trays and grids
- *It is recommend that all combi steamers be installed with water treatment system*

4 PAN DIGITAL CONTROL

SPECIFICATIONS

MODEL	EKA EKF 416 DUD
ELECTRICITY	6.4kW, 380V, 3 Phase + N
DIMENSIONS	790 x 750 x 635mm high
WEIGHT	58kg
CHAMBER DIM CAPACITY	660 x 445 x 380mm high (4x) 1/1 GN pans (4x) 600 x 400mm trays

RUNNER SPACING	73mm
TEMP RANGE	30 to 270°C
NUMBER OF PROGRAMS	99
PROG. COOKING STEPS	4
PRE-HEAT TEMPERATURE	180°C

ORDER CODE

EKF416DUD



FEATURES

- Outer casing manufactured from stainless steel
- Cooking chamber is manufactured from 1mm thick, moulded, AISI 304 18/10 stainless steel with fully rounded edges
- Cooking chamber lighting via LED bar fitted into the door
- Available in bottom or right hand hinged door models
- 5 Levels of direct steam controlled by a electromechanical control panel situated on the left hand side of the door
- The side supports and drip tray can easily be removed for cleaning
- Fitted with 2 bidirectional fan motors for even heat distribution
- IPX3 protection rating against water
- Supplied without trays and grids
- *It is recommend that all combi steamers be installed with water treatment system*

4 PAN MANUAL CONTROL

SPECIFICATIONS

ELECTRICITY	6.4kW, 380V, 3 Phase + N
DIMENSIONS	790 x 785 x 635mm high
WEIGHT	57kg
CHAMBER DIMENSIONS CAPACITY	660 x 430 x 380mm high (4x) 1/1 GN pans (4x) 600 x 400mm trays
RUNNER SPACING	73mm
TEMP RANGE	30 to 270°C

RIGHT HAND HINGED DOOR

MODEL	EKA EKF 416 ALUD
ORDER CODE	EKF416ALUD

BOTTOM HINGED DOOR

MODEL	EKA EKF 416 UD
ORDER CODE	EKF416UD



OPTIONAL EXTRAS (FULL SPECS • PAGE 72 - 73)

INSERTS

1/1 GN PAN - 65mm	GNF8065
1/1 GN PAN - 65mm (perforated)	GNF8065.P

BAKING TRAYS

600 x 400 x 20mm	BTA0013
------------------	----------------

OVEN STAND

ORDER CODE	SOE0416
-------------------	----------------

GRIDS

1/1 GN GRID	OGS0011
600 x 400mm GRID	OGS0064

CLEANING

MANUAL SPRAY KIT	EKF-EKKD
------------------	-----------------



FEATURES

- Outer casing manufactured from stainless steel
- Cooking chamber is manufactured from 1mm thick AISI 430 18/10 stainless steel with fully rounded edges
- 1 halogen light fitted into the cooking chamber
- The side supports and drip tray can easily be removed for cleaning
- Electromechanical control panel fitted at the bottom of the door
- Fitted with 2 bidirectional fan motors for even heat distribution
- IPX3 protection rating against water
- Stackable
- Supplied without trays and grids
- Bottom hinged door
- Supplied without stand



HUMIDIFICATION (PULSE)

4 PAN WITH HUMIDIFICATION

SPECIFICATIONS

MODEL	EKA EKF 416
ELECTRICITY	3.4kW, 220V, Single Phase
DIMENSIONS	790 x 750 x 635mm high
WEIGHT	51kg
CHAMBER DIMENSIONS	660 x 445 x 380mm high

CAPACITY	(4x) 1/1 GN pans (4x) 600 x 400mm trays
RUNNER SPACING	73mm
TEMP RANGE	50 to 300°C

ORDER CODE **EKF416**



FEATURES

- Outer casing manufactured from stainless steel
- Cooking chamber is manufactured from 1mm thick AISI 304 18/10 stainless steel with fully rounded edges
- 1 halogen light fitted into the cooking chamber
- Available in bottom or right hand hinged door models
- The side supports and drip tray can easily be removed for cleaning
- Electromechanical control panel situated at the bottom of the door
- Fitted with a bidirectional fan motor for even heat distribution
- IPX3 protection rating against water
- Supplied without trays and grids
- Stackable
- Supplied without stand

4 PAN

SPECIFICATIONS

ELECTRICITY	6.2kW, 380V, 2 Phase + N
DIMENSIONS	790 x 750 x 635mm high
WEIGHT	51kg
CHAMBER DIMENSIONS	660 x 445 x 380mm high
CAPACITY	(4x) 1/1 GN Pans (4x) 600 x 400mm trays
RUNNER SPACE	73mm
TEMP RANGE	50 to 300°C

RIGHT HAND HINGED DOOR

MODEL EKA EKF 416 ALP
ORDER CODE **EKF416ALP**

BOTTOM HINGED DOOR

MODEL EKA EKF 416 P
ORDER CODE **EKF416P**



OPTIONAL EXTRAS (FULL SPECS • PAGE 72 - 73)

BAKING TRAY

600 x 400 x 20mm

BTA0013

OVEN STAND

ORDER CODE

SOE0416

OVEN GRIDS

1/1 GN GRID
600 x 400mm GRID

OGS0011
OGS0064

CONVECTION OVENS

EVOLUTION MANUAL CONTROL



FEATURES

- Outer casing manufactured from stainless steel
- Cooking chamber is manufactured from 1mm thick AISI 304 18/10 stainless steel with fully rounded edges
- 1 halogen light fitted into the cooking chamber
- The side supports and drip tray can easily be removed for cleaning
- Bottom hinged door
- Electromechanical control panel situated at the bottom of the door
- Fitted with 1 unidirectional fan motor for even heat distribution
- IPX3 protection rating against water
 - Stackable
- Supplied without stand
 - Supplied without grids
- Supplied with (4x) 430 x 345mm baking sheets

4 PAN MULTI-FUNCTIONAL

SPECIFICATIONS

MODEL	EKA EKF 423 M
ELECTRICITY	2.8kW, 220V, Single Phase
DIMENSIONS	590 x 695 x 590mm high
WEIGHT	35kg
CHAMBER DIMENSIONS	450 x 395 x 330mm high

CAPACITY	(4x) 430 x 345mm trays
RUNNER SPACING	73mm
TEMP RANGE	50 to 300°C

ORDER CODE

EKF423M



FEATURES

- Outer casing manufactured from stainless steel
- Cooking chamber is manufactured from 1mm thick AISI 304 18/10 stainless steel with fully rounded edges
- 1 halogen light fitted into the cooking chamber
- The side supports and drip tray can easily be removed for cleaning
- Bottom hinged door
- Electromechanical control panel situated at the top of the door
- Fitted with a unidirectional fan motor for even heat distribution
- IPX3 protection rating against water
 - Stackable
- Supplied without stand
 - Supplied without grids
- Supplied with (4x) 430 x 345mm baking sheets

4 PAN MANUAL CONTROL

SPECIFICATIONS

MODEL	EKA EKF 423 P
ELECTRICITY	2.8kW, 220V, Single Phase
DIMENSIONS	590 x 695 x 590mm high
WEIGHT	35kg
CHAMBER DIMENSIONS	450 x 395 x 330mm high

CAPACITY	(4x) 430 x 345mm trays
RUNNER SPACING	73mm
TEMP RANGE	50 to 300°C

ORDER CODE

EKF423



OPTIONAL EXTRAS (FULL SPECS • PAGE 72 - 73)

BAKING TRAY

430 x 345 x 10mm

BTA0043

OVEN STAND

ORDER CODE

SOE0423

OVEN GRID

430 x 345mm GRID

COA2003

OPTIONAL EXTRAS - EKA COMBI STEAMERS & CONVECTION OVENS

FULL SPECIFICATIONS

PUSH-IN TROLLEYS



FEATURES

- Manufactured from AISI 304 Stainless steel
- Fitted with 4 robust castors, 2 lockable
- Fitted with removable handle



20 PAN PUSH-IN GASTRONOMY TROLLEY

SPECIFICATIONS

MODEL	EKA EKCR20TC
DIMENSIONS	740 x 561 x 1750mm high
WEIGHT	34kg
CAPACITY	(20x) 1/1 GN pans
RUNNER SPACING	66mm
ORDER CODE	EKF-EKCR20TC

16 TRAY PUSH-IN BAKING TROLLEY

SPECIFICATIONS

MODEL	EKA EKCR16TC
DIMENSIONS	740 x 561 x 1750mm high
WEIGHT	34kg
CAPACITY	(16x) 600 x 400mm baking tray
RUNNER SPACING	80mm
ORDER CODE	EKF-EKCR16TC

COMPATIBLE WITH THE FOLLOWING MODELS

- EKA MKF 2011 TS
- EKA MKF 2011 S

INSERTS

- 1/1GN - 40mm deep
- 1/1GN - 40mm (perforated)
- 1/1GN - 55mm deep
- 1/1GN - 55mm (perforated)
- 1/1GN - 65mm deep
- 1/1GN - 65mm (perforated)
- 2/3 GN - 20mm deep
- 2/3 GN - 65mm deep
- 2/3 GN - 40mm (perforated)
- 1/3 GN - 40mm deep
- 1/3 GN - 65mm deep

- GNF8040
- GNF8040.P
- GNF8055
- GNF8055.P
- GNF8065
- GNF8065.P
- GN2T8020
- GN2T8065
- GN2T8040.P
- GNT8040
- GNT8065

GRIDS

- OVEN GRID - 1/1 GN
- OVEN GRID - 600 x 400mm
- COOLING GRID - 600 x 400mm

- OGS0011
- OGS0064
- CTS0064



BAKING TRAYS

- 430 x 345 x 10mm deep
- 600 x 400 x 20mm deep
- 600 x 400 x 30mm deep

- BTA0043
- BTA0013
- BTA0064

CORE PROBE FOR MILLENNIAL OVENS



CORE PROBE - with support and 1300mm cable
ORDER CODE EKF-EKSCS

CLEANING & FLUSHING



MANUAL SPRAY KIT
ORDER CODE

EKF-EKGD

CLEANING DETERGENT for Millennial Touch Ovens
ORDER CODE MKF-MKDET

OVEN STANDS

FEATURES

- Runners to accommodate GN Pans, 600 x 400mm or 435 x 315mm baking trays
- Manufactured from 1.2mm thick, 430 Stainless steel
- Fitted with 4 height adjustable plastic feet



HEIGHT
ADJUSTABLE FEET



STURDY STAINLESS STEEL
CONSTRUCTION

11 PAN MILLENNIAL OVENS

SPECIFICATIONS

DIMENSIONS	600 x 730 x 750mm high
WEIGHT	23kg
RUNNER SPACING	40mm
COMPATIBLE WITH	EKA MKF 1111 TS EKA MKF 1111 S EKA MKF 1111 GS

ORDER CODE

MKF-MKTS1111-L



7 PAN MILLENNIAL OVENS

SPECIFICATIONS

DIMENSIONS	600 x 730 x 900mm high
WEIGHT	28kg
RUNNER SPACING	40mm
COMPATIBLE WITH	EKA MKF 711 TS EKA MKF 711 S EKA MKF 711 GS

ORDER CODE

MKF-MKTS711-L



10 PAN MILLENNIAL OVENS

SPECIFICATIONS

DIMENSIONS	790 x 850 x 750mm high
WEIGHT	30kg
RUNNER SPACING	40mm
COMPATIBLE WITH	EKA MFK 1064 S EKA MFK 1064 GS

ORDER CODE

MKF-MKTS1064-L



6 PAN MILLENNIAL OVENS

SPECIFICATIONS

DIMENSIONS	790 x 850 x 900mm high
WEIGHT	35kg
RUNNER SPACING	40mm
COMPATIBLE WITH	EKA MFK 664 S EKA MFK 664 SP EKA MFK 664 GS

ORDER CODE

MKF-MKTS664-L



4 PAN EVOLUTION OVENS

SPECIFICATIONS

DIMENSIONS	800 x 750 x 850mm high
WEIGHT	19kg
RUNNER SPACING	70mm
COMPATIBLE WITH	EKA EKF 416 DUD EKA EKF 416 UD EKA EKF 416 ALUD EKA EKF 416 EKA EKF 416 P EKA EKF 416 ALP

ORDER CODE

SOE0416



4 PAN CONVECTION OVENS

SPECIFICATIONS

DIMENSIONS	600 x 700 x 850mm high
WEIGHT	17kg
RUNNER SPACING	70mm
COMPATIBLE WITH	EKA EKF 423 M EKA EKF 423 P EKA EKF 523 NTUD EKA EKF 523 NUD

ORDER CODE

SOE0423





MODEL	EKA MKF 2011 TS	EKA MKF 2011 S	EKA MKF 1111 TS	
CAPACITY	(20x) 1/1 GN Pans or *(16x) 600 x 400mm Baking Trays	(20x) 1/1 GN Pans or *(16x) 600 x 400mm Baking Trays	(11x) 1/1 GN Pans	
RUNNER SPACING	66mm	66mm	68mm	
ELEC / BTU RATING	31kW, 380V, 3 Phase + N	31kW, 380V, 3 Phase + N	15.4kW, 380V, 3 Phase + N	
CONTROL PANEL	Touch Control with Quick Selection knob	Manual Control	Touch Control with Quick Selection knob	
BAKING	✓	✓	✓	
ROASTING	✓	✓	✓	
STEAMING	✓	✓	✓	
STEAM METHOD	Direct Steam - 10 Levels	Direct Steam - 5 Levels	Direct Steam - 10 Levels	

*16 pan capacity available with optional 16 pan trolley



MODEL	EKA MKF 711 TS	EKA MKF 711 S	EKA MKF 711 GS	
CAPACITY	(7x) 1/1 GN Pans	(7x) 1/1 GN Pans	(7x) 1/1 GN Pans	
RUNNER SPACING	68mm	68mm	68mm	
ELEC / BTU RATING	11.4kW, 380V, 3 Phase + N	11.4kW, 380V, 3 Phase + N	0.5kW, 220V, Single Phase / 46 000	
CONTROL PANEL	Touch Control with Quick Selection knob	Manual Control	Manual Control	
BAKING	✓	✓	✓	
ROASTING	✓	✓	✓	
STEAMING	✓	✓	✓	
STEAM METHOD	Direct Steam - 10 Levels	Direct Steam - 5 Levels	Direct Steam - 5 Levels	



MODEL	EKA EKF 523 NUD	EKA EKF 416 DUD	EKA EKF 416 UD / ALUD	
CAPACITY	(5x) 2/3 GN Pans	(4x) 1/1 GN Pans (4x) 600 x 400mm Baking Trays	(4x) 1/1 GN Pans (4x) 600 x 400mm Baking Trays	
RUNNER SPACING	80mm	73mm	73mm	
ELEC / BTU RATING	3.2kW, 230V, Single Phase	6.4kW, 380V, 3 Phase + N	6.4kW, 380V, 3 Phase + N	
CONTROL PANEL	Manual Control	Digital Control	Manual Control	
BAKING	✓	✓	✓	
ROASTING	✓	✓	✓	
STEAMING	✓	✓	✓	
STEAM METHOD	Direct Steam - 5 Levels	Direct Steam - 10 Levels	Direct Steam - 5 Levels	



	EKA MKF 1111 S	EKA MKF 1111 GS	EKA MKF 1064 S	EKA MKF 1064 GS
	(11x) 1/1 GN Pans	(11x) 1/1 GN Pans	(10x) 600 x 400mm Baking Trays	(10x) 600 x 400mm Baking Trays
	68mm	68mm	80mm	80mm
	15.4kW, 380V, 3 Phase + N	0.7kW, 220V, Single Phase / 60 000	15.4kW, 380V, 3 Phase + N	0.7kW, 220V, Single Phase / 61 000
	Manual Control	Manual Control	Manual Control	Manual Control
	✓	✓	✓	✓
	✓	✓	✓	✓
	✓	✓	✓	✓
	Direct Steam - 5 Levels	Direct Steam - 5 Levels	Direct Steam - 5 Levels	Direct Steam - 5 Levels



	EKA MKF 664 S	EKA MKF 664 GS	EKA MKF 664 SP	EKA EKF 523 NTUD
	(6x) 600 x 400mm Baking Trays	(6x) 600 x 400mm Baking Trays	(6x) 600 x 400mm Baking Trays	(5x) 2/3 GN Pans
	80mm	80mm	80mm	80mm
	10.4kW, 380V, 3 Phase + N	0.7kW, 220V, Single Phase / 46 000	10.4kW, 380V, 3 Phase + N	3.2kW, 230V, Single Phase
	Manual Control	Manual Control	Manual Control	Touch Control
	✓	✓	✓	✓
	✓	✓	✓	✓
	✓	✓	-	✓
	Direct Steam - 5 Levels	Direct Steam - 5 Levels	-	Direct Steam - 5 Levels



	EKA EKF 416 P / ALP	EKA EKF 416	EKA EKF 423 M	EKA EKF 423
	(4x) 1/1 GN Pans (4x) 600 x 400mm Baking Trays	(4x) 1/1 GN Pans (4x) 600 x 400mm Baking Trays	(4x) 430 x 345mm Baking Trays	(4x) 430 x 345mm Baking Trays
	73mm	73mm	73mm	73mm
	6.2kW, 380V, 3 Phase + N	3.4kW, 380V, 3 Phase + N	2.6kW, 240V, Single Phase	2.6kW, 240V, Single Phase
	Manual Control	Manual Control	Manual Control	Manual Control
	✓	✓	✓	✓
	✓	✓	✓	✓
	-	-	-	-
	-	Indirect steam with button	-	-

WATER SOFTENER vs WATER FILTER

WATER FILTER

Water filter's is used to supply better tasting and cleaner water by removing a wide array of contaminants. Minerals are not contaminants therefore they pass through the filter.

WATER SOFTENER

Water softeners is a different treatment process. Water softeners remove minerals like calcium and magnesium that causes hard water "mineral rich water". Hard water can cause scale build-up inside the solenoid valve, on elements, fan blades, motors and discolour the steel inside a steam oven chamber. Dishwashers develops scale build-up inside the solenoid valve, boiler, the tanks, and wash arms which in time will cause wash and rise jets to block up. Ice machines develops scale build-up inside the solenoid valve, the bins and water jets. Coffee machines develops scale build-up in the solenoid valve, the boiler and water components.



Installing a water softener to the water inlet of equipment can aid in the cleaning of your equipment and prolong the life of your equipment.

WARRANTY ON WATER-USING EQUIPMENT

Any damages to water-using products caused by scale build-up will not be covered under warranty if a water softener is not installed on the intake water connection.

It is recommended that the customer test the hardness of the water by a company specialising in water treatment to determine the softening system that is needed to work best with the equipment being installed.

If no softening system is installed, a water hardness test dated before the installation date will have to be provided for warranty claims.

EXAMPLE OF FILTRATION SYSTEM



Filter cartridge

to be replaced as indicated by the flow meter



Filter head

*once off purchase
NOT SOLD SEPARATELY



Flow meter

*once off purchase
NOT SOLD SEPARATELY



FILTRATION SYSTEM - XLARGE FOR 10/11/16/20 PAN OVENS

SPECIFICATIONS

DIMENSIONS	136ø x 471mm high
FLOW RATE	3.7 LPM
PRESSURE	29 to 116 psi
TEMP. RANGE	4 to 30°C

ORDER CODE **WFS0000-XL**

FILTRATION SYSTEM - LARGE FOR 4/6/7 PAN OVENS

SPECIFICATIONS

DIMENSIONS	136ø x 360mm high
FLOW RATE	4 LPM
PRESSURE	29 to 116 psi
TEMP. RANGE	4 to 30°C

ORDER CODE **WFS0000-L**

REPLACEMENT FILTER CARTRIDGES



XLARGE

SPECIFICATIONS

DIMENSIONS	136ø x 471mm high
FLOW RATE	3.7 LPM
PRESSURE	29 to 116 psi
TEMP. RANGE	4 to 30°C

ORDER CODE **WFS0000-XL-RC**



LARGE

SPECIFICATIONS

DIMENSIONS	136ø x 360mm high
FLOW RATE	4 LPM
PRESSURE	29 to 116 psi
TEMP. RANGE	4 to 30°C

ORDER CODE **WFS0000-L-RC**



CONVECTION OVENS

SmartChef



FEATURES

- Durable stainless steel construction
- Double-glazed door for better heat retention
- Electromechanical temperature control
- 2 Fans installed
- Manual control timer installed (0 to 120 minutes)

SPECIFICATIONS

MODEL	SmartChef HECO-A1E
ELECTRICITY	2.7kW, 230V, Single Phase
DIMENSIONS	600 x 600 x 570mm high
CHAMBER DIM	460 x 370 x 360mm high
WEIGHT	51kg
CAPACITY	(4x) 435 x 315mm trays
TEMP RANGE	50 to 300°C

ORDER CODE

COS0004

BAKERY CONVECTION OVENS

BakeMark



FEATURES

- Manufactured from 201 non-magnetic stainless steel
- Doors are fitted with tempered glass
- Internal lighting for improved view of the product
- Fitted with a heavy duty door handle
- Fitted with bi-directional fans
- Adjustable air duct, for more baking varieties
- Timer and Steam function

10 TRAY

SPECIFICATIONS

MODEL	BakeMark RX10D
ELECTRICITY	18kW, 380V, 3 Phase + N
DIMENSIONS	930 x 1320 x 1550mm high
WEIGHT	250kg
CAPACITY	(10x) 600 x 400mm trays
RUNNER SPACING	80mm
TEMP RANGE	90 to 300°C



ORDER CODE

COB-RX10D

OPTIONAL STAND

DIMENSIONS	920 x 1000 x 480mm high
RUNNER SPACING	40mm

ORDER CODE

SOB0010

6 TRAY

SPECIFICATIONS

MODEL	BakeMark RX6D
ELECTRICITY	9kW, 380V, 3 Phase + N
DIMENSIONS	910 x 1370 x 890mm high
WEIGHT	170kg
CAPACITY	(6x) 600 x 400mm trays
RUNNER SPACING	80mm
TEMP RANGE	90 to 300°C



ORDER CODE

COB-RX6D

OPTIONAL STAND

DIMENSIONS	910 x 1000 x 770mm high
RUNNER SPACING	40mm

ORDER CODE

SOB0006

OPTIONAL EXTRAS

BAKING TRAY
600 x 400 x 30mm

BTA0064

OVEN GRIDS
600 x 400mm

OGS0064

COOLING RACK
600 x 400mm

CTS0064



FEATURES

- Manufactured from 201 stainless steel
- Polyurethane foam insulation
- Fitted with a fan circulation system, more uniform proofing effect
- Automatic hydration system - inlet and outlet
- Micro-computer /digital display control panel with timing function
- Big tempered glass windows for improved viewing of the proofing process
- Fitted with (4x) castors

32 TRAY

SPECIFICATIONS

MODEL	BakeMark XF32B
ELECTRICITY	3.2kW, 230V, Single Phase
DIMENSIONS	1020 x 820 x 1980mm high
WEIGHT	110kg
CAPACITY	(32x) 600 x 400mm trays
TEMP RANGE	20 to 60°C
HUMIDITY	80 to 90%



ORDER CODE

PCB-XF32B

16 TRAY

SPECIFICATIONS

MODEL	BakeMark XF16B
ELECTRICITY	2.4kW, 230V, Single Phase
DIMENSIONS	500 x 770 x 1980mm high
WEIGHT	55kg
CAPACITY	(16x) 600 x 400mm trays
TEMP RANGE	20 to 60°C
HUMIDITY	80 to 90%



ORDER CODE

PCB-XF16B



FEATURES

- Manufactured from 201 stainless steel
- Polyurethane foam insulation
- Fitted with a fan circulation system, more uniform proofing effect
- Automatic hydration system - inlet and outlet
- Manual control panel with timing function
- Tempered glass window for improved viewing of the proofing process
- Fitted with (4x) castors
- Stackable with the BakeMark RX6D convection oven

10 TRAY

SPECIFICATIONS

MODEL	BakeMark XF10
ELECTRICITY	3kW, 230V, Single Phase
DIMENSIONS	930 x 1200 x 750mm high
WEIGHT	80kg
CAPACITY	(10x) 600 x 400mm trays
RUNNER SPACING	80mm
TEMP RANGE	20 to 60°C
HUMIDITY	80 to 90%



ORDER CODE

PCB-XF10



STACKABLE

OPTIONAL EXTRAS

BAKING TRAY
600 x 400 x 30mm

BTA0064

OVEN GRIDS
600 x 400mm

OGS0064

COOLING RACK
600 x 400mm

CTS0064



FEATURES

- Oven body manufactured from stainless steel
- Oven body is insulated
- Oven fitted with hood
- Oven fitted with removable ash drawer for easy cleaning
- Door bottom hinged for easy loading
- Fitted with dial thermometer
- Available in red (on special request)

890mm OVEN

SPECIFICATIONS

MODEL	Empero EMP.PKF-50-S
DIMENSIONS	890 x 825 x 648mm high (Hood + 646mm high)
WEIGHT	190kg
GRILL RACK DIMENSIONS	740 x 650mm
CAPACITY	20kg meat per hour
WORKING TEMPERATURE	250 to 500°C

CHARCOAL BLACK
FIRE RED

EMP.PKF-50-S
EMP.PKF-50-K



COLOUR OPTIONS



CHARCOAL BLACK



FIRE RED

710mm OVEN

SPECIFICATIONS

MODEL	Empero EMP.PKF-40-S
DIMENSIONS	710 x 730 x 666mm high (Hood + 646mm high)
WEIGHT	160kg
GRILL RACK DIMENSIONS	560 x 524mm
CAPACITY	20kg meat per hour
WORKING TEMPERATURE	250 to 500°C

CHARCOAL BLACK
FIRE RED

EMP.PKF-40-S
EMP.PKF-40-K



SHOWN WITH OPTIONAL CABINET & TOP GRILL



PROFESSIONAL CHARCOAL OVENS

OPTIONAL EXTRAS



890mm

SPECIFICATIONS

DIMENSIONS
WEIGHT

890 x 825 x 825mm high
73kg

ORDER CODE

EMP.PKF-50-D



CABINET

FEATURES

- Oven cabinet manufactured from stainless steel
- Fitted with robust castors

710mm

SPECIFICATIONS

DIMENSIONS
WEIGHT

710 x 725 x 825mm high
63kg

ORDER CODE

EMP.PKF-40-D



890mm

SPECIFICATIONS

DIMENSIONS
WEIGHT

890 x 825 x 825mm high
78kg

ORDER CODE

EMP.PKF-50-AS



STAND

FEATURES

- Oven Stand manufactured from painted mild steel
- Fitted with 2 shelves
- Fitted with 4 robust castors

710mm

SPECIFICATIONS

DIMENSIONS
WEIGHT

710 x 725 x 825mm high
60kg

ORDER CODE

EMP.PKF-40-AS



890mm

SPECIFICATIONS

DIMENSIONS
WEIGHT

890 x 825 x 210mm high
43kg

ORDER CODE

EMP.PKF-50-US



TOP GRID

FEATURES

- Manufactured from high quality stainless steel
- Supplied with 2 grids

710mm

SPECIFICATIONS

DIMENSIONS
WEIGHT

710 x 725 x 210mm high
33kg

ORDER CODE

EMP.PKF-40-US



ONE OVEN FOR PIZZA AND ARTISAN BREADS

FEATURES

- Robust stainless steel construction
- Bottom hinged doors for easy loading
- Additional internal height for baking
- Ceramic base for pizza and artisan breads
- Expanded glass viewing window on oven door
- Top and bottom element controlled individually
- Fitted with a dial thermostat
- Compatible with 600 x 400mm baking trays



DOUBLE DECK OVEN - 4 TRAY

SPECIFICATIONS

MODEL Prismafood Trays 66L
 ELECTRICITY 20.4kW, 380V, 3 Phase + N
 DIMENSIONS 1500 x 1080 x 745mm high
 WEIGHT 225kg
 CHAMBER DIMENSIONS (2x) 1230 x 840 x 175mm high
 CHAMBER CAPACITY (4x) 600 x 400mm trays
 (6x) 40cm Pizzas
 TEMP RANGE 50 to 500°C

ORDER CODE **DOP0066**



DOUBLE DECK OVEN - 2 TRAY

SPECIFICATIONS

MODEL Prismafood Trays 44
 ELECTRICITY 14kW, 380V, 3 Phase + N
 DIMENSIONS 1100 x 1080 x 745mm high
 WEIGHT 172kg
 CHAMBER DIMENSIONS (2x) 820 x 840 x 175mm high
 CHAMBER CAPACITY (2x) 600 x 400mm trays
 (4x) 40cm Pizzas
 TEMP RANGE 50 to 500°C

ORDER CODE **DOP0044**



DIAL THERMOSTAT



CERAMIC STONE BASE

PIZZA / DECK OVENS OPTIONAL EXTRAS



STANDS

SPECIFICATIONS

MODEL Prismafood ST 66
 DIMENSIONS 1520 x 982 x 960mm high
 WEIGHT 44kg
 COMPATIBLE WITH DOP0066

ORDER CODE SDP0066



SPECIFICATIONS

MODEL Prismafood ST 44
 DIMENSIONS 1117 x 982 x 960mm high
 WEIGHT 39kg
 COMPATIBLE WITH DOP0044

ORDER CODE SDP0044



HOODS

SPECIFICATIONS

MODEL Prismafood KT6L-66L
 DIMENSIONS 1500 x 1115 x 120mm high
 WEIGHT 18kg
 COMPATIBLE WITH DOP0066

ORDER CODE HDP0066



ELECTRIC PIZZA OVENS TABLE MODEL

SmartChef

FEATURES

- Robust construction
- Internal chamber lighting
- Fitted with a glass viewing windows
- Each deck fitted with a heat gauge
- Top and bottom element is individually controlled
- Fitted with a bottom hinged doors for easy loading
- Supplied with a ceramic pizza stone base
- Fitted with (4x) non-slip rubber feet



DOUBLE DECK SPECIFICATIONS

MODEL SmartChef HEP-2
ELECTRICITY 8.4kW, 380V, 3 Phase + N
DIMENSIONS 890 x 790 x 750mm high
WEIGHT 90kg
CHAMBER DIMENSIONS (2x) 610 x 610 x 170mm high
CHAMBER CAPACITY (4x) 30cm Pizzas per deck
TEMP RANGE 50 to 400°C

ORDER CODE

POS2408



SINGLE DECK SPECIFICATIONS

MODEL SmartChef HEP-1
ELECTRICITY 4.2kW, 380V, 3 Phase + N
DIMENSIONS 890 x 790 x 430mm high
WEIGHT 52kg
CHAMBER DIMENSIONS (1x) 610 x 610 x 170mm high
CHAMBER CAPACITY (4x) 30cm Pizzas per deck
TEMP RANGE 50 to 400°C

ORDER CODE

POS1404



TEMPERATURE CONTROLLER AND HEAT GAUGE



EACH DECK FITTED WITH A CERAMIC PIZZA STONE BASE

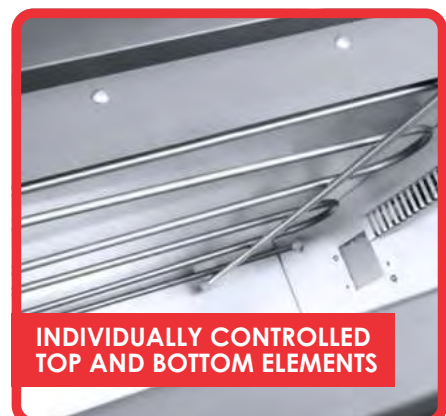

INDIVIDUALLY CONTROLLED TOP AND BOTTOM ELEMENTS

ELECTRIC PIZZA OVENS TABLE MODEL

FEATURES

- Body manufactured from stainless steel
- Internal chamber lighting
- Fitted with a glass viewing window
- Fitted with (4x) non-slip rubber feet
- Top and bottom element is individually controlled
- Fitted with a bottom hinged door for easy loading
- Supplied with a pizza stone base



DOUBLE DECK SPECIFICATIONS

MODEL	SmartChef HEP-2ST
ELECTRICITY	3kW, 240V, Single Phase
DIMENSIONS	560 x 570 x 440mm high
WEIGHT	27kg
CHAMBER DIMENSIONS	(2x) 400 x 400 x 155mm high
CHAMBER CAPACITY	(1x) 30cm Pizza
TEMP RANGE	50 to 350°C

ORDER CODE

POS2102



SINGLE DECK SPECIFICATIONS

MODEL	SmartChef HEP-1ST
ELECTRICITY	2kW, 240V, Single Phase
DIMENSIONS	560 x 570 x 280mm high
WEIGHT	18kg
CHAMBER DIMENSIONS	(1x) 400 x 400 x 155mm high
CHAMBER CAPACITY	(1x) 30cm Pizza
TEMP RANGE	50 to 350°C

ORDER CODE

POS1101



MANUAL TEMPERATURE
AND TIMER CONTROLS



FITTED WITH
NON-SLIP FEET



INDIVIDUALLY CONTROLLED
TOP AND BOTTOM ELEMENTS

ELECTRIC PIZZA OVENS TABLE MODEL



FEATURES

- Body manufactured from stainless steel
- Refractory stone cooking surface
- Rockwool insulation
- Sheathed heating elements
- The internal lighting
- Fitted with (4x) non-slip rubber feet

DOUBLE DECK

SPECIFICATIONS

MODEL	Prismafood Basic 2/40 VERTO 4T
ELECTRICITY	2.4kW, 230V, Single Phase
DIMENSIONS	568 x 500 x 430mm
WEIGHT	32kg
CHAMBER DIMENSIONS	(2x) 410 x 360 x 90mm
CHAMBER CAPACITY	(1x) 30cm Pizza
TEMP RANGE	40 to 320°C

ORDER CODE:

POP0240



SINGLE DECK

SPECIFICATIONS

MODEL	Prismafood Basic 1/40 VERTO 2T
ELECTRICITY	1.6kW, 230V, Single Phase
DIMENSIONS	568 x 500 x 280mm
WEIGHT	21kg
CHAMBER DIMENSIONS	(1x) 410 x 360 x 90mm
CHAMBER CAPACITY	(1x) 30cm Pizza
TEMP RANGE	40 to 320°C

ORDER CODE:

POP0140

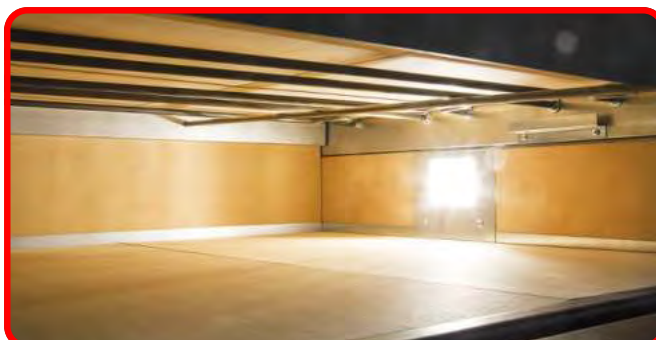



ELECTRIC DECK OVENS WITH HUMIDIFICATION



FEATURES

- Robust body manufactured from stainless steel
- 16 program settings
- Top hinged door with front glass for easy loading and viewing
- Ceramic stone bases on each deck
- Steam function
- Each deck fitted with adjustable vent
- Fitted with (4x) robust casters

TRIPLE DECK SPECIFICATIONS

MODEL	BakeMark SmartStone XYF-39H-N
ELECTRICITY	25kW, 380V, 3 Phase + N
DIMENSIONS	1750 x 1080 x 1750mm high
WEIGHT	750kg
CHAMBER DIMENSIONS	(3x) 1300 x 750 x 170mm high
CHAMBER CAPACITY	(3x) 600 x 400mm trays
TEMP RANGE	20 to 300°C

ORDER CODE

DOB/S3309

- **Electronic control**
- **Humidification**
- **Stone base**



OPTIONAL EXTRAS

BAKING TRAY

600 x 400 x 30mm

BTA0064



FEATURES

- Robust construction
- Fitted with glass viewing windows
- Individually controlled internal lighting per deck
- Fitted with (4x) castors
- Bottom hinged doors for easy loading
- Top and bottom elements individually controlled for each deck
- Timer with buzzer individually controlled per deck
- Ceramic stone bases available on request



3 DECK, 9 TRAY

SPECIFICATIONS

MODEL	BakeMark HEO-39
ELECTRICITY	25kW, 380V, 3 Phase + N
DIMENSIONS	1650 x 815 x 1530mm high
WEIGHT	230kg
CHAMBER DIMENSIONS	(3x) 1300 x 620 x 220mm
CHAMBER CAPACITY	(3x) 600 x 400mm trays
TEMP RANGE	50 to 300°C

ORDER CODE

DOB3309



3 DECK, 6 TRAY

SPECIFICATIONS

MODEL	BakeMark HEO-36
ELECTRICITY	19.5kW, 380V, 3 Phase + N
DIMENSIONS	1220 x 815 x 1530mm high
WEIGHT	165kg
CHAMBER DIMENSIONS	(3x) 860 x 620 x 220mm
CHAMBER CAPACITY	(2x) 600 x 400mm trays
TEMP RANGE	50 to 300°C

ORDER CODE

DOB3206



2 DECK, 4 TRAY

SPECIFICATIONS

MODEL	BakeMark HEO-24
ELECTRICITY	13.2kW, 380V, 3 Phase + N
DIMENSIONS	1220 x 815 x 1260mm high
WEIGHT	125kg
CHAMBER DIMENSIONS	(2x) 860 x 620 x 220mm
CHAMBER CAPACITY	(2x) 600 x 400mm tray
TEMP RANGE	50 to 300°C

ORDER CODE

DOB2204



OPTIONAL EXTRAS

BAKING TRAY
600 x 400 x 30mm

BTA0064

FEATURES

- Robust construction
- Top and bottom elements individually controlled for each deck
- Fitted with the glass viewing window
- HEO-24 & HEO-22 - Fitted with (4x) castors
- Ceramic stone bases available on request
- Bottom hinged doors for easy loading
- Individually controlled internal lighting per deck
- Timer with buzzer individually controlled per deck
- HEO-11 - Fitted with (4x) non-slip rubber feet



2 DECK, 2 TRAY

SPECIFICATIONS

MODEL	BakeMark HEO-22
ELECTRICITY	6.4kW, 230V, Single Phase
DIMENSIONS	880 x 580 x 770mm high
WEIGHT	50kg
CHAMBER DIMENSIONS	(2x) 620 x 420 x 160mm
CHAMBER CAPACITY	(1x) 600 x 400mm tray
TEMP RANGE	50 to 300°C

ORDER CODE

DOB2102



1 DECK, 1 TRAY

SPECIFICATIONS

MODEL	BakeMark HEO-11
ELECTRICITY	3.2kW, 230V, Single Phase
DIMENSIONS	880 x 580 x 350mm high
WEIGHT	35kg
CHAMBER DIMENSIONS	(1x) 620 x 420 x 160mm
CHAMBER CAPACITY	(1x) 600 x 400mm tray
TEMP RANGE	50 to 300°C

ORDER CODE

DOB1101



OPTIONAL EXTRAS

BAKING TRAY

600 x 400 x 30mm

BTA0064



FEATURES

- Body manufactured from 0.8mm, 430 grade stainless steel
- Flame-out protection function
- Gas burner manufactured from SS304 stainless steel
- Fitted with timer to control
- Fitted with high quality digital display panels
- Fitted with heat resisting light
- Aluminum plated chambers for increased thermal radiation
- Double electromagnetic valve control
- Bottom hinged door with double tempered glass windows
- Each deck is fitted with a pizza stone base
- Electricity required for control operations
- Ceramic stone bases available on request



3 DECK, 9 TRAY

SPECIFICATIONS

MODEL	BakeMark HLY-309E
ELECTRICITY	0.2kW, 220V, Single Phase
BTU RATING	102 000
DIMENSIONS	1750 x 965 x 1720mm high
WEIGHT	370kg
CHAMBER DIMENSIONS	(3x) 1330 x 710 x 185mm high
CHAMBER CAPACITY	(3x) 600 x 400mm trays per deck
TEMP RANGE	30 to 400°C

ORDER CODE **DOB/3309G**



2 DECK, 6 TRAY

SPECIFICATIONS

MODEL	BakeMark HLY- 206E
ELECTRICITY	0.15 kW, 220V, Single Phase
BTU RATING	68 000
DIMENSIONS	1750 x 965 x 1375mm high
WEIGHT	290kg
CHAMBER DIMENSIONS	(3x) 1330 x 710 x 185mm high
CHAMBER CAPACITY	(3x) 600 x 400mm trays per deck
TEMP RANGE	30 to 400°C

ORDER CODE **DOB/2306G**



1 DECK, 3 TRAY

SPECIFICATIONS

MODEL	BakeMark HLY-103E
ELECTRICITY	0.075kW, 220V, Single Phase
BTU RATING	34 000
DIMENSIONS	1750 x 965 x 650mm high
WEIGHT	250kg
CHAMBER DIMENSIONS	1330 x 710 x 185mm high
CHAMBER CAPACITY	(3x) 600 x 400mm trays
TEMP RANGE	30 to 400°C

ORDER CODE **DOB/1303G**



GAS OVEN
LPG or NATURAL GAS



3 TRAYS PER DECK

OPTIONAL EXTRAS

BAKING TRAY
600 x 400 x 30mm

BTA0064

FEATURES

- Body manufactured from 0.8mm, 430 grade stainless steel
- Flame-out protection function
- Gas burner manufactured from SS304 stainless steel
- Fitted with timer to control
- Fitted with high quality digital display panels
- Fitted with heat resisting light
- Aluminum plated chambers for increased thermal radiation
- Double electromagnetic valve control
- Bottom hinged door with double tempered glass windows
- Each deck is fitted with a pizza stone base
- Electricity required for control operation
- Ceramic stone bases available on request



2 DECK, 4 TRAY

SPECIFICATIONS

MODEL	BakeMark HLY-204
ELECTRICITY	0.15kW, 220V, Single Phase
BTU RATING	51 000
DIMENSIONS	1395 x 965 x 1240mm high
WEIGHT	260kg
CHAMBER DIMENSIONS	(2x) 870 x 665 x 185mm high
CHAMBER CAPACITY	(2x) 600 x 400mm trays per deck
TEMP RANGE	30 to 400°C

ORDER CODE

DOB/2204G



1 DECK, 2 TRAY

SPECIFICATIONS

MODEL	BakeMark HLY-102
ELECTRICITY	0.075kW, 220V, Single Phase
BTU RATING	27 000
DIMENSIONS	1395 x 965 x 710mm high
WEIGHT	150kg
CHAMBER DIMENSIONS	870 x 665 x 185mm high
CHAMBER CAPACITY	(2x) 600 x 400mm trays per deck
TEMP RANGE	30 to 400°C

ORDER CODE

DOB/1202G



GAS OVEN
LPG or NATURAL GAS

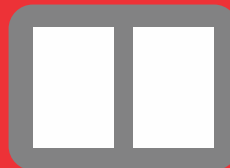

**2 TRAYS
PER DECK**

OPTIONAL EXTRAS

BAKING TRAY

600 x 400 x 30mm

BTA0064

ALUMINUM BAKING TRAYS

SmartChef



600 x 400 x 30mm

MODEL SmartChef BTA0064
DIMENSIONS 600 x 400 x 30mm deep

ORDER CODE **BTA0064**

430 x 345 x 10mm

MODEL SmartChef BTA0043
DIMENSIONS 430 x 345 x 10mm deep

ORDER CODE **BTA0043**

STAINLESS STEEL OVEN GRIDS



600 x 400mm

MODEL SmartChef OGS0064
DIMENSIONS 600 x 400mm

ORDER CODE **OGS0064**

GN 1/1

MODEL SmartChef OGS0011
DIMENSIONS 530 x 325mm

ORDER CODE **OGS0011**

STAINLESS STEEL COOLING RACKS



600 x 400mm

MODEL SmartChef CTS0064
DIMENSIONS 600 x 400mm

ORDER CODE **CTS0064**

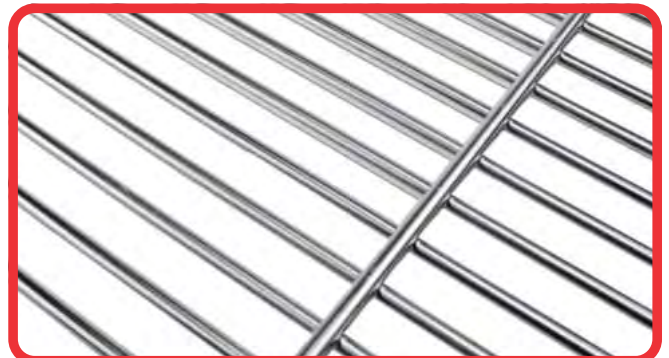



COMPACT
DESIGN



210mm

210mm

Same size as an
A4 page



Goshen[®]
Cool & Compact

SECTION INDEX

Blenders	99
Coffee brewers	96, 98
Coffee urns	97
Frappe makers	100
Gelato machines	104
Hot chocolate machines	98
Hot water urns	97
Ice cream machines	104-106
Ice crushers	100
Juice dispensers	101
Milkshake machines	100
Percolators	98
Slush machines	102-103
Smoothie makers	99
Soft serve machines	105-106
Urns	97

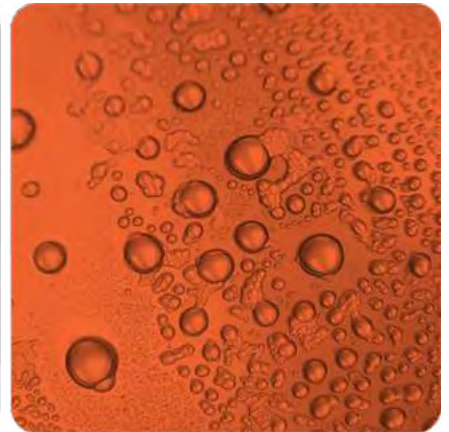

FEATURES

- Manufactured from Stainless Steel 304
- Built-in, concealed heating element with "dry-boil" protection
- Fitted with cool-touch handles
- Fitted with a non-drip tap and clear water gauge
- Supplied with a removable drip tray
- Double walled body for improved insulation
- Waterproof on/off switch for improved safety
- Equipped with a "twist-lock" lid to avoid spilling
- Supplied with an internal, stainless steel coffee strainer
- Available in black(matt) and stainless steel



18 LITRE

MODEL CaterLot 0018
 ELECTRICITY 1.5kW, 220V, Single Phase
 DIMENSIONS Ø310 x 581mm high
 WEIGHT 5kg
 CAPACITY 18Lt

Stainless steel
 Matt black

CBC0018
CBC0018-B



14 LITRE

MODEL CaterLot 0014
 ELECTRICITY 1.5kW, 220V, Single Phase
 DIMENSIONS Ø310 x 517mm high
 WEIGHT 4kg
 CAPACITY 14Lt

Stainless steel
 Matt black

CBC0014
CBC0014-B



8 LITRE

MODEL CaterLot 0008
 ELECTRICITY 0.95kW, 220V, Single Phase
 DIMENSIONS Ø230 x 504mm high
 WEIGHT 3kg
 CAPACITY 8Lt

Stainless steel
 Matt black

CBC0008
CBC0008-B





FEATURES

- Manufactured from Stainless Steel 304
- Double walled body for improved insulation
- Built-in, concealed heating element with "dry-boil" protection
- Fitted with an adjustable thermostat (30 ~ 110°C), with "keep warm" function
- Waterproof on/off switch for improved safety
- Fitted with cool-touch handles
- Equipped with a "twist-lock" lid to avoid spilling
- Fitted with a non-drip tap and clear water gauge
- Supplied with a removable drip tray
- Available in matt black, matt red, yellow, copper colour and stainless steel



24 LITRE SPECIFICATIONS

MODEL CaterLot 0024
 ELECTRICITY 2.5kW, 220V, Single Phase
 DIMENSIONS Ø310 x 640mm high
 WEIGHT 5kg
 CAPACITY 24Lt

Stainless steel
 Copper colour
 Yellow
 Matt black
 Matt red

URN0024
 URN0024-O
 URN0024-MY
 URN0024-B
 URN0024-MR



16 LITRE SPECIFICATIONS

MODEL CaterLot 0016
 ELECTRICITY 2.5kW, 220V, Single Phase
 DIMENSIONS Ø310 x 517mm high
 WEIGHT 4kg
 CAPACITY 16Lt

Stainless steel
 Copper colour
 Yellow
 Matt black
 Matt red

URN0016
 URN0016-O
 URN0016-MY
 URN0016-B
 URN0016-MR



9 LITRE SPECIFICATIONS

MODEL CaterLot 0009
 ELECTRICITY 1.5kW, 220V, Single Phase
 DIMENSIONS Ø230 x 504mm high
 WEIGHT 3kg
 CAPACITY 9Lt

Stainless steel
 Copper colour
 Yellow
 Matt black
 Matt red

URN0009
 URN0009-O
 URN0009-MY
 URN0009-B
 URN0009-MR



NON-DRIP TAP



WATERPROOF SWITCH



MANUAL THERMOSTAT



FEATURES

- Polypropylene with black rubber coated and stainless steel casing
- Coffee is kept at optimal temperature
- Supplied with (1x) 1.8L glass decanter
- Two separate teflon coated heating plates
- Suitable for 110mm/250mm filters
- Dry heating protection and overheating protection

SPECIFICATIONS

MODEL	Bravida RB-686P
ELECTRICITY	2.1kW, 230V, Single Phase
DIMENSIONS	200 x 350 x 400mm high
CAPACITY	1.8Lt
WEIGHT	6kg
BREWING TEMP	93 to 96°C
HEATING PLATE TEMP	80°C
BREWING TIME	100 cups/hr

ORDER CODE CMB1018



ADDITIONAL JUG

CAPACITY 1.8Lt
ORDER CODE CMJ0018



FEATURES

- 5 Litre capacity
- Mixes while heating up
- Digital control panel
- Disassembles for easy cleaning
- Modern design
- Temperature 30°C to 90°C
- Temperature display function

SPECIFICATIONS

MODEL	Bravida CH5L
ELECTRICITY	0.4kW, 230V, Single Phase
DIMENSIONS	400 x 320 x 470mm high
WEIGHT	6kg
CAPACITY	5Lt
TEMP RANGE	30 to 90°C

ORDER CODE HCP0005



FEATURES

- Modern design ABS housing with an "unbreakable" food grade Polycarbonate jar
- Various speed control, time and pulse action
- Removable dosing cup and stir bar included
- Industrial grade, heavy duty motor with pure copper coil
- VORTEX SC fitted with a Polycarbonate soundproof cover as standard (Optional extra for the VORTEX)
- Fitted with a stainless steel blade assembly
- Fitted with an over-heat, auto shut-off safety function
- Housing fitted with non-slip feet



VORTEX SC (WITH SOUND COVER)

SPECIFICATIONS

MODEL	SmartBlend VORTEX SC 1680C
ELECTRICITY	1.68kW, 220V, Single Phase
DIMENSIONS	230 x 250 x 540mm high (closed) 230 x 250 x 790mm high (open)
WEIGHT	9kg
SPEED	32 000rpm - Touch control
JAR CAPACITY	2L†
ORDER CODE	BSB1680C/C



VORTEX

SPECIFICATIONS

MODEL	SmartBlend VORTEX 1680
ELECTRICITY	1.68kW, 220V, Single Phase
DIMENSIONS	230 x 250 x 520mm high
WEIGHT	6kg
SPEED	32 000rpm - Analog control
JAR CAPACITY	2L†
ORDER CODE	BSB1680



STORM

SPECIFICATIONS

MODEL	SmartBlend STORM 112
ELECTRICITY	1.1kW, 220V, Single Phase
DIMENSIONS	225 x 210 x 490mm high
WEIGHT	4kg
SPEED	26 000rpm - Analog control
JAR CAPACITY	2L†
ORDER CODE	BSB0112

OPTIONAL EXTRAS



SOUND COVER

Compatible with VORTEX SC 1680C
VORTEX 1680

ORDER CODE **BSB1680-S/COVER**



2L JAR & TAMPER

Compatible with VORTEX SC 1680C
VORTEX 1680

ORDER CODE **BSB1680-JAR2L**

2L JAR & TAMPER

Compatible with STORM 112

ORDER CODE **BSB0112-JAR2L**

MILKSHAKE MACHINE / FRAPPE MIXER



FEATURES

- Manufactured from durable, food-grade ABS material
- Fitted with a two speed on/off switch
- Motor ventilation grooves prevents over heating
- Fitted with a powerful 400W motor with re-activated thermal cut-off for the safety of the appliance and the protection of the motor
- Fitted with non-slip feet
- Supplied with a stainless steel mixer cup. Optional ABS cup available
- Available in 5 colours to compliment any bar or kitchen theme

SPECIFICATIONS

MODEL	Johny AK/2-2T
ELECTRICITY	0.4kW, 220V, Single Phase
DIMENSIONS	170 x 175 x 465mm high
WEIGHT	4.5kg
SPEED	14 000 / 20 000rpm
CONTAINER CAPACITY	1 000ml

GREY	MMJ0001
RED	MMJ0002
GREEN	MMJ0003
BLUE	MMJ0004
SILVER	MMJ0005



1L STAINLESS STEEL CUP

ORDER CODE **MMJ1000**



1L POLYCARBONATE CUP

ORDER CODE **MMJ2000**

AVAILABLE COLOURS

- Dark Red
- Dark Blue
- Dark Green
- Dark Grey
- Silver



ICE CRUSHER



FEATURES

- Stainless steel body cover
- Front face cover manufactured from ABS
- Transparent feed cover. Manufactured from polycarbonate
- 2L transparent ice bucket with water draining grate. Manufactured from polycarbonate
- Isolating double-wall housing prevents immediate melting of ice
- Fitted with a 120W motor with thermal protection
- Fitted with Auto-stop safety micro switches on feed cover and ice bucket
- Fitted with non-slip feet

SPECIFICATIONS

MODEL	Johny AK/14 ECO
ELECTRICITY	0.12kW, 220V, Single Phase
DIMENSIONS	300 x 190 x 400mm high
WEIGHT	7kg
SPEED	40 rpm
CRUSH CAPACITY	40 kg/h
BUCKET CAPACITY	2L

ORDER CODE **ICJ0001**



FEATURES

- Body manufactured from high quality stainless steel
- Electromagnetic drive shaft
- Supplied with drip trays
- High resistance, non-toxic Polycarbonate tank
- Air cooling
- Fitted with (4x) non-slip feet



3 x 12L JUICE DISPENSER

SPECIFICATIONS

MODEL PolarCab LSJ12X3
ELECTRICITY 0.38kW, 220V, Single Phase
DIMENSIONS 610 x 410 x 660mm high
WEIGHT 36kg
CAPACITY (3x) 12L
TEMP RANGE 7 to 12 °C
REFRIGERANT GAS R134a

ORDER CODE

JDP0312



2 x 12L JUICE DISPENSER

SPECIFICATIONS

MODEL PolarCab LSJ12X2
ELECTRICITY 0.28kW, 220V, Single Phase
DIMENSIONS 410 x 410 x 660mm high
WEIGHT 27kg
CAPACITY (2x) 12L
TEMP RANGE 7 to 12 °C
REFRIGERANT GAS R134a

ORDER CODE

JDP0212



FEATURES

- R304, Stainless steel Body panel, louver panel for ventilation
- Durable, high density PC tanks with brandable lids
- Imported European brand compressor, durable, energy saving, low noise
- Dual beater mixing system (inner and outer cooling cylinder) to avoid "ice jam"
- Electromagnetic drive shaft
 - Fitted with an all red copper condenser
 - Fitted with (4x) non-slip feet
- Includes drip trays



3 x 10L SLUSH MACHINE

SPECIFICATIONS

MODEL	PolarCab XRJ10LX3
ELECTRICITY	0.8kW, 220V, Single Phase
DIMENSIONS	610 x 510 x 770mm high
WEIGHT	63kg
VOLUME	(3x) 10L
TEMP RANGE	-2 to -3°C
REFRIGERANT GAS	R134a

ORDER CODE **SMP0310**



2 x 10L SLUSH MACHINE

SPECIFICATIONS

MODEL	PolarCab XRJ10LX2
ELECTRICITY	0.6kW, 220V, Single Phase
DIMENSIONS	430 x 510 x 770mm high
WEIGHT	41kg
VOLUME	(2x) 10L
TEMP RANGE	-2 to -3°C
REFRIGERANT GAS	R134a

ORDER CODE

SMP0210



1 x 10L SLUSH MACHINE

SPECIFICATIONS

MODEL	PolarCab XRJ10LX1
ELECTRICITY	0.6kW, 220V, Single Phase
DIMENSIONS	220 x 510 x 770mm high
WEIGHT	28kg
VOLUME	10L
TEMP RANGE	-2 to -3°C
REFRIGERANT GAS	R134a

ORDER CODE

SMP0110



- FEATURES**
- Bottom housing manufactured from stainless steel
 - Durable PVC tanks
 - Easy to use touch control panel.
 - Three operation settings - Margarita, Slush, and Cold drinks
 - LCD display clearly shows the machine operation status
 - Independent Control System for each tank
 - LED lighting for easy nighttime operation and improved esthetics
 - Motor current protection and compressor overload protection
 - Large vents for fast heat dissipation and improved cooling efficiency



2 x 3L SLUSH MACHINE

SPECIFICATIONS

MODEL	PolarCab RL3x2
ELECTRICITY	0.4kW, 220V, Single Phase
DIMENSIONS	390 x 490 x 545mm high
VOLUME	(2x) 3L
WEIGHT	27kg
TEMP RANGE	-10 to 10°C
REFRIGERANT GAS	R290

ORDER CODE

SMP0203



1 x 3L SLUSH MACHINE

SPECIFICATIONS

MODEL	PolarCab RL3x1
ELECTRICITY	0.3kW, 220V, Single Phase
DIMENSIONS	240 x 490 x 545mm high
VOLUME	3L
WEIGHT	19kg
TEMP RANGE	-10 to 10°C
REFRIGERANT GAS	R290

ORDER CODE

SMP0103



GELATO MACHINES COUNTER TOP



FEATURES

- Body manufactured from stainless steel
- Compact design uses less workspace
- Transparent polycarbonate feeder hopper located in the front of the machine for easy and accurate operation
- Large stainless steel freezing cylinder increases output and "fluffiness" of the ice cream
- Retractable, rotating mixer blade inside the cylinder further improves the smoothness of the ice cream
- Fitted with a powerful, energy saving compressor
- Fitted with a digital, waterproof control panel
- Fitted with (4x) non-slip feet

SPECIFICATIONS

MODEL	Goshen BQ12T
ELECTRICITY	1kW, 220V, Single Phase
DIMENSIONS	500 x 705 x 800mm high
WEIGHT	110kg
HOPPER VOLUME	5.1Lt
REFRIGERANT GAS	R404a
HOURLY OUTPUT	10 ~ 14Lt/hour

ORDER CODE

ICM/BQ12T



OPTIONAL EXTRAS

ICE CREAM INSERT - 360 x 165 x 120mm deep
ORDER CODE **GNI8120**

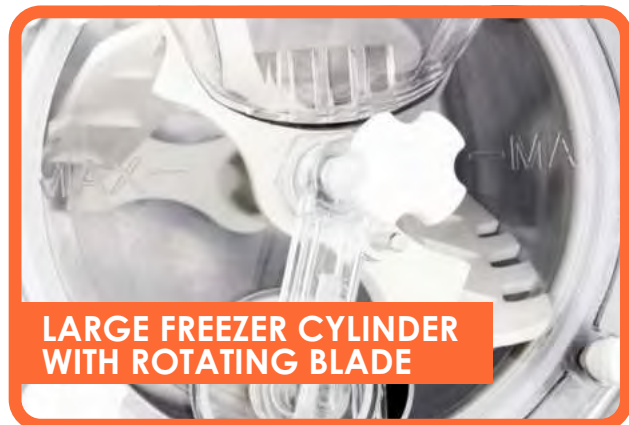
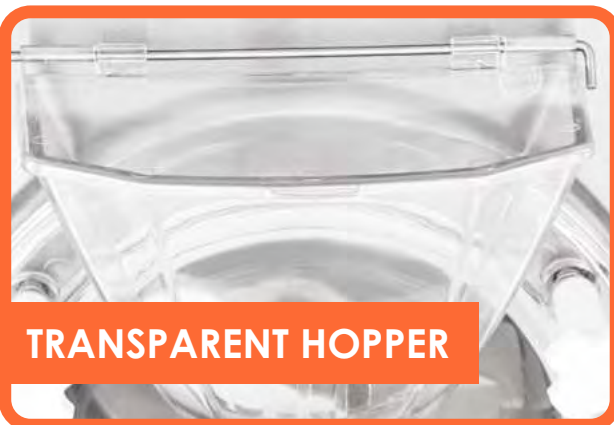

SOFT SERVE MACHINES COUNTER TOP



FEATURES

- Exquisite modern design. Small and portable
- Silent operation
- Fitted with a stainless steel refrigerated hopper
- Mixer installed inside hopper makes for smoother ice cream
- Fitted with a stainless steel beater
- Built-in air pump
- Fitted with a 7inch, touch screen control panel
- One-touch thaw function
- Fitted with (4x) non-slip feet



COOL & COMPACT

SPECIFICATIONS

MODEL	Goshen ST16RELW
ELECTRICITY	1.25kW, 220V, Single Phase
DIMENSIONS	210 x 554 x 740mm high
WEIGHT	45kg
HOPPER VOLUME	6Lt
REFRIGERANT GAS	R290
HOURLY OUTPUT	16 ~ 18Lt/hour
REALISTIC OUTPUT	12Lt (100 x 120g servings)

ORDER CODE **SSM/ST16RELW-W**

FEATURES

- Exquisite modern design. Small and portable
- Silent operation
- Fitted with a stainless steel hopper
- Fitted with a food grade plastic beater
- Built-in air pump
- Fitted with a 5inch, waterproof, touch control panel
- Built-in thaw function
- Fitted with (4x) non-slip feet
- Available in 3 exciting candy colours



COMPACT

SPECIFICATIONS

MODEL	Goshen ST16E
ELECTRICITY	1.15kW, 220V, Single Phase
DIMENSIONS	210 x 554 x 740mm high
WEIGHT	43kg
HOPPER VOLUME	6Lt
REFRIGERANT GAS	R290
HOURLY OUTPUT	16 ~ 18Lt/hour
REALISTIC OUTPUT	12Lt (100 x 120g servings)

ORDER CODE **SSM/ST16E-W** WHITE
SSM/ST16E-P PINK



SOFT SERVE MACHINES WITH REFRIGERATED HOPPER



FEATURES

- Compact design - can be installed in small areas
- Unique mixing shaft manufactured with stainless steel axes with non-toxic corkscrew plastic scrapers
- Fitted with 2 stainless steel refrigerated hoppers with clear plastic lids for easy viewing
- Quick recovery time
- Low noise and vibrations
- Easy to disassemble and clean
- Fitted with removable plastic drip tray
- IT Push panel (one touch switch) controller with indicator light for easy operation



WITH REFRIGERATED HOPPER



FLOOR STANDING

SPECIFICATIONS

MODEL	SQL922-RH-AP
ELECTRICITY	2kW, 230V, Single Phase
DIMENSIONS	550 x 700 x 1330mm high
WEIGHT	140kg
HOPPER CAPACITY	(2x) 5.8Lt
OUTPUT PER HOUR	180 cones
REFRIGERANT GAS	R404

ORDER CODE

SSM0002





**DRINK
MIXER**



ICE CRUSHER



**PRE-RINSE
UNITS**

RELIABILITY BUILT IN

**CONSERVE
UP TO**

60%

WATER

WASHING & HARDWARE

SECTION INDEX

Cleaning trolleys	125
Dishwasher basket trolleys	124
Dishwasher baskets	122-123
Dishwashers	
• Front loading	111, 113
• Hoodtype	112, 114-115
Faucets	117-118
Glass rinsers	119
Glass washers	110
Hand wash basins	121
Hose reels	120
Janitor trolleys	125
Knee operated hand wash basins	121
Laundry trolleys	125
Overhead sprays	116-117
Pre-rinse sprays	116-117



FEATURES

- The machine body is manufactured from AISI 304 18/10 stainless steel
- The powerful 1HP wash pump, designed and manufactured by Omniwash, ensures maximum performance wash after wash
- The rinse boiler is fitted with internal baffles to provide consistent clean rinse water and prevents the rinse temperature from dropping off too quickly
- High performance wash arms and jets are designed to work together with the Omniwash wash pump to deliver maximum washing action
- The powerful jets can cut through baked-on food soils
- Fitted with easy-to-use illustrated push buttons
- The wash and rinse arms are easy to remove and clean
- Wash tank filters keeps the machine free of excess food soils resulting in cleaner water for longer



SINGLE PHASE GRAVITY DRAIN

SPECIFICATIONS

MODEL	Omniwash Jolly 40
ELECTRICITY	3.15kW, 220V, Single Phase
DIMENSIONS	475 x 505 x 720mm high
WEIGHT	40kg
PC BOARDS	No - Electro Mechanical
MAX GLASS HEIGHT	290mm high
CYCLE TIME	120 seconds
CYCLES PER HOUR	30
HOURLY OUTPUT	Up to 1200 glasses
DRAIN PUMP	No - Gravity Drain
BASKET DIMENSIONS	400 x 400 x 100mm high
BASKETS SUPPLIED	1 x Open Bowl Dish Rack 1 x Cutlery Holder
BOILER CAPACITY	5.5Lt
WASH TANK CAPACITY	14Lt
WASH TANK TEMP	55°C
RINSE TEMP	80 ~ 85°C

ORDER CODE

GWO0040



*** WASTE POINT, NOT HIGHER THAN 100mm ABOVE FLOOR LEVEL IS REQUIRED FOR ALL GRAVITY DRAIN MODELS**

OPTIONAL STAND

STAINLESS STEEL WITH BASKET RUNNERS - 600mm high

SDO0040



FEATURES

- The machine body is manufactured from AISI 304 18/10 stainless steel
- The powerful 1HP wash pump, designed and manufactured by Omniwash, ensures maximum performance wash after wash
- The rinse boiler is fitted with internal baffles to provide consistent clean rinse water and prevents the rinse temperature from dropping off too quickly
- High performance wash arms and jets are designed to work together with the Omniwash wash pump to deliver maximum washing action
- The powerful jets can cut through baked-on food soils
- Fitted with easy-to-use illustrated push buttons
- The wash and rinse arms are easy to remove and clean
- Wash tank filters keeps the machine free of excess food soils resulting in cleaner water for longer



SINGLE PHASE GRAVITY DRAIN

SPECIFICATIONS

MODEL	Omniwash 5000 ST
ELECTRICITY	3.75kW, 220V, Single Phase
DIMENSIONS	590 x 600 x 815mm high
WEIGHT	59kg
PC BOARDS	Yes
MAX GLASS HEIGHT	320mm high
CYCLE TIME	120 seconds
CYCLES PER HOUR	30
HOURLY OUTPUT	Up to 1500 glasses Up to 540 dishes
DRAIN PUMP	No - Gravity Drain
BASKET DIMENSIONS	500 x 500 x 100mm high
BASKETS SUPPLIED	1 x All Purpose / Dish Rack 1 x Open Bowl Dish Rack 1 x Cutlery Holder
BOILER CAPACITY	6Lt
WASH TANK CAPACITY	29Lt
WASH TANK TEMP	55°C
RINSE TEMP	85°C

ORDER CODE

DWO0050



3 PHASE GRAVITY DRAIN

SPECIFICATIONS

MODEL	Omniwash Jolly 50 T
ELECTRICITY	6.75kW, 380V, 3 Phase + N
DIMENSIONS	590 x 600 x 815mm high
WEIGHT	59kg
PC BOARDS	No - Electro Mechanical
MAX GLASS HEIGHT	320mm high
CYCLE TIME	120 seconds
CYCLES PER HOUR	30
HOURLY OUTPUT	Up to 1500 glasses Up to 540 dishes
DRAIN PUMP	No - Gravity Drain
BASKET DIMENSIONS	500 x 500 x 100mm high
BASKETS SUPPLIED	1 x All Purpose / Dish Rack 1 x Open Bowl Dish Rack 1 x Cutlery Holder
BOILER CAPACITY	6Lt
WASH TANK CAPACITY	29Lt
WASH TANK TEMP	55°C
RINSE TEMP	85°C

ORDER CODE

DWO8050



* WASTE POINT, NOT HIGHER THAN 100mm ABOVE FLOOR LEVEL IS REQUIRED FOR ALL GRAVITY DRAIN MODELS

OPTIONAL STAND

STAINLESS STEEL WITH BASKET RUNNERS - 600mm high

SDO0050



FEATURES

- AISI 304 Stainless steel body
- Ergonomic design
- Easy to use electro mechanical control panel
- 4.5 kW boiler resistance provides the fixed 82.5 °C water temperature level for the best washing results
- Specially designed wash and rinse spraying arm provides the best washing results
- Adjustable wash programs. 60, 90, 120 or 180 seconds
- Specially designed rubber water transfer system, prevents pressure loss and provides more effective washing



SINGLE PHASE WITH DRAIN & DETERGENT PUMPS SPECIFICATIONS

MODEL	Crystal CRW500 TPD
ELECTRICITY	5.2kW, 220V, Single Phase
DIMENSIONS	590 x 610 x 830mm high
WEIGHT	60kg
PC BOARDS	No - Electro Mechanical
MAX GLASS HEIGHT	320mm high
CYCLE TIME	60 ~ 180 seconds
CYCLES PER HOUR	20 ~ 60
HOURLY OUTPUT	Up to 1500 glasses Up to 540 dishes
DRAIN PUMP	Yes
RINSE & CHEM PUMP	Yes
BASKET DIMENSIONS	500 x 500 x 100mm high
BASKETS SUPPLIED	1 x All Purpose / Dish Rack 1 x Open Bowl Dish Rack 1 x Cutlery Holder
BOILER CAPACITY	6Lt
WASH TANK CAPACITY	14Lt
WASH TANK TEMP	55°C
RINSE TEMP	80 ~ 85°C

ORDER CODE **CRY-CRW500.TPD**

SINGLE PHASE WITH DRAIN PUMP SPECIFICATIONS

MODEL	Crystal CRW500 T
ELECTRICITY	5.2kW, 220V, Single Phase
DIMENSIONS	590 x 610 x 830mm high
WEIGHT	60kg
PC BOARDS	No - Electro Mechanical
MAX GLASS HEIGHT	320mm high
CYCLE TIME	60 ~ 180 seconds
CYCLES PER HOUR	20 ~ 60
HOURLY OUTPUT	Up to 1500 glasses Up to 540 dishes
DRAIN PUMP	Yes
RINSE & CHEM PUMP	No
BASKET DIMENSIONS	500 x 500 x 100mm high
BASKETS SUPPLIED	1 x All Purpose / Dish Rack 1 x Open Bowl Dish Rack 1 x Cutlery Holder
BOILER CAPACITY	6Lt
WASH TANK CAPACITY	14Lt
WASH TANK TEMP	55°C
RINSE TEMP	80 ~ 85°C

ORDER CODE **CRY-CRW500.T**

OPTIONAL STAND

STAINLESS STEEL WITH BASKET RUNNERS - 600mm high

SDO0050





FEATURES

- AISI 304 Stainless steel body with esthetic finish
- Ergonomic design with rounded corners
- Easy to use electro mechanical control panel
- Specially designed hood spring system
- 9.7kW boiler resistance provides the fixed 82.5°C water temperature level for the best washing results
- Specially designed wash and rinse spraying arm provides the best washing results
- 2 cycles - 90 or 180 seconds
- Specially designed rubber water transfer system, prevents pressure loss and provides more effective washing

SPECIFICATIONS

ELECTRICITY	9.7kW, 380V, 3 Phase + N
DIMENSIONS	610 x 730 x 1460mm high 610 x 730 x 1950mm high (open)
WEIGHT	95kg
MAX GLASS HEIGHT	380mm high
CYCLE TIME	90 ~ 180 seconds
CYCLES PER HOUR	20 ~ 40
HOURLY OUTPUT	Up to 2000 glasses Up to 700 dishes
BASKET DIMENSIONS	500 x 500 x 100mm high
BASKETS SUPPLIED	(1x) All Purpose / Plate Dish Rack (1x) Open Bowl Dish Rack
BOILER CAPACITY	7Lt
WASH TANK CAPACITY	45Lt
WASH TANK TEMP	55°C
RINSE TEMP	80 ~ 85°C

GRAVITY DRAIN

MODEL	Crystal CRW1000
DRAIN PUMP	No
RINSE & CHEM PUMP	No
ORDER CODE	CRY-CRW1000

DRAIN PUMP

MODEL	Crystal CRW1000 T
DRAIN PUMP	Yes
RINSE & CHEM PUMP	No
ORDER CODE	CRY-CRW1000.T

DRAIN & DETERGENT PUMPS

MODEL	Crystal CRW1000 TPD
DRAIN PUMP	Yes
RINSE & CHEM PUMP	Yes
ORDER CODE	CRY-CRW1000.TPD



* WASTE POINT, NOT HIGHER THAN 100mm ABOVE FLOOR LEVEL IS REQUIRED FOR ALL GRAVITY DRAIN MODELS



FEATURES

- AISI 304 stainless steel body and digital control panel
- Instant display of tank and boiler water temperatures
- 5 different washing programs, adjustable to 60-90-120-180-240 seconds
- 1 dishwashing basket consumes 3 liters of water
- EPDM rubber hose substance conforming to Food Codex standards
- Effective washing results with a specially designed washing and rinsing arms structure
- Thanks to a specially-designed card technology, the rinsing process does not start before the boiler water temperature reaches 85°C. This guarantees hygienic rinsing according to HACCP standards
- Automatic pause and resume feature when opening or closing the door
- 9 kW boiler heating element, 4,5 kW tank heating element
- Front cover allows easy technical service without moving / dragging the product around

DIGITAL CONTROL

SPECIFICATIONS

MODEL	Crystal CRWD1000
ELECTRICITY	9.7kW, 380V, 3 Phase + N
DIMENSIONS	610 x 730 x 1460mm high 610 x 730 x 1950mm high (open)
WEIGHT	95kg
MAX GLASS HEIGHT	380mm high
CYCLE TIME	60 ~ 240 seconds
CYCLES PER HOUR	15 ~ 60
HOURLY OUTPUT	Up to 2000 glasses Up to 1000 dishes
BASKET DIMENSIONS	500 x 500mm
BASKETS SUPPLIED	(1x) All Purpose / Plate Dish Rack (1x) Open Bowl Dish Rack
BOILER CAPACITY	7Lt
WASH TANK CAPACITY	45Lt
WASH TANK TEMP	55°C
RINSE TEMP	80 ~ 85°C

ORDER CODE

CRY-CRWD1000

* WASTE POINT, NOT HIGHER THAN 100mm ABOVE FLOOR LEVEL IS REQUIRED FOR ALL GRAVITY DRAIN MODELS





DECK MOUNTED PRE-RINSE SPRAY

- Single Hole Base • 18" Flexible Inlet Hoses

SPECIFICATIONS

INLET	In-Line Check Valves - G 1/2 (BSPP) Male
OUTLET	1.15 GPM Spray Valve
HANDLE	Euro Lever
CARTRIDGE	Quarter-Turn Ceramic
PRESSURE RATING	20 to 125 psi
TEMP. RATING	4 to 60°C

ORDER CODE **TS/5PR-2S00**



WALL MOUNTED PRE-RINSE SPRAY

- 8" Wall Mounted Base

SPECIFICATIONS

INLET	In-Line Check Valves - 1/2" NPT Female
OUTLET	1.15 GPM Spray Valve
HANDLE	Euro Lever
CARTRIDGE	Quarter-Turn Ceramic
PRESSURE RATING	20 to 125 psi
TEMP. RATING	4 to 60°C

ORDER CODE **TS/5PR-8W00**

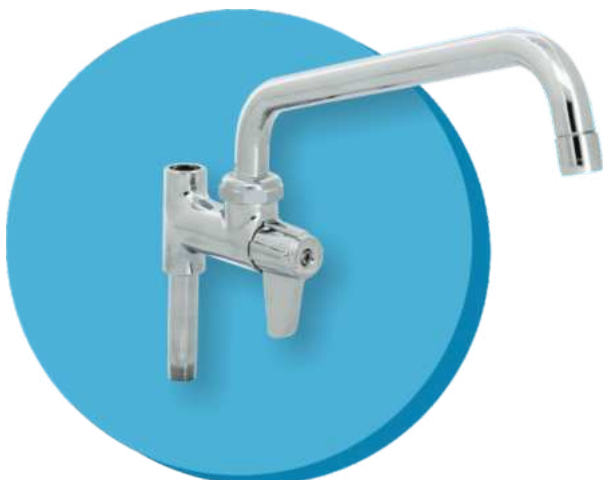

PRE-RINSE ADD-ON-FAUCET

- Add-On for Pre-Rinse • 12" Swing Nozzle Equip

SPECIFICATIONS

INLET	3/8" NPT Male
OUTLET	4.52 GPM Laminar Flow Device
HANDLE	Euro Lever
CARTRIDGE	Ceramic
PRESSURE RATING	20 to 125 psi
TEMP. RATING	4 to 60°C

ORDER CODE **TS/5AFL12**

PRE-RINSE SPRAYS



DECK MOUNTED MINI PRE-RINSE SPRAY WITH 8" FAUCET

- Single Hole Base • 18" Flexible Inlet Hoses
- 8" Add-on Faucet • 628 mm Low-Profile Height

SPECIFICATIONS

INLET	In-Line Check Valves - G 1/2 (BSPP) Male
SPRAY OUTLET	1.15 GPM Spray Valve
NOZZLE	3.83 GPM 8" Add-On-Faucet Swing Nozzle
HANDLE	Euro Leve
CARTRIDGE	Quarter-Turn Ceramic
PRESSURE RATING	20 to 125 psi
TEMP. RATING	4 to 60°C

ORDER CODE TS/5MPH-2SLN-08



WALL MOUNTED MINI PRE-RINSE SPRAY WITH 8" FAUCET

- 8" Wall mounted base • 8" Add-on Faucet
- 628 mm Low-Profile Height

SPECIFICATIONS

INLET	In-Line Check Valves - 1/2" NPT Female
SPRAY OUTLET	1.15 GPM Spray Valve
NOZZLE	4.62 GPM 8" Add-On-Faucet Swing Nozzle
HANDLE	Euro Lever
CARTRIDGE	Quarter-Turn Ceramic
PRESSURE RATING	20 to 125 psi
TEMP. RATING	4 to 60°C

ORDER CODE TS/5MPH-8WLN-08

KITCHEN FAUCETS



WALL MOUNTED KITCHEN FAUCET

- 6" Wall Mount Faucet • 12" Swing Nozzle

SPECIFICATIONS

INLET	G 1/2 (BSPP) Male Offset Inlets
OUTLET	3.96 GPM Laminar Flow Device
HANDLE	Euro Lever
CARTRIDGE	Quarter-Turn Ceramic
PRESSURE RATING	20 to 125 psi
TEMP. RATING	4 to 60°C

ORDER CODE TS/EU-6WF12



SINGLE LEVER KITCHEN FAUCET

- Single Hole Base • 19" Flexible Inlet Hoses
- 9" Swivel Nozzle

SPECIFICATIONS

INLET	G 1/2" Female
OUTLET	Full Flow Aerator
HANDLE	Single Lever
CARTRIDGE	Single Lever Ceramic
PRESSURE RATING	20 to 125 psi
TEMP. RATING	4 to 60°C

ORDER CODE TS/EA-1DF09-LH



HIGH SPOUT BAR FAUCET SINGLE LEVER

- Single Hole Base • 18" Flexible Inlet Hoses
- 8" Nozzle Single Lever • High Rise

SPECIFICATIONS

Inlet	G 1/2" Female
Outlet	3.96 GPM Full Flow Aerator
Handle	Single Lever
Cartridge	Single Lever Ceramic
Pressure Rating	20 ~ 125 psi
Temp. Rating	4 ~ 60°C

ORDER CODE TS/EA-1DF08-300



DECK MOUNTED KITCHEN FAUCET

- Single Hole Base • 18" Flexible Inlet Hoses
- 8" Swing Nozzle

SPECIFICATIONS

Inlet	5/8" OD Copper Tubing or 1/2" NPSM Male
Outlet	4.65 GPM Laminar Flow Device
Handle	Euro Lever
Cartridge	Quarter-Turn Ceramic
Pressure Rating	20 ~ 125 psi
Temp. Rating	4 ~ 60°C

ORDER CODE TS/5F-2SLX08



DECK MOUNTED GOOSENECK FAUCET

- Single Hole Base • 18" Flexible Inlet Hoses
- 5.5" Swivel Gooseneck Nozzle

SPECIFICATIONS

Inlet	5/8" OD Copper Tubing or 1/2" NPSM Male
Outlet	2.2 GPM Aerator
Handle	Euro Lever
Cartridge	Quarter-Turn Ceramic
Pressure Rating	20 ~ 125 psi
Temp. Rating	4 ~ 60°C

ORDER CODE TS/5F-2SLX05A



WALL MOUNTED POT FILLER

- Single Control • 18" Double Joint Nozzle
- Insulated On-Off Control

SPECIFICATIONS

Inlet	5/8" OD Copper Tubing or 1/2" NPSM Male
Outlet	4.24 GPM Heat Resistant On-Off Volume Control
Handle	4-Arm
Cartridge	Compression
Pressure Rating	20 ~ 125 psi
Temp. Rating	4 ~ 60°C

ORDER CODE TS/B-0592



180 x 170mm

SPECIFICATIONS

INLET	1/2" BSP Drain inlet spigot
WASH MOUTH	114mm Ø
PRESSURE RATING	14.5 psi
CUT-OUT SIZE	157 x 144mm

ORDER CODE TS/EX-RINSER-1



630 x 220mm

SPECIFICATIONS

INLET	1/2" BSP Drain inlet spigot
WASH MOUTH	114mm Ø
PRESSURE RATING	14.5 psi
CUT-OUT SIZE	180 x 610mm

ORDER CODE TS/EX-RINSER-3

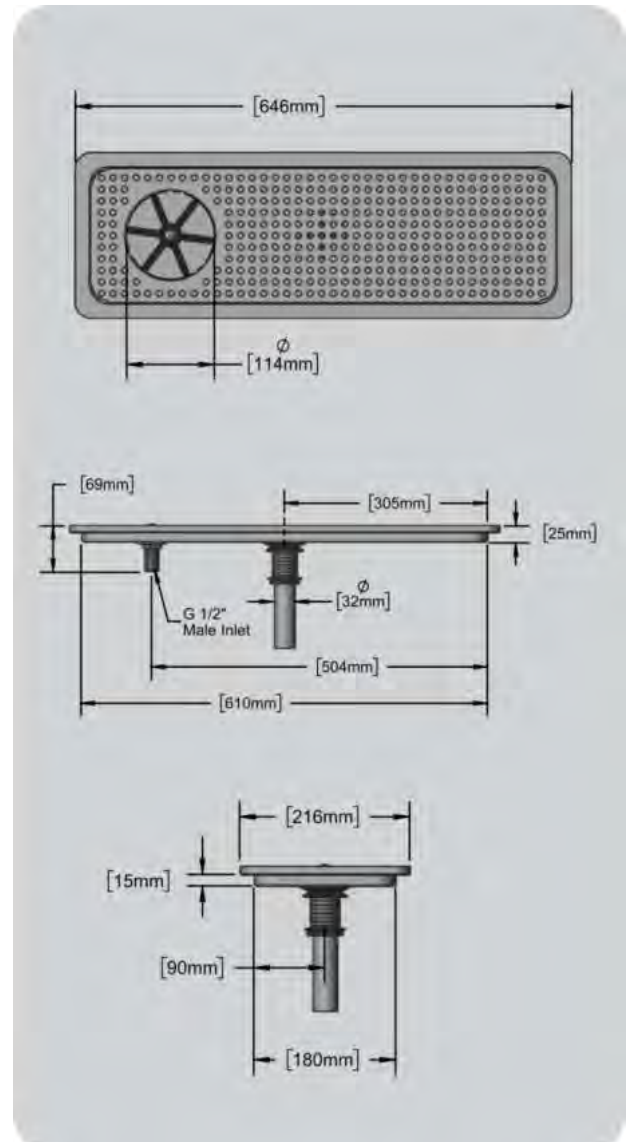
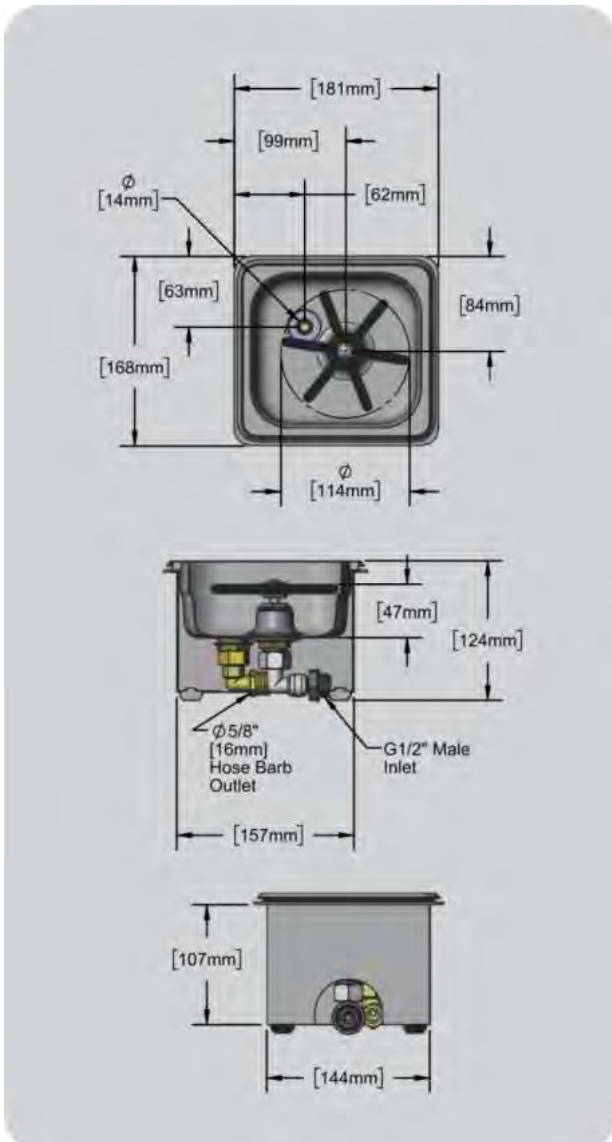

HOSE REELS



10m STAINLESS STEEL

SPECIFICATIONS

INLET	3/8" NPT female inlet
HOSE SIZE	3/8 x 35 in
HOSE LENGTH	10.7m
SPRAY VALVE	Front trigger water gun
SPRAY VALVE FLOW	15.5 L/min
PRESSURE RATING	20 to 125 psi
TEMP. RATING	4 to 93°C

ORDER CODE TS/B-7132-05



10m EPOXY COATED

SPECIFICATIONS

INLET	3/8" NPT female inlet
HOSE SIZE	3/8 x 35 in
HOSE LENGTH	10.7m
SPRAY VALVE	Front trigger water gun
SPRAY VALVE FLOW	15.5 L/min
PRESSURE RATING	20 to 125 psi
TEMP. RATING	4 to 93°C

ORDER CODE TS/B-7232-05



15m EPOXY COATED (ECONO MODEL)

SPECIFICATIONS

INLET	3/8" NPT female inlet
HOSE SIZE	3/8 x 50 in
HOSE LENGTH	15.2m
SPRAY VALVE	Front trigger water gun
SPRAY VALVE FLOW	15.5 L/min
PRESSURE RATING	20 to 125 psi
TEMP. RATING	4 to 60°C

ORDER CODE TS/5HR-242-12



UNIVERSAL SWING BRACKET FOR HOSE REELS

DIMENSIONS	121 x 279 x 209mm
WEIGHT	3.5kg

FEATURES

Designed for one person installation
Easy Install stainless steel wall mount swing bracket
Fits all T&S 3/8" and 1/2" hose reels
Includes reel-to-bracket mounting hardware
Positive stops built in to bracket to keep hose reel from hitting or damaging wall

ORDER CODE TS/G019430-45



FEATURES

- Manufactured from AISI 304 stainless steel
- High splash-back with deep-drawn tank
- Hot and cold water supply
- Adjustable single lever mixer tap with non-return valve
- Fitted with a "swan-neck" faucet
- Smooth rounded corners for increased esthetics

KNEE OPERATED

SPECIFICATIONS

MODEL SmartChef GDLVB2
 DIMENSIONS 400 x 330 x 570mm high
 WEIGHT 7kg

ORDER CODE

HWS0001



FEATURES

- Manufactured from AISI 304 stainless steel
- Splash-back with deep-drawn tank
- Smooth rounded corners for increased esthetics
- Faucets and hardware not included

STANDARD

SPECIFICATIONS

MODEL SmartChef GDLVB1
 DIMENSIONS 380 x 300 x 190mm high
 WEIGHT 2.5kg

ORDER CODE

HWS0000

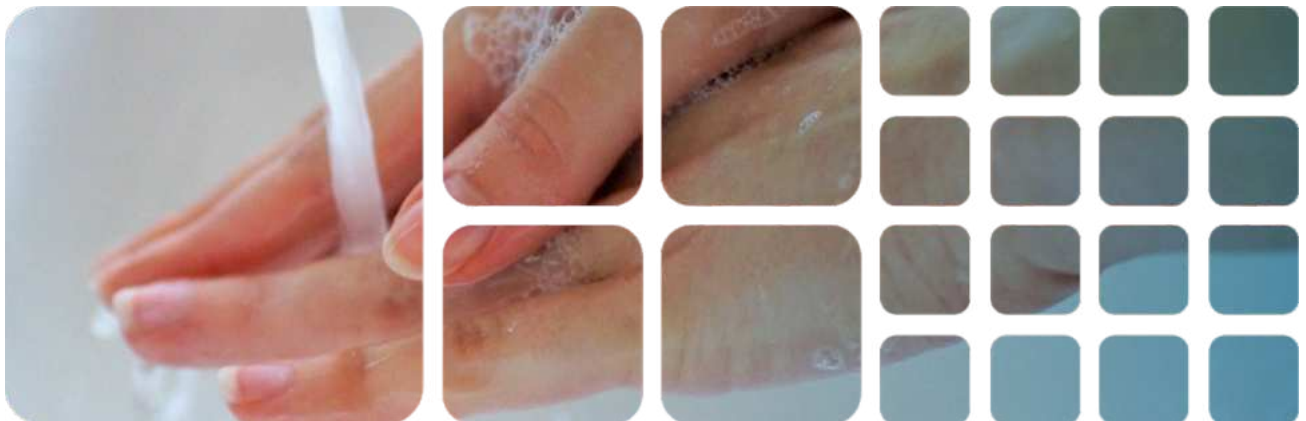

DISHWASHER BASKETS

NOTE: All Baskets dimensions are 500 x 500 x 100mm deep

16 COMPARTMENT

ORDER CODE DWB-GR0016



20 COMPARTMENT

ORDER CODE DWB-GR0020



25 COMPARTMENT

ORDER CODE DWB-GR0025



36 COMPARTMENT

ORDER CODE DWB-GR0036



NOTE: All Extenders dimensions are 500 x 500 x 45mm deep

16 COMP EXTENDER

ORDER CODE DWB-GR0016E

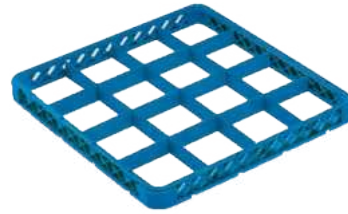

OPEN EXTENDER

ORDER CODE DWB-EX0000



25 COMP EXTENDER

ORDER CODE DWB-GR0025E



36 COMP EXTENDER

ORDER CODE DWB-GR0036



DISHWASHER BASKETS

CUTLERY BASKET

DIMENSIONS 500 x 500 x 100 mm deep
ORDER CODE DWB-CR0000



1 COMP CUTLERY BASKET

DIMENSIONS 107 x 107 x 139 mm deep
ORDER CODE DWB-CH0001



8 COMP CUTLERY BASKET

DIMENSIONS 427 x 208 x 151 mm deep
ORDER CODE DWB-CH0008



RACKS

64 PEG PLATE RACK

DIMENSIONS 500 x 500 x 100mm deep
ORDER CODE DWB-AP0064



RACK COVER

COMPATIBLE WITH ALL BASKETS
ORDER CODE DWB-RC0000



RACK DOLLY WITH HANDLE

DIMENSIONS 540 x 540 x 785 mm high
ORDER CODE DWB-RD0000





FEATURES

- Can be used for air drying cutlery and crockery
- Ideal for the transportation of cutlery and crockery
- Frame manufactured from 25mm stainless steel tubing
- L-shaped stainless steel runners
- Fitted with tray stops on each end
- Fitted with 4 castors, 2 lockable (100mm Ø)
- Baskets not included

SPECIFICATIONS

MODEL	SmartChef RWR-7
DIMENSIONS	560 x 510 x 1700mm high
SHELVES	7
RUNNER SPACING	200mm
BASKET COMPATIBILITY	500 x 500mm baskets
LOADING CAPACITY	200kg
WEIGHT	14kg

ORDER CODE

DBT0007



LAUNDRY TROLLEY

FEATURES

- Frame manufactured 201 stainless steel round tubing
- High quality canvas bag included
- (10x) Metal clasp hooks to secure canvas bag to frame
- Easy to assemble (Supplied flatpacked)
- Fitted with 4 castors, 2 lockable



SPECIFICATIONS

MODEL	SmartChef LC-Q
DIMENSIONS	910 x 560 x 920mm high
BAG DIMENSIONS	850 x 550 x 600mm high
WEIGHT	8kg
LOADING CAPACITY	150kg

ORDER CODE **LDT0001**

JANITOR TROLLEY

FEATURES

- Manufactured from polypropylene plastic
- Supplied with (1x) 60Lt PVC bag
- 3 Sturdy shelves plus built-in mop, broom holders and hooks to keep things organized
- Spacious front platform is large enough to hold an additional trash can or mop bucket and wringer
- Easy to assemble (Supplied flatpacked)
- Fitted with (2x) 80mm front wheels and (2x) 200mm rear wheels



SPECIFICATIONS

MODEL	SmartChef 600503
DIMENSIONS	1250 x 510 x 950mm high
WEIGHT	12kg

ORDER CODE **JTP0001**



HIGH QUALITY CANVAS BAG



CONVENIENCE



inoxserv

LUXERIOUS BUFFET WARE

CHAFING DISHES • SOUP STATIONS • CEREAL DISPENCERS • JUICE DISPENCERS • URNS

BUFFET WARE

SECTION INDEX

Cereal dispensers	135
Chafing dish heating elements	129
Chafing dish stands	128-129
Chafing dishes	
Econo series	131
Electric	132
Induction series	128-129
PC cover series	132
Window series	131
Delux coffee urns	137
Electric chafing dishes	132
Gastronome pans	133
Heating elements for chafing dishes	129
Hot water urns	137
Induction chafing dishes	128-129
Induction warmers	130
Inserts	133
Juice dispensers	136
Soup kettles	131, 134
Soup warmers	129
Urns	137



CHAFING DISHES

INDUCTION SERIES

inoxserv

REMOVABLE LID WITH TRANSPARENT GLASS

- It provides a clear view of food, even when closed
- It is easy to open and it engages at various opening angles
- It is easy to remove for cleaning and storage
- The lid movement is controlled by a long-life damping hinge
- It provides a water internal recycle system around the lid edge



REMOVABLE LID



INDUCTION HEATING

HEAT SOURCES

- **Induction warmer** - Table top - Counter sunk - In stand
- **Electric heater** - In stand
- **Solid alcohol** - In stand



CAPSULATED BOTTOM

CAPSULATED BOTTOM

- Provides even heat distribution
- Minimises heat loss improving energy efficiency



*SHOWN WITH OPTIONAL STAND



*SHOWN WITH OPTIONAL STAND

CHAFING DISH WITH HYDRAULIC GLASS LID RECTANGULAR

SPECIFICATIONS

MODEL	Inoxserv Induction Series S60593
DIMENSIONS	580 x 440 x 330mm high
CAPACITY	8.5Lt
HEAT SOURCE	Induction warmer Heating element Chafing fuel
SUPPLIED WITH	(1x) 1/1GN pan - 65mm deep Serving spoon holder
ORDER CODE	BEI-S60593



*STAND AND HEAT SOURCE NOT INCLUDED

CHAFING DISH WITH HYDRAULIC GLASS LID SQUARE

SPECIFICATIONS

MODEL	Inoxserv Induction Series S60293
DIMENSIONS	400 x 440 x 320mm high
CAPACITY	4.8Lt
HEAT SOURCE	Induction warmer Heating element Chafing fuel
SUPPLIED WITH	(1x) 2/3 GN pan - 65mm deep Serving spoon holder
ORDER CODE	BEI-S60293



*STAND AND HEAT SOURCE NOT INCLUDED

STAND FOR CHAFING DISH - RECTANGULAR

SPECIFICATIONS

MODEL	Inoxserv Induction Series S60590
DIMENSIONS	565 x 330 x 155mm high
HEAT SOURCE	Induction warmer > ISC-BT-70T Heating element > BEI-S305T Chafing fuel
SUPPLIED WITH	(2x) Chafing fuel holders
ORDER CODE	BEI-S60590



*HEAT SOURCE NOT INCLUDED

STAND FOR CHAFING DISH - SQUARE

SPECIFICATIONS

MODEL	Inoxserv Induction Series S60290
DIMENSIONS	385 x 385 x 155mm high
HEAT SOURCE	Induction warmer > ISC-BT-70T Heating element > BEI-S305T Chafing fuel
SUPPLIED WITH	(1x) Chafing fuel holders
ORDER CODE	BEI-S60290



*HEAT SOURCE NOT INCLUDED

CHAFING DISHES INDUCTION SERIES



*SHOWN WITH OPTIONAL STAND

CHAFING DISH WITH HYDRAULIC GLASS LID ROUND

SPECIFICATIONS

MODEL	Inoxserv Induction Series S50293
DIMENSIONS	440 x 480 x 320mm high
CAPACITY	5Lt
HEAT SOURCE	Induction warmer Heating element Chafing fuel
SUPPLIED WITH	(1x) Round pan - 65mm deep Serving spoon holder
ORDER CODE	BEI-S50293

*STAND AND HEAT SOURCE NOT INCLUDED



STAND FOR CHAFING DISH - ROUND

SPECIFICATIONS

MODEL	Inoxserv Induction Series S50280
DIMENSIONS	300 x 300 x 155mm high
HEAT SOURCE	Induction warmer > ISC-BT-70T Heating element > BEI-S205T Chafing fuel
SUPPLIED WITH	(1x) Chafing fuel holders
ORDER CODE	BEI-S50290

*HEAT SOURCE NOT INCLUDED



inoxserv



*SHOWN WITH OPTIONAL STAND

SOUP STATION WITH HYDRAULIC GLASS LID

SPECIFICATIONS

MODEL	Inoxserv Induction Series S50288
DIMENSIONS	410 x 490 x 410mm high
CAPACITY	10Lt
HEAT SOURCE	Induction warmer Heating element Chafing fuel
SUPPLIED WITH	(1x) Round pan - 210mm deep Serving spoon holder
ORDER CODE	BEI-S50288

*STAND AND HEAT SOURCE NOT INCLUDED



STAND FOR BUFFET SOUP STATION

SPECIFICATIONS

MODEL	Inoxserv Induction Series S50290
DIMENSIONS	315 x 315 x 155mm high
HEAT SOURCE	Induction warmer > ISC-BT-70T Heating element > BEI-S205T Chafing fuel
SUPPLIED WITH	(1x) Chafing fuel holders
ORDER CODE	BEI-S50280

*HEAT SOURCE NOT INCLUDED



HEATING ELEMENT WITH CONTROLLER - 250mm

SPECIFICATIONS

MODEL	Inoxserv S305T
ELECTRICITY	0.38kW, 230V, Single Phase
DIMENSIONS	250 x 200mm
COMPATIBLE WITH	Oblong - BEI-S60590 Square - BEI-S60290

ORDER CODE **BEI-S305T**



HEATING ELEMENT WITH CONTROLLER - 175mm

SPECIFICATIONS

MODEL	Inoxserv S205T
ELECTRICITY	0.33kW, 230V, Single Phase
DIMENSIONS	175 x 200mm
COMPATIBLE WITH	Round - BEI-S50280 Soup Station - BEI-S50290

ORDER CODE **BEI-S205T**



DROP IN / COUNTERSUNK MODELS - TOUCH CONTROL



SPECIFICATIONS

MODEL SmartChef-i BT-200T1
 ELECTRICITY 2kW, 230V, Single Phase
 DIMENSIONS 305 x 375 x 75mm high
 TEMP RANGE 60 to 240°C
 COMPATIBLE WITH BEI-S60593
 BEI-S60293
 BEI-S50293
 BEI-S50288

ORDER CODE **ISC-BT-200T1**

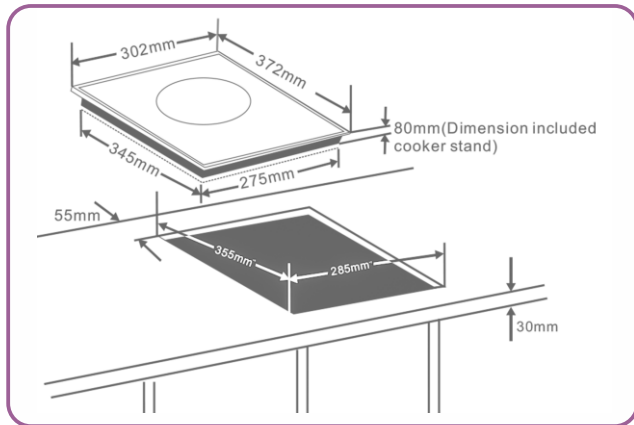

SPECIFICATIONS

MODEL SmartChef-i BT-100T
 ELECTRICITY 2kW, 230V, Single Phase
 DIMENSIONS Ø245 x 60mm high
 TEMP RANGE 60 to 240°C
 COMPATIBLE WITH BEI-S60593
 BEI-S60293
 BEI-S50293
 BEI-S50288

ORDER CODE **ISC-BT100T**

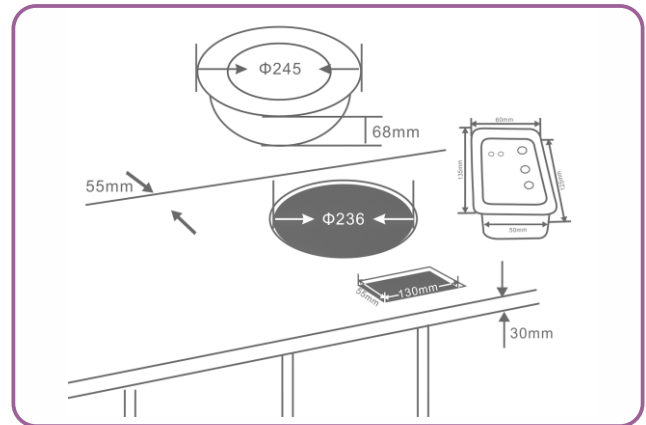

TABLE TOP MODEL - MANUAL CONTROL



SPECIFICATIONS

MODEL SmartChef-i BF-100A
 ELECTRICITY 1kW, 230V, Single Phase
 DIMENSIONS 460 x 315 x 60mm high
 TEMP RANGE 60 to 240°C
 COMPATIBLE WITH BEI-S60593
 BEI-S60293
 BEI-S50293
 BEI-S50288

ORDER CODE **ISC-BF100A**

IN-STAND MODEL - TOUCH CONTROL



SPECIFICATIONS

MODEL SmartChef-i BT-70T
 ELECTRICITY 1kW, 230V, Single Phase
 DIMENSIONS Ø180 x 70mm high
 TEMP RANGE 60 to 240°C
 COMPATIBLE WITH BEI-S60590
 BEI-S60290
 BEI-S50290
 BEI-S50280

ORDER CODE **ISC-BT70T**

CHAFING DISHES WINDOW / ECONOMIC SERIES

inoxserv



*HEAT SOURCE NOT INCLUDED

CHAFING DISH WITH SHOW WINDOW - RECTANGULAR SPECIFICATIONS

MODEL Innoxserv Show Window Series KS61363-2
DIMENSIONS 645 x 475 x 435mm high
CAPACITY 8.5Lt
HEAT SOURCE Chafing fuel
SUPPLIED WITH (1x) 1/1GN pan - 65mm deep
Stand
(2x) Chafing fuel holders

ORDER CODE

BEI-KS61363-2



*HEAT SOURCE NOT INCLUDED

CHAFING DISH WITH SHOW WINDOW - ROUND SPECIFICATIONS

MODEL Innoxserv Show Window Series KS51363
DIMENSIONS Ø530 x 450mm high
CAPACITY 5Lt
HEAT SOURCE Chafing fuel
SUPPLIED WITH (1x) Round pan - 65mm deep
Stand
(1x) Chafing fuel holder

ORDER CODE

BEI-KS51363



*HEAT SOURCE NOT INCLUDED

CHAFING DISH - RECTANGULAR SPECIFICATIONS

MODEL Innoxserv Economic Series AT61363-2
DIMENSIONS 645 x 475 x 435mm high
CAPACITY 8.5Lt
HEAT SOURCE Chafing fuel
SUPPLIED WITH (1x) 1/1GN pan - 65mm deep
Stand
(2x) Chafing fuel holders

ORDER CODE

BEI-AT61363-2



*HEAT SOURCE NOT INCLUDED

CHAFING DISH - ROUND SPECIFICATIONS

MODEL Innoxserv Economic Series AT51363
DIMENSIONS Ø530 x 450mm high
CAPACITY 5Lt
HEAT SOURCE Chafing fuel
SUPPLIED WITH (1x) Round pan - 65mm deep
Stand
(1x) Chafing fuel holder

ORDER CODE

BEI-AT51363



SOUP KETTLE SPECIFICATIONS

MODEL Innoxserv Economic Series AT51388
DIMENSIONS Ø330 x 330mm high
CAPACITY 9Lt
SUPPLIED WITH (1x) Round pan - 200mm deep

ORDER CODE

BEI-AT51388

CHAFING DISHES ELECTRIC



FEATURES

- Users can control the water temperature in electric water pan by temperature control knob.
- The unit is equipped with an indicating light.
- Water line indicator to ensure the heating element is fully covered with water.

SPECIFICATIONS

MODEL ZCK100P
ELECTRICITY 0.9kW, 230V
CAPACITY (1x) 1/1GN x 100mm Pan

ORDER CODE

BEI-KS62160-1

CHAFING DISHES - PC COVER SERIES

FEATURES

- Stainless steel body
- Stainless steel pan
- Polycarbonate roll-top cover



NEUTRAL DISPLAY

SPECIFICATIONS

MODEL Inoxserv KS62160-1
DIMENSIONS 490 x 410 x 410mm high
PAN DIMENSIONS 475 x 270 x 60mm deep

ORDER CODE

BEI-KS62160-1



HEATED DISPLAY

SPECIFICATIONS

MODEL Inoxserv SK62160-1
ELECTRICITY 1kW, 230V, Single Phase
DIMENSIONS 490 x 410 x 410mm high
PAN DIMENSIONS 475 x 270 x 60mm deep

ORDER CODE

BEI-SK62160-1



COLD DISPLAY

SPECIFICATIONS

MODEL Inoxserv SC62140-1
DIMENSIONS 490 x 410 x 410mm high
PAN DIMENSIONS 475 x 270 x 40mm deep
SUPPLIED WITH (2x) Freezer packs

ORDER CODE

BEI-SC62140-1

FEATURES

- Manufactured from 0.8mm heavy duty stainless steel
- Rounded edges
- Anti-Jam system
- Reinforced corners



FULL INSERT SPECIFICATIONS

DIMENSIONS 325 x 530 x 20mm deep
CAPACITY 2.5Lt
ORDER CODE **GNF8020**

DIMENSIONS 325 x 530 x 55mm deep
CAPACITY 7.5Lt
ORDER CODE **GNF8055**

DIMENSIONS 325 x 530 x 65mm deep
CAPACITY 9Lt
ORDER CODE **GNF8065**



1/2 INSERT SPECIFICATIONS

DIMENSIONS 325 x 256 x 65mm deep
CAPACITY 4Lt
ORDER CODE **GNH8065**



2/3 INSERTS SPECIFICATIONS

DIMENSIONS 325 x 352 x 20mm deep
CAPACITY 1.5Lt
ORDER CODE **GN2T8020**

DIMENSIONS 325 x 352 x 65mm deep
CAPACITY 5.5Lt
ORDER CODE **GN2T8065**



1/3 INSERT SPECIFICATIONS

DIMENSIONS 325 x 176 x 40mm deep
CAPACITY 1.5Lt
ORDER CODE **GNT8040**

DIMENSIONS 325 x 176 x 65mm deep
CAPACITY 2.5Lt
ORDER CODE **GNT8065**





FEATURES

- Available in black or Stainless steel
- Stainless steel base (powder coated/polished)
- 304 stainless steel seamless insert
- Temperature control via thermostat
- Fitted with a hinged lid
- Fitted with non-slip feet

SPECIFICATIONS

ELECTRICITY	0.4kW, 220V, Single Phase
DIMENSIONS	Ø 330mm x 380mm high
WEIGHT	4Kg
TEMPERATURE RANGE	0 ~ 95°C
CAPACITY	10Lt

BLACK

MODEL	Inoxserve 83010SP
ORDER CODE	SKI0010

STAINLESS STEEL

MODEL	Inoxserve 81010SP
ORDER CODE	SKI1010

**POWDER
COATED
STAINLESS
STEEL BASE**

**TEMP.
CONTROL
(0 ~ 95°C)**

**NON
SLIP
FEET**

**HINGED
STAINLESS
STEEL LID**

**304
STAINLESS
STEEL
INSERT**



CEREAL DISPENSERS

inoxserv



CEREAL DISPENSER - DOUBLE LEVER PORTION CONTROL

SPECIFICATIONS

MODEL Inoxserv AT90123-2
DIMENSIONS 450 x 420 x 620mm high
CAPACITY (2x) 7Lt

ORDER CODE BEI-AT90123-2



CEREAL DISPENSER - SINGLE LEVER PORTION CONTROL

SPECIFICATIONS

MODEL Inoxserv AT90123
DIMENSIONS 230 x 420 x 620mm high
CAPACITY 7Lt

ORDER CODE BEI-AT90123



CEREAL DISPENSER - DOUBLE ROTATION PORTION CONTROL

SPECIFICATIONS

MODEL Inoxserv AT90133-2
DIMENSIONS 480 x 380 x 660mm high
CAPACITY (2x) 9Lt

ORDER CODE BEI-AT90133-2



CEREAL DISPENSER - SINGLE ROTATION PORTION CONTROL

SPECIFICATIONS

MODEL Inoxserv AT90133
DIMENSIONS 230 x 380 x 660mm high
CAPACITY 9Lt

ORDER CODE BEI-AT90133



DOUBLE WITH FREEZER PACK

SPECIFICATIONS

MODEL Inoxserv AT90212-2
 DIMENSIONS 450 x 365 x 535mm high
 CAPACITY (2x) 7Lt
 SUPPLIED WITH (2x) Freezer packs

ORDER CODE BEI-AT90212-2



DOUBLE WITH CENTRE ICE TUBE

SPECIFICATIONS

MODEL Inoxserv AT90512-2
 DIMENSIONS 540 x 350 x 580mm high
 CAPACITY (2x) 8Lt

ORDER CODE

BEI-AT90512-2



SINGLE WITH FREEZER PACK

SPECIFICATIONS

MODEL Inoxserv AT90212
 DIMENSIONS 230 x 365 x 535mm high
 CAPACITY 7Lt
 SUPPLIED WITH (1x) Freezer pack

ORDER CODE BEI-AT90212



SINGLE WITH CENTRE ICE TUBE

SPECIFICATIONS

MODEL Inoxserv AT90512
 DIMENSIONS 260 x 350 x 580mm high
 CAPACITY 8Lt

ORDER CODE

BEI-AT90512





*HEAT SOURCE NOT INCLUDED

FEATURES

- Full stainless steel construction
- Conveniently placed handles with removable stainless steel base for easy refilling
- High polish finish
- Fuel holder not included

19 LITRE

SPECIFICATIONS

MODEL	Inoxserv AT80019
DIMENSIONS	350 x 310 x 620mm high
CAPACITY	19Lt
HEAT SOURCE	Induction warmer Chafing fuel

ORDER CODE

BEI-AT80019



*HEAT SOURCE NOT INCLUDED

12 LITRE

SPECIFICATIONS

MODEL	Inoxserv AT80012
DIMENSIONS	350 x 310 x 500mm high
CAPACITY	12Lt
HEAT SOURCE	Induction warmer Chafing fuel

ORDER CODE

BEI-AT80012





POLARCAB

**MORE THAN JUST
REFRIGERATION...**



FRIDGES ❄️ FREEZERS ❄️ COOLERS ❄️ ICE MACHINES...

SECTION INDEX

Back bar coolers	150
Beverage coolers	151
Blast chillers	141
Chef bases	149
Display freezers	153-154
Display fridges	152
<i>Freezers</i>	
• Display freezers	153-154
• Gelato storage freezer	155
• Ice cream scoop freezers	154
• Upright storage freezers	142-145
<i>Fridges</i>	
• Back bar coolers	150
• Beverage coolers	151
• Display fridges	152
• Pizza ingredient fridges	148
• Saladette cabinets	146-147
• Sushi display fridges	148
• Upright storage fridges	142-145
Gelato machines	156
Gelato storage freezer	155
Ice cream scoop freezers	154
<i>Ice machines</i>	
• Modular	158-161
• Self-contained	162-163
Pizza ingredient fridges	148
Saladette cabinets	146-147
Soft serve machines	156-157
Sushi display fridges	148
Upright freezers	142-145
Upright fridges	142-145





REFRIGERATED DISPLAY UNITS

FEATURES

- Manufactured from 304 Stainless steel
- Self closing doors with magnetic door gasket
- Combi chill / freezer
- Holds GN 1/1 pans and 600 x 400mm baking trays
- Internal food probe
- Recessed safety door handle
- Even temperature chilling



10 PAN SPECIFICATIONS

MODEL PolarCab EBF-10
ELECTRICITY 2.5kW, 230V, Single Phase
DIMENSIONS 750 x 830 x 1435mm high
WEIGHT 140kg
RUNNER SPACING 178mm
CAPACITY (10x) 1/1 GN trays (55mm deep)
 (10x) 600 x 400mm trays
BLAST CHILL PERFORMANCE 50kg, 90 to 3°C in 90min
SHOCK FREEZE PERFORMANCE 30kg, 90 to -18°C in 240min
REFRIGERANT GAS R290

ORDER CODE

PCY/EBF-10



5 PAN SPECIFICATIONS

MODEL PolarCab EBF-05
ELECTRICITY 1.3kW, 230V, Single Phase
DIMENSIONS 750 x 815 x 870mm high
WEIGHT 89kg
RUNNER SPACING 65mm
CAPACITY (5x) 1/1 GN trays (55mm deep)
 (5x) 600 x 400mm trays
BLAST CHILL PERFORMANCE 25kg, 90 to 3°C in 90min
SHOCK FREEZE PERFORMANCE 15kg, 90 to -18°C in 240min
REFRIGERANT GAS R290

ORDER CODE

PCY/EBF-05



3 PAN SPECIFICATIONS

MODEL PolarCab EBF-03
ELECTRICITY 1.1kW, 230V, Single Phase
DIMENSIONS 755 x 832 x 581mm high
WEIGHT 72kg
RUNNER SPACING 65mm
CAPACITY (3x) 1/1 GN trays (55mm deep)
 (3x) 600 x 400mm trays
BLAST CHILL PERFORMANCE 10kg, 90 to 3°C in 90min
SHOCK FREEZE PERFORMANCE 5kg, 90 to -18°C in 240min
REFRIGERANT GAS R290

ORDER CODE

PCY/EBF-03



FEATURES

- Exterior and interior stainless steel body (AISI304)
- Air managing system - provides inside refrigeration balance
- Lockable, reversible and self closing doors
- 20 level embossed guides for shelves or GN containers
- Auto defrost with heating element
- CFC free, high pressure injected polyurethane insulation
- High class energy saving design
- Hygienic and ergonomic interior custom design
- Ventilated air chamber with interior LED lighting



DOUBLE DOOR FREEZER

SPECIFICATIONS

MODEL	Crystal ECO 1400D
ELECTRICITY	0.87kW, 230V, Single Phase
DIMENSIONS	1400 x 840 x 2060mm high
WEIGHT	177kg
INTERNAL DIMENSIONS	1240 x 690 x 1950mm high
CAPACITY	1250Lt
RUNNER SPACING	50mm
GRIDS SUPPLIED	(6x) 530 x 630mm
TEMPERATURE RANGE	-18 to -10°C
REFRIGERANT GAS	R134a

ORDER CODE **CRY-ECO-E1400D**



SINGLE DOOR FREEZER

SPECIFICATIONS

MODEL	Crystal ECO 700D
ELECTRICITY	0,55kW, 230V, Single Phase
DIMENSIONS	700 x 840 x 2060mm high
WEIGHT	125kg
INTERNAL DIMENSIONS	620 x 690 x 1950mm high
CAPACITY	600Lt
RUNNER SPACING	50mm
GRIDS SUPPLIED	(3x) 530 x 630mm
TEMPERATURE RANGE	-18 to -10°C
REFRIGERANT GAS	R134a

ORDER CODE **CRY-ECO-E700D**

OPTIONAL EXTRAS

GRIDS

2/1 GN GRIDS	530 x 630mm
ORDER CODE	OGS0021

SHELF RUNNERS

LEFT SIDE	XECO-YELK53623L
RIGHT SIDE	XECO-YELK53624L



FEATURES

- Complete structure manufactured from stainless steel
- Sturdy U-rail, wire shelves
- Fitted with interior LED lighting
- Automatic defrost function
- Fitted with 4 device leveling legs
- Fitted with lockable, reversible, self-closing doors
- The adjustable support rails can also be used for GN pans
- Ventilated cooling
- Digital Dixell / Carel thermostat



DOUBLE DOOR FRIDGE

SPECIFICATIONS

MODEL	PolarCab MBF8117
ELECTRICITY	0.35kW, 230V, Single Phase
DIMENSIONS	1315 x 805 x 2065mm high
WEIGHT	171kg
INTERNAL DIMENSIONS	1194 x 685 x 1550mm high
CAPACITY	1240Lt
RUNNER SPACING	100mm
GRIDS SUPPLIED	(6x) 530 x 630mm
TEMPERATURE RANGE	2 to 8°C
REFRIGERANT GAS	R600a

ORDER CODE **PCY/MBF8117**



SINGLE DOOR FRIDGE

SPECIFICATIONS

MODEL	PolarCab MBF8116
ELECTRICITY	0.22kW, 230V, Single Phase
DIMENSIONS	730 x 805 x 2065mm high
WEIGHT	107kg
INTERNAL DIMENSIONS	610 x 685 x 1550mm high
CAPACITY	670Lt
RUNNER SPACING	100mm
GRIDS SUPPLIED	(3x) 530 x 630mm
TEMPERATURE RANGE	2 to 8°C
REFRIGERANT GAS	R600a

ORDER CODE **PCY/MBF8116**



DOUBLE DOOR FREEZER

SPECIFICATIONS

MODEL	PolarCab MBF8114
ELECTRICITY	0.98kW, 230V, Single Phase
DIMENSIONS	1315 x 805 x 2065mm high
WEIGHT	177kg
INTERNAL DIMENSIONS	1194 x 685 x 1550mm high
CAPACITY	1240Lt
RUNNER SPACING	100mm
GRIDS SUPPLIED	(6x) 530 x 630mm
TEMPERATURE RANGE	-18 to -10°C
REFRIGERANT GAS	R290

ORDER CODE **PCY/MBF8114**



SINGLE DOOR FREEZER

SPECIFICATIONS

MODEL	PolarCab MBF8113
ELECTRICITY	0.6kW, 230V, Single Phase
DIMENSIONS	730 x 805 x 2065mm high
WEIGHT	115kg
INTERNAL DIMENSIONS	610 x 685 x 1550mm high
CAPACITY	670Lt
RUNNER SPACING	100mm
GRIDS SUPPLIED	(3x) 530 x 630mm
TEMPERATURE RANGE	-18 to -10°C
REFRIGERANT GAS	R290

ORDER CODE **PCY/MBF8113**



OPTIONAL EXTRAS

GRIDS

2/1 GN GRIDS	530 x 630mm
ORDER CODE	OGS0021

SHELF RUNNERS

LEFT SIDE	XPCY-80037407
RIGHT SIDE	XPCY-80037408

REFRIGERATED STAINLESS STEEL STORAGE CABINETS



FEATURES

- Stainless steel exterior
- Plastic coated grid shelves
- Interior LED lighting
- ABS interior
- Dixell / Carel digital thermostat
- Reversible self-closing door with lock

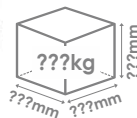

580 LITRE FREEZER

SPECIFICATIONS

MODEL	PolarCab SF58VS
ELECTRICITY	0.32kW, 220V, Single Phase
DIMENSIONS	775 x 750 x 1860mm high
INTERNAL DIMENSIONS	635 x 450 x 1627mm high
GROSS VOLUME	580Lt
GRID SUPPLIED	5
WEIGHT	128kg
TEMPERATURE RANGE	-18 to -10°C
REFRIGERANT GAS	R290

ORDER CODE **PCG/SF58VS**

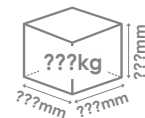

300 LITRE FREEZER (GLASS DOOR)

SPECIFICATIONS

MODEL	PolarCab SF30VGS
ELECTRICITY	0.3kW, 220V, Single Phase
DIMENSIONS	600 x 600 x 1850mm high
INTERNAL DIMENSIONS	460 x 460 x 1627mm high
GROSS VOLUME	300Lt
GRID SUPPLIED	5
WEIGHT	115kg
TEMPERATURE RANGE	-18 to -10°C
REFRIGERANT GAS	R290

ORDER CODE **PCG/SF30VGS**

580 LITRE FRIDGE

SPECIFICATIONS

MODEL	PolarCab SR58VS
ELECTRICITY	0.24kW, 220V, Single Phase
DIMENSIONS	775 x 750 x 1860mm high
INTERNAL DIMENSIONS	635 x 460 x 1627mm high
GROSS VOLUME	580Lt
GRID SUPPLIED	4
WEIGHT	90kg
TEMPERATURE RANGE	2 to 8°C
REFRIGERANT GAS	R600a

ORDER CODE **PCG/SR58VS**

300 LITRE FRIDGE (GLASS DOOR)

SPECIFICATIONS

MODEL	PolarCab SR30VGS
ELECTRICITY	0.18kW, 220V, Single Phase
DIMENSIONS	600 x 600 x 1860mm high
INTERNAL DIMENSIONS	460 x 460 x 1627mm high
GROSS VOLUME	300Lt
GRID SUPPLIED	4
WEIGHT	103kg
TEMPERATURE RANGE	2 to 8°C
REFRIGERANT GAS	R600a

ORDER CODE **PCG/SR30VGS**

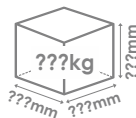

300 LITRE FREEZER

SPECIFICATIONS

MODEL	PolarCab SF30VS
ELECTRICITY	0.3kW, 220V, Single Phase
DIMENSIONS	600 x 600 x 1860mm high
INTERNAL DIMENSIONS	460 x 460 x 1627mm high
GROSS VOLUME	300Lt
GRID SUPPLIED	4
WEIGHT	100kg
TEMPERATURE RANGE	-18 to -10°C
REFRIGERANT GAS	R290

ORDER CODE **PCG/SF30VS**

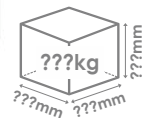

120 LITRE FREEZER

SPECIFICATIONS

MODEL	PolarCab SF12VS
ELECTRICITY	0.17kW, 220V, Single Phase
DIMENSIONS	600 x 600 x 850mm high
INTERNAL DIMENSIONS	460 x 410 x 465mm high
GROSS VOLUME	120Lt
GRID SUPPLIED	3
WEIGHT	52kg
TEMPERATURE RANGE	-18 to -10°C
REFRIGERANT GAS	R600a

ORDER CODE **PCG/SF12VS**

300 LITRE FRIDGE

SPECIFICATIONS

MODEL	PolarCab SR30VS
ELECTRICITY	0.18kW, 220V, Single Phase
DIMENSIONS	600 x 600 x 1860mm high
INTERNAL DIMENSIONS	460 x 460 x 1627mm high
GROSS VOLUME	300Lt
GRID SUPPLIED	4
WEIGHT	118kg
TEMPERATURE RANGE	2 to 8°C
REFRIGERANT GAS	R600a

ORDER CODE **PCG/SR30VS**

120 LITRE FRIDGE

SPECIFICATIONS

MODEL	PolarCab SR12S
ELECTRICITY	0.14kW, 220V, Single Phase
DIMENSIONS	600 x 600 x 850mm high
INTERNAL DIMENSIONS	460 x 410 x 645mm high
GROSS VOLUME	120Lt
GRID SUPPLIED	3
WEIGHT	48kg
TEMPERATURE RANGE	2 to 8°C
REFRIGERANT GAS	R600a

ORDER CODE **PCG/SR12S**

SALADETTE

PREP / ASSEMBLY WORKTOP FRIDGE



FEATURES

- Heavy duty construction, exterior and interior of high grade 304 stainless steel and galvanised steel back
- Fitted with granite top
- Automatic defrost
- Self closing doors
- Efficient refrigeration system
- Fitted with digital Dixell / Carel thermostat
- Supplied with GN tray slides in all doors
- Bottom mounted motor suitable for use in high temperature areas
- Fitted with (4x) adjustable legs

SPECIFICATIONS

MODEL	PolarCab ESL3852
ELECTRICITY	0.22kW, 230V, Single Phase
DIMENSIONS	1365 x 700 x 1030mm high
WEIGHT	190kg
NUMBER OF DOORS	3
RUNNER SPACING	55mm
SHELVES SUPPLIED	(3x) GN 1/1 grids
CAPACITY	380Lt
TEMPERATURE RANGE	2 ~ 8°C
REFRIGERANT GAS	R134a

ORDER CODE

PCY/ESL3852



SALADETTE GRANITE TOP WITH SNEEZE GUARD



FEATURES

- Exterior and interior manufactured from 304 Stainless Steel and Galvanised steel back
- Fitted with granite top
- Fitted with glass sneeze guard
- Automatic defrost
- Self closing doors
- Efficient refrigeration system
- Fitted with digital Dixell / Carel thermostat
- Supplied with GN tray slides in all doors
- Bottom mounted motor suitable for use in high temperature areas
- Insert pans not included
- Fitted with (4x) adjustable legs

SPECIFICATIONS

MODEL	PolarCab ESL3864
ELECTRICITY	0.31kW, 230V, Single Phase
DIMENSIONS	1365 x 700 x 1100mm high
WEIGHT	170kg
NUMBER OF DOORS	3
RUNNER SPACING	55mm
SHELVES SUPPLIED	(3x) GN 1/1 grids
CAPACITY	380Lt
DISPLAY CAPACITY	(7x) 1/3 GN pans
TEMPERATURE RANGE	2 ~ 8°C
REFRIGERANT GAS	R134a

ORDER CODE

PCY/ESL3864



SALADETTE

PIZZA TOP WITH HINGED LID



FEATURES

- Exterior and interior manufactured from 304 Stainless Steel and Galvanised steel back
- Bottom mounted motor suitable for use in high temperature areas
- Automatic defrost
- Efficient refrigeration system
- Supplied with GN tray slides in all doors
- Fitted with (4x) adjustable legs
- Self closing doors
- Fitted with digital Dixell / Carel thermostat
- Insert pans not included



SPECIFICATIONS

MODEL	PolarCab ESL3853
ELECTRICITY	0.31kW, 230V, Single Phase
DIMENSIONS	1365 x 700 x 1040mm high
WEIGHT	105kg
NUMBER OF DOORS	3
RUNNER SPACING	55mm
SHELVES SUPPLIED	(3x) GN 1/1 grids
CAPACITY	380Lt
TEMPERATURE RANGE	2 to 8°C
REFRIGERANT GAS	R134a

ORDER CODE

PCY/ESL3853



SALADETTE CUTTING BOARD WITH HINGED LID

FEATURES

- Exterior and interior manufactured from 304 Stainless Steel and Galvanised steel back
- Bottom mounted motor suitable for use in high temperature areas
- Automatic defrost
- Efficient refrigeration system
- Supplied with GN tray slides in all doors
- Fitted with (4x) adjustable legs
- Self closing doors
- Fitted with digital Dixell / Carel thermostat
- Insert pans not included



SPECIFICATIONS

MODEL	PolarCab ESL3850
ELECTRICITY	0.31kW, 230V, Single Phase
DIMENSIONS	1365 x 700 x 890mm high
WEIGHT	87kg
NUMBER OF DOORS	3
RUNNER SPACING	55mm
SHELVES SUPPLIED	(3x) GN 1/1 grids
CAPACITY	380Lt
TEMPERATURE RANGE	2 to 8°C
REFRIGERANT GAS	R134a

ORDER CODE

PCY/ESL3850



FEATURES

- Compact design to minimize footprint
- Low maintenance auto defrost function
- Fitted with digital temperature controller
- Glass panels are easy to remove for cleaning
- Can accommodate 1/4 and 1/2 GN pans
- GN pans not included



8 DIVISION 1/3 GN

SPECIFICATIONS

MODEL	PolarCab ESL 3888
ELECTRICITY	3kW, 230V, Single Phase
DIMENSIONS	1805 x 395 x 420mm high
WEIGHT	53kg
CAPACITY	(8x) 1/3 GN pans
TEMP RANGE	2 to 8°C
REFRIGERANT GAS	R134a

ORDER CODE **PCY/ESL3888**



6 DIVISION 1/4 GN

SPECIFICATIONS

MODEL	PolarCab ESL 3861
ELECTRICITY	3kW, 230V, Single Phase
DIMENSIONS	1405 x 395 x 465mm high
WEIGHT	41kg
CAPACITY	(6x) 1/4 GN pans
TEMP RANGE	2 to 8°C
REFRIGERANT GAS	R134a

ORDER CODE **PCY/ESL3861**



SUSHI DISPLAY FRIDGES



FEATURES

- Brilliant Internal LED illumination on top
- Digital temperature controller and display
- Front Curved glass
- Sliding doors
- Direct cooling system
- Automatic defrost
- Top evaporator with basin to collect condensation
- GN pans not included

6 DIVISION

SPECIFICATIONS

MODEL	PolarCab RTS-83L
ELECTRICITY	0.16kW, 230V, Single Phase
DIMENSIONS	1483 x 450 x 330mm high
GROSS VOLUME	83Lt
CAPACITY	(6x) 1/3 GN Inserts 40mm deep
WEIGHT	39kg
TEMP. RANGE	2 to 12°C
REFRIGERANT GAS	R290a

ORDER CODE **PCG/RTS-83L**



7 DIVISION

SPECIFICATIONS

MODEL	PolarCab RTS-103L
ELECTRICITY	0.16kW, 230V, Single Phase
DIMENSIONS	1754 x 450 x 330mm high
GROSS VOLUME	103Lt
CAPACITY	(6x) 1/3 + 1/2 GN Inserts 40mm deep
WEIGHT	44kg
TEMP. RANGE	2 to 12°C
REFRIGERANT GAS	R290a

ORDER CODE **PCG/RTS-103L**



FEATURES

- Stainless steel exterior and interior
- Carel digital controller
- Gravity fed self closing drawers
- Magnetic drawer gaskets
- Stainless steel inserts included
- One-Piece heavy duty reinforced stainless steel top
- Recessed door handles
- Heavy Duty stainless steel drawer slides and rollers
- Pre-installed casters



1800mm

SPECIFICATIONS

MODEL CookRite MGF8453GR
 ELECTRICITY 0.3kW, 230V, Single Phase
 DIMENSIONS 1840 x 814 x 675mm high
 WEIGHT 136kg
 NUMBER OF DRAWERS 4
 PANS PER DRAWER (2x) 1/1GN
 TEMP RANGE 2 to 5°C
 REFRIGERANT GAS R290

ORDER CODE

CR/MGF8453GR



1200mm

SPECIFICATIONS

MODEL CookRite MGF8450GR
 ELECTRICITY 0.3kW, 230V, Single Phase
 DIMENSIONS 1230 x 814 x 675mm high
 WEIGHT 117kg
 NUMBER OF DRAWERS 2
 PANS PER DRAWER (2x) 1/1GN
 TEMP RANGE 2 to 5°C
 REFRIGERANT GAS R290

ORDER CODE

CR/MGF8450GR

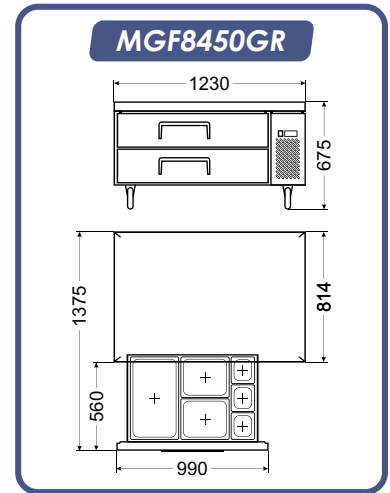
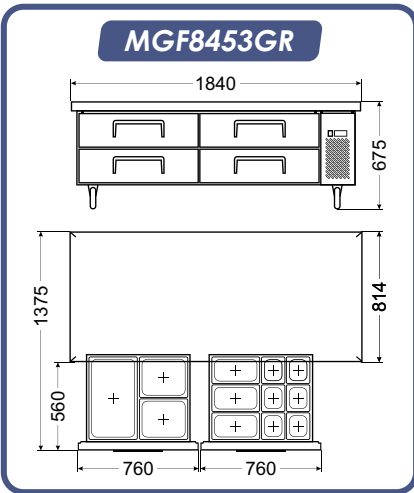

FEATURES

- Black units - Outer cabinet manufactured from coated mild steel
- Stainless steel units - Outer cabinet manufactured stainless steel
- High pressure injected 40mm cyclopentane insulation
- Cabinet interior manufactured from compressed aluminium
- 14W square fan assisted condenser
- Automatic defrost function
- Doors are fitted with tempered glass
- Fitted with adjustable feet for easy leveling
- Fitted with a digital temperature control and display
- Smooth action sliding doors / hinged doors
- Standard with internal LED lights and locks



3 DOOR

SPECIFICATIONS

MODEL PolarCab LG320
ELECTRICITY 0.67kW, 220V, Single Phase
EXTERNAL DIMENSIONS 1350 x 520 x 850mm high
WEIGHT 80kg
INTERNAL DIMENSIONS 1260 x 385 x 700mm high
GROSS VOLUME 320Lt
TEMP RANGE 2 to 10°C
REFRIGERANT GAS R600a
SHELVES SUPPLIED (6x) 400 x 345mm

SLIDING DOORS - BLACK BBP2003
HINGED DOORS - BLACK BBP1003
HINGED DOORS - S/STEEL BBP3003



2 DOOR

SPECIFICATIONS

MODEL PolarCab LG198
ELECTRICITY 0.23kW, 220V, Single Phase
EXTERNAL DIMENSIONS 900 x 520 x 850mm high
WEIGHT 62kg
INTERNAL DIMENSIONS 820 x 385 x 700mm high
GROSS VOLUME 198Lt
TEMP RANGE 2 to 10°C
REFRIGERANT GAS R600a
SHELVES SUPPLIED (4x) 400 x 345mm

SLIDING DOORS - BLACK BBP2002
HINGED DOORS - BLACK BBP1002
HINGED DOORS - S/STEEL BBP3002



SINGLE DOOR

SPECIFICATIONS

MODEL PolarCab LG128
ELECTRICITY 0.18kW, 220V, Single Phase
EXTERNAL DIMENSIONS 600 x 520 x 850mm high
WEIGHT 46kg
INTERNAL DIMENSIONS 520 x 385 x 700mm high
GROSS VOLUME 128Lt
TEMP RANGE 2 to 10°C
REFRIGERANT GAS R600a
SHELVES SUPPLIED (2x) 500 x 345mm

HINGED DOOR - BLACK BBP1001
HINGED DOOR - S/STEEL BBP3001



DIGITAL TEMPERATURE CONTROL AND DISPLAY



BEVERAGE COOLER

360 LITRE



Comes In
BLACK & WHITE

MODEL
LG-360XP

POWER CONSUMPTION
1.84kW / 24h

ELECTRICITY
220V, Single Phase

TEMP. RANGE
2 to 10°C

WEIGHT
75kg

DIMENSIONS
620 x 635 x 1732mm high

GROSS VOLUME
360 Litre

ORDER CODE
BCP0360-B (Black)
BCP0360-W (White)



CR 600



CRF 400 3D



CRF 400

SINGLE DOOR FRIDGE

SPECIFICATIONS

MODEL	Crystal CR 600
ELECTRICITY	0.36kW, 230V, Single Phase
DIMENSIONS	667 x 716 x 2018mm high
WEIGHT	102kg
INTERNAL DIMENSIONS	587 x 510 x 1593mm high
GROSS VOLUME	477Lt
GRIDS SUPPLIED	5
TEMP RANGE	2 to 7°C
REFRIGERANT GAS	R290

ORDER CODE **CRYGR-CR600**



FEATURES

- Body manufactured from non-toxic, pre-painted sheet steel
- Fitted with self-closing glass doors
- Internal LED lighting
- Fitted with a digital controller
- Cr600 - EBD electronic evaporator fan motor
- Hi efficiency compressor
- Two regulators
- Air cooled condenser
- Drainage outlet
- CR600 - Auto-defrost function
- CR600 - (5x) adjustable reinforced shelves
- CRF400 - (6x) evaporation shelves + floor shelf
- Fitted with (4x) castors

SINGLE DOOR FREEZER

SPECIFICATIONS

MODEL	Crystal CRF 400
ELECTRICITY	0.82kW, 230V, Single Phase
DIMENSIONS	667 x 620 x 2018mm high
WEIGHT	108kg
INTERNAL DIMENSIONS	547 x 490 x 1553mm high
GROSS VOLUME	417Lt
RUNNER SPACING	170mm
GRIDS SUPPLIED	6
TEMP RANGE	-20 to -18°C
REFRIGERANT GAS	R290

ORDER CODE **CRYGR-CRF400**



SINGLE DOOR FREEZER 180° VIEW

SPECIFICATIONS

MODEL	Crystal CRF 400 3D
ELECTRICITY	0.82kW, 230V, Single Phase
DIMENSIONS	667 x 620 x 2018mm high
WEIGHT	118kg
INTERNAL DIMENSIONS	547 x 490 x 1553mm high
GROSS VOLUME	417Lt
RUNNER SPACING	170mm
GRIDS SUPPLIED	6
TEMP RANGE	-20 to -18°C
REFRIGERANT GAS	R290

ORDER CODE

CRYGR-CR400-3D



FEATURES

- Hi efficiency compressor
- Thermometer
- Internal LED light
- 2 grid shelves
- Frameless door
- Self closing door with double glazed glass
- Air cooled condenser
- Four regulators



SPECIFICATIONS

MODEL	CRYSTAL CRTF 70
ELECTRICITY	0.53kW, 230V, Single Phase
INTERNAL DIMENSIONS	430 x 440 x 480mm high
EXTERNAL DIMENSIONS	566 x 542 x 628mm high
WEIGHT	40kg
CAPACITY	73Lt
TEMP RANGE	-18 to -22°C
REFRIGERANT GAS	R290

ORDER CODE

CRYGR-CRTF70



HORIZONTAL DISPLAY FREEZERS

FEATURES

- Manufactured from non-toxic, pre-painted sheet steel
- Air cooled condenser
- Temperature display
- Lock
- High efficiency compressor
- Mechanical thermostat
- Sliding glass access panels
- Drainage outlet



535 LITRE

SPECIFICATIONS

MODEL	Crystal EKTOR 56 SGL
ELECTRICITY	0.4kW, 230V, Single Phase
DIMENSIONS	1654 x 644 x 895mm high
WEIGHT	73kg
INTERNAL DIMENSIONS	1530 x 520 x 737mm high
GROSS VOLUME	535Lt
TEMP RANGE	-25 to -18°C
REFRIGERANT GAS	R290

ORDER CODE

CRYGR-EKTO56SGL



356 LITRE

SPECIFICATIONS

MODEL	Crystal EKTOR 36 SGL
ELECTRICITY	0.2kW, 230V, Single Phase
DIMENSIONS	1184 x 644 x 895mm high
WEIGHT	58kg
INTERNAL DIMENSIONS	1060 x 520 x 737mm high
GROSS VOLUME	356Lt
TEMP RANGE	-25 to -18°C
REFRIGERANT GAS	R290

ORDER CODE

CRYGR-EKTO36SGL



ICE CREAM SCOOP FREEZERS FLOOR STANDING



FEATURES

- Manufactured from non-toxic sheet steel
- High efficiency compressor
- Air cooled condenser
- Mechanical Thermostat
- Temperature display
- Stainless steel sockets for stainless steel or plastic ice cream inserts
- Storage space with a separate door
- Serving bench with a scoop washer system
- LED illuminated canopy
- Fitted with (4x) castors
- Supplied without inserts

540 LITRE

SPECIFICATIONS

MODEL	Crystal ELEGANTE 56
ELECTRICITY	0.3kW, 230V, Single Phase
DIMENSIONS	1676 x 862 x 1263mm high
WEIGHT	119kg
INTERNAL DIMENSIONS	1530 x 560 x 688mm high
GROSS VOLUME	540Lt
BIN CAPACITY	(13x) 360 x 165mm S/steel bins (14x) 360 x 155mm Plastic bins
TEMP RANGE	-22 to -15°C
REFRIGERANT GAS	R290

ORDER CODE

CRYGR-ELEGANT56



358 LITRE

SPECIFICATIONS

MODEL	Crystal ELEGANTE 36
ELECTRICITY	0.23kW, 230V, Single Phase
DIMENSIONS	1206 x 862 x 1263mm high
WEIGHT	95kg
INTERNAL DIMENSIONS	1060 x 560 x 688mm high
GROSS VOLUME	358Lt
BIN CAPACITY	(9x) 360 x 165mm S/steel bins (9x) 360 x 155mm Plastic bins
TEMP RANGE	-22 to -15°C
REFRIGERANT GAS	R290

ORDER CODE

CRYGR-ELEGANT36



OPTIONAL EXTRAS



ICE CREAM INSERT - 360 x 165 x 120mm deep
ORDER CODE GNI8120





FEATURES

- Hi efficiency compressor
- Digital controller
- Automatic fan switch off with door opening
- Self closing door with lock
- Four castors
- Five (5) adjustable shelves
- Two regulators
- Decompression valve for easy door opening
- Fan assisted static refrigeration
- High temperature alarm
- Easily removable grill
- Air cooled condenser
- Drainage

SPECIFICATIONS

MODEL	CRYSTAL GELOBOX
ELECTRICITY	0.53kW, 230V, Single Phase
EXTERNAL DIMENSIONS	667 x 895 x 2020mm high
INTERNAL DIMENSIONS	547 x 775 x 1553mm high
WEIGHT	121kg
CAPACITY	(66x) Ice cream container set
TEMP RANGE	-15 to -25°C
REFRIGERANT GAS	R290

ORDER CODE

CRYGR-GELOBOX



GELATO MACHINES COUNTER TOP



FEATURES

- Body manufactured from stainless steel
- Compact design uses less workspace
- Transparent polycarbonate feeder hopper located in the front of the machine for easy and accurate operation
- Large stainless steel freezing cylinder increases output and "fluffiness" of the ice cream
- Retractable, rotating mixer blade inside the cylinder further improves the smoothness of the ice cream
- Fitted with a powerful, energy saving compressor
- Fitted with a digital, waterproof control panel
- Fitted with (4x) non-slip feet

SPECIFICATIONS

MODEL	Goshen BQ12T
ELECTRICITY	1kW, 220V, Single Phase
DIMENSIONS	500 x 705 x 800mm high
WEIGHT	100kg
HOPPER VOLUME	5.1Lt
REFRIGERANT GAS	R404a
HOURLY OUTPUT	10 ~ 14Lt/hour

ORDER CODE

ICM/BQ12T



OPTIONAL EXTRAS



ICE CREAM INSERT - 360 x 165 x 120mm deep
ORDER CODE **GNI8120**

SOFT SERVE MACHINE



WITH REFRIGERATED HOPPER



FLOOR STANDING

SPECIFICATIONS

MODEL	SQL922-RH-AP
ELECTRICITY	2kW, 230V, Single Phase
DIMENSIONS	550 x 700 x 1330mm high
WEIGHT	140kg
HOPPER CAPACITY	(2x) 5.8Lt
OUTPUT PER HOUR	180 cones
REFRIGERANT GAS	R404

ORDER CODE

SSM0002



SOFT SERVE MACHINES COUNTER TOP



FEATURES

- Exquisite modern design. Small and portable
- Silent operation
- Fitted with a stainless steel refrigerated hopper
- Mixer installed inside hopper makes for smoother ice cream
- Fitted with a stainless steel beater
- Built-in air pump
- Fitted with a 7inch, touch screen control panel
- One-touch thaw function
- Fitted with (4x) non-slip feet



FEATURES

- Exquisite modern design. Small and portable
- Silent operation
- Fitted with a stainless steel hopper
- Fitted with a food grade plastic beater
- Built-in air pump
- Fitted with a 5inch, waterproof, touch control panel
- Built-in thaw function
- Fitted with (4x) non-slip feet
- Available in 3 exciting candy colours



COOL & COMPACT SPECIFICATIONS

MODEL	Goshen ST16RELW
ELECTRICITY	1.25kW, 220V, Single Phase
DIMENSIONS	210 x 554 x 740mm high
WEIGHT	45kg
HOPPER VOLUME	6Lt
REFRIGERANT GAS	R290
HOURLY OUTPUT	16 ~ 18Lt/hour
REALISTIC OUTPUT	12Lt (100 x 120g servings)

ORDER CODE SSM/ST16RELW-W

COMPACT SPECIFICATIONS

MODEL	Goshen ST16E
ELECTRICITY	1.15kW, 220V, Single Phase
DIMENSIONS	210 x 554 x 740mm high
WEIGHT	43kg
HOPPER VOLUME	6Lt
REFRIGERANT GAS	R290
HOURLY OUTPUT	16 ~ 18Lt/hour
REALISTIC OUTPUT	12Lt (100 x 120g servings)

ORDER CODE SSM/ST16E-W WHITE
SSM/ST16E-P PINK
SSM/ST16E-Y YELLOW





160KG

SPECIFICATIONS

MODEL
ELECTRICITY
DIMENSIONS
WEIGHT
PRODUCTION CAPACITY
REFRIGERANT GAS

PolarCab LB400TA
1kW, 230V, Single Phase
520 x 700 x 620mm high
64kg
160kg/h
R404a

ORDER CODE

IMP/LB400TA



300KG

SPECIFICATIONS

MODEL
ELECTRICITY
DIMENSIONS
WEIGHT
PRODUCTION CAPACITY
REFRIGERANT GAS

PolarCab LB700TA
1.5kW, 230V, Single Phase
770 x 715 x 685mm high
85kg
300kg/h
R404a

ORDER CODE

IMP/LB700TA



450KG

SPECIFICATIONS

MODEL
ELECTRICITY
DIMENSIONS
WEIGHT
PRODUCTION CAPACITY
REFRIGERANT GAS

PolarCab LB1000TA
3.8kW, 230V, Single Phase
765 x 685 x 795mm high
110kg
450kg/h
R404a

ORDER CODE

IMP/LB1000TA





140KG
SPECIFICATIONS

MODEL
DIMENSIONS
WEIGHT
CAPACITY
COMPATIBLE ICE MACHINE

PolarCab LB140B
585 x 990 x 920mm high
34kg
140kg
LB400TA

ORDER CODE

IMP/BIN/LB140B



200KG
SPECIFICATIONS

MODEL
DIMENSIONS
WEIGHT
CAPACITY
COMPATIBLE ICE MACHINE

PolarCab LB200B
785 x 930 x 1000mm high
44kg
200kg
LB700TA

ORDER CODE

IMP/BIN/LB200B



600KG
SPECIFICATIONS

MODEL
DIMENSIONS
WEIGHT
CAPACITY
COMPATIBLE ICE MACHINE

PolarCab LB600B
1230 x 945 x 1100mm high
74kg
600kg
LB1000TA

ORDER CODE

IMP/BIN/LB600B

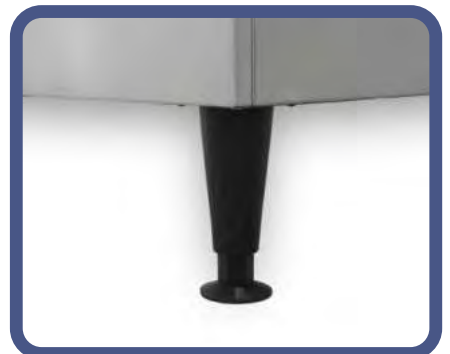



FEATURES

- Body manufactured from AISI304 stainless steel
- Unit requires installation, water connection and a waste drainage point
- Electromechanical unit - no PC boards
- Ice production calculated at ambient temperature 21°C and water temperature 15°C

INSTALLATION CONDITIONS

- Ambient temperature: Min +10°C / Max +38°C
- Water temperature: Min +3°C / Max +28°C
- Voltage: +/-10%
- Water pressure: Min 1 bar (14psi) / Max 6 bar (84psi)



FLAT CUBE - 400kg

SPECIFICATIONS

MODEL	Brice EFM500A
ELECTRICITY	3kW, 220V, Single Phase
DIMENSIONS	770 x 550 x 805mm high
WEIGHT	113kg
PRODUCTION /24H	400kg
CUBE	Flat shape - 7gr
REFRIGERANT GAS	R452a
COMPATIBLE BIN	IMB/BIN350



ORDER CODE

IMB/EFM500A



**ICE MACHINE
SHOWN WITH ICE BIN**



ICE ON DEMAND: WHERE COOL MEETS CONVENIENCE!



COOL YOUR WORLD WITH ICE

SELF-CONTAINED ICE MACHINES



GOURMET CUBE

FEATURES

- Body manufactured from AISI304 stainless steel
- Unit requires installation, water connection and a waste drainage point
- Electromechanical unit - no PC boards
- Ice production calculated at ambient temperature 21°C and water temperature 15°C

INSTALLATION CONDITIONS

- Ambient temperature: Min +10°C / Max +38°C
- Water temperature: Min +3°C / Max +28°C
- Voltage: +/-10%
- Water pressure: Min 1 bar (14psi) / Max 6 bar (84psi)

28kg

SPECIFICATIONS

MODEL	Brice ECP28A
ELECTRICITY	0.27kW, 220V, Single Phase
DIMENSIONS	387 x 470 x 687mm high
WEIGHT	33kg
PRODUCTION /24H	25kg
STORAGE CAPACITY	9kg
CUBE	Gourmet Bell shape - 18gr
REFRIGERANT GAS	R452a

ORDER CODE

IMB/ECP28A



18kg

SPECIFICATIONS

MODEL	Brice ECP18A
ELECTRICITY	0.32kW, 220V, Single Phase
DIMENSIONS	355 x 404 x 590mm high
WEIGHT	28kg
PRODUCTION /24H	22kg
STORAGE CAPACITY	4kg
CUBE	Gourmet Bell shape - 13gr
REFRIGERANT GAS	R452a

ORDER CODE

IMB/ECP18A



BULLET ICE MACHINE



BULLET / HOLLOW CUBE

FEATURES

- Air cooled system with side ventilation
- Stainless steel housing and door
- Under counter design with adjustable feet
- Protected against overload
- Good insulation and hygiene

SPECIFICATIONS

MODEL	GDZB-28
ELECTRICITY	0.19kW, 220V, Single Phase
DIMENSIONS	330 x 503 x 607mm high
WEIGHT	27Kg
PRODUCTION CAPACITY	28kg/24h
STORAGE CAPACITY	5kg
REFRIGERANT GAS	R290a

ORDER CODE

IMPGD/ZB-2S





FEATURES

- Durable body with s/s cabinet
- Space saving design
- Ideal for bar and undercounter application
- Removable filter for easy cleaning - Protects against condenser blockage
- Supplied with in-line water filter
- Supplied with water inlet pipe, ice scoop and water drainage pipe
- LCD control panel

INSTALLATION CONDITIONS

- Ambient temperature: Min +10°C / Max +38°C
- Water temperature: Min +3°C / Max +28°C
- Voltage: +/-10%
- Water pressure: Min 1 bar (14psi) / Max 6 bar (84psi)

60kg

SPECIFICATIONS

MODEL	PolarCab LB120S-C
ELECTRICITY	0.42kW, 220V, Single Phase
DIMENSIONS	510 x 600 x 840mm high
WEIGHT	45kg
PRODUCTION /24H	60kg
STORAGE CAPACITY	27kg
CUBE	Square Cube shape - 8gr
REFRIGERANT GAS	R404a

ORDER CODE IMP/LB120S-C



40kg

SPECIFICATIONS

MODEL	PolarCab LB80S-C
ELECTRICITY	0.32kW, 220V, Single Phase
DIMENSIONS	510 x 450 x 840mm high
WEIGHT	35kg
PRODUCTION /24H	40kg
STORAGE CAPACITY	20kg
CUBE	Square Cube shape - 8gr
REFRIGERANT GAS	R134a

ORDER CODE IMP/LB80S-C



25kg

SPECIFICATIONS

MODEL	PolarCab LB55S-C
ELECTRICITY	0.26kW, 220V, Single Phase
DIMENSIONS	510 x 450 x 840mm high
WEIGHT	35kg
PRODUCTION /24H	25kg
STORAGE CAPACITY	20kg
CUBE	Square Cube shape - 8gr
REFRIGERANT GAS	R134a

ORDER CODE IMP/LB55S-C



SQUARE CUBE





 **IGLOO**
OPEN COOLER MERCHANDISER

SECTION INDEX

Cake displays	167
<i>Display cabinets</i>	
• Heated	172, 175
• Neutral	169, 173, 175
• Refrigerated	166-171, 173-174
Floor standing display cabinets	166-170, 173-175
Heated Display cabinets	172, 175
<i>Merchandisers</i>	
• Open cooler	177-179
• Open island	180
• Wall chillers	177-179
Neutral Display cabinets	169, 173, 175
Open cooler merchandisers	177-179
Open island merchandisers	180
Pie warmers	181
Refrigerated Display cabinets	166-171, 173-174
Sneeze guards	176
Table model display cabinets	166-167, 171-172
Wall chillers	177-179

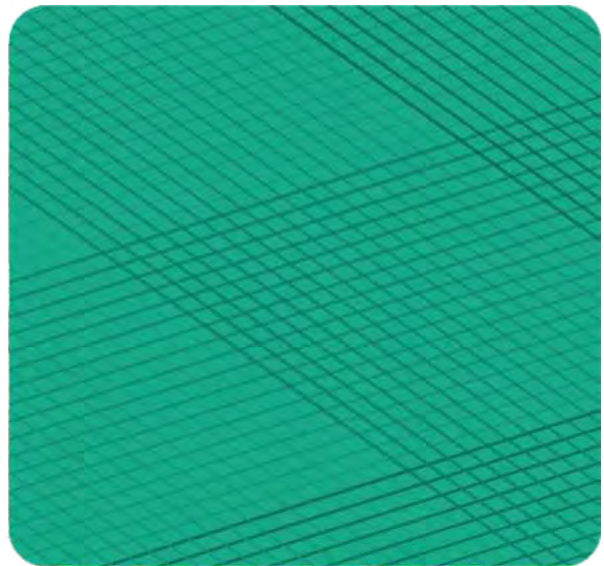

FEATURES

- Plastic housing
- 4 sided double glazing
- Forced air-cooling
- Plastic coated adjustable grid shelves
- LED interior lighting
- Automatic defrost
- Removable bottom plate, easy to clean
- Digital thermostat



56 LITRE

SPECIFICATIONS

MODEL Galileo SC-58
ELECTRICITY 0.15kW, 230V, Single Phase
DIMENSIONS 434 x 398 x 854mm high
GROSS VOLUME 56Lt
SHELVES (2x) 300 x 290mm
230 x 240mm (base)
WEIGHT 37kg
TEMP RANGE 2 to 8°C
REFRIGERANT GAS R600a



ORDER CODE

White PCG/SC-58W
Black PCG/SC-58B

74 LITRES

SPECIFICATIONS

MODEL Galileo SC-78
ELECTRICITY 0.15kW, 230V, Single Phase
DIMENSIONS 434 x 398 x 1004mm high
GROSS VOLUME 74Lt
SHELVES (3x) 300 x 290mm
230 x 240mm (base)
WEIGHT 42kg
TEMP RANGE 2 to 8°C
REFRIGERANT GAS R600a



ORDER CODE

White PCG/SC-78W
Black PCG/SC-78B

92 LITRES

SPECIFICATIONS

MODEL Galileo SC-98
ELECTRICITY 0.2kW, 230V, Single Phase
DIMENSIONS 434 x 398 x 1154mm high
GROSS VOLUME 92Lt
SHELVES (4x) 300 x 290mm
230 x 240mm (base)
WEIGHT 48kg
TEMP RANGE 2 to 8°C
REFRIGERANT GAS R600a



ORDER CODE

White PCG/SC-98W
Black PCG/SC-98B

279 LITRES

SPECIFICATIONS

MODEL Galileo SC-278
ELECTRICITY 0.3kW, 230V, Single Phase
DIMENSIONS 515 x 553 x 1800mm high
GROSS VOLUME 279Lt
SHELVES (5x) 370 x 400mm
330 x 360mm (base)
WEIGHT 86kg
TEMP RANGE 2 to 8°C
REFRIGERANT GAS R600a



ORDER CODE

White PCG/SC-278W
Black PCG/SC-278B

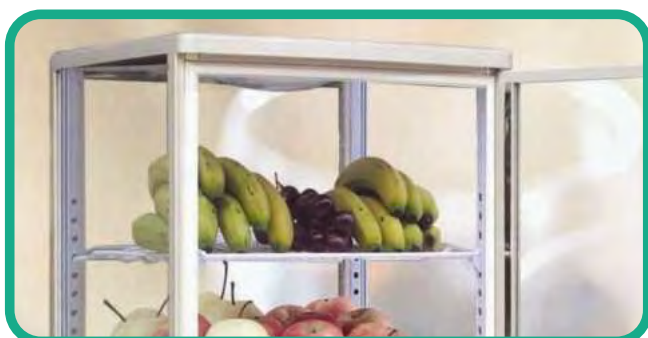

FEATURES

- Circular stainless steel base
- Curved, double glazed, self-closing glass door
- Automatic defrost function
- Digital temperature control
- Curved, double glazed glass window
- Manual rotation, circular glass shelves with adjustable height
- LED internal lighting



4 TIER COUNTER TOP

SPECIFICATIONS

MODEL	Galileo ARC-100R
ELECTRICITY	0.21kW, 230V, Single Phase
DIMENSIONS	480 x 480 x 1030mm high
WEIGHT	50kg
VOLUME	100Lt
SHELVES	(3x) Ø335mm 150 x 270mm (base)
TEMP. RANGE	2 to 8°C
REFRIGERANT GAS	R600a

ORDER CODE

DCG/ARC-100R



5 TIER FLOOR STANDING

SPECIFICATIONS

MODEL	Galileo ARC-400R
ELECTRICITY	0.46kW, 230V, Single Phase
DIMENSIONS	680 x 680 x 1750mm high
WEIGHT	140kg
VOLUME	400Lt
SHELVES	(4x) Ø535mm 350 x 470mm (base)
TEMP. RANGE	2 to 8°C
REFRIGERANT GAS	R290a

ORDER CODE

DCG/ARC-400R

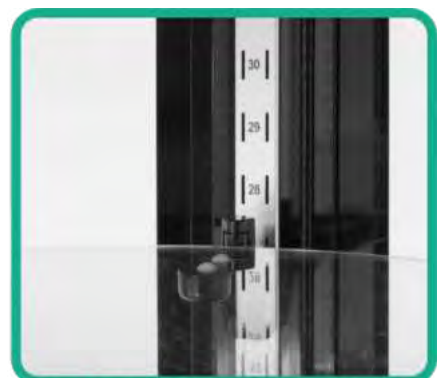

REFRIGERATED DISPLAY CABINETS

CURVED GLASS

Galileo
by POLARCAR

FEATURES

- Circular stainless steel base
- Self-closing, sliding glass door
- Automatic defrost function
- Digital temperature control
- Curved, double glazed glass window
- Supplied with 3 adjustable shelves
- LED internal lighting



1.5 METER

SPECIFICATIONS

MODEL Galileo WDF157D
ELECTRICITY 0.8kW, 240V, Single Phase
DIMENSIONS 1500 x 750 x 1350mm high
WEIGHT 241kg
DISPLAY SURFACE 2.55m²
SHELF DIM (3x) 1395 x 345mm
(1x) 1500 x 740mm (base)
TEMP. RANGE 2 to 8°C
REFRIGERANT GAS R290

ORDER CODE

DCG/WDF157D



1.2 METER

SPECIFICATIONS

MODEL Galileo WDF127D
ELECTRICITY 0.74kW, 240V, Single Phase
DIMENSIONS 1200 x 750 x 1350mm high
WEIGHT 203kg
DISPLAY SURFACE 2.02m²
SHELF DIMENSIONS (3x) 1095 x 345mm
(1x) 1200 x 740mm (base)
TEMP. RANGE 2 to 8°C
REFRIGERANT GAS R290

ORDER CODE

DCG/WDF127D



0.9 METER

SPECIFICATIONS

MODEL Galileo WDF097D
ELECTRICITY 0.53kW, 240V, Single Phase
DIMENSIONS 900 x 750 x 1350mm high
WEIGHT 173kg
DISPLAY SURFACE 1.48m²
SHELF DIMENSIONS (3x) 795 x 345mm
(1x) 900 x 740mm (base)
TEMP. RANGE 2 to 8°C
REFRIGERANT GAS R290

ORDER CODE

DCG/WDF097D





FEATURES

REFRIGERATED

- Stainless steel decorative front panel
- LED lighting under each shelf - Energy saving
- Fitted with a SECOP compressor
- Fitted with a Dixell electronic controller
- Electric heating front glass for de-fogging
- Automatic defrost function
- Fitted with removable, sliding glass doors
- Supplied with 3 adjustable stainless steel shelves
- Fitted with adjustable feet

NEUTRAL

- Stainless steel decorative front panel
- LED lighting under each shelf - Energy saving
- Fitted with removable, sliding glass doors
- Supplied with 3 adjustable stainless steel shelves
- Fitted with adjustable feet

REFRIGERATED

1.5 METER SPECIFICATIONS

MODEL	Galileo WDF157Z
ELECTRICITY	0.83kW, 220V, Single Phase
DIMENSIONS	1500 x 750 x 1350mm high
WEIGHT	298kg
DISPLAY SURFACE	2.55m ²
SHELF DIM	(3x) 1395 x 345mm (1x) 1500 x 740mm (base)
TEMP RANGE	2 to 8°C
REFRIGERANT GAS	R290

ORDER CODE

DCG/WDF157Z



NEUTRAL

1.5 METER SPECIFICATIONS

MODEL	Galileo WDF157ZSA11
ELECTRICITY	0.2kW, 220V, Single Phase
DIMENSIONS	1500 x 750 x 1350mm high
WEIGHT	288kg
DISPLAY SURFACE	2.55m ²
SHELF DIM	(3x) 1395 x 345mm (1x) 1500 x 740mm (base)

ORDER CODE

DCG/WDF157ZSA11



1.2 METER SPECIFICATIONS

MODEL	Galileo WDF127Z
ELECTRICITY	0.74kW, 220V, Single Phase
DIMENSIONS	1200 x 750 x 1350mm high
WEIGHT	273kg
DISPLAY SURFACE	2.02m ²
SHELF DIMENSIONS	(3x) 1095 x 345mm (1x) 1200 x 740mm (base)
TEMP RANGE	2 to 8°C
REFRIGERANT GAS	R290

ORDER CODE

DCG/WDF127Z



1.2 METER SPECIFICATIONS

MODEL	Galileo WDF127ZSA11
ELECTRICITY	0.2kW, 220V, Single Phase
DIMENSIONS	1200 x 750 x 1350mm high
WEIGHT	263kg
DISPLAY SURFACE	2.02m ²
SHELF DIMENSIONS	(3x) 1095 x 345mm (1x) 1200 x 740mm (base)

ORDER CODE

DCG/WDF127ZSA11



0.9 METER SPECIFICATIONS

MODEL	Galileo WDF097Z
ELECTRICITY	0.53kW, 220V, Single Phase
DIMENSIONS	900 x 750 x 1350mm high
WEIGHT	231kg
DISPLAY SURFACE	1.48m ²
SHELF DIMENSIONS	(3x) 795 x 345mm (1x) 900 x 740mm (base)
TEMP RANGE	2 to 8°C
REFRIGERANT GAS	R290

ORDER CODE

DCG/WDF097Z



0.9 METER SPECIFICATIONS

MODEL	Galileo WDF097ZSA11
ELECTRICITY	0.2kW, 220V, Single Phase
DIMENSIONS	900 x 750 x 1350mm high
WEIGHT	221kg
DISPLAY SURFACE	1.48m ²
SHELF DIMENSIONS	(3x) 795 x 345mm (1x) 900 x 740mm (base)

ORDER CODE

DCG/WDF097ZSA11





FEATURES

- Stainless steel decorative front panel
- Fitted with a SECOP compressor
- Electric heating front glass for de-fogging
- Fitted with removable, sliding glass doors
- Fitted with adjustable feet
- LED lighting under each shelf - Energy saving
- Fitted with a Dixell electronic controller
- Automatic defrost function
- Supplied with 2 adjustable stainless steel shelves

1.2 METER

SPECIFICATIONS

MODEL	Galileo WDF127F
ELECTRICITY	0.7kW, 220V, Single Phase
DIMENSIONS	1200 x 750 x 1200mm high
WEIGHT	243kg
DISPLAY SURFACE	1.64m ²
SHELF DIMENSIONS	(2x) 1095 x 345mm (1x) 1200 x 740mm (base)
TEMP RANGE	2 to 8°C
REFRIGERANT GAS	R290

ORDER CODE

DCG/WDF127F



0.9 METER

SPECIFICATIONS

MODEL	Galileo WDF097F
ELECTRICITY	0.51kW, 220V, Single Phase
DIMENSIONS	900 x 750 x 1200mm high
WEIGHT	200kg
DISPLAY SURFACE	1.2m ²
SHELF DIMENSIONS	(2x) 795 x 345mm (1x) 900 x 740mm (base)
TEMP RANGE	2 to 8°C
REFRIGERANT GAS	R290

ORDER CODE

DCG/WDF097F



FEATURES

- Stainless steel exterior & interior
- (2x) stainless steel shelves standard
- (2x) rear sliding glass doors
- Fitted with (4x) leveling feet
- Fitted with an electronic digital controller
- Digital temperature control
- LED interior lighting - Energy saving and durable



0.9 METER CURVED

SPECIFICATIONS

MODEL	Galileo WTY130L
ELECTRICITY	0.3kW, 220V, Single Phase
DIMENSIONS	900 x 560 x 680mm high
WEIGHT	72kg
DISPLAY SURFACE	0.7m ²
SHELF DIMENSIONS	(1x) 830 x 230 (1x) 830 x 280 (1x) 830 x 285mm (base)
TEMP. RANGE	2 to 8°C
REFRIGERANT GAS	R290

ORDER CODE **DCG/WTY130L**



0.9 METER SQUARE

SPECIFICATIONS

MODEL	Galileo WTF160L
ELECTRICITY	0.3kW, 220V, Single Phase
DIMENSIONS	900 x 560 x 670mm high
WEIGHT	75kg
DISPLAY SURFACE	1m ²
SHELF DIMENSIONS	(1x) 850 x 280mm (1x) 850 x 330mm (1x) 850 x 285mm (base)
TEMP. RANGE	2 to 8°C
REFRIGERANT GAS	R290

ORDER CODE **DCG/WTF160L**



0.7 METER CURVED

SPECIFICATIONS

MODEL	Galileo WTY110L
ELECTRICITY	0.2kW, 220V, Single Phase
DIMENSIONS	700 x 560 x 680mm high
WEIGHT	63kg
DISPLAY SURFACE	0.5m ²
SHELF DIMENSIONS	(1x) 640 x 230mm (1x) 640 x 280mm (1x) 640 x 285mm (base)
TEMP. RANGE	2 to 8°C
REFRIGERANT GAS	R290

ORDER CODE **DCG/WTY110L**



0.7 METER SQUARE

SPECIFICATIONS

MODEL	Galileo WTF120L
ELECTRICITY	0.2kW, 220V, Single Phase
DIMENSIONS	700 x 560 x 670mm high
WEIGHT	65kg
DISPLAY SURFACE	0.7m ²
SHELF DIMENSIONS	(1x) 650 x 280mm (1x) 650 x 330mm (1x) 650 x 285mm (base)
TEMP. RANGE	2 to 8°C
REFRIGERANT GAS	R290

ORDER CODE **DCG/WTF120L**



SLIDING BACK DOORS



DIGITAL TEMP. CONTROL

FEATURES

- Stainless steel exterior & interior
- Fitted with an electronic digital controller
- Digital temperature control
- LED interior lighting - Energy saving and durable
- Removable water pan to add humidity
- (3x) stainless steel shelves standard
- (2x) rear sliding glass doors
- Fitted with (4x) leveling feet



0.9 METER CURVED

SPECIFICATIONS

MODEL	Galileo WHY160L
ELECTRICITY	1.6kW, 220V, Single Phase
DIMENSIONS	900 x 570 x 678mm high
WEIGHT	49kg
DISPLAY SURFACE	0.86m ²
SHELF DIMENSIONS	(1x) 850 x 240mm (1x) 850 x 290mm (1x) 850 x 340mm
TEMP RANGE	30 to 90°C

ORDER CODE

DCG/WHY160L



0.9 METER SQUARE

SPECIFICATIONS

MODEL	Galileo WHF200L
ELECTRICITY	1.65kW, 220V, Single Phase
DIMENSIONS	900 x 570 x 678mm high
WEIGHT	55kg
DISPLAY SURFACE	0.86m ²
SHELF DIMENSIONS	(3x) 850 x 340mm
TEMP RANGE	30 to 90°C

ORDER CODE

DCG/WHF200L



0.7 METER CURVED

SPECIFICATIONS

MODEL	Galileo WHY125L
ELECTRICITY	1.2kW, 220V, Single Phase
DIMENSIONS	700 x 580 x 678mm high
WEIGHT	43kg
DISPLAY SURFACE	0.86m ²
SHELF DIMENSIONS	(1x) 650 x 240mm (1x) 650 x 290mm (1x) 650 x 340mm
TEMP RANGE	30 to 90°C

ORDER CODE

DCG/WHY125L



0.7 METER SQUARE

SPECIFICATIONS

MODEL	Galileo WHF150L
ELECTRICITY	1.25kW, 220V, Single Phase
DIMENSIONS	700 x 570 x 678mm high
WEIGHT	46kg
DISPLAY SURFACE	0.66m ²
SHELF DIMENSIONS	(3x) 650 x 340mm
TEMP RANGE	30 to 90°C

ORDER CODE

DCG/WHF150L



REMOVABLE WATER PAN



STAINLESS STEEL GRID SHELVES

FEATURES

- External body manufactured from stainless steel
- 2 Glass shelves with height and angle adjustable frames
- Internal top and each shelf illuminated with LED lights
- Digital temperature controller on refrigerated units
- Glass side panels
- Sliding glass doors (*removable*)
- Automatic defrost on refrigerated units
- Fitted with height adjustable feet



REFRIGERATED

0.9 METER

SPECIFICATIONS

MODEL	IGLOO Slim Cube 0.9
ELECTRICITY	0.55kW, 220V, Single Phase
DIMENSIONS	910 x 750 x 1250mm high
WEIGHT	170kg
DISPLAY SURFACE	1.1m ²
SHELF DIMENSIONS	(1x) 870 x 420mm (1x) 870 x 480mm (1x) 880 x 440mm (<i>base</i>)
TEMP RANGE	5 to 15°C
REFRIGERANT GAS	R134a

ORDER CODE

IGL8009-SL



0.6 METER

SPECIFICATIONS

MODEL	IGLOO Slim Cube 0.6
ELECTRICITY	0.3kW, 220V, Single Phase
DIMENSIONS	610 x 750 x 1250mm high
WEIGHT	120kg
DISPLAY SURFACE	0.76m ²
SHELF DIMENSIONS	(1x) 570 x 420mm (1x) 570 x 480mm (1x) 580 x 440mm (<i>base</i>)
TEMP RANGE	5 to 15°C
REFRIGERANT GAS	R134a

ORDER CODE

IGL8006-SL



NEUTRAL

0.9 METER

SPECIFICATIONS

MODEL	IGLOO Slim Cube 0.9
ELECTRICITY	0.05kW, 220V, Single Phase
DIMENSIONS	910 x 750 x 1250mm high
WEIGHT	160kg
DISPLAY SURFACE	1.1m ²
SHELF DIMENSIONS	(1x) 870 x 420mm (1x) 870 x 480mm (1x) 880 x 440mm (<i>base</i>)

ORDER CODE

IGL8209-SL



0.6 METER

SPECIFICATIONS

MODEL	IGLOO Slim Cube 0.6
ELECTRICITY	0.05kW, 220V, Single Phase
DIMENSIONS	610 x 750 x 1250mm high
WEIGHT	110kg
DISPLAY SURFACE	0.76m ²
SHELF DIMENSIONS	(1x) 570 x 420mm (1x) 570 x 480mm (1x) 580 x 440mm (<i>base</i>)

ORDER CODE

IGL8206-SL





FEATURES

- External body manufactured stainless steel
- Glass side panels
- 2 Glass shelves with height and angle adjustable frames
- Back sliding doors with combined glass
- Internal top and each shelf illuminated with LED lights
- Automatic defrost on refrigerated units
- Digital temperature controller on refrigerated and heated units
- Fitted with height adjustable feet

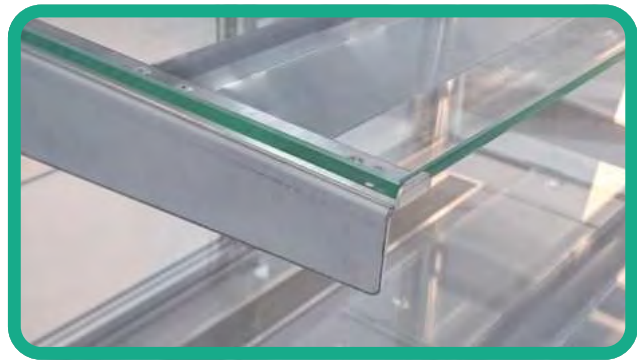

REFRIGERATED

1.3 METER

SPECIFICATIONS

MODEL Igloo Cube 1.3
 ELECTRICITY 0.7kW, 220V, Single Phase
 DIMENSIONS 1310 x 840 x 1250 mm high
 WEIGHT 210kg
 DISPLAY SURFACE 1.9m²
 SHELF DIMENSIONS (1x) 1280 x 425mm
 (1x) 1280 x 515mm
 (1x) 1290 x 525mm (base)

TEMP RANGE 5 to 15°C
 REFRIGERANT GAS R134a

ORDER CODE IGL8013



0.9 METER

SPECIFICATIONS

MODEL Igloo Cube 0.9
 ELECTRICITY 0.55kW, 220V, Single Phase
 DIMENSIONS 910 x 840 x 1250mm high
 WEIGHT 170kg
 DISPLAY SURFACE 1.3m²
 SHELF DIMENSIONS (1x) 870 x 425mm
 (1x) 870 x 515mm
 (1x) 880 x 525mm (base)

TEMP RANGE 5 to 15°C
 REFRIGERANT GAS R134a

ORDER CODE IGL8009



0.6 METER

SPECIFICATIONS

MODEL Igloo Cube 0.6
 ELECTRICITY 0.3kW, 220V, Single Phase
 DIMENSIONS 610 x 840 x 1250mm high
 WEIGHT 120kg
 DISPLAY SURFACE 0.87m²
 SHELF DIMENSIONS (1x) 570 x 425mm
 (1x) 570 x 515mm
 (1x) 580 x 525mm (base)

TEMP RANGE 5 to 15°C
 REFRIGERANT GAS R134a

ORDER CODE IGL8006





HEATED

1.3 METER SPECIFICATIONS

MODEL Igloo Cube 1.3
 ELECTRICITY 3kW, 230V, Single Phase
 DIMENSIONS 1310 x 840 x 1250 mm high
 WEIGHT 220kg
 DISPLAY SURFACE 1.9m²
 SHELF DIMENSIONS (1x) 1280 x 425mm
 (1x) 1280 x 515mm
 (1x) 1290 x 525mm (base)
 TEMP RANGE 30 to 60°C

ORDER CODE **IGL8113**



0.9 METER SPECIFICATIONS

MODEL Igloo Cube 0.9
 ELECTRICITY 3kW, 220V, Single Phase
 DIMENSIONS 910 x 840 x 1250mm high
 WEIGHT 170kg
 DISPLAY SURFACE 1.3m²
 SHELF DIMENSIONS (1x) 870 x 425mm
 (1x) 870 x 515mm
 (1x) 880 x 525mm (base)
 TEMP RANGE 30 to 60°C

ORDER CODE **IGL8109**



0.6 METER SPECIFICATIONS

MODEL Igloo Cube 0.6
 ELECTRICITY 3kW, 220V, Single Phase
 DIMENSIONS 610 x 840 x 1250mm high
 WEIGHT 120kg
 DISPLAY SURFACE 0.87m²
 SHELF DIMENSIONS (1x) 570 x 425mm
 (1x) 570 x 515mm
 (1x) 580 x 525mm (base)
 TEMP RANGE 30 to 60°C

ORDER CODE **IGL8106**



NEUTRAL

0.9 METER SPECIFICATIONS

MODEL Igloo Cube 0.9
 ELECTRICITY 0.05kW, 220V, Single Phase
 DIMENSIONS 910 x 840 x 1250mm high
 WEIGHT 160kg
 DISPLAY SURFACE 1.3m²
 SHELF DIMENSIONS (1x) 870 x 425mm
 (1x) 870 x 515mm
 (1x) 880 x 525mm (base)

ORDER CODE **IGL8209**



0.6 METER SPECIFICATIONS

MODEL Igloo Cube 0.6
 ELECTRICITY 0.05kW, 220V, Single Phase
 DIMENSIONS 610 x 840 x 1250mm high
 WEIGHT 110kg
 DISPLAY SURFACE 0.87m²
 SHELF DIMENSIONS (1x) 570 x 425mm
 (1x) 570 x 515mm
 (1x) 580 x 525mm (base)

ORDER CODE **IGL8206**



FEATURES

- Straight front, top and side glass
- Optional self help front glass available
- Illuminated by LED lighting below top glass
- Designed to be fitted on counter top (not on appliance)

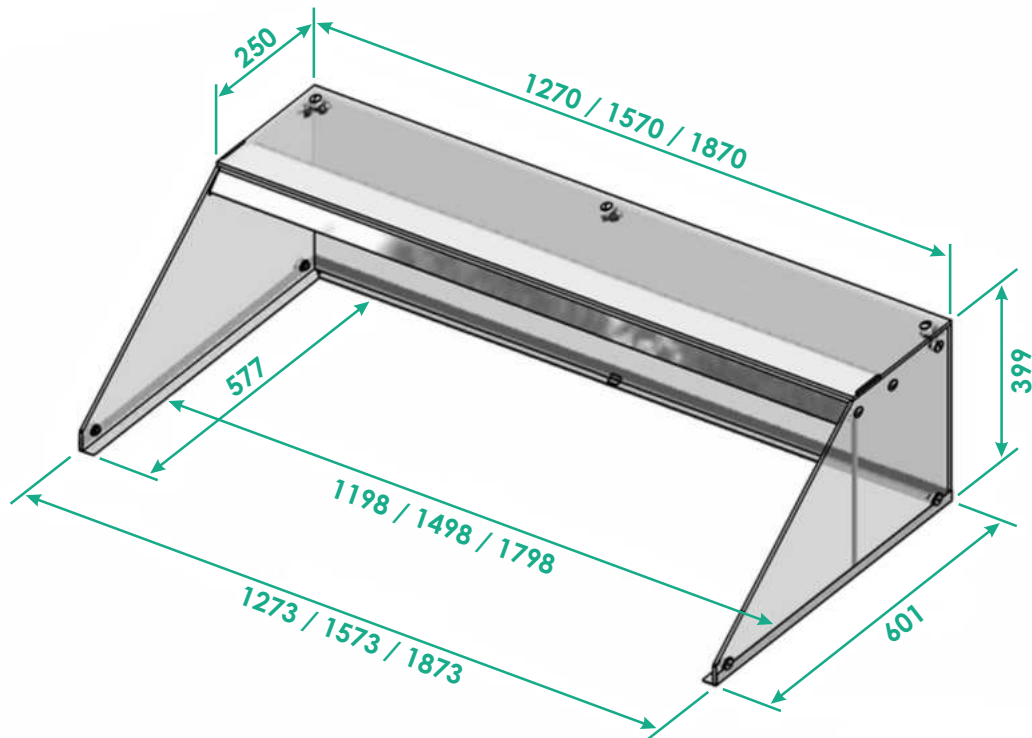

SQUARE GLASS 1800mm

SPECIFICATIONS

MODEL	Igloo Gastroline
ELECTRICITY	220V, Single Phase
DIMENSIONS	1800 x 600 x 400mm high
WEIGHT	40kg
CUT SIZE	1800 x 660mm

ORDER CODE IGL8818

SELF HELP FRONT GLASS 1800mm

ORDER CODE IGL8818-SH

SQUARE GLASS 1500mm

SPECIFICATIONS

MODEL	Igloo Gastroline
ELECTRICITY	220V, Single Phase
DIMENSIONS	1500 x 600 x 400mm high
WEIGHT	35kg
CUT SIZE	1500 x 660mm

ORDER CODE IGL8815

SPECIFICATIONS

MODEL	Igloo Gastroline
ELECTRICITY	220V, Single Phase
DIMENSIONS	1200 x 600 x 400mm high
WEIGHT	30kg
CUT SIZE	1200 x 660mm

ORDER CODE IGL8812

SELF HELP FRONT GLASS 1200mm

ORDER CODE IGL8812-SH

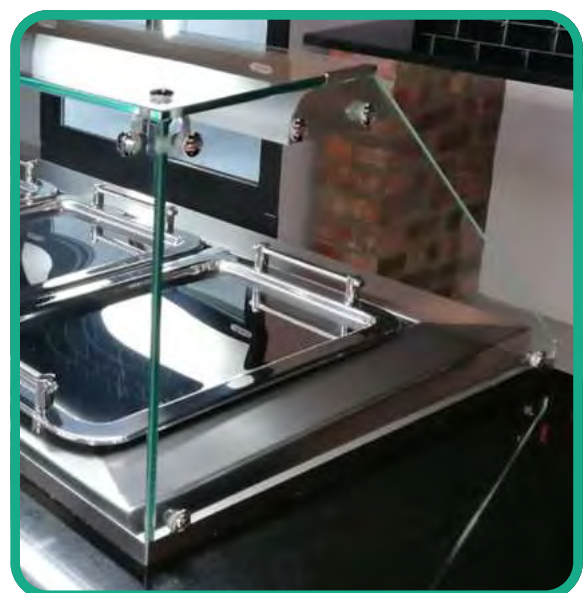

OPEN COOLER MERCHANDISERS

Galileo
by POLARCAR



NIGHT CURTAIN



LED LIGHTING

FEATURES

- High quality glass & stainless steel body
- Dixell digital temperature control
- Heavy duty Embraco compressor
- 3 fixed stainless steel shelves
- LED lighting for each level
- Stainless steel front guard
- Includes retractable night curtain
- Fitted with (4x) castors

SPECIFICATIONS

MODEL	Galileo YLK240L
ELECTRICITY	1.3kW, 220V, Single Phase
DIMENSIONS	535 x 600 x 1830mm high
WEIGHT	110kg
DISPLAY SURFACE	0.55m ²
SHELF DIMENSIONS	(3x) 480 x 270mm (1x) 500 x 330mm (base)
TEMP RANGE	4 to 10°C
REFRIGERANT GAS	R404

ORDER CODE

OCG/YLK240L



OPEN COOLER MERCHANDISERS PAROS

IGLOO



FEATURES

- Internal cooling aggregate
- Dynamic cooling (ventilated)
- Ecological polyurethane foam insulation
- Internal top illuminated - LED light (white colour)
- Fitted with night roller blind
- Exposition shelves with height and angle adjustment
- ABS 40mm side panels with glass
- Electronic temperature controller with digital display
- Automatic defrost
- Condenser impurity or fan operation failure alarm
- Shelves fitted with price strips
- Fitted with device levelling legs

1.3 METER

SPECIFICATIONS

MODEL	Igloo Paros 1.3
ELECTRICITY	1.13kW, 220V, Single Phase
DIMENSIONS	1310 x 695 x 2020mm high
WEIGHT	190kg
DISPLAY SURFACE	2.2m ²
SHELF DIM	(4x) 1200 x 360mm (1x) 1200 x 440mm (base)
TEMP RANGE	3 to 10°C
REFRIGERANT GAS	R134a

ORDER CODE

IGL9013-B



FEATURES

- Ventilated dynamic cooling
- Automatic evaporation of condensate
- Powder coated display area
- LED lighting upper internal
- Powder coated external housing
- Manual night blind (VL100.70L)
- Shelf fence
- Ecological polyurethane foam insulation
- Automatic off-cycle defrosting
- Electronic temperature controller with digital display
- Adjustable shelves
- Energy saving EC fans
- Price stripes
- Double glazed glass doors (VL100.70L.UD)
- Powder coated side panels



GLASS DOORS

SPECIFICATIONS

MODEL Igloo Variant VL100.70L.UD
 ELECTRICITY 0.6kW, 220V, Single Phase
 DIMENSIONS 1070 x 720 x 2000mm high
 WEIGHT 241kg
 DISPLAY SURFACE 2.4m²
 TEMP RANGE 2 to 10°C
 REFRIGERANT R290

ORDER CODE IGL9010.B



OPEN COOLER

SPECIFICATIONS

MODEL Igloo Variant VL100.70L
 ELECTRICITY 0.86kW, 220V, Single Phase
 DIMENSIONS 1070 x 720 x 2000mm high
 WEIGHT 235kg
 DISPLAY SURFACE 2.4m²
 TEMP RANGE 2 to 10°C
 REFRIGERANT R290

ORDER CODE IGL9010



NEW

IGLOO

VARIANT

REFRIGERATED CABINET SERIES

FEATURES

- Body manufactured from powder painted steel
- Individual LED lighting under each shelf
- Fitted with a night curtain
- Dynamic cooling (ventilated)
- Ecological polyurethane foam insulation
- Condenser impurity or fan operation failure alarm
- Adjustable, stainless steel shelving
- Digital temperature control
- Fitted with adjustable feet
- Automatic defrost
- Automatic condenser vaporization
- Shelves fitted with price strips



1.2 METER

SPECIFICATIONS

MODEL Igloo Luna 120
ELECTRICITY 1,5kW, 230V, Single Phase
DIMENSIONS 1200 x 660 x 1440mm high
WEIGHT 155kg
DISPLAY SURFACE 1.6m²
SHELF DIMENSIONS (1x) 1140 x 250mm
 (1x) 1140 x 340mm
 (1x) 1140 x 400mm
 (1x) 1140 x 450mm (base)

TEMPERATURE RANGE 2 to 10°C
REFRIGERANT GAS R290

ORDER CODE

IGL5013



0.9 METER

SPECIFICATIONS

MODEL Igloo Luna 90
ELECTRICITY 1,4kW, 230V, Single Phase
DIMENSIONS 900 x 660 x 1440mm high
WEIGHT 137kg
DISPLAY SURFACE 0.9m²
SHELF DIMENSIONS (1x) 820 x 250mm
 (1x) 820 x 340mm
 (1x) 820 x 400mm
 (1x) 820 x 450mm (base)

TEMPERATURE RANGE 2 to 10°C
REFRIGERANT GAS R290

ORDER CODE

IGL5009





FEATURES

- Glass exposition shelves on frame
- Ecological polyurethane foam insulation
- Side glass with silk screen printing
- External housing, interior and frame made of powder painted steel
- Upper interior lighting + additional illumination of each shelf - *LED lights (confectionery color)*
- Automatic defrost
- Automatic condenser vaporization
- Electronic temperature controller with digital display
- Condenser impurity or fan operation failure alarm
- External housing made of painted steel
- Interior and frame made of stainless steel sheet
- Exposition shelf frames made of powder painted steel
- Shelves fitted with price strips



REFRIGERATED MERCHANDISERS



0.9 METER SPECIFICATIONS

MODEL Igloo Petro Select PR101S
 ELECTRICITY 0.76kW, 220V, Single Phase
 DIMENSIONS 900 x 755 x 1400mm high
 WEIGHT 170kg
 DISPLAY SURFACE 1.2m²
 TEMP RANGE 2 to 10°C
 REFRIGERANT R134a

ORDER CODE IGL3009



0.6 METER SPECIFICATIONS

MODEL Igloo Petro Select PR100S
 ELECTRICITY 0.35kW, 230V, Single Phase
 DIMENSIONS 600 x 755 x 1400mm high
 WEIGHT 125kg
 DISPLAY SURFACE 0.8m²
 TEMP RANGE 2 to 10°C
 REFRIGERANT R134a

ORDER CODE IGL3006



90° NEUTRAL CORNER UNITS



SPECIFICATIONS

MODEL Igloo Petro PRSNZ90NL
 DIMENSIONS 425 x 755 x 1400mm high
 WEIGHT 30kg
 DISPLAY SURFACE 0.6m²

ORDER CODE IGL3001 (LEFT)
 ORDER CODE IGL3002 (RIGHT)



FEATURES

- Powder coated stainless steel exterior
- Front and rear sliding doors provide quick, easy access
- Internal lighting
- Front mounted temperature gauge for monitoring temperature
- Thermostatically controlled heater
- 430 Grade stainless steel interior and shelving racks
- Glass side panels for optimum display
- Humidity pan prevents drying out
- Adjustable shelves
- Fitted with (4x) non-slip feet



900mm SPECIFICATIONS

MODEL SmartChef HW-60-2
 ELECTRICITY 1.84kW, 220V, Single Phase
 DIMENSIONS 900 x 480 x 610mm high
 WEIGHT 50kg
 TEMP RANGE 50 to 90°C
 SHELF DIMENSIONS (3x) 815 x 360mm

ORDER CODE

PWS0002



660mm SPECIFICATIONS

MODEL SmartChef HW-60-1
 ELECTRICITY 1.84kW, 220V, Single Phase
 DIMENSIONS 660 x 480 x 610mm high
 WEIGHT 33kg
 TEMP RANGE 50 to 90°C
 SHELF DIMENSIONS (3x) 575 x 360mm

ORDER CODE

PWS0001



FEATURES

- Manufactured from 430 Grade stainless steel
- Internal lighting
- Adjustable shelves
- Thermostatically controlled heater
- Front sliding glass doors
- Humidity pan prevents drying out
- Front mounted temperature gauge for monitoring temperature
- Fitted with (4x) non-slip feet



640mm SPECIFICATIONS

MODEL SmartChef HW-580
 ELECTRICITY 1kW, 220V, Single Phase
 DIMENSIONS 640 x 360 x 530mm high
 WEIGHT 45kg
 TEMP RANGE 50 to 90°C
 SHELF DIMENSIONS (4x) 565 x 300mm

ORDER CODE

PWS0004



FURMIS



SUPERIOR
pizza and meal
delivery bags



SECTION INDEX

Baking trolleys	192
Beverage containers	185
Delivery bags	188
Delivery boxes	187
Food pan carriers	185-186
Food serving carts	184
GN trolleys	192-193
Meal delivery bags	188
Meal delivery boxes	187
Meal delivery carts	184
Pizza delivery bags	188
Platform trolleys	189
Rack trolleys	192-193
Tea trolleys	190-191
Tray trolleys	192-193





FEATURES

- Constructed from light weight material
- Fitted with push handles
- Fitted with heavy duty swivel castors, 2 with brakes
- Modular design for east replacement in case of damaged parts
- Fitted with removable latched doors

24 TRAY TROLLEY

SPECIFICATIONS

MODEL TrayPort 1100-T3D-39
 DIMENSIONS 1500 x 750 x 1250mm high
 WEIGHT 60kg
 CAPACITY (3x) 8 Trays
 TRAY SIZE 380 x 525mm (Tuff Tray No.14)
 380 x 515mm (Camtray 1520)
 RUNNER SPACE 120mm

ORDER CODE **PLA-1100-T3D-39**



16 TRAY TROLLEY

SPECIFICATIONS

MODEL TrayPort 1100-D3D-39
 DIMENSIONS 1000 x 750 x 1250mm high
 WEIGHT 40kg
 CAPACITY (2x) 8 Trays
 TRAY SIZE 380 x 525mm (Tuff Tray No.14)
 380 x 515mm (Camtray 1520)
 RUNNER SPACE 120mm

ORDER CODE **PLA-1100-D3D-39**



8 TRAY TROLLEY

SPECIFICATIONS

MODEL TrayPort 1100-S3D-39
 DIMENSIONS 500 x 750 x 1250mm high
 WEIGHT 20kg
 CAPACITY 8 Trays
 TRAY SIZE 380 x 525mm (Tuff Tray No.14)
 380 x 515mm (Camtray 1520)
 RUNNER SPACE 120mm

ORDER CODE **PLA-1100-S3D-39**



FEATURES

- Holds multiple pans of hot or cold food for up to 4 hours
- Door removes for easy cleaning
- Menu clip reduces need to open door
- Built-in seal eliminates need for removable gasket
- Durable polyethylene shell and thick polyurethane foam insulation
- Integrated pan-staging area eases service
- Robust, molded-in handles for comfortable two-person carrying
- Single 23cm nylon latch for quick and secure opening and closing



12 PAN FRONT LOADING

SPECIFICATIONS

MODEL	Cambro UPC800
DIMENSIONS	520 x 690 x 1370mm high
WEIGHT	39kg
INTERNAL DIMENSIONS	330 x 545 x 485mm high
CAPACITY	(12x) 65mm deep 1/1 GN Pans (8x) 100mm deep 1/1 GN Pans (6x) 150mm deep 1/1 GN Pans (4x) 200mm deep 1/1 GN Pans Also holds 1/2 and 1/3 GN Pans



ORDER CODE

CAM-UPC800401



6 PAN FRONT LOADING

SPECIFICATIONS

MODEL	Cambro Ultra Camcart UPC400
DIMENSIONS	425 x 620 x 570mm high
WEIGHT	16kg
INTERNAL DIMENSIONS	340 x 535 x 360mm high
CAPACITY	(6x) 65mm deep 1/1 GN pans (4x) 100mm deep 1/1 GN pans (3x) 150mm deep 1/1 GN pans (2x) 200mm deep 1/1 GN pans Also holds 1/2 and 1/3 GN pans



ORDER CODE

CAM-UPC400/401

INSULATED BEVERAGE CONTAINERS



FEATURES

- Use to hold, transport and serve hot or cold beverages
- One piece, seamless double-wall polyethylene with thick foam insulation
- Drip-proof recessed faucet
- Two position faucet - continuous pouring or individual dispensing
- Fitted with vent cap to equalise pressure for easy opening

18 LITRE

SPECIFICATIONS

MODEL	Cambro LCD500
DIMENSIONS	420 x 230 x 620 mm high
WEIGHT	7kg
CAPACITY	18Lt

ORDER CODE

CAM-500LCD



5.5 LITRE

SPECIFICATIONS

MODEL	Cambro LCD100
DIMENSIONS	290 x 260 x 440 mm high
WEIGHT	5kg
CAPACITY	5.5Lt

ORDER CODE

CAM-100LCD





FEATURES

- Double walled and internally foamed with CFC-Free polyurethane, providing optimum insulation with high resistance
- Fulfill all requirements of the food hygiene regulation
- Easy stackable for transport allowing for the multiple distribution of goods
- Side handles provide a convenient reliable and highly accessible means of transportation
- Its highly accessible design makes it easy to clean
- Integrated menu card holder
- GN Pans not included



6 PAN FRONT LOADING

SPECIFICATIONS

MODEL	Avatherm 601 M
DIMENSIONS	450 x 625 x 575mm high
WEIGHT	10kg
INTERNAL DIMENSIONS	330 x 540 x 460mm high
LOAD CAPACITY	(6x) 65mm deep 1/1 GN pans (4x) 100mm deep 1/1 GN pans (3x) 150mm deep 1/1 GN pans Also holds 1/2 & 1/3 GN pans

ORDER CODE
 ORDER CODE

AVA-100155-HD
 AVA-100160-HD



LOADING EXAMPLE

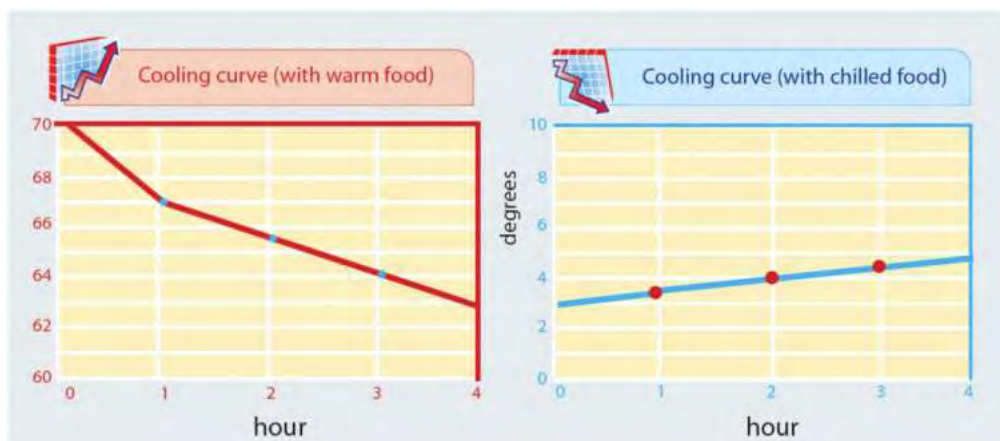

FEATURES

- Manufactured from lightweight, odorless, non-toxic plastic
- Durable & long-lasting
- Perfect heat insulation keeps products warm for longer
- The cover is fitted with hydraulic arms for easy loading and unloading
- Fitted with a durable safety latch to ensure that the lid remains sealed
- Fitted with durable hinges
- Easily to clean
- Specially designed to be fitted on most motorcycle brands
- The product increases your prestige in front of the customer during service



PIZZA BOX (FRONT LOADING)

SPECIFICATIONS

MODEL	Avatherm AVA-100305
OUTER DIMENSIONS	600 x 460 x 375mm high
INNER DIMENSIONS	460 x 460 x 330mm high
VOLUME	70Lt
WEIGHT	7.2kg

ORDER CODE **AVA-100305**



THERMOBOX 640 (TOP LOADING)

SPECIFICATIONS

MODEL	Avatherm AVA-100275
OUTER DIMENSIONS	600 x 470 x 375mm high
INNER DIMENSIONS	530 x 380 x 270mm high
VOLUME	54Lt
WEIGHT	6.6kg

ORDER CODE **AVA-100275**



FEATURES

- Manufactured from durable, easy washable Nylon material
- Patented 'CLICKBYCLICK' closing system based on plates and magnets sewn into the bag
- Fitted with side pockets for drinks
- Fitted with a transparent pocket for bills
- Stiffening frame and 12V heating pad available as optional extras



8 x PIZZA BAG SPECIFICATIONS

MODEL Furmis T8S
 DIMENSIONS 400 x 400 x 420mm high
 INTERNAL DIMENSIONS 360 x 360 x 400mm high
 CAPACITY (8x) 350 x 350mm boxes

ORDER CODE **FUR-T8S-NM**



4 x PIZZA BAG SPECIFICATIONS

MODEL Furmis T4S
 DIMENSIONS 400 x 400 x 250mm high
 INTERNAL DIMENSIONS 360 x 360 x 210mm high
 CAPACITY (4x) 350 x 350mm boxes

ORDER CODE **FUR-T4S-NM**



FEATURES

- Manufactured from durable, easy washable Nylon material
- Velcro closing system
- Fitted with a transparent pocket for bills

4 x MEAL BAG

SPECIFICATIONS

MODEL Furmis ECO S
 DIMENSIONS 400 x 400 x 240mm high
 INTERNAL DIMENSIONS 370 x 370 x 220mm high
 CAPACITY (4x) 350 x 350mm containers

ORDER CODE **FUR-ECO-S**

OPTIONAL EXTRAS



12V HEATING PAD

SPECIFICATIONS

MODEL Furmis HP-TS
 ELECTRICITY 12V

ORDER CODE **FUR-HP-TS**

**Supplied with 2.5m power cord*

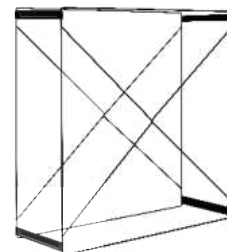

STIFFENING FRAME FOR T8S

ORDER CODE **FUR-T8S-FRAME**

FEATURES

- Heavy-duty plastic platform
- Light weight and soft in motion
- Collapsible stainless steel handlebar
- Fitted with (4x) swivel castors



SPECIFICATIONS

MODEL SmartChef GD-ST46
 DIMENSIONS 880 x 580 x 860mm high
 WEIGHT 12kg
 CAPACITY 200kg

ORDER CODE

PTP0001



SPECIFICATIONS

MODEL SmartChef GD-ST47
 DIMENSIONS 730 x 490 x 830mm high
 WEIGHT 9kg
 CAPACITY 100kg

ORDER CODE

PTP0002



DISH & TOTE HOLDER



SPECIFICATIONS

DIMENSIONS 500 x 400 x 130mm deep

ORDER CODE

DTH0001

FEATURES

- Stainless steel frame
- Easy to assemble
- Fitted with 100mm diameter swivel castors, 2 lockable



2 TIER

SPECIFICATIONS

MODEL SmartChef RPD-M2
 DIMENSIONS 850 x 540 x 900mm high
 WEIGHT 13kg
 SHELF DIMENSIONS (2x) 830 x 430mm high
 WEIGHT CAPACITY 50kg per tier

ORDER CODE **TTT1002**



3 TIER

SPECIFICATIONS

MODEL SmartChef RPD-M3
 DIMENSIONS 850 x 540 x 900mm high
 WEIGHT 15kg
 SHELF DIMENSIONS (3x) 830 x 430mm high
 WEIGHT CAPACITY 50kg per tier

ORDER CODE **TTT1003**



5 TIER

SPECIFICATIONS

MODEL SmartChef GD-L5
 DIMENSIONS 850 x 540 x 1250mm high
 WEIGHT 19kg
 SHELF DIMENSIONS (5x) 830 x 430mm high
 WEIGHT CAPACITY 50kg per tier

ORDER CODE **TTT1005**



FEATURES

- Tiers manufactured from durable plastic
- Light weight and soft in motion
- Fitted with (4x) swivel castors
- Pillars manufactured from aluminium
- Easy to assemble



3 TIER - NO BINS

SPECIFICATIONS

MODEL SmartChef ST-48
 DIMENSIONS 1040 x 510 x 970mm high
 WEIGHT 12.5kg
 SHELF DIMENSIONS (3x) 1000 x 500mm
 WEIGHT CAPACITY 30kg per tier

ORDER CODE **TTP0000**

3 TIER - WITH BINS

SPECIFICATIONS

MODEL SmartChef ST-48
 DIMENSIONS 1040 x 510 x 970mm high
 WEIGHT 12.5kg
 SHELF DIMENSIONS (3x) 1000 x 500mm
 WEIGHT CAPACITY 30kg per tier

ORDER CODE **TTP0001**



3 TIER - NO BINS

SPECIFICATIONS

MODEL SmartChef ST-49
 DIMENSIONS 870 x 430 x 940mm high
 WEIGHT 7kg
 SHELF DIMENSIONS (3x) 850 x 400mm
 WEIGHT CAPACITY 20kg per tier

ORDER CODE **TTP0002**

OPTIONAL SIDE BINS



LARGE

SPECIFICATIONS

MODEL SmartChef TTP0011
 DIMENSIONS 330 x 240 x 560mm high

ORDER CODE **TTP0011**

SMALL

SPECIFICATIONS

MODEL SmartChef TTP0012
 DIMENSIONS 330 x 240 x 170mm high

ORDER CODE **TTP0012**



FEATURES

- Manufactured from high quality stainless steel
- Fitted with (4x) castors. 2 with brakes
- Assembly required (*Supplied flat packed*)

15 TIER BAKING TROLLEY

SPECIFICATIONS

MODEL	SmartChef BTT1-15-64
DIMENSIONS	530 x 690 x 1700mm high
WEIGHT	22kg
COMPATIBILITY	600 x 400mm baking trays
RUNNER SPACING	80mm

ORDER CODE

BTT1-15-64



7 TIER BAKING TROLLEY

SPECIFICATIONS

MODEL	SmartChef BTT1-7-64
DIMENSIONS	670 x 495 x 1800mm high
WEIGHT	13kg
COMPATIBILITY	400 x 600mm baking trays
RUNNER SPACING	220mm

ORDER CODE

BTT1-7-64



STAINLESS STEEL MULTI-FUNCTION RACK TROLLEY

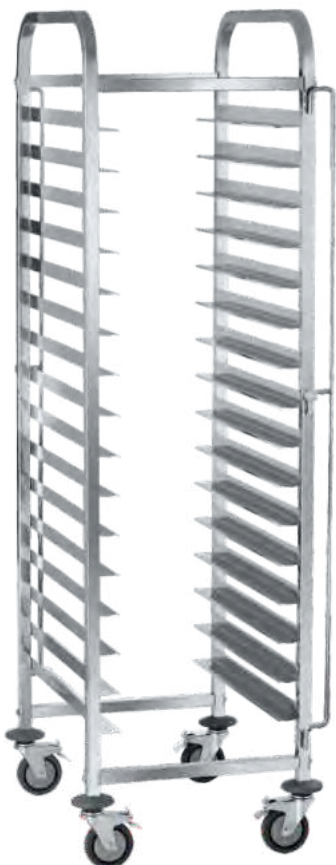

FEATURES

- Manufactured from high quality stainless steel
- Shelf locking mechanisms on both openings
- Fitted with (4x) castors. 2 with brakes
- Assembly required (*Supplied flat packed*)

18 TIER RACK TROLLEY

SPECIFICATIONS

MODEL	SmartChef L/TR-16A
DIMENSIONS	470 x 620 x 1700mm high
WEIGHT	26kg
COMPATIBILITY	1/1 GN Pans
RUNNER SPACING	600 x 400mm baking trays
	85mm

ORDER CODE

GNT1-16-16





2 x 16 TIER RACK TROLLEY

SPECIFICATIONS

MODEL SmartChef GNT2-16-11
DIMENSIONS 800 x 620 x 1705mm high
WEIGHT 33kg
COMPATIBILITY 1/1 GN Pans
RUNNER SPACING 80mm

ORDER CODE GNT2-16-11



FEATURES

- Manufactured from high quality stainless steel
- Shelf locking mechanisms on both openings
- Fitted with (4x) castors. 2 with brakes
- Assembly required (Supplied flat packed)



6 TIER RACK TROLLEY

SPECIFICATIONS

MODEL SmartChef TR-6A
DIMENSIONS 380 x 550 x 1000mm high
WEIGHT 10kg
COMPATIBILITY 1/1 GN Pans
RUNNER SPACING 85mm

ORDER CODE GNT1-6-11



7 TIER RACK TROLLEY (1/1GN) WITH WORK TOP

SPECIFICATIONS

MODEL SmartChef TR-7AT
DIMENSIONS 380 x 550 x 1000mm high
WEIGHT 12kg
COMPATIBILITY 1/1 GN Pans
RUNNER SPACING 85mm

ORDER CODE GNT1-7-11



7 TIER RACK TROLLEY (2/1GN) WITH WORK TOP

SPECIFICATIONS

MODEL SmartChef TR-7DT
DIMENSIONS 595 x 665 x 1000mm high
WEIGHT 12kg
COMPATIBILITY 2/1 GN Pans
RUNNER SPACING 80mm

ORDER CODE GNT1-7-21





SmartChef

CHROME WIRE SHELVING

SECTION INDEX

Chrome shelving	196
Counting scales	203
Inserts & lids	198-201
Kitchen scales	203
Plate shelf	197
Platform scales	202
Portion scales	202-203
Scales	
• Counting scales	203
• Kitchen scales	203
• Platform scales	202
• Portion scales	202-203
Shelving	
• Chrome shelves	196
• Spice shelf	197
• Plate shelf	197
Spice shelf	197
Ticket holders	197
Wall mounted shelving	197





FEATURES

- Shelves are manufactured from chrome plated steel
- Easy to assemble – no tools needed
- Sturdy construction makes them durable and versatile
- Shelf heights can be adjusted to suit your application
- Grid style shelves allow increased air circulation, prolonging the life of products
- Fitted with adjustable, unit leveling legs



ADJUSTABLE SHELF HEIGHT



STURDY UNIT LEVELING LEGS

4 TIER, 1800mm

SPECIFICATIONS

MODEL SmartChef CJ1800
 DIMENSIONS 1800 x 450 x 1800mm high
 WEIGHT 20kg
 SHELF DIMENSIONS 1800 x 450mm

ORDER CODE **SCS1800**



4 TIER, 1500mm

SPECIFICATIONS

MODEL SmartChef CJ1500
 DIMENSIONS 1500 x 450 x 1800mm high
 WEIGHT 15kg
 SHELF DIMENSIONS 1500 x 450mm

ORDER CODE **SCS1500**



4 TIER, 1200mm

SPECIFICATIONS

MODEL SmartChef CJ1200
 DIMENSIONS 1200 x 450 x 1800mm high
 WEIGHT 10kg
 SHELF DIMENSIONS 1200 x 450mm

ORDER CODE **SCS1200**



4 TIER, 900mm

SPECIFICATIONS

MODEL SmartChef CJ900
 DIMENSIONS 900 x 450 x 1800mm high
 WEIGHT 8kg
 SHELF DIMENSIONS 900 x 450mm

ORDER CODE **SCS0900**



ADDITIONAL SHELVING



1800mm

ORDER CODE **SCS1801**

1500mm

ORDER CODE **SCS1501**

1200mm

ORDER CODE **SCS1201**

900mm

ORDER CODE **SCS0901**

WALL MOUNTED STAINLESS STEEL KITCHEN ACCESSORIES

WALL MOUNTED SPICE SHELF FOR GN 1/6 PANS



FEATURES

- Manufactured from high quality stainless steel
- GN Pans not included

SPECIFICATIONS

MODEL	SmartChef WSS2-1000
DIMENSIONS	1195 x 300 x 182mm high
WEIGHT	3kg
SHELF THICKNESS	30mm
COMPATIBILITY	(6x) 1/6 GN Pans

ORDER CODE

WSS2-1000

GN 1/6 INSERTS



65mm

ORDER CODE

GNS8065



100mm

ORDER CODE

GNS8100



150mm

ORDER CODE

GNS8150

WALL MOUNTED PLATE SHELF



FEATURES

- Manufactured from high quality stainless steel

SPECIFICATIONS

MODEL	SmartChef WSS1-1000
DIMENSIONS	1195 x 300 x 182mm high
WEIGHT	2kg
SHELF THICKNESS	30mm

ORDER CODE

WSS1-1000

WALL MOUNTED TICKET HOLDER



FEATURES

- Manufactured from high quality stainless steel
- Paper held in place by marbles inside the clamping mechanism

SPECIFICATIONS

MODEL	SmartChef NHZ1000
DIMENSIONS	1000 x 80mm high

ORDER CODE

NHZ1000



FEATURES

- Manufactured from 0.8mm heavy duty stainless steel
- Rounded edges
- Anti-Jam system
- Reinforced corners



FULL INSERTS

SPECIFICATIONS

DIMENSIONS 325 x 530 x 20mm deep
 CAPACITY 1.9Lt
ORDER CODE GNF8020

DIMENSIONS 325 x 530 x 40mm deep
 CAPACITY 5Lt
ORDER CODE GNF8040
ORDER CODE GNF8040.P (perforated)

DIMENSIONS 325 x 530 x 55mm deep
 CAPACITY 7.4Lt
ORDER CODE GNF8055
ORDER CODE GNF8055.P (perforated)

DIMENSIONS 325 x 530 x 65mm deep
 CAPACITY 9.4Lt
ORDER CODE GNF8065
ORDER CODE GNF8065.P (perforated)

DIMENSIONS 325 x 530 x 100mm deep
 CAPACITY 15Lt
ORDER CODE GNF8100

DIMENSIONS 325 x 530 x 150mm deep
 CAPACITY 24Lt
ORDER CODE GNF8150

FULL LID

SPECIFICATIONS

DIMENSIONS 325 x 530mm
ORDER CODE GNF8000

HERMETIC SEAL LID

SPECIFICATIONS

DIMENSIONS 325 x 530mm
ORDER CODE PLA-HSL-11



1/2 INSERTS

SPECIFICATIONS

DIMENSIONS 265 x 325 x 65mm deep
 CAPACITY 3.5Lt
ORDER CODE GNH8065

DIMENSIONS 265 x 325 x 100mm deep
 CAPACITY 5.5Lt
ORDER CODE GNH8100

DIMENSIONS 265 x 325 x 150mm deep
 CAPACITY 8.5Lt
ORDER CODE GNH8150

1/2 LID

SPECIFICATIONS

DIMENSIONS 265 x 325mm
ORDER CODE GNH8000



2/3 INSERTS

SPECIFICATIONS

DIMENSIONS 325 x 352 x 20mm deep
 CAPACITY 1.25Lt
ORDER CODE GN2T8020

DIMENSIONS 325 x 352 x 40mm deep
 CAPACITY 4.5Lt
ORDER CODE GN2T8040.P (perforated)

DIMENSIONS 325 x 352 x 150mm deep
 CAPACITY 11.5Lt
ORDER CODE GN2T8150

DIMENSIONS 325 x 352 x 65mm deep
 CAPACITY 5.25Lt
ORDER CODE GN2T8065

2/3 LID

SPECIFICATIONS

DIMENSIONS 325 x 352mm
ORDER CODE GN2T8000



1/3 INSERTS

SPECIFICATIONS

DIMENSIONS 175 x 325 x 40mm deep
 CAPACITY 1.5Lt
 ORDER CODE **GNT8040**

DIMENSIONS 175 x 325 x 65mm deep
 CAPACITY 2.25Lt
 ORDER CODE **GNT8065**

DIMENSIONS 175 x 325 x 100mm deep
 CAPACITY 3.5Lt
 ORDER CODE **GNT8100**

DIMENSIONS 175 x 325 x 120mm deep
 CAPACITY 3.5Lt
 ORDER CODE **GNT8120**

DIMENSIONS 175 x 325 x 150mm deep
 CAPACITY 5.5Lt
 ORDER CODE **GNT8150**

1/3 LID

SPECIFICATIONS

DIMENSIONS 175 x 325mm
 ORDER CODE **GNT8000**



1/4 INSERTS

SPECIFICATIONS

DIMENSIONS 162 x 265 x 65mm deep
 CAPACITY 1.5Lt
 ORDER CODE **GNQ8065**

DIMENSIONS 162 x 265 x 150mm deep
 CAPACITY 3.75Lt
 ORDER CODE **GNQ8150**

1/4 LID

SPECIFICATIONS

DIMENSIONS 162 x 265mm
 ORDER CODE **GNQ8000**



1/6 INSERTS

SPECIFICATIONS

DIMENSIONS 160 x 175 x 65mm deep
 CAPACITY 1Lt
 ORDER CODE **GNS8065**

DIMENSIONS 160 x 175 x 100mm deep
 CAPACITY 1.5Lt
 ORDER CODE **GNS8100**

DIMENSIONS 160 x 175 x 150mm deep
 CAPACITY 2.25Lt
 ORDER CODE **GNS8150**

1/6 LID

SPECIFICATIONS

DIMENSIONS 160 x 175mm
 ORDER CODE **GNS8000**



1/9 INSERTS

SPECIFICATIONS

DIMENSIONS 108 x 175 x 100mm deep
 CAPACITY 0.8Lt
 ORDER CODE **GNN8100**

1/9 LID

SPECIFICATIONS

DIMENSIONS 108 x 175mm
 ORDER CODE **GNN8000**





FEATURES

- Large, backlit LCD display
- Stainless steel platform and column with ABS housed indicator
- Fitted with an internal rechargeable battery with up to 80hr lifetime
- Fitted with a built-in spirit level
- Easy to operate
- Fitted with (4x) adjustable, devise leveling feet

PLATFORM SCALE

SPECIFICATIONS

MODEL	TCS150
POWER SOURCE	220V or Internal battery
DIMENSIONS	400 x 500 x 600mm high
PLATFORM DIMENSIONS	400 x 500mm
MAX WEIGHT	150kg
ACCURACY	10g

ORDER CODE **SW/PSS0150**

FEATURES

- Manufactured from 430 Stainless steel
- Fully waterproof. IP68 rated certified
- Dual backlit LED display (front and rear)
- Fitted with a built-in spirit level
- Waterproof rubber keypad and an all-sealed PC board
- Fully Enclosed 6V/4Ah rechargeable battery inside
- Automatic power-off timing function
- Fitted with height adjustable feet



WATERPROOF PORTION SCALE

SPECIFICATIONS

MODEL	SmartChef JSF-15000
ELECTRICITY	220V / 6V Built-in battery
DIMENSIONS	297 x 246 x 127mm high
PLATFORM DIMENSIONS	230 x 190mm
WEIGHT	4.7kg
READABLE WEIGHT	15Kg
ACCURACY	0.5g

ORDER CODE **SW/PSS1015**

DUAL DIGITAL DISPLAY



FEATURES

- Fitted with a maintenance-free rechargeable battery
- Automatic fault detection, automatic calibration
- Overweight alarm function
- LCD display
- Supports a variety of weighing units
- Overload / impact protection
- Stainless steel weighing pan
- Fitted with a built-in spirit level



PORTION SCALE

SPECIFICATIONS

MODEL	JS15-05
POWER SOURCE	220V or Internal battery
DIMENSIONS	320 x 290 x 115mm high
PLATFORM DIMENSIONS	280 x 210mm
READABLE WEIGHT	15kg
ACCURACY	0.5g

ORDER CODE SW/PSS0015

FEATURES

- LCD display
- Overload and impact protection function
- 4V/4Ah rechargeable battery inside
- Sampling function
- Built-in spirit level
- Fitted with a Stainless steel pan
- Automatic fault detection and calibration
- Fixed tare weight
- Single item weight and accumulate function
- **No printer and not compatible with a printer**



COUNTING SCALE - 15Kg

SPECIFICATIONS

MODEL	SmartChef JSA 15-05
ELECTRICITY	220V / 4V Built-in battery
DIMENSIONS	320 x 290 x 115mm high
PLATFORM DIMENSIONS	280 x 210mm
WEIGHT	3kg
READABLE WEIGHT	15Kg
ACCURACY	0.5g

ORDER CODE SW/PSS3015

FEATURES

- Stainless steel weighing platform pan
- Fast & accurate weighing results
- LCD display
- Supports a variety of weighing units
- 1.5V (2x) AA Batteries (not included)
- Equipped with a high precision strain gauge sensor
- Easy to operate
- Count / tare function
- USB interface / power supply



KITCHEN SCALE

SPECIFICATIONS

MODEL	LD5000S
POWER SOURCE	(2x) AA batteries or USB
DIMENSIONS	240 x 165 x 60mm high
PLATFORM DIMENSIONS	155 x 155mm
WEIGHT	0.5kg
READABLE WEIGHT	5kg
ACCURACY	1g

ORDER CODE SW/PSS0005

INDEX

A

ANKARSRUM Kitchen assistant	14-15
ARISCO Electric cooking ranges	38-39
ARISCO Gas cooking ranges with electric oven	36-37
ARISCO Tilting / Brat pans	40
AVATHERM Delivery boxes	187
AVATHERM Food pan carriers	186

B

Back bar coolers	150
BAKEMARK Convection ovens	74
BAKEMARK Deck ovens	88-92
BAKEMARK Dough divider	19
BAKEMARK Dough proofers	79
BAKEMARK Pastry sheeters	21
BAKEMARK Planetary mixers	16
BAKEMARK Spiral dough mixers	17
Baking ovens	82, 88-92
Baking trolleys	192
Beverage containers	185
Beverage coolers	151
Blades for Vege prep machine	6
Blast chillers	141
Blenders	8, 99
Boiling tables (Gas)	31
Bowl cutters	7
Brat pans	40-41
BRAVIDA Coffee brewers	98
BRAVIDA Hot chocolate machines	98
Bread mixers	17
BRICE Modular ice machines	160-161
BRICE Self-contained ice machines	162
Burger patty presses	12

C

Cake displays	167
Cake mixers	14-16
CAMBRO Beverage containers	185
CAMBRO Food pan carriers	185
CATERLOT Coffee brewers	96
CATERLOT Urns	97
Cereal dispensers	135
Chafing dish heating elements	129
Chafing dish stands	128-129
Chafing dishes	
• Econo series	131
• Electric	132
• Induction series	128-129
• PC cover series	132
• Window series	131
Char grillers (Gas)	32
Charcoal ovens	80-81
Chef bases	35, 149
Chip cutters	9
Chip dumps	49
Chrome shelving	196
Cleaning trolleys	125
CLEME Slicers	10
Coffee brewers	96, 98
Coffee urns	97
Cold meat slicers	10-11
Combi steam ovens	
• Electric	60-63, 65, 67
• Gas	64, 66
Cone bakers	57
Contact grills	50
Continuous sealers	26
Convection ovens	68, 70-71, 78
Conveyor toasters	52
Cooking ranges	
• Electric (Full)	38-39
• Gas (Full)	30
• Gas (Electric oven)	36-37

COOKRITE Boiling tables (Gas)	31
COOKRITE Chef bases	35, 149
COOKRITE Cooking ranges with oven (Gas)	30
COOKRITE Flat top griddles (Gas)	33
COOKRITE Gas fryers (Floor standing)	45
COOKRITE Radiant / Char grillers (Gas)	32
COOKRITE Salamanders (Gas)	53
COOKRITE Stands	34
Corn dog bakers	58
Counting scales	203
Crepe makers	58
CRYSTAL Dishwashers (Front loading)	113
CRYSTAL Dishwashers (Hoodtype)	114-115
CRYSTAL GR Display freezers	152-153
CRYSTAL GR Display fridges	152
CRYSTAL GR Gelato storage freezer	155
CRYSTAL GR Ice cream scoop freezers	154
CRYSTAL Upright freezers	142
CRYSTAL Upright fridges	142

D

Deck ovens	
• Electric	82, 88-90
• Gas	91-92
Delivery bags	188
Delivery boxes	187
Delux coffee urns	137
Dishwasher basket trolleys	124
Dishwasher baskets	122-123
Dishwashers	
• Front loading	111, 113
• Hoodtype	112, 114-115
Display cabinets	
• Heated	172, 175
• Neutral	169, 173, 175
• Refrigerated	166-171, 173-174
Display freezers	153-154
Display fridges	152
Double chamber vacuum sealers	24
Dough divider & rounder	19
Dough mixers	17-18
Dough proofers	79
Dough rollers	20
Dough sheeters	21

E

EKA Combi steam ovens	60-67, 69
EKA Convection ovens	68, 70-71
Electric chafing dishes	132
EMPERO Charcoal ovens	80-81

F

Faucets	117-118
Flat top griddles	
• Electric	50
• Gas	33
Floor standing display cabinets	166-170, 173-175
Food pan carriers	185-186
Food processors	7
Food serving carts	184
Frappe makers	100
Freezers	
• Display freezers	153-154
• Gelato storage freezer	155
• Ice cream scoop freezers	154
• Upright storage freezers	142-145
Fridges	
• Back bar coolers	150
• Beverage coolers	151
• Display fridges	152
• Pizza ingredient fridges	148
• Saladette cabinets	146-147
• Sushi display fridges	148
• Upright storage fridges	142-145

Fry cutters	9
Fryers	
• Electric (Floor standing)	44
• Electric (Table model)	48
• Gas (Floor standing)	45-46
• Pressure	47-48
FURMIS Delivery bags	188

G

GALILEO Display cabinets	166-172
GALILEO Open merchandiser	177
Gastronome pans	133
Gelato machines	104, 156
Gelato storage freezer	155
GENERAL WAVE Microwave ovens	53
Glass rinsers	119
Glass washers	110
GN trolleys	192-193
GOSHEN Gelato machines	104-156
GOSHEN Soft serve machines	105, 157

H

Hamburger press	12
Hand wash basins	121
Hand-press impulse sealers	27
Heat sealing machines	27
Heated Display cabinets	172, 175
Heating elements for chafing dishes	129
Horizontal continuous sealers	26
Hose reels	120
Hot chocolate machines	98
Hot water urns	97, 137

I

Ice cream machines	104-106, 156-157
Ice cream scoop freezers	154
Ice crushers	100
Ice machines	
• Modular	158-161
• Self-contained	162-163
IGLOO Display cabinets	173-175
IGLOO Open cooler merchandisers	177-179
IGLOO Open island merchandisers	180
IGLOO Sneezeguards	176
Impulse sealers	27
Induction chafing dishes	128-129
Induction cookers	42
Induction warmers	130
INOXSERV Cereal dispensers	135
INOXSERV Chafing dishes	128-132
INOXSERV Hot water urns	137
INOXSERV Inserts & lids	198-201
INOXSERV Juice dispensers	136
INOXSERV Soup kettles	131, 134
Inserts & lids	198-201

J

Janitor trolleys	125
JOHNY Ice crushers	100
JOHNY Milkshake machines	100
Juice dispensers	101, 136

K

Kitchen assistant	14-15
Kitchen scales	203
Knee operated hand wash basins	121
KROMET Tilting / Brat pans	41

L

Laundry trolleys	125
------------------------	-----

M

Manual lift toasters	52
Meal delivery bags	188
Meal delivery boxes	187
Meal delivery carts	184
Meat slicers	10-11
Merchandisers	
• Open cooler	177-179
• Open island	180
• Wall chillers	177-179
Microwave ovens	53
Milkshake machines	100
Mixers	14-18

N

Neutral Display cabinets	169, 173, 175
--------------------------------	---------------

O

Oil filter cart	46
OMNIWASH Dishwashers (Front loading)	111
OMNIWASH Dishwashers (Hood-type)	112
OMNIWASH Glass washers	110
Open cooler merchandisers	177-179
Open island merchandisers	180
Oven grids & pans	72, 93
Ovens	
• Charcoal ovens	80-81
• Convection ovens	66, 68-69, 74
• Combi steam ovens	60-67, 69
• Deck ovens	82, 88-92
• Pizza ovens	82-86
Overhead sprays	116-117

P

Packing stations	49
Pastry sheeters	21
Patty press	12
Percolators	98
Pie warmers	181
Pizza delivery bags	188
Pizza dough rollers	20
Pizza ingredient fridges	148
Pizza ovens	82-86
Planetary mixers	14-16
Plate shelf	197
Platform scales	202
Platform trolleys	189
POLARCAB Back bar coolers	150
POLARCAB Beverage coolers	151
POLARCAB Blast chillers	141
POLARCAB Ice machines (Modular)	158-159
POLARCAB Ice machines (Self-contained)	163
POLARCAB Juice dispensers	101
POLARCAB Pizza ingredient fridges	148
POLARCAB Saladette cabinets	146-147
POLARCAB Slush machines	102-103
POLARCAB Soft serve machines	106, 156
POLARCAB Sushi display fridges	148
POLARCAB Upright freezers	143-145
POLARCAB Upright fridges	143-145
Polony slicers	10-11
Portion scales	202-203
Potato chippers	9
Pre-rinse sprays	116-117
Proofers	79

Q

INDEX

R

Rack trolleys	192-193
Radiant grillers (Gas)	32
Refrigerated Display cabinets	166-171, 173-174
Rice cookers	54

S

Saladette cabinets	146-147
Salamanders	53
Sandwich toasters	51
Scales	
• Counting scales	203
• Kitchen scales	203
• Platform scales	202
• Portion scales	202-203
Shelving	
• Chrome shelves	196
• Spice shelf	197
• Plate shelf	197
Single chamber vacuum sealers	24-25
Slicers	10-11
Slush machines	102-103
SMARTBLEND Blenders	8, 99
SMARTCHEF Baking trolleys	192
SMARTCHEF Bowl cutters	7
SMARTCHEF Chip dumps	49
SMARTCHEF Chrome shelving	196
SMARTCHEF Cleaning trolleys	125
SMARTCHEF Cone bakers	57
SMARTCHEF Contact grills	50
SMARTCHEF Convection ovens	78
SMARTCHEF Conveyor toasters	52
SMARTCHEF Comdog bakers	58
SMARTCHEF Flat top griddles	50
SMARTCHEF Fry cutters	9
SMARTCHEF Fryers (Floor standing)	44-45
SMARTCHEF Fryers (Table model)	48
SMARTCHEF Hand wash basins	121
SMARTCHEF Meat slicers	11
SMARTCHEF Oil filter cart	46
SMARTCHEF Patty press	12
SMARTCHEF Pie warmers	181
SMARTCHEF Pizza ovens	84-85
SMARTCHEF Pressure fryers	47-48
SMARTCHEF Rack trolleys	192-193
SMARTCHEF Rice cookers	54
SMARTCHEF Salamanders	53
SMARTCHEF Sandwich toasters	51
SMARTCHEF Sous-vide cookers	54
SMARTCHEF Spiral potato cutter	9
SMARTCHEF Tea trolleys	190-191
SMARTCHEF Ticket holders	197
SMARTCHEF Toasters	52
SMARTCHEF Tomato slicers	7
SMARTCHEF Vegetable preparation machines	6
SMARTCHEF Waffle bakers (Round)	56
SMARTCHEF Waffle bakers (Square)	55
SMARTCHEF Waffle lolly bakers	55
SMARTCHEF Wall mounted shelving	197
SMARTCHEF-i Induction cookers	42
SMARTCHEF-i Induction warmers	130
SMARTVAC Continuous sealers	26
SMARTVAC Impulse sealers	27
SMARTVAC Vacuum sealers	24-25
SMARTVAC Wrapping machines	27
SMARTWAY Scales	202-203
Smoothie makers	8, 99
Sneeze guards	176
Soft serve machines	105-106, 156-157
Soup kettles	131, 134
Soup warmers	129
Sous-vide cookers	54
Spice shelf	197
Spiral dough mixers	17-18

Spiral potato cutter	9
Sushi display fridges	148

T

T&S Faucets	117-118
T&S Glass rinsers	119
T&S Hose reels	120
T&S Pre-rinse sprays	116-117
Table model display cabinets	166-167, 171-172
Tea trolleys	190-191
Ticket holders	197
Tilting pans	40-41
Toasters	
• Contact grills	50
• Conveyor	52
• Manual lift	52
• Sandwich	51
Tomato slicers	7
Tray trolleys	192-193
TRAYPORT Food serving carts	184

U

Upright freezers	142-145
Upright fridges	142-145
Urns	97, 137

V

Vacuum sealers	24-25
Vegetable preparation machines	6
Vertical continuous sealers	26

W

Waffle bakers	
• Belgian	55
• Cone bakers	57
• Lolly (Waffle on a stick)	55
• Round	56
Wall chillers	177-179
Wall mounted shelving	197
Water filtration system	77
Wrapping machines	27

X

Y

Z

SmartVac

Seal in the freshness...



Introducing

Swash

GLASS & DISH
WASHERS

The Smartwash Option

Germ-Free Dishes
Worry-Free Life



GREENER



SMALLER



FASTER



EASIER

 **IGLOO**
MORE THAN COOLING

Brand Spanking New!
Multideck Display Fridges



Cook Rite

Commercial Gas Cooking Equipment



Certified



WESTERN CAPE

Unit 7 Radnor industrial park, 21 Radnor St, Parow Industrial, Cape Town
+27 21 949 7325
info@catermarket.co.za

GAUTENG

11 Milano close, Cosmo business park, Cosmo City, Johannesburg
+27 11 708 0191
jhb@catermarket.co.za

KWAZULU-NATAL

Unit 5 Villa Commercial Park, 5 Garlicke Drive, Ballito, Dolphin Coast
+27 32 648 0092
kznadmin@catermarket.co.za



www.catermarket.co.za



DISCLAIMER

CaterMarket has made every effort to ensure that the information contained in this catalogue at the time of publishing is true and accurate. However, neither CaterMarket nor their associated agents can guarantee that this information is accurate at all times.

Images used are only for illustration purposes and may vary from the actual product.

CaterMarket reserves the right to make any changes considered necessary, at any time and without warning, to improve its products. As a result CaterMarket accepts no responsibility or liability that may arise through the reliance of the information contained herein.

CaterMarket strictly prohibits the reproduction, even partial, of images, text, etc of this catalogue for commercial purpose, without specific authorisation by CaterMarket.



eka *SmartChef* ✱ IGLOO **JOHNY** arisco. CRYSTAL
SmartBlend Goster* POLARCAB omniWASH *SmartWay*
 @terLot *SmartWave* prismafood EMPERO *SmartVac* T&S
 ✓BakeMark *CookRite* inoxserv Galileo CRYSTAL

