

## Hangzhou Yamei Dental Medical Equipment Factory



Catalog

### Pursuit of Yamei, Beauty of Teeth



# Company Profile

Hangzhou Yamei Dental Medical Equipment Factory is located in Hangzhou, Yuhang district, Liangzhu university science park. It is a high-tech enterprises with 2000 square meters' manufacturing base which is committed to the researching , developing, manufacturing and managing of professional orthodontic materials for more than 20 years. Our factory missions are “People Oriented, Quality Excellence, Aggressive Innovation, Safety Production” .Our factory has introduced advanced production equipment and the production technical process, and in accordance with advanced product testing method and equipment, in order to guarantee our goods high quality and can be the top grade goods in the market.

We insist on taking the technology as the first productivity, and strive for promoting the development and introduction of new production and technology. We would try our best to meet customers' needs, and devote ourselves to enhance the quality of orthodontic equipment. Our factory are mainly produce various of orthodontic brackets, molar bands, buccal tubes, orthodontic accessories, archwires, elastics power rings, oral auxiliary materials and tools. Among them CNC brackets and passive self-ligating brackets have won the good market reputation and brought good experience and orthodontic effect to dentists and patients.

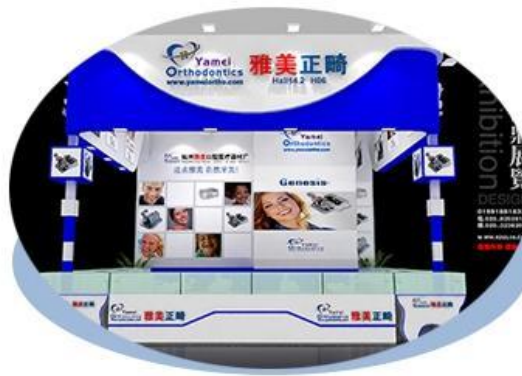

# Catalog

# Products Quality Certificates

we have established a strict quality control system throughout the entire manufacturing process, from raw materials organization, production, packing to shipment.

We have obtained registration certificates of Class I, Class II and Class III in China, and have passed ISO9001 & ISO13485, EU CE certificates and US FDA registration.



中华人民共和国医疗器械注册证

注册证编号: 浙械注准20172630537

注册人名称	杭州雅美口腔医疗器械厂
注册人住所	杭州市西湖区三墩镇双桥村油车桥80号1幢101室
生产地址	杭州市西湖区三墩镇双桥村油车桥80号1幢101室
代理人名称	不适用
代理人住所	不适用
产品名称	正畸带环颊面管
型号、规格	见附表
结构及组成	产品由带环和颊面管焊接而成,由符合GB/T3089-2008和GB/T1220-2007中规定的不锈钢材料制成,其中带环由06Cr19Ni10不锈钢制成;颊面管由06Cr18Ni11Ti不锈钢制成。
适用范围	产品供人体牙列正畸用。
附件	产品技术要求
其他内容	/
备注	/

审验部门:浙江省食品药品监督管理局

中华人民共和国医疗器械注册证

注册证编号: 浙械注准20172630536

注册人名称	杭州雅美口腔医疗器械厂
注册人住所	杭州市西湖区三墩镇双桥村油车桥80号1幢101室
生产地址	杭州市西湖区三墩镇双桥村油车桥80号1幢101室
代理人名称	不适用
代理人住所	不适用
产品名称	正畸托槽
型号、规格	型号: 直丝弓托槽、方丝弓托槽; 规格: (0.57*0.71) mm
结构及组成	产品由托槽体和基底板组成,由符合GB/T4976-2012和GB/T1220-2007中规定的06Cr19Ni10不锈钢材料制成。
适用范围	产品供人体牙列正畸用。
附件	产品技术要求
其他内容	/
备注	/

审验部门:浙江省食品药品监督管理局

中华人民共和国医疗器械注册证

注册证编号: 浙械注准20182630096

注册人名称	杭州雅美口腔医疗器械厂
注册人住所	浙江省杭州市西湖区东塘街道凤鸣路9号2幢3楼
生产地址	浙江省杭州市余杭区良渚街道康乐街9号2号4楼
代理人名称	不适用
代理人住所	不适用
产品名称	游离牵引钩
型号、规格	见附表、加长型
结构及组成	产品符合GB/T1220-2007的06Cr19Ni10(S30408)不锈钢材料制成。
适用范围	产品与其他正畸产品配套,用于口腔正畸用。
附件	产品技术要求
其他内容	/
备注	/

审验部门:浙江省食品药品监督管理局



1. Orthodontic Bracket/  
Molar Bands/Buccal Tubes

Metal Bracket/Self-ligating Bracket

Ceramic Bracket/Sapphire Bracket

Molar Bands/Buccal Tubes

2. Orthodontic Accessories

Intra-oral Accessories

Extra-oral Accessories

3. Orthodontic Wires &  
Related Products

Archwires

Elastic Products

Adhesive

Orthodontic Consumable Items

4. Orthodontic Tools

Orthodontic Instrument

Orthodontic Pliers

Y

## Yamei Orthodontic Bracket System

Self-ligating Bracket/Metal Brackets/Ceramic Bracket/Sapphire Bracket

A

M

E



### Yamei Advanced Orthodontic Bracket Design Concept

- ✦ Yamei Orthodontic brackets are endowed with innovation in terms of design. Orthodontic brackets are produced not only using advanced manufacturing technology and mechanical equipment, but also absorbing aesthetic idea of human body.
- ✦ So that orthodontic brackets manufacturing moves on to the stage of personalization and miniaturization, and makes dentists and patients get maximum comfort.

# Orthodontic Metal Passive Self-ligating Bracket

## Metal Passive Self-ligating Roth Plus 6/MBT Plus 8 Bracket

### Advantages

- 1) Mini Shape, adjust size and height so as to realize optimal condition.
- 2) Unlocking is towards the same direction: downwards.
- 3) The ligation space of ligation wings is ample.
- 4) With bottom sliding ball hook.
- 5) With auxiliary hole of orthodontic wires: 0.42\*0.42;
- 6) Rectangle wires are adopted CNC machining, process, the 3 sides of bracket slots are bright and smooth, which can reduce the friction between wires and bracket slot greatly.
- 7) Bracket base is 80 molgbdemum mesh, and hook is ball spherical arc shape design, which can both increase bonding strength.
- 8) 4 sides of bracket are adopted laser welding process, bracket base can be sandblasted and laser marked as clients requirement.



### Special Process

Base Marked Easier to identify the teeth position



Base Sandblasted Increase bonding Strength of mesh base



### Teeth Position Identification

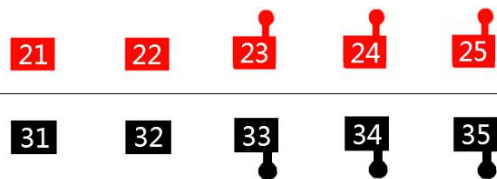
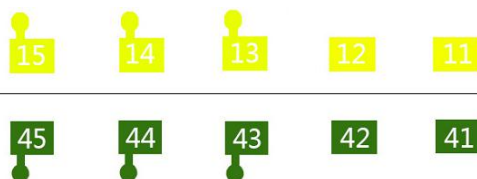

## Orthodontic Metal Passive Self-ligating Bracket

Maxillary		Torque Tip		.022R	.022L	.018R	.018L
Central	Roth	12°	4°	BL22-2011	BL22-2021		
	MBT	17°	4°	BL32-2011	BL32-2021		
Lateral	Roth	8°	8°	BL22-2012	BL22-2022		
	MBT	10°	8°	BL32-2012	BL32-2022		
Cuspid	Roth	0°	8°	BL22-2113	BL22-2123		
	MBT	0°	8°	BL32-2113	BL32-2123		
1st Bicuspid	Roth	-7°	0°	BL22-2114	BL22-2124		
	MBT	-7°	0°	BL32-2114	BL32-2124		
2nd Bicuspid	Roth	-7°	0°	BL22-2115	BL22-2125		
	MBT	-7°	0°	BL32-2115	BL32-2125		

Mandibular		Torque Tip		.022R	.022L	.018R	.018L
Central	Roth	-2°	0°	BL22-2041	BL22-2031		
	MBT	-6°	0°	BL32-2041	BL32-2031		
Lateral	Roth	-2°	0°	BL22-2042	BL22-2032		
	MBT	-6°	0°	BL32-2042	BL32-2032		
Cuspid	Roth	-11°	3°	BL22-2143	BL22-2133		
	MBT	-6°	3°	BL32-2143	BL32-2133		
1st Bicuspid	Roth	-17°	0°	BL22-2144	BL22-2134		
	MBT	-12°	0°	BL32-2144	BL32-2134		
2nd Bicuspid	Roth	-22°	0°	BL22-2145	BL22-2135		
	MBT	-17°	0°	BL32-2145	BL32-2135		

Products Name	Roth Series	MBT Series
Metal Passive Self-ligating Bracket no Hook	BL22-20	BL32-20
Metal Passive Self-ligating Bracket 3 with Hook	BL22-23	BL32-23
Metal Passive Self-ligating Bracket 345 with Hook	BL22-24	BL32-24
(Note: 6-7 tubes and archwires are available)		

Products Name	Low Torque	Middle Torque	High Torque
Metal Passive Self-ligating Bracket no Hook	BX12-20	BX12-20	BX12-20
Metal Passive Self-ligating Bracket 3 with Hook	BX22-23	BX22-23	BX22-20
Metal Passive Self-ligating Bracket 345 with Hook	BX32-24	BX32-24	BX32-20
(Note: 6-7 tubes and archwires are available)			

## Orthodontic Metal Passive Self-ligating Low/Middle/High Torque Bracket

### Advantages

Innovative auxiliary hole design which can accelerate teeth movement

Sliding unlocking & locking design, the placement and removal of wires are both convenient, which is easy for doctors to operate. Reducing lean-on operation, patients have no discomfort.

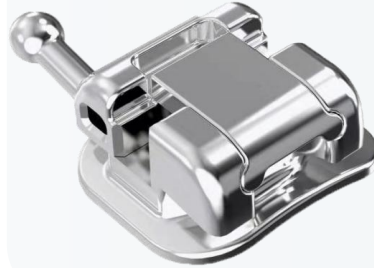

The walls of passive self-ligating bracket are smooth and solid. The slots are high precision which can offer 3 options : high/middle/low torque.

Round shape which is not only comfortable for patients to wear, but also easy to clean. Passive unlocking design is more stable, reliable, not distortion comparing to active self-ligating design.

All sides laser cold welding process provides high welding strength, maintains precision of bracket data, and ensures accuracy of orthodontics.

Maxillary		Torque Tip		.022R	.022L	.018R	.018L
Central	Low Torque	2°	5°	BX12-2011	BX12-2021		
	Middle Torque	12°	5°	BX22-2011	BX22-2021		
	High Torque	22°	5°	BX32-2011	BX32-2021		
Lateral	Low Torque	-5°	9°	BX12-2012	BX12-2022		
	Middle Torque	8°	9°	BX22-2012	BX22-2022		
	High Torque	13°	9°	BX32-2012	BX32-2022		
Cuspid	Low Torque	-9°	5°	BX12-2113	BX12-2123		
	Middle Torque	7°	5°	BX22-2113	BX22-2123		
	High Torque	11°	5°	BX32-2113	BX32-2123		
1st Bicuspid	Low Torque	-11°	2°	BX12-2114	BX12-2124		
	Middle Torque	-11°	2°	BX22-2114	BX22-2124		
	High Torque	-11°	2°	BX32-2114	BX32-2124		
2nd Bicuspid	Low Torque	-11°	2°	BX12-2115	BX12-2125		
	Middle Torque	-11°	2°	BX22-2115	BX22-2125		
	High Torque	-11°	2°	BX32-2115	BX32-2125		

Mandibular		Torque Tip		.022R	.022L	.018R	.018L
Central/Lateral	Low Torque	-11°	0°	BX12-2041	BX12-2031		
	Middle Torque	-6°	0°	BX22-2041	BX22-2031		
	High Torque	-2°	0°	BX32-2041	BX32-2031		
Cuspid	Low Torque	0°	5°	BX12-2042	BX12-2032		
	Middle Torque	7°	5°	BX22-2042	BX22-2032		
	High Torque	13°	5°	BX32-2042	BX32-2032		
1st Bicuspid	Low Torque	-12°	2°	BX12-2143	BX12-2133		
	Middle Torque	-12°	2°	BX22-2143	BX22-2133		
	High Torque	-5°	2°	BX32-2143	BX32-2133		
2nd Bicuspid	Low Torque	-17°	2°	BX12-2144	BX12-2134		
	Middle Torque	-17°	2°	BX22-2144	BX22-2134		
	High Torque	-17°	2°	BX32-2144	BX32-2134		

# Orthodontic Metal Active Self-ligating Bracket



Accurate positioning of brackets: Make the teeth move faster. No ligatures required, there is no dental plaque caused by ligating, more efficient.

Round shape which is not only comfortable for patients to wear but also easy to clean. Its unique polishing process which Reduces the friction between brackets and wires.

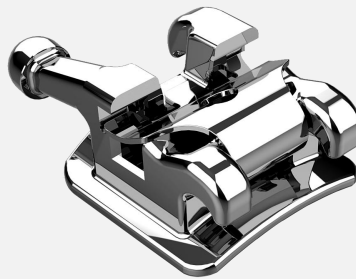

The walls of active self-ligating bracket are smooth and solid. The slots are high precision. Smooth streamline edges: improve patients' comfort.

All sides laser cold welding process provides high welding strength, maintains precision of bracket data, and ensures accuracy of orthodontics.

Maxillary		Torque Tip		.022R	.022L	.018R	.018L
Central	Roth	12°	4°	BH22-2011	BH22-2021		
	MBT	17°	4°	BH32-2011	BH32-2021		
Lateral	Roth	10°	8°	BH22-2012	BH22-2022		
	MBT	10°	8°	BH32-2012	BH32-2022		
Cuspid	Roth	2°	8°	BH22-2113	BH22-2123		
	MBT	0°	8°	BH32-2113	BH32-2123		
1st Bicuspid	Roth	-7°	0°	BH22-2114	BH22-2124		
	MBT	-7°	0°	BH32-2114	BH32-2124		
2nd Bicuspid	Roth	-7°	0°	BH22-2115	BH22-2125		
	MBT	-7°	0°	BH32-2115	BH32-2125		

Mandibular		Torque Tip		.022R	.022L	.018R	.018L
Central	Roth	-1°	0°	BH22-2041	BH22-2031		
	MBT	-6°	0°	BH32-2041	BH32-2031		
Lateral	Roth	-1°	0°	BH22-2042	BH22-2032		
	MBT	-6°	0°	BH32-2042	BH32-2032		
Cuspid	Roth	-11°	6°	BH22-2143	BH22-2133		
	MBT	-6°	3°	BH32-2143	BH32-2133		
1st Bicuspid	Roth	-17°	0°	BH22-2144	BH22-2134		
	MBT	-12°	0°	BH32-2144	BH32-2134		
2nd Bicuspid	Roth	-17°	0°	BH22-2145	BH22-2135		
	MBT	-17°	0°	BH32-2145	BH32-2135		

Products Name	Roth Series	MBT Series
Metal Active Self-ligating Bracket 3 with Hook	BH22-23	BH32-23
Metal Active Self-ligating Bracket 345 with Hook	BH22-24	BH32-24



## Orthodontic Passive Machining Self-ligating PLUS 3 Bracket

### Advantages

High flexible material ensures clip still maintain the original effect after unlocking & locking hundreds of times. It is easy and convenient with the use of professional unlocking tools and dental probes.

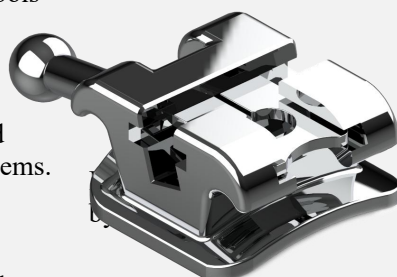

Reliable structural design to avoid clip deformation and falling problems.

Clip can be directly closed with a finger, which is easy for operation.

80 molgbdemum mesh base retains more bonding area, which can make bonding more accurate and strong.

The clips are easily to operate for both unlocking and locking, and it is also durable.

Maxillary		Torque Tip		.022R	.022L	.018R	.018L
Central	Roth	12°	4°	BT22-2011	BT22-2021		
	MBT	17°	4°	BT32-2011	BT32-2021		
Lateral	Roth	8°	8°	BT22-2012	BT22-2022		
	MBT	10°	8°	BT32-2012	BT32-2022		
Cuspid	Roth	-2°	8°	BT22-2113	BT22-2123		
	MBT	-7°	8°	BT32-2113	BT32-2123		
1st Bicuspid	Roth	-7°	0°	BT22-2114	BT22-2124		
	MBT	-7°	0°	BT32-2114	BT32-2124		
2nd Bicuspid	Roth	-7°	0°	BT22-2115	BT22-2125		
	MBT	-7°	0°	BT32-2115	BT32-2125		

Mandibular		Torque Tip		.022R	.022L	.018R	.018L
Central	Roth	0°	0°	BT22-2041	BT22-2031		
	MBT	-6°	0°	BT32-2041	BT32-2031		
Lateral	Roth	0°	0°	BT22-2042	BT22-2032		
	MBT	-6°	0°	BT32-2042	BT32-2032		
Cuspid	Roth	-11°	7°	BT22-2143	BT22-2133		
	MBT	-6°	3°	BT32-2143	BT32-2133		
1st Bicuspid	Roth	-17°	0°	BT22-2144	BT22-2134		
	MBT	-12°	2°	BT32-2144	BT32-2134		
2nd Bicuspid	Roth	-22°	0°	BT22-2145	BT22-2135		
	MBT	-17°	2°	BT32-2145	BT32-2135		

Products Name	Roth Series	MBT Series
Passive Self-ligating Bracket 3 with Hook	BT22-23	BT32-23
Passive Self-ligating Bracket 345 with Hook	BT22-24	BT32-24

## Orthodontic CNC Bracket

### Advantages

The 3 sides of slots are equally smooth, and the sizes of slots' 3 sides are all the same. Which can reduce friction between brackets and wires greatly.

The slots are curve which can realize good match between bracket and wires, in this way can improve the orthodontic effect.



Brackets surface are circular bead design, and which is specially polished. Patients those who wear occur rejection very little.

Ultra-thin low wing design can avoid occlusal interference and brackets falling off problems effectively. What's more, it will make patients more comfortable.

Maxillary		Torque Tip		.022R	.022L	.018R	.018L
Central	Roth	12°	5°	BN22-2011	BN22-2021	BN22-1011	BN22-1021
	MBT	17°	4°	BN32-2011	BN32-2021	BN32-1011	BN32-1021
Lateral	Roth	8°	8°	BN22-2012	BN22-2022	BN22-1012	BN22-1022
	MBT	10°	8°	BN32-2012	BN32-2022	BN32-1012	BN32-1022
Cuspid	Roth	0°	10°	BN22-2113	BN22-2123	BN22-1113	BN22-1123
	MBT	-7°	8°	BN32-2113	BN32-2123	BN32-1113	BN32-1123
1st Bicuspid	Roth	-7°	0°	BN22-2114	BN22-2124	BN22-1114	BN22-1124
	MBT	-7°	0°	BN32-2114	BN32-2124	BN32-1114	BN32-1124
2nd Bicuspid	Roth	-7°	0°	BN22-2115	BN22-2125	BN22-1115	BN22-1125
	MBT	-7°	0°	BN32-2115	BN32-2125	BN32-1115	BN32-1125

Mandibular		Torque Tip		.022R	.022L	.018R	.018L
Central	Roth	-1°	0°	BN22-2041	BN22-2031	BN22-1041	BN22-1031
	MBT	-6°	0°	BN32-2041	BN32-2031	BN32-1041	BN32-1031
Lateral	Roth	-1°	0°	BN22-2042	BN22-2032	BN22-1042	BN22-1032
	MBT	-6°	0°	BN32-2042	BN32-2032	BN32-1042	BN32-1032
Cuspid	Roth	-11°	7°	BN22-2143	BN22-2133	BN22-1143	BN22-1133
	MBT	-6°	3°	BN32-2143	BN32-2133	BN32-1143	BN32-1133
1st Bicuspid	Roth	-17°	0°	BN22-2144	BN22-2134	BN22-1144	BN22-1134
	MBT	-12°	2°	BN32-2144	BN32-2134	BN32-1144	BN32-1134
2nd Bicuspid	Roth	-22°	0°	BN22-2145	BN22-2135	BN22-1145	BN22-1135
	MBT	-17°	2°	BN32-2145	BN32-2135	BN32-1145	BN32-1135

Products Name	Roth 0.018	Roth 0.022	MBT 0.018	MBT 0.022
CNC Bondable Bracket no Hook	BN22-10	BN22-20	BN32-10	BN32-20
CNC Bondable Bracket 3 with Hook	BN22-13	BN22-23	BN32-13	BN32-23
CNC Bondable Bracket 345 with Hook	BN22-14	BN22-24	BN32-14	BN32-24

# Orthodontic MIM Bondable Bracket



## Advantages

Ligating wings is smooth ball head design which reduces the stimulation of oral, and it can improve the patient's sense of rejection greatly.



Brackets surface are circular bead design, and which is specially polished. Patients those who wear occur rejection very little.

Metal slots are precisely machined, the entrance and exit of wires are processed carefully which can not only reduce the friction between slots and wires, but also can improve torque control of wires.

The center lines of slots are clearly visible which is easy and accurate for teeth position locating.

Maxillary		Torque Tip		.022R	.022L	.018R	.018L
Central	Roth	12°	5°	BI22-2011	BI22-2021	BI22-1011	BI22-1021
	MBT	17°	4°	BI32-2011	BI32-2021	BI32-1011	BI32-1021
Lateral	Roth	8°	9°	BI22-2012	BI22-2022	BI22-1012	BI22-1022
	MBT	10°	8°	BI32-2012	BI32-2022	BI32-1012	BI32-1022
Cuspid	Roth	-2°	10°	BI22-2113	BI22-2123	BI22-1113	BI22-1123
	MBT	-7°	8°	BI32-2113	BI32-2123	BI32-1113	BI32-1123
1st Bicuspid	Roth	-7°	0°	BI22-2114	BI22-2124	BI22-1114	BI22-1124
	MBT	-7°	0°	BI32-2114	BI32-2124	BI32-1114	BI32-1124
2nd Bicuspid	Roth	-7°	0°	BI22-2115	BI22-2125	BI22-1115	BI22-1125
	MBT	-7°	0°	BI32-2115	BI32-2125	BI32-1115	BI32-1125

Mandibular		Torque Tip		.022R	.022L	.018R	.018L
Central	Roth	-1°	0°	BI22-2041	BI22-2031	BI22-1041	BI22-1031
	MBT	-6°	0°	BI32-2041	BI32-2031	BI32-1041	BI32-1031
Lateral	Roth	-1°	0°	BI22-2042	BI22-2032	BI22-1042	BI22-1032
	MBT	-6°	0°	BI32-2042	BI32-2032	BI32-1042	BI32-1032
Cuspid	Roth	-11°	7°	BI22-2143	BI22-2133	BI22-1143	BI22-1133
	MBT	-6°	3°	BI32-2143	BI32-2133	BI32-1143	BI32-1133
1st Bicuspid	Roth	-17°	0°	BI22-2144	BI22-2134	BI22-1144	BI22-1134
	MBT	-12°	2°	BI32-2144	BI32-2134	BI32-1144	BI32-1134
2nd Bicuspid	Roth	-22°	0°	BI22-2145	BI22-2135	BI22-1145	BI22-1135
	MBT	-17°	2°	BI32-2145	BI32-2135	BI32-1145	BI32-1135

Products Name	Roth 0.018	Roth 0.022	MBT 0.018	MBT 0.022
MIM Bondable Bracket no Hook	BI22-10	BI22-20	BI32-10	BI32-20
MIM Bondable Bracket 3 with Hook	BI22-13	BI22-23	BI32-13	BI32-23
MIM Bondable Bracket 345 with Hook	BI22-14	BI22-24	BI32-14	BI32-24

# Orthodontic Clear Self-ligating Bracket



## Advantages

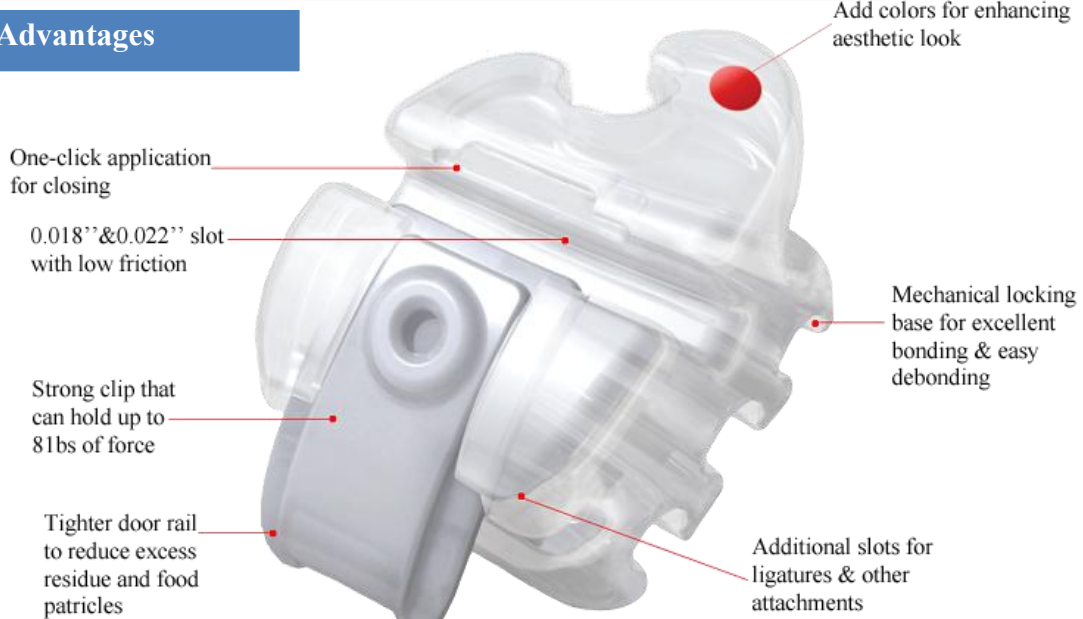

Maxillary		Torque Tip		.022R	.022L	.018R	.018L
Central	Roth	12°	5°	BR22-2011	BR22-2021	BR22-1011	BR22-1021
	MBT	17°	5°	BR32-2011	BR32-2021	BR32-1011	BR32-1021
Lateral	Roth	8°	9°	BR22-2012	BR22-2022	BR22-1012	BR22-1022
	MBT	10°	8°	BR32-2012	BR32-2022	BR32-1012	BR32-1022
Cuspid	Roth	-2°	8°	BR22-2113	BR22-2123	BR22-1113	BR22-1123
	MBT	0°	8°	BR32-2113	BR32-2123	BR32-1113	BR32-1123
1st Bicuspid	Roth	-7°	0°	BR22-2114	BR22-2124	BR22-1114	BR22-1124
	MBT	-7°	0°	BR32-2114	BR32-2124	BR32-1114	BR32-1124
2nd Bicuspid	Roth	-7°	0°	BR22-2115	BR22-2125	BR22-1115	BR22-1125
	MBT	-7°	0°	BR32-2115	BR32-2125	BR32-1115	BR32-1125

Mandibular		Torque Tip		.022R	.022L	.018R	.018L
Central	Roth	0°	0°	BR22-2041	BR22-2031	BR22-1041	BR22-1031
	MBT	-6°	0°	BR32-2041	BR32-2031	BR32-1041	BR32-1031
Lateral	Roth	0°	0°	BR22-2042	BR22-2032	BR22-1042	BR22-1032
	MBT	-6°	0°	BR32-2042	BR32-2032	BR32-1042	BR32-1032
Cuspid	Roth	-11°	5°	BR22-2143	BR22-2133	BR22-1143	BR22-1133
	MBT	0°	3°	BR32-2143	BR32-2133	BR32-1143	BR32-1133
1st Bicuspid	Roth	-17°	0°	BR22-2144	BR22-2134	BR22-1144	BR22-1134
	MBT	-12°	2°	BR32-2144	BR32-2134	BR32-1144	BR32-1134
2nd Bicuspid	Roth	-22°	0°	BR22-2145	BR22-2135	BR22-1145	BR22-1135
	MBT	-17°	2°	BR32-2145	BR32-2135	BR32-1145	BR32-1135

Products Name	Roth 0.018	Roth 0.022	MBT 0.018	MBT 0.022
Clear Self-ligating Bracket 3 with Hook	BR22-13	BR22-23	BR32-13	BR32-23
Clear Self-ligating Bracket 345 with Hook	BR22-14	BR22-24	BR32-14	BR32-24

## Advantages

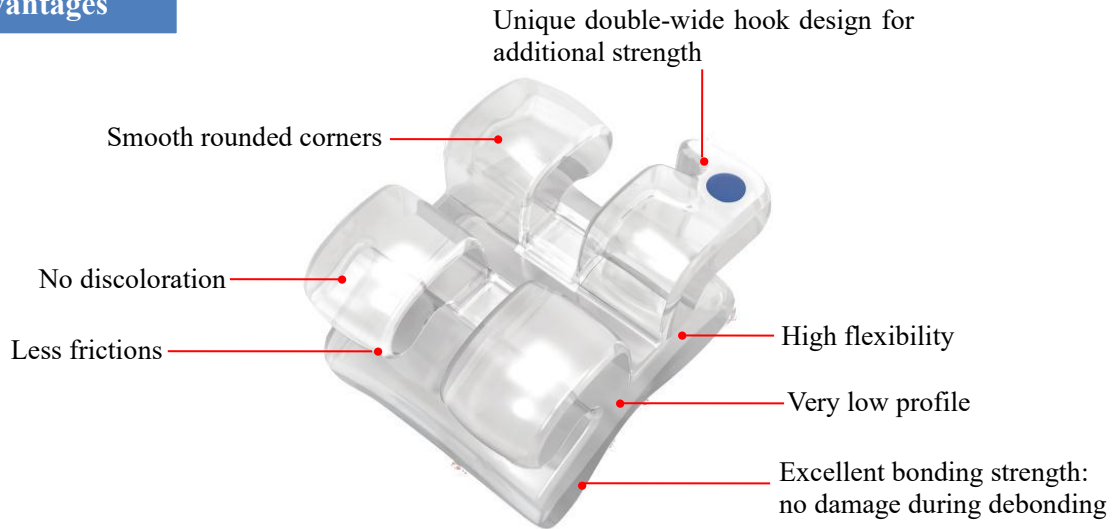

Maxillary	Torque Tip		.022R	.022L	.018R	.018L
Central	Roth	12° 5°	BC22-2011	BC22-2021	BC22-1011	BC22-1021
	MBT	17° 4°	BC32-2011	BC32-2021	BC32-1011	BC32-1021
Lateral	Roth	8° 9°	BC22-2012	BC22-2022	BC22-1012	BC22-1022
	MBT	10° 8°	BC32-2012	BC32-2022	BC32-1012	BC32-1022
Cuspid	Roth	-2° 10°	BC22-2113	BC22-2123	BC22-1113	BC22-1123
	MBT	-7° 8°	BC32-2113	BC32-2123	BC32-1113	BC32-1123
1st Bicuspid	Roth	-7° 0°	BC32-2114	BC22-2124	BC22-1114	BC22-1124
	MBT	-7° 0°	BC32-2114	BC32-2124	BC32-1114	BC32-1124
2nd Bicuspid	Roth	-7° 0°	BC22-2115	BC22-2125	BC22-1115	BC22-1125
	MBT	-7 0°	BC32-2115	BC32-2125	BC32-1115	BC32-1125

Mandibular	Torque Tip		.022R	.022L	.018R	.018L
Central	Roth	-1° 0°	BC22-2041	BC22-2031	BC22-1041	BC22-1031
	MBT	-6° 0°	BC32-2041	BC32-2031	BC32-1041	BC32-1031
Lateral	Roth	-1° 0°	BC22-2042	BC22-2032	BC22-1042	BC22-1032
	MBT	-6° 0°	BC32-2042	BC32-2032	BC32-1042	BC32-1032
Cuspid	Roth	-11° 7°	BC32-2143	BC22-2133	BC22-1143	BC22-1133
	MBT	-6° 3°	BC32-2143	BC32-2133	BC32-1143	BC32-1133
1st Bicuspid	Roth	-17° 0°	BC22-2144	BC22-2134	BC22-1144	BC22-1134
	MBT	-12° 2°	BC32-2144	BC32-2134	BC32-1144	BC32-1134
2nd Bicuspid	Roth	-22° 0°	BC22-2145	BC22-2135	BC22-1145	BC22-1135
	MBT	-17 2°	BC32-2145	BC32-2135	BC32-1145	BC32-1135

Products Name	Roth 0.018	Roth 0.022	MBT 0.018	MBT 0.022
Ceramic Bracket no Hook	BC22-10	BC22-20	BC32-10	BC32-20
Ceramic Bracket 3 with Hook	BC22-13	BC22-23	BC32-13	BC32-23
Ceramic Bracket 345 with Hook	BC22-14	BC22-24	BC32-14	BC32-24

## Orthodontic Ceramic Self-ligating Bracket with Metal Clip



### Advantages

Three-finger mechanism: Secure the wires in the slot while preventing mesial-distal movement.

Smooth rounded hook design: to add patient comfort and secure engagement of elastics.

Advanced ceramic material: Superior aesthetic appearance, strength and fracture resistance.

Triple X base: Superior mechanical bonding with reliable and consistent debonding

Nickel-Titanium tension clip: Exceptional memory properties ensure reliable open & closing for the entire length of treatment.

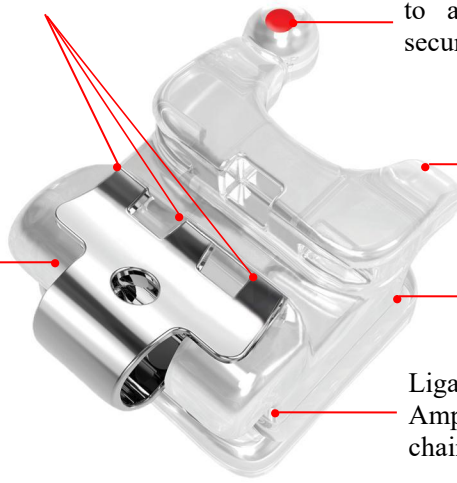

Ligating wing: Ample undercuts for use of elastic chains and other ligation auxiliaries.

Maxillary		Torque Tip		.022R	.022L	.018R	.018L
Central	Roth	12°	5°	BE22-2011	BE22-2021	BE22-1011	BE22-1021
	MBT	17°	4°	BE32-2011	BE32-2021	BE32-1011	BE32-1021
Lateral	Roth	8°	9°	BE22-2012	BE22-2022	BE22-1012	BE22-1022
	MBT	10°	8°	BE32-2012	BE32-2022	BE32-1012	BE32-1022
Cuspid	Roth	-2°	11°	BE22-2113	BE22-2123	BE22-1113	BE22-1123
	MBT	-7°	8°	BE32-2113	BE32-2123	BE32-1113	BE32-1123
1st Bicuspid	Roth	-7°	0°	BE22-2114	BE22-2124	BE22-1114	BE22-1124
	MBT	-7°	0°	BE32-2114	BE32-2124	BE32-1114	BE32-1124
2nd Bicuspid	Roth	-7°	0°	BE22-2115	BE22-2125	BE22-1115	BE22-1125
	MBT	-7°	0°	BE32-2115	BE32-2125	BE32-1115	BE32-1125

Mandibular		Torque Tip		.022R	.022L	.018R	.018L
Central	Roth	0°	0°	BE22-2041	BE22-2031	BE22-1041	BE22-1031
	MBT	-6°	0°	BE32-2041	BE32-2031	BE32-1041	BE32-1031
Lateral	Roth	0°	0°	BE22-2042	BE22-2032	BE22-1042	BE22-1032
	MBT	-6°	0°	BE32-2042	BE32-2032	BE32-1042	BE32-1032
Cuspid	Roth	-11°	5°	BE22-2143	BE22-2133	BE22-1143	BE22-1133
	MBT	-5°	3°	BE32-2143	BE32-2133	BE32-1143	BE32-1133
1st Bicuspid	Roth	-17°	0°	BE22-2144	BE22-2134	BE22-1144	BE22-1134
	MBT	-12°	2°	BE32-2144	BE32-2134	BE32-1144	BE32-1134
2nd Bicuspid	Roth	-22°	0°	BE22-2145	BE22-2135	BE22-1145	BE22-1135
	MBT	-17°	2°	BE32-2145	BE32-2135	BE32-1145	BE32-1135

Products Name	Roth 0.018	Roth 0.022	MBT 0.018	MBT 0.022
Ceramic Self-ligating Bracket with Metal Clip 3 with Hook	BE22-13	BE22-23	BE32-13	BE32-23
Ceramic Self-ligating Bracket with Metal Clip 345 with Hook	BE22-14	BE22-24	BE32-14	BE32-24

Note: LL4,LR4,LL5,LR5 are full metal brackets.

# Orthodontic Full Ceramic Self-ligating Bracket



## Advantages

Esthetic self ligation bracket:

The world best Nano ceramic refining technology through the co-work of R&D with KICET (korea institute of ceramic engineering and technology), which is known to possess the best Nano ceramic material technology in korea, enables the optimal transparency.



Sub-Micron pure alumina ceramic refining technology and Nano particle polishing treatment reduces friction, and discoloration from food such as coffee, tea or curry to maintain stable dental esthetics.

More stable, easier unlocking & locking  
Patented snap spring door mechanism disperses force during opening & closing to prevent door fracture even though in excessive force.

Base contour design which is optimized for teeth surface curvature and fits perfectly on the surface of the teeth.

Maxillary		Torque Tip		.022R	.022L	.018R	.018L
Central	Roth	12°	5°	BA22-2011	BA22-2021	BA22-1011	BA22-1021
	MBT	17°	4°	BA32-2011	BA32-2021		
Lateral	Roth	8°	9°	BA22-2012	BA22-2022	BA22-1012	BA22-1022
	MBT	10°	8°	BA32-2012	BA32-2022		
Cuspid	Roth	0°	11°	BA22-2113	BA22-2123	BA22-1113	BA22-1123
	MBT	0°	8°	BA32-2113	BA32-2123		
1st Bicuspid	Roth	-7°	0°	BA22-2114	BA22-2124	BA22-1114	BA22-1124
	MBT	-7°	0°	BA32-2114	BA32-2124		
2nd Bicuspid	Roth	-7°	0°	BA22-2115	BA22-2125	BA22-1115	BA22-1125
	MBT	-7°	0°	BA32-2115	BA32-2125		

Mandibular		Torque Tip		.022R	.022L	.018R	.018L
Central	Roth	-1°	0°	BA22-2041	BA22-2031	BA22-1041	BA22-1031
	MBT	-6°	0°	BA32-2041	BA32-2031		
Lateral	Roth	-1°	0°	BA22-2042	BA22-2032	BA22-1042	BA22-1032
	MBT	-6°	0°	BA32-2042	BA32-2032		
Cuspid	Roth	-11°	7°	BA22-2143	BA22-2133	BA22-1143	BA22-1133
	MBT	0°	3°	BA32-2143	BA32-2133		
1st Bicuspid	Roth	-17°	0°	BA22-2144	BA22-2134	BA22-1144	BA22-1134
	MBT	-12°	2°	BA32-2144	BA32-2134		
2nd Bicuspid	Roth	-22°	0°	BA22-2145	BA22-2135	BA22-1145	BA22-1135
	MBT	-17°	2°	BA32-2145	BA32-2135		

Products Name	Roth 0.018	Roth 0.022	MBT 0.018	MBT 0.022
Full Ceramic Self-ligating Bracket 3 with Hook	BA22-13	BA22-23	BA32-13	BA32-23
Full Ceramic Self-ligating Bracket 345 with Hook	BA22-14	BA22-24	BA32-14	BA32-24

# Orthodontic Ceramic Self-ligating Bracket



## Advantages

The ceramic bracket whole body is round and smooth, which avoids the damage to soft tissue.



“T”-type ball shape hooks, it is more stable for elastic loops traction.

The hook is in the middle of bracket which is suitable for mesial & distal orthodontic, and is more durable.

Install Ni-Ti spring bolt inside the ceramic self-ligating brackets, so the locking and unlocking operation of brackets is more flexible.

This ceramic self-ligating bracket mesh base is deepen design which can strengthen bonding.

Maxillary		Torque Tip		.022R	.022L	.018R	.018L
Central	Roth	12°	5°	BO22-2011	BO22-2021		
	MBT	17°	4°	BO32-2011	BO32-2021		
Lateral	Roth	8°	9°	BO22-2012	BO22-2022		
	MBT	10°	8°	BO32-2012	BO32-2022		
Cuspid	Roth	-2°	10°	BO22-2113	BO22-2123		
	MBT	-7°	8°	BO32-2113	BO32-2123		
1st Bicuspid	Roth	-7°	0°	BO22-2114	BO22-2124		
	MBT	-7°	0°	BO32-2114	BO32-2124		
2nd Bicuspid	Roth	-7°	0°	BO22-2115	BO22-2125		
	MBT	-7°	0°	BO32-2115	BO32-2125		

Mandibular		Torque Tip		.022R	.022L	.018R	.018L
Central	Roth	-1°	0°	BO22-2041	BO22-2031		
	MBT	-6°	0°	BO32-2041	BO32-2031		
Lateral	Roth	-1°	0°	BO22-2042	BO22-2032		
	MBT	-6°	0°	BO32-2042	BO32-2032		
Cuspid	Roth	-11°	-1°	BO22-2143	BO22-2133		
	MBT	0°	3°	BO32-2143	BO32-2133		
1st Bicuspid	Roth	-17°	0°	BO22-2144	BO22-2134		
	MBT	-12°	2°	BO32-2144	BO32-2134		
2nd Bicuspid	Roth	-22°	0°	BO22-2145	BO22-2135		
	MBT	-17°	2°	BO32-2145	BO32-2135		

<b>Products Name</b>	Roth 0.018	Roth 0.022	MBT 0.018	MBT 0.022
Ceramic Self-ligating Bracket 345 with Hook	BO22-14	BO22-24	BO32-14	BO32-24



# Orthodontic Lingual Bracket

## Advantages

Perfectly concealed: the brackets and wires are mounted invisibly on the backs of the teeth.



Hardly noticeable: no sharp edges



Quick visible results: through optimal transfer of forces of the teeth.

Maxillary	Torque Tip		.022R	.022L	.018R	.018L
Central	68°	0°	BZ22-2011	BZ22-2021	BZ22-1011	BZ22-1021
Lateral	60°	0°	BZ22-2012	BZ22-2022	BZ22-1012	BZ22-1022
Cuspid	57°	0°	BZ22-2113	BZ22-2123	BZ22-1113	BZ22-1123
1st Bicuspid	10°	0°	BZ32-2114	BZ22-2124	BZ22-1114	BZ22-1124
2nd Bicuspid	10°	0°	BZ22-2115	BZ22-2125	BZ22-1115	BZ22-1125

Mandibular	Torque Tip		.022R	.022L	.018R	.018L
Central	45°	0°	BZ22-2041	BZ22-2031	BZ22-1041	BZ22-1031
Lateral	45°	0°	BZ22-2042	BZ22-2032	BZ22-1042	BZ22-1032
Cuspid	50°	0°	BZ22-2143	BZ22-2133	BZ22-1143	BZ22-1133
1st Bicuspid	10°	0°	BZ22-2144	BZ22-2134	BZ22-1144	BZ22-1134
2nd Bicuspid	10°	0°	BZ22-2145	BZ22-2135	BZ22-1145	BZ22-1135

Products Name	Item No.
Lingual Bracket	BZ22-24

# Orthodontic Sapphire Bracket

## Advantages

The base is mechanical lock, it has a good firm bonding, as well as for easy disassembly.

Unique double-wide hook design for additional strength.

Smooth rounded hook design for add patients comfort, and secure engagement of elastics.

The slots are smooth, and the surface of brackets are processed Specially. It has good biocompatibility.



Maxillary		Torque Tip		.022R	.022L	.018R	.018L
Central	Roth	12°	5°	BK22-2011	BK22-2021	BK22-1011	BK22-1021
	MBT	17°	4°	BK32-2011	BK32-2021	BK32-1011	BK32-1021
Lateral	Roth	8°	9°	BK22-2012	BK22-2022	BK22-1012	BK22-1022
	MBT	10°	8°	BK32-2012	BK32-2022	BK32-1012	BK32-1022
Cuspid	Roth	-2°	8°	BK22-2113	BK22-2123	BK22-1113	BK22-1123
	MBT	0°	8°	BK32-2113	BK32-2123	BK32-1113	BK32-1123
1st Bicuspid	Roth	-7°	0°	BK22-2114	BK22-2124	BK22-1114	BK22-1124
	MBT	-7°	0°	BK32-2114	BK32-2124	BK32-1114	BK32-1124
2nd Bicuspid	Roth	-7°	0°	BK22-2115	BK22-2125	BK22-1115	BK22-1125
	MBT	-7°	0°	BK32-2115	BK32-2125	BK32-1115	BK32-1125

Mandibular		Torque Tip		.022R	.022L	.018R	.018L
Central	Roth	0°	0°	BK22-2041	BK22-2031	BK22-1041	BK22-1031
	MBT	-6°	0°	BK32-2041	BK32-2031	BK32-1041	BK32-1031
Lateral	Roth	0°	0°	BK22-2042	BK22-2032	BK22-1042	BK22-1032
	MBT	-6°	0°	BK32-2042	BK32-2032	BK32-1042	BK32-1032
Cuspid	Roth	-11°	7°	BK22-2143	BK22-2133	BK22-1143	BK22-1133
	MBT	0°	3°	BK32-2143	BK32-2133	BK32-1143	BK32-1133
1st Bicuspid	Roth	-17°	3°	BK22-2144	BK22-2134	BK22-1144	BK22-1134
	MBT	-12°	2°	BK32-2144	BK32-2134	BK32-1144	BK32-1134
2nd Bicuspid	Roth	-21°	6°	BK22-2145	BK22-2135	BK22-1145	BK22-1135
	MBT	-17°	2°	BK32-2145	BK32-2135	BK32-1145	BK32-1135

Products Name	Roth 0.018	Roth 0.022	MBT 0.018	MBT 0.022
Sapphire Bracket no Hook	BK22-10	BK22-20	BK32-10	BK32-20
Sapphire Bracket 3 with Hook	BK22-13	BK22-23	BK32-13	BK32-23
Sapphire Bracket 345 with Hook	BK22-14	BK22-24	BK32-14	BK32-24

# Orthodontic Buccal Tube

## Advantages

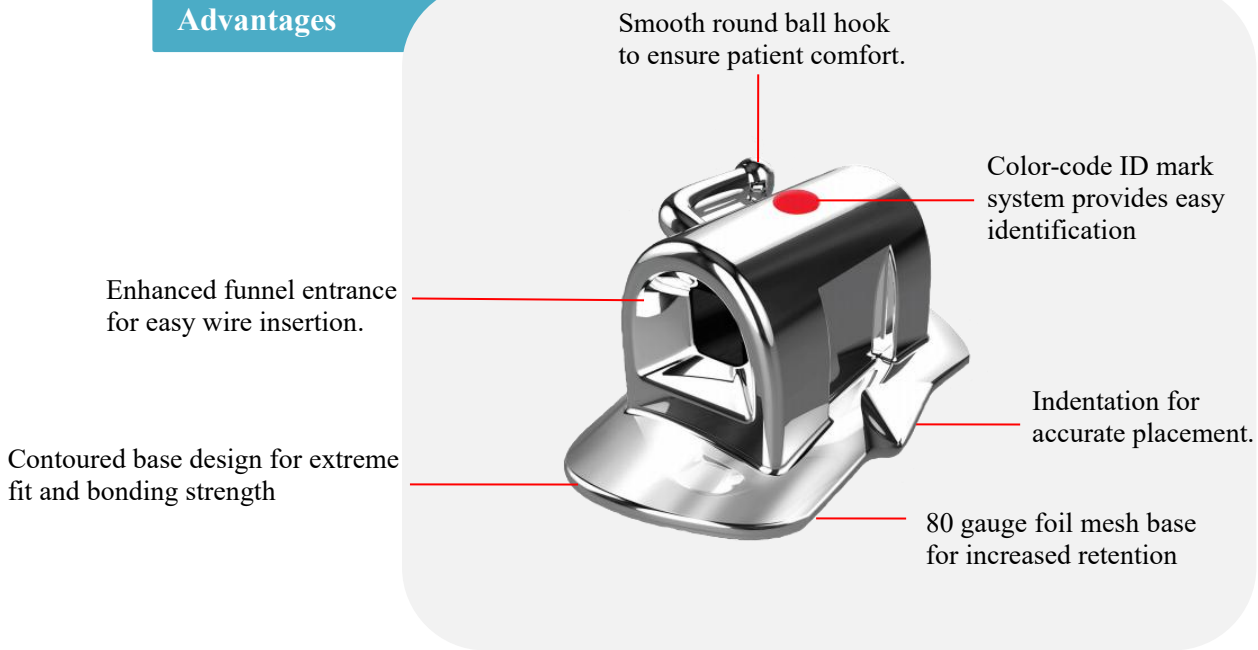

## More features

Mature casting technology is applied to buccal tubes manufacturing, which avoids drawbacks of years domestic manufacturer buccal tubes, and increases the strength and accuracy of buccal tube itself.

The buccal tubes' mesh base and buccal tubes whole part are both applied the most advanced laser welding technology. Cold welding avoids deforming and false welding and etc.

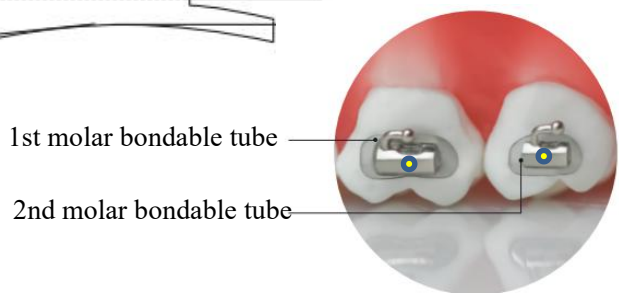
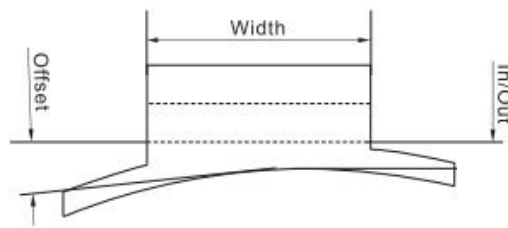
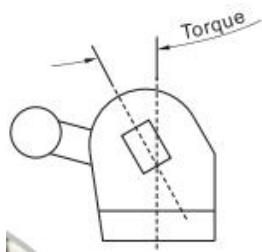

1st molar bondable tubes' different mesh base sizes





Large base: 7.2mm      Standard base: 6.8mm      Mini base: 6mm



2nd molar bondable tubes' different mesh base sizes





Mini base: 5.2mm      Large base: 5.5mm

## Orthodontic Bondable Buccal Tube(Luxe Series)

Non-convertible Bondable Tubes		Roth System				MBT System			
		Torque	Offset	0.018	0.022	Torque	Offset	0.018	0.022
<b>1st Single (mini)</b>  6 mm	UR	14°	10mm	TL12-1116	TL22-1116	14°	10mm	TL13-1116	TL23-1116
	UL	14°	10mm	TL12-1126	TL22-1126	14°	10mm	TL13-1126	TL23-1126
	LL	25°	4mm	TL12-1136	TL22-1136	20°	0mm	TL13-1136	TL23-1136
	LR	25°	4mm	TL12-1146	TL22-1146	20°	0mm	TL13-1146	TL23-1146
<b>1st Single (standard)</b>  6.8 mm	UR	14°	10mm	TL12-1216	TL22-1216	14°	10mm	TL13-1216	TL23-1216
	UL	14°	10mm	TL12-1226	TL22-1226	14°	10mm	TL13-1226	TL23-1226
	LL	25°	4mm	TL12-1236	TL22-1236	20°	0mm	TL13-1236	TL23-1236
	LR	25°	4mm	TL12-1246	TL22-1246	20°	0mm	TL13-1146	TL23-1246
<b>1st Single (Large)</b>  7.2 mm	UR	14°	10mm	TL12-1316	TL22-1316	14°	10mm	TL13-1316	TL23-1316
	UL	14°	10mm	TL12-1326	TL22-1326	14°	10mm	TL13-1326	TL23-1326
	LL	25°	4mm	TL12-1336	TL22-1336	20°	0mm	TL13-1336	TL23-1336
	LR	25°	4mm	TL12-1346	TL22-1346	20°	0mm	TL13-1346	TL23-1346

Convertible Bondable Tubes		Roth System				MBT System			
		Torque	Offset	0.018	0.022	Torque	Offset	0.018	0.022
<b>1st Single (mini)</b>  6 mm	UR	14°	10mm	TL12-1116	TL22-1116	14°	10mm	TL13-1116	TL23-1116
	UL	14°	10mm	TL12-1126	TL22-1126	14°	10mm	TL13-1126	TL23-1126
	LL	25°	4mm	TL12-1136	TL22-1136	20°	0mm	TL13-1136	TL23-1136
	LR	25°	4mm	TL12-1146	TL22-1146	20°	0mm	TL13-1146	TL23-1146
<b>1st Single (standard)</b>  6.8 mm	UR	14°	10mm	TL12-1216	TL22-1216	14°	10mm	TL13-1216	TL23-1216
	UL	14°	10mm	TL12-1226	TL22-1226	14°	10mm	TL13-1226	TL23-1226
	LL	25°	4mm	TL12-1236	TL22-1236	20°	0mm	TL13-1236	TL23-1236
	LR	25°	4mm	TL12-1246	TL22-1246	20°	0mm	TL13-1146	TL23-1246
<b>1st Single (Large)</b>  7.2 mm	UR	14°	10mm	TL12-1316	TL22-1316	14°	10mm	TL13-1316	TL23-1316
	UL	14°	10mm	TL12-1326	TL22-1326	14°	10mm	TL13-1326	TL23-1326
	LL	25°	4mm	TL12-1336	TL22-1336	20°	0mm	TL13-1336	TL23-1336
	LR	25°	4mm	TL12-1346	TL22-1346	20°	0mm	TL13-1346	TL23-1346

Non-convertible Bondable Tubes		Roth System				MBT System			
		Torque	Offset	0.018	0.022	Torque	Offset	0.018	0.022
<b>2nd Single (standard)</b>  5.2 mm	UR	-14°	10mm	TL12-1117	TL22-1117T	-14°	10mm	TL13-1117T	TL23-1117
	UL	-14°	10mm	TL12-1127	L22-1127TL	-14°	10mm	L13-1127TL	TL23-1127
	LL	-25°	4mm	TL12-1137	22-1137TL2	-10°	0mm	13-1137TL1	TL23-1137
	LR	-25°	4mm	TL12-1147	2-1147	-10°	0mm	3-1147	TL23-1147

Noble Series		Roth System				MBT System			
		Torque	Offset	0.018	0.022	Torque	Offset	0.018	0.022
1st Single 	UR	-14°	10mm	TN12-1116	TN22-1116	-14°	10mm	TN13-1116	TN23-1116
	UL	-14°	10mm	TN12-1126	TN22-1126	-14°	10mm	TN13-1126	TN23-1126
	LL	-25°	0mm	TN12-1136	TN22-1136	-20°	0mm	TN13-1136	TN23-1136
	LR	-25°	0mm	TN12-1146	TN22-1146	-20°	0mm	TN13-1146	TN23-1146
2nd Single 	UR	-14°	10mm	TN12-1117	TN22-1117	-14°	10mm	TN13-1117	TN23-1117
	UL	-14°	10mm	TN12-1127	TN22-1127	-14°	10mm	TN13-1127	TN23-1127
	LL	-25°	0mm	TN12-1137	TN22-1137	-20°	0mm	TN13-1137	TN23-1137
	LR	-25°	0mm	TN12-1147	TN22-1147	-20°	0mm	TN13-1147	TN23-1147

Double Rect. Tubes		Roth System				MBT System			
		Torque	Offset	0.018	0.022	Torque	Offset	0.018	0.022
Non-conv.	UR	-14°	10mm	TD12-1116	TD22-1116	-14°	10mm	TD13-1116	TD23-1116
	UL	-14°	10mm	TD12-1126	TD22-1126	-14°	10mm	TD13-1126	TD23-1126
	LL	-25°	4mm	TD12-1136	TD22-1136	-20°	0mm	TD13-1136	TD23-1136
	LR	-25°	4mm	TD12-1146	TD22-1146	-20°	0mm	TD13-1146	TD23-1146
Conv.	UR	-14°	10mm	TD12-1117	TD22-1117	-14°	10mm	TD13-1117	TD23-1117
	UL	-14°	10mm	TD12-1127	TD22-1127	-14°	10mm	TD13-1127	TD23-1127
	LL	-25°	4mm	TD12-1137	TD22-1137	-20°	0mm	TD13-1137	TD23-1137
	LR	-25°	4mm	TD12-1147	TD22-1147	-20°	0mm	TD13-1147	TD23-1147

One Round & One Rect.		Roth System				MBT System			
		Torque	Offset	0.018	0.022	Torque	Offset	0.018	0.022
Non-conv.	UR	-14°	10mm	TC12-1116	TC22-1116	-14°	10mm	TC13-1116	TC23-1116
	UL	-14°	10mm	TC12-1126	TC22-1126	-14°	10mm	TC13-1126	TC23-1126
Conv.	UR	-14°	10mm	TC12-2116	TC22-2116	-14°	10mm	TC13-2116	TC23-2116
	UL	-14°	10mm	TC12-2126	TC22-2126	-14°	10mm	TC13-2126	TC23-2126

Triple Tubes		Roth System				MBT System			
		Torque	Offset	0.018	0.022	Torque	Offset	0.018	0.022
Non-conv.	UR	-14°	10mm	TT12-1116	TT22-1116	-14°	10mm	TT13-1116	TT23-1116
	UL	-14°	10mm	TT12-1126	TT22-1126	-14°	10mm	TT13-1126	TT23-1126
Conv.	UR	-14°	10mm	TT12-2116	TT22-2116	-14°	10mm	TT13-2116	TT23-2116
	UL	-14°	10mm	TT12-2126	TT22-2126	-14°	10mm	TT13-2126	TT23-2126

## Advantages

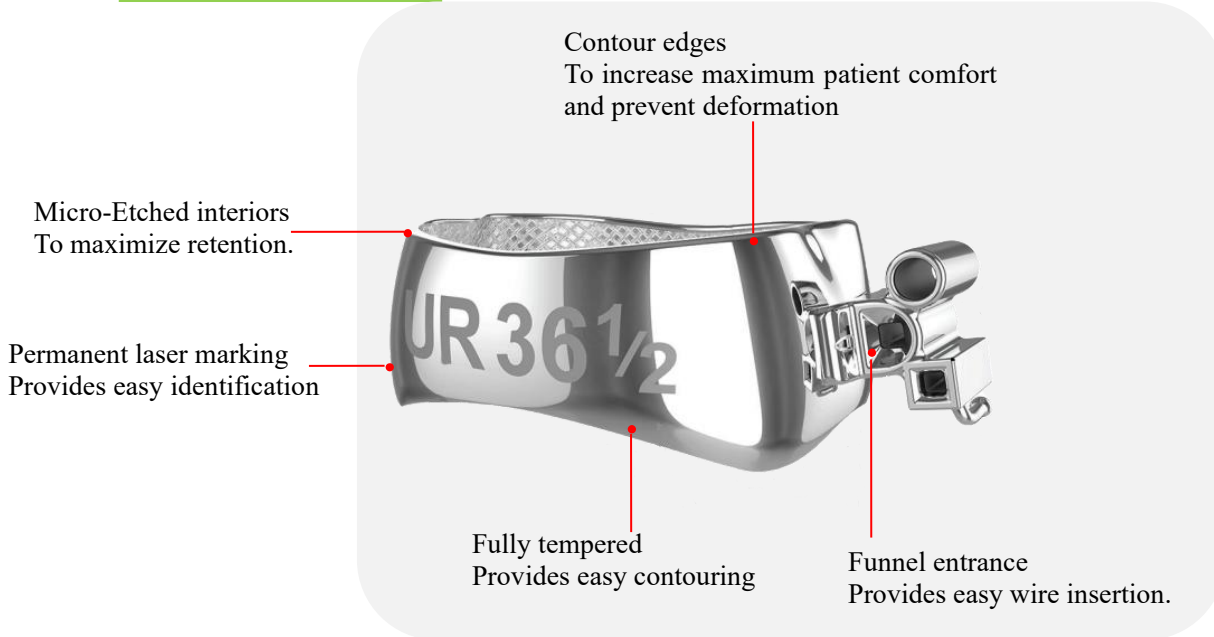

Domestic Molar Bands: Size #10-36 (1st/2nd molar )

- The bands are all round is curved contour which can realize good fitness on the surface of teeth.
- Memory & elasticity maintained after pre-fit and removal.
- Increased occlusal edge strength to prevent deformation
- Available with micro-etched interiors for maximum retention
- Superior tooth morphology.



Pro-Fit Molar Bands: Size #29.0-44.5

- The bands are all round is curved contour which can realize good fitness on the surface of teeth.
- Memory & elasticity maintained after removal.
- Increased occlusal edge strength to prevent deformation
- Available with micro-etched interiors for maximum retention
- Firm material to withstand additional pressure of extra and intraoral appliances



Pre-Fit Molar Bands: Size #1-36

- Enhanced contoured edges
- Permanent laser marking
- Available with micro-etched interiors for maximum retention



Bicuspid Molar Bands: Size #(Upper #1-28, Lower #3-28)

- Full sizes are available.
- Permanent Size Marking
- Fully Tempered, special processing, more perfect.

## Step 1: Select molar bands

Domestic Molar Bands: Size: #10-36	Pro-Fit Molar Bands: Size: #29.5-44	Pre-Fit Molar Bands: Size: #1-32	Bicuspid Molar Bands: Size: upper#1-28 lower#3-28
---------------------------------------	--	-------------------------------------	---

## Step 2: Select buccal tubes (note: bicuspid molars bands preweld with brackets)

	Single	Double	Triple	OCBT	CBT
Non-convertible					
Convertible					

## Step 3: Add Attachments

	Lingual button curved	Bicuspid lingual cleat	Molar lingual cleat	Seating lug
Lingual attachments				
Lingual sheath	Lingual sheath without hook 	Lingual sheath with hook 	MIM Lingual sheath without hook 	MIM Lingual sheath with hook 



## Kit Package



# Orthodontic Molar Bands

## Advantages

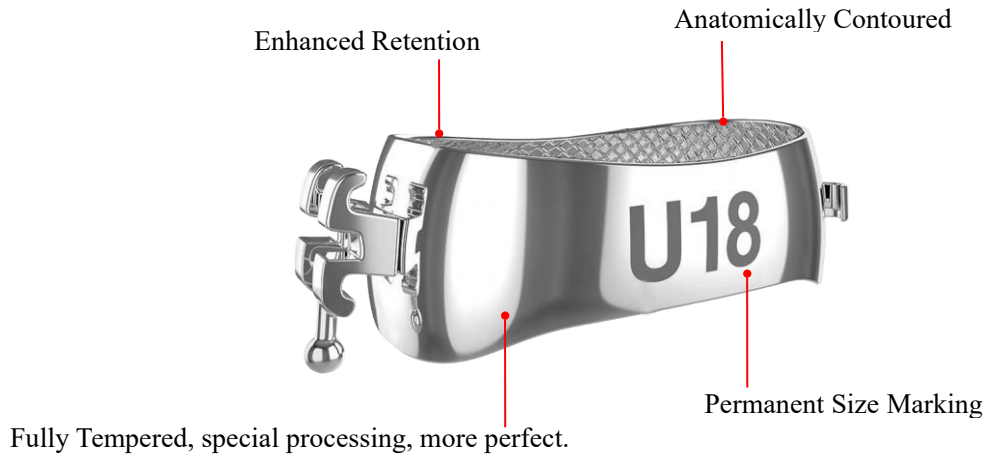



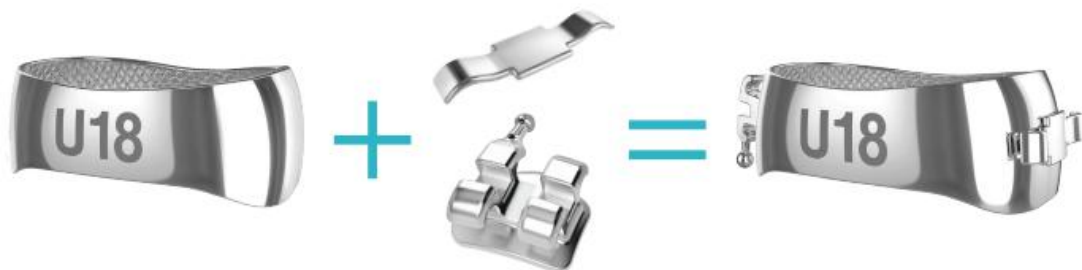







Bicuspid molar bands	Order bulk molar bands	<ol style="list-style-type: none"> <li>1. Choose teeth position(the 1st/2nd molar)</li> <li>2. Choose upper/lower/left/right</li> <li>3. Choose sizes</li> <li>4. Order quantity</li> </ol>
	Order kit package full sizes (upper#1-28 lower#3-28)	<ol style="list-style-type: none"> <li>1. 112pcs/box(the 4th or 5th teeth position)</li> <li>2. 168pcs/box(the 4th &amp; 5th teeth position)</li> </ol>
	Preweld with bracket	<ol style="list-style-type: none"> <li>1. Choose: ROTH/MBT bracket</li> <li>2. Choose 0.018'' /0.022''</li> </ol>

















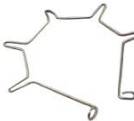







## Orthodontic Accessory(Intraoral)

Item Name	Item Code	Package	
Bondable Round Flat Base Lingual Button	A101	10pcs/pack	
Bondable, Round Elliptical Base Lingual Button	A102	10pcs/pack	
Bondable, Square Flat Base Lingual Button	A103	10pcs/pack	
Bondable, Square Elliptical Base Lingual Button	A104	10pcs/pack	
Bondable, Round Perforated Lingual Button	A105	10pcs/pack	
Monoblock Lingual Button	A106	10pcs/pack	
Weldable Lingual Button	A107	10pcs/pack	
Double Wings Lingual Button	A108	10pcs/pack	
Lingual Rings (Round Base)	A109	10pcs/pack	
Lingual Rings (Square Base)	A110	10pcs/pack	











## Orthodontic Accessory(Intraoral)

Item Name Stop	Item Code A111	Package 10pcs/pack	
Item Name T Type Crimpable Hook Short,Medium,Long	Item Code A112	Package 10pcs/pack	
Item Name Crimpable Ball Hook Short,Medium,Long	Item Code A113	Package 10pcs/pack	
Item Name Long Curve Crimpable Hook, Left&Right	Item Code A114	Package 10pcs/pack	
Item Name Extra Long Curve Crimpable Hook, Left&Right	Item Code A115	Package 10pcs/pack	
Item Name Spiral Crimpable Hook, Left&Right	Item Code A116	Package 10pcs/pack	
Item Name Torque Spring no Curve, Large,Medium,Small	Item Code A117	Package 5pcs/pack	
Item Name Mini Stop	Item Code A118	Package 10pcs/pack	
Item Name Parallel stop	Item Code A119	Package 10pcs/pack	
Item Name Cross Shape Stop	Item Code A120	Package 10pcs/pack	







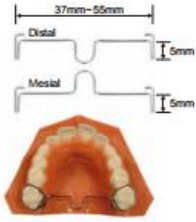

## Orthodontic Accessory(Intraoral)

Item Name	Item Code	Package	
Active Crimpable Hook	A121	10pcs/pack	
Sliding Crimpable Hook Left&Right Hook	A122	10pcs/pack	
Sliding Crimpable Hook Straight Hook	A123	10pcs/pack	
Bondable Lingual Sheath with Hook	A124	10pcs/pack	
Bondable Lingual Sheath without Hook	A125	10pcs/pack	
Weldable Lingual Sheath with Hook	A126	10pcs/pack	
Weldable Lingual Sheath without Hook	A127	10pcs/pack	
Lingual Button with Eyelet	A128	10pcs/pack	
Tongue Tamer	A129	10pcs/pack	
Bite Guide	A130	10pcs/pack	













## Orthodontic Accessory(Intraoral)

Item Name Lingual Button Chain	Item Code A131	Package 10pcs/pack	
Item Name Golden Lingual Button Chain	Item Code A132	Package 10pcs/pack	
Item Name Lingual Button Square Base with Eyelet	Item Code A133	Package 10pcs/pack	
Item Name Lingual Button with Cleat	Item Code A134	Package 10pcs/pack	
Item Name Lingual Button Double Sides with Cleats	Item Code A135	Package 10pcs/pack	
Item Name Ceramic Lingual Button	Item Code A136	Package 10pcs/pack	
Item Name Lingual Retainer (1.2mm/2.0mm)	Item Code A137	Package 2pcs/pack	
Item Name Wavy Lingual Retainer Size:Upper38/40/42/45/47 Lower29/31/33/35/37	Item Code A138	Package 2pcs/pack	
Item Name Door Type Torque Spring Size:1622/1725/1825/1925 Large, Small	Item Code A139	Package 10pcs/pack	
Item Name Door Type Torque Spring Normal Type	Item Code A140	Package 10pcs/pack	

## Orthodontic Accessory(Intraoral)

Item Name Palatal Bar Mesial/Distal  Size:37/39/41/43/45/47/ 49/51/53/55mm	Item Code A141	Package 10pcs/pack	
Item Name Expansion Screw Hyrax I Size: 13mm/15mm	Item Code A142	Package 1pcs/pack	
Item Name Expansion Screw Hyrax II Size: 8/9/11/13/15mm	Item Code A143	Package 1pcs/pack	
Item Name Expansion Screw Retraction I	Item Code A144	Package 1pcs/pack	
Item Name Expansion Screw Retraction II	Item Code A145	Package 1pcs/pack	
Item Name Gap Retainer	Item Code A146	Package 4pcs/pack	
Item Name SS Crown	Item Code A147	Package 10pcs/pack	
Item Name Implant  Size:(1606/1607/1608/1609/1610/1611/1612) (2006/2007/2008/2009/2010/2011/2012)	Item Code A148	Package 1pcs/pack	
Item Name Matching Handle	Item Code A149	Package 1pcs/pack	

## Orthodontic Accessory(Intraoral)

Item Name	Item Code	Package	
Occlusal Cheek Retractor Color: blue&clear Size: large/medium/small	I101	1pcs/pack	
Lateral Cheek Retractor Clear,Standard	I102	1pcs/pack	
3C Cheek Retractor Color: blue&clear Size: large/medium/small	I103	1pcs/pack	
Intraoral Cheek Retractor Color: blue&clear Size: large/medium/small	I104	1pcs/pack	
Lip Ring Retractor Color: blue&white&orange	I105	1pcs/pack	
Double-sided Retractor Color: clear Size: large/small	I106	1pcs/pack	
Multifunctional Cheek Retractor Color: clear Size: large/medium/small	I107	1pcs/pack	
3D Cheek Retractor Color: white small/blue large	I108	1pcs/pack	
Anterior Lip Cheek Retractor Color: clear Size: large/small	I109	1pcs/pack	
Double-sided Anterior Lip Cheek Retractor Color: clear Size: standard	I110	1pcs/pack	
Double 3C Cheek Retractor Color: clear Size: standard	I111	1pcs/pack	
Cheek Retractors with Suction Function Color:white/green	I112	1pcs/pack	

# Orthodontic Accessory(Intraoral)



Item Name: Boon Gauge (Metal Core/Pencil Core)  
 Item Code: I201  
 Package: 1pcs/pack



## Arch Turret

Torque	Slots	Item Code	Package
0°	.016/.017/.018/.019/ .020/.021/.022	I301	1pcs/pack
5,7	.017/.018/.019	I302	1pcs/pack
10,16	.017/.018/.019	I303	1pcs/pack



## Oral Photographic Glass Mirrors

G-01 Buccal	I401-Double sided rhodium coated, autoclavable up to 121°C
G-02 Lingual	I402-Reflectivity close to 100%
G-03 Child Occlusal	I403-True color representation
G-04 Adult Occlusal	I404-High durability for repetitive work
G-05 XL Occlusal	I405

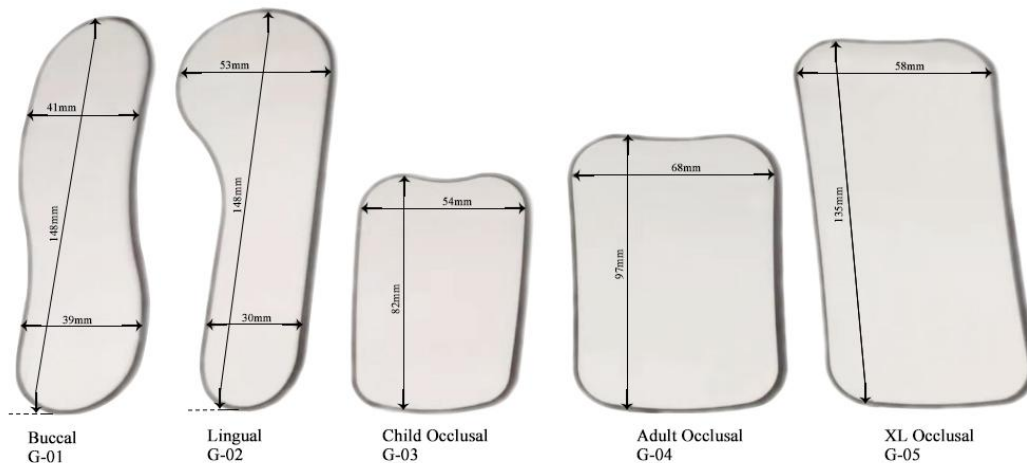

# Orthodontic Accessory(Extraoral)

High Pull Headgear with Safety Module



A801L Large  
A801M Medium  
A801S Small

High Pull Headgear with J Hook



A802L Large  
A802M Medium  
A802S Small

Combination Pull Headgear



A803L Large  
A803M Medium  
A803S Small

Safety Neck Pad



A804

J Hook



A807 2pcs/pack

Neck Pad



A805

Chin Cup



A808

Mandibular Pull Headgear



A806L Large A806M Medium A806S Small

Safety Module



A809

Face Bow Symmetry

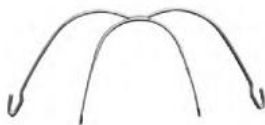

A810L Large  
A810S Small

Face Bow Asymmetry



A811L Large  
A811S Small

Face Bow with Curve



A812L Large  
A812S Small

Reverse Pull Headgear



A813B Blue  
A813R Red

Face Mask Adjustable



A814

Face Mask All Adjustable



A815



# Orthodontic Archwires

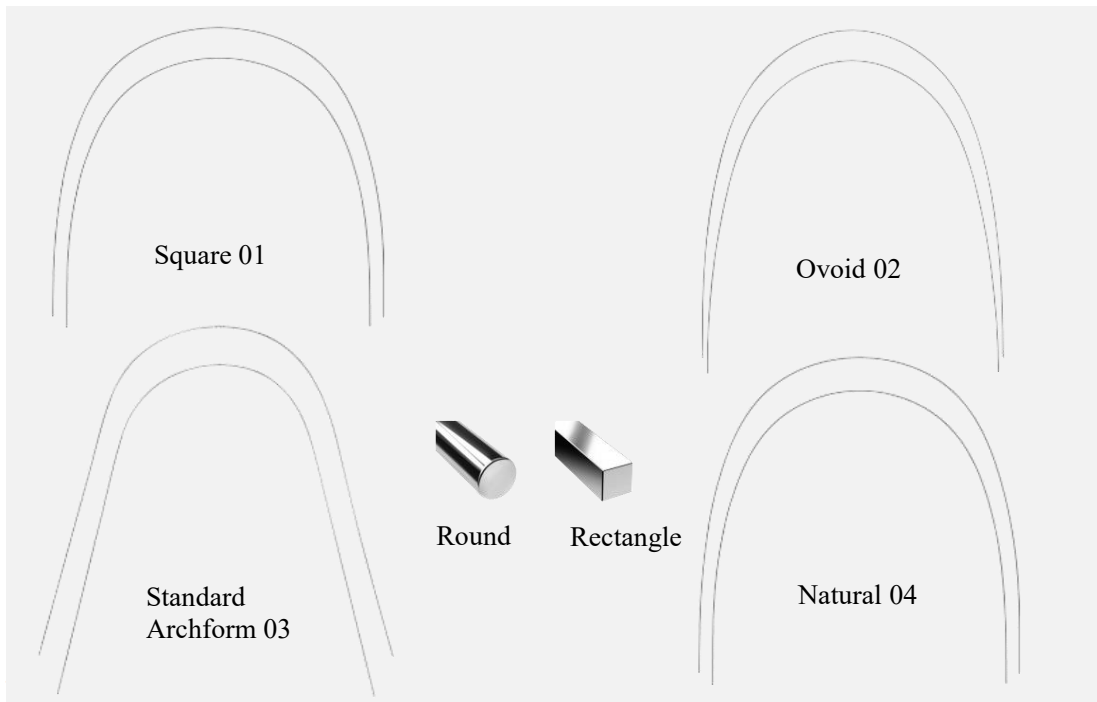

## Super Elastic Ni-Ti Archwires (SE)

- Predictable, light continuous force levels.
- Bright finish for optimal sliding mechanics.
- Resistant to deformation for high spring back.
- Consistent accurate arch shapes.
- Satisfaction guaranteed.

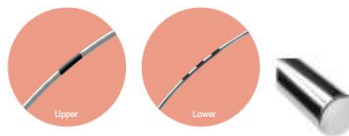

Upper 1 point mark  
Lower 3 point marks

Round	Upper	Lower
.012	SE011201	SE011202
.014	SE011401	SE011402
.016	SE011601	SE011602
.018	SE011801	SE011802
.020	SE012001	SE012002

## Stainless Steel Archwires (SS)

- Stainless steel archwires are manufactured with the highest quality medical grade type 304v stainless steel. These wires have an extremely high tensile strength and accept intricate bends without breaking.
- High luster polish for reduced friction



Rectangle	Upper	Lower
.016*0.16	SE01161601	SE01161602
.016*0.22	SE01162201	SE01162202
.016*0.25	SE01162501	SE01162502
.017*0.22	SE01172201	SE01172202
.017*0.25	SE01172501	SE01172502
.018*0.18	SE01181801	SE01181802
.018*0.22	SE01182201	SE01182202
.018*0.25	SE01182501	SE01182502
.019*0.25	SE01192501	SE01192502
.021*0.25	SE01212501	SE01212502

## Thermal Active Niti Archwire (SM)

- Thermal active Niti archwires is provided in the martensitic or soft and pliable state and becomes super elastic once it reaches the transformation temperature of 90°F/32°C and becomes activated or austenitic. It provides gentle, lower force levels and a smooth, bright finish.
- The extreme pliability of our thermal active Niti archwires offers easy ligation and therefore larger sizes wires can be introduced at earlier phases in treatment without compromising patient comfort.



## Orthodontic Archwires

1. Normal Reverse Curve Archwires (RC01)
2. Straight Reverse Curve Archwires (RC02)

Release occlusion, which can not only avoid molars rotation, but also hold on the torque.



Round	Upper	Lower
.012	RC011201	RC011202
.014	RC011401	RC011402
.016	RC011601	RC011602
.018	RC011801	RC011802
.020	RC012001	RC012002

Rectangle	Upper	Lower
.016*0.16	RC01161601	RC01161602
.016*0.22	RC01162201	RC01162202
.017*0.22	RC01172201	RC01172202
.017*0.25	RC01172501	RC01172502
.018*0.22	RC01182201	RC01182202
.018*0.25	RC01182501	RC01182502
.019*0.25	RC01192501	RC01192502
.021*0.25	RC01212501	RC01212502

1. Three Strands of Twisted Wires (01)
2. Six Strands of Twisted Wires (02)

10pcs/barrel



Size:	3 Strands	6 Strands
0.0155 (0.40)	01155	02175
0.0175 (0.45)	01175	02175
0.0195 (0.50)	01195	02195
0.0215 (0.55)	01215	02215

1. Cu-Ti Archwires (01)
2. Lingual Archwires(LW)
3. TMA Archwires(TM)
4. Coated Archwires(TC)

Pack: 1pcs/pack (The sizes of lingual archwires, TMA archwires and coated wires are all same.)



Cu-Ti archwires round:

.013	TT1301
.014	TT1401
.016	TT1601
.018	TT1801

Cu-Ti archwires Rectangle:

.014*.025	TT142501
.016*.025	TT162501
.018*.025	TT182501
.019*.025	TT192501

Round	Upper	Lower
.012	LW1201	LW1202
.014	LW1401	LW1402
.016	LW1601	LW1602
.018	LW1801	LW1802
.020	LW2001	LW2002

Rectangle	Upper	Lower
.016*0.16	LW161601	LW161602
.016*0.22	LW162201	LW162202
.016*0.25	LW162501	LW162502
.017*0.22	LW172201	LW172202
.017*0.25	LW172501	LW172502
.018*0.18	LW181801	LW181802
.018*0.22	LW182201	LW182202
.018*0.25	LW182501	LW182502
.019*0.25	LW192501	LW192502
.021*0.25	LW212501	LW212502

## Orthodontic Archwires

Item Name	Item Code	Package	
NiTi Close Springs (Two Small Eyelets/One Big Eyelet&One Small Eyelet/No eyelet) Size: Inch: 0.08/0.10/0.12/0.14 Length(mm): 3/6/9/12/15	OC01	10pcs/pack	

Item Name	Item Code	Package	
NiTi Open Springs 180mm/910mm Size: Inch: 0.08/0.10/0.12/0.14	OC02	2pcs/bowl package	

Item Name	Item Code	Package	
5 Meter NiTi Spool Wires Size: Inch: 0.012/0.014/0.016/ 0.018/0.020	OC03	10pcs/pack	

Item Name	Item Code	Package	
Ligature Wires Size: Inch: 0.20/0.25/0.30	OC04	10pcs/pack	

Item Name	Item Code	Package	
Close Coiled Spring (180mm) Size: Inch: 0.08/0.10/0.12/0.14	OC05	2pcs/pack	

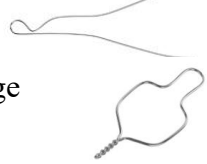
Item Name	Item Code	Package	
Kobayashi (Long/Short) Size: Inch: 0.10/0.12	OC06	50pcs/bowl package	

Item Name	Item Code	Package	
Prewelded Type Wires (Long/Short) Size: Inch: 0.10/0.12	OC07	50pcs/bowl package	

## Orthodontic Elastics Products

Ligature Ties Color Code No.	Normal	Flower Shape	Mickey Mouse	Kitty Cat	
1.Clear		EL01-01	--	--	EL04-01
2.Silver Gray		EL01-02	EL02-02	EL03-02	EL04-02
3.White		EL01-03	EL02-03	EL03-03	EL04-03
4.Magenta		EL01-04	EL02-04	EL03-04	--
5.Deep Red		EL01-05	EL02-05	EL03-05	EL04-05
6.Red		EL01-06	EL02-06	EL03-06	EL04-06
7.Autumn Orange		EL01-07	EL02-07	EL03-07	EL04-07
8.Orange		EL01-08	EL02-08	EL03-08	EL04-08
9.Pink		EL01-09	EL02-09	EL03-09	EL04-09
10.Baby Pink		EL01-10	EL02-10	EL03-10	EL04-10
11.Deep Pink		EL01-11	--	EL03-11	--
12.Neon Purple		EL01-12	EL02-12	EL03-12	EL04-12
13.Purple		EL01-13	EL02-13	EL03-13	EL04-13
14.Golden		EL01-14	EL02-14	EL03-14	EL04-14
15.Neon Green		EL01-15	EL02-15	EL03-15	EL04-15
16.Green		EL01-16	EL02-16	--	EL04-16
17.Grape		EL01-17	--	EL03-17	--
18.Baby Blue		EL01-18	EL02-18	--	EL04-18
19.Crystal Blue		EL01-19	--	EL03-19	--
20.Black		EL01-20	EL02-20	EL03-20	EL04-20
21.Deep Metallic Blue		EL01-21	EL02-21	EL03-21	EL04-21
22.Blue		EL01-22	--	--	--
23.Gem Blue		EL01-23	--	--	--
24.Deep Metallic Purple		EL01-24	--	EL03-24	EL04-24
25.Crystal Purple		EL01-25	--	--	--
26.Yellow		EL01-26	EL02-26	--	EL04-26
27.Lake Blue		EL01-27	--	--	EL04-27
28.Ivory		EL01-28	--	--	--
29.Sky Blue		EL01-29	EL02-29	EL03-29	EL04-29
30.Desert Blue		EL01-30	EL02-30	EL03-30	--
31..Cyan		EL01-31	EL02-31	EL03-31	EL04-31
32.Crystal Yellow		EL01-32	--	--	--
33.Light Purple		EL01-33	--	--	--
34.Mexico Green		EL01-34	--	--	--
35.Light Green		EL01-35	--	--	--
36.Wine Red		EL01-36	--	--	--
37.Light Blue		EL01-37	--	--	--
38.Dark Green		EL01-38	--	--	--
39.Crystal		EL01-39	--	--	--
40.Colorful		EL01-40	EL02-40	EL03-40	EL04-40

- Superior color stability, fade resistant.
- High elasticity and excellent rebound.
- Medical grade polyurethane.
- Latex free safe for sensitive patients.



40sticks\*26pcs 1040pcs/pack



Flower Shape



Mickey Mouse



Kitty Cat

40sticks\*25pcs 1000pcs/pack

# Orthodontic Elastics Products

Power Chain Color No.	Close	Short	Long	Color No.	Close	Short	Long
1.Clear	EL05-01	EL06-01	EL07-01	21.Deep Metallic Blue	EL05-21	EL05-21	EL05-21
2.Silver Gray	EL05-02	EL06-02	EL07-02	22.Blue	EL05-22	EL05-22	EL05-22
3.White	EL05-03	EL06-03	EL07-03	23.Gem Blue	EL05-23	EL05-23	EL05-23
4.Magenta	EL05-04	EL06-04	EL07-04	24..Deep Metallic Purple	--	--	--
5.Deep Red	EL05-05	EL06-05	EL07-05	25.Crystal Purple	--	--	--
6.Red	EL05-06	EL06-06	EL07-06	26.Yellow	EL05-26	EL05-26	EL05-26
7.Autumn Orange	EL05-07	EL06-07	EL07-07	27.Lake Blue	EL05-27	EL05-27	EL05-27
8.Orange	EL05-08	EL06-08	EL07-08	28.Ivory	--	--	--
9.Pink	EL05-09	EL06-09	EL07-09	29.Sky Blue	EL05-29	EL05-29	EL05-29
10.Baby Pink	EL05-10	EL06-10	EL07-10	30.Desert Blue	EL05-30	EL05-30	EL05-30
11.Deep Pink	EL05-11	EL06-11	EL07-11	31..Cyan	EL05-31	EL05-31	EL05-31
12.Neon Purple	EL05-12	EL06-12	EL07-12	32.Crystal Yellow	--	--	--
13.Purple	EL05-13	EL06-13	EL07-13	33..Light Purple	--	--	--
14.Golden	EL05-14	EL06-14	EL07-14	34.Mexico Green	--	--	--
15.Neon Green	EL05-15	EL06-15	EL07-15	35.Light Green	--	--	--
16.Green	EL05-16	EL06-16	EL07-16	36..Wine Red	--	--	--
17.Grape	EL05-17	EL06-17	EL07-17	37.Light Blue	--	--	--
18.Baby Blue	--	--	--	38.Dark Green	--	--	--
19.Crystal Blue	--	--	--	39.Crystal	--	--	--
20.Black	EL05-20	EL02-20	EL07-20				

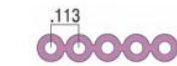

Close 15ft/roll



Short 15ft/roll

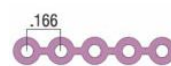

Long 15ft/roll



## O-ring



Size	1/8	3/16	1/4	5/16	3/8	Quantity
	3.2mm	4.8mm	6.4mm	8.0mm	9.5mm	
2.5	EO-132	EO-148	EO-164	EO-180	EO-195	5000pcs/box
3.5	EO-232	EO-248	EO-264	EO-280	EO-295	5000pcs/box
4.5	EO-332	EO-348	EO-364	EO-380	EO-395	4000pcs/box
6.5	EO-432	EO-448	EO-464	EO-480	EO-495	2500pcs/box



S separator  
750pcs/bag  
EB01



Rotation Wedges:  
(Clear/Gray)  
20sticks/pack  
EB02



Elastic attacher  
50pcs/bag  
EB03

# Orthodontic Adhesive

## Self-cure Adhesive

A912  
Standard Package

Primer(10ml)	1pcs
Paste(3.5g)	3pcs
Etchant Acid(2.5ml)	1pcs
Accessories (brush,plastic stick)	



A913  
Mini Package

Primer(3ml)	1pcs
Paste(3.5g)	1pcs
Etchant Acid(2.5ml)	1pcs
Accessories (brush,plastic stick)	



## Light-cure Adhesive

A914  
Standard Package

Primer(10ml)	1pcs
Paste(3.5g)	3pcs
Etchant Acid(2.5ml)	1pcs
Accessories (brush,plastic stick)	



A915  
Mini Package

Primer(3ml)	1pcs
Paste(3.5g)	1pcs
Etchant Acid(2.5ml)	1pcs
Accessories (brush,plastic stick)	

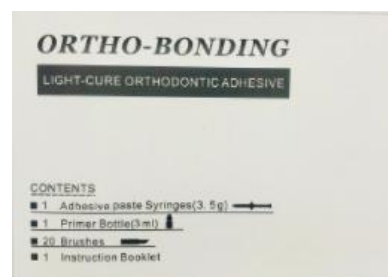

## Orthodontic Consumable Items

Item Name	Item Code	Package
Orthodontic Kits	H1001	box/网纱袋



Item Name	Item Code	Package
Interdental brush	H1002	8pcs/pack



Item Name	Item Code	Package
Tongue Scraper	H1003	1pcs/pack



Item Name	Item Code	Package
Orthodontic Aligner Chewie	H1004	2pcs/pack



Item Name	Item Code	Package
Orthodontic Invisible Bracket Extractor	H1005	1pcs/pack



Item Name	Item Code	Package
Orthodontic Medical Rod Blue/Green/Pink/Purple/White	H1006	100pcs/pack



Item Name	Item Code	Package
Medical Face Shield Disposable Sponge 1+10 (replaceable)	H1007	塑料袋/盒装



Item Name	Item Code	Package
Stainless Steel K Files  Size: (Inch 21mm 15-40, 25mm 15-40)	H1008	10pcs/pack



# Orthodontic Instruments



I501 I502 I503 I504 I505 I506 I507 I508 I509 I510

- I501 Standard Bracket Tweezers with Slot Aligner
- I502 Long Bracket Tweezers with Slot Aligner
- I503 Direct Bond Bracket Holder
- I504 Direct Bond Bracket Holder with Slim Head
- I505 Direct Bond Bracket Holder with Curved Head
- I506 Bracket Placer
- I507 Easy Access Tweezers/Buccal Tube Tweezers
- I508 Buccal Tube Tweezers Long
- I509 Long Bracket Tweezers with Slim Head & Slot Aligner
- I510 Long Slim Buccal Tube Tweezers with Slot Aligner



I601 Needle Holder Wide Head I602 Needle Holder Pointed Head



- I605 Hemostatic Forceps-Curve Head
- I606 Hemostatic Forceps-Vertical Head
- I607 Hemostatic Forceps-Straight Head
- I608 Needle Forceps-Hollow



I603 Needle Holder Mini Head I604 Needle Holder Slim Head



I701 I702 I703 I704 I705 I706 I707

I708

I709

- I701 Ligature Remover Director
- I702 Double Sided Ligature Director
- I703 Ligature Director Scaler
- I704 Band Pusher Scaler
- I705 Distal Bender
- I706 Elastic Remover
- I707 Band Pusher
- I708 Force Gauge
- I709 Ligature Gun



# Orthodontic Pliers



**B01-102**  
Light Wire Pliers



**B01-103**  
Heavy Cutter Pliers



**B01-105**  
Light Wire  
Forming Pliers



**B01-106**  
Torque Bending Pliers  
(Round Head)



**B01-107**  
KIM Pliers



**B01-108**  
Tweed Loop Pliers



**B01-109**  
How's Pliers



**B01-110**  
Slim Head Weingart  
Pliers



**B01-111**  
Long Head Weingart  
Pliers



**B01-112**  
Brackets Removing Pliers



**B01-113**  
Band Removing Pliers



**B01-114**  
Adhesive Removing Pliers



**B01-115**  
Crimpable Hook Pliers



**B01-116**  
Separator Placing  
Pliers



**B01-117**  
Universal Pliers



**B01-118**  
Nance Loop Bending Pliers



**B01-119**  
Ligature Wires  
Forming Pliers



**B01-120**  
Loop Bending Pliers



**B01-121**  
Cap Removing Pliers



**B01-122**  
NiTi Cinch Back Pliers  
(Long Handle)

# Orthodontic Pliers



**B01-123**  
V Stop Pliers



**B01-124**  
Light Wire Curved  
Forming Pliers



**B01-125**  
Double Sides Pliers



**B01-126**  
Jarabak Light Wires Pliers



**B01-127**  
Adams Pliers



**B01-128**  
Johnson Contouring  
Pliers



**B01-129**  
Omega Loop  
Bending Pliers



**B01-130**  
Distal End Cutter  
(Long Handle)



**B01-131**  
Light Wires Forming  
Pliers (with Cutter)



**B01-132**  
Twin Heads  
Torque Pliers



**B01-133**  
Posterior Brackets  
Removing Pliers



**B01-134**  
Band Removing Pliers  
(Enhanced)



**B01-135**  
Pull Hook Retainer  
Pliers



**B01-136**  
Three Jaw Pliers



**B01-137**  
Cutter Pliers (Mini)



**B01-138**  
Torque Bending Pliers  
(Square Head)



**B01-139**  
Light Wire Pliers Angle 45°

## *Pursuit of Yamei, Beauty of Teeth*

In addition to the above common orthodontic products, we company also produces other special customized orthodontic products, if there is need to be individually customized,the price will be negotiated.



Choose Yamei  
Have a good taste



**Hangzhou Yamei Dental Medical Equipment Factory**

Add.:4th floor, Building 2, No.9 Naxian Road, Liangzhu Street, Yuhang District, Hangzhou, Zhejiang

TEL: 0086-88963019 FAX: 0086-88963019

Email: [yamei@yamei-china.com](mailto:yamei@yamei-china.com) [sales-y@yamei-china.com](mailto:sales-y@yamei-china.com) [sales-i@yamei-china.com](mailto:sales-i@yamei-china.com)

Website: [www.yameiortho.com](http://www.yameiortho.com)/[www.yamei-china.com](http://www.yamei-china.com)