



Attributes

Product Code
Net weight
Max. weight load
Dimensions (w x l x h)
Color options

For more color options, discuss with your sales representative.

2-1-052
41 kg
350 kg
700x710x1365 mm



Warranty

Structure
Steel
Paint
Plastic
Rubber
Moving parts

Detailed information in the warranty document

25-15 years
5-10 years
2 years
5-10 years
1-3 years
2 years

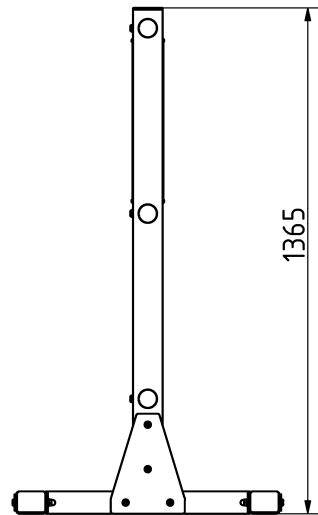
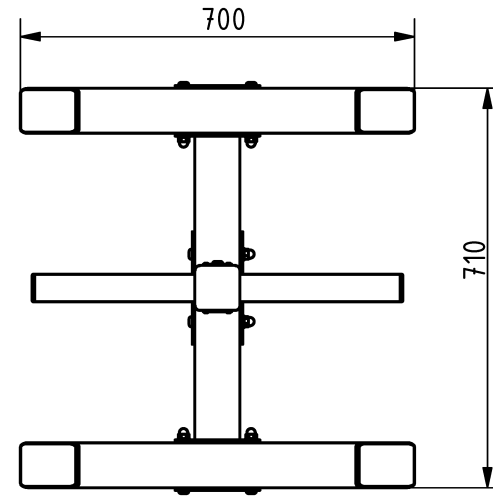
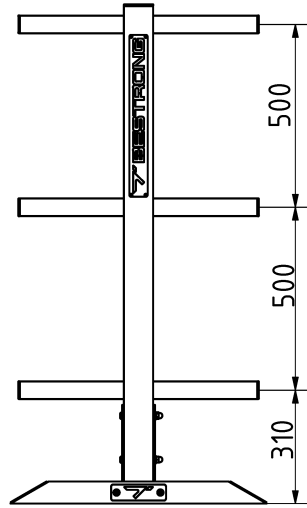

BESTRONG

 [bestrongworld](#)  [bestrongworld](#)  [global.bestrong.com](#)  info@bestrong.com

