

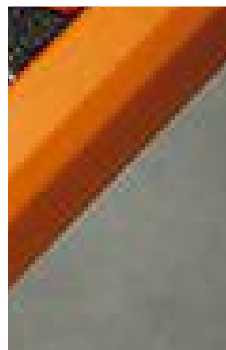

2024

NOWOŚCI

NOVELTIES НОВИНИ

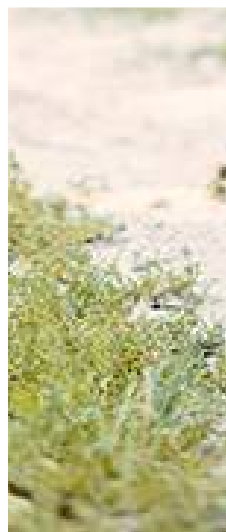

GTX

NEO
TOOLS

GRAPHITE
VERTO

NEO TOOLS



25
years
GUARANTEE



NEO TOOLS to...

- wysokiej klasy specjalistyczne i popularne narzędzia dla profesjonalistów, wymagających użytkowników oraz osób realizujących różne prace w domu
- w skład marki wchodzi wiele kategorii produktowych
- główne filary marki stanowi kategoria moto oraz BHP
- NEO Tools rozwija się również w zupełnie nowych obszarach, które idealnie wpisują się w męski świat
- marka pomaga realizować zarówno ciężkie zadania jak i swoje pasje
- w produkcji wykorzystane są najnowsze technologie i materiały
- 25 lat gwarancji* jakości i niezawodności

NEO TOOLS is...

- high-quality specialist and popular tools for professionals, demanding users and those who perform various works at home
- the brand includes many different product categories
- the main categories of the brand are Moto and OHS
- NEO Tools is also expanding in completely new areas that perfectly fit the male world
- the brand helps to perform both difficult tasks and fulfil one's passions
- in the production we use the latest technologies and materials
- 25 years of quality and reliability guarantee*

NEO TOOLS це...

- високі класні спеціалізовані та популярні інструменти для професіоналів, вимогливих користувачів та людей, які виконують різноманітні роботи по дому
- бренд включає в себе багато товарних категорій
- основними стовпами бренду є категорії „мото” та охорона праці
- NEO Tools також розвивається в абсолютно нових напрямках, які ідеально вписуються в чоловічий світ
- бренд допомагає реалізовувати як свою професійну працю, так і свої хобі
- у виробництві використовуються новітні технології та матеріали
- 25 років гарантії* якості та надійності



neo-tools.com



@NEOTOOLS



Informacje o nowościach produktowych, wydarzeniach, konkursy, porady oraz video

Information about novelities, events, competitions, tips and videos

Інформація про нові продукти, події, конкурси, поради та відео



@NEOTOOLSOFFICIAL



VIDEO produktowe, porównania i testy produktów w wielu wersjach językowych

Product related VIDEOS, product comparisons and tests in multiple language versions

ВІДЕО про продукцію, порівняння продукції та тести на декількох мовах



NEOmov





JAKOŚĆ

Najwyższa jakość materiałów i najnowocześniejsze rozwiązania technologiczne to kluczowe założenia standardów jakości NEO TOOLS. Narzędzia NEO TOOLS to ergonomiczne, precyzyjnie wykonane narzędzia stworzone do pracy w najcięższych warunkach. Produkty NEO TOOLS testowane są zarówno w specjalistycznych laboratoriach jak i w miejscach pracy profesjonalistów.

QUALITY

High quality of materials and well proven technical solutions are the key foundations of the NEO TOOLS quality standards. High quality and precision of workmanship make the NEO TOOLS tools fit for use in the harshest conditions. NEO TOOLS products are tested in specialised laboratories as well as in professionals' workplaces.

ЯКІСТЬ

Найвища якість матеріалів та найсучасніші технологічні рішення - головні засади стандартів якості NEO TOOLS. Інструменти NEO TOOLS - це ергономічні, точно виготовлені інструменти, створені для роботи в найскладніших умовах. Продукція NEO TOOLS тестується як у спеціалізованих лабораторіях, так і на робочих місцях професіоналів.

Laboratorium

Narzędzia NEO TOOLS poddawane są specjalistycznym i rygorystycznym testom wytrzymałościowym. System zarządzania jakością, stosowany w Laboratorium, w którym badane są narzędzia NEO TOOLS, posiada certyfikat zgodności z jedną z najważniejszych regulacji dotyczących kontroli jakości, czyli ISO 9001:2015.

Laboratory

NEO TOOLS tools undergo specialized and rigorous endurance testing. The quality management system used in the Laboratory, where NEO TOOLS tools are tested, is certified to one of the most important quality control regulations, ISO 9001:2015.

Лабораторія

Інструменти NEO TOOLS піддаються спеціалізованим і суворим випробуванням на міцність. Система управління якістю, яка використовується в лабораторії, де проводяться випробування інструментів NEO TOOLS, сертифікована на відповідність одному з найважливіших стандартів контролю якості - ISO 9001:2015.





Narzędzia NEO TOOLS cieszą się zaufaniem wymagających użytkowników oraz profesjonalistów, którzy poszukują rozwiązań na najwyższym poziomie. O niezawodności i uznaniu ze strony środowiska biznesowego świadczą liczne wyróżnienia. Najważniejszym z nich jest międzynarodowy certyfikat TÜV, który jest jednym z najbardziej rozpoznawalnych znaków jakości na świecie.

NEO TOOLS earned trust of demanding users and professionals who search for solutions of the highest standards. Reliability and recognition in the business sector are confirmed with numerous prizes and distinctions. The most important of all is the international TÜV certificate, one of the most recognised quality marks in the world.

Інструменти NEO TOOLS користуються довірою вимогливих користувачів і професіоналів, які шукають рішення на найвищому рівні. Про надійність та визнання з боку бізнес-спільноти свідчать численні нагороди. Найважливішим з них є міжнародний сертифікат TÜV, який є одним з найбільш визнаних знаків якості у світі.

W procesie produkcji wykorzystywane są starannie wyselekcjonowane materiały, a jakość narzędzi jest stale weryfikowana w trakcie rygorystycznych procedur kontrolnych. Produkty NEO TOOLS spełniają najwyższe kryteria jakościowe, czego znakiem jest 25-letni okres ochrony gwarancyjnej na narzędzia mechaniczne NEO TOOLS.

Manufacturing process uses carefully selected materials, and the tool quality is constantly verified with rigorous control procedures. NEO TOOLS products meet the highest quality criteria, which is confirmed with 25 years warranty for NEO TOOLS mechanical tools.

У процесі виробництва використовуються ретельно відібрані матеріали, а якість інструментів постійно перевіряється під час суворих процедур контролю. Продукція NEO TOOLS відповідає найвищим критеріям якості, ознакою чого є 25-річний гарантійний захист механічних інструментів NEO TOOLS.



GRAPHITE

POWER IN YOUR HANDS

3

YEARS
WARRANTY



Marka **GRAPHITE** zapewnia pełną dostępność części zamiennych oraz materiałów eksploatacyjnych dla urządzeń i elektronarzędzi. Dzięki temu urządzenia mogą być sprawne przez długi czas.

We ensure constant availability of spare parts and consumable materials for devices and power tools. Therefore, the **GRAPHITE** power tools stay operational for years.

Забезпечуємо постійну доступність запчастин та витратних матеріалів для обладнання та електроінструменту. Завдяки цьому електроінструмент GRAPHITE залишається справним протягом довгих років.

GRAPHITE to:

- ▶ szeroki asortyment wysokiej jakości elektronarzędzi i akcesoriów
- ▶ ważny i wiodący element marki stanowi system Energy+
- ▶ elektronarzędzia przeznaczone do intensywnego użytkowania, przy obciążeniach bliskich profesjonalnym
- ▶ produkty z optymalnym zestawem cech: wytrzymałe, ergonomiczne, o mocnych silnikach

GRAPHITE is:

- ▶ a wide range of high quality power tools and accessories
- ▶ an important and leading element of the brand is the Energy+ System
- ▶ power tools designed for intensive semi-professional use
- ▶ products with optimum set of features: durable, ergonomic, with powerful motors

GRAPHITE це:

- ▶ широкий асортимент високоякісного електроінструменту та аксесуарів до нього
- ▶ важливим та провідним елементом бренду є система Energy +
- ▶ електроінструмент, призначений для інтенсивного використання при навантаженнях, наближених до професійних
- ▶ продукти з оптимальним набором якостей: міцні, з потужними двигунами та ергономічною конструкцією

ZAPRASZAMY NA KANAŁY MARKI GRAPHITE W MEDIACH SPOŁECZNOŚCIOWYCH

COME AND BROWSE GRAPHITE SOCIAL MEDIA CHANNELS

ЗАПРОШУЄМО НА КАНАЛИ МАРКИ GRAPHITE У СОЦІАЛЬНИХ МЕРЕЖАХ



GRAPHITE

Informacje o nowościach produktowych, porady oraz VIDEO



Information on new products, advice and VIDEOS

Інформація про нові продукти, події, поради та відео



GRAPHITEmov

VIDEO produktowe, porównania i testy produktów w wielu wersjach językowych



Product related VIDEOS, product comparisons and tests in multiple language versions

ВІДЕО про продукцію, порівняння продукції та тести на декількох мовах



QR-code obok produktu to dedykowane dla niego części zamienne

Scan the QR code to purchase spare parts for each GRAPHITE tool

QR-код поряд із продуктом присвячений запасним до нього частинам

graphite.pl

Nasze wieloletnie doświadczenie i znajomość rynku elektronarzędzi pomogła nam w opracowaniu rozwiązań ekspozycji produktów, które wspierają naszych partnerów handlowych w codziennym biznesie.

- **unikalność** - regały dedykowane dla marki GRAPHITE (elektronarzędzia i akcesoria)
- **solidność** - konstrukcje wykonane z dobrej jakości materiałów
- **nowoczesność** - ciekawe rozwiązanie na komunikację o produktach, markach, akcjach promocyjnych
- **uniwersalność** - odpowiednie dopasowanie do ilości miejsca w sklepie

Many years of experience and knowledge of tool market allowed us to develop solutions for product exposition, which create a great support in everyday business for our trade partners.

- **unique features** – cabinets dedicated for GRAPHITE brand (power tools and accessories)
- **reliability** – designs include good quality materials
- **modern design** – interesting solution for communication about products, brands, promotional events
- **versatility** – matching to space available in a shop

Завдяки нашому багаторічному досвіду та знанню ринку інструменту, ми розробили рішення щодо ефективної презентації товарів, які допомагають нашим комерційним партнерам у їхній повсякденній роботі

- **унікальність** – стелажі, призначені для бренду GRAPHITE (електроінструменти та аксесуари)
- **міцність** – конструкції виготовлені з якісних матеріалів
- **сучасність** – цікаві рішення з маркетингової комунікації - про товари, бренди, промо-акції
- **універсальність** – відповідне пристосування до площі магазину

OFERTA SZYTA NA MIARĘ TAILORED-MADE OFFER ПРОПОЗИЦІЯ ПІД ЗАМОВЛЕННЯ



GRAPHITE

ENERGY+
system



System Energy+

System Energy+ to linia produktów zasilanych akumulatorami tego samego typu. Dzięki takiemu rozwiązaniu istnieje możliwość dowolnej konfiguracji zestawu produktów i doboru optymalnej ilości potrzebnych akumulatorów.

Energy+ System

Energy+ System is the range of products powered with batteries of the same type. This solution allows to configure set of products at will and choose optimal number of required batteries.

Система Energy+

Система Energy+ це лінійка продуктів з живленням від акумуляторних батарей одного і того ж типу. Завдяки такому рішенню можна вільно конфігурувати набір продуктів і підбирати оптимальну кількість необхідних акумуляторів.



JEDEN akumulator
WIELE możliwości

ONE battery
MANY possibilities

ОДНА акумуляторна батарея
БЕЗЛІЧ можливостей

Szafka narzędziowa

Tool cabinet / Werkzeugschrank / Шкафчик для инструментов / Шафа інструментальна / Műhelykocsi / Dulap pentru scule / Skříňka na nářadí / Skrinka na náradie / Omarica za orodje / Įrankių spintelė / Instrumentu skapis / Tööriistakapp / Шкафче за инструменти / Ormar za alate / Ormaric za alatke / Ντουλαπάκι για εργαλεία / Armario de almacenaje para herramientas / Carrello porta utensili / Estante p. Ferramentas / Rmoire à outils / Gereedschapskast

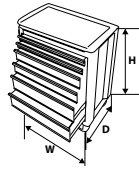

84-236



84-240



84-230



84-242



84-237



84-238



84-235



84-234



84-232

129 elements

Ref.	D [mm]	W [mm]	H [mm]	capacity [kg]	☐	EAN
84-222-9	460	680	1030	280	0/1	5907558426441

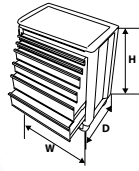

84-230



84-231



84-232



84-233



84-234



84-236



84-237



84-239



84-238

176 elements

Ref.	D [mm]	W [mm]	H [mm]	capacity [kg]	☐	EAN
84-222-12	460	680	1030	280	0/1	5907558426427

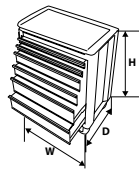

84-230



84-231



84-232



84-233



84-234



84-236



84-237



84-239



84-238

149 elements

Ref.	D [mm]	W [mm]	H [mm]	capacity [kg]	☐	EAN
84-221-9	460	680	1030	280	0/1	5907558426403

Szafka narzędziowa

Tool cabinet / Werkzeugschrank / Шкафчик для инструментов / Шафа інструментальна / Műhelykocsi / Dulap pentru scule / Skříňka na nářadí / Skrinka na náradie / Omarica za orodje / Įrankių spintelė / Instrumentu skapis / Tööriistakapp / Шкафче за инструменти / Ormar za alate / Ormaric za alatke / Ντουλαπάκι για εργαλεία / Armario de almacenaje para herramientas / Carrello porta utensili / Estante p. Ferramentas / Rmoire à outils / Gereedschapskast



117 elements



84-230



84-234



84-236

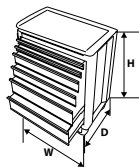

84-237



84-238



84-247

Ref.	D [mm]	W [mm]	H [mm]	capacity [kg]	☒	EAN
84-214-6	460	680	825	280	0/1	5907558426380

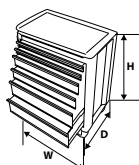

Ref.	D [mm]	W [mm]	H [mm]	capacity [kg]	☒	EAN
84-214	460	680	825	280	0/1	5907558426373



Klucze sześciokątne

Hex key set / Sechskantschlüssel / Ключи шестигранные / Ключ шестигранный / Imbuskulcs készlet / Set chei cu șase laturi / Šestihranný klíč / Súprava imbus klúčov (dlhé) / Garnitura imbus ključev / Šešakampij raktų komplektas / Seškanšu atslēgu komplekts / Kuuskant-mutrivõtmete komplekt / Лумбцы номн. / Ključ imbus set / Ključ imbus set / Συλλογή εξαγωνικών κλειδίων / Llaves Allen / Chiavi esagonali / Chaves hexagonais / Clefs à 6 pans / Zeskantsleutels



☉ H2.5; H3; H4; H5; H6; H8



Ref.	☒	EAN
84-254	1/12	5907558483956

Klucze Torx

Torx key wrench set / Torx-Schlüssel / Ключи Torx / Ключи "Torx" / Torx kulcskészlet / Set chei de tip "torx" / Klíče Torx / Súprava Torx klúčov / Garnitura ključev torx / Raktai TORX / Torx atslēgu komplekts / "Torx" mutrivõtmete komplekt / Лумбцы номн. / Ključ imbus / Кλειδιά Torx / Llaves torx / Set chiavi Torx / Chaves torx / Clefs Torx / Torxsleutels



☉ T10; T15; T20; T25; T30; T45



Ref.	☒	EAN
84-264	1/12	5907558483963

Plecak monterski

Tool backpack / Monteurrucksack / Рюкзак монтерский / Рюкзак монтерський / Szerszámós hátizsák / Rucsac pentru mecanic / Batoh na náradí / Plecniak na náradie / Nahrbtnik za orodje / Montuotojo įrankių kuprinė / Instrumentu mugursoma / Tööriistade seljakott / Монтьорска раница / Rusak za montere / Monterski ranac / Σάκος εργαλείων / Mochila de montador / Zaino porta utensili / Mochila para ferramentas / Sac à dos porte-outils / Monteur rugzak



Ref.	Icon	EAN
84-318	1/8	5907558474589

Torba monterska

Tool bag / Monteurtasche / Сумка монтерская / Торба інструментальна / Szerszámátáska csálakú fém fogantyúval / Geanta scule / Montérská brašna / Taška montérská kožená / Torba za orodje / Monterio krepšys / Instrumentu soma / Tööriistakott / Күфәр за инструменти / Torba za alat / Torba za alat / Σάκος για εργαλεία / Bolsa para herramientas / Borsa per meccanico / Saco p. montagem / Sac de monteur / Montagetas



Ref.	Icon	EAN
84-319	1/10	5907558474596

Plecak na narzędzia

Tool backpack / Werkzeug-Rucksack / Сумка для инструментов / Рюкзак для инструменти / Szerszámártó hátizsák / Raniță pentru scule / Batoh na náradí / Ruksak na náradie / Nahrbtnik za orodja / Įrankių krepšys / Instrumentu mugursoma / Seljakott tööriistadele / Чанта за инструменти / Ruksak za alate / Ranac za alate / Σάκος εργαλείων / Mochilas para herramientas / Zaino per attrezzi / Mochila p. ferramentas / Sac à dos pour outils / Gereedschapsrugzak



NEW

CAPACITY **20L** POLYESTER **600D**

4 OUTSIDE POCKETS **35** INSIDE POCKETS

HARD SHELL **RUBBER BOTTOM**

W 37 cm
D 27,5 cm
H 51,5 cm



Ref.	Icon	EAN
84-329	0/2	5907558477429

Stół warsztatowy

Work bench / Werkstattbank / Смон-верстак / Верстак / Állítható munkapad / Tejghea tîmplărie / Dilenský stůl / Stolik pracovný / Delavníška miza / Darbastalis / Darba galds / Tööpink / Работна маса / Stol radionički / Radni sto / Πάγκος εργασίας / Banco de trabajo / Banco da lavoro / Mesa de oficina / Etabli d'atelier / Werkplaatstafel



AL + STEEL

7 HEIGHT LEVELS

100 max kg

STABLE

2 HAND CRANKS

FOLDABLE

EASY TO STORE AND TRANSPORT

Ref.	Icon	EAN
44-700	0/1	5907558496017



Zestaw nasadek przelotowych

Socket set / Aufsatzset / Набор головок торцевых / Набор насадок торцевых / Dugókulcs készlet / Set duze / Sada násadek / Súprava nástr. klíčův / Garnitura nasadnih ključev / Antgalių rinkinys / Muciņu komplekts / Padrunikomplekt / Гедорэ компл. / Set nasadnih ključeva / Gedora set / Συλλογή καρδαικών / Llaves de vaso / Set di boccole / Kit de bicos / Jeu de douilles / Set van messen

1/4" - 4.5-5-5.5-6-7-8-9-10-11-12-13 mm
3/8" - 10-11-12-13-14-15 -16-17-18-19-21-22-24 mm

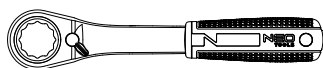

1/4", 72T
3/8", 72T

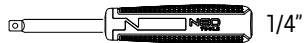

1/4"



1/4"



1/4", 100 mm

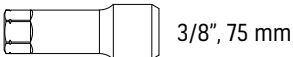

3/8", 75 mm

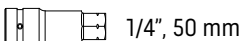

1/4", 50 mm



1/4" 13 mm

3/8" 19 mm

1/2" 19 mm

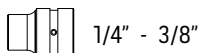

1/4" - 3/8"



1/4"

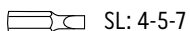

SL: 4-5-7

PH: 1-2

PZ: 1-2

T: 10-15-20



25 years
GUARANTEE

CrV
steel

1/4"

3/8"

72T



46
elements



Ref.	📦	EAN
10-019	0/5	5907558495782

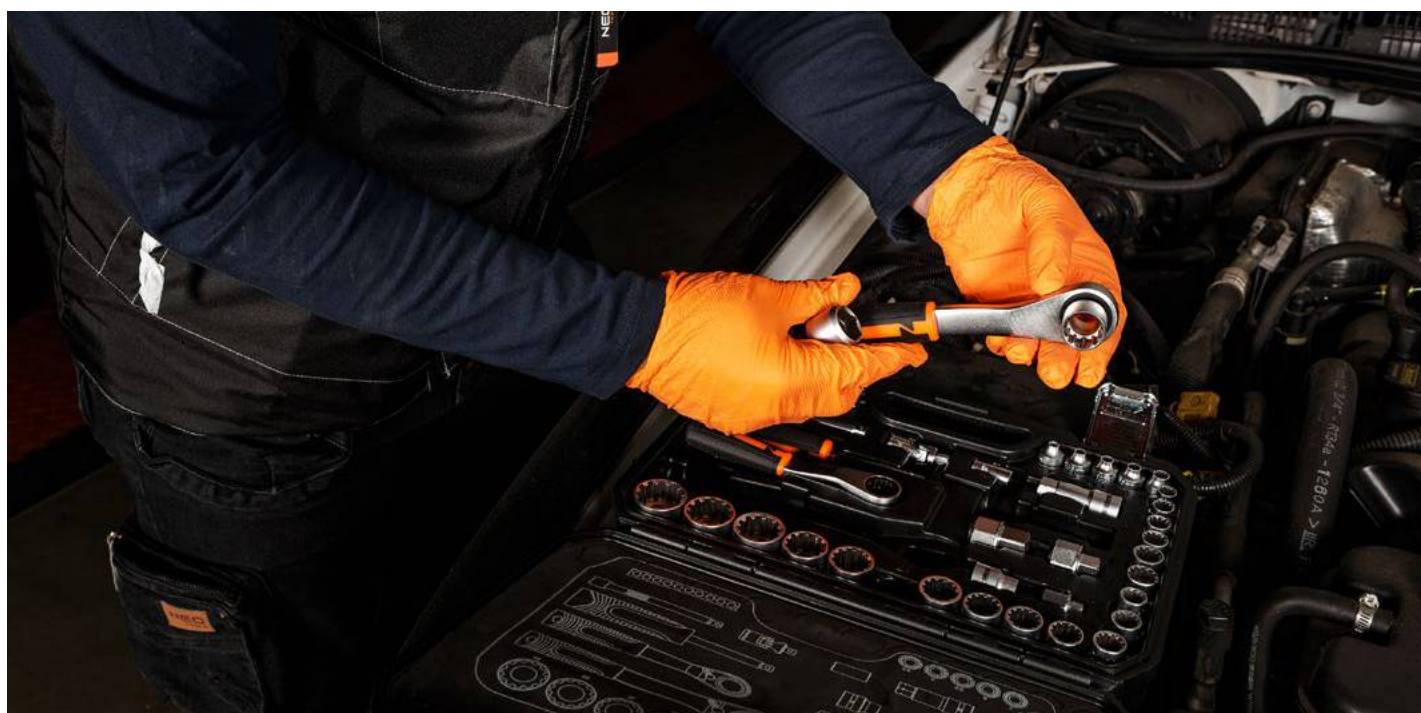

Szczypce do zaciskania końcówek

Crimping pliers / Feinzunge, zur Verklammerung der Endungen / Клещи для обжима кабельных наконечников / Щипцы кабельные, затиски / Kábelsarú fogó / Cleste pentru sertizat / conectori / Kliešte na sviráni koncovky / Kliešte na koncovky / Klešče za stiskanje konic / Replés, antagiliú užspaidimui / Knaibles kabeļu uzgaļu saspiēšanai / Otsakinnitusnäpitsad / Клещи за прутискане на краища на кабелу / Klijesta za pritiskanje nastavaka / Klešta za pričvršćivanje krajeva / Πένσα ακροδεκτών / Pinzas de presión para puntas / Pinza per terminali / Pinças p. Grampear pontas / Pince universelle de serrage d'embouts / Tang voor eindstukken



HEX: 8.1 / 6.5 / 5.4 / 2.6 / 1.72 mm

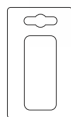

Ref.	L[mm]	⊠	EAN
01-545	240	10/40	5907558493696

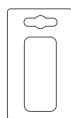

Ref.	L[mm]	⊠	EAN
01-548	200	10/40	5907558421842

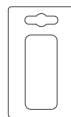

Ref.	L[mm]	⊠	EAN
01-544	190	10/40	5907558493689

Ściągacz izolacji

Wire stripper / Abziehvorrichtung für Isolierung / Съемник изоляции / Знімач ізоляції / Kábelcsupaszoló / Dispozitiv de scos izolația / Stahovač izolace / Kliešte na stahovanie izolácie / Snematnik izolacije / Izolacijs nuėmimo replės / Izolācijas noņēmejs / Isolatsioonitõmmits / Изолирава сџоба / Skidač izolacije / Skidač izolacije / Εργαλείο για αφαίρεση μόνωσης / Alicates pelacables / Spelafli universale / Ponta de aperto de solacão / Dénudeur d'isolation / Trekker voor isolatie

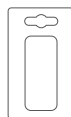

Ref.	L[mm]	⊠	EAN
01-547	190	20/100	5907558421835

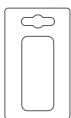

Ref.	L[mm]	⊠	EAN
01-546	165	20/100	5907558499735



SPLITTING CLAMPING CUTTING STRIPPING CRIMPING WINDING

0,8 – 3,2mm



Ref.	L[mm]	⊠	EAN
01-549	180	10/100	5907558421859

Nóż monterski 1000V

Fitter's knife / Monteurmesser / Нож монтерский / Ніж монтерський / Kábelvágó kés / Cutit pentru cabluri / Nůž montérský / Montérsky nôž / Montažni nôž / Montuotojo peilis / Montiera nazis / Elektrikunuga / Монтьорски нож / Monterski nôž / Monterski nôž / Μαχαίρι ηλεκτρολόγου / Cuchillo recto para cables / Coltello per elettricisti / Faca p. montagem / Couteau de montage / Montagernes

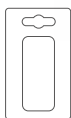

Ref.	⊠	EAN
01-552	10/100	5907558497410

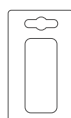

Ref.	⊠	EAN
01-553	10/100	5907558497427

Uchwyt do końcówek

Bit holder / Aufnahme für Spitzen / Зажим для наконечников / Тримач до наконечників / Csavarbehajtószer / Dispozitiv de prinderea capetelor / Skličadlo na nástavce / Upínadlo na nástavce / Vpenjalo za nastavke / Laikikkili antgaliams / Uzgaļu patrona / Otsakuradrin / Държач за накрайници / Drška za nastavke / Hvat za nastavke / Προσάρμογας μπιτών / Mandril de sujeción para puntas / Innesto per inserti con impugnatura / Suporte de ponteiros / Manche pour embouts / Houder voor eindstukken



Ref. 06-074 EAN 12/120 5907558483895

Wkrętak z giętkim grotem

Screwdriver with flexible shank with bits / Schraubendreher mit flex. Spitze / Отвертка с гибким стержнем / Відкрутка з жолом на шарпіри / Csavarhúzó készlet flexibilis nyéllel / Šurubelnitá cu corp flexibil cu vîrf / Šroubovák s pružným hrotem / Skrutkovač Flexi+Bity / Izvijáč s pregibno konico / Atsuktuvus su lanksčia šerdimi / Skrūvgrieziš ar lokano galu uzgaļiem / Painduva kāperidemeņa krūvķeeraja / Отвертка с Накрайници / Odvijac / Καταβίδι με εύκαμπτη λαβή και σει μπιτών / Destornillador con vástago flexible + puntas / Cacciavite con la punta flessibile / Chave de fenda com ponta flexível / Tournevis à pointe douce / Schroeveendraaier met zachte eindstuk

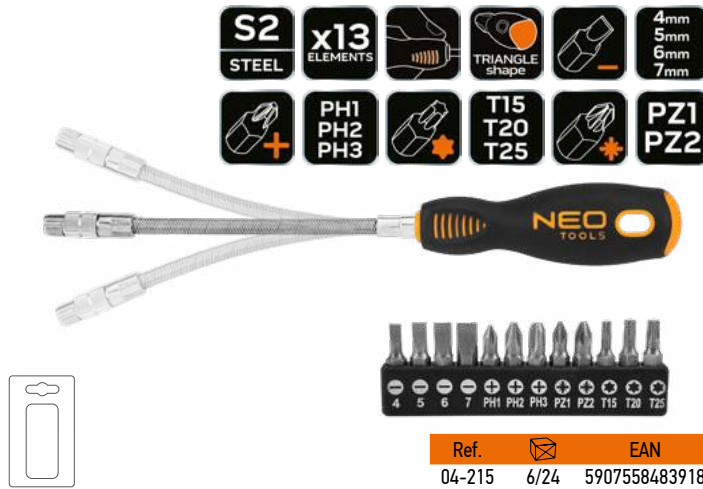

Ref. 04-215 EAN 6/24 5907558483918

Wkrętak krzyżowy

Screwdriver phillips / Kreuzschraubendreher / Отвертка крестовая / Відкрутка хрестовидна / Csavarhúzó phillips / Šurubelnitá tip "phillips" / Šroubovák křížový / Skrutkovač křížový / Křížni izvijač / Kryžminis atsuktuvus / Skrūvgrieziš krusta ph / Ristpeakrūvķeeraja / Отвертка / Odvijac / Οδνιιας / Σταυρωτό καταβίδι για βίδες τύπου phillips / Destornillador phillips / Cacciavite crociforme / Chave de fenda de cruzeta / Tournevis en croix / Slagkruiusschroeveendraaier

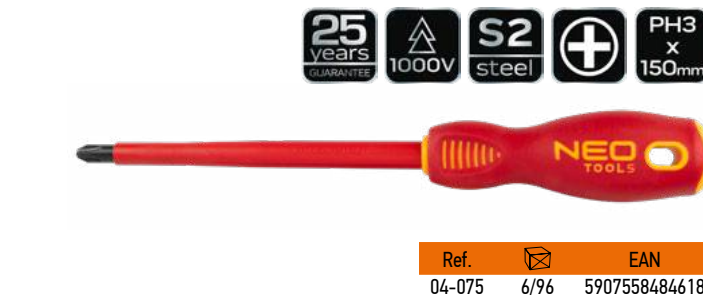

Ref. 04-075 EAN 6/96 5907558484618

Wkrętak Torx

Torx screwdriver / Schraubendreher Torx / Отвертка torx / Вукрyтка «torx» / Torx csavarhúzó / Šurubelnitá varf torx / Šroubovák Torx / Skrutkovač Torx / Izvijáč Torx / Atsuktuvus, torcinis / Torx skrūvgrieziš / Torx krūvķeeraja / Отвертка torx / Odvijac torx / Odvijac torx / Καταβίδι torx / Destornillador con punta torx / Cacciavite torx / Chave de fenda torx / Tournevis Torx / Torx schroeveendraaier



Ref. 04-074 EAN 12/240 5907558484601

Haki

Hooks / Hacken / Крюки / Гаки / Horgok / Cârlige / Háký / Skoby / Kjúke / Kabliai / Āķi / Haagid / Кукы / Kuke / Kuke / Γάντζοι / Ganchos / Ganci / Anzóis / Crochets / Haken



Ref. 04-231 L[mm] 150 EAN 6/72 5907558483901

Wkrętaki precyzyjne

Precision screwdriver set / Präzisionschraubendreher / Отвертки прецизионные / Відкрутки прецизійні, набір / Műszerész csavarhúzókészlet / Set šurubelnitá / Šroubováký jemná mech. / Súprava mikroskrutkovačov / Garnitura natančinių izvijačev / Atsuktuvai tiksliams darbams / Skrūvgriežu komplekts / Tāppiskrūvķeeraja komplekt / Отвертки компл. / Odvijac / Odvijac set / Συλλογή καταβιδιών ακριβείας / Destornilladores de precisión / Set giraviti di precisione / Chaves de fenda precisas / Tournevis de précision / Fijnschroeveendraaiers



Ref. 04-224 EAN 6/36 5907558483925

Wkrętaki 1000V

Screwdriver set / Schraubendreher / Отвертки / Відкрутки, набір / Csavarhúzókészlet / set šurubelnitá / Šroubováký / Súprava skrutkovačov+bity / Komplet izvijačev / Atsuktuvų komplektas / Skrūvgriežu komplekts / Krūvķeeraja komplekt / Отвертки компл. / Odvijac / Odvijac set / Συλλογή καταβιδιών / Destornilladores / Set giraviti 1000V / Chaves de fenda / Tournevis / Schroeveendraaiers



SL 1.0x5.5x125mm, SL 0.5x3.0x100mm, PH2x100mm, PH1x80mm

Ref. 04-144 EAN 6/24 5907558495393

Wkrętak plus-minus 1000V

Screwdriver / Kreuzschraubendreher / Отвертка крестовая / Відкрутка хрестови́дна / Csavarhúzó / šurubelníča / Šroubovák křížový / Skrutkovač / Křížni izvijač / Kryžminis atsuktavas / Skrūvgrizis krusta / Ristpeakruvikeeraja / Отвертка / Odvijač / Odvijac / Καταβίβι σταυρωτό τύπου / Destornillador phillips / Giravite / Chave de fenda de cruzeta / Tournevis en croix / Kriusschroevendraaier



Ref.	📦	EAN
04-218	12/240	5907558495409
04-219	12/240	5907558495416

Praska ręczna hydrauliczna do końcówek elektrycznych

Hydraulic hand press for electric bits / Hydraulische Handpresse für Elektrobohrer / Гидравлический ручной пресс для электросверл / Прес гидравлічний ручний для електричних доліт / Hidraulikus kézi sajító elektromos bitekhez / Presă hidraulică manuală pentru biți electrice / Hydraulický ruční lis pro elektrické bity / Hydraulický ručný lis pre elektrické bity / Hidraulična ročna stiskalnica za električne svedre / Hidraulinis rankinis presas elektriniams gražtams / Hidrauliškā rokas prese elektriskajiem bitiem / Υδραυλική ρεχνα ηλεκτρικά εργαλεία / Pressa manuale idraulica per punte elettriche / Prensa manual hidráulica para brocas eléctricas / Prensa manual hidráulica para brocas eléctricas / Presse hydraulique à main pour mèches électriques / Hydraulische handpers voor elektrische bits



Ref.	[mm ²]	📦	EAN
01-543	16-300	0/4	5907558485523

Kluczyk uniwersalny do szafek

Universal control cabinet key / Universalschlüssel für Schränke / Ключ универсальный для шкафов / Ключ універсальний до шаф / Chiave universale per armadietti / Cheie univesala pentru dulapuri / Univerzální klíč na rozvodné skříně / Univerzálny klúčik na skrinky / Univerzalni ključ za električne omarice / Elektros spīntelių raktas, universalus / Univeršāla atslēga skapjiem / Univeršaalne karivõti / Универсальен ключ за шкафчета / Univerzalni ključ za ormare / Univerzalni ključ / Κλειδιά γενικής χρήσης για ντουλάπια εργασίας / Llave universal para armarios / Chiave universale per armadietti / Chave universal para armários / Clé pour armoires universelle

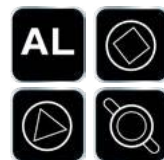

Ref.	📦	EAN
02-002	50/200	5907558499780

Klucz do armatury łamany

Fitting spanner / Montageschlüssel / Монтажный ключ / Наклидний ключ / Illesztőkulcs / Cheie de montare / Montážní klíč / Montážny klúč / Montažni ključ / Tvirtinimo veržliaraktis / Montāžas uzgriežņu atslēga / Paigaldusvõti / Монтажен гаечен ключ / Ključ za montažu / Монтажни клjuč / Кλειδί προσαρμογής / Llave de montaje / Chiave di montaggio / Chave de montagem / Clé de montage / Passende sleutel



Ref.	📦	EAN
02-446	20/40	5907558499797

Klucz do armatury przegubowy

Fitting spanner / Montageschlüssel / Монтажный ключ / Наклидний ключ / Illesztőkulcs / Cheie de montare / Montážní klíč / Montážny klúč / Montažni ključ / Tvirtinimo veržliaraktis / Montāžas uzgriežņu atslēga / Paigaldusvõti / Монтажен гаечен ключ / Ključ za montažu / Монтажни клjuč / Кλειδί προσαρμογής / Llave de montaje / Chiave di montaggio / Chave de montagem / Clé de montage / Passende sleutel



Ref.	📦	EAN
02-447	6/36	5907558499803

Klucz płasko-oczkowy z grzechotką

Combination spanner with ratchet / Ringschlüssel mit Ratsche / Ключ комбинированный с трещоткой / Ключ ріжково-наклидний з тріскоткою / Csillag-villáskulcs racsnis / Cheie fixă –inelară cu clichet / Očkorplochy klíč ráčnový / Plochy-ockový klúč s račťou / Ploščato-obročni ključ z raglja / Raktas plokščias, kilpinis su terkšle / Kombinētā atslēga / Kõristiga leht-silmusvõti / Комбинирана тресчотка / Plosnato-okasti ključ s nastavkom / Plošno-okasti ključ sa čegrtaljom / Кλειδί γερμανοπολύγωνο με κασάνια / Llaves combinadas (de estrella y a carraca abierta) con carraca / Chiave combinata a cricchetto / Chave plana-de luneta z catraca de furar / Clef à fourche-polygonale à cliquet / Moersleutel met ratel



Ref.	● [mm]	L [mm]	📦	EAN
09-255	8	6/72	6/72	5907558495669
09-256	9	6/72	6/72	5907558495676
09-257	10	6/72	6/72	5907558495683
09-258	11	6/72	6/72	5907558495690
09-259	12	6/72	6/72	5907558495706
09-260	13	6/72	6/72	5907558495713
09-261	14	6/72	6/72	5907558495720
09-262	15	6/48	6/48	5907558495737
09-263	16	6/48	6/48	5907558495744
09-264	17	6/48	6/48	5907558495751
09-265	18	6/48	6/48	5907558495768
09-266	19	6/48	6/48	5907558495775

Plecak elektryka

Electrician's backpack / Elektriker-Rucksack / Рюкзак электрика / Рюкзак електрика / Elektromos hátizsák / Rucsac de electrician / Elektrikářský batoh / Elektrikáryský batoh / Elektrikarski nahrbtnik / Elektriko kuprine / Elektriķa mugursoma / Elektriku seļakott / Электрическа раница / Električarski ruksak / Električarski ruksak / Σακίδιο ηλεκτρολόγου / Mochila de electricista / Zaino da elettricista / Mochila de electricista / Sac à dos d'électricien / Rugzak voor elektricien

170 mm, 0,25 x 6 mm²

2 m

0,5 - 6 mm²

1000 V, 200 mm

1000 V, 160 mm

1000 V, 180 mm

190 mm
100 - 250 V

LCD 1999

V DC 0-600V / V AC 0-600V
A DC 0-10A / A AC 0-10A
0-200M Ω, CAT III 600V

Data hold function

Continuity test
20KHZ
0-2mF

Auto Range

LCD backlight
Auto Power OFF

1000 V, 190 mm

0,34-6 mm²
RG6/59 8-13 mm²

1000 V, 200 mm

19 mm x 10 mm, BLACK

1,5 / 2 / 2,5 / 3 / 4 / 5 / 6 / 8 / 10 mm

1000 V, 180mm

1000 V, 160mm

1000 V,
PH0 x 60 mm
PH1 x 80 mm
PH2 x 100 mm
PH3 x 150 mm
SL 2,5 x 75 mm
SL 4 x 100 mm
SL 5,5 x 125 mm
SL 8 x 175 mm

31 pcs

1000V

CrV steel

S2 steel

TPE + PP

ABS + TPR

POLYESTER 600D

CAPACITY 20L

10 OUTSIDE POCKETS

18 INSIDE POCKETS

HARD SHELL

RUBBER BOTTOM

W 37 cm
D 27,5 cm
H 51,5 cm

Ref. 01-313

EAN 5907558472349

Zestaw narzędzi izolowanych do aut elektrycznych

Insulated tool kit for electric cars / Isolierter Werkzeugsatz für Elektroautos / Изолированный набор инструментов для электромобилей / Изольований набір інструментів для електромобілів / Szigetelt szerszámkészlet elektromos autókhoz / Trusă de scule izolată pentru mașini electrice / Izolovaná sada nářadí pro elektromobily / Izolovaná súprava náradia pre elektromobily / Izoliran komplet orodja za električne avtomobile / Izoliotas elektrinių automobilių įrankių rinkinys / Izolēts instrumentu komplekts elektromobilijem / Isoleeritud tööriistakomplekt elektriikutode jaoks / Изолиран комплект инструменти за електрически автомобили / Set izoliranih alata za električne automobile / Set izolovalanih alata za električne automobile / Σετ μονωμένων εργαλείων για ηλεκτρικά αυτοκίνητα / Kit de herramientas aislado para coches eléctricos / Kit di attrezzi isolati per auto elettriche / Geïsoleerde gereedschapset voor elektrische auto's / Kit d'outils isolés pour les voitures électriques

20/10mm

178 mm

3/8" - 200mm

3/8" - 250mm

3/8" - 125mm

3/8" - 75mm: M8 / M10 / M12

3/8" - 6 / 7 / 8 / 9 / 10 / 11 / 12 / 13 / 14 / 16 / 17 / 18 / 19 / 20 / 22

500m x 50 mm

250 mm

200 mm

180 mm

160 mm

200 mm

250 mm

PH3x150mm

T30x130mm

T25x125mm

PH2x100mm

T20x100mm

SL4x100mm

SL3x100mm

PH1x80mm

SL3,0x75mm

SL2,5x75mm

51 elements

1000V

CRV steel

S2 steel

8Cr14 steel

3/8"

Ref. 01-312

EAN 5907558493726

Walizka elektryka

Electrician's suitcase / Elektriker-Koffer / Чемодан электрика / Valiza električna / Villanyszerelő koffer / Valiza electricianului / Kufr elektrikáře / Elektrikáry kufrik / Kovček za električarje / Lagaminas elektrikiui / Električka instrumentu koferis / Elektriku kohver / Кухарче на електротехник / Kovček za električare / Kofer električara / Βαλίτσα εργαλείων ηλεκτρολόγου / Maletin de eléctrico / Valigetta da elettricista / Mala de electricista / Malette à outils pour électricien / Gereedschapstas elektricien



- 1/2" - 15-16-17-19-20-21-22-24-27-30-32 mm
1/4" - 4-4.5-5-5.5-6-7-8-9-10-11-12-13-14 mm
- 1/2" - E20-E22-E24
3/8" - E10-E11-E12-E14-E16-E18
1/4" - E4-E5-E6-E7-E8
- 1/2" - 72T
1/4" - 72T
- 1/2" - 125, 250 mm
1/4" - 50, 100 mm
- 1/2" - 16, 21 mm
- 1/4" - 115 mm
- 1/4" - 150 mm
- 1000V
SL 5.5x125, SL 3x100mm
PH0x60mm, PH1x80mm
PH2x100mm
- 250 V CE
- 160 mm
- 1000V, 160 mm
- 1000V, 160 mm
- 190 mm
- 0,34-6 mm²
- 0,25-6 mm²
- 0,5-6 mm²
- 0,5-16 mm²
- 25 mm - PH1, PH2, PH2, PH3, PZ1, PZ2, PZ2, PZ3, SL3, SL4, SL5, SL6, T10, T15, T20, T25, T27, T30, T40, T110, T115, T120, T125, T127, T130, T140, H3, H4, H5, H6



108
elements

NEW

Ref. 01-310-1 EAN 5907558477078

Cyfrowy próbnik napięcia

Digital voltage tester / Digitaler Spannungsprüfer / Цифровой тестер напряжения / Цифровий тестер напруги / Digitális feszültségvizsgáló, fázisceruza, / Tester digital de tensiune / Digitální zkoušečka napětí / Digitálny tester napätia / Digitalni tester napetosti / Skaitmeninis įtampos testeris / Digitalais sprieguma testeris / Digitalne ringe tester / Цифров тестер за напрежение / Digitalni ispitivač napona / Дигитални тестер напона / Ψηφιακός ηλεκτρικής τάσης / Comprobador de tensión digital / Tester digitale di tensione / Testador de tensão digital / Testeur de tension numérique / Digitale spanningstester



Ref. 94-005 EAN 5907558495430

Indukcyjny tester napięcia

Inductive voltage tester / Induktiver Spannungsprüfer / Индуктивный тестер напряжения / Индуктивний тестер напруги / Érintés nélküli feszültségvizsgáló, fázisceruza / Tester de tensiune inductivă / Indukční zkoušečka napětí / Indukčný tester napätia / Induktivni tester napetosti / Indukcinės įtampos testeris / Induktivā sprieguma testeris / επαγωγικός ηλεκτρικής τάσης / Индуктивни тестер за напрежение / Induktivni ispitivač napona / Индуктивни тестер напона / επαγωγικός ηλεκτρικής τάσης / Comprobador de tensión inductiva / Tester di tensione / Testador de tensão indutiva / Testeur de tension inductive / Inductieve spanningstester



145cm

Ref. 94-007 EAN 5907558495454

Wielofunkcyjny tester napięcia

Multifunction voltage tester / multifunktionaler Spannungsprüfer / Многофункциональный тестер напряжения / Багатофункціональний тестер напруги / Feszültségvizsgáló, fázisceruza, / Tester de tensiune multifuncțional / Multifunkční zkoušečka napětí / Multifunkčný tester napätia / Večnamenski tester napetosti / daugiafunkcinis įtampos testeris / daudzfunkcionāls sprieguma testeris / Multifunktionaalne ringe tester / Многофункционален тестер за напрежение / Višenamjenski ispitivač napona / Многофункционални тестер напона / Πολυλειτουργικός ηλεκτρικής τάσης / Comprobador de tensión multifunción / Tester digitale di tensione multifunzionale / Testador de tensão multifuncional / Testeur de tension multifonctionnel / multifunctionele spanningstester



Ref. 94-006 EAN 5907558495447

Próbnik instalacji elektrycznej

Electrical tester / Prüfgerät für Elektroinstallationen / Тестер электроустановок / Тестер електроустановок / Villanyszerelési tesztelő / Tester pentru instalatii electrice / Zkoušečka elektrické instalace / Tester elektrické inštalácie / Tester električnih inštalacij / Elektros instaliacijos testeris / Elektroinstalācijas testeris / Električarigaldise testija / Тестер за електротехнически инсталации / Ispitivač električnih instalacija / Тестер електричних инсталация / Δοκιμαστικός ηλεκτρικής εγκατάστασης / Comprobador de instalaciones eléctricas / Tester per installazioni elettriche / Testador de instalações eléctricas / Testeur d'installation électrique / Elektrische installatie tester



Ref. 94-008 EAN 5907558499742

Zwijadło pneumatyczne

Pneumatic reel / Pneumatische Rolle / Пневматическая катушка / Пневматична катушка / Pneumatikus orsó / Bobina pneumatica / Pneumatický naviják / Pneumatický navijak / Pnevmatiski kolut / Pneumatine ríté / Pneimatiskā spole / Pneumaatiline rull / Пневматична макара / Pneumatiski kolut / Пневматски колут / Пневматік кароулі / Carrete neumático / Bobina pneumatica / Carretilha pneumática / Enrouleur pneumatique / Pneumatische haspel



Ref. 10-700
EAN 5907558497359



Ref. 10-701
EAN 5907558497366

Przewód ciśnieniowy spiralny

High pressure spiral hose / Spiraldruckleitung / Шланг сжатого воздуха спиральный / Шланг високого тиску / Pneumatikus spirálátmű / Furtun spiral presiune înaltă / Tlakové potrubí spirálové / Vysokotlaká špirálová hadica / Visokotlačna spiralna gibka cev / Spiraline aukšto slėgio žarna / Spirálveida gaisa caurulvads / Kõrgsurvevoolik (spiraal) / Маркуч за компресор / Spiralno crijevo najlonsko / Crevo za visoki pritisak / Σπυροειδής πύργος υψηλής πίεσης / Tubo de presión / Tubo a spirale in nylon / Cabo de tensão espiral / Durite de pression hélicoïdale / Spiraal drukleiding



Ref.	L [m]	⌀ [mm]	⌀ [mm]	⊠	EAN
12-070-1	5	6,5	10,0	1/20	5907558474787
12-071-1	10	6,5	10,0	1/10	5907558474794
12-072-1	15	6,5	10,0	1/6	5907558474800
12-074-1	5	8,0	12,0	1/20	5907558474817
12-075-1	10	8,0	12,0	1/10	5907558474824
12-076-1	15	8,0	12,0	1/6	5907558474831

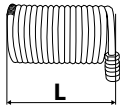
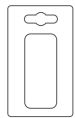

Ref.	L [m]	⌀ [mm]	⌀ [mm]	⊠	EAN
14-800-1	15	10,0	15,0	1/6	5907558474848
14-802-1	15	12,0	17,0	1/6	5907558474855

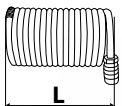
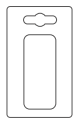

Ref.	L [m]	⌀ [mm]	⌀ [mm]	⊠	EAN
14-808-1	5	5,0	8,0	1/20	5907558474886
14-804-1	10	5,0	8,0	1/10	5907558474862
14-806-1	15	5,0	8,0	1/6	5907558474879

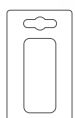

Smarownica dźwigniowa

Lever-operated grease gun / Schmierspritze mit Hebel / Шприц рычажно-плунжерный / Шприц важільно-плунжерный / Karos zsírzó / Gresor cu prghie / Páková maznice / Páková mazica / Ročna mazalka / Rankinis tepalo presas / Leeļotājs ar sviru / Kangiga määrimisead / Ръчна масло̀нка / Mazalica ručna / Mazalica na pumpu / Γρασαδόρος με μοχλό / Engrasadora de palanca / Pistola per grasso / Pistola de lubrificação / Graisseur à levier



Ref. 11-501
EAN 5907558426465

Wężyk do smarownic z końcówką

Hose for grease gun / Schlauch für Schmiergeräte / Шланг смазочный / Шланг до дозаторів оливи / Zsírzó cső / Furtun pentru pistol de gresare/ungere / Hadicka pro mazničky / Hadicka do maznic / Cev za mazalnike / Žarnelè tepalinèms / Caurulite eļļas kanniņai / Òlipùstolivoolik / Маркуч за масло̀нка / Crijevo za mazalice / Crevo za podmazivanje / Εύκαμτος σωλήνας λιπανσης / Manguera para engrasadoras / Tubo in Nylon / Mangueira para lubrificadores / Flexible de graisseur / Slang voor smeearapparaten



Ref. 11-502
EAN 5907558426472

Końcówka smarownicy 4 szczękowa

Lubricating nipple 4 jaw / Schmiernippel 4 Backe / Смазочный ниппель 4 щепки / Мазтильний ніпель 4 губки / Kenõbimbó 4 állkapocs / Niplu de lubrifiere 4 falci / Mazací vsuvka 4 čelisti / Mazalica vsuvka 4 čeluste / Mazalna bradavica 4 čeljust / Tepimo nipelis 4 žandikaulis / Eļļošanas sprausla 4 spailis / Määrdenippel 4 lõualu / Смазoац нипел 4 челоуст / Vrh pištolja za podmazivanje s 4 čeljusti / 4-челоусти врх пиштоља за подмазивање / Θηλή λιπανσης 4 αισάγια / Engrasador 4 mordazas / Niplo di lubrificazione 4 ganasce / Bocal de lubrificação 4 maxilas / Graisseur 4 mâchoires / Smeernippel 4 kaken



25pcs

Ref. 11-503
EAN 5907558426489

Lejek

Funnel / Trichter / Воронка / Воронка / Tölcsér, flexibilis, szűrővel / Pâlnie / Nálevka / Lievik / Lijak / Piltuvēlis / Piltuve / Lehter / Фунья / Lijevak / Levak / Χωπί / Embudo / Imbuto / Funil / Entonnoir / Trechter

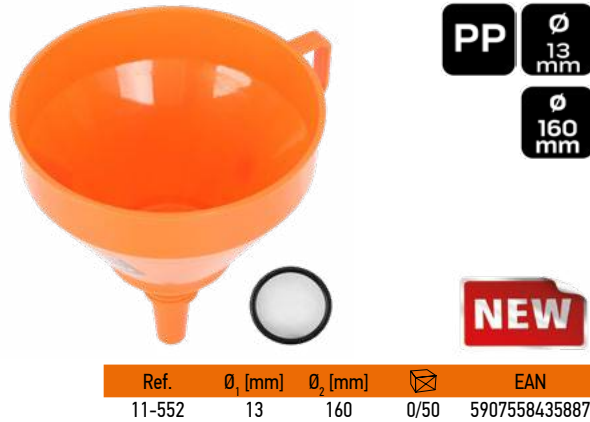
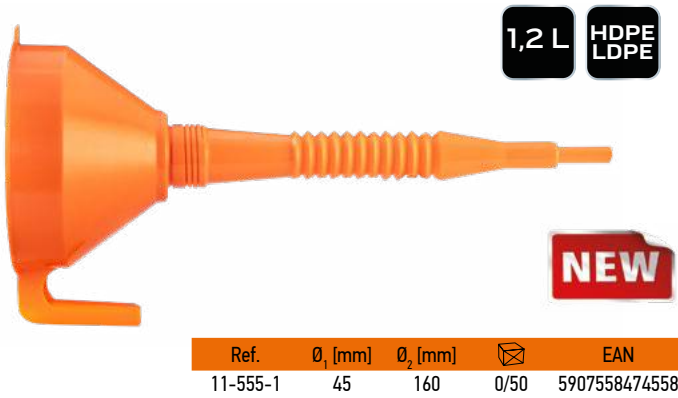

Lejek uniwersalny z uchwytem montażowym

Universal funnel with mounting handle / Universalttrichter mit Montagehalterung / Универсальная воронка с монтажным кронштейном. / Воронка универсальна з кронштейном для кріплення / Univerzální tölcsér tartókonzollal / Pâlnie universală cu suport de montare / Univerzální trychtýř s montážním držákem / Univerzálny lievnik s montážnou konzolou / Univerzálni lijak z nosilcem za pritržitev / Universalus piltuvas su tvirtinimo laikikliu / Universála piltuve ar stiprinājuma kronšteinu / Universaalne lehter koos kinnitusklaambriga / Универсална фуния с монтажна скоба / Univerzálni lijevak s nosačem za montažu / Универзални левак са монтажним носачем / Χωπί γενικής χρήσης με βραχίονα στήριξης / Embudo universal con soporte de montaje / Imbuto universale con staffa di montaggio / Funil universal com suporte de montagem / Entonnoir universel avec support de montage / Universele trechter met montagebeugel



Lejek silikonowy elastyczny, składany

Silicone funnel, flexible and foldable / Flexibler, faltbarer Silikontrichter / Гибкая складная силиконовая воронка. / Гнучна складна силиконова воронка / Rugalmas, összecukható szilikon tölcsér / Pâlnie din silicon flexibilă, pliatibilă / Flexibilní, skládací silikonový trychtýř / Flexibilny, składací silikonový lievnik / Prilagodljiv, zlozljiv silikonski lijak / Lankstus, sulankstomas silikoninis piltuvas / Elastiga, salokäma silikon piltuve / Paindlik kokkupandav silikoonlehter / Гъвкава, съваема силиконова фуния / Fleksibilni, sklopivi silikonski lijevak / Флексибилни, склопиви силиконски левак / Εύκαμπτο, αναδιπλούμενο χωπί σιλικόνης / Embudo de silicona flexible y plegable. / Imbuto in silicone flessibile e pieghevole / Funil de silicona flexibil et dobrável / Entonnoir en silicone flexible et pliable / Flexibele, opvouwbare siliconen trechter



Miska do zlewania oleju, płynu chłodniczego

Bowl for pouring oil, coolant / Schüssel zum Umfüllen von Öl und Kühlmittel / Чаша для слива масла, охлаждающей жидкости / Чаша для зливання масла, охолоджуючої рідини / Tál olaj, hűtőfolyadék dekantálásához / Bol pentru decantarea uleiului, lichidului de răcire / Nádoba na stáčení oleje, chladicí kapaliny / Miska na dekantáciu oleja, chladiacej kvapaliny / Miska na dekantáciu oleja, chladiacej kvapaliny / Dubuo alyvai, aušinimo skysčių nupilti / Bloda eļļas, dzesēšanas šķidruma dekantēšanai / Kausis ūļi, jahutusvedeliku dekanteerimiseks / Κύπα για δεκαντιράνε на масло, охладжаща течност / Posuda za pretakanje ulja, rashladne tekućine / Посуда за преливање уља, расхладне течности / Μπολ για μετάγγιση λαδιού, ψυκτικό / Recipiente para decantar aceite, refrigerante / Ciotola per travaso olio, refrigerante / Recipiente para decantar óleo, líquido de arrefecimento / Bol pour décanter l'huile, le liquide de refroidissement / Kom voor het decanteren van olie, koelvloeistof



Miska do zlewania oleju

Oil drain pan / Öl auffangwanne / Поддон для слива масла / Піддон для зливу масла / Olajleeresztő edény / Tava de scurgere a uleiului / Вырушечні nádoba на olej / Nádoba na vypúšťanie oleja / Posoda za izpust olja / Alyvos nutekėjimo indas / Eļļas notekas ranna / Ūļi tūhjudensrapp / Съд за източване на масло / Posuda za ispuštanje ulja / Посуда за испуштање уља / Ταψί αποστράγγισης λαδιού / Ταψί αποστράγγισης λαδιού / Vaschetta di scarico dell'olio / Bandeja de drenagem de óleo / Bac de vidange d'huile / Olie oprvangbak



Nalewak warsztatowy, konewka

Workshop pourer, watering can / Werkstattausgießer, Gießkanne / Наливная мастерская, лейка / Майстерня наливека, ліўка / Műhelyöntő, öntözőkanna / Atelier de turnare, adaptatoare / Dilenský nalievač, konev / Dielenský nalievač, kanva / Delavniški točilnik, zalivalka / Dirbtuvių piltuvai, laistytuvas / Darbniecas lejējs, lejkanna / Töökoja valaja, kastekann / Работилница за наливане, лейка / Radionička sipalica, kanta za zalivanje / Радионички сипач, канта за заливање / Χημική συσκευή, ποτιστήρι / Vertedor de taller, regadera / Versatore da officina, annaffiatoio / Despejador de oficina, regador / Verseur d'atelier, arrosoir / Werkplaatsschenker, gieter

PE



Ref.	V [l]	☒	EAN
10-802	1	1/24	5907558495812
10-803	3	1/20	5907558495829
10-804	5	1/16	5907558495836

Mobilna zlewarko-wysysarka do oleju pneumatyczna ze zbiornikiem kontrolnym

Mobile pneumatic oil sink and extractor with a control tank / Mobile pneumatische Ölspüle und -absaugung mit Kontrolltank / Передвижной пневматический маслосборник и экстрактор с контрольным баком / Мобільний пневматичний маслоспійомник і екстрактор з резервуаром управління / Mobil pneumatikus olajmosó és elszívó vezérlőtartállyal / Chiuvetă pneumatică mobilă pentru ulei și extractor cu rezervor de control / Mobilní pneumatický olejový dřez a odsavač s kontrolní nádrží / Mobilný pneumatický olejový dřez a odsávač s kontrolnou nádržou / Mobilni pnevmatski zbirnik in ekstraktor olja s krmilnim rezervoarjem / Mobilni pnevmatinė alyvos kriauklė ir siurblys su valdymo baku / Mobilā pnevmatskā eļļas izlietne un nosūcējs ar vadības tvertni / Mobilne pnevmatiline õlivalamu ja väljatõmbeseade koos juhtpaagiga / Мобилен пневматичен маслен мивка и екстрактор с резервоар за управление / Mobilni pnevmatski sudoper i ekstraktor ulja s kontrolnim spremnikom / Мобилни пневматски уљни судопер и извлачи са контролним резервоаром / Κινητός πνευματικός νεροχύτης λαβίου και εξολκέα με δεξαμενή ελέγχου / Fregadero y extractor de aceite neumático móvil con tanque de control / Dissipatore ed estrattore d'olio pneumatico mobile con serbatoio di controllo / Dissipador e extrator de óleo pneumático móvel com tanque de controle / Puits et extracteur d'huile pneumatiques mobiles avec réservoir de contrôle / Mobeile pneumatische olie-afzuiging en -afzuiger met controletank



NEW

10L CONTROL TANK

TANK DISCHARGE PRESSURE 1-3 BAR

70L TANK CAPACITY

6-8 BAR WORKING PRESSURE

25KG

Ref.	☒	EAN
10-811	0/1	5907558499858

Strzykawka do płynów eksploatacyjnych

Syringe for operating fluids / Spritze für Betriebsflüssigkeiten / Шприц для рабочих жидкостей / Шприц для операційних рідин / Fecskendő működési folyadékokhoz / Seringă pentru fluide de operare / Sřřřkačka na provozní kapaliny / Striekačka na prevádzkové kvapaliny / Brizga za operativne tekočine / Švirkštas darbiniam skysčiams / Širice darbišas šķidrumiem / Sústal töövedelike jaoks / Спринцовка за работни течности / Šprica za radne tekučine / Шприц за оперативне течности / Σύριγγα για υγρά λειτουργίας / Jeringa para fluidos operativos / Siringa per fluidi operativi / Seringa para fluidos operacionais / Seringue pour fluides opératoires / Smit voor bedrijfsvloestoffen

PP + PVC

HOSE 30cm + 30cm



Ref.	V [l]	☒	EAN
10-805	0,2	1/25	5907558495843
10-806	0,5	1/20	5907558495850
10-807	1,5	1/10	5907558495867

Mobilna zlewarka do oleju, grawitacyjna

Mobile oil siphon, gravity / Mobilier Ölsiphon, Schwerkraft / Передвижной масляный сифон, гравитационный / Мобільний масляний сифон, гравіт / Mobil olajszifon, gravitáció / Sifon mobil de ulei, gravitațional / Mobilní olejový sifon, gravitace / Mobilný olejový sifón, gravitačný / Mobilni sifon za olje, gravitacijski / Mobilus alyvos sifonas, gravitacija / Mobilais eļļas sifons, gravitācija / Mobilne õlisisoon, gravitatsioon / Мобилен маслен сифон, гравитачен / Mobilni sifon za ulje, gravitacijski / Мобилни сифон за уље, гравитација / Κινητό σιφόν λαβίου, βαρύτητας / Sifón de aceite móvil, gravedad / Sifone olio mobile, gravità / Sifão de óleo móvel, gravidade / Siphon à huile mobile, gravité / Mobeile oliesifon, zwaartekracht



NEW

TANK DISCHARGE PRESSURE 0,1-1 BAR

70L TANK CAPACITY

18KG

Ref.	☒	EAN
10-810	0/1	5907558499841

Pompa do oleju

Oil pump / Ölpumpe / Масляный насос / Pompa do oleju / Olajrutpa / Pompă de ulei / Čerpadlo na olej / Čerpadlo na olej / Срапка за олеј / Алуvos pompa / Ејас сүкпнiс / Ölүpmp / Маслена помпа / Ујпа руппа / Pompa za ulje / Αντλία λαδιού / Bomba para aceite / Pompa dell'olio / Bomba de óleo / Pompe à huile



- TELESCOPIC
- capacity 18L/min
- for barrels 60/200/220L
- 800x90x90mm
- PVC/NBR



Ref.	☒	EAN
11-565	0/10	5907558426496

Spryskiwacz ciśnieniowy warsztatowy

Workshop pressure washer / Werkstatt-Hochdruckreiniger / Мойка высокого давления для мастерских / Μύηλην νισοκόγυ τισυ για μαιςτρικι / Μύηλην tagasnyomású mosó / Mašinã de spãlat cu presiune de atelier / Dilenskã tlakovã mýčka / Dielenskã tlakovã umývačka / Tlačni čistilnik za delavnice / Dirbtuvių slėginis plovimo įrenginys / Darbnīcas spīdiena mazgātājs / Töökoja surverpesur / Работилница за миене под налягане / Radionički visokotlačni prgač / Радионична машина за прање под притиском / Πλυτήριο πίεσης συνεργείου / Hidrolimpadora de taller / Idropolitrice da officina / Máquina de lavar a pressão para oficina / Nettoyeur haute pression d'atelier / Werkplaats hogedrukreiniger



- NEW
- 1,5L
- PP+PE

Ref.	☒	EAN
10-815	0/20	5907558473933

Najazd samochodowy

Car ramp / Autorampe / Автомобильная раampa / Автомобильна раampa / Autó rámpa / Rampa auto / Nájезд na auto / Nájезд na auto / Avtorampa / Avtomobilij rampa / Auto rampa / Auto kaldtee / Рампа за кола / Rampa za auto / Ауто рампа / Рáмпа аутокінтэу / Rampa de coche / Rampa per auto / Rampa de carro / Rampe de voiture / Auto oprijlaat



- 910x310x170 mm
- 3000kg
- 2pcs
- PP

Ref.	[t]	☒	EAN
10-478	3	1/1	5907558495874

Podnośnik przesuwny

Floor jack / Schiebeheber / Домкрат подкатной / Домкрат / Aluminium hidraulikus krokodilemelő / Cric de podea / Přenosný zvedák / Zdvihák hydraulický vozík / Hidraulicna dvigalka / Domkratas / Pacēlājs / Tungraud / Крук / Hidraulicna auto dizalica / Hidraulicna auto dizalica / Γρύλος τρολλέϊ / Gato hidráulico / Sollevatore a carrello / Elevador de deslize / Cric mobile / Schuifhijshoestel

- 2.5 T
- MAX 385 mm MIN 85 mm H
- 12.5 kg

NEW

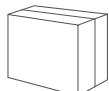

Ref.	[t]	☒	EAN
11-733	2.5	0/1	5907558476132

Podnośnik pneumatyczny

Air floor jack / Werkstattheber / Пневматический домкрат / Кран гаражний / Műhelydaru / Cric de atelier / Dilenský zvedák / Dielenský zdvihák / Dvigalka / Keltuväs dirbtuvėms / Profesjonālais pacēlājs / Töökojatungraud / Поддугач / Radionička dizalica / Radionička dizalica / εραπός για γκαράζ / Gato de taller / Cric da officina / Elevador de oficina / Vérin d'atelier / Werkplaats hijstoestel

- 3T
- MAX 420 mm MIN 145 mm H
- 6-12 bar
- 16,5 kg

NEW

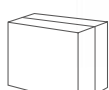

Ref.	[t]	☒	EAN
11-737	3.0	0/1	5907558476125

Ležanka warsztatowa

Car creeper / Werkstattliege / Лежанка рабочая / Візок на роликach для / Роботи під автомобілем / Szerelőágy, összecskható / Sezlong de atelier / Dilenská lehátka / Montážne ležadlo / Delavníški ležalnik / Sulankstoma lova, dirbtuvėms / Darba gulamkrėsls / Veerevalus / Монтёрско килмиче / Radionička ležaljka / Radionički kauč / Запλώστρα συνεργείου / Camilla de taller / Lettino sottomacchina / Carrinho de oficina / Divan d'atelier / Werkplaatsbank



Ref.	m _{max} [kg]	☒	EAN
11-601-1	150	1/1	5907558445282

Mata środowiskowa

Environmental mat / Umweltmatte / экологический коврик / екологічний мат / Környezetvédelmi szőnyeg / Covoară de mediu / Environmentální podložka / Environmentálna podložka / Okoljska podloga / Aplinkos kilimėlis / Vides paklājīņš / Keskonna matt / Экологична мат / Ekološki mat / Ekološka prostirka / περιβαλλοντικό χαλάκι / Alfombra ambiental / Tappetino ambientale / Tapete ambiental / Tapis environnemental / Milieumat



Ref.	☒	EAN
10-600	0/4	5907558499865

Składana mata do pracy pod samochodem

Foldable mat for working under the car / Faltbare Matte für Arbeiten unter dem Auto / Складної коврик для роботи під автомобілем / Sкладний килмич для роботи під автомобілем / Összecskható szőnyeg az autó alatti munkához / Covoară pliabil pentru lucrul sub mașină / Skladací podložka pro práci pod autem / Kladacia podložka na prácu pod autom / Skladacia podložka na prácu pod autom / Sulankstomas kilimėlis darbui po automobiliu / Salokāms paklājīņš darbam zem automašīnas / Kokkurandav matt auto all töötamiseks / Сгъваема постелка за работа под колата / Sklopiva prostirka za rad ispod automobila / Πτυσσόμενο χαλάκι για εργασία κάτω από το αυτοκίνητο / Alfombra plegable para trabajar debajo del coche / Tappetino pieghevole per lavorare sotto l'auto / Tapete dobrável para trabalhar embaixo do carro / Tapis pliable pour travailler sous la voiture / Opvouwbare mat voor werkzaamheden onder de auto

NEW

120x40x2 cm



Ref.	☒	EAN
10-599	0/4	5907558473957

Zestaw nasadek na przegubach, do świec zapłonowych

Set of sockets on joints, for spark plugs / Satz Steckschlüsseinsätze für Zündkerzen / Комплект насадок на шарниры для свечей зажигания / Набор розеток на шарниры, для свечок запалювання / Csatlakozók készlete gyújtógyertyákhoz / Set prize pe îmbinări, pentru bujii / Sada objímek na klouby, pro zapalovací svíčky / Sada objímek na kľby, pre zapalovacie sviečky / Komplet nastavkov na spojih, za vžigalne svečke / Kištukinių lizdų komplektas ant jungčių, uždegimo žvakėms / Savienojumu ligzdu komplekts, aizdedzes svecēm / Liigendite pesade komplekt, süüteküünalde jaoks / Комплект фасунги на шарниры, за свещи / Set utičnica na zglobovima, za svjećice / Set utičnica na zglobovima, za svećice / Set pričvín se armoús, gia jnouvči / Juego de vasos sobre juntas, para bujías / Serie di bussole su snodi, per candele / Conjunto de soquetes nas juntas, para velas de ignição / Jeu de douilles sur joints, pour bougies d'allumage / Set doppen op scharnieren, voor bougies

NEW



14 mm x 100 mm, 16 mm x 100 mm, 21 mm x 150 mm
14 mm x 150 mm, 16 mm x 150 mm, 16 mm x 280 mm



Ref.	☒	EAN
08-095	0/10	5907558473971

Ściernice do czyszczenia piast

Wheel hub grinder Schleifmittel zur Reinigung von Naben / Шлифовальные круги для очистки ступицы / Шлифувальні круги для очищення маточин / Kerékagy tisztító dörzstárcsa / Discuri pentru curățarea butucilor / Brusné kotoúče pro čištění nábojů / Brusné kotúče na čistenie nábojov / Brusni za čiščenje pest / Įrankiai ratų stebulių valymui / Ritepa rumbas tiršanas slėpdiskai / Rataste puhastamise lihvketad / Почистюващи четки за главни / Diskovi za čiščenje glavčine / Brusione ploče za čiščenje čvorišta / Τροχοί λείανσης για καθαρισμό πλήμνης τροχού / Amoladora para limpiar cubos de ruedas / Dischi abrasivi per la pulizia di mozzi / Escovas circulares para limpeza de cubos de rodas / Meules pour nettoyage des moyeux / Wielnaaf grinder voor reiniging

NEW

ø150 mm 1/2"



11-136

Ref.	☒	EAN
11-136	0/30	5907558411423
11-136-150	0/100	5907558474770



Prostownik

Car battery charger / Stromrichter / Выпрямитель / Выпрямляч / Egyenirányító / Redresor auto / Usměrnovač / Usmernovač / Usmernik / Įkroviklis / Akumulatora lādētājs / Alaldi / Τοκουσπρωμεν / Ispravljiač / Ispravljiač / Ανορθωτής / Rectificador / Raddrizzatore carica batterie / Gelijkrichter



Ref.	[A/W]	Ah	☒	EAN
11-891-1	4/70	3-120	1/10	5907558495126
11-892-1	6/100	3-150	1/10	5907558495126
11-893-1	10/160	3-200	1/10	5907558495140

Pad polerski

Foam pad / Polierkissen / Полировальная подушка / Полировальная подушка / Polírozó betét / Tampon de lustruit / Lešćići podložka / Lešćića podložka / Blazinica za poliranje / Poliravimo padas / Pulšanas spilventiņš / Poleerimisradi / Полирава гъба / Spružna za poliranje / Подлога за полирање / Σπόγγος στίλβωσης / Almohadilla de pulido / Tamponi per lucidatura / Almofada de polimento / Tampon de polissage / Polijstpad

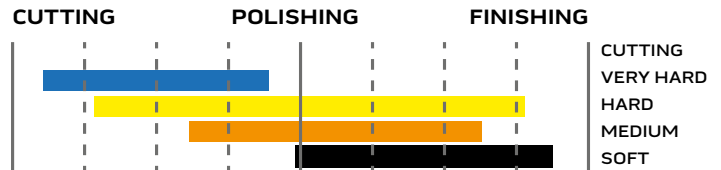

Ref.	Info	☒	EAN
08-978	cutting	1/100	5907558495157
08-979	very hard	1/100	5907558495164
08-980	hard	1/100	5907558495171
08-981	medium	1/100	5907558495188
08-982	soft	1/100	5907558495195

Miska magnetyczna, kątowa

Magnetic bowl, angular / Magnetschale, eckig / Магнитная чаша, угловая / Миска магнітна, кутова / Mágneses tál, szögletes / Bol magnetic, unghiular / Magnetická miska, hranatá / Magnetická miska, hranatá / Magneta posoda, kotna / Magnetinis dubuo, kampinis / Magnētiskā bļoda, kantaina / Magnetkauss, purgelīne / Магнитна чаша, ъглова / Magneta zdjela, ugaona / Магнетна посуда, угаона / Μαγνητικό μπολ, γωνιώδες / Cuenco magnético, angular / Ciotola magnetica, angolare / Tigela magnética, angular / Bol magnétique, angulaire / Magnetische schaal, hoekig



Ref.	☒	EAN
11-617	0/12	5907558499834

Pokrowiec ochronny, folia ECO 5w1

Protective cover, ECO foil 5in1 / Schutzhülle, ECO 5in1 Folie / Защитный чехол, фольга ECO 5in1 / Зашисне покрывта, фольга ECO 5e1 / Védőburkolat, ECO 5in1 fólia / Husa de protectie, folie ECO 5in1 / Ochranný kryt, fólie ECO 5v1 / Ochranný kryt, fólia ECO 5v1 / Zaščitna prevleka, folija ECO 5v1 / Apsauginis dangtelis, ECO 5in1 folija / Aizsargpārvalks, ECO 5in1 folija / Kaitsekate, ECO 5in1 foilium / Защитно покрывное ЕКО фоліу 5e1 / Zaštitna navlaka, ECO 5u1 folija / Защитни поклопац, ЕЦО 5y1 фоліуја / Funda protectora, lámina ECO 5 en 1

5in1
200 pcs



Ref. 10-485 1/1 EAN 5907558495270

Siatka zabezpieczająca do bagażnika

Safety net for the trunk / Sicherheitsnetz für den Kofferraum / Защитная сетка для багажника / Зашисна сітка для багажника / Biztonsági háló a csomagtartóhoz / Plasa de siguranta pentru portbagaj / Bezpečnostní síť do kufru / Ochranná sieť do kufru / Varnostna mreža za prtljažnik / Apsauginis tinklas bagažinei / Bagażniaka drożības tīkls / Pagasiruumi turvanõrk / Предпазна мрежа за багажника / Zaštitna mreža za prtljažnik / Sigurnosna mreža za prtljažnik / Δίκτυ ασφαλείας για το πορτπλαγκάζ / Red de seguridad para el maletero / Rete di sicurezza per il bagagliaio / Rede de segurança para o porta-malas / Filet de sécurité pour le coffre / Veiligheidsnet voor de kofferbak

90x70 cm



NEW

Ref. 10-860 0/48 EAN 5907558474572

Szczotka skrobaczka samochodowa do śniegu

Car snow scraper brush / Auto-Schneekratzer-Bürste / Автомобильная щетка для скребка снега / Щітка для чистення снігу для автомобіля / Autó hókaparagó kefe / Perie de răzuire a zăpezii pentru mașini / Kartáč na škrabání sněhu do auta / Škrabka na sneh do auta / Krtača za strganje snega v avtomobilu / Automobilinis sniego grandiklio šepetys / Automašīnas sniega skrāpja birste / Auto lumekkaripijahari / Четка за почистване на сняг за кола / Četka za čišćenje snijega za automobil / Автомобилска четка за стругање снега / Βούρτσα ξύστρας χιονιού αυτοκινήτου / Cerpillo rascador de nieve para coche / Spazzola raschia-neve per auto / Raspador de neve para automóveis / Brosse à neige pour voiture / Auto sneeuwscraper borstel

60 cm **2 in 1** BRUSH SCRAPER ERGONOMIC HANDLE



Ref. GD029 1/24 EAN 5907558495287

Wielowarstwowy pokrowiec na samochód

A multi-layer car cover / Mehrschichtige Autoabdeckung / Βαζατοσhαρωίύ αυτομοβιλνίύ chολ / Многослоный автомобильный чехол / Többretegű autóvédő / Husá auto multistrat / Vícevrstvý potah na auto / Viacvrstvový potah na auto / Večplastna prevleka za avto / Kelių sluoksnių / Automobila pārsegs vairākos slāņos / Покривало за кола в няколко слоя / Κάλυμμα αυτοκινήτου πολλαπλών στρώσεων / Copertura per auto multistrato / Funda de coche multicapa / Housse de voiture en plusieurs couches / Cobertura de automóvel em várias camadas / Autohoes in meerdere lagen /

REFLECTIONS **5,3 x 1,8 x 1,2m** 2 layers waterproof PEVA + cotton + waterproof belt



Ref. 10-475 0/5 EAN 5907558473940



Pistolet do opasek zaciskowych

Cable tie gun / Anziehpistole / Стяжной пистолет / Пистолет для краваток / Meghúzó pisztoly / Pistol cu cravată / Krvatová pistole / Krvatová pištol / Pištol za kравate / Kaklaraiščio pistoletas / Kaklasaites pistole / Kaabli sidumispistol / Пистолет за кабелни връзки / Pištolj za vezivanje kabala / Пистоль за везивање каблова / Πιστόλι γραβάτας / Pistola de atar / Pistola per cravatta / Pistola de amarrar / Pistolet à cravate / Spanpistol

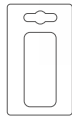

Ref. 01-615
 0/50
 EAN 5907558495386

Opaski zaciskowe

Band clips / Klemmschellen / Хомутки стяжные / Хомутки стяжні / Kábelkötegelő / Cleme conexiune / Hadicové pásky / Fixačné pásky / PVC vezice / Užspauđejas / Savilcēji / Rihmaklamber / PVC vezice / Κολλάρα σύσφιξης / Fascette per cavi / Cintas p. grampear / Bride de serrage / Klembanden



Ref. 01-672
 0/250
 EAN 5907558473919

Opaski zaciskowe

Band clips / Klemmschellen / Хомутки стяжные / Хомутки стяжні / Kábelkötegelő / Cleme conexiune / Hadicové pásky / Fixačné pásky / PVC vezice / Užspauđejas / Savilcēji / Rihmaklamber / PVC vezice / Κολλάρα σύσφιξης / Fascette per cavi / Cintas p. grampear / Bride de serrage / Klembanden

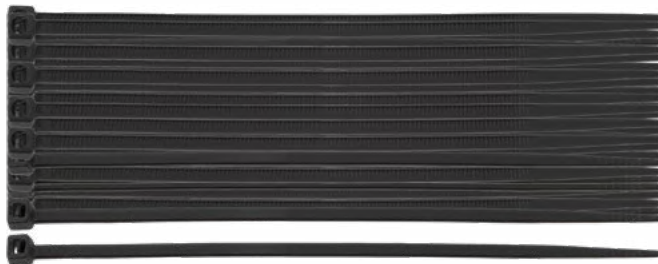

Ref.	W [mm]	L [mm]	N	☒	EAN
01-620	2.5	80	100	0/500	5907558473391
01-621	2.5	100	100	0/500	5907558473407
01-622	2.5	150	100	0/250	5907558473414
01-623	2.5	200	20	0/625	5907558473421
01-624	2.5	200	100	0/250	5907558473438
01-625	3.6	150	20	0/625	5907558473445
01-626	3.6	150	100	0/125	5907558473452
01-627	3.6	200	20	0/500	5907558473469
01-628	3.6	200	100	0/125	5907558473476
01-629	3.6	300	20	0/250	5907558473483
01-630	3.6	300	100	0/100	5907558473490
01-631	4.8	150	100	0/100	5907558473506
01-632	4.8	200	20	0/250	5907558473513
01-633	4.8	200	100	0/100	5907558473520
01-634	4.8	300	20	0/250	5907558473537
01-635	4.8	300	100	0/60	5907558473544
01-636	4.8	370	50	0/100	5907558473551
01-637	4.8	450	50	0/100	5907558473568
01-638	7.6	200	50	0/100	5907558473575
01-639	7.6	300	50	0/50	5907558473582
01-640	7.6	400	50	0/50	5907558473599
01-641	7.6	500	50	0/50	5907558473605
01-642	9.0	450	50	0/50	5907558473612
01-643	9.0	550	50	0/50	5907558473629
01-644	9.0	650	50	0/50	5907558473636
01-645	12.0	700	50	0/25	5907558473643

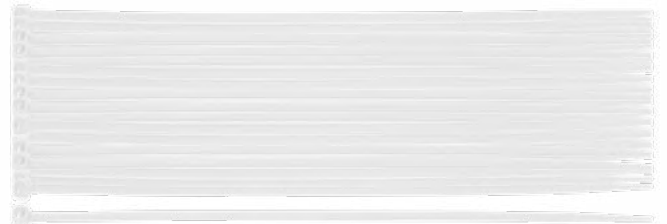

Ref.	W [mm]	L [mm]	N	☒	EAN
01-646	2.5	80	100	0/500	5907558473650
01-647	2.5	100	100	0/500	5907558473667
01-648	2.5	150	100	0/250	5907558473674
01-649	2.5	200	20	0/625	5907558473681
01-650	2.8	200	100	0/250	5907558473698
01-651	3.6	150	20	0/625	5907558473704
01-652	3.6	150	100	0/125	5907558473711
01-653	3.6	200	20	0/500	5907558473728
01-654	3.6	200	100	0/125	5907558473735
01-655	3.6	300	20	0/250	5907558473742
01-656	3.6	300	100	0/100	5907558473759
01-657	4.8	150	100	0/100	5907558473766
01-658	4.8	200	20	0/250	5907558473773
01-659	4.8	200	100	0/100	5907558473780
01-660	4.8	300	20	0/250	5907558473797
01-661	4.8	300	100	0/60	5907558473803
01-662	4.8	370	50	0/100	5907558473810
01-663	4.8	450	50	0/100	5907558473827
01-664	7.6	200	50	0/100	5907558473834
01-665	7.6	300	50	0/50	5907558473841
01-666	7.6	400	50	0/50	5907558473858
01-667	7.6	500	50	0/50	5907558473865
01-668	9.0	450	50	0/50	5907558473872
01-669	9.0	550	50	0/50	5907558473889
01-670	9.0	650	50	0/50	5907558473896
01-671	12.0	700	50	0/25	5907558473902

Miara zwijana

Pocket rule / Wickelmessband / Рулетка / Рулетка / Mérőszalag / Ruletă de măsurat / Měřidlo svinovací / Meter rolovací / Meter / Ruletë pënieinë / Mërlente rulete / Taskujoonlaud / Ponemka / Metar / Metar / Σπειρούμενη μετρητική ταινία / Flexómetro / Flessometro / Medidor enrolado / Mesure enroulée / Rolmaat



Ref.	L [m]	W [mm]	☒	EAN
67-221	2	16	12/144	5907558499926
67-222	5	19	12/96	5907558499933
67-223	5	25	6/72	5907558499940
67-224	7.5	25	6/48	5907558499957
67-225	10	25	6/36	5907558499964



Ref.	L [m]	W [mm]	☒	EAN
67-241	3	16	12/120	5907558472233
67-242	5	19	12/96	5907558472240
67-243	5	25	6/60	5907558472257
67-244	7.5	25	6/36	5907558472264
67-245	10	25	6/24	5907558472271



Ref.	L [m]	W [mm]	☒	EAN
67-231	2	16	12/144	5907558499971
67-232	5	19	12/96	5907558499988
67-233	5	25	6/72	5907558499995
67-234	7.5	25	6/48	5907558472219
67-235	10	25	6/36	5907558472226



Ref.	L [m]	W [mm]	☒	EAN
67-112-1	2	16	6/48	5907558495201
67-113-1	3	19	12/120	5907558495218
67-115-1	5	25	12/72	5907558495225
67-111-1	8	25	12/72	5907558495232



Ref.	L [m]	W [mm]	☒	EAN
67-200	2	13	0/240	5907558472288

Poziomnica

Sprit level / Richtwaage / Уровень / Рівень / Vízmerék / Nivel spring / Vodováha / Vodováha / Libela / Gulsčiukas alumininis / Līmeņrādis / Lood / Нивелур / Libela / Libela / Αλφάδι / Nivel / Livella / Nivel / Nivelle / Staand waterpas



Ref.	L [cm]	☒	EAN
71-131	40	0/50	5907558472233
71-132	60	0/50	5907558472240
71-133	80	0/40	5907558472257
71-134	100	0/40	5907558472264
71-135	120	0/40	5907558472271
71-136	150	0/25	5907558472233
71-137	180	0/25	5907558472240



Ref.	☒	EAN
71-002	10/60	5907558491531



Ref.	☒	EAN
71-220	6/60	5907558476088

Poziomnica do słupków

Post level / Wasserwaage für Pfähle / Уровень складной магнитный с шарниром / Рівень складний магнітний з шарніром / Oszlopvizmértek / Nivelă pentru montate / Sloupková vodováha / Sĺpiková vodováha / Libela za drogove / Kampinis gulsčiukas / Saliekamais magnēta līmenrādīs ar šarnīru / Postilood / Λιβέλα za στύλβουε / Libela za stupove / Libela za stubove / Μαγνητικό αλφάδι σωλήνων / Nivel para postes / Livella di controllo, mobile / Nivel / Nivelle à poteaux / Palenwaterpas



Ref. EAN
71-003 20/100 5907558471779

Κατόμιερz nastawny

Mitre gauge / Verstellbarer Winkelmesser / Универсальный угломер / Транспортур / Állítható szögmérő / Echer réglabil / Nastavovací úhlohměr / Nastavitel'ny uhlomer / Nastavljiv kotomer / Reguliuojamas kampainis / Universālais leņķmērs / Regulēeritav nurgatōdāik / Регулируем ъгломер / rodesivi kutomjer / Uglomer za podešavanje / μοιρογνωμόνιο γενικής χρήσης / Falsa escuadra / Goniometro / Transferidor regulável / Rapporteur réglable /



Ref. EAN
72-225 1/8 5907558471762

Grafit

Graphite / Graphit / Графитум / Графим / Grafit / Grafit / Grafit / Tuha / Grafit / Grafitas / Grafitis / Grafit / Графитум / Grafit / Grafit / Граφίτης / Engrase / Grafite / Grafite / Graphite / Grafiet

6 psc **BLACK**

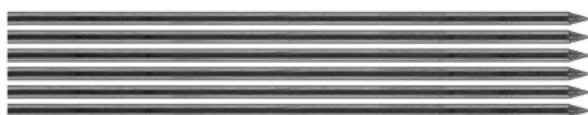

Ref. EAN
13-823 50/500 5907558430448



Mikrometr noniuszowy

Vernier micrometer / Feinmessschraube / Верньерный микрометр / Микрометр Верньера / Nullás mikrométer / Micrometru Vernier / Vernierovský mikrometr / Vernierov mikrometer / Vernierjev mikrometer / Vernier mikrometras / Vernjē mikrometrs / Vernier mikromeeter / Микрометр Верние / Vernier mikrometar / Нонус микрометар / Μικρόμετρο Βερνιέρας / Micrómetro vernier / Micrometro a corso / Micrómetro Vernier / Micromètre à vernier / Vernier-micrometer



Ref.	Ra [mm]		EAN
75-020	0-25	0/50	5907558491548
75-021	25-50	0/50	5907558491555
75-022	50-75	0/36	5907558491562
75-023	75-100	0/36	5907558491579

Łata tynkarska

Trapezoid floating rule / Anschlaglatte / Правило шпукатурное / Рейки тинькарські / Kardeczni / Răzătoare trapezoidală / Strhovaci lat' na omítku / Lata lichobežníková / Zidarska letev / Liniuotė tinkavimo darbams / Armetēja trapeces / Trapeziķuļine joonlaud / Маслар / Specijalna libela / Specijalna libela / Τραπεζοειδής μετρητής υποδιαστολής / Reglón de yesero / Biffa per intonaco / Remendo de estuque / Latte de plâtrage

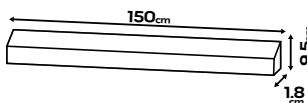

ALUMINIUM **150 CM**



Ref. EAN
72-552 0/10 5907558485554

Ścisk narożnikowy

Angle clamp / Winkelzwinne / Струбцина угловая / Струбцина нарижна / Sarokszorító / Clemă unghiulară / Rohová spojka / Zvierka rohová / Kotna spona / Gnybtai kampiniai / Spiles stūra / Nurgaklamber / Cmaea ъглова / Kutna stega / Ugaona stega / Γωνιακός σφιγκτήρας / Tornillo de banco de esquina / Morsa angolare / Grampo de canto / Serre-joint angulaire / Hoekklemmen

4 pcs **7,8 x 8,5 x 5,1 cm** **ABS** **PE** **5-22 mm**



Ref. EAN
45-492 1/40 5907558491524

Nóż z ostrzem trapezowym

Knife with utility blade / Messer mit Trapezklinge / Нож с трапецевидным лезвием / Ніж з трапецевидним вістрям / Trapézpengés összecusukható kés / Cutter cu tăiş trapezoidal / Nůž s trapézovým ostrím / Nůž s trapézovou čepelou / Nož s trapeznim rezilom / Peilis su trapezine geležte / Nazis ar trapezeida asmeni / Trapetsteraga nuga / Нож с трапецоидно острпе / Nož s trapezastom ostricom / Nož sa trapezastom ostricom / Μαχαίρι με τραπεζοειδή ακμή / Cúter con hoja trapezoidal / Taglierino a lama fissa / Faca com Lâminas de trapézio / Couteau à lame trapézoidale / Trapezium mes



Ref. 63-705 EAN 12/96 5907558472295

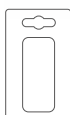

Ref. 63-706 EAN 12/48 5907558472325

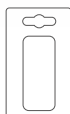

NEW



Ref. 63-708 EAN 0/80 5907558477153



Nóż trapezowy mini

Trapezoidal knife mini / Mini-Trapezmesser / Мини-нож трапецевидной формы / Мини-трапецеоподібний ніж / Mini trapéz alakú kés / Mini čužit trapezoidal / Mini lichoběžníkový nůž / Mini lichoběžníkový nůž / Nož s trapezoidnim rezilom, varnostni / Peilis su trapezijos formos asmenimis, saugus / Nazis ar trapezeida asmeni, drošs / Trapetsikujulise teraga nuga, seif / Нож с трапецоидно острпе / Nož s trapezastom ostricom / Nož sa trapezastom ostricom / Μαχαίρι με τραπεζοειδή ακμή / Cúter con hoja trapezoidal / Coltello a lama trapezoidale / Faca com lâminas de trapézio / Couteau à lame trapézoidale / Trapezium mes



Ref. 63-703 EAN 30/300 5907558499773



Ref. 63-707 EAN 10/80 5907558472356



Ref. 63-704 EAN 10/80 5907558472318

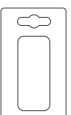

Ostrza trapezowe

Knife blades / Trapezklingen / Лезвия трапецевидные / Laza nožovoi / Pvc penge / Čužit lamě / Lichoběžníkové ostří / Ostrie lichoběžníkové / Nadomestna rezila / Keičiamos geležtės / Naža asmeni / Noaterad / Острпе резервно / Nožiči za skalpel / Nožici za skalpel / Ανταλλακτικές λεπίδες / Hojas trapezoidales / Lame trapezoidali / Lâminasde trapézio / Tranchants trapézoidaux / Trapezium mesbladen



NEW

Ref. 64-016 EAN 0/100 5907558477160

Nóż do folii i taśm

Film and tape cutter / Film- und Bandschneider / Устройство для резки пленки и ленты / Пліюка та різак для стрічок / Film- és szalagvágó / Tăietor de film și bandă / Rezačka fólii a pásek / Rezačka fólii a pásek / Rezalnik filmov in trakov / Plėvelės ir juostos pjaustytuvas / Plėves un lentes griezējs / Lindi lōikur / Нож за фолпо и лента / Rezač trake / Резач траке / Κόφτης ταινιών και ταινιών / Cortadora de película y cinta / Taglierina per pellicole e nastri / Cortador de película e de fita / Coupeur de films et de bandes / Film- en tapesnijder



Ref. 63-018 EAN 10/80 5907558499766

Nožyczki

Scissors / Schere / Ножницы / Ножуци / Olló / Forjate / Nůžky / Nožnice / Škarje / Žirkles / Šķēres / Käärid / Ножуци / Škare / Μακασε / Ψαλίδι / Tijeras / Forbici / Tesoura / Ciseaux / Schaar



215 mm

Ref. 64-005 EAN 12/144 5907558426588

Nožyczki kute

Forged scissors / Geschmiedete Schere / Кованые ножницы / Ковані ножуци / Kovácsolt olló / Foarfecе forjate / Kované nůžky / Kované nožnice / Kovane škarje / Kaltinēs žirkles / Kaltas šķēres / Sepistatud käärid / Ковани ножуци / Kovane škare / Коване макасе / Σφυρήλατο ψαλίδ / Tijeras forjadas / Forbici forjate / Tesoura forjada / Ciseaux forgés / Gesmede schaar

200 mm FORGED JAWS TITANIUM COATED



NEW

Ref. 64-003 EAN 12/72 5907558474909

Nožyczki krawieckie

Sewing scissors / Nähscchere / Швейные ножницы / Швейні ножуци / Varró olló / Foarfecе de cusut / Šići nůžky / Šijacie nožnice / Šivalne škarje / Stuvimo žirkles / Šūšanas šķēres / Ūtbluskäärid / Швейицки ножуци / Šivaće škare / Μακασе за шивење / Ψαλίδι ραπτικής / Tijeras de coser / Forbici da cucito / Tesoura de costura / Ciseaux à coudre / Naaischaar

200 mm FORGED JAWS HIGH QUALITY



NEW

Ref. 64-004 EAN 10/60 5907558474893

Dispenser do taśmy

Tape dispenser / Klebebandabroller / Диспенсер для ленты / Диспенсер для стрічки / Szalagadagoló / Distributor de bandă / Dávkovač pásky / Dávkovač pásky / Razpršilec traku / Juostos dozatorius / Lentės dozators / Kleplindi dosaator / Диспенсър / Dozator ljepljive trake / Дозатор лепенљиве траке / Διανομέας ταινίας / Dispensador de cinta / Dispenser per nastro adesivo / Dispensador de fita adesiva / Distributeur de ruban adhésif / Tapeafroller



50 mm

NEW

Ref. 56-041 EAN 0/24 5907558475258

Nożyki modelarskie

Precision knives / Messer für Modellbauzwecke / Ножу моделуцта / Ножі моделіцта / Modellezzó kések / Foarfeca / Modelářské nůžky / Modelárske nožiky / Modelarske škarje / Žirkles modelaviimui / Modelēšanas naži / Hobikäärid / Моделуерски ножчета / Rezbarske škarice / Modelarski nožići / Μαχαίρια μοντελαριού / Cuchillos de precisión / Taglierini per modellismo / Facas p. modelação / Couteau de modelage / Precisie kleine messen



14 pcs

AL handle

Ref. 63-023 EAN 24/96 5902062025722

Skrobak

Scraper / Ziehklinge / Скребок / Скребок / Film- és szalagvágó / Rázuitor / Škrabka / Škrabka / Strgalo / Gremžtukas / Skrāpis / Kaabits / Стъргалка / Strugač / Спрувач / Ξύστρα / Rascador / Raschietto / Raspador / Grattoir / Schrapper



6 blades 108mm

EASY BLADE CHANGE STAINLESS STEEL

RUBBER GRIP TPR +ABS

Ref. 63-019 EAN 12/96 5907558499759

Punktak

Centre punch / Körner / Кернер / Кернер / Pontozó / Punctator / Důlčik / Razník / Točkalo / Žymeklis / Punktsītis / Augmārgisti / Керна / Ručni bušač / Obeleživač / Πόντα σιδέρου / Punzón centrador / Punzone / Punção / Pointeau / Doorslag



CrV steel 58-64 HRC AUTO

Ref. 33-090 EAN 0/20 5907558426243

Szczotka druciana do kostki brukowej ze skrobakiem

Wire brush for paving stones with scraper / Drahtbürste für Pflastersteine mit Abstreifer / Щетка для тротуарной плитки со скребком / Дротяна щітка для бруківки зі скребком / Drátkefe burkolókövekhez kaparóval / Perie de sârmă pentru pavele cu racletă / Drátěný kartáč na dlažbu se škrabkou / Drôtená kefa na dlažbu so škrabkou / Žična krtača za tlakovce s strgalom / Vielinis šaligatvio plytelių šepetys su grandikliu / Stieplu birste bručakmeņiem ar skrāpi / Traathari sillutuskividele koos kaabitsaga / Телена четка за тротоарни плочки със стъргалка / Žična četka za porločavanje sa strugalicom / Сщзотна друциана до костки брукowej зе скробакием / Συρμάτινη βούρτσα για κυβόλιθους με ξύστρα / Cepillo de alambre para adoquines con rascador / Spazzola metallica per pavimentazione con raschietto / Escova de arame para pedras de pavimentação com raspador / Brosse métallique pour pavés avec raclette / Staalborstel voor straatstenen met schrapper /



Ref. 39-220 EAN 0/75 5907558477122

Nitownica

Riveter / Nietmaschine / Заклепочник / Клепальный инструмент / Popszegecszó / Maşină de nituit / Nytovačka / Kliešte nitovacie oceľové / Pištola za kovčenje / Kniediklis / Kniežu stangas / Needitangid / Нитачка / Klijesta za zakovice / Pistolj za pop nitne / Ηλκι / Remachadora / Rivettatrice / Rebitadora / Riveuse / Klinknagelmaschine



Steel	Ø 2.4/3.0/3.2/4.0/4.8/5.0 mm	Al	Ø 2.4/3.0/3.2/4.0/4.8/5.0 mm
Cu	Ø 2.4/3.0/3.2/4.0/4.8/5.0 mm	Stainless Steel	Ø 2.4/3.0/3.2/4.0 mm

Ref.	Ø [mm]	L [mm]	⊠	EAN
18-101-1	2.4/3.2/4.0/4.8	264	6/24	5907558497304



Steel	Ø 2.4/3.0/3.2/4.0/4.8/5.0 mm	Al	Ø 2.4/3.0/3.2/4.0/4.8/5.0 mm
Cu	Ø 2.4/3.0/3.2/4.0/4.8/5.0 mm	Stainless Steel	Ø 2.4/3.0/3.2/4.0/4.8/5.0 mm

Ref.	Ø [mm]	L [mm]	⊠	EAN
18-103-1	2.4/3.2/4.0/4.8	265	6/24	5907558497328

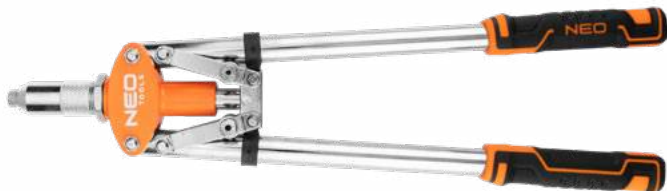

Steel	Ø 2.4/3.0/3.2/4.0/4.8/5.0/6.0/6.4 mm	Al	Ø 2.4/3.0/3.2/4.0/4.8/5.0/6.0/6.4 mm
Cu	Ø 2.4/3.0/3.2/4.0/4.8/5.0/6.0/6.4 mm	Stainless Steel	Ø 2.4/3.0/3.2/4.0/4.8/5.0/6.0/6.4 mm

Ref.	Ø [mm]	L [mm]	m [kg]	⊠	EAN
18-106-1	3.2/4.0/4.8/6.0/6.4	480	1.95	0/12	5907558497380



Steel	Ø 2.4/3.0/3.2 mm	Al	Ø 2.4/3.0/3.2/4.0/4.8/5.0 mm
Cu	Ø 2.4/3.0/3.2 mm	Stainless Steel	Ø 2.4 mm

Ref.	Ø [mm]	L [mm]	⊠	EAN
18-102-1	2.4/3.2/4.0/4.8	280	6/24	5907558497311

Zszywacz tapicerski

Stapler / Polsterheftmaschine / Стенплер обивочный / Стенплер / Tűzágép / Capsator / Sešivačka čalounická / Sponkovačka / Spenjač / Kabių pistoletas / Skavu pistole / Klammerdaja / Танкер за мелчерна / Klamerica / Heftalica / Μηχανή συρραφής για εμπέτασμα / Grapadora de tapicero / Cucitrice da tappezziere / Máquina de pontear / Agrafeuse de tapisserie / Hechters

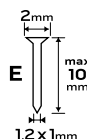
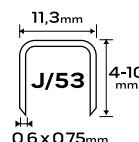

Ref.	⊠	EAN
16-050	1/10	5907558483277

Lutownica oporowa

Soldering iron / WiderstandsLötkolben / Паяльник контактный / Паяльник / Forrasztóráka / Ciocan de lipit / Odporová páječka / Pájkovačka hrotová odporová / Spajkalnik / Lituoklis / Lodāmurs / Jootekalb / Паяльник / Električna lemilica / Pistolj lemilica / Εμβολο συγκολλησεων / Soldador / Soldatoio da resistenza / Soldador por resistència / Fer à souder à résistance



Ref.	P [W]	L [mm]	⊠	EAN
19-155	40	235	6/24	5907558497304
19-156	60	240	6/24	5907558497304
19-157	100	270	6/24	5907558497304

Lutownica bezprzewodowa

Cordless soldering iron / Kabelloser Lötkolben / Аккумуляторный паяльник / Аккумуляторный паяльник / Akkumulátoros forrasztóráka / Fier de lipit fără fir / Akumulátorová páječka / Bezdátová spajkovačka / Brežični spajkalnik / Belaidis lituoklis / Bezvadu lodāmurs / Juhtmeta jootekalb / Безжичен паяльник / Bežično lemilo / Безжична мелулица / Ασύρματο κολλητήρι / Soldador inalámbrico / Soldatore a batteria / Ferro de soldar sem fios / Fer à souder sans fil / Draadloze soldeerbout



Ref.	⊠	EAN
19-250	10/20	5907558491449

Lutownica do plastiku + zszywki

Plastic welder + staples / Kunststoffschweißgerät + Heftklammern / Сварщик пластика + скобы / Зварювач пластику + скоби / Műanyag hegesztő + kapcsok / Sudor plastic + capse / Svářečka plastů + sponky / Zváračka plastov + sponky / Varilec plastike + sponke / Plastikinis suvirintojas + kabės / Plastmasas metinātājs + skavas / Plastikust keevitaja + klambrid / Пластмассов заварчик + скобы / Varilica za plastiku + sprajalice / Пластични заварувач + снајалуце / Пластиковός συγκολλητής + συνδετήρες / Soldador de plástico + grapas / Saldatore plastica + graffette / Soldador de plástico + grampos / Soudeuse plastique + agrafes / Kunststof lasapparaat + nietjes /



Ref. 19-158 EAN 5907558475272

Zszywki do plastiku

Staples for plastic / Heftklammern für Kunststoff / Скобы для пластика / Набор пластикових скоб / Tűzőkapcsok műanyaghoz / Capse pentru plastic / Svorky na plasty / Svorky na plasty / Sponke za plastiko / Plastikto sqvarželës / Plastmasas skavas / Plastist klambrid / Скобы за пластмасса / Plastične sprajalice / Пластичне снајалуце / Συρραπτικά για πλαστικό / Grapas para plástico / Puntti metallici per plastica / Agrafas para plástico / Agrafes pour plastique / Nietjes voor plastic



NEW

Ref. 19-159 EAN 5907558475289

Poduszka monterska

Mounting Cushion / Montagekissen / Монтажная подушка / Монтажна подушка / Szerelőpárna / Perné de montaj / Montážní polštárek / Montážni vankúšik / Montažna blazina / Pagalvė montavimo / Montāžas spilvens / Paigalduspadi / Монтажна възглавница / Montažni jastuk / Монтажни јастук / Μαξιλάρι τοποθέτησης / Cojín de montaje / Cuscino di montaggio / Almofoada de montagem / Coussin de montage / Montage kussen



Ref. 50-900 EAN 5907558495249

Uchwyt do brzeszczotów, uniwersalny

Saw blade holder, universal / Sägeblatthalter, universal / Держатель пильного диска, универсальный / Тримач пильного полотна, универсальный / Fűrészlap-tartó, univerzális / Suport pentru rânza de ferăstrău, universal / Držák pilového kotouče, univerzální / Držiak pilového kotúča, univerzálny / Držalo za žagin list, univerzalno / Pjūklø disklo laikiklis, universalus / Žąga asmens turētājs, universāls / Saetera hoidik, universaalne / Държач за трион, универсален / Držák lista pile, univerzalan / Држач сечива тестере, универзалан / Υποβοήθι προανάλαμας, γενικής χρήσης / Portacuchillas de sierra, universal / Supporto per lama, universale / Suporte da lâmina de serra, universal / Porte-lame de scie, universel / Zaaqbladhouder, universeel



Ref. 44-650 EAN 5907558440744

Wózek transportowy

Multipurpose trolley / Transportwagen / Тележка грузовая / Візок транспортувальний / Szállítókosci / Cărucior de transport / Převravní vozík / Prepravný vozík / Transportni voziček / Maišelis transportavimui / Ratiņi / Veokāru / Транспортна количка / Transportna kolica / Transportna kolica / Καρότσια μεταφοράς / Carretila de transporte / Carrello di trasporto / Carrinho de transporte / Chariot de manutention / Transportwagen



Ref. 84-406 EAN 5907558430424



Marker

Marker / Marker / маркер / маркер / Marker / Marker / Popisovač / Popisovač / Marker / Markeris / Markieris / Marker / маркер / Marker / Marker / Μαρκαδόρος / Marcador / Marker / Marcador / Marqueur / Markeerstift



NEW

Ref.	✉	EAN
13-850	12/144	5907558475944
13-852	12/144	5907558475968
13-856	12/144	5907558476002



NEW

Ref.	✉	EAN
13-851	12/144	5907558475951
13-853	12/144	5907558475975
13-857	12/144	5907558476019



NEW

Ref.	✉	EAN
13-855	300/900	5907558475982
13-858	200/600	5907558476026



NEW

Ref.	✉	EAN
13-860	144/864	5907558477115



NEW

Ref.	✉	EAN
13-865	144/1152	5907558477108

Reper do wylewek

Leveling scale / Nivellierskala / Шкала выравнивания / Шкала нівелювання / Szintező skála / Scala de nivelare / Ораковач про вүводу / Ораковач пре вүлевку / Ponavljalnik za izlivke / Pakartojimo itaisas čurkšlėms / Atkārtotājs sprauslām / Kordusvoolikute kordusvoolik / Ποστομην за чүчүрү / Mjerilo za estrihe / Мерило за нивульице / Επαληθής για στόμια / Repetidor para caños / Ripetitore per beccucci / Repetidor de bicos / Répétiteur de becs / Herhaler voor uitlopen



Ref.	✉	EAN
50-430	0/250	5907558430455

Worki na odpady

Waste bags / Abfallsäcke / Мешки для мусора / Мишки для сміття / Hulladékgyűjtő zsákok / Saci pentru deseuri / Pytle na odpad / Vrecia na odpad / Vreče za odpadke / Atlieky mašai / Atkritumu maisi / Prügikotid / Чували за отпадци / Vreče za otpad / Kesce za otpad / Σάκοι απορριμμάτων / Bolsas de basura / Sacchi per rifiuti / Sacos de lixo / Sacs à déchets / Afvalzakken



x10

60 L 35 μm

60x70 cm

120 L 40 μm

70x140 cm

200 L 40 μm

90x120 cm

NEW

Ref.	V [l]	☒	EAN
15-990	60	0/20	5906692015924
15-991	120	0/20	5906692015931
15-992	200	0/10	5906692015948



x10

60 L 35 μm

60x70 cm

120 L 35 μm

70x110 cm

200 L 40 μm

90x120 cm

NEW

Ref.	V [l]	☒	EAN
15-993	60	0/20	5906692015948
15-994	120	0/24	5906692015955
15-995	200	0/10	5906692015962

Kurtyna, osłona przeciwpyłowa z zamkiem

Curtain, dust cover with lock / Vorhang, Staubschutz mit Reißverschluss / Шторка, пылезационный чехол на молнии / Штора, пилозахисний чохол на блискавці / Fügőny, porvédő zárral / Perdea, sacac de protecție împotriva prafului cu blocare / Clona, protiprachový kryt se zámkem / Závěs, protiprachový kryt so zámkom / Zavesa, protiprašni pokrov s ključavnico / Užualoia, dulkių dangtelis su užraktu / Aizkars, putekļu sega ar slēdzēni / Tõmbelukuga ukse tolmukaitse / Завеса, капак за прах със заключване / Zavjesa, zaštitna od prašine s bravom / Завеса, поклопац за праšину са бравом / Κοιρίνα, κάλυμμα σκόνης με κλειδαριά



TYPE L



TYPE I



Ref.	type	☒	EAN
49-800	L	0/10	5907558491586
49-801	I	0/10	5907558491593

Linka

Line / Seil / Верева / Шнур / Zsinór / Linie / Šňůra / Šnúra / Vrvica / Lynas / Virve / Kõis / Върже / Uže / Κοιροναύ / Σχοινί / Cuerda / Corda / Linha / Corde /



NEW **PP**

Ref.	L [m]	Ø [mm]	daN	MAX kg	☒	EAN
49-941	600	3	160	160	0/1	5907558476545
49-942	400	4	180	180	0/1	5907558476552
49-943	300	6	360	360	0/1	5907558476569
49-944	300	8	650	650	0/1	5907558476576
49-945	200	10	885	885	0/1	5907558476583
49-946	130	12	1160	1160	0/1	5907558476590
49-947	100	14	1600	1600	0/1	5907558476606
49-948	60	16	1750	1750	0/1	5907558476613

Sznurek

Rope / Schnur / Шнурок / Шнур / Spárga / Snur / Provázek / Šnúrka / Vrv / Raištelis / Aukliņa / Nöör / Върже / Κοιροναύ / Κοιροναύ, uzica / Κορδόν / Cuerda / Spago / Corda / Fil



PP

Ref.	L [m]	☒	EAN
49-932	250	0/112	5907558476095
49-933	500	0/8	5907558476101
49-934	2000	2/12	5907558476118

Szpaczła do wiadra

Bucket spatula / Eimer Spachtel / Ведро-шпатель / Κοιρωσούι шпатель / Vödör spatula / Spatulă cu găleată / Špachtle / Špachtla universálna / Strgalo / Gļaištyklē / Špaktelis / Kaabits / Шпакля / Višenamjenska lopatica za kit / Spahlla / Σπάτουλα οδοντωτή / Espátula universal / Spatola / Betumadeira / Spatule / Platuurmes



STAINLESS STEEL

NEW

Ref.	☒	EAN
50-361	12/60	5907558474916



Mata składana do siedzenia

Folding seat mat / Складной коврик для сидения / Складаний килимок для сидіння / Összecsukható szőnyeg az ülőhelyhez / Covoraș pliabil pentru scaune / Folding seat mat / Klappsitzmatte / Складной коврик для сидения / Складаний килимок для сидіння / Összecsukható ülészőnyeg / Covoraș rabatabil pentru scaune / Skládací podložka pod sedadlo / Skladacia podložka pod sedadlo / Zložljiva podloga za sedeže / Sulankstomas sėdūnių kilimėlis / Salokāms sēdekļu paklājs / Kokkupandav matt istumiseks / Съваема постелна за седалката / Sklopiva prostirka za sedenje / Склопива простирка за седиште / Πτυσσόμενο χαλάκι για καθίσματα / Alfombrilla de asiento plegable / Tappetino pieghevole / Tapete de banco rebatível / Tapis de siège pliable / Orklapbare stoelmat

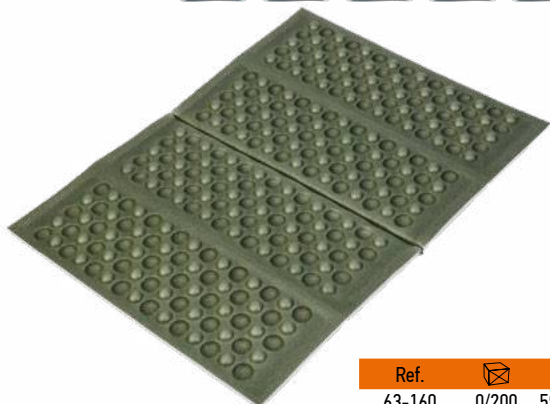

Ref.	📦	EAN
63-160	0/200	5907558499575

Karimata składana

Folding carrimat / Klappkarimat / Складной карримат / Складаний карримат / Összecsukható szőnyeg / Carrimat pliabil / Skládací karimatka / Skladací karimatka / Zložljivi karimatski voziček / Sulankstomas karimatas / Salokāmie karinātie ratiņi / Kokkupandav auto / Съваема карима / Sklopiva prostirka za spanje / Склопива простирка за спавање / Πτυσσόμενο carrimat / Carrimato plegable / Carrimato pieghevole / Carrilhão dobrável / Carrimat pliant / Vouwwagen

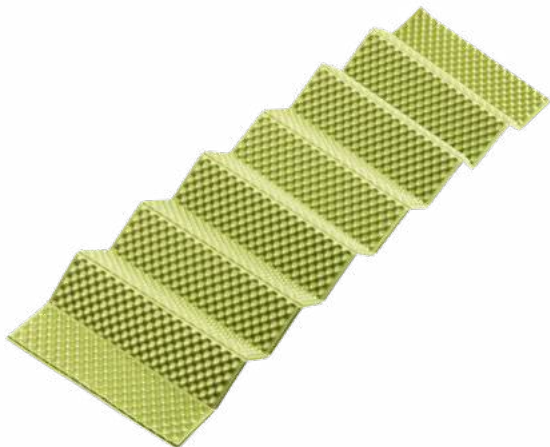

Ref.	📦	EAN
63-161	0/20	5907558499582

Ręcznik szybko schnący

Quick-dry towel / Schnell trocknendes Handtuch / Быстросохнущее полотенце / Швидкоковисихаючий рушник / Gyorsan száradó törölköző / Prosop cu uscare rapidă / Rychleschnoucí ručník / Rýchloschnúci uterák / Hitro suha brisača / Greitai džiūstantis rankšluostis / Ātri žūstošs dvielis / Kiirelt kuivan rätik / Кърпа за бързо сушене / Ručník za brzo sušenje / Пешкир који се брзо суши / Πετσέτα γρήγορου στεγνώματος / Toalla de secado rápido / Asciugamano ad asciugatura rapida / Toalha de secagem rápida / Serviette à séchage rapide / Sneldrogende handdoek



Ref.	📦	EAN
63-163	0/100	5907558499490

Prysznic kempingowy

Camping shower / Camping Dusche / Душ для кемпинга / Похідний душ / Kemping zuhanyzó / Duș de camping / Kempinková sprcha / Kempová sprcha / Tuš za kampinganje / Kempingo duša / Kempinga duša / Kāmpingu dušš / Душ за кэмпингэ / Tuš za kampinganje / Туш за камповање / Camping vtuos / Ducha de camping / Doccia da campeggio / Duche de campismo / Douche de camping / Camping douche



Ref.	📦	EAN
63-164	0/36	5907558499506

Worek wodoodporny

Waterproof bag / Wasserdichter Beutel / Водонепроницаемая сумка / Водонепроничний мішок / Vízálló tásk / Geantă impermeabilă / Vodotěsný vak / Vodotesná taška / Nepremočljiva vreča / Neperšlampamas krepšys / Ūdensnecaurlaidīgs maiss / Veekindel kott / Водоустойчива чанта / Vodootporna torba / Водоотпорна торба / Абидрохот таанта / Bolsa impermeable / Borsa impermeabile / Saco impermeável / Sac étanche / Waterdichte tas



Ref.	V [l]	📦	EAN
63-169	5	0/250	5907558499544
63-170	10	0/200	5907558499551

Plecak wodoodporny

Waterproof bag / Wasserdichter Sack / Водонепроницаемая сумка / Водонепроничний мішок / Vízálló tásk / Sac impermeabil / Vodotěsná taška / Vodotesná taška / Nepremočljiva vreča / Neperšlampamas krepšys / Ūdensnecaurlaidīga soma / veekindel seljakott / Водоустойчива чанта / vodootporan ruksak / водоотпорни ранца / абидрохот саккибо платъс / Bolsa estanca / Borsa impermeabile / Saco impermeável / Sac étanche / Waterdichte tas



Ref.	📦	EAN
63-171	0/20	5907558499568



Ref.	📦	EAN
63-162	0/25	5907558499537

Butelka turystyczna

Water bottle / Wasserflasche / Бутылка для воды / Пляшка води / Vizes palack / Sticliá de ará / Láhev na vodu / Flaša na vodu / Steklenica za vodo / Vandens butelis / Üdens pudele / Turistmüdel / Бутылка за вода / Turistička boca / Туристичка боца / Τουριστικό μπουκάλι / Botella de agua / Bottiglia d'acqua / Garrafa de água / Bouteille d'eau / Waterfles



800 ml

TRITAN
BPA FREE



Ref. 63-167 EAN 5907558499483

Piersiówka

Breastplate / Brustschild / Нагрудный знак / Нагрудник / Mellvért / Plastron / Prsní štít / Prsný štít / Prsna plošča / Krūtinės lenta / Krūšu plāksne / Rinnpraat / Нагрудник / Pljoska / Пльоска / Θώρακας / Coraza / Corpetto / Peitoral / Plastron / Plastron /



220 ml

STAINLESS
STEEL

Ref. 63-174 EAN 5907558499476

Kieliszki turystyczne

Tourist glasses / Touristische Brille / Туристические очки / Туристичні окуляри / Turista szemüveg / Ochelari pentru turiști / Turistické brýle / Turistické okuliare / Turistična očala / Turistiniai akiniai / Turisma brillas / Turisti prillid / Туристически очила / Turističke naočale / Туристичке наочаре / Τουριστικά γυαλιά / Gafas turísticas / Occhiali da turismo / Oculos para turistas / Lunettes touristiques / Toeristische bril



x6 30 ml STAINLESS STEEL

Ref. 63-173 EAN 5907558499469

Niezbędnik

Essentials / Grundlegendes / Essentials / Essentials / Essentials / Essenziële / Essentials / Základy / Essentials / Essentials / Essentials / Essentials / Osnove / Эссенциалс / Βασικά στοιχεία / Esenciales / Essenziali / Essenciais / Essentiels / Essentiële



3in1

ABS

Ref. 63-168 EAN 5907558499520

Ponczo termiczne NRC

NRC thermal poncho / NRC Thermo-Poncho / Термопончо NRC / Термопончо NRC / NRC termál poncsó / Poncho termic NRC / Termální pončo NRC / Termo pončo NRC / Termični pončo NRC / NRC terminis pončas / NRC termáils pončo / NRC termiline pončo / Термално пончо NRC / NRC termalni pončo / HPLC термални пончо / Вєрміко пончо NRC / Poncho térmico NRC / Poncho termico NRC / Poncho térmico NRC / Poncho thermique du CNRC / NRC thermische poncho



142 x 96cm WATER PROOF

90% HEAT REFLECTIVITY WIND PROOF

77g

Ref. 63-172 EAN 5907558499513

Plaszcz przeciwdeszczowy

Raincoat / Regenjacke / Плащ / Дождюк / Esőkabát / Pelerina de ploaie / Pláštěnka / Pláštenka / Dežni plašč / Lietpaltis / Lietusmētelis / Vihmamantel / Дъждобран / Kabanica / Кишини мантил / Αδιάβροχο / Impermeable / Impermeabile / Capa de chuva / Impermeable / Regenjas



ONE SIZE

PE

Ref. 63-176 EAN 5907558440706

Tarp wodoodporny

Tarp waterproof / Tarp wasserdicht / Брезент водонепроницаемый / Брезент водонепроникний / Vízálló ponyva / Prelata impermeabilă / Voděodolná plachta / Plachta vodotesná / Nepremočljiva ponjava / Neperšlampamas tentas / Brezenta ūdensnecaurlaidīga / Veekindel tarp / Водоустойчива брезент / Vodootporna cerada / Водоотпорна церада / Αδιάβροχος μολισμας / Lona impermeable / Telo impermeabile / Lona impermeável / Bâche impermeable / Dekzeil waterdicht



1x tarp
4x hooks
6x ropes
2x bags

210T POLIESTER

x6

360 x 290 cm

Ref. 63-180 EAN 5907558440751

Krzeseło turystyczne

Tourist chair / Touristenstuhl / Туристический стул / Стілець туристичний / Turista szék / Scaun turistic / Turistická židle / Turistická stolička / Turistični stol / Turistinē kēdē / Tūrisma krēsls / Туристическу стол / Τουριστική καρέκλα / Silla de turismo / Sedia da turismo / Cadeira de turismo / Chaise touristique / Toeristenstoel



MATERIAL
600D
Polyester

MAX
120kg

W **80 cm**
x
D **70 cm**
H **80 cm**

Ref. 63-177 0/4 EAN 5907558440720

Krzesełko biwakowe

Camping chair / Кемпинг стул / Кемпінгове крісло / Kemping szék / Scaun de camping / Kemptingová židle / Kemptingová stolička / Stol za kampinganje / Stovyklavietēs kēdē / Kemptinga krēsls / Matkatool / Къмпинг стол / Stolica za kampinganje / Столица за кампованье / Καρέκλα κάμπινγκ / Sedia da campeggio / Silla de camping / Cadeira de acampamento / Chaise de camping / Kampeerstool



Ref. 63-157 1/8 EAN 5907558493597

Zestaw biwakowy stół i 4 krzesła

Camping table set with 4 chairs / Походный стол с 4 стульями / Кемпінговий стіл з 4 стільцями / Kemptingasztal készlet 4 székkal / Set masa de camping cu 4 scaune / Sada kemptingového stolu se 4 židlemi / Súprava kemptingového stola so 4 stoličkami / Komplet mize za kampinganje s 4 stoli / Kemptingo stalo komplektas su 4 kėdėmis / Kemptinga galda komplektas ar 4 krėslėliem / Matkalaua komplekt 4 tooliga / Къмпинг маса с 4 стола / Stol za kampinganje sa 4 stolice / Сем стола за кампованье са 4 столуце / Σετ τραπέζακι κάμπινγκ με 4 καρέκλες / Tavolo da campeggio con 4 sedie / Juego de mesa de camping con 4 sillas / Conjunto de mesa de camping com 4 cadeiras / Table de camping avec 4 chaises / Campingtafelset met 4 stoelen

set size folded:
60x60
x**10.5cm**

table size:
120x60
x**54cm**

chair size:
30x28
x**40cm**

TRANSPORT
HANDLE

MDF
+
ALUMINIUM

ADJUSTABLE
HEIGHT
MAX
70cm

loading
capacity
of chair:
110kg



Ref. 63-159 1/1 EAN 5907558493658

Lornetka

Binoculars / Ferngläser / Бинокли / Бінюкль / Távszó / Binoclu / Dalekohledy / Ďalekohľad / Daljnogledi / Žiūronai / Binoklis / Binokkel / Бинокли / Dvogled / Двоглед / Kuália / Prismáticos / Binocolo / Binóculos / Jumelles / Verrekijker /



Ref. 63-165 0/20 EAN 5907558499605



Ref. 63-166 0/10 EAN 5907558499612

Nóż Finka

Fink knife / Нож Fink / Нож Fink / Fink kés / Çuřit Fink / Nůž Fink / Nóż Fink / Cuchillo Fink / Cottole Fink / Couteau Fink / Нож Fink / Fink peilis / Fink nazis / Faca Fink



Ref. 63-175 12/72 EAN 5907558440713

Toporek taktyczny

Tactical hatchet / Taktisches Kriegsbeil / Тактический топорик / Тактична сокира / Taktikai balta / Topor tatic / Taktická sekera / Taktična sekira / Taktinis kirvis



Ref. 63-178 5/20 EAN 5907558440737

Piła ręczna łańcuchowa

Hand chain saw / Ручная цепная пила / Ручна ланцюгова пила / Kézi láncfűrész / Ferästräu manual cu lanț / Ruční řetězová pila / Ručná reťazová pila / Ročna verižna žaga / Rankinis grandininis pjūklas / Rokas kėdes žągis / Käsi kettsaag / Ръчен верижен трион / Ručna lančana pila / Ручна моторна теснера / Αλυσοπίριο χειρός / Motosega a mano / Motosierra manual / Serra manual / Scie à chaîne à main / Hand kettingzaag



BLADE
LENGTH:
53cm

52-54
HRC

Ref.	📦	EAN
63-158	1/30	5907558493603

Rękawice taktyczne

Tactical gloves / Taktische Handschuhe / Тактические перчатки / Рукavicни тактичні / Taktikai kesztyű / Mānuši tactice / Taktické rukavice / Taktické rukavice / Taktične rokavice / Taktinēs pirštīnēs / Taktiskie cimdi / Taktikalised kindad / Тактически ръкавици / Taktičke rukavice / Тактичне рукавице / Такτικά γάντια / Guantes tácticos / Guanti tattici / Luvas táticas / Gants tactiques / Tactische handschoenen



Ref.	Size	📦	EAN
97-608-8	8"	10/100	5907558493610
97-608-9	9"	10/100	5907558493627
97-608-10	10"	10/100	5907558493634

Opiekacz do kanapek na ognisko

Campfire sandwich maker / Сэндвичница у костра / Сендвичница на базамми / Táborťuzes szendvicssütő / Aparat pentru sandvișuri pentru foc de tabără / Sendvičovač na táborák / Sendvičovač na táborák / Aparat za pripravo sendvičev za taborni ogen / Sumuštinij keptuvė su laužu / Ugunskura sviestmaīžu cepējs / Lökke vöileivaküpsetaja / Машина за сендвичи на лагерен огън / Aparat za sendviče uz logorsku vatru / Сендвич апарат за логорску ватру / Μηχανή σάντουιτς με φωτιά / Sandwichera de fogata / Macchina per sandwich al fuoco / Sanduicheira de fogueira / Machine à sandwich feu de camp / Kampvuur tosti apparaat



handle
length:
41,5cm

15,5x
13,5cm

aluminium



Ref.	📦	EAN
63-156	1/16	5907558493641

Saszetka

Waist bag / Gürteltasche / Поясная сумка / Торба на паску / Övtáska / Borseta / Ledvinka / L'advinka / Pasna torbica / Dėklas / Jostas soma / Vöökott / Паласка / Pasna torbica / Torbica / Τσάντζκι μέσης / Riñonera / Marsupio porta utensili / Bolsa / Sacoche porte-outils à ceinture



POLYESTER
600D

Ref.	📦	EAN
84-327	1/60	5907558474602

Plecak turystyczny

Outdoor backpack / Reiserucksack / Туристический рюкзак / Туристичний рюкзак / Turista hátizsák / Rucsac turistic / Cestovni batoh / Turistický batoh / Nahrbtnik / Montuotojo įrankių kuprinė / Pārgājēju mugursoma / Seljakott / Туристическа раница / Ruksak / Ranac / Σακίδιο πεζοπορίας / Mochila para senderismo / Zaino turistico / Caminhadas rucksack / Sac à dos de randonnée



POLYESTER

Ref.	📦	EAN
84-328	0/10	5907558474619

Palnik gazowy turystyczny + 2 naboje z gazem

Tourist gas burner + 2 gas cartridges / Tourist Gasbrenner + 2 Gaskartuschen / Туристическая газовая горелка + 2 газовых картриджа / Туристичний газовий пальник + 2 газові картриджі / Kamping gázégő+ 2db gázpalack / Arzător cu gaz Tourist + 2 cartușe de gaz / Turistický plynový hořák + 2 plynové kartuše / Turistický plynový horák + 2 plynové kartuše / Turistični plinski gorilnik + 2 plinska vložka / Turistinis dujų degiklis + 2 dujų kasetės / Turisma gāzes deglis + 2 gāzes kasetnes / Turisti gaasipõleti + 2 gaasikasseti / Туристическа газова горелка + 2 газовой касету / Turistički plinski plamenik + 2 plinske kartuše / Туристични газни горюници + 2 газне патроне / Τουριστικός καυστήρας αερίου + 2 φιαλίδια αερίου / Quemador de gas turístico + 2 cartuchos de gas / Set Bruciatore a gas da campeggio + 2 cartucce di gas / Queimador de gás Tourist + 2 cartuchos de gás / Brûleur à gaz touristique + 2 cartouches de gaz / Toeristische gasbrander + 2 gaspatronen



Ref.	📦	EAN
20-060	0/10	5907558495263

Spodnie robocze

Working trousers / Arbeitshose / Брюки рабочие / Штаны рабочие / Munkadzseki / Pantaloni de lucru / Pracovní kalhoty / Montérky / Delovne hlače / Darbinės kelnės / Darba bikses / Tööpüksid / Работни панталони / Radne hlače / Radne pantalone / Παντελόνι εργασίας / Pantalón de trabajo / Pantaloni da lavoro / Calças de trabalho / Pantalon de travail



POLYAMIDE
90%
SPANDEX
10%

170g/m²

4-WAY
STRETCH

PROFILED

PROFILED

PROFILED

CE



Ref.	Size	⊠	EAN
81-290-XS	XS/46	0/30	5907558497038
81-290-S	S/48	0/30	5907558497045
81-290-M	M/50	0/30	5907558497052
81-290-L	L/52	0/30	5907558497069
81-290-XL	XL/54	0/30	5907558497076
81-290-XXL	XXL/56	0/30	5907558497083
81-290-XXXL	XXXL/58	0/30	5907558497090



COTTON
100%

425g/m²

PROFILED

PROFILED

PROFILED

CE



Ref.	Size	⊠	EAN
81-234-XS	XS/46	1/10	5907558470215
81-234-S	S/48	1/10	5907558470222
81-234-M	M/50	1/10	5907558470239
81-234-L	L/52	1/10	5907558470246
81-234-XL	XL/54	1/10	5907558470253
81-234-XXL	XXL/56	1/10	5907558470260
81-234-XXXL	XXXL/58	1/10	5907558470277



COTTON
60%
POLYESTER
37%
SPANDEX
3%

255g/m²

PROFILED

PROFILED

PROFILED

PROFILED

PROFILED

PROFILED

PROFILED

PROFILED



Ref.	Size	⊠	EAN
81-232-XS	XS/46	1/20	5907558459975
81-232-S	S/48	1/20	5907558459982
81-232-M	M/50	1/20	5907558459999
81-232-L	L/52	1/20	5907558460001
81-232-XL	XL/54	1/20	5907558460018
81-232-XXL	XXL/56	1/20	5907558460025
81-232-XXXL	XXXL/58	1/20	5907558460032

Spodnie robocze ogrodniczki

Working dungarees / Arbeitslatzhose / Полукомбинезон / Наніокомбінезон / Munkaruha - kertész nadrág / Pantaloni de lucru cu pieptar / Pracovní kalhoty s laclem / Pracovné nohavice do záhrady / Delovne hlače / Darbinės kelnės (sodininkams) / Dārznieces darba bikses / Töödunked / Градинарски работен панталон / Radne hlače na tregere / Pantalone za rad u vrtu / Θάρμα εργασίας με τράντες / Pantalón de trabajo tipo mono / Calças de trabalho / Pantalon de travail salopette / Tuinbroek



COTTON
100%

425g/m²

PROFILED

PROFILED

PROFILED

PROFILED

PROFILED

PROFILED

PROFILED

PROFILED

PROFILED

PROFILED

PROFILED

PROFILED

PROFILED

PROFILED

PROFILED

PROFILED

PROFILED

PROFILED

PROFILED

PROFILED

PROFILED

PROFILED

PROFILED

PROFILED

PROFILED

PROFILED

PROFILED

PROFILED

PROFILED

PROFILED

PROFILED

PROFILED

PROFILED

PROFILED

PROFILED

PROFILED

PROFILED

PROFILED

PROFILED

PROFILED

PROFILED

PROFILED

PROFILED

PROFILED



Ref.	Size	⊠	EAN
81-249-XS	XS/46	1/10	5907558470284
81-249-S	S/48	1/10	5907558470291
81-249-M	M/50	1/10	5907558470307
81-249-L	L/52	1/10	5907558470314
81-249-XL	XL/54	1/10	5907558470321
81-249-XXL	XXL/56	1/10	5907558470338
81-249-XXXL	XXXL/58	1/10	5907558470345



COTTON
60%
POLYESTER
37%
SPANDEX
3%

255g/m²

PROFILED

PROFILED

PROFILED

PROFILED

PROFILED

PROFILED

PROFILED

PROFILED

PROFILED

PROFILED

PROFILED

PROFILED

PROFILED

PROFILED

PROFILED

PROFILED

PROFILED

PROFILED

PROFILED

PROFILED

PROFILED

PROFILED

PROFILED

PROFILED

PROFILED

PROFILED

PROFILED

PROFILED

PROFILED

PROFILED



Ref.	Size	⊠	EAN
81-252-XS	XS/46	1/20	5907558460049
81-252-S	S/48	1/20	5907558460056
81-252-M	M/50	1/20	5907558460063
81-252-L	L/52	1/20	5907558460070
81-252-XL	XL/54	1/20	5907558460087
81-252-XXL	XXL/56	1/20	5907558460094
81-252-XXXL	XXXL/58	1/20	5907558460100

Krótkie spodniki

Shorts / Kurz hose / Шорты / Коротки Штаны / Rövidnadrág / Pantaloni Scurți / Kratasy / Krátke Nohavice / Krátke Hlače / Darbiniai Šortai / Šorti / Lühikesed Püksid / Къси Панталони / Krátke Hlače / Krátke Pantalone / Βερμούδες / Pantalones Cortos / Pantaloncini Corti / Calças Curtas / Culotte / Korte Broek



Ref.	Size	⊠	EAN
81-277-XS	XS/46	0/30	5907558472387
81-277-S	S/48	0/30	5907558472394
81-277-M	M/50	0/30	5907558472400
81-277-L	L/52	0/30	5907558472417
81-277-XL	XL/54	0/30	5907558472424
81-277-XXL	XXL/56	0/30	5907558472431
81-277-XXXL	XXXL/58	0/30	5907558472448

POLYAMIDE
90%
SPANDEX
10%

170g/m²

4-WAY
STRETCH

4-WAY
STRETCH

PROFILED

PROFILED

PROFILED

PROFILED

PROFILED

PROFILED

PROFILED

PROFILED

Spodnie robocze

Working trousers / Arbeitshosen / Брюки рабочие / Штаны рабочие / Munkaruha nadrág / Pantaloni de lucru / Pracovní kalhoty / Pracovné nohavice / Delovne hlače / Darbinės kelnės / Darba bikses / Tööpüksid / Работни панталони / Radne hlače / Rande pantalone / Παντελόνι εργαίας / Pantalón de trabajo / Pantaloni da lavoro / Calças de trabalho / Pantalon de travail / Werkbroek



NEW

Ref.	Size	☒	EAN
81-285-XS	XS/46	0/24	5907558472455
81-285-S	S/48	0/24	5907558472462
81-285-M	M/50	0/24	5907558472479
81-285-L	L/52	0/24	5907558472486
81-285-XL	XL/54	0/24	5907558472493
81-285-XXL	XXL/56	0/24	5907558472509
81-285-XXXL	XXXL/58	0/24	5907558472516



NEW

Ref.	Size	☒	EAN
81-291-XS	XS/46	0/30	5907558473049
81-291-S	S/48	0/30	5907558473056
81-291-M	M/50	0/30	5907558473063
81-291-L	L/52	0/30	5907558473070
81-291-XL	XL/54	0/30	5907558473087
81-291-XXL	XXL/56	0/30	5907558473094
81-291-XXXL	XXXL/58	0/30	5907558473100



NEW

Ref.	Size	☒	EAN
81-292-XS	XS/46	0/20	5907558472592
81-292-S	S/48	0/20	5907558472608
81-292-M	M/50	0/20	5907558472615
81-292-L	L/52	0/20	5907558472622
81-292-XL	XL/54	0/20	5907558472639
81-292-XXL	XXL/56	0/20	5907558472646
81-292-XXXL	XXXL/58	0/20	5907558472653



NEW

Ref.	Size	☒	EAN
81-293-XS	XS/46	0/30	5907558473117
81-293-S	S/48	0/30	5907558473124
81-293-M	M/50	0/30	5907558473131
81-293-L	L/52	0/30	5907558473148
81-293-XL	XL/54	0/30	5907558473155
81-293-XXL	XXL/56	0/30	5907558473162
81-293-XXXL	XXXL/58	0/30	5907558473179



NEW

Ref.	Size	☒	EAN
81-294-XS	XS/46	0/20	5907558472660
81-294-S	S/48	0/20	5907558472677
81-294-M	M/50	0/20	5907558472684
81-294-L	L/52	0/20	5907558472691
81-294-XL	XL/54	0/20	5907558472707
81-294-XXL	XXL/56	0/20	5907558472714
81-294-XXXL	XXXL/58	0/20	5907558472721



NEW

Ref.	Size	☒	EAN
81-297-XS	XS/46	0/20	5907558472738
81-297-S	S/48	0/20	5907558472745
81-297-M	M/50	0/20	5907558472752
81-297-L	L/52	0/20	5907558472769
81-297-XL	XL/54	0/20	5907558472776
81-297-XXL	XXL/56	0/20	5907558472783
81-297-XXXL	XXXL/58	0/20	5907558472790

Spodnie robocze

Working trousers / Arbeitshosen / Брюки рабочие / Штани робочі / Munkaruha nadrág / Pantaloni de lucru / Pracovní kalhoty / Pracovné nohavice / Delovne hlače / Darbinės kelnės / Darba bikses / Тööpüksid / Работни панталони / Radne hlače / Rande pantalone / Παντελόνι εργασίας / Pantalón de trabajo / Pantaloni da lavoro / Calças de trabalho / Pantalon de travail / Werkbroek



NEW

Ref.	Size	☒	EAN
81-286-XS	XS/46	1/20	5907558472523
81-286-S	S/48	1/20	5907558472530
81-286-M	M/50	1/20	5907558472547
81-286-L	L/52	1/20	5907558472554
81-286-XL	XL/54	1/20	5907558472561
81-286-XXL	XXL/56	1/20	5907558472578
81-286-XXXL	XXXL/58	1/20	5907558472585

Kurtka robocza

Work jacket / Arbeitsjacke / Куртка рабочая / Куртка робоча / Munkakabát / Jacheta de lucru / Pracovní bunda / Pracovná bunda / Delovni jopič / Darbine striuke / Darba jaka / Тööjope / Работно яке / Radna jakna / Radnička jakna / Μπουφάν εργασίας / Chaqueta de trabajo / Giubbotta da lavoro / Blusão de trabalho / Veste de travail



NEW

Ref.	Size	☒	EAN
81-579-S	S/48	0/10	5907558472929
81-579-M	M/50	0/10	5907558472936
81-579-L	L/52	0/10	5907558472943
81-579-XL	XL/54	0/10	5907558472950
81-579-XXL	XXL/56	0/10	5907558472967
81-579-XXXL	XXXL/58	0/10	5907558472974

Bluza polarowa

Polar fleece jacket / Arbeitskittel aus Polarfleece / Блуза из флиса / Майстерка / Polár munkadzseki / Bluza polar / Fleeceová mikina / Flisová bunda / Jopič iz flisa / Džemperis iš polarinio fliso audinio / Flisa jaka / Flis / Блузка от флиса / Bluza od polara / Jakna / Μηλούζα φλις / Chaqueta de polar / Giacca in pile / Camisola polar / Polo polaire / Fleece trui



NEW

Ref.	Size	☒	EAN
81-509-S	S/48	0/20	5907558475296
81-509-M	M/50	0/20	5907558475302
81-509-L	L/52	0/20	5907558475319
81-509-XL	XL/54	0/20	5907558475326
81-509-XXL	XXL/56	0/20	5907558475333
81-509-XXXL	XXXL/58	0/20	5907558475340

Bluza robocza

Working top / Arbeitsshirt / Блуза рабочая / Куртка робоча / Munkadzseki / Bluza de lucru / Pracovní blůza / Pracovná bunda / Delovna jakna / Darbiniai marškiniai / Darba kreklis / Тööjakk / Работна блуза / Radna bluz / Radna bluza / Μηλούζα εργασίας / Sudadera de trabajo / Giacca da lavoro / Blusão de trabalho / Veste de travail



NEW

Ref.	Size	☒	EAN
81-515-S	S/48	0/10	5907558472806
81-515-M	M/50	0/10	5907558472813
81-515-L	L/52	0/10	5907558472820
81-515-XL	XL/54	0/10	5907558472837
81-515-XXL	XXL/56	0/10	5907558472844
81-515-XXXL	XXXL/58	0/10	5907558472851

Bluza softshell

Softshell jacket / Softshelljacke / Куртка softshell / Куртка софтшелл / Softshell dzseki / Jacheta softshell / Softshellová bunda / Softshellová bunda / Softshell jakna / Softshell striuke / Softshell jaka / Chaqueta softshell / Софтшелл яке / Softshell majica / Софтшелл джэкс / Sudadera softshell / Giacca softshell / Casaca softshell / Veste softshell / Softshell jack



NEW

Ref.	Size	☒	EAN
81-516-S	S/48	0/10	5907558472868
81-516-M	M/50	0/10	5907558472875
81-516-L	L/52	0/10	5907558472882
81-516-XL	XL/54	0/10	5907558472899
81-516-XXL	XXL/56	0/10	5907558472905
81-516-XXXL	XXXL/58	0/10	5907558472912



NEW

Ref.	Size	☒	EAN
81-517-S	S/48	0/10	5907558472998
81-517-M	M/50	0/10	5907558472981
81-517-L	L/52	0/10	5907558473001
81-517-XL	XL/54	0/10	5907558473018
81-517-XXL	XXL/56	0/10	5907558473025
81-517-XXXL	XXXL/58	0/10	5907558473032

Bluza robocza

Working top / Arbeitsshirt / Блуза рабочая / Куртка рабочая / Munkdzsekki / Bluza de lucru / Pracovní blůza / Pracovná bunda / Delovna jakna / Darbiniai marškiniai / Darba kreklis / Tööjakk / Рабочна блуза / Radna bluza / Radna bluza / Μπλούζα εργαίας / Sudadera de trabajo / Giacca da lavoro / Blusaõ de trabalho / Veste de travail



Ref.	Size	☒	EAN
81-212-S	S/48	1/20	5907558459913
81-212-M	M/50	1/20	5907558459920
81-212-L	L/52	1/20	5907558459937
81-212-XL	XL/54	1/20	5907558459944
81-212-XXL	XXL/56	1/20	5907558459951
81-212-XXXL	XXXL/58	1/20	5907558459968



Ref.	Size	☒	EAN
81-214-S	S/48	1/10	5907558470154
81-214-M	M/50	1/10	5907558470161
81-214-L	L/52	1/10	5907558470178
81-214-XL	XL/54	1/10	5907558470185
81-214-XXL	XXL/56	1/10	5907558470192
81-214-XXXL	XXXL/58	1/10	5907558470208



Bluza polarowa

Polar fleece jacket / Arbeitskittel aus Polarfleece / Блуза из флиса / Маістерка / Polár munkdzsekki / Bluza polar / Fleeceová mikina / Flísová bunda / Jopič iz flisa / Džemperis iš polarinio fliso audinio / Flíša jaka / Flísis / Блузка от флорте / Bluza od polara / Jakna / Μπλούζα φλις / Chaqueta de polar / Giacca in pile / Carnisola polar / Polo polaire / Fleece trui



Ref.	Size	☒	EAN
81-502-S	S/48	1/20	5907558482706
81-502-M	M/50	1/20	5907558482713
81-502-L	L/52	1/20	5907558482720
81-502-XL	XL/56	1/20	5907558482744
81-502-XXL	XXL/58	1/20	5907558482751
81-502-XXXL	XXXL/60	1/20	5907558482817



Ref.	Size	☒	EAN
81-503-S	S/48	1/20	5907558482768
81-503-M	M/50	1/20	5907558482775
81-503-L	L/52	1/20	5907558482782
81-503-XL	XL/56	1/20	5907558482799
81-503-XXL	XXL/58	1/20	5907558482805
81-503-XXXL	XXXL/60	1/20	5907558482812



Ref.	Size	☒	EAN
81-504-S	S/48	1/20	5907558482829
81-504-M	M/50	1/20	5907558482836
81-504-L	L/52	1/20	5907558482843
81-504-XL	XL/56	1/20	5907558482850
81-504-XXL	XXL/58	1/20	5907558482867
81-504-XXXL	XXXL/60	1/20	5907558482874

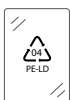

Ref.	Size	☒	EAN
81-507-S	S/48	0/16	5907558498417
81-507-M	M/50	0/16	5907558498400
81-507-L	L/52	0/16	5907558498394
81-507-XL	XL/54	0/16	5907558498424
81-507-XXL	XXL/56	0/16	5907558498431
81-507-XXXL	XXXL/58	0/16	5907558498448

Bluza robocza

Working top / Arbeitsshirt / Блуза рабочая / Нуртка робоча / Munkadzseki / Bluza de lucru / Pracovni blůza / Pracovná bunda / Delovna jakna / Darbiniai marškiniai / Darba kreklis / Tööjakk / Работна блуза / Radna bluza / Radna bluza / Μπλουζα εργασίας / Sudadera de trabajo / Giacca da lavoro / Blusão de trabalho / Veste de travail



Ref.	Size	☒	EAN
81-513-S	S/48	0/30	5907558498479
81-513-M	M/50	0/30	5907558498462
81-513-L	L/52	0/30	5907558498455
81-513-XL	XL/54	0/30	5907558498486
81-513-XXL	XXL/56	0/30	5907558498493
81-513-XXXL	XXXL/58	0/30	5907558498509



Ref.	Size	☒	EAN
81-514-S	S/48	0/22	5907558498530
81-514-M	M/50	0/22	5907558498523
81-514-L	L/52	0/22	5907558498516
81-514-XL	XL/54	0/22	5907558498547
81-514-XXL	XXL/56	0/22	5907558498554
81-514-XXXL	XXXL/58	0/22	5907558498561



Ref.	Size	☒	EAN
81-650-S	S/48	0/32	5907558498592
81-650-M	M/50	0/32	5907558498585
81-650-L	L/52	0/32	5907558498578
81-650-XL	XL/54	0/32	5907558498608
81-650-XXL	XXL/56	0/32	5907558498615
81-650-XXXL	XXXL/58	0/32	5907558498622



Ref.	Size	☒	EAN
81-651-S	S/48	0/26	5907558498653
81-651-M	M/50	0/26	5907558498646
81-651-L	L/52	0/26	5907558498639
81-651-XL	XL/54	0/26	5907558498660
81-651-XXL	XXL/56	0/26	5907558498677
81-651-XXXL	XXXL/58	0/26	5907558498684

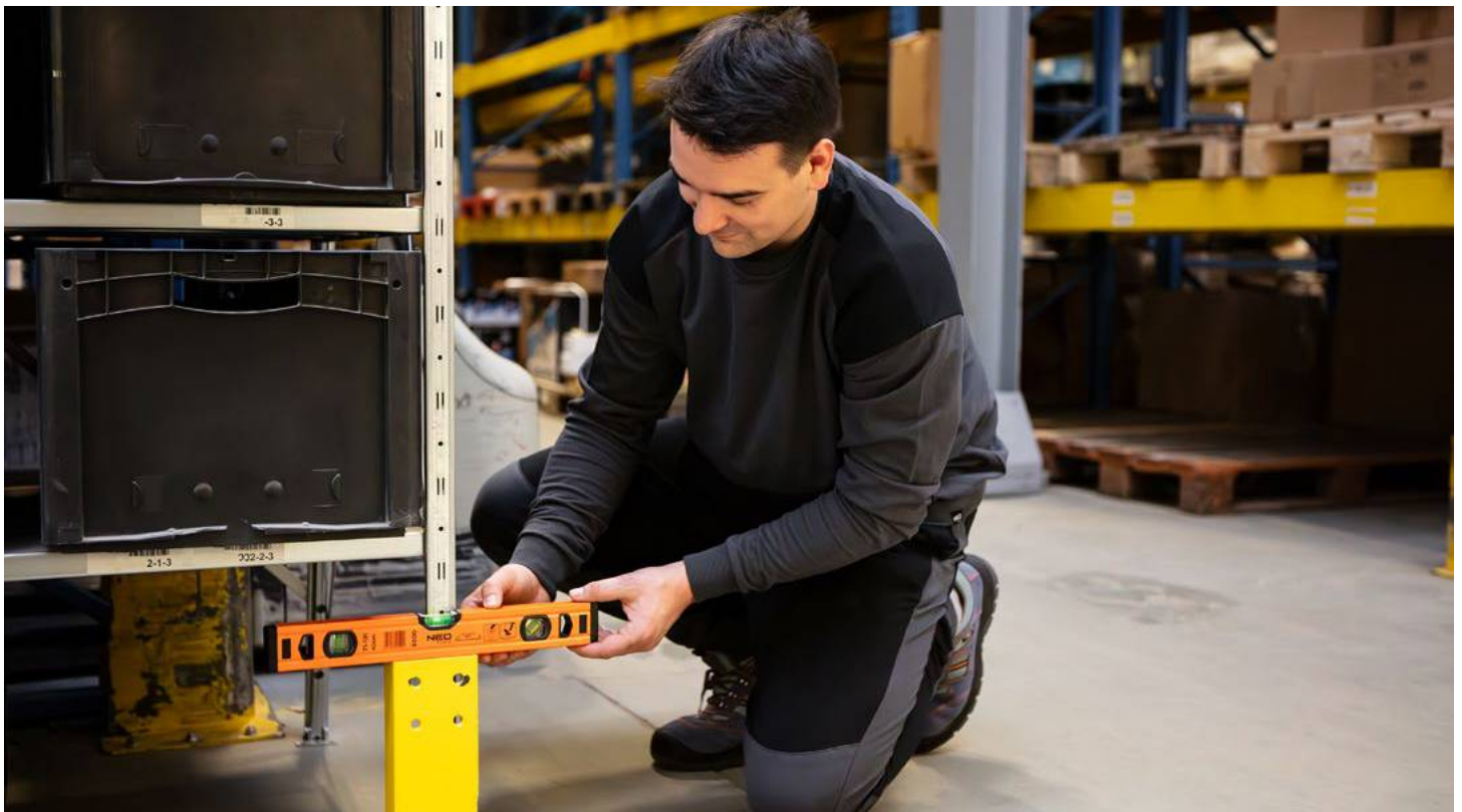

Spodnie robocze

Working trousers / Arbeitshosen / Брюки рабочие / Штаны робочи / Munkaruha nadrág / Pantaloni de lucru / Pracovní kalhoty / Pracovné nohavice / Delovne hlače / Darbinės kelnės / Darba bikses / Тööpüksid / Работни панталони / Radne hlače / Rande pantalone / Παντελόν εργασιός / Pantalón de trabajo / Pantaloni da lavoro / Calças de trabalho / Pantalon de travail / Werkbroek



COTTON 79%
VISCOSE 8%
POLYESTER 13%

320g/m²

WARM



Ref.	Size	☒	EAN
81-280-S	S/48	0/28	5907558498233
81-280-M	M/50	0/28	5907558498226
81-280-L	L/52	0/28	5907558498219
81-280-XL	XL/54	0/28	5907558498240
81-280-XXL	XXL/56	0/28	5907558498257
81-280-XXXL	XXXL/58	0/28	5907558498264

Koszula flanelowa

Flannel shirt / Flanelhemd / Фланелевая рубашка / Сорочка фланелева / Flanel ing / Cămașă de flanelă / Flanelová košile / Flanelová košeľa / Flanelasta srajca / Flaneliniai marškiniai / Flanela kreklis / Flannelsärk / Фланелена риза / Košulja od flanela / Flanelaska košulja / Φανελένιο πουκάμισο / Camisa de franela / Camicia di flanela / Camisa de flanela / Chemise en flanelle



COTTON 100%

170g/m²

Ref.	Size	☒	EAN
81-545-S	S/48	1/36	5907558484366
81-545-M	M/50	1/36	5907558484373
81-545-L	L/52	1/36	5907558484380
81-545-XL	XL/56	1/36	5907558484397
81-545-XXL	XXL/58	1/36	5907558484403
81-545-XXXL	XXXL/60	1/36	5907558484410



COTTON 57%
POLYESTER 39%
ELASTANE 4%

320g/m²



Ref.	Size	☒	EAN
81-282-S	S/48	0/24	5907558498295
81-282-M	M/50	0/24	5907558498288
81-282-L	L/52	0/24	5907558498271
81-282-XL	XL/54	0/24	5907558498301
81-282-XXL	XXL/56	0/24	5907558498318
81-282-XXXL	XXXL/58	0/24	5907558498325

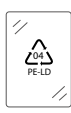

COTTON 100%

170g/m²

Ref.	Size	☒	EAN
81-546-S	S/48	1/36	5907558484427
81-546-M	M/50	1/36	5907558484434
81-546-L	L/52	1/36	5907558484441
81-546-XL	XL/56	1/36	5907558484458
81-546-XXL	XXL/58	1/36	5907558484465
81-546-XXXL	XXXL/60	1/36	5907558484472

Bokserki

Boxers / Boxer / Боксеры / Боксеру / Bokszolók / Boxeri / Boxeři / Boxerky / Boksarice / Boksininkai / Bokseri / Poksijad / Боксерки / Boksačice / Боксеру / Μπόξερ / Boxeadores / Pugili / Pugilistas / Boxeurs / Boksera



COTTON 57%
POLYESTER 39%
ELASTANE 4%

320g/m²



Ref.	Size	☒	EAN
81-283-S	S/48	0/20	5907558498356
81-283-M	M/50	0/20	5907558498349
81-283-L	L/52	0/20	5907558498332
81-283-XL	XL/54	0/20	5907558498363
81-283-XXL	XXL/56	0/20	5907558498370
81-283-XXXL	XXXL/58	0/20	5907558498387



COTTON 95%
ELASTAN 5%

180g/m²

x3



Ref.	Size	☒	EAN
81-679-M	M/50	0/50	5907558498769
81-679-L	L/52	0/50	5907558498752
81-679-XL	XL/56	0/50	5907558498776
81-679-XXL	XXL/58	0/50	5907558498783

T-shirt

T-shirt / T-Shirt / Футболка сигнальная / Футболка / Póló / T-shirt / Tričko / Tričko / Majica / Apatiniai marškinėliai - T / T-kreklis / T-särk / Тушэpm / T-shirt / Majica kratkih rukava / Κομπούνηκη μιλιόζα / Camiseta / Maglietta / Camisola / T-shirt / T-shirt



Ref.	Size	☒	EAN
81-609-S	S/48	1/25	5907558470352
81-609-M	M/50	1/25	5907558470369
81-609-L	L/52	1/25	5907558470376
81-609-XL	XL/56	1/25	5907558470383
81-609-XXL	XXL/58	1/25	5907558470390
81-609-XXXL	XXXL/60	1/25	5907558470406



Ref.	Size	☒	EAN
81-656-S	S/48	0/50	5907558498714
81-656-M	M/50	0/50	5907558498707
81-656-L	L/52	0/50	5907558498691
81-656-XL	XL/54	0/50	5907558498721
81-656-XXL	XXL/56	0/50	5907558498738
81-656-XXXL	XXXL/58	0/50	5907558498745



NEW

Ref.	Size	☒	EAN
81-645-S	S/48	0/50	5907558473247
81-645-M	M/50	0/50	5907558473261
81-645-L	L/52	0/50	5907558473261
81-645-XL	XL/54	0/50	5907558473278
81-645-XXL	XXL/56	0/50	5907558473285
81-645-XXXL	XXXL/58	0/50	5907558473292



NEW

Ref.	Size	☒	EAN
81-644-S	S/48	0/50	5907558473186
81-644-M	M/50	0/50	5907558473193
81-644-L	L/52	0/50	5907558473209
81-644-XL	XL/54	0/50	5907558473216
81-644-XXL	XXL/56	0/50	5907558473223
81-644-XXXL	XXXL/58	0/50	5907558473230



Ref.	Size	☒	EAN
81-646-S	S/48	0/50	5907558473322
81-646-M	M/50	0/50	5907558473315
81-646-L	L/52	0/50	5907558473308
81-646-XL	XL/56	0/50	5907558473339
81-646-XXL	XXL/58	0/50	5907558473346
81-646-XXXL	XXXL/60	0/50	5907558473353

Kominiarka

Balaclava / Sturmhaube / Балаклава / Балаклава / Balaclava / Cagulă / Kukla / Balaklava / Balaklava / Balaklava / Balaclava / Balaclava / Балаклава / Балаклава / Balaclava / Балаклава / Μπακλάβα / Prasmontañas / Passamontagna / Balaclava / Cagoule / Bivakmuts



NEW

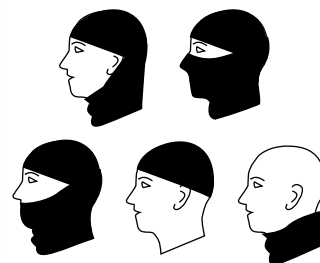

Ref.	☒	EAN
81-638	0/100	5907558478051



NEW



Ref.	☒	EAN
81-639	0/80	5907558478068



Kombinezon malarski

Painting suit / Malkombi / Костюм для рисования / Костюм для фарбування / Festőruha / Costum de pictură / Oblek na malování / Oblek na malovanie / Obleka za slikanje / Dažuto kostiumas / Gležnošanas kostīms / Vārvimīšūlīkond / Костюм за рисуване / Odijelo za slikanje / Сликарско одело / Κοστούμι ζωγραφικής / Traje de pintura / Tuta da pittore / Foto para pintura / Combinaison de peinture / Schilderspak



Ref.	Size	☒	EAN
81-850-M	M/50	1/50	5907558485684
81-850-XL	XL/56	1/50	5907558485691
81-850-XXXL	XXXL/60	1/50	5907558485707



Kombinezon ochronny

Protective overalls / Schutz-Overall / Защитный комбинезон / Комбінезон захисний / Védőoverál / Salopetă de protecție / Ochranná kombinéza / Ochranná kombinéza / Zaštitni kombinezon /

Apsauginis kombinezonas / Aizsardzības kombinezons / Kaitseüllikond / Защитен комбинезон / Zaštitna uniforma / Защитна униформа / Προστατευτική φόρμα / Mono de protecção / Tuta protettiva / Cobertura de protecção / Combinaison de protection / Beschermingsoverall



Ref.	Size	☒	EAN
81-851-M	M/50	1/50	5907558485714
81-851-XL	XL/56	1/50	5907558485721
81-851-XXXL	XXXL/60	1/50	5907558485738



Fartuch spawalniczy skórzany

Leather welding apron / Leder-Schweißerschürze / Кожаный сварочный фартук / Фартук зварювальний шкіряний / Bőr hegesztő kőtény / Şort de sudură din piele / Kožená svářečská zástěra / Kožená zvaračská zástera / Usnjeni varilni predpasnik / Odinē suvirinimo prijuostė / Ādas metināšanas priekšauts / Delantal de soldadura de cuero / Кожена престилна за заваряване / Kožna pregača za varjenje / Кожна нецеля за заваряване / Дерматинη ποδιά συγκόλλησης / Delantal de soldadura de cuero / Grembiule da saldatura in pelle / Avental de soldadura de couro / Tablier de soudage en cuir / Lederen lasschort



Ref.	☒	EAN
81-890	1/25	5907558484557



Ref.	☒	EAN
81-891	1/25	5907558484564

Trzewiki spawalnicze

Safety boots / Arbeitsschuhe / Ботинки рабочие / Черевини работчи / Munkabakancs / Vocanci de lucru / Kotníková pracovní obuv / Pracovné topánky / Visoki delovni čevlji / Darbo batai / Darba zābaki / Töösaapad / Работни обувки високи / Radne visoke cipele / Radne cipele / Μπoτάκια εργασίας / Botas de seguridad altas / Scarpa alta da lavoro / Botas de trabalho / Chaussures de sécurité / Hoge werkschoenen

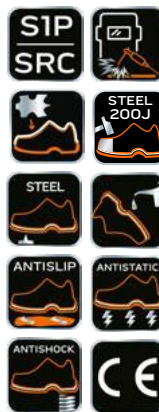

Ref.	Size	Size [cm]	☒	EAN
82-180-39	39	26	1/10	5907558493733
82-180-40	40	26.7	1/10	5907558493740
82-180-41	41	27.3	1/10	5907558493757
82-180-42	42	28	1/10	5907558493764
82-180-43	43	28.7	1/10	5907558493771
82-180-44	44	29.3	1/10	5907558493788
82-180-45	45	30	1/10	5907558493795
82-180-46	46	30.7	1/10	5907558493801
82-180-47	47	31.3	1/10	5907558493818



Ref.	Size	Size [cm]	☒	EAN
82-181-39	39	26	1/10	5907558493825
82-181-40	40	26.7	1/10	5907558493832
82-181-41	41	27.3	1/10	5907558493849
82-181-42	42	28	1/10	5907558493856
82-181-43	43	28.7	1/10	5907558493863
82-181-44	44	29.3	1/10	5907558493870
82-181-45	45	30	1/10	5907558493887
82-181-46	46	30.7	1/10	5907558493894
82-181-47	47	31.3	1/10	5907558493900



Póľbuty robocze

Safety shoes / Arbeitshalbschuhe / Полуботинки рабочие / Півчеревики робочі / Munkcipő / Pantofi de lucru / Pracovní obuv / Pracovné poltopánky / Nizki delovni čevlji / Darbo pusbačiai / Darba puszabaki / Töökingad / Работни обувки ниски (половинки) / Radne cipele / Poluduboke radne cipele / Низькотоєвтуг / Botas de seguridad / Scarpa da lavoro / Zapatos de trabajo / Souliers de sécurité / Werkschoenen

SB
SR FO



Ref.	Size	Size [cm]	☒	EAN
82-161-39	39	26	0/10	5907558499094
82-161-40	40	26.7	0/10	5907558499100
82-161-41	41	27.3	0/10	5907558499117
82-161-42	42	28	0/10	5907558499124
82-161-43	43	28.7	0/10	5907558499131
82-161-44	44	29.3	0/10	5907558499148
82-161-45	45	30	0/10	5907558499155
82-161-46	46	30.7	0/10	5907558499162
82-161-47	47	31.3	0/10	5907558499179

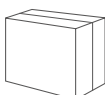

SIPL
SR



Ref.	Size	Size [cm]	☒	EAN
82-163-39	39	26	0/10	5907558499278
82-163-40	40	26.7	0/10	5907558499285
82-163-41	41	27.3	0/10	5907558499292
82-163-42	42	28	0/10	5907558499308
82-163-43	43	28.7	0/10	5907558499315
82-163-44	44	29.3	0/10	5907558499322
82-163-45	45	30	0/10	5907558499339
82-163-46	46	30.7	0/10	5907558499346
82-163-47	47	31.3	0/10	5907558499353

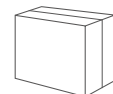

02
SR FO



Ref.	Size	Size [cm]	☒	EAN
82-741-39	39	26	0/10	5907558499186
82-741-40	40	26.7	0/10	5907558499193
82-741-41	41	27.3	0/10	5907558499209
82-741-42	42	28	0/10	5907558499216
82-741-43	43	28.7	0/10	5907558499223
82-741-44	44	29.3	0/10	5907558499230
82-741-45	45	30	0/10	5907558499247
82-741-46	46	30.7	0/10	5907558499254
82-741-47	47	31.3	0/10	5907558499261

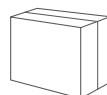

S1
FO

NEW



Ref.	Size	Size [cm]	☒	EAN
82-162-39	39	26	0/10	5907558426137
82-162-40	40	26.7	0/10	5907558426120
82-162-41	41	27.3	0/10	5907558426151
82-162-42	42	28	0/10	5907558426168
82-162-43	43	28.7	0/10	5907558426328
82-162-44	44	29.3	0/10	5907558426335
82-162-45	45	30	0/10	5907558426342
82-162-46	46	30.7	0/10	5907558426359
82-162-47	47	31.3	0/10	5907558426366

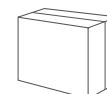

Trzewiki robocze

Safety boots / Arbeitsschuhe / Ботинки рабочие / Черевини робочі / Munkabakancs / Vocanci de lucru / Kotníková pracovní obuv / Pracovné topánky / Visoki delovni čevlji / Darbo batai / Darba zăbaki / Töösaapad / Работни обувки високи / Radne visoke cipele / Radne cipele / Μητοτάκια εργασίας / Botas de seguridad altas / Scarpa alta da lavoro / Botas de trabalho / Chaussures de sécurité / Hoge werkschoenen



Ref.	Size	Size [cm]	☒	EAN
82-751-39	39	26	0/10	5907558499001
82-751-40	40	26.7	0/10	5907558499018
82-751-41	41	27.3	0/10	5907558499025
82-751-42	42	28	0/10	5907558499032
82-751-43	43	28.7	0/10	5907558499049
82-751-44	44	29.3	0/10	5907558499056
82-751-45	45	30	0/10	5907558499063
82-751-46	46	30.7	0/10	5907558499070
82-751-47	47	31.3	0/10	5907558499087

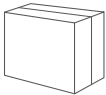
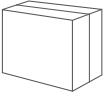

Ref.	Size	Size [cm]	☒	EAN
82-167-39	39	26	0/10	5907558498912
82-167-40	40	26.7	0/10	5907558498929
82-167-41	41	27.3	0/10	5907558498936
82-167-42	42	28	0/10	5907558498943
82-167-43	43	28.7	0/10	5907558498950
82-167-44	44	29.3	0/10	5907558498957
82-167-45	45	30	0/10	5907558498974
82-167-46	46	30.7	0/10	5907558498981
82-167-47	47	31.3	0/10	5907558498998



NEW

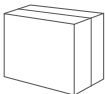

Ref.	Size	Size [cm]	☒	EAN
82-168-39	39	26	0/10	5907558475166
82-168-40	40	26.7	0/10	5907558475173
82-168-41	41	27.3	0/10	5907558475180
82-168-42	42	28	0/10	5907558475197
82-168-43	43	28.7	0/10	5907558475203
82-168-44	44	29.3	0/10	5907558475210
82-168-45	45	30	0/10	5907558475227
82-168-46	46	30.7	0/10	5907558475234
82-168-47	47	31.3	0/10	5907558475241

Sandaly robocze

Working sandals / Arbeitssandale / Рабочие сандалии / Sandale de lucru / Робочі стандарти / Munkaszandál / Pracovní sandály / Pracovné sandále / Delovni sandali / Darbo sandalai / Darba sandales / Töösandalaalid / Работни сандали / Radne sandale / Radne sandale / Σανδάλια εργασίας / Sandalias de trabajo / Sandali da lavoro / Sandálias de proteção / Sandales de travail / Werksandalen



Ref.	Size	Size [cm]	☒	EAN
82-089-39	39	26	0/10	5907558426229
82-089-40	40	26.7	0/10	5907558426250
82-089-41	41	27.3	0/10	5907558426267
82-089-42	42	28	0/10	5907558426298
82-089-43	43	28.7	0/10	5907558426281
82-089-44	44	29.3	0/10	5907558426274
82-089-45	45	30	0/10	5907558426304
82-089-46	46	30.7	0/10	5907558426311
82-089-47	47	31.3	0/10	5907558426144

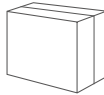

Śniegowce

Snow boots / Schneestiefel / Зимние сапоги / Чизові чоботи / Hótaposó / Vocanci de zapada / Boty do sněhu / Topánky do sněhu / Sneg škornji / Sniego batai / Sniega zăbaki / Lumesaapad / Обувки за снег / Čizme za snijeg / Чизме за снег / Μητοτσες χιονιού / Botas de nieve / Scarponcini anti neve / Snow Botas / Bottes de neige / Sneeuwlaarzen



Ref.	Size	Size [cm]	☒	EAN
82-138-41	41	26.9	1/10	5907558497106
82-138-42	42	27.6	1/10	5907558497113
82-138-43	43	28.3	1/10	5907558497120
82-138-44	44	28.9	1/10	5907558497137
82-138-45	45	29.6	1/10	5907558497144
82-138-46	46	30.3	1/10	5907558497151



Ref.	Size	Size [cm]	☒	EAN
82-139-41	41	26.9	1/10	5907558497168
82-139-42	42	27.6	1/10	5907558497175
82-139-43	43	28.3	1/10	5907558497182
82-139-44	44	28.9	1/10	5907558497199
82-139-45	45	29.6	1/10	5907558497205
82-139-46	46	30.3	1/10	5907558497212

Kalosze

Rubber boots / Gummistiefel / Γαλοσι / Чоботи / Gumicsizma / Cizme cauciuc / Holinky / Gumáky / Galošė / Guminniai batai / Galošas / Kummikud / Гумєну ботуши / Gumene cizme / Čizme za kišu / Γαλόσες από / Botas de agua / Calosce / Galochas / Bottes en caoutchouc / Støvler



Ref.	Size	Size [cm]	☒	EAN
82-902-39	39	26	0/12	5907558499360
82-902-40	40	26.7	0/12	5907558499377
82-902-41	41	27.3	0/12	5907558499384
82-902-42	42	28	0/12	5907558499391
82-902-43	43	28.7	0/12	5907558499407
82-902-44	44	29.3	0/12	5907558499414
82-902-45	45	30	0/12	5907558499421
82-902-46	46	30.7	0/12	5907558499438

Sznurowadła

Shoelaces / Schnürsenkel / Шнури / Шнури / Cipófüző / Šireturi / Tkaničky / Šnúrky do topánok / Vezalce / Batraičšiai / Kirpju šporės / Kīngaraelad / Връзки на обувки / Vezice / Пертєне / Κορδονια παπουτσιων / Cordones / Lacci delle scarpe / Cadarços / Les lacets / Schoenveters



x10

Ref.	L [cm]	info	☒	EAN
82-390	120		10/1360	5907558495515
82-391	150		10/1360	5907558495522
82-392	120		10/1360	5907558495539
82-393	150		10/1360	5907558495546

Skarpety robocze

Working socks / Arbeitssocke / Рабочие носки / Шкарпетка робоча / Munkazokni / Šosetā de lucru / Pracovní ponožka / Pracovné ponožky / Delovna nogavica / Darbinės kojines / Darba zeķes basic / Töösokid / Рабочие носки / Radne čarape / Radna čarapa / Κάλσα εργασίας / Calcetín de trabajo / Calza da lavoro / Meias de trabalho / Chaussette de travail / Werksok



Ref.	Size	info	☒	EAN
GD030	39-42	short	50/600	5907558495294
GD031	43-46	short	50/600	5907558495300

Wkładki do butów

Shoe inserts / Einlegesohlen / Стелька для обуви / Устілка до черевиків / Talpabetét / Branđ de încălțăminte / Vložka do obuvi / Vložka do topánok / Vložek za čevlje / Batų vidpadis / Αραυνη ieliktnis / Sisetallad / Вложка за обувку / Uložak za cipele / Uložak za obuću / Πάτος παπουτσιων / Plantilla para zapatos / Soletta per scarpe / Palmilha / Insert de chaussure / Inlegzool



Ref.	Size	☒	EAN
82-315	36-40	1/200	5907558495492
82-316	41-45	1/200	5907558495508

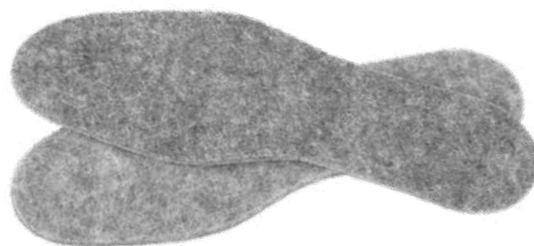

Ref.	Size	☒	EAN
82-325	38-39	0/200	5907558476712
82-326	40-41	0/300	5907558476729
82-327	42-43	0/220	5907558476736
82-328	44-45	0/220	5907558476743
82-329	46-47	0/200	5907558476750

Łyżka do butów

Shoehorn / Schuhanzieher / Сапожний рожок / Рожок для взуття / Cipókanál / Potsoavă / Botič / Obuvničny roh / Škorenj / Batų raištis / Zāģis araviem / Ρογач за обувки / Κέρατο παπουτσιων / Calzador / Calzascarpe / Calçadeira / Chausse-pied / Schoenlepel

59 cm PP



Ref.	Size [cm]	☒	EAN
GD035	56	0/200	5907558499599

Czapka z daszkiem, robocza

Work cap / Schildmütze / Бейсболка рабочая / Бейсболка робоча / Munkaruha baseball sapka / Sapca cu cozoroc / Pracovní kšiltovka / Čiapka so šiltom, pracovná / Delovna kapa s šiltom / Kepure su snapelju / Darba cepure ar nagu / Nokaga töömüts / Рабочая шапка с козырком / Radna kapa / Radnička kapa / Καπέλο εργασίας τύπου μπέιζμπολ / Gorra de trabajo / Berretto da lavoro / Boné de trabalho / Casquette de travail à visière



COTTON
100%

ONE
SIZE



Ref.	color	☒	EAN
81-635		0/200	5907558473360
81-636		0/200	5907558473377
81-637		0/200	5907558473384



COTTON
100%



Ref.	Info	☒	EAN
97-591		0/50	5907558495584



COTTON
75%
POLYESTER
25%



Ref.	☒	EAN
97-592	0/50	5907558495591

Pasek podbródkowy do hełmu

Chin strap for helmet / Kinnriemen für Helm / Подбородочный ремень для шлема / Підборідний ремінь для шолома / Állszij a sisakhoz / Curea de bărbie pentru cască / Podbradni pásek pro přilbu / Podbradný remienok na prilbu / Trak za brado za čelado / Šalmo smakro dirželis / Kıveres zoda sikсна / Наушка за брадичката на каската / Λουράκι πηγούινι για κράνος / Mentonera para casco / Mentoniera per casco / Correia de queixo para capacete / Mentonnière pour casque / Kinband voor helm



4
POINT

LENGTH
ADJUSTABLE
WIDTH

Ref.	☒	EAN
97-209	0/400	5907558499452

Rękawice robocze

Working gloves / Arbeitshandschuhe / Перчатки рабочие / Рукավушкі рабочыі / Munkakesztyű / Mănuși de lucru / Pracovní rukavice / Pracovné rukavice / Delovne rokavice / Darbo pirštīnēs / Darba cimdi / Töökindad / Ръкавици работни / Radne rukavice / Radne rukavice / Γάντια εργασίας / Guantes de trabajo / Guanti da lavoro / Luvas de trabalho / Gants de travail / Werkhandschoenen



LATEX
COATED

KAT
II



3141X



Ref.	Size	☒	EAN
97-641-11	11"	10/100	5907558495607



NITRILE
COATED

KAT
II



4131X



Ref.	Size	☒	EAN
97-621-11	11"	10/100	5907558495614



2xLATEX
COATED

KAT
II



3141X



Ref.	Size	☒	EAN
97-643-11	11"	10/100	5907558495638

Rękawice robocze

Working gloves / Arbeitshandschuhe / Перчатки рабочие / Руквици работчи / Munkakesztyű / Mănuși de lucru / Pracovní rukavice / Pracovné rukavice / Delovne rokavice / Darbo pirštines / Darba cimdi / Töökindad / Ръкавици работни / Radne rukavice / Radne rukavice / Γάντια εργασίας / Guantes de trabajo / Guanti da lavoro / Luvas de trabalho / Gants de travail / Werkhandschoenen



Ref.	Size	☒	EAN
97-641-11	10"	10/100	5907558495621



Ref.	Size	☒	EAN
97-655-11	11"	12/120	5907558495645



Ref.	Size	☒	EAN
97-656-11	11"	12/120	5907558495652



Ref.	Size	☒	EAN
97-646-7	7"	0/120	5907558477764
97-646-8	8"	0/120	5907558477771
97-646-9	9"	0/120	5907558477788
97-646-10	10"	0/120	5907558477795
97-646-11	11"	0/120	5907558477801



Ref.	Size	☒	EAN
97-614-8	8"	10/100	5907558477863
97-614-9	9"	10/100	5907558477870
97-614-10	10"	10/100	5907558477887
97-614-11	11"	10/100	5907558477894



Ref.	Size	☒	EAN
97-622-8	8"	12/120	5907558475128
97-622-9	9"	12/120	5907558475135
97-622-10	10"	12/120	5907558475142
97-622-11	11"	12/120	5907558475159



Ref.	Size	☒	EAN
97-645-7	7"	12/120	5907558475074
97-645-8	8"	12/120	5907558475081
97-645-9	9"	12/120	5907558475098
97-645-10	10"	12/120	5907558475104
97-645-11	11"	12/120	5907558475111



Ref.	Size	☒	EAN
97-647-7	7"	0/120	5907558477818
97-647-8	8"	0/120	5907558477825
97-647-9	9"	0/120	5907558477832
97-647-10	10"	0/120	5907558477849
97-647-11	11"	0/120	5907558477856

Ochraniace spawalnicze skórzane na buty

Welding leather boot protectors / Stiefelschützer aus Leder zum Schweißen / Протекторы для сварочных кожаных ботинок / Зварювання шкіряних ботинок / Hegesztő bőr csizmanvédők / Protectorii de cizme din piele pentru sudură / Svářečské kožené chrániče bot / Zváračské kožené chrániče topánok / Zaščitni usnjeni škornji za varjenje / Suvirinimo odinju batų apsaugos / Metināšanas ādas zābaku aizsargi / Protectores de piel para botas de soldador / Кожени предпазители за обувки за заваряване / Zavarivanje navlaka za cipele / Навлаке за ципеле за заварявање / Δερμάτινα προστατευτικά υπόδησ συγκόλλησης / Protectores de piel para botas de soldador / Protezioni per stivali in pelle per saldatura / Protectores de botas de couro para soldadura / Protections de bottes en cuir pour le soudage / Lasleren laarsbeschermers



Ref.	📦	EAN
97-673	1/50	5907558491388

Zarękawki spawalnicze skórzane

Leather welding arm protector / Schweißerhandschuhe aus Leder / Кожаные сварочные перчатки / Рукавички зварювальні шкіряні / Bőr hegesztőkesztyű / Mānuši de sudurā din piele / Kožené svářečské rukavice / Kožené zváračské rukavice / Usnjene varilne rokavice / Odinēs suvirinimo pirštines / Ādas metināšanas cimdi / Guantes de soldadura de cuero / Кожени ръкавици за заваряване / Kožne navlake za zavarivanje / Кожни рукави за заварявање / Δερμάτινα γάντια συγκόλλησης / Guantes de soldadura de cuero / Guanti da saldatura in pelle / Luvas de soldadura em couro / Gants de soudage en cuir / Lederen lashandschoenen



Ref.	📦	EAN
97-672	1/50	5907558491371

Rękawice spawalnicze długie z nicią kevlarową

Long welding gloves with Kevlar thread / Lange Schweißerhandschuhe mit Kevlarfaden / Длинные сварочные перчатки с кевларовой нитью / Довгі зварювальні рукавички з кевларовою ниткою / Hosszú hegesztőkesztyű kevlárszállal / Mānuši lungi de sudurā cu fir de Kevlar / Dlouhé svářečské rukavice s kevlarovým vláknem / Dlhé zváračské rukavice s kevlarovým vláknem / Dolge varilne rokavice s kevlarsko nitjo / Ilgos suvirinimo pirštines su kevlaro siūlais / Garie metināšanas cimdi ar kevlara pavedienu / Guantes largos de soldadura con hilo de Kevlar / Дълги ръкавици за заваряване с кевларена нишка / Duge rukavice za zavarivanje s kevlar niti / Duge рукавице за заварявање са кевларским концем / Μακριά γάντια συγκόλλησης με νήμα Kevlar / Guantes largos de soldadura con hilo de Kevlar / Guanti lunghi per saldatura con filo di Kevlar / Luvas longas de soldadura com fio Kevlar / Gants de soudure longs avec fil en Kevlar



Ref.	📦	EAN
97-670	12/60	5907558491357

Oslona przeciwdpryskowa

Face protection shield / Splitterschutz / Щиток противосколочный / Щиток противосколочный / Arcvédő / Ecran protecție față / Clona proti odpryskům / Ochranný štít / Štitník za obraz / Apsauginis skydelis veidui / Pretlauskų aizsargmaska / Kaitsevisiir / Предпазен щит / Štitník za lice / Štitník za lice / Μάσκα κεφαλής προστασίας από θραύσματα / Máscara protectora facial / Visiera ribaltabile anti scheggia / Proteção / Protector anti-éclats / Bescherming tegen tegen slingerende deeltjes

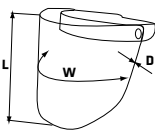

Ref.	L [mm]	W [mm]	D [mm]	📦	EAN
97-390	190	345	1	1/50	5907558468953

Okulary ochronne

Safety goggles / Schutzbrille / Очки защитные / Окуляри противосколочні / Védőszemüveg / Ochelari protecție / Ochranné brýle / Ochranné okuliare / Zaščitna očala / Apsauginiai akiniai / Aizsargbrilles / Kaitseprillid / Очила предпазни / Zaštitne naočale / Zastitne naočari / Γυαλιά προστασίας / Gafas protectoras / Occhiali di sicurezza / Óculos de proteção / Lunettes de protection / Beschermingsbril



Ref.	📦	EAN
97-520	12/120	5907558495553



Ref.	📦	EAN
97-521	12/120	5907558495560



Ref.	📦	EAN
97-522	12/120	5907558495577

Lampa akumulatorowa 2w1

Rechargeable lamp 2in1 / Wiederaufladbare Lampe 2in1 / Аккумуляторная лампа 2 в 1 / Аккумуляторная лампа 2in1 / Ujratölthető lámpa 2in1 / Lámpa reíncárcabilă 2in1 / Dobijeci lamp 2v1 / Dobijacia lamp 2v1 / Akumulatorska svetilka 2v1 / Akumulatoriaus lempa 2in1 / Uzlādējama lamp 2in1 / Laetav lamp 2in1 / Аккумуляторная лампа 2в1 / Punjiva lamp 2v1 / Аккумуляторна лампа 2v1 / Επαναφορτιζόμενη λάμπα 2в1 / Lámpara recargable 2en1 / Lampada ricaricabile 2in1 / Lâmpada recarregável 2 em 1 / Lampe rechargeable 2en1 / Oplaadbare lamp 2in1



- 2in1
- CHARGER INCLUDED
- COB LED
- 4W+ 1W
- LAMP+ TORCH
- max 400lm
- torch
- ABS
- 3.7V 2200mAh Li-ion
- cable included USB C
- CHARGING TIME 3-3.5h
- WORKING TIME 4-4.5h for 50% brightness
- IP20
- IK07
- battery indicator
- HOOK



Ref. 99-102 | EAN 5907558495478

Lampa 3w1

Lamp 3in1 / Lampe 3in1 / Лампа 3 в 1 / Лампа 3in1 / Lámpa 3in1 / Lampă 3în1 / Lamp 3v1 / Lamp 3v1 / Svetilka 3v1 / Lamp 3in1 / Lamp 3in1 / Lamp 3in1 / Лампа 3в1 / Lamp 3v1 / Лампа 3v1 / Lámpa 3в1 / Lámpara 3en1 / Lampada 3in1 / Lâmpada 3 em 1 / Lampe 3en1 / Lamp 3in1

- 2200mAh Li-ion 3.7V
- 3in1
- 150m max range
- IP44
- ZOOM
- max 350lm
- battery indicator
- CHARGING TIME 4h
- COB LED
- cable included USB C
- WORKING TIME 6-8h
- quick easy change



Ref. 99-107 | EAN 5907558499674

Lampa na szyje

Neck lamp / Nackenlampe / Нашейная лампа / Нашийний світильник / Nyaklámpa / Lampă pentru gât / Lamp ă na krk / Lamp ă na krk / Svetilka za vrat / Kaklo lempa / Kakla lamp / Kaela lamp / Лампа за врата / Svetiljka za vrat / Лампа за врат / Φωτιστικό λαιμού / Lámpara de cuello / Lampada da collo / Lâmpada de pescocă / Lampe de cou

- movable heads
- WORKING TIME 8h
- CHARGING TIME 3h
- Function High-Low-SOS
- +2W
- 2x 150lm
- 2x 3.7V 1200mAh
- ABS +TPE
- cable included USB C
- 10000K
- IK07
- IP44



Ref. 99-112 | EAN 5907558475715

Latarka czółowa

Headlamp / Stirnlampe / Фонарь налобный / Лихтарик наліпний / Fejlámpa / Lampă cap / Čelní baterka / Lamp ă čelová / Čelna svetilka / Žibintuvélis / Lukturītis uz pieres / Esilatern / Лампа за глава / Lamp ă za glavu / Ручна лампа / Φακός κεφαλής / Linterna de frente / Lampadina frontale / Lanterna de testa / Torche frontale / Hoofdzaklamp

- XPE+ COB LED
- MOTION SENSOR
- 350LM
- 1200mAh Li-ion
- 5 LIGHT FUNCTIONS
- RUBBER BODY
- WORKING TIME 3-6.5h
- CHARGING TIME 2.5h
- cable included USB C
- 67g
- IPX4



Ref. 99-097 | EAN 5907558493702

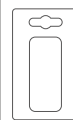

- 500lm
- 8W
- Li-ion 3.7V 500mah
- 180g
- COB LED
- TURBO MODE
- MOTION DETECTOR
- charge indicator
- USB C cable included
- 7h working
- 2h charging
- CAP CLIP



Ref. 99-115 | EAN 5907558475913

Lampa do inspekcji lakieru

Paint inspection lamp / Inspektionslampe für Farbe / Лампа для проверки лакокрасочного покрытия / Лампа для перевірки фарби / Festékellenőrző lámpa / Lampă de inspecție a vopselei / Kontrolní lampa na nátěry / Lampa na kontrolu farby / Svetilka za pregled barve / Dažų tikrinimo lempa / Krāsas pārbaudes lampa / Väri kontroll-lamp / Лампа за проверка на боята / Lampa za pregled boje / Лампа за презлед боје / Λαμπτήρας επιθεώρησης βαφής / Lampada di ispezione della vernice / Lâmpada de inspecção da pintura / Lâmpara de inspección de pintura / Lampe d'inspection de la peinture / Verf inspectielamp



cable included USB C	COB SMD	2in1	max 400lm	4000mAh 3.7V Li-Ion
WORKING TIME max 4h	UV	battery indicator	charging indicator	LIGHT warm natural cold
HOOK	CRI Ra ≥ 90	CHARGING TIME 4,5h	CHARGER INCLUDED	charger 5V 2A to 230V AC 50Hz
		185x 50x 32mm	245g	IP56



Ref.	📦	EAN
99-098	1/10	5907558493719

Lampa 360 stopni

Lamp 360 degrees / 360-Grad-Lampe / Лампа 360 градусов / Лампа на 360 градуса / Lámpa 360 fokos / Lampă de 360 de grade / Lampa 360° / Lampa 360° / Svetilka 360-stopinjna / Lampa 360 laiprni / Lampă 360 grădu / Lamp 360 kraadi / Лампа 360-градусова / Lampă 360 stupnjeva / Лампа 360 степени / Λαμπτήρας 360 μοιρών / Lampada a 360 gradi / Lampadina frontale / Lámpara de 360 grados / Lampe 360 degrés / Lamp 360 graden



2x 4300lm	2x 40W	SMD LED
360°	AC 220-240V 50Hz	cable 5m
5000K	HANDLE	MAX WIDTH 94 cm
PC + ABS	IK08	5,8kg
easy transport & storage		IP54



Ref.	📦	EAN
99-099	1/2	5907558495461

Lampa szperacz

Searchlight / Suchscheinwerfer / Прожектор / Прожектор / Fényező / Reflector / Světlo / Svetlo / Žaromet / Prožektorius / Prožektors / Prožektor / Прожектор / Reflektor / Рефлектор / Προβολέας / Reflector / Proiettore / Holofote / Projecteur / Zoeklicht



NEW

1000lm	RANGE 350m
Li-ion 3.7V 2200mah	USB C
6h charging	8h working
SST40 LED	ABS
USB C cable included	STROBE function
	IP44

Ref.	📦	EAN
99-114	10/20	5907558475265

Lampa biwakowa 3 w 1

3-in-1 camping lamp / 3-in-1-Campinglampe / Походная лампа 3 в 1 / Кемпінговий ліхтар 3-в-1 / 3 az 1-ben kemping lámpa / Lampă de camping 3 în 1 / Kempingová lampă 3 v 1 / Kempingová lampă 3 v 1 / Kamping svetilka 3 v 1 / 3-in-1 stovyklavim lamp / 3-in-1 kempinga lamp / Лампа за кэмпінг 3 в 1 / Lámpara de camping 3 en 1 / Lampada da campeggio 3 in 1 / Candeiro de campismo 3 em 1 / Lampe de camping 3 en 1 / 3-in-1 campinglamp



NEW

USB C cable included	USB or DYNAMO CHARGING	Li-ion 3.7V
202g	POWER INDICATOR	2000 mAh
XPE LED	COB LED	ABS +PC
500LM	3in1 LAMP FLASHLIGHT POWERBANK	USB C

Ref.	📦	EAN
99-118	25/50	5907558477610

Lampa solarna

Solar lamp / Solarleuchte / Солнечный светильник / Сонячний світильник / Napelemes lámpa / Lampă solară / Solární lamp / Solárna lamp / Solarna svetilka / Šviestuvus su saulės energija / Solārā lamp / Päikesetoitel lamp / Соларна лампа / Solarna lamp / Solarna lamp / Ηλιακός λαμπτήρας / Lámpara solar / Lampada solare



ON OFF	30lm
1200mAh Li-Ion 3.7V	17 LED
2500K	CHARGING TIME 8h
120x 120x 135cm	ABS
170g	IP65

Ref.	📦	EAN
99-108	0/72	5907558499681

Girlanda

Garland / Girlande / Гирлянда / Гирлянда / Füzér / Ghirlandă / Girlanda / Girlanda / Venček / Girlianda / Virtene / Garland / Гирлянд / Girlanda / Гарланд / Гирланта / Guirnalda / Ghirlanda / Grinalda / Guirlande / Slinger

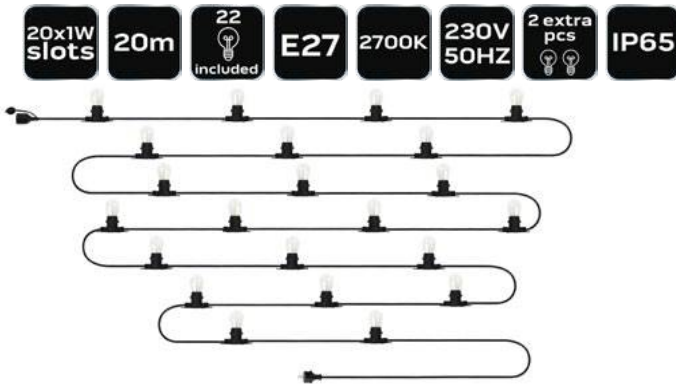

Ref. 99-106
EAN 5907558499667

Žarówki do girlandy

Bulbs for garland / Glühbirnen für Girlande / Лампочки для гирлянды / Лампочки для гирлянди / Izzók füzérhez / Becuri pentru ghirlandă / Žarovky pro girlandu / Žarovky pre girlandu / Žarnice za girlando / Lemputės skirtos girlandai / Spuldzes virtenei / Pirnid vaniiku jaoks / Електрически крушки за гирлянд / Žarulje za girlandu / Συζαλιτζε за виџенац / Λαμπτήρες για γιρλάντα / Bombillas para guirnalda / Lampadine per ghirlanda / Gloeilampen voor slinger / Ampoules pour guirlande



1W E27
2700k 5pcs

Ref. 99-111
EAN 5907558499889

Stupek ogrodowy LED solarny

LED solar garden post / LED solar garden post / Светодиодный садовый столб на солнечных батареях / Светлодиодний сонячний садовий стовп / LED napeletes kerti oszlop / LED solar gradina post / LED solární zahradní sloupek / LED solárny záhradný stĺpik / LED sončna vrtna pošta / LED saulės sodo stulpas / LED saules dārza stabs / LED päikesenergia aiapost / LED стлнчев зрадински стълб / LED vrtni stup / ЛЕД баштенски стуб / LED ηλιακή κήπου post / Palo da giardino solare a LED / Poste de jardim solar LED / Poste solar LED para jardín / Poteau de jardin solaire LED / LED solar tuinpaal



WORKING TIME 8h
LED height 43cm
10 000h work life IP44
1.2V 100mAh Ni-MH AAA
CHARGING TIME 8h
stainless steel

Ref. 99-113
EAN 5907558499698

Lampka do kluczy

Key lamp / Schlüssel Lampe / Ключевая лампа / Лампа для ключів / Kulcslámpa / Lampă cu cheie / Kľúčová lampra / Kľúčová lampra / Kľučna svetilka / Pagrindinis žibintas / Galvenais lukturis / Vötte lamp / Ключова лампа / Лампа за кључеве / Лампа за кључеве / Лампа κλειδί / Lámpara de llave / Lampada a chiave / Lámpara de chave / Lampe à clé / Sleutel lamp



5V 500mAh Li-ion
4 FUNCTIONS
COB LED
cable included USB C
500 LM
30pcs LED
58 gr
6cm x 4.6cm
CHARGING TIME 15min
WORKING TIME 3h
IPX4

Ref. 99-109
EAN 5907558499728

Przedłużacz bębnowy

Extension cord / Verlängerungskabel / Удлинительный кабель / Подовжжувач / Hosszabbító kábel / Cablu prelungitor / Prodlužovací kabel / Predlžovací kábel / Podaljševalni kabel / Prailginito kabelis / Pagarinātājs / Pikenduskaabel / Удължителен кабел / Produžni kabel / Продужни кабл / Καλώδιο επέκτασης / Cable alargador / Cavo di prolunga / Cabo de extensão / Câble d'extension / Verlengkabel



100% Cu
E/F
IP20
thermal fuse
E

NEW

Ref.	L [m]	Ø [mm]	⊠	EAN
90-170	20	3x1.5mm ²	0/2	5907558426526
90-171	30	3x1.5mm ²	0/2	5907558426533
90-172	40	3x1.5mm ²	0/2	5907558426540
90-173	30	3x2.5mm ²	0/2	5907558426557
90-174	40	3x2.5mm ²	0/2	5907558426564
90-175	50	3x2.5mm ²	0/2	5907558426571

Przedłużacz listwowy

Extension cable / Verlängerungskabel / Удлинительный кабель / Подовжжувач / Hosszabbító kábel / Hosszabbító kábel / Prodlužovací kabel / Predlžovací kábel / Podaljševalni kabel / Prailginito kabelis / Pagarinātājs / Strip extender / Удължителен кабел / Strip produžni kabel / Скините продужни кабл / Επίεκταση λωρίδας / Cable alargador / Cavo di prolunga / Cabo de extensão / Câble d'extension / Verlengkabel

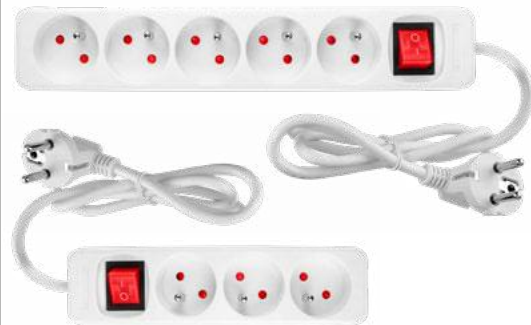

100% Cu
ON/OFF SWITCH
E
E/F

Ref.	Info	⊠	EAN
90-176	1.5m, 3x1.5mm ² , 3G,	0/40	5907558474923
90-177	1.5m, 3x1.5mm ² , 5G,	0/40	5907558474930
90-178	3m, 3x1.5mm ² , 3G,	0/40	5907558474947
90-179	3m, 3x1.5mm ² , 5G,	0/40	5907558474954
90-180	5m, 3x1.5mm ² , 3G,	0/30	5907558474961
90-181	5m, 3x1.5mm ² , 5G,	0/30	5907558474978

NEW



100% Cu
ON/OFF SWITCH
E
E/F

Ref.	Info	⊠	EAN
90-182	1.5m, 3x1.5mm ² , 3G,	0/40	5907558474985
90-183	3m, 3x1.5mm ² , 3G,	0/40	5907558474992
90-184	1.5m, 3x1.5mm ² , 4G,	0/40	5907558475005
90-185	3m, 3x1.5mm ² , 4G,	0/40	5907558475012

NEW

Nagrzewnica olejowa

Oil heater / Ölheizung / Масляный нагреватель / Масляний обігрівач / Olajmelegítő / Încalzitor cu ulei / Ohřivač oleje / Ohřivač oleja / Grelnik olja / Alyvos šildytuvas / Eļļas sildītājs / Ölkütteseade / Нагревател на масло / Grijač ulja / Грејач уља / Θερμαντήρας λαδιού / Calentador de aceite / Riscaldatore dell'olio / Olie verwarmers / Réchauffeur d'huile



Ref.	☒	EAN
90-086	1/1	5907558495423

Grzejnik olejowy

Oil heater / Ölheizung / Масляный обогреватель / Масляний обігрівач / Olajfűtés / Încalzitor de ulei / Olejový ohřivač / Olejový ohřivač / Oljni grelnik / Alyvos šildytuvas / Eļļas sildītājs / Ölisoojendi / Маслен нагревател / Uljni grijač / Уљни грејач / Θερμαντήρας πετρελαίου / Riscaldatore a olio / Aquecedor a óleo / Calentador de aceite / Chauffage à l'huile / Olieverwarming

MAX POWER 1500W

x7

3 HEATING MODES
1500W
900W
600W

ADJUSTABLE THERMOSTAT

CABLE SUPPORT

TILT SWITCH

POWER INDICATOR

HANDLE and CASTERS

MAX POWER 2000W

x9

3 HEATING MODES
2000W
1200W
800W

MAX POWER 2500W

x11

3 HEATING MODES
2500W
1500W
1000W

NEW

Ref.	☒	EAN
90-151	0/1	5907558476668
90-152	0/1	5907558476675
90-153	0/1	5907558476682

Grzejnik konwektorowy z termostatem

Convecter heater with thermostat / Konvektorheizung mit Thermostat / Конвекторный обогреватель с термостатом / Конвекторний обігрівач з термостатом / Konvektoros fűtőtest termosztáttal / Convecter de încălzire cu termostat / Konvektorový ohřivač s termostatem / Konvektorový ohřivač s termostatom / Konvektorski grelnik s termostatom / Konvektorinis šildytuvas su termostatu / Konvektora sildītājs ar termostatu / Konvektorsoojendi termostaadiga / Конвекторен нагревател с термостат / Konvektorska grijalica sa termostatom / Конвекторски грејач са термостатом / Θερμοσίφωνας με Θερμοστάτη στήνταρ / Riscaldatore a convettore con termostato / Aquecedor convetor com termostato / Convecter con termostato / Convector avec thermostat / Convectorverwarming met thermostat



Ref.	info	☒	EAN
90-154	standard	0/1	5907558476699
90-155	turbo	0/1	5907558476705

Termowentylator

Thermoelectric fan / Thermoelektrischer Ventilator / Термоелектричний вентилятор / Термоелектричний вентилятор / Thermoelektrischer Ventilator / Ventilator termoelectric / Thermoelektrický ventilátor / Thermoelektrický ventilátor / Thermoelektrični ventilator / Thermoelektrinis ventilatorius / Thermoelektriskais ventilators / Thermoelektriline ventilator / Термоелектрически вентилятор / Thermoelektrični ventilator / Термоелектрични вентилятор / Θερμοηλεκτρικός ανεμιστήρας / Ventilador termoelectrico / Ventilatore termoelettrico / Thermo-elektrische ventilator / Ventilateur thermoelectrique

2 HEATING MODES
2000W
1000W

COPPER ENGINE

COLD AIR FUNCTION

ADJUSTABLE THERMOSTAT

CARRYING HANDLE

MAX POWER 2000W

NEW

Ref.	☒	EAN
90-116	0/8	5907558476620

2 HEATING MODES
2000W
1000W

COPPER ENGINE

COLD AIR FUNCTION

ADJUSTABLE THERMOSTAT

POWER INDICATOR

CARRYING HANDLE

MAX POWER 2000W

VERTICAL and HORIZONTAL USE

NEW

Ref.	☒	EAN
90-117	0/6	5907558476637

FLAME EFFECT

PTC

800/1500 W

Ref.	☒	EAN
90-110	1/1	5907558495324

Promiennik podczerwieni

Infrared heater / Infrarotstrahler / Инфракрасный обогреватель / Инфрачервоный обігрівач / Infrarörs melegítő / Incälzitor cu infraroșu / Infraczerwenj ohřivač / Infraczerwenj ohrievač / Infrardeci grelec / Infraraudonuju spinduliju šildytuvus / Infrasarkanais sildītājs / Infraruna kütteseade / Инфрачервен нагревател / Infracrveni grijač / Инфрачервени грејач / Υπέριθρη θερμάστρα / Calentador infrarrojo / Riscaldatore a infrarossi / Infrarood verwarming / Chauffage infrarouge



600/1200 W QUARZ WHEELS

Ref. 90-111 EAN 5907558495331



QUARZ 400/800 W

Ref. 90-112 EAN 5907558495348



ROTARY BASE 400/800/1200W CARRYING HANDLE HALOGEN LAMP

Ref. 90-113 EAN 5907558495355



400/800/1200W HALOGEN LAMP ROTARY BASE

Ref. 90-114 EAN 5907558495362

Piecyk gazowy na butle z reduktorem i wężem

Gas heater for cylinders with a reducer and a hose / Gasheizofen mit Regler und Schlauch / Газовый обогреватель для баллонов / Балонний газовий обігрівач / Gázpalackos sugárázó fűtőtest / Incälzitor radiant cu butelie de gaz / Plynový sálavý ohřivač / Plynový ohrievač pre plynové fľaše / Plinski grelnik z jeklenko / Dujų baliono spindulinis šildytuvus / Gāzes balona starojuma sildītājs / Gaasisoojendi balloonidele / Льчист нагревател с газова бутылка / Plinski grijač za boce / Гасни грејач за циплино̀ре / Θερμάστρα Υγραερίου για φιάλη / Riscaldatore radiante con bombola / Aquecedor radiante de botija de gás 4600W / Calefactor radiante de cilindro de gas / Chauffage au gaz de bouteille de gaz avec réducteur et tuyau / Gaskachel voor cilinders met regelaar en slang /

Promiennik gazowy na butle

Radiant gas heater for cylinder / Gasflaschen-Heizstrahler / Газовый обогреватель для баллонов / Балонний газовий обігрівач / Gázpalackos sugárázó fűtőtest / Incälzitor radiant cu butelie de gaz / Plynový sálavý ohřivač / Plynový ohrievač pre plynové fľaše / Plinski grelnik z jeklenko / Dujų baliono spindulinis šildytuvus / Gāzes balona starojuma sildītājs / Gaasisoojendi balloonidele / Льчист нагревател с газова бутылка / Plinski grijač za boce / Гасни грејач за циплино̀ре / Θερμάστρα Υγραερίου για φιάλη / Riscaldatore radiante con bombola / Aquecedor radiante de botija de gás 4600W / Calefactor radiante de cilindro de gas / Chauffage radiant à gaz / Gasflesstraler



MAX POWER 4,2kW PIEZO 5 OR 11 KG 3 HEATING MODES 4200W 2800W 1500W REDUCER + HOSE INCLUDED TILT PROTECTION G30/G31 MIXTURE 10KG ODS OXYGEN DEFICIENCY SENSOR CONSUMPTION MAX 305 g/h FOLDABLE DESIGN 13 B/P 0,37 pressure BAR

NEW

Ref. 90-118 EAN 5907558476644



NEW

MAX POWER 4,6kW REDUCER + HOSE INCLUDED CONSUMPTION MAX 0,335 kg/h 2 HEATING MODES 4600W 2800W OUTPUT PRESSURE G30/G31 MIXTURE 0,37 BAR HEATER SIZE AL 34 13 40

Ref. 90-119 EAN 5907558476651

Koparka 4 w 1 dla dzieci

4 in 1 excavator for children / 4-in-1-Bagger für Kinder / Детский экскаватор 4 в 1 / Дитячий экскаватор 4 в 1 / 4 az 1-ben kotrórgép gyerekeknek / Excavator 4 in 1 pentru copii / Bager 4v1 pro děti / Bager 4v1 pre deti / Bager 4 v 1 za otroke / Escavatore 4 in 1 per bambini / Escavatore 4 in 1 per bambini

NEW



Ref.	📦	EAN
GD041	12/24	5907558477450



Plac budowy z piaskiem kinetycznym, zabawka w walizce

Construction site with kinetic sand, toy in a suitcase / Baustelle mit kinetischem Sand, Spielzeug im Koffer / Строительная площадка с кинетическим песком, игрушкой в чемодане / Будмайданчик з кінетичним піском, іграшка у валізі / Építkezés kinetikus homokkal, játék a bőröndben / Šantier cu nisip cinetic, jucărie într-o valiză / Stavenište s kinetickým pískem, hračka v kufru / Stavenisko s kinetickým pískom, hračka v kufriku / Gradbišče s kinetičnim peskom, igrača v kovčku / Cantiere con sabbia cinetica, giocattolo in valigia / Būvlaukums ar kinētiskām smiltīm, rotaļlieta koferī

NEW



Ref.	📦	EAN
GD042	0/12	5907558477467



Grabie

Hoe / Handhacke / Мотыжка / Сапка / Кара / Särpäligä / Motyka / Motyčka / Motika / Purentuvus / Karplis / Kõblas / Мотика / Motika / Motičica / Σκαλιστήρι / Azada / Zappetta / Enxada / Brosse à joints



Ref.	☒	EAN
95-041	0/50	5907558475739



Ref.	☒	EAN
95-043	0/70	5907558475753



Ref.	☒	EAN
95-042	0/60	5907558475746



Ref.	☒	EAN
95-044	0/30	5907558475760

Trzonek

Shank / Stiel / Рукоятка / Хвостовик / Nyél / Maner / Násada / Tříř / Ročaj / Kotas / Spals / Vars / Цонгл / Držak / Drška, držalo / Χειρολαβή / Vástago / Manico / Cabo / Manche / Handvat



Ref.	☒	EAN
95-045	0/10	5907558477177

Mocowanie na trzonek

Shank mount / Schafthbefestigung / Крепление хвостовика / Криплення для хвостовика / Lábszár rögzítés / Montare cu tijă / Upevnění na dřík / Uchytenie na stopku / Pritrditev na trn / Koto tvirtinimas / Kāta stiprinājums / Varre kinnitus / Монтаж на шенгела / Montaža stabiljke / Монтажа стабільке / Βάση στερέωσης στελέχους / Montaje de vástago / Montaggio su gambo / Montagem da haste / Montage de la tige / Schachtbevestiging /



Ref.	☒	EAN
95-040	0/250	5907558475722

Szpadel

Spade / Spaten / Заступ / Лопата багнетова / Ásó nyelzeve / Лопатица / Rýč / Rýč / Rýč lichobežníkový / Lopata / Kastuvas / Lápsta / Labidas / Лопата права / Lopata / Lopata / Φτυάρι / Pala / Pala / Pá / Louchet / Spade



Ref.	☒	EAN
95-008-1	1/1	5907558430417
95-007-1	1/1	5907558430400
95-004	1/1	5907558430394

Szklarnia

Оранжерия / Skleník / Gewächshaus / Θερμοκήπιο / Greenhouse / Invernadero / Serre / Üvegház / Serra / Šiltarnis / Siltumnica / Serre / Estufa / Serā / Парник / Skleník / Rastlinjak



68x 49x 160cm	foldable
EASY ASSEMBLY	
metal structure 0.35mm	4 shelves
folia PE	

Ref.	☒	EAN
15-903	0/1	5907558499896

90x 90x 240cm	foldable	EASY ASSEMBLY		metal structure 0.3mm	folia PE
---------------------	----------	------------------	--	-----------------------------	-------------

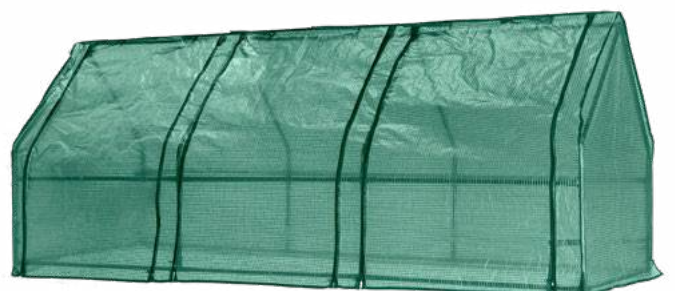

Ref.	☒	EAN
15-912	0/1	5907558499902

Rękawice robocze

Working gloves / Arbeitshandschuhe / Перчатки рабочие / Руквици работни / Bőr kesztyű / Měnuši de lucru / Pracovní rukavice / Pracovné rukavice / Delovne rokavice / Darbo pirštines / Darba cimdi / Töökindad / Ръкавици работни / Radne rukavice / Radne rukavice / Γάντια εργαίας / Guantes de trabajo / Guanti di lavoro / Luvas de trabalho / Gants de travail / Werkhandschoenen



Ref.	info	📦	EAN
97H139	11"	12/120	5902062102737



Ref.	info	📦	EAN
97H123	11"	12/120	5902062038944

Szpadel

Spade / Spaten / Заступ / Лопата багнетова / Ásó nyelezve / Lopátjica / Ryč / Ryč / Ryl' lichobežníkový / Lopata / Kastuvus / Lāpsta / Labidas / Лопата права / Lopata / Lopata / Φτυάρι / Pala / Pala / Pá / Louchet / Spade



Ref.	📦	EAN
15G026	0/1	5902062042859
15G027	0/1	5902062042866



Ref.	📦	EAN
15G010-1	0/1	5902062181336
15G011-1	0/1	5902062044785

Łopata

Shovel / Schaufel / Лопата / Лопата совковая / Lapát nyelezve / Lopatä / Lopata / Lopata ocelová / Lopata / Kastuvus / Lāpsta / Kūhvel / Лопата крива / Lopata / Lopata / Φτυάρι / Pala / Badile / Pá / Pelle / Schep



Ref.	📦	EAN
15G012-1	0/1	5902062102775



Ref.	📦	EAN
15G020	0/1	5902062040008
15G021	0/1	5902062042842



Ref.	📦	EAN
15G018	0/1	5902062039989
15G019	0/1	5902062039996

Motyka

Hoe / Handhacke / Мотыжка / Сапка / Кара / Särpälligä / Motyka / Motyčka / Motika / Purentuvus / Kaplis / Kõblas / Мотика / Motika / Motičica / Σκαλιστήρι / Azada / Zappetta / Enxada / Brosse à joints



Ref.	info		EAN
15G039	14 cm	0/1	5902062042873

Trzonek

Shank / Stiel / Рукотка / Хаостовик / Baltanyél / Mânier / Násada / Тiй / Ročaj / Kotas / Spals / Vars / Цокъл / Držak / Drška, držalo / Χειρολαβή / Vástago / Manica per ascia / Cabo / Manche / Handvat



Ref.	info		EAN
15G061	T 38/90	0/1	5902062043184
15G062	38/100	0/1	5902062043191
15G063	28/130	0/1	5902062043207

Grabie

Hoe / Handhacke / Мотыжка / Сапка / Кара / Särpälligä / Motyka / Motyčka / Motika / Purentuvus / Kaplis / Kõblas / Мотика / Motika / Motičica / Σκαλιστήρι / Azada / Zappetta / Enxada / Brosse à joints



Ref.	info		EAN
15G056	12 teeth	0/1	5902062042934
15G057	14 teeth	0/1	5902062043054
15G058	18 teeth	0/1	5902062043115



Ref.		EAN
15G085	0/50	5902062108326



Ref.		EAN
15G086	0/70	5902062108333

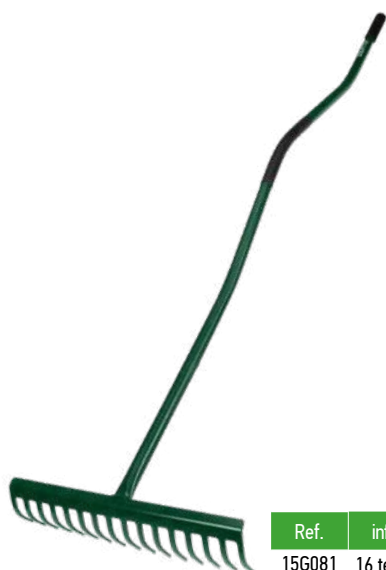

Ref.	info		EAN
15G081	16 teeth	0/1	5902062043375



Ref.		EAN
15G087	0/30	5902062108340

Łopatka

Garden trowel / Kleiner spaten / Лопатка / Лопатка / Kislápát / Lopata pentru zapada / Lopata na sniž / Lopata na sneh / Lopata za sneg / Kastuvas sniegui / Lāpsta sniegam / Lumelabidas / Лопатка / Lopatica / Lopata za sneg / Φτυάρι για το χιόνι / Hombro / Spalla / Ombro / Lépaule / Schepje



Ref.		EAN
15G414	1/48	5902062107602



Ref.		EAN
15G413	1/48	5902062107596

Pazurki

Hand cultivator / Handkultivator / Тяпка посадочная / Розпушувач / Talajlazító / Cultivator / Купріч / Kultivátor Zzubovj / Kultivator / Purentuvus / Kultivātors / Kultivaator / Куптиватор градински / Kultivator / Kultivator / Фрежаторо / Rastrillo pequeño / Coltivatore / Garras / Griffes / Kweker



Ref.		EAN
15G415	1/48	5902062107619



Ref.		EAN
15G416	1/48	5902062107626

Grabki

Small rake / Kleiner rechen / Грабелънки / Грабелънки / Gereblye mini / Greblä / Hrable / Hrabličky / Grabljice / Grēbliukas / Grābeklis / Reha / Градинарско гребло / Grablje / Grabljice / Τσουγκράνα / Rastrillo / Rastrellino / Forquilhas / Petit râseau



Ref.		EAN
15G411	1/48	5902062107572

Widelki

Forks / Gabeln / Вилки / Виделки / Villa, mini / Furculițe / Vidlice / Plastové / Plastične / Plastikines / Plastmasas / Kahvlid / Вилуци / Vilice / Форк / Προούνια / Horquillas / Forchette / Garfos / Fourchettes / Vorken



Ref.		EAN
15G412	1/48	5902062107589

Motyczka

Small hoe / Handhacke / Тяпка / Сапка / Últető kapra / Grapă / Motyčka / Motyčka / Motika / Каптукас / Kaplis / Kōblas / Мотична градинска / Motika / Motika / Тоάνα / Zappa / Enxada / Houlette / Schoffel



Ref.		EAN
15G417	1/48	5902062107633

Zestaw narzędzi ogrodowych

Garden tool set / Gartenwerkzeugset / Комплект садових інструментов / Комплект городского инструментария / Kerti szerszámkészlet / Set unelte de grădinărit / Sada zahradnického nářadí / Súprava záhradného nářadia / Komplet vrtnih orodij / Sodo įrankių rinkinys / Dārza instrumentu komplekts / Aiatööriistade komplekt / Комплект градинарски инструменти / Set vrtnog alata / Pribor alata za baštu / Σετ εργαλείων κήπου / Juego de herramientas de jardín / Completo di attrezzi per giardinaggio / Kit de ferramentas / Jeu d'outils / Set van doppen



Ref.		EAN
15G419	1/12	5902062107640

Pikownik z trzonkiem drewnianym

Sow dibbler / Pflanzler / Сажалка-луннообразователь / Сажалка-лунноутворювач / Ültetőbot / Plantator rasaduri / Sázeći kolik / Kolik na sadenie / Sadilni klin / Sodinimo įrankis / Stādīšanas rīks / Istutusööriistad / Садуло за расад / Klin za sadenje / Садыкя клына / Φύτευτήρι / Piantatori in acciaio / Foraterra in acciaio / Plantador Bico / Plantoir conique / Pootstok



Ref.		EAN
15G425	1/100	5902062107497

Tabliczki do roślin

Garden stake tags / Gartenpfahl-Tags / Бирки для садовык кольев / Теги для садовык колів / Növény címkék / Etichetele plantelor / Štítky rostlin / Štítky rastlín / Oznake rastlin / Augalu etiketes / Augu etiķetes / Aia vaia sildid / Етикету за растения / Etikete za biljke / Бильне етикете / Ετικέτες φυτών / Etiquetas de plantas / Etichette vegetali / Rótulos de plantas / Étiquettes de plantes / Labels voor planten



Ref.		EAN
15G460	4/160	5902062107473

Zestaw do sadzenia

Planting kit / Pflanzset / Набор для посадки / Ültetőkészlet / Trusa de plantare / Sada pro výsadbu / Set za sajenje / Sodinimo rinkinys / Stādīšanas komplekts / Istutuskomplekt / Комплект за засаждане / Set za sadnju / Set за садњу / Σετ φύτευσης / Kit de plantación / Kit per piantare / Kit de plantio / Kit de plantation / Plantenset



Ref.		EAN
15G467	1/18	5902062107657

Sadzarka ręczna

Hand bulb planter / Manuelle Pflanzmaschine / Ручная севалка / Ручна саджалка / Kézi ültető, rugós / Plantator manual / Ručni sázeći stroj / Ručný sadzač / Ročni sadilnik / Rankinis sodintuvas / Manuālā sējmašīna / Ръчна саксия / Χειροκίνητη γλάστρα / Jardinera manual / Fioriera manuale / Plantador manual / Planteuse manuelle / Handmatige plantenbak



Ref.		EAN
15G426	1/60	5902062107503

Rozsadniki torfowe

Peat seedpods / Torftöpfe / Торфяные горшочки / Торф'яні горшочки / Tőzegedények / Vase de turbă / Rašelinové hrnce / Rašelinové hrnce / Šotni lončki / Durrių puodai / Kūdras podi / Turbarotid / Торфени саксии / Tresetne posude / Тресетне посуде / Глăстрес тұрпăрс / Macetas de turba / Vasi di torba / Vasos de turfa / Pots de tourbe / Turf potten



Ref.	info		EAN
15G463	8x8x7.8 cm	1/12	5902062107510



Ref.	info		EAN
15G465	16x12x4.5 cm	1/24	5902062107534



Ref.	info		EAN
15G464	8x8x7.8 cm	1/24	5902062107527



Ref.	info		EAN
15G466	16x12x4.5 cm	1/24	5902062107541

Odstraszacz solarny

Solar deterrent / Solare Abschreckung / Солнечный отпугиватель / Відлякувач сонячних променів / Napelemes kártevőriasztó / Dispositiv solar de descurajare / Solární odstrašující prostředek / Solární odstrašující prostředek / Solarni odvračalni element / Saulės atgrasymo priemonė / Saules atbaidīšanas līdzeklis / Pāikesetājirēvahend / Соларен възпиращ елемент / Solarni repelent / Соларни репелент / Ηλιακός αποτρεπτικός μηχανισμός / Disuasor solar / Deterrente solare / Dissuasor solar / Dissuasion solaire / Zonneschrikmiddel



Ref.	Box	EAN
156441	00/30	5902062107480

Chwytnak do śmieci

Trash grab / Müllgreifer / Захват мусора / Сміттєзбірник / Hulladékszipesz / Captură de gunoi / Popelnice / Uchopenie odpadu / Zgrabite smeti / Šiuokščių griebimas / Atkritumu sagrābšana / Prügipiüüdja / Вземане на боклук / Нватач смећа / Цхвѣтѣк до смеѣци / Αρπάχτε τα ακουπιδία / Agarre de basura / Afferrare la spazzatura / Apanhar o lixo / Pince à ordures / Prullenbak

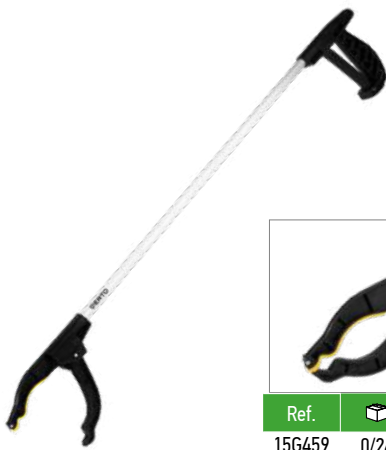

Ref.	Box	EAN
156459	0/24	5902062107367

Aerator ręczny, wertykulator walcowy do trawy

Hand aerator, lawn roller velocirculator / Handbelüfter, Rasenwalze Velocirculator / Ручной аэратор, газонный каток-велоциркулятор / Ручний аератор, газонний велоциркулятор / Kézi levegőtető, gyepszellőztető henger / Aerator de mână, role de gazon velocirculator / Ruční provzdušňovač, travní válec velocirkulátor / Ručnú prevzdušňovač, valec na trávnik / Ročni prezračevalnik, valjček za trato velocirkulator / Rankinis aeratorius, vejos volas velocirkuliacinis / Rokas aerators, zāļena veltnis velocirkulators / Käsiaerator / Ръчен аератор, валяк за тревни площи / Ručni aerator, velo cirkulacija s valjkom za travnjak / Ручни аератор, велоциркулятор са вальном за травњак / Χειροκίνητος εξερωτήρας, ρολό γκαζόν, κυκλοφορητής / Aireador manual, rodillo de césped velocirculator / Arieggiatore manuale, rullo velocipede / Arejador manual, rolo de relva velocirculator / Aérateur à main, rouleau à gazon velocirculateur / Handbeluchter, gazonroller velocirculator

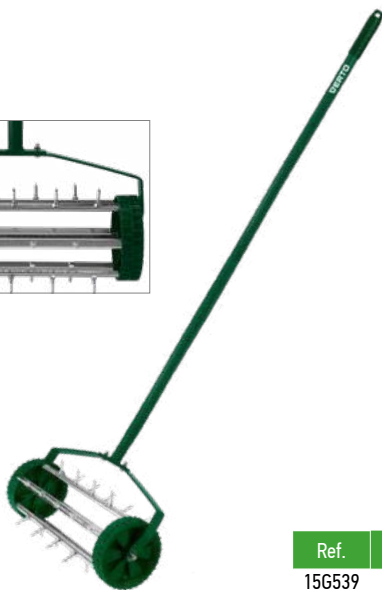

Ref.	Box	EAN
156539	4/4	5902062107565

Taśma ogrodnicza z siatki

Garden tape / Gartennetzband / Садовая лента / Садова стрічка / Kerti szalag / Bandă de grădină / Zahradní páska / Záhradná páska / Vrtni trak / Sodo juosta / Dārza lente / Aiateip / Градинска лента / Vrtna traka / Баштенска трака / Ταβία κήπου / Cinta de jardin / Nastro da giardino / Fita de jardim / Ruban de jardin / Tuingaasband



50 m

Ref.	Box	EAN
156471	1/20	5902062107558

Swider do gleby

Soil auger / Erdbohrer / Почвенного шнека / Грунтовогo шнека / Talajcsiga / Burghilui de sol / Půdní šnek / Půdny vrták / Sveder za zemljo / Dirvos sraigas / Augsnis urbis / Mullatigu / Шнек за почва / Svrdo za zemljo / Свез за тно / Τρυπάνι εδάφους / Barrena de suelo / Coclea del terreno / Trado de solo / Tarière à terre / Grondboor



DURABLE

Ref.	info	Box	EAN
156071	110 mm	0/1	5902062043344
156072	250 mm	0/1	5902062043351

Spryskiwacz

Spraying machine / Spritzgerät / Опрыскиватель / Οπρυσκυσвач / Permetező / Aparat de stropit / Postřikovač / Postrekovač / Škropilnik / Purkštuvas / Smidzinātājs / Piserdi / Πυλνερισματορ / Prskalica / Prskalica / Ψεκαστήρας / Aspersor / Atomizzatore / Máquina regadora / Pulvérisateur / Spuittoestel



Ref.	info	Box	EAN
156545	550 ml	0/100	5902062103123
156546	1000 ml	0/48	5902062103130

Sektor ogrodowy

Garden pruner / Gartenschere / Секатор садовий / Секатор садовий / Metszőlő / Foarfeca de gradina / Zahradnické nůžky / Nožnice záhradnicke / Vrtné škarje / Sodo sekatorius / Dārza grieznes / Oksakäärid / Ηοξικα λοζαρικα / Škare za obrezivanje / Makaze za orezivanje / Ψαλίδι κλαδέματος / Tijeras de jardín / Cesoa da giardino / Podadeira para jardim / Sécateur de jardin / Tuintakenschaar



Ref.	info	EAN
15G208	6/72	5902062107466

Lanca zraszająca

Spray lance / Sprühlanze / Распылитель / Ροζπιλυσач / Permetező lándzsa / Lance de stropit / Postřikovací tyč / Rozprašovacie kopije / Rozpršilna palica / Purkštukas / Izsmidzināšanas lance / Pihustustu / Разпръсквач / Prskalica / Прскалица, телескопска / Μακρύς ψεκαστήρας / Lanca pulverizadora / Lancia a spruzzo / Lança de pulverização / Lance de pulvérisation / Spuitlans



Ref.	info	info	EAN
15G681	40 cm	1/24	5902062107435



Ref.	info	info	EAN
15G682	77-113 cm	1/24	5902062107442

Zraszacz prosty

Straight water spray nozzle / Sprühregner / Ороситель прямой / Зрошувач прямий / Őntöző fej / Spritzer stropit / Postřikovač na hadici / Jednoduchý postrekovač / Ravna brizgalka / Tiesus purkštukas / Laistīšanas uzgalis (taisnais) / Tavaline pihustusotsak / Прав струйник / Obični raspršivač / Obična prskalica / Εκτοξευτή νερού λόγην / Aspersor recto / Irrigatore dritto / Agulheta de aspersão / Arroseur simple / Spuitpistool



Ref.	info	EAN
15G698	1/200	5902062107411

Prysznic ogrodowy

Garden shower / Gartendusche / Душ в саду / Садовий душ / Kerti zuhanyzó / Duš de grădină / Zahradní sprcha / Záhradná sprcha / Vrtni tuš / Sodo dušas / Dārza duša / Aia dušš / Градински душ / Vrtni tuš / Βασημενικυ μυλυ / Ντους κήπου / Ducha de jardín / Doccia da giardino / Duche de jardim / Douche de jardin / Tuindouche



Ref.	info	info	EAN
15G685	160-230 cm	1/10	5902062107459

Zestaw ze zraszaczem prostym

Gardening set with straight nozzle / Набор с прямым оросителем / Set mit Sprühregner / Набор із прямим зрошувачем опрыскувачем / Őntöző fejszett / Set cu spritzer de stropit / Sada s postřikovačem na hadici / Súprava s jednoduchým postrekovačom / Komplet z ravno brizgalko / Laistymo komplektas su tiesiu purkštuku / Komplekts ar taisno laistīšanas uzgali / Tavalise otsakuga komplekt / Комплект с прав струйник / Set s običnim raspršivačem / Pribor sa običnom prskalicom / Set με εκτοξευτή νερού λόγην / Set con aspersor recto pistola / Kit irrigatore dritto / Kit com agulheta / Ensemble d'arroseur simple / Set met spuitpistool



Ref.	info	EAN
15G699	1/48	5902062107428



Zraszacz pistoletowy

Water spray gun / Опрыскатель пистолетный / Sprühpistole Spritze / Опрыскувач пистолетный / Üntözö piztolý / Pistol de stropire / Postřikovací pistole / Pištoľový postrekovač / Brizgalna pištola / Purkštukas - pistoletas / Laistīšanas pistole / Pūstol-pihustusotsak / Пистолет струйник / Raspršivač na pištoli / Pištoľ prskalica / Εκτοξευτής νερού πιστόλι / Aspersor tipo pistola / Irrigatore a pistola / Pistola de aspersão / Arroseur à pistolet / Spuitpistool



Ref.	📦	EAN
15G716	1/48	5902062107404



Ref.	📦	EAN
15G718	25/100	5902062107374



Ref.	📦	EAN
15G714	1/48	5902062107381



Ref.	📦	EAN
15G717	1/48	5902062107398

Nakolanniki

Knee protectors / Наколенники / Наколінники / Térdvédők / Perne de geniunchi / Chráníče kolen / Chráníče kolien / Zaščita za koleno / Kelių apsaugas / Ceļa aizsargi / Põlvekaitsmed / Наколенници / Štitnici za koljena / Štitnici za kolena / Επιγονατίδες / Rodilleras de protecció / Copriginocchia / Protecção de joelhos / Protège-genoux / Kniebescherming



EVA
FOAM

Ref.	📦	EAN
97H201	0/50	5902062096258

Mata pod kolena

Knee mat / Коленный коврик / Колінний килимок / Térdszőnyeg / Mat de geniunchi / Podložka pod kolena / Podložka pod kolena / Podloga za kolena / Keliõ kilimõis / Ceļa paklājs / Põlvematt / Подложка за кољена / Podloga za koljena / Подлога за колена / Χαλάκι γονάτων / Rodillera / Tappetino per ginocchia / Joelheira / Genouillere / Knie mat



EVA
FOAM

2cm
↕

Ref.	info	📦	EAN
97H200	40x20 cm	0/48	5902062096241

Wiertarko-wkrętarka akumulatorowa

Cordless drill / Akku-Bohrschrauber / Дрель-шуруповерт аккумуляторная / Дрель-шуруповерт аккумуляторный / Akkus fűró csavarozó / Masină de găurit și înșurubat cu acumulator / Akumulátorová vrtačka-šroubovák / Akumulátorový vrtací skrutkovač / Baterijski izvijač/vrtalnik / Akumulatorinis gręžtuvas - suktuvas / Akumulatora urbjašana-skrūvgriezis / Akudrell / Бормашина / Akumulatorska bušilica / Akumulatorska bušilica / Εναρφαρτιζόμενο βραpanοκατασφίδιο / Taladradora atornilladora a batería / Trapano avvitavite senza filo / Aparafuradora de bateria / Perceuse-visseuse à batterie / Accu boor-draaimachine

NEO
TOOLS

ENERGY+
system

NEO GRAPHITE



METALOWY UCHWYT WIERTARSKI
METAL DRILL CHUCK
СВЕРЛИЛЬНЫЙ ПАТРОН ПО МЕТАЛЛУ



WIERCENIE Z UDAREM
DRILLING WITH IMPACT
СВЕРЛЕНИЕ С УДАРОМ



BRUSHLESS MOTOR

IŁOŚĆ USTAWIEŃ MOMENTU OBROTOWEGO 24
TORQUE SETTINGS 24
КОЛИЧЕСТВО УСТАНОВОК КРУТЯЩЕГО МОМЕНТА 24



KARBIDOWE SZCZĘKI UCHWYTU WIERTARSKIEGO
CARBIDE DRILL CHUCK JAWS
ТВЕРДОСПЛАВНЫЕ ГУБКИ СВЕРЛИЛЬНОГО ПАТРОНА



75 Nm



max 100 Nm



18V Li-Ion



2 - 13 mm



1-24 + drilling + impact drilling



I: 0-480 min⁻¹



I: 0-7680 min⁻¹



Ref. 04-616 1/5 EAN 5907558484595

ENERGY+
system
NEO GRAPHITE

Ref. 58GE139

18V
Li-Ion



BRUSHLESS MOTOR



18V Li-Ion



I. 0-400 min⁻¹
II. 0-1350 min⁻¹



0.8-10 mm



40 Nm



55 Nm

1-20 + drilling

NEW



BATTERY NOT INCLUDED



Ref. 58GE139 1/5 EAN 5902062169297

NEO
TOOLS

ENERGY+
system

NEO GRAPHITE



BRUSHLESS MOTOR



18V Li-Ion



2 - 13 mm



70 Nm



1-20 + drilling + impact drilling



I: 0-320 min⁻¹



II: 0-1700 min⁻¹

NEW



70 Nm



max 95 Nm



I: 0-4800 min⁻¹



II: 0-25500 min⁻¹



Ref. 04-619 1/5 EAN 5907558498189

Wkrętarka akumulatorowa ENERGY+

Cordless screwdriver / Akku-Schraubendreher / Шуруповерт аккумуляторный / Шуруповерт аккумуляторный / Akkus fűró csavarozó / Masină de găurit și înșurubat cu acumulator / Akumulátorový šroubovák / Akumulátorový skrutkovač / Akumulatorski izvijač / Akumulatorinis gręžtuvas / Akumulatora skrūvgriezis / Akutrell / Аккумуляторен винтиверт / Akumulatorska izvijačica / Akumulatorski odvijač / Εναρφαρτιζόμενο κατασφίδιο / Atornillador a batería / Avvitatore a batteria / Chave de fenda de bateria / Visseuse à batterie / Elektrische schroevendraaier

Ref. 58GE111

18V
Li-Ion

ENERGY+
system
NEO GRAPHITE



REGULACJA GŁĘBOKOŚCI WKRECANIA
SREWING DEPTH ADJUSTMENT
ΡΕΓΥΛΙΡΟΚΑ ΓΛΥΒΗΝΗ ΖΑΒΙΝΧΙΒΑΝΗΑ



BRUSHLESS MOTOR



18V Li-Ion



HEX 6,35mm (1/4")



n₀ = 4400 min⁻¹



max 7 Nm



BATTERY NOT INCLUDED



Ref. 58GE111 1/5 EAN 5902062082497

Zakrętkarka akumulatorowa ENERGY+

Cordless driver / Akku-Schraubmaschine / Гайковерт аккумуляторный / Мутроверт аккумуляторный / Akkus ütvecsavarozó / Inchizator de acumulator / Akumulátorový šroubovák / Akumulátorový šroubovák / Akumulatorski vrtalnik / Akumulatorinis suktuvas / Akumulatora uzvāznis / Keermepuur / Ударен заїковерт / Akumulatorski zavijač / Akumulatorski navojni čep / Επιαφοριζόμενο καταβίδι / Dispositivo de cierre a batería / Avvitatore a batteria ad impulsi / Máquina de travar com bateria / Visseuse à batterie / Accu schroefmachine

NEO
TOOLS



ENERGY+
system

NEO GRAPHITE



BRUSHLESS
MOTOR



max 300 Nm



18V Li-Ion



6.35mm (1/4")



I. 0-1500 min⁻¹
II. 0-2500 min⁻¹
III. 0-3200 min⁻¹
IV. 0-3600 min⁻¹



I. 1800 min⁻¹
II. 3200 min⁻¹
III. 4000 min⁻¹
IV. 4500 min⁻¹



I. max 45 Nm
II. max 120 Nm
III. max 210 Nm
IV. max 270 Nm



Ref. 04-612 | 1/5 | EAN 5907558465600

Zestaw elektronarzędzi

Power tool set / Elektogeräteset / Набор электроинструментов / Набор електроінструменту / Elektromos szerszámkészlet / Set de scule electrice / Sada elektrického nářadí / Súprava elektrického náradia / Komplet elektrických orodíj / Elektrinių įrankių komplektas / Elektroinstrumentu komplekts / Elektriitööriistade komplekt / Комплек электроинструменту / Set elektrických uredařa / Komplet elektrouredařa / Σε ηλεκτρικών εργαλείων / Juego de herramientas eléctricas / Completo di elettrotroutensili / Kit de eletroferramentas / Jeu d'outils électriques / Set van elektrogereedschap

Ref. 58G012-S15

ENERGY+
system
NEO GRAPHITE

18V
Li-Ion



Ref. 58G012-S15 | 1/2 | EAN 5902062070012

Klucz udarowy akumulatorowy ENERGY+

Impact wrench / Schlagschlüssel / Ключ ударный / Мутроверт ударный / Ütvecsavarozó / Cheie cu percuție / Rázový utahovák / Prikleповý ključ / Udamni vijaičnik / Atskelimo plaktukas / Sitama atslėga / Löökvõti / Ударен ключ / Udamni ključ / Pneumatski ključ / Κλειδί κρούσης / Llave de impacto / Avvitatore ad impulsi / Chave de impacto / Clef à chocs / Slagsleutel

NEO
TOOLS



ENERGY+
system
NEO GRAPHITE



SILNIK BEZSZCZOTKOWY
BRUSHLESS MOTOR



WZMOCNIIONA OBUDOWA
ROBUST HOUSING



REGULACJA OBRÓTÓW
SPEED ADJUSTMENT



NAKŁADKI ANTYPOŚLIŹZGOWE
ANTI-SLIP HANDLE



BRUSHLESS
MOTOR



18V Li-Ion



12.7 mm (1/2")



max 850 Nm



I. 0-1200 min⁻¹
II. 0-1600 min⁻¹
III. 0-2400 min⁻¹



I. 1500 min⁻¹
II. 2000 min⁻¹
III. 3000 min⁻¹



ZACZEP NA PASEK
BELT CLIP



OSWIETLENIE LED
LED LIGHT

NEW



Ref. 04-608 | 1/5 | EAN 5907558410761



Klucz udarowy akumulatorowy ENERGY+

Impact wrench / Schlagschlüssel / Ключ ударный / Мутровёрт ударный / Útvevcsavarozó / Cheie cu percucie / Rázový utahovák / Příklepový klíč / Udarni vijačnik / Atskėlimo plaktukas / Sitama atslega / Löökvõti / Ударен ключ / Udarni ključ / Pneumatski ključ / Ключи кроушис / Llave de impacto / Avvitatore ad impulsi / Chave de impacto / Clef à chocs / Slagsleutel

NEO
TOOLS

ENERGY+
system

NEO GRAPHITE



BRUSHLESS MOTOR



18V Li-Ion



12.7 mm (1/2")



max 1100 Nm



I. 0-1000 min⁻¹
II. 0-1200 min⁻¹
III. 0-1800 min⁻¹



I. 560 Nm
II. 680 Nm
III. 1100 Nm



Ref.	[kg]	Box	EAN
04-618	3,01	1/4	5907558495973



BATTERY NOT INCLUDED

NEO
TOOLS

ENERGY+
system

NEO GRAPHITE



18V Li-Ion



12.7 mm (1/2")



max 350 Nm



I. 0-1500 min⁻¹
II. 0-2000 min⁻¹
III. 0-2500 min⁻¹



I. 1850 min⁻¹
II. 2500 min⁻¹
III. 3200 min⁻¹



I. max 80 Nm
II. max 200 Nm
III. max 320 Nm



Ref.	Box	EAN
04-613	1/5	5907558465617



BRUSHLESS MOTOR



BATTERY NOT INCLUDED

Ref. 58G028-1

18V
Li-Ion



BRUSHLESS MOTOR



18V Li-Ion



max 330 Nm



I. 0-1600 min⁻¹
II. 0-2000 min⁻¹
III. 0-2600 min⁻¹



12.7 mm (1/2")



I. 2000 min⁻¹
II. 2500 min⁻¹
III. 3300 min⁻¹



I. max 180 Nm
II. max 280 Nm
III. max 320 Nm



Ref.	Box	EAN
58G028-1	1/5	5902062172013



BATTERY NOT INCLUDED

Ref. 58G038

18V
Li-Ion



BRUSHLESS MOTOR



18V Li-Ion



I. max 200 Nm
II. max 320 Nm
III. max 450 Nm



I. 0-1600 min⁻¹
II. 0-2100 min⁻¹
III. 0-2600 min⁻¹



max 450 Nm



I. 1800 min⁻¹
II. 2500 min⁻¹
III. 3300 min⁻¹



Ref.	Box	EAN
58G038	1/5	5902062089076



ELEKTRONICZNA ZMIANA BIEGÓW
ELECTRONIC GEAR SHIFT
ЭЛЕКТРОННОЕ ПЕРЕКЛЮЧЕНИЕ ПЕРЕДАЧ



BATTERY NOT INCLUDED

Grzechotka akumulatorowa

Cordless ratchet / Schnurlose Ratsche / Аккумуляторная трещотка / Аккумуляторна тріскачка / Akkus racsní / Clichet fähr fir / Akumulátorová ráčna / Akumulátorová račňa / Akumulatorska vrtavka / Akumulatorinis reketas / Bezvadu tarkšķis / Juhtmeta ratas / Аккумуляторна тресчотка / Bežična čegraljka / Аккумуляторска чертаљна / Ασύρματη καστίνα / Carraca inalámbrica / Cricchetto a batteria / Catraca sem fio / Cliquet sans fil / Draadloze ratel

NEO
TOOLS

ENERGY+
system

NEO GRAPHITE



BATTERY NOT INCLUDED



BRUSHLESS MOTOR



18V Li-Ion



0-250 min⁻¹

3/8"-1/2"



60 Nm



3/8"



ANTYPOŚLIZGOWA RĘKOJĘC
ANTI SLIP HANDLE
НЕСКОЛЬЗЯЩАЯ РУЧКА



SWIATŁO LED
LED LIGHT
СВЕТОДИОДНЫЙ СВЕТ



BLOKADA WŁĄCZNIKA
LOCK LEVER
ЗАПОРНЫЙ РЫЧАГ

Ref.	Box	EAN
04-603	1/20	5907558465525

Szlifierka kątowa akumulatorowa ENERGY+

Cordless angle grinder / Winkelschleifer / Аккумуляторная угловая шлифовальная машина / Шліфмашина кутова (болгарка) / Akkus sarokcsiszoló / Masina de slefuit unghiulara / Uhlová bruska / Uhlová brúška / Kotni brusilnik / Kampinis šlifuoškis / Lenka slīrmašīna / Nurklīhvija / Ёлошлайф / Kutna brusilica / Ugaona brusilica / Γωνιακό τρίβείο / Amoladora angular / Smergliatrice angolare / Disco de limar p. cantos / Meuleuse d'angle / Versteckschuermachine

Ref. 58GE130

18V
Li-Ion

ENERGY+
system
NEO GRAPHITE

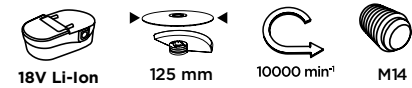

DWUSTRONNY MONTAŻ UCHWYTU
TWO-POSITION HANDLE
ДВУХПОЗИЦИОННАЯ ФИКСАЦИЯ РУКОЯТКИ

Ref.	Box	EAN
58GE130	1/4	5902062088123

Polerka

Polisher / Poliermaschine / Машина полировальная / Машинка полирувальна / Polírozógép / Dispozitiv șlefuire / Leštīčka / Brúška excentrická / Polirka / Poliruoklis / Pulētājs / Poleerimisvahend / Машина за полиране / Polir aparat / Polir aparat / Λεαντήρας / Pulidora / Lucidatrice / Aparelho polidor / Polisseuse / Polijstmachine

NEO
TOOLS

ENERGY+
system
NEO GRAPHITE



Ref.	Box	EAN
04-602	1/4	5907558465518

Ref. 58GE142

18V
Li-Ion

ENERGY+
system
NEO GRAPHITE



Ref.	Box	EAN
58GE142	1/6	5902062559166

Strug akumulatorowy ENERGY+

Cordless planer / Schnurlose Habelmaschine / Аккумуляторный рубанок / Аккумуляторный рубанок / Akkus gyalu / Mašinā de rindeluit fārā fir / Аккумуляторный рубанок / Аккумуляторный рубанок / Akumulatorski skobeljnik / Akumulatorinės obliavimo staklės / Bezvadu ēvele / Juhtmeta hõõvel / Аккумуляторно ренде / Akumulatorska blanjalica / Аккумуляторски планер / Πλάνη μπαταρίας / Cepillo sin cable / Spruzzatore a batteria / Piatta a batteria / Rabot sans fil / Draadloze schaafmachine

Ref. 58GE135

18V
Li-Ion

ENERGY+
system
NEO GRAPHITE



Ref.	Box	EAN
58GE135	1/4	5902062096029

Zestaw noży do struga

Knife set / Messersatz / Набор ножей / Ножы, набір / Pvc kés készlet / Set cutite / Sada noží / Súprava nožov / Komplet nožev / Peilių komplektas / Nažu komplekts / Nugade komplekt / Set nozeva / Συλλογή από μαχαίρια / Juego de cuchillos / Set di coltelli / Kit de facas / Jeu de couteaux / Set van messen en vijlen



x2

Ref.	Box	EAN
58GE135-30	1/1000	5902062096265

Szlifierka taśmowa ENERGY+

Belt sander / Bandschleifmaschine / Ленточная шлифовальная машина / Шліфмашина стрічкова / Szalagcsiszoló / Masina de slefuit cu banda / Pásová bruska / Pásová brúška / Tračni brusilnik / Juostinis šlifluoklis / Lentas slīpmašīna / Lintlihvija / Шліфмашина ексцентрична / Tračna brusilica / Trakasta brusilica / Ταϊσφιείο / Lijadora de banda / Levigatrice a nastro / Disco de limar de fita / Meuleuse à bande / Bandschuurmachine

Ref. 58GE136

18V
Li-Ion



18V Li-Ion



16000 min⁻¹



76 x 457mm

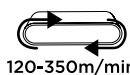

120-350m/min



REGULACJA PRĘDKOŚCI OBROTOWEJ
SPEED CONTROL
КОНТРОЛЬ СКОРОСТИ



BATTERY
NOT INCLUDED



Ref.	Box	EAN
58GE136	1/4	5902062096036

Mieszarka akumulatorowa ENERGY+

Cordless mixer / Akku-Rührmaschine / Миксер аккумуляторный / Змішувач акумуляторний / Akkumulátoros keverőgép / Mixer cu acumulator / Mišačka akumulátorové / Akumulátorové miešačka / Baterijsko mešalnik / Akumulātorinis maisytuvas / Akumulatora mikseris / Akuga segumikser / Akumulatorna mikser / Akumulatorski mješalica / Akumulatorska mikser / Αναβελτήρας / Mezclador a batería / Miscelatore a batteria / Misturador de batería / Mélangeur à batterie / Accu mixer

Ref. 58G084

18V
Li-Ion



NEO GRAPHITE



BRUSHLESS MOTOR



DWUSTOPNIOWE PRZEŁOŻENIE
TWO GEARS
ДВУХСТУПЕНЧАТЫЙ РЕДУКТОР



18V Li-Ion



250-400 min⁻¹
350-650 min⁻¹



M14



BATTERY
NOT INCLUDED

Ref.	Box	EAN
58G084	1/2	5902062064202

Ref. 58GE129

18V
Li-Ion



NEO GRAPHITE



BRUSHLESS MOTOR



BATTERY
NOT INCLUDED



DWA BIEGI
TWO MECHANICAL GEARS
ДВЕ МЕХАНИЧЕСКИЕ ПЕРЕДАЧИ



UCHWYT SAMOZACISKOWY
QUICK CHUCK
БЫСТРОЗАЖИМНОЙ ПАТРОН



18V Li-Ion



250-400 min⁻¹
350-650 min⁻¹



Ref.	Box	EAN
58GE129	1/2	5902062087966

Pilarka ukosowa

Mitre saw / Schrägsäge / Торцово-усовочная пила / Пилка-стусло / Gérfűrész / Frastrau obliqu lemn / Pokosová pila / Pokosová pila / Zajeralna žaga / Skersavimo pjūklas / Lenka ząbis / Nurgasaag / Циркуляр скосящ / Nagibna pila / Testera za zasecanje / Φαλοσπίριο / Ingletadora / Troncatrice radiale / Plaina inclinada / Scie à chanfreiner / Verstekzaag

Ref. 58GE121

18V
Li-Ion



NEO GRAPHITE



Ø 210/30 mm



18V Li-Ion



3000 min⁻¹



0-45°



max
70x220 mm



PRECYZYJNY LASER
PRECISION LASER



REGULACJA KĄTA CIĘCIA
CUTTING ANGLE ADJUSTMENT



BATTERY
NOT INCLUDED

Ref.	Box	EAN
58GE121	1/1	5902062082565

Satyniarka akumulatorowa

Cordless satin / Schnurlose Satiniermaschine / Аккумуляторный сатин / Акумуляторна сатинова машина / Vezeték nélküli szaténkészítő / Aparat de satin fără fir / Bezdrôtový satinovač / Bezdrôtový výrobnik saténu / Brezžični izdelovalec satnic / Belaidis satino gaminimo įrenginys / Bezvadu satina veidotājs / Juhtmeta satiniivalmista / Безжичен производител на сатен / Akumulatorski stroj za glačanje / Akumulatorska mašina za poliranje / Ασύρματο σατανολείο / Satinadora sin cable / Satinatore a batteria / Máquina de cetim sem fios / Satineuse sans fil / Draadloze satijnmaker

Ref. 58GE137

18V
Li-Ion



NEO GRAPHITE



BRUSHLESS MOTOR



18V Li-Ion



1500-3300 min⁻¹

Napięcie akumulatora / Battery voltage	18 V DC
Zakres prędkości obrotowej na biegu jałowym / Range of idle rotational speed	1500-3300 min ⁻¹
Średnica trzpienia mocującego / Arbor diameter	19 mm
Maksymalna średnica wałki / Maximum shaft diameter	80 mm
Maksymalna szerokość wałki / Maximum roller width	100 mm
Klasa ochrony / Protection class	III
Masa / Weight	2,43 kg



BATTERY
NOT INCLUDED

Ref.	Box	EAN
58GE137	0/6	5902062103116



Szlifierka oscylacyjna delta

Finishing sander / Vibrationsschleifer Delta / Машина шлифовальная вибрационная, дельта / Шліфмашина оциляційна дельта / Vibrációs deltacsiszoló / Polizor oscilant delta / Vibrační delta bruska / Vibračná delta bruska / Vibracijski brusilnik delta / Ekscentrinis šliuoklis delta / Delta-vibrācijas slīpmašīna / Kolmurtklihvija / Вибраційна шліфмашина дельта / Vibracijska brusilica delta / Oscilatorna brusilica delta / Τροχαλοφόρο τριβείο Delta / Lijadora orbital delta / Levigatrice orbitale delta / Lixadeira orbital delta / Ponceuse orbitale delta / Oscillatie deltaschuurmachine

Ref. 58GE141

18V
Li-Ion

NEW



ANTYPOŚLIZGOWA REKOJEŚĆ
ANTI-SLIP GRIP

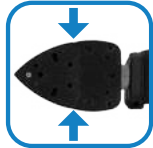

SMUKŁY KSZTAŁT
SLIM BODY



WYŁĄCZNIK PRZECIWPYŁOWY
DUST-PROTECTED SWITCH



SYSTEM ODPROWADZANIA PYŁU
DUST-AWAY



18V Li-Ion



140x140x80 mm



13000 min⁻¹



BATTERY
NOT INCLUDED



Ref.	Box	EAN
58GE141	1/8	5902062545176

Opryskiwacz akumulatorowy ENERGY+

Cordless sprayer / Schnurloses Sprüngerät / Акумуляторний распылитель / Акумуляторний обприскувач / Vezeték nélküli permetező / Pulverizator fāra cablu / Akumulátorový postřikovač / Akumulátorový postrekoč / Brezžični razpršilec / Belaidis purkštuvos / Akumulatora smidzinātājs / Juhtmeta pihusti / Акумуляторна пръскачка / Akumulatorska prskalica / Акумуляторска прскалица / Ασύρματος ψεκαστήρας / Pulverizador inalámbrico / Spruzzatore a batteria / Pulverizador sem fios / Pulvérisateur sans fil / Snoerloze sproeier

Ref. 58GE106

18V
Li-Ion



Napięcie akumulatora / Battery voltage	18 V DC
Pojemność zbiornika / Max. torque (soft drive)	15 L
Maksymalne ciśnienie robocze / Max. torque (hard drive)	0,3 MPa
Maksymalny przepływ wody / Max. diameter of drilling wood	0,8L/min
Temperatura wody zasilającej / Max. diameter of drilling metal	<60°C
Stopień ochrony IP / Max. diameter of drilling meta	IPX0
Klasa ochronności / Protection class	III
Masa / Weight	5,2 kg



18V Li-Ion



BATTERY
NOT INCLUDED



58GE106-24



Ref.	Box	EAN
58GE106	1/1	5902062073037
58GE106-24	1/150	5902062096272

Pilarka tarczowa akumulatorowa ENERGY+

Cordless circular saw / Kreissäge / Акумуляторна дискова пила / Пила дискова / Akkus körfűrész / Circular / Kotočová pila / Okružná pila / Krožna žaga / Diskinis pjūklas / Ripzågs / Ketassaag / Циркулярный диск / Kružna pila / Kružna testera / Διακοπιοβο / Sierra circular / Sega circolare / Plainade disco / Scie circulaire / Schijfzaag

Ref. 58G008-BC

18V
Li-Ion



NEO GRAPHITE



18V Li-Ion



4200 min⁻¹



ø 10mm



48/36 mm (90/45°)



4Ah

2,3A



Ref.	Box	EAN
58G008-BC	1/2	5902062096135

Wyciskacz ENERGY+

Caulking gun / Auspresser / Пистолет для силикона / Пистолет до силикону / Kinyomázósztylo / Seringă etanșare sudură / Pistol na silikonové tuby / Pištol na silikóny / Silikonka pištola / Pistoletas sandarinimo priemonėms / Silikona spiedpistole / Tihtimispistol / Пистолет за силикон / Pištoľ za silikón / Pistol za silikon / Πιστόλι αλκόνης / Pistola para tubos de silicona / Spremitoio / Espremedor / Pistolet / Afdichtingspistol

Ref. 58GE114

18V
Li-Ion



NEO GRAPHITE



18V Li-Ion



6 USTAWIEN PRĘDKOŚCI
6 SPEED SETTINGS
6 НАСТРОЕК СКОРОСТИ



310ml
325mm



0,7-11m/s

MAX FORCE: 4500N

Ref.	Box	EAN
58GE114	1/4	5902062082527

Ref. 58GE115

18V
Li-Ion



NEO GRAPHITE



18V Li-Ion



6 USTAWIEN PRĘDKOŚCI
6 SPEED SETTINGS
6 НАСТРОЕК СКОРОСТИ



400ml
468mm



0,7-11mm/s

MAX FORCE: 4500N

Ref.	Box	EAN
58GE115	1/4	5902062082534

Frezarka

Router / Fräsmaschine / Фрезер / Верстат фрезувальний / Felsómaró / Traszator / Frézka / Fréza horná / Rezkalnik / Freza / Fréze / Profílfreespínk / Фреза / Glodalica / Frezar / Фρέζα / Fresadora / Fresatrice / Fresa / Fraiseuse / Freismaschine

Ref. 58GE140

18V
Li-Ion

ENERGY+
system
NEO GRAPHITE



BRUSHLESS MOTOR



BATTERY NOT INCLUDED

18V Li-Ion
12000-28000 min⁻¹
6; 6.5 mm

Ref.	Box	EAN
58GE140	1/10	5902062103086



Pistolet natryskowy HVLP ENERGY+

Spray gun HVLP / Sprühpistole HVLP / Пистолет-распылитель HVLP / Фарбопульт HVLP / Szórópisztoly HVLP / Pistol de duş HVLP / Stříkací pistole HVLP / Striekacia pištoľ HVLP / Brizgalna pištola HVLP / Purškimo pistoletas HVLP / Pistole-smidzinātājs HVLP / Pihustuspüstol HVLP / Пистолет - нульеризатор HVLP / Pištoľ za prskanje HVLP / Pištoľ za prskanje HVLP / Πιστόλι ψεκασμού HVLP / Pistola de asperción HVLP / Pistola a spruzzo HVLP / Pistola de borrifar HVLP / Pistolet à projection HVLP / Spuitpistool HVLP

Ref. 58GE103

18V
Li-Ion

ENERGY+
system
NEO GRAPHITE



18V Li-Ion
900 ml



BATTERY NOT INCLUDED

REGULACJA STRUMIENIA
ADJUSTABLE NOZZLE
РЕГУЛИРУЕМА НАСАДКА

REGULACJA PRZEPŁYWU
PAINT FLOW ADJUSTMENT
РЕГУЛИРОВКА ПОТОКА КРАСКИ

Ref.	Box	EAN
58GE103	1/2	5902062071309

Miniszlifierka ENERGY+

Minigrinder / Minischleifer / Мини-шлифовальная машина / Шліфмашинка / Mini csiszológép / Minipolizor / Minibruska / Minibrúška / Mini brusilnik / Mini šljufoklis / Mini-šljapašina / Otslihvija / Мини шлайфмашина / Mini brusilica / Mini brusilica / Μικρό τριβείο / Mini amoladora recta / Minitrapano fresatore / Esmerilhadora mini / Mini-ponceuse / Minischuurmachine

Ref. 58GE107

18V
Li-Ion

ENERGY+
system
NEO GRAPHITE



BATTERY NOT INCLUDED

18V Li-Ion

5000 - 33000 min⁻¹



REGULACJA PRĘDKOŚCI
VARIABLE SPEED
РЕГУЛИРОВКА СКОРОСТИ

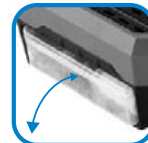

MIĘSCIE NA AKCESORIA
ACCESSORY STORAGE
МЕСТО ДЛЯ АКЦЕССУАРОВ



MAX ŚRED. 3,2MM
MAX DIAMETER 3,2MM
MAX ДИАМЕТР 3,2MM

Ref.	Box	EAN
58GE107	1/8	5902062073044

Przecinarka do glazury

Tile cutter / Fliesenschneidemaschine / Плиткорез / Плиткоріз / Csempevágó / Tăietor plăci de glazură / Rezačka dlažby / Rezačka dlaždic / Žaga za keramiko / Plytelių pjūstyklė / Flīžu griezējs / Plaadilõikur / Rezačka za fаянсови плочки / Rezač pločica / Sečivo za gled / Κόπτης πλακιδίων / Tagliapiastrelle / Cortador p. Azulejos / Tronçonneuse à carrelage / Glazuurknipper

Ref. 58GE138

18V
Li-Ion

ENERGY+
system
NEO GRAPHITE



18V Li-Ion

110x22,2 mm
305x335 mm
3800 min⁻¹

BATTERY NOT INCLUDED

Ref.	Box	EAN
58GE138	1/4	5902062103109



Kompresor akumulatorowy z osprzętem ENERGY+

Inflator with accessories / Akku-Kompressor mit Zubehör / Компрессор аккумуляторный с оснасткой / Компрессор аккумуляторный з принадлежностями / Léggömbzszipító tartozékokkal / Compresor de cumulator cu accesorii / Akumulátorový kompresor s príslušenstvom / Akumulátorový kompresor s príslušenstvom / Akumulatorski kompresor z opremo / Automobilijski kompresorius su iranga / Akumulatora kompresors ar piederumiem / Akukompressor koos tarvikutega / Аккумуляторен компресор с оборуђаене / Akumulatorski kompresor s opremom / Baterijski akumulator s priborom / Συμπιεστής επαναφορτιζόμενος με βοηθητικά εξαρτήματα / Compresor a bateria con accesorios / Compresore a batteria con accessori / Compresor de ar para bateria com acessórios / Compresseur à batterie avec accessoires / Batterijcompressor met accessoires

Ref. 58GE113

18V
Li-Ion



NEO
TOOLS



18V Li-Ion



11 BAR



S2 = 10min



KOMPRESOR / POMPKA
COMPRESSOR / PUMP
КОМПРЕССОР / НАСОС



3 KOŃCÓWKI DO POMPOWANIA
3 PUMPING TIPS
3 НАСАДКИ ДЛЯ НАСОСА



OPCJA ŁADOWANIA Z ZAPALNICZKI
CHARGING FROM THE CAR CIGARETTE LIGHTER
ЗАРЯДКА ОТ ПРИКУРИВАТЕЛЯ



BATTERY
NOT INCLUDED



Ref.	Box	EAN
58GE113	1/4	5902062082510

Odkurzacz warsztatowy ENERGY+

Workshop vacuum cleaner / Werkstattstaubsauger / Пылесос промышленный / Пилосос професійний / Műhelyporszívó / Aspirator atelier cu sistem vacuum / Dilenský vysavač / Dielenský vysávač / Industrijski sesalnik / Pramoninis siurblys / Rūpniecības puteklisūcējs / Toöstuslik tolmuimeja / Промышленна прахосмукачка / Radionički usisivač / Industrijski usisivač / Ηλεκτρική σκούπα επαγγελματική / Aspirador / Aspirapolvere da officina / Aspirador de oficina / Aspirateur d'atelier / Werkplaatsstofzuiger

Ref. 58GE105

18V
Li-Ion



18V Li-Ion



10l



BATTERY
NOT INCLUDED



DO PRACY NA SUCHO I MOKRO
FOR DRY AND WET OPERATION
ДЛЯ СУХОЙ И ВЛАЖНОЙ УБОРКИ



WYSOKOWYDAJNY, WODOODPORNY FILTR
HI DENSITY WASHABLE FILTER
ВЫСОКОПРОИЗВОДИТЕЛЬНЫЙ, ВОДОСТОЙКИЙ ФИЛЬТР



Ref.	Box	EAN
58GE105	1/1	5902062073013

Odkurzacz do popiołu ENERGY+

Ash extractor / Aschesauger / Зольный экстрактор / Виттяжка золи / Hamuelszívó / Extractor de cenușă / Odsávání popela / Odsávač popola / Odstranjivalec pepela / Pelenų ekstraktoriūs / Pelnu nosūcējs / Tuha vājātombur / Извлчачене на пепел / Usisivač pepela / Асх экстрактор / Εξαγωγέας τέφρας / Extractor de cenizas / Estrattore di cenere / Extractor de cinzas / Extracteur de cendres / Asafzuiging

Ref. 58GE125

18V
Li-Ion



18V Li-Ion



max 8 kPa



BATTERY
NOT INCLUDED



15L



RURA ALUMINIOWA 20 CM
20 CM ALUMINUM TUBE
20 CM АЛЮМИНИЕВАЯ ТРУБКА



WĄŻ 1 M
1 M HOSE
ШЛАНГ 1 M



Ref.	Box	EAN
58GE125	1/1	5902062082589

Odkurzacz warsztatowy ENERGY+

Workshop vacuum cleaner / Werkstattstaubsauger / Пылесос промышленный / Пилосос професійний / Műhelyporszívó / Aspirator atelier cu sistem vacuum / Dilenský vysavač / Dielenský vysávač / Industrijski sesalnik / Pramoninis siurblys / Rūpniecības putekļsūcējs / Промышленна прахосмукачка / Promišljena prašosmukavka / Radionički usisavač / Industrijski usisivač / Ηλεκτρική σκούπα επαγγελματική / Aspirador / Aspirador de oficina / Aspirador de oficina / Aspirateur d'atelier / Werkplaatsstofzuiger

Ref. 58GE124



18V
Li-Ion



FUNKCJA DMUCHAWY
BLOWER FUNCTION
ФУНКЦИЯ ВОЗДУХОДУВКИ



ZBIORNIK 20L
20L TANK
РЕЗЕРВУАР 20 Л



KÓŁKA
WHEELS
КОЛЕСА

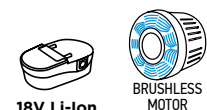

18V Li-Ion



BRUSHLESS
MOTOR



20l

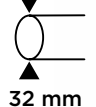

32 mm



16 kPa
14 l/s



BATTERY
NOT INCLUDED



Ref. 58GE124 1/1 EAN 5902062082572

Ref. 58GE133



18V
Li-Ion



FUNKCJA DMUCHAWY
BLOWER FUNCTION
ФУНКЦИЯ ВОЗДУХОДУВКИ



ZBIORNIK 12L
12L TANK
РЕЗЕРВУАР 12 Л



KÓŁKA
WHEELS
КОЛЕСА



12l

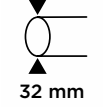

32 mm



10 kPa
10 l/s



BATTERY
NOT INCLUDED

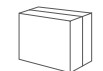

Ref. 58GE133 1/1 EAN 5902062096333

Radio akumulatorowo-sieciowe ENERGY+

Battery-powered network radio / Internet-Radio mit Akku / Беспроводное радио на батарейках / Бездротове радио на батарейках / Akkumulátoros-hálózati rádió / Radio cu alimentare de la rețea și cu baterii / Rádio na baterie a síťové napájení / Akumulátorovo-sieťové rádio / Akumulatorsko-omrežni radio / Radijo imtuvus maitinamas akumuliatoriumi ir iš tinklo / Akumulatora elektriskais radio / Aku-võrguradio / Радио, захраняно с батерии и от мрежата / Bateriajki, mrežni radio na baterije / Ραδιόφωνο δικτύου με μπαταρία / Radio de baterías y red / Radio batteria rete / Rádio de bateria e de rede / Radio sans fil et batterie / Internetradio op batterij

Ref. 58GE104



18V
Li-Ion



2IN1 FM I BLUETOOTH
2IN1 FM AND BLUETOOTH
2 B 1 FM I BLUETOOTH



WYŚWIETLACZ LCD
LCD DISPLAY
ЖК-ДИСПЛЕЙ



DUAL
POWER



3W



18V Li-Ion



1500 lm /
700 lm /
350 lm



LED 15W



BATTERY
NOT INCLUDED



Ref. 58GE104 1/10 EAN 5902062073020

Ref. 58GE128



18V
Li-Ion



GNIAZDO USB
USB SOCKET
USB-PAZEBEM



GNIAZDO AUX
AUX SOCKET
PAZEBEM AUX

2x15W
FM, DAB+
COLOR LCD



18V Li-Ion



ALARM
CLOCK



DUAL
POWER



5.0



BATTERY
NOT INCLUDED

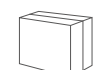

Ref. 58GE128 1/2 EAN 5902062087959

Dmucha akumulatorowa ENERGY+

Cordless blower / Akku-gebläse / Аккумуляторная воздуходувка / Повітрядувка акумуляторна (нілосса садовуї) / Akkumulátoros lombfúvó / Suflantei/aspiratorului cu acumulator / Akumulátorový fukar / Akumulátorové dýchadlo / Baterijski pihalnik / Akumulátorinis lapų pūstuvus / Akumulatoria lapu pūtējs / Akutitel lehepuhur / Аккумуляторна духалка / Akumulatorski puhač lišča / Za upotrebu bežičnog ventilatora / Εναρφορτιζόμενο φουσητήρασ / Soplador a batería / Soffiatore a batteria / Soprador de Folhas à Bateria / Souffleur à batterie / Accu blazer

Ref. 58GE118



18V
Li-Ion



18V Li-Ion



I: 6000 min⁻¹
II: 12000 min⁻¹
III: 18000 min⁻¹



3-STOPIŃOWA REGULACJA NAWIEWU
3-STAGE SPEED ADJUSTMENT
3-СТУПЕНЧАТЫЙ КОНТРОЛЬ СКОРОСТИ



FUNKCJA ODKURZACZA
VACUUM FUNCTION
ФУНКЦИЯ ПЫЛЕСОСА



MAX 252 km/h
0,2-6m³/min



Ref.	Box	EAN
58GE118	1/2	5902062082466

Trymer do trawy i żywopłotu ENERGY+

Grass and hedge trimmer / Rasen- und heckentrimmer / Триммер для газона и живой изгороди / Триммер для травы та живоплоту / Fű- és bokornyíró olló / Foarfeca pentru iarba si gard viu / Nůžky na trávu a živý plot / Vyžinač trávy a živého plotu / Trimer za travo in živo mejo / Gyvatvorių ir žolės žirklės / Trimmeris zālei un dzīvžogam / Rohu- ja hekitrimmer / Триммер за трева и жив плет / Trimer za travu i živicu / Trimer za travu i živicu / Θαμνοκοπίκο - χορτοκοπίκο / podadora de césped y cortasetos / Trimmer per erba e siepi / Mini tesoura para relva e sebes / Peigne pour herbe et haie vive / Trimmer voor gras en heg

Ref. 58GE119



18V
Li-Ion



18V Li-Ion

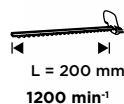

NOŻYCE DO KRZEWÓW 20 CM
HEDGE TRIMMER 20 CM
НОЖИЦЫ ДЛЯ КУСТАРНИКОВ 20 CM



3 W 1
3 IN 1
3 B 1



Ref.	Box	EAN
58GE119	1/4	5902062082473

Mini pilarka łańcuchowa akumulatorowa

Mini cordless chainsaw / Mini-Akku-Kettensäge / Мини-аккумуляторная бензопила / Миниатюрна акумуляторна бензопила / Mini akkumulátoros láncfűrész / Mini ferästräu cu lanț färä fir / Mini akumulatorová řetězová pila / Mini akumulatorová řetězová pila / Mini akumulatorska verižna žaga / Mini akumulatorinis grandininis pjūklas / Mini bezvadu ķēdes zāģis / Mini akutoitega mootorsaa / Мини акумуляторна моторна пила / Мини акумуляторска моторна пила / Мини акумуляторска моторна пила / Μίνι αλυσοπίριο μπαταρίας / Mini motosega a batteria / Mini motosierra inalámbrica / Mini serra eléctrica sem fios / Mini tronçonneuse sans fil / Mini draadloze kettingzaag

Ref. 58GE116

18V
Li-Ion



18V Li-Ion



Napięcie akumulatora Battery voltage	18 V DC
Prędkość silnika (bez obciążenia) Motor speed (no load)	3000 min ⁻¹
Prędkość liniowa łańcucha (bez obciążenia) Linear speed of chain (no load)	4,6 m/s
Pojemność zbiornika oleju łańcuchowego Chain oil tank capacity	70 ml
System podawania oleju łańcuchowego Chain oil feed system	manualny manual
Koło łańcuchowe (zęby x podziałka) Sprocket (teeth x pitch)	6 x 0,3" (7,62mm)
Typ prowadnicy Guide type	6" (152 mm)
Podziałka łańcucha Chain pitch	0,3" (7,62 mm)
Grubość łańcucha Chain thickness	1,1 mm
Klasa ochronności Protection class	III
Masa Mass	1,25 kg

Ref.	Box	EAN
58GE116	1/5	5902062082541



Kosiarka akumulatorowa

Cordless lawn mower / Batteriemäher / Аккумуляторная косилка / Аккумуляторна косарка / Akkumulátor fűnyíró / Cositoare de baterii / Akumulátorová sekačka / Akumulátorová kosačka / Baterijska kosilnica / Akumulatorinis vejarpjovė / Akumulatoru pļaujmašīna / Aku niiduk / Батерия косачка / Akumulatorski kosilica / Akumulatorska kosačica / Ασύρματο χλοοκοπτικό / Cortadora de batería / Rásaerba batteria / Cortador de batería / Tondeuse à batterie / Accu maaiër

NEO
TOOLS

ENERGY+
system

NEO GRAPHITE

36V
Li-Ion
BRUSHLESS



PRACUJE Z DWOMA AKUMULATORAMI ENERGY+ 18V
WORKS WITH TWO ENERGY+ 18V BATTERIES
РАБОТАЕТ С ДВУМЯ АККУМУЛЯТОРАМИ ENERGY+ 18V



ADJUSTABLE HEIGHT
REGULOWANA WYSOKOŚĆ
РЕГУЛИРУЕМА ВЫСОТА



LATWE SKŁADANIE
EASY FOLDING
ЛЕГКОЕ СКЛАДЫВАНИЕ



BEZPIECZEŃSTWO UŻYTKOWANIA
SAFETY USAGE
БЕЗОПАСНОСТЬ ИСПОЛЬЗОВАНИЯ



ZNACZNIK WYPEŁNIENIA KOSZA
BASKET FILL INDICATOR
МАРКЕР ЗАПОЛНЕНИЯ КОРЗИНЫ



2x18V Li-Ion
2xЕ+ 4.0 Ah

2800 min⁻¹

400 mm

75mm
65mm
55mm
45mm
35mm
25mm

40 l

Ref. EAN
04-610 1/1 5907558465587



PRACUJE Z DWOMA AKUMULATORAMI ENERGY+ 18V
WORKS WITH TWO ENERGY+ 18V BATTERIES
РАБОТАЕТ С ДВУМЯ АККУМУЛЯТОРАМИ ENERGY+ 18V



LATWE SKŁADANIE
EASY FOLDING
ЛЕГКОЕ СКЛАДЫВАНИЕ



WYRZUT BOCZNY
SIDE-EJECTION
БОКОВОЙ ВЫБРОС



ZNACZNIK WYPEŁNIENIA KOSZA
BASKET FILL INDICATOR
МАРКЕР ЗАПОЛНЕНИЯ КОРЗИНЫ

NEO
TOOLS

ENERGY+
system

NEO GRAPHITE

36V
Li-Ion
BRUSHLESS



BRUSHLESS
MOTOR

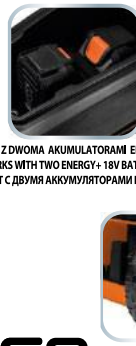

DUŻE KOLA
LARGE WHEELS
БОЛЬШИЕ КОЛЕСА

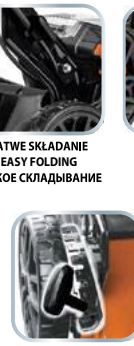

REGULOWANA WYSOKOŚĆ
ADJUSTABLE HEIGHT
РЕГУЛИРУЕМА ВЫСОТА

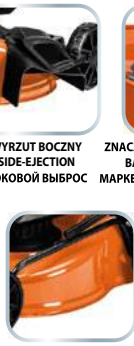

METALOWY KORPUS
METAL BODY
МЕТАЛЛИЧЕСКИЙ КОРПУС



UCHWYT NA KUBEK
CUP HOLDER
ПОДСТАКАННИК



2x18V Li-Ion
2xЕ+ 4.0 Ah

2800 min⁻¹

450 mm

75mm
65mm
55mm
45mm
35mm
25mm

50 l

Ref. EAN
04-611 1/1 5907558465594

Robot koszący akumulatorowy

Cordless mowing robot / Schnurloser Mähroboter / Аккумуляторный робот-газонокосильщик / Аккумуляторний робот для косіння / Vezeték nélküli fűnyíró robot / Robot de tuns iarba fără fir / Akumulátorový sekáč robot / Akumulátorový robot na kosenie / Akumulatorski robot za košnju / Akumulatorinis pjovimo robotas / Bezvadu pļaušanas robots / Juhtmeta niitmisrobot / Безжичен робот за носене / Robot za košnju na baterije / Robot за кошење на батерије / Ασύρματο ρομπότ κοπής / Robot rásaerba a batteria / Robot cortacésped sin cable / Robò corta-relva sem fios / Robot tondeuse sans fil / Draadloze maairobot /

NEO
TOOLS

ENERGY+
system

NEO GRAPHITE



BRUSHLESS
MOTOR

18V Li-Ion

3100 min⁻¹

ø 180 mm

60mm
50mm
40mm
30mm
20mm

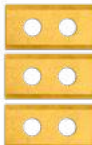

04-621-30

Ref. EAN
04-621 1/1 5907558430431
04-621-30 1/200 5907558426236

Podkaszarka akumulatorowa ENERGY+

Cordless grass trimmer / Akku-rasentrimmer / Аккумуляторный триммер / Триммер електричний / Akkumulátoros szegélynyíró / Cositoare cu acumulator / Akumulátorový vyzinač / Akumulátorový vyžinač / Akumulatorska kosilnica / Akumulatorinė žoliajovė / Akumulatora trimmeris / Akutoitel trimmer / Akumulatorien trimer / Akumulatorski trimer za travu / Akumulatorska kosilica / Εναρφορτζόμενο χορτοκοπτικό / Desbrozadora a batería / Tosaerba a filo a batteria / Aparador de grama à batería / Débroussaillouse sans fil / Accu grastrimmer /

Ref. 58GE112

18V
Li-Ion

ENERGY+
system

NEO GRAPHITE



1.1 m - 1.4 m

280 mm

9000 min⁻¹



ø 1.6 mm



58GE112-18



BATTERY
NOT INCLUDED



REGULOWANA GŁOWICA
ADJUSTABLE HEAD
РЕГУЛИРУЕМА ГОЛОВКА



TELESKOPOWA RĄCZKA
ADJUSTABLE LENGTH
ТЕЛЕСКОПИЧЕСКАЯ РУЧКА



REGULOWANA RĄCZKA
ADDITIONAL 3D HANDLE
РЕГУЛИРУЕМА РУЧКА

Ref. EAN
58GE112 1/2 5902062082503
58GE112-18 1/50 5902062096173

Nitownica akumulatorowa

Riveter / Nietmaschine / Заклепочник / Клепальний інструмент / Popszegecsűző / Mašina de nituit / Nýtovačka / Kliešte nitovacie ocelové / Pištola za kovčenje / Kniediklis / Kniežu stangas / Needitangid / Нитачна / Klijesta za zakovice / Pistolj za pop nitne / Ηλοι / Remachadora / Rivettatrice / Rebitadora / Riveuse / Klinknagelmachine

NEO TOOLS **ENERGY+ system**

NEO GRAPHITE

3 YEARS WARRANTY
PRODUKT NA SPRÁVILNÝM ZPŮSOBĚ REPARABLE

BRUSHLESS MOTOR

18V Li-Ion

12000 N

ø 2.4/3.2/5.0/6.4 mm

max 26 mm



BATTERY NOT INCLUDED

Ref. 04-617 1/5 EAN 5907558496000

Lampa akumulatorowa ENERGY+

Battery lamp / Akku-Lampe / Акумуляторная лампа / Акумуляторна лампа / Akkumulátoros lámpa / Lampă cu baterie / Bateriová lampa / Batériová lampa / Baterijska svetilka / Akumuliatoriaus lempa / Akumulatora lukuris / Akulamp / Лампа за батерији / Punjiva lampa / Пуњива лампа / Λαμπτήρας μπαταρίας / Lámpara de batería / Lampada a batteria / Lâmpada de baterie / Lampe à piles / Acculamp

Ref. 58GE109

18V Li-Ion

ENERGY+ system

NEO GRAPHITE

PRODUKT NA SPRÁVILNÝM ZPŮSOBĚ REPARABLE

18V Li-Ion



DWA TRYBY ŚWIĘCENIA 2000/ 1000 LM
2 LIGHTING MODES 2000/ 1000 LM
2 РЕЖИМА ОСВЕЩЕНИЯ 2000/ 1000 LM

BATTERY NOT INCLUDED

Ref. 58GE109 1/12 EAN 5902062082480

Uchwyt na akumulator Energy+

Energy+ battery holder / Energy+ Batteriehalter / Держатель аккумулятора Energy+ / Тримач аккумулятора Energy+ / Energy+ elemtartó / Suport baterie Energy+ / Držák baterie Energy+ / Držiak batérie Energy+ / Nosilec baterije Energy+ / Energy+ akumuliatoriaus laikiklis / Energy+ akumulatora turėtušis / Energy+ akuhoidija / Държач за батерия Energy+ / Energy+ držáč baterije / Энерджи+ држач батерије / Στήριγμα μπαταρίας Energy+ / Portapilas Energy+ / Portabatterie Energy+ / Supporte de baterie Energy+ / Supporte de batterie Energy+ / Energie+ batterijhouder /

Ref. 58G090

ENERGY+ system

NEO GRAPHITE



Ref. 58G090 1/50 EAN 5902062493781



Akumulator

Battery / Akkumulator / Аккумулятор / Акумулятор / Akkumulátor / Acumulator / Akumulátor / Akumulátor / Akumulátor / Akumuliatorius / Akumulators / Aku / Акумулятор / Akumulator / Akumulator / Ηλεκτρικός συσσωρευτής / Batería / Accumulatore / Bateria / Batterie / Accu

Ref. 58G004-1

18V Li-Ion

NEW

ENERGY+ system

NEO GRAPHITE

BOOST UP

Li-Ion

18V DC 72Wh 4.0Ah

BALANCE SYSTEM

Równoważenie prądu dostarczanego i pobieranego z każdego ogniwa.

SLEEP SYSTEM

Długotrwałe przechowywanie nie powoduje znacznej utraty energii.

COMPACT

Dzięki ulepszonym parametrom, akumulatory zachowują kompaktowe wymiary.

Li-Ion

Technologia litowo-jonowa zapewnia brak efektu pamięci. Dodatkowe diody LED informują o stanie naładowania.



Ref. 58G004-1 1/20 EAN 5902062107350

Ref. 58GE152

18V Li-Ion

NEW

ENERGY+ system

NEO GRAPHITE

BOOST UP

Li-Ion

18V DC 144Wh 8.0Ah

BALANCE SYSTEM

Równoważenie prądu dostarczanego i pobieranego z każdego ogniwa.

SLEEP SYSTEM

Długotrwałe przechowywanie nie powoduje znacznej utraty energii.

COMPACT

Dzięki ulepszonym parametrom, akumulatory zachowują kompaktowe wymiary.

Li-Ion

Technologia litowo-jonowa zapewnia brak efektu pamięci. Dodatkowe diody LED informują o stanie naładowania.



Ref. 58GE152 1/10 EAN 5902062595164

Młotowiertarka

Rotary hammer drill / Hammerbohrmaschine / Перфоратор / Перфоратор / Fúrókalapács / Bormasina percutanta / Vrtací kladivo / Vrtacie kladivo / Vrtalno kladivo / Perforatorius / Perforators / Lööktrell / Бормашина ударна / Čekić-bušilica / Bušilica sa čekićem / Σφύρα / Martillo-taladro / Martello perforatore / Martelo-Berbequim / Perceuse-marteau / Boorhammer



UCHWYT SDS-PLUS
SDS-PLUS CHUCK
ПАТРОН SDS-PLUS



PRZEŁĄCZNIK BLOKADY
LOCKING SWITCH
БЛОКИРОВОЧНЫЙ
ВЫКЛЮЧАТЕЛЬ



4 FUNCTION

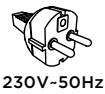

230V-50Hz



3M CABLE



58G537



710W



2.6J



0-5500 min⁻¹



n₀=0-1350 min⁻¹

58G538



800W



2.8J



0-5500 min⁻¹



n₀=0-1350 min⁻¹

58G539



900W



3,4 J



0-5300 min⁻¹



n₀=0-950 min⁻¹

Ref.	Box	EAN
58G537	1/4	5902062073082
58G538	1/4	5902062073105
58G539	1/4	5902062073099

Wiertarko-wkrętarka sieciowa

Electric drill driver / Netzbohrschrauber / Дрель-шуруповерт сетевая / Дрель-шуруповерт дротовий / Hálózáti fúrócsavarozó / Bormasina – surubelnitza, de retea / Síťová vrtačka / šroubovák / Sieťový vrtací skrutkovač / Elektrišni vrtalnik-vijačnik / Elektrinis gręžtuvas-suktuvas / Elektrotilka urbjmašina-skrūvgriezis / Elektritrell-kruvikeeraja / Пробуен електрически винтоверт / Električna bušilica izvijač / Električna bušilica-odvijač / Καλωδιακό δρανποκατασβίδο / Taladro atornillador eléctrico / Trapano avvitatore / Berbequim/aparafusador / Perceuse/visseuse



SZYBKOWYMIENNY UCHWYT
QUICK CHUCK
БЫСТРОСМЕННЫЙ ПАТРОН



DWIE FUNKCJE
TWO FUNCTIONS
ДВУХРЕЖИМНЫЙ ДО



GNAZDO NA BITY
HEX SOCKET
ПАТРОН ДЛЯ БИТ



REGULOWANA GLEBOKOŚĆ WKRĘCANIA
ADJUSTABLE SCREWING DEPTH
РЕГУЛИРОВАНИЕ ГЛУБИНЫ ВИНТА



GNAZDO NA BITY
HEX SOCKET
ПАТРОН ДЛЯ БИТ



300W



230V-50Hz



n₀=0-400 min⁻¹
n₀=0-1600 min⁻¹



left-right



Ø 10 mm



22+1 positions



6m



Ref.	Box	EAN
58G793	1/4	5902062087805



520W



230V-50Hz



n₀: 0-4200 min⁻¹



1/4" left-right



4 m



Ref.	Box	EAN
58G794	1/4	5902062087812

Młot udarowy

Hammer drill / Schlaghammer / Перфоратор / Перфоратор / Vésőkalapács / Pickamer / Bourací kladivo / Prikleповé kladivo / Udarno kladivo / Atskelimo plaktukas / Triecienveseris / Puurvasar / Кървач / Udarni čekić / Udarni čekić / Σφύρα / Martillo de percusión / Martello demolitore / Martelo de impacto / Marteau à chocs / Sloophammer



900W
3850 min⁻¹
4,0 J
n₀: 980 min⁻¹
230V-50Hz

max 13mm max 28mm max 40mm
4 m

UCHWYT SDS-PLUS
SDS-PLUS CHUCK
ПАТРОН SDS-PLUS

TRZYFUNKCYJNY
THREE FUNCTIONS
ТРЕХРЕЖИМНЫЙ

Ref.	Box	EAN
58G860	1/2	5902062073068

Wiertnica diamentowa

Core drill / Diamant-Kernbohrmaschine / Алмазная коронка / Дриль алмазного свердління / Gyémánt magfúró / Masina de găurit cu carotă diamantată / Diamantová jádrová vrtáčka / Korunková vrtáčka / Diamantni vrtnik / Deimantinis gręzimo įrenginys / Urbšanas iekārta ar dimanta serdi / Teemantpuur / Диамантно-пробивна машина / Jezgrena bušilica / Jezgrena dijantska bušilica / Δράπανο διαμαντοκόρυνας / Taladro de diamante / Trapano a corona / Perforadores com broca de diamante / Foreuse diamant / Diamantboor



2200W
MAX ø180 mm
n₀: 0-2000 min⁻¹
ø1/4"
3m

PODŁĄCZENIE WODY
WATER INLET
ВОЗМОЖНОСТЬ ВОДЯНОГО
ОХЛАЖДЕНИЯ

STATYW
STAND
ШТАТИВ

Ref.	Box	EAN
58G540	1/1	5902062085580

Młot wyburzeniowy

Demolition hammer / Abbruchhammer / Бетонолом / Молоток відбійний / Bontókalapács / Ciocan demolator / Bourací kladivo / Búracie kladivo / Rušilno kladivo / Atskelimo plaktukas / Betona laužnis / Piikvasar / Кървач / Čekić za lomljenje / Čekić za rušenje / Σφύρα / Martillo picador / Martello demolitore / Martelo de demolição / Marteau de démolition / Slagmoer



1300W
230V-50Hz
2400 min⁻¹
4 m

20 J

UCHWYT SDS MAX
SDS MAX CHUCK
ПАТРОН SDS MAX

REGULOWANA REKOJEŚĆ
ADJUSTABLE HANDLE
РЕГУЛИРУЕМАЯ РУКОЯТКА

Ref.	Box	EAN
58G877	1/2	5902062071194



1700W
230V-50Hz
45 J
1500 min⁻¹
14 kg

UCHWYT TYPU HEX
HEXAGONAL CHUCK
ПАТРОН ТИПА HEX

Ref.	Box	EAN
58G868	1/1	5902062071217

Urządzenie wielofunkcyjne

Multi-function tool / Mehrfunktionsgerät / Многофункциональный инструмент / Багатофункційний пристрій / Többfunkciós berendezés / Dispositiv multifuncional / Multifunkční zařízení / Multifunkčné zariadenie / Večfunkcijska naprava / Daugiafunkcinis įrankis / Daudzfunkcionālā iekārta / Multifunktsionaalne seade / Мултифункционално устројство / Višenamjenski uređaj / Višefunkcionalni uređaj / Εργαλείο πολλαπλών χρήσεων / Dispositivo multifunción / Dispositivo multifunzione / Dipositivo multifuncional / Appareil multifonction



250W
230V-50Hz
3,2°
n₀: 15000 - 21000 min⁻¹
3m

REGULACJA PRĘDKOŚCI
VARIABLE SPEED
РЕГУЛІРОВАКА ОБОРОТОВ

ALUMINIOWY KORPUS
ALUMINIUM BODY
АЛЮМИНІЕВИЙ КОРПУС

Ref.	Box	EAN
59G023	1/4	5902062087133



230V-50Hz
500W
n₀: 8000 - 16000 min⁻¹
5°
3m

REGULACJA PRĘDKOŚCI
VARIABLE SPEED
РЕГУЛІРОВАКА ОБОРОТОВ

SZYBKE MOCOWANIE
QUICK CHANGE
СИСТЕМА БЫСТРОЙ ЗАМЕНЫ

Ref.	Box	EAN
59G025	1/4	5902062087836

Szlifierka kątowa

Angle grinder / Winkelschleifer / Машина шлифовальная угловая / Шліфмашина кутова (болгарна) / Sarokcsiszoló / Polizor unghiular / Úhlová bruska / Uhlová brúška / Kotni brusilnik / Karpintis šljufoklis / Leņķa slīpmašīna / Nurklihvija / Ъглошлайф / Kutna brusilica / Ugaona brusilica / Γωνιακό τριβείο / Amoladora angular / Smerigliatrice angolare / Disco de limar p. cantos / Meuleuse d'angle / Versteckschuurmachine



NAKRĘTKA SZYBKOMOCUJĄCA
QUICK-CLAMPING NUT



ŁAGODNY ROZRUCH
SOFT START



ANTYWIBRACYJNY UCHWYT
ANTI-VIBRATION HANDLE



PRZYCIŚK BLOKADY WRZECIONA
SPINDLE LOCK BUTTON



REGULOWANA RĘKOJĘĆ
ADJUSTABLE HANDLE



ŁATWY DOSTĘP
EASY ACCESS



BLOKADA WŁĄCZNIKA
LOCKING SWITCH



TRZYPOZYCYJNY MONTAŻ UCHWYTU
THREE-POSITION HANDLE ASSEMBLY



230 V ~ 50 Hz



3000W



∅ 230 mm



6600min⁻¹



3 m

NEO
TOOLS



NEW



Ref. 04-715 0/2 EAN 5907558498202



NAKRĘTKA SZYBKOMOCUJĄCA
QUICK-CLAMPING NUT



REGULACJA OBROTÓW
SPEED ADJUSTMENT



BLOKADA WŁĄCZNIKA
LOCKING SWITCH



ANTYWIBRACYJNY UCHWYT
ANTI-VIBRATION HANDLE



NEO
TOOLS



DWUPOZYCYJNY MONTAŻ UCHWYTU
TWO-POSITION HANDLE ASSEMBLY



PRZYCIŚK BLOKADY WRZECIONA
SPINDLE LOCK BUTTON



230 V ~ 50 Hz



1000W



∅ 125 mm



3 m



3000-12000 min⁻¹



NEW



Ref. 04-716 0/6 EAN 5907558465303

Polerka

Polisher / Poliermaschine / Машина полировальная / Машина полирувальна / Polírozógép / Dispozitiv șlefuire / Leštička / Brúška excentrická / Polirka / Poliruoklis / Pulētājs / Poleerimisvahend / Машина за полуране / Polir aparat / Polir aparat / Λεαντήρας / Pulidora / Lucidatrice / Aparelho polidor / Polisseuse / Polijstmachine

NEO
TOOLS



DUAL ACTION



PLYNNA REGULACJA OBROTÓW
VARIABLE SPEED
ПЛАВНАЯ РЕГУЛИРОВКА ОБОРОТОВ



REGULOWANA RĘKOJĘĆ
ADJUSTABLE HANDLE
РЕГУЛИРУЕМАЯ РУКОЯТКА



PLYNNY ROZRUCH
SOFT START
ЛАВНЫЙ ПУСК



TORBA NARZĘDZIOWA
TOOL BAG
СУМКА ДЛЯ ИНСТРУМЕНТА



NEO
TOOLS



ANTYPOŚLIZGOWY UCHWYT
ANTI-SLIP SOFT GRIP



REGULOWANA RĘKOJĘĆ
ADJUSTABLE HANDLE



PLYNNA REGULACJA OBROTÓW
VARIABLE SPEED



PRZEŁĄCZNIK BLOKADY
LOCKING SWITCH



230 V ~ 50 Hz



710W



n₀: 2000-4600 min⁻¹



∅ max 125 mm



Ref. 04-700 1/6 EAN 5907558467994

NEO
TOOLS



230 V ~ 50 Hz



900W



∅ max 150 mm



600-3000min⁻¹



6 m



Ref. 04-701 0/4 EAN 5907558498196

Szlifierka mimośrodowa

/ Orbital sander / Excenter Schleifmaschine / Машина шлифовальная эксцентриковая / Шліфмашинка ексцентрикова / Excentercsiszó / Masina de slefuit excentrica / Excentrická bruska / Excentrická brúska / Ekscentrični brusilnik / Ekscentrisin šliřuoklis / Ekscentra šlīpmašīna / Ekstsentriklihvija / Шлайфмашина ексцентрична / Vibracijska bušilica / Ekscentrična brusilica / Экцентро трибейло / Lijadora excentrica / Levigatrice rotoorbitale / Disco de limar / Meuleuse excentrique

3
YEARS
WARRANTY



REGULACJA OBROTÓW
SPEED ADJUSTMENT



MOŻLIWOŚĆ PODŁĄCZENIA ODKURZACZA
VACUUM CLEANER CONNECTION



OGUMOWANY UCHWYT
SOFT GRIP HANDLE

NEO
TOOLS



230V-50Hz



350W



ø 150 mm



10 000 min⁻¹

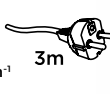

3m



NEW

Ref.	Box	EAN
04-721	0/4	5907558410778



300W



230V-50Hz



n₀=7000-13000 min⁻¹



ø125mm



PLYNNA REGULACJA OBROTÓW
VARIABLE SPEED
ПЛАВНАЯ РЕГУЛИРОВКА ОБОРОТОВ

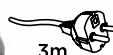

3m



MOCOWANIE NA RZEP
VELCRO
СИСТЕМА КРЕПЛЕНИЯ "ЛИПУЧКА"

Ref.	Box	EAN
59G348	1/8	5902062087881



450W



230V-50Hz

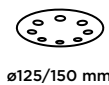

ø125/150 mm

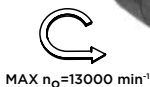

MAX n₀=13000 min⁻¹



3m



PLYNNA REGULACJA OBROTÓW
VARIABLE SPEED
ПЛАВНАЯ РЕГУЛИРОВКА
ОБОРОТОВ



MOCOWANIE NA RZEP
VELCRO
СИСТЕМА КРЕПЛЕНИЯ "ЛИПУЧКА"

Ref.	Box	EAN
59G349	1/4	5902062087898

Wyrzynarka

Jigsaw / Ausschneidemaschine / Лобзик / Лобзик / Dekörfűrész / Ferästräu / Vyřezávací pila / Pila priamočiara / Vhodna žaga / Pjükleis / Figürzägis / Jöhvsag / Трюн зезе / Ubodna pila / Ubodna testera / Žéya / Sierra de calar / Traforatrice / Máquina de entalhar / Scie sauteuse / Decoupeerzaag



600W



230V-50Hz



n₀: 800-3000 min⁻¹

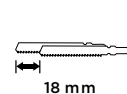

18 mm



max 80 mm



max 8 mm



PLYNNA REGULACJA OBROTÓW
VARIABLE SPEED
ПЛАВНАЯ РЕГУЛИРОВКА ОБОРОТОВ



BEZNARZĘDZIOWA WYMIANA BRZESZCZOTU
TOOLLESS BLADE REPLACEMENT
ЗАМЕНА ПОЛОТНА БЕЗ ИНСТРУМЕНТОВ

Ref.	Box	EAN
58G078	1/6	5902062073112

Trymer do krawędzi

Edge trimmer / Kantenfräsmaschine / Кромкообрезчик / Кромкообрезчик / Szélmáró / Trimmer pentru margini / Ořezávačka hran / Ořezávač hrán / Obrezovalnik robov / Krašto žolijapjöv / Malu trimmeris / Äärekäär / Тример за ръбове / Rubni trimer / Рубни тример / Recortadora de bordes / Tagliabordi / Aparador de borda / Taille-bordures



510W



230V-50Hz



n₀=30000 min⁻¹



6 / 8mm



REGULACJA GŁĘBOKOŚCI FREZOWANIA
MILLING DEPTH ADJUSTMENT
РЕГУЛИРОВАНИЕ ГЛУБИНЫ ФРЕЗЕРОВАНИЯ



PRZECZYSTA STOPA
TRANSPARENT BASE
ПРОЗРАЧНАЯ ОСНОВА



Ref.	Box	EAN
59G718	1/8	5902062069641

Pilarka szablowa

Sabre saw / Motorstichsäge / Пила сабельная / Пилка шабельна / Szablyafűrész / Ferästräu sabie / Šavlová pila / Chvostová pila / Sabljasta žaga / Tiesinis pjüklas / Zobenzägis / Saabelsaag / Саблен трюн / Sabljasta pila / Sabljasta testera / Σαβόσαγα / Sierra de vaivén / Segä universale / Serra de sabre / Scie ä sabre / Sabelzaag



230V-50Hz



710W



n₀: 0-2800 min⁻¹

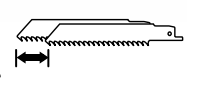

20 mm

Ref.	Box	EAN
58G961	1/6	5902062103093

Szlifierka oscylacyjna

Finishing sander / Vibrationschleifmaschine / Вибрационная шлифовальная машина / Шліфмашинка осциляційна / Vibrációs csiszoló / Masina de slefuit oscilatoare / Vibrationssandpaper / Vibracijski brusilnik / Ploktūminis šlifjuoklis / Orbitālā slīpmašīna / Taldlihvija / Вибрационный шлайф / Vibracijska brusilica / Oscilatorna brusilica / Παλμικό τριβείο / Lijadora orbital / Levigatrice orbitale / Disco de limar oscilante / Meuleuse oscillatoire / Oscillatie schuurmachine



240W 230V-50Hz n_o : 13000 min⁻¹ 100 x 110mm

3m

OSŁONA PRZECIPIYLOWA
DUST PROTECTION
ЗАЩИТА ОТ ПЫЛИ

Ref.	Box	EAN
59G322	1/8	5902062087843



180W 230V-50Hz n_o =13000 min⁻¹

140x140x80 mm

3m

MOCOWANIE NA RZEP
VELCRO
СИСТЕМА КРЕПЛЕНИЯ
"ЛИПУЧКА"

OSŁONA PRZECIPIYLOWA
DUST PROTECTION
ЗАЩИТА ОТ ПЫЛИ

Ref.	Box	EAN
59G336	1/8	5902062087874



260W 230V-50Hz n_o : 7000-13000 min⁻¹ 90 x 187mm

3m

SZYBKE MOCOWANIE
QUICK CHANGE
СИСТЕМА БЫСТРОЙ ЗАМЕНЫ

PLYNNA REGULACJA OBROTÓW
VARIABLE SPEED
ПЛАВНАЯ РЕГУЛИРОВКА
ОБОРОТОВ

Ref.	Box	EAN
59G326	1/6	5902062087850



380W 230V-50Hz n_o : 7000-13000 min⁻¹ 115 x 230mm

3m

SZYBKE MOCOWANIE
QUICK CHANGE
СИСТЕМА БЫСТРОЙ ЗАМЕНЫ

PLYNNA REGULACJA OBROTÓW
VARIABLE SPEED
ПЛАВНАЯ РЕГУЛИРОВКА
ОБОРОТОВ

Ref.	Box	EAN
59G329	1/4	5902062087867



Opalarka

Hot air gun / Sengmaschine / Термофен / Фен / Hótlégfúvó / Masina de parlit / Opalovací pistole / Opalovacia pištoľ / Fen / Techninis fėnas / Celniecības fēns / Kuumapuhur / Пустолет за горещ въздух / Puhala vrućeg zraka / Fen / Πιστόλι θερμού αέρα / Decapador por aire caliente / Termosoffiatore / Soprador de ar quente / Décapeur thermique

3
YEARS
WARRANTY



CYFROWY WSKAZNIK TEMPERATURY
DIGITAL TEMPERATURE DISPLAY
ЦИФРОВОЙ ПОКАЗАТЕЛЬ ТЕМПЕРАТУРЫ



PRECYZYJNE STEROWANIE
PRECISE CONTROL
ТОЧНОЕ УПРАВЛЕНИЕ



OGUMOWANY UCHWYT
SOFT GRIP HANDLE
РЕЗИНОВАЯ РУЧКА



REGULACJA SIŁY NAWIEWU
AIR FLOW ADJUSTMENT
РЕГУЛИРОВАНИЕ СИЛЫ
ВОЗДУШНОГО ПОТОКА

NEO
TOOLS



2000W

230 V ~ 50 Hz

I: 50°C
II: 70-600°C

300 - 500
l/min



6m

Ref. 04-710 EAN 5907558470550



GRAPHITE



2000W



230V-50Hz



I: 50°C
II: 50-550°C
III: 50-550°C



I: 350 l/min
II: 350 l/min
III: 500 l/min



3m



REGULACJA SIŁY NAWIEWU
AIR FLOW ADJUSTMENT
РЕГУЛИРОВАНИЕ СИЛЫ
ВОЗДУШНОГО ПОТОКА



REGULACJA ZAKRESU TEMPERATURY
TEMPERATURE ADJUSTMENT
РЕГУЛИРОВКА ТЕМПЕРАТУРЫ

Ref. 59G526 EAN 5902062086747

GRAPHITE



2000W

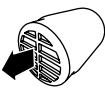

I: 300 l/min
II: 500 l/min



I: 350°C
II: 550°C

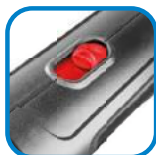

2-STOPNIOWY PRZEŁĄCZNIK
SWITCH SETTING I/II
НАСТРОЙКА ПЕРЕКЛЮЧАТЕЛЯ I/II



PROSTY UCHWYT
COMPACT HANDLE
ЭРГОНОМИЧНАЯ РУЧКА

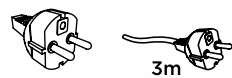

230V-50Hz

3m



Ref. 59G523 EAN 5902062086730



Klucz udarowy

Impact wrench / Schlagschlüssel / Ключ ударный / Мутроверт ударний / Útvecsavarozó / Cheie cu percutie / Rázový utahovák / Priklepojý ključ / Udarni vijacnik / Sitama atslega / Celniecības fēns / Löökvõti / Ударен ключ / Udarni ključ / Pneumatski ključ / Κλειδί κρούσης / Llave de impacto / Avvitatore ad impulsi / Chave de impacto / Clef à chocs



UCHWYT KWADRAT 1/2"
1/2" SQUARE HEAD



MAKS. MOMENT OBROTOWY 350NM
MAX TORQUE 350NM



6 M PRZEWÓD GUMOWY
RUBBER CABLE 6 M



ANTYPOŚLIZGOWA RĘKOJEŚĆ
ANTI-SLIP GRIP

NEO
TOOLS

3
YEARS
WARRANTY



450W

230V-50Hz

max 330 Nm

4000min⁻¹

6m



NEW



Ref. 04-719 EAN 5907558477061

NEO
TOOLS

3
YEARS
WARRANTY



4 PCS SOCKET
17/19/21/22 mm

950 Nm

WYSOKI MOMENT OBROTOWY
MAX TORQUE 950 Nm



UCHWYT 1/2"
CHUCK 1/2"



ERGONOMICZNY WŁĄCZNIK
ERGONOMIC SWITCH



1020W

230V-50Hz

no= 2600 min⁻¹

6m



ANTYPOŚLIZGOWA RĘKOJEŚĆ
ANTI-SLIP HANDLE



Ref. 04-720 EAN 5907558483673



Pompa wodna zanurzeniowa do brudnej wody

Dirty water submersible pump / Wassertauchpumpe für Schmutzwasser / Насос погружной для грязной воды / Насос водний запливний до стічних вод / Merülő szennyvízszivattyú / Pompa de cufundat in apa murdara / Vodní ponorné čerpadlo na špinavou vodu / Ponorné čerpadlo na znečistenú vodu / Potopna vodna črpalka za umazano vodo / Panardinama vandens pompa užiterštam vandeniu / Iegremdējamais ūdenssūkņis netīram ūdenim / Sukelpump mudasele veele / Подводна помпа за мръсна вода / Сръпка за вода - uranjajuća - za prljavu vodu / Pumpa za vodu potopljena u prljavu vodu / Καταβύθιμη αντλία ακαθάρτων υδάτων / Bomba de immersión / Pompa a immersione per acque sporche / Bomba de água de imersão / Pompe à eau immergée / Dompeelpomp voor vies water

NEO
TOOLS

3
YEARS
WARRANTY

OPRACUNKI WPROWADZANE
REPAIRABLE



WŁĄCZNIK W PŁYWAKU ADAPTER DO WĘŻA METALOWA OBUDOWA
SWITCH IN THE FLOAT ADAPTER FOR HOSE METAL CASE

NEW



Model	04-735	04-736
Napięcie zasilania / Supply voltage	230 V AC	
Częstotliwość zasilania / Power frequency	50 Hz	
Moc znamionowa / Rated power	900W	1100W
Maksymalna robocza głębokość zanurzenia / Maximum working depth	7 m	
Maksymalna wysokość podnoszenia wody / Maximum water head	9 m	9.5 m
Maks. wydajność / Max. capacity	17000 l/h	18000 l/h
Średnica króćca do węża wodnego / Water hose connection diameter	1", 1 1/2"	1", 1 1/2"
Głębokość wody włączająca pompę / Water depth activating the pump	50cm	
Maksymalny poziom wody po odessaniu / Maximum water level after suction	3,5cm	
Maksymalna średnica zanieczyszczeń / Maximum diameter of contaminants	25 mm	
Maks. Temperatura wody / Max. water temperature	35°C	
Minimalne zanurzenie / Minimum immersion	11.5 cm	
Wymiary (WxLxH) / Dimensions (WxLxH)	17,5 x 15,8 x 36,5 cm	
Klasa ochronności / Protection class	I	
Stopień ochrony / Degree of protection	IPX8	
Masa / Mass	6,1 kg	6,3 kg
EAN	5907558465280	5907558465297

Ref. EAN
04-735 1/4 5907558465280

Ref. EAN
04-736 1/4 5907558465297

Agregat prądowórczy

Electric generator / Stromerzeugungsaggregat / Электрогенератор бензиновый / Электрогенератор бензиновый / Áramfejlesztő / Grup electrogen/generator / Elektrický agregát / Prúdový agregát / Električni generator / Generatorius / Benzina elektrogenators / Voolluotomisseade / Електрически агрегат / Agregat za struju / Naponski generator / Γεννήτρια βενζίνης / Grupo electrógeno / Gruppo elettrogeno / Gerador de eletricidade / Groupe électrogène / Elektrische generator



GNAZDO 2X16A/230V AC
AC SOCKETS



GNAZDO 12V
DC TERMINALS



ROZRUSZNIK ELEKTRYCZNY
ENGINE SWITCH



WOLTMIERZ
VOLTMETER



FILTR POWIETRZA
AIR FILTER



LINKA ROZRUCHOWA
RECOIL STARTER



KÓŁKA TRANSPORTOWE
TRANSPORTATION WHEELS



UCHWYTY TRABSPORTOWE
TRANSPORT HANDLES

NEO
TOOLS



2800W /
max 3000W

230V ~ 50Hz

12V

15L



Ref. EAN
04-730 1/1 5907558483680



GNAZDO 32A 230 V AC
AC SOCKETS



GNAZDO 2X16A 230V AC
AC SOCKETS



GNAZDO 1x12V
DC TERMINALS



WOLTMIERZ
VOLTMETER



ROZRUSZNIK ELEKTRYCZNY
ENGINE SWITCH



LINKA ROZRUCHOWA
RECOIL STARTER



KÓŁKA TRANSPORTOWE
TRANSPORTATION WHEELS



FILTR POWIETRZA
AIR FILTER

NEO
TOOLS



6000W /
max 6500W

230V ~ 50Hz

12V

25 L



Ref. EAN
04-731 1/1 5907558483697

NEO
TOOLS



7000W /
max 7500W



400V ~ 50Hz



12V



25 L

GRAPHITE

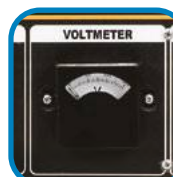

WOLTMIERZ
VOLTMETER



GNAZDO 2X16A/230V AC
AC SOCKETS



GNAZDO 12V DC
DC TERMINALS



2000W /
max 2200W



230V ~ 50Hz



12V



Ref. [kg] EAN
04-732 91 kg 1/1 5907558495997

Ref. EAN
586904 1/1 5902062087928

Przecinarka do glazury

Tile cutter / Fliesensäge / Плиткорез электрический / Плиткоріз електричний / Csempévágógép / Tāietor placā / Pila na glazuru / Rezačka dlažby stolová / Žaga za ploščice / Plytelių pjaustyklė / Flīzgriezējs / Plaaditõikur / Циркуляр / Pila za pločice / Stona testera / Κόφτης πλακιδίων / Cortador eléctrico de azulejos / Tagliapiastrelle elettrico / Serra para ladrilho / Scie à carrelage

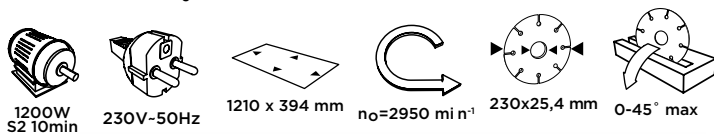

SYSTEM POSUWU TARCZY CUTTING DISC WITH FEED
ОТРЕЗНОЙ КРУГ С ПОДАЧИ

PODŁĄCZENIE WODY WATER INLET
ВОЗМОЖНОСТЬ ВОДЯНОГО ОХЛАЖДЕНИЯ

Ref.	Box	EAN
59G891	1/1	5902062092977

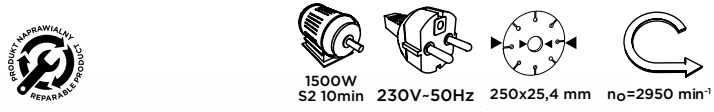

SYSTEM POSUWU TARCZY CUTTING DISC WITH FEED
ОТРЕЗНОЙ КРУГ С ПОДАЧИ

PODŁĄCZENIE WODY WATER INLET
ВОЗМОЖНОСТЬ ВОДЯНОГО ОХЛАЖДЕНИЯ

Ref.	Box	EAN
59G892	1/1	5902062092984

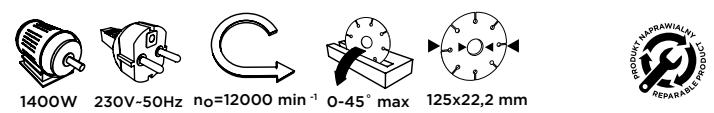

PODŁĄCZENIE WODY WATER INLET
ВОЗМОЖНОСТЬ ВОДЯНОГО ОХЛАЖДЕНИЯ

Ref.	Box	EAN
59G888	1/4	5902062087904

Pilarka stołowa

Table saw / Tischsäge / Настольная пила / Пилка верстатна / Asztali fűrész / Ferstrau de banc / Stolní pila / Stolová pila / Namizna žaga / Stacionarus diskinis pjūklas / Galda žaigis / Saepink / Циркуляр настольн / Stolna pila / Stona testera / Επιτραπέζιο πριόνι / Sierra de mesa / Sega circolare da banco / Plaina de mesa / Scie d'établi / Tafelzagg



DWUPUNKTOWY ODCIĄG WIÓRÓW
DOUBLE-POINT DUST EXTRACTION
ПОДКЛЮЧЕНИЕ ПЫЛЕСОСА

DWUPUNKTOWY ODCIĄG WIÓRÓW
DOUBLE-POINT DUST EXTRACTION
ПОДКЛЮЧЕНИЕ ПЫЛЕСОСА

ROZSUWANY STÓL ALUMINIOWY
EXTENDABLE ALUMINUM WORKSPACE
РАЗДВИЖНОЙ АЛЮМИНИЕВЫЙ СТОЛ

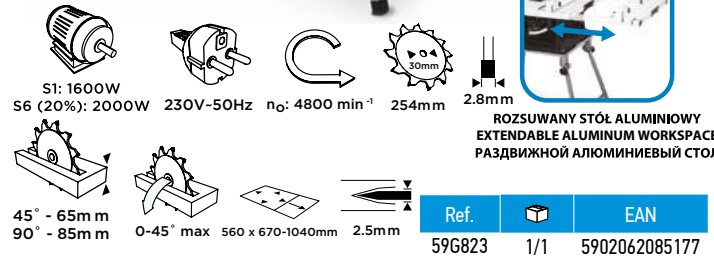

Ref.	Box	EAN
59G823	1/1	5902062085177

Odciąg wiórów

Workshop vacuum cleaner / Werkstattstaubsauger / Пылесос промышленный / Пилосос професійний / Műhelyporszívó / Aspirator atelier cu sistem vacuum / Dilenský vysavač / Dielenský vysávač / Industrijski sesalnik / Pramoninis siurblys / Rūpniecības putekļsūcējs / Toöstuslik tolmuimeja / Промышленна прахосмукачка / Radionički usisavač / Industrijski usisivač / Ηλεκτρική οούλα επαγγελματική / Aspirador / Aspirapolvere da officina / Aspirador de oficina / Aspirateur d'atelier / Werkplaatsstofzuiger



ŚREDNICA WEŻA 107 MM
PIPE DIAMETER 107 MM
ДИАМЕТР ШЛАНГА 107 MM

ZBIORNIK ZE STALI
STEEL CONTAINER
СТАЛЬНЫЙ БАК

Ref.	Box	EAN
59G611	1/1	5902062085542

Worki do odciażu wiórów

Workshop vacuum cleaner bags / Säcke für die Späneabsaugung / Мешки для извлечения стружки / Мішки для видалення стружки / Chip extrakciós zsákok / Saci de extracție a aşchililor / Vaky na extrakci trisek / Vrecká na extrakciu štiepky / Vrečke za ekstrakcijo čipov / Skaldos ištraukimo maišai / Škeldas ekstrakcijas maiši / Laastude ekstraheerimise kotid / Торби за извлчачане на чипове / Vrečice za vadenje strugotine / Вреће за вађење чипова / Σακοίλες εξαγωγής τσιπ / Bolsas de extracción de virutas / Sacchetti per l'estrazione di trucioli / Sacos de extracção de lascas / Sacs d'extraction de copeaux / Spaanderafzuigzakken



Ref.	Box	EAN
59G611-145	1/18	5902062085559

Odkurzacz przemysłowy

Industrial vacuum cleaner / Industriestaubsauger / Пылесос промышленный / Пилосос промисловий / Ipari porszívó / Aspirator industrial / Průmyslový vysavač / Priemyselný vysávač / Industrijski sesalnik / Pramoninis dulkių siurblys / Rūpnieciskais puteklšūcējs / Tööstuslik imur / Промышленна прахосмукачка / Industrijski usisavač / Industrijski usisivač / Βιομηχανική ηλεκτρική σκούπα / Aspirador industrial / Aspiratore industriale / Aspirador industrial / Aspireteur industriel / Industrielle stofzuiger



1400W



230V- 50Hz



30 L



32 mm



MAX 2000W



1600W



230V- 50Hz



35 L



32 mm



MAX 1800W



Ref.	☒	EAN
04-738	0/1	5907558483079



Ref.	☒	EAN
04-739	0/1	5907558483086



04-738-145



04-738-20



04-738-146



04-738-147



04-738-151



04-739-145



04-739-146



04-739-30

Ref.	☒	EAN
04-738-145	0/10	5907558483178
04-738-146	0/24	5907558475807
04-738-147	0/13	5907558475791
04-738-151	0/50	5907558475821
04-738-20	0/50	5907558475777

Ref.	☒	EAN
04-739-145	0/10	5907558413618
04-739-146	0/18	5907558475814
04-739-30	0/50	5907558475784

Worki do odkurzacza

Vacuum cleaner bags / Staubsaugerbeutel / Мешки-пылесборники / Мішки до пылесоса / Porzsák porszívóhoz / Saci pentru aspiratori de praf / Sacky do vysavače / Vrecká do vysávača / Vreče za sesalnik / Maisšeliai dulkių siurbliui / Puteklšūcēja maisiņi / Tolmuitejaktid / Торби за прахосмукачки / Vrečice za usisavač / Vakuüm kese / Σάκοι συλλογής σκόνης / Bolsas para aspirador / Sacchetti per aspirapolvere / Sacs de aspirador / Sacs aspirateur / Zakken voor zwaar afval



x5

Ref.	for	☐	EAN
58GE124-145	58GE124	1/14	5902062102454
58GE133-145	58GE133	1/14	5902062102461

Pilarka łańcuchowa spalinowa

Gasoline chain saw / Kettensäge / Пила цепная бензиновая / Пила ланцюгова бензинова / Motoros lánctűrés / Ferestrău cu lanț cu motor / Motorová řetězová pila benzínová / Benzinová reťazová píla / Bencinska verižna žaga / Grandininis benzininis pjūklas / Benzina ķēžu zāģis / Kettsaag / Вержен трощ бензинов / Lančana benzinska pila / Benzinska lančana testera / Βενζινοκίνητο αλυσοπίλοιο / Motosierra / Motosega a catena / Motosserra / Scie à bois à essence / Benzine kettingzaag

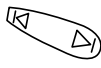
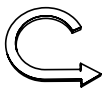
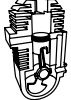

2 kW/2,7 KM n_o: 10 500 min⁻¹ 52 cm³ 18" / 45 cm 0,325" 550 ml



Ref.	☐	EAN
58G953	1/2	5902062077745



2 kW/2,7 KM n_o: 10 500 min⁻¹ 52 cm³ 18" / 45 cm 0,325" 550 ml



Ref.	☐	EAN
58G954	1/2	5902062077752

Myjka wodna ciśnieniowa

High pressure cleaner / Wasserhochdruckreiniger / Моечная машина / Машина мююча / Magasnyomású mosó / Masina de spalat cu presiune / Vodni tlaková myčka / Tlaková vodná čistička / Visokotlačni čistilec / Aukšto slėgio plovimo įrenginys / Augstspiediena mazgājama ierīce / Survepesur / Водоструйка под налягане / Visokotlačni čistač / Čistač sa visokim pritiskom / Πλυτήριο / Limpiadora de presión / Ιδρωπυλitrice / Aparelho de lavar de pressão / Nettoyeur à eau haute pression / Hogedrukreiniger

NEO TOOLS

AUTOMATYCZNE USTAWIENIE MOCY ŚREDNIA
FIXED POWER LEVEL MEDIUM
УСТАНОВКА МОЩНОСТИ НА СРЕДНЕМ УРОВНЕ

AUTOMATYCZNE USTAWIENIE MOCY NISKA
FIXED POWER LEVEL LOW
УСТАНОВКА МОЩНОСТИ НА НИЗКОМ УРОВНЕ

AUTOMATYCZNE USTAWIENIE MOCY WYSOKA
FIXED POWER LEVEL HIGH
УСТАНОВКА МОЩНОСТИ НА ВЫСОКОМ УРОВНЕ

WŁĄCZANIE/WYŁĄCZANIE
ON/OFF SWITCH
ВКЛЮЧЕНИЕ/ВЫКЛЮЧЕНИЕ

WSKAŹNIK POZIOMU MOCY
POWER LEVEL INDICATOR
ИНДИКАТОР УРОВНЯ МОЩНОСТИ



RĘCZNA REGULACJA: ZMNIEJSZANIE MOCY
MANUAL ADJUSTMENT: POWER DECREASE
РУЧНАЯ РЕГУЛИРОВКА Понижения мощности

RĘCZNA REGULACJA: ZWIĘKSZANIE MOCY
MANUAL ADJUSTMENT: POWER INCREASE
РУЧНАЯ РЕГУЛИРОВКА Увеличения мощности



2000W



230 V ~ 50 Hz

IN:
MAX 40°C
1.2 MPa

OUT:
100 bar
MAX 150 bar

AUTO
STOP
system



6L/min
MAX 7.5L/min



Ref.	☐	EAN
04-705	1/1	5907558469493

Szlifierka do gipsu

Drywall sander / Gipsschleifer / Машина шлифовальная для стен и потолков / Шлифмашина по гипсу / Falcsiszó / Polizor pentru pereti gips-carton / Bruska na sádr / Brúska na sadru / Brusilnik za gips / Šljufoklis gipsui / Šljfmašina sienu un griestu šljpešanai / Kipslihvija / Шлайфмашина за зинс / Brusilica za gips / Brusilica za gips / Λειαντήρας για τοίχους και ταβάνια / Amoladora para yeso / Levigatrice per cartongesso / Disco de limar p. gesso / Meuleuse à plâtre / Gipsslijpmachine



SKŁADANA
FOLDING
СКЛАДНАЯ



OŚWIETLENIE LED
LIGHTING LED
ОСВЕЩЕНИЕ



REGULOWANA DŁUGOŚĆ
ADJUSTABLE LENGTH
РЕГУЛИРУЕМАЯ ГОЛОВКА

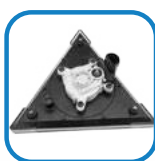
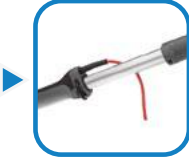

WYMIENNA STOPA
REMOVABLE PAD
СМЕННЫЙ ОСНОВА



230V-50Hz



710W



215mm



n_o: 800-1700min⁻¹



280mm



5m

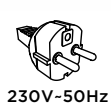

230V-50Hz



800W



215mm

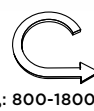

n_o: 800-1800min⁻¹



5m

Ref.	Box	EAN
59G265	1/2	5902062088239



SYSTEM ODSYSANIA PYŁU
DUST EXTRACTION SYSTEM
СИСТЕМА ВСАСЫВАНИЯ ПЫЛИ



OŚWIETLENIE LED
LIGHTING LED
ОСВЕЩЕНИЕ



230V-50Hz



900W



M5



180mm



n_o: 1400-2700 min⁻¹

Ref.	Box	EAN
59G263	1/4	5902062088215



OŚWIETLENIE LED
LIGHTING LED
ОСВЕЩЕНИЕ



SKŁADANA
FOLDING
СКЛАДНАЯ



Kosiarka elektryczna do trawy

Electric lawn mower / Elektrorasenmäher / Газонокосилка электрическая / Газонокосарка електрична / Elektromos fűnyírógép / Cositoare electrică p/t gazon / Elektrická sekačka na trávu / Elektrická kosačka / Elektrická kosilnica za travo / Elektrinė žolijavė / Elektriskå zåles plujmåšina / Elektriline muruniiduk / Електрическа косачка за трева / Električna kosilica za travu / Električna kosilica za travu / Ηλεκτροκίνητη χλοοκοπτική μηχανή / Cortacésped eléctrico para césped / Rasaerba elettrica / Ceifeira para relva elétrica / Tondeuse électrique à gazon / Elektrische grasmaaiër



REGULACJA WYSOKOŚCI RĘKOJEŚCI
HANDLE HEIGHT ADJUSTMENT
РЕГУЛИРОВКА ВЫСОТЫ РУКОЯТКИ



KOSZ
BASKET
КОРЗИНА



1500W



230V-50Hz



ZNACZNIK WYPEŁNIENIA KOSZA
BASKET FILL INDICATOR
МАРКЕР ЗАПОЛНЕНИЯ КОРЗИНЫ



REGULACJA WYSOKOŚCI RĘKOJEŚCI
HANDLE HEIGHT ADJUSTMENT
РЕГУЛИРОВКА ВЫСОТЫ РУКОЯТКИ

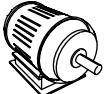

2000W

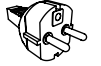

230V-50Hz



ZNACZNIK WYPEŁNIENIA KOSZA
BASKET FILL INDICATOR
МАРКЕР ЗАПОЛНЕНИЯ КОРЗИНЫ

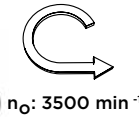

n_0 : 3500 min⁻¹

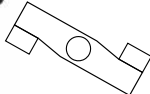

360 mm

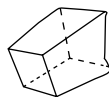

35 l

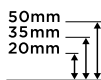

50mm
35mm
20mm



CENTRALNA REGULACJA WYSOKOŚCI KOSZENIA
CENTRAL CUTTING HEIGHT ADJUSTMENT
ЦЕНТРАЛЬНАЯ РЕГУЛИРОВКА ВЫСОТЫ КОШЕНИЯ

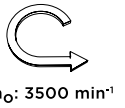

n_0 : 3500 min⁻¹

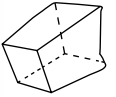

45 l



430 mm

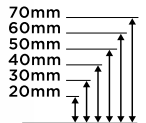

70mm
60mm
50mm
40mm
30mm
20mm



Ref.		EAN
59G474	1/1	5902062082947



Ref.		EAN
59G475	1/1	5902062082954





Łańcuch do pilarki łańcuchowej

Chain for chain saw / Kettensägekette / Цепь для цепной пилы / Ланцюг до пилки ланцюгової / Fűrészlánc / Lanț p/u ferăstrău cu lanț / Rețez țetozové pily / Rețaz do rețazovej pily / Veriga za veržno žago / Grandine grandiniuam pjučkliu / Kēde kēžu zājim / Ketsae kett / Веруза за веружен трион / Lanac za lančanu pilu / Lanac za lančanu testeru / Αλυσίδα για αλυσοπίριο / Cadena para sierra de cadena / Catena per sega a catena / Corrente para serra de motor / Chaîne pour scie à chaîne / Ketting voor kettingzaag



Do / For / Для:
58G098

1,3mm
x34 @ 0,050"
3/8"

Ref.	Box	EAN
58G098-20	0/100	5902062034274

Prowadnica do pilarki spalinowej

Guide bar for petrol chain saw / Führung für Kettensäge / Направляющая для бензопилы / Напрямна до бензинової пилки / Vezetősín a benzines sövényvágóhoz / Ghidaj pentru ferăstrăul cu lanț / Vodici lista pro benzínovou pilu / Vodiaca lista benzínovej pily / Меč motorne žage / Kreipiančioji pjučkliu, su vidaus degimo varikliu / Benzina zăga vadikla / Motorsae juhik / Направляваща за веружен трион / Vodilica za benzinsku pilu / Vodiaca za motornu testeru / Οδηγός για βενζινοκίνητο αλυσοπίριο / Guia para motosierra / Guida per motosega / Guia para serra com motor de combustão / Guide pour scie à essence / Geleider voor benzinezaag



Do / For / Для:
58G098

8" / 20 cm

Ref.	Box	EAN
58G098-30	0/20	5902062034328

Žytko do podkaszarki

Cutting line for grass cutter / Rasentrimmerfaden / Струна для газонокосилки / Волосінь до газонокосарки / Vágószinór fűszegélynyíróhoz / fir taietor pentru cositoare de gazon / Struna pro vyžinač / Struna do vyžinača / Nitka za kosilnico / Valas žoliapjovei / Aukla trimmerim / Murutrimmeri jöhv / Корда за косачка / Uložak za kosilicu / Žilica za kosilicu, vodiča za kosilicu / Μεσινέζα για χλοοκοπτική μηχανή / Hilo de nilón para podadora de bordes / Filo per tosaerba / Linha para ceifeadeira / Fil à coupeur d'herbes / Metselknijlijn

NEO
TOOLS



15m

Ref.	info	Box	EAN
07-100	● ø 1,6 mm x 15 m	0/50	5907558483178
07-101	● ø 2 mm x 15 m	0/50	5907558475807
07-102	● ø 2,4 mm x 15 m	0/50	5907558475791
07-103	■ 3 mm x 15 m	0/50	5907558475821

Akcesoria do miniszlifierki

Accessories for mini grinder / Zubehör für Minischleifer / Принадлежности для мини шлифовальный станок / Приладдя для міні шліфувальна машина / Tartozékok mini darálóhoz / Accesorii pentru mini polizor / Příslušenství pro mini mlynek / Příslušenstvo pre mini mlynček / Dodatki za mini mlinček / Mini malunélio priedai / Aksesuári mini dzimavariām / Miniveski tarvikud / Аксесоари за мини мелница / Pribor za mini mlin / Прибор за мини млин / Αξεσουάρ για μίνι μύλο / Accessori per mini-smerigliatrice / Accesorios para minipimer / Acessórios para mini-moedor / Accessoires pour mini-moulin / Accessoires voor minisljper



CERAMIC



GLASS



METAL



WOOD



PLASTIC

Do / For / Для:
58G095

GRINDING

POLISHING

12,7mm

50mm

no: 3000-9000 min⁻¹



Ref.	Box	EAN
58G095-20	0/20	5902062107343

Ostrza 24T i 32T

24T and 32T blades / 24Z und 32Z Klängen / Отвалы 24T и 32T / Леза 24T и 32T / 24T és 32T pengék / Lame de 24T și 32T / Čepele 24T a 32T / Čepele 24T a 32T / 24T in 32T rezila / 24T ir 32T peiliukai / 24T un 32T asmeņi / 24T ja 32T labad / 24T u 32T ostruema / 24T i 32T oštrice / Оштрице од 24T u 32T / Λεπίδες 24T και 32T / 24T ja 32T labad / Lame 24T e 32T / Láminas 24T e 32T / Lames 24T et 32T / 24T en 32T messen

NEO
TOOLS

24T
x5

32T
x5

for air body saw
14-034

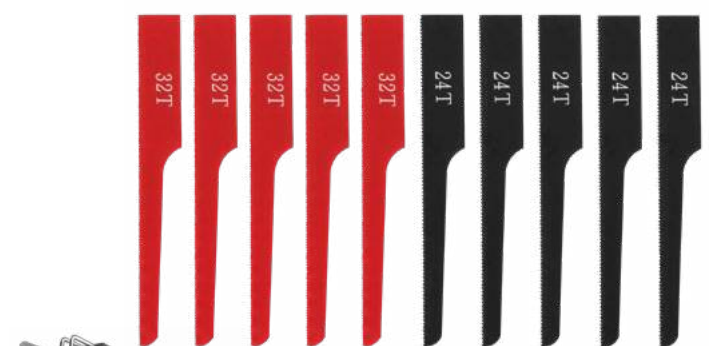

Ref.	Box	EAN
14-034-401	20/200	5907558495898

Wiertło do metalu

Metal drill / Bohrer für Metall / Сверло для металла / Сверло по металлу / Fémfúrósár / Burghiu pentru metal / Vrták na kov / Vrták do kovu / Sveder za kovino / Metalo gražtas / Metāla urbis / Metallipuur / Сверло за метал / Svrdlo za metal / Burgija za metal / Τρυπάνι για μέταλλο / Broca para metal / Punta per metallo / Broca p. metal / Foret à métal / Boor voor metaal

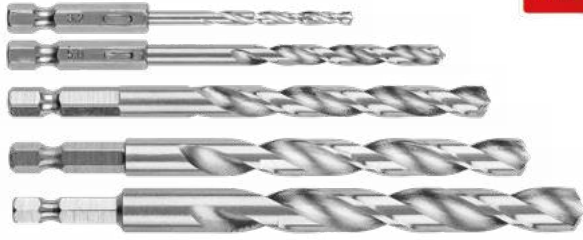

NEW

Ref.	Ø [mm]	N	☐	EAN
54T700	2.0	3	40/80	5902062072818
54T701	2.5	2	40/80	5902062072849
54T702	3.0	2	40/80	5902062072887
54T703	3.2	2	40/80	5902062072948
54T704	3.5	2	40/80	5902062072955
54T705	4.0	2	40/80	5902062072870
54T706	4.2	2	40/80	5902062072894
54T707	4.5	2	40/80	5902062947420
54T708	4.8	2	40/80	5902062202000
54T709	5.0	2	40/80	5902062888945
54T710	5.5	2	40/80	5902062889041
54T711	6.0	2	40/80	5902062064189
54T712	6.5	2	25/50	5902062064196
54T713	7.0	2	25/50	5902062508720
54T714	7.5	2	25/50	5902062508737
54T715	8.0	1	25/50	5902062508744
54T716	8.5	1	25/50	5902062508751
54T717	9.0	1	25/50	5902062087157
54T718	10.0	1	25/50	5902062088130
54T719	11.0	1	25/50	5902062088147
54T720	12.0	1	25/50	5902062088154
54T721	13.0	1	25/50	5902062086754

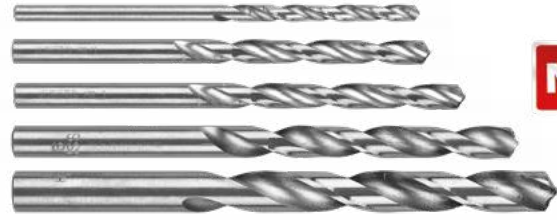

NEW

Ref.	Ø [mm]	N	☐	EAN
54T980	1 mm	3	50/100	5902062022332
54T981	1,5 mm	3	50/100	5902062022349
54T982	2 mm	3	50/100	5902062032508
54T983	2,5 mm	2	50/100	5902062059925
54T984	3 mm	2	50/100	5902062060563
54T985	3,2 mm	2	50/100	5902062060570
54T986	3,5 mm	2	40/80	5902062060730
54T987	4 mm	2	40/80	5902062060938
54T988	4,5 mm	2	40/80	5902062055682
54T989	5 mm	2	40/80	5902062054470
54T990	6 mm	2	40/80	5902062037947
54T991	8 mm	1	25/50	5902062038074
54T992	10 mm	1	25/50	5902062038081

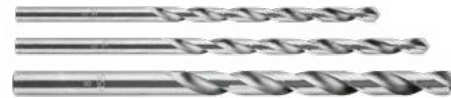

NEW

Ref.	Ø [mm]	☐	EAN
54T993	3 mm	125/500	5902062037077
54T994	4 mm	125/500	5902062037206
54T995	5 mm	125/500	5902062037213
54T996	6 mm	100/400	5902062037220
54T997	8 mm	100/200	5902062037497
54T998	10 mm	100/200	5902062036957

Wiertła do drewna łopatkowe

Wood flat drill bit / Holzbohrer / Сверло перьевое по дереву / Сверло по дереву пероше / Lapos marófúrú / Burghiu lat pentru lemn / Vrták lopatkový na dřevo / Vrták do dreva plochý / Sveder za les / Ploščias gražtas medžiui / Spalvu urbis kokam / Lame puidudrelli otsik / Burgija za beton / Τρυπάνια φτερού για διάτρηση ξύλου / Broca de pala para madera / Punta per legno piatta / Broca de pá p. madeira / Foret à bois plat / Vlakboor voor hout

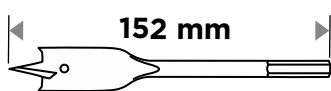
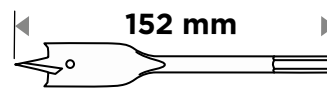

NEW

Ref.	Ø [mm]	☐	EAN
54T500	10	50/300	5902062087140
54T501	12	50/300	5902062087720
54T502	14	50/300	5902062088178
54T503	16	50/300	5902062088185
54T504	18	50/300	5902062088192
54T505	20	50/300	5902062088208
54T506	22	50/300	5902062462602
54T507	24	50/300	5902062464262
54T508	26	50/300	5902062456724
54T509	28	50/300	5902062457448
54T510	30	50/300	5902062500007
54T511	32	50/300	5902062500069
54T512	34	50/300	5902062538260
54T513	36	50/300	5902062003317
54T514	38	50/300	5902062004987

- Ø 10 mm
- Ø 13 mm
- Ø 16 mm
- Ø 19 mm
- Ø 22 mm
- Ø 25 mm

NEW



Ref.	☐	EAN
54T515	25/100	5902062004994

Szpicak

Point chisel / Spitzeisen / Долово-пика / Пробувач / Hegyveső / Daltű / Špičák / Sekáč špicatý / Koničasti sekač / Pincetas / Kalts spicais / Шило / Špica / Σπιλή αχμηρού άκρου / Terava otsaga peitel / Spic / Cincel / Punteruolo / Cinzel / Poinçon / Puntbeitel

for **SDS^{MAX}**

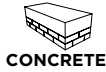

CONCRETE



SELF SHARPENING

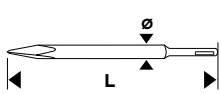

Ref.	L [mm]	Ø [mm]		EAN
57H547	400	18	13/26	5902062078353
57H548	600	18	10/20	5902062078360

for **SDS^{plus}**



CONCRETE

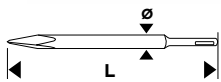

Ref.	L [mm]	Ø [mm]		EAN
57H553	250	14	15/60	5902062078414

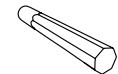

HEX GRIP CONCRETE

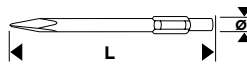

Ref.	L [mm]	Ø [mm]		EAN
57H574	280	17	25/50	5902062078452

Groszkownik

Bush hammer / Stockhammer / Крестовая бучарда / Хрестова бучарда / Szemcsésző kalapács / Buciardă / Pemrlice / Kamenárske kladivo / Kladivo za štokanje / Dantytasis plaktukas / Bučarde / Põõsasvasar / Каменоделски чук / Čekić za štokanje / Čekić za grmlje / Σφουριά με αιχμές / Bujarda / Vocciardatore / Bujarda / Boucharde / Textuur hamer

for **SDS^{MAX}**

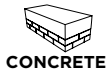

CONCRETE

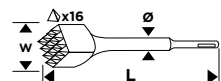

Ref.	L [mm]	W [mm]	Ø [mm]		EAN
57H552	240	40x40	18	10/20	5902062078407

for **SDS^{plus}**



CONCRETE

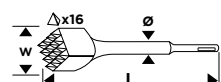

Ref.	L [mm]	W [mm]	Ø [mm]		EAN
57H573	250	40x40	14	10/20	5902062078445

Dłuto

Chisel / Beitel / Долово / Зубило / Laposvésző / Daltű / Dłuto / Sekáč / Sekáč / Kaltas / Kalts / Peitel / Сечак / Sjekáč / Sekac / Σπιλή / Formón / Scalpello / Raspador / Ciseau / Beitel

for **SDS^{MAX}**



CONCRETE

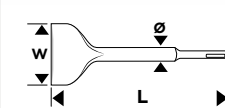

Ref.	L [mm]	W [mm]	Ø [mm]		EAN
57H549	300	75	18	10/30	5902062078377
57H550	400	50	18	13/26	5902062078384
57H551	450	100	18	5/10	5902062078391

for **SDS^{plus}**



CONCRETE



CERAMIC

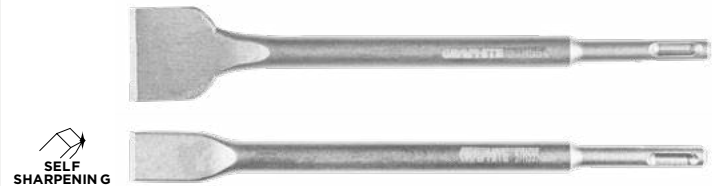

SELF SHARPENING

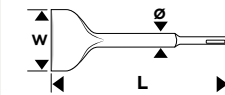

Ref.	L [mm]	W [mm]	Ø [mm]		EAN
57H554	250	40	18	15/60	5902062078421
57H555	250	20	18	15/60	5902062078438

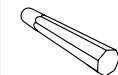

HEX GRIP



CONCRETE

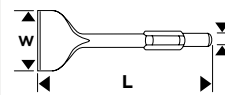

Ref.	L [mm]	W [mm]	Ø [mm]		EAN
57H575	400	115	17	5/10	5902062078469

Świder glebowy

Soil drill / Bodenbohrer / Почвенный бур / Грунтовоый бур / Földfúró / Burghiu de sol / Půdní vrták / Zemný vrták / Sveder za vrtnje v zemljo / Dirvožemio sraigtas / Zemes urbis / Mullatigu / Почвен саредел / Svrldo za zemlju / Burgija za zemljište / Γεωτρύπανο / Taladro de tierra / Trivella per il suolo / Perforador de solo / Foreuse de terre / Grondboor

4 mm

65Mn

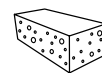

SOIL



M14

Do / For / Для
58G084

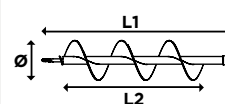

Ref.	L1 [mm]	L2 [mm]	Ø [mm]		EAN
56H780	600	480	80	1/10	5902062071477
56H781	600	520	120	1/10	5902062071484

Tarcza do pilarki

Circular saw blade / Sägeblatt / Диск пильный / Диск пильный до пилки циркулярной / Körfürészlap / Lamă circulară p/ă ferăstrău / Pílový kotouč / Pílový kotúč / List za krožno žago / Plovimo diskas pjūklui / Ząga ripa / Kreissaeketas / Диск за циркуляр / Kružna pila / List kružne testere / Δίσκος κοπής διακοπρίουου / Disco de corte para sierra circular / Disco per segatrice / Disco p. disco de limar / Disque à scie rotative / Schijf voor slijpmachine

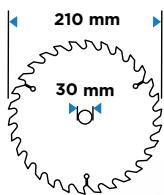

NEW

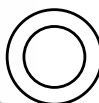
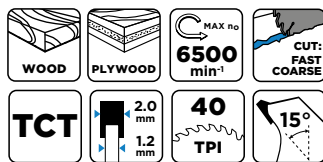

REDUCTIONS:
 ø 30x25.4 mm
 ø 30x20 mm
 ø 30x16 mm



Ref.	Box	EAN
57H683	0/50	5902062061942

Otwornica

Hole saw / Lochsäge / Ножовка / Фреза / Kórkivágó / Ferăstrău pentru găuri / Dėrovka / Dierovacica pila / Luknjarica / Vianarankis pūklas / Rokzāģis / Augusaag / Тесен трион / Kružna pila za rupe / Kružna testera za rupe / Πρίονι / Sierra de corona / Segá a tazza / Serra para recorte / Scie à guichet / Gatensnipper

NEW

L450mm



Ref.	Ø [mm]	T	Box	EAN
57H858	52	5	0/10	5902062508096
57H859	62	6	0/10	5902062508102
57H861	82	8	0/10	5902062508126
57H862	102	9	0/5	5902062508119
57H863	112	10	0/5	5902062508140
57H864	122	11	0/5	5902062508133
57H867	132	11	0/5	5902062508195

Przedłużka

Extension / Verlängerung / Удлинитель / Подовжувач / Toldósár / Prelungitor / Prodlužovák / Predĺženie / Podaljšek / Ilgiklis / Pagarinātājs / Pikenodus / Удължител / Produženi poluga / Produziena poluga / Προέκταση / Alargadera / Prolunga / Extensão / Prolongation / Verlengstuk



NEW

Ref.	L [mm]	Box	EAN
57H897	200	0/10	5902062508157
57H898	300	0/10	5902062508164
57H899	500	0/5	5902062508171



Krażki ścierne

Abrasive discs / Schleifscheibe / Шлифовальные круги / Круги шлифовальні / Csiszolókorongok / Discuri abrazive / Brúsné kroužky / Brúsné kotúče / Brusne plošče / Šlijavimo diskeliai / Slipšanas aplī / Lihvrångad / Αβρασιβни дискоче / Brusni kalutiči / Diskovi za brušenje / Δίσκοι λείανσης / Hoja de lija circular / Dischi abrasivi / Discos abrasivos / Roulette abrasive / Schuurwielen

NEO TOOLS

NEW

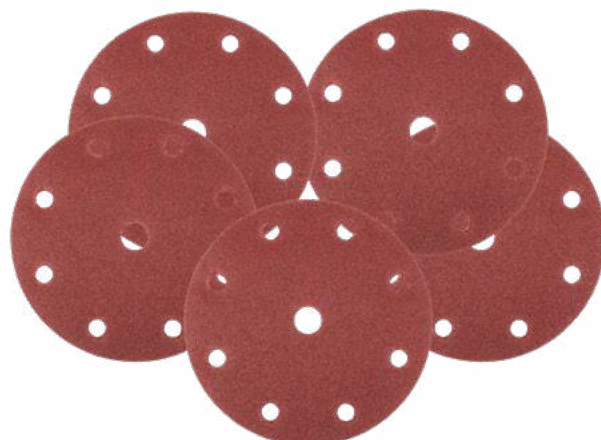

Ref.	info	Ø [mm]	Box	EAN
08-990	K40	150	0/100	5907558475845
08-991	K60	150	0/100	5907558475852
08-992	K80	150	0/100	5907558475869
08-993	K100	150	0/100	5907558475876
08-994	K120	150	0/100	5907558475883
08-995	K180	150	0/100	5907558475890
08-996	K240	150	0/100	5907558475906

Szczotka druciana do kosy spalinowej

Wire brush for trimmer / Drahtbürste für Motorsense / Проволочная щетка для мотококосы / Дротяна щетка для мотококосы / Drótkéfe benzines kaszához / Disc perie sărmă pentru motocoasă / Drátěný kartáč pro křovinořez / Hrnčeková drátená do křovinořezu / Žična ščetka za motorno koso / Benzininēs krūmrajovēs vielinīs šepetys / Stieplu birste krūmgriezīm / Traathari trimmerile / Телена четка за бензиново косо / Žičana četka za trimer / Čelična četka za trimer / Συρμάτινη βούρτσα για θαμνοκοπικές και χλοοκοπικές μηχανές εσωτερικής καύσης / Cepillo para desbrozadora / Spazzola metallica per decespugliatore a benzina / Escova de arame para a motorroçadeira / Brosse métallique pour la débroussailluse / Draadborstel voor benzine bosmaaijer

HARD



up to 6500



twisted steel wire
Ø0.5mm



Ø25,4mm



Ref.	Ø [mm]	Box	EAN
55H100	150	1/10	5902062082688
55H101	200	1/10	5902062082695

SOFT



up to 6500



wave steel wire
Ø0.3mm



Ø25,4mm



Ref.	Ø [mm]	Box	EAN
55H102	150	1/10	5902062082701
55H103	200	1/10	5902062082718

Tarcza widiowa do kosy spalinowej

Carbide-tipped blade for trimmer / Hartmetallscheibe für Motorsense / Диск для мотококосы / Диск для мотококосы / Vídíatárcsa benzines kaszához / Disc widia pentru motocoasă / Vidiový disk pro křovinořez / Vidiový kotúč do křovinořezu / Nazobčan disk za motorno koso / Benzininēs krūmrajovēs šakinis disks / Griežējdiskis krūmgriezīm / Vāsaketas trimmerile / Диск с видия за бензиново косо / Kružna pila za trimer / Rezni disk za trimer sa vidijom / Τρύπανα μικρού στελέχους για θαμνοκοπικές και χλοοκοπικές μηχανές εσωτερικής καύσης / Hoja de sierra circular de carburo cementado para desbrozadora / Disco di carburo per decespugliatore a benzina / Disco dentado para a motorroçadeira / Disque pour débroussailluse / Vorkmessen voor bosmaaiers

Ø 255x25.4 mm



GRASS

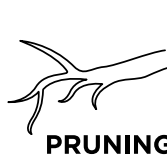

PRUNING

40T



max 5500 min⁻¹

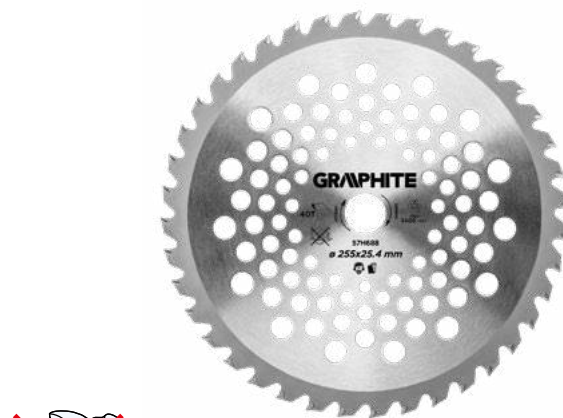

Ref.	Box	EAN
57H688	1/50	5902062082725

Papier ścierny

Sanding paper / Schleifpapier / Бумага наждачная / Папір наждачний / Csiszolópapír / Hirtie şmirghel / Brusný papier / Papier brúsný / Brusni papir / Šlifavimo popierius / Smiltšpāpīrs / Liivapaber / Шкурка / Brusni papir / Brusni papir / Лианткџ ѓрапапа / Lija / Carta abrasiva / Folha de lixa / Papier abrasif / Schuurpapier

x5



59G329

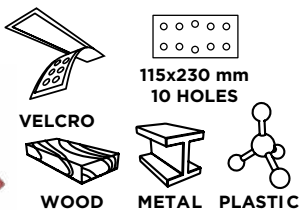

115x230 mm
10 HOLES

VELCRO



WOOD



METAL



PLASTIC

Ref.	info	Box	EAN
54H001	K40	1/88	5902062091055
54H002	K60	1/88	5902062091109
54H003	K80	1/88	5902062091123
54H004	K100	1/88	5902062091147
54H005	K120	1/88	5902062091208
54H006	K180	1/88	5902062091215
54H007	K240	1/88	5902062091222

x15



K180



59G336

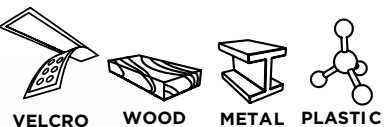

VELCRO

WOOD

METAL

PLASTIC

92,3x32 mm

Ref.	Box	EAN
54H008	1/300	5902062091352

x5



59G336

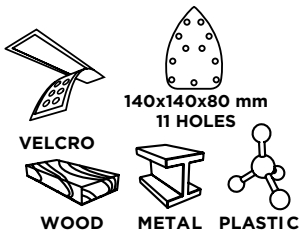

140x140x80 mm
11 HOLES

VELCRO



WOOD



METAL



PLASTIC

Ref.	info	Box	EAN
54H009	K40	1/167	5902062091369
54H010	K60	1/167	5902062091376
54H011	K80	1/167	5902062091413
54H012	K100	1/167	5902062091420
54H013	K120	1/167	5902062091437
54H014	K180	1/167	5902062091741
54H015	K240	1/167	5902062091758

x5



59G349

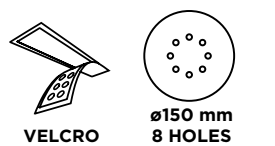

VELCRO

Ø150 mm
8 HOLES

WOOD

METAL

PLASTIC

Ref.	info	Box	EAN
54H016	K40	1/100	5902062091925
54H017	K60	1/100	5902062092021
54H018	K80	1/100	5902062092038
54H019	K100	1/100	5902062092052
54H020	K120	1/100	5902062092441
54H021	K150	1/100	5902062092496

Krażki ścierne

Abrasive discs / Schleifscheibe / Шлифовальные круги / Круги шліфовальні / Csiszolókorongok / Discuri abrazive / Brusné kroužky / Brúsne kotúče / Brusne plošče / Šlifavimo diskeliji / Šlīpēšanas aplī / Lihvrångad / Абразивни дискове / Brusni kolutiči / Diskovi za brušenje / Δίσκοι λείανσης / Hoja de lija circular / Dischi abrasivi / Discos abrasivos / Roulette abrasive / Schuurwielen

DO SZLIIFIERKI DO GIPSU
FOR DRYWALL SANDER
ДЛЯ ШЛИФОВАЛЬНОЙ МАШИНЫ

59G263

x5

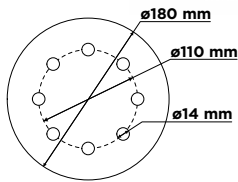

ø180 mm
8 HOLES

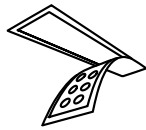

VELCRO

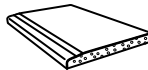

DRYWALL

Ref.	K		EAN
54H022	80	1/100	5902062098764
54H023	120	1/100	5902062098771
54H024	180	1/100	5902062098788

DO SZLIIFIERKI DO GIPSU
FOR DRYWALL SANDER
ДЛЯ ШЛИФОВАЛЬНОЙ МАШИНЫ

59G264
59G265

x5

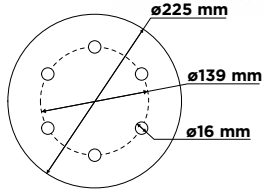
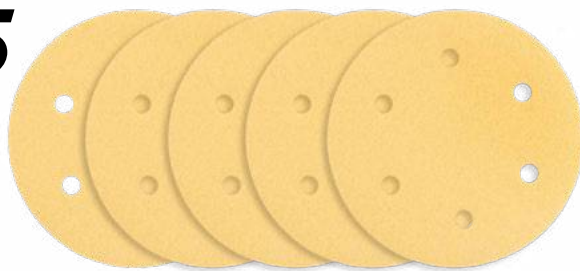

ø225 mm
6 HOLES

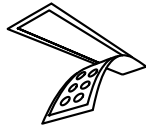

VELCRO

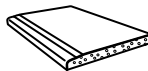

DRYWALL

Ref.	K		EAN
54H029	80	1/50	5902062098795
54H030	120	1/50	5902062098801
54H031	180	1/50	5902062098818



Siatka ścierna

Abrasive mesh disc / Schleifgitter / Сетка шлифовальная / Сітка абразивна / Csiszolórács / Plasă abrazivă / Brusná mřížka / Mriežka brúsna / Vodobrusni papir / Šlifavimo tinktelis / Abrazivais siets / Lihvimisvõrk / Шкурка / Vodobrusni papir / Vodobrusni papir / Λειαντικό πλέγμα / Malla de lijado / Rete abrasiva / Rede abrasiva / Grille abrasive / Schuurmet

DO SZLIIFIERKI DO GIPSU
FOR DRYWALL SANDER
ДЛЯ ШЛИФОВАЛЬНОЙ МАШИНЫ

59G263

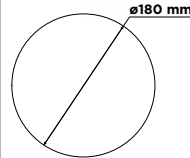

x5 ø180 mm

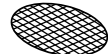

MESH



DRYWALL

Ref.	K		EAN
54H025	40	1/50	5902062098825
54H026	80	1/50	5902062098832
54H027	120	1/50	5902062098849
54H028	180	1/50	5902062098856

Papier ścierny

Sanding paper / Schleifpapier / Бумага наждачная / Папір наждачний / Csiszolópapír / Hírtie smirghel / Brusný papir / Papier brúsny / Brusni papir / Šlifavimo popierius / Smilšpapīrs / Lijvapaper / Шкурка / Brusni papir / Λειαντικό ύφασμα / Lija / Carta abrasiva / Folha de lixa / Papier abrasif / Schuurpapier

DO SZLIIFIERKI DO GIPSU
FOR DRYWALL SANDER
ДЛЯ ШЛИФОВАЛЬНОЙ МАШИНЫ

59G264

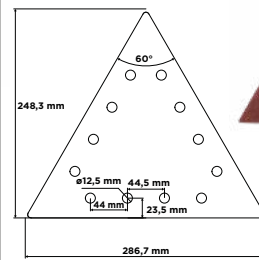

x5 248,3 x 286,7 mm
12 HOLES



VELCRO



DRYWALL

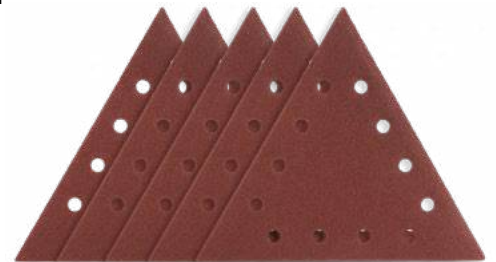

Ref.	K		EAN
54H032	80	1/50	5902062098863
54H033	120	1/50	5902062098870
54H034	180	1/50	5902062098887

x4



WOOD



METAL



PLASTIC



100 x 80 mm

Do / For / Для:
58GE137



Ref.	K		EAN
54H035	60	0/24	5902062043467
54H036	80	0/24	5902062043474
54H037	100	0/24	5902062043481
54H038	120	0/24	5902062043665
54H039	240	0/24	5902062043672

Wałek do satynowania

Satin roller / Satinierwalze / Сатирующий валик / Валик для сатинования / Satírozó henger / Rola de finisare satinată / Saténový váleček / Satinovací valček / Satenski valj za dodelavo / Satino apdailos volelis / Satina apdaires rullītis / Satiin-viimistlusrull / Валяк за сатиране / Valjak za satiniranje / Сатен-завершни валик / Κύλινδρος σατινέ φινιρίσματος / Rullo per satinatura / Rodillo de satinado / Rolo de acabamento acetinado / Rouleau de satinage / Satineerroller



Do / For / Для:
58GE137

100x80mm/ø19mm

Ref.		EAN
54H040		5902062043689

Wałek z włókniny

Fleece roller / Vliesrolle / Флисовый валик / Флисовий валик / Гуарпійу хенгер / Role de fleece / Fleecový váleček / Fleecový valček / Valjček iz flisa / Vilnonis volelis / Vilnas rullītis / Fliisruller / Ролка от рьно / Valjak od netkanog materijala / Валяк од нетканог материјала / Κύλινδρος fleece / Rullo in pile / Rodillo de vellón / Rolo de lã / Rouleau en polaire / Fleece rol



Do / For / Для:
58GE137

100x80mm/ø19mm

Ref.		EAN
54H041		5902062043696

Wałek druciany

Wire roller / Drahtrolle / Проволочный ролик / Дротяний ролик / Dróthenger / Role de sârmă / Drátěný váleček / Drôtený valec / Žični valjček / Vleios ritinēlis / Stieples veltnis / Traadrull / Валяк за метал / Žičani valjak / Жичани валик / Κύλινδρος σύρματος / Rullo a filo / Rodillo de alambre / Rolo de arame / Rouleau métallique / Draadroller



Do / For / Для:
58GE137

100x80mm/ø19mm

Ref.		EAN
54H042		5902062043702

Szczotka nylonowa

Nylon brush / Nylonbürste / Нейлоновая щетка / Нейлонова щетка / Nylon kefe / Perie de nailon / Nylonový kartáč / Nylonová kefa / Najlonska krtača / Nailoninis šepetys / Neilona birste / Nailonhari / Нейлонова четка / Najlonska četka / Najlonska четка / Νάilon βούρτια / Spazzola in nylon / Cepillo de nylon / Escova de nylon / Brosse en nylon / Nylon borstel



Do / For / Для:
58GE137

100x80mm/ø19mm

Ref.		EAN
54H043		5902062044099

Tarcza tnąca

Cutting disc / Trennscheibe / Отрезной диск / Відрізний диск / Vágókorong / Disc de tăiere / Řezací kotouč / Rezací kotůč / Rezalni disk / Pjovimo diskas / Griešanas disks / Lõikeketas / Режущий диск / Disk za rezanje / Диск за сечење / Δίσκος κοπής / Disco cortante / Disco da taglio / Disco de corte / Scie circulair / Doorslijpschijf

NEO
TOOLS

Ø75 mm for cut-off tool 14-017 x5



Ref.		EAN
14-017-400	20/200	5907558495881

NEO
TOOLS

MAX 12200 min⁻¹ MAX 80 m/s INOX MADE IN POLAND EN12413 16469



Ref.	ø1 [mm]	ø2 [mm]	W [mm]	Info			EAN
08-720	125	22	1.0	41 A60-S-BF	25	0/1	5907558430356
08-722	125	22	1.0	41 A60-S-BF	100	0/1	5907558472363
08-721	230	22	1.9	41 A60-S-BF	25	0/1	5907558430370

x10 EN 12413

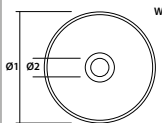

Ref.	ø1 [mm]	ø2 [mm]	W [mm]	Info			EAN
55H577	115	22	1.0	41 A60-T-BF	10	5/40	5902062107022
55H578	125	22	1.0	41 A60-T-BF	10	5/40	5902062107039

x5 EN 12413

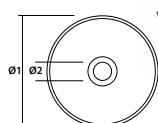

Ref.	ø1 [mm]	ø2 [mm]	W [mm]	Info			EAN
55H579	230	22	1.9	A46-S-BF	5	5/20	5902062107046

Frez do drewna

Counter - sink drill / Holzfräser / Фреза на дърепя / Фреза на дърепя / Fenékfúró vidáris / Frezã p/u lemn / Fréza na dřevo / Vrták „sukovník“ tvrdokovový / Rezkala za les / Freza medziui / Fréze kokam / Süvisedrell / Буръза за омеору / Svrldo za rupe / Burgija za klap sarke / Фрѐза ѓѐлуу / Brocas fresadoras para madeira / Fresa per legno / Fresa p. madeira / Fraise à bois / Houtfrees

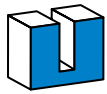

Ref.	L [mm]	Ø1 [mm]	Ø2 [mm]	☐	EAN
56H200	11	3,96	6	10/200	5902062070203
56H201	11	3,96	8	10/200	5902062070210
56H202	19	6	8	10/200	5902062070333
56H203	19	8	8	10/200	5902062070340
56H204	25	12	12	10/200	5902062070357
56H205	19	20	8	10/200	5902062070364
56H206	19	20	12	10/200	5902062070371
56H207	50	10	8	10/200	5902062070388
56H208	50	10	12	10/100	5902062070395

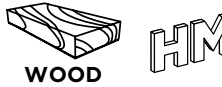
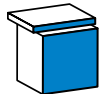
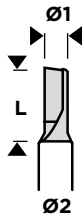

Ref.	L [mm]	Ø1 [mm]	Ø2 [mm]	☐	EAN
56H215	25	12,7	8	10/200	5902062070463
56H216	50	13	8	10/100	5902062070470

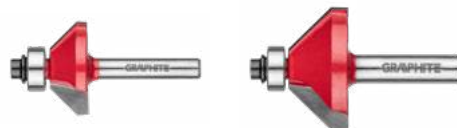
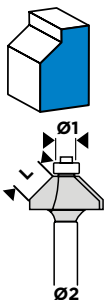

Ref.	L [mm]	Ø1 [mm]	Ø2 [mm]	☐	EAN
56H217	9,25	26,6	6	10/200	5902062070487
56H218	15,9	35,5	8	10/200	5902062070494

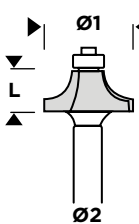
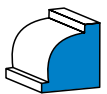

Ref.	L [mm]	Ø1 [mm]	Ø2 [mm]	☐	EAN
56H222	9	22,5	6	10/200	5902062070524
56H224	6,5	19	6	10/200	5902062070548
56H225	15,4	34,9	8	10/200	5902062070555
56H226	15,4	34,9	12	10/100	5902062070562
56H227	12,9	32	6	10/200	5902062070579
56H228	12,9	32	8	10/200	5902062070586
56H229	15,9	38,6	12	10/100	5902062070593

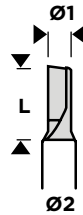
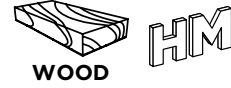
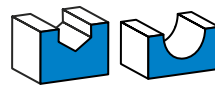

Ref.	L [mm]	Ø1 [mm]	Ø2 [mm]	☐	EAN
56H209	8	8	8	10/200	5902062070401
56H210	25,4	25,4	8	10/200	5902062070418
56H211	6	3,97	8	10/200	5902062070425
56H212	15,5	6,35	8	10/200	5902062070432
56H213	19,6	12,7	8	10/200	5902062070449
56H214	22,5	25,4	8	10/200	5902062070456

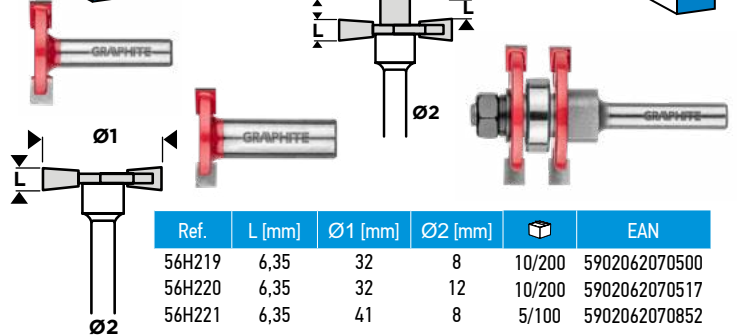

Ref.	L [mm]	Ø1 [mm]	Ø2 [mm]	☐	EAN
56H219	6,35	32	8	10/200	5902062070500
56H220	6,35	32	12	10/200	5902062070517
56H221	6,35	41	8	5/100	5902062070852

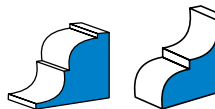

Ref.	L [mm]	Ø1 [mm]	Ø2 [mm]	☐	EAN
56H230	12,7	31,7	6	10/200	5902062070609
56H231	15,9	39,3	8	5/100	5902062070616
56H232	11,7	28,6	6	10/200	5902062070623
56H233	15	34,9	8	10/200	5902062070630
56H234	18,3	41,3	12	5/100	5902062070647
56H235	15,9	35,2	8	10/200	5902062070654
56H236	17,5	38,4	12	10/100	5902062070661
56H237	9,7	25,7	6	10/200	5902062070678
56H238	9,7	25,7	8	10/200	5902062070685
56H239	15,9	28,8	8	10/200	5902062070807

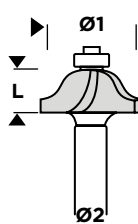

Frez do drewna

Counter - sink drill / Holzfräser / Фреза на дереу / Фреза на дереу / Fenékfúró vialás / Frezã p/u lemn / Frëza na dřevo / Vrták „sukovník“ tvrdokovový / Rezkala za les / Freza medžiui / Frëze kokam / Süvsedrell / Бурзла за омеру / Svrldo za rupe / Burgija za klap sarké / Фрëза çýлуу / Brocas fresadoras para madera / Fresa per legno / Fresa p. madeira / Fraise à bois / Houtfrees

ø8mm

HM



WOOD



PLYWOOD



x35

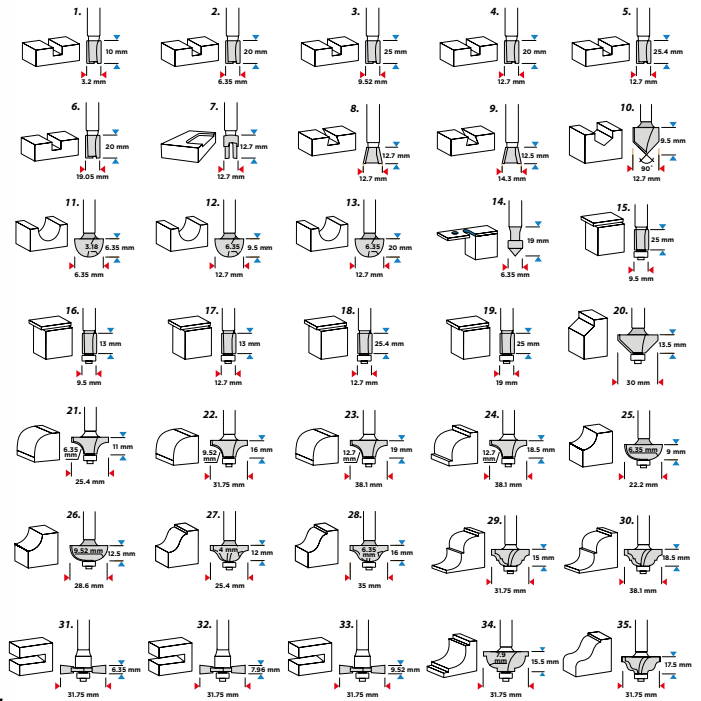

Ref.	Icon	EAN
56H240	1/5	5902062070869

Tarcza diamentowa

Diamond disc / Diamantscheibe / Диск алмазний / Диск алмазний / Gyémánt-vágótárcsa / Disc de diamant / Diamantový kotouč / Diamantový kotúč / Diamantna plošča / Deimantinis diskas / Dimanta griezējdisks / Teemantketas / Диск диамантен / Dijamantna rezna ploča / Dijamantski disk / Διαμαντένιοι δίσκοι κοπής / Disco de corte de diamante / Disco di diamante / Disco de diamante / Disque diamanté / Diamantschijf

230x25,4 mm

EN13236



dla / for / для
59G891



CERAMIC



DIAMOND CUT



WET CUT



Ref.	Icon	EAN
57H647	1/25	5902062098894

110x22,2 mm

EN13236



dla / for / для
58GE138

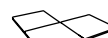

CERAMIC



DIAMOND CUT



WET CUT



Ref.	Icon	EAN
57H603	50/100	5902062107336



GRINDING



DIAMOND CUT

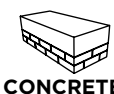

CONCRETE



STONE

Ref.	info	Ø [mm]	Icon	EAN
57H892	segment L	115	1/24	5902062082633
57H893	segment L	125	1/24	5902062082640
57H894	segment C	115	1/24	5902062082657
57H895	segment C	125	1/24	5902062082664
57H896	heavy duty	125	1/25	5902062082671

Otwornica

Hole saw / Lochsäge / Ножовка / Фреза / Körkivágó / Ferăstrău pentru găuri / Děrovka / Dierovacia píla / Luknjarica / Vianarankis pjūklas / Rokzāģis / Augusaag / Тесен трион / Kružna píla za rupe / Kružna testera za rupe / Придві / Sierra de corona / Segã a tazza / Serra para recorte / Scie à guichet / Gatenknipper

TCT



SDS PLUS

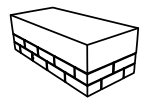

CONCRETE



IMPACT DRILLING



Ref.	Ø [mm]	Icon	EAN
55H321	65	0/24	5902062107305
55H322	80	0/24	5902062107312
55H323	85	0/24	5902062107329

Adapter do urządzenia wielofunkcyjnego

Multi-purpose adapter / Adapter für Multifunktionsgerät / Переходник для многофункционального устройства / Адаптер для багатифункціонального пристрою / Adapter univerzális berendezéshez / Adaptor pentru dispozitiv multifuncțional / Adaptér pro multifunkční zařízení / Adaptér pre multifunkčné zariadenie / Priključek za večnamensko napravo / Daugiafunkcio įrenginio adapteris / Adapteris daudzfunkcionālai iekārtai / Multifunktsionaalse seadme adapter / Adapter za višenamjenski uređaj / Adapter za višefunkcionalne uređaje / Προσαρμογέας πολυεργαλείων / Adaptador para el dispositivo multifunción / Adattatore per il dispositivo multifunzionale / Adaptador para o dispositivo multifunção / Adaptateur pour le dispositif multifonction / Adapter voor multifunctioneel apparaat

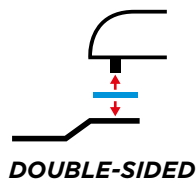

DOUBLE-SIDED



for
MULTIFUNCTION
TOOL

Ref.	Box	EAN
56H420	10/100	5902062071316

Nasadka uniwersalna

Versatile adapter / Universalaufsatz / Универсальная насадка / Універсальна насадка / Univerzális tartó / Atașament universal / Univerzální nástavec / Univerzálny nadstavec / Univerzalni nastavek / Universalus antgalis / Univerzála uztava / Universaalne otsak / Универсальна приставка / Univerzalni nastavak / Univerzalni nasadni ključ / Μύτη γενικής χρήσεως / Llave de vaso universal / Cappuccio universale / Acessório universal / Fixation universelle / Universeeel dop

1/4"-3/4"
7 mm - 19 mm



Ref.	Box	EAN
55H224	1/50	5902062082879

Ostrzałka do noży kosiarki

Mower blade grinder / Rasenmähermesserschärfer / Точилка для ножевой косилки / Точилка для ножиw косарок / Élező fűnyírókész / Mașina de ascuțit cuțite pentru tuns / Bruska na nože sekačky / Brúska požov na kosenie / Ostrilec za nože kosilnice / Žoljarjovės peilių galąstuvas / Pļāvēja nažu asinātājs / Niidukiterade teritaja / Точило за ножове на косачки / Brusilica za poževе kosilice / Oštrač poža kosilice / Ξύτρα για λεπίδες μηχανής κοπής / Affilatrice e bilanciatore / Afilador y balanceador / Afijador e balanceador / Aiguiseur et équilibreur / Slijper en balancerapparaat

GRINDING

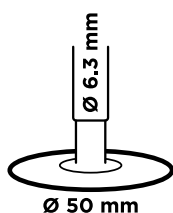

Ref.	Box	EAN
55H228	1/250	5902062082923

Fazownik

Beveler / Kegelsenker / Фаска / Фаска / Kúpos élettörő / Frezė de sanfrenare / Děrovka / Vyhľbovací fréza / Robilnik / Freza grioveliams / Fāzes uzgalis / Servaja / Уред за фаска / Glodaló za skošenje / Uređaj za zakošenje / Φρεζοτρύπανο / Biselador / Smussatore / Chanfrador / Outil de fraisage / Afschuinapparaat

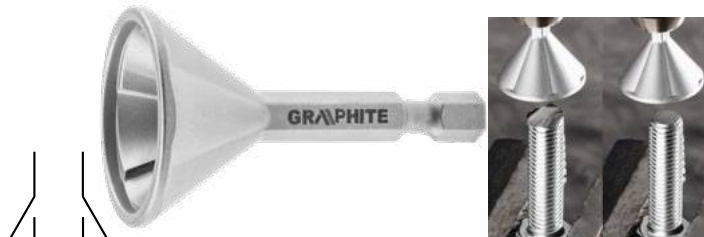
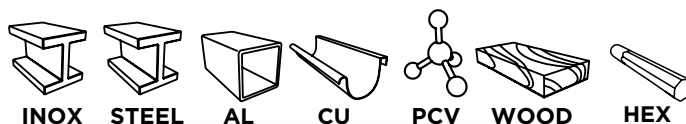

Ref.	Box	EAN
56H246	10/100	5902062075499

Pochłaniacz pyłu do wiertarki

Dust absorber for drill / Staubabsorber für Bohrmaschine / Пылепоглотитель для дрели / Пилопоглинач для дреля / Porelnyelő fűrógéphez / Absorbant de praf pentru burghiu / Pohlcovač prachu pro vrtačku / Pohlcovač prachu pre vrtačku / Absorber prahu za vrtalnik / Grežtuvo dulkių sugėriklis / Putekļu absorbētājs urbim / Pori tolmueemaldaja / Прахоуловител за бормашина / Уријач праšине за бушилицу / Унијач праšине за бушилицу / Απορροφητής σκόνης για τρυπάνι / Assorbitore di polvere per trapano / Absorbedor de polvo para taladro / Absorvedor de pó para berbequim / Absorbeur de poussière pour perceuse / Stofdemper voor boormachine

Ø 4 - 10 mm



Ref.	Box	EAN
55H223	0/160	5902062250834

Szablon do odwzorowania kształtów

Shape stencil / Vorlage zur Nachbildung von Formen / Шаблон для отображения форм / Шаблон для відображення форм / Sablon alakzatok / Šablon contour / Šablona pro zobrazení tvarů / Obrysová šablóna na prenášanie tvarov / Šablona za oblikovanje oblik / Formų atvaizdavimo šablonas / Šablons formu kartēšanai / Vormide kavandamise šabloon / Шаблон за kopiranje na formu / Ravnalo za kopiranje oblika / Šablon za projektovanje oblika / Εργαλείο σχεδίασης περιγράμματος / Medidor de contorno / Modello di mappatura della forma / Modelo para reproducir formas / Modèle de projection de formes / Een sjabloon om de vormen over te trekken

MATERIAL: ABS
MAXIMUM SHAPE: 250x30mm
SHAPE LOCK



Ref.	Box	EAN
55H226	20/40	5902062082893

Nakrętka szybko mocująca

Quick-action nut / Schnellspannende Mutter / Быстрозажимная гайка / Швидкозатиснена гайка / Gyorszáras anya / Piullitja cu acțiune rapidă / Rychloúpinací matice / Rýchloúpinacia matica / Hitro delujoča matica / Greito veikimo veržlė / Ātrās darbības uzgriežnis / Pikamutter / Гайка с бързо действие / Παξμίδι ταχείας δράσης / Brza matica / Наєртка са брзим дејством / Tuerca de acción rápida / Dado ad azione rapida / Porca de acção rápida / Écrou à action rapide

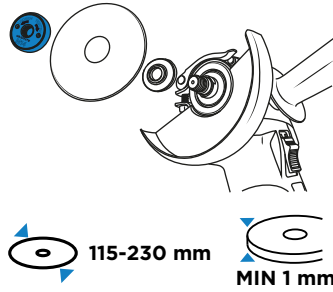

Ref.	Box	EAN
56H421	12/120	5902062107015

Bity udarowe

Impact bits / Schlagbits / Ударные биты / Ударні біти / Útési bitek / Biṭi de impact / Nárazové bity / Nárazové bity / Udarnih bitov / Smúgja bitai / Trieciena bitī / Löögibitsid / Ударни битове / Udarni bitovi / Udarni bitovi / Κομμάτια κρούσης / Bits de impacto / Bit di impatto / Bits de impacto / Bits d'impact / Slagstukken

NEO
TOOLS

S2 steel **50 mm** x**5**



Ref.	Info	Box	EAN
09-575	PH1	12/96	5907558450484
09-576	PH2	12/96	5907558450491
09-577	PH3	12/96	5907558450507
09-578	PZ1	12/96	5907558450514
09-579	PZ2	12/96	5907558450521
09-580	PZ3	12/96	5907558450538
09-584	T20	12/96	5907558450576
09-585	T25	12/96	5907558450583
09-587	T30	12/96	5907558450606
09-588	T40	12/96	5907558450613

Bity udarowe

Impact bits / Schlag-Bits / Ударные вставки / Бити ударні / Útvecsavarozó bitek / Bit de impact / Úderové bity / Nárazové bity / Udarni bitovi / Smúgjiniai antgaliai / Triecienuzgali / Löökmeislid / Ударни битове / Udarni bitovi / Udarni bitovi / Κρουστικές μύτες / Bits de impacto / Inserti a percussione / Pontas de percussão / Embouts à choc / Slagbits



Ref.	Info	L [mm]	Box	Box	EAN
56H544	TX15	25	20	10/100	5902062102362
56H545	TX20	25	20	10/100	5902062102386
56H546	TX25	25	20	10/100	5902062102393
56H547	TX30	25	20	10/100	5902062102409

Adapter

Adaptor / Adapter / Адаптер / Перехідник / Közdarab, adapter / Adaptor / Adaptér / Adaptér / Adapter / Jungtis / Adapteris / Adapter / Адаптер / Adapter / Adapter / Αντάπτορας / Adaptador / Adattatore / Adaptador / Adaptateur / Adapter



Ref.	L [mm]	Box	EAN
56H557	50	20/40	5902062102416



Ref.	L [mm]	Box	EAN
56H559	220	0/30	5902062011572

Przedłużka

Extension / Erweiterung / Расширение / Rozšíření / Hosszabbítás / Extensie / Prodloužení / Rozšírenie / Podajšiek / Pratešimas / Paplašinājums / Pikenudis / Удължение / Proširenje / Продужетак / Επέκταση / Extensión / Estensione / Extensão / Extension / Utbreiding



Ref.	L [mm]	Box	EAN
56H558	150	10/40	5902062102423

Końcówki wkrętkowe

Driver bits / Einsätze für Schraubendreher / Насадки / Наконечники викртові / Csavarhúzó bit / Set bit / Šroubovákové nástavce / Skrutkovacie nástavce / Nastavki za izvijače / Atskutvo antgaliai / Skrivgrieža uzgali / Kruvikeeraajatsakud / Накраїниці за отвєртка / Nastavci za odvijač / Nastavci za odvijač / Καταβιδόμυτες / Puntas destornilladoras / Punta giravite / Ponteiros Chave de fenda / Embouts de tournevis / Schroevendraaierendstukken



x100

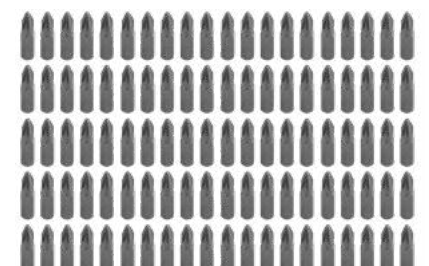

Ref.	Info	L [mm]	Box	Box	EAN
56H624	PZ2	25	100	1/20	5902062102430
56H626	PH2	25	100	1/20	5902062102447

Zestaw bitów specjalnych

Set of special bits / Ein Satz spezieller Bits / Набор специальных бит / Набор спеціальних біт / Speciális bithegy készlet / Set de biți speciali / Sada speciálních bitů / Súprava špeciálnych bitov / Komplet posebnih nastavkov / Specialių antgalių rinkinys / Speciālu uzgaļu komplekts / Eriotsstarbeliste tihvtide komplekt / Комплект специальных битовое / Set posebnih bitova / Σετ ειδικών μπιτών / Kit de puntas especiales / Set di punte di trivellazione speciali / Kit de bits especiaes / Kit de bits spéciaux / Set speciale bits

S2

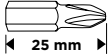
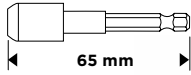

8/10/15/20/
25/27/30/40



2/2.5/3/4/5/6
5/64", 3/32", 7/64",
1/8", 9/64", 5/32"



1/2/3/4



6/8/10



4/6/8/10



x32

Ref.	Box	EAN
56H618	12/48	5902062082848

Końcówka wkrętakowa

Drive bit / Endstück für Schraubendreher / Отвёрточный наконечник / Наконечник викрутовий / Csavarhúzó betét / Capăt de șurubelniță / Šroubovákový nástavec / Skrutkovací nástavec / Vijačni nastavak / Atsuktuvo antgalis / Skrūvgriežu uzgalis / Kruvikeerajaotsak / Накрайник за отвёртка / Nastavak za izvijač / Kraj za odvijanje / Μύτη καταβίδιού / Punta tornilladora / Inserto per avvitare / Ponteiro chave de fenda / Embout à tournevis / Schroevendraaiereindstuk

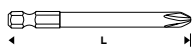

S2 HEX
1/4"

Ref.	info	L [mm]	Box	EAN
56H570	PZ1	150	60/240	5902062082732
56H571	PZ1	300	30/120	5902062082749
56H572	PZ2	150	60/240	5902062082756
56H573	PZ2	300	30/120	5902062082763
56H574	PZ3	150	60/240	5902062082770
56H575	PH1	150	60/240	5902062082787
56H576	PH1	300	30/120	5902062082794
56H577	PH2	150	60/240	5902062082800
56H578	PH2	300	30/120	5902062082817
56H579	PH3	150	60/240	5902062082824
56H580	PH3	300	30/120	5902062082831

Zestaw wiertel diamentowych

Diamond tipped drill bit set / Diamantbohrer-Set / Комплект алмазных сверл / Набор алмазных свердел / Gyémántfúró-készlet / Set de burghie diamantate / Sada diamantových vrtáků / Sada diamantových vrtákov / Komplet diamantnih svetrov / Deimantinių gražtų rinkinys / Dimanta urbuju kompleks / Teemantpuuride komplekt / Комплект диамантени свердена / Set dijamantnih svrta / Komplet dijamantskih burjija / Σετ τρυπανιών διαμαντιού / Conjunto para brocas de diamante / Set punte di diamante / Conjunto de brocas de diamante / Kit de forets à diamant / Diamantboorkit

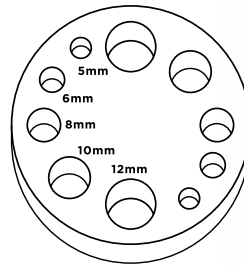

x6

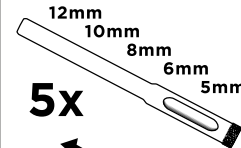

QUICK ACTION

GRESS

DIAMOND DRILLS



WET USE

Ref.	Box	EAN
55H541	5/20	5902062075451

Zestaw do wiercenia i fazowania

Drilling and bevelling drill / Bohr- und Anfasungsset / Набор для сверления и кантования / Набор для сверління і кантування / Készlet fúráshoz és élettöréshöz / Set de găurire și șanțrenare / Sada pro vrtání a srážení / Sada na vrtanie a fazovanie / Komplet za vrtnanje in robljenje / Gražtų ir frezų rinkinys / Urbsanas un fāzēšanas komplekts / Puurimis- ja servamiskomplekt / Комплект за пробиване и фаску / Set za bušenje i skošenje / Set za bušenje i zakošenje / Σετ διάτρησης και φρεζαρίσματος / Conjunto para taladrar y biselar / Set foratura e smussatura / Kit de perforar e chanfrar / Kit de forage et fraisage / Boor- en afschuinkit

HSS

STEEL

WOOD

PLYWOOD PCV



Step drill bit: 4-12 / 3-12 mm
Umbrella drill 8-20 mm
Saw drill 4 / 5 / 6 mm
Counter sink drill: 12.4 mm

x7

Ref.	Box	EAN
56H245	10/50	5902062075482



Wiertło uniwersalne

Universal drill bit / Universalbohrer / Универсальное сверло / Універсальне сверло / Univerzální vrták / Burghiu universal / Univerzální vrták / Univerzalen sveder / Universalus gražtas / Universāls urbis / Universaalne puur / Универсально сверло / Univerzalno svrdlo / Univerzalna burgija / Trundāvi universal / Broca universal / Punta da trapano universale / Broca universal / Foret à usage universel / Universele boor



Ref.	Ø [mm]	L [mm]	Box	EAN
56H400	3	64	50/500	5902062071392
56H401	4	64	50/500	5902062071408
56H402	5	64	50/500	5902062071415
56H403	6	64	50/500	5902062071422
56H404	7	64	50/500	5902062071439
56H405	8	76	50/400	5902062071446
56H406	10	76	50/400	5902062071453
56H407	12	90	50/400	5902062071460

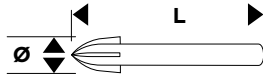

Ostrzałka do wiertel

Grinder / Schärfer / Тоцилка / Тоцилка / Éléző / Dispozitiv de ascuțit / Bruska / Brúška / Ostrilec / Galgštuvus / Asinātājs / Teritaja / Тоцило / Brusilica / Оштрач / Ξύστρα / Afilador / Affilatrice / Afidador / Fusil à aiguiser / Puntenslijper



fit for
Ø 2 mm - 12.5 mm

Ref.	Box	EAN
55H229	1/100	5902062082930

Szablon do montażu zawiasów meblowych

Furniture hinge installation template / Montage-Schablone für Möbelscharniere / Шаблон для монтажа мебельных петель / Шаблон для монтажу меблевих петель / Šablon bítorzanérok felszereléséhez / Šablon pentru montarea balamalelor de mobilier / Šablona pro montáž nábytkových pantů / Šablóna na montáž nábytkových pántov / Predlaga za montažo pohištenih tečajev / Šablonas baldų vyriams tvirtinti / Šablons mēbeļu eņģu montāžai / Mööblhingede paigaldamise šabloon / Шаблон за монтирање на мебелни пантви / Šablon za montažu baglata za nameštaj / Šablon za montažu baglata za nameštaj / Πρότυπο συναρμολόγησης μεντεσέδων επίπλων / Patrón para el montaje de bisagras de muebles / Sagoma per il montaggio di cerniere dei mobili / Gabarito para montagem de dobradiças de móveis / Gabarit pour le montage des charnières de meubles / Šabloon voor de montage van meubel scharnieren

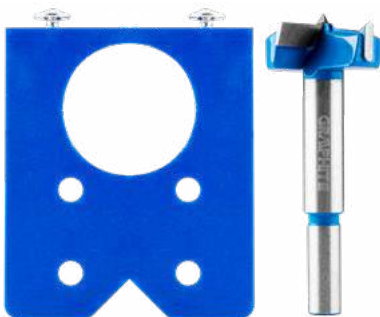

Ø 35 mm



Ref.	Box	EAN
57H002	10/60	5902062082886

Prowadnica do wiertel

Drill bit guide sleeve / Bohrerführung / Направляющая для сверления / Направляюча для свердел / Fúróvezető / Ghidaj pentru burghie / Vodič na vrtáky / Vodiaci prvok na vrtanie / Vodilo za svedre / Gražtų kreipiklis / Urbja vadotne / Puuride juhik / Водяч за саредна / Šablona za bušenje / Vodica za burgije / Οδηγός διάτρησης / Guía de taladro / Guida per trapano / Guia para brocas / Guide pour forets / Boorgids

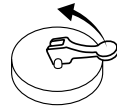
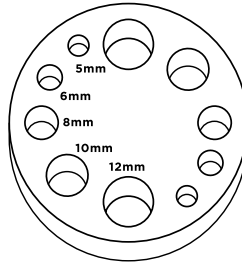

QUICK ACTION

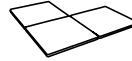

GRESS



DIAMOND DRILLS



WET USE

Ref.	Box	EAN
55H542	3/30	5902062075444

Zestaw do połączeń niewidocznych

Undercover jig set / Unsichtbare Verbindungen-Set / Комплект для невидимых соединений / Комплект для невидимих з'єднань / Készlet rejtett kötésekhöz / Set pentru conexiuni invizibile / Sada pro neviditelné spoje / Sada na neviditelné spoje / Komplet za nevidne priključke / Nematomu jungčių rinkinys / Kompleks neredziamiem savienojumiem / Nähtamatute ühenduste komplekt / Комплект за невидими връзки / Set za nevidljive spojeve / Komplet za nevidljive spojeve / Οδηγός κρυφών ενώσεων / Conjunto para ensambles invisibles / Set per giunzioni invisibili / Conjunto para conexões invisíveis / Kit raccordements invisibles / Kit voor onzichtbare verbindingen



WOOD



x76

Ref.	Box	EAN
55H250	1/10	5902062082855

Przedłużka elastyczna

Flexible bit holder / Flex. Verlängerung / Удлинитель гибкий / Подовжувач гнучкий / Toldósárzár flexibilis / Prelungtor flexibil / Pružný prodlužovák / Predĺženie flexi / Gibki podaljšek / Lankstus ilgiklis / Pagarinātājs elastīgs / Paindlīk pikendusvarb / Удължител / Fleksibilni držač bitova / Produžena poluga / Εύκαμπτη προέκταση / Alargadera flexible / Prolunga flessibile / Extensão elástica / Prolongation flexible / Flexibel verlengstuk



HEX 6.35 mm

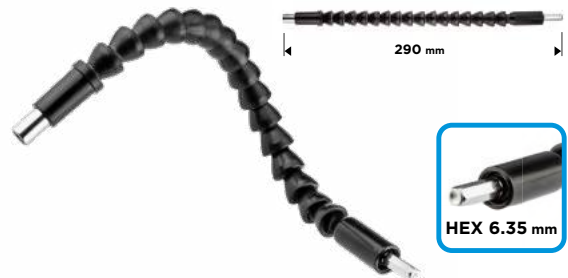

HEX 6.35 mm

Ref.	Box	EAN
55H227	1/100	5902062082916

Podkładki filcowe

Adhesive felt pad set / Filzunterlagen / Подкладки фетровые / Підкладки повстинні / Bútorcsúsztató filc készlet / Set fetru / Plstěné podložky / Filcové podložky / Podložke iz filca / Minkštvū veltīniū tarpikliū komplektas / Filca palīkri / Nakkuv vildīpolstri komplekt / Самозалепаца филц / Filc samolepljiv / Filc samolepljiv / Συλλογή ντουκόχαρτων / Almohadillas de fieltro protectoras de suelo, adhesivas / Rondelle di feltro / Calços de feltro / Rondelles à feutre / Vilt onderlagen

T TOPEX

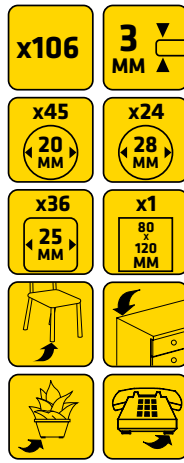
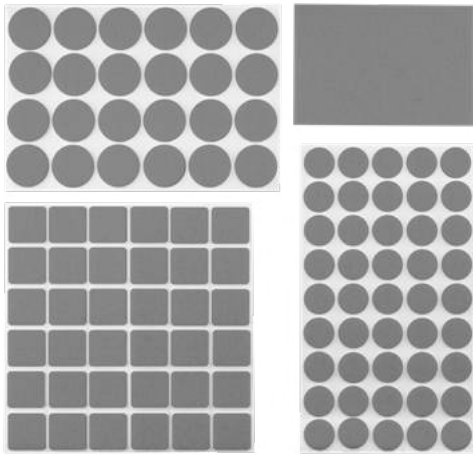

Ref.	Icon	EAN
98Z148	12/96	5902062107275

T TOPEX

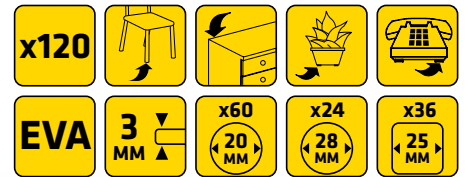
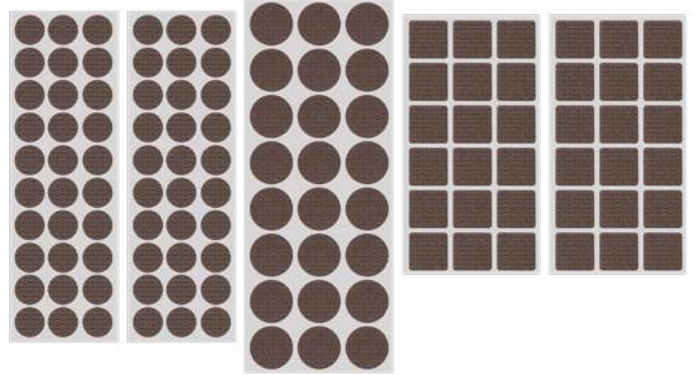

Ref.	Icon	EAN
98Z149	24/96	5902062107282

T TOPEX

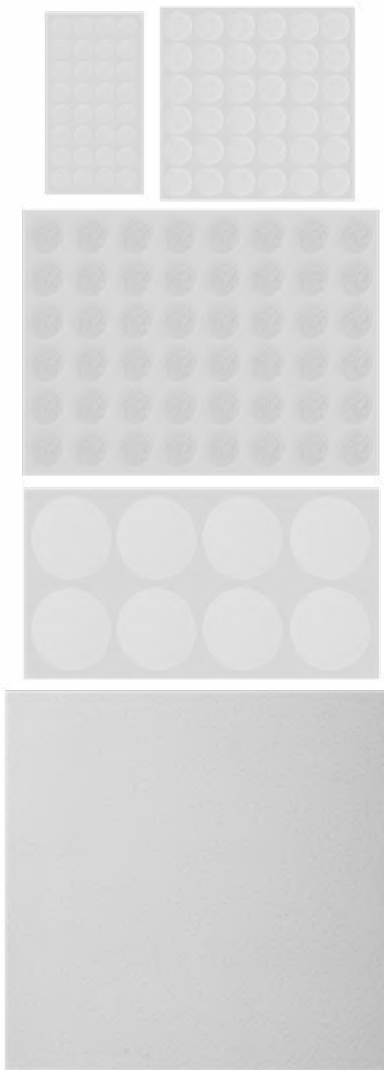

Ref.	Icon	EAN
98Z150	24/72	5902062107299

T TOPEX

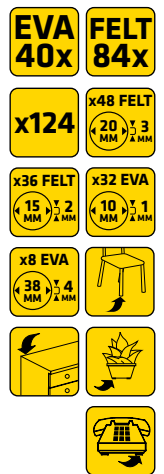
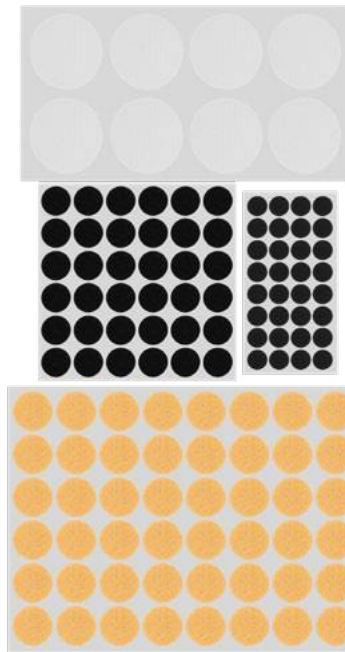

Ref.	Icon	EAN
98Z151	24/144	5902062028334

Suwmiarka

Vernier caliper / Messschieber / Штангенциркуль / Штангенциркуль / Tolómérő / Suport / Posuvné měřítko / Meradlo posuvné / Pomocno merilo / Slankmatis / Bidmērs / Mōdētēsirkel / Шублер / Pomocno mjerilo / Pomocno merilo / Αναλογικό παχύμετρο / Calibre / Calibra a cursore / Calibrador de correção / Pied à coulisse / Schuifmaat



0 ÷ 150 MM
MM / INCH



Ref.	Icon	EAN
31C621-1	25/100	5902062202444

Ref	p.	Ref	p.	Ref	p.	Ref	p.	Ref	p.	Ref	p.	Ref	p.
01-310-1	18	04-231	15	09-579	103	15-995	35	49-933	35	54T704	94	56H219	100
01-312	17	04-602	71	09-580	103	15G010-1	61	49-934	35	54T705	94	56H220	100
01-313	17	04-603	70	09-584	103	15G011-1	61	49-941	35	54T706	94	56H221	100
01-543	16	04-608	69	09-585	103	15G012-1	61	49-942	35	54T707	94	56H222	100
01-544	14	04-610	78	09-587	103	15G018	61	49-943	35	54T708	94	56H224	100
01-545	14	04-611	78	09-588	103	15G019	61	49-944	35	54T709	94	56H225	100
01-546	14	04-612	69	10-019	13	15G020	61	49-945	35	54T710	94	56H226	100
01-547	14	04-613	70	10-475	25	15G021	61	49-946	35	54T711	94	56H227	100
01-548	14	04-616	68	10-478	22	15G026	61	49-947	35	54T712	94	56H228	100
01-549	14	04-617	79	10-485	25	15G027	61	49-948	35	54T713	94	56H229	100
01-552	14	04-618	70	10-599	23	15G039	62	50-361	35	54T714	94	56H230	100
01-553	14	04-619	68	10-600	23	15G056	62	50-430	34	54T715	94	56H231	100
01-615	26	04-620	75	10-700	19	15G057	62	50-900	33	54T716	94	56H232	100
01-620	26	04-621	78	10-701	19	15G058	62	54H001	97	54T717	94	56H233	100
01-621	26	04-621-30	78	10-800	20	15G061	62	54H002	97	54T718	94	56H234	100
01-622	26	04-700	82	10-801	20	15G062	62	54H003	97	54T719	94	56H235	100
01-623	26	04-701	82	10-802	21	15G063	62	54H004	97	54T720	94	56H236	100
01-624	26	04-705	90	10-803	21	15G071	65	54H005	97	54T721	94	56H237	100
01-625	26	04-710	85	10-804	21	15G072	65	54H006	97	54T980	94	56H238	100
01-626	26	04-715	82	10-805	21	15G081	62	54H007	97	54T981	94	56H239	100
01-627	26	04-716	82	10-806	21	15G085	62	54H008	97	54T982	94	56H240	101
01-628	26	04-719	85	10-807	21	15G086	62	54H009	97	54T983	94	56H245	104
01-629	26	04-720	85	10-808	20	15G087	62	54H010	97	54T984	94	56H246	102
01-630	26	04-721	83	10-809	20	15G208	66	54H011	97	54T985	94	56H400	105
01-631	26	04-730	87	10-810	21	15G411	63	54H012	97	54T986	94	56H401	105
01-632	26	04-731	87	10-811	21	15G412	63	54H013	97	54T987	94	56H402	105
01-633	26	04-732	87	10-815	22	15G413	63	54H014	97	54T988	94	56H403	105
01-634	26	04-735	86	10-860	25	15G414	63	54H015	97	54T989	94	56H404	105
01-635	26	04-736	86	11-136	23	15G415	63	54H016	97	54T990	94	56H405	105
01-636	26	04-738	89	11-136-150	23	15G416	63	54H017	97	54T991	94	56H406	105
01-637	26	04-738-20	89	11-501	19	15G417	63	54H018	97	54T992	94	56H407	105
01-638	26	04-738-145	89	11-502	19	15G419	63	54H019	97	54T993	94	56H420	102
01-639	26	04-738-146	89	11-503	19	15G425	64	54H020	97	54T994	94	56H421	103
01-640	26	04-738-147	89	11-551	20	15G426	64	54H021	97	54T995	94	56H544	103
01-641	26	04-738-151	89	11-552	20	15G441	65	54H022	98	54T996	94	56H545	103
01-642	26	04-739	89	11-553	20	15G459	65	54H023	98	54T997	94	56H546	103
01-643	26	04-739-30	89	11-555-1	20	15G460	64	54H024	98	54T998	94	56H547	103
01-644	26	04-739-145	89	11-565	22	15G463	64	54H025	98	55H100	97	56H557	103
01-645	26	04-739-146	89	11-601-1	23	15G464	64	54H026	98	55H101	97	56H558	103
01-646	26	06-074	15	11-617	24	15G465	64	54H027	98	55H102	97	56H559	103
01-647	26	07-100	93	11-733	22	15G466	64	54H028	98	55H103	97	56H570	104
01-648	26	07-101	93	11-737	22	15G467	64	54H029	98	55H223	102	56H571	104
01-649	26	07-102	93	11-891-1	24	15G471	65	54H030	98	55H224	102	56H572	104
01-650	26	07-103	93	11-892-1	24	15G539	65	54H031	98	55H226	102	56H573	104
01-651	26	08-095	23	11-893-1	24	15G545	65	54H032	98	55H227	105	56H574	104
01-652	26	08-720	99	12-070-1	19	15G546	65	54H033	98	55H228	102	56H575	104
01-653	26	08-721	99	12-071-1	19	15G681	66	54H034	98	55H229	105	56H576	104
01-654	26	08-722	99	12-072-1	19	15G682	66	54H035	98	55H250	105	56H577	104
01-655	26	08-978	24	12-074-1	19	15G685	66	54H036	98	55H321	101	56H578	104
01-656	26	08-979	24	12-075-1	19	15G698	66	54H037	98	55H322	101	56H579	104
01-657	26	08-980	24	12-076-1	19	15G699	66	54H038	98	55H323	101	56H580	104
01-658	26	08-981	24	13-823	29	15G714	67	54H039	98	55H541	104	56H618	104
01-659	26	08-982	24	13-850	34	15G716	67	54H040	99	55H542	105	56H624	103
01-660	26	08-990	96	13-851	34	15G717	67	54H041	99	55H577	99	56H626	103
01-661	26	08-991	96	13-852	34	15G718	67	54H042	99	55H578	99	56H780	95
01-662	26	08-992	96	13-853	34	16-050	32	54H043	99	55H579	99	56H781	95
01-663	26	08-993	96	13-855	34	18-101-1	32	54T500	94	56-041	31	57H002	105
01-664	26	08-994	96	13-856	34	18-102-1	32	54T501	94	56H200	100	57H547	95
01-665	26	08-995	96	13-857	34	18-103-1	32	54T502	94	56H201	100	57H548	95
01-666	26	08-996	96	13-858	34	18-106-1	32	54T503	94	56H202	100	57H549	95
01-667	26	09-255	16	13-860	34	19-155	32	54T504	94	56H203	100	57H550	95
01-668	26	09-256	16	13-865	34	19-156	32	54T505	94	56H204	100	57H551	95
01-669	26	09-257	16	14-017-400	99	19-157	32	54T506	94	56H205	100	57H552	95
01-670	26	09-258	16	14-034-401	93	19-158	33	54T507	94	56H206	100	57H553	95
01-671	26	09-259	16	14-800-1	19	19-159	33	54T508	94	56H207	100	57H554	95
01-672	26	09-260	16	14-802-1	19	19-250	32	54T509	94	56H208	100	57H555	95
02-002	16	09-261	16	14-804-1	19	20-060	39	54T510	94	56H209	100	57H573	95
02-446	16	09-262	16	14-806-1	19	31C621-1	106	54T511	94	56H210	100	57H574	95
02-447	16	09-263	16	14-808-1	19	33-090	31	54T512	94	56H211	100	57H575	95
04-074	15	09-264	16	15-903	60	39-220	31	54T513	94	56H212	100	57H603	101
04-075	15	09-265	16	15-912	60	44-650	33	54T514	94	56H213	100	57H647	101
04-144	15	09-266	16	15-990	35	44-700	12	54T515	94	56H214	100	57H683	96
04-215	15	09-575	103	15-991	35	45-492	29	54T700	94	56H215	100	57H688	97
04-218	16	09-576	103	15-992	35	49-800	35	54T701	94	56H216	100	57H858	96
04-219	16	09-577	103	15-993	35	49-801	35	54T702	94	56H217	100	57H859	96
04-224	15	09-578	103	15-994	35	49-932	35	54T703	94	56H218	100	57H861	96

Ref	p.	Ref	p.	Ref	p.	Ref	p.	Ref	p.	Ref	p.	Ref	p.
57H862	96	59G329	84	71-133	28	81-283-M	45	81-504-XL	43	81-644-S	46	82-162-39	48
57H863	96	59G336	84	71-134	28	81-283-S	45	81-504-XXL	43	81-644-XL	46	82-162-40	48
57H864	96	59G348	83	71-135	28	81-283-XL	45	81-504-XXXL	43	81-644-XXXL	46	82-162-41	48
57H867	96	59G349	83	71-136	28	81-283-XXL	45	81-507-L	43	81-644-XXXL	46	82-162-42	48
57H892	101	59G474	92	71-137	28	81-283-XXXL	45	81-507-M	43	81-645-L	46	82-162-43	48
57H893	101	59G475	92	71-220	28	81-285-L	41	81-507-S	43	81-645-M	46	82-162-44	48
57H894	101	59G523	85	72-225	29	81-285-M	41	81-507-XL	43	81-645-S	46	82-162-45	48
57H895	101	59G526	85	72-552	29	81-285-S	41	81-507-XXL	43	81-645-XL	46	82-162-46	48
57H896	101	59G611	88	75-020	29	81-285-XL	41	81-507-XXXL	43	81-645-XXL	46	82-162-47	48
57H897	96	59G611-145	88	75-021	29	81-285-XS	41	81-509-L	42	81-645-XXXL	46	82-163-39	48
57H898	96	59G718	83	75-022	29	81-285-XXL	41	81-509-M	42	81-646-L	46	82-163-40	48
57H899	96	59G823	88	75-023	29	81-285-XXXL	41	81-509-S	42	81-646-M	46	82-163-41	48
58G004-1	79	59G888	88	75-140	27	81-286-L	42	81-509-XL	42	81-646-S	46	82-163-42	48
58G008-BC	73	59G891	88	75-141	27	81-286-M	42	81-509-XXL	42	81-646-XL	46	82-163-43	48
58G012-S15	69	59G892	88	75-207	27	81-286-S	42	81-509-XXXL	42	81-646-XXL	46	82-163-44	48
58G028-1	70	63-018	30	75-208	27	81-286-XL	42	81-513-L	44	81-646-XXXL	46	82-163-45	48
58G038	70	63-019	31	81-212-L	43	81-286-XS	42	81-513-M	44	81-650-L	44	82-163-46	48
58G078	83	63-023	31	81-212-M	43	81-286-XXL	42	81-513-S	44	81-650-M	44	82-163-47	48
58G084	72	63-156	39	81-212-S	43	81-286-XXXL	42	81-513-XL	44	81-650-S	44	82-167-39	49
58G090	79	63-157	38	81-212-XL	43	81-290-L	40	81-513-XXL	44	81-650-XL	44	82-167-40	49
58G095-20	93	63-158	39	81-212-XXL	43	81-290-M	40	81-513-XXXL	44	81-650-XXL	44	82-167-41	49
58G098-20	93	63-159	38	81-212-XXXL	43	81-290-S	40	81-514-L	44	81-650-XXXL	44	82-167-42	49
58G098-30	93	63-160	36	81-214-L	43	81-290-XL	40	81-514-M	44	81-651-L	44	82-167-43	49
58G537	80	63-161	36	81-214-M	43	81-290-XS	40	81-514-S	44	81-651-M	44	82-167-44	49
58G538	80	63-162	36	81-214-S	43	81-290-XXL	40	81-514-XL	44	81-651-S	44	82-167-45	49
58G539	80	63-163	36	81-214-XL	43	81-290-XXXL	40	81-514-XXL	44	81-651-XL	44	82-167-46	49
58G540	81	63-164	36	81-214-XXL	43	81-291-L	41	81-514-XXXL	44	81-651-XXL	44	82-167-47	49
58G793	80	63-165	38	81-214-XXXL	43	81-291-M	41	81-515-L	42	81-651-XXXL	44	82-168-39	49
58G794	80	63-166	38	81-232-L	40	81-291-S	41	81-515-M	42	81-656-L	46	82-168-40	49
58G860	81	63-167	37	81-232-M	40	81-291-XL	41	81-515-S	42	81-656-M	46	82-168-41	49
58G877	81	63-168	37	81-232-S	40	81-291-XS	41	81-515-XL	42	81-656-S	46	82-168-42	49
58G904	87	63-169	36	81-232-XL	40	81-291-XXL	41	81-515-XXL	42	81-656-XL	46	82-168-43	49
58G953	90	63-170	36	81-232-XS	40	81-291-XXXL	41	81-515-XXXL	42	81-656-XXL	46	82-168-44	49
58G954	90	63-171	36	81-232-XXL	40	81-232-L	41	81-516-L	42	81-656-XXXL	46	82-168-45	49
58G961	83	63-172	37	81-232-XXXL	40	81-292-M	41	81-516-M	42	81-679-L	45	82-168-46	49
58GE103	74	63-173	37	81-234-L	40	81-292-S	41	81-516-S	42	81-679-M	45	82-168-47	49
58GE104	76	63-174	37	81-234-M	40	81-292-XL	41	81-516-XL	42	81-679-XL	45	82-180-39	47
58GE105	75	63-175	38	81-234-S	40	81-292-XS	41	81-516-XXL	42	81-679-XXL	45	82-180-40	47
58GE106	73	63-176	37	81-234-XL	40	81-292-XXL	41	81-516-XXXL	42	81-850-M	47	82-180-41	47
58GE106-24	73	63-177	38	81-234-XS	40	81-292-XXXL	41	81-517-L	42	81-850-XL	47	82-180-42	47
58GE107	74	63-178	38	81-234-XXL	40	81-293-L	41	81-517-M	42	81-850-XXXL	47	82-180-43	47
58GE109	79	63-180	37	81-234-XXXL	40	81-293-M	41	81-517-S	42	81-851-M	47	82-180-44	47
58GE111	68	63-703	30	81-249-L	40	81-293-S	41	81-517-XL	42	81-851-XL	47	82-180-45	47
58GE112-18	78	63-704	30	81-249-M	40	81-293-XL	41	81-517-XXL	42	81-851-XXXL	47	82-180-46	47
58GE113	75	63-705	30	81-249-S	40	81-293-XS	41	81-517-XXXL	42	81-890	47	82-180-47	47
58GE114	73	63-706	30	81-249-XL	40	81-293-XXL	41	81-545-L	45	81-891	47	82-181-39	47
58GE115	73	63-707	30	81-249-XS	40	81-293-XXXL	41	81-545-M	45	82-089-39	49	82-181-40	47
58GE116	77	63-708	30	81-249-XXL	40	81-294-L	41	81-545-S	45	82-089-40	49	82-181-41	47
58GE118	77	64-003	31	81-249-XXXL	40	81-294-M	41	81-545-XL	45	82-089-41	49	82-181-42	47
58GE119	77	64-004	31	81-252-L	40	81-294-S	41	81-545-XXL	45	82-089-42	49	82-181-43	47
58GE121	72	64-005	31	81-252-M	40	81-294-XL	41	81-545-XXXL	45	82-089-43	49	82-181-44	47
58GE124	76	64-016	30	81-252-S	40	81-294-XS	41	81-546-L	45	82-089-44	49	82-181-45	47
58GE124-145	90	67-111-1	28	81-252-XL	40	81-294-XXL	41	81-546-M	45	82-089-45	49	82-181-46	47
58GE125	75	67-112-1	28	81-252-XS	40	81-294-XXXL	41	81-546-S	45	82-089-46	49	82-181-47	47
58GE128	76	67-113-1	28	81-252-XXL	40	81-297-L	41	81-546-XL	45	82-089-47	49	82-315	50
58GE129	72	67-115-1	28	81-252-XXXL	40	81-297-M	41	81-546-XXL	45	82-138-41	49	82-316	50
58GE130	71	67-200	28	81-277-L	40	81-297-S	41	81-546-XXXL	45	82-138-42	49	82-325	50
58GE133	76	67-221	28	81-277-M	40	81-297-XL	41	81-579-L	42	82-138-43	49	82-326	50
58GE133-145	90	67-222	28	81-277-S	40	81-297-XS	41	81-579-M	42	82-138-44	49	82-327	50
58GE135	71	67-223	28	81-277-XL	40	81-297-XXL	41	81-579-S	42	82-138-45	49	82-328	50
58GE135-30	71	67-224	28	81-277-XS	40	81-297-XXXL	41	81-579-XL	42	82-138-46	49	82-329	50
58GE136	72	67-225	28	81-277-XXL	40	81-502-L	43	81-579-XXL	42	82-139-41	49	82-390	50
58GE137	72	67-231	28	81-277-XXXL	40	81-502-M	43	81-579-XXXL	42	82-139-42	49	82-391	50
58GE138	74	67-232	28	81-280-L	45	81-502-S	43	81-609-L	46	82-139-43	49	82-392	50
58GE139	68	67-233	28	81-280-M	45	81-502-XL	43	81-609-M	46	82-139-44	49	82-393	50
58GE140	74	67-234	28	81-280-S	45	81-502-XXL	43	81-609-S	46	82-139-45	49	82-741-39	48
58GE141	73	67-235	28	81-280-XL	45	81-502-XXXL	43	81-609-XL	46	82-139-46	49	82-741-40	48
58GE142	71	67-241	28	81-280-XXL	45	81-503-L	43	81-609-XXL	46	82-161-39	48	82-741-41	48
58GE152	79	67-242	28	81-280-XXXL	45	81-503-M	43	81-609-XXXL	46	82-161-40	48	82-741-42	48
59G023	81	67-243	28	81-282-L	45	81-503-S	43	81-635	51	82-161-41	48	82-741-43	48
59G025	81	67-244	28	81-282-M	45	81-503-XL	43	81-636	51	82-161-42	48	82-741-44	48
59G263	91	67-245	28	81-282-S	45	81-503-XXL	43	81-637	51	82-161-43	48	82-741-45	48
59G264	91	71-002	28	81-282-XL	45	81-503-XXXL	43	81-638	46	82-161-44	48	82-741-46	48
59G265	91	71-003	29	81-282-XXL	45	81-504-L	43	81-639	46	82-161-45	48	82-741-47	48
59G322	84	71-131	28	81-282-XXXL	45	81-504-M	43	81-644-L	46	82-161-46	48	82-751-39	49
59G326	84	71-132	28	81-283-L	45	81-504-S	43	81-644-M	46	82-161-47	48	82-751-40	49

Ref	p.	Ref	p.	Ref	p.	Ref	p.
82-751-41	49	90-153	57	97-608-8	39	98Z148	106
82-751-42	49	90-154	57	97-608-9	39	98Z149	106
82-751-43	49	90-155	57	97-608-10	39	98Z150	106
82-751-44	49	90-170	56	97-614-8	52	98Z151	106
82-751-45	49	90-171	56	97-614-9	52	99-097	54
82-751-46	49	90-172	56	97-614-10	52	99-098	55
82-751-47	49	90-173	56	97-614-11	52	99-099	55
82-902-39	50	90-174	56	97-621-11	51	99-102	54
82-902-40	50	90-175	56	97-622-8	52	99-106	56
82-902-41	50	90-176	56	97-622-9	52	99-107	54
82-902-42	50	90-177	56	97-622-10	52	99-108	55
82-902-43	50	90-178	56	97-622-11	52	99-109	56
82-902-44	50	90-179	56	97-641-11	51	99-111	56
82-902-45	50	90-180	56	97-641-11	52	99-112	54
82-902-46	50	90-181	56	97-643-11	51	99-113	56
84-214-6	11	90-182	56	97-645-7	52	99-114	55
84-221-9	10	90-183	56	97-645-8	52	99-115	54
84-222-9	10	90-184	56	97-645-9	52	99-118	55
84-222-12	10	90-185	56	97-645-10	52	GD029	25
84-254	11	94-005	18	97-645-11	52	GD030	50
84-264	11	94-006	18	97-646-7	52	GD031	50
84-318	12	94-007	18	97-646-8	52	GD032	50
84-319	12	94-008	18	97-646-9	52	GD033	50
84-327	39	95-004	60	97-646-10	52	GD035	50
84-328	39	95-007-1	60	97-646-11	52	GD041	59
84-329	12	95-008-1	60	97-647-7	52	GD042	59
84-406	33	95-040	60	97-647-8	52		
90-086	57	95-041	60	97-647-9	52		
90-110	57	95-042	60	97-647-10	52		
90-111	58	95-043	60	97-647-11	52		
90-112	58	95-044	60	97-655-11	52		
90-113	58	95-045	60	97-656-11	52		
90-114	58	97-209	51	97-670	53		
90-116	57	97-390	53	97-672	53		
90-117	57	97-520	53	97-673	53		
90-118	58	97-521	53	97H123	61		
90-119	58	97-522	53	97H139	61		
90-151	57	97-591	51	97H200	67		
90-152	57	97-592	51	97H201	67		



