



Candil
iluminación

CATÁLOGO DE PRODUCTOS



LÍNEA PROFESIONAL Y DECORATIVA

2025



Quiénes Somos

En **Candil Iluminación** llevamos una vida marcando la diferencia en el mundo de la iluminación. Somos una empresa familiar con más de 60 años de trayectoria en el mercado argentino, construida sobre valores sólidos como la seriedad, el compromiso y la cercanía con nuestros clientes. Desde hace más de tres décadas, nos dedicamos a la importación y distribución mayorista de productos de iluminación, lámparas y accesorios eléctricos, brindando soluciones confiables para todo tipo de proyectos.

Nos especializamos en ofrecer productos innovadores, eficientes y de alta calidad, desarrollados con un enfoque práctico que garantiza una instalación segura, prolija y duradera. Cada artículo de nuestro catálogo está pensado en detalle para responder a las exigencias del usuario final y del profesional que lo instala.

Colaboramos estrechamente con prestigiosos estudios de ingeniería y diseño, lo que nos permite interpretar con precisión las tendencias del mercado y las necesidades concretas de nuestros clientes. Gracias a esta sinergia, desarrollamos soluciones a medida que combinan excelente rendimiento, diseño funcional y costos competitivos, logrando así una propuesta de valor diferencial.

En cada producto que ofrecemos hay una historia: la de una empresa que ha crecido de la mano de sus clientes, adaptándose a los cambios del mercado sin perder su esencia. Nos destacamos por abordar a nuestros clientes desde el lado humano, estableciendo relaciones duraderas basadas en la confianza, el respeto y una atención cercana que va más allá de la transacción comercial. Para nosotros, cada cliente es un vínculo que cuidamos y valoramos.

Respaldados por décadas de experiencia, un equipo comprometido y una mirada puesta en el futuro, en **Candil Iluminación** nos posicionamos como un socio estratégico en iluminación para proyectos residenciales, comerciales e industriales.

Por qué elegirnos

- Calidad garantizada en todos nuestros productos.
- Stock permanente y variedad para cada necesidad.
- Atención personalizada y asesoramiento especializado.

Lo invitamos a recorrer nuestro nuevo catálogo y descubrir la solución ideal para cada espacio. En **Candil Iluminación**, transformamos la luz en confianza.



ÍNDICE

1

LÁMPARAS Y LUMINARIAS LED

	11	Lámparas Dicro
GU10	14	Lámparas AR111
	16	Formato profesional
	18	Lámparas E27
E27	24	Lámparas PAR30
	26	Lámparas High Power
G9	28	Lámparas G9
E14	30	Lámparas E14
R7S	32	Lámparas R7S
	34	Filamento E27
Filamento	36	Filamento E14
	38	Filamento Gold
	42	Listones bajo alacena
Listones y Tubos	44	Listones para techo
	46	Tubos LED
	48	Plafones LED Redondos
Plafones LED	50	Plafones LED Cuadrados

2

LUMINARIAS DE EMBUTIR PARA INTERIOR

	56	Selec
	57	Técnico
	58	Orson
	60	Cosme
	62	Walid
Embutidos para Dicro	64	Blas
	66	Fidel
	68	Wilbur
	70	Werner
	72	Afro
	74	Truman
	76	Roque
	80	Ecua para Dicro
Cardánicos de Embutir	82	Ecua para AR111
	84	Zafir
	86	Zac



3

LUMINARIAS DE APLICAR PARA INTERIOR

Semiembutidos	90	Balcony I
	91	Balcony II
	92	Gallery I
	93	Gallery II
Cardánicos de Aplicar	94	Plafón Ecuá para Dicro
	96	Plafón Ecuá para AR111
Plafones Monovolúmen	98	Asin
	99	Senku
	100	Tona
Cabezales para Dicro	102	Cala
	103	Runa
	104	Lalo
	105	Fork
	106	Webb
	108	Lupe
Cabezales para AR111	109	Cinema
	110	C700
Accesorios	112	TAPA090

4

SISTEMAS PARA LÁMPARAS LED

116	Eitu
120	Pola
124	Cachen
126	Memo
128	Ayelen
130	Julita
134	Sheila
138	Sonata
144	Témpano
148	Konus
152	Party
154	Promo
156	Super
158	Vulcano
159	Vistra
162	Lenora
166	Nuria

ÍNDICE

5

APLIQUES DECO PARA G9

- 172 Aplique Fiore
- 176 Aplique Mica
- 178 Aplique Sensei
- 180 Aplique Solo
- 182 Aplique Buda

6

COLGANTES DECO PARA E27

- 186 Concret
- 188 Soviet
- 192 Galeón
- 194 Goleta
- 198 Corbeta
- 200 Micro
- 201 Mega
- 202 Arypa
- 203 Prius
- 204 Faceta
- 206 Jirón
- 208 Piluso
- 210 Chin
- 212 Bebe
- 214 Corona
- 216 Depot

7

COLGANTES Y PLAFONES DECO PARA G9

- 220 Colgantes Ciro
- 222 Plafones Ball

8

COLGANTES Y PLAFONES HIGH DECO

- 228 Colgante Panal
- 230 Plafón Panal
- 234 Colgante Aruba
- 236 Colgante Vector
- 238 Colgante Pope
- 240 Colgante Lupin
- 242 Colgante Nube
- 244 Plafón Nube
- 246 Colgante Tampa
- 248 Colgante Olimpico
- 250 Colgante Siesta
- 251 Colgante Sarasota
- 252 Colgante Longboat
- 254 Colgante Bahamas
- 256 Plafón Coral
- 258 Plafón Medusa
- 260 Plafón Burako
- 262 Plafón Nemo
- 264 Plafón Mara
- 266 Plafón Siro
- 268 Plafón Naples
- 270 Plafón Venice

9

ESCRITORIO CABECERA Y PIE

Lámparas de Escritorio para E27	274	Pipo Mesa	
	276	Pipo Pinza	
	278	Tablero	
Lineas Madera	280	Fiona	
	281	Rufo	
	282	Paulo	
	284	Serena	
	286	Vinicio	
	288	Aplique Fiona	
	Lámparas de Escritorio LED	290	Teen
		291	Flip
292		Bonnie	
Apliques de Cabecera LED	295	Aki y Neo	
Lámparas de Pie	298	Lámpara de pie Rufo	
	299	Lámpara de pie Goal	

11

TIRAS LED Y PERFILES

Tiras LED para interior	330	Tiras LED 12V IP33
	332	Tiras LED 24V IP33
Tiras LED para exterior	338	Tiras LED 12V IP66
	340	Tiras LED 24V IP66
Para techo	342	Perfiles para aplicar
	344	Perfiles para embutir
Fuentes	346	Fuentes IP20
	347	Fuentes IP67

10

LUMINARIAS DE EXTERIOR

De pared	302	Apliques para GU10
	306	Apliques LED
	314	Empotrables LED
Para piso	316	Embutidos de piso
	318	Tero y Jabalina
Para techo	321	Sena y Silo
Proyectores	322	Proyectores Pegasus
	324	Proyectores Alta Potencia
Tortugas	326	Tortugas LED Integrado





LÁMPARAS Y LUMINARIAS LED

LÁMPARAS LED GU10 :::: DICRO Y AR111



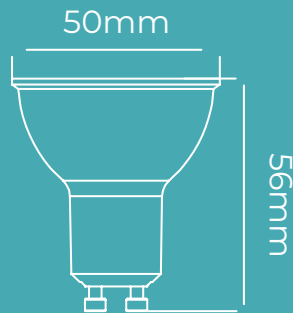

Lámpara LED Dicro 4W Difusa

LGU-1004



4W
275LM

GU10, 4W, 220V 50Hz, Dicro, IP20

3000K, 6500K

275LM

100°

No dimerizable

100 unidades

LINEA BLACK: PROFESIONAL

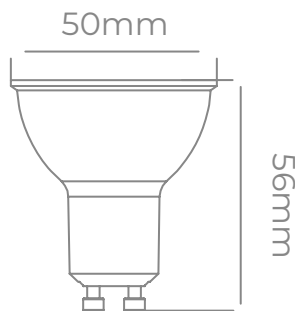

Lámpara LED Dicro 5W Profesional

LGU-4005-DIM



5W
450LM

GU10, 5W, 220V 50Hz, Dicro, IP20

3000K, 6500K

450LM

15°

Dimerizable

100 unidades

LINEA BLACK: PROFESIONAL

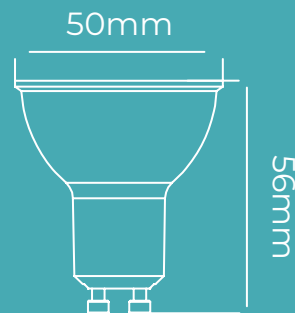

Lámpara LED Dicro 7W Profesional

LGU-4007-DIM



7W
600LM

GU10, 7W, 220V 50Hz, Dicro, IP20

3000K, 6500K

600LM

15°

Dimerizable

100 unidades

Lámpara LED Dicro 4W Puntual

LGU-8004



4W
325LM

GU10, 4W, 220V 50Hz, Dicro, IP20

3000K, 6500K

325LM

35°

No dimerizable



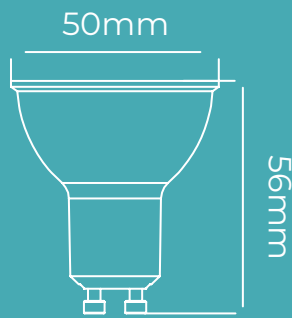

100 unidades



Lámpara Dicro LED de Colores

LGU-8004 

4.5W
325LM

-  GU10, 4.5W, 220V 50Hz, Dicro, IP20
-  Amarillo, Rojo, Azul, Verde
-  325LM
-  35°
-  No dimerizable



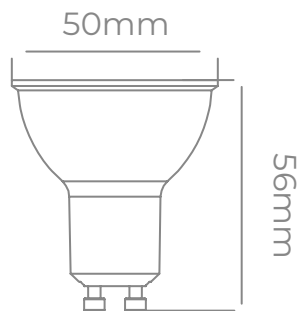

 100 unidades



Lámpara Dicro LED 7W Difusa

LGU-1807   

7W
530LM

-  GU10, 7W, 220V 50Hz, Dicro, IP20
-  3000K, 4000K, 6500K
-  530LM
-  100°
-  No dimerizable



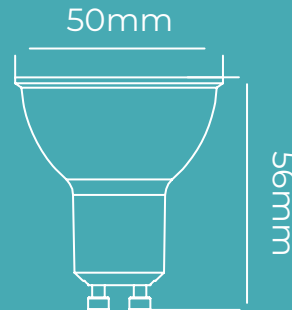

 100 unidades



Lámpara Dicro LED 7W Difusa Dimerizable

LGU-1807-DIM  

7W
480LM

-  GU10, 7W, 220V 50Hz, Dicro, IP20
-  3000K, 6500K
-  480LM
-  100°
-  Dimerizable



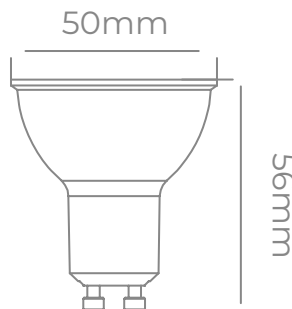

 100 unidades



Lámpara Dicro LED 7W Difusa Silver

LGU-1807 SV  

7W
480LM

-  GU10, 7W, 220V 50Hz, Dicro, IP20
-  3000K, 6500K
-  480LM
-  100°
-  No dimerizable



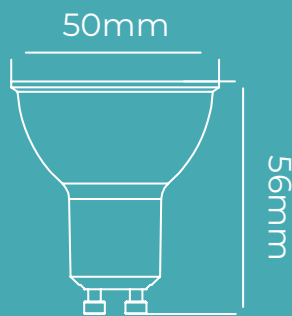

 100 unidades



Lámpara Dicro LED 7W Difusa Dimerizable Silver

LGU-1807-DIM SV ●

7W
480LM

-  GU10, 7W, 220V 50Hz, Dicro, IP20
-  3000K, 6500K
-  480LM
-  100°
-  Dimerizable



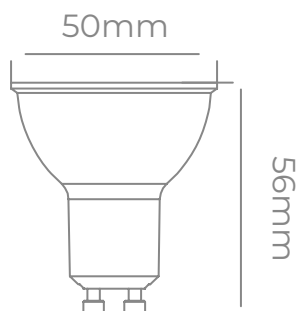

 100 unidades



Lámpara Dicro LED 7W Puntual

LGU-8007 ● ○ ●

7W
520LM

-  GU10, 7W, 220V 50Hz, Dicro, IP20
-  3000K, 4000K, 6500K
-  520LM
-  36°
-  No dimerizable



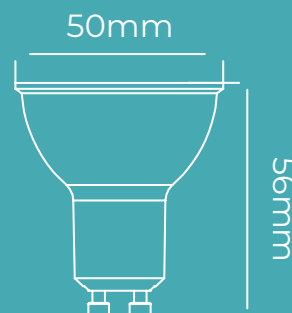

 100 unidades



Lámpara Dicro LED 7W Puntual Dimerizable

LGU-8007-DIM ● ○

7W
520LM

-  GU10, 7W, 220V 50Hz, Dicro, IP20
-  3000K, 6500K
-  520LM
-  36°
-  Dimerizable



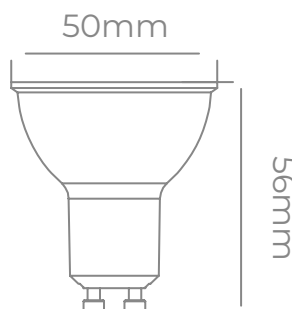

 100 unidades



Lámpara Dicro LED 7W Puntual

LGU-9007 ● ○

7W
560LM

-  GU10, 7W, 220V 50Hz, Dicro, IP20
-  3000K, 6500K
-  560LM
-  35°
-  No dimerizable

 100 unidades







LINEA BLACK: PROFESIONAL

Lámpara LED Tipo AR111 Profesional

LGU-AR4012 DIM 

12W
1100LM

-  GU10, 12W, 220V 50Hz, AR111, IP20
-  3000K, 6500K
-  1100LM
-  15°
-  Dimerizable





 48 unidades



Lámpara LED Tipo AR111 12W

LGU-1212L   

12W
1055LM

-  GU10, 12W, 220V 50Hz, AR111, IP20
-  3000K, 4000K, 6500K
-  1055LM
-  30°
-  No dimerizable





 48 unidades



Lámpara LED Tipo AR111 Dimerizable

LGU-1212-DIM  

12W
1055LM

-  GU10, 12W, 220V 50Hz, AR111, IP20
-  3000K, 6500K
-  1055LM
-  30°
-  Dimerizable

 48 unidades



Lámpara LED Tipo AR111 Dimerizable Silver

LGU-1212-DIM SV ●

12W
1055LM

GU10, 12W, 220V 50Hz, AR111, IP20

3000K, 6500K

1055LM

30°

Dimerizable

48 unidades



Lámpara LED Tipo AR111 15W

LGU-1215 ● ○

15W
1500LM

GU10, 15W, 220V 50Hz, AR111, IP20

3000K, 6500K

1500LM

30°

No dimerizable

48 unidades



Lámpara LED Tipo AR111 15W Silver

LGU-1215 SV ● ○

15W
1500LM

GU10, 15W, 220V 50Hz, AR111, IP20

3000K, 6500K

1500LM

30°

No dimerizable

48 unidades

LÁMPARAS LED FORMATO PROFESIONAL



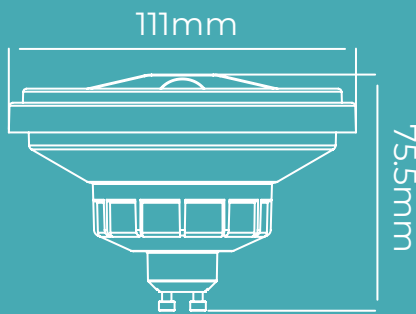

Lámpara LED Profesional tipo Halógena 12W

LGU-ARPRO2412 DIM ● ●

12W
950LM

GU10, 12W, 220V 50Hz, AR111, IP20

3000K, 6500K

950LM

36°

Dimerizable

36 unidades

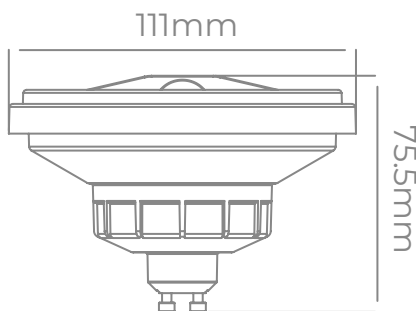

Lámpara LED Profesional tipo Halógena 15W

LGU-ARPRO2415 ● ●

15W
1250LM

GU10, 15W, 220V 50Hz, AR111, IP20

3000K, 6500K

1250LM

36°

No dimerizable

36 unidades



LÁMPARAS LED E27



Lámpara LED Fantasia 7W

LE27-VE2007-DIM ●

- E27, 7W, 220V 50Hz, C37, IP20
- 3000K, 6500K
- 720LM
- 200°
- Dimerizable

7W
720LM

100 unidades

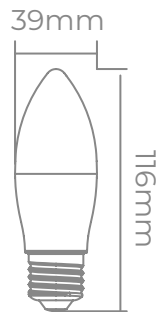

Lámpara LED Fantasia 8W

LE27-VE2808 ● ●

- E27, 8W, 220V 50Hz, C37, IP20
- 3000K, 6500K
- 806LM
- 200°
- No dimerizable

8W
806LM

100 unidades

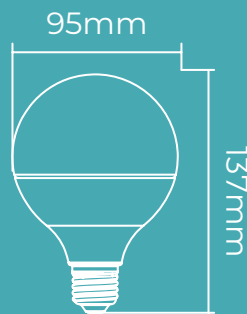

Lámpara LED Globo Bocha Chica

LE27-BC3012 ● ●

- E27, 12W, 220V 50Hz, C100, IP20
- 3000K, 6500K
- 1105LM
- 180°
- No dimerizable

12W
1105LM

24 unidades

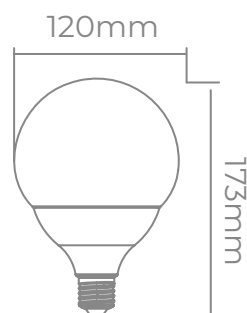

Lámpara LED Globo Bocha Grande

LE27-BG3012 ● ●

- E27, 12W, 220V 50Hz, G120, IP20
- 3000K, 6500K
- 1200LM
- 220°
- No dimerizable

12W
1200LM

16 unidades

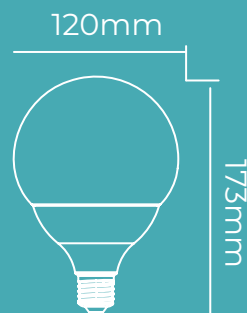

Lámpara LED Globo Bocha Grande

LE27-BG4215 ● ●

- E27, 15W, 220V 50Hz, G120, IP20
- 3000K, 6500K
- 1521LM
- 220°
- No dimerizable

15W
1521LM

16 unidades



45mm Ø



78mm

Lámpara LED Gota 4W

LE27-G124 ● ●

E27, 4W, 220V 50Hz, G124, IP20

2700K, 6500K

470LM

150°

No dimerizable

4W
470LM

100 unidades



56,5mm

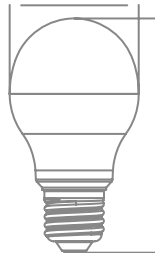

103mm

Lámpara LED Anti Insecto 4W

LE27-A5504-AI ●

E27, 4W, 220V 50Hz, A55, IP20

3000K

55LM

150°

No dimerizable

4W
55LM

100 unidades



60mm Ø



110mm

Lámpara LED Bulbo 6W Dimerizable

LE27-G2406-DIM ● ●

E27, 6W, 220V 50Hz, A60, IP20

3000K, 6500K

510LM

200°

Dimerizable

6W
510LM

100 unidades



60mm

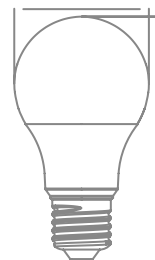

108mm

Lámpara LED A60 7W

LE27-ECA60007 ● ●

E27, 7W, 220V 50Hz, A60, IP20

3000K, 6500K

680LM

180°

No dimerizable

7W
680LM

100 unidades



60mm



108mm

Lámpara LED A60 9W

LE27-ECA60009 ● ●

E27, 9W, 220V 50Hz, A60, IP20

3000K, 6500K

750LM

180°

No dimerizable

9W
750LM

100 unidades

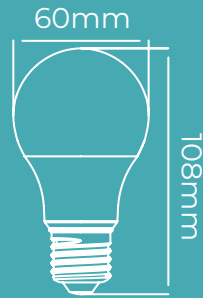

Lámpara LED A60 11W

LE27-ECA60011 ● ●

E27, 11W, 220V 50Hz, A60, IP20

3000K, 6500K

1150LM

180°

No dimerizable

11W
1150LM

100 unidades

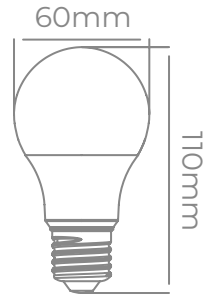

Lámpara LED A60 12W

LE27-ECA60012 ● ●

E27, 12W, 220V 50Hz, A60, IP20

3000K, 6500K

1055LM

180°

No dimerizable

12W
1055LM

100 unidades



Lámpara LED A60 15W

LE27-ECA60015 ● ●

E27, 15W, 220V 50Hz, A60, IP20

3000K, 6500K

1521LM

180°

No dimerizable

15W
1521LM

100 unidades

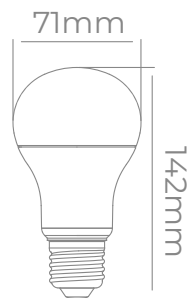

Lámpara LED A70 18W

LE27-ECA70018 ● ●

E27, 18W, 220V 50Hz, A70, IP20

3000K, 6500K

1901LM

180°

No dimerizable

18W
1901LM

200 unidades



Lámpara LED A80 20W

LE27-ECA80020 ● ●

E27, 20W, 220V 50Hz, A80, IP20

3000K, 6500K

2452LM

200°

No dimerizable

20W
2452LM

100 unidades

LÁMPARAS LED E27 ::::





Lámpara LED Bulbo 12W

LE27-G3012



E27, 12W, 220V 50Hz, A60, IP20

3000K, 6500K

1200LM

180°

No dimerizable

12W
1200LM

100 unidades

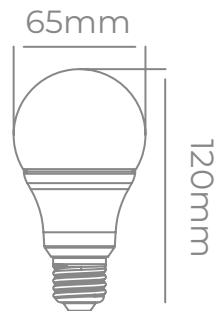

Lámpara LED Bulbo 15W

LE27-A6515



E27, 15W, 220V 50Hz, A65, IP20

3000K, 6500K

1521LM

150°

No dimerizable

15W
1521LM

100 unidades



Lámpara LED Bulbo 23W

LE27-A7523



E27, 23W, 220V 50Hz, A65, IP20

3000K, 6500K

2452LM

150°

No dimerizable

23W
2452LM

100 unidades

LÁMPARAS LED PAR30



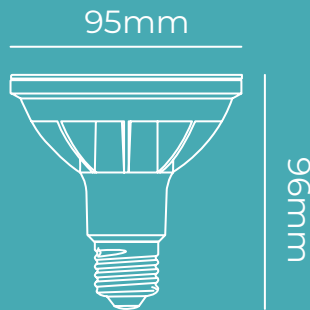

Lámpara LED High Power PAR30

LE27-HPPAR363011 ● ●

E27, 11W, 220V 50Hz, PAR30, IP20

3000K, 6500K

860LM

36°

No dimerizable

11W
860LM

20 unidades

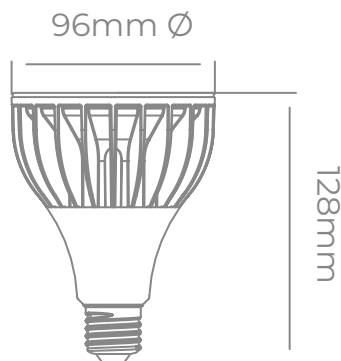

Lámpara LED High Power PAR30

LE27-HPPAR243030 ●

E27, 30W, 220V 50Hz, PAR30, IP20

3000K

2700LM

36°

No dimerizable

30W
2700LM

16 unidades



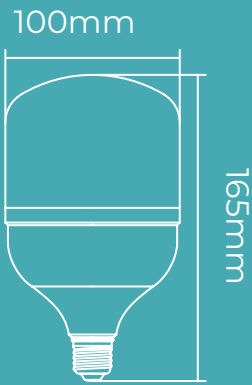

LÁMPARAS LED E27 HIGH POWER ::::





Lámpara LED High Power 30W

LE27-HP360030 ● ●

-  E27, 30W, 220V 50Hz, T120, IP20
-  3000K, 6500K
-  2500LM
-  180°
-  No dimerizable



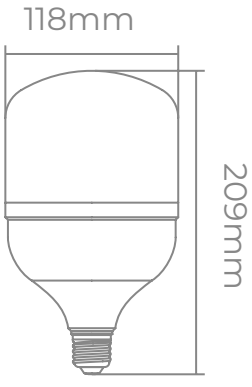

30W
2500LM

 20 unidades



Lámpara LED High Power 40W

LE27-HP360040 ● ●

-  E27, 40W, 220V 50Hz, T140, IP20
-  3000K, 6500K
-  3300LM
-  180°
-  No dimerizable



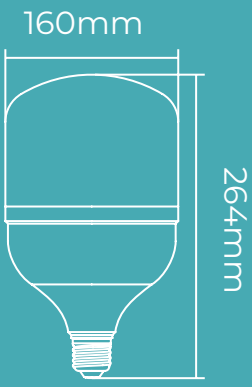

40W
3300LM

 10 unidades



Lámpara LED High Power 60W

LE27-HP360060 ● ●

-  E27, 60W, 220V 50Hz, T160, IP20
-  3000K, 6500K
-  5500LM
-  180°
-  No dimerizable

60W
5500LM

 8 unidades

LÁMPARAS LED G9



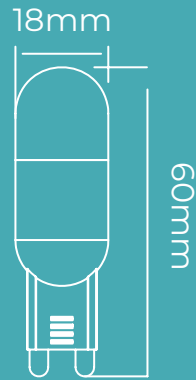





Lámpara LED G9 3W

LG9-5003L



3W
300LM

-  G9, 3W, 220V 50Hz, G9, IP20
-  3000K, 6500K
-  300LM
-  270°
-  No dimerizable

 480 unidades

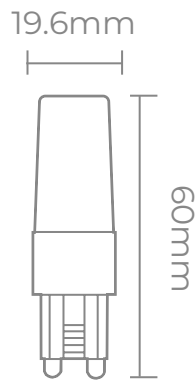





Lámpara LED G9 Ultracompacta

LG9-4503



3,5W
470LM

-  G9, 3,5W, 220V 50Hz, G9, IP20
-  3000K, 6500K
-  470LM
-  310°
-  No dimerizable

 480 unidades

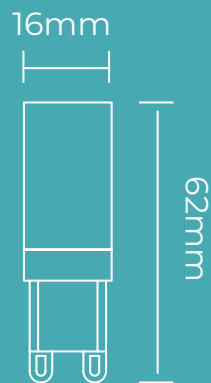





Lámpara LED G9 5W

LG9-7505L



5W
400LM

-  G9, 5W, 220V 50Hz, G9, IP20
-  3000K, 6500K
-  400LM
-  310°
-  No dimerizable

 480 unidades

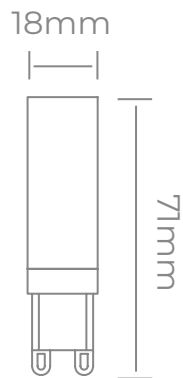





Lámpara LED G9 8W

LG9-7008



8W
680LM

-  G9, 8W, 220V 50Hz, G9, IP20
-  3000K, 6500K
-  680LM
-  310°
-  No dimerizable

 480 unidades

LÁMPARAS LED E14 ::::

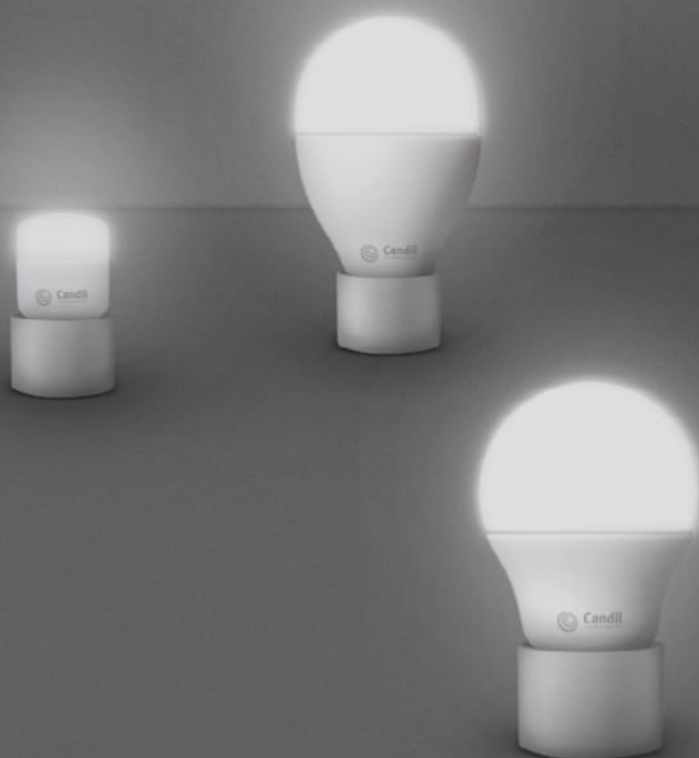



Lámpara LED Perfume

LE14-8001



E14, 5W, 220V 50Hz, T26, IP20

3000K, 6500K

135LM

120°

No dimerizable

1.5W
135LM

200 unidades

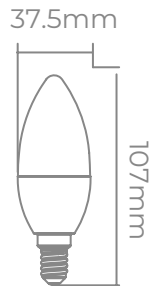

Lámpara LED Velita 5W

LE14-VE1605



E14, 5W, 220V 50Hz, C35, IP20

3000K, 6500K

495LM

200°

No dimerizable

5W
495LM

100 unidades



Lámpara LED Velita 8W

LE14-C3708



E14, 8W, 220V 50Hz, C35, IP20

3000K, 6500K

806LM

200°

No dimerizable

8W
806LM

100 unidades

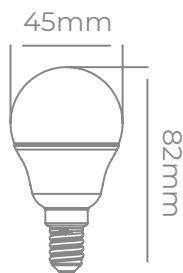

Lámpara LED Gota 5W

LE14-G4505



E14, 5W, 220V 50Hz, G45, IP20

3000K, 6500K

470LM

150°

No dimerizable

5W
470LM

100 unidades

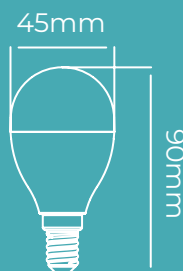

Lámpara LED Gota 8W

LE14-G4508



E14, 8W, 220V 50Hz, G45, IP20

3000K, 6500K

806LM

150°

No dimerizable

8W
806LM

100 unidades

LÁMPARAS LED TIPO CUARZO





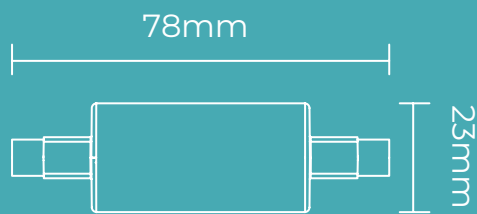

8W
720LM

 100 unidades



Lámpara LED Tipo Cuarzo Corto 8W
R7S-J78008  



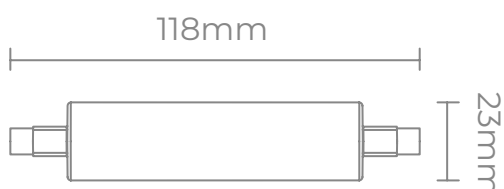

-  R7S, 6W, 220V 50Hz, J78, IP20
-  3000K, 6500K
-  720LM
-  360°
-  No dimerizable

15W
1400LM

 50 unidades



Lámpara LED Tipo Cuarzo Largo 15W
R7S-J11815  

-  R7S, 7W, 220V 50Hz, J118, IP20
-  3000K, 6500K
-  1400LM
-  360°
-  No dimerizable

LÁMPARAS FILAMENTO E27



4W
470LM

 100 unidades





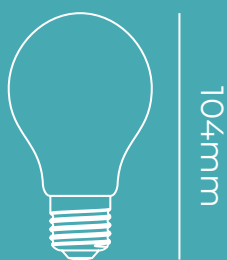

60mm



Lámpara LED Filamento 4W

LE27-FILC004



-  E27, 4W, 220V 50Hz, A60, IP20
-  3000K
-  470LM
-  360°
-  No dimerizable

4W
425LM

 100 unidades



45mm

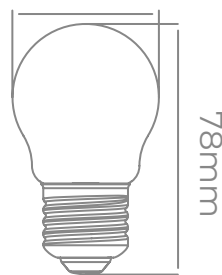

Lámpara LED Filamento Gota 4W

LE27-FILG45004



-  E27, 4W, 220V 50Hz, G45, IP20
-  2500K, 2700K
-  425LM
-  360°
-  No dimerizable

5W
470LM

 100 unidades





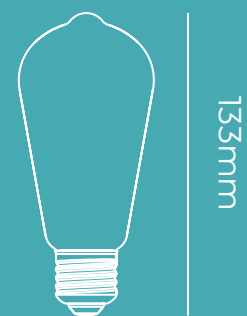

58mm



Lámpara LED Filamento Pera 5W

LE27-FILC005



-  E27, 5W, 220V 50Hz, ST58, IP20
-  3000K
-  470LM
-  360°
-  No dimerizable



6W
806LM

20 unidades

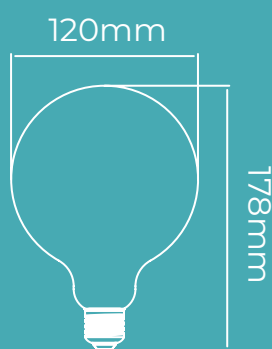

Lámpara LED Filamento Globo 6W
LE27-FILG006

- E27, 6W, 220V 50Hz, G125, IP20
- 3000K
- 806LM
- 360°
- No dimerizable

7W
806LM

80 unidades

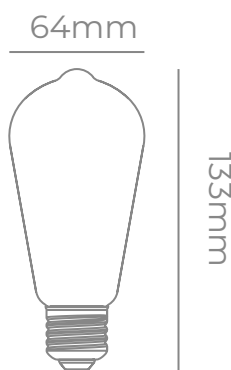

Lámpara LED Filamento Pera 7W
LE27-FILC007

- E27, 7W, 220V 50Hz, ST64, IP20
- 3000K
- 806LM
- 360°
- No dimerizable

7W
720LM

40 unidades

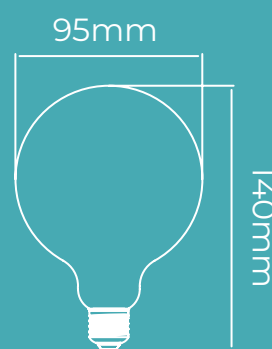

Lámpara LED Filamento Globo 7W
LE27-FILG95007

- E27, 7W, 220V 50Hz, G95, IP20
- 2500K, 2700K
- 720LM
- 360°
- No dimerizable



LÁMPARAS LED FILAMENTO E14



4W
470LM

 100 unidades



35mm



123mm

Lámpara LED Filamento Vela Deco 4W

LE14-FILVD04



 E14, 4W, 220V 50Hz, CF35, IP20

 3000K

 470LM

 360°

 No dimerizable

4W
420LM

 100 unidades



35mm





97mm

Lámpara LED Filamento Vela 4W

LE14-FILVE04



 E14, 4W, 220V 50Hz, ST35, IP20

 3000K

 420LM

 360°

 No dimerizable

LÁMPARAS FILAMENTO GOLD

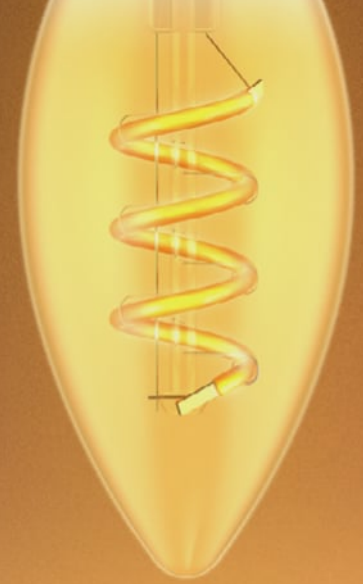





3W
136LM

 100 unidades



Lámpara LED Filamento Gold 3W
LE14-FVSC3503  



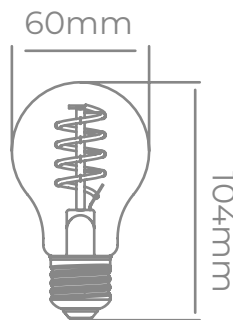

-  E14, 3W, 220V 50Hz, C35, IP20
-  2000K
-  136LM
-  360°
-  No dimerizable

5W
250LM

 100 unidades



Lámpara LED Filamento Gold 5W
LE27-FVSA6005  



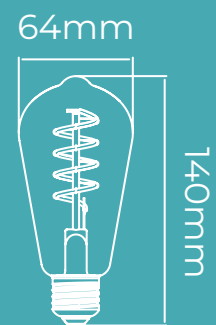

-  E27, 5W, 220V 50Hz, A60, IP20
-  2000K
-  250LM
-  360°
-  No dimerizable

5W
250LM

 80 unidades



Lámpara LED Filamento Gold 5W
LE27-FVST6405  

-  E27, 5W, 220V 50Hz, ST64, IP20
-  2000K
-  250LM
-  360°
-  No dimerizable

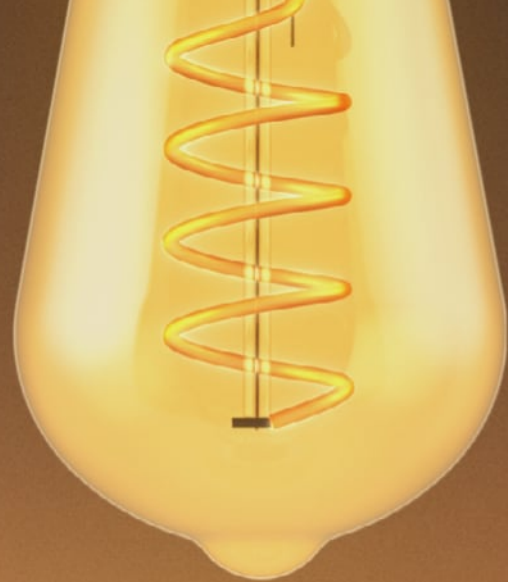



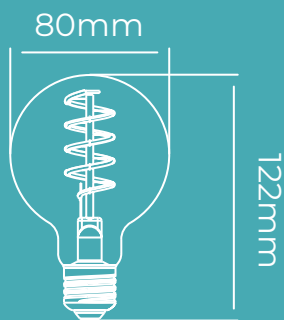

5W
250LM

 80 unidades



Lámpara LED Filamento Gold 5W
LE27-FVSG8005  



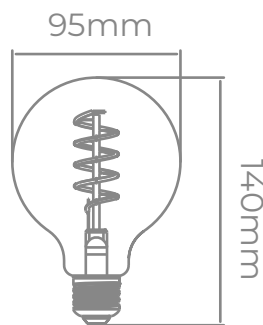

-  E27, 5W, 220V 50Hz, G80, IP20
-  2000K
-  250LM
-  360°
-  No dimerizable

5W
250LM

 20 unidades



Lámpara LED Filamento Gold 5W
LE27-FVSG9505  



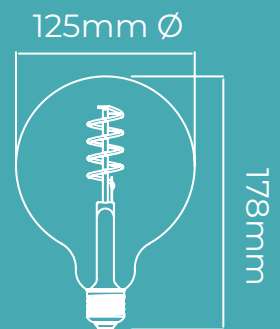

-  E27, 5W, 220V 50Hz, G95, IP20
-  2000K
-  250LM
-  360°
-  No dimerizable

5W
250LM

 20 unidades



Lámpara LED Filamento Gold 5W
LE27-FVSG12505  

-  E27, 5W, 220V 50Hz, G125, IP20
-  2000K
-  250LM
-  360°
-  No dimerizable



LÁMPARAS FILAMENTO GOLD ::::

5W
250LM



6 unidades



160mm Ø

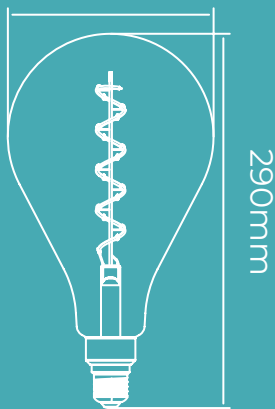

Lámpara LED Filamento Gold 5W
LE27-FVSPS16005



E27, 5W, 220V 50Hz, S160, IP20

2000K

250LM

360°

No dimerizable

5W
250LM



6 unidades



164mm

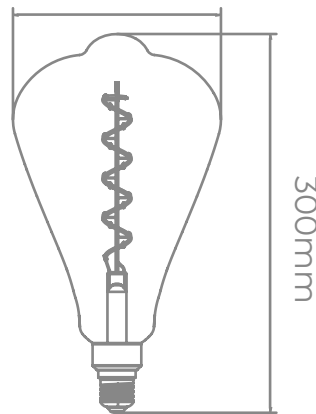

Lámpara LED Filamento Gold 5W
LE27-FVST16405



E27, 5W, 220V 50Hz, T164, IP20

2000K

250LM

360°

No dimerizable

5W
250LM



8 unidades



65mm

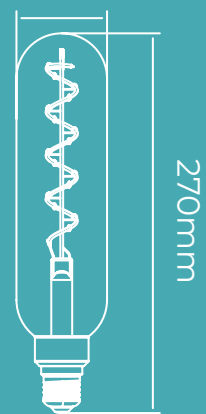

Lámpara LED Filamento Gold 5W
LE27-FVST6505



E27, 5W, 220V 50Hz, T65, IP20

2000K

250LM

360°

No dimerizable

LISTONES LED BAJO ALACENA



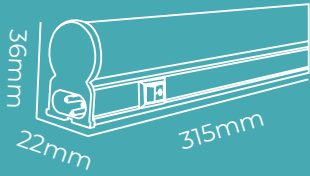

Listón LED Bajo Alacena 5W

BALT8005

LED, 5W, 220V 50Hz, IP20

4000K, 6500K

400LM

200°

No dimerizable

5W
400LM

25 unidades

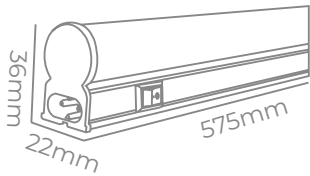

Listón LED Bajo Alacena 9W

BALT8009

LED, 9W, 220V 50Hz, IP20

4000K, 6500K

720LM

200°

No dimerizable

9W
720LM

25 unidades

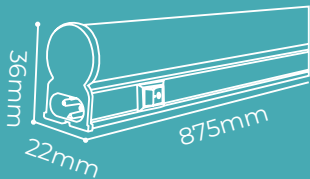

Listón LED Bajo Alacena 12W

BALT8012

LED, 12W, 220V 50Hz, IP20

4000K, 6500K

960LM

200°

No dimerizable

12W
960LM

25 unidades

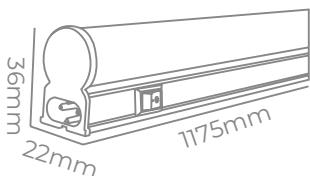

Listón LED Bajo Alacena 18W

BALT8018

LED, 18W, 220V 50Hz, IP20

4000K, 6500K

1440LM

200°

No dimerizable

18W
1440LM

25 unidades

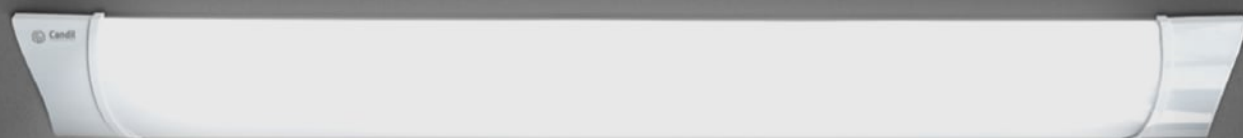

LISTONES LED PARA TECHO



18W
1440LM

 36 unidades

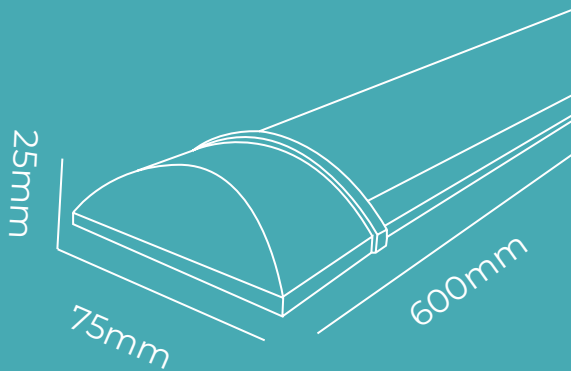

Listón LED para techo 18W

BALT060018  

 LED, 18W, 220V 50Hz, IP20

 3000K, 6500K

 1440LM

 200°



 No dimerizable

36W
2880LM

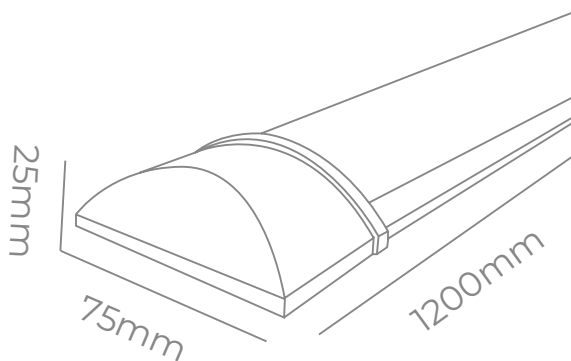
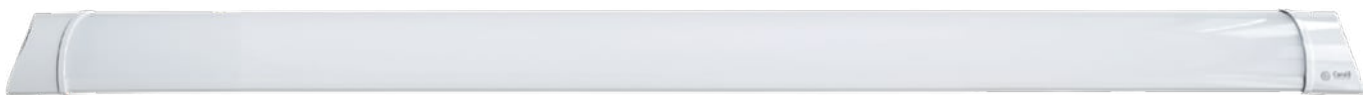
 24 unidades



Listón LED para techo 36W

BALT120036  

 LED, 36W, 220V 50Hz, IP20

 3000K, 6500K

 2880LM

 200°

 No dimerizable

TUBOS LED ZÓCALO G13





Tubo LED de Policarbonato 9W

LG13-4806009



9W
800LM

LED, 9W, 220V 50Hz, T8, IP20

4000K

800LM

200°

No dimerizable

25 unidades

Conexión: un solo extremo



Tubo LED de Vidrio 18W

LG13-5012018



18W
1800LM

G13, 18W, 220V 50Hz, T8, IP20

4000K, 6500K

1800LM

200°

No dimerizable

25 unidades

Conexión: un solo extremo





PLAFONES LED REDONDOS



*Plafones LED redondos
de 6W, 12W, 18W y 28W,
construidos en chapa de
acero.*

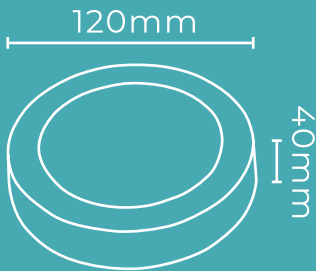

DRIVER DE REPUESTO
DISPONIBLE

PLRE1206-30 BT
PLRE1206-30 NM
PLRE1206-30 NT
PLRE1206-65 BT
PLRE1206-65 NM
PLRE1206-65 NT

Plafón LED
Redondo 6W
Art.: PLRE1206



- LED 6W, 220V, 50Hz, IP20
- Blanco texturado, Negro texturado, Niquel mate
- 3000K, 6500K
- 280LM
- Chapa de acero
- Clase II

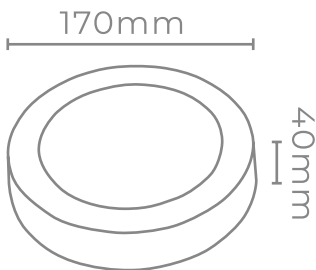

DRIVER DE REPUESTO
DISPONIBLE

PLRE1712-30 BT
PLRE1712-30 NM
PLRE1712-30 NT
PLRE1712-65 BT
PLRE1712-65 NM
PLRE1712-65 NT

Plafón LED
Redondo 12W
Art.: PLRE1712

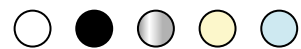

- LED 12W, 220V, 50Hz, IP20
- Blanco texturado, Negro texturado, Niquel mate
- 3000K, 6500K
- 820LM
- Chapa de acero
- Clase II

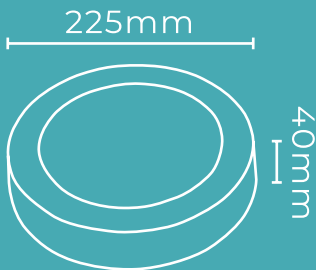

DRIVER DE REPUESTO
DISPONIBLE

PLRE22218-30 BT
PLRE22218-30 NM
PLRE22218-30 NT
PLRE22218-65 BT
PLRE22218-65 NM
PLRE22218-65 NT

Plafón LED
Redondo 18W
Art.: PLRE22218



- LED 18W, 220V, 50Hz, IP20
- Blanco texturado, Negro texturado, Niquel mate
- 3000K, 6500K
- 1300LM
- Chapa de acero
- Clase II

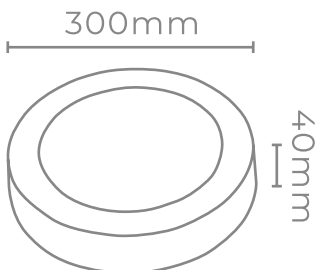

DRIVER DE REPUESTO
DISPONIBLE

PLRE3028-30 BT
PLRE3028-30 NM
PLRE3028-65 BT
PLRE3028-65 NM
PLRE3028-65 NT

Plafón LED
Redondo 28W
Art.: PLRE3028



- LED 28W, 220V, 50Hz, IP20
- Blanco texturado, Negro texturado, Niquel mate
- 3000K, 6500K
- 1800LM
- Chapa de acero
- Clase II



PLAFONES LED CUADRADOS



Plafones LED cuadrados de 6W, 12W, 18W, 24W, 28W y 36W, contruidos en chapa de acero.

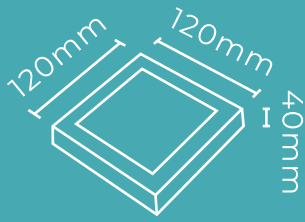

PL121206-30 BT
 PL121206-30 NM
 PL121206-65 BT
 PL121206-65 NM



DRIVER DE REPUESTO DISPONIBLE

Plafón LED

Cuadrado 6W

Art.: PL121206



- LED 6W, 220V, 50Hz, IP20
- Blanco texturado, Níquel mate
- 3000K, 6500K
- 280LM
- Chapa de acero
- Clase II

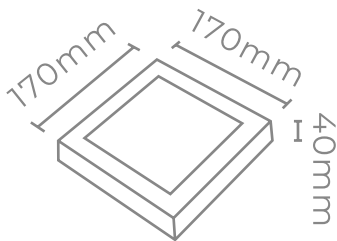

PL1717212-30 BT
 PL1717212-30 NM
 PL1717212-65 BT
 PL1717212-65 NM



DRIVER DE REPUESTO DISPONIBLE

Plafón LED

Cuadrado 12W

Art.: PL1717212

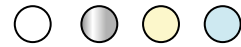

- LED 12W, 220V, 50Hz, IP20
- Blanco texturado, Níquel mate
- 3000K, 6500K
- 820LM
- Chapa de acero
- Clase II

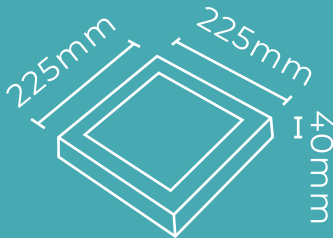

PL222218-30 BT
 PL222218-30 NM
 PL222218-30 NT
 PL222218-65 BT
 PL222218-65 NM
 PL222218-65 NT



DRIVER DE REPUESTO DISPONIBLE

Plafón LED

Cuadrado 18W

Art.: PL222218



- LED 18W, 220V, 50Hz, IP20
- Blanco texturado, Negro texturado, Níquel mate
- 3000K, 6500K
- 1300LM
- Chapa de acero
- Clase II

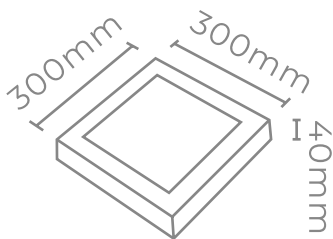

PL303028-30 BT
 PL303028-30 NM
 PL303028-30 NT
 PL303028-65 BT
 PL303028-65 NM
 PL303028-65 NT



DRIVER DE REPUESTO DISPONIBLE

Plafón LED

Cuadrado 28W

Art.: PL303028

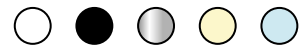

- LED 28W, 220V, 50Hz, IP20
- Blanco texturado, Negro texturado, Níquel mate
- 3000K, 6500K
- 1800LM
- Chapa de acero
- Clase II

PLAFÓN LED 36W





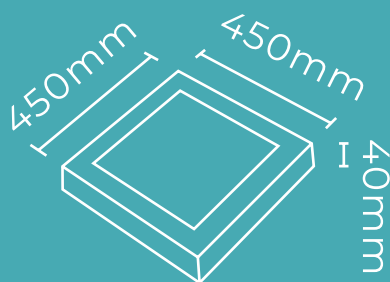
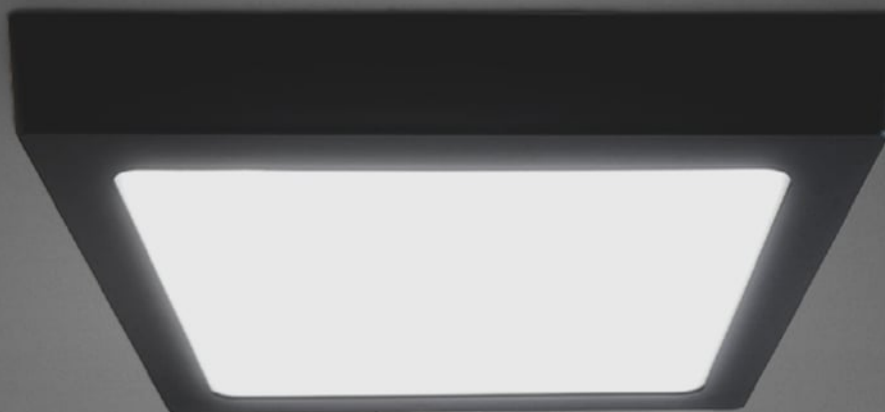



Plafón LED cuadrado 45x45cm, 36W, construido en chapa de acero.



PL454536-30 BT
PL454536-30 NT
PL454536-65 BT
PL454536-65 NT

Plafón LED
Cuadrado 36W
Art.: PL454536



-  LED 36W, 220V, 50Hz, IP20
-  Blanco texturado, Negro texturado
-  3000K, 6500K
-  2500LM
-  Chapa de acero
-  Clase II



DRIVER DE REPUESTO
DISPONIBLE



PLAFÓN LED 24W





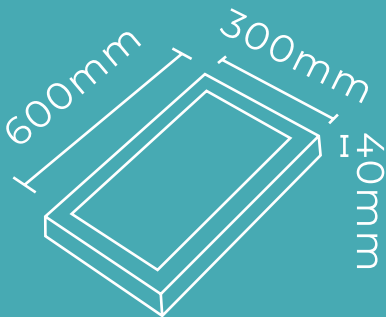



Plafón LED rectangular construido en chapa de acero.



PL603024-30 BT
PL603024-65 BT

Plafón LED
Rectangular 24W
Art.: PL603024



-  LED 24W, 220V, 50Hz, IP20
-  Blanco texturado
-  3000K, 6500K
-  1920LM
-  Chapa de acero
-  Clase II





LUMINARIAS DE EMBUTIR PARA INTERIOR

SELEC



Embutido
SELEC
Art.: EGU3715 BT



Embutido
SELEC
Art.: EGU3715 NT



- 1xGU10, Max 15W, 220V, 50Hz, IP20
- Negro texturado, Blanco texturado
- Aluminio
- Fijo
- Antideslumbrante
- Clase II



*Embutido circular fijo para
dicroica GU10 construido
íntegramente en fundición
de aluminio.*

80mm

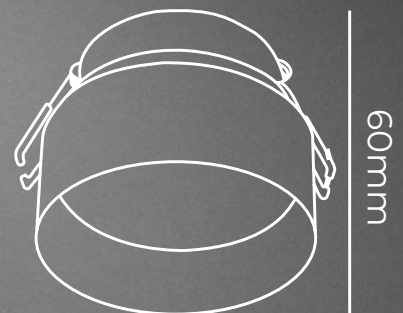

TÉCNICO

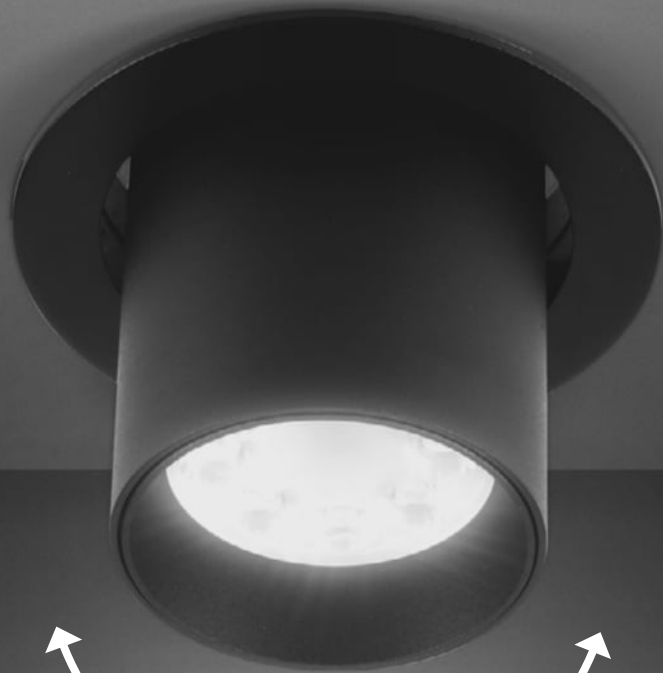

ORIENTABLE



Embutido circular orientable para dicroica GU10 construido íntegramente en fundición de aluminio.



Embutido
TÉCNICO
Art.: EGU3719 BT



Embutido
TÉCNICO
Art.: EGU3719 NT



- 1xGU10, Max 15W, 220V, 50Hz, IP20
- Negro texturado, Blanco texturado
- Aluminio
- Orientable
- Antideslumbrante
- Clase II

ORSON

REDONDO



Embutido
ORSON
Art.: EGU10022A BL



Embutido
ORSON
Art.: EGU10022 NG



- 1xGU10, Max 50W, 220V, 50Hz, IP20
- Blanco texturado, Negro texturado
- Aluminio
- Fijo
- Antideslumbrante
- Clase II

*Embutido circular fijo para
dicroica GU10 construido
íntegramente en fundición
de aluminio.*

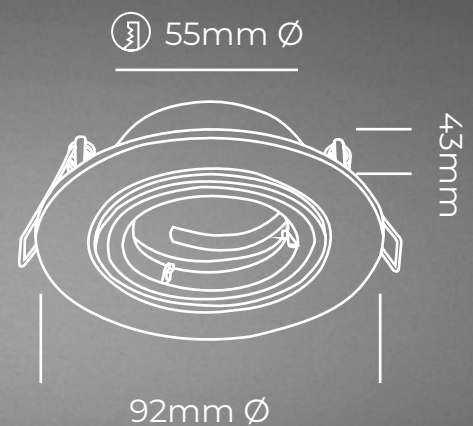

ORSON

CUADRADO

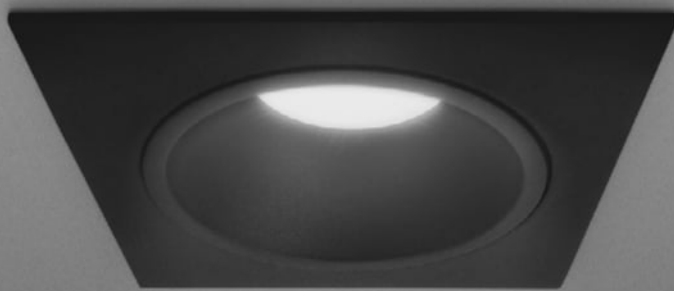



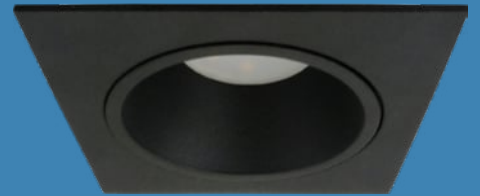

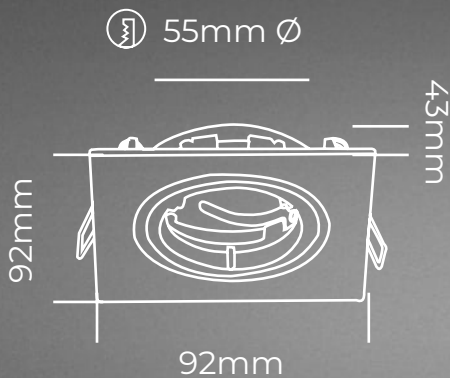

Embutido
ORSON
Art.: EGU10022B BL 



Embutido
ORSON
Art.: EGU10022B NG 



Embutido cuadrado fijo para dicroica GU10 construido íntegramente en fundición de aluminio.

-  1xGU10, Max 50W, 220V, 50Hz, IP20
-  Blanco texturado, Negro texturado
-  Aluminio
-  Fijo
-  Antideslumbrante
-  Clase II



COSME







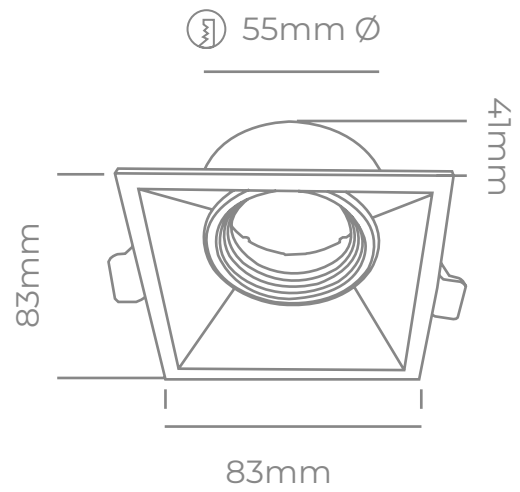

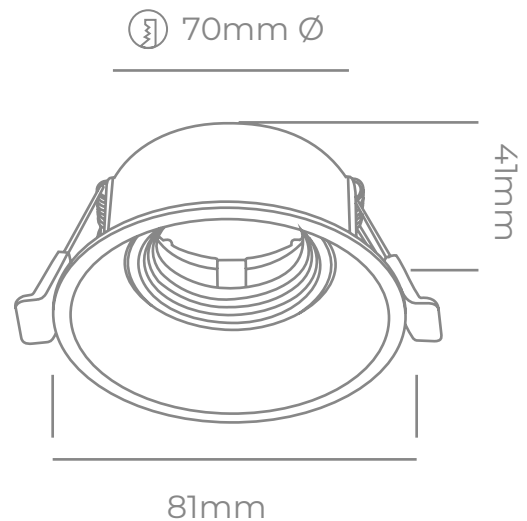

Embutido
COSME
Art.: EGU10051B BL



Embutido
COSME
Art.: EGU10051A BL



*Embutido fijo para dicroica GU10,
construido íntegramente en fundición
de aluminio.*

-  1xGU10, Max 50W, 220V, 50Hz, IP20
-  Blanco texturado
-  Aluminio
-  Fijo
-  Antideslumbrante
-  Clase II

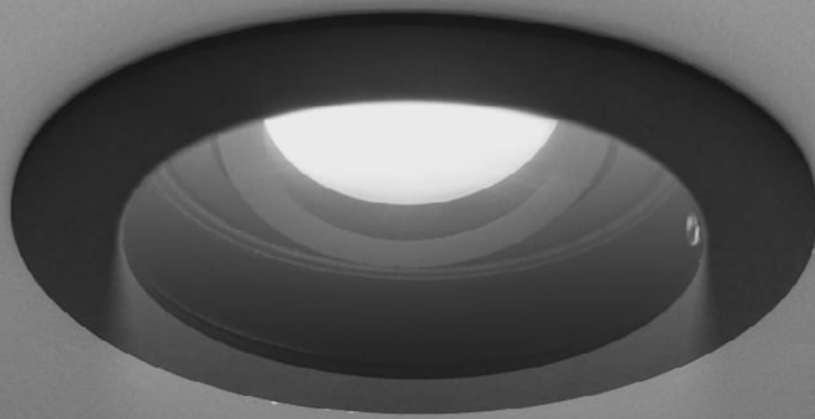

*Embutido redondo orientable
para dióptica GU10, construido
íntegramente en fundición de
aluminio. Antideslumbrante.*

WALID 





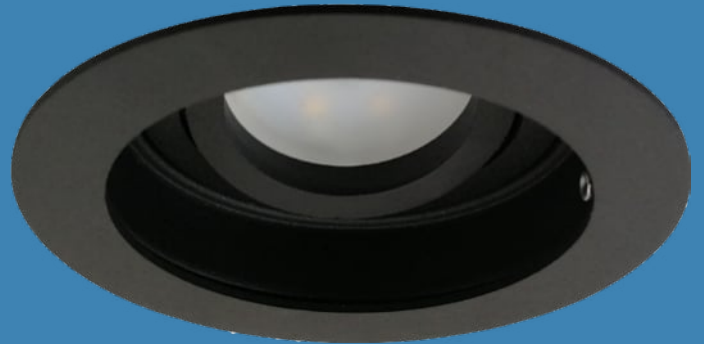

Embutido
WALID
Art.: EGU120015 BL

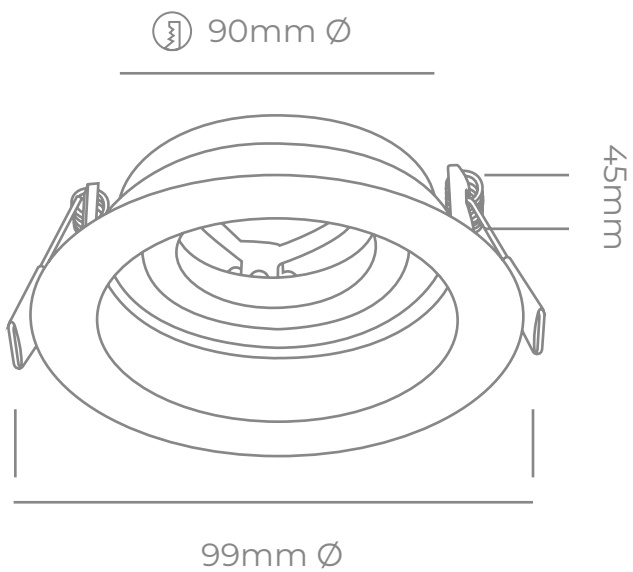

Embutido
WALID
Art.: EGU120015 NG



-  1xGU10, Max 50W, 220V, 50Hz, IP20
-  Blanco texturado, Negro texturado
-  Aluminio
-  Orientable
-  Clase II

BLAS

REDONDO

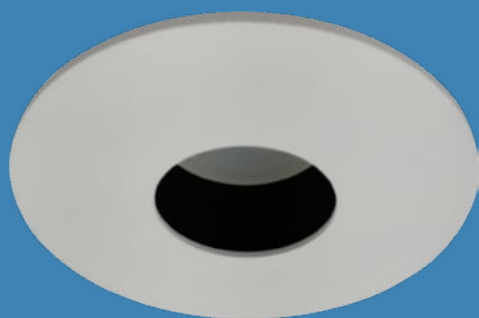

Embutido

BLAS

Art.: EGU10001A BL

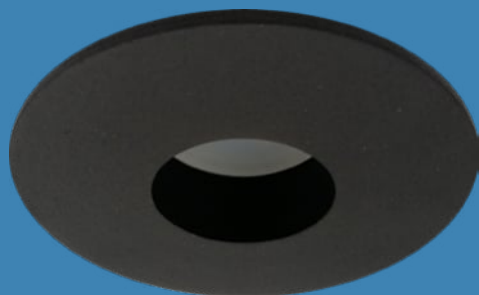

Embutido

BLAS

Art.: EGU10001A NG



- 1xGU10, Max 50W, 220V, 50Hz, IP20
- Blanco texturado, Negro texturado
- Aluminio
- Orientable
- Antideslumbrante
- Clase II

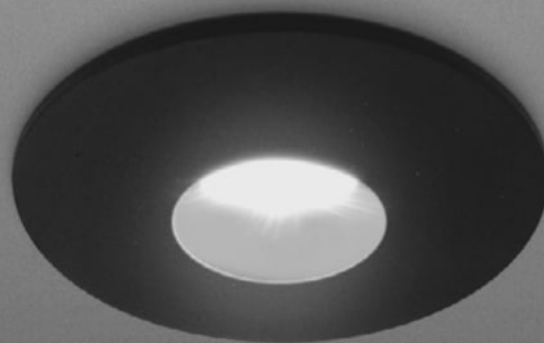

*Embutido circular
Orientable para dicroica
GU10 construido
Íntegramente en fundición
de aluminio.*

70mm Ø

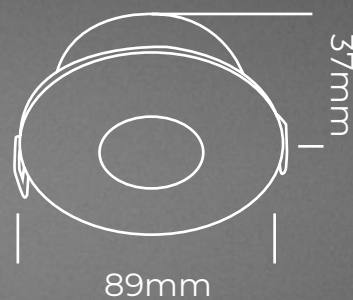

BLAS

CUADRADO

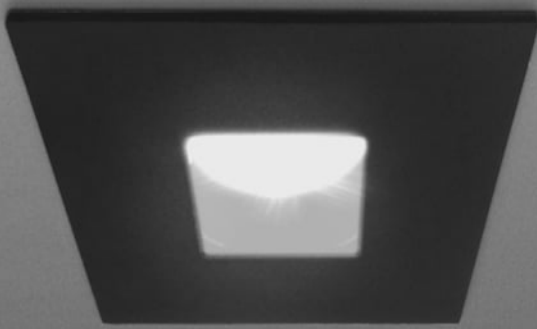





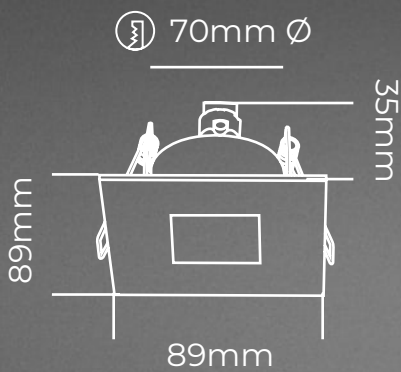

Embutido
BLAS
Art.: EGU10001B BL 



Embutido
BLAS
Art.: EGU10001B NG 



Embutido cuadrado orientable para dicroica GU10 construido íntegramente en fundición de aluminio.

-  1xGU10, Max 50W, 220V, 50Hz, IP20
-  Blanco texturado, Negro texturado
-  Aluminio
-  Orientable
-  Antideslumbrante
-  Clase II



*Embutido orientable para
dicroica GU10, construido
íntegramente en fundición de
aluminio.*

FIDEL 



Embutido
FIDEL
Art.: EGU10020A BL



Embutido
FIDEL
Art.: EGU10020A NG



Embutido
FIDEL
Art.: EGU10020A NM



Embutido
FIDEL
Art.: EGU10020B BL

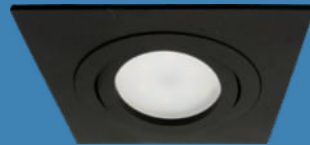



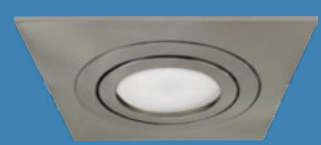

Embutido
FIDEL
Art.: EGU10020B NG

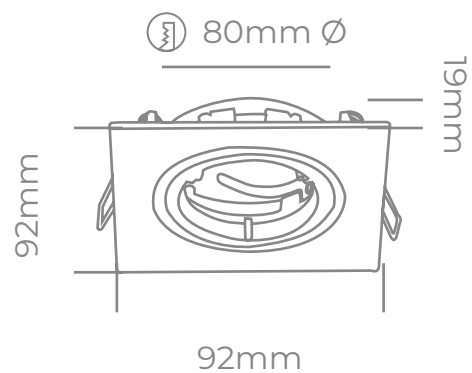
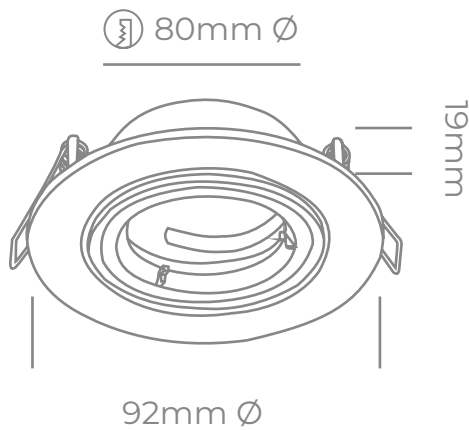

Embutido
FIDEL
Art.: EGU10020B NM



-  1xGU10, Max 50W, 220V, 50Hz, IP20
-  Blanco texturado, Negro texturado, Niquel mate
-  Aluminio
-  Orientable
-  Clase II



Embutido cuadrado orientable para dicroica GU10, construido íntegramente en chapa.

WILBUR



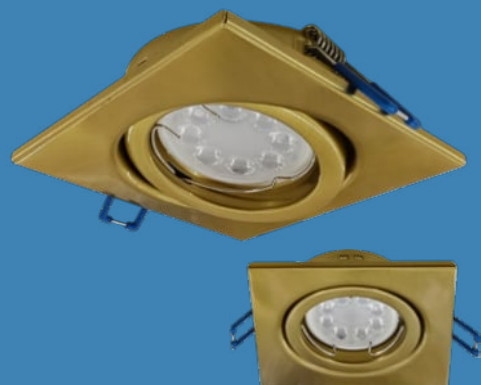

Embutido
WILBUR
Art.: EGU120245 BT



Embutido
WILBUR
Art.: EGU120245 NT







Embutido
WILBUR
Art.: EGU120245 OA

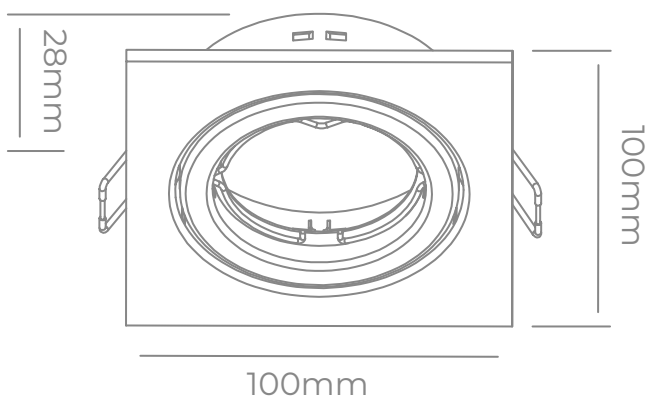

80mm Ø



-  1xGU10, Max 15W, 220V, 50Hz, IP20
-  Blanco texturado, Negro texturado, Oro Antiguo
-  Chapa
-  Orientable
-  Clase II

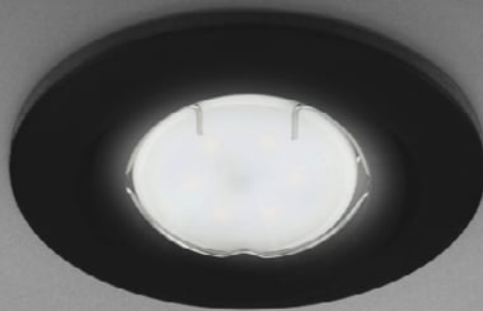

Embutido
WERNER
Art.: EGU120240 NG



Embutido
WERNER
Art.: EGU120240 BL



Embutido
WERNER
Art.: EGU120240 NM



WERNER



*Embutido circular
orientable para dicroica
GU10 construido en chapa.*





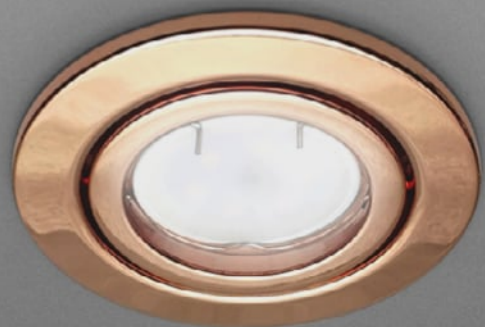

Embutido
WERNER
Art.: EGU120240 OA

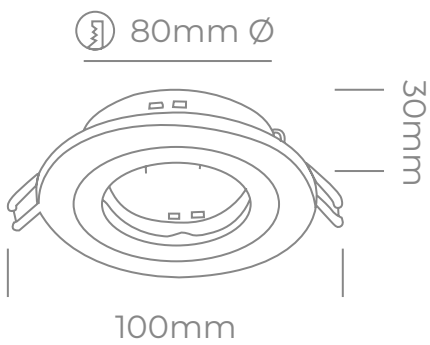

Embutido
WERNER
Art.: EGU120240 CO



-  1xGU10, Max 50W, 220V, 50Hz, IP20
-  Blanco, Negro texturado, Niquel mate, Cobre, Oro Antiguo
-  Chapa
-  Orientable
-  Clase II

AFRO



*Embutido orientable para
dicroica GU10 construido en
chapa. Antideslumbrante.*



Embutido

AFRO 1

Art.: EGU30101 BT



Embutido

AFRO 1

Art.: EGU30101 NT



90mm Ø

38mm

100mm

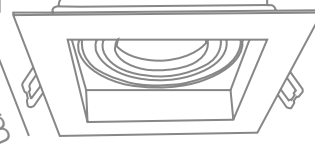

100mm

- 1xGU10, Max 15W, 220V, 50Hz, IP20
- Blanco texturado, Negro Texturado
- Chapa
- Orientable
- Clase II



Embutido
AFRO 1
Art.: EGU30102 BT



Embutido
AFRO 1
Art.: EGU30103 BT



Embutido
AFRO 1
Art.: EGU30102 NT



Embutido
AFRO 1
Art.: EGU30103 NT

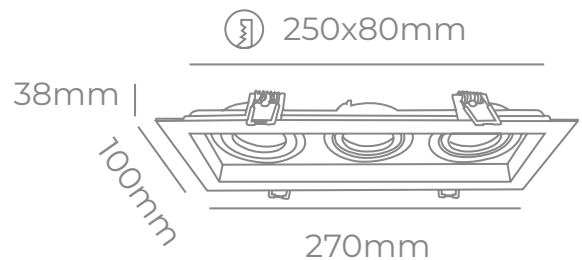
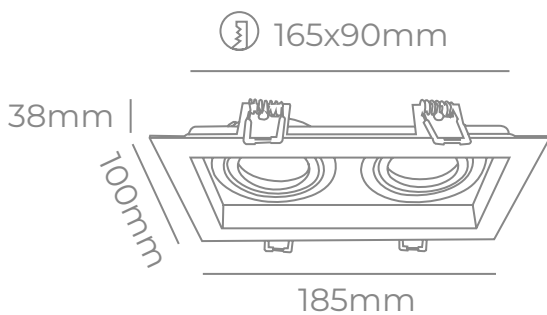

- 2xGU10, Max 15W, 220V, 50Hz, IP20
- Blanco texturado, Negro texturado
- Chapa
- Orientable
- Clase II

- 3xGU10, Max 15W, 220V, 50Hz, IP20
- Blanco texturado, Negro texturado
- Chapa
- Orientable
- Clase II

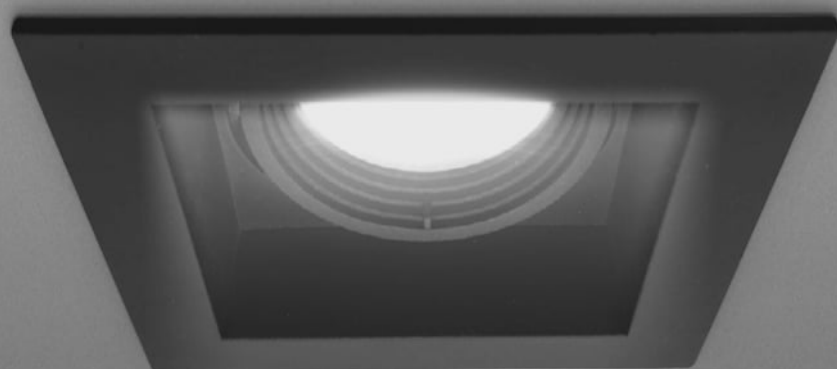

Embutido de 1,2 y 3 luces,
para dicroica GU10,
construido en fundición de
aluminio. Antideslumbrante.

TRUMAN

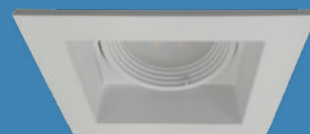



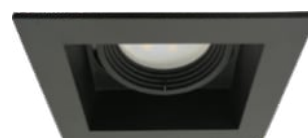

Embutido
TRUMAN 1
Art.: EGU170301 BL

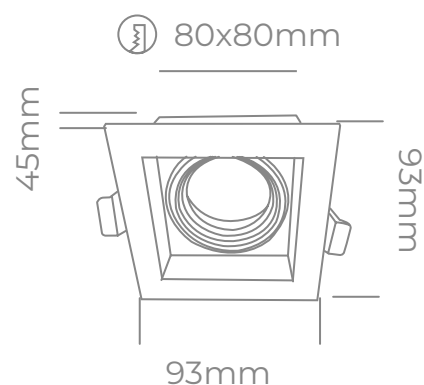

Embutido
TRUMAN 1
Art.: EGU170301 NG



-  1xGU10, Max 50W, 220V, 50Hz, IP20
-  Blanco texturado, Negro texturado
-  Aluminio
-  Orientable
-  Clase II



Embutido
TRUMAN 2
Art.: EGU170302 BL



Embutido
TRUMAN 3
Art.: EGU170303 BL









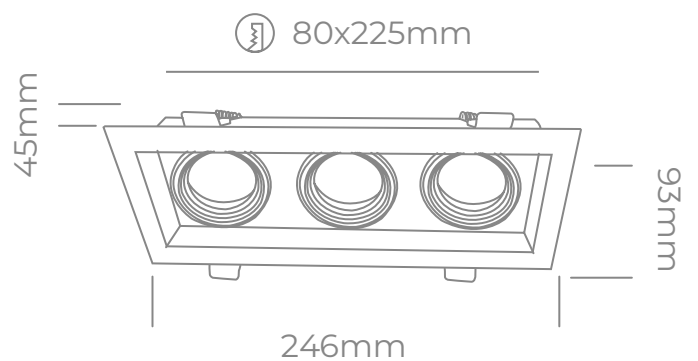
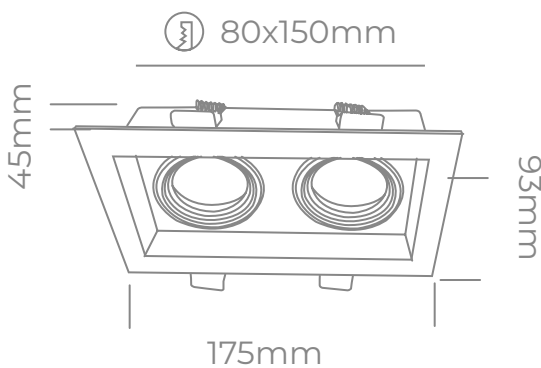



Embutido
TRUMAN 2
Art.: EGU170302 NG



Embutido
TRUMAN 3
Art.: EGU170303 NG



-  2xGU10, Max 50W, 220V, 50Hz, IP20
-  Blanco texturado, Negro texturado
-  Aluminio
-  Orientable
-  Clase II

-  3xGU10, Max 50W, 220V, 50Hz, IP20
-  Blanco texturado, Negro texturado
-  Aluminio
-  Orientable
-  Clase II

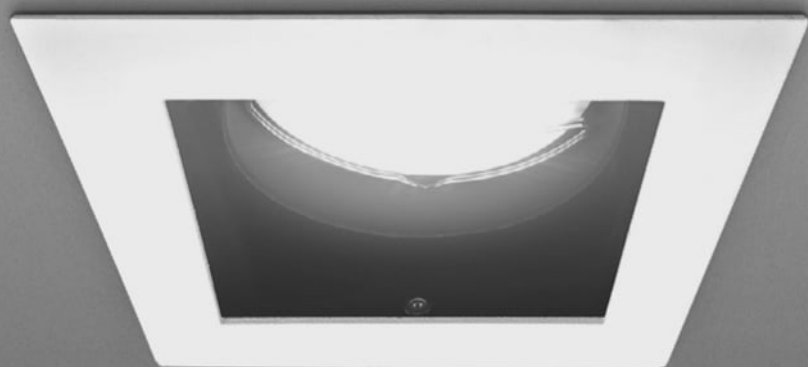

Embutido cuadrado antideslumbrante orientable para dicroica GU10, construido en chapa.

ROQUE



Embutido
ROQUE 1
Art.: EGU150401 BL



Embutido
ROQUE 1
Art.: EGU150401 NG

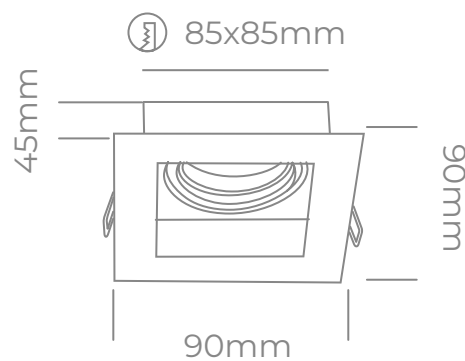

- 1xGU10, Max 50W, 220V, 50Hz, IP20
- Blanco texturado, Negro texturado
- Chapa
- Orientable
- Clase II



Embutido
ROQUE 2
Art.: EGU150402 BL



Embutido
ROQUE 3
Art.: EGU150403 BL



Embutido
ROQUE 2
Art.: EGU150402 NG



Embutido
ROQUE 3
Art.: EGU150403 NG

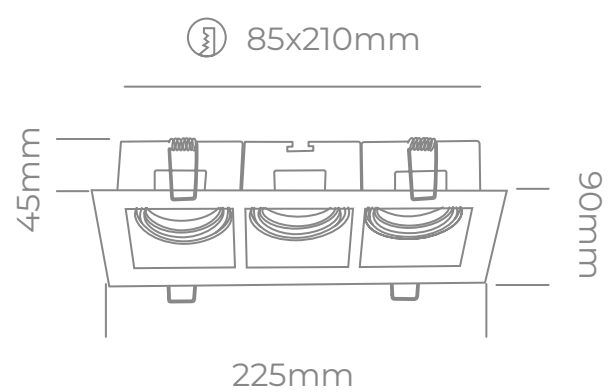
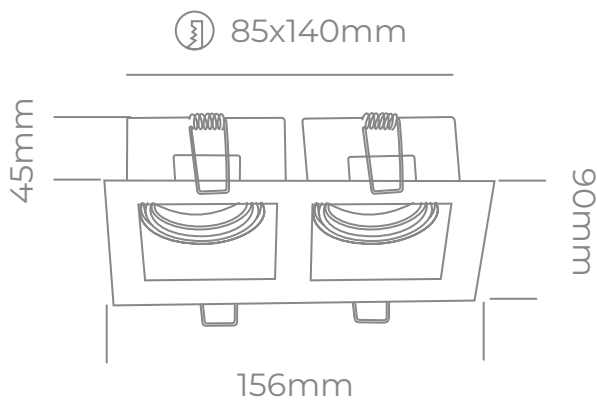

- 2xGU10, Max 50W, 220V, 50Hz, IP20
- Blanco texturado, Negro texturado
- Chapa
- Orientable
- Clase II

- 3xGU10, Max 50W, 220V, 50Hz, IP20
- Blanco texturado, Negro texturado
- Chapa
- Orientable
- Clase II



ROQUE



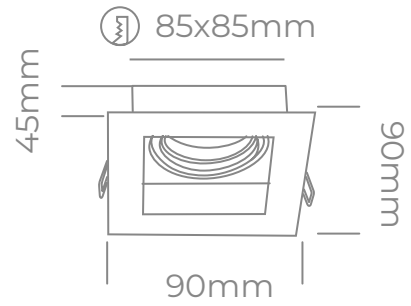
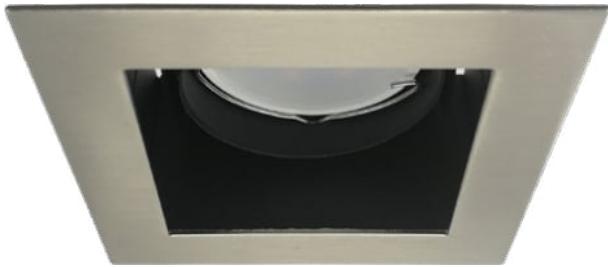

Embutido

ROQUE 1

Art.: EGU150401 NM



1xGU10, Max 50W, 220V, 50Hz, IP20

Niquel mate

Chapa

Orientable

Clase II

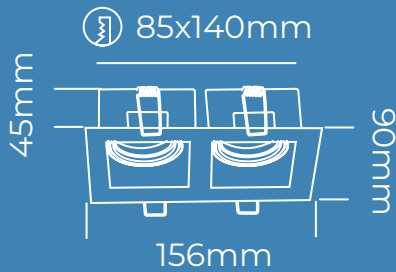

Aplique

ROQUE 2

Art.: EGU150402 NM



2xGU10, Max 50W, 220V, 50Hz, IP20

Niquel mate

Chapa

Orientable

Clase II

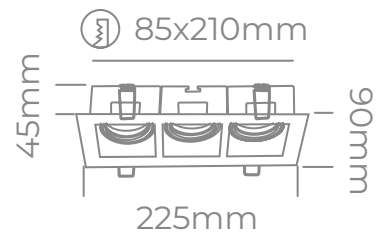

Aplique

ROQUE 3

Art.: EGU150403 NM



3xGU10, Max 50W, 220V, 50Hz, IP20

Niquel mate

Chapa

Orientable

Clase II





Embutido cardánico para
dicroica GU10, construido en
chapa.

ECUA PARA DICRO

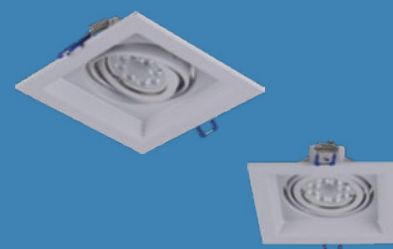

Embutido
ECUA DICRO | 1
Art.: EGU30201 BT



Embutido
ECUA DICRO | 1
Art.: EGU30201 NT



105x105mm

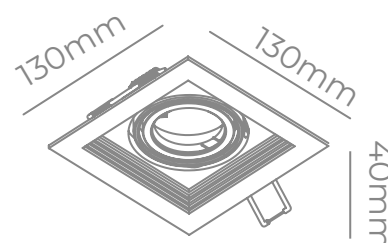

- 1xGU10, Max 15W, 220V, 50Hz, IP20
- Blanco texturado, Negro texturado
- Chapa
- Cardánico
- Clase II



Embutido
ECUA DICRO | 2
Art.: EGU30202 BT

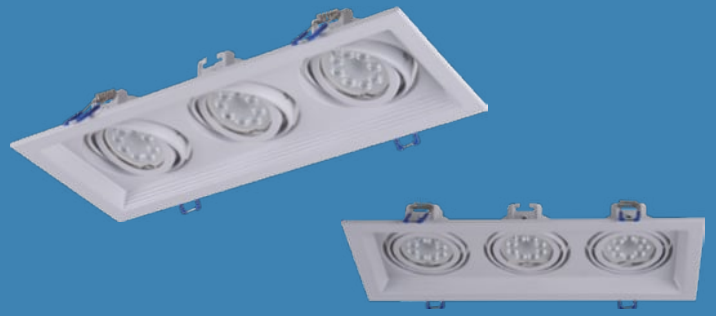

Embutido
ECUA DICRO | 3
Art.: EGU30203 BT



Embutido
ECUA DICRO | 2
Art.: EGU30202 NT



⌀ 195x105mm

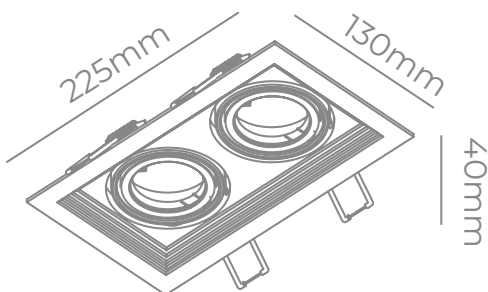







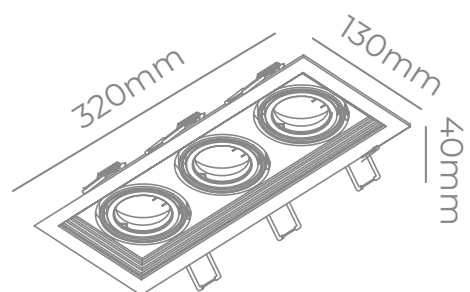



Embutido
ECUA DICRO | 3
Art.: EGU30203 NT



⌀ 200x105mm



-  2xGU10, Max 15W, 220V, 50Hz, IP20
-  Blanco texturado, Negro texturado
-  Chapa
-  Cardánico
-  Clase II

-  3xGU10, Max 15W, 220V, 50Hz, IP20
-  Blanco texturado, Negro texturado
-  Chapa
-  Cardánico
-  Clase II



*Embutido cardánico
para lámpara tipo AR111,
construido en chapa.*

ECUA PARA AR111



Embutido
ECUA AR111 | 1
Art.: EGU40101 BT







Embutido
ECUA AR111 | 1
Art.: EGU40101 NT

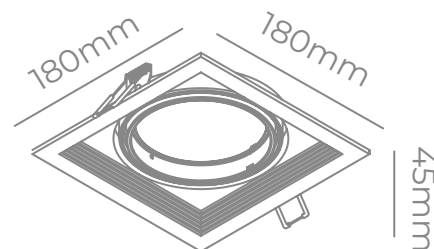

⌀ 160x160mm



-  1xAR111, Max 15W, 220V, 50Hz, IP20
-  Blanco texturado, Negro texturado
-  Chapa
-  Cardánico
-  Clase II



Embutido
ECUA AR111 | 2
Art.: EGU40102 BT



Embutido
ECUA AR111 | 3
Art.: EGU40103 BT



Embutido
ECUA AR111 | 2
Art.: EGU40102 NT



Embutido
ECUA AR111 | 3
Art.: EGU40103 NT





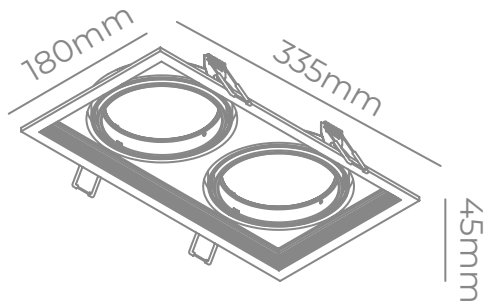



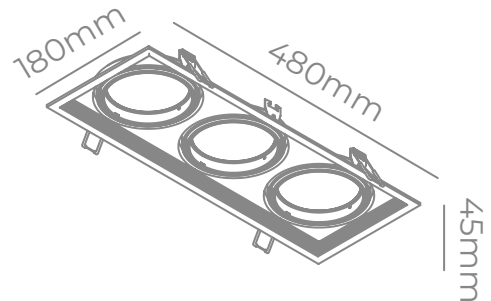



⌀ 305x160mm



⌀ 460x160mm



-  2xAR111, Max 15W, 220V, 50Hz, IP20
-  Blanco texturado, Negro texturado
-  Chapa
-  Cardánico
-  Clase II

-  3xAR111, Max 15W, 220V, 50Hz, IP20
-  Blanco texturado, Negro texturado
-  Chapa
-  Cardánico
-  Clase II



*Embutido cardánico
para lámpara tipo AR11,
construido en chapa.*

ZAFIR



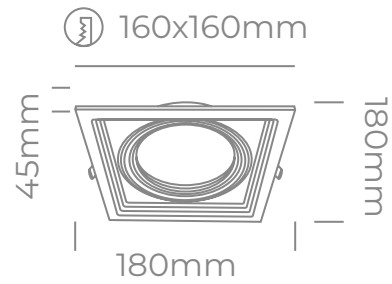

Aplique

ZAFIR 1

Art.: EGU110401 BL



1xAR111, Max 50W, 220V, 50Hz, IP20

Blanco texturado

Chapa

Cardánico

Clase II

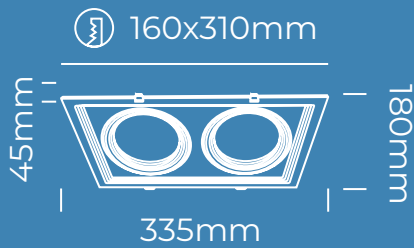

Aplique

ZAFIR 2

Art.: EGU110402 BL



2xAR111, Max 50W, 220V, 50Hz, IP20

Blanco texturado

Chapa

Cardánico

Clase II

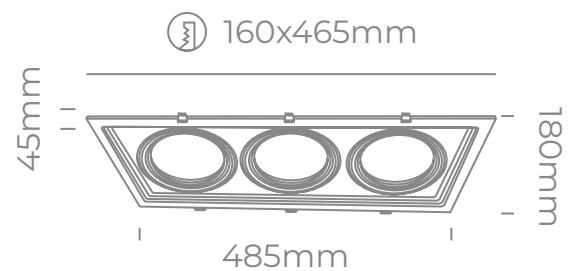

Aplique

ZAFIR 3

Art.: EGU110401 BL



3xAR111, Max 50W, 220V, 50Hz, IP20

Blanco texturado

Chapa

Cardánico

Clase II





Embutido cuadrado orientable para AR111, construido íntegramente en Chapa.

ZAC 







Embudo
ZAC
Art.: EGU120340 BL

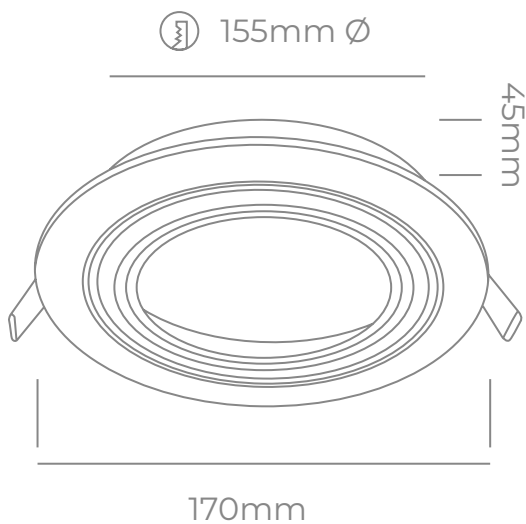

Embudo
ZAC
Art.: EGU120340 NG



-  1xAR111, Max 50W, 220V, 50Hz, IP20
-  Blanco texturado, Negro texturado
-  Chapa
-  Cardánico
-  Clase II





LUMINARIAS DE APLICAR PARA INTERIOR







Luminaria Semi Embutida
BALCONY I
Art.: AGU85001A BT



Luminaria Semi Embutida
BALCONY I
Art.: AGU85001A NT



-  1xGU10, Max 7W, 220V, 50Hz, IP20
-  Blanco texturado, Negro texturado
-  Chapa
-  Orientable
-  Clase I

BALCONY I



Luminaria semi embutida circular orientable para dicroica GU10, construida íntegramente en chapa de acero. Para aplicar sobre caja octogonal chica.

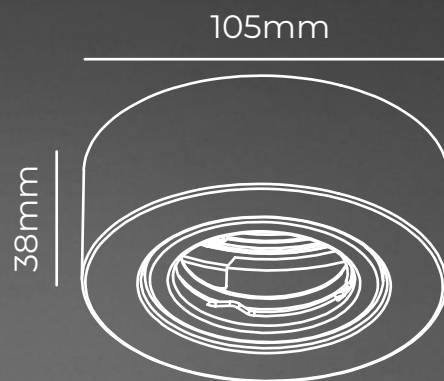

BALCONY II

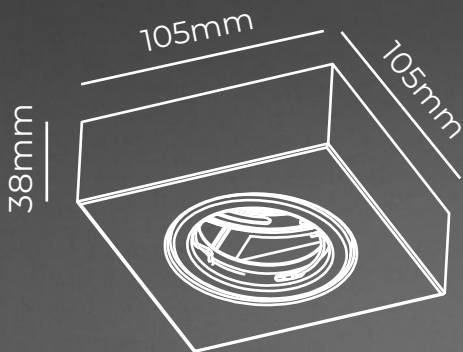

Luminaria semi embutida cuadrada orientable para dicroica GU10, construida íntegramente en chapa de acero. Para aplicar sobre caja octogonal chica.







Luminaria Semi Embutida
BALCONY II
Art.: AGU87001A BT



Luminaria Semi Embutida
BALCONY II
Art.: AGU87001A NT



-  1xGU10, Max 7W, 220V, 50Hz, IP20
-  Blanco texturado, Negro texturado
-  Chapa
-  Orientable
-  Clase I



Luminaria Semi Embutida

GALLERY I

Art.: AGU85001B BT



Luminaria Semi Embutida

GALLERY I

Art.: AGU85001B NT



GALLERY I



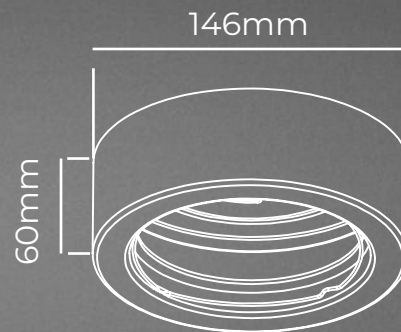

Luminaria semi embutida circular orientable para AR111, construida íntegramente en chapa de acero. Para aplicar sobre caja octogonal chica.

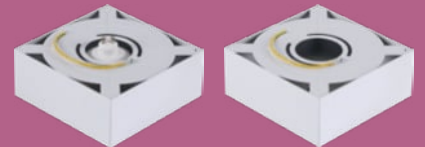

- 1xAR111, Max 7W, 220V, 50Hz, IP20
- Blanco texturado, Negro texturado
- Chapa
- Orientable
- Clase I

GALLERY II





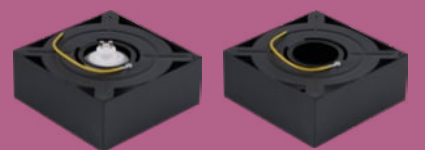

Luminaria Semi Embutida
GALLERY II
Art.: AGU87001B BT 

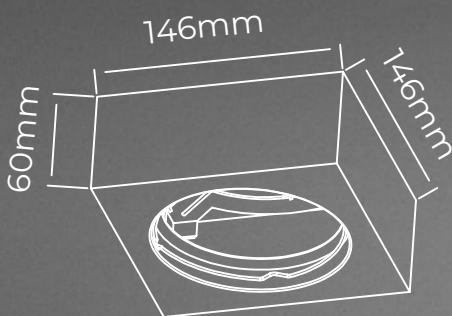

Luminaria Semi Embutida
GALLERY II
Art.: AGU87001B NT 



Luminaria semi embutida cuadrada orientable para AR111 construida íntegramente en chapa de acero. Para aplicar sobre caja octogonal chica.

-  1xAR111, Max 7W, 220V, 50Hz, IP20
-  Blanco texturado, Negro texturado
-  Chapa
-  Orientable
-  Clase I

Plafón cardánico para dicroica GU10 construido en chapa.



PLAFÓN ECUA PARA DICRO



Plafón
ECUA DICRO 1
Art.: AGU80001 BT



Plafón
ECUA DICRO 1
Art.: AGU80001 NT

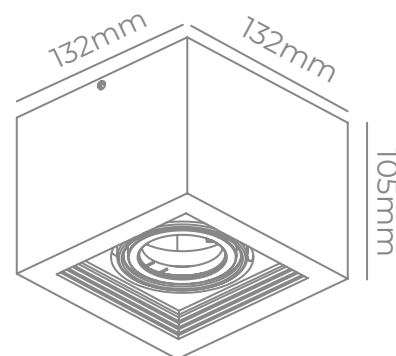

- 1xGU10, Max 7W, 220V, 50Hz, IP20
- Blanco texturado, Negro texturado
- Chapa
- Cardánico
- Clase I



Plafón
ECUA DICRO 2
Art.: AGU80002 BT



Plafón
ECUA DICRO 3
Art.: AGU80003 BT









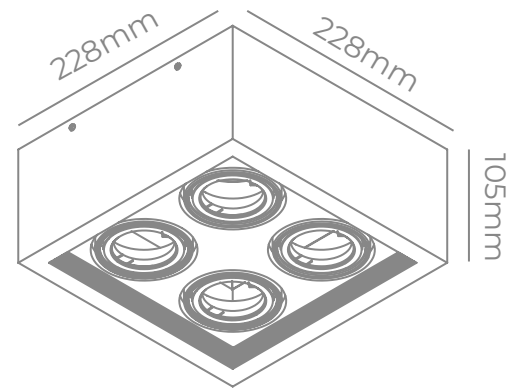
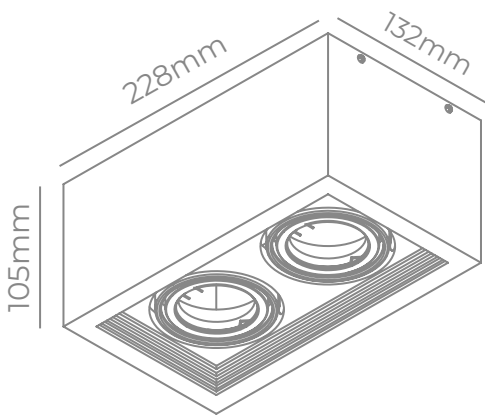



Plafón
ECUA DICRO 2
Art.: AGU80002 NT



Plafón
ECUA DICRO 3
Art.: AGU80003 NT



-  2xGU10, Max 7W, 220V, 50Hz, IP20
-  Blanco texturado, Negro texturado
-  Chapa
-  Cardánico
-  Clase I

-  3xGU10, Max 7W, 220V, 50Hz, IP20
-  Blanco texturado, Negro texturado
-  Chapa
-  Cardánico
-  Clase I

Plafón cardánico para lámpara tipo AR111 construido en chapa.



PLAFÓN ECUA PARA AR111







Plafón
ECUA AR111 | 1
Art.: AGU90001A BT

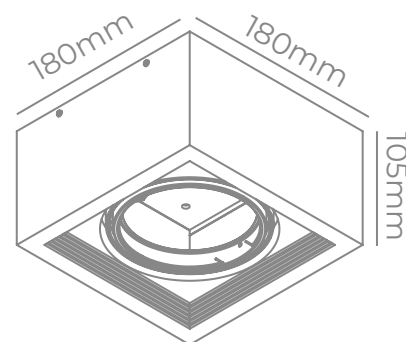

Plafón
ECUA AR111 | 1
Art.: AGU90001A NT



-  1xAR111, 220V, 50Hz, IP20
-  Blanco texturado, Negro texturado
-  Chapa
-  Cardánico
-  Clase I



Plafón
ECUA AR111 | 2
Art.: AGU90002A BT



Plafón
ECUA AR111 | 3
Art.: AGU90003A BT









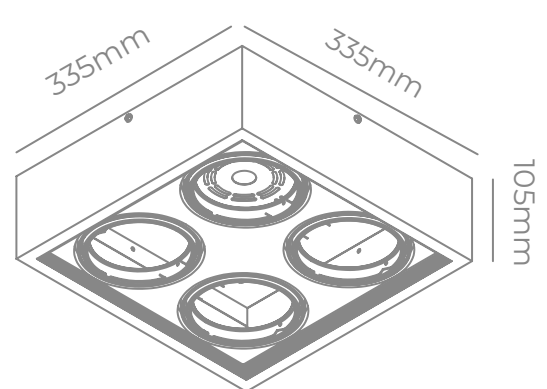
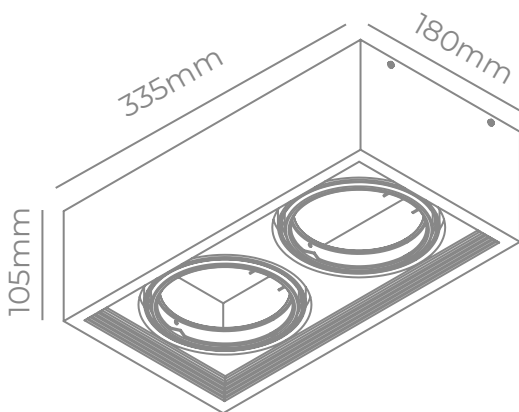



Plafón
ECUA AR111 | 2
Art.: AGU90002A NT



Plafón
ECUA AR111 | 3
Art.: AGU90003A NT



-  2xAR111, 220V, 50Hz, IP20
-  Blanco texturado, Negro texturado
-  Chapa
-  Cardánico
-  Clase I

-  4xAR111, 220V, 50Hz, IP20
-  Blanco texturado, Negro texturado
-  Chapa
-  Cardánico
-  Clase I



ASIN



Plafón

ASIN

Art.: AGU93005 BT



Plafón

ASIN

Art.: AGU93005 NT



1xAR111, 220V, 50Hz, IP20



Blanco texturado, Negro texturado



Aluminio



Fijo



Clase I

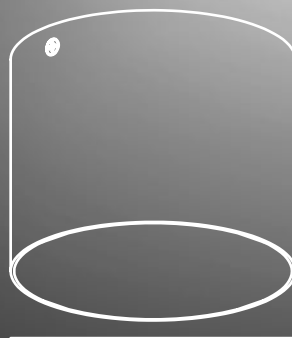

95mm

120mm

Plafón monovolumen cilíndrico fijo para lámpara tipo AR111 construido íntegramente en fundición de aluminio.



SENKU

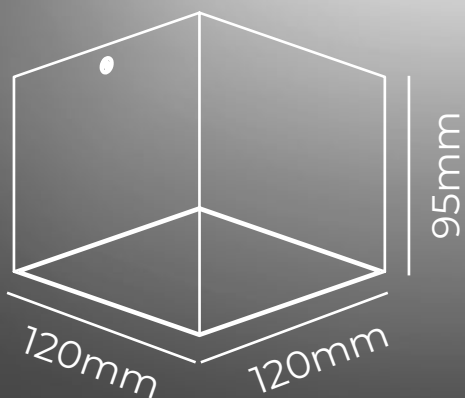

Plafón monovolumen cúbico fijo para lámpara tipo AR111 construido íntegramente en fundición de aluminio.







Plafón
SENKU
Art.: AGU93010 BT



Plafón
SENKU
Art.: AGU93010 NT



-  1xAR111, 220V, 50Hz, IP20
-  Blanco texturado, Negro texturado
-  Aluminio
-  Fijo
-  Clase I

TONA



*Plafón cilíndrico orientable
para lámpara tipo AR111
construido íntegramente en
fundición de aluminio.*





Plafón
TONA
Art.: AGU93015 BT







Plafón
TONA
Art.: AGU93015 NT

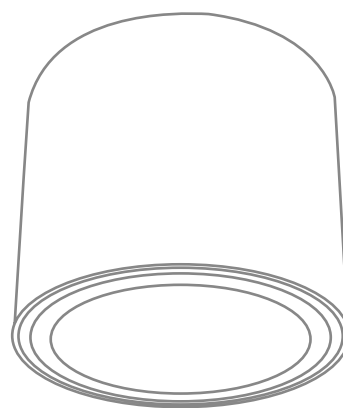

135mm



105mm

-  1xAR111, 220V, 50Hz, IP20
-  Blanco texturado, Negro texturado
-  Aluminio
-  Orientable
-  Clase I

●●●●● CALA



Cabezal
CALA
Art.: CGU6820 BT



Cabezal
CALA
Art.: CGU6820 NT



- 1xGU10, Max 15W, 220V, 50Hz, IP20
- Negro texturado
- Aluminio
- Orientable
- Clase I

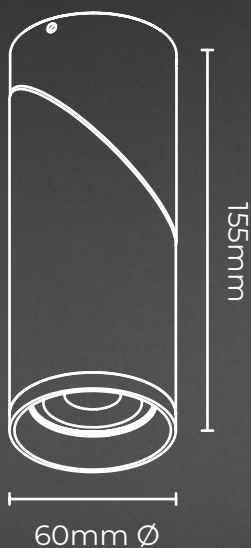

Cabezal orientable para lámpara GU10, construido en fundición de aluminio.

RUNA



Cabezal orientable para lámpara GU10, construido en fundición de aluminio.







Cabezal
RUNA
Art.: CGU6715 BT



Cabezal
RUNA
Art.: CGU6715 NT



-  1xGU10, Max 15W, 220V, 50Hz, IP20
-  Blanco texturado
-  Aluminio
-  Orientable
-  Clase I

 **LALO**







Cabezal
LALO
Art.: CGU6720 BT

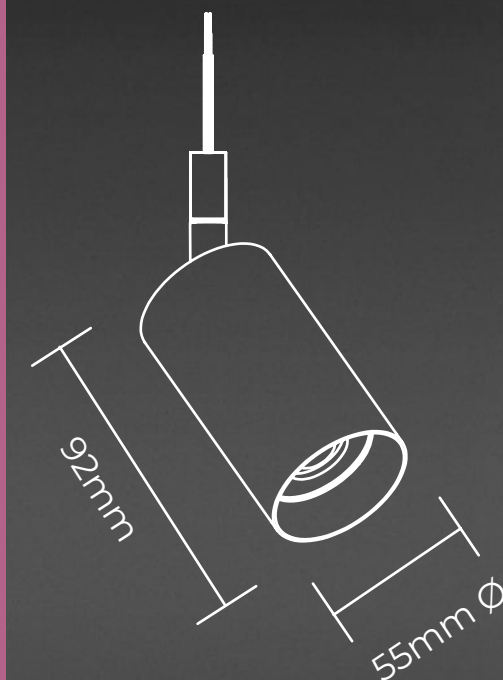

Cabezal
LALO
Art.: CGU6720 NT



Cabezal orientable para lámpara GU10 construido en fundición de aluminio.

-  1xGU10, Max 15W, 220V, 50Hz, IP20
-  Negro texturado
-  Aluminio
-  Orientable
-  Clase I

FORK



Cabezal
FORK
Art.: CGU6900 BT



Cabezal
FORK
Art.: CGU6900 NT



Cabezal orientable para lámpara GU10 construido en fundición de aluminio.

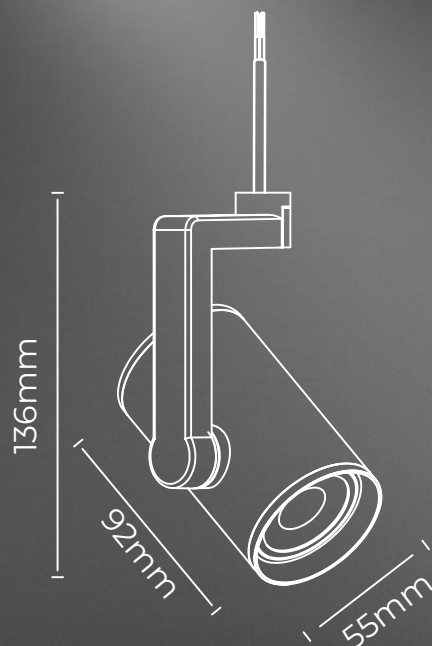

- 1xGU10, Max 15W, 220V, 50Hz, IP20
- Blanco texturado, Negro Texturado
- Aluminio
- Orientable
- Clase I

WEBB



*Cabezal orientable para
lámpara GU10 construido
íntegramente en aluminio.*







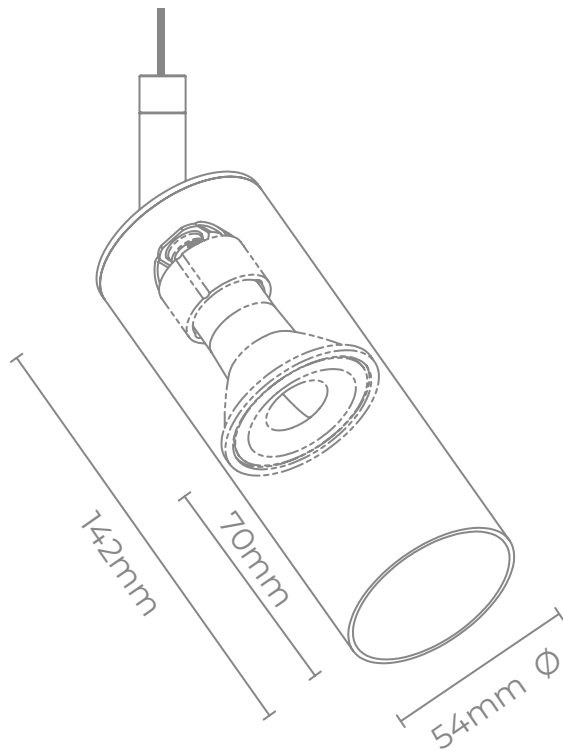

Cabezal
WEBB
Art.: CGU6950 BT



Cabezal
WEBB
Art.: CGU6950 NT



-  1xGU10, Max 15W, 220V, 50Hz, IP20
-  Blanco texturado, Negro Texturado
-  Aluminio
-  Orientable
-  Antideslumbrante
-  Clase I



Cabezal
LUPE
Art.: CGU8000 BT



Cabezal
LUPE
Art.: CGU8000 NT



- 1xAR111, Max 15W, 220V, 50Hz, IP20
- Negro texturado
- Aluminio
- Orientable
- Clase I



LUPE

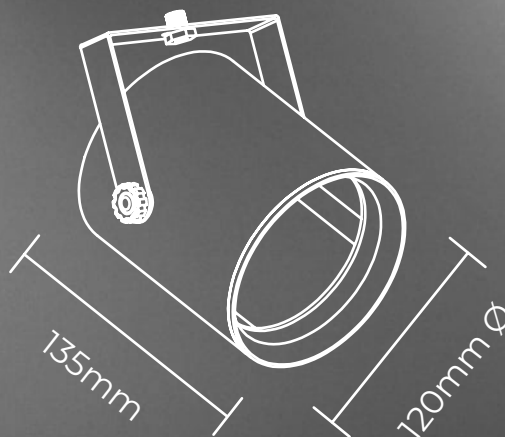

Cabezal orientable para lámpara AR111 construido en fundición de aluminio.

CINEMA

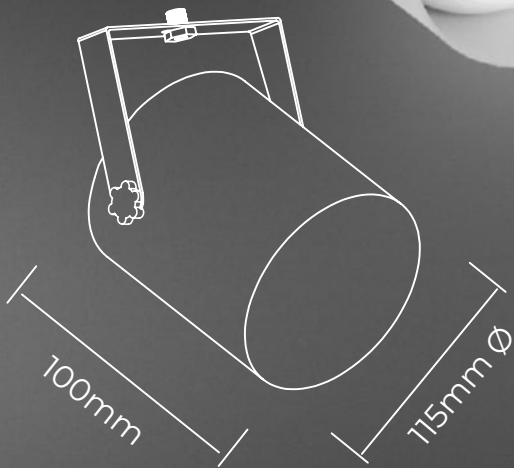

Cabezal orientable para lámpara AR111 construido en chapa de acero.







Cabezal
CINEMA
Art.: CGU8050 BT



Cabezal
CINEMA
Art.: CGU8050 NT



-  1xAR111, Max 15W, 220V, 50Hz, IP20
-  Blanco texturado, Negro texturado
-  Chapa
-  Orientable
-  Clase I

C700



*Cabezal orientable para
lámpara AR111 construido
íntegramente en chapa de
acero.*



Cabezal
C700
Art.: C700/BT







Cabezal
C700
Art.: C700/NT

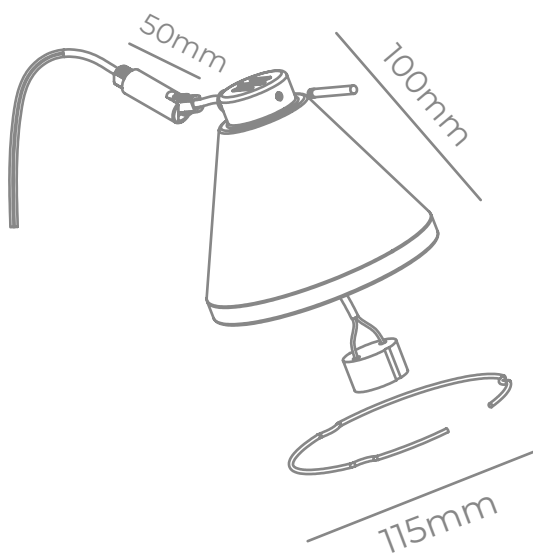

Cabezal
C700
Art.: C700/PL



-  1xAR111, Max 50W, 220V, 50Hz, IP20
-  Blanco texturado, Negro texturado, Platil
-  Chapa
-  Orientable
-  Clase I

TAPA090

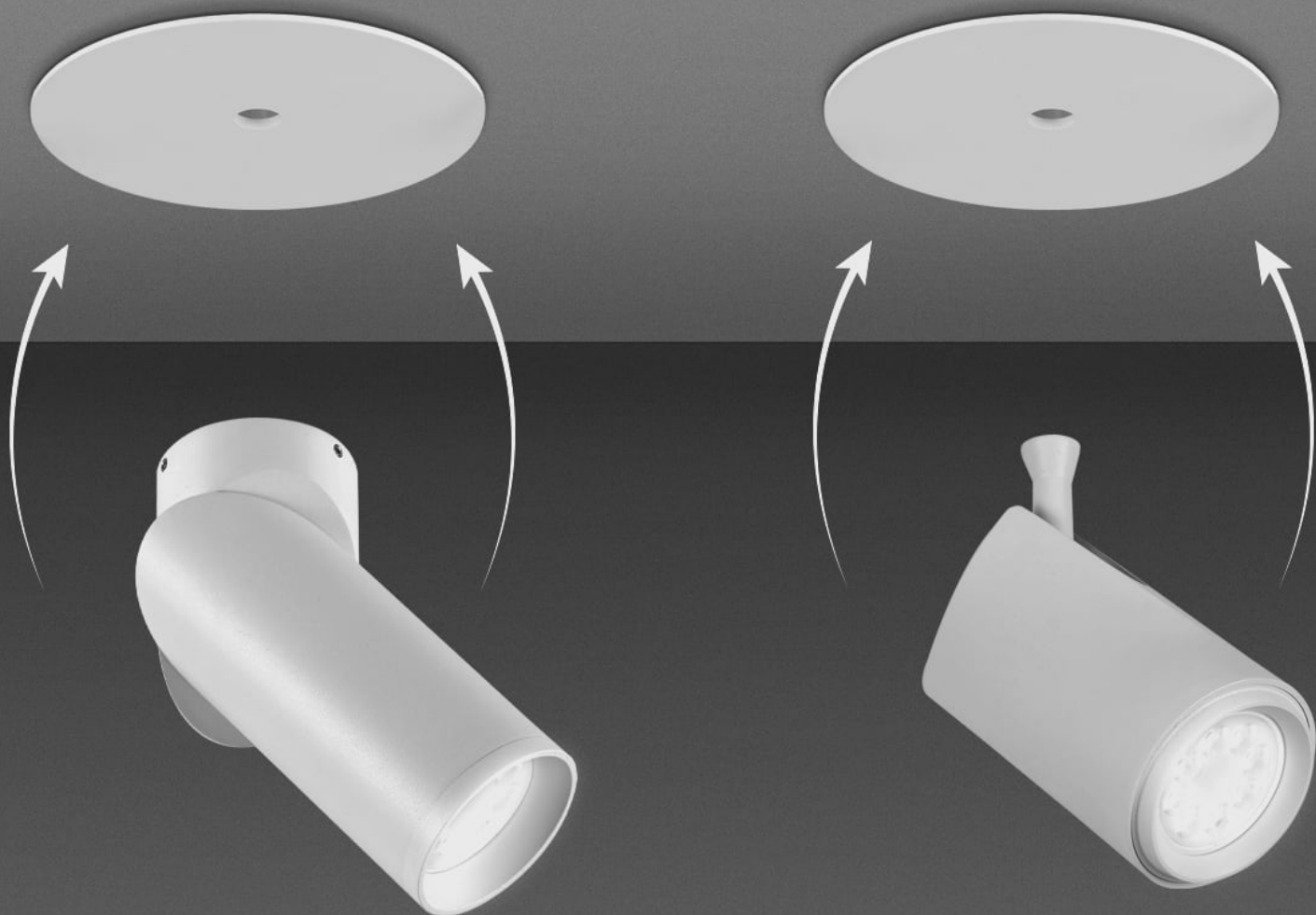

*Tapa ciega con resortes.
Ideal para ser utilizada con
cabezales.*





Tapa ciega
TAPA090
Art.: TAPA090 BT

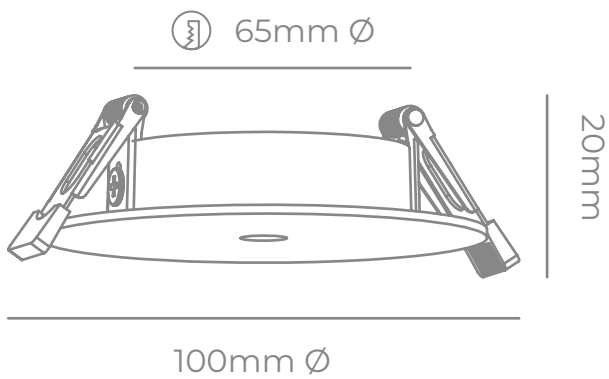

Tapa ciega
TAPA090
Art.: TAPA090 NT



-  Blanco texturado, Negro texturado
-  Chapa





SISTEMAS PARA LÁMPARAS LED

*Apliques GU10 de 1 a 3 luces.
Bases construidas en chapa de acero,
cabezales de aluminio.*



APLIQUE EITU

 Con interruptor en base

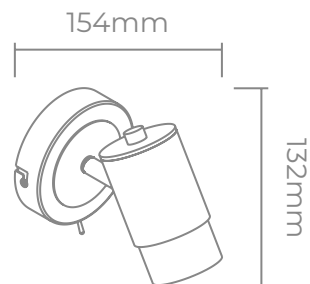





Aplique

EITU 1

Art.: C310/1 NG-OA



-  1xGU10, Max 7W, 220V, 50Hz, IP20
-  Negro mate+Oro Antiguo
-  Chapa de acero
-  Orientable
-  Clase I

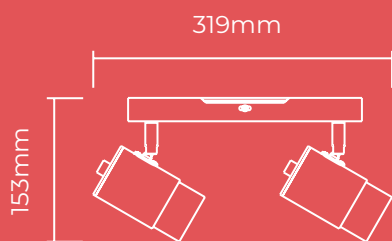





Aplique

EITU 2

Art.: C310/2 NG-OA



-  2xGU10, Max 7W, 220V, 50Hz, IP20
-  Negro mate+Oro Antiguo
-  Chapa de acero
-  Orientable
-  Clase I

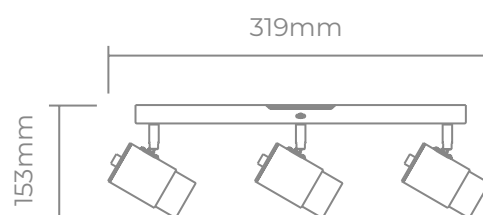





Aplique

EITU 3

Art.: C310/3 NG-OA



-  3xGU10, Max 7W, 220V, 50Hz, IP20
-  Negro mate+Oro Antiguo
-  Chapa de acero
-  Orientable
-  Clase I



Apliques GU10 de 1 a 3 luces
construidos en chapa.



APLIQUE EITU



Aplique
EITU 1
Art.: C310/1 NT







Aplique
EITU 1
Art.: C310/1 BT

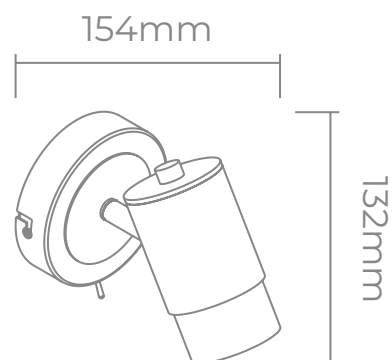

 Con interruptor en base



-  1xGU10, Max 7W, 220V, 50Hz, IP20
-  Blanco texturado
-  Chapa de acero
-  Orientable
-  Clase I



Aplique
EITU 2
Art.: C310/2 NT



Aplique
EITU 3
Art.: C310/3 NT



Aplique
EITU 2
Art.: C310/2 BT



Aplique
EITU 3
Art.: C310/3 BT

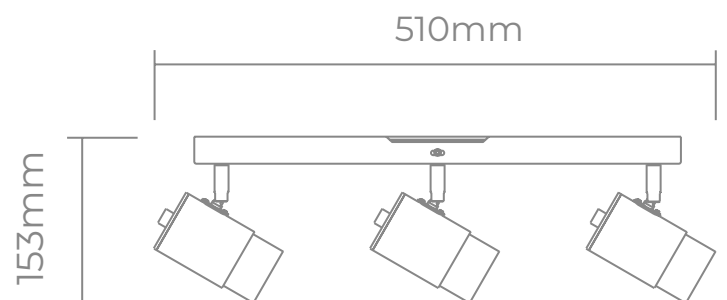
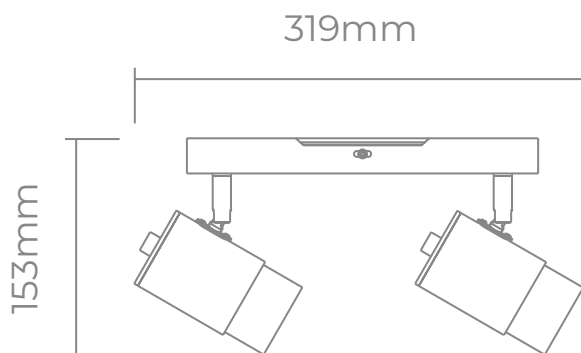

- 2xGU10, Max 7W, 220V, 50Hz, IP20
- Blanco texturado
- Chapa de acero
- Orientable
- Clase I

- 3xGU10, Max 7W, 220V, 50Hz, IP20
- Blanco texturado
- Chapa de acero
- Orientable
- Clase I

*Apliques GU10 de 1 a 3 luces
construidos en chapa.*



APLIQUE POLA

 Con interruptor en base

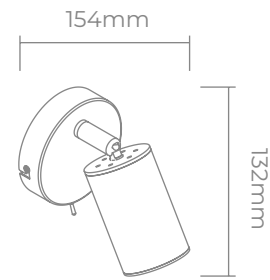





Applique

POLA 1

Art.: C330/1 NG-OA



-  1xGU10, Max 7W, 220V, 50Hz, IP20
-  Negro texturado, Oro Antiguo
-  Chapa de acero
-  Orientable
-  Clase I

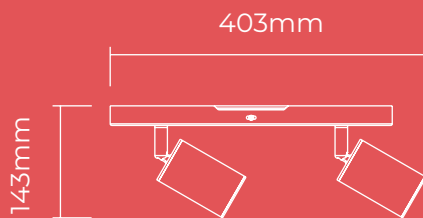





Applique

POLA 2

Art.: C330/2 NG-OA



-  2xGU10, Max 7W, 220V, 50Hz, IP20
-  Negro texturado, Oro Antiguo
-  Chapa de acero
-  Orientable
-  Clase I

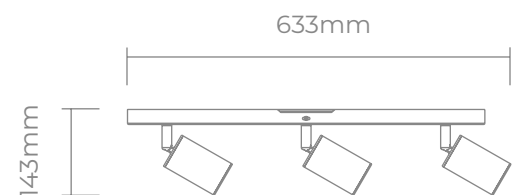





Applique

POLA 3

Art.: C330/3 NG-OA



-  3xGU10, Max 7W, 220V, 50Hz, IP20
-  Negro texturado, Oro Antiguo
-  Chapa de acero
-  Orientable
-  Clase I

Apliques GU10 de 1 a 3 luces
construidos en chapa.



APLIQUE POLA



Aplique
POLA 1
Art.: C330/1 NT







Aplique
POLA 1
Art.: C330/1 BT

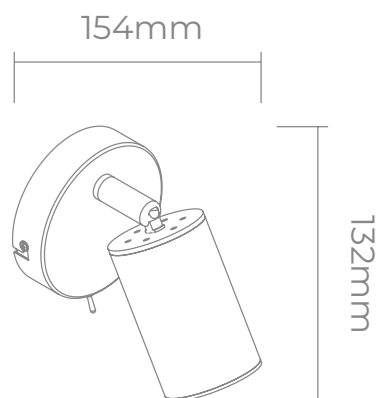

 Con interruptor en base



-  1xGU10, Max 7W, 220V, 50Hz, IP20
-  Negro texturado, Blanco texturado
-  Chapa de acero
-  Orientable
-  Clase I



Aplique
POLA 2
Art.: C330/2 NT



Aplique
POLA 3
Art.:C330/3 NT



Aplique
POLA 2
Art.: C330/2 BT



Aplique
POLA 3
Art.: C330/3 BT

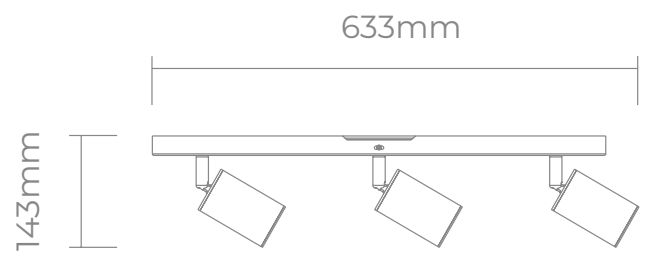
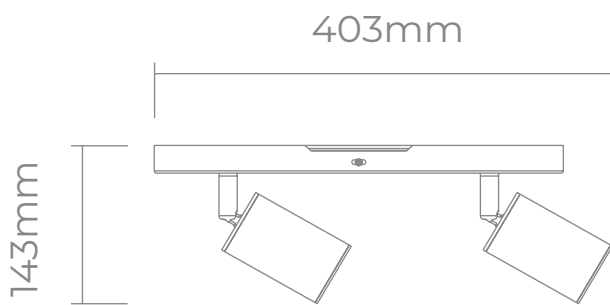

- 2xGU10, Max 7W, 220V, 50Hz, IP20
- Negro texturado, Blanco texturado
- Chapa de acero
- Orientable
- Clase I

- 3xGU10, Max 7W, 220V, 50Hz, IP20
- Negro texturado, Blanco texturado
- Chapa de acero
- Orientable
- Clase I

Apliques GU10 de 1 a 3 luces
construidos en chapa.



APLIQUE CACHEN



Aplique
CACHEN 1
Art.: C320/1 NT









Aplique
CACHEN 1
Art.: C320/1 BT

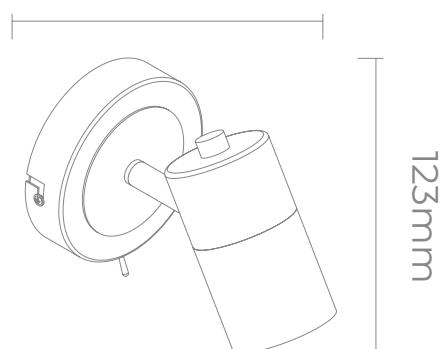

 Con interruptor en base

155mm



-  1xGU10, Max 7W, 220V, 50Hz, IP20
-  Negro texturado, Blanco texturado
-  Chapa de acero
-  Orientable
-  Clase I



Aplique
CACHEN 2
Art.: C320/2 NT



Aplique
CACHEN 3
Art.: C320/3 NT



Aplique
CACHEN 2
Art.: C320/2 BT



Aplique
CACHEN 3
Art.: C320/3 BT

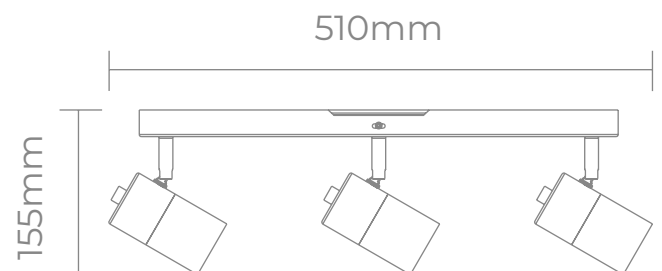
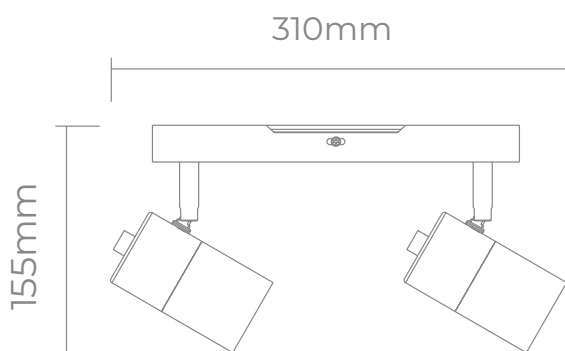

- 2xGU10, Max 7W, 220V, 50Hz, IP20
- Negro texturado, Blanco texturado
- Chapa de acero
- Orientable
- Clase I

- 3xGU10, Max 7W, 220V, 50Hz, IP20
- Negro texturado, Blanco texturado
- Chapa
- Orientable
- Clase I

Apliques GU10 de 1 a 3 luces
construidos en chapa.



APLIQUE MEMO



Aplique
MEMO 1
Art.: C300/1 NT







Aplique
MEMO 1
Art.: C300/1 BT

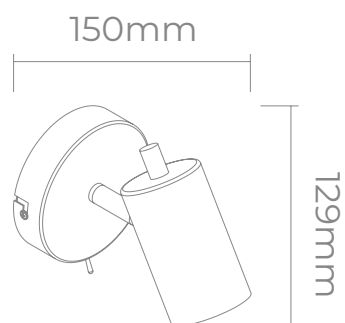

 Con interruptor en base



-  1xGU10, Max 7W, 220V, 50Hz, IP20
-  Negro texturado, Blanco texturado
-  Chapa de acero
-  Orientable
-  Clase I



Aplique
MEMO 2
Art.: C300/2 NT



Aplique
MEMO 3
Art.: C300/3 NT



Aplique
MEMO 2
Art.: C300/2 BT

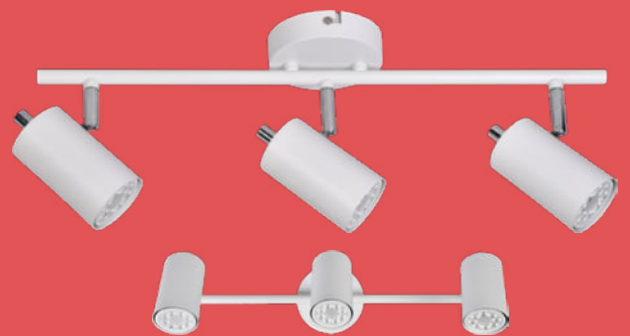

Aplique
MEMO 3
Art.: C300/3 BT

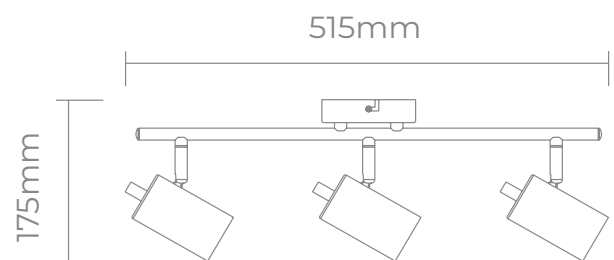
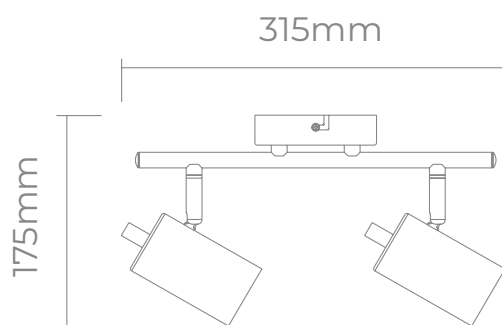

- 2xGU10, Max 7W, 220V, 50Hz, IP20
- Negro texturado, Blanco texturado
- Chapa de acero
- Orientable
- Clase I

- 3xGU10, Max 7W, 220V, 50Hz, IP20
- Negro texturado, Blanco texturado
- Chapa de acero
- Orientable
- Clase I

*Apliques GU10 de 1 a 3 luces
construidos en chapa.*



APLIQUE
AYELEN

 Con interruptor en base

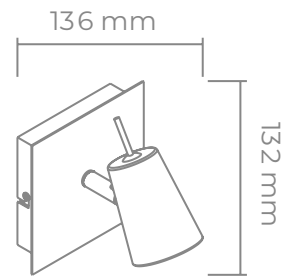





Aplique

AYELEN 1

Art.: C852/1 BL



-  1xGU10, Max 50W, 220V, 50Hz, IP20
-  Blanco mate
-  Chapa de acero
-  Orientable
-  Clase I

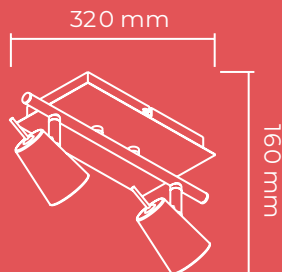





Aplique

AYELEN 2

Art.: C852/2 BL



-  2xGU10, Max 50W, 220V, 50Hz, IP20
-  Blanco mate
-  Chapa de acero
-  Orientable
-  Clase I

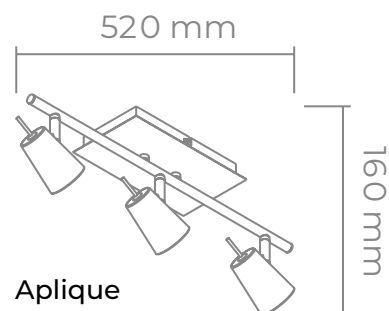





Aplique

AYELEN 3

Art.: C852/3 BL



-  3xGU10, Max 50W, 220V, 50Hz, IP20
-  Blanco mate
-  Chapa de acero
-  Orientable
-  Clase I

Apliques GU10 de 1 a 4 luces
construidos en chapa.



APLIQUE JULITA

 Con interruptor en base

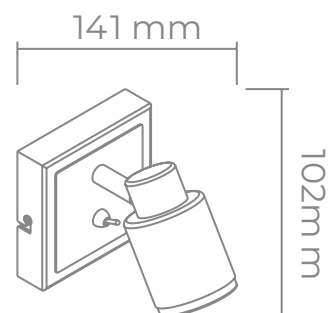





Aplique

JULITA 1

Art.: C791/1 NG



-  1xGU10, Max 50W, 220V, 50Hz, IP20
-  Negro mate
-  Chapa de acero
-  Orientable
-  Clase I

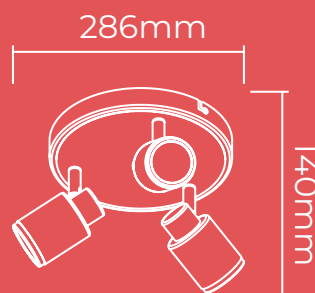





Aplique

JULITA 3 REDONDO

Art.: C791/3R NG



-  3xGU10, Max 50W, 220V, 50Hz, IP20
-  Negro mate
-  Chapa de acero
-  Orientable
-  Clase I

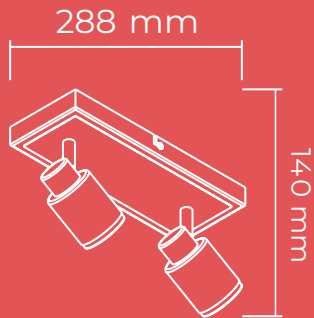

Aplique
JULITA 2
 Art.: C791/2 NG

- 2xGU10, Max 50W, 220V, 50Hz, IP20
- Negro mate
- Chapa de acero
- Orientable
- Clase I

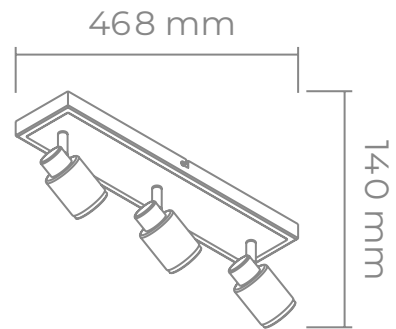

Aplique
JULITA 3
 Art.: C791/3 NG

- 3xGU10, Max 50W, 220V, 50Hz, IP20
- Negro mate
- Chapa de acero
- Orientable
- Clase I

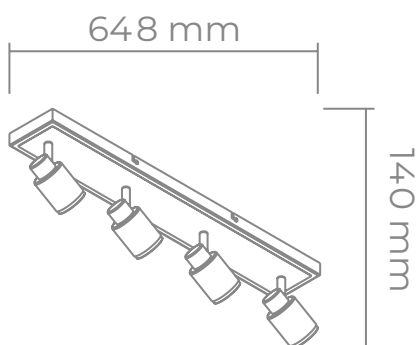

Aplique
JULITA 4 LINEAL
 Art.: C791/4 NG

- 4xGU10, Max 50W, 220V, 50Hz, IP20
- Negro mate
- Chapa de acero
- Orientable
- Clase I

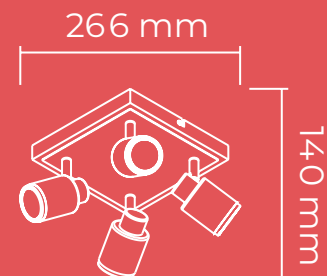

Aplique
JULITA 4 CUADRADO
 Art.: C791/4C NG

- 4xGU10, Max 50W, 220V, 50Hz, IP20
- Negro mate
- Chapa de acero
- Orientable
- Clase I

Apliques GU10 de 1 a 4 luces
construidos en chapa.



APLIQUE JULITA

 Con interruptor en base

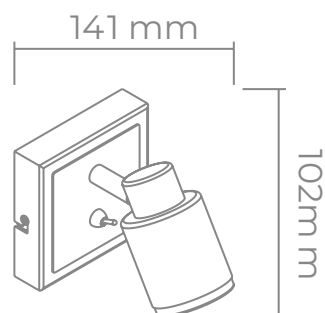





Aplique

JULITA 1

Art.: C791/1 BL



-  1xGU10, Max 50W, 220V, 50Hz, IP20
-  Blanco mate
-  Chapa
-  Orientable
-  Clase I

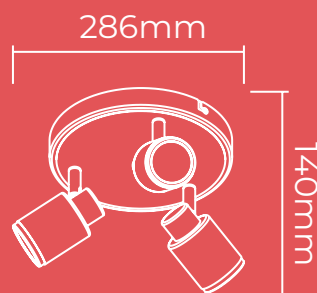





Aplique

JULITA 3 REDONDO





Art.: C791/3R BL

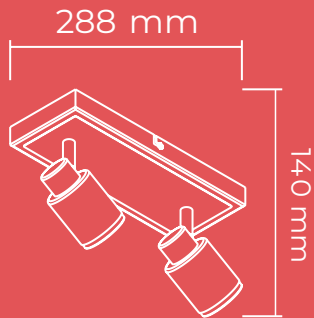

-  3xGU10, Max 50W, 220V, 50Hz, IP20
-  Blanco mate
-  Chapa
-  Orientable
-  Clase I





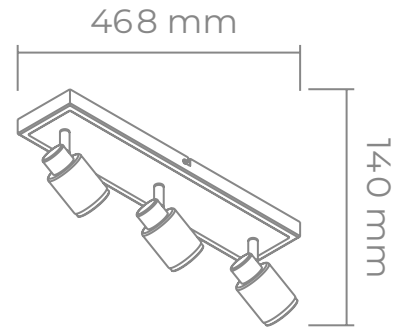

Aplique
JULITA 2
 Art.: C791/2 BL

-  2xGU10, Max 50W, 220V, 50Hz, IP20
-  Blanco mate
-  Chapa
-  Orientable
-  Clase I





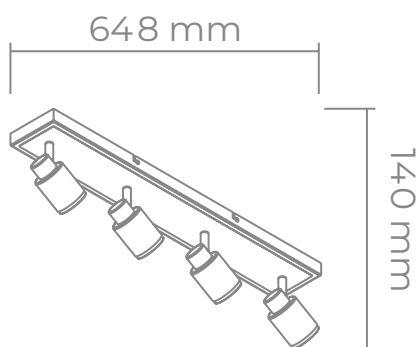

Aplique
JULITA 3
 Art.: C791/3 BL

-  3xGU10, Max 50W, 220V, 50Hz, IP20
-  Blanco mate
-  Chapa
-  Orientable
-  Clase I





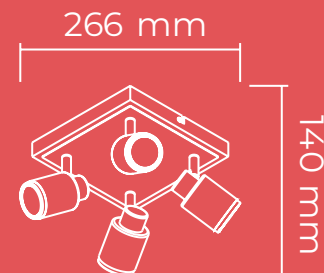

Aplique
JULITA 4 LINEAL
 Art.: C791/4 BL

-  4xGU10, Max 50W, 220V, 50Hz, IP20
-  Blanco mate
-  Chapa
-  Orientable
-  Clase I



Aplique
JULITA 4 CUADRADO
 Art.: C791/4C BL

-  4xGU10, Max 50W, 220V, 50Hz, IP20
-  Blanco mate
-  Chapa
-  Orientable
-  Clase I

*Apliques GU10 de 1 a 3 luces
construidos en chapa.*





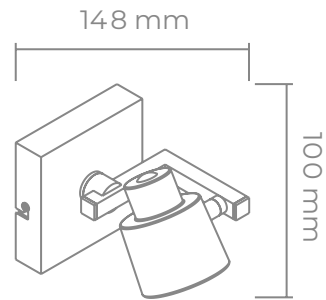

APLIQUE
SHEILA

 Con interruptor en base



Aplique
SHEILA 1
Art.: C684/1 NT





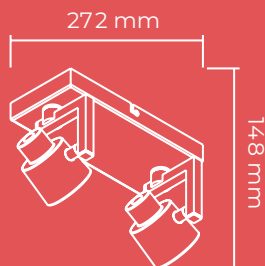

-  1xGU10, Max 50W, 220V, 50Hz, IP20
-  Negro texturado
-  Chapa
-  Orientable
-  Clase I



Aplique
SHEILA 2
Art.: C684/2 NT





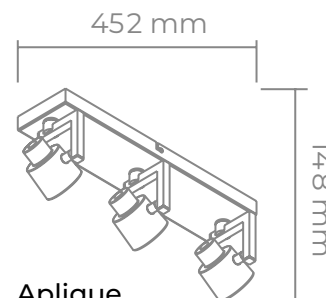

-  2xGU10, Max 50W, 220V, 50Hz, IP20
-  Negro texturado
-  Chapa
-  Orientable
-  Clase I



Aplique
SHEILA 3
Art.: C684/3 NT



-  3xGU10, Max 50W, 220V, 50Hz, IP20
-  Negro texturado
-  Chapa
-  Orientable
-  Clase I

Apliques GU10 de 1 a 3 luces
construidos en Chapa.



APLIQUE SHEILA



Aplique
SHEILA 1
Art.: C684/1 BL



Aplique
SHEILA 1
Art.: C684/1 NM





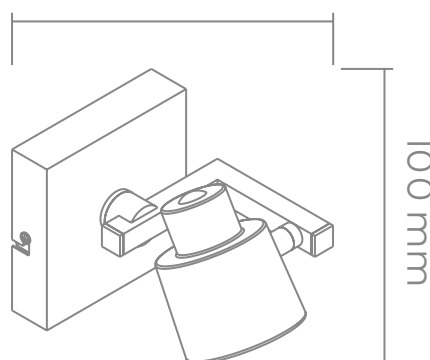

 Con interruptor en base

148 mm



100 mm

-  1xGU10, Max 50W, 220V, 50Hz, IP20
-  Blanco texturado, Níquel mate
-  Chapa
-  Orientable
-  Clase I



Aplique
SHEILA 2
Art.: C684/2 BL



Aplique
SHEILA 3
Art.: C684/3 BL



Aplique
SHEILA 2
Art.: C684/2 NM



Aplique
SHEILA 3
Art.: C684/3 NM

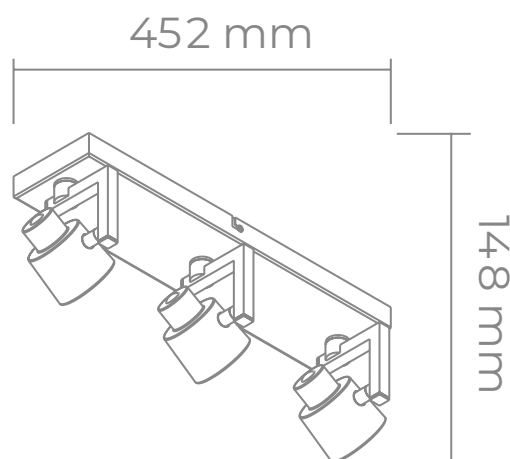
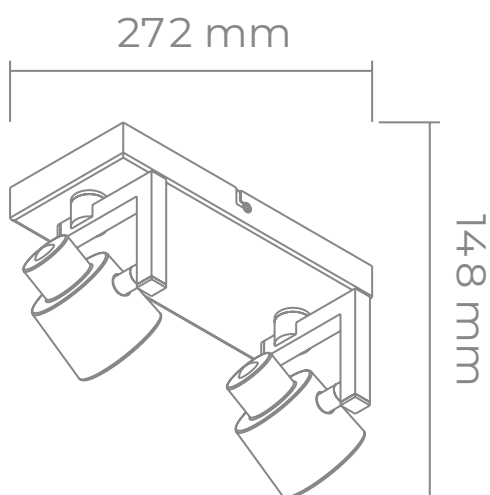

- 2xGU10, Max 50W, 220V, 50Hz, IP20
- Blanco texturado, Niquel mate
- Chapa
- Orientable
- Clase I

- 3xGU10, Max 50W, 220V, 50Hz, IP20
- Blanco texturado, Niquel mate
- Chapa
- Orientable
- Clase I

APLIQUE SONATA







*Apliques GU10 de 1 a 3 luces
construidos en chapa de acero.*





Aplicue
SONATA 1
Art.: C955/1 NM



-  1xGU10, Max 7W, 220V, 50Hz, IP20
-  Niquel mate
-  Chapa
-  Orientable
-  Clase I

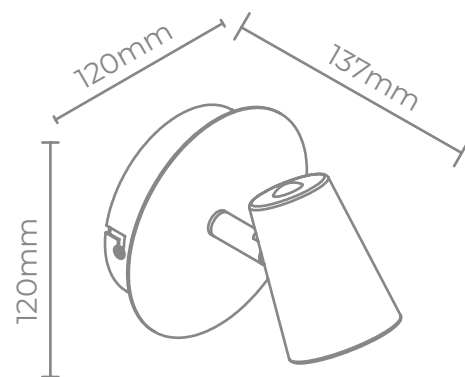





 Con interruptor en base



Aplicue
SONATA 2
Art.: C955/2 NM





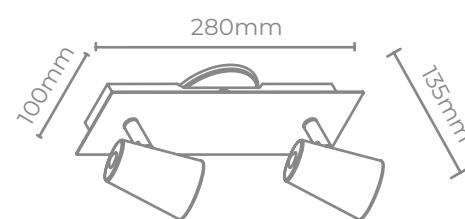

-  2xGU10, Max 7W, 220V, 50Hz, IP20
-  Niquel mate
-  Chapa
-  Orientable
-  Clase I



Aplicue
SONATA 3
Art.: C955/3 NM





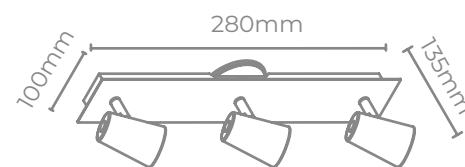

-  3xGU10, Max 7W, 220V, 50Hz, IP20
-  Niquel mate
-  Chapa
-  Orientable
-  Clase I



Aplicue
SONATA 3 REDONDO
Art.: C955/3R NM



-  3xGU10, Max 7W, 220V, 50Hz, IP20
-  Niquel mate
-  Chapa
-  Orientable
-  Clase I

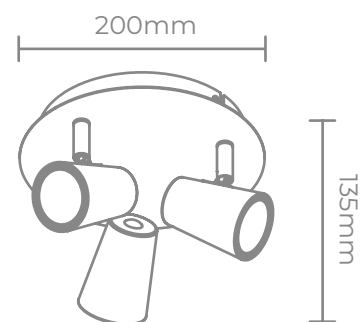



Art.: C955/1 BL

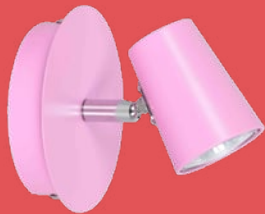

Art.: C955/1 RS

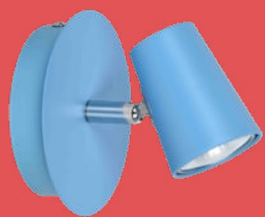

Art.: C955/1 AZ



Art.: C955/2 BL



Art.: C955/2 RS

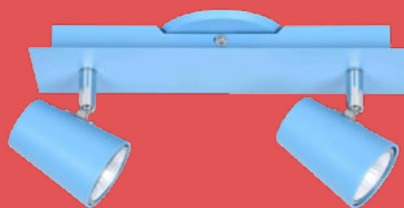





Art.: C955/2 AZ

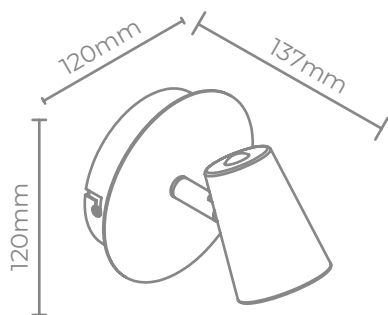

 Con interruptor en base





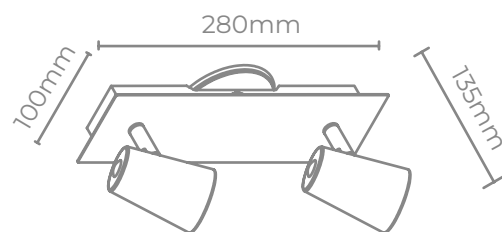

Aplique
SONATA 1

-  1xGU10, Max 40W, 220V, 50Hz, IP20
-  Blanco, Rosa, Celeste
-  Chapa de acero
-  Orientable
-  Clase I



Aplique
SONATA 2

-  2xGU10, Max 40W, 220V, 50Hz, IP20
-  Blanco, Rosa, Celeste
-  Chapa de acero
-  Orientable
-  Clase I



Art.: C955/3 BL



Art.: C955/3 RS



Art.: C955/3 AZ



Art.: C955/3R BL



Art.: C955/3 RS



Art.: C955/3R AZ

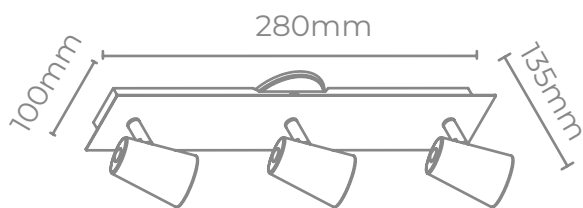

Aplique
SONATA 3 LINEAL

- 3xGU10, Max 40W, 220V, 50Hz, IP20
- Blanco, Rosa, Celeste
- Chapa de acero
- Orientable
- Clase I

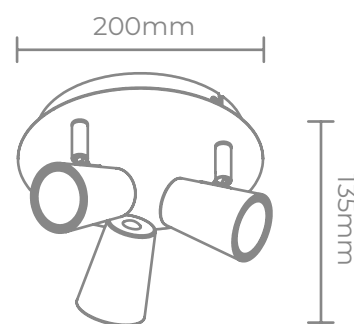

Aplique
SONATA 3 REDONDO

- 3xGU10, Max 40W, 220V, 50Hz, IP20
- Blanco, Rosa, Celeste
- Chapa de acero
- Orientable
- Clase I





APLIQUE SONATA

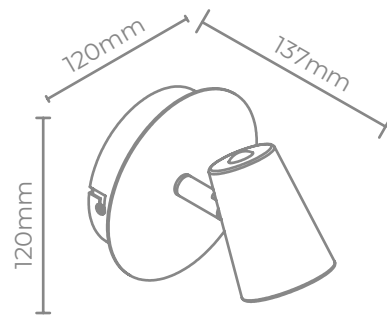

 Con interruptor en base





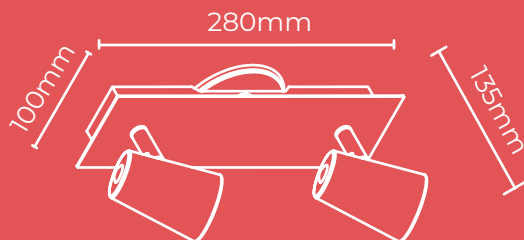

Aplique
SONATA 1
Art.: C955/1 NT

-  1xGU10, Max 50W, 220V, 50Hz, IP20
-  Negro texturado
-  Chapa de acero
-  Orientable
-  Clase I





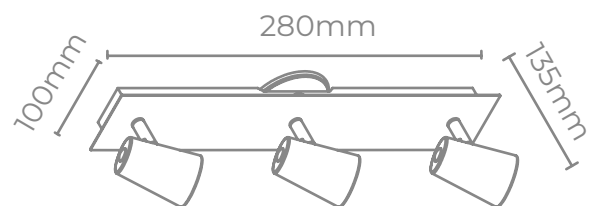

Aplique
SONATA 2
Art.: C955/2 NT

-  2xGU10, Max 50W, 220V, 50Hz, IP20
-  Negro texturado
-  Chapa de acero
-  Orientable
-  Clase I



Aplique
SONATA 3
Art.: C955/3 NT

-  3xGU10, Max 50W, 220V, 50Hz, IP20
-  Negro texturado
-  Chapa de acero
-  Orientable
-  Clase I



*Apliques GU10 de 1 a 4 luces
construidos en chapa de
acero.*

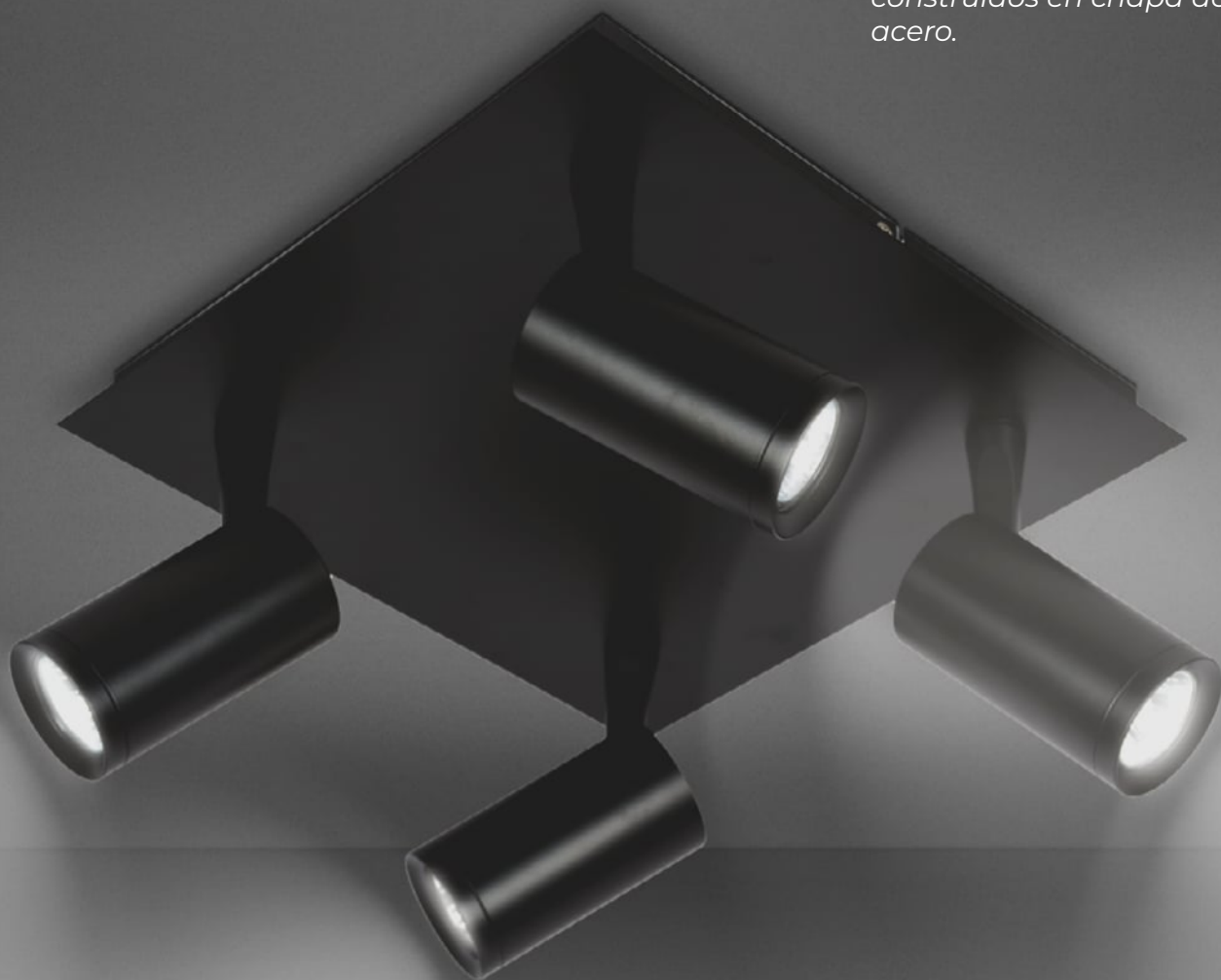

APLIQUE TÉMPANO





Aplicue
TÉMPANO 1
Art.: C965/1 NT

- 1xGU10, Max 50W, 220V, 50Hz, IP20
- Negro texturado
- Chapa de acero
- Orientable
- Clase I

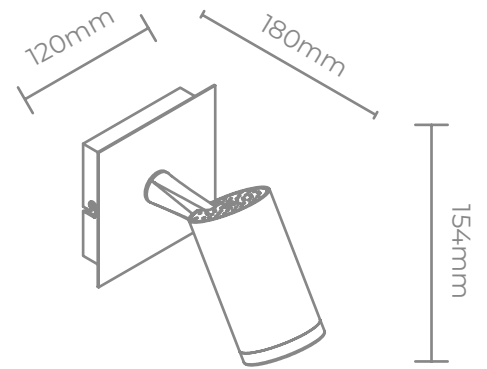

Con interruptor en base



Aplicue
TÉMPANO 2
Art.: C965/2 NT

- 2xGU10, Max 50W, 220V, 50Hz, IP20
- Negro texturado
- Chapa de acero
- Orientable
- Clase I

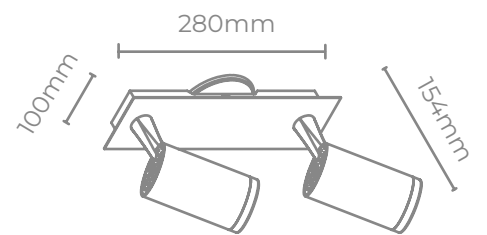

Aplicue
TÉMPANO 3
Art.: C965/3 NT

- 3xGU10, Max 50W, 220V, 50Hz, IP20
- Negro texturado
- Chapa de acero
- Orientable
- Clase I

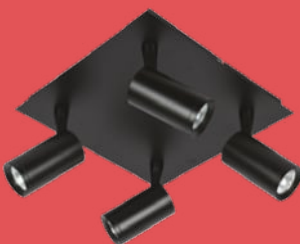
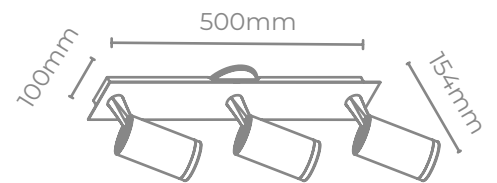

Aplicue
TÉMPANO 4
Art.: C965/4 NT

- 4xGU10, Max 50W, 220V, 50Hz, IP20
- Negro texturado
- Chapa de acero
- Orientable
- Clase I

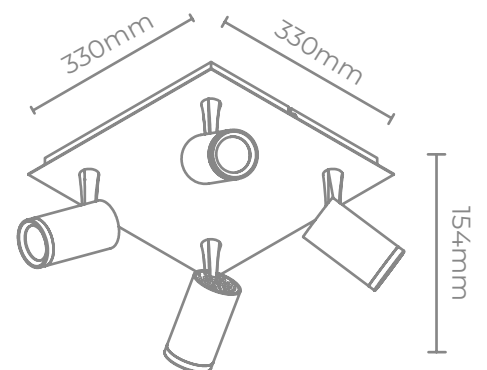



Art.: C965/1 BL



Art.: C965/1 NM



Art.: C965/2 BL







Art.: C965/2 NM

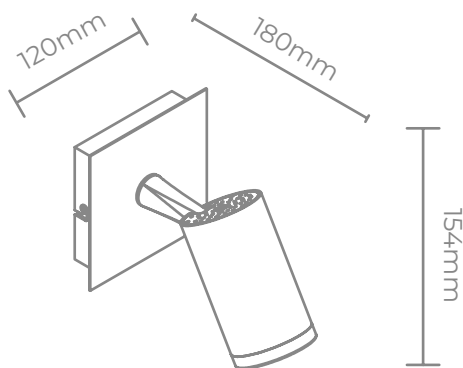

 Con interruptor en base





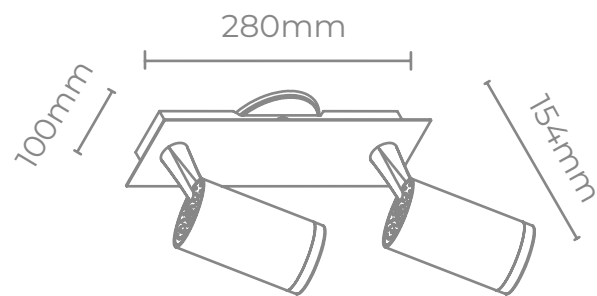

Aplique
TÉMPANO 1

-  1xGU10, Max 50wW, 220V, 50Hz, IP20
-  Blanco, Niquel mate
-  Chapa de acero
-  Orientable
-  Clase I



Aplique
TÉMPANO 2

-  2xGU10, Max 50W, 220V, 50Hz, IP20
-  Blanco, Niquel mate
-  Chapa de acero
-  Orientable
-  Clase I



Art.: C965/3 BL



Art.: C965/3 NM

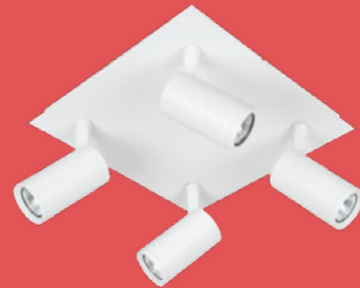

Art.: C965/4 BL



Art.: C965/4 NM

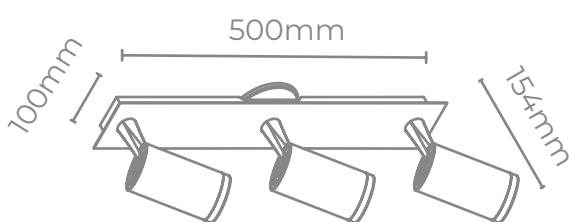

Aplique
TÉMPANO 3

- 3xGU10, Max 50W, 220V, 50Hz, IP20
- Blanco, Niquel mate
- Chapa de acero
- Orientable
- Clase I

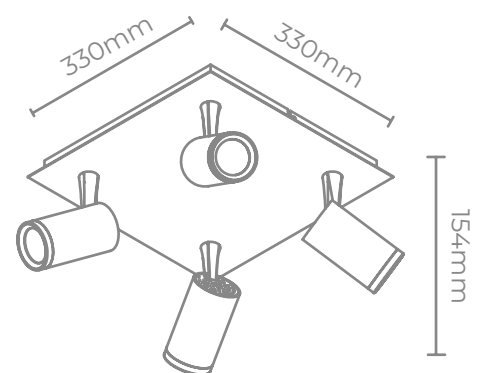

Aplique
TÉMPANO 4

- 4xGU10, Max 50W, 220V, 50Hz, IP20
- Blanco, Niquel mate
- Chapa de acero
- Orientable
- Clase I

*Apliques GU10 de 1 a 3 luces
construidos en chapa de
acero.*



APLIQUE KONUS

 Con interruptor en base

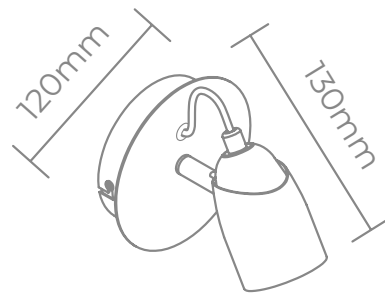





Aplique

KONUS 1

Art.: C100/1 NM



-  1xGU10, Max 50W, 220V, 50Hz, IP20
-  Níquel mate
-  Chapa de acero
-  Orientable
-  Clase I

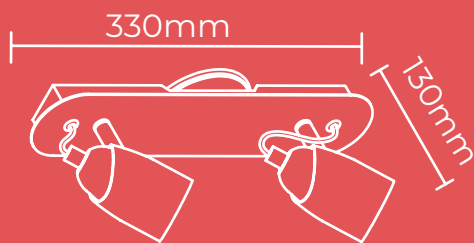





Aplique

KONUS 2

Art.: C100/2 NM



-  2xGU10, Max 50W, 220V, 50Hz, IP20
-  Níquel mate
-  Chapa de acero
-  Orientable
-  Clase I

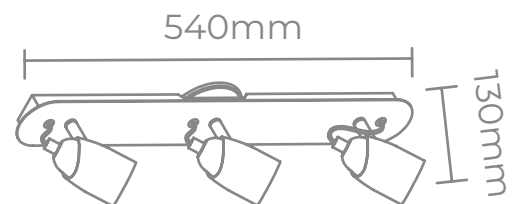





Aplique

KONUS 3

Art.: C100/3 NM



-  3xGU10, Max 50W, 220V, 50Hz, IP20
-  Níquel mate
-  Chapa de acero
-  Orientable
-  Clase I



APLIQUE KONUS



Applique
KONUS 1
Art.: C100/1 NT







Applique
KONUS 1
Art.: C100/1 BT

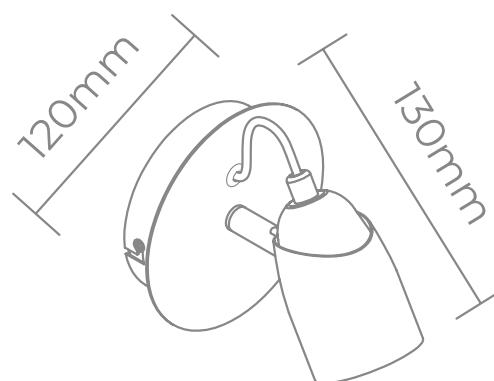

 Con interruptor en base



-  1xGU10, Max 50W, 220V, 50Hz, IP20
-  Negro texturado, Blanco texturado
-  Chapa de acero
-  Orientable
-  Clase I



Aplique
KONUS 2
Art.: C100/2 NT



Aplique
KONUS 3
Art.: C100/3 NT



Aplique
KONUS 2
Art.: C100/2 BT



Aplique
KONUS 3
Art.: C100/3 BT

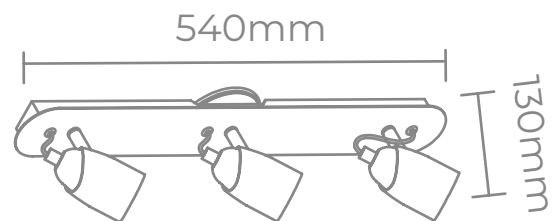
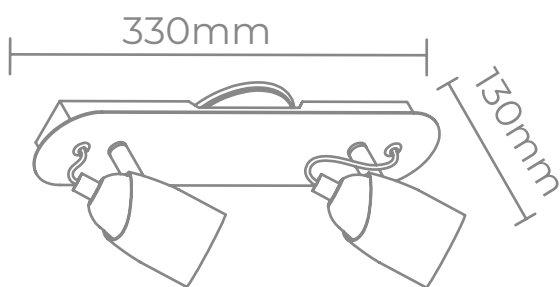

- 2xGU10, Max 50W, 220V, 50Hz, IP20
- Negro texturado, Blanco texturado
- Chapa de acero
- Orientable
- Clase I





- 3xGU10, Max 50W, 220V, 50Hz, IP20
- Negro texturado, Blanco texturado
- Chapa de acero
- Orientable
- Clase I

APLIQUE PARTY

 Con interruptor en base





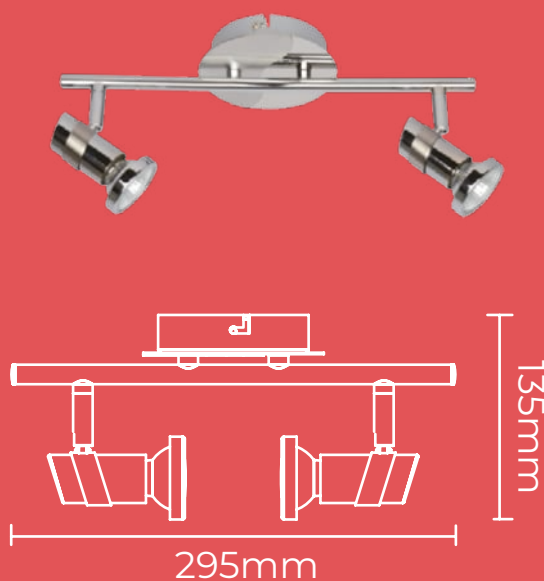

Aplique
PARTY 1
Art.: C090/1

-  1xGU10, Max 50W, 220V, 50Hz, IP20
-  Platil
-  Chapa de acero
-  Orientable
-  Clase I



Aplique
PARTY 2
Art.: C090/2

-  2xGU10, Max 50W, 220V, 50Hz, IP20
-  Platil
-  Chapa de acero
-  Orientable
-  Clase I



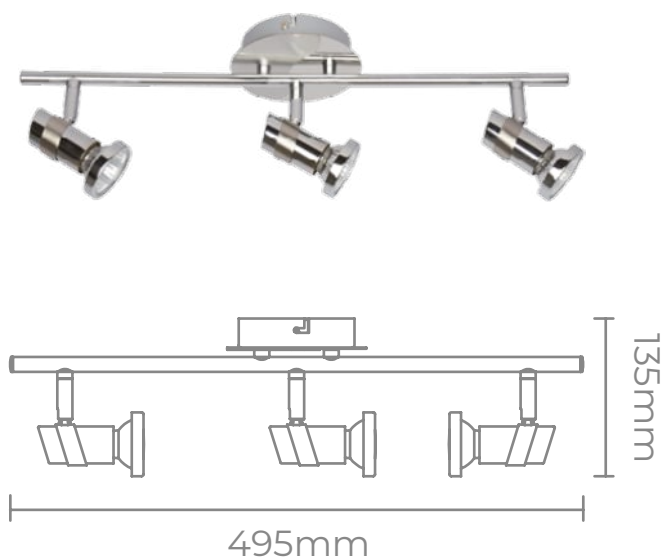

*Apliques GU10 de 1 a 4 luces
construidos en chapa de acero.*



Aplique

PARTY 3

Art.: C090/3



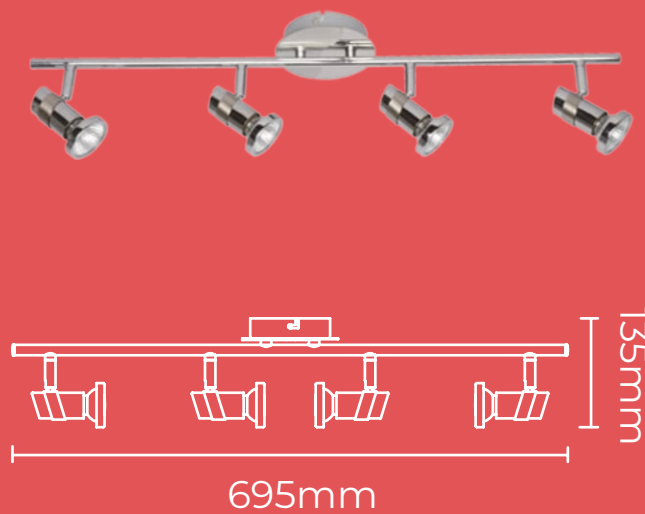

-  3xGU10, Max 50W, 220V, 50Hz, IP20
-  Platil
-  Chapa de acero
-  Orientable
-  Clase I



Aplique

PARTY 4

Art.: C090/4

-  4xGU10, Max 50W, 220V, 50Hz, IP20
-  Platil
-  Chapa de acero
-  Orientable
-  Clase I

APLIQUE PROMO



 Con interruptor en base







Art.: C208/1 BL

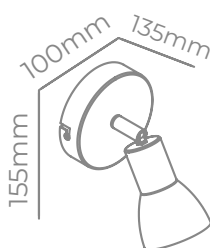

Art.: C208/1 NM



Aplique PROMO 1

-  1xGU10, Max 50W, 220V, 50Hz, IP20
-  Blanco texturado, Niquel mate
-  Chapa de acero
-  Orientable
-  Clase I







Art.: C2082 BL

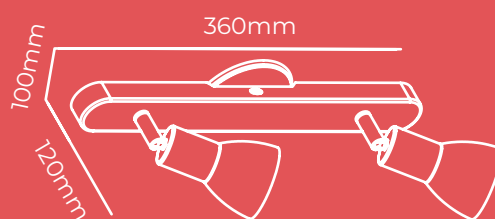

Art.: C208/2 NM



Aplique PROMO 2

-  2xGU10, Max 50W, 220V, 50Hz, IP20
-  Blanco texturado, Niquel mate
-  Chapa de acero
-  Orientable
-  Clase I

*Apliques GU10 de 1 a 3 luces
construidos en chapa de acero.*



Art.: C208/3 BL



Art.: C208/3 NM

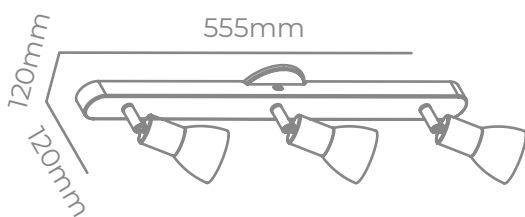

Aplique
PROMO 3 LINEAL

- 3xGU10, Max 50W, 220V, 50Hz, IP20
- Blanco texturado, Níquel mate
- Chapa de acero
- Orientable
- Clase I



Art.: C208/3R BL



Art.: C208/3R NM

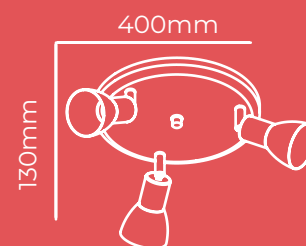

Aplique
PROMO 3 REDONDO

- 3xGU10, Max 50W, 220V, 50Hz, IP20
- Blanco texturado, Níquel mate
- Chapa de acero
- Orientable
- Clase I

APLIQUE SUPER



 Con interruptor en base







Art.: C900/1 BL

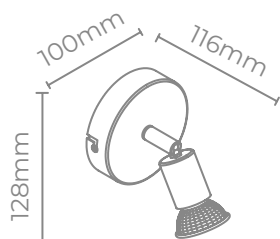

Art.: C900/1 NM



**Aplique
SUPER 1**

-  1xGU10, Max 50W, 220V, 50Hz, IP20
-  Blanco mate, Níquel mate
-  Chapa de acero
-  Orientable
-  Clase I





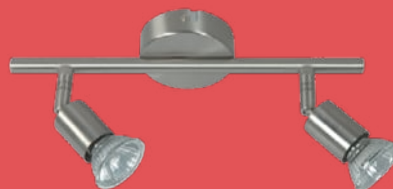

Art.: C900/2 BL

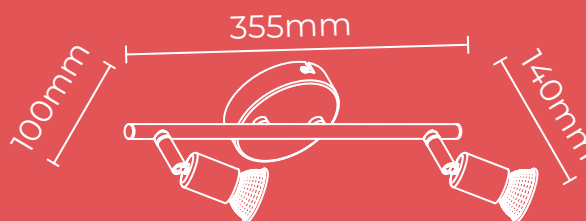

Art.: C900/2 NM



**Aplique
SUPER 2**

-  2xGU10, Max 50W, 220V, 50Hz, IP20
-  Blanco mate, Níquel mate
-  Chapa de acero
-  Orientable
-  Clase I

Apliques GU10 de 1 a 4 luces
construidos en chapa de acero.

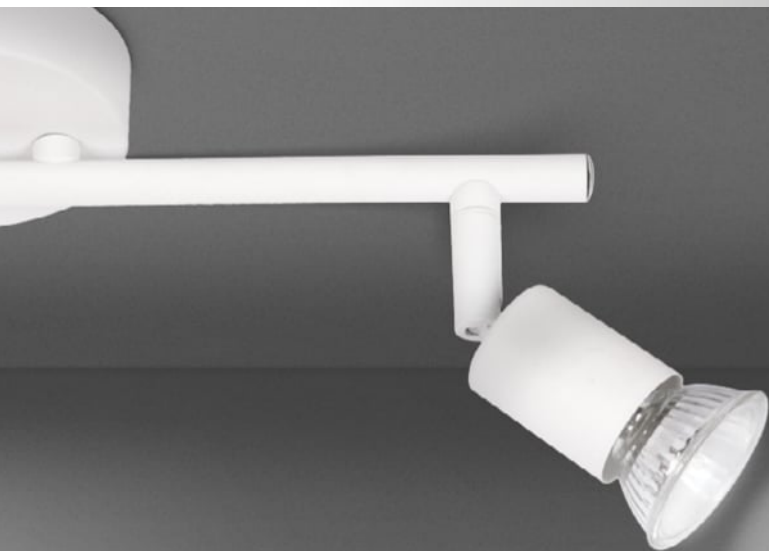

Art.: C900/3 BL



Art.: C900/3 NM

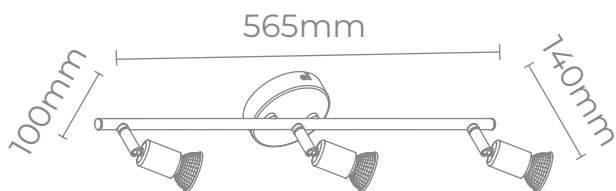

**Aplique
SUPER 3**

- 3xGU10, Max 40W, 220V, 50Hz, IP20
- Blanco mate, Niquel mate
- Chapa de acero
- Orientable
- Clase I



Art.: C900/4 BL



Art.: C9004 NM



**Aplique
SUPER 4**

- 4xGU10, Max 50W, 220V, 50Hz, IP20
- Blanco mate, Niquel mate
- Chapa de acero
- Orientable
- Clase I

APLIQUE VULCANO







*Apliques GU10 de 1 a 3 luces
construidos en chapa de acero.*





Aplique
VULCANO 1
Art.: C950/1 CR



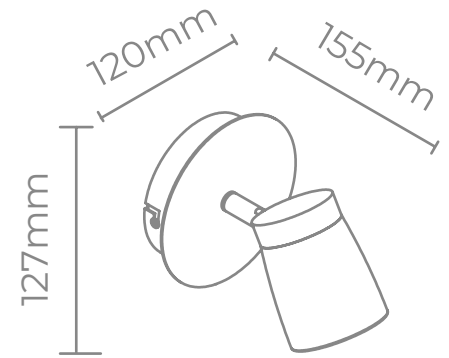

-  1xGU10, Max 40W, 220V, 50Hz, IP20
-  Cromado
-  Chapa de acero
-  Orientable
-  Clase I



 Con interruptor en base





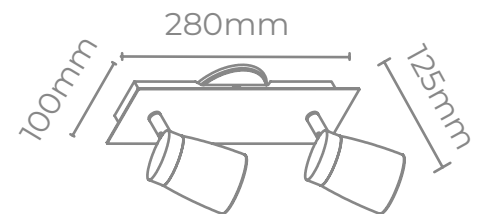

Aplique
VULCANO 2
Art.: C950/2 CR

-  2xGU10, Max 40W, 220V, 50Hz, IP20
-  Cromado
-  Chapa de acero
-  Orientable
-  Clase I





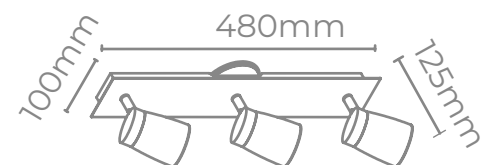

Aplique
VULCANO 3
Art.: C950/3 CR

-  3xGU10, Max 40W, 220V, 50Hz, IP20
-  Cromado
-  Chapa de acero
-  Orientable
-  Clase I



Aplique
VULCANO 3 REDONDO
Art.: C950/3R CR

-  3xGU10, Max 40W, 220V, 50Hz, IP20
-  Cromado
-  Chapa de acero
-  Orientable
-  Clase I

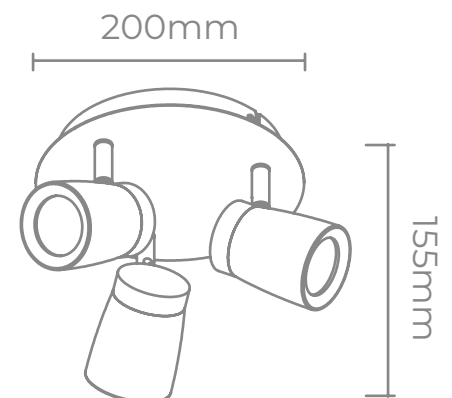





APLIQUE VISTRA

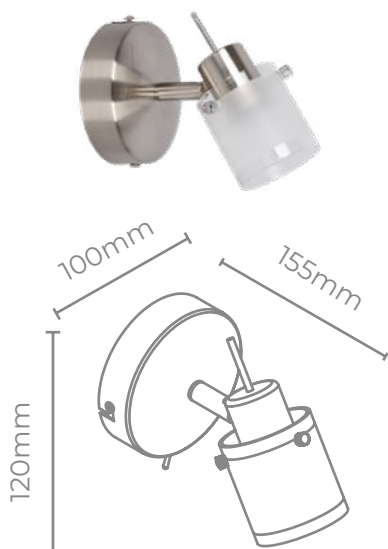

 Con interruptor en base





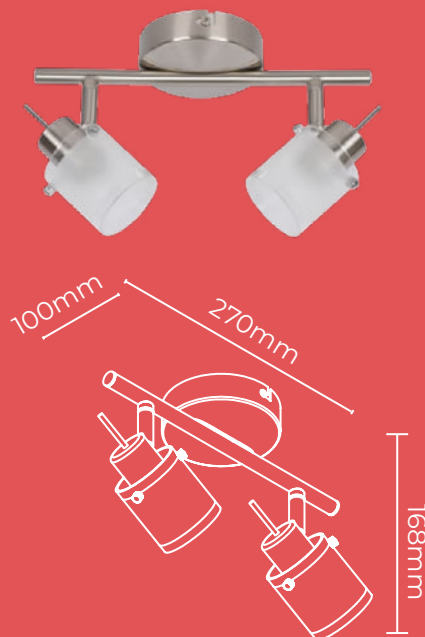

Aplique
VISTRA 1
Art.: C960/1 PL

-  1xGU10, Max 50W, 220V, 50Hz, IP20
-  Platil
-  Chapa de acero
-  Orientable
-  Clase I



Aplique
VISTRA 2
Art.: C960/2 PL

-  2xGU10, Max 50W, 220V, 50Hz, IP20
-  Platil
-  Chapa de acero
-  Orientable
-  Clase I

Apliques GU10 de 1 a 3 luces
construidos en chapa.

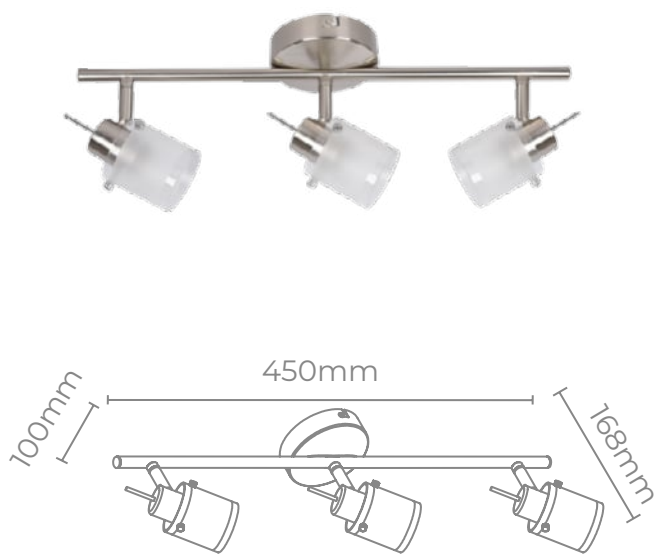





Aplique

VISTRA 3 LINEAL

Art.: C960/3 PL



-  3xGU10, Max 50W, 220V, 50Hz, IP20
-  Platil
-  Chapa de acero
-  Orientable
-  Clase I

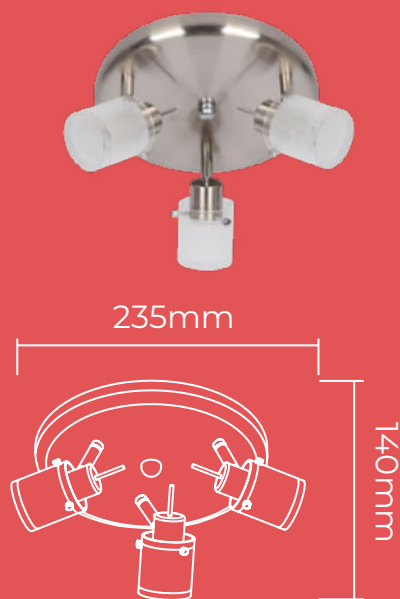





Aplique

VISTRA 3 REDONDO

Art.: C960/3R PL



-  3xGU10, Max 50W, 220V, 50Hz, IP20
-  Platil
-  Chapa de acero
-  Orientable
-  Clase I

APLIQUE LENORA



*Apliques E14 de 1 a 4 luces
construidos en chapa de acero.*

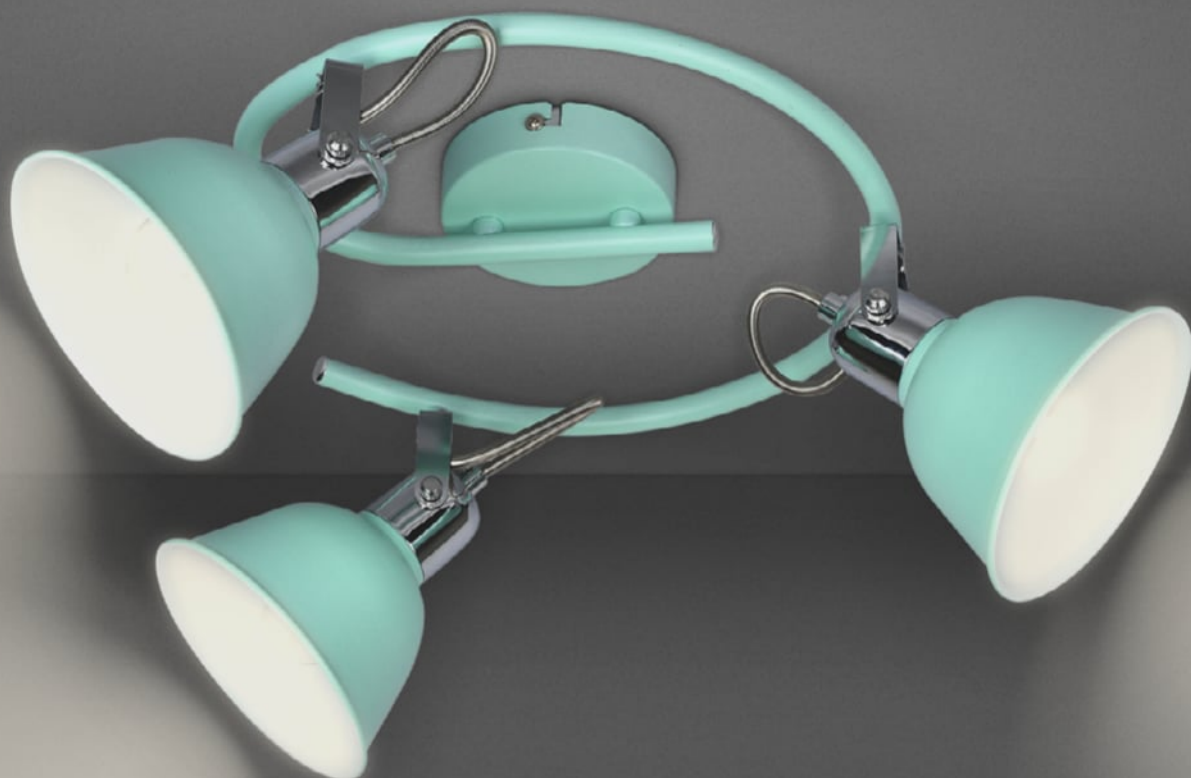







Applique

LENORA 1

Art.: APE147341 V V



-  1xE14, Max 40W, 220V, 50Hz, IP20
-  Verde vintage
-  Chapa de acero
-  Orientable
-  Clase I

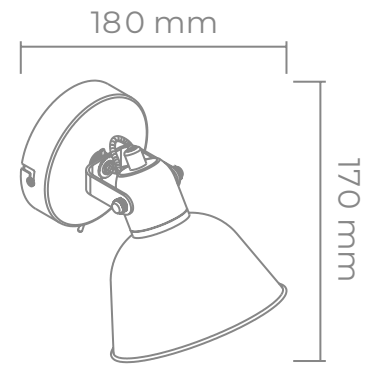

 Con interruptor en base







Applique

LENORA 2

Art.: APE147342 V V



-  2xE14, Max 40W, 220V, 50Hz, IP20
-  Verde vintage
-  Chapa de acero
-  Orientable
-  Clase I

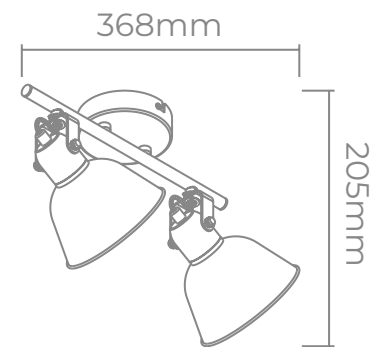





Applique

LENORA 3

Art.: APE147343 V V



-  3xE14, Max 40W, 220V, 50Hz, IP20
-  Verde vintage
-  Chapa de acero
-  Orientable
-  Clase I

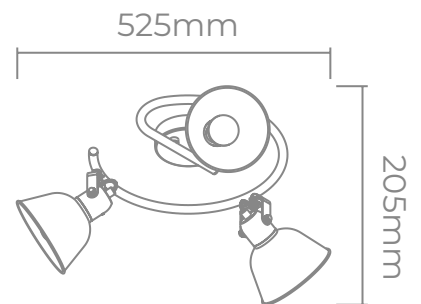





Applique

LENORA 4

Art.: APE147344 V V



-  4xE14, Max 40W, 220V, 50Hz, IP20
-  Verde vintage
-  Chapa de acero
-  Orientable
-  Clase I

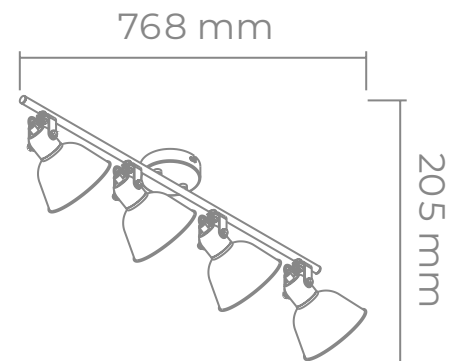



Art.: APE147341 NG ●



Art.: APE147341 BL ○



Art.: APE147342 NG ●





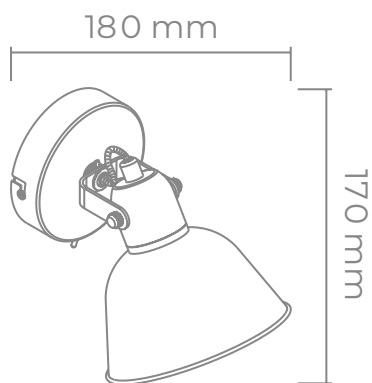

Art.: APE147341 BL ○

 Con interruptor en base





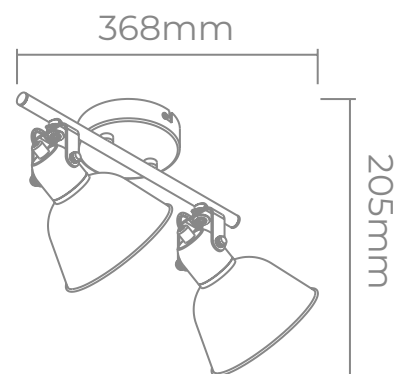

Aplique
LENORA 1

-  1xE14, Max 40W, 220V, 50Hz, IP20
-  Blanco mate, Negro mate
-  Chapa de acero
-  Orientable
-  Clase I



Aplique
LENORA 2

-  2xE14, Max 40W, 220V, 50Hz, IP20
-  Blanco mate, Negro mate
-  Chapa de acero
-  Orientable
-  Clase I



Art.: APE147343 NG ●



Art.: APE147343 BL ○



Art.: APE147344 NG ●



Art.: APE147344 BL ○

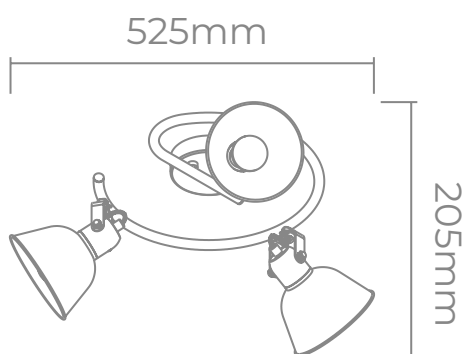

Aplique
LENORA 3

- 💡 3xE14, Max 40W, 220V, 50Hz, IP20
- ⊗ Blanco mate, Negro mate
- 📏 Chapa de acero
- 🔄 Orientable
- ⚡ Clase I

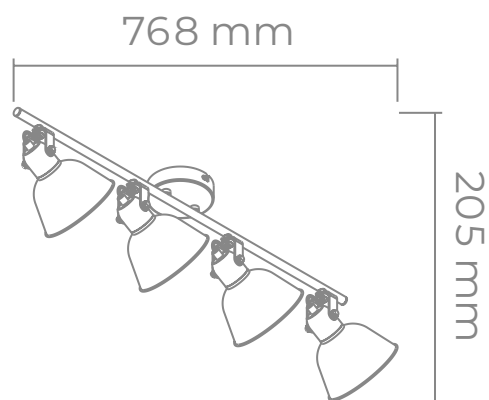

Aplique
LENORA 4

- 💡 4xE14, Max 40W, 220V, 50Hz, IP20
- ⊗ Blanco mate, Negro mate
- 📏 Chapa de acero
- 🔄 Orientable
- ⚡ Clase I

*Apliques E14 de 1 a 4 luces
construidos en chapa de acero.*

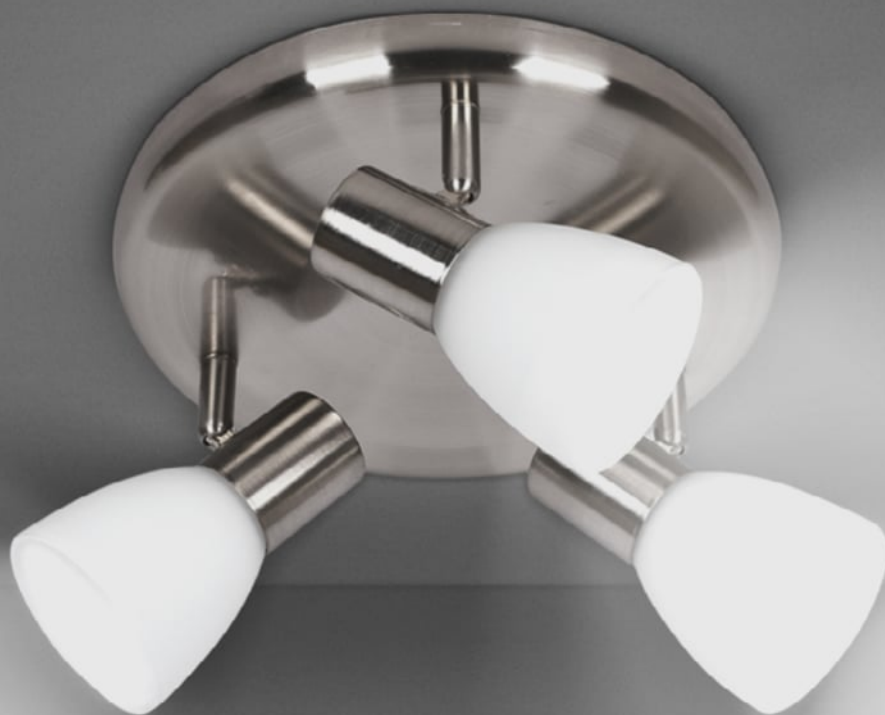

APLIQUE
NURIA

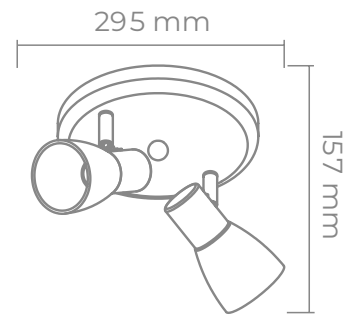

Aplique
NURIA 2 REDONDO
 Art.: APE143582P NM



- 2xE14, Max 40W, 220V, 50Hz, IP20
- Niquel mate
- Chapa de acero
- Orientable
- Clase I

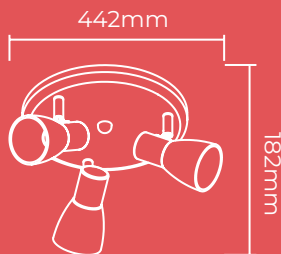

Aplique
NURIA 3 REDONDO
 Art.: APE143583P NM



- 3xE14, Max 40W, 220V, 50Hz, IP20
- Niquel mate
- Chapa de acero
- Orientable
- Clase I



Aplique
NURIA 3 ESPIRAL
 Art.: APE143583E NM





- 3xE14, Max 40W, 220V, 50Hz, IP20
- Niquel mate
- Chapa de acero
- Orientable
- Clase I



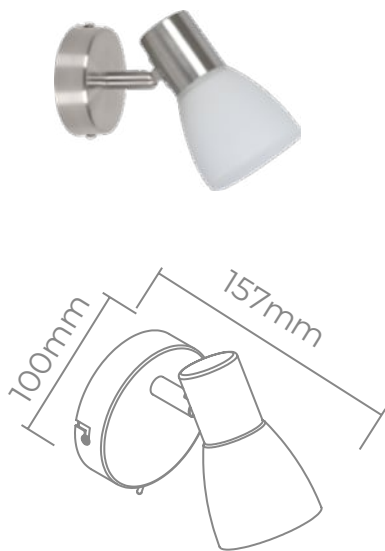

APLIQUE NURIA





 Con interruptor en base





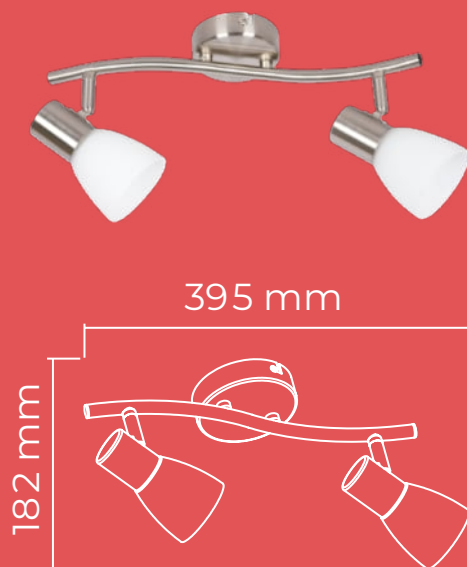

Aplique
NURIA 1
Art.: APE143581 NM 

-  1xE14 Max 40W, 220V, 50Hz, IP20
-  Niquel mate
-  Chapa de acero
-  Orientable
-  Clase I





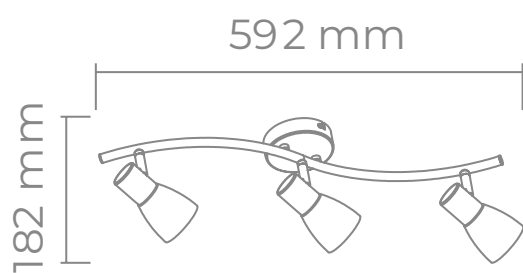

Aplique
NURIA 2 LINEAL
Art.: APE143582 NM 

-  2xE14, Max 40W, 220V, 50Hz, IP20
-  Niquel mate
-  Chapa de acero
-  Orientable
-  Clase I



Aplique
NURIA 3 LINEAL
 Art.: APE143583 NM





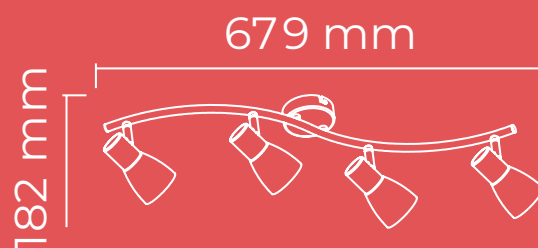

-  3xE14, Max 40W, 220V, 50Hz, IP20
-  Niquel mate
-  Chapa de acero
-  Orientable
-  Clase I



Aplique
NURIA 4 LINEAL
 Art.: APE143584 NM



-  4xE14, Max 40W, 220V, 50Hz, IP20
-  Niquel mate
-  Chapa de acero
-  Orientable
-  Clase I





APLIQUES DECO PARA G9

APLIQUE FIORE



*Apliques de 1, 2 y 4 luces para lámpara G9.
Base construida en chapa de acero.
Tulipas de vidrio con terminación opal.*



Aplique
FIORE 1
Art.: CG130100/1 BL







Aplique
FIORE 1
Art.: CG130100/1 NG

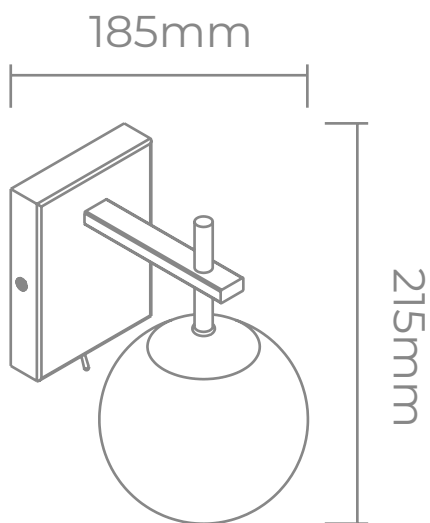

 Con interruptor en base



-  1xG9, Max 8W, 220V, 50Hz, IP20
-  Blanco mate, Negro mate
-  Chapa de acero
-  Fijo
-  Clase I

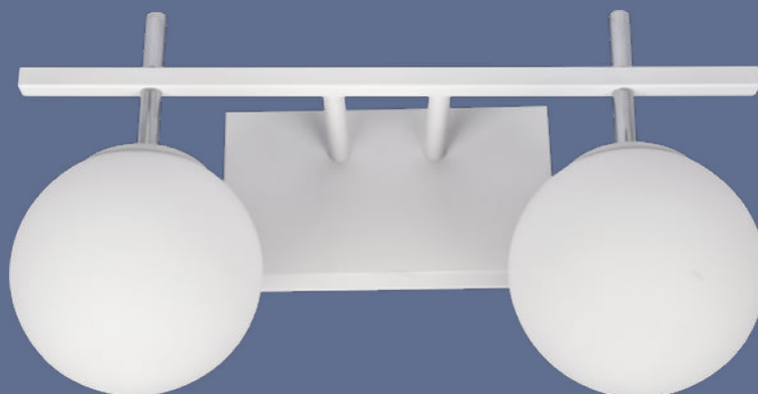





Aplique
FIORE 2
Art.: CG130100/2 BL

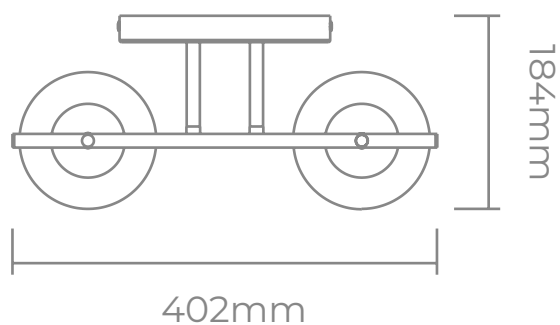

Aplique
FIORE 2
Art.: CG130100/2 NG



-  2xG9, Max 8W, 220V, 50Hz, IP20
-  Blanco mate, Negro mate
-  Chapa de acero
-  Fijo
-  Clase I

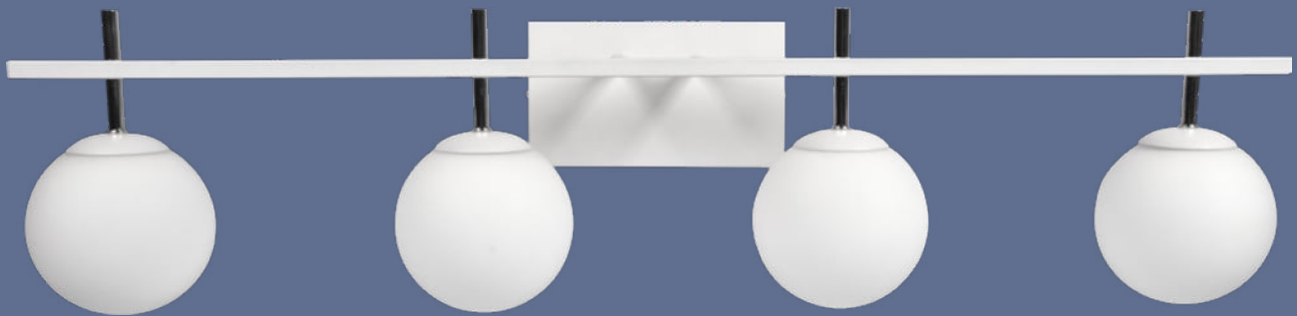

Aplique
FIORE 4
Art.: CG130100/4 BL

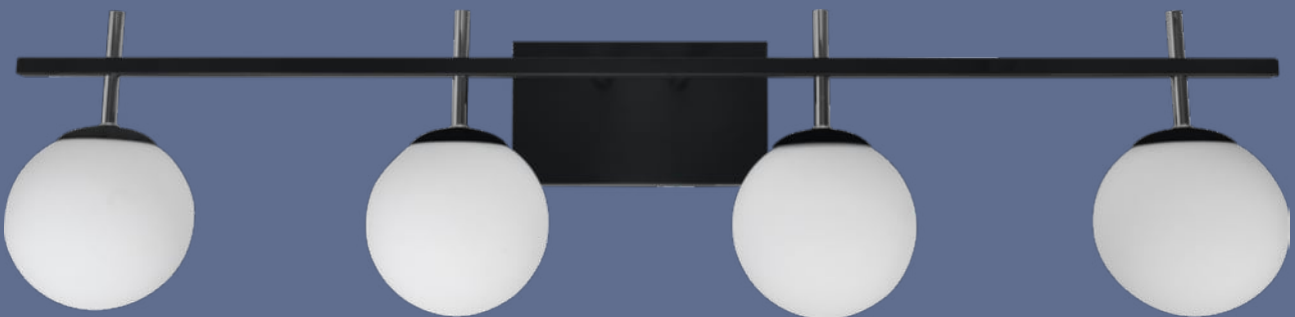



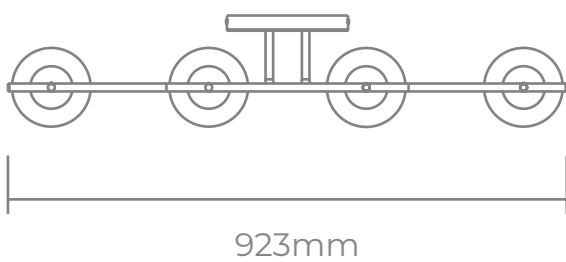

Aplique
FIORE 4
Art.: CG130100/4 NC



184mm

923mm

-  4xG9, Max 8W, 220V, 50Hz, IP20
-  Blanco mate, Negro mate
-  Chapa de acero
-  Fijo
-  Clase I

APLIQUE MICA

*Apliques de 2 y 4 luces para lámpara
G9, base construida en chapa de acero,
tulipas de vidrio con terminación opal.*





Aplique
MICA 2
Art.: CG130120/2 NG



 2xG9, Max 8W, 220V, 50Hz, IP20

 Negro mate

 Chapa de acero

 Fijo

 Clase I

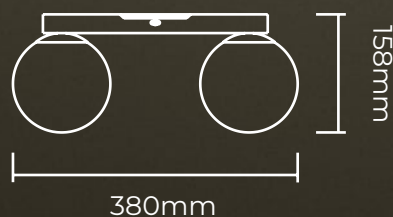

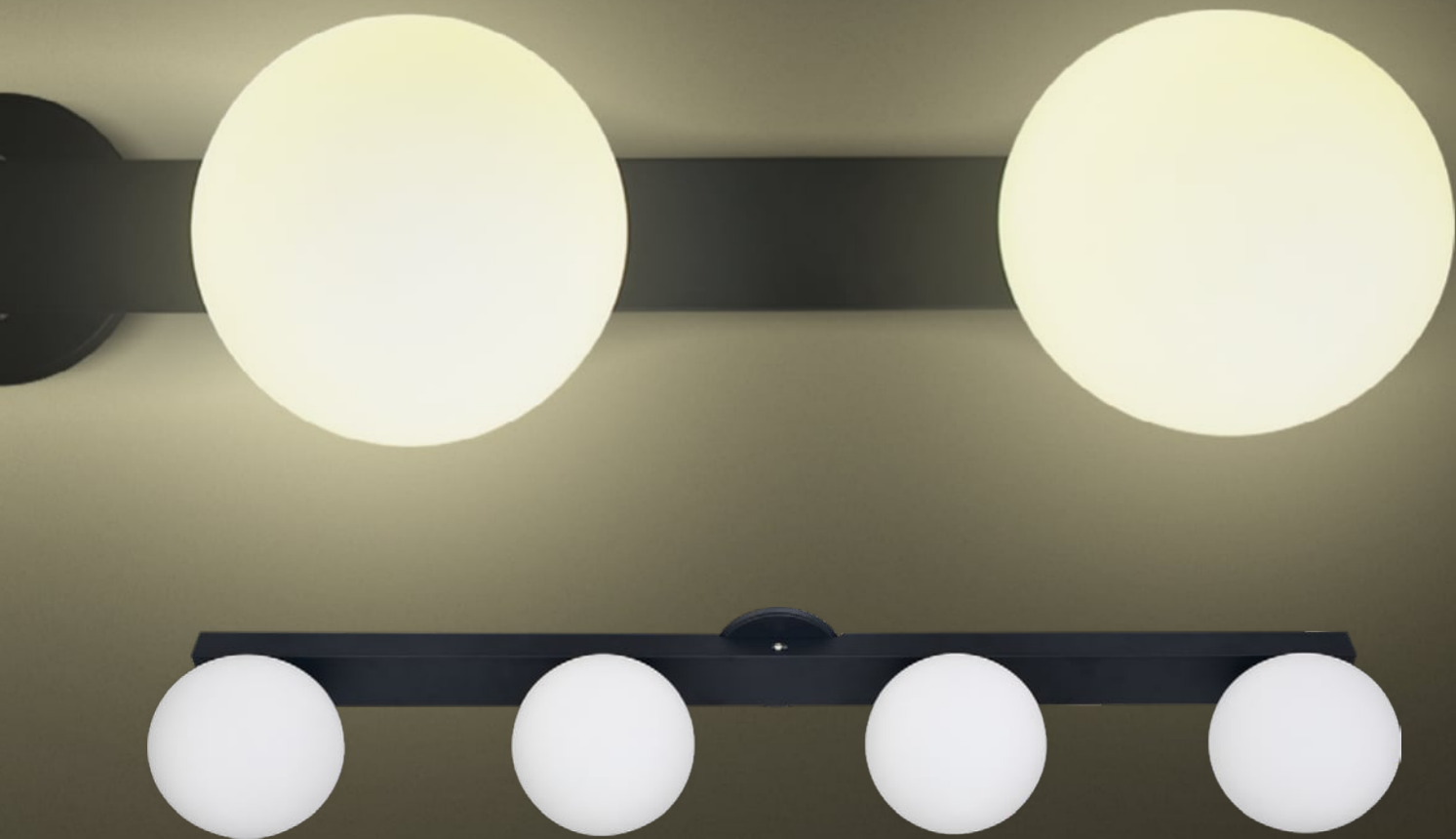



Aplique
MICA 4
Art.: CG130120/4 NG



 4xG9, Max 8W, 220V, 50Hz, IP20

 Negro mate

 Chapa de acero

 Fijo

 Clase I

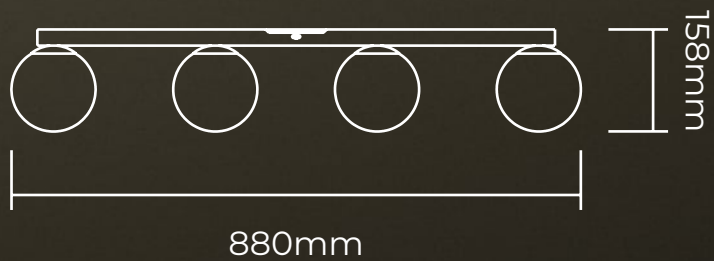

APLIQUE SENSEI

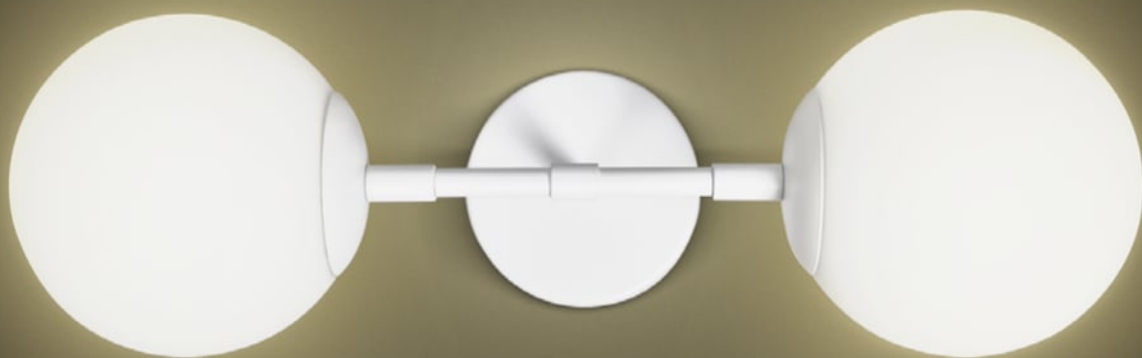

*Aplique para lámpara G9.
Base construida en chapa de acero.
Tulipas de vidrio con terminación opal.*

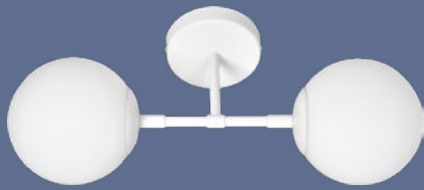
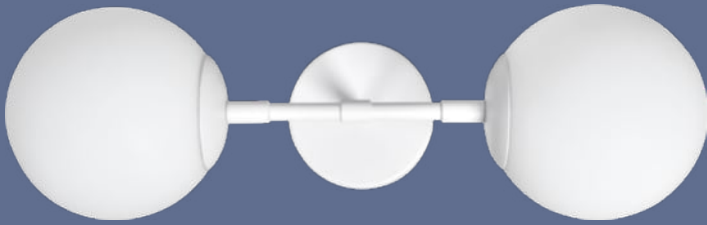



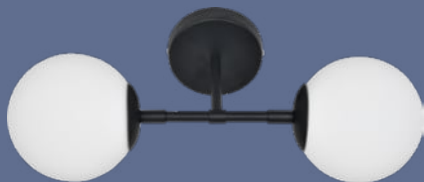

Aplique
SENSEI
Art.: CG130210/2 BL

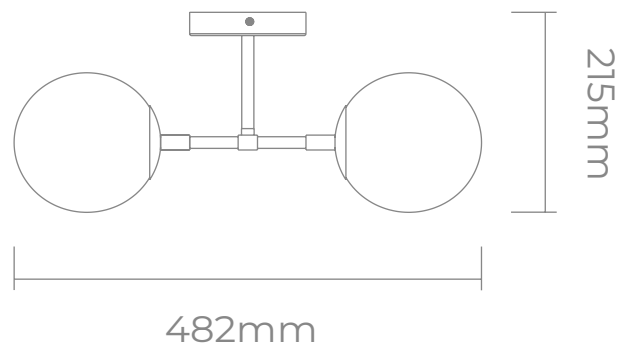

Aplique
SENSEI
Art.: CG130210/2 NG



-  2xG9, Max 8W, 220V, 50Hz, IP20
-  Blanco mate, Negro mate
-  Chapa de acero
-  Fijo
-  Clase I

APLIQUE SOLO



*Aplique para lámpara G9.
Base construida en chapa de acero.
Tulipas de vidrio con terminación opal.*







Aplique
SOLO
Art.: CG130300 BL

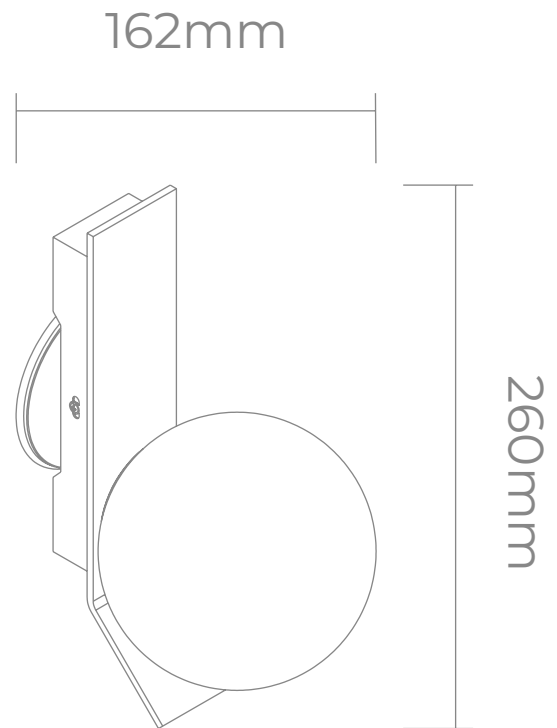

Aplique
SOLO
Art.: CG130300 NG



-  1xG9, Max 8W, 220V, 50Hz, IP20
-  Blanco mate, Negro mate
-  Chapa de acero
-  Fijo
-  Clase I

*Apliques G9 de 1 a 3 luces
construidos en chapa de
acero. Tulipas de vidrio con
terminación opal.*



APLIQUE BUDA

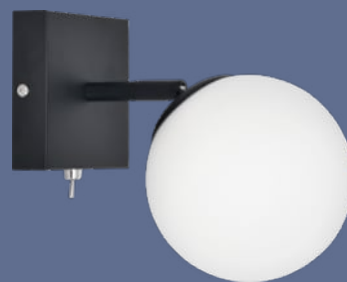

Aplique
BUDA 1
Art.: CG130400/1 NG









Aplique
BUDA 1
Art.: CG130400/1 BL

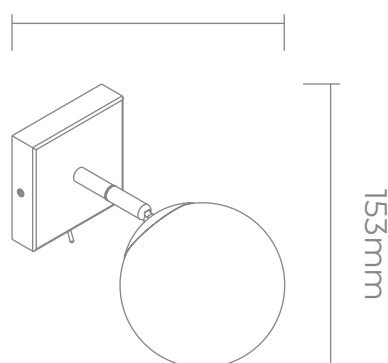

 Con interruptor en base

228mm



-  1xG9, Max 8W, 220V, 50Hz, IP20
-  Negro mate, Blanco mate
-  Chapa de acero
-  Orientable
-  Clase I



Aplique
BUDA 2
Art.: CG130400/2 NG ●



Aplique
BUDA 3
Art.: CG130400/3 NG ●



Aplique
BUDA 2
Art.: CG130400/2 BL ○



Aplique
BUDA 3
Art.: CG130400/3 BL ○

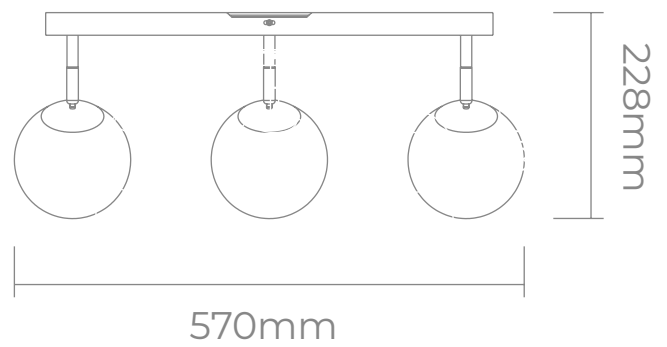
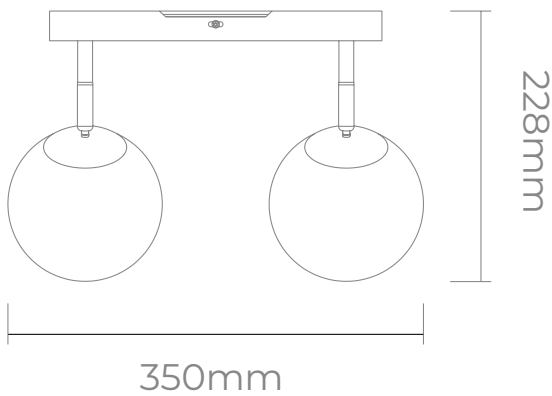

- 2xG9, Max 8W, 220V, 50Hz, IP20
- Negro mate, Blanco mate
- Chapa de acero
- Orientable
- Clase I

- 3xG9, Max 8W, 220V, 50Hz, IP20
- Negro mate, Blanco mate
- Chapa de acero
- Orientable
- Clase I

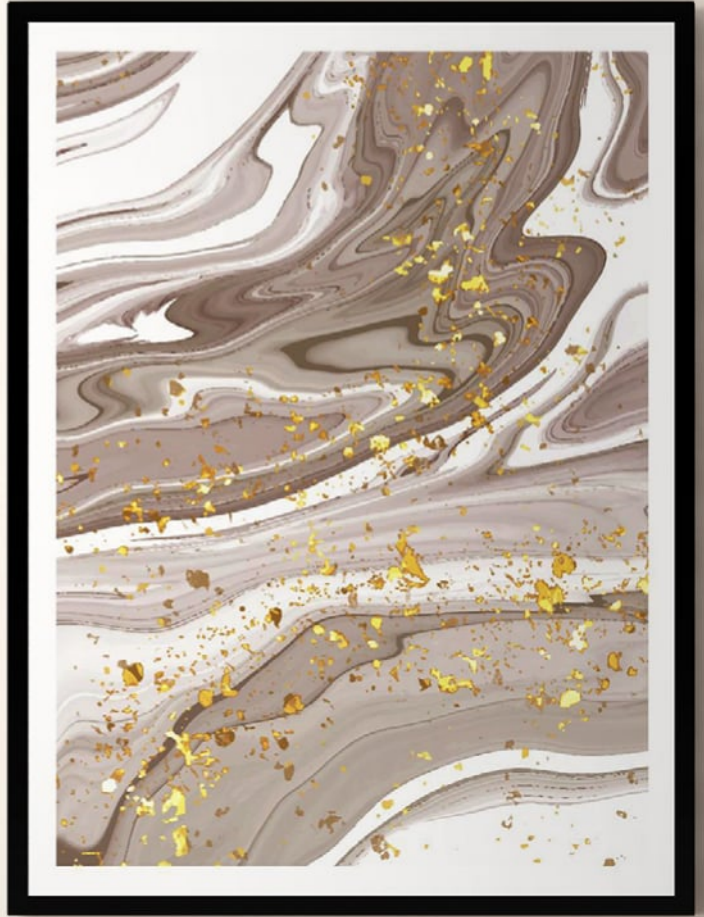

6



COLGANTES DECO *PARA E27*

COLGANTE CONCRET

Colgantes de 1 y 3 luces para lámpara E27, construido en chapa de acero.

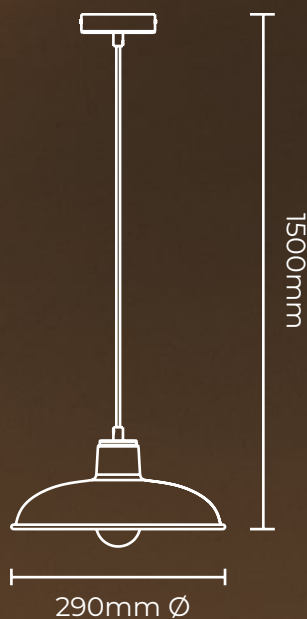



Colgante
CONCRET 1
Art.: CCT70129/1 NG





 1xE27, Max 15W, 220V, 50Hz, IP20



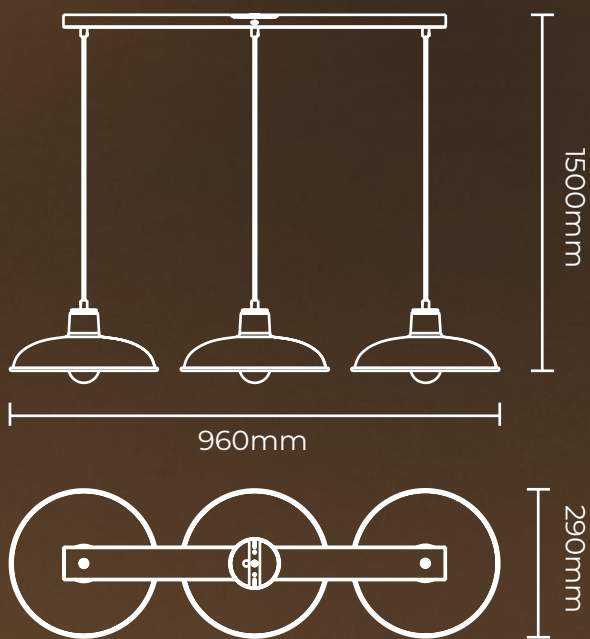

 Negro mate+Oro antiguo



 Chapa de acero

 Clase II



Colgante
CONCRET 3
Art.: CCT70129/3 NG  

-  3xE27, Max 15W, 220V, 50Hz, IP20
-  Negro mate+Oro antiguo
-  Chapa de acero
-  Clase II

  Negro mate + Oro antiguo



COLGANTE SOVIET I



*Colgante para lámpara E27 construido
en chapa de acero.*







Colgante
SOVIET I
Art.: CCT9500A NG

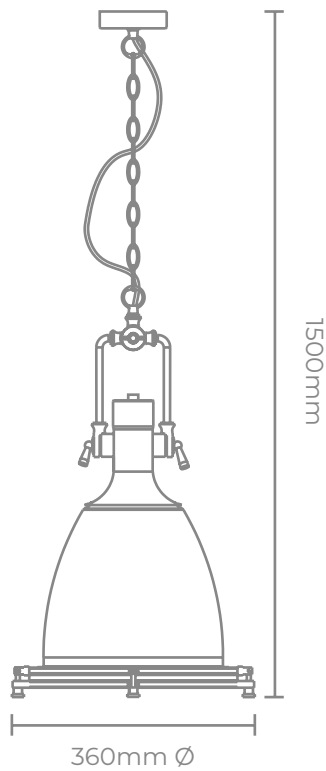

Colgante
SOVIET I
Art.: CCT9500A BL



-  1xE27, Max 15W, 220V, 50Hz, IP20
-  Negro mate, Blanco mate
-  Chapa de acero
-  Clase II

COLGANTE SOVIET II



*Colgante para lámpara E27, construido
en chapa de acero.*







Colgante
SOVIET II
Art.: CCT9500B NG

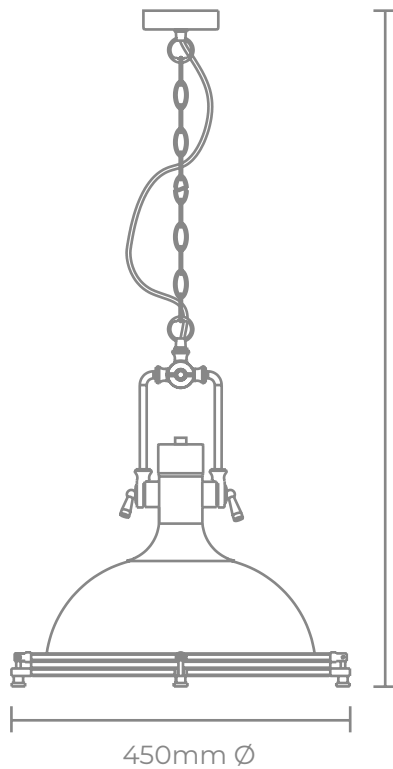

Colgante
SOVIET II
Art.: CCT9500B BL



-  1xE27, Max 15W, 220V, 50Hz, IP20
-  Negro mate, Blanco mate
-  Chapa de acero
-  Clase II

COLGANTE GALEÓN



Colgante para lámpara E27 construido en chapa de acero.

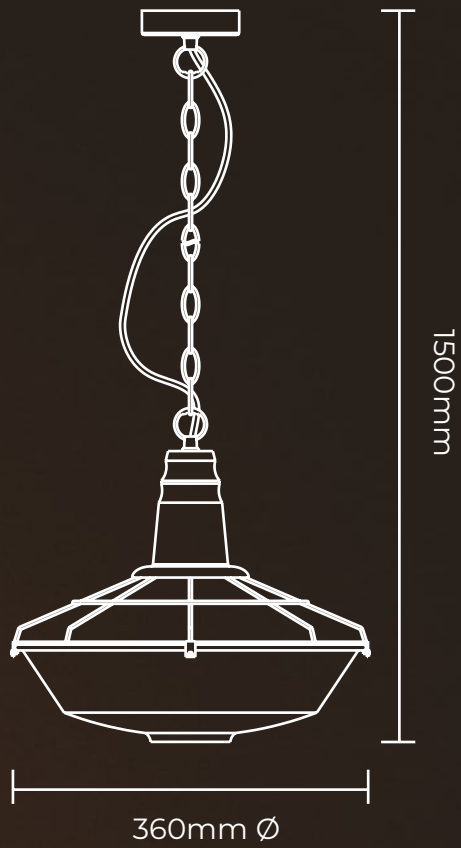

Colgante

GALEÓN

Art.: CCT70535 NG



1xE27, Max 15W, 220V, 50Hz, IP20



Negro mate



Chapa de acero



Clase II

COLGANTE GOLETA 30



*Colgante para lámpara E27 construido
en chapa de acero.*

CAJA MASTER



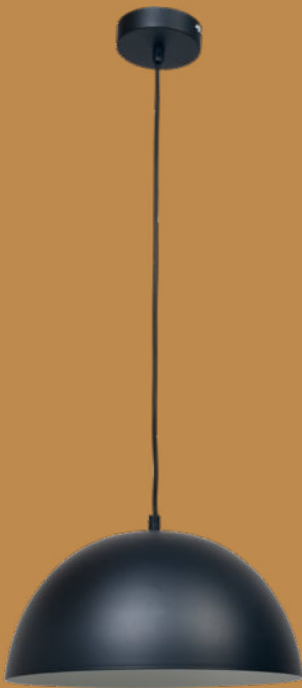

Colgante
GOLETA 30
Art.: CCT71030 NG

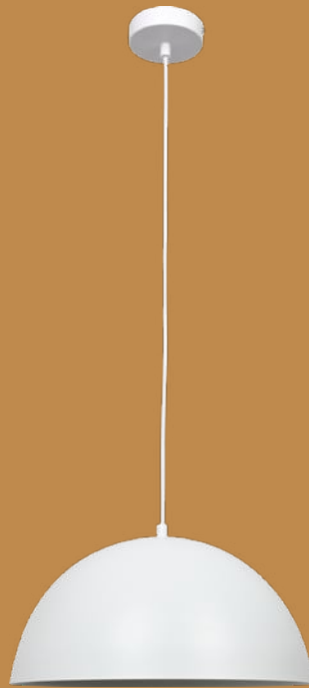



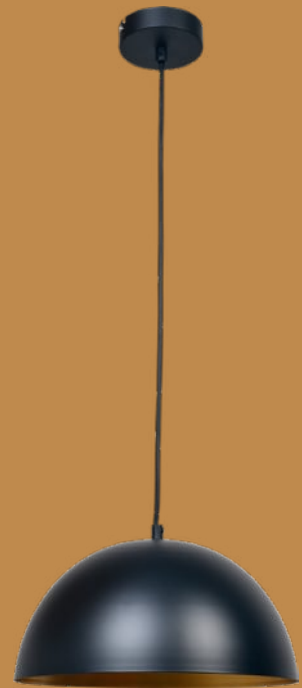

Colgante
GOLETA 30
Art.: CCT71030 BL

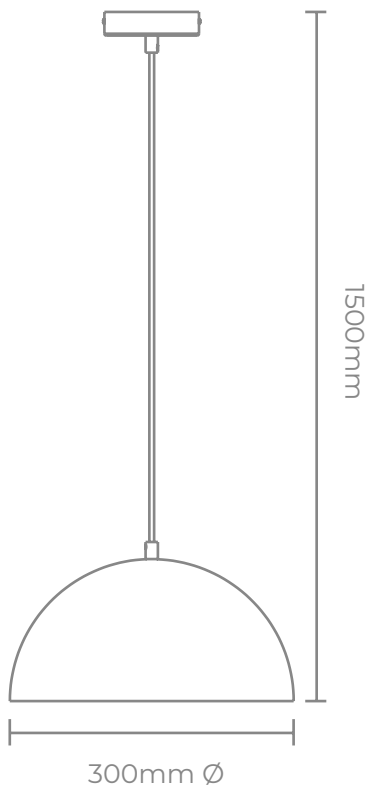

Colgante
GOLETA 30
Art.: CCT71030 NG-OA



-  1xE27, Max 15W, 220V, 50Hz, IP20
-  Negro mate, Blanco mate, Negro mate+Oro Antiguo
-  Chapa de acero
-  Clase II

COLGANTE GOLETA 35



Colgante para lámpara E27 construido en chapa de acero.

CAJA MASTER



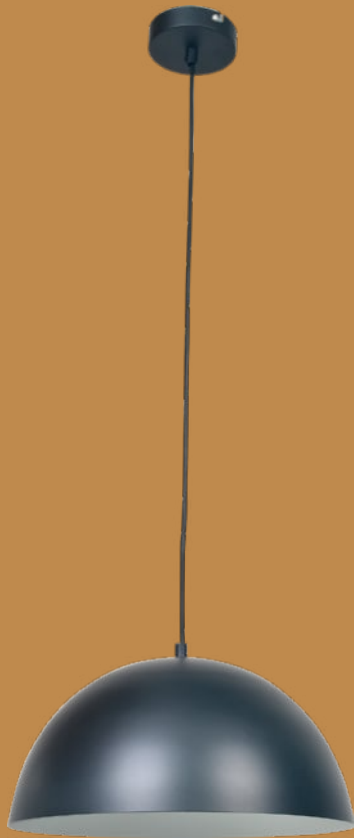



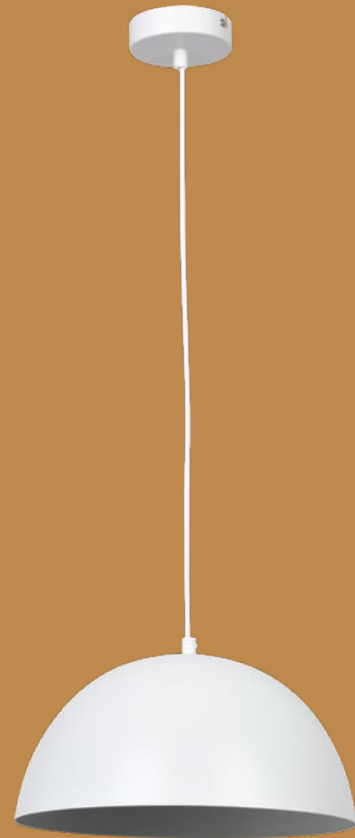

Colgante
COLETA 35
Art.: CCT71035 NG

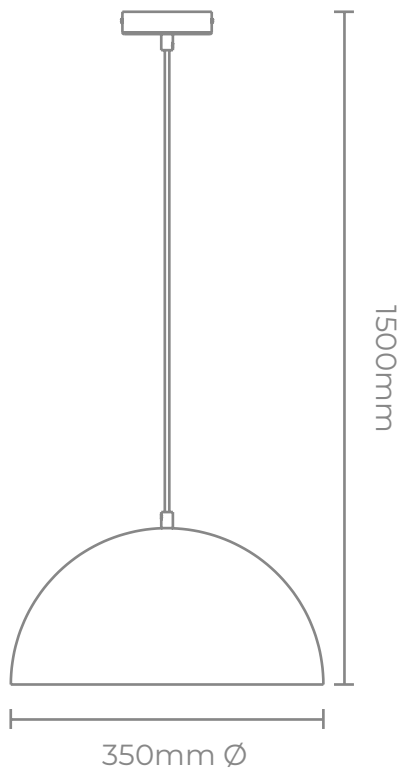

Colgante
COLETA 35
Art.: CCT71035 BL



-  1xE27, Max 15W, 220V, 50Hz, IP20
-  Negro mate, Blanco mate
-  Chapa de acero
-  Clase II



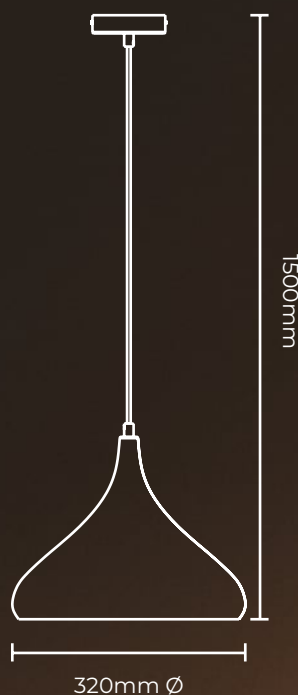

COLGANTE CORBETA 32



Colgante CORBETA 32

Art.: CCT71532 NG-OA



-  1xE27, Max 15W, 220V, 50Hz, IP20
-  Negro mate+Oro antiguo
-  Chapa de acero
-  Clase II

CAJA MASTER

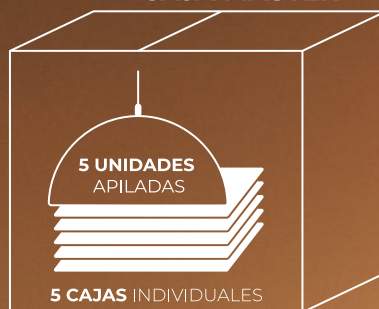

*Colgante para lámpara E27
construido en chapa de
acero.*

COLGANTE CORBETA 42

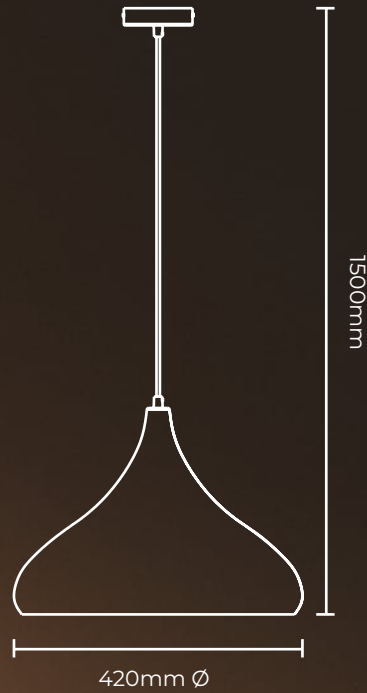

Colgante para lámpara E27
construido en chapa de
acero.



Colgante

CORBETA 42

Art.: CCT71542 NG-OA



 1xE27, Max 15W, 220V, 50Hz, IP20

 Negro mate+Oro antiguo

 Chapa de acero



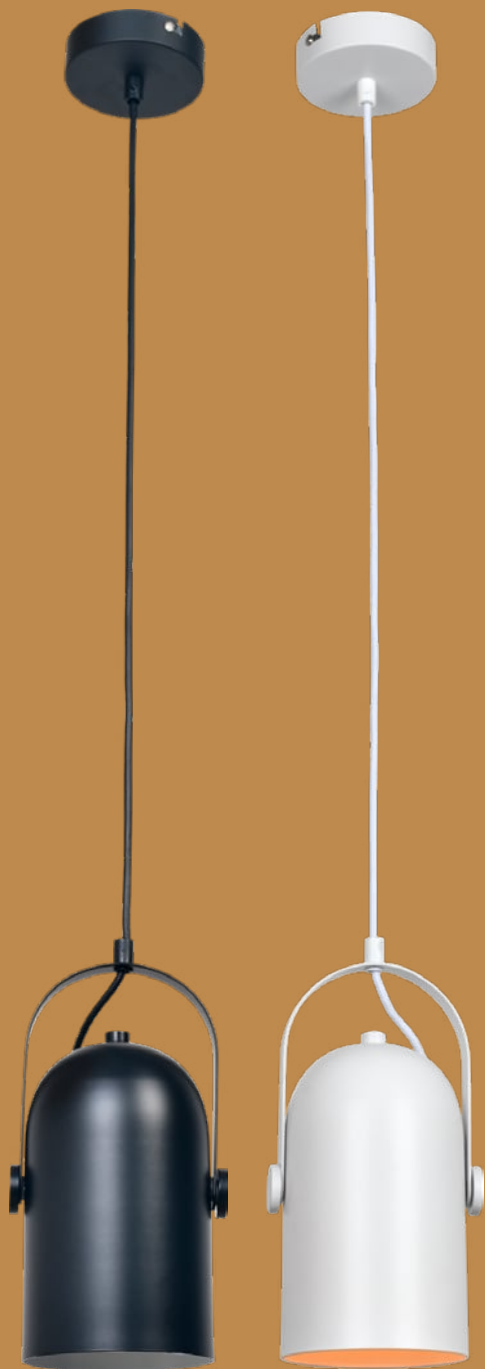

 Clase II

COLGANTE MICRO



Colgante
MICRO
Art.: CCT7808



-  1xE27, Max 15W, 220V, 50Hz, IP20
-  Negro mate, Blanco
-  Chapa de acero
-  Clase II

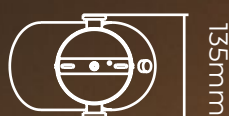

*Colgante para lámpara E27
construido en chapa de acero.*

COLGANTE MEGA

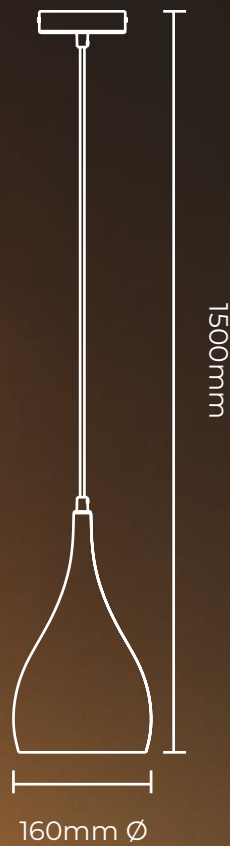

Colgante para lámpara E27
construido en chapa de acero.

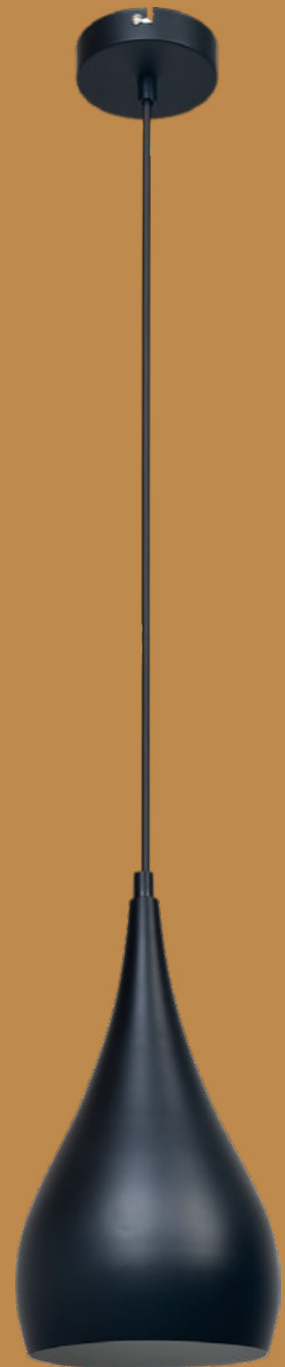

Colgante

MEGA

Art.: CCT72516 NG



1xE27, Max 15W, 220V, 50Hz, IP20



Negro mate



Chapa de acero





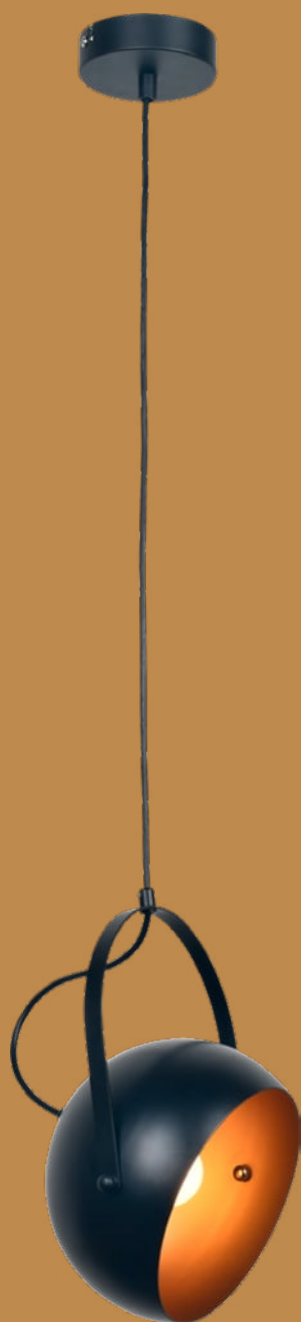

Clase II

COLGANTE ARYPA



Colgante
ARYPA
Art.: CCT77018 NG



-  1xE27, Max 15W, 220V, 50Hz, IP20
-  Negro mate
-  Chapa de acero
-  Clase II

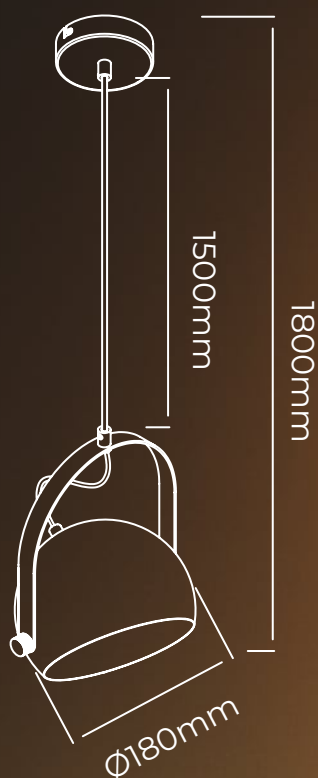

*Colgante para lámpara E27
construido en chapa de acero.*

COLGANTE PRIUS

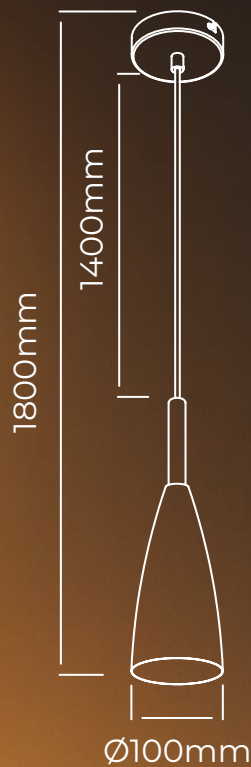



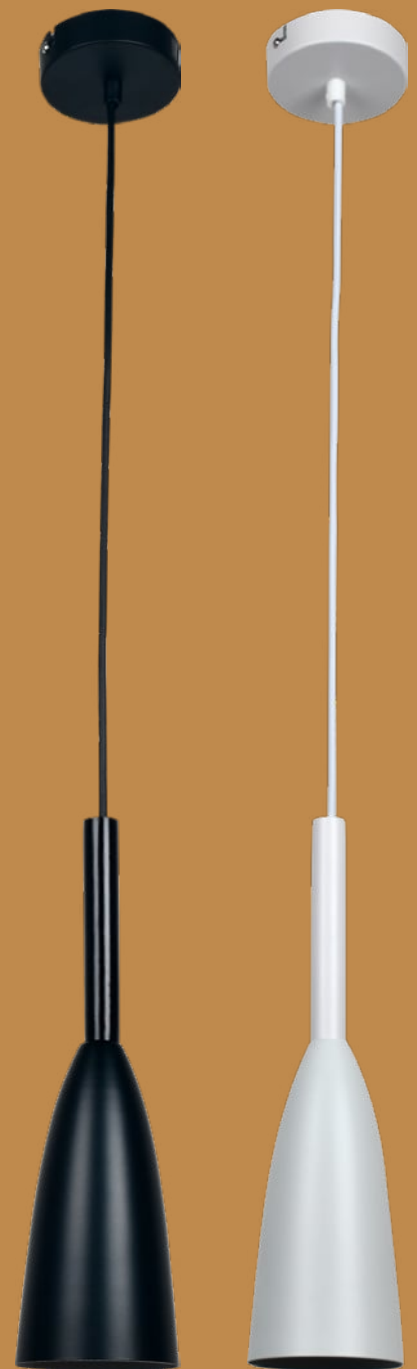

Colgante para lámpara E27
construido en chapa de acero.



Colgante
PRIUS
Art.: CCT72516



-  1xE27, Max 15W, 220V, 50Hz, IP20
-  Negro mate, Blanco
-  Chapa de acero
-  Clase II

COLGANTE FACETA



Colgante facetado para lámpara E27 construido en chapa de acero.

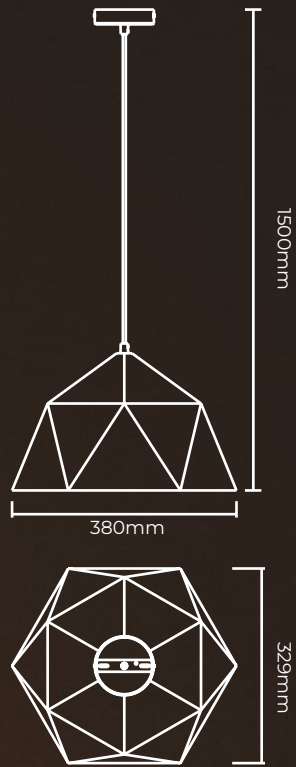

Colgante

FACETA

Art.: CCT73038 NG-OA



- 1xE27, Max 15W, 220V, 50Hz, IP20
- Negro mate+Oro antiguo
- Chapa de acero
- Clase II

CAJA MASTER



Negro mate + Oro antiguo

COLGANTE JIRÓN



Colgante para lámpara E27 construido en chapa de acero.

CAJA MASTER

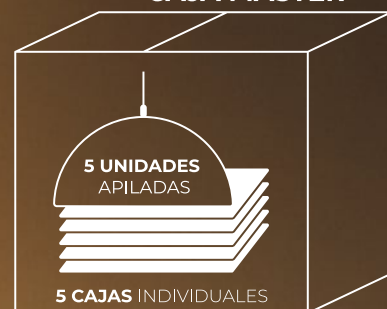

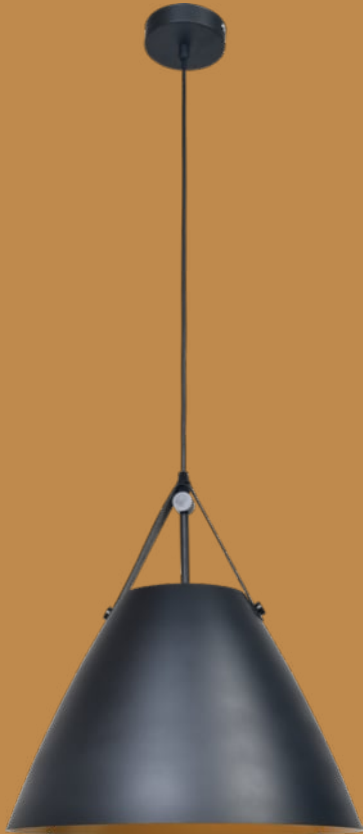



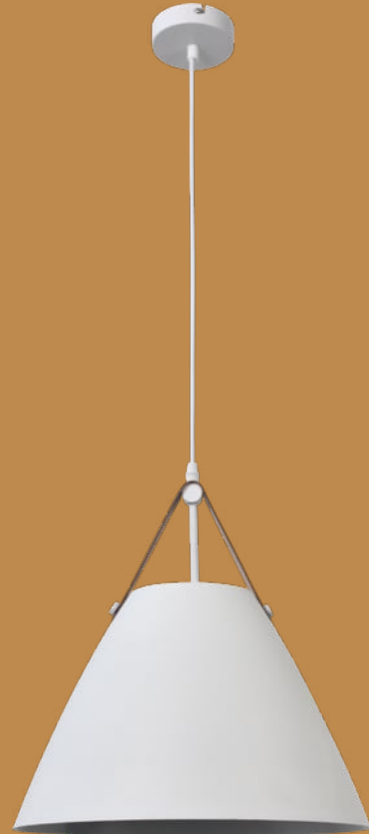

Colgante
JIRÓN
Art.: CCT74035 NG-OA

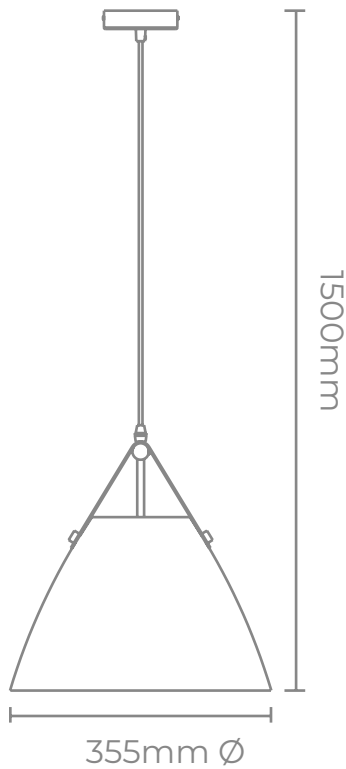

Colgante
JIRÓN
Art.: CCT74035 BL



-  1xE27, Max 15W, 220V, 50Hz, IP20
-  Negro mate+Oro antiguo, Blanco mate+Plata
-  Chapa de acero
-  Clase II

COLGANTE PILUSO



Colgante para lámpara E27 construido en chapa de acero.

CAJA MASTER





Colgante
PILUSO



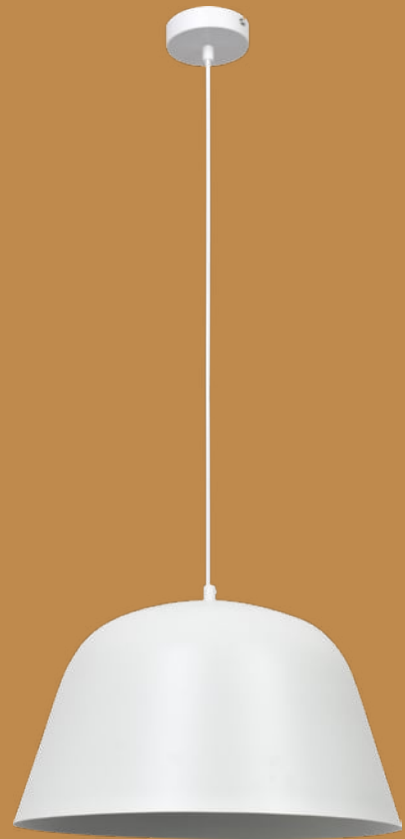

Art.: CCT75040 NG+OA

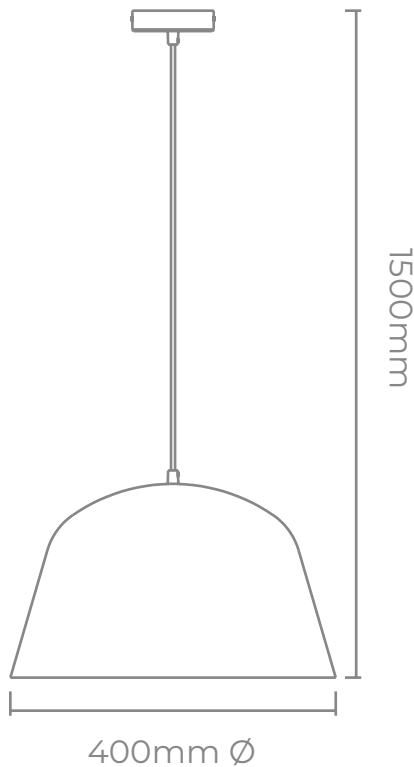

Colgante
PILUSO

Art.: CCT75040 BL



-  1xE27, Max 15W, 220V, 50Hz, IP20
-  Negro mate+Oro antiguo, Blanco mate
-  Chapa de acero
-  Clase II

COLGANTE CHIN



Colgante para lámpara E27 construido en chapa de acero.

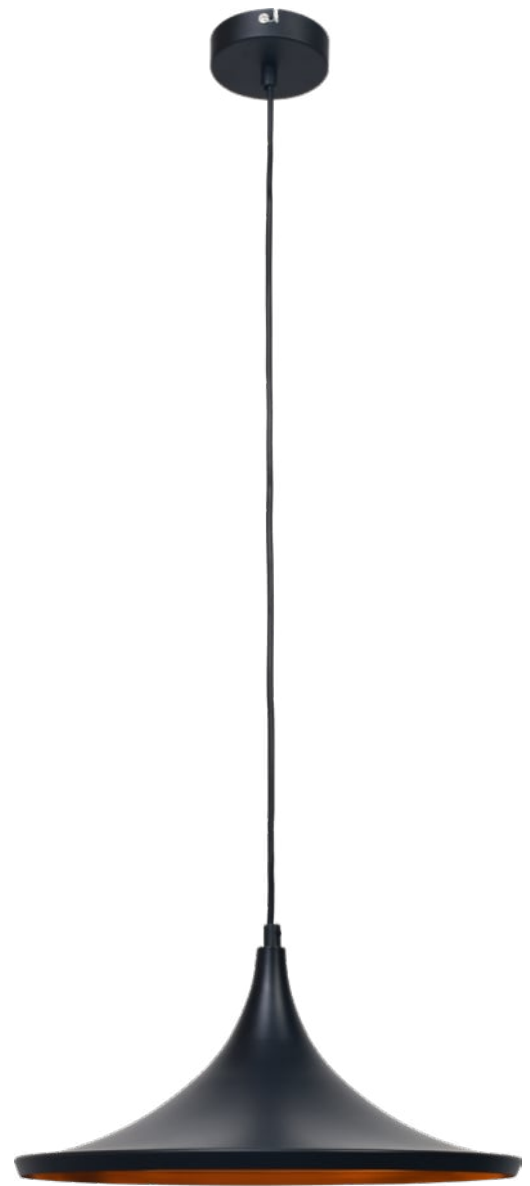
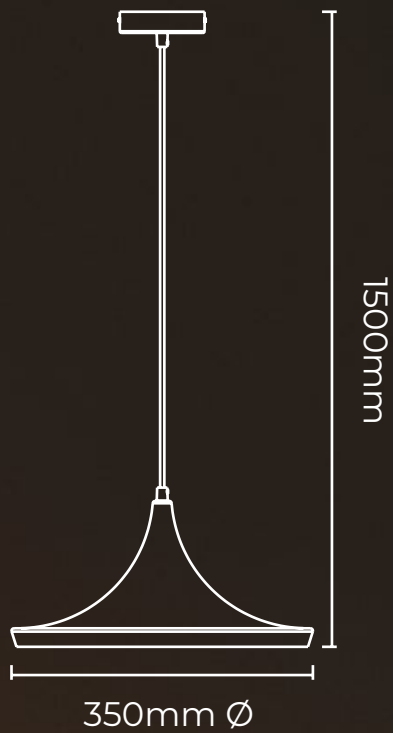



Colgante

CHIN

Art.: CCT76036 NG-OA



 1xE27, Max 15W, 220V, 50Hz, IP20

 Negro mate+Oro antiguo

 Chapa de acero

 Clase II

CAJA MASTER

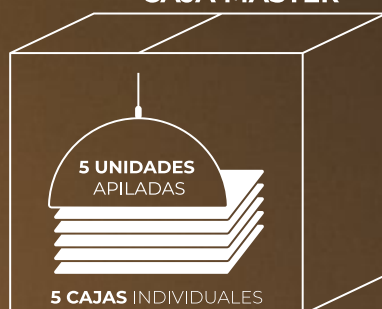

COLGANTE BEBE

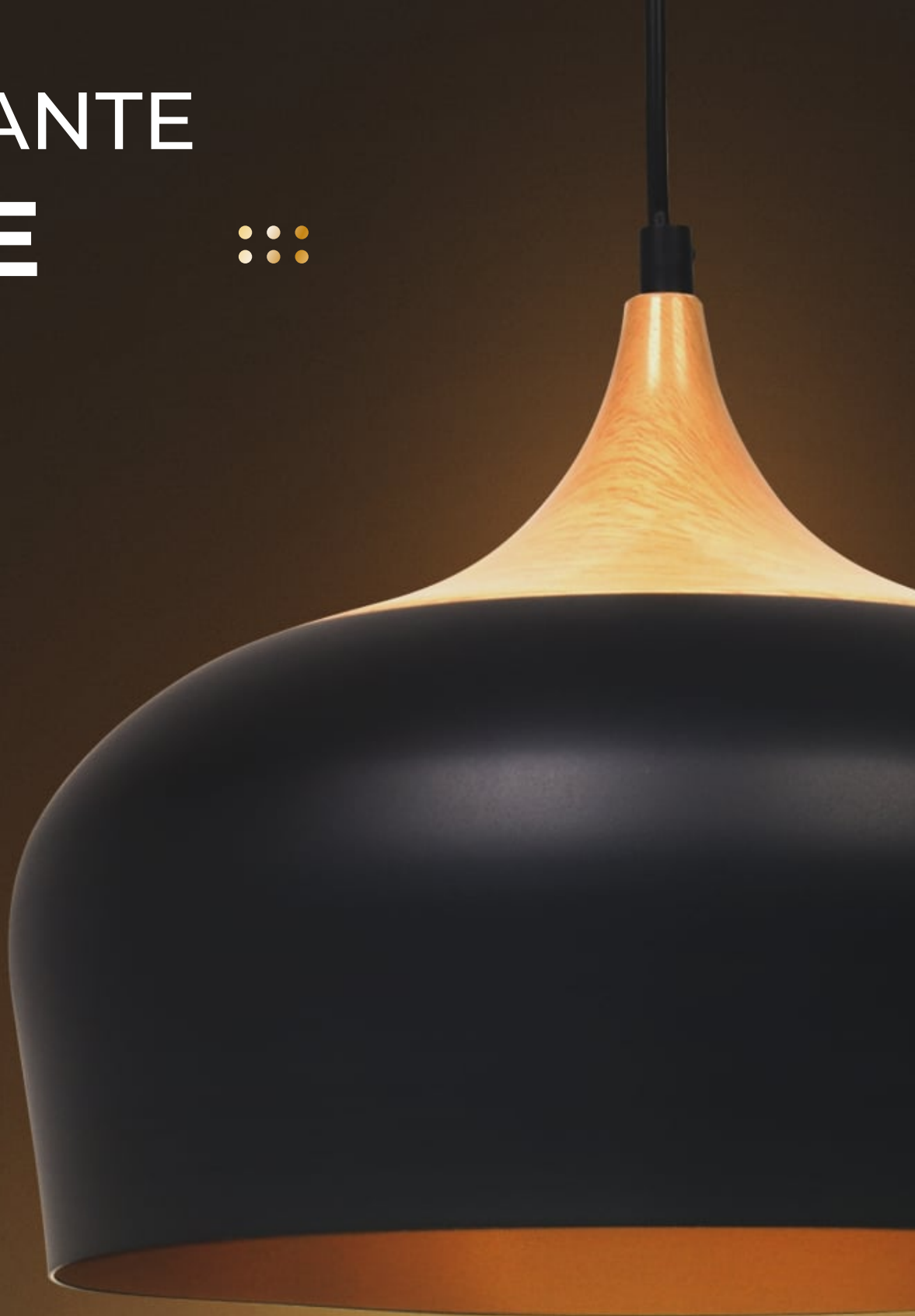

Colgante para lámpara E27 construido en chapa de acero.

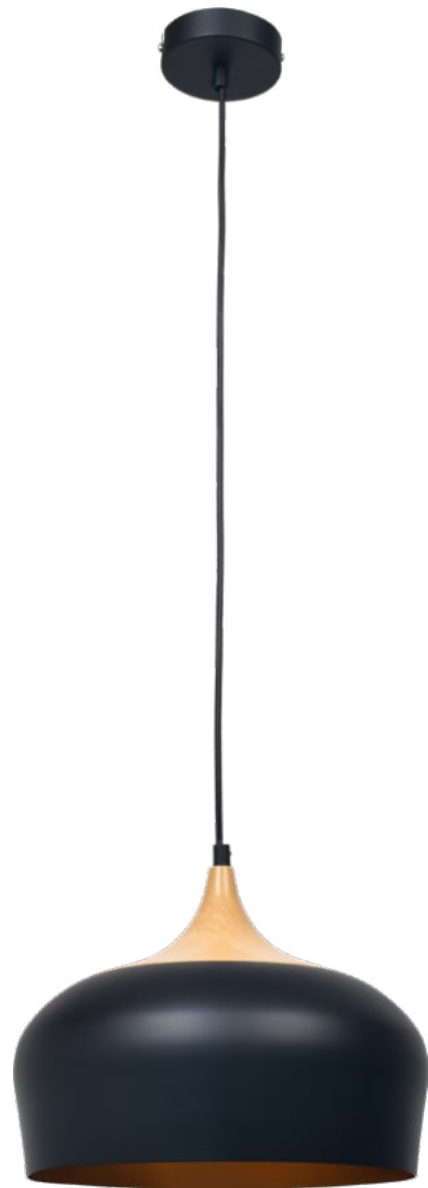
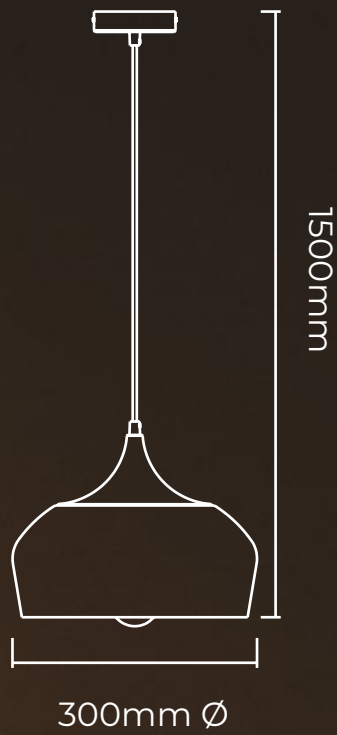

Colgante

BEBE

Art.: CCT76532 NG-OA



1xE27, Max 15W, 220V, 50Hz, IP20



Negro mate+Oro antiguo



Chapa de acero



Clase II



Negro mate + Oro antiguo



COLGANTE CORONA 6 ::::

Colgante de 6 luces para lámpara E27 construido en chapa de acero.

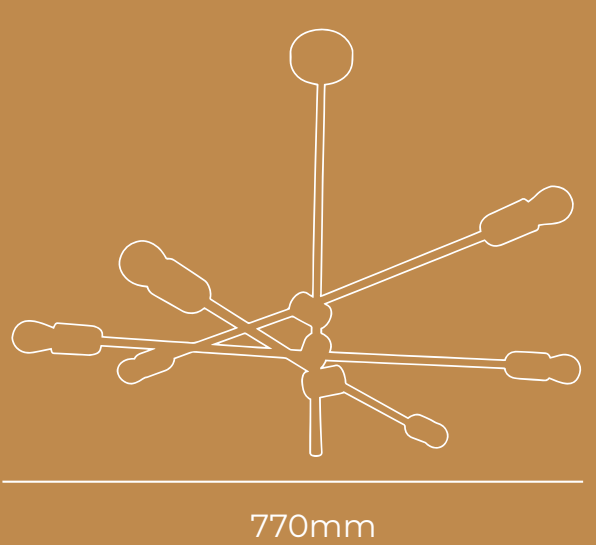





785mm

770mm

Colgante
CORONA 6
Art.: PT894006



-  6xE27, Max 12W, 220V, 50Hz, IP20
-  Negro mate, Bronce mate
-  Chapa de acero
-  Clase I

COLGANTE DEPOT





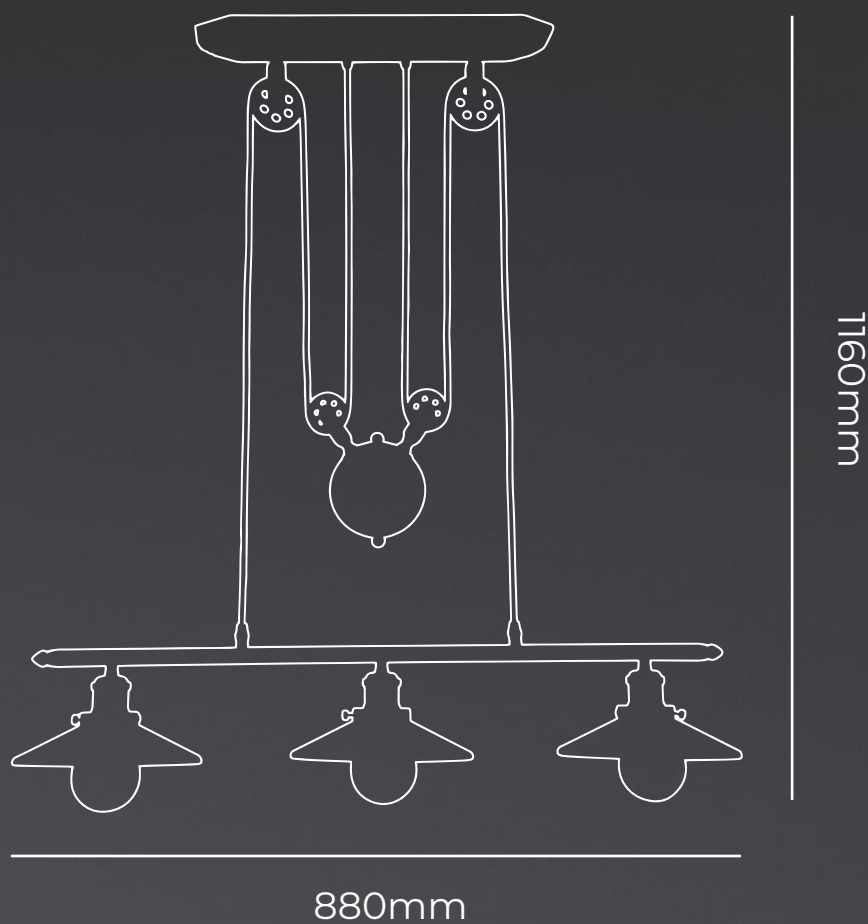
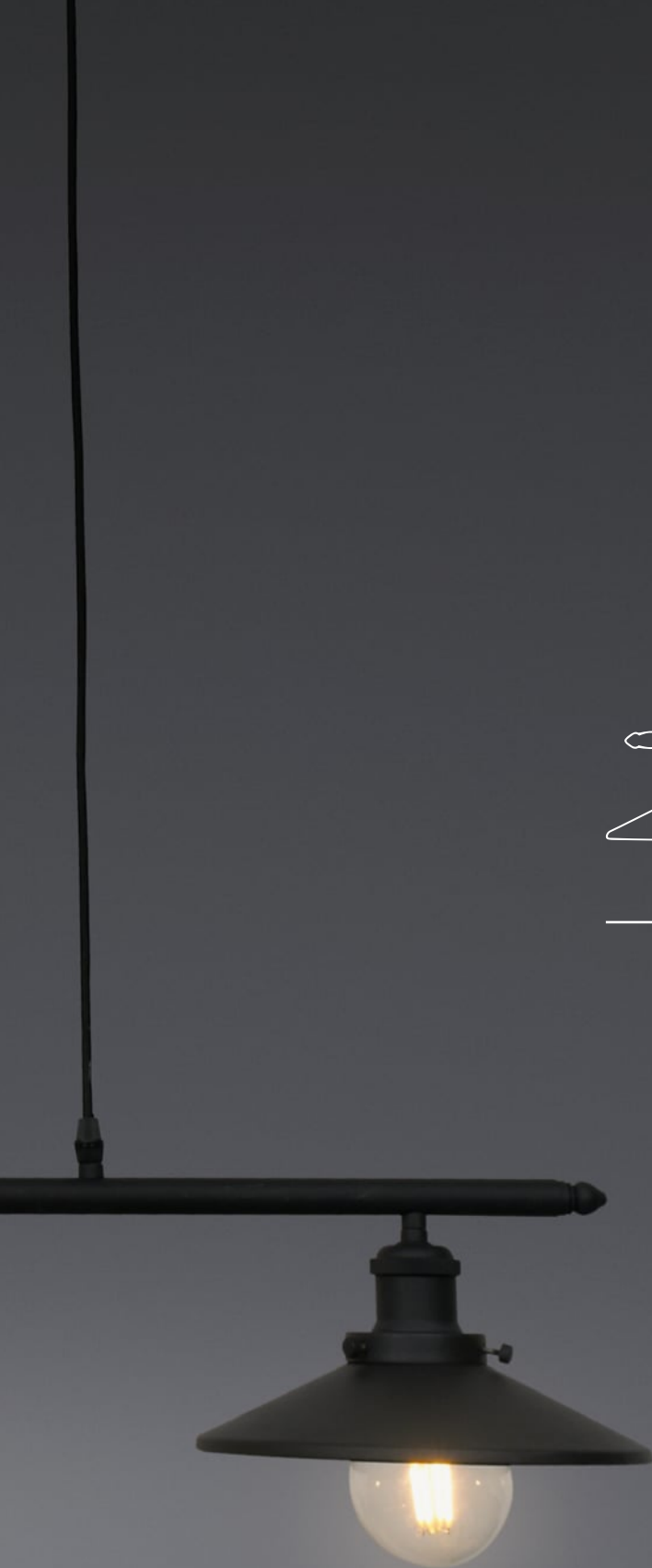

*Colgante de 3 luces para lámpara E27
construido en chapa de acero.*





Colgante
DEPOT
Art.: PT912003



-  3xE27, Max 12W, 220V, 50Hz, IP20
-  Negro mate
-  Chapa de acero
-  Clase I





COLGANTES Y PLAFONES DECO PARA G9

Colgantes G9 de 2 a 4 luces
construidos en chapa de
acero. Tulipas de vidrio con
terminación opal.

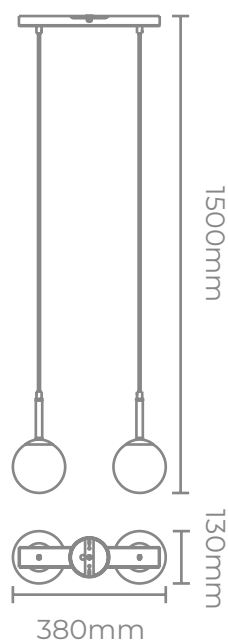
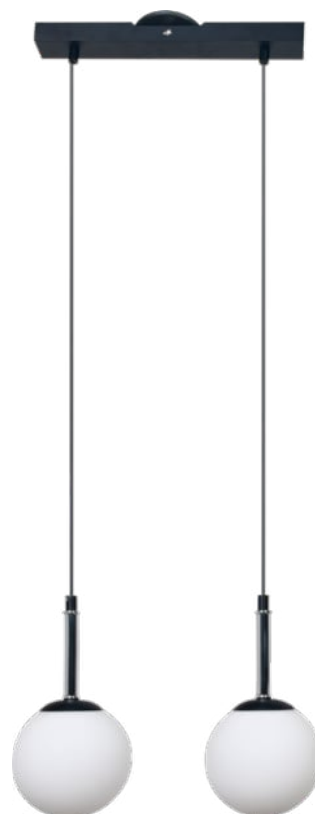

COLGANTE CIRO







Colgante

CIRO 2





Art.: CG130150/2 NG

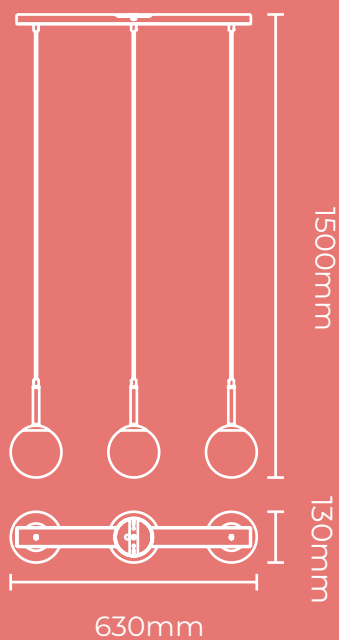
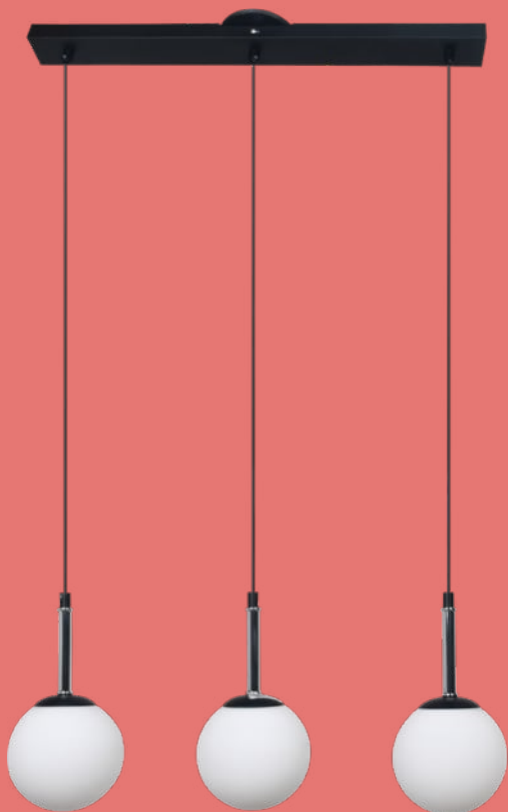

-  2xG9, Max 8W, 220V, 50Hz, IP20
-  Negro mate
-  Chapa de acero
-  Orientable
-  Clase I





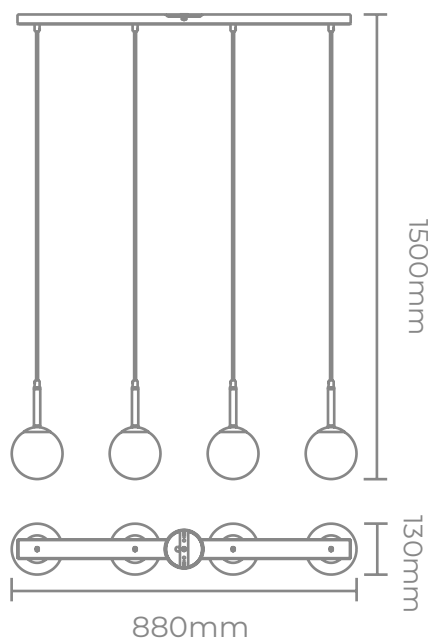

Colgante
CIRO 3
 Art.: CG130150/3 NG

-  3xG9, Max 8W, 220V, 50Hz, IP20
-  Negro mate
-  Chapa de acero
-  Orientable
-  Clase I



Colgante
CIRO 4
 Art.: CG130150/4 NG

-  4xG9, Max 8W, 220V, 50Hz, IP20
-  Negro mate
-  Chapa de acero
-  Orientable
-  Clase I

PLAFÓN BALL 10





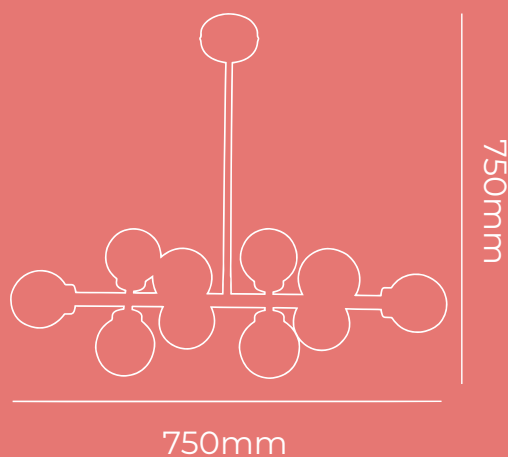

Plafón de 10 luces para lámpara G9 construido en chapa de acero.



Plafón
BALL 10
Art.: PT907010



-  10xG9, Max 12W, 220V, 50Hz, IP20
-  Bronce
-  Chapa de acero
-  Clase I

PLAFÓN BALL 12



Plafón de 12 luces para lámpara G9 construido en chapa de acero.

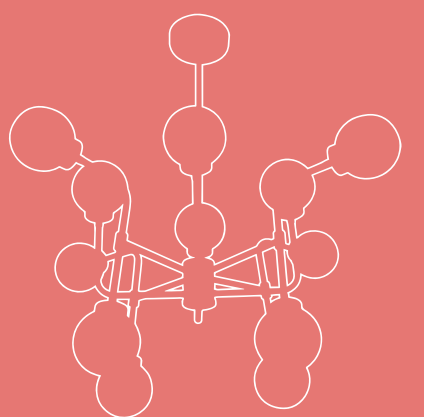





754mm

804mm

Plafón
BALL 12
Art.: PT907012



-  12xG9, Max 12W, 220V, 50Hz, IP20
-  Bronce
-  Chapa de acero
-  Clase I

PLAFÓN BALL COLOR NEGRO



*Plafones de 5, 9 y 10 luces para lámpara G9
construidos en chapa de acero.*

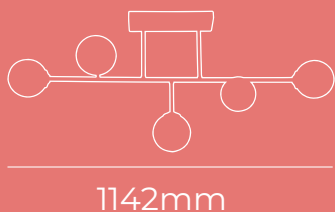

515mm

1142mm

Plafón

BALL 5

Art.: PT907005



 5xG9, Max 12W, 220V, 50Hz, IP20

 Negro texturado

 Chapa de acero

 Clase I

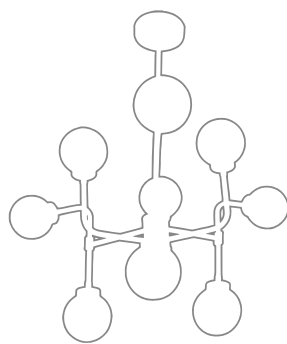

726mm

673mm

Plafón

BALL 9

Art.: PT907009



 9xG9, Max 12W, 220V, 50Hz, IP20

 Negro texturado

 Chapa de acero

 Clase I

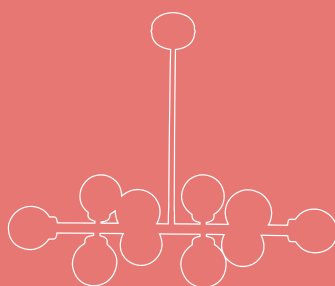
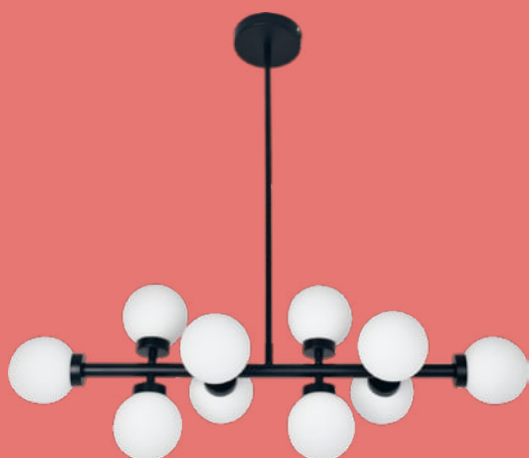

750mm

750mm

Plafón

BALL 10

Art.: PT907010



 10xG9, Max 12W, 220V, 50Hz, IP20

 Negro texturado

 Chapa de acero

 Clase I

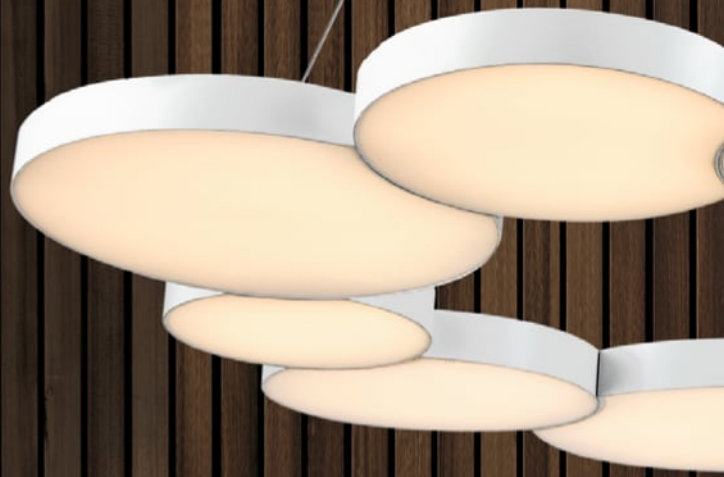



COLGANTES Y PLAFONES HIGH DECO LED

COLGANTE PANAL 6



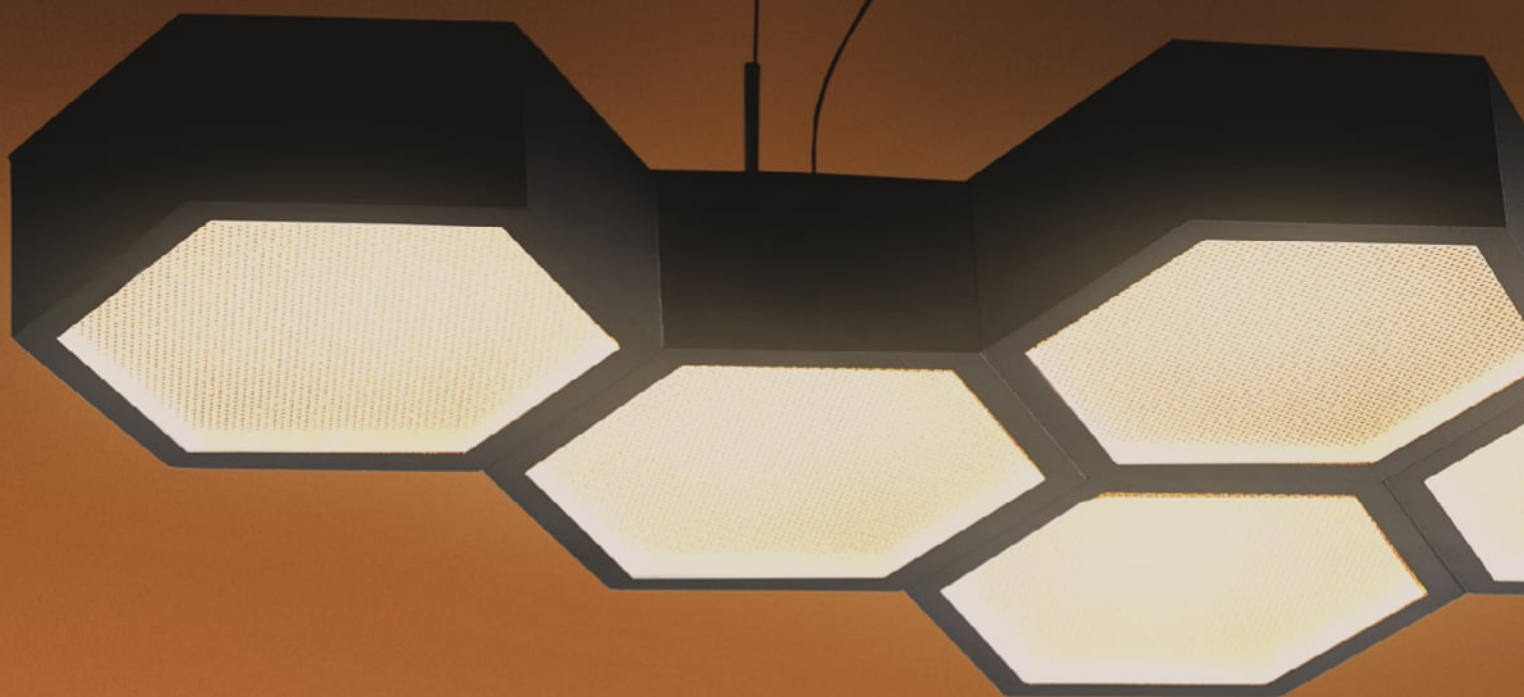

Colgante LED de 6 luces construido en aluminio.



Colgante
PANAL 6
Art.: CTL8806402833





 LED 36W, 220V, 50Hz, IP20

 Negro texturado, Blanco texturado

 3000K

 3240LM

 Aluminio

 Clase I

 Dimerizable

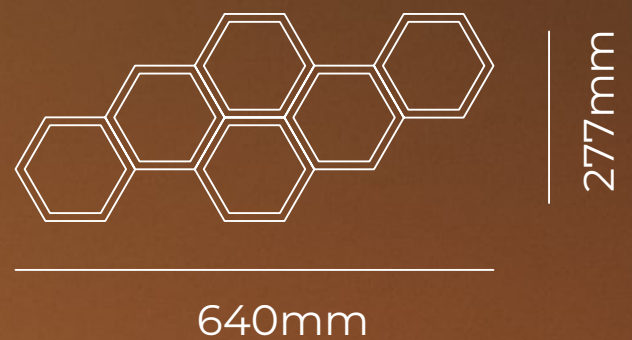
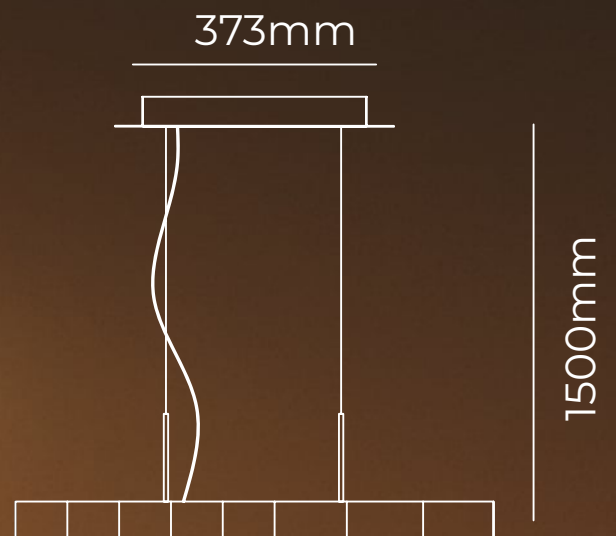

 Negro Texturado

 Blanco Texturado

PLAFÓN PANAL







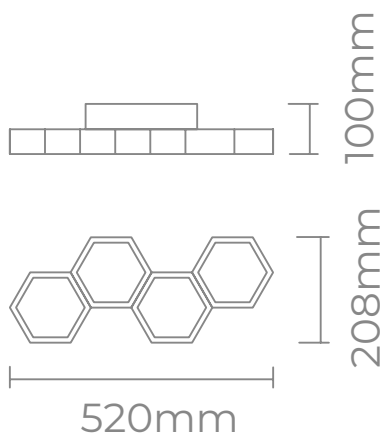

Plafones LED de 4, 5, 6 y 10 luces contruidos en aluminio.



Plafón
PANAL 4
Art.: PTL8804002825



-  LED 25W, 220V, 50Hz, IP20
-  Negro texturado, Blanco texturado
-  3000K
-  2250LM
-  Aluminio
-  Clase I
-  Dimerizable

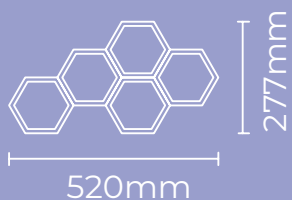
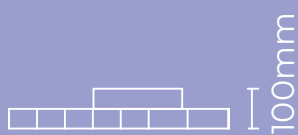



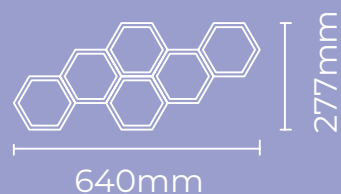
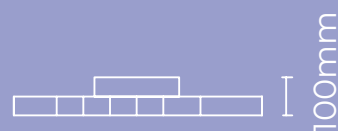
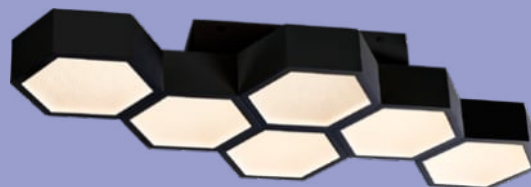











Plafón
PANAL 5
Art.: PTL8806402825



Plafón
PANAL 6
Art.: PTL8806402833









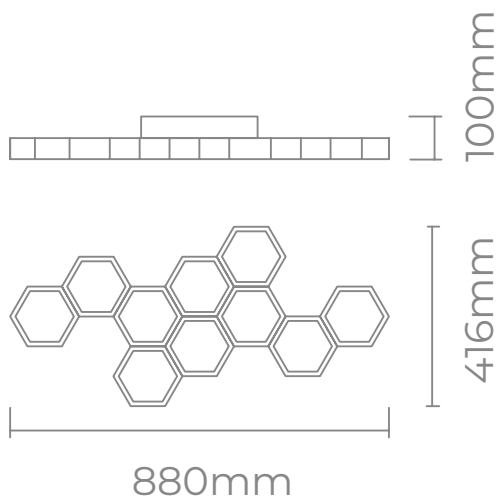

-  LED 28W, 220V, 50Hz, IP20
-  Negro texturado, Blanco texturado
-  3000K
-  2520LM
-  Aluminio
-  Clase I
-  Dimerizable

-  LED 36W, 220V, 50Hz, IP20
-  Negro texturado, Blanco texturado
-  3000K
-  3240LM
-  Aluminio
-  Clase I
-  Dimerizable



Plafón
PANAL 10
Art.: PTL8808804239



-  LED 54W, 220V, 50Hz, IP20
-  Negro texturado, Blanco texturado
-  3000K
-  4860LM
-  Aluminio
-  Clase I
-  Dimerizable

COLGANTE ARUBA



Colgantes LED de 1, 3 y 5 luces
construidos en aluminio.

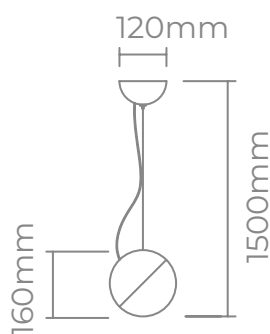

Colgante
ARUBA 1
Art.: CTL77RE01610M



- LED 10W, 220V, 50Hz, IP20
- Negro texturado
- 3000K
- 900LM
- Aluminio
- Clase I
- Dimerizable

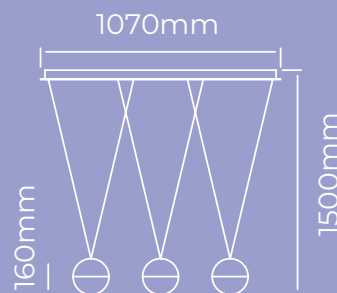
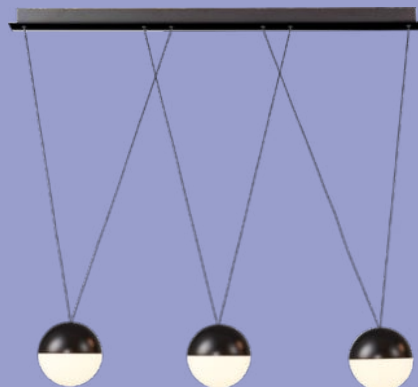

Colgante
ARUBA 3
Art.: CTL7710301632



- LED 32W, 220V, 50Hz, IP20
- Negro texturado
- 3000K
- 2880LM
- Aluminio
- Clase I
- Dimerizable

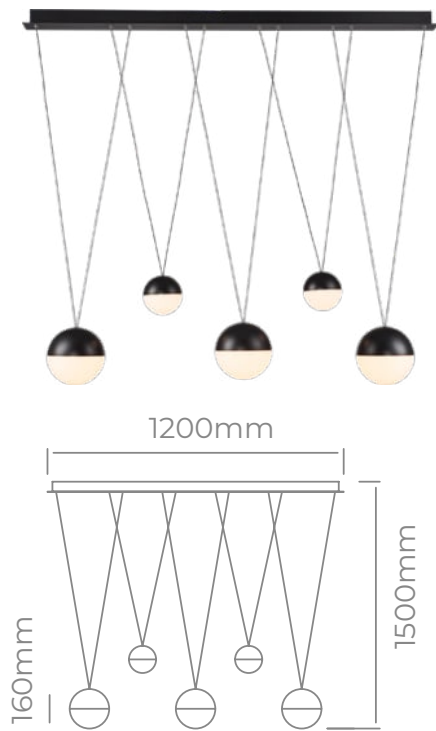
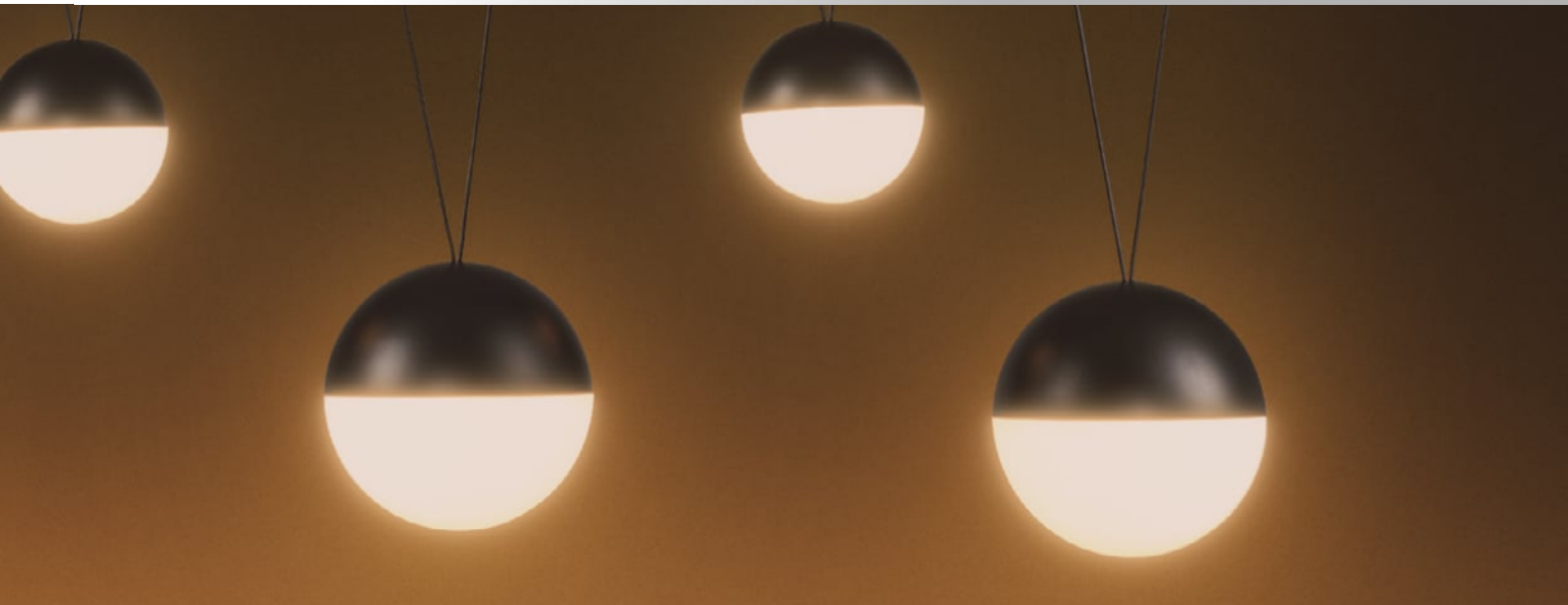

Colgante
ARUBA 5
 Art.: CTL7712001636



-  LED 36W, 220V, 50Hz, IP20
-  Negro texturado
-  3000K
-  3240LM
-  Aluminio
-  Clase I
-  Dimerizable

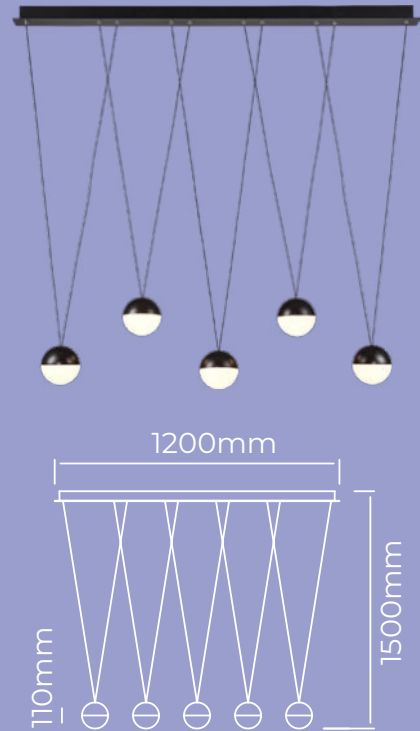

Colgante
ARUBA 5
 Art.: CTL7715001643



-  LED 36W, 220V, 50Hz, IP20
-  Negro texturado
-  3000K
-  3240LM
-  Aluminio
-  Clase I
-  Dimerizable

COLGANTE VECTOR





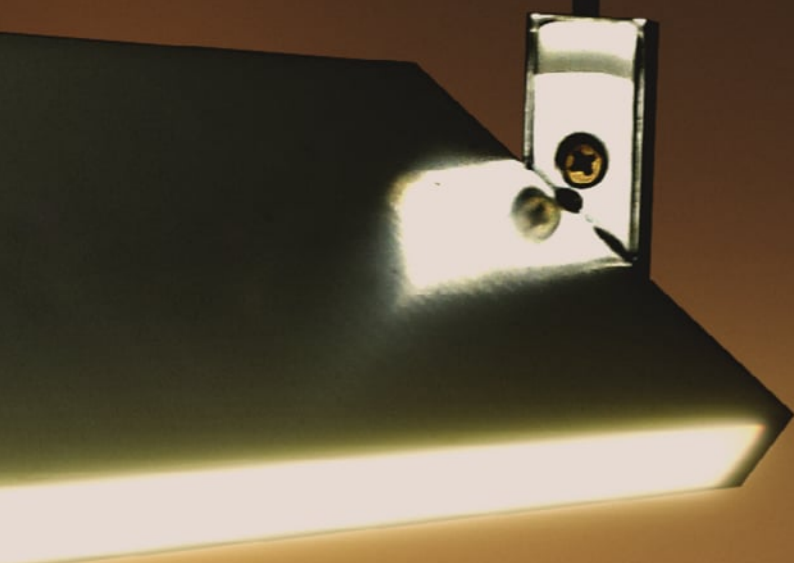
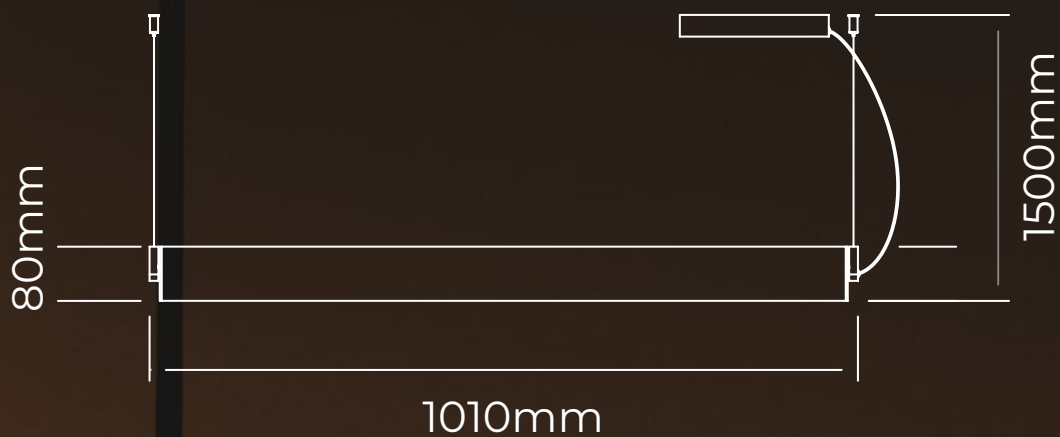



Colgante LED luz cálida, construido en aluminio.



Colgante
VECTOR
Art.: CTL8510408029



-  LED 29W, 220V, 50Hz, IP20
-  Negro texturado
-  3000K
-  2610LM
-  Aluminio
-  Clase I
-  Dimerizable



COLGANTE POPE



Colgantes LED de 6 y 8 luces, contruidos en aluminio.

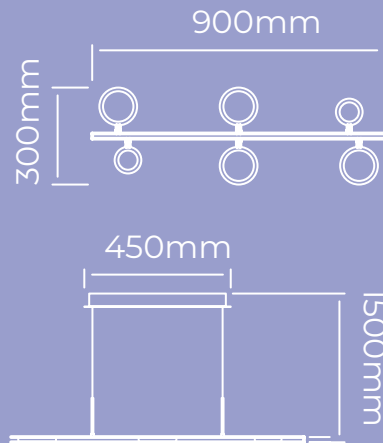
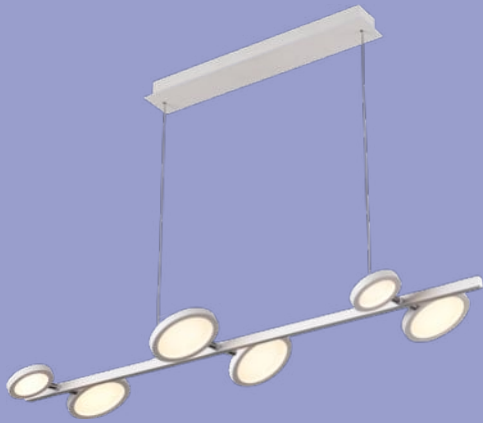

Colgante

POPE 6

Art.: CTL6009003029



-  LED 29W, 220V, 50Hz, IP20
-  Blanco texturado
-  3000K
-  2610LM
-  Aluminio
-  Clase I
-  Dimerizable

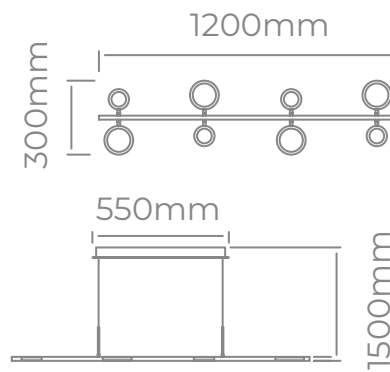

Colgante

POPE 8 LINEAL

Art.: CTL6012003038



-  LED 38W, 220V, 50Hz, IP20
-  Blanco texturado
-  3000K
-  3420LM
-  Aluminio
-  Clase I
-  Dimerizable

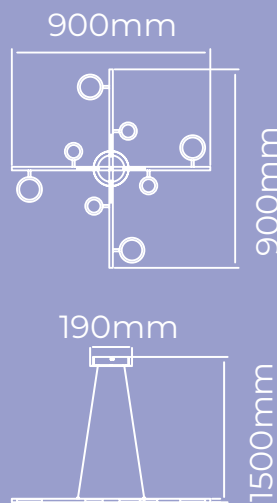
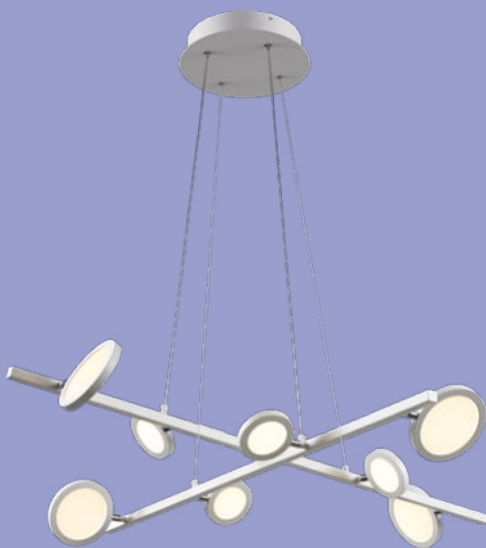

Colgante

POPE 8 BASE REDONDA

Art.: CTL60RE090038



-  LED 38W, 220V, 50Hz, IP20
-  Blanco texturado
-  3000K
-  3420LM
-  Aluminio
-  Clase I
-  Dimerizable

COLGANTE LUPIN



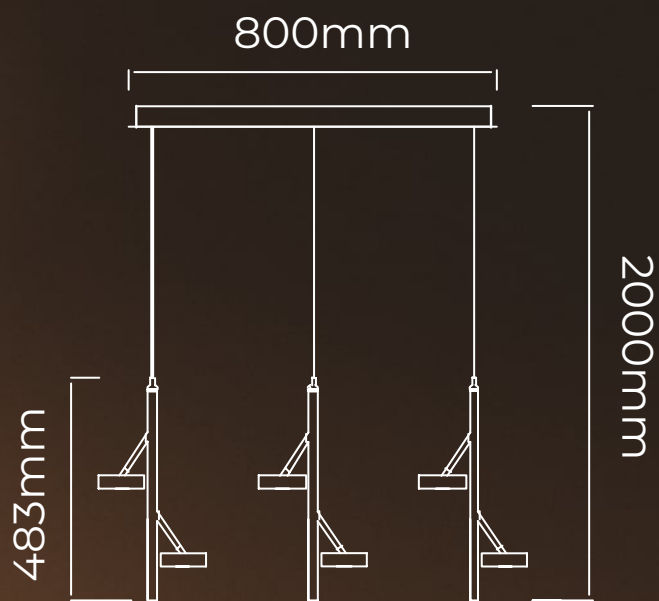
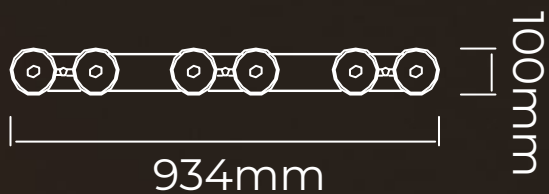

Colgante LED de 6 luces construido en aluminio



Colgante
LUPIN
Art.: CTL37934830



 LED 37W, 220V, 50Hz, IP20

 Blanco texturado

 3000K

 2700LM

 Aluminio

 Clase I

 Dimerizable

COLGANTE NUBE



Colgantes LED de 3, 6 y 9 luces contruidos en aluminio

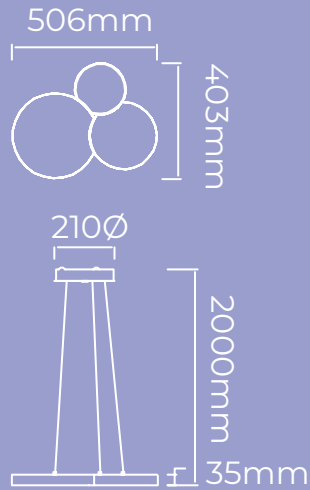

Colgante

NUBE 50

Art.: CTL50X4037A



-  LED 37W, 220V, 50Hz, IP20
-  Blanco texturado
-  3000K
-  3330LM
-  Aluminio
-  Clase I
-  Dimerizable

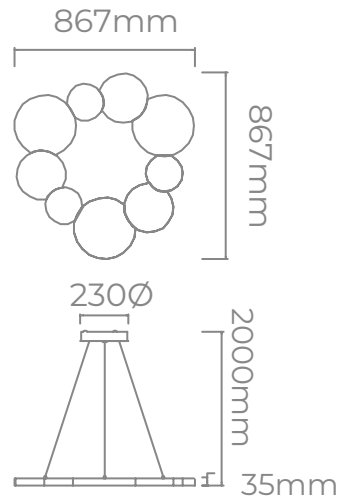

Colgante

NUBE 100

Art.: CTL50X9075A



-  LED 54W, 220V, 50Hz, IP20
-  Blanco texturado
-  3000K
-  4860LM
-  Aluminio
-  Clase I
-  Dimerizable

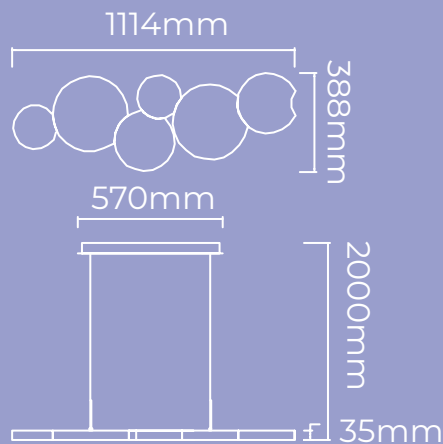
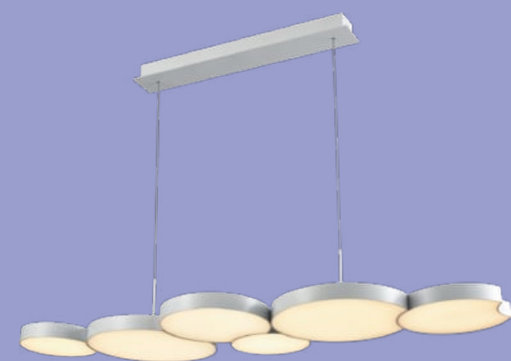

Colgante

NUBE 120

Art.: CTL50X6054C



-  LED 75W, 220V, 50Hz, IP20
-  Blanco texturado
-  3000K
-  6750LM
-  Aluminio
-  Clase I
-  Dimerizable

PLAFÓN NUBE





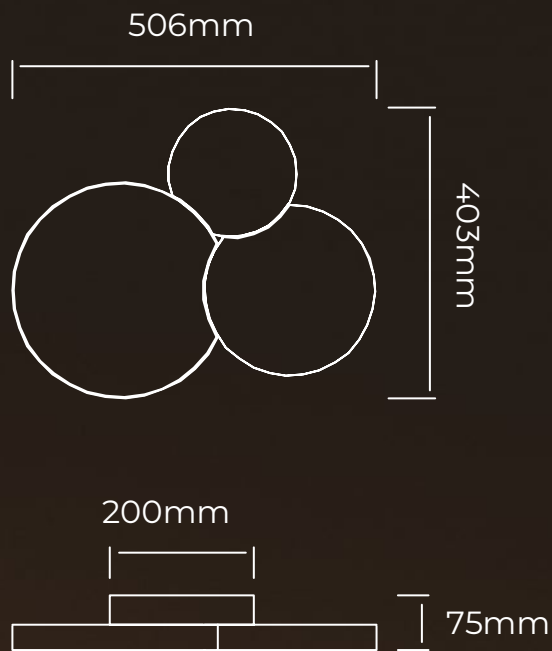

Plafón LED de 3 luces construido en aluminio



Plafón
NUBE 50
Art.: PTL50X3037A



-  LED 37W, 220V, 50Hz, IP20
-  Blanco texturado
-  3000K
-  3330LM
-  Aluminio
-  Clase I
-  Dimerizable

 Blanco texturado

COLGANTE TAMPA 60

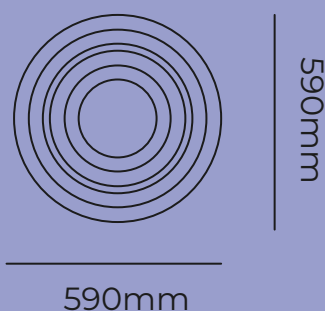
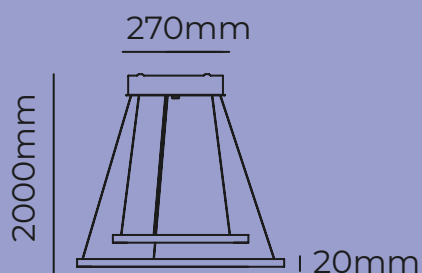

Colgante
TAMPA 60
Art.: CTL22058054



 LED 54W, 220V, 50Hz, IP20

 Blanco texturado

 3000K

 4860LM

 Aluminio

 Clase I

 No dimerizable



*Colgante LED de 2 aros, construido
integralmente en aluminio.*

COLGANTE TAMPA 80



Colgante LED de 3 aros, construido
integralmente en aluminio.

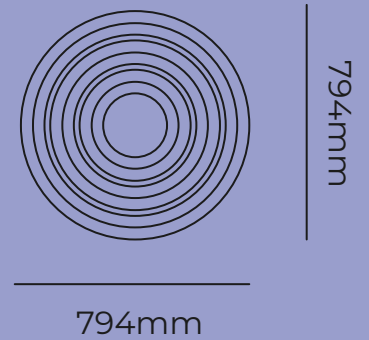
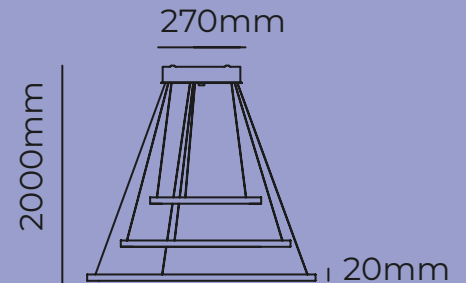

Colgante
TAMPA 80
Art.: CTL22079098



-  LED 98W, 220V, 50Hz, IP20
-  Blanco texturado
-  3000K
-  8820LM
-  Aluminio
-  Clase I
-  No dimerizable

COLGANTE OLIMPIC



*Colgantes LED de 3, 6 y 9 aros,
construidos en aluminio.*



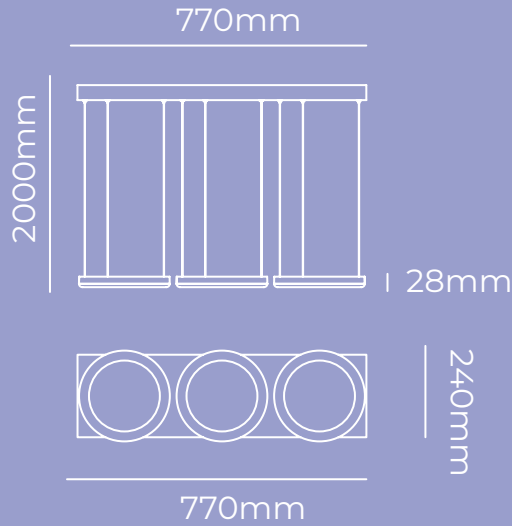

Colgante
OLIMPIC 3
Art.: CTL26772225



-  LED 25W, 220V, 50Hz, IP20
-  Blanco texturado
-  3000K
-  2250LM
-  Aluminio
-  Clase I
-  Dimerizable

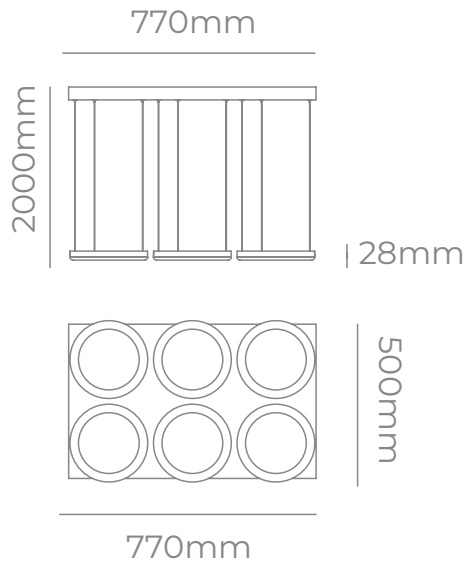

Colgante
OLIMPIC 6
Art.: CTL26774860



-  LED 60W, 220V, 50Hz, IP20
-  Blanco texturado
-  3000K
-  5400LM
-  Aluminio
-  Clase I
-  Dimerizable

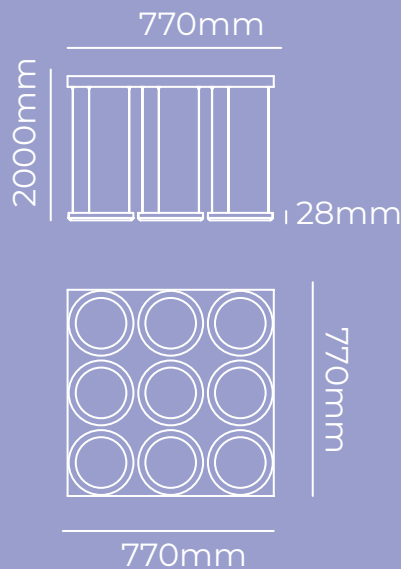
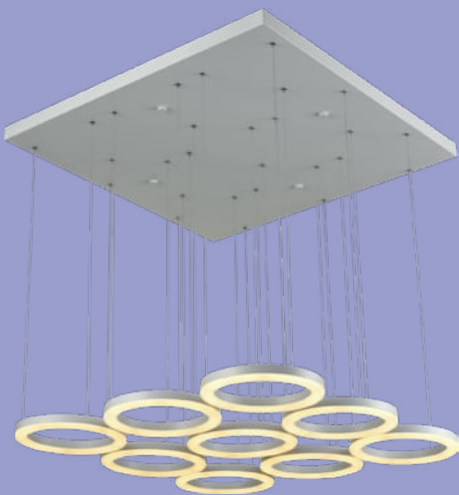

Colgante
OLIMPIC 9
Art.: CTL26777795





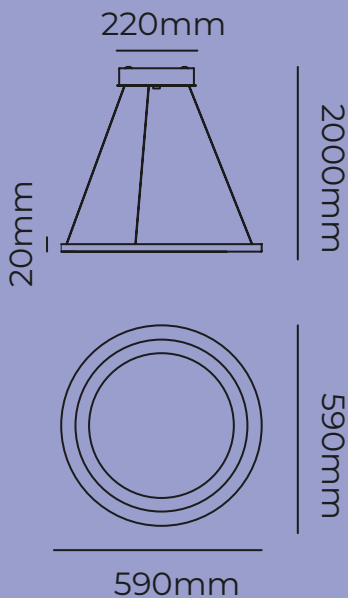

-  LED 95W, 220V, 50Hz, IP20
-  Blanco texturado
-  3000K
-  8550LM
-  Aluminio
-  Clase I
-  Dimerizable

COLGANTE SIESTA 60



Colgante
SIESTA 60
Art.: CTL21058033



-  LED 33,5W, 220V, 50Hz, IP20
-  Blanco texturado
-  3000K
-  3015LM
-  Aluminio
-  Clase I
-  No dimerizable

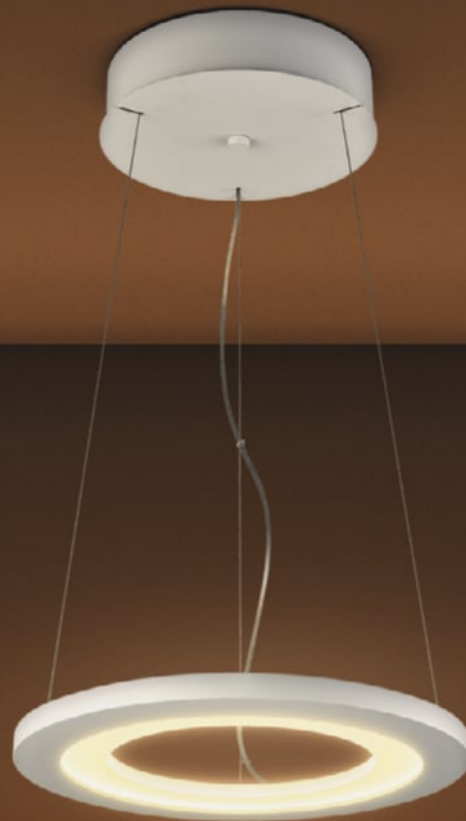

*Colgante LED de un aro
construido en aluminio.*

COLGANTE

●●● SARASOTA 80



Colgante LED de seis aros
construido en aluminio.

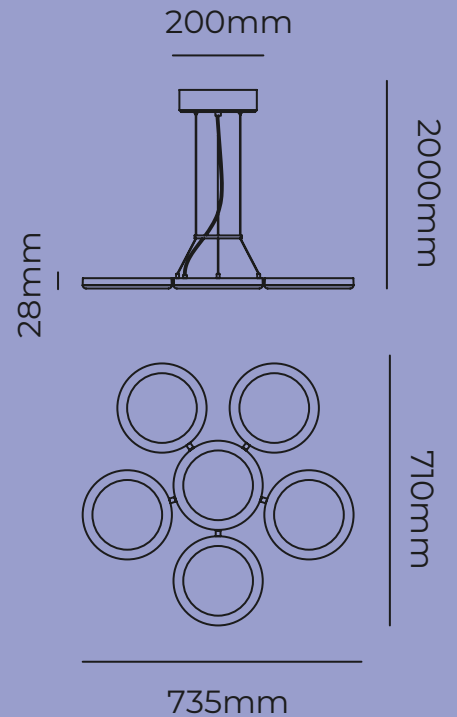

Colgante
SARASOTA 80
Art.: CTL2407660



-  LED 60W, 220V, 50Hz, IP20
-  Blanco texturado
-  3000K
-  5400LM
-  Aluminio
-  Clase I
-  Dimerizable

COLGANTE LONGBOAT SINGLE

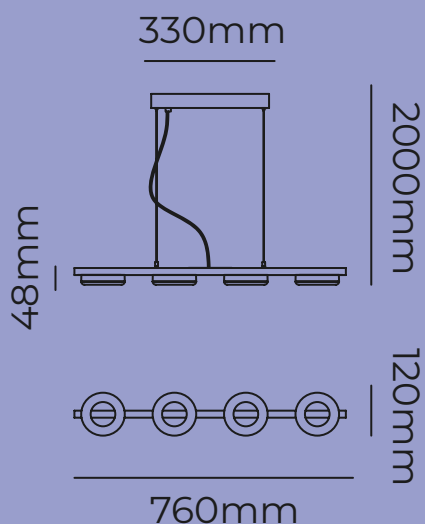

Colgante
LONGBOAT SIMPLE
Art.: CTL24761236



-  LED 36W, 220V, 50Hz, IP20
-  Blanco texturado
-  3000K
-  3240LM
-  Aluminio
-  Clase I
-  Dimerizable



Colgante LED de cuatro luces, no dimerizable, construido en aluminio.

COLGANTE LONGBOAT DOUBLE



Colgante LED de seis luces,
dimerizable, construido en aluminio.

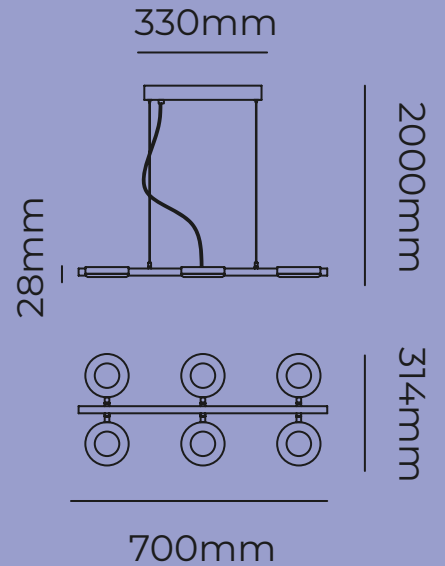

Colgante
LONGBOAT DOUBLE
Art.: CTL24703040



-  LED 40W, 220V, 50Hz, IP20
-  Blanco texturado
-  3000K
-  3600LM
-  Aluminio
-  Clase I
-  Dimerizable

COLGANTE BAHAMAS ::::



Colgante LED de 4 luces construido en aluminio.

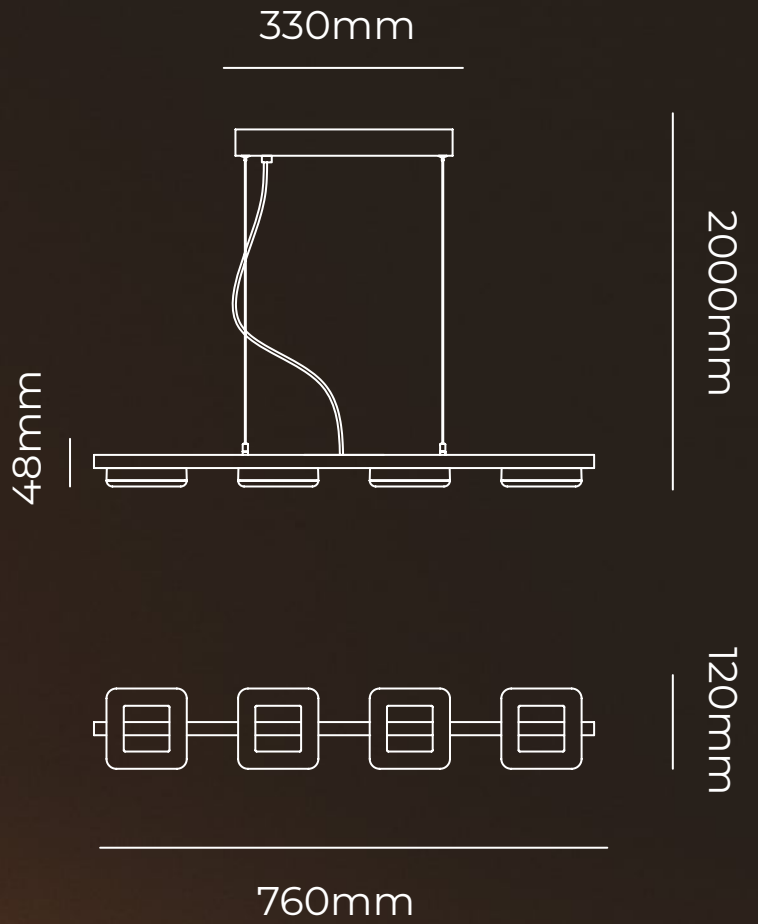
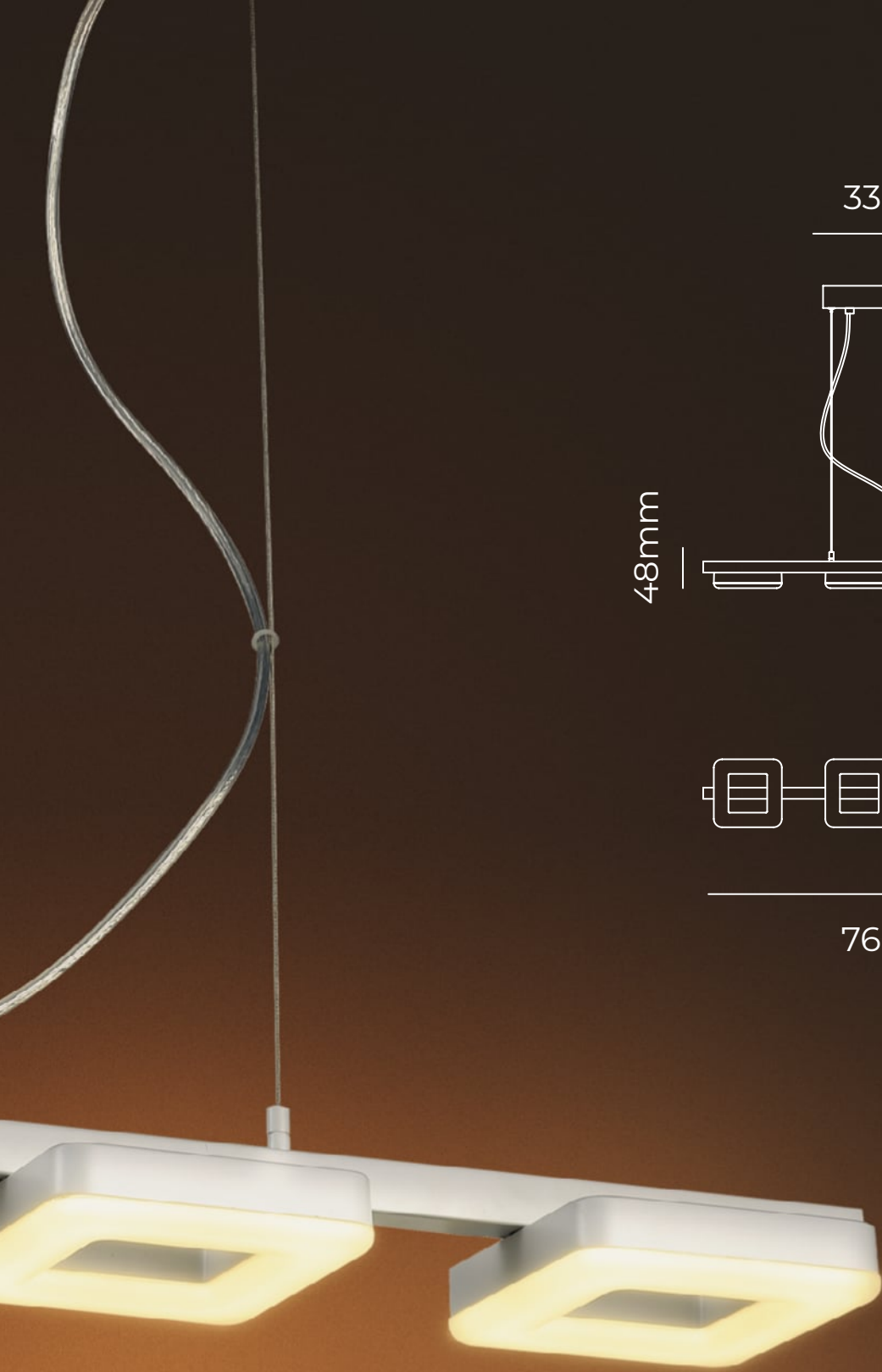

Colgante
BAHAMAS
Art.: CTL25761236



-  LED 36W, 220V, 50Hz, IP20
-  Blanco texturado
-  3000K
-  3240LM
-  Aluminio
-  Clase I
-  Dimerizable

 Blanco texturado

PLAFÓN CORAL 60X40



94mm

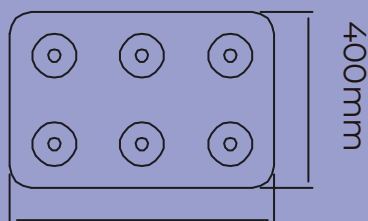

400mm

600mm

Plafón

CORAL 60X40
Art.: PTL33604030



 LED 30W, 220V, 50Hz, IP20

 Blanco texturado

 3000K

 2700LM

 Aluminio

 Clase I

 Dimerizable



*Plafón LED de 6 luces,
dimerizable luz cálida,
construido en aluminio.*

PLAFÓN CORAL 60X60



*Plafón LED de 9 luces,
dimerizable luz cálida,
construido en aluminio*

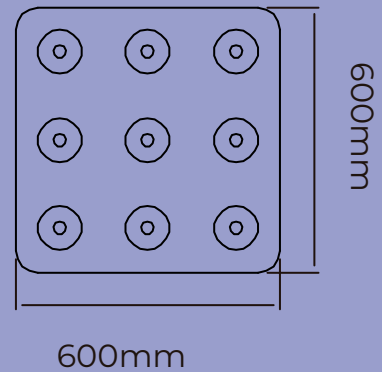

Plafón
CORAL 60X60
Art.: PTL33606044



-  LED 44W, 220V, 50Hz, IP20
-  Blanco texturado
-  3000K
-  3960LM
-  Aluminio
-  Clase I
-  Dimerizable

PLAFÓN MEDUSA



*Plafones LED de 6, 10 y 18 luces, dimerizables
luz cálida, contruidos en aluminio.*

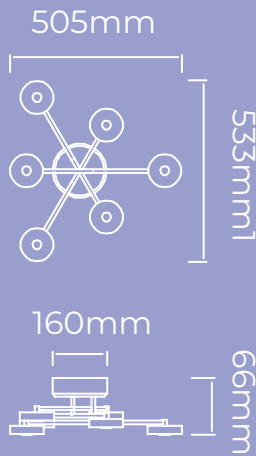
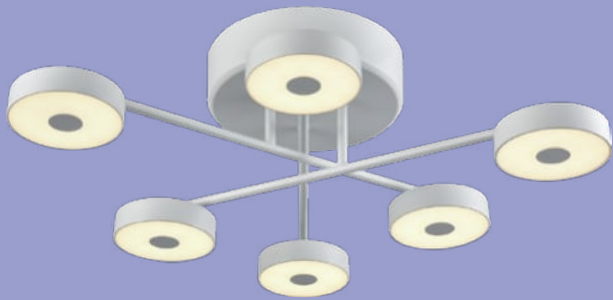

Plafón

MEDUSA 50

Art.: PTL35535330



-  LED 30W, 220V, 50Hz, IP20
-  Blanco texturado
-  3000K
-  2700LM
-  Aluminio
-  Clase I
-  Dimerizable

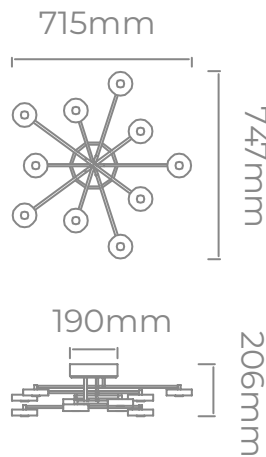

Plafón

MEDUSA 70

Art.: PTL35787853



-  LED 53W, 220V, 50Hz, IP20
-  Blanco texturado
-  3000K
-  4770LM
-  Aluminio
-  Clase I
-  Dimerizable

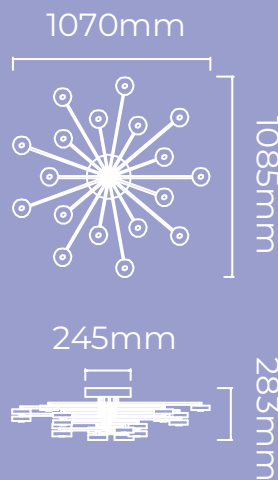
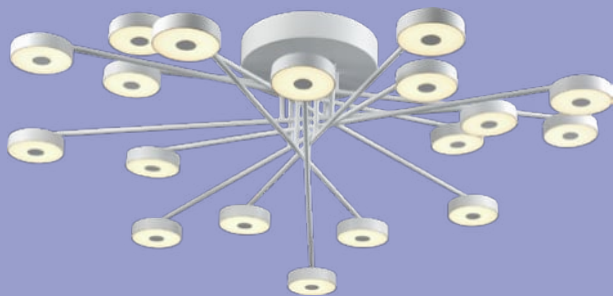

Plafón

MEDUSA 100

Art.: PTL35111186



-  LED 86W, 220V, 50Hz, IP20
-  Blanco texturado
-  3000K
-  7740LM
-  Aluminio
-  Clase I
-  Dimerizable

PLAFÓN BURAKO



*Plafones LED dimerizables luz cálida,
construidos en aluminio.*

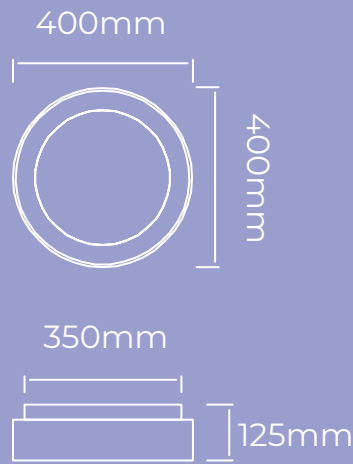
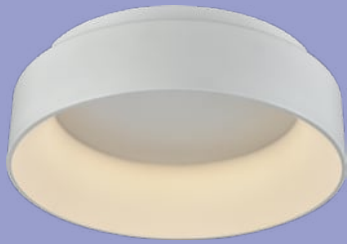

Plafón

BURAKO 40

Art.: PTL31040026



-  LED 26W, 220V, 50Hz, IP20
-  Blanco texturado
-  3000K
-  2340LM
-  Aluminio
-  Clase I
-  Dimerizable

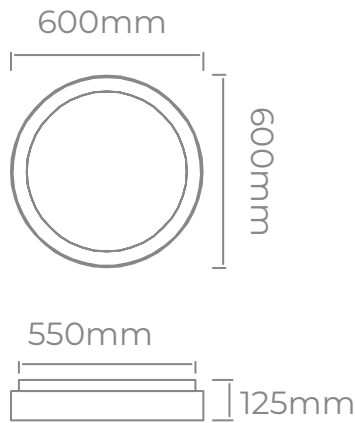

Plafón

BURAKO 60

Art.: PTL31060045



-  LED 45W, 220V, 50Hz, IP20
-  Blanco texturado
-  3000K
-  4050LM
-  Aluminio
-  Clase I
-  Dimerizable

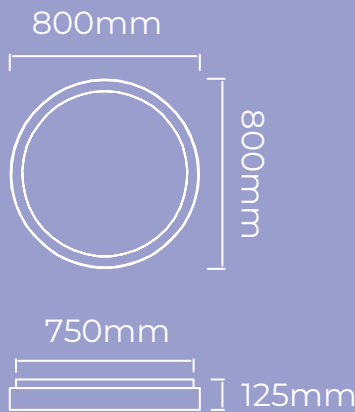

Plafón

BURAKO 80

Art.: PTL31080055



-  LED 55W, 220V, 50Hz, IP20
-  Blanco texturado
-  3000K
-  4950LM
-  Aluminio
-  Clase I
-  Dimerizable

PLAFÓN NEMO 60

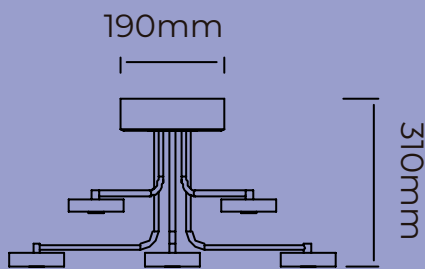
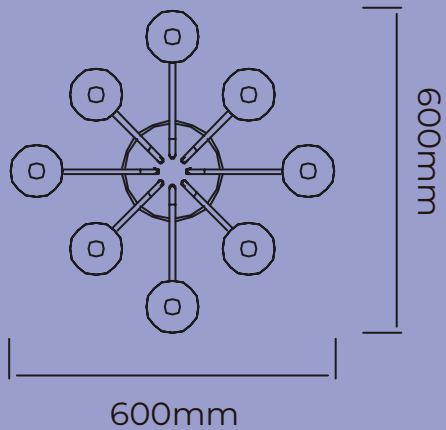

Plafón
NEMO 60
Art.: PTL35454544



-  LED 44W, 220V, 50Hz, IP20
-  Blanco texturado
-  3000K
-  3960LM
-  Aluminio
-  Clase I
-  Dimerizable



*Plafón LED de 8 luces dimerizable
luz cálida, construido en aluminio.*

PLAFÓN NEMO 70



Plafón LED de 8 luces dimerizable luz cálida, construido en aluminio.

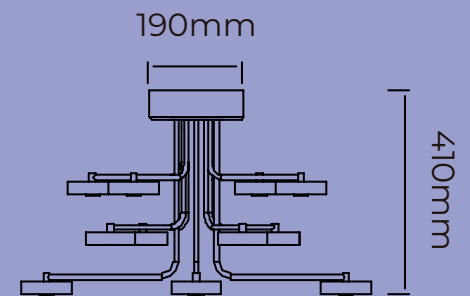
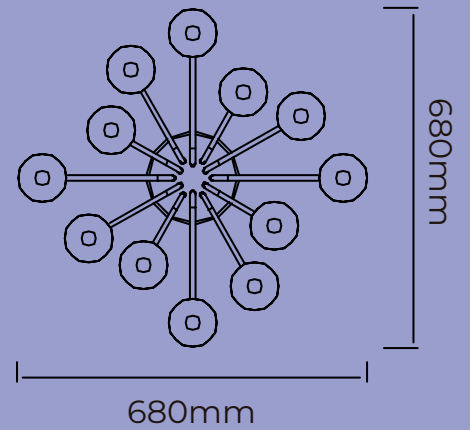

Plafón
NEMO 70
Art.: PTL35525252



-  LED 52W, 220V, 50Hz, IP20
-  Blanco texturado
-  3000K
-  4680LM
-  Aluminio
-  Clase I
-  Dimerizable

PLAFÓN MARA



*Plafón LED dimerizable luz cálida,
construido en aluminio.*



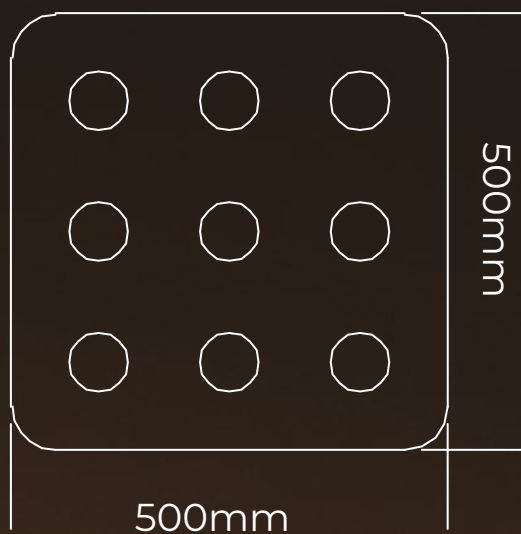

46.5mm



Plafón
MARA
Art.: PTL5205005055



 LED 55W, 220V, 50Hz, IP20

 Blanco texturado

 3000K

 4950LM

 Aluminio

 Clase I

 Dimerizable

 Blanco texturado

PLAFÓN SIRO 40

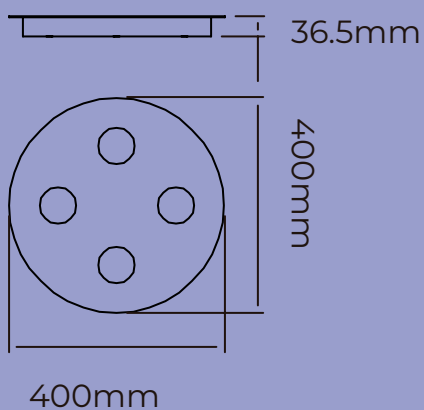



Plafón

SIRO 40

Art.: PTL53040022



 LED 22W, 220V, 50Hz, IP20

 Blanco texturado

 3000K

 1980LM

 Aluminio

 Clase I

 Dimerizable

Plafón LED de 4 luces, dimerizable luz cálida, construido en aluminio.

PLAFÓN SIRO 50



Plafón LED de 7 luces dimerizable luz cálida, construido en aluminio.

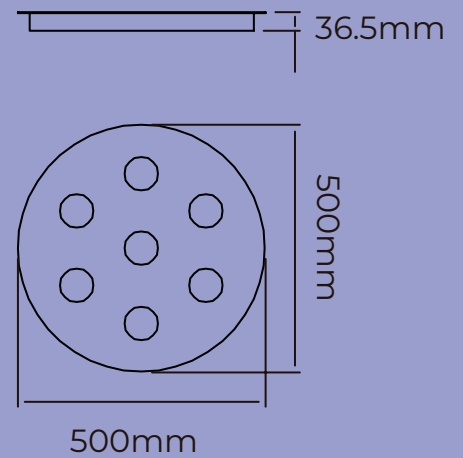

Plafón
SIRO 60
Art.: PTL53056038



-  LED 38W, 220V, 50Hz, IP20
-  Blanco texturado
-  3000K
-  3420LM
-  Aluminio
-  Clase I
-  Dimerizable

PLAFÓN NAPLES 40

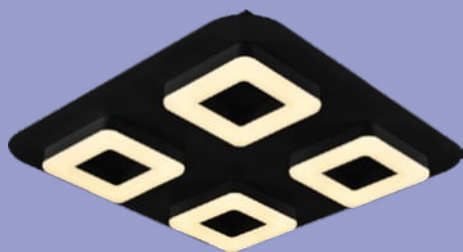

70mm

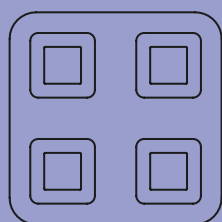

400mm

400mm









Plafón

NAPLES 40

Art.: PTL2504036



-  LED 36W, 220V, 50Hz, IP20
-  Blanco texturado, Negro texturado
-  3000K
-  3240LM
-  Aluminio
-  Clase I
-  Dimerizable

Plafón LED de 4 luces, dimerizable luz cálida, construido en aluminio.

PLAFÓN ::: NAPLES 60



Plafón LED de 9 luces, dimerizable luz cálida, construido en aluminio.

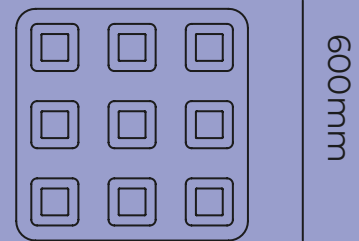

600mm

Plafón
NAPLES 60
Art.: PTL2506060



 LED 60W, 220V, 50Hz, IP20

 Blanco texturado

 3000K

 5400LM

 Aluminio

 Clase I

 Dimerizable

PLAFÓN VENICE 40

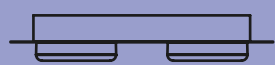
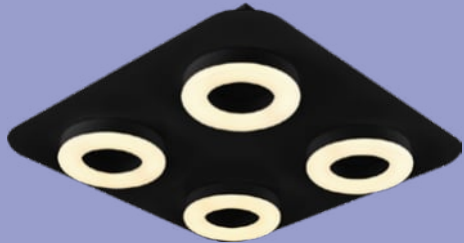

70mm

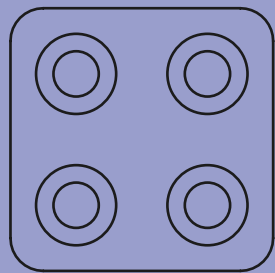

400mm

400mm









Plafón

VENICE 40

Art.: PTL2304036



-  LED 36W, 220V, 50Hz, IP20
-  Blanco texturado, Negro texturado
-  3000K
-  3240LM
-  Aluminio
-  Clase I
-  Dimerizable

Plafón LED de 4 luces, dimerizable luz cálida, construido en aluminio.

PLAFÓN VENICE 60



Plafón LED de 9 luces, dimerizable luz cálida, construido en aluminio.



70mm

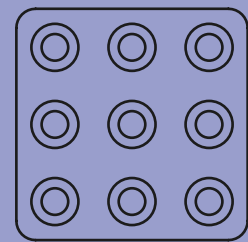

600mm

600mm

Plafón

VENICE 60

Art.: PTL2306060



 LED 60W, 220V, 50Hz, IP20

 Blanco texturado

 3000K

 3240LM

 Aluminio

 Clase I

 Dimerizable





ESCRITORIO, CABECERA y PIE

LÁMPARA DE ESCRITORIO PIPO MESA



Lámpara de escritorio con zócalo E27, brazo flexible, construida en chapa de acero.









Art.: 1790

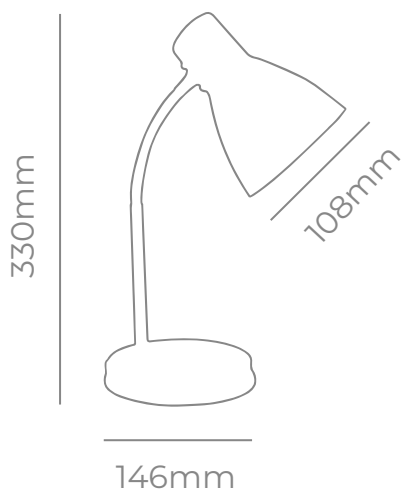

Art.: 1790



Lámpara de escritorio
PIPO MESA

-  1xE27, Max 60W, 220V, 50Hz, IP20
-  Blanco, Negro
-  Chapa de acero
-  Clase II

LÁMPARA DE ESCRITORIO PIPO PINZA



*Lámpara tipo pinza con zócalo E27, brazo flexible,
construida en chapa de acero.*





Art.: 1791



Art.: 1791



Art.: 1791



Art.: 1791



Art.: 1791



Art.: 1791

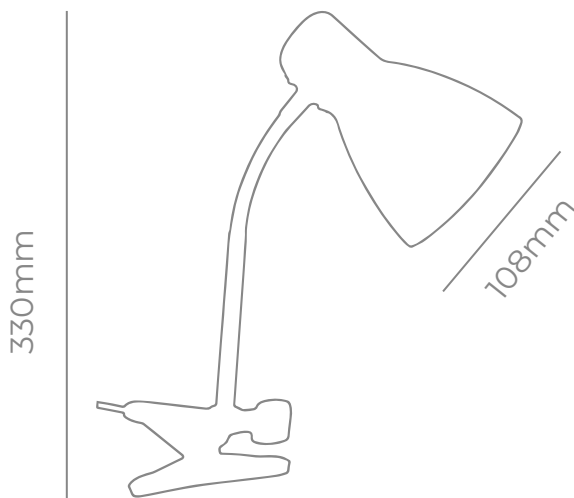

Lámpara de escritorio
PIPO PINZA

- 1xE27, Max 60W, 220V, 50Hz, IP20
- Blanco, Negro, Gris, Rojo, Verde Vintage, Rosa Vintage
- Chapa de acero
- Clase II

LÁMPARA DE ESCRITORIO TABLERO

*Lámpara de escritorio para E27, construida
en chapa de acero.*





Art.: 1794



Art.: 1794



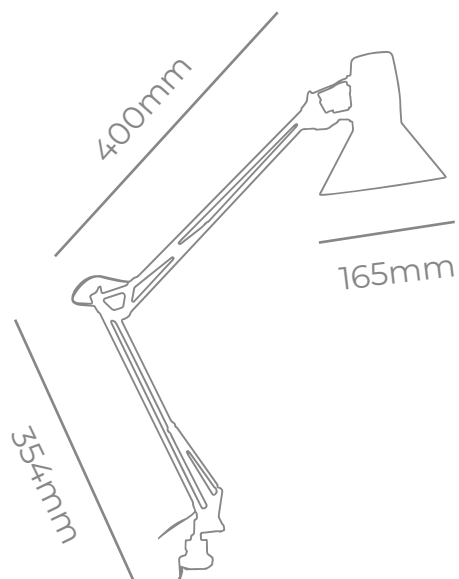

Art.: 1794



Lámpara de escritorio
TABLERO

 1xE27, Max 60W, 220V, 50Hz, IP20

 Blanco, Gris, Negro

 Chapa de acero

 Clase II



LÁMPARA DE ESCRITORIO **FIONA** ●●●●

Lámpara de escritorio para E27, estructura de madera, cabezal contruido en chapa de acero.

Art.: DL70518 ●

Art.: DL70518 ●

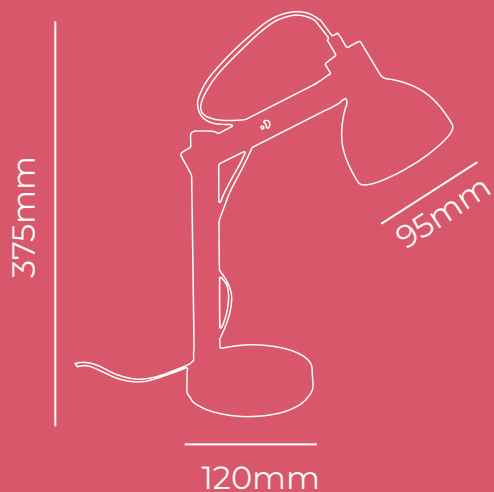

Lámpara de escritorio FIONA

- 1xE14, Max 40W, 220V, 50Hz, IP20
- Cobre, Negro
- Madera + Chapa de acero
- Clase II

LÁMPARA DE ESCRITORIO RUFO







Lámpara de escritorio para E27, base de madera, cabezal contruido en chapa de acero.

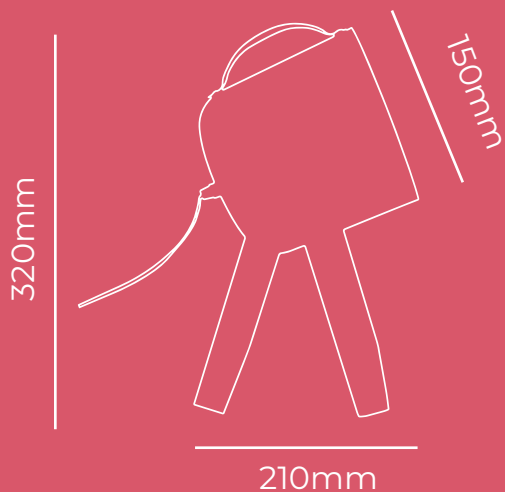

Art.: DL57418



Lámpara de escritorio RUFO

-  1xE27, Max 60W, 220V, 50Hz, IP20
-  Negro
-  Madera + Chapa de acero
-  Clase II

LÁMPARA DE ESCRITORIO PAULO



Lámpara de escritorio para E27, estructura de madera, cabezal contruido en chapa de acero.





Art.: DL47329







Art.: DL47329

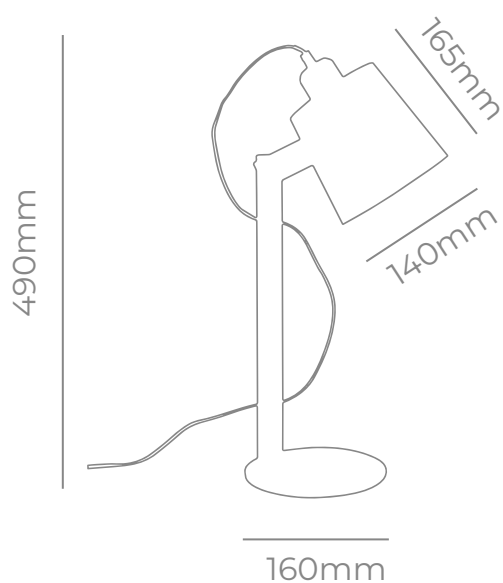

Art.: DL47329



Lámpara de escritorio
PAULO

-  1xE27, Max 60W, 220V, 50Hz, IP20
-  Cobre, Negro, Verde Vintage
-  Madera + Chapa de acero
-  Clase II

LÁMPARA DE ESCRITORIO SERENA



Lámpara de escritorio para E27, estructura de madera, cabezal contruido en chapa de acero.





Art.: DL51725







Art.: DL51725

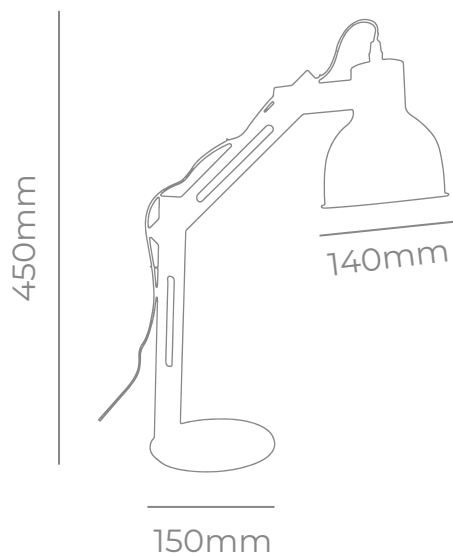

Art.: DL51725



Lámpara de escritorio
SERENA

-  1xE27, Max 60W, 220V, 50Hz, IP20
-  Cobre, Negro, Verde Vintage
-  Madera + Chapa de acero
-  Clase II

LÁMPARA DE ESCRITORIO VINICIO



Lámpara de escritorio para E27, estructura de madera, cabezal contruido en chapa de acero.









Art.: DL49122

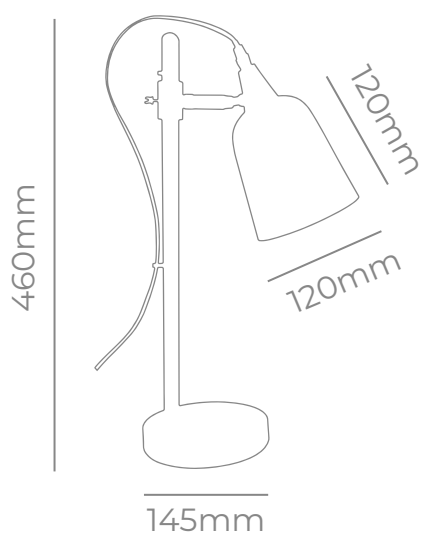

Art.: DL49122



Lámpara de escritorio
VINICIO

-  1xE27, Max 60W, 220V, 50Hz, IP20
-  Cobre, Verde Vintage
-  Madera + Chapa de acero
-  Clase II

APLIQUES DE CABECERA

E14



*Apliques E14 para cabecera,
estructura de madera, cabezal
construido en chapa de acero.*



Art.: APL145501



Art.: APL145501

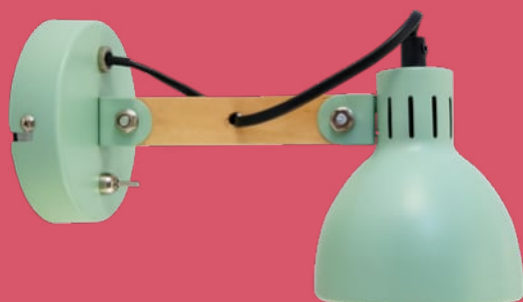

Art.: APL145501



 Con interruptor en base

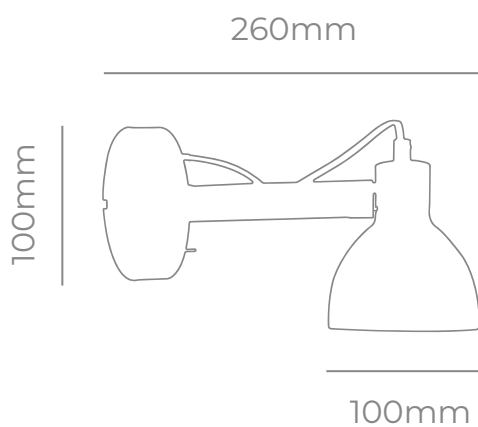

Aplique

FIONA

Art.: APL145501



1xE14, Max 40W, 220V, 50Hz, IP20



Cobre, Negro, Verde Vintage



Madera + Chapa de acero



Clase I

LÁMPARA DE ESCRITORIO

TEEN

Lámpara de escritorio LED con lapicero,
dimerizable.

Lámpara de escritorio

TEEN

Art.: LEP77207



LED 7W, 220V, 50Hz, IP20

Blanco mate

3000K

630LM

Plástico

Clase II

Dimerizable

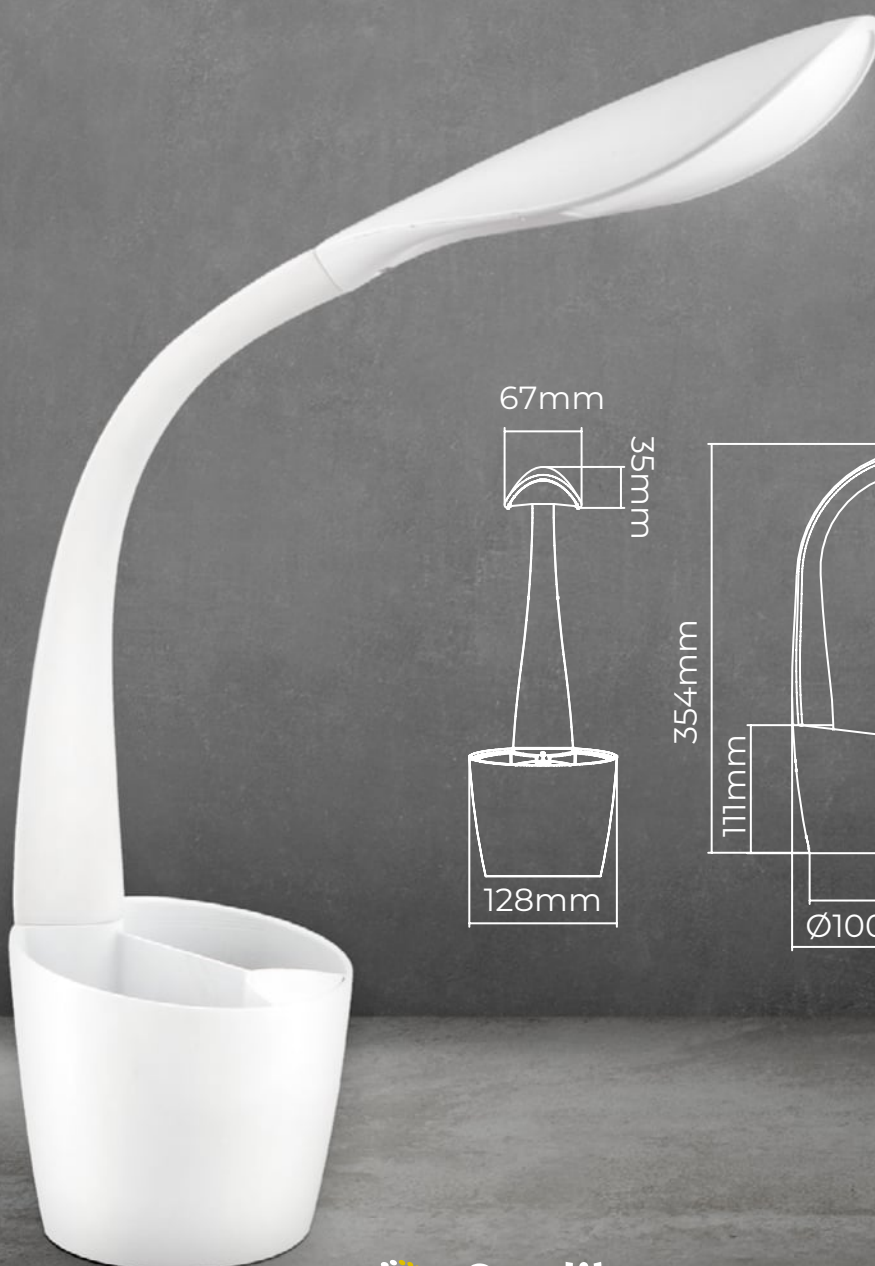

LÁMPARA DE ESCRITORIO

FLIP



Lámpara de escritorio LED, dimerizable.

Lámpara de escritorio

FLIP

Art.: LEP56107

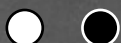



 LED 7W, 220V, 50Hz, IP20

 Blanco mate, Negro mate

 3000K

 630LM

 Plástico

 Clase II

 Dimerizable



60mm

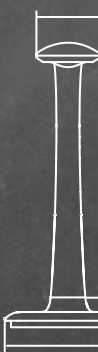

120mm

28mm

376mm

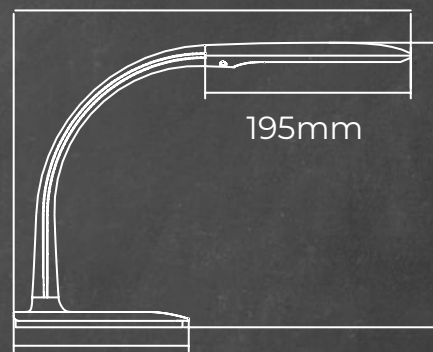

195mm

66mm

270mm

 Blanco mate

 Negro mate

LÁMPARA DE ESCRITORIO **BONNIE**

Lámpara de escritorio LED dimerizable, brazo flexible, construida en plástico.





Art.: LEP49307 



Art.: LEP49307 



Art.: LEP49307 

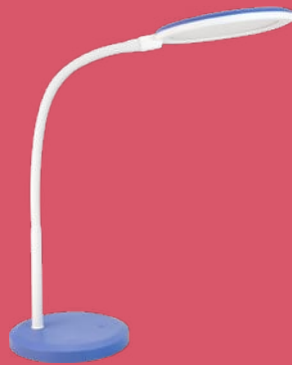

Art.: LEP49307 



Art.: LEP49307 

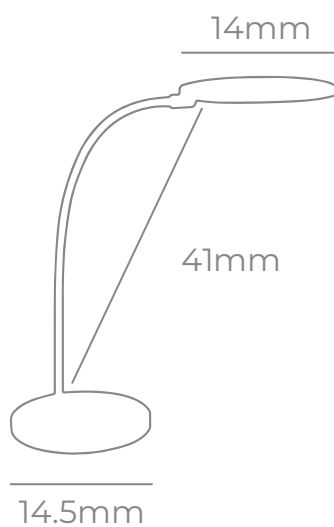

Lámpara de escritorio

BONNIE

-  LED 7.5W, 220V, 50Hz, IP20
-  Blanco, Negro, Rosa, Azul, Rojo
-  3000K
-  675LM
-  Plástico
-  Clase II
-  Dimerizable

APLIQUES DE CABECERA LED



Apliques LED para cabecera, contruidos íntegramente en fundición de aluminio.

 Con interruptor en base

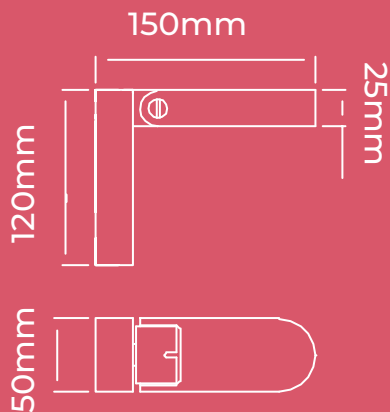

Aplique

AKI

Art.: APL14205



 LED 5W, 220V, 50Hz, IP20

 Blanco texturado, Cromado

 3000K

 450LM

 Aluminio

 Clase I

 Con interruptor en base

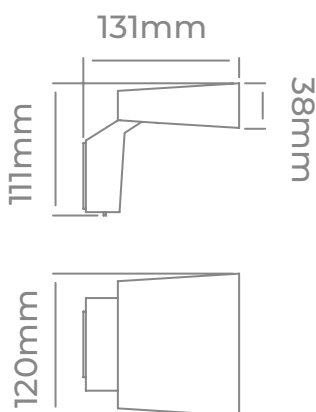



Aplique

NEO

Art.: APL14307



 LED 6.5W, 220V, 50Hz, IP20

 Blanco texturado, Cromado

 3000K

 585LM

 Aluminio

 Clase I

APLIQUES DE CABECERA ::::

Aplique EITU



Aplique POLA

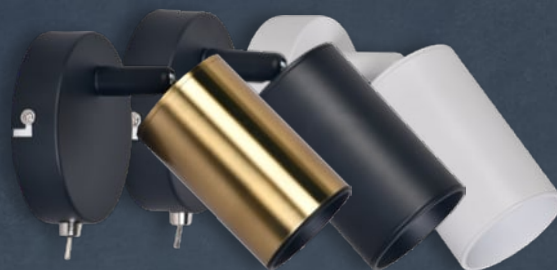

Aplique CACHEN



Aplique MEMO



Aplique JULITA



Aplique SHEILA



Aplique TÉMPANO

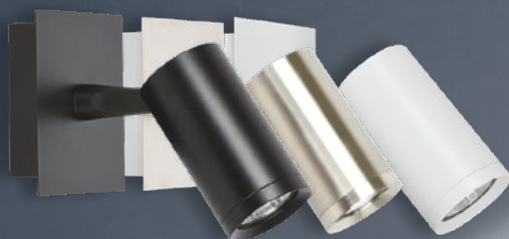

Aplique KONUS



Sistemas de 1 luz con interruptor, disponibles para ser utilizados como apliques de cabecera.

Aplique SONATA



Aplique AYELEN



Aplique PARTY



Aplique SUPER



Aplique PROMO



Aplique MAMBRÚ



Aplique BUDA



Aplique VULCANO



Aplique LENORA



Aplique FIORE



LÁMPARA DE PIE

RUFO

Lámpara de pie tipo proyector para lámpara E27.
Base de madera, cabezal construido en chapa de acero.
Acabado mate.

Art.: FL59541



 1xE27, Max 60W, 220V, 50Hz, IP20

 Gris

 Chapa de acero + Madera

 Clase II



LÁMPARA DE PIE

GOAL

Lámpara de pie para E27 con base de mármol, cuerpo de acero. Altura y largo regulable. Acabado en cromo.

Art.: 1795



 1xE27, Max 100W, 220V, 50Hz, IP20

 Blanco, Negro

 Acero

 Clase II



Disponible también con mármol negro.





LUMINARIAS PARA EXTERIOR

EXTERIOR DE APLICAR GU10



Apliques GU10 para exterior, contruidos íntegramente en fundición de aluminio.



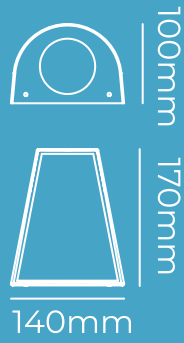
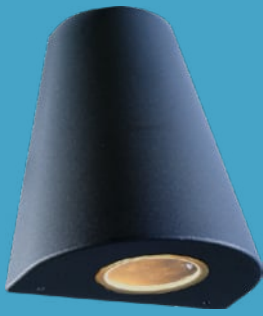

Aplique
ABEL
Art.: B4126



- 1xGU10, Max 35W, 220V, 50Hz, IP54
- Negro texturado
- Aluminio
- Clase I



Aplique
ADRIEL
Art.: B4220



- 1xGU10, Max 35W, 220V, 50Hz, IP44
- Blanco texturado, Negro texturado, Plata texturado
- Aluminio
- Clase I



Aplique
AKIM
Art.: B4221



- 2xGU10, Max 35W, 220V, 50Hz, IP44
- Blanco texturado, Negro texturado, Plata texturado
- Aluminio
- Clase I



Aplique
ALON
Art.: B4230



- 1xGU10, Max 35W, 220V, 50Hz, IP44
- Blanco texturado, Negro texturado, Plata texturado
- Aluminio
- Clase I

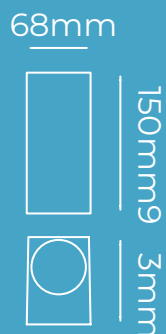

Aplique
AMIR
Art.: B4231



- 2xGU10, Max 35W, 220V, 50Hz, IP44
- Blanco texturado, Negro texturado, Plata texturado
- Aluminio
- Clase I

APLIQUES ODA Y MAO



Apliques GU10, unidireccionales y bidireccionales para exterior, contruidos íntegramente en fundición de aluminio.



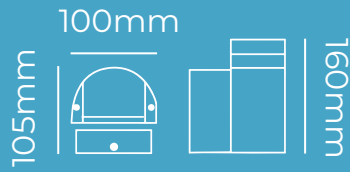

Aplique
ODA I
Art.: AP50001



- 1xGU10, Max 50W, 220V, 50Hz, IP54
- Blanco texturado, Negro texturado, Plata texturado
- Aluminio
- Clase I

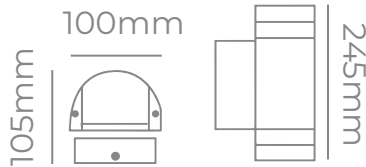

Aplique
ODA II
Art.: AP50002



- 2xGU10, Max 50W, 220V, 50Hz, IP54
- Blanco texturado, Negro texturado, Plata texturado
- Aluminio
- Clase I

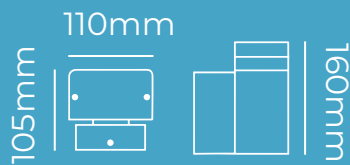

Aplique
MAO I
Art.: AP50003



- 1xGU10, Max 50W, 220V, 50Hz, IP54
- Blanco texturado, Negro texturado, Plata texturado
- Aluminio
- Clase I

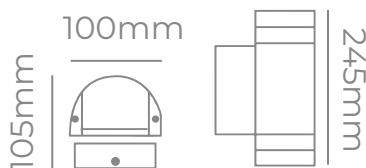

Aplique
MAO II
Art.: AP50004



- 2xGU10, Max 50W, 220V, 50Hz, IP54
- Blanco texturado, Negro texturado, Plata texturado
- Aluminio
- Clase I

EXTERIOR DE APLICAR LED



Apliques LED para exterior, contruidos en fundición de aluminio.

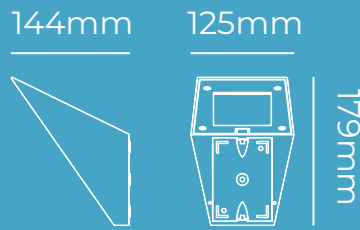

Aplicue

ASHER

Art.: B4400



LED 8.2W, 220V, 50Hz, IP54

Negro Texturado

3000K

738LM

Aluminio

Clase I

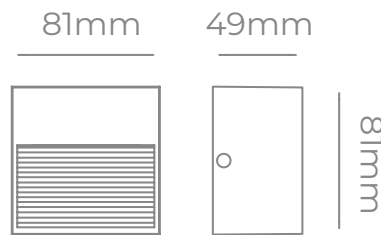

Aplicue

BOXER

Art.: B5250



LED 4.8W, 220V, 50Hz, IP54

Blanco texturado

3000K

432LM

Aluminio

Clase I

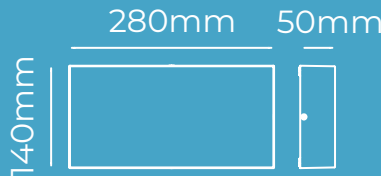
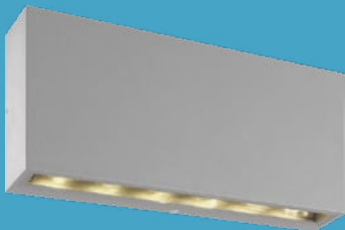

Aplicue

CHAIM 1 GRANDE

Art.: B4470B



LED 8.2W, 220V, 50Hz, IP54

Blanco texturado, Plata texturado

3000K

732LM

Aluminio

Clase I

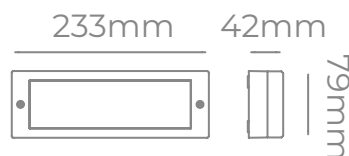

Aplicue

DUDE

Art.: B4615



LED 4.3W, 220V, 50Hz, IP54

Blanco texturado, Negro texturado, Plata texturado

3000K

387LM

Aluminio

Clase I

APLIQUE DONALD



Aplicador LED para exterior, luz cálida,
construido íntegramente en fundición de
aluminio.

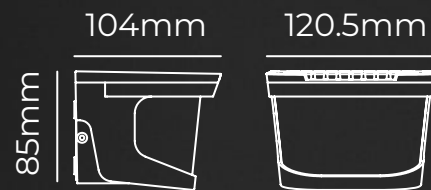

Aplicador
DONALD I
Art.: B4490



- LED 4.8W, 220V, 50Hz, IP54
- Negro texturado
- 3000K
- 432LM
- Aluminio
- Clase I

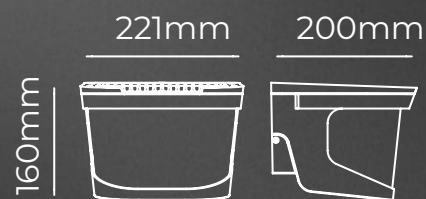

Aplicador
DONALD II
Art.: B4491



- LED 11.7W, 220V, 50Hz, IP54
- Negro texturado
- 3000K, 6500K
- 1053LM
- Aluminio
- Clase I

APLIQUE EITAN



*Aplique LED para exterior, luz cálida,
construido íntegramente en fundición de
aluminio.*



140mm5





8mm

140mm

Aplique
EITAN I
Art.: B4720





 LED 4.8W, 220V, 50Hz, IP54

 Negro texturado

 3000K, 6500K

 432LM

 Aluminio

 Clase I

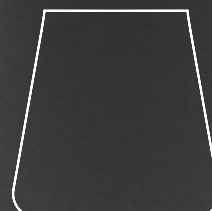

224mm





92mm

225mm

Aplique
EITAN II
Art.: B4721



 LED 8.5W, 220V, 50Hz, IP54

 Negro texturado

 3000K, 6500K

 765LM

 Aluminio

 Clase I

EXTERIOR DE APLICAR LED ::::

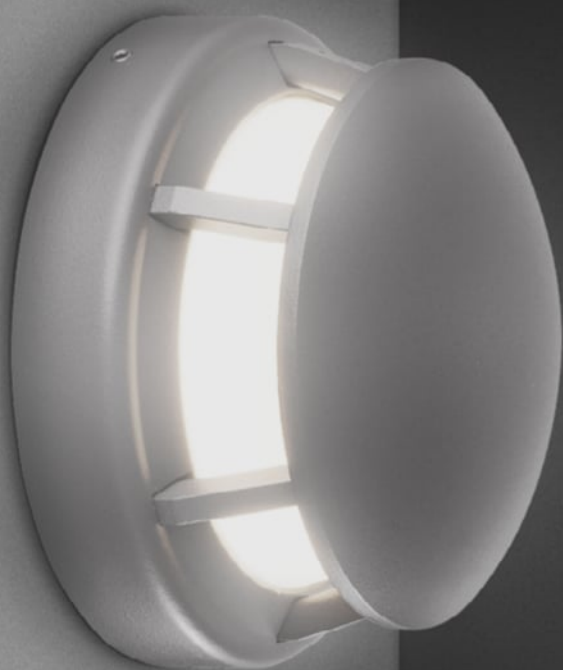

Apliques LED para exterior, contruidos íntegramente en fundición de aluminio.

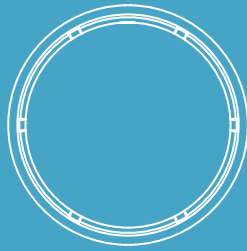
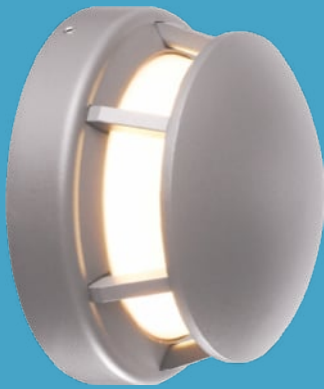



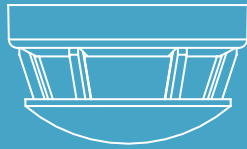



140mm



81mm

Aplique
ÉXITO
Art.: B5810



-  LED 4.4W, 220V, 50Hz, IP54
-  Blanco texturado, Plata texturado
-  3000K
-  396LM
-  Aluminio
-  Clase I



90mm

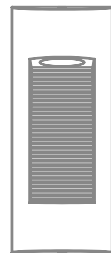



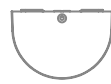



220mm



60mm

Aplique
FALE
Art.: B4725



-  LED 4.8W, 220V, 50Hz, IP54
-  Negro texturado
-  3000K, 6500K
-  432LM
-  Aluminio
-  Clase I

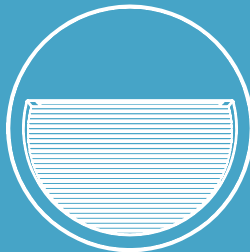







180mm



60mm

Aplique
FISHI
Art.: B5350



-  LED 8.5W, 220V, 50Hz, IP54
-  Negro texturado
-  3000K
-  765LM
-  Aluminio
-  Clase I

EXTERIOR DE APLICAR LED ::::



Apliques LED para exterior, contruidos íntegramente en fundición de aluminio.

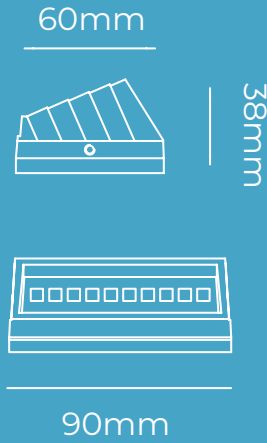

Aplique
RAMPA CHICO
Art.: B6010



- LED 2.1W, 220V, 50Hz, IP54
- Blanco texturado, Negro texturado
- 3000K
- 189LM
- Aluminio
- Clase I

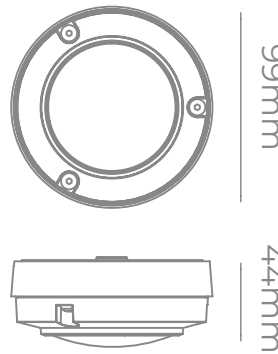

Aplique
SASON
Art.: APL3000



- LED 2.2W, 220V, 50Hz, IP54
- Negro texturado
- 3000K
- 198LM
- Aluminio
- Clase I

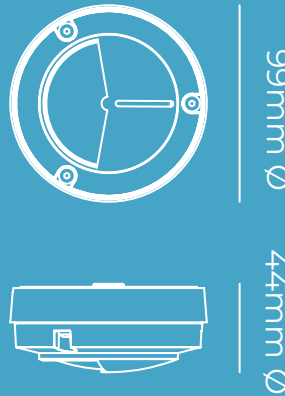

Aplique
SASON CON VICERA
Art.: APL3000V



- LED 2.2W, 220V, 50Hz, IP54
- Negro texturado
- 3000K
- 189LM
- Aluminio
- Clase I

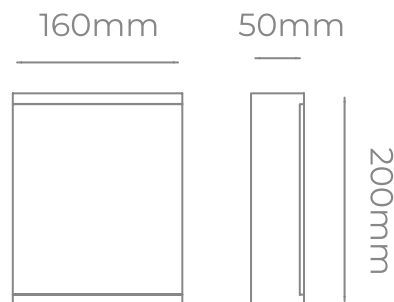

Aplique
SEÑAL
Art.: B5790



- LED 8W, 220V, 50Hz, IP54
- Negro texturado
- 3000K
- 720LM
- Aluminio
- Clase I

EXTERIOR DE EMPOTRAR LED

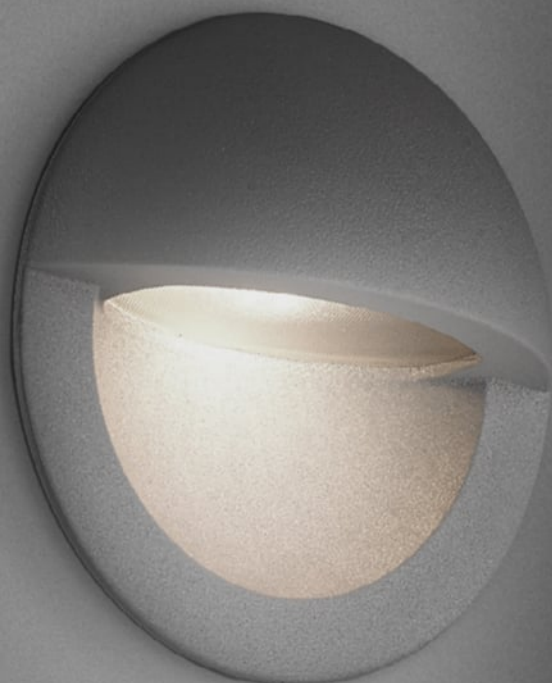

Empotrables LED para exterior, contruidos íntegramente en fundición de aluminio.

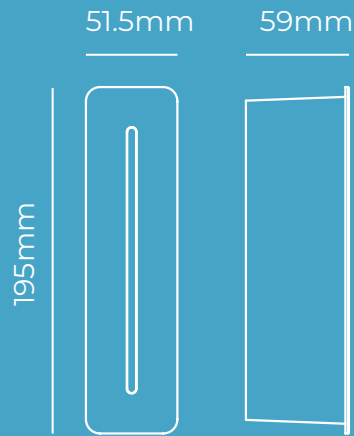

Empotrable

BALTHA

Art.: EP30003



- LED 3.8W, 220V, 50Hz, IP54
- Plata texturado
- 6500K
- 342LM
- Aluminio
- Clase I

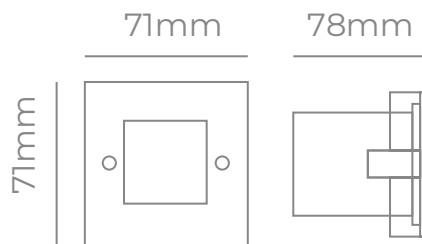

Empotrable

FAN CUADRADO

Art.: EP10007



- LED 1.8W, 220V, 50Hz, IP54
- Plata
- 3000K, 6500K
- 162LM
- Aluminio
- Clase I

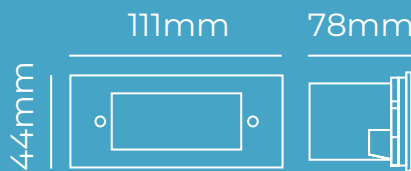

Empotrable

FAN RECTANGULAR

Art.: EP10005



- LED 1.8W, 220V, 50Hz, IP54
- Plata
- 3000K, 6500K
- 162LM
- Aluminio
- Clase I

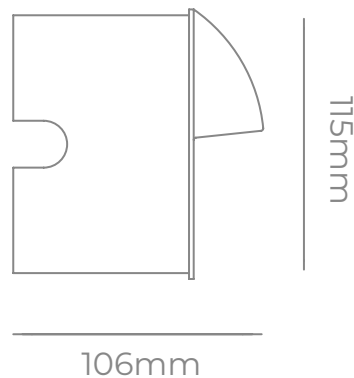
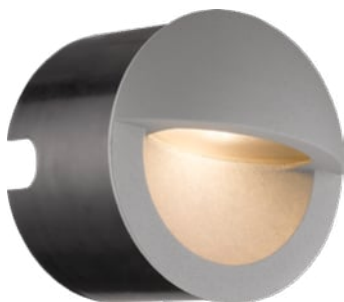

Empotrable

NINO

Art.: EP30004



- LED 3.8W, 220V, 50Hz, IP54
- Blanco texturado, Negro texturado, Plata texturado
- 3000K
- 342LM
- Aluminio
- Clase I

EMBUTIDOS DE PISO



Embutidos GU10 para exterior contruidos íntegramente en fundición de aluminio.



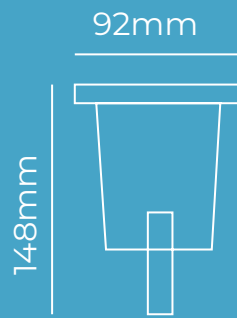

Embutido
E2001



1xGU10, Max 60W, 220V, 50Hz, IP54

Negro texturado

Aluminio

Clase I



FRENTE DE ACERO INOXIDABLE

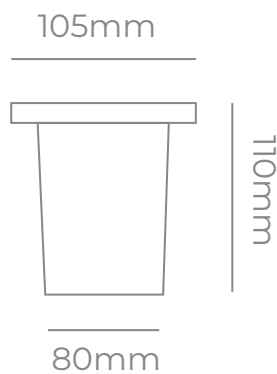

Embutido
E2001P



1xGU10, Max 60W, 220V, 50Hz, IP54

Niquel mate

Aluminio

Clase I



Embutido
E2001C



1xGU10, Max 50W, 220V, 50Hz, IP54

Negro texturado

Aluminio

Clase I

SPOTS Y ESTACAS



*Spots para lámpara dicro GU10 construido en PVC.
Estaca para embutido E2001 construida en PVC*



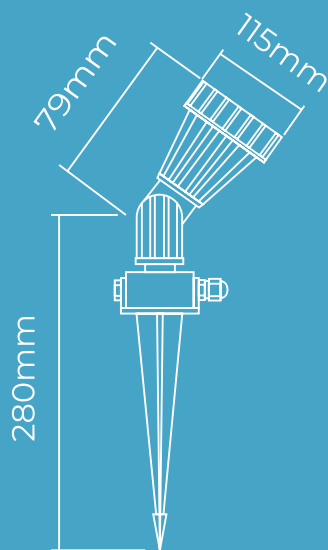

Spot con Jabalina TERO

Art.: EJ15001/J

1xGU10, Max 7W, 220-240V, 50Hz, IP54

Negro texturado

PVC

Clase II

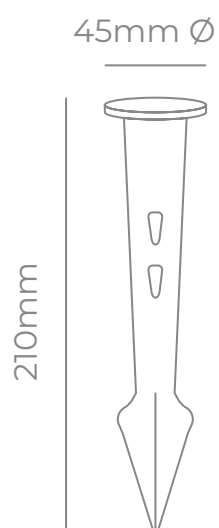

Jabalina ACCESORIO PARA E2001

Art.: JABALINA

Negro texturado

PVC

EXTERIOR PARA TECHO





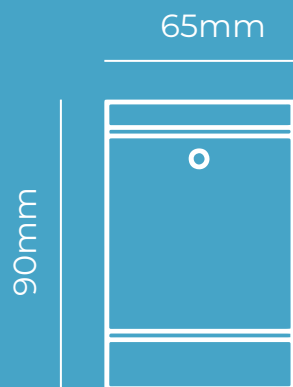

*Apliques para techo contruidos en fundición
de aluminio.*



Aplique
SENA CHICO
Art.: T501





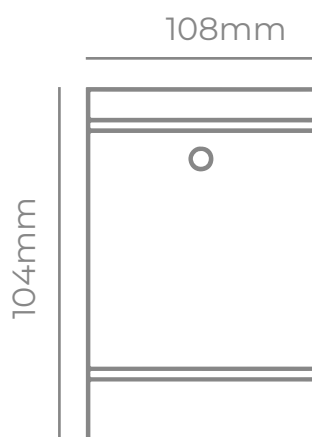

-  1xGU10, Max 50W, 220V, 50Hz, IP54
-  Blanco texturado, Plata texturado
-  Aluminio
-  Clase I



Aplique
SILO GRANDE
Art.: T408





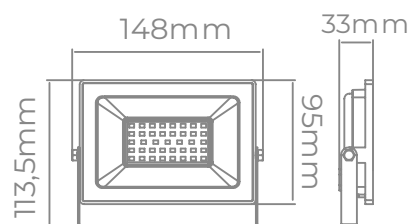
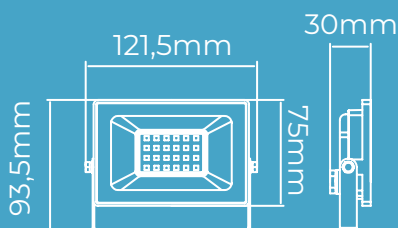
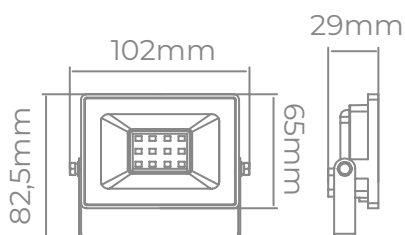

-  1xE27, Max 75W, 220V, 50Hz, IP54
-  Plata texturado
-  Aluminio
-  Clase I





PROYECTORES LED PEGASUS









Proyector LED   
PEGASUS 10W
Art.: PL5010

-  LED 10W, 220V, 50Hz, IP65
-  Negro texturado
-  4000K, 6500K
-  Aluminio
-  Clase II

Proyector LED   
PEGASUS 20W
Art.: PL5020

-  LED 20W, 220V, 50Hz, IP65
-  Negro texturado
-  4000K, 6500K
-  Aluminio
-  Clase II



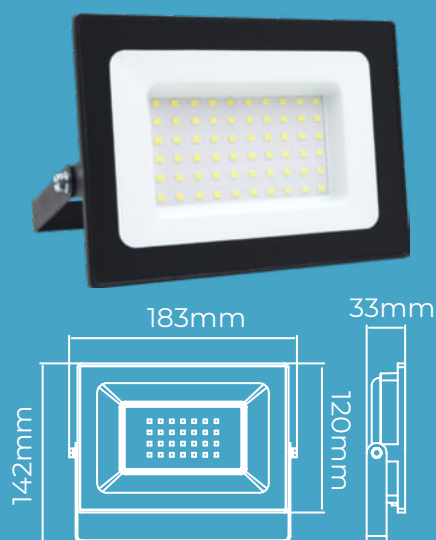

Proyector LED   
PEGASUS 30W
Art.: PL5030

-  LED 30W, 220V, 50Hz, IP65
-  Negro texturado
-  4000K, 6500K
-  Aluminio
-  Clase II

Proyectores LED de 10W, 20W, 30W, 50W y 100W, contruidos íntegramente en fundición de aluminio.







Proyector LED
PEGASUS 50W
 Art.: PL5050

-  LED 50W, 220V, 50Hz, IP65
-  Negro texturado
-  4000K, 6500K
-  Aluminio
-  Clase II



Proyector LED
PEGASUS 100W
 Art.: PL5100

-  LED 100W, 220V, 50Hz, IP65
-  Negro texturado
-  6500K
-  Aluminio
-  Clase II

PROYECTORES LED PEGASUS ALTA POTENCIA





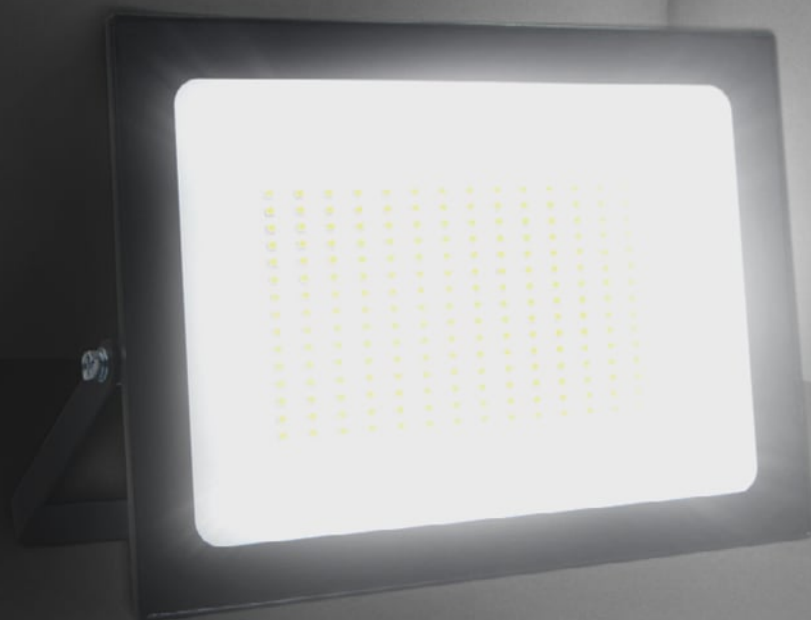

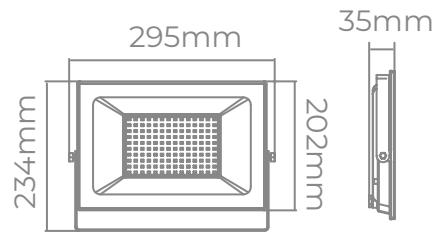
*Proyectores LED de 150W, 200W y 300W
construidos íntegramente en fundición de
aluminio.*





Proyector LED
PEGASUS 150W
 Art.: PL5150-60 NT





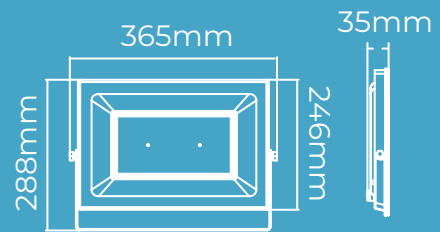

-  LED 150W, 220V, 50Hz, IP65
-  Negro texturado
-  6000K
-  Aluminio
-  Clase II



Proyector LED
PEGASUS 200W
 Art.: PL5200-60 NT





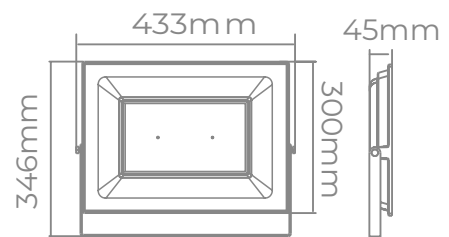

-  LED 200W, 220V, 50Hz, IP65
-  Negro texturado
-  6000K
-  Aluminio
-  Clase II



Proyector LED
PEGASUS 300W
 Art.: PL5300-60 NT



-  LED 300W, 220V, 50Hz, IP65
-  Negro texturado
-  6000K
-  Aluminio
-  Clase II

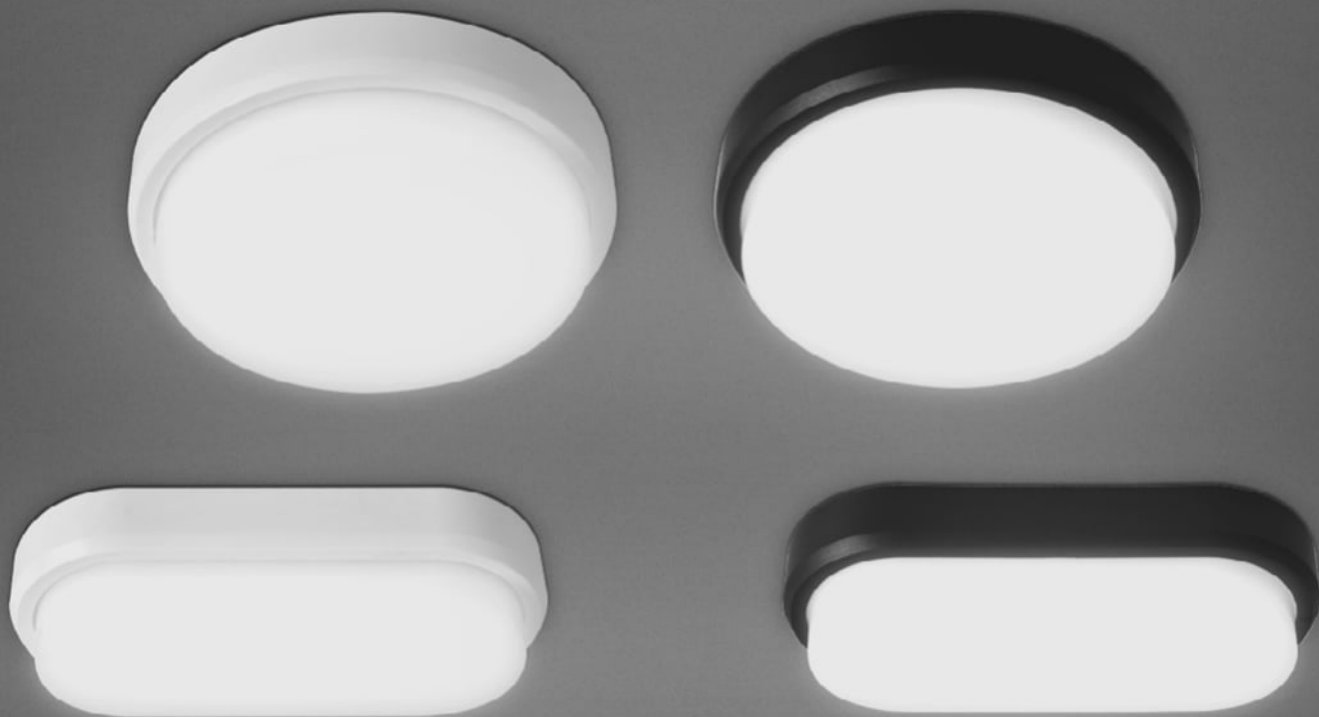

TORTUGAS LED INTEGRADO



*Tortugas LED integrado
construidas íntegramente
en policarbonato.*

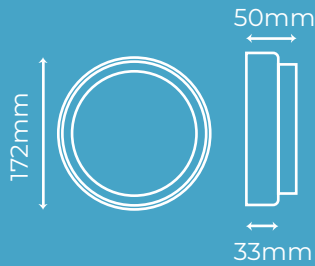

TL1017012-40 BL
TL1017012-40 NG
TL1017012-65 BL
TL1017012-65 NG

Tortuga LED
Redonda 12W
Art.: TL1017012



- LED 12W, 220V, 50Hz, IP54
- Blanco texturado, Negro texturado
- 4000K, 6500K
- Policarbonato
- Clase II

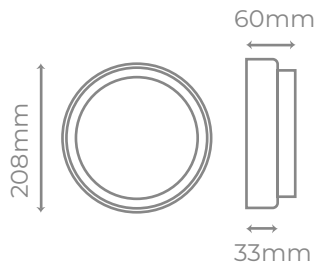

TL1021018-40 BL
TL1021018-40 NG
TL1021018-65 BL
TL1021018-65 NG

Tortuga LED
Redonda 18W
Art.: TL1021018



- LED 18W, 220V, 50Hz, IP54
- Blanco texturado, Negro texturado
- 4000K, 6500K
- Policarbonato
- Clase II

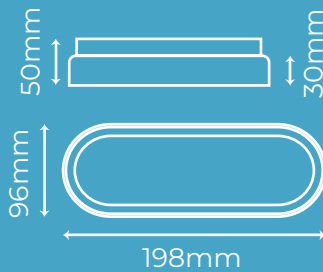

TL2019012-40 BL
TL2019012-40 NG
TL2019012-65 BL
TL2019012-65 NG

Tortuga LED
Ovalada 12W
Art.: TL2019012



- LED 12W, 220V, 50Hz, IP54
- Blanco texturado, Negro texturado
- 4000K, 6500K
- Policarbonato
- Clase II

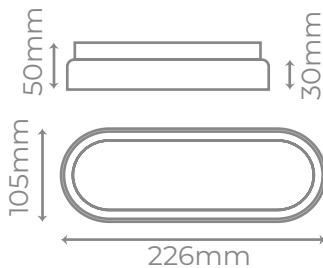

TL2030018-40 BL
TL2030018-40 NG
TL2030018-65 BL
TL2030018-65 NG

Tortuga LED
Ovalada 18W
Art.: TL2030018



- LED 18W, 220V, 50Hz, IP54
- Blanco texturado, Negro texturado
- 4000K, 6500K
- Policarbonato
- Clase II





TIRAS LED PERFILES Y FUENTES

TIRAS LED :: 12V IP33

Tira LED
CHIP 2835 12V IP33

Artículos:
W13308060283527
W13308060283565
W133080602835RJ
W133080602835VD
W133080602835AZ
W133080602835AM
W133080602835RGB

Chip 2835, 60 LEDS por metro

9.5W por metro, 12V, IP33

2700K, 6500K

800LM por metro

5m x 8mm

Clase III

Autoadhesivo

Dimerizable

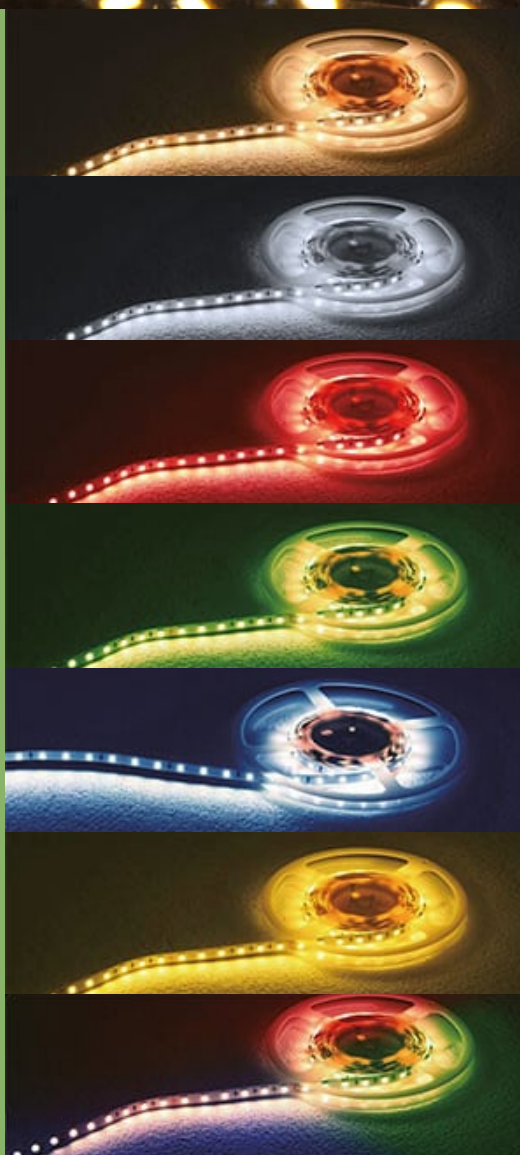

 Luz cálida (2700K)

 Luz fría (6500K)

 Rojo

 Verde

 Azul

 Amarillo

 RGB



Tira LED
CHIP 5050 12V IP33

Artículos:

W13310060505027
W13310060505065
W133100605050RJ
W133100605050VD
W133100605050AZ
W133100605050AM
W133100605050RGB

 Chip 5050, 60 LEDs por metro

 12W por metro, 12V, IP33

 2700K, 6500K

 950LM por metro

 5m x 10mm

 Clase III

 Autoadhesivo

 Dimerizable

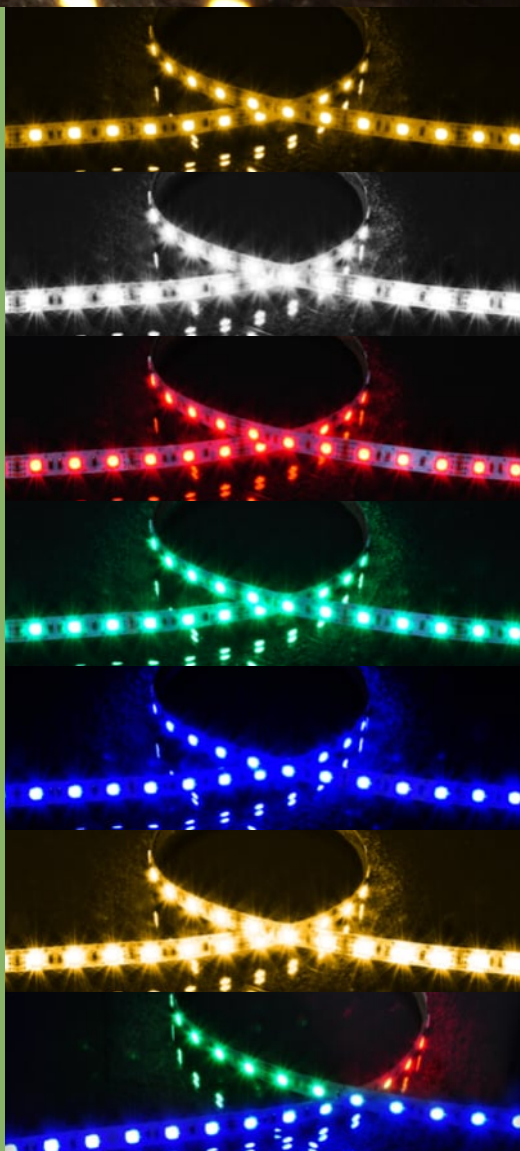

 Luz cálida (2700K)

 Luz fría (6500K)

 Rojo

 Verde

 Azul

 Amarillo

 RGB

TIRAS LED :: 24V IP33



● Luz cálida (2400K)

Tira LED
CHIP 3528 24V IP33

Artículos:
W23308060352824

- Chip 3528, 60 LEDS por metro
- 4W por metro, 12V, IP33
- 2400K
- 300LM por metro
- 5m x 8mm
- Clase III
- Autoadhesivo
- Dimerizable





● Luz cálida (2400K)

Tira LED
CHIP 2835 24V IP33

Artículos:
W23308098283524

-  Chip 2835, 98 LEDS por metro
-  12W por metro, 24V, IP33
-  2400K
-  950LM por metro
-  10m x 8mm
-  Clase III
-  Autoadhesivo
-  Dimerizable



 Luz cálida (2700K)



 Luz fría (6000K)



 RGB



Tira LED
CHIP 2835 24V IP33

Artículos:
W23310060505027
W23310060505060
W233100605050RGB

 Chip 5050, 60 LEDs por metro

 12W por metro, 12V, IP66

 2700K, 6000K, RGB

 950LM por metro

 5m x 10mm

 Clase III

 Autoadhesivo

 Dimerizable

 Luz cálida (2700K)



 Luz cálida (3000K)



 Luz neutra (4200K)



Tira LED
CHIP 5730 24V IP33

Artículos:
W23310060573027
W23310060573030
W23310060573042

-  Chip 5730, 60 LEDS por metro
-  12W por metro, 24V, IP33
-  2700K, 3000K, 4200K
-  1000LM por metro
-  5m x 10mm
-  Clase III
-  Autoadhesivo
-  Dimerizable

Tira LED
CHIP 2835 24V IP33

Artículos:
W23334280573027
W23334280573030
W23334280573040

 Chip 2835, 280 LEDS por metro

 17W por metro, 24V, IP33

 2700K, 3000K, 4000K

 1800LM por metro

 2.5m x 34mm

 Clase III

 Dimerizable

 Luz cálida (2700K)



 Luz cálida (3000K)



 Luz neutra (4000K)



Tira LED
CHIP 2835 24V IP33

Artículos:
W23320300573027
W23320300573030
W23320300573042

- Chip 5730, 300 LEDS por metro
- 22W por metro, 24V, IP33
- 2700K, 3000K, 4200K
- 2000LM por metro
- 2.5m x 20mm
- Clase III
- Dimerizable

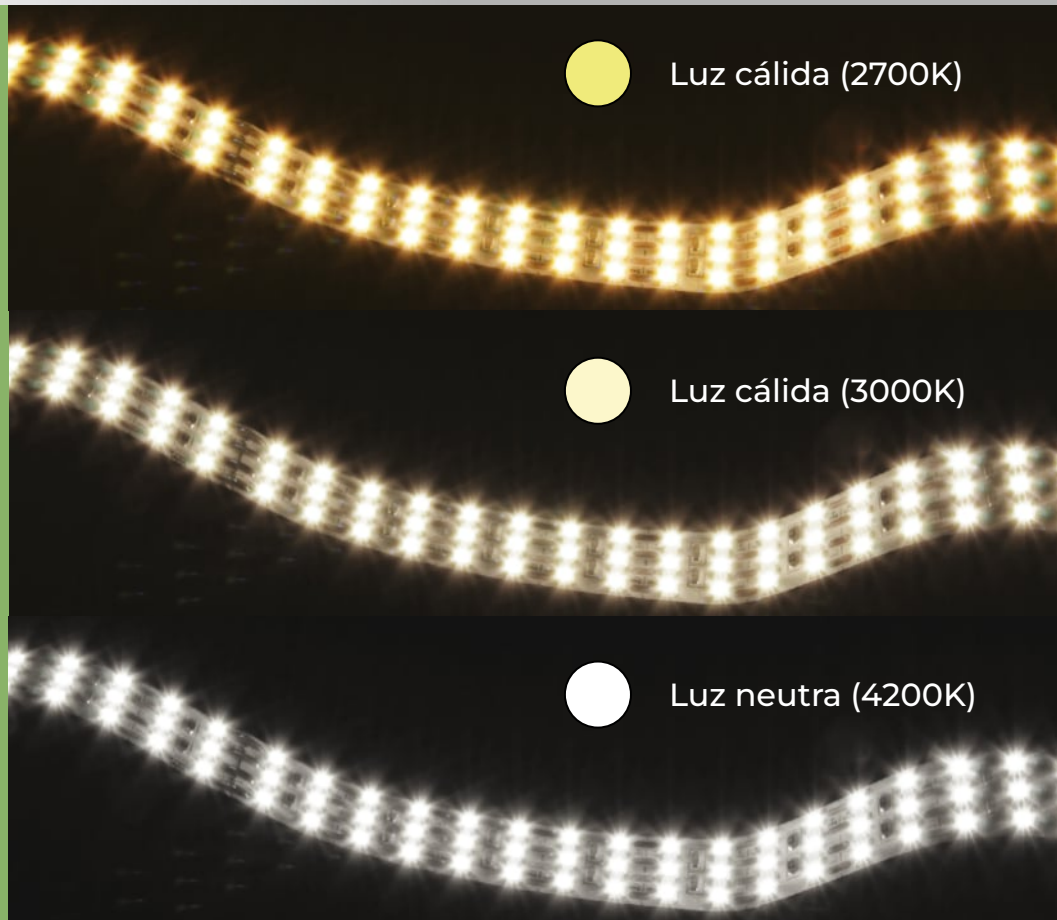

Tira LED
CHIP 2835 24V IP33

Artículos:
W23352420573030
W23352420573042

- Chip 2835, 420 LEDS por metro
- 25W por metro, 24V, IP33
- 3000K, 4200K
- 2500LM por metro
- 2.5m x 52mm
- Clase III
- Dimerizable

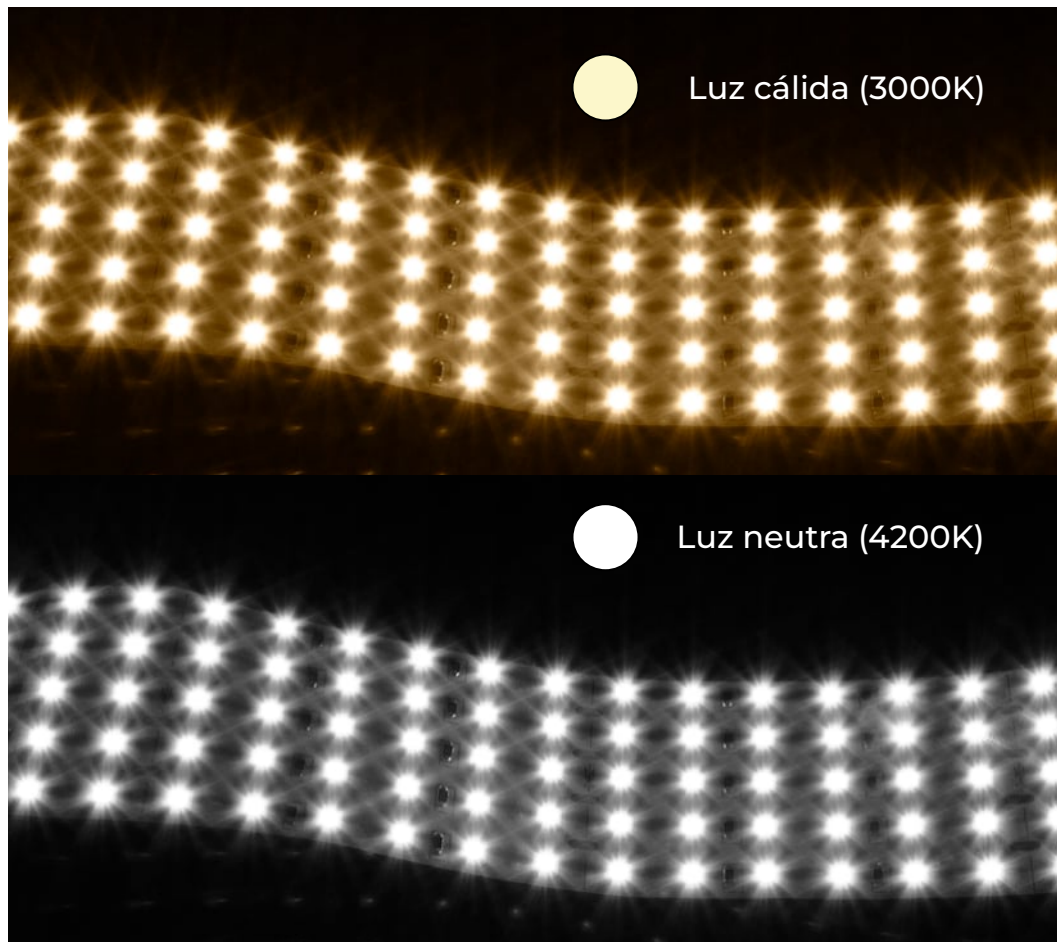

TIRAS LED :: 12V IP66

Tira LED
CHIP 2835 12V IP66

Artículos:

W16608060283527
W16608060283560
W166080602835RJ
W166080602835VD
W166080602835AZ
W166080602835AM
W166080602835RGB

 Chip 2835, 60 LEDS por metro

 9.5W por metro, 12V, IP66

 2700K, 6000K

 800LM por metro

 5m x 8mm

 Clase III

 Dimerizable

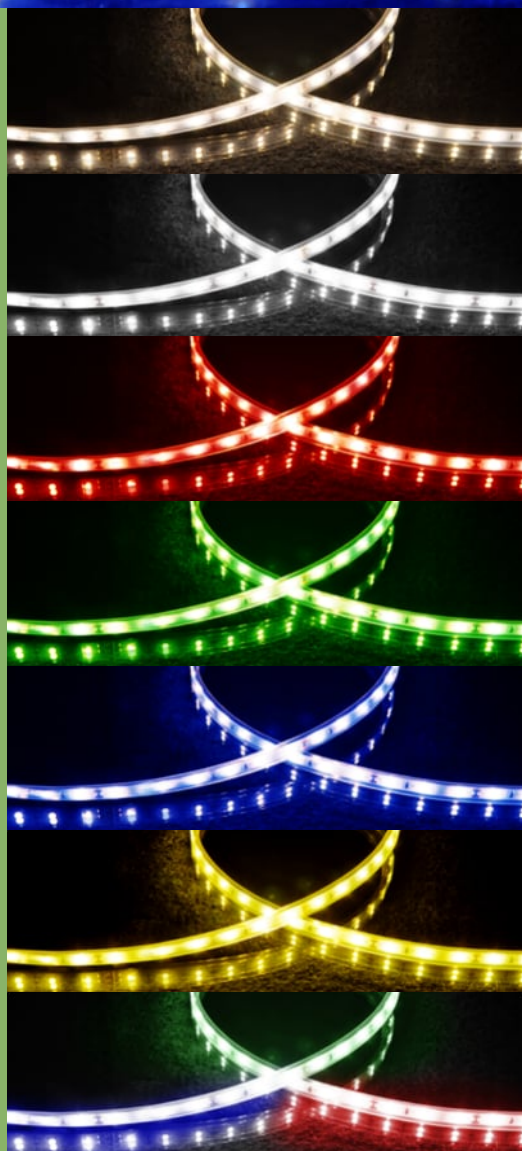

 Luz cálida (2700K)

 Luz fría (6000K)

 Rojo

 Verde

 Azul

 Amarillo







 RGB





Tira LED
CHIP 5050 12V IP66

Artículos:

W16610060505027
W16610060505060
W166100605050RJ
W166100605050VD
W166100605050AZ
W166100605050AM
W166100605050RGB

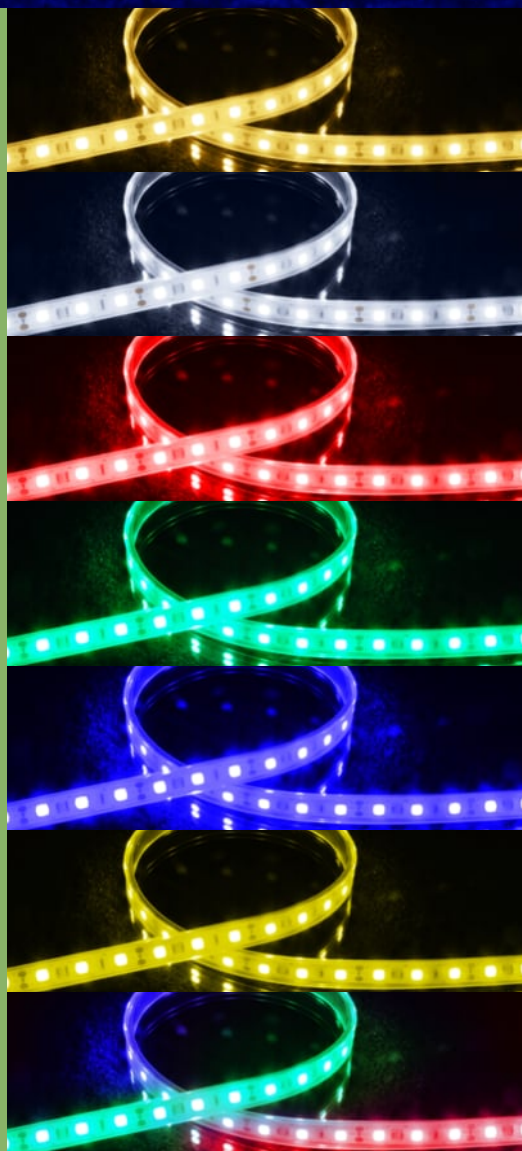
-  Chip 5050, 60 LEDS por metro
-  12W por metro, 12V, IP66
-  2700K, 6000K
-  950LM por metro
-  5m x 10mm
-  Clase III
-  Dimerizable



-  Luz cálida (2700K)
-  Luz fría (6000K)
-  Rojo
-  Verde
-  Azul
-  Amarillo
-  RGB

TIRAS LED :: 24V IP66

Tira LED
CHIP 3528 24V IP66

Artículos:
W26608060352824

- Chip 2835, 60 LEDS por metro
- 4W por metro, 24V, IP66
- 2400K
- 300LM por metro
- 5m x 8mm
- Clase III
- Dimerizable

Tira LED
CHIP 2835 24V IP66

Artículos:
W26608098283524
W26608098283530

- Chip 2835, 98 LEDS por metro
- 12W por metro, 24V, IP66
- 2700K, 3000K
- 950LM por metro
- 5m x 10mm
- Clase III
- Dimerizable

 Luz cálida (2400K)





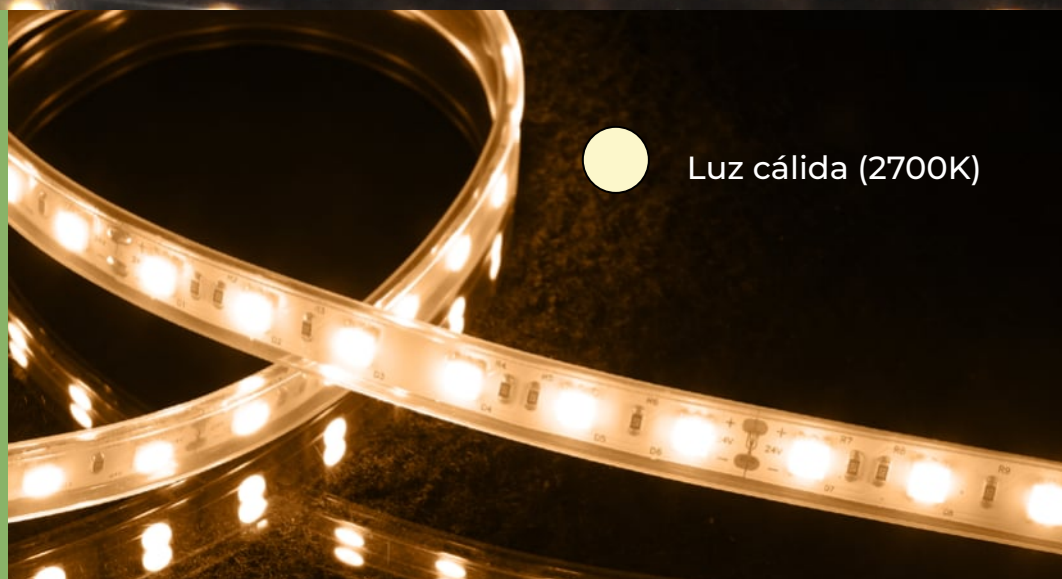

 Luz cálida (2400K)

 Luz cálida (2700K)



Tira LED
CHIP 2835 24V IP66

Artículos:
W26610060505027
W266100605050RGB

-  Chip 5050, 60 LEDS por metro
-  12W por metro, 24V, IP66
-  2700K, RGB
-  950LM por metro
-  5m x 10mm
-  Clase III
-  Dimerizable



PERFILES DE APLICAR PARA TIRAS LED



Perfiles para tiras LED, contruidos en aluminio. Con difusor de policarbonato.

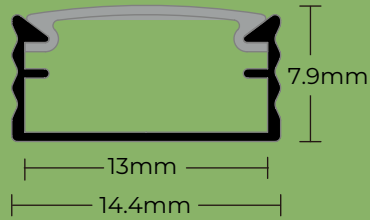

PER-A-1407-1M PL
 PER-A-1407-2M BL
 PER-A-1407-2M PL
 PER-A-1407-2M NG

Perfil de aplicar
 Para tiras de hasta 13mm



1 metro, 2 metros

Blanco, Negro, Plata

Aluminio

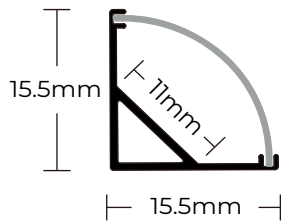

PER-A45-1616-2M PL

Perfil de aplicar a 45°
 Para tiras de hasta 11mm



2 metros

Plata

Aluminio

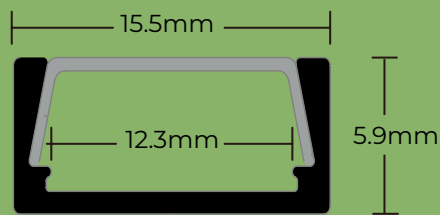

PER-A-1506-1M PL
 PER-A-1506-2M PL
 PER-A-1506-2M BL
 PER-A-1506-2M NG

Perfil de aplicar
 Para tiras de hasta 12mm



1 metro, 2 metros

Blanco, Negro, Plata

Aluminio

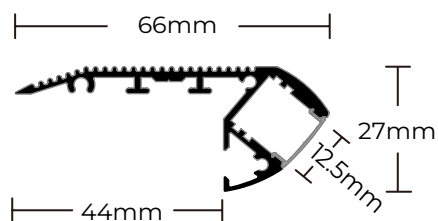

PER-ESC-6627-2M PL

Perfil de aluminio para escaleras
 Para tiras de hasta 12mm



2 metros

Plata

Aluminio

PERFILES DE EMBUTIR PARA TIRAS LED



Perfiles para tiras LED, contruidos en aluminio. Con difusor de policarbonato.

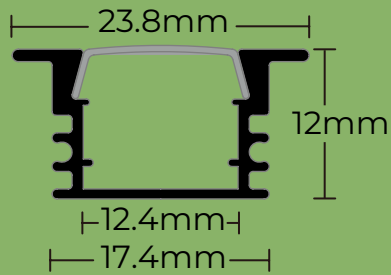

PER-E-2412-2M PL
PER-E-2412-2M BL

Perfil de embutir
Para tiras de hasta 12mm



2 metros

Blanco, Plata

Aluminio

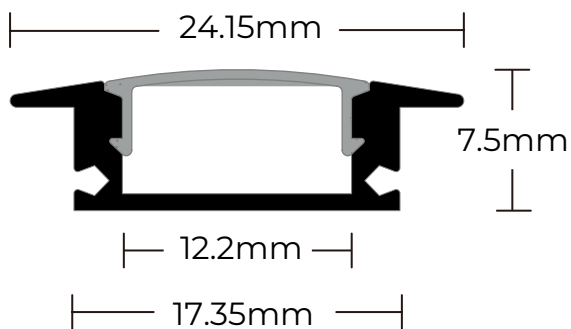

PER-E-1707-2M PL
PER-E-1707-2M BL
PER-E-1707-2M NG

Perfil de embutir
Para tiras de hasta 12mm



2 metros

Blanco, Negro, Plata

Aluminio

Fuente de alimentación para tiras LED IP20 12V.
Con protección de cortocircuito y sobre tensión.

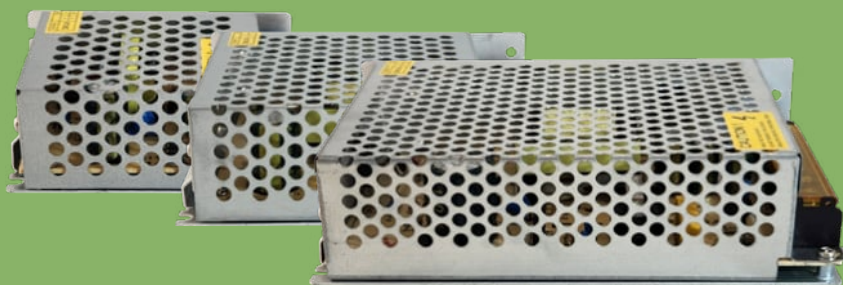

IP20

12V

ARTÍCULO	POTENCIA	MEDIDAS (W:H:D)	ENTRADA	HZ
DRV-12V-IP20-025W	25W-2A	85x59x33mm	176-264V	50/60Hz
DRV-12V-IP20-040W	40W-3.3A	159x98x42mm	176-264V	50/60Hz
DRV-12V-IP20-060W	60W-5A	159x98x42mm	176-264V	50/60Hz
DRV-12V-IP20-100W	100W-8.5A	159x98x42mm	176-264V	50/60Hz
DRV-12V-IP20-120W	120W-10A	159x98x42mm	176-264V	50/60Hz
DRV-12V-IP20-150W	150W-12.5A	198x98x42mm	176-264V	50/60Hz

Fuente de alimentación para tiras LED IP20 24V.
Con protección de cortocircuito y sobre tensión.

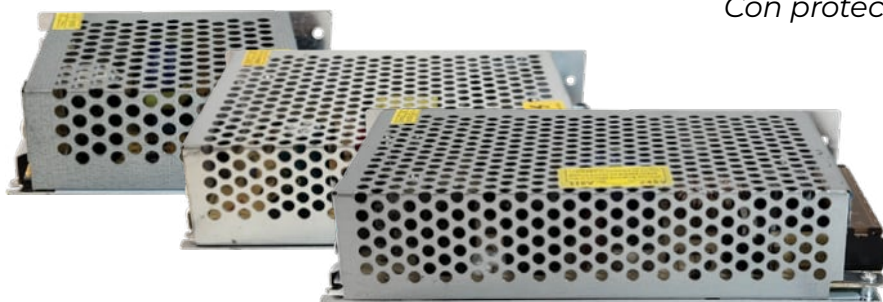

IP20

24V

ARTÍCULO	POTENCIA	MEDIDAS (W:H:D)	ENTRADA	HZ
DRV-24V-IP20-048W	48W-2A	159x98x42mm	176-264V	50/60Hz
DRV-24V-IP20-072W	72W-3A	198x98x42mm	176-264V	50/60Hz
DRV-24V-IP20-120W	120W-5A	198x98x42mm	176-264V	50/60Hz

Fuente de alimentación para tiras LED IP67 12V.
Con protección de cortocircuito y sobre tensión.



IP67 12V

ARTÍCULO	POTENCIA	MEDIDAS (W:H:D)	ENTRADA	HZ
DRV-12V-IP67-030W	30W-2.5A	221x30x20mm	176-264V	50/60Hz
DRV-12V-IP67-060W	60W-5.0A	159x41x21mm	176-264V	50/60Hz
DRV-12V-IP67-100W	100W-10A	188x64x22mm	176-264V	50/60Hz
DRV-12V-IP67-120W	120W-10A	188x64x22mm	176-264V	50/60Hz
DRV-12V-IP67-150W	150W-12.5A	188x64x22mm	176-264V	50/60Hz

Fuente de alimentación para tiras LED IP67 24V.
Con protección de cortocircuito y sobre tensión.











IP67 24V

ARTÍCULO	POTENCIA	MEDIDAS (W:H:D)	ENTRADA	HZ
DRV-24V-IP67-060W	60W-5.0A	85x59x33mm	176-264V	50/60Hz
DRV-24V-IP67-150W	150W-6.25A	159x98x42mm	176-264V	50/60Hz
DRV-24V-IP67-200W	200W-8.5A	250x70x32mm	176-264V	50/60Hz









GLOSARIO



ICONOGRAFÍA

-  Colores disponibles
-  Material
-  Temperatura
-  Lúmenes
-  Dimerizable
-  No dimerizable
-  Lámpara tipo E27
-  Lámpara tipo Dicroica
-  Lámpara tipo AR111
-  Lámpara G9
-  Lámpara E14
-  Lámpara R7S
-  Lámpara LED
-  Clase I
-  Clase II
-  Clase III
-  Dimensiones de tira LED
-  Orientable
-  Fijo
-  Antideslumbrante
-  Tipo de Chip
-  Autoadhesivo
-  Ángulo
-  Unidades por caja
-  Largo de perfil

INDICADORES DE COLOR

-  Blanco Texturado/Blanco mate/Blanco
-  Negro Texturado/Negro mate/Negro
-  Niquel mate
-  Cobre
-  Bronce
-  Plata/Plata texturado/Gris
-  Platil
-  Cromado
-  Negro mate+Oro Antiguo
-  Blanco mate+Plata
-  Rosa/Rosa Vintage
-  Celeste/Azul
-  Rojo
-  Verde Vintage
-  2000K
-  2500K
-  2700K
-  3000K
-  4000K
-  6500K
-  Vidrio Ambar
-  Vidrio Claro



Candil
iluminación

www.candil.com.ar

ventas@candil.com.ar

(5411) 2150-5398

