

NAHANCO

2025

aiding & encouraging customer success since 1925

Retail Refresh

rock your products with new hanging accessories

page 55

BUILD your BRAND

custom
w/out the
stress

choose from our extensive inventory and customize in days – OR – let us make your dream design come true

pages 4-5

ATHLEISURE

MUST HAVE rubber-wrapped, non-slip hangers in a range of styles and colors

page 24

MANNEQUINS & forms

- body forms
- premium fitness forms
- fiberglass forms



SWIM & intimates

LARGEST SELECTION
including unique display products

pages 33-35

BRIDAL formal

Everything you need in one place – the industry's BEST bridal hangers

pages 4-5

LUXE

Luxury items for less – our products sell yours!

100 years  nahanco.com
established 1925

Contents

3 - 10

INTRO PAGES about NAHANCO, custom work, best sellers, Luxe lines

10 - 49

HANGERS wood, plastic, metal, and more

25 - 28

BRIDAL hangers, body forms, gown covers, bridal supplies

50 - 54

DIVIDERS size dividers, divider kits, size markers

55 - 60

HANGING SOLUTIONS accessory hangers, hooks, clips, and more

61 - 64

BACKROOM reachers, hanger storage, work tables, folding boards

65 - 70

PRICING SUPPLIES pricing and marking tools, supplies, and tags

71 - 72

GARMENT BAGS poly bags, suit bags, travel bags, gown covers

73 - 90

RACKS & MERCHANDISERS racks, merchandisers, shelves, cases

91 - 102

WALL SYSTEMS slat wall, grid wall, wall mount and accessories

103 - 110

SIGNAGE metal & card stock signs, sign holders & hangers

111 - 114

SECURITY traffic control and security devices

115 - 118

DRESSING ROOM fabric care, room checks, tailor supplies, steamers

119 - 128

BODY FORMS jersey forms, mannequins, display forms

129 - 131

DISPLAY FIXTURES jewelry and accessory displayers, mirrors











132 - 134

SHOE DISPLAYS shoe forms, hangers, racks, foot sizers, displayers

135 - 138

PACKAGING bags, boxes, tissue paper

A GUIDE TO THE SYMBOLS

-  **Our new items**
-  **Items that ship via truck**
-  **Products made in the USA**
-  **California Proposition 65 Warning**
Products containing chemicals known to cause cancer, birth defects or other reproductive harm. For more information: www.P65Warnings.ca.gov.
-  **Sustainable product**
-  **Items that can be customized**
-  **Assembly video available on our website and YouTube channel**
-  **Everyday Value Items**
Low prices on items you use every day
-  **Hangers with concave bodies**
-  **Our economy items**

A NOTE ON WEIGHTS

Many of our items now list both the **actual** and the **dimensional** or shipping weight as follows: *actual/dimensional* or 1/3, 3/7, etc. When **multiple cartons** are shipped, commas separate the weights as follows: 2, 5 (2 ctns) or 3, 5/8 (2 ctns), etc.

NAHANCO
1925 - 2025

100 years in business

THE BENEFITS OF WORKING WITH US

Our US-based industry professionals are available to consult with you on your business needs.



We have unmatched experience in building and executing **custom programs** designed for your individual business needs.

We offer customizable reporting on your historical usage and spend.



We leverage our buying power to offer highly **competitive prices** on the items you buy - whether a one-off need or a high-volume, ongoing supply program.

THE RANGE OF SERVICES WE PROVIDE



E COMMERCE ORDERING PLATFORM

Our web-based ordering platform can be customized to your brand-specific catalog.



LOGISTICS & DISTRIBUTION

Services are scaled to fit your needs: to your warehouse, direct roll-outs or consolidated shipments.



SOURCING

Custom, branded or generic merchandising supplies; domestic or imported, we have you covered.



WAREHOUSING & INVENTORY MGMT

We can maintain inventory of the items you buy from us, so they are ready to ship when you need them.

SUSTAINABILITY

One of the most important and sensitive topics on the planet today - especially as it applies to the business world. The **NAHANCO** operations have become much more sustainable in recent years, and continue to make improvements.

SUSTAINABILITY AND NAHANCO HANGERS:

WOOD

All of our Wood Hangers are made from sustainable materials - Lotus wood and Bamboo - that are grown in China.



PLASTIC

Plastic Hangers have a useable shelf life of over ten years. And if damaged, the hanger can be recycled.

We recycle our own scrap plastic from the manufacturing process.

A granulator (and we have a big one!) is used to grind the scrap so we can re-use it.

Zero plastic goes into the waste stream.



RECYCLED PLASTICS

Our black hangers are made of up to 80% internal and external recycled plastic material. All other hangers we manufacture use up to 20% of internal recycled plastic.



luxe edit

A collection of products meant to inspire, inform and emphasize the best our brand has to offer via a lens of creativity and freshness. These products are both diverse and appropriate for many categories of retail.

A blend of legacy and newly developed products can be used in whatever way excites or moves you. The collections are inventoried and brandable for an effortless execution of your vision.

Luxury can often be difficult to define. We'd love to be part of how you express and define your own brand of luxury.



classic /p10



timeless style & high-quality construction



menswear /p23



sophisticated, solid styles for suiting



urban /p14

space-saving solutions without compromising quality



lingerie hangers in wood & metal

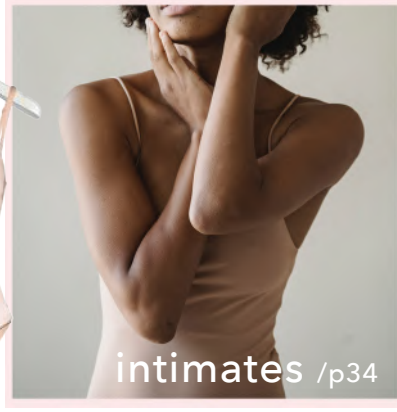

intimates /p34

bridal /p25

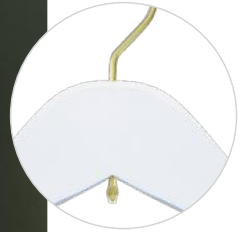

elegant bridal hangers



swim /p33



children /p10



modern accessory hangers

Designed with a woman's body in mind, a curvaceous shaped wire drop is everything. Our hybrid hangers are made for both hanging and visual display.



athleisure /p24

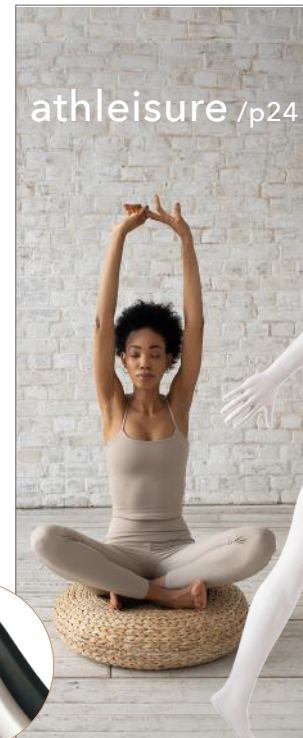

athletic mannequins

Designed for the performance wear industry. Weighty, wood bodies are enveloped in a smooth, no-slip, rubber coating.

A beautiful complement to athletic wear, the coating is buttery to the touch, adding a luxurious, tactile element.



Custom Creations

NAHANCO offers a robust custom program, that includes something for every customer no matter how big or how small. The program falls into 3 categories:

1/ BUILDABRAND

Considered our "bespoke" option, for customers looking for something completely unique to their brand. We develop custom plans, executed with full involvement of both your creative teams and ours.

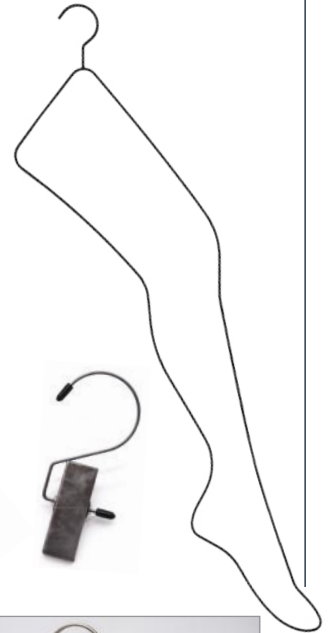

KITH

WE CREATED KITH'S ICONIC BLACK LINE OF HANGERS, WHICH GREW TO INCLUDE A LINE OF KIDS HANGERS



AN ANNIVERSARY LINE WAS LATER CREATED TO CELEBRATE ALL OF THE COLORS OF KITH

Custom Creations

2/ INSTABRAND

A popular option for customers looking to add branded elements to their store supplies.

Hangers are the most common choice, we can print custom designs onto size dividers, bags, and other objects. Select products from our extensive inventory and add your logo.

Custom items ship in DAYS, not months!

Large Inventory of hangers from which to choose.

Call us at **1-800-HANGERS**,
live chat at [nahanco.com](https://www.nahanco.com),
or email us at mail@nahanco.com

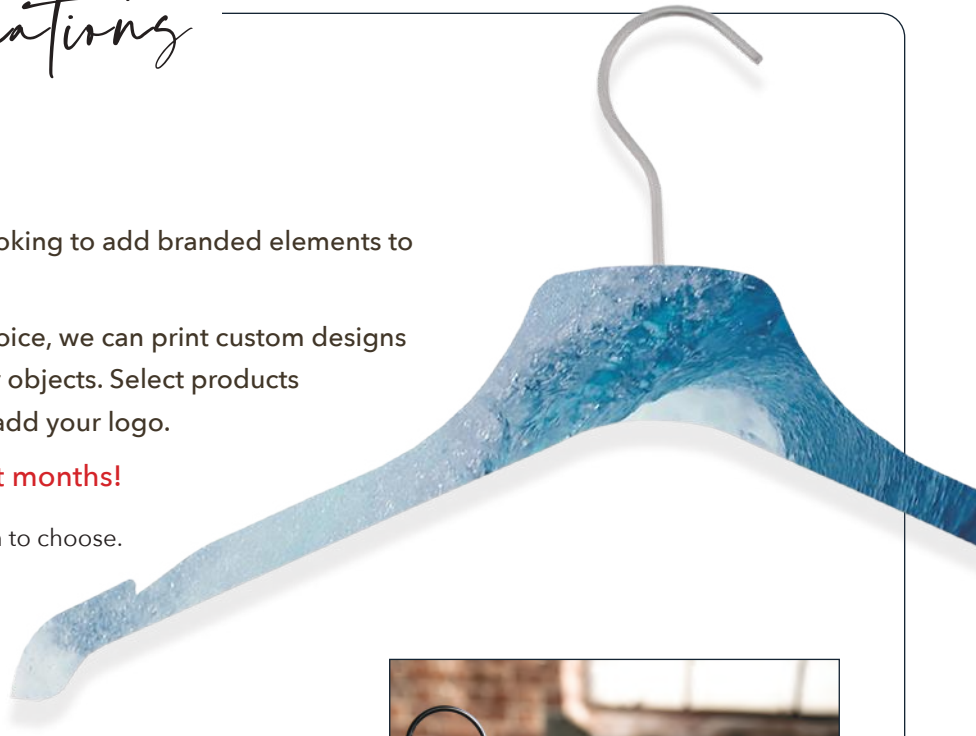

3/ CUSTOM CREATOR TOOL

This is our easy-to-use, Do-It-Yourself online customization tool.

A curated selection of our most popular wood hangers are sold in small 24-piece batches, ready for your logo, text, photos... whatever you want to create. Or work with a fun collection of elements available in the tool.

Ideal for smaller boutiques, offices, wedding parties, gifts, and home closets. It can also be used as a fun way to "test" out logo designs with a small-scale order.



Try out our
Custom Creator Tool
at [nahanco.com](https://www.nahanco.com)



Our Best Selling Hangers

wood

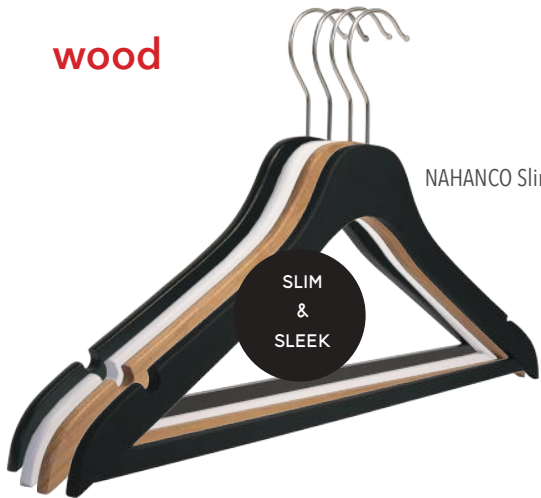

SLIM & SLEEK

NAHANCO Slimline Wood /pages 14-15



TRIED & TRUE

▲ NAHANCO Line /pages 10-13
Our most popular wood hanger!



A MODERN CLASSIC

< NORTHSHIRE Line /page 20



CONCAVE

EXECUTIVE Line /page 17

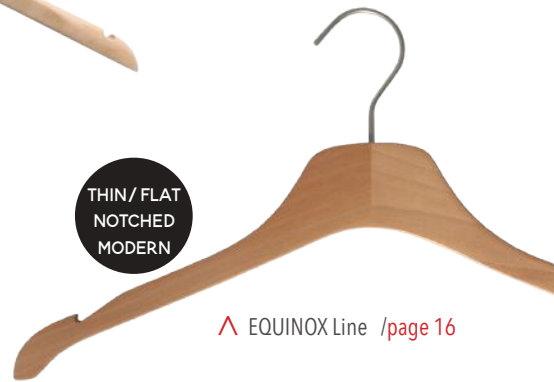

THIN / FLAT NOTCHED MODERN

▲ EQUINOX Line /page 16



FLOWING LINES

SIGNATURE Line /page 18



NATURAL CURVES

▲ CONTEMPORARY Line /page 19



RETRO

RETRO Line /page 18



GREAT ALL-AROUND

▲ TRADITIONAL Line /pages 21-23

✓ RUBBERIZED Line /page 24



RUBBER COATED



BODY FORM

< WOOD/METAL Body Form swim & Lingerie/ pages 33-35

Our Best Selling Hangers



SWIMWEAR

^ SWIMWEAR Hangers >
pages 33-35 Body-shaped,
round, tiered and more



metal

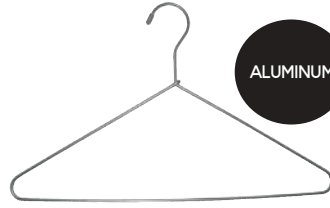

ALUMINUM

ALUMINUM Line /page 38



GUNMETAL
FINISH

GUNMETAL Line /page 38



CHROME

CHROME Line /pages 36-37



STEEL

STEEL Line /page 38

plastic



TRADITIONAL
STYLES



TRADITIONAL Plastic /pages 41-45
Many styles made by us in the USA



CHILDREN'S

KIDS' Styles /pages 46-47



JACKET
&
SUIT

JACKET Line /
page 29



DISPLAY

DISPLAY Lines /page 32



SLIM &
VERSATILE

^ VELVET Slimline /page 31



INTIMATE Lines /page 35

INTIMATE
STYLES



satin

INTIMATE Lines /page 34



ECONOMY

ECONOMY Lines /page 49

HANGERS NAHANCO Line Wood

WOOD 

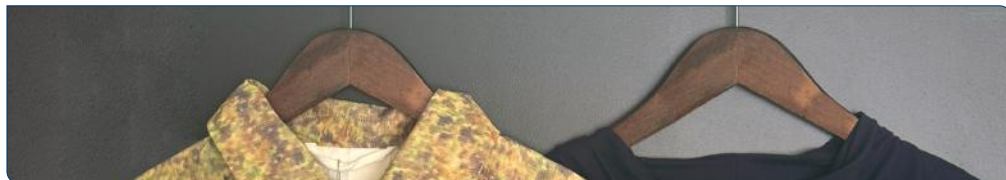

NAHANCO LINE FLAT SHIRT /DRESS HANGERS

Our most popular wood hanger style - and the style most often chosen for customization. Hardware is brushed chrome, bright chrome, gunmetal, black or gold. Range of wood finishes. Inset grippers.

17" wide - 1/2" thick body; 100 pcs /case. SHIRT: 28 lbs. / Dimensional wgt. 34 lbs

19" width - 1/2" thick body; 100 pcs /case.

14" width - 1/2" thick body; 100 pcs /case.

12" width - 1/2" thick body; 100 pcs /case.

10" width - 1/2" thick body; 100 pcs /case.

SHIRT: 31/42 lbs;

SHIRT: 25/25 lbs;

SHIRT: 18/23 lbs

SHIRT: 15/16 lbs

Inset Grippers

Featured on all styles except black rubber



Low gloss natural w/brushed chrome

Low gloss white w/brushed chrome

Low gloss black w/brushed chrome

Low gloss mahogany w/brushed chrome

High gloss black w/bright chrome

High gloss white w/bright chrome

Low gloss beech w/brushed chrome

Low gloss espresso w/gunmetal

Black rubber w/brushed chrome /no grippers 

Low gloss whitewash w/brushed chrome

Raw finish w/gunmetal

Low gloss greywash w/brushed chrome

Low gloss black w/black

High gloss black w/gold

High gloss white w/gold

SHIRT HANGERS

20019	\$166.41	19"
20017	\$129.59	17"
20014	\$128.29	14"
20012	\$125.70	12"
20010	\$125.70	10"

20119	\$166.41	19"
20117	\$129.59	17"
20114	\$128.29	14"
20112	\$125.70	12"
20110	\$125.70	10"

20219	\$166.41	19"
20217	\$129.59	17"
20214	\$128.29	14"
20212	\$125.70	12"
20210	\$125.70	10"

20319	\$166.41	19"
20317	\$129.59	17"
20314	\$128.29	14"
20312	\$125.70	12"
20310	\$125.70	10"

20417	\$127.00	17"
-------	----------	-----

20517	\$127.00	17"
-------	----------	-----

20617	\$151.99	17"
-------	----------	-----

20717	\$127.00	17"
-------	----------	-----

20817	\$139.99	17"
-------	----------	-----

20917	\$151.99	17"
-------	----------	-----

21517	\$127.00	17"
-------	----------	-----

29917	\$151.99	17"
-------	----------	-----

20217BH	\$124.40	17"
---------	----------	-----

20219BH	\$158.10	19"
---------	----------	-----

20417GH	\$124.40	17"
---------	----------	-----

20517GH	\$124.40	17"
---------	----------	-----

14" & 12" KIDS' SHIRT HANGERS





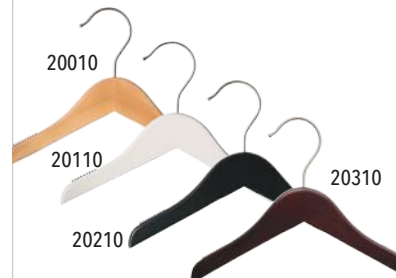

















10" INFANT SHIRT HANGERS



NAHANCO Line Wood **HANGERS**

SUIT HANGERS w/ BAR

	Low gloss natural w/brushed chrome	19"	20019WB	\$135.99
	Low gloss white w/brushed chrome	17"	20119WB	\$135.99
	Low gloss black w/brushed chrome	17"	20117WB	\$120.99
	Low gloss mahogany w/brushed chrome	14"	20014WB	\$115.99
	Low gloss mahogany w/brushed chrome	19"	20219WB	\$135.99
	Low gloss mahogany w/brushed chrome	17"	20217WB	\$120.99
	Low gloss mahogany w/brushed chrome	14"	20214WB	\$115.99
	High gloss black w/ bright chrome	19"	20319WB	\$154.99
	High gloss black w/ bright chrome	17"	20317WB	\$150.99
	High gloss black w/ bright chrome	14"	20314WB	\$146.99
	High gloss white w/ bright chrome	17"	20417WB	\$120.99
	Low gloss beech w/ brushed chrome	17"	20517WB	\$120.99
	Low gloss espresso w/ gunmetal	17"	20617WB	\$125.99
	Black rubber w/brushed chrome /no grippers	17"	20717WB	\$125.99
	Low gloss whitewash w/brushed chrome	17"	20817WB	\$150.99 
	Raw finish w/gunmetal	17"	20917WB	\$150.99
	Low gloss greywash w/brushed chrome	17"	21517WB	\$125.99
	Low gloss black w/black	17"	29917WB	\$150.99
	Low gloss black w/black	17"	20217WBBH	\$120.99
	Low gloss black w/black	19"	20219WBBH	\$135.99
	High gloss black w/ gold	17"	20417WBGH	\$120.99
	High gloss white w/ gold	17"	20517WBGH	\$120.99



NAHANCO LINE FLAT SUIT HANGERS

Our most popular wood style in a suit hanger. Most styles have inset grippers. Hardware is brushed chrome, bright chrome, gunmetal, black or gold, depending on the finish.

17" width - 1/2" thick body; 100 pcs /case.

SUIT: 30 lbs. / Dim.wgt. 36 lbs

19" width - 1/2" thick body; 100 pcs /case.

SUIT: 33/35 lbs

14" width - 1/2" thick body; 100 pcs /case.

SUIT: 22/22 lbs



17" SUIT HANGER

29917WB

INSET GRIPPERS
Featured on all styles
except black rubber



20219WB

19" SUIT HANGER

14" KIDS' SUIT HANGERS



20214WB

20114WB

20014WB

260-17RC

261-17RC

262-17RC

263-17RC



FLAT 17" SUIT HANGER w/ CLIPS

260-17RC	Low gloss natural	\$125.99
261-17RC	Low gloss white	\$125.99
262-17RC	Low gloss black	\$125.99
263-17RC	Low gloss mahogany	\$139.99



INSET GRIPPERS

1/2" thick; brushed chrome hardware and inset grippers; 1 1/2" drop with brushed chrome clips; 100 /case; 37 lbs; available in four finishes

HANGERS NAHANCO Line Wood

NAHANCO LINE JACKET HANGERS



17" wide and 3/4" thick; features a 1 1/2" notched flare end; brushed chrome, bright chrome or gunmetal hook, depending on the finish; 24 /case; 16/19 lbs; available in ten finishes.

17" CONCAVE JACKET HANGER

23017	118.99	Low gloss natural /brushed chrome hook
23117	118.99	Low gloss white /brushed chrome hook
23217	118.99	Low gloss black /brushed chrome hook
23317	118.99	Low gloss mahogany /brushed chrome hook
23417	118.99	High gloss black /bright chrome hook
23517	118.99	High gloss white /bright chrome hook
23617	146.99	Low gloss beech /brushed chrome hook
23717	118.99	Low gloss espresso /gunmetal hook
23817	118.99	Black rubber /brushed chrome hook 
23917	152.49	Low gloss whitewash /brushed chrome hook

NAHANCO LINE PANT/SKIRT HANGERS

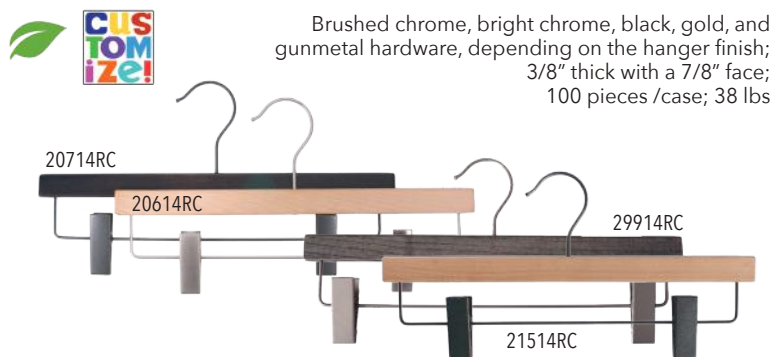

Brushed chrome, bright chrome, black, gold, and gunmetal hardware, depending on the hanger finish; 3/8" thick with a 7/8" face; 100 pieces /case; 38 lbs

FLAT 14" & 12" SKIRT/PANT HANGERS w/ CLIPS

21014RC	159.99	14"	Low gloss natural
21012RC	159.99	12"	Low gloss natural
21114RC	159.99	14"	Low gloss white
21112RC	159.99	12"	Low gloss white
21216RC	159.90	16"	Low gloss black
21214RC	159.99	14"	
21212RC	159.99	12"	
21314RC	159.99	14"	Low gloss mahogany
21312RC	159.99	12"	Low gloss mahogany
20414RC	159.99	14"	High gloss black w/ bright chrome
20514RC	194.39	14"	High gloss white w/ bright chrome
20614RC	161.99	14"	Low gloss beech
20714RC	161.99	14"	Low gloss espresso w/ gunmetal
20814RC	169.99	14"	Black rubber 
20914RC	163.99	14"	Low gloss whitewash
21514RC	163.99	14"	Raw finish w/ gunmetal
29914RC	163.99	14"	Low gloss greywash
21214BRC	159.99	14"	Low gloss black w/ black hook & bar
21216BRC	159.99	16"	Low gloss black w/ black hook & bar
20414RCGH	159.99	14"	High gloss black w/ gold
20514RCGH	159.99	14"	High gloss white w/ gold

For a visual reference to all of the NAHANCO Line finishes, see page 10



3/8" thick with a low gloss finish; brushed chrome hardware and locking wooden bar; 100 /case; 27 lbs; available in four finishes \$151.99

FLAT 14" PANT HANGERS w/ LOCKING BAR

21014PB	Low gloss natural
21114PB	Low gloss white
21214PB	Low gloss black
21314PB	Low gloss mahogany

NAHANCO Line Wood HANGERS

NAHANCO LINE DISPLAY HANGERS

17" CONCAVE DISPLAY HANGER

24017	Low gloss natural	\$91.99
24117	Low gloss white	\$91.99
24217	Low gloss black	\$91.99
24317	Low gloss mahogany	\$95.99

17" wide and 3/4" thick with a 14" drop; with a 1 1/2" notched flare end and brushed chrome hardware; 12 /case; 14/27 lbs; available in four finishes



NAHANCO LINE BODY-SHAPED DISPLAY HANGERS

Introducing two new styles of display hangers. NAHANCO Line wood flat shirt hangers and jacket hangers are combined with a body-shaped wire drop to create a hybrid wood/wire product.

Both styles are ideal for hanging and displaying a wide range of garments, from swimwear and lingerie, to dresses and more.

Each style comes in a choice of 4 finishes.

See page 33 for more details.

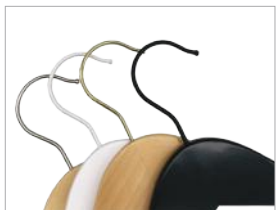

4 finish/metal combinations

NAHANCO LINE RUBBERIZED WOOD HANGERS

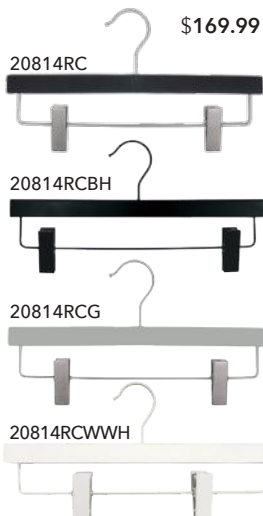

black rubber w/brushed chrome hardware

black rubber w/black hardware

grey rubber w/brushed chrome hardware

white rubber w/white hardware



3 rubberized finishes

Designed for the performance wear industry. Wood hanger bodies are enveloped in a smooth, no-slip, no-snag, rubber coating.

100 pieces /case starting at \$139.99

See page 24 for more details.

HANGERS SLIMLINE Wood



Fit **TWICE** the merchandise on your racks without giving up the luxury of a wood hanger.

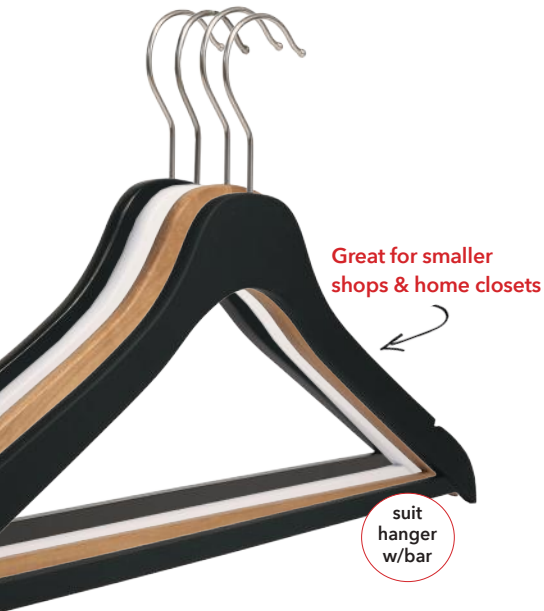

NAHANCO SLIMLINE WOOD

Behold our SlimLine wood hanger! Almost as thin as our slimline velvet hangers, and as luxe as our NAHANCO line hangers.

Available in a range of finishes, including natural, black, white, and matte black rubber coated, mahogany, high gloss white, unfinished – all with swivel hooks and various hardware finishes, including brushed chrome, gold, black, and gunmetal hardware.



Adhesive Foam Non-slip Attachments

Available in Black or White; 2 1/4" long; 1000 /case; 2/3 lbs.

FGSL1000B Black \$55.47
FGSL1000W White \$55.47

SLIMLINE JACKET HANGERS

The SlimLine shape is also available in a heavier jacket style!

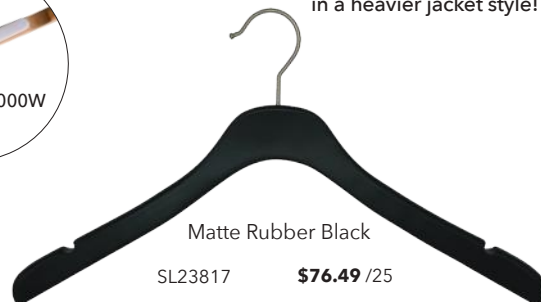

width comparisons

The Slimline jacket hanger (far left) flares to 1/2" in width, compared to the 3/4" flare of the NAHANCO jacket hanger (near left). The NAHANCO line shirt hanger (far right) is 1/2", twice the width of the Slimline version (near right), which has a flat 1/4" body.





SLIMLINE Wood HANGERS

The complete SLIMLINE wood collection: 5 styles, each in 8 finishes

SHIRT HANGERS 50 /case 17" wide, ¼" thick; 8/13 lbs.

SL7001750	Low gloss Natural	65.49
SL7011750	Low gloss White	65.49
SL7021750	Low gloss Black	65.49
SL7081750	Matte Black Rubber coated	71.99
SL7051750GH	High gloss White w/Gold hook	65.49
SL7021750BH	Low gloss Black w/Black hook	65.49
SL7031750GH	Mahogany w/Gold hook	65.49
SL7151750GM	Raw finish w/Gunmetal hook	65.49

SHIRT/DRESS



JACKET HANGERS 25 /case 17" wide, ½" thick; 27 lbs.

SL23017	Low gloss Natural	71.49
SL23117	Low gloss White	71.49
SL23217	Low gloss Black	71.49
SL23817	Matte Black Rubber coated	76.49
SL23517GH	High Gloss White /gold hook	71.49
SL23217BH	Low gloss Black w/black hook	71.99
SL23317GH	Mahogany w/gold hook	71.99
SL25517GM	Raw finish w/gunmetal hook	71.49

JACKET



SKIRT/PANT HANGERS

50 /case 14" wide, ¼" thick; 12/12 lbs.

SL70014RC50	Low gloss Natural	79.99
SL70114RC50	Low gloss White	79.99
SL70214RC50	Low gloss Black	79.99
SL70814RC50	Matte Black Rubber coated	85.89
SL70514RC50GH	High gloss White w/Gold hook	79.99
SL70214RC50BH	Low gloss Black w/Black hook	79.99
SL70314RC50GH	Mahogany w/Gold hook	79.99
SL71514RC50GM	Raw finish w/Gunmetal hook	79.99

SKIRT/PANT



SUIT HANGERS

50 /case 17" wide, ¼" thick; 10/14 lbs.

with bar:

SL70017WB50	Low gloss Natural	79.99
SL70117WB50	Low gloss White	79.99
SL70217WB50	Low gloss Black	79.99
SL70817WB50	Matte Black Rubber coated	89.99
SL70517WB50GH	High gloss White w/Gold hook	79.99
SL70217WB50BH	Low gloss Black w/Black hook	79.99
SL70317WB50GH	Mahogany w/Gold hook	79.99
SL71517WB50GM	Raw finish w/Gunmetal hook	79.99

w/ bar

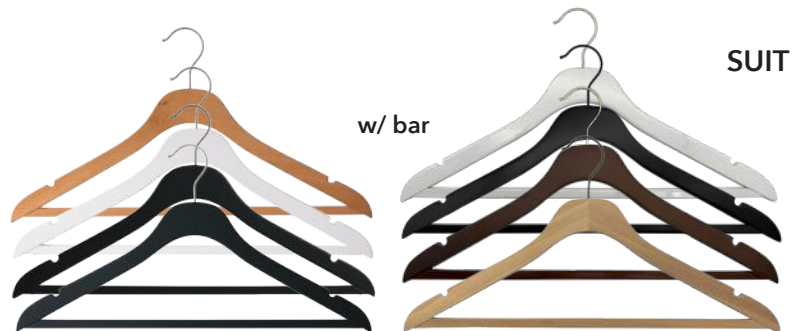

SUIT

with clips:

50 /case 17" wide, ¼" thick; 12/19 lbs.

SL70017RC50	Low gloss Natural	97.99
SL70117RC50	Low gloss White	97.99
SL70217RC50	Low gloss Black	97.99
SL70817RC50	Matte Black Rubber coated	99.99
SL70517RC50GH	High gloss White w/Gold hook	97.99
SL70217RC50BH	Low gloss Black w/Black hook	97.99
SL70317RC50GH	Mahogany w/Gold hook	97.99
SL71517RC50GM	Raw finish w/Gunmetal hook	97.99

w/ clips

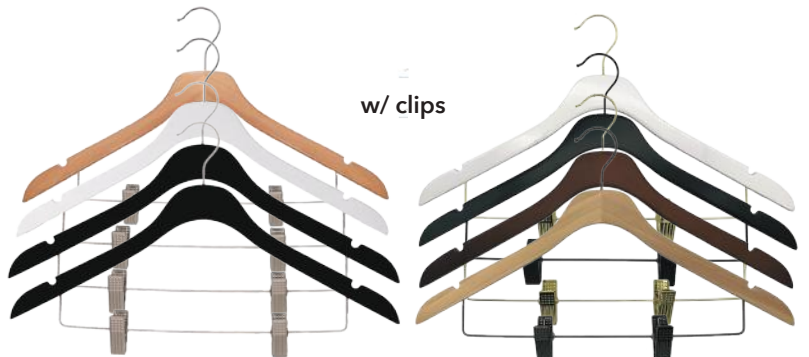

HANGERS Equinox Line

EQUINOX LINE SHIRT & PANT/SKIRT HANGERS

Thin, flat and sleek with deep, sculpted notches. Perfect for customizing. Everything you could want from a modern hanger.

Available in both wood and acrylic styles.



EQUINOX WOOD HANGERS



High Gloss Black & White and Low Gloss Natural w/ brushed chrome hardware; Low Gloss Espresso w/gunmetal hardware



Shirt hangers:

17"; 5/16" thick; 50 /case; 13/15 lbs.

29201750	Black	\$124.80
29101750	White	\$124.80
29701750	Espresso	\$124.80
29001750	Natural	\$124.80

Pant/skirt hangers:

14"; 5/16" thick; 50 /case; 16 lbs.

292014RC50	Black	\$137.38
291014RC50	White	\$137.38
297014RC50	Espresso	\$137.38
290014RC50	Natural	\$137.38



EQUINOX ACRYLIC HANGERS

High Gloss Black, White & Clear

Shirt hangers:

17"; 5/16" thick; 50 /case; 14 lbs.

w/ brushed chrome hardware:

9201750	Black	\$159.54
9101750	White	\$159.54
9001750	Clear	\$159.54

w/ gold hardware:

92017GH50	Black	\$159.54
91017GH50	White	\$159.54
90017GH50	Clear	\$159.54

w/ black hardware:

92017BH50	Black	\$159.54
-----------	-------	----------

w/ shiny chrome hardware:

92017CH50	Black	\$159.54
91017CH50	White	\$159.54
90017CH50	Clear	\$159.54

Pant/skirt hangers:

14"; 5/16" thick; 50 /case; 17 lbs.

w/ brushed chrome hardware:

92014RC50	Black	\$179.90
91014RC50	White	\$179.90
90014RC50	Clear	\$179.90

w/ gold hardware:

92014RCG50	Black	\$179.90
91014RCG50	White	\$179.90
90014RCG50	Clear	\$179.90

w/ black hardware:

92014BRC50BH	Black	\$179.90
--------------	-------	----------

w/ shiny chrome hardware:

92014RCCH50	Black	\$179.90
91014RCCH50	White	\$179.90
90014RCCH50	Clear	\$179.90

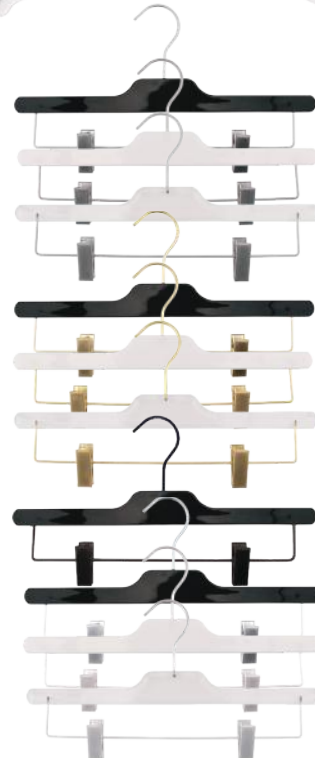

With its thin, flat face, the Equinox is perfect for customizing

Executive Line Wood HANGERS

EXECUTIVE HANGERS

SHIRT HANGERS

50 /case 17 1/2" wide, 1/2" thick; 13 lbs. **\$62.20**

- 2007-14N Natural
- 2007-14W White
- 2007-14B Black
- 2007-14C Cherry

SUIT HANGERS w/bar

50 /case 17 1/2" wide, 1/2" thick; 15 lbs. **\$68.68**

- 2007-15N Natural
- 2007-15W White
- 2007-15B Black
- 2007-15C Cherry

SUIT HANGERS w/clips

50 /case 17 1/2" wide, 1/2" thick; 21 lbs. **\$90.99**

- 2007-16N Natural
- 2007-16W White
- 2007-16B Black
- 2007-16C Cherry

EXECUTIVE FLARE HANGERS

SHIRT HANGERS

25 /case 17 1/2" wide, 1/2" thick; 13/19 lbs. **\$62.20**

- 2007-17N Natural
- 2007-17W White
- 2007-17B Black
- 2007-17C Cherry

SUIT HANGERS w/bar

25 /case 17 1/2" wide, 1/2" thick; 16/22 lbs. **\$64.79**

- 2007-18N Natural
- 2007-18W White
- 2007-18B Black
- 2007-18C Cherry

SUIT HANGERS w/clips

25 /case 17 1/2" wide, 1/2" thick; 17/19 lbs. **\$90.99**

- 2007-19N Natural
- 2007-19W White
- 2007-19B Black
- 2007-19C Cherry

SKIRT/PANT HANGERS

25 /case 14" wide, 1/2" thick; 7/9 lbs. **\$55.47**

- 200713N Natural
- 200713W White
- 200713B Black
- 200713C Cherry

EXECUTIVE HANGER LINE

Concave with chrome hardware and a gloss finish



EXECUTIVE FLARE HANGER LINE

Concave with chrome hardware and a gloss finish



EXECUTIVE PANT HANGER

Flat with chrome hardware and a gloss finish



HANGERS Signature, Retro & Flat Wood

SIGNATURE WOOD HANGERS

Flat with brushed chrome hardware

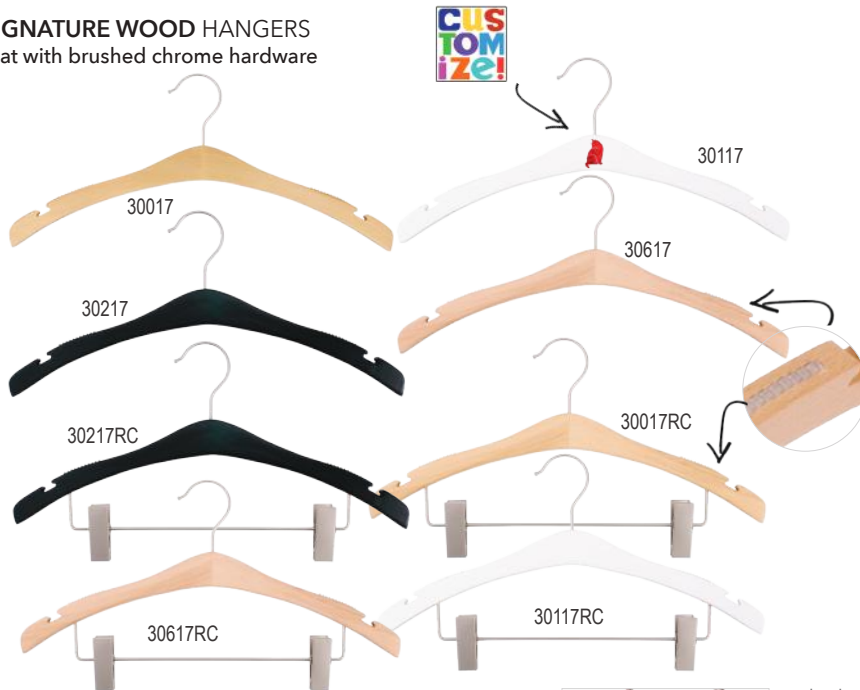

RETRO WOOD HANGERS

Flat with brushed chrome hardware

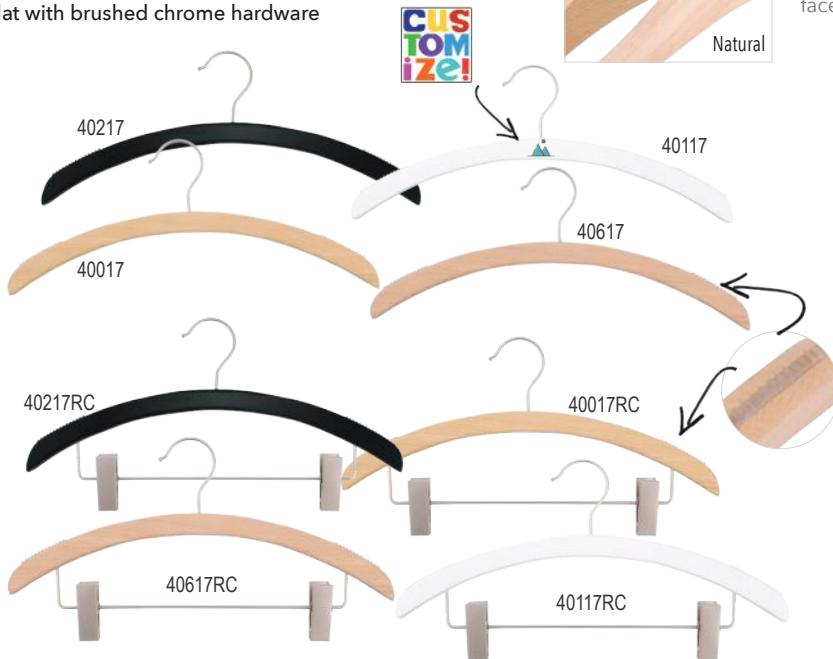

SHIRT HANGER

SUIT HANGER

SKIRT/PANT HANGER

SIGNATURE HANGERS

SHIRT HANGERS

100 /case 16 3/4" wide, 1/2" thick; 28 lbs.

30017	159.99	Low gloss natural
30117	159.99	Low gloss white
30217	159.99	Low gloss black
30617	179.99	Low gloss beech

SUIT HANGERS w/clips

100 /case 16 3/4" wide, 1/2" thick; 37/42 lbs.

30017RC	169.99	Low gloss natural
30117RC	169.99	Low gloss white
30217RC	169.99	Low gloss black
30617RC	179.99	Low gloss beech

The beauty of our wooden hangers comes in part from the individual craftsmanship required to produce them. Each hanger is unique, so expect slight variations in the lighter wood colors, wood grains and the landscape of each hanger face (resulting in minute differences in logo placement).

RETRO HANGERS

SHIRT HANGERS

100 /case 16" wide, 1/2" thick; 22/28 lbs.

40017	121.99	Low gloss natural
40117	121.99	Low gloss white
40217	121.99	Low gloss black
40617	144.99	Low gloss beech

SUIT HANGERS w/clips

100 /case 16" wide, 1/2" thick; 37 lbs.

40017RC	167.99	Low gloss natural
40117RC	167.99	Low gloss white
40217RC	167.99	Low gloss black
40617RC	181.99	Low gloss beech

FLAT HANGERS

100 /case Natural gloss; chrome hardware

3117CH	106.99	16 1/2" wide, 3/8" thick; 24/25 lbs.
3117RC	148.99	16 1/2" wide, 3/8" thick; 35 lbs.
32-17	136.99	14" wide, 3/8" thick; 7/8" face; 27 lbs.

Contemporary Wood HANGERS



 **CONTEMPORARY HANGER LINE**
Flat body with a softer slope, chrome hardware, ball end hook and a gloss finish

SHIRT HANGERS w/notches

100 /case; 17" wide, 3/8" thick; 27/29 lbs. **\$143.99**

200720NN	Natural
200720WN	White
200720BN	Black



CONTEMPORARY PANT/SKIRT w/standard clips

100 /case; 14" wide, 3/8" thick; 30 lbs. **\$127.49**

200723N	Natural
200723W	White
200723B	Black



SHIRT HANGERS - no notches

100 /case; 17" wide, 3/8" thick; 34/35 lbs. **\$143.99**

2007-20N	Natural
2007-20W	White
2007-20B	Black
2007-20C	Cherry

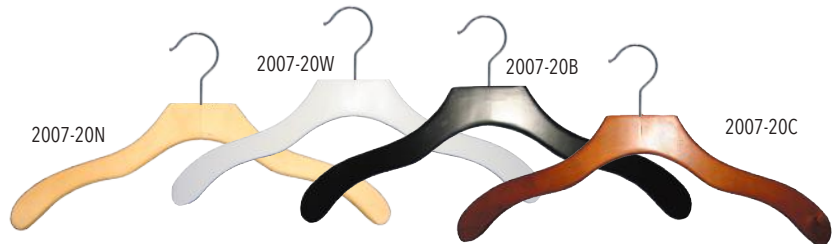

SUIT HANGERS w/bar

100 /case; 17" wide, 3/8" thick; 37 lbs. **\$152.99**

2007-21N	Natural
2007-21W	White
2007-21B	Black
2007-21C	Cherry

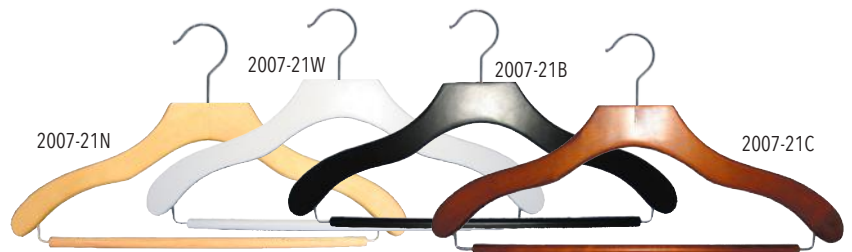

SUIT HANGERS w/Euro clips

100 /case; 17" wide, 3/8" thick; 37 lbs. **\$159.99**

2007-22N	Natural
2007-22W	White
2007-22B	Black
2007-22C	Cherry

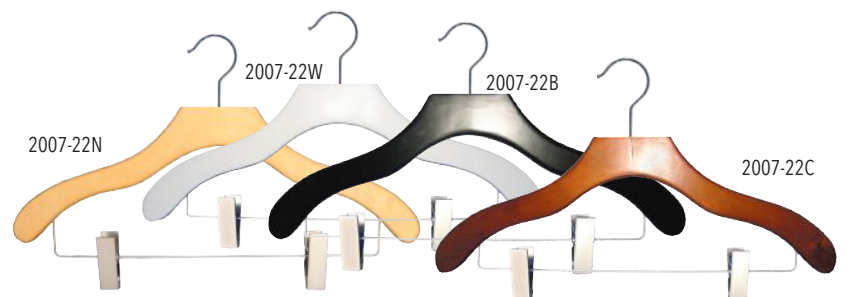

HANGERS Northshire & Specialty

NORTHSHIRE LINE JACKET HANGERS

A classic jacket hanger with a 3/8" shoulder, a 1 1/8" flare and a ball end hook. 16 1/2" wide; 24 pieces per carton; 9/15 lbs.



Northshire hangers feature notched, flared ends



25217	25117	25517	25717	29517	25317
Low Gloss Black w/ brushed chrome hardware	Low Gloss White w/ brushed chrome hardware	Raw Finish w/ gunmetal hardware	Low Gloss Espresso w/ gunmetal hardware	Low Gloss Greywash w/ brushed chrome hardware	Low Gloss Mahogany w/ brushed chrome hardware
24 pieces/ \$71.99	24 pieces/ \$71.99	24 pieces/ \$87.99	24 pieces/ \$87.99	24 pieces/ \$87.99	24 pieces/ \$87.99

SPECIALTY WOOD HANGERS

BAMBOO HANGERS Flat with chrome hardware



SLIMLINE BAMBOO Low gloss finish; 1/4" thick; 50 pieces/case.

Shirt hanger; 17" wide; 13 lbs; **SL21417CH \$ 77.99**
 Pant/Skirt hanger; 14" wide w/ 7/8" face; 19 lbs; **SL21414RCCH \$ 106.49**
 Suit hanger w/drop bar & clear sleeve; 17" wide; 13 lbs; **SL21417DBSCH \$ 110.99**
 Suit hanger w/drop bar and clips; 17" wide; 13 lbs; **SL21417RCCH \$ 124.49**

STANDARD BAMBOO Low gloss finish; 1/2" thick; 50 pieces/case.

Shirt hanger; 17" wide; 13 lbs; **21417 \$89.99**
 Pant/Skirt hanger; 14" wide w/ 7/8" face; 19 lbs; **21414RC \$103.99**

DARK WOOD HANGERS

Flat with gunmetal hardware

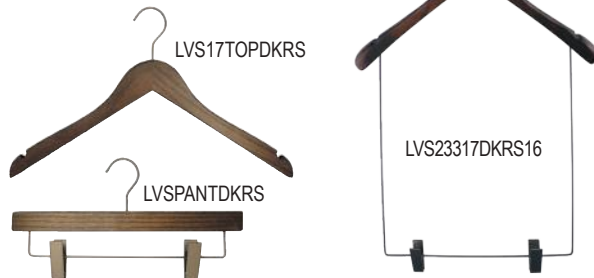

Low gloss dark wood; 1/2" thick; 100 pieces/case.
 Shirt hanger; 17" wide; 28/32 lbs; **LVS17TOPDKRS \$110.99**
 Pant/Skirt hanger; 14" wide w/ 1 1/8" face; 38 lbs; **LVSPANTDKRS \$153.99**
 Display hanger; 12 pieces/case.
 17" wide w/ 16" drop; 17/27 lbs; **LVS23317DKRS16 \$78.99**

WALNUT GOLD SERIES HANGERS Gloss walnut finish with gold hardware



Flat Shirt hanger; 17" wide; 1/2" thick; 100 pieces/case; 26/29 lbs; **8317GH (no notches) \$98.99**

Concave Shirt hanger; 17" wide; 1" thick; 40 pieces/case; 24/28 lbs; **2017GH \$127.99**

Pant/Skirt hanger; 14" wide; 1/2" thick w/ 7/8" face; flat w/metal clips; 100 pieces/case; 30 lbs; **CLIPGH \$126.99**

WOOD PET HANGERS 8" mini wood hangers engraved with paws or bone design

Natural finish; 1/2" thick; 5 pieces/carton

no clips 4 lbs **\$17.04**

Paws MINI8ENGPW

Bone MINI8ENGBONE

w/ clips 5 lbs **\$19.32**

Paws MINI8RCENGPW

Bone MINI8RCENGBONE



BENTWOOD HANGERS Flat with chrome hardware



Low gloss natural finish; 1/2" thick; 100 pieces/case.

Shirt hanger; 17" wide; 17 lbs; **664 \$106.99**

Pant/Skirt hanger; 15" wide; 22 lbs; **652 \$120.99**



Traditional Wood HANGERS



TRADITIONAL HANGER LINE

Premium wood hanger at an economy price



SHIRT HANGERS w/notches

100 /case; 17" wide, 1/2" thick; 28/29 lbs. **\$79.90**

- 81-17CH Natural gloss
- 8217CHNOBAR Black gloss
- 8117WCHNOTCH White gloss



FLAT SHIRT HANGER
with Shoulder Notches
Chrome hook

SHIRT HANGERS - no notches

100 /case; 17" wide, 1/2" thick; 28/29 lbs. **\$79.90**

- 8117CHNONOTCH Natural gloss
- 8117WCH White gloss

FLAT SHIRT HANGER
without Shoulder Notches
Chrome hook



SUIT HANGERS w/bar

100 /case; 17" wide, 1/2" thick; 30/31 lbs. **\$79.90**

- 80-17 Natural gloss
- 8017W White gloss
- 8217CH Black gloss



FLAT SUIT HANGER
Stationary pant bar
Chrome hook

SUIT HANGERS w/2" chrome drop

100 /case; 17" wide, 1/2" thick; 30/31 lbs. **\$109.90**

- 8017CHRC Natural

FLAT SUIT HANGER
2" chrome drop
Chrome hook



PANT/SKIRT w/clips

100 /case; 14" wide, 1/2" thick; 31 lbs.

- 1214RCCH White w/chrome hardware **94.90**
- 6214RCCH Natural w/chrome hardware **94.90**
- 6214RCGH Natural w/gold hardware **124.90**
- 8214RCCH Walnut w/chrome hardware **109.99**
- 8214RCGH Walnut w/gold hardware **129.99**
- 2214RCCH Black w/chrome hardware **94.90**
- 2214RCGH Black w/gold hardware **129.99**

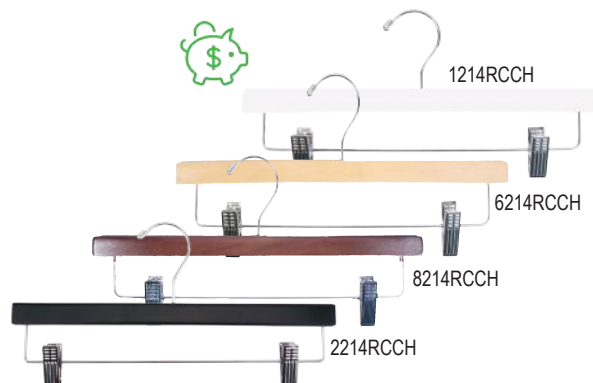

SKIRT/PANT HANGER
Flat with chrome or gold hardware



HANGERS Traditional Wood



EXTRA-THICK CONCAVE JACKET HANGER
Chrome hook



JACKET HANGERS / 1" thick

40 /case 17" wide, 1" thick; 22/32 lbs.

\$123.99

2017CH	Walnut gloss
2117CH	Natural gloss
2217CH	Black gloss
2317CH	Natural w/waxed finish



1" thick

EXTRA-THICK CONCAVE SUIT HANGER
Chrome hardware and locking trouser bar



SUIT HANGERS / 1" thick

40 /case 17" wide, 1" thick; 29/39 lbs.

2017CHPB	134.99	Walnut gloss
2117CHPB	134.99	Natural gloss
2217CHPB	134.99	Black gloss

2317CHPB 153.99 Natural w/waxed finish

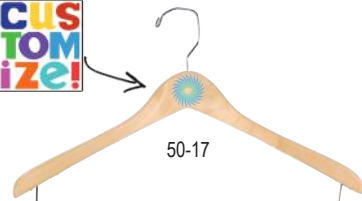

CONCAVE SUIT HANGER
Chrome or gold hardware with locking trouser bar



* Waxed hanger has a square hook

HOOK finishes:
CH /Chrome Hook
GH /Gold Hook



SUIT HANGERS / 1/2" thick

100 /case; 1/2" thick

50-14	203.86	14" Natural w/waxed finish, sq hook	27/35
50-17	198.29	17" Natural w/waxed finish, sq hook	39/40
50-19	203.86	19" Natural w/waxed finish, sq hook	42/48
7017CH	162.26	17" Walnut, chrome hook	38/49
70-19GH	203.86	19" Walnut, gold hook	38/44
7117CH	162.26	17" Natural, chrome hook	38/45
71-19GH	203.86	19" Natural, gold hook	41/48
72-17CH	165.11	17" Black, chrome hook	33/48
72-17	165.11	17" Black, gold hook	33/48

SUIT HANGERS / 1/2" thick w/2" drop

100 /case; 1/2" thick

70-17RH	171.98	19" Walnut, gold hardware	39/45
7117RCCH	171.98	17" Natural, chrome hardware	39/45
7217RCCH	171.98	17" Black, chrome hardware	39/48
72-17RC	191.42	17" Black, gold hardware	39/48



NOTCHED CONCAVE SUIT HANGER
Chrome or gold hardware



Traditional Wood HANGERS



JACKET HANGERS - Concave & 1/2" thick

100 /case; 17" wide, 1/2" thick **\$127.99**

1217CH	Black w/chrome hardware	29/31
12-17	Black w/gold hardware	29/31
14-17	Natural, waxed w/chrome hardware	29/31
1017CH	Walnut w/chrome hardware	29/33
1017GH	Walnut w/gold hardware	29/33
10-19GH	19" wide - Walnut w/gold hardware	33/36
11155CH	15 1/2" wide - Natural w/chrome hardware	22/30
1117CH	Natural w/chrome hardware	29/33
11-17GH	Natural w/gold hardware	29/33



SUIT HANGERS - 1" thick w/BLACK FLOCKED BAR

40 /case; 17" wide, 1" thick; 29/39 lbs.

w/ CHROME hardware **\$153.90**

2017CHFB	Walnut gloss
2117CHFB	Natural gloss
2217CHFB	Black gloss

w/ GOLD hardware **\$156.49**

2017GHFB	Walnut gloss
2117GHFB	Natural gloss
2217GHFB	Black gloss



SUIT HANGERS - 1/2" thick w/BLACK FLOCKED BAR

100 /case; 17" wide, 1/2" thick; 29/39 lbs.

w/ CHROME hardware **\$137.99**

7017CHFB	Walnut gloss
7117CHFB	Natural gloss
7217CHFB	Black gloss

w/ GOLD hardware **\$142.49**

7017GHFB	Walnut gloss
7117GHFB	Natural gloss
7217GHFB	Black gloss

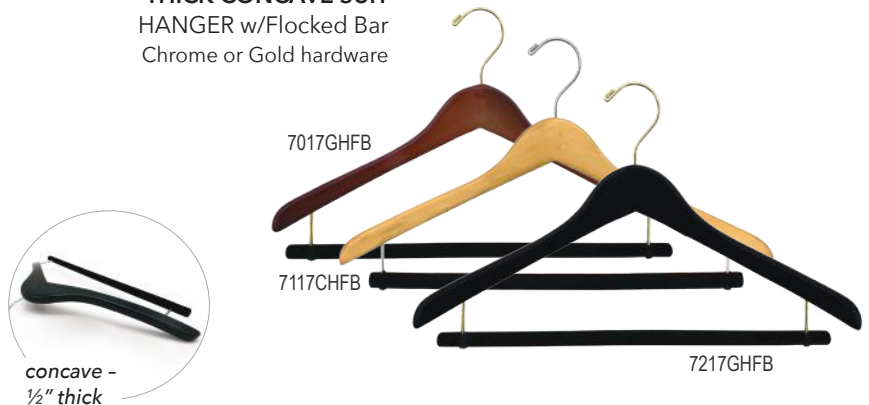

DISPLAY HANGERS - 1/2" thick w/10" drop

12 /case; 17" wide, 1/2" thick; 7/34 lbs. **\$51.32**

100-17RC	Natural w/chrome hardware
101-17RC	Walnut w/chrome hardware

NOTCHED CONCAVE DISPLAY HANGER

Chrome hardware

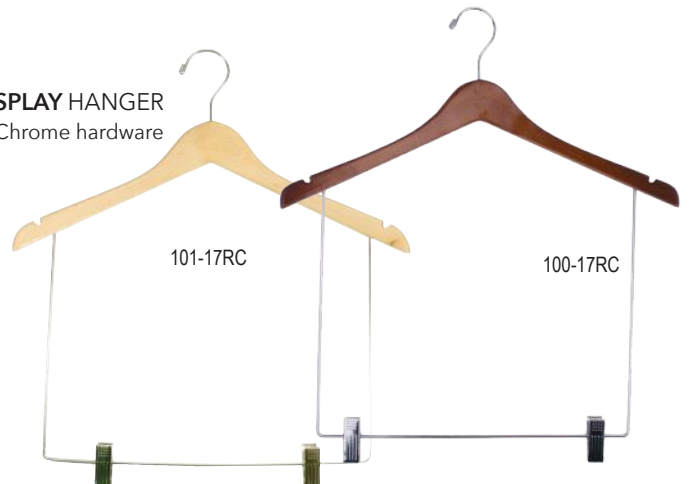

HANGERS Rubberized Wood Athletic

Non-slip with a buttery soft finish - designed for Athletic wear

new

NAHANCO LINE RUBBERIZED WOOD HANGERS

Designed for the performance wear industry. Heavy, wood bodies are enveloped in a smooth, no-slip, no-snag, rubber coating. 100 pieces /case

17" FLAT TOP HANGERS

17" wide; 1/2" thick; rubber coated w/notched ends; 33/34lbs \$139.99

- 20817 Black rubber, chrome hook
- 20817BH Black rubber, black hook
- 20817G Grey rubber, brushed chrome hook
- 20817WWH White rubber, white hook



14" FLAT PANT HANGERS

14" wide; 3/8" thick; rubber-coated; 31 /31 lbs \$169.99

- 20814RC Black rubber, chrome hardware
- 20814RCBH Black rubber, black hardware
- 20814RCG Grey rubber, brushed chrome hardware
- 20814RCWWH White rubber, white hardware

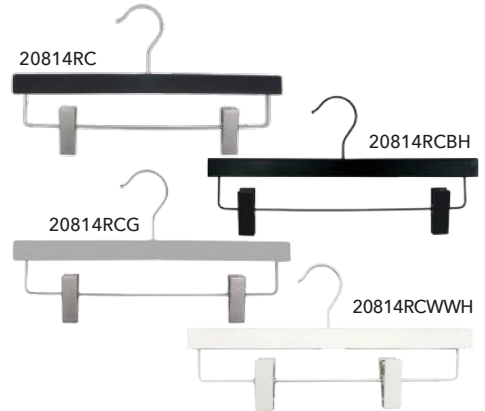

RUBBERIZED WOOD INTIMATE HANGERS

Smaller than traditional top hangers, black rubber wrapped wood lingerie styles with no-snag brushed chrome clips are ideal for hanging sports bras and stretchy yoga apparel, which can be overwhelmed by full-sized hangers. 100 pieces /case

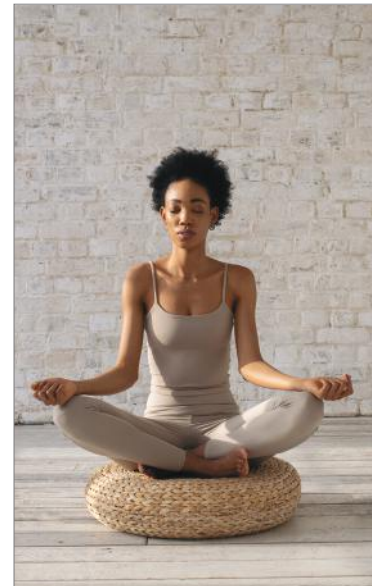
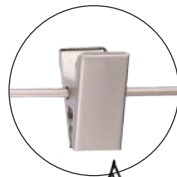

WITH DROP

- NH11BR 11 7/8" wide 16 /24lbs \$142.99
- NH13BR 14" wide 27lbs \$152.99

WITHOUT DROP

- NH12BR 11 7/8" wide 16 lbs \$115.99
- NH14BR 14" wide 18 lbs \$115.99

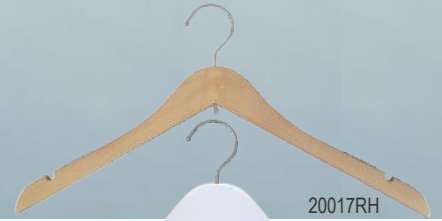

NAHANCO WOOD BRIDAL HANGERS

Traditional NAHANCO line wooden hangers with reinforced heavy-duty hooks to prevent the hooks being pulled out from the weight of heavier garments. Soft grippers for delicate fabrics and notches for formalwear straps.

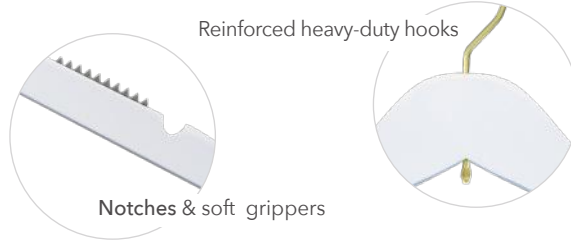

We are your branding and personalization partner. Custom imprint in as little as 5 to 7 days. Make it beautiful. Make it yours. Contact us and/or scan the QR code for further details.



Hangers are 17" wide and 1/2" thick. Available in packs of 100 and 25.



100 pack 28/29 lbs.

\$115.49	20017RH	Low gloss Natural w/ brushed chrome hardware
\$115.49	20117RH	Low gloss White w/ brushed chrome hardware
\$115.49	20217RH	Low gloss Black w/ brushed chrome hardware
\$115.49	20317RH	Low gloss Mahogany w/brushed chrome hardware
\$119.49	20417GHRH	Low gloss Black w/ gold hardware
\$119.49	20517GHRH	Low gloss White w/ gold hardware

25 pack 10/10 lbs.

20017RH25	\$34.99
20117RH25	\$34.99
20217RH25	\$34.99
20317RH25	\$34.99
20417GHRH25	\$35.99
20517GHRH25	\$35.99



17" CONCAVE JACKET & GOWN HANGER

Ultra luxurious extra thick wooden hanger. Bridal. Menswear. Formsl. 17" wide and 3/4" thick; features a 1 1/2" notched flare end; 24 /case; 16/19 lbs; See **pages 12** for all ten options. **\$118.99**

23017	Low gloss natural /brushed chrome hook	23217	Low gloss black /brushed chrome hook
23117	Low gloss white /brushed chrome hook	23317	Low gloss mahogany /brushed chrome hook

BRIDAL & FORMALWEAR



IMPRINTED BRIDAL PARTY HANGERS

Use for bridalwear, pre-wedding clothing, robes and lingerie. They make great gifts or photographers' props, and can be sold in boutique settings. High quality wood hangers in stock. Buy as single hangers, or in sets.

Single hanger: **\$9.90**
 Sets of 2: **\$18.90**

Visit the entire bridal party - bride, groom, bridesmaids, best man, etc. - and the complete range of options and finishes at nahanco.com. Scan the QR code and go directly to the Wedding Party hangers section.



LINGERIE WOOD HANGERS

Wood lingerie styles with rubber-tipped, no-snap clips are ideal for silky, slim straps. Drop bar with mini-clips for delicate items are ideal for coordinated lingerie sets.



See page 34 for lingerie hangers



LINGERIE PADDED SATIN HANGERS

Satin hangers for intimate apparel. Resell, give away or display. Perfect for monogrammed sets, robes and lingerie.



MODERN HANGING ACCESSORIES

A high-end line of metal hanging accessories perfect for gloves, veils, scarves and shawls. Available in five fabulous finishes.



See page 55 for details



HALF-ROUND HANGERS



ROUND HANGERS



HANG-ALL CLIPS



C-SHAPED HOOKS

PINNABLE FORMS

High quality, pinnable forms.
See **pages 119-122**
to view our full line.



MUSLIM GOWN COVERS

Cloth covers w/ a 4" gusset and button closures.

\$35.99 /each

GOWN COVERS

Garment bags, specially designed for formalwear, keep items safe, wrinkle and damage free.
Also great for archiving, storage and transportation.

NON WOVEN GOWN COVERS

With large or extra-large gussets, great for ball gowns, mermaid styles and extra long trains.



CRYSTAL CLEAR GUSSETED VINYL GOWN COVERS

Reinforced hanger opening, 10" side gusset, and full-length zipper. 4 gauge vinyl. 54" to 72" long.
from \$65.97 /12 pcs



Gusset detail

SMOOTH TAFFETA GOWN COVERS

Reinforced hanger opening, 10" side gusset, and full-length zipper. 4 gauge vinyl. 54" to 72" long.
from \$65.97 /12 pcs



See **pages 71-72**
for details and our
full selection of
garment bags

BRIDAL & FORMALWEAR

Gold & Silver hangers, page 40



TRADITIONAL PLASTIC HANGERS



17" traditional plastic hangers with deep notches, strap holders and swivel hooks. High quality, durable and long lasting. Made in the USA. See page 42 for more product details.

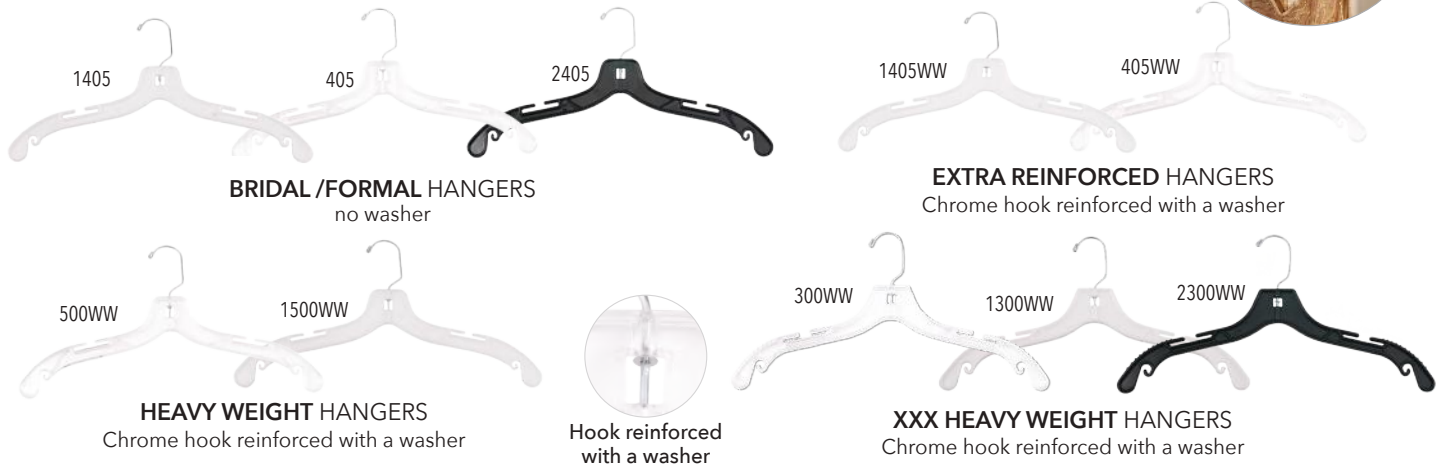

1405

405

2405

1405WW

405WW

BRIDAL / FORMAL HANGERS
no washer

EXTRA REINFORCED HANGERS
Chrome hook reinforced with a washer

500WW

1500WW

300WW

1300WW

2300WW

HEAVY WEIGHT HANGERS
Chrome hook reinforced with a washer

Hook reinforced with a washer

XXX HEAVY WEIGHT HANGERS
Chrome hook reinforced with a washer

ASSORTED BRIDAL/FORMALWEAR BOUTIQUE SUPPLIES



TAILOR SUPPLIES
page 117

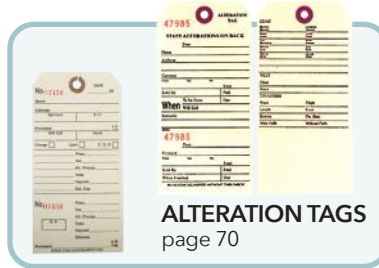

ALTERATION TAGS
page 70



PRICING SUPPLIES
pages 65-67



TRY-ON PANTIES
page 115



TIE/SCARF HANGERS
page 58



CLIPS See pages 55-58 for more product details



FITTING CLIPS

PANTS CLIPS

HANG-ALL CLIPS

SHIRT CLIPS



STEAMERS
page 118

Plastic Jacket & Suit HANGERS

CONCAVE EXTRA WIDE-SHOULDERED PLASTIC SUIT HANGER

Black textured finish with smooth area for label. Chrome hook; 1½" shoulder; 50/case



H70	63.34	17" wide	17/45
H90	72.19	19" wide	20/48
H110	68.04	21" wide	23/56



CONCAVE PLASTIC SUIT HANGER

Black textured finish with smooth area for label. Chrome hook. 100 /case

H17SQ	62.47	17" wide	21/44
H17RH	62.47	17" wide	21/44
H19RH	83.20	19" wide	22/44



CONCAVE WIDE-SHOULDERED SUIT HANGER

Textured finish with smooth area for label & locking trouser bar. Chrome hardware 50 /case; H1800RH **\$77.99**

2593	95.50	19" wide; 1½" shoulder	21/48
2563	87.35	18" wide; 1¾" shoulder	20/43



CONCAVE PLASTIC SUIT HANGER

Textured finish with smooth area for label & locking trouser bar. Chrome hardware 15" wide; 26/31 lbs; 100 /case; 2515 **\$97.07**



CONCAVE WIDE-SHOULDERED SUIT HANGER

Textured finish with smooth area for label. Chrome hook and clear support strap; 50 /case

2393	95.50	19" wide	16/39
2363	87.35	16½" wide	18/43



CONCAVE STURDY SUIT PLASTIC HANGER

Matte finish with locking trouser bar. Chrome hardware

8517RH	126.23	Tan	17" wide	28/34
2517RH	103.67	Black	17" wide	28/34
2518	91.49	Black	18" wide	37/48
8518RH	91.49	Tan	18" wide	36/48



FLAT PLASTIC SUIT HANGER

Non-slip plastic bar and chrome hook; 17" wide; available in Black, White or Clear: 100 /case; 22/34 lbs. **\$59.99**

2700PB	Black
1700PB	White
700PB	Clear



PANT HANGER w/CUSHION GRIP CLIPS

Black with chrome hook and padded clips. 15 1/4" wide; 100 /case; 15/24 lbs. 2015PC **\$96.42**



SUPER STRONG PANT HANGER

For outerwear and jeans. Black hanger with chrome hardware; 14" wide; 100 /case; 22 lbs; 2690EC **\$90.85**



HANGERS Plastic Jacket & Outerwear

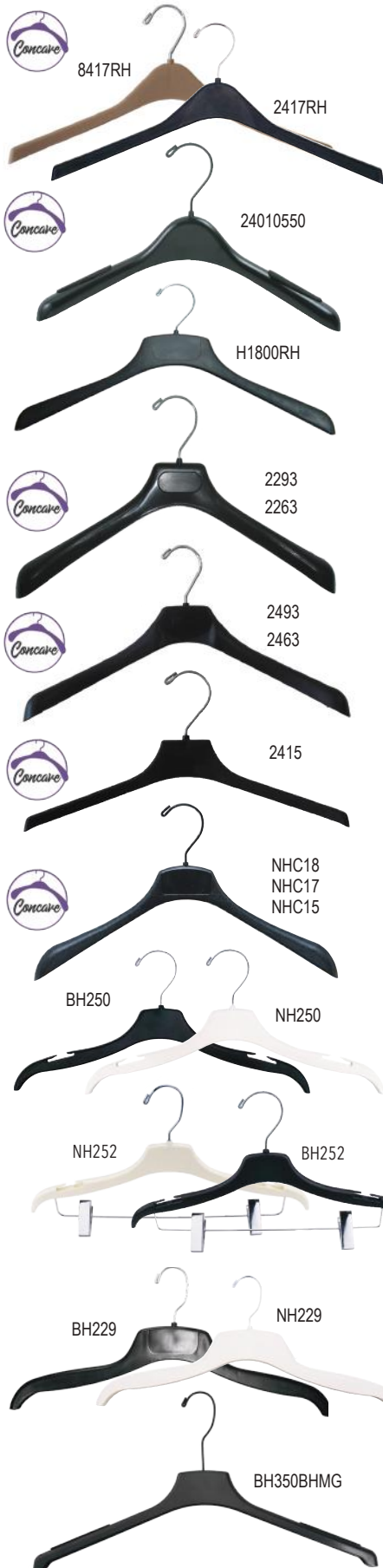

CONCAVE STURDY PLASTIC JACKET HANGER

Textured finish with smooth area for label.
Round or Square chrome hook; 100/case.

2417RH	53.99	17" Black	20/34
8417RH	53.99	17" Tan	18/28
2418	59.99	18" Black	22/46
8418RH	59.99	18" Tan	22/46
8417SQ	59.99	18" Tan	22/46



RH = Round Hook | SQ = Square Hook

CONCAVE JACKET HANGER

Black with non-slip pads and black hook. 15" wide; 50 /case; 9/22 lbs; 24010550 **\$54.17**

FLAT PLASTIC ACTIVE SPORTS HANGER

Smooth finish with area for label application. Black w/ chrome hook; 18" wide; 20/30 lbs; 100 /case; H1800RH **\$77.99**

CONCAVE WIDE-SHOULDERED JACKET HANGER

Textured finish with smooth area for label. Black w/chrome hook; 50 /case.

2293	69.34	19" wide	16/39
2263	66.61	16½" wide	16/38

CONCAVE WIDE-SHOULDERED JACKET HANGER

Textured finish with smooth area for label. Black w/chrome hook; 50 /case.

2493	65.97	19" wide; 1½" shoulder	14/39
2463	56.25	18" wide; 1¾" shoulder	14/35

PLASTIC CONCAVE JACKET HANGER

Textured finish with smooth area for label. Black w/chrome hook; 15" wide; 14/26 lbs; 100 /case; 2415 **\$67.91**

PLASTIC CONTOUR JACKET HANGER

Textured finish with smooth area for label.
Black w/black hook; 100 /case.

NHC18	78.93	18" wide	21/40
NHC17	64.67	17" wide	20/39
NHC15	63.37	15" wide	18/28

FLAT ELEGANT SHIRT HANGER

17" wide; chrome hook; available in Ivory or Black: 100 /case; 13/21 lbs. **\$60.39**

NH250	Ivory
BH250	Black

FLAT ELEGANT COORDINATE SUIT HANGER

17" wide w/ notches; chrome hardware; available in Ivory or Black: 100 /case; 29/38 lbs.

NH252	138.54	Ivory
BH252	152.41	Black

FLAT ELEGANT SHIRT/SWEATER HANGER

18½" wide; chrome hook; available in Ivory or Black: 100 /case; 18/31 lbs. **\$83.98**

NH229	Ivory
BH229	Black

FLAT SPORTSMEN'S OUTERWEAR HANGER

Black hanger, black hook, molded grippers; 18¾" wide; 100 /case; 21/32 lbs; BH350BHM **\$79.06**

Flocked Velvet HANGERS

SLIMLINE FLOCKED HANGER SERIES

Thin 17 3/8" wide, velvet flocked hangers with chrome hooks, often referred to as "huggables"

SHIRT with NOTCHES

HSL17NB	55.56	black	100/case	12/18 lbs
HSL17NG	36.84	moss grey	50/case	6 lbs
HSL17NP	36.84	pink	50/case	6 lbs

SHIRT NO NOTCHES

HSL17SB	52.80	black	100/case	12/18 lbs
---------	--------------	-------	----------	-----------

SHIRT with NOTCHES

HSL17PB	58.32	black	100/case	12/18 lbs
HSL17PG	43.68	moss grey	50/case	6 lbs
HSL12PB	37.99	11.4" /black	100/case	12/12 lbs

add-on CLIPS

Color-coordinated plastic clips for SlimLine Suit Hangers. 2 3/4" high x 1 1/2" wide; 100/case; 4 lbs. **\$21.99**

HSLCLIPB	black
HSLCLIPG	moss grey



SLIMLINE CLIPS



FLOCKED SLIMLINE HANGERS

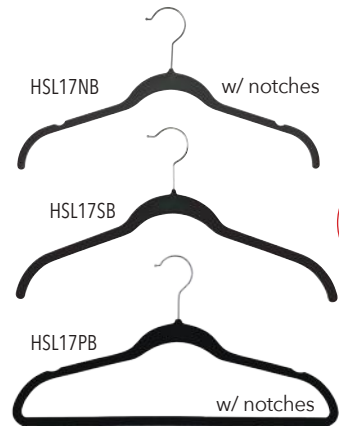

Top Sellers!

FLOCKED VELVET HANGERS

FLOCKED THINLINE DISPLAY HANGER

Black w/chrome hook; 17" wide; 1" thick; 12 /case; 5/9 lbs. FNHDH4 **\$44.45**



FLAT FLOCKED SHIRT HANGER

Black T-shirt weight plastic shirt hanger with velvet finish and chrome hook. 17" wide; 100 /case; 14/22 lbs. FLK2506 **\$91.63**
*while supplies last



FLAT FLOCKED ELEGANT SHIRT HANGER

Black w/chrome hook; 17" wide w/notches; 12 /case; 12/21 lbs. FNH250 **\$26.44**



FLAT FLOCKED ELEGANT SHIRT/SWEATER HANGER

Black w/chrome hook; 18 1/2" wide; 12 /case; 18/31 lbs. FNH229 **\$29.81**



FLAT FLOCKED WOOD SHIRT & SKIRT/PANT HANGER

Wood base; Black w/chrome hardware; 25 /case; 9/10 lbs.

F24022222	58.32	16" wide
F24044444	66.61	14" wide



SHIRT/SUIT HANGERS W/ STATIONARY HOOK & EXTENDED DROP

Perfect for Conveyor Systems.

Black polystyrene; 18 1/4" wide; 3" thick; 4 3/4" long hook; 100 /case.



NH450	51.49	Shirt/dress	12/21
NH452	101.49	Suit w/clips	23/29

DISPLAY HANGERS



DISPLAY HANGERS w/ DROP
 White with 8 or 10" chrome drop
 Black with 8 or 12" chrome drop
 Pewter with 12" chrome drop

DISPLAY HANGERS - 1½" thick

12 /case; 4" chrome hook; available in black or white

DHWS124W	24.36	12" w; White w/white	4/8
DHBS124B	24.36	12" w; Black w/black	
DHWS15WH12	27.73	15½" w; White w/white	5/12
DHBS15BH12	29.03	15½" w; Black w/black	5/18
DHBS17/4B	31.23	17¼" w; Black	6/15
DHWS15CH12	27.73	15½" w; White w/chrome	
DHBS15CH12	29.03	15½" w; Black w/chrome	4/8

DISPLAY HANGERS w/ DROP - 1½" thick

12 /case; available in black or white

WSK8124W	41.47	White; 12" - 8" drop	6/15
BSK8124B	48.60	Black; 12" - 8" drop	
WSK10144W	45.75	White; 15½" - 10" drop	8/25
BSK12164B		Black; 15½" - 12" drop	8/26
BSK12174B		Black; 17¼" - 12" drop	
PSK10174C	48.60	Pewter; 17¼" - 12" drop	8/30

THINLINE DISPLAY HANGERS

Black w/chrome hardware; 12 /case **\$20.49**

DH4	17" wide; 1" thick	5/9
DH3	17" wide; 1½" thick; 2" drop	7/19

FROSTED & BLACK DISPLAY HANGERS /FLAT

Clear frosted w/brushed chrome hardware or Black with chrome hardware; 100/case.

W004	78.07	15½" w; Clear Frosted	17/21
W004B	60.04	15½" w; Black	
W005	279.04	14" w; Clear Frosted	37
W005B	219.78	14" w; Black	
W006	78.07	17" w; Clear Frosted	18/25
W006B	72.93	17" w; Black	
W006RC	284.19	Clear Frosted	33/40
W006BRC	194.01	Black	

FROSTED & BLACK DISPLAY HANGERS /CONCAVE

Clear frosted w/brushed chrome hardware or Black with chrome hardware; 17" wide; 100/case.

W007	37.88	Clear Frosted	
W007B	30.46	Black	10/22
W007RC	81.17	Clear Frosted	13/28
W007BRC	61.38	Black	



Frosted hangers are available in a range of custom colors, minimum order of 3000 pieces (same color). Call our sales department for more information.



flared end

Wide flared ends give dimension, and deep notches hold straps.

CONCAVE BODY-SHAPED DISPLAY HANGERS

Wood; 17" wide, ¾" thick, 1 ½" flared ends; 12 pcs; 12 lbs

23217BHDISPLAY	Black w/black hardware	104.49
23117WHDISPLAY	White w/white hardware	104.49
23017GHDISPLAY	Natural w/gold hardware	117.49
23017DISPLAY	Natural w/brushed chrome hardware	111.49

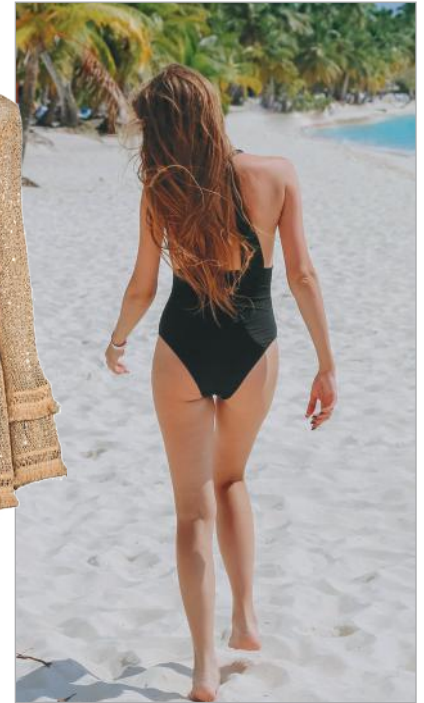

BODY-SHAPED HANGERS

Designed with a woman's body in mind, a curvaceous, shaped wire drop is everything.

All three hanger styles - wire only; hybrid flat wood/wire; and a bulkier hybrid concave wood/wire - are made for both hanging and visual display.

FLAT BODY-SHAPED DISPLAY HANGERS

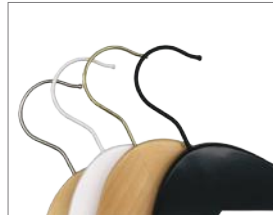

4 finish/metal combinations



Soft grippers for delicate clothing, swimwear/lingerie.

Wood/metal; 17" wide; flat w/soft grippers; 12 pcs; 9 lbs

20217BHDISPLAY	Black w/black hardware	60.49
20117WHDISPLAY	White w/white hardware	60.49
20017GHDISPLAY	Natural w/gold hardware	73.49
20017DISPLAY	Natural w/brushed chrome hardware	67.49



ROUND METAL HANGERS

4mm wire; 14" dia; 12 pieces; 5 lbs.

BCH14	27.73	Chrome
BBH14	27.73	Black
BBH14BR	38.23	Black Rubber

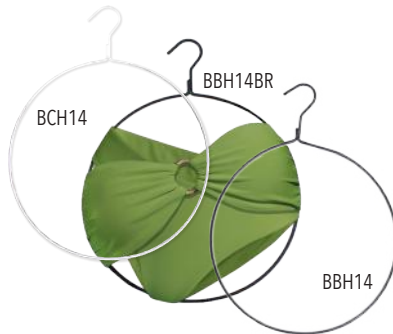

CHROME METAL BIKINI HANGER

w/2 bars & 4 clips
3.5mm wire; 12" wide;
50 pieces; 34/35 lbs.

BSH12-50

\$120.66

4.5mm WIRE BODY-SHAPED HANGERS



Formed with 4.5mm wire; 30" length from crotch to neck; 15" across shoulders; 11" waist; 16" hips; 12 pcs; 10/11 lbs.

BFWC12	Chrome	60.99
BFWB12	Black	56.49
BFWBR12	Black Rubberized	68.99
BFWW12	White	61.49

HANGERS Lingerie

WOOD

Wood hangers with fine, rubber-tipped lingerie strap clips are perfect for intimate apparel.

The drop bar styles feature sliding, mini-clips that are superb for all types of panties, garter belts and other intimate accessories.



BR = Black Rubber non-slip coating

Wooden hanger w/chrome hardware with and without drops; 2 widths available; 100 pcs

11 7/8" w/drop; 16/24 lbs.

NH11	Unfinished beech	125.99
NH11B	Low gloss black	125.99
NH11BR	Black rubber coated w/brushed chrome	142.99

11 7/8" no drop; 16 lbs

NH12	Unfinished beech	105.99
NH12B	Low gloss black	105.99
NH12BR	Black rubber coated w/brushed chrome	115.99

14" w/drop; 27 lbs.

NH13	Unfinished beech	142.99
NH13B	Low gloss black	142.99
NH13BR	Black rubber coated w/brushed chrome	152.99

14" no drop; 18 lbs

NH14	Unfinished beech	115.99
NH14B	Low gloss black	115.99
NH14BR	Black rubber coated w/brushed chrome	125.99



SATIN Traditional padded satin hangers are constructed with a wood core, padded and wrapped in satin fabric. Chrome posts with rounded heads hold straps. Adjustable clips are great for pairing lingerie sets.

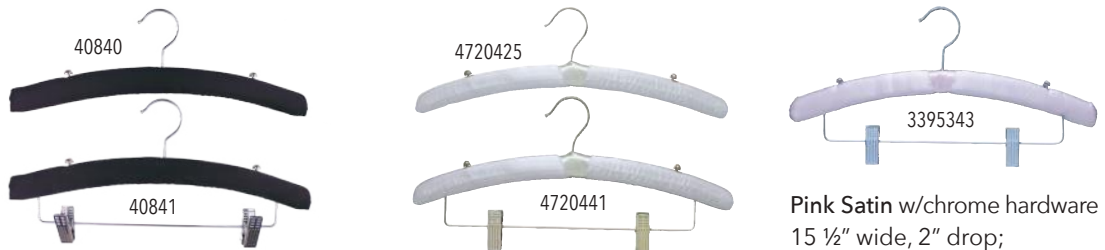

Black Satin w/ chrome hardware
15 3/4" wide; 100 pcs

40840	w/out drop	131.49	25 lbs
40841	w/ 2" drop	159.54	36 lbs

Ivory Satin w/chrome hardware
15 1/2" wide; 100 pcs

4720425	w/out drop	138.67	25 lbs
4720441	w/ 2" drop	149.82	27/35 lbs

Pink Satin w/chrome hardware
15 1/2" wide, 2" drop;
100 pcs; 27/37 lbs

3395343 153.96



Satin hangers w/ coordinating hook & bow

15" wide; 6 pcs; 3/15 lbs

806-1	White	13.87
806-2	Ivory	14.64
806-5	Pink	11.79
806-25	Black	13.87
806-99	Plush Tiger w/gold hook	16.72

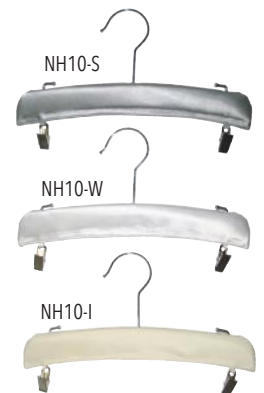

Satin w/ drop clips & brushed chrome hardware
\$134.40

10 1/2" wide; 100 pcs; 15 lbs

NH10-S	Silver
NH10-W	White
NH10-I	Ivory

Body-shaped hangers are also ideal for displaying lingerie.
See page 33 for details

Lingerie **HANGERS**



Thin molded polystyrene hangers
 10" wide; 1/8" thick; 500 pieces; 17 lbs.
 Black NH01B \$79.83
 Opaque NH01 \$92.92

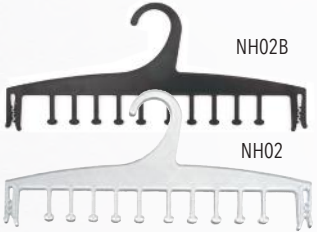

Molded polystyrene hangers w/prongs
 10" wide; 1/8" thick;
 500 pieces; 24 lbs.
 Black NH02B \$82.94
 Opaque NH02 \$101.35

Thin molded polystyrene hangers
 10" wide; 1/8" thick; choose from 3 pack sizes



<i>Clear</i>			
1000pcs	NHGS19	\$115.86	21/30 lbs
250pcs	NHGS19250	\$40.31	6/10 lbs
100pcs	NHGS19100	\$13.74	3/6 lbs
<i>Clear w/logo area</i>			
1000pcs	NHGS23	\$146.32	21/35 lbs
250pcs	NHGS23250	\$45.75	10/15 lbs
100pcs	NHGS23100	\$15.16	7/11 lbs

Thin molded polystyrene hangers
 10" wide; 1/8" thick; choose from 2 pack sizes



<i>Black</i>			
1000pcs	BNHGS19	\$115.86	21/30 lbs
100pcs	BNHGS19100	\$13.74	3/6 lbs
<i>Black w/logo area</i>			
1000pcs	BNHGS23	\$146.32	7/11 lbs
100pcs	BNHGS23100	\$15.16	25/35 lbs

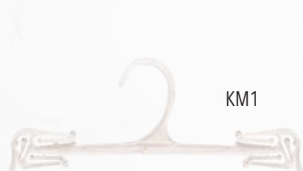

Clear economy hanger
 10" wide; 1000 pieces; 27/37 lbs.
 KM1 \$118.99

Grey dip coated metal hanger
 w/chrome hook
 12" wide; 100 pieces; 12/21 lbs.

NH08 \$83.07

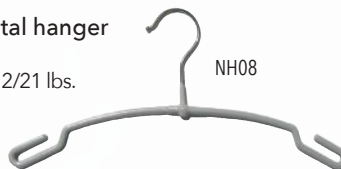

Chrome bottom hanger
 w/clear plastic clips and grey tips
 11" wide; 100 pieces; 13 lbs.
 NH09 \$87.35

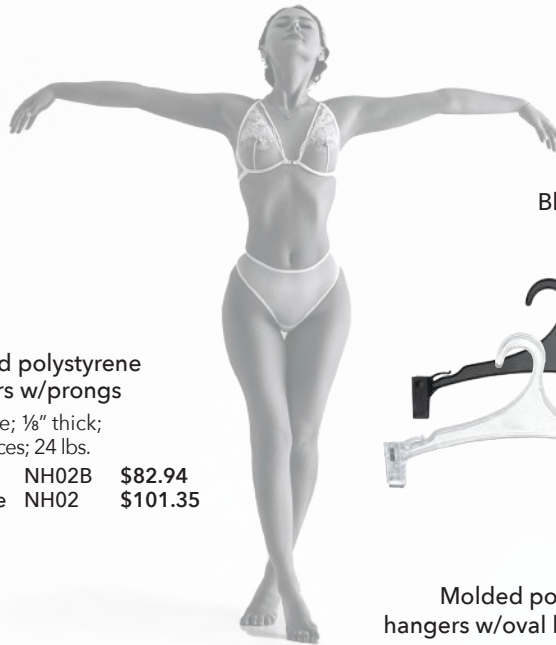
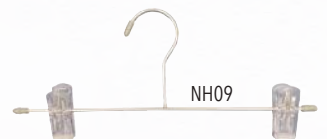

Black plastic hanger w/soft padded clips
 12" wide; 200 pieces; 19/31 lbs.
 8212 \$72.84



Molded polystyrene hangers w/plastic clips
 10 1/2" wide; 250 pieces;
 17/22 lbs.
 Black NH04B \$102.64
 Opaque NH04 \$109.64

Molded polystyrene hangers w/oval logo area
 12 1/4" wide;
 500 pieces; 22/23 lbs.
 Black NH03B \$102.64
 Opaque NH03 \$109.64



Polystyrene hangers
 w/notches & non-slip applied to shoulders
 15" wide; 1/4" thick; 100 pieces



Opaque w/brushed chrome hardware
Black w/chrome hardware
 TOP hangers; 15 lbs:
 black NH07B \$63.89
 opaque NH07 \$87.35
 SKIRT/PANT hangers; 25 lbs:
 black NH06B \$121.31
 opaque NH06 \$166.28

HANGERS Chrome-Plated Metal



CHROME-PLATED HANGERS

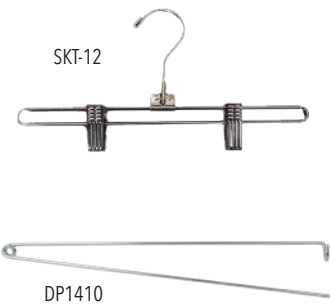
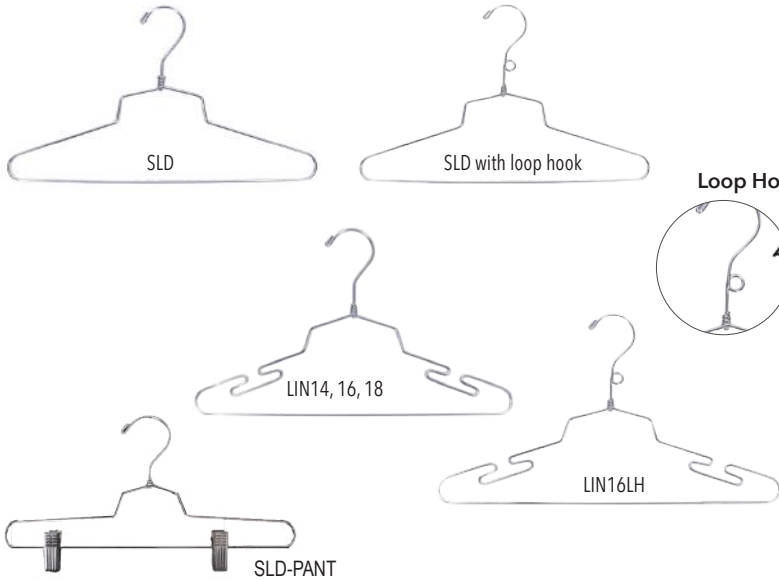

Pictured: 10x SKT12LH w/ DP1410 threaded through the loops



METAL SWIM HANGERS



See page 33 for more images & details.

SHIRT/DRESS HANGERS /3.5mm wire gauge

100 /case; select width; standard or loop hook

SLD12	68.99	12"	standard hook	18
SLD-12LH	113.99	12"	loop hook	
SLD14	78.99	14"	standard hook	20
SLD-14LH	107.99	14"	loop hook	
SLD16	88.78	16"	standard hook	22
SLD-16LH	85.99	16"	loop hook	
SLD18	95.99	18"	standard hook	22
SLD-18LH	99.99	18"	loop hook	
SLD19	99.99	19"	standard hook	24
SLD-19LH	127.49	19"	loop hook	

SHIRT/DRESS HANGERS w/notches /3.5mm wire gauge

100 /case; select width

LIN14	119.36	14"	standard hook	22
LIN16	105.49	16"	standard hook	24
LIN16LH	151.89	16"	loop hook	24
LIN18	112.36	18"	standard hook	24

PANT/SKIRT HANGERS /3.5mm wire gauge

100 /case

SLD-PANT	133.23	14" wide	22
SKT-12	117.94	12" wide; standard hook	20
SKT12LH		12" wide; loop hook	

DIAPER PIN ROD for Loop Hook Hangers

14" wide; 10 pieces; 4 lbs. DP1410 \$22.94

COORDINATE HANGERS /3.5mm wire gauge

100 /case; 16" wide; standard or loop hook; 24lbs. \$156.69

SLC-16	Standard hook
SLC16LH	w/ Loop Hook

COORDINATE ATTACHMENT HANGERS /3.5mm wire gauge

100 /case; 14" wide

DSA9	133.23	w/ 9" drop	24
DSA16	117.94	w/ 16" drop	29

CHROME BIKINI HANGERS w/2 bars & 4 clips /3.5mm wire

12" wide; 50 pieces; 34/35 lbs. 8212-50 \$120.72

BODY SHAPE METAL HANGERS /4.5 mm wire gauge

30" length (crotch to neck); 15" across shoulders; 11" waist; 16" hips; 12 pcs; 10/11 lbs.

BFWC12	60.99	Chrome
BFWB12	56.49	Black
BFWBR12	68.99	Black Rubberized
BFWW12	61.49	White

ROUND METAL HANGERS /4mm wire gauge

14" dia; 12 pieces; 5lbs.

BCH14	27.73	Chrome
BBH14	27.73	Black
BBH14BR	38.23	Black Rubber

Chrome-Plated, Steel & Black HANGERS



BLACK CLAMP Pant Hanger
 Chrome with black, rubberized coating;
 10" wide; 50/case; 37 lbs; CP200 **\$80.48**

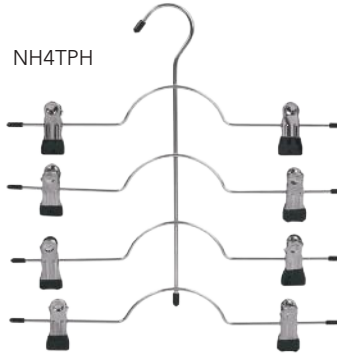

Chrome TIERED Metal Pant Hanger
 Four-tiered pant hanger with rubber-tipped clips.
 13" w x 15" h; 3/case; 3/6 lbs;
 NH4TPH **\$16.72**



S-SHAPE Multilayer Metal Hanger
 Lightweight and durable stainless steel w/ clear cap ends.
 12" w x 15½" h; 3/case; 3/6 lbs;
 NHMLPH **\$11.79**

Chrome-Plated GLOVES & HAT Hangers

Chrome plated; 3.5mm wire gauge; available in 100/case, 27 lbs. OR 12/case, 7 lbs.

- SLGLOVE **\$125.58** 10" wide at bottom & 11½" high
- SLGLOVE12 **\$33.18**
- SLHAT **\$137.38** 9" wide at bottom & 11½" high
- SLHAT12 **\$33.18**

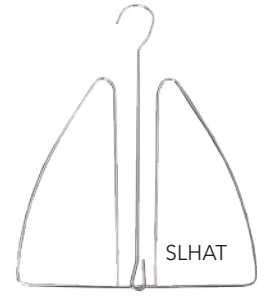

BEDSPREAD, DRAPERY & SLEEPING BAG HANGERS



Heavy-Duty BLACK Metal Hangers
 These hangers sell individually, 1/pack.

NHTHSFR1 **\$20.87**
 25" wide; 4 lbs.

NHTHSFR2 **\$21.51**
 31" wide; 8 lbs.

NHTHSHM1 **\$22.29**
 23" wide;
 Hooded mummy sleeping bag hanger;
 5 lbs

Chrome-Plated Metal Hangers
 These hangers sell 12/pack.

SBD22 **\$66.64** 22" wide; 3mm wire gauge 9 lbs

201 **\$41.60** 22" wide; 6.5mm wire gauge 9 lbs

201NOTAIL19 **\$47.17** 19" wide; w/rubber sleeve; 9 lbs
 8mm wire gauge

HANGERS Aluminum, Gunmetal & Steel

BRUSHED ALUMINUM HANGERS

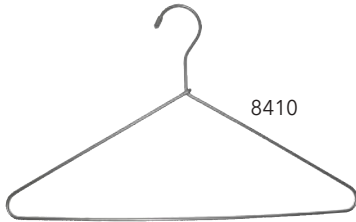

8410

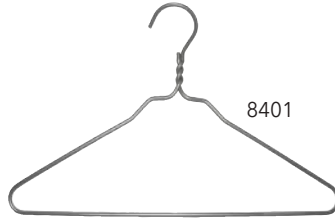

8401

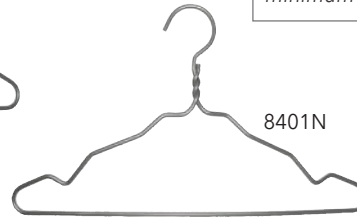

8401N

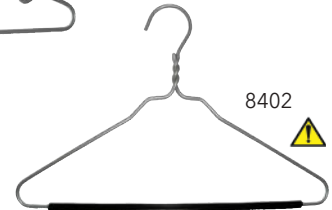

8402



TINTED ALUMINUM

Any of our aluminum hangers can be tinted with a custom pantone shade for an additional \$.03 per piece. There is a 5000 piece minimum for custom tinting.

SHIRT/DRESS Hangers /4mm wire gauge

Brushed aluminum; 100 /case.

8410	112.49	16¼" w/ straight neck	9/15 lbs
8401	149.82	16½" w/ twisted neck	11/16 lbs
8401N	130.99	16½" w/ twisted neck and notches	11/13 lbs
8402	116.99	16½" w/ twisted neck and black rubber sleeve	13/18 lbs

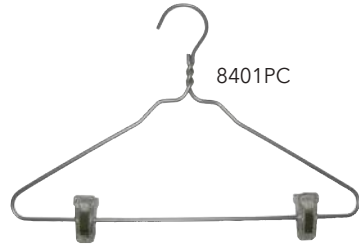

8401PC

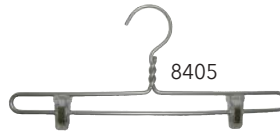

8405

SUIT & PANT/SKIRT Hangers /4mm wire gauge

Brushed aluminum; twisted neck; clear plastic clips; 100 /case.

8401PC	140.49	16½" suit hanger	9/15 lbs
8405	150.99	15" pant hanger	11/16 lbs

GUNMETAL HANGERS

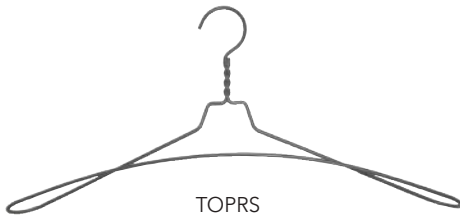

TOPRS

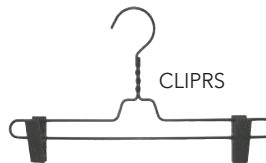

CLIPRS

SHIRT & PANT/SKIRT Hangers /3.5mm wire gauge

Gunmetal finish w/ twisted neck; 100 /case.

TOPRS	166.41	Shirt hanger; 18" w; 1¾" deep	23 lbs
CLIPRS	180.27	Pant hanger w/metal clips; 14" wide	27 lbs

STEEL HANGERS

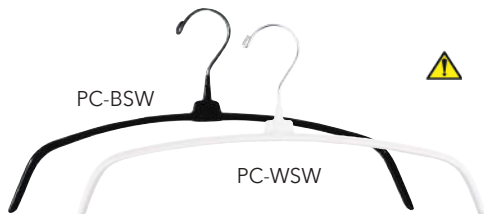

PC-BSW

PC-WSW



NON-SLIP STEEL Shirt Hanger /3.5mm wire gauge

A slim, tempered steel shirt hanger coated with a non-slip rubber. Chrome hook does not swivel; 16" wide; 100/case; 22/24 lbs. **\$71.49**

PC-BSW	Black
PC-WSW	White



2



CHROME-PLATED STEEL Skirt/Pant Hanger /5.4mm wire gauge

Black, vinyl-covered, non-slip bar; 100/case.

2	119.36	12½"	31 lbs
2-16	127.66	16"	38 lbs



NAHANCO HOTEL FLAT WOODEN & CHROME HANGERS

Our Hotel Collection features flat suit ball top wooden hangers, a closed hook chrome hanger and the A-style and B-style security rings used with the ball top hangers. Flat wooden hangers feature a low gloss finish, notched ends, pant bars or clips, and are great for imprinting your company's logo.

FLAT SUIT Ball Top Wood Hanger

w/Metal Sliding Clips
17 1/2" wooden suit hanger features a dropped bar and sliding chrome clips. Notched ends accommodate garments with straps. 100 pieces/case. 33/35 lbs. **\$166.41**

FLAT SUIT Ball Top Wood Hanger

w/Pant Bar
17 1/2" wooden flat suit hanger features a stationary pant bar. Notched ends accommodate garments with straps. 100 pieces/case. 29/30 lbs. **\$127.66**



Black
60217BECR
Mahogany
60317BECR
Natural
60017BECR



Black
60217BEC
Mahogany
60317BEC
Natural
60017BEC

Most of our wooden hangers can be fitted with a ball post for hotel use. Please call Customer Service for details.



A-RING for Ball Top Hangers

Chrome plated steel hotel-style ring stays put when installed on any standard closet bar; easily detach from the circular hook. 100 pcs/bag. 9 lbs; HHSRA100 **\$30.59**



B-RING for Ball Top Hangers

Chrome finished steel clamping hanger. The B-Style Ring clamps down over the bar. 100 pcs/bag. 5/8 lbs; HHSRB100 **\$34.73**

17" CLOSED HOOK Chrome Hanger

Made with heavy duty 4mm chrome plated wire, this hanger is durable and long lasting. The opening diameter of the hook measures 1 1/2". 100 pieces/case. 25 lbs; 89017 **\$130.38**

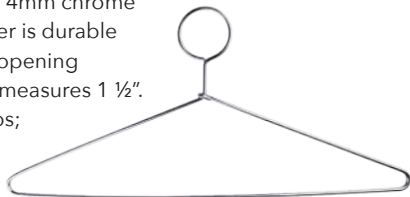

17" MINI HOOK Hangers

17" wooden suit hangers with a natural gloss finish and a flat 1/2" thick profile, feature notched ends for straps and a mini chrome hook to fit a 5/8" diameter hang bar. 100 pieces/case; w/ 2" drop bar and pinch clips: 8017RCMH **\$165.76**
w/ round wood pant bar: 8017NOTCHMH **\$126.88**



More HOTEL hanger options include:

- **NAHANCO** LINE - see p 10
- **Executive** LINE - see p 17
- **Contemporary** LINE - see p 19
- **Northshire** LINE - see p 20
- **Equinox** LINE - see p 16
- **Retro** LINE - see p 18
- **Signature** LINE - see p 18
- **Bamboo** styles - see p 20



HANGERS Silver & Gold

SILVER AND GOLD

A bold hanger collection for eye-catching garment displays. Strong, traditional plastic hangers are coated with gold or silver plating for a shiny alternative to everyday merchandisers.



Silver detail



Gold detail



4405

3405 G

4500RC

3700G

3500RC G

4600RC

3600RC G

JUMBO WEIGHT SHIRT HANGERS

17" wide; metallic coated w/notches and notched ends; 100/case; 15/22lbs

3405 G **179.63** Gold w/gold hook

4405 **167.18** Silver w/silver chrome hook

HEAVY WEIGHT COAT HANGER

17" wide; gold metallic coated w/gold hook; 100/case; 20/23lbs

3700G **\$173.40**

HEAVY WEIGHT SUIT HANGERS

17" wide; metallic coated w/notches, notched ends metal clips & hooks; 100/case

3500RC G **235.74** Gold w/gold hardware 24/29

4500RC **192.84** Silver w/silver chrome hardware 25/26

HEAVY WEIGHT SKIRT/PANT HANGERS

14" wide; metallic coated w/notches, notched ends metal clips & hooks; 100/case; 19lbs. **\$235.74**

3600RC G Gold w/gold hardware 24/29

4600RC Silver w/silver chrome hardware 25/26

Plastic Traditional Shirt & Dress HANGERS

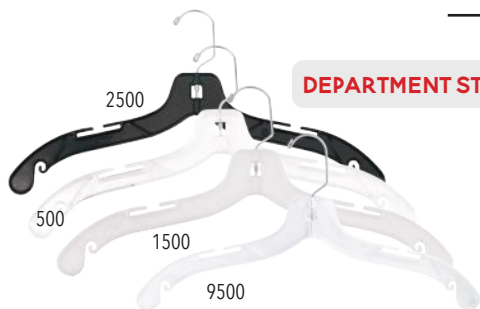

DEPARTMENT STORE STYLE

HEAVY WEIGHT SHIRT HANGERS

17" wide; 100 /case; 15/22 lbs.

500	Clear w/chrome hardware	\$34.99
1500	White hi-impact w/chrome hardware	\$34.99
2500	Black w/ chrome hardware	\$34.99
2500BH	Black w/ black hardware	\$28.09
9500	Clear Break Resistant w/chrome	\$66.49
1500APWW	White hi-impact w/washer & foam strips	\$58.49

weight is 15/26 lbs:

8500	High Gloss Black w/ chrome hook	\$35.99
8500BH	High Gloss Black w/ black hook	\$35.99

VALUE HANGERS



MIDDLE WEIGHT SHIRT HANGERS

17" wide; 100 /case; 13/26 lbs.

507	Clear w/chrome hardware	\$30.99
1507	White hi-impact w/chrome hardware	\$30.99
2507	Black w/ chrome hardware	\$30.99
2507BH	Black w/ black hardware	\$30.09

T-SHIRT HANGERS



T-SHIRT WEIGHT SHIRT HANGERS

17" wide; 100 /case; 12/18 lbs.

1508	Opaque white w/chrome hardware	\$29.99
2508	Black w/ chrome hardware	\$29.99
2508BH	Black w/ black hardware	\$29.99

HEAVY WEIGHT SHIRT HANGERS w/ molded grippers

17" wide; 100 /case; 13/26 lbs.

95500	Clear break resistant w/chrome	\$61.49
15500	White w/chrome hardware	\$30.99
25500	Black w/ chrome hardware	\$30.99
25500BH	Black w/ black hardware	\$30.99
25500BHM	Black w/ black hardware & grippers	\$48.49



WITH MOLDED RUBBER GRIPPERS & COORDINATE HOLE



CHAIN STORE FAVORITES

MEDIUM HEAVY WEIGHT SHIRT HANGERS

17" wide; 100 /case; 15/22 lbs.

505	Clear w/chrome hardware	\$31.99
1505	White hi-impact w/chrome hardware	\$31.99
2505	Black w/ chrome hardware	\$31.99
2505BH	Black w/ black hardware	\$31.09



Black plastics

MEDIUM HEAVY WEIGHT SHIRT HANGERS w/molded ridges

17" wide; 100 /case

WITH MOLDED RIDGES



weight is 14/24 lbs:

505R	Clear w/chrome hardware	\$35.90
1505R	White hi-impact w/chrome hardware	\$35.90
2505R	Black w/ chrome hardware	\$35.90

weight is 15/22 lbs:

2505RBH	Black w/ black hardware	\$35.90
---------	-------------------------	----------------



WITH MOLDED RUBBER GRIPPERS



MEDIUM HEAVY WEIGHT SHIRT HANGERS w/molded rubber grippers

17" wide; 100 /case

505MG	Clear w/chrome hardware	\$48.48	13/13
2505MG	Black w/ chrome hardware	\$48.48	14/22
2505BHM	Black w/ black hardware	\$48.48	15/24

WITH MOLDED RIDGES & COORDINATE LOOP

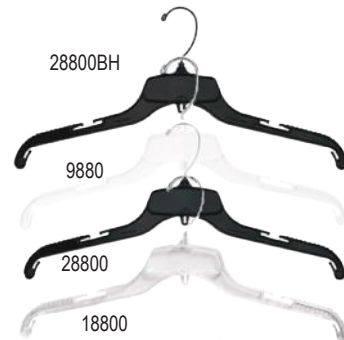

HEAVY WEIGHT SHIRT HANGERS w/ridges & loop

17" wide; 100 /case, 12/26 lbs

98800	Clear w/chrome hardware	\$53.49
18800	Clear break resistant w/chrome	\$34.99
28800	Black w/ chrome hardware	\$34.99
28800BH	Black w/ black hardware	\$34.99

MORE SIZES ON PAGE 48

HANGERS Traditional Gown & Bridal

BRIDAL & FORMAL / GOWN



BRIDAL & FORMAL HANGERS

17" wide; 100 /case; 17/22 lbs.

405	Clear w/chrome hardware	\$44.49
2405	Black w/ chrome hardware	\$44.49
1405	White hi-impact w/chrome hardware	\$44.49
2405BH	Black w/ black hardware	\$44.49
weight is 17/24 lbs:		
1405APW	White hi-impact w/chrome & foam strips applied	\$67.49



EXTRA REINFORCED BRIDAL & GOWN HANGERS

Chrome hook reinforced with a washer
17" wide; 100 /case

405WW	Clear w/washer	\$58.19	16/22
1405WW	White hi-impact w/washer	\$58.19	18/22
1405APWW	White hi-impact w/washer & foam strips	\$74.49	18/24

FOAM STRIPS APPLIED

REINFORCED W/ WASHER

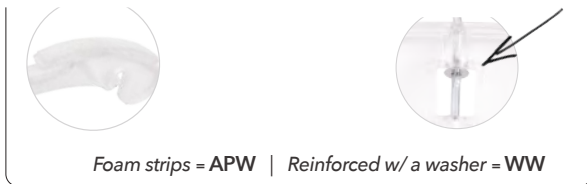

See page 25 for our selection of **WOOD BRIDAL HANGERS**



DEPARTMENT STORE

Black plastics



HEAVY WEIGHT HANGERS

Chrome hook reinforced with a washer
17" wide; 100 /case



XXX HEAVY WEIGHT HANGERS

Chrome hook reinforced with a washer
17" wide; 100 /case

300WW	Clear w/washer	\$60.91	20/24
1300WW	White hi-impact w/washer	\$60.91	20/24
2300WW	Black w/washer	\$60.91	19/22

NO NOTCHES

GREAT FOR SWEATERS & OUTERWEAR



19" HEAVY WEIGHT SHIRT HANGERS

19" wide; 100 /case

900	Clear w/chrome hardware	\$59.99	18/31
1900	White hi-impact w/chrome hardware	\$59.99	18/33
2900	Black w/ chrome hardware	\$59.99	18/33



NO-SNAG® HANGERS

17" wide; 100 /case; 19/22 lbs.

905	Clear w/chrome hardware	\$41.99
1905	White hi-impact w/chrome hardware	\$41.99
2905	Black w/ chrome hardware	\$41.99

Traditional Plastic Skirt & Pant HANGERS

14" HEAVY WEIGHT SKIRT/PANT HANGER

14" wide; 100/case; 19lbs.

\$41.90

- 600RC Clear
- 1600RC White hi-impact
- 2600RC Black
- 600PC Clear
- 1600PC White hi-impact
- 2600PC Black

14" wide; 100/case; 19lbs.

\$52.90

- 8600RC Black Hi-gloss (**metal clips**)
- 8600RCBH Black w/Black Hook
- 8600PC Black Hi-gloss (**plastic clips**)
- 8600PCBH Black w/Black Hook



Black plastics



Metal clip (RC)
w/ vinyl insert



Plastic clip (PC)
available in
white or black



14" HEAVY WEIGHT SKIRT/PANT HANGER w/LONG HOOK

14" wide; 100/case; 19lbs.

\$41.99

- 600RCLH Clear
- 1600RCLH White hi-impact
- 2600RCLH Black
- 600PCLH Clear
- 1600PCLH White hi-impact
- 2600PCLH Black
- 2600RCBH Black w/Black Hook
- 2600PCBH Black w/Black Hook



14" JUMBO WEIGHT SKIRT/PANT HANGER

14" wide; 100/case; 20lbs.

\$58.68

- 602RC Clear
- 1602RC White hi-impact
- 2602RC Black
- 602PC Clear
- 1602PC White hi-impact
- 2602PC Black

Standard Hook



Long Hook (LH)



14" JUMBO WEIGHT SKIRT/PANT HANGER w/LONG HOOK

14" wide; 100/case; 20lbs.

\$58.68

- 602RCLH Clear
- 1602RCLH White hi-impact
- 2602RCLH Black
- 602PCLH Clear
- 1602PCLH White hi-impact
- 2602PCLH Black

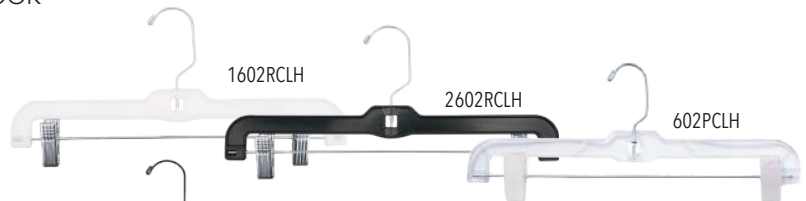

Black w/black hook; 14" wide; 100/case; 20lbs.

\$50.28

- 2602RCBH Black w/Black Hook
- 2602PCBH Black w/Black Hook



14" JUMBO WEIGHT SKIRT/PANT HANGER

Clear; 14" wide; 100/case; 19lbs.

9206RC

\$70.99

9602RC



16" HEAVY WEIGHT SKIRT/PANT HANGER

16" wide; 100/case; 21lbs.

\$58.19

- 616RC Clear
- 1616RC White hi-impact
- 2616RC Black



COORDINATE ATTACHMENT FOR SKIRTS & PANTS

14" wide; 4 1/2" drop; 100/case; 19lbs

\$59.90

- 614RC Clear
- 1614RC White hi-impact
- 2614RC Black
- 614PC Clear
- 1614PC White hi-impact
- 2614PC Black



HANGERS Traditional Plastic



BREAK RESISTANT



GLOSSY BLACK



HEAVY WEIGHT SUIT HANGERS

17" wide; 100/case

500RC	Clear	26/27
1500RC	White hi-impact	26/34
2500RC	Black	26/34
2500RCBH	Black w/ black hook	27/34
500PC	Clear	27/34
1500PC	White hi-impact	27/34
2500PC	Black	27/34
2500PCBH	Black w/ black hook	26/27
9500RC	Clear - Break Resistant	27/34
8500RC	Black Hi-gloss (metal clips)	26/28
8500RCBH	Black w/Black Hook	26/34
8500PC	Black Hi-gloss (plastic clips)	26/28
8500PCBH	Black w/Black Hook	26/34

\$73.48

\$94.99

\$74.49

\$79.19

\$79.49

\$79.19

HEAVY WEIGHT COAT HANGERS

Black plastics

WITH LONG HOOK

WITH SHORT HOOK



COAT HANGERS/LONG HOOK

17" wide; 100 /case; 19/26 lbs.

5 15/16" HANGER LENGTH

700	Clear w/chrome hardware	\$43.49
2700	Black w/ chrome hardware	\$44.99
1700	White hi-impact w/chrome hardware	\$44.99
9700	Clear Break Resistant w/chrome hardware	\$85.99
8700LH	Black High Gloss w/ chrome hardware	\$44.99

COAT HANGERS/SHORT HOOK

17" wide; 100 /case; 18/26 lbs.

3 15/16" HANGER LENGTH

2700BH	Black w/ black hardware	\$43.49
2700SH	Black w/chrome hardware	\$43.49
700SH	Clear w/chrome hardware	\$43.49
1700SH	White hi-impact w/chrome hardware	\$43.49
9700SH	Clear Break Resistant w/chrome hardware	\$84.99
8700SH	Black High Gloss w/ chrome hardware	\$44.99
8700BH	Black Hi-gloss w/ black hardware	\$44.99

IMPRINT SERIES

GREAT FOR IMPRINTING!



SHIRT HANGERS 17" wide; 100 /case

RBK1400	\$66.99	Solid White	19/21
RBK2400	\$66.99	Black	

SKIRT/PANT HANGERS 14" wide; 100 /case

RBK1605	\$95.77	Solid White	21
RBK2605	\$94.35	Black	

SHIRT HANGERS 17" wide; 100 /case

9705	\$73.48	Break-resistant CLEAR	23
2705BH	\$67.26	BLACK w/black hook	17/33
2705CH	\$67.26	BLACK	17/33

Plastic Skirt & Pant HANGERS



SNAP GRIP PLASTIC HOOK SKIRT/PANT HANGER

200/case

2681-8	\$65.19	Black	8" w	15
2681-10	\$68.04	Black	10" w	14/19
2681-12	\$72.19	Black	12" w	18/19
1681/8W	\$68.04	White	8" w	11/19
1681/10W	\$72.19	White	10" w	13/18
1681/12W	\$77.76	White	12" w	15/23

SNAP IN SIDE SIZE CLIPS

White w/black imprint; ¼"L x ⅝"H x ¼"W;
1000/case; 2lbs. **\$22.29**

SCXS	size: XS
SCS	size: S
SCM	size: M
SCL	size: L
SCXL	size: XL
SC2XL	size: 2XL



← snap in
size clip

SIZE CLIPS work with:
P12, P13, P14, P16, B14, 2681-10, 2681-12,
1681/8W, 1681/10W, 1681/12/W



PINCH CLIP PLASTIC HOOK SKIRT/PANT HANGER

100/case **\$50.99**

H29B	Black	9 ½" wide	10/15
H29W	White	9 ½" wide	10/15
H211B	Black	11 ½" wide	11/19
H211W	White	11 ½" wide	11/19



PINCH GRIP SWIVEL HOOK SKIRT/PANT HANGER

200/case

6008	\$63.99	CLEAR	8" w	18/20
6010	\$65.99	CLEAR	10" w	20/22
6012	\$71.49	CLEAR	12" w	23/32
6008B	\$42.49	BLACK	8" w	20
6010B	\$45.99	BLACK	10" w	16/22
6012B	\$48.49	BLACK	12" w	17/26
6014B	\$51.49	BLACK	14" w	21/32

w/ Soft Pad:

6210B	\$50.99	BLACK	10" w	16/22
6212B	\$49.49	BLACK	12" w	17/26
6214B	\$52.49	BLACK	14" w	21/32



SNAP GRIP SWIVEL HOOK SKIRT/PANT HANGER

200/case

1686-8	\$65.19	White	8"	15
1686-10	\$66.61	White	10"	17
1686-12	\$74.91	White	12"	18/19
2686-8	\$65.19	Black	8"	15
2686-10	\$66.61	Black	10"	17
268610BH	\$66.61	Black w/black hook	10"	17
2686-12	\$74.91	Black	12"	18/19



PINCH CLIP SWIVEL HOOK SKIRT/PANT HANGER

100/case **\$53.99**

H39B	Black	9 ½" wide	10/15
H39W	White	9 ½" wide	10/15
H311B	Black	11 ½" wide	11/19
H311W	White	11 ½" wide	11/19



Soft pad clip
- great for leather

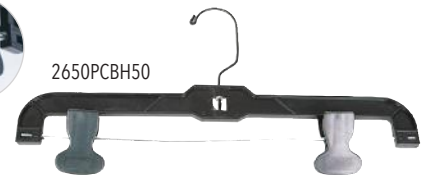

SKIRT/PANT HANGER w/BLACK HOOK & CLIPS

14" wide; 50/case; 10lbs.

\$55.47



14" BLACK PLASTIC SKIRT/PANT HANGER

w detachable strap & foam bar; 200/case; 25/34lbs. **\$106.49**

HANGERS Junior Plastic Hangers



Black plastics



SUPER HEAVY WEIGHT SHIRT HANGER

14" wide; 100/case; 11/15lbs.

\$28.99

414	Clear	
1414	White hi-impact	
2414	Black	
2414BH	Black w/Black hook	



SUPER HEAVY WEIGHT SUIT HANGER

14" wide; 100/case

\$59.90

414RC	Clear	20/22
1414RC	White hi-impact	20
2414RC	Black	18
2414RCBH	Black w/Black hook	18/24



Metal clip (RC)
w/ vinyl insert



Plastic clip (PC)
available in
white or black

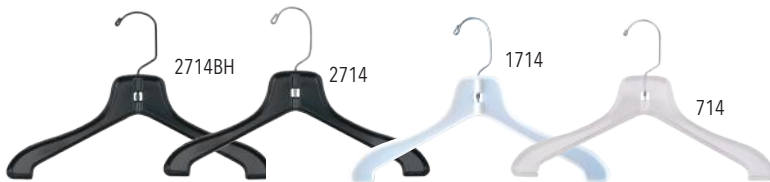

SUPER HEAVY WEIGHT COAT HANGER

14" wide; 100/case; 18/22lbs.

\$44.49

714	Clear	
1714	White hi-impact	
2714	Black	
2714BH	Black w/Black hook	

SUPER HEAVY WEIGHT SKIRT/PANT HANGER

12" wide; 100/case; 18lbs.

\$59.90

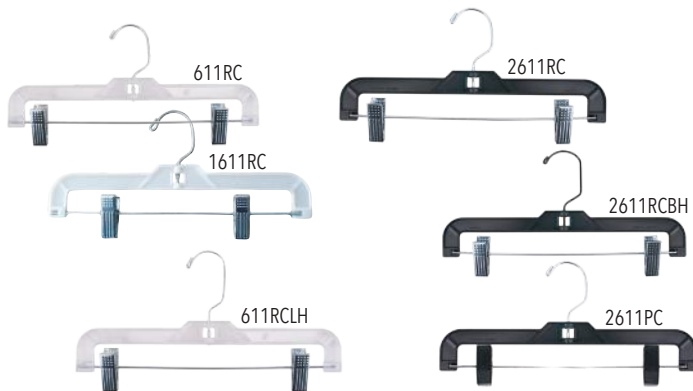

with metal clips:

611RC	Clear
1611RC	White hi-impact
2611RC	Black
2611RCBH	Black w/Black hook

with long hook & metal clips:

611RCLH	Clear
1611RCLH	White hi-impact
2611RCLH	Black

with plastic clips:

611PC	Clear
2611PC	White hi-impact
1611PC	Black
2611PCBH	Black w/Black hook

COORDINATE ATTACHMENT SKIRT/PANT HANGER

12" wide; 100/case; 19lbs.

\$59.90



with metal clips:

612RC	Clear
1612RC	White hi-impact
2612RC	Black

with plastic clips:

2612PC	Black
--------	-------



Black plastics

SUPER HEAVY WEIGHT SHIRT HANGER

12"wide; 100/case; 10lbs.

\$26.99

- 412 Clear
- 1412 White hi-impact
- 2412 Black
- 2412BH Black w/Black hook



with LONG HOOK

12"wide; 100/case; 10/12lbs.

- 412LH **\$27.49** Clear
- 1412LH **\$26.99** White hi-impact



long hook (LH)

SUPER HEAVY WEIGHT INFANT SHIRT HANGER

10"wide; 200/case; 13lbs.

\$44.99

- 410 Clear
- 1410 White hi-impact
- 2410 Black
- 2410BH Black w/Black hook



Clear; 10"wide; 100/case; 7lbs.

\$23.99

- CP410 Clear

SUPER HEAVY WEIGHT SUIT HANGER

12"wide; 100/case; 19/22lbs.

\$59.90

- 412RC Clear
- 1412RC White hi-impact
- 2412RC Black
- 2412RCBH Black w/Black hook



with LONG HOOK

12"wide; 100/case; 19/22lbs.

\$59.90

- 412RCLH Clear w/Long hook
- 1412RCLH White w/Long hook



long hook (LH)

SUPER HEAVY WEIGHT COAT HANGER

12"wide; 100/case

- | | | | |
|--------|----------------|--------------------|-------|
| 712 | \$37.99 | Clear | 14/22 |
| 1712 | \$37.99 | White hi-impact | 14/22 |
| 2712 | \$37.99 | Black | 14/28 |
| 2712BH | \$37.90 | Black w/Black hook | 14/28 |



SUPER HEAVY WEIGHT INFANT SKIRT/PANT HANGER

Metal or plastic clips; Long hook only; 9"wide; 100/case; 16/23lbs

\$59.90

- 610RCLH Clear
- 610PCLH Clear
- 1610RCLH White hi-impact
- 1610PCLH White hi-impact
- 2610RCLH Black
- 2610PCLH Black



HANGERS VICS /Floor-Ready Hangers

NAHANCO works directly with YOUR garment factories.
We can supply any of our hanger styles, giving you control over the hangers that you receive.

For more information and images, please visit nahanco.com



ECONOMY SHIRT HANGER
Black with molded non-slip shoulder
200/case

485B	\$52.75	15"	18/24
484B	\$49.90	17"	15/29
479B	\$61.49	19"	16/36



HEAVY WEIGHT SHIRT HANGER
With molded non-slip shoulder.
17" wide; 100/case; 13/22lbs.

98800	\$53.49	Break-resistant CLEAR
28800	\$34.99	BLACK
28800BH	\$34.99	BLACK w/Black hook
18800	\$34.99	WHITE



SUPER HEAVY WEIGHT SHIRT HANGER
17" wide; 100/case; 14/22lbs

95500	\$61.49	Break-resistant CLEAR
25500	\$30.99	BLACK
25500BH	\$30.99	BLACK w/Black hook
15500	\$30.99	WHITE



SHIRT HANGER With molded non-slip shoulder
Break-resistant clear; 19" wide; 100/case; 13/27lbs

99900	\$69.34
-------	---------



SHIRT HANGER
With molded non-slip shoulder.
15" wide; 100/case; 11/15lbs

94400	\$48.99	Break-resistant CLEAR
24400	\$34.20	BLACK
24400BH	\$34.99	BLACK w/Black hook
14400	\$34.99	WHITE



SHIRT HANGER
With molded non-slip shoulder.
12" wide; 100/case; 8/15lbs

92200	\$47.99	Break-resistant CLEAR
22200	\$40.49	BLACK
22200BH	\$40.49	BLACK w/Black hook
12200	\$40.49	WHITE



SHIRT HANGER
Black w/black hook; 200/case

NHPJ41	\$73.48	16"	15/36
NHPJ46	\$92.92	18"	23/38



SHIRT HANGER Black; 18½" wide; 200/case; 25/36lbs

2358	\$81.91
------	---------



Heavy Weight Coat Hanger
17" wide; 100/case

9705	\$73.48	Break-resistant CLEAR	23
2705BH	\$67.26	BLACK w/black hook	17/33
2705CH	\$67.26	BLACK	17/33



Snap Grip Skirt/Pant Hanger 200/case

9686-8	\$97.07	Break-resistant CLEAR	8"	15
2686-8	\$83.20	BLACK	8"	15
9686-10	\$59.49	Break-resistant CLEAR	10"	17
2686-10	\$92.92	BLACK	10"	17
9686-12	\$105.49	Break-resistant CLEAR	12"	18/22
2686-12	\$97.07	BLACK	12"	18/22
9686-13	\$120.66	Break-resistant CLEAR	12½"	18/22



PINCH GRIP SKIRT/PANT HANGER 200/case

w/ Soft Pad:				
6210B	\$70.76	BLACK	10"	16/22
6212B	\$73.48	BLACK	12"	17/26
6214B	\$72.99	BLACK	14"	21/32

6008	\$72.19	CLEAR	8"	18/20
6010	\$74.91	CLEAR	10"	20/22
6012	\$77.76	CLEAR	12"	23/32
6008B	\$63.49	BLACK	8"	20
6010B	\$58.32	BLACK	10"	16/22
6012B	\$54.90	BLACK	12"	17/26
6014B	\$70.99	BLACK	14"	21/32

SIZE MARKERS

Angular VICS size markers. Black with white print. 3/4" wide; 500 pieces/pack; 1 lb. Style VSM \$20.87

Call or see our website for a complete list of VSM size marker options

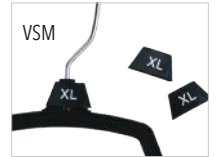

SIZE MARKER REMOVAL TOOL

5/8" metal tool removes size markers from hanger. 1/pack; 1 lb. Style VSMT00L \$9.49





INFANTS ALL PLASTIC HANGER

White; 10" wide; 500/case; 15/21lbs.
1150 \$83.20



SNAP IN SIDE SIZE CLIPS

White w/black imprint; 1/4"L x 5/8"H x 1/4"W;
1000/case; 2lbs. \$22.29



SCXS size: XS
SCS size: S
SCM size: M
SCL size: L
SCXL size: XL
SC2XL size: 2XL

SIZE CLIPS work with:
P12, P13, P14, P16, B14, 2681-10,
2681-12, 1681/8W, 1681/10W,
1681/12/W

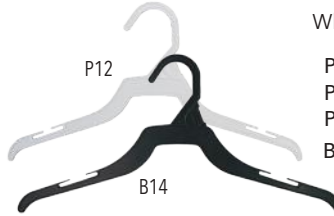

PLASTIC SHIRT/DRESS HANGER

White (P) Black (B)

P12	\$87.35	500	White	12"	16/20
P13	\$50.67	200	White	13 3/4"	11/20
P14	\$100.57	500	White	14"	20/31
B14	\$97.07	500	Black	14"	20/31



ECONOMY SHIRT HANGER

P18100

White; 18"w; 500/case; 8/9lbs. \$16.99

B18100

Black; 18"w; 500/case; 8/9lbs. \$14.99

HIGH-IMPACT PLASTIC SHIRT HANGER

18"w; 500/case \$97.07

1158 White; 29/46lbs.

2158 Black; 30/42lbs.



ONE PIECE SUIT HANGERS

R16WB

white; 16"w; 500/case; 34/70lbs. \$189.00

R16WB250

white; 16"w; 250/case; 18/37lbs. \$92.90



FRAME HANGERS

FR10

9 1/2"w; 500/case; 34/70lbs. \$189.00

FR11

11 1/2"w; 200/case; 18/37lbs. \$92.90



SKIRT/PANT HANGER

SK8

White; 8"w; 500/case; 23/27lbs. \$92.88

SK11

White; 11"w; 500/case; 34/70lbs. \$109.68



COORDINATE SKIRT/PANT HANGER

SP8

White; 8"w; 500/case; 28lbs. \$126.99

SP11

White; 11"w; 500/case; 34/70lbs. \$109.68



TUBULAR HANGERS

144/case \$44.90

TBB	Black		
TBR	Red	16 3/8"	15/22
TBW	White		
TBI	Ivory		
TBB2	Black		16/41
TBR2	Red	17"	16/41
TBW2	White		16/44



SP8

TBW

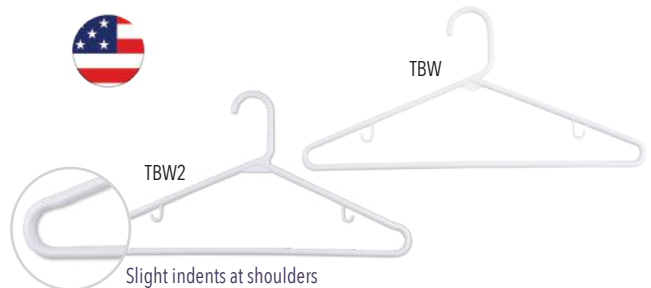

CLIPS FOR TUBULAR HANGERS

White; 100/case; 2 1/4"h; 100/case; 3lbs. \$44.90

Tubular Add-On Clip



CLIP100

Slight indents at shoulders

DRY CLEANING HANGERS

NT140

18"w; 14 gauge white wire; 500/case; 28lbs. \$74.99

NT145RS

16"w; 14 gauge wire w/ round, white cardboard;
500/case; 38lbs. \$81.91

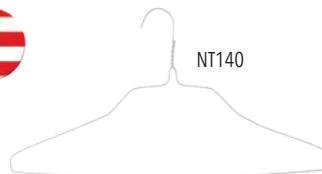

SIZE DIVIDERS



We make most of our sizing products in the USA



Scan to explore more sizing details, or visit nahanco.com

ROUND STANDARD

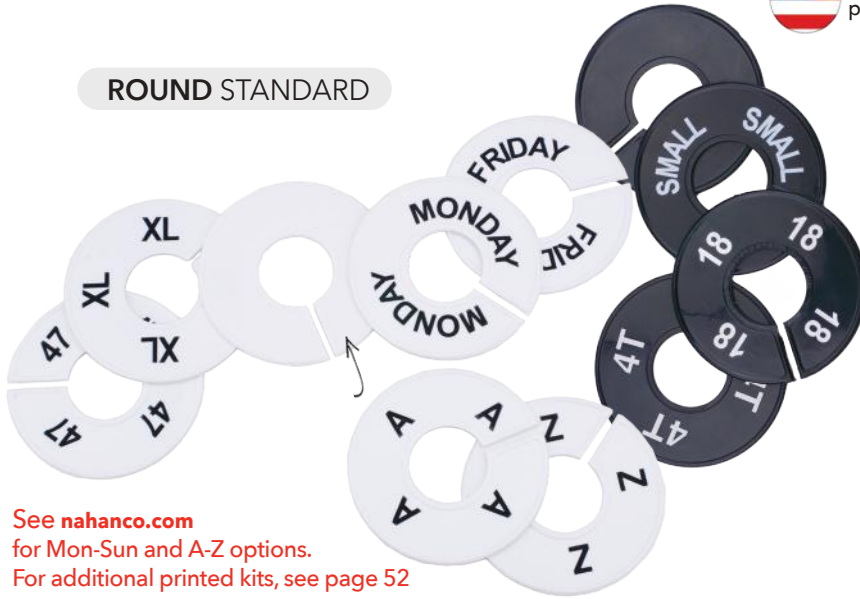

See nahanco.com for Mon-Sun and A-Z options. For additional printed kits, see page 52

3 1/2" outside diameter; 1 3/8" inside diameter; 1/2 lbs.

Imprinted: .35 each
 White w/black: "C"
 Black w/gold: "CG"
Imprinted: .35 each
 Black w/silver: CBS
 Black w/white: CBW

Blank: .17 each
 Blank White: CWHIT-BLANK
 Blank Black: CBLK-BLANK

C2WHITE/
C2BLACK



ROUND LARGE INTERIOR

3 1/2" outside diameter; 1 5/8" inside diameter; 1/2 lbs.

Imprinted: .35 each
 White w/black: C2WHITE
 Black w/gold: C2BLACK

Blank: .17 each
 Blank White: C2WHITE-BLANK
 Blank Black: C2BLACK-BLANK

CUSTOM
 colors and/or printing available for most styles.
 Give us a call!



UNIVERSAL

Fits round, square and rectangular hangrails. Choice of sizes or blank. 2"W x 5"H; 1 3/8" inside diameter; 1/2 lbs.

Imprinted: .35 each
 White w/black: QSD-W
 Black w/gold: QSD-B
 Black w/silver: QSDBS
 Black w/white: QSDBW

Blank: .17 each
 Blank White: QSDWHT-BLANK
 Blank Black: QSDBLK-BLANK

QSD



REGULAR

Fits round, square and rectangular hangrails. Choice of sizes or blank. 2 3/4"W x 6 3/4"H; 1 3/8" inside diameter; 1/2 lbs.

.56 each - printed
 White w/black: RSD-W
 Black w/gold: RSD-B

.39 each - blank
 Blank White: RSD-WHITE-BLANK
 Blank Black: RSD-BLACK-BLANK

RSD



GRAND

Fits round, square and rectangular hangrails. Choice of sizes or blank. 2 5/8"W x 5 3/4"H; 1 3/8" inside diameter; 1/2 lbs.

.56 each - printed
 White w/black: GSD-W
 Black w/white: GSD-B

.39 each - blank
 Blank White: GSDWHT-BLANK
 Blank Black: GSDBLK-BLANK

PRICE **QUOTES** ... CUSTOM **COLOR** ... CUSTOM **PRINT** ... PRICE **QUOTES** ... CUSTOM **COLOR** ... CUSTOM **PRINT**

SIZE DIVIDERS



EXTRA LARGE

Fits round, square and rectangular hangrails.
Choice of sizes or blank.
4"W x 7"H; 1 3/8" inside diameter; 1/2 lbs.

.64 each - printed

White w/black: XLRSDW
Black w/white: XLRSDB

.39 each - blank

Blank White: XLRSD-WHITE-BLANK
Blank Black: XLRSD-BLACK-BLANK



QUEEN

Fits round hangrails. Choice of sizes or blank.
3 3/4"W x 9 1/2"H; 1 3/8" inside diameter;
5/6 lbs.
50 pieces per pack

Blank:

Blank White: D15 **19.44**
Blank Clear: D05 **19.44**
Blank Black: D25 **19.44**

Imprinted*:

White w/black: D15I **27.86**
Clear w/black: D05I **27.86**
Black w/white: D25I **27.86**



** Minimum order
of 100 pieces
(same size) for
imprinting*



KING

Slot for inter-changeable
sizes. Packed with blank
white inserts or specify
pre-printed.
3 3/4"W x 10 3/4"H; 1 3/8"
inside diameter;
200 pack /21lbs;
100 pack /11lbs.

White:	200	175 "E"	97.90
	100	175E-100	50.54
Clear:	200	75 "E"	97.90
	100	75E-100	50.54
Black:	200	275 "E"	97.90
	100	275E-100	50.54

DELUXE

Works with E1 inserts.
3 3/4"W x 10"H; 1 3/4"
inside diameter; 8 lbs.

50 pieces per pack/ **36.29**

White: D120W
Black: D220B



Extra Inserts (E1)

Fits Deluxe and King size dividers.
3 1/4"W x 2 1/2"H; 1/2 lbs.

100 pieces per pack

White w/black imprint: "E1" **23.33**
Blank White: E1-BLANK **14.26**



SIZE DIVIDERS



PRINTED KITS

Round and Universal dividers. Choose from black, white, or mixed colors.

5 SIZES / XSMALL - XLARGE

Choose Black, White or Color; Round or Universal

Sizes include: XS, S, M, L, XL



2 PIECES EACH SIZE

BLACK or WHITE 10-Piece Kit; 1 lb; **\$5.05 /kit**

Round / White CWBKIT1
Round /Black CBWKIT1

Universal / White QSDWBKIT1
Universal/Black QSDBKIT1

MIXED COLORS 10-Piece Kit; 1 lb; **\$5.83 /kit**

Round CCKIT1
Universal QSDCKIT1

5 PIECES EACH SIZE

BLACK or WHITE 25-Piece Kit; 1 lb; **\$10.50 /kit**

Round / White CWBKIT2
Round /Black CBWKIT2

Universal / White QSDWBKIT2
Universal/Black QSDBKIT2

MIXED COLORS 25-Piece Kit; 1 lb; **\$13.35 /kit**

Round CCKIT2
Universal QSDCKIT2

8 SIZES / XXSMALL - XXLARGE + BLANK

Choose Black, White or Color; Round or Universal

Sizes include: XXS, XS, S, M, L, XL, XXL, blank



2 PIECES EACH SIZE

BLACK or WHITE 16-Piece Kit; 1 lb; **\$8.04 /kit**

Round / White CWBKIT3
Round /Black CBWKIT3

Universal / White QSDWBKIT3
Universal/Black QSDBKIT3

MIXED COLORS 16-Piece Kit; 1 lb; **\$9.20 /kit**

Round CCKIT3
Universal QSDCKIT3

5 PIECES EACH SIZE

BLACK or WHITE 40-Piece Kit; 1 lb; **\$16.72 /kit**

Round / White CWBKIT4
Round /Black CBWKIT4

Universal / White QSDWBKIT4
Universal/Black QSDBKIT4

MIXED COLORS 40-Piece Kit; 1 lb; **\$19.96 /kit**

Round CCKIT4
Universal QSDCKIT4

10 SIZES / 3 MOS - 4T

Black or White; Round or Universal; Sizes include: 3 Mo, 6 Mo, 9 Mo, 12 Mo, 18 Mo, 24 Mo, 30 Mo, 2T, 3T, 4T



1
PIECE
EACH SIZE

10-Piece Kit; 1 lb; **\$5.05 /kit**

Round / White CWBKIT5
Round /Black CBWKIT5

Universal / White QSDWBKIT5
Universal/Black QSDBKIT5

5
PIECES
EACH SIZE

50-Piece Kit; 2 lbs; **\$20.87 /kit**

Round / White CWBKIT6
Round /Black CBWKIT6

Universal / White QSDWBKIT6
Universal/Black QSDBKIT6

PRICE **QUOTES** ... CUSTOM **COLOR** ... CUSTOM **PRINT** ... PRICE **QUOTES** ... CUSTOM **COLOR** ... CUSTOM **PRINT**

SIZE DIVIDERS



BLANK KITS

Round and Universal dividers. Choose from black, white, or mixed colors. Blank divider kits are available in a range of quantities.

BLACK & WHITE



SET OF 20 Black or White; Round or Universal; 1 lb; **\$4.67 /kit**

Round / White CWHTBLANK20
Round /Black CBLKBLANK20
Universal /White QSDWBLANK20
Universal /Black QSDBBLANK20



SET OF 50 Black or White; Round or Universal; 2 lbs; **\$9.98 /kit**

Round / White CWHTBLANK50
Round /Black CBLKBLANK50
Universal /White QSDWBLANK50
Universal /Black QSDBBLANK50



SET OF 100 Black or White; Round or Universal; 3 lbs; **\$16.72 /kit**

Round / White CWHTBLANK100
Round /Black CBLKBLANK100
Universal /White QSDWBLANK100
Universal /Black QSDBBLANK100

MIXED COLOR KITS

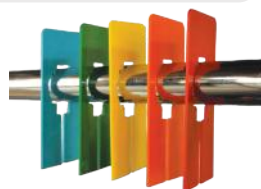

SET OF 5 COLORS

KITS OF 10 /2 each color; Round or Universal; 1 lb; **\$4.15 /kit**

Round CCKIT5
Universal QSDCKIT5



KITS OF 25 /5 each color; Round or Universal; 1 lb; **\$9.98 /kit**

Round CCKIT6
Universal QSDCKIT6



SET OF 8 COLORS

KITS OF 16 /2 each color; Round or Universal; 1 lb; **\$6.74 /kit**

Round CCKIT7
Universal QSDCKIT7



KITS OF 40 /5 each color; Round or Universal; 2 lb; **\$16.72 /kit**

Round CCKIT8
Universal QSDCKIT8

SALE & CLEARANCE KITS



SALE Red & white; Round or Universal; 1 lb; **\$10.50 /kit**

Round CWRSALE25
Universal QSDWRSALE25



CLEARANCE Red & white; Round or Universal; 1 lb; **\$10.50 /kit**

Round CRWCLEARANCE25
Universal QSDRWCLEARANCE25

BACK ROOM RAIL DIVIDERS



UNIVERSAL ROUND DIVIDER / HEAVY DUTY

5" dia w/ 1 1/2" inside dia.; 1/1 lbs. **\$0.82 /each**

C5B Black
C5R Red
C5W White

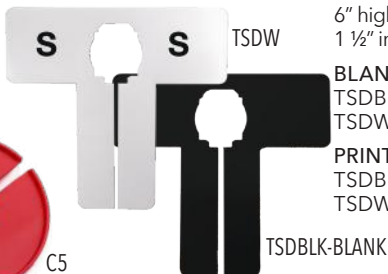

T-SHAPE STOCKROOM DIVIDER

6" high x 6 1/2" wide; 1 1/2" inside dia.; 1/3 lbs.

BLANK \$0.31 /each
TSDBLK-BLANK black
TSDWHT-BLANK white

PRINTED \$0.75 /each
TSDB black
TSDW white



EXTRA-LONG STOCKROOM DIVIDER

Black; 21 1/2" long; 4/7 lbs. **BRDAB \$20.00 /25 pieces**

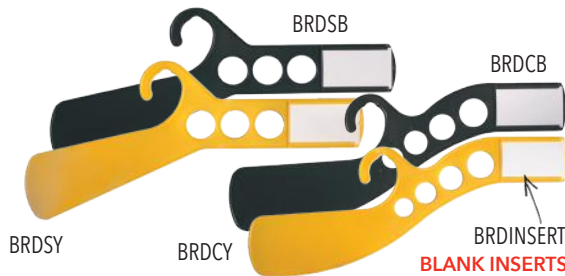

Packs OF 25

Choose Black or Yellow; Straight or Curvy body; 19" long; 4/5 lb.

Black Straight Body BRDSB **\$17.82**
Black Curvy Body BRDCB **\$23.65**
Yellow Straight Body BRDSY **\$17.82**
Yellow Curvy Body BRDCY **\$23.65**

White Blank Inserts each 3 9/16" x 2 1/8"; 1 lb. 50 pcs/pack **BRDINSERT \$0.25 each**
BRDINSERT50 \$9.59

PRICE **QUOTES** ... CUSTOM **COLOR** ... CUSTOM **PRINT** ... PRICE **QUOTES** ... CUSTOM **COLOR** ... CUSTOM **PRINT**

SIZE DIVIDERS Size Markers & Labels

PLASTIC SIZE MARKERS



Black/White Size Markers 3/4"



Red/White Size Markers 3/4"



Mini Size Markers 1/2"



Size Marker Remover Tool



snap in size clip



Storage Tray for Size Markers

Side Size Clips

TRAY

SM variations

Please visit nahanco.com for a complete list of all of the imprinted sizes available for our SM lines

SM /SMB /SM25

BLACK or WHITE 3/4" round; 1/2 lbs

SM	WHITE w/black print	100 pcs	\$13.74
SMB	BLACK w/white print	100 pcs	\$13.74
SM25	WHITE w/black print	25 pcs	\$4.15

SMSALE

RED w/white print 3/4" round; 100 pcs; 1/2 lbs **\$13.74**

MSM

WHITE w/black print 1/2" round; 100 pcs; 1/2 lbs **\$11.15**

VSM /VSMTOOL

VSM BLACK w/white print 500 pcs **\$20.87**
Angular 3/4" markers; 1lb
(pictured on 484B hanger)

VSMTOOL METAL tool removes VSM markers from hanger; 1lb **\$9.49**

SMCOLOR

PLAIN COLOR (specify) 3/4" round; 100 pcs; 1/2 lbs **\$6.87**

COLORS: black, white, violet, brown, green, lt green, dk green, orange, beige, magenta, yellow, lt yellow, blue, dk blue, pink, neon-orange red, dk red, grey
(Actual colors may vary slightly from image)

RBKSM

Specify size 3/4" round; 100 pcs; 1/2 lbs **\$13.74**

SMALL (Red); MEDIUM (Orange); LARGE (Yellow); X-LARGE (Green); XXL (Navy Blue); XXXL (Black)

SC

WHITE w/black print 1/4" l x 5/8" h x 1/4" w; 1000 pcs; 2 lbs **\$22.29**

Specify size: sx (SCXS); s (SCS); m (SCM); l (SCL); xl (SCXL); xxl (SCXXL)
(works with hangers P12, P13, P14, P16, B14, 2681-10, 2681-12, 1681/8W, 1681/10W, 1681/12/W)

TRAY

14 x 8 1/2 x 2"; 2/6 lbs **\$18.01 /each**

Clear heavy duty tray w/ locking clasps; Adjusts to up to 24 compartments

SIZING LABELS



DSM



DSM HEM /INSEAM LABELS **Custom available**

BLACK print on white background

1 1/4" w x 5" h; 250 pcs; 1/2 lbs **\$5.44**

Please visit nahanco.com for a complete list of available sizes

CLEAR ACETATE LABELS

CLEAR ROUND LABEL

w/Black Print

1/2" w; 1000 pcs; 1 lb **\$7.00**

IMPRINTS

LBXS	XS
LBS	S
LBM	M
LBL	L
LBXL	XL
LBXXL	XXL
LB1X	1X
LB2X	2X
LB3X	3X



Modern Accessories HANGING SOLUTIONS

MODERN ACCESSORIES

Introducing our new, high-end line of metal hanging accessories. Available in five fabulous finishes

New



HALF-ROUND ACCESSORY HANGERS

Metal accessory hangers in 5 finishes with a fixed cut end hook.
Dims: 7" (top to bottom), 5.9" Diameter (holder), 4 mm wire; packs of 100 (19 lbs) or 10-(3 lbs) pieces:

AHLHMB	Matte black	100	\$62.49
AHLHMB10	Matte black	10	\$7.99
AHLHMC	Brushed chrome	100	\$82.49
AHLHMC10	Brushed chrome	10	\$10.49
AHLHMW	Matte white	100	\$62.49
AHLHMW10	Matte white	10	\$7.99
AHLHMC	Chrome	100	\$62.49
AHLHMC10	Chrome	10	\$7.99
AHLHMG	Shiny gold	100	\$90.49
AHLHMG10	Shiny gold	10	\$11.49



ROUND ACCESSORY HANGERS

Metal accessory hangers in 5 finishes with a 360° swiveling ball end hook.
Dims: 9.5" (top to bottom), 5.9"; diameter (holder) 4 mm wire; packs of 100 (19 lbs) or 10-(3 lbs) pieces:

AHLFMB	Matte black	100	\$96.99
AHLFMB10	Matte black	10	\$12.49
AHLFMC	Brushed chrome	100	\$119.49
AHLFMC10	Brushed chrome	10	\$14.99
AHLFMW	Matte white	100	\$96.99
AHLFMW10	Matte white	10	\$12.49
AHLFMC	Chrome	100	\$96.99
AHLFMC10	Chrome	10	\$12.49
AHLFMG	Shiny gold	100	\$130.99
AHLFMG10	Shiny gold	10	\$16.49



HANG-ALL CLIPS

Metal accessory clips in 5 finishes with a 360° rubber-tipped swiveling hook.
Dims: 6" (top to bottom), 2.5" H Euroclip;
Packs of 100 (10 lbs) or 10 (1 lb) pieces

610LESB	Matte black	100	\$79.99
610LESB10	Matte black	10	\$9.99
610LESBC	Brushed chrome	100	\$99.49
610LESBC10	Brushed chrome	10	\$12.49
610LESW	Matte white	100	\$79.99
610LESW10	Matte white	10	\$9.99
610LESC	Chrome	100	\$79.99
610LESC10	Chrome	10	\$9.99
610LESG	Shiny gold	100	\$113.99
610LESG10	Shiny gold	10	\$14.49



C-SHAPED ACCESSORY HOOKS

Metal accessory hooks in 5 finishes.
Dims: 4.3" (top to bottom), 0.32" wide.
Packs of 100 (9 lbs) or 10 (2 lbs) pieces.

CMHB	Matte black	100	\$40.99
CMHB10	Matte black	10	\$5.49
CMHBC	Brushed chrome	100	\$46.99
CMHBC10	Brushed chrome	10	\$5.99
CMHW	Matte white	100	\$40.99
CMHW10	Matte white	10	\$5.49
CMHCH	Chrome	100	\$40.99
CMHCH10	Chrome	10	\$5.49
CMHBG	Shiny gold	100	\$46.99
CMHBG10	Shiny gold	10	\$5.99



HANGING SOLUTIONS Accessories

MODERN ACCESSORY CLIPS

Introducing our new, high-end line of metal accessory clips with padded mini clips. Available in three finishes.



New



UNIVERSAL ACCESSORY CLIPS

Metal accessory clips with padded mini clip in 3 finishes.

Dims: 2.5" hang length, 1" ring diameter; packs of 50 or 20 pieces; 1 lb.

UACBLK50	Matte black	50	\$36.99
UACBLK20	Matte black	20	\$11.99
UACBC50	Brushed chrome	50	\$36.99
UACBC20	Brushed chrome	20	\$11.99
UACWHT50	Matte white	50	\$36.99
UACWHT20	Matte white	20	\$11.99

New

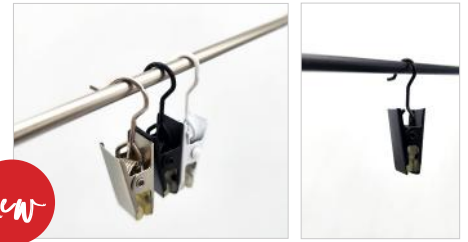

PEG HOOK ACCESSORY CLIPS

Metal accessory clip with padded mini clip in 3 finishes.

Dims: 1.25" hang length; packs of 50 or 20 pieces; 1 lb.

PHCBLK50	Matte black	50	\$36.99
PHCBLK20	Matte black	20	\$11.99
PHCBC50	Brushed chrome	50	\$36.99
PHCBC20	Brushed chrome	20	\$11.99
PHCWHT50	Matte white	50	\$36.99
PHCWHT20	Matte white	20	\$11.99

JEAN HOOKS



SHKL

7" HOOKS

Metal jean hooks in 5 finishes. Dims: 7" from top to bottom, 1 3/4" opening; sold in packs of 12; 2 lbs. Also sold individually. See nahanco.com for details.

SHKLG	Zinc	\$9.72
SHKLGRS	Gunmetal	\$13.87
SHKLGBC	Satin Chrome	\$13.87
SHKLGW	White	\$9.72
SHKLG B	Black	\$9.72

SHKS



4" HOOKS

Metal jean hooks in 5 finishes. Dims: 4" from top to bottom, 1 3/4" opening; sold in packs of 50; 3 1/4 lbs. Also sold individually and in packs of 12. See nahanco.com for details.

SHKSM	Zinc	\$26.44
SHKSMRS	Gunmetal	\$31.23
SHKSMBC	Satin Chrome	\$31.23
SHKSMW	White	\$26.44
SHKSMB	Black	\$26.44

HANG-ALL CLIPS

Hang-all clips with metal hang hook. Available in six styles. 4.5" in length; sell in packs of 100; 6 7/8 lbs.



610ECS	\$83.20	610	\$32.90	610W	\$32.90	610EC	\$54.17	610B	\$32.90	610BBH	\$37.45
Brushed Chrome		Chrome		White		Brushed Chrome		Black		Black w/black hook	

Clips HANGING SOLUTIONS

style #	\$	qty	description	size	wgt
610PB	24.36	100	Black	3 1/4"	2/6
HC101	28.51	100	Black	2"	3
HC100	28.51	100	White	2"	3
FITTING CLIPS	28.51	100	White	2"	3
FITTING CLIPS 12	8.29	12	White	2"	1
FITTING CLIP BC	71.41	100	Brushed chrome	2 3/8"	4
FITTING CLIP BC-12	10.50	12	Brushed chrome	2 3/8"	1
GIANT FITTING CLIP	34.73	50	White	4"	3
CC2W	17.90	100	White	2"	1/3
CC2B	17.90	100	Black	2"	1/3
CC2C	21.51	100	Clear	2"	1/3
RCW	59.62	500	White		4/6
RCW100	21.51	100	White		1/2
RCB	34.73	500	Black	2"	4/7
RCB100	8.42	100	Black		1/3
PC	41.47	500	Natural	1 1/2"	3
PC100	13.74	100	Natural	1 1/2"	1/3
PCB	38.75	500	Black -		2/2
PCB100	12.44	100	Pant Strut Clip	138"Lx38"W	2/2
PCW	22.29	500	White -		2/2
PCW100	7.00	100	Pant Strut Clip	138"Lx38"W	2/2
TIE BK	7.00	100	White	1 1/2"/ 2 1/4" elast.	1
LONG	5.57	500	Clear	1 1/2"	1/3
LONGWHITE	8.42	500	White	1 7/16"	2/2
LONGWHITE100	4.15	100	White	1 7/16"	2/2
LJC200	4.15	200	Clear	2"	1/1
SHCLIP	13.22	500	White -		2/2
SHCLIP100	4.92	100	Triangle Shape Shirt Clip	1 1/4"L x 5/8"W x 1/4"H"	2/2
CLIP100	24.36	100	White	2 1/4" thick	3

HANG ALL CLIP

610PB



CLOTHING CLIPS

HERCULES CLIP

HC101/
HC100



FITTING CLIPS

FITTING CLIP



FITTING CLIP BC



GIANT FITTING CLIP

CLEVER CLIPS



CC2W

CC2B

CC2C

PANTS CLIPS

PC



PCB /
PCB100



PCW /
PCW100



RING CLIPS

RCW



RCB

SHIRT CLIPS

TIE BACK CLIP

TIE BK



LONG CLIPS

LONG

LONGWHITE



ALLIGATOR SHIRT CLIP

LJC200

TRIANGLE SHIRT CLIP

SHCLIP /
SHCLIP100



CLIP100



TUBULAR HANGER CLIP

Clip snaps on to any of our tubular hangers.

See page 49 for tubular hangers

HANGING SOLUTIONS Accessory Hangers

TIE / LEGGINGS / SCARF HANGERS

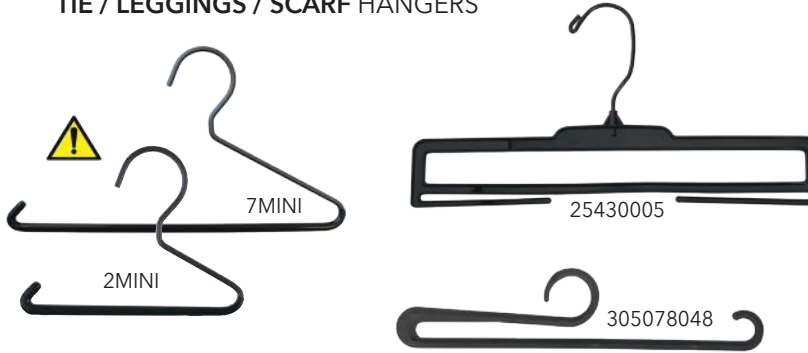

SCARF & ACCESSORIES RINGS /HANGERS

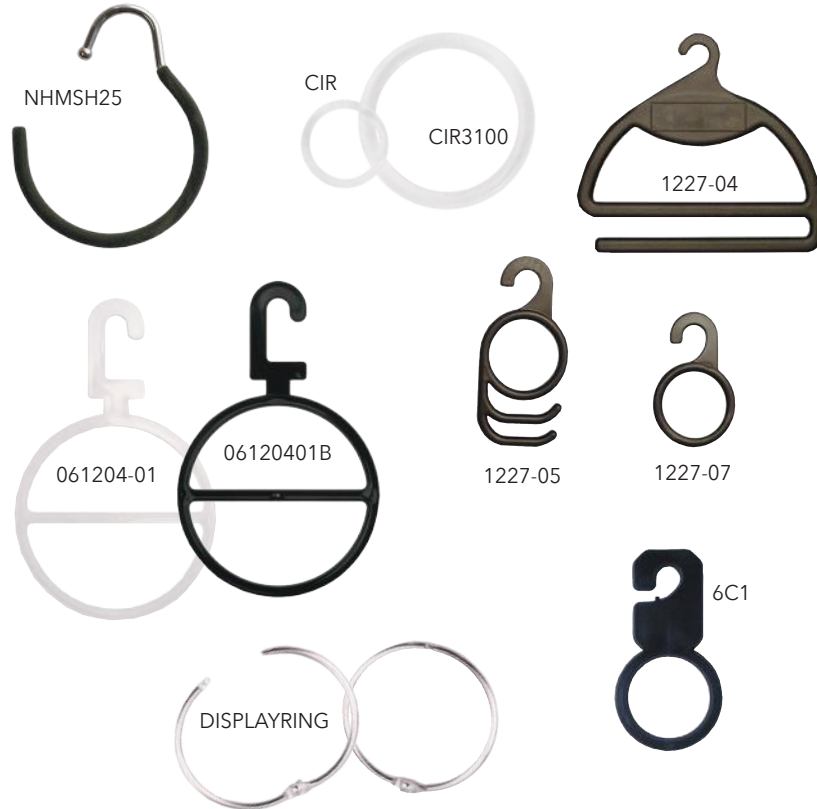

SOCK HANGERS



BELT HANGER

BC

style #	\$	qty	description	size	wgt
2MINI	49.99	100	Gunmetal with Black coating;	4 3/4" W x 3 3/4" H	6
7MINI	78.41	100	hook measures 1 1/4" in dia.	8" W X 4 1/4" H	8
25430005	31.88	50	Black w/black hook	11 1/2"	5/9
305078048	23.46	100	Black	7"	2/3
NHMSH25	20.87	25	Flocked Chrome	3 3/4"H x 3"W 1/4" thick	4
CIR1M	40.31	1000	Clear	1 1/4" inside dia.	5/6
CIR	22.94	500			3
CIR100	8.04	100			1/2
CIR3100	19.44	100	Clear	2 1/2" inside dia.	4
1227-04	13.87		Black	3 1/8"H x 3 5/8"W	2/6
1227-05	11.15	100	Black	3 1/2"H x 1 5/8"W	2
1227-07	8.42		Black	2 3/4"H x 1 3/4" dia.	1/2
061204-01	16.72	100	Natural	6 3/8"H x 4 1/8" dia.	3/7
06120401B	16.72		Black		
DISPLAYRING	49.25	100	Chrome	2 1/4" dia.	3
6C1	24.36	500	Black	2 3/4" h, 1" dia. ring	3
6C1-100	9.72	100			1
SH1	17.99	500	Black	3 1/2"	2
SH1-100	5.99	100			1/2
SH2	17.44	500	Black	3 7/8"	3
SH2-100	5.99	100			1/2
TC	24.36	500	Black	2 7/8"	6
TC100	6.35	100			2/3
BC	41.60	500	Black	open 5"	4
BC100	11.02	100			1

Specialty Items HANGING SOLUTIONS

MINI WOODEN HANGERS



See page 20 for pet themed mini hangers.

High quality wooden mini hangers in 6 and 8" widths. Great for doll clothes and accessories. Also works with pet clothes and accessories. Natural w/chrome hardware: 100 pcs/carton;

Without clips:

MINI6	6" wide	5lbs	72.19
MINI8	8" wide	10lbs	90.85

With clips:

MINI6RC	6" wide	9lbs	113.79
MINI8RC	8" wide	14lbs	123.51



MINI6



MINI8



MINI6RC



MINI8RC

Can be imprinted for an additional charge. Contact us via phone, email or chat for details.

BACK ROOM HOOKS

Heavy duty black, space-saving, plastic hook with attached nylon loop strap for hanger management; black;

100 pcs/carton:

GHB100 7"L; 8 lbs.; **\$59.62**
GHB200 5 1/2"L; 7 lbs.; **\$59.62**

12 pcs/carton:

GHB10012 7"L; 1 lb.; **\$11.65**



GHB100

GHB200



DISPLAY-IT HOOKS

You'll find hundreds of uses for this inexpensive display method. 1 1/4" long

1000 pcs/carton; 2/3 lbs:

DH	Black	13.99
DH-WH	White	14.99

500 pcs/carton; 1/3 lbs:

DH500	Black	9.49
DHWH500	White	9.49



DH

PRESSURE SENSITIVE PACKAGE HANG TABS



PS1



PS2



NHH3



NHH1C



NHH4C

HOOK STYLE

1 5/8"H x 1"W pre-cut hang tabs with adhesive strip; clear:

PS1 500 pcs; 1 lb; **\$34.73**
PS1100 100 pcs; 1 lb; **\$13.87**

WIDE, DELTA HOLE STYLE

The delta hole fits almost any style hook; plastic material with a clear adhesive backing; .015" thick; tab measures 1 5/8"W x 1 1/4"H; clear:

PS2 500 pcs; 1 lb; **\$26.44**
PS2100 100 pcs; 1 lb; **\$9.59**

ECONOMY - ROUND STYLE

13/16" x 1 1/2" economy round hole hang tab with adhesive strip; clear:

NHH3 500 pcs; 1 lb; **\$15.29**

ECONOMY - HOOK STYLE

1 1/2" x 1 11/16" economy hook hang tab with adhesive strip; clear:

NHH1C 500 pcs; 1 lb; **\$24.36**

ECONOMY - DELTA HOLE STYLE

1 7/16"H x 1 5/8"W delta hole hang tab, wide with adhesive strip; clear:

NHH4C 500 pcs; 1 lb; **\$22.29**

HANGING SOLUTIONS

NON-SLIP ATTACHMENTS



Adhesive Gripper

Black or white adhesive gripper with a raised dotted surface; 3 1/4" long

BNT	1000 /case; 5 lbs.	\$112.90
BNT200	200 /case; 2 lbs.	\$33.31
WNT200	200 /case; 2 lbs.	\$33.31

Stretch Foam Covers

White (w) and grey (c); 17" w; in packs of 500 and 100

2045W	White; 500 /case; 4/14 lbs.	\$42.12
2045C	Grey; 500 / case; 4/14 lbs.	\$42.12
2041W	White; 100 /case; 2/8 lbs.	\$9.72
2041C	Grey; 100 /case; 2/8lbs.	\$9.72

Adhesive Foam Non-slip Attachments

Black or White; 3 1/2" long or 2 1/4" long

regular	FG1000B	Black; 1000 /case; 2/3 lbs.	\$31.88
	FG1000W	White; 1000 /case; 2/3 lbs.	\$31.88
slim	FGSL1000B	Black; 1000 /case; 2/3 lbs.	\$55.47
	FGSL1000W	White; 1000 /case; 2/3 lbs.	\$55.47

Hanger Grips - Straight w/ Fins

Non-Slip Long Adhesive Grips; these flexible rubber grips are feathered with adhesive backing.; 4" long x 3/8" wide

NSLONG	Natural; 1000 /case; 4 lbs.	\$70.76
NSLONG100	Natural; 100 /case; 1/2 lbs.	\$9.72
BNSLONG	Black; 1000 /case; 4 lbs.	\$70.76
BNSLONG100	Black; 100 /case; 1/2 lbs.	\$9.72

Adhesive Foam Strips

Adhesive backed foam strips; 3/8" w x 4" l; White or Grey; Choose AP and add this cost to the price of any 100-hanger carton to have the non-slip applied

FP2W	White; 200 /case; 1/2 lbs.	\$9.72
FP7W	White; 1600 /case; 2/8 lbs.	\$41.60
FP2	Grey; 200 /case; 1/2 lbs.	\$8.29
FP-7	Grey; 1600 /case; 2/8 lbs.	\$27.73
AP	Specify color; 100 pairs.	\$27.73

Rubber Non-slip Hanger Attachments

Grippers that fit over notched, plastic hanger arms without adhesives; 4" long; black or natural; available in packs of 1000 and 200

NS	Natural; 1000 /case; 7 lbs.	\$57.99
NS2	Natural; 200 /case; 2 lbs.	\$16.49
BNS	Black; 1000 /case; 7 lbs.	\$57.99
BNS2	Black; 200 /case; 2 lbs.	\$16.49



Round Rubber Gripper

Available in Natural or Black; gripper stretches over end of most hanger styles and stays put without adhesive; 1" d

NSROUND	Natural; 100 /case; 1/2 lb.	\$15.29
BNSROUND	Black; 100 /case; 1/2 lb.	\$15.29



HANGER CONNECTORS



PB / BPB



Piggy Back Connectors

Plastic connector strips; natural & black: 10" (4 slots) & 2 1/2" (1 slot) lengths; 100 & 500 piece quantities;

Natural; 2 1/2":

PB 500 pcs; 2 lbs.; **\$34.73**

PB100 100 pcs; 1 lb.; **\$9.72**

Natural; 10":

PB10 500 pcs; 5/8 lbs; **\$99.79**

PB10-100 100 pcs; 2 lbs; **\$27.35**

Black; 10":

BPB-10 500 pcs; 5/8 lbs; **\$34.73**

BPB10-100 100 pcs; 2 lbs; **\$9.72**

PB10 / BPB-10

PB8 BPB8



BPB1606

PB16 BPB16



Coordinate Strips

Displayer hanger strips; 50 pieces;

With 5 slots; 8"L x 1"W:

PB8 Clear; 1 lb.; **\$12.57**

BPB8 Black; 1 lb; **\$12.57**

With 11 slots; 16"L x 1"W:

PB16 Clear; 2 lbs.; **\$27.09**

BPB16 Black; 2 lbs; **\$19.90**

BPB1606 Black heavy weight; 2 lbs.; **\$22.29**

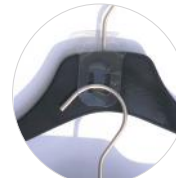

NHHIPB



HC001

Clear, flexible connectors; 2 5/8" L x 1 5/8" W; 1000 pieces; 3 lbs; **NHHIPB \$61.04**



NHHIPB



HC001B

Plastic connectors; 1 3/4"; 1000 pieces; 3/4 lbs; **HC001** Natural **\$41.60**
HC001B Black **\$34.73**

Reachers, Boxes & Bins **BACKROOM**

style #	\$	qty	description	size	wgt
RH1MP	11.90	1	Chrome w/ wood handle 2 pieces, easy assembly	54" L	2/4
RH2	15.49	1	Chrome w/ wood handle 4 pieces, assembly required	70" L	2/3
RH3	18.49	1	Chrome w/ wood handle 5 pieces, assembly required	84" L	2/3
ARH	13.87	1	Aluminum w/ plastic tip -adjustable-	24" - 60" L	1/4
48S	38.75	1	Chrome	47 1/2" L	2/16
MBR	37.45	1	Wood w/ metal end	60" L	3/7
BX500	40.31	25	Cardboard	14x14x17	39/49
CHH-2	39.90	12	Cardboard holds 17" dress hangers	17½ x 5½ x 23	18/21
CHH-3	39.90	12	Cardboard holds 14" skirt/slack hangers	14½ x 3 x 23	14/16
CHH-2 WHITE	68.30	12	White cardboard holds 17" dress hangers	17½ x 5½ x 23	18/21
CHH-3 WHITE	68.30	12	White cardboard holds 14" skirt/slack hangers	14½ x 3 x 23	14/16
H H	83.20	1	Black break resistant plastic	17½ x 6½ x 23	8/22
BB100	59.90	1	Black corrugated plastic w/ removable divider	Assembled: 22 x 21½ x 13 Collapsed: 22 x 21½ x 3	7/23

REACHING HOOKS



BOX REACHER LONG ARM

Pole with metal device for removing shoe boxes from high shelves



STORAGE BOXES & BINS

Cardboard Hampers Hold 50 hangers each

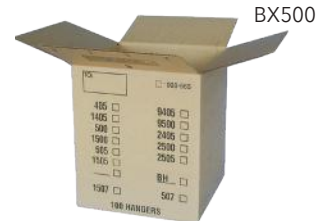

CHH-2/CHH-3



CHH-2/CHH-3 WHITE

Hanger Hamper Reinforced corners



H H

BLACK BOX HANGER STORAGE

With reinforced corners and velcro closure. Boxes are foldable and stackable. Each box holds up to 100 hangers.



BB100



BACKROOM Hanger Racks & Stackers

HANGER COLLECTION RACKS



All racks shown with bars attached (bars sold separately)

NOTE: These items ship in 7-10 business days

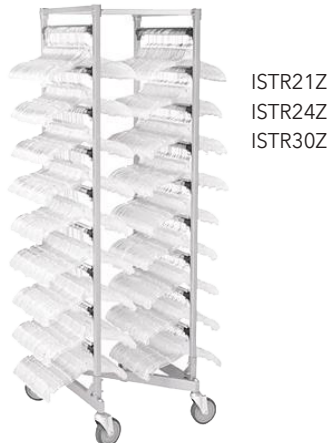

ISTR21Z
ISTR24Z
ISTR30Z

TRANSFER RACKS

COORDINATING HANGER BARS



IHB2100 / IHB2400 / IHB3000



NH6CR



6-BAR HANGER RACK

style #	\$	qty	description	size	wgt
---------	----	-----	-------------	------	-----

MOBILE COLLECTION RACK 24" SYSTEM

(takes IHB2400 bars - see below)

8 bar capacity

CFR6024M4	287.06	1	bars sold separately	20d x	27/48
CFR6024M4WB	429.88		includes 8 (24") bars	26 3/8w x	34/48
				66 3/8 h	

6 bar capacity

CFR5024M4	241.32	1	bars sold separately	18d x	20/42
CFR5024M4WB	352.25		includes 6 (24") bars	26 1/4w x 55 h	25/42

IN STORE TRANSFER RACKS - 21", 24" & 30" SIZES

(bars not included)

ISTR21Z	432.30	1	21" rack /uses IHB2100	20w x 22 3/8 x77h	27
ISTR24Z	447.30	1	24" rack /uses IHB2400	20w x 26 x77h	33
ISTR30Z	475.60	1	30" rack /uses IHB3000	20w x 31 1/4 x77h	37

(Each rack holds 18 hang bars - bars sold separately)

COORDINATING HANGER BARS WITH CLAMPS - 3 SIZES

IHB2100	22.29	1	use with ISTR21Z	21" long	4
IHB2400	22.94	1	use with ISTR24Z & CFR mobile rack system	24" long	1/3
IHB3000	25.01	1	use with ISTR30Z	30" long	6

(24" long hang bar holds approximately 55 hangers)

NH6CR	158.99	1	Metal 6 Bar Rack w/ casters; rack is not adjustable	22 1/2" w x 18" d x 51 1/4" h	19
				Bars evenly spaced at 8" apart	

Hanger Stackers, Racks & Caddies **BACKROOM**

style # \$ qty description size wgt

101 12.90 1 Chrome 33" H; base - 19 1/4" x 7 1/2" 5



Chrome Hanger Stackers Hold 100 hangers of average size.

Most Popular!

101



101N-WD Natural
 101W-WD 34.08 1 White 33 1/2" high, 19 1/4" x 7 1/8" base 5
 101B-WD Black
 101M-WD Mahogany



Deluxe Wood Hanger Stackers Accommodates most of our wood styles.

HANGER STACKERS

101N-WD



101W-WD



101B-WD



101M-WD

HANGER CADDIES

- sort /organize hangers by style
- eliminates tangling /breakage
- available in two sizes
- 21" holds approx. 40 hangers
- 29" holds approx. 55 hangers

S21 77.76 1 Chrome 21" H skirt 5/18
 S29 79.06 1 Chrome 29" H skirt 5/23
 D21 77.76 1 Chrome 21" H dress 5/18
 D29 81.91 1 Chrome 29" H dress 5/23



UNDER CABINET SLIDING RACK (frame only)

HCUCRS 122.08 1 Chrome Hanger Caddy Under Cabinet Sliding Rack (frame only) Fits into 26"H x 20"W x 26" D space 11

Use with S21 & D21 Caddies (sold separately)



Rack frame pulled out



Rack frame tucked in

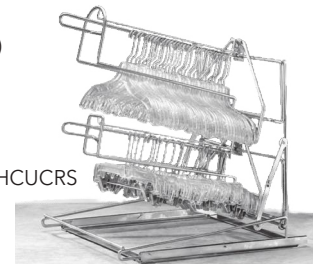

HCUCRS

HCSR 143.60 1 Black Adjusts to hold 21" or 29" hanger caddies 13/25

Use with S21 & D21 Caddies (sold separately)

HANGER CADDY SPINNER



HCSR

BACKROOM Workstations & Folding

style #	\$	qty	description	size	wgt
---------	----	-----	-------------	------	-----

MOBILE WORKSTATION



VTL2046

VTL2046	290.56	1	Steel tube folding table w/grey powdercoat finish and laminated work surface. With folding leaves and 2 shelves.	20" w x 18" d x 34 3/4" h without leaves Leaves are 20" x 14" each	7/23
---------	--------	---	--	---	------

**Note that this item ships in 7-10 business days*



FLAT SHELF UTILITY CART
Durable plastic cart

RUB452500

RUB452500	295.99	1	Grey with 5" non-marking casters	26" W x 40" L x 33" H	49/75
-----------	--------	---	----------------------------------	-----------------------	-------

Flat top shelf and lower tray with 3"H sides. Ergonomically designed push handle allows for easy steering. Cart rolls on 2 swivel and 2 rigid casters. Assembles easily.

MOBILE FOLD SYSTEM

NHMOBILEFOLD



NHMOBILEFOLD	360.79	1	Mobile Fold Station w/ casters	31"L x 12-33"W x 36" h base; center panel adjusts 7-13"; base 21" w	50
--------------	--------	---	--------------------------------	---	----

SHIRT FOLDING BOARDS

NHSHB25



Eco-friendly, white cardboard for folded shirts, new packaged look

NHSHB25	36.16	1	25LB pack/375 pieces	24-point shirt boards; bio-degradable cardboard	8" x 12"	25
---------	-------	---	----------------------	---	----------	----



Choose from 5 sizes



Simply fold and remove for a neat presentation



FB1301PR



FB1301	8.04			1/8" Clear Acrylic	8 1/2" x 12"	
1301SF	9.72				8 1/2" x 15"	
FB1302	9.72	1			10" x 12"	1/2
FB1303	10.50				11" x 12"	
FB1304	10.50				9 1/2" x 14"	

FB1301PR	11.02	1	Acrylic Board with printed folding instructions	8 1/2" x 12"	2
----------	-------	---	---	--------------	---



With printed instructions

Tagging Accessories PRICING SUPPLIES

style # \$ qty description size wgt

National Standard

J11SKIT 19.99 1 J11S tool, needles & fasteners KIT 2/6

J11S 7.90 1 National Standard RED Tagging Tool Standard 1/3

Standard Replacement Needles

300R 8.29 4 pack Plastic w/steel needles Standard 1

Standard Fasteners - Natural

F1/2	5000	Natural	1/2"	1/3
F1	5000	Natural	1"	1/3
F2	4.15 5000	Natural	2"	1/3
F3	5000	Natural	3"	1/3
F5	5000	Natural	5"	1/3

Standard Fasteners - Colors

F1-COLORS	11.02	5000	Specify	1"	1/3
F3-COLORS	11.02	5000	Specify	3"	1/3
954718	11.02	5000	Black	1/2"	1/3

C-Hook (Tacking Hook)

TH 15.29 5000 Natural 1 7/8" 2/7

National Fine

J11F 13.87 1 National Fine RED Tagging Tool Fine 1/3

Fine Fabric Replacement Needles

400F 10.90 4 pack Plastic w/steel needles Fine 1

Fine Fabric Fasteners - Natural

FF1	5.57	5000	Natural	1"	1/3
FF2	5.57	5000	Natural	2"	1/3

NATIONAL STANDARD TAGGING TOOL



Tagging Tool Kit
Nahanco one J11S tagging tool, one pack needles & one pack each of 1" and 3" natural standard fasteners (5000 pieces each)

NATIONAL STANDARD TAGGING FASTENERS

F1/F3 - Colors

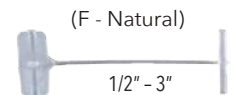
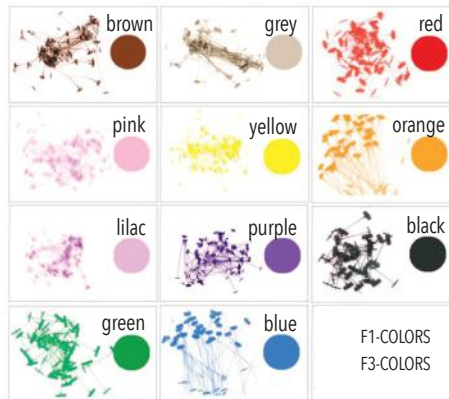

C-HOOK FASTENERS

Pair and tag with one hook. For use in standard guns



NATIONAL FINE TAGGING TOOL



NATIONAL FINE TAGGING FASTENERS
FF1 (1") /FF2 (2")

PRICING SUPPLIES Tagging Accessories

DENNISON STANDARD TAGGING TOOLS



**DENNISON MARK III®
STANDARD
TAGGING TOOL**

MTGS



**DENNISON SCISSOR GRIP
STANDARD
TAGGING TOOL**



**DENNISON
NEEDLE LOCKS**



08941

**DENNISON STANDARD
REPLACEMENT NEEDLES**



**DENNISON STANDARD
TAGGING FASTENERS**
06214 (1")/06215 (3")

style #	\$	qty	description	size	wgt
---------	----	-----	-------------	------	-----

Dennison Standard

MTGS	23.99	1	TEAL Tagging Tool	Standard	1/3
STGS	36.99	1	BEIGE Tagging Tool	Standard	1/3
76011801	3.87	1	Needle Locks: For MTGS	Standard	1/3
760034907	3.87	1	For STGS	Standard	1/3
08941	16.90	4 pack	Replacement needles	Standard	1
06214	9.90	5000	Natural	1"	2/7
06215	9.90	5000	Natural	3"	2/7

DENNISON MARK III® FINE TAGGING TOOLS



**DENNISON MARK III® FINE
TAGGING TOOL**

76011801 / 760034907



DENNISON NEEDLE LOCKS



08944

**DENNISON
FINE
REPLACEMENT
NEEDLES**



**DENNISON SCISSOR GRIP
FINE
TAGGING TOOL**

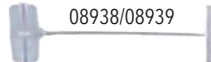

**DENNISON STANDARD
TAGGING FASTENERS**

Dennison Fine

MTGF	31.90	1	ORANGE Tagging Tool	Fine	1/3
STGF	67.99	1	BLUE Tagging Tool	Fine	1/3
76011801	3.87	1	Needle Locks: For MTGF	Fine	1/3
760034907	3.87	1	For STGF	Fine	1/3
08944	16.72	4 pack	Replacement needles	Fine	1
08938	14.90	5000	Natural	3/4"	1/3
08939	14.90	5000	Natural	2"	1/3

DENNISON SYSTEM1000 TAGGING TOOL



SYS1000



760796901

**DENNISON SYS1000
NEEDLE LOCKS**



**DENNISON
STANDARD
REPLACEMENT
NEEDLES**

08941



**DENNISON SYS1000
FASTENERS**
(08284/5)

Dennison System 1000

SYS1000	49.90	1	PURPLE Tagging Tool	Standard	2/7
760796901	2.58	1	Needle Locks: For SYS1000	Standard	1/3
08941	18.10	4 pack	Replacement needles	Standard	1
08284	17.90	5000	Natural	1"	1/2
08285	17.90	5000	Natural	2 1/2"	2/10

Tagging & Marking PRICING SUPPLIES

style #	\$	qty	description	size	wgt
DH	13.99	1000	Black		2/3
DH500	9.49	500	Black	1 3/4"	1/3
DH-WH	14.99	1000	White		2/3
DHWH500	9.49	500	White		1/3
<hr/>					
SC3	15.90	5000	Natural	3"	1/3
SC5	15.90	5000	Natural	5"	1/3
SC9	17.90	5000	Natural	9"	1/3
<hr/>					
08302	34.90	5000	Natural	3"	1/3
08300	29.90	5000	Natural	5"	1/3
<hr/>					
08350	69.21	5000	Natural	5"	2/3
08350M	41.47	5000	Natural	5"	2/3
08470	39.90	1000	Natural	7"	2/7
08471	44.90	1000	Natural	11"	2/7
08401	55.90	1000	Black (solid barlock)	8"	2/7

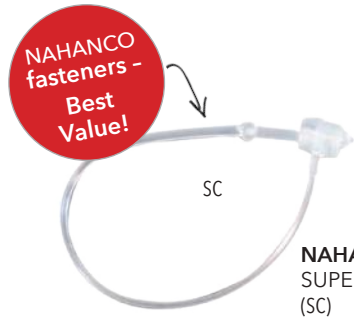

DISPLAY-IT-HOOK (DH)
You'll find hundreds of uses for this inexpensive display method



NAHANCO SUPER CIRCLE FASTENERS - 3", 5", 9" (SC)



DENNISON SECURE-A-TAC - 5" (08300/2)



**DENNISON SECURE-A-TIE - 5"
ECONOMY SECURE-A-TIE - 5"**



DENNISON BARLOCK LADDER TIES



Dennison Marking Tools

09225	49.90	1	Pricing Tool Single line		2/7
09140	66.99	15M	Labels: White	1/2x7/8"	
09141	66.99	15M	Red	1/2x7/8"	1/3
H89891	13.87	5 Pack	Ink rolls - black		1/2
<hr/>					
06220	89.90	1	Pricing Tool Double line		2/7
06298	66.99	12.5M	Labels: White	5/8x7/8"	2/3
06302	66.99	12.5M	Red	5/8x7/8"	
H89892	13.87	5 Pack	Ink rolls - black		1/2

DENNISON MARKING TOOLS

DENNISON 09225 THE MIGHTY ONE™
Prints 1 line, 8 characters

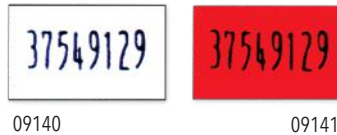

**INK ROLLER
H89891**



DENNISON 06220 MODEL 210 HAND LABELER
Prints 2 lines, 10 characters

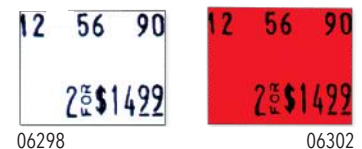

**INK ROLLER
H89892**



PRICING SUPPLIES Marking Tools

Monarch Marking Tools



MONARCH 1110-2
Prints 1 line, 6 characters



INK ROLLER
3003

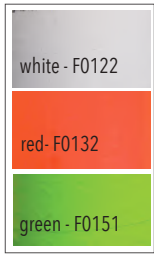

LABELS



1130 TOOLS
Prints 1 line, 6 characters



1130-IR



SILICONE LUBRICANT
3002

PLASTIC LABEL PEELER
3104-1



MONARCH 1115-4
Prints 2 lines, 8 characters

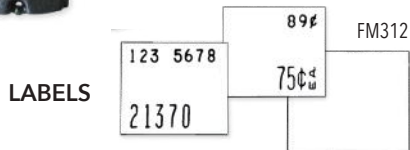

INK ROLLER
3004

style # \$ qty description size wgt

Monarch Marking Tools

style #	\$	qty	description	size	wgt
1110-2	91.63	1	Pricing Tool Single Line		2/7
REB111	22.29	17M	Labels: White	3/8x3/4"	
REB135	24.90	17M	Red/Yellow	3/8x3/4"	2/3
REB112	17.90	17M	Red	3/8x3/4"	
3003	6.99	1	Ink roller replacement		2/3

1130	74.26	1	Pricing Tool, Compact Size Single line		1/3
F0122	27.73	25M	Labels: White	.62x.44"	
F0132	34.73	25M	Red	.62x.44"	2/3
F0151	48.60	25M	Green	.62x.44"	
1130-IR	8.42	1	Ink roller replacement		1

3002	12.57	1	SILICONE	1/2 oz.	1
3104-1	2.85	1	PLASTIC	5"	1

1115-4	139.90	1	Pricing Tool Double Line		2/7
FM312	26.44	15M	Labels: White	5/8x3/4"	2/3
3004	6.99	1	Ink roller replacement		1

Tags & Labels PRICING SUPPLIES

style #	\$	qty	description	size	wgt
Unstrung T1	11.49	1000	Specify	1 3/8x2 3/4"	2
T1-12,13,19	11.49				
Strung T1S	24.36	1000	Specify	1 3/8x2 3/4"	2
Unstrung T2-1	11.49	1000			
T2-3,4,5,9,10, 12,14-16	11.49		Specify	1 3/4x2 7/8"	2
T2-13	11.49	1000			
T2-19	11.49				
T3-3	8.99	1000			
T3-1,4,5,9,12, 13-15	8.99		Specify	1 1/4x1 7/8"	2
T3-16	8.99	1000			
T3-10,19	8.99				
Strung T2S-5,9	24.49	1000	Specify	1 3/4x2 7/8"	2
T2S-1,3,4,10, 12-16,19					
T3S-5					
T3S-1,19	21.51	1000	Specify	1 1/4x1 7/8"	2
T3S-3,4,9,10, 12-16					
Unstrung T4	11.49	1000	White	1 3/4x2 7/8"	2
T5	8.99			1 1/4x1 7/8"	2
Strung T4S	16.72	1000	White	1 3/4x2 7/8"	2
T5S	18.79			1 1/4x1 7/8"	2
Unstrung 641	26.44	1000	Red/white	1 7/8x3 1/2"	3
510	18.01			1 3/4x2 7/8"	2
Strung 641S	36.16	1000	Red/white	1 7/8x3 1/2"	3
510S	24.36			1 3/4x2 7/8"	3
Unstrung 328	17.90	1000	Red/white	1 3/4x2 7/8"	2/3
328C	17.90		Red/yellow	1 3/4x2 7/8"	2/3
316	12.57		Red/white	1 1/4x1 7/8"	1/3
316C	12.57		Red/yellow	1 1/4x1 7/8"	1/3
Strung 328S	18.90	1000	Red/white	1 3/4x2 7/8"	3
328CS	18.90		Red/yellow	1 3/4x2 7/8"	2
316S	18.90		Red/white	1 1/4x1 7/8"	2
316CS	18.90		Red/yellow	1 1/4x1 7/8"	2
Unstrung 200	18.01	1000	Red/white	1 3/4x2 7/8"	2
380			Red/yellow	1 3/4x2 7/8"	
320			Red/white	1 3/4x2 7/8"	
Strung 200S	24.36	1000	Red/white	1 3/4x2 7/8"	2
380S			Red/yellow	1 3/4x2 7/8"	
320S			Red/white	1 3/4x2 7/8"	
Unstrung 348	18.01	1000	Red/white	1 3/4x2 7/8"	2/3
346	13.87			1 1/4x1 7/8"	
Strung 348S	24.36	1000	Red/white	1 3/4x2 7/8"	2
346S	21.51			1 1/4x1 7/8"	1

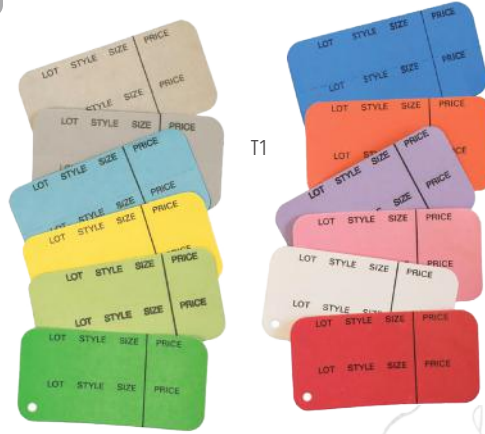

COUPON TAGS HORIZONTAL

- T1 /T2 /T3 available in:
- (1) white
 - (2) lavender
 - (3) grey
 - (4) dark blue
 - (5) pink
 - (9) yellow
 - (10) red
 - (12) lavender
 - (13) buff
 - (14) orange
 - (15) light green
 - (16) dark green
 - (19) light blue

1 3/8" x 2 3/4"

COUPON TAGS VERTICAL



T2 / T3



T4 / T5

CLEARANCE TAGS



SALE TAGS

SPECIAL TAGS



DISCOUNT TAGS

PRICING SUPPLIES Tags & Labels



SLIT TAGS
Slip over existing tag

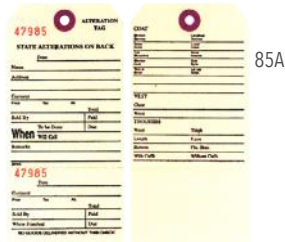

ALTERATION, LAYAWAY AND REPAIR TAGS



DELUXE LAYAWAY ALTERATION



4473TAG
BLANK TAG



PRESSURE SENSITIVE LABELS



4S
5S
6S
7S
8S



4NS
5NS
6NS
7NS
8NS

MERCHANDISE TAGS

(4S - 8NS)
Available strung or unstrung.



KRAFT TAGS

Shipping & Merchandise tags



MANILA ALL-PURPOSE TAGS (APT)

Available strung or unstrung.

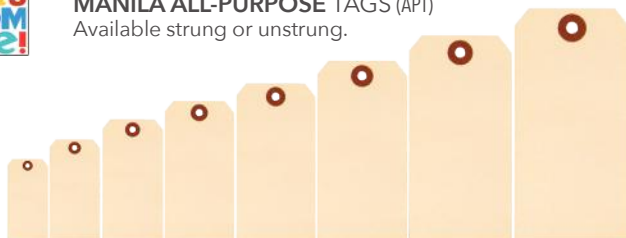

style #	\$	qty	description	size	wgt
HOLD	16.90		Blue/white	2 3/8x4 3/4"	
SOLD	16.90	1000	Red/white	2 5/8x4 1/4"	5
SALE	27.90		Red/yellow	2 3/8x4 3/4"	

85L	39.90		2 sided, manila Strung	3 1/2x8 1/2"	6
85A	22.94	500	Unstrung, Button hole	3 1/2x6 1/4"	
TL			1 sided, strung	3 1/8x6 1/4"	4
TA	35.38	500	manila		
TR					

975				1"	
970	8.42	500	Red/white	1"	1
962				1x1 1/4"	
965				1x1 1/4"	

4473TAG	5.44	250	White	1 3/4x2 7/8"	1
---------	------	-----	-------	--------------	---

Strung					
4S	18.01			1 x 1 1/2"	1/2
5S	17.37	1000	White	1 1/8x1 13/16"	1/2
6S	18.01			1 5/16x1 15/16"	2/3
7S	22.29			1 1/2x2 1/4"	2/3
8S	23.59			1 3/4x2 11/16"	2/3

Unstrung					
4NS	7.00			1 x 1 1/2"	1
5NS	8.42	1000	White	1 1/8x1 13/16"	1
6NS	8.42			1 5/16x1 15/16"	2/3
7NS	9.07			1 1/2x2 1/4"	2/3
8NS	12.57			1 3/4x2 11/16"	2/3

Kraft Shipping Tags, Unstrung:					
APT5NKFT	4.92	50	Large	2.375" x 4.75"	1/1
APT2NKFT	4.14	50	Small	1.625" x 3.25"	1/1

Kraft Merchandise Tags, Strung:					
8SKFT	5.57	50	Large	1.75" x 2.875"	1/1
6SKFT	4.92	50	Small	1.25" x 1.875"	1/1

Strung					
APT1	28.50	1000		2 3/4x1 3/8"	2
APT2	29.80	1000		3 1/4x1 5/8"	2
APT3	31.09	1000		3 3/4x1 7/8"	3
APT4	37.57	1000	Manila	4 1/2x2 1/8"	3
APT5	40.16	1000		4 3/4x2 3/8"	4
APT6	42.76	1000		5 1/4x2 5/8"	5/6
APT7	24.61	500		5 3/4x2 7/8"	3
APT8	27.20	500		6 1/4x3 1/8"	3

Unstrung					
APT1N	15.54	1000		2 3/4x1 3/8"	2
APT2N	19.43	1000		3 1/4x1 5/8"	3
APT3N	20.72	1000	Manila	3 3/4x1 7/8"	3/4
APT4N	22.02	1000		4 1/2x2 1/8"	4
APT5N	27.20	1000		4 3/4x2 3/8"	4/6
APT6N	29.80	1000		5 1/4x2 5/8"	6
APT8N	23.32	500		6 1/4x3 1/8"	3

GARMENT BAGS

style #	\$	qty	description	size	wgt
K30	116.49	1	Chrome Bagjack adjusts 39-68"H	18x31x74H	29
K31	69.90	1	Chrome Bagjack adjusts 39-68"H	13" x 18"	14
K32	83.46	1	Chrome Bagjack adjusts 39-68"H	Base: 12" dia.	14

LARGE RUN CUSTOM POLYBAGS

Minimum 50 rolls (can mix sizes same color bag and print).

Customer must supply camera-ready artwork.

Black or white bags - stock ink colors include: red, blue, black, white, orange, yellow, green. One time plate charge of \$75.00

Call us for a low, low price quote!

NTP330	840	Clear	21x4x30"	
NTP338	663	1/2 mil	21x4x38"	
NTP340	55.47	562	opening at top of each bag	21x7x40"
NTP354	466			21x4x54"
NTP372	350			21x4x72"
X336	75.69	999		21x3x36"
X354	75.69	666	Clear	21x3x54"
X372	75.69	500	1/2 mil	21x3x72"
U336	75.69	519	Clear	21x3x36"
U354	75.69	333	1 mil	21x3x54"
U372	75.69	249		21x3x72"
W336	85.28	500		21x3x36"
W354	85.28	333	White	21x3x54"
W372	85.28	249	1 mil	21x3x72"
B336	500			21x3x36"
B354	84.63	333	Black	21x3x54"
B372	249		1 mil	21x3x72"
HL38L	60.99		Dark Blue	38"
HL48L	68.49	1	Dark Blue	48"
HL57L	75.49		Dark Blue	57"

UV340BB	198.99	100	Black poly	24 x 40"	29/33
NW40BB	217.99	100		24 x 40"	22
NW48BBTUX	81.99	50	Black w/ID pocket	24 x 48"	24
NW54BB	156.69	50		24 x 54"	27
NW455B	217.99	50	Black w/handles and 4" gusset	24 x 45"	32

Customize "NW" styles with a a minimum order of 100 PIECES

POLYBAG STANDS



GARMENT BAG DISPENSER /SINGLE ROLL POLYBAGS

Base made of 1" square tubing w/ball bearing mounted platform for ease of turning

K31



3-ROLL BAG DISPENSER

Base made of 1" square tubing

K30



K32



BAGGING JACK

For polybags; with heavy weight base

POLYBAGS



GARMENT BAGS (POLYBAGS) ON A ROLL

- 1/2 mil Medium Weight Clear Poly Bags (NTP, X)
- 1 mil Super Weight Clear Poly Bags (U)
- 1 mil Super Weight Poly Bags in White (W) or Black (B)

TRANSPORTATION GARMENT BAGS

Water-repellent cotton duck w/ full length heavy-duty zippers and 15" hanging bar (with accessory pocket)

Holds up to 25 garments



HL38L
HL48L
HL57L



40" SUIT COVERS

Polyethylene (taffeta finish), 3 gauge



UV340BB

GARMENT BAGS



NW40BB / NW48BBTUX

NON-WOVEN SUIT COVERS

Cloth-type covers



NW455B

NON-WOVEN FUR COVERS

Cloth-type covers

GARMENT BAGS



ZIPPERED SUIT COVERS
3 gauge, taffeta finish
S40 / S54

SEWN SHOULDER COVERS



N8X21

CRYSTAL CLEAR GUSSETED VINYL GOWN COVERS
Reinforced hanger opening and full-length zipper. 4 gauge



Gusset detail

BB54
BB60
BB66
BB72



BLK72

W72

PNK72

HEAVY-DUTY EMBOSSED VINYL BRIDAL GOWN COVERS

Features a clear vinyl pouch. 3 gauge

MUSLIM GOWN COVERS
Cloth covers w/ button closures



MDGB1



NW7210/206
WHITE NON-WOVEN BRIDAL COVER
Cloth-type material



HEAVY-DUTY FULL LENGTH GOWN COVERS

Clear vinyl pouch and reinforced hanger opening. 3 gauge

WGS72



C54

OVERLAP CLEAR COVERS
Heavy binding, reinforced hanger opening and extra-wide overlap. 2 gauge

style #	\$	qty	description	size	wgt
S40	206.99 200.49	100	Clear White or Black	24 x 40"	34
S54	261.99	100	Color - specify Clear, White, or Black	24 x 54"	36
N8X21	75.99	100	Clear /2 gauge	8 x21"	6/10
10" Gusset / Imprint available					
BB72	69.49		CLEAR	24 x 72"	12
BB66	65.49	12	CLEAR	24 x 66"	11
BB60	60.49		CLEAR	24 x 60"	10
BB54	56.49		CLEAR	24 x 54"	10
BLK72	50.49		Black Vinyl	24" wide at top; 36" at bottom; 72" long	9/10
W72	50.49	12	White Vinyl		
PNK72	54.99		Pink Vinyl		
MDGB1	35.99	1	Natural muslim garment bag for gowns with a 4" gusset and button closures	62 x 24"	?
NW7210	221.49	50	Non-woven white cloth 10" gusset	24 x 72"	35
NW72206	144.49	25	Large 7"-20" full side gusset	24 x 68"	25
Customize "NW" styles with a minimum order of 100 PIECES					
WGS72	58.49	12	Full 10" Gusset White Vinyl	24 x 72"	11/12
C36	19.99		Clear Vinyl	24 x 36"	4/7
C54	25.99	12	Clear Vinyl	24 x 54"	6/8
C72	38.49		Clear Vinyl	24 x 72"	7/8

Collapsible Racks RACKS & MERCHANDISERS

COLLAPSIBLE RACKS

RCS-1

Chrome; 1" round tubing w/4" casters; 22 1/2" wide.
Adjustable height: 55" - 60" - 65"; 48" hangrail tubing w/12" pullouts;
weight capacity of 200 lbs.
1/carton; 16/24lbs. **\$59.90**

RCS2

Heavy Gauge Chrome. Lightweight, foldable rolling rack with a weight capacity of 250 lbs. Features include: adjustable height risers - 66" - 71"; Center bar that extends 8" on either side; 4 casters
1/carton; 17lbs. **\$41.90**



RCS-1		RCS2
\$69.99	cost	\$63.90
Actual 16lbs /shipping 24lbs	weights	Actual 17lbs/shipping 17lbs
Holds up to 400 lbs	capacity	Holds up to 300 lbs
55" - 65"H 48"L x 22.5"W	measurements	65.5" - 70"H 48"L x 22.5"W
NO locking wheels	wheels	TWO locking wheels
4.45"H collapsed	compact	3"H collapsed

style #	\$	qty	description	wgt
---------	----	-----	-------------	-----

RCS1AO	\$13.90	each	Add on hang bar to create a lower level for hanging (works with both RCS-1 & RCS2)	4/5 lbs
--------	---------	------	--	---------

RCA5	\$54.04	each	Chrome: Opened, 45" x 38" /Folded, 45" x 19" Screen only, rack not included (for RCS-1 rack) Includes two connecting brackets, one stabilizing hook, and 3" wheels with 3/8" stems. Fold in half to serve as merchandise shelf.	13/19 lbs
------	---------	------	--	-----------

BRSWF	\$63.89	each	Black heavy canvas carrying bag for collapsible rolling rack RCS1 (see RCS-1 pg 24)	4/12 lbs
-------	---------	------	---	----------

RCA100	\$98.50	each	60"L x 50"H x 24"W Deluxe zipper garment rack cover. Navy blue nylon	3/10 lbs
--------	---------	------	---	----------

COLLAPSIBLE ROLLING RACKS

Fold flat for easy transportation and storage



BOTH RACKS HAVE:



12" extending sides



Clip for storage



Adjustable heights

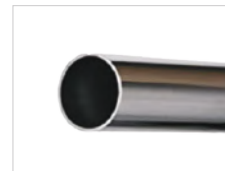

Heavy duty steel frame

RCS-1/RCS2 ACCESSORIES

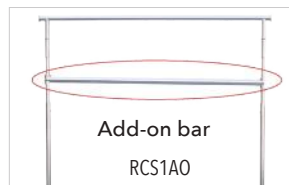

Add-on bar
RCS1AO

Shelf/Display Screen



RCA5

Garment Rack Cover



RCA100



Carrying Bag BRSWF

RACKS & MERCHANDISERS Rolling Z Racks

STANDARD Z RACKS

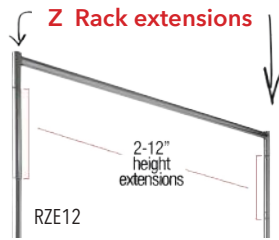

NESTING Z RACKS

Industrial "Z" Rack
Racks nest together
to save space



HEAVY DUTY Z RACKS

Z RACK COVER

Z2464



UNIVERSAL RACK COVER

style #	\$	qty	description / size	wgt
Z101	\$74.90	1	Chrome finish stockroom rolling Z clothes rack	33/70
			<ul style="list-style-type: none"> • 73" overall height, 60"L x 69"H x 21W" • Ideal for use in showrooms and warehouses • Will nest together for easy storage when not in use • Heavy Z base is one piece construction • The hangrail is made of 1-1/4" round tubing • Includes 4" industrial rubber casters 	
RZE12	\$10.50	2	2 - 12" height extensions for Z101	33/20
RZH60	\$28.51	1	60" add on hangrail for Z101	2
Z201	\$94.99	1	Chrome finish industrial rolling Z clothes rack	34/39
			<ul style="list-style-type: none"> • 63"L x 66"H x 22"W with a blue base • Heavy duty Z base is one piece construction • Will nest together for easy storage when not in use • Features 4" industrial casters • Hangrail made of 1 1/4" square tubing and is 58 1/2" in length • Ideal for showrooms and warehouses • Ships Oversized UPS 	
Z2464	\$78.41	1 set	Clear Z-rack cover and 2 support bars set for Z101 & Z201; 63.5"W x 69.5"H x 22.5"D	4/4
NHRCPB100	\$82.99	100 pc/ctn	Rack cover: large, flat polly bag; 58"W x 100"L; 1 mil. thick	43
NHRCPB25	\$33.99	25 pc/ctn	Rack cover: large, flat polly bag; 58"W x 100"L; 1 mil. thick	10

Utility Racks RACKS & MERCHANDISERS

style #	\$	qty	description / size	wgt
---------	----	-----	--------------------	-----

RCS3	\$82.80	1	Chrome, 22" wide 1" round chrome tubing Double 48" hangrails with four 12" pull-out rods Height adjustable from 55 to 60 to 65" 4" ball bearing casters	40/45
------	---------	---	---	-------



HEAVY DUTY COLLAPSIBLE RACK

EL8000	\$79.90	1	Classic Utility Rack w/ 5 shelves 38" L x 14"W x 60" H (61.5"H w/casters) Zinc-plated industrial-strength steel SHIPS TRUCK	29/29
--------	---------	---	--	-------



HEAVY DUTY UTILITY RACK

CLASSIC UTILITY RACK w/5 WIRE SHELVES



EL8162	\$199.90	1	Chrome Utility Rack 6 Shelves 48"W x 18"D x 72"H 2 3/4" dia. casters	98
--------	----------	---	---	----

EL9000	\$209.90	1	Utility Rack with four casters; holds up to 2500 lbs (250 lbs per shelf); 36"Wx18"Dx72"H; Includes leveling feet and 3" rubber wheels; easy assemble - no tools required	49
--------	----------	---	--	----

HEAVY DUTY MOBILE SHELVING UNIT /UTILITY RACK



K43	\$90.20	1	60" L, 1 1/4" hangrail Adjusts in height from 54 - 74"; 20" W; 3" casters	27
-----	---------	---	---	----

Pairs with casters **WHEL** and **TW10KIT** (details on page 80)



STOCKROOM ROLLING RACK

R504	\$98.90	1	70"H x 66"L 1 1/4" chrome tubing 4" ball bearing casters Ships Oversize UPS	34
------	---------	---	---	----



HEAVY DUTY INDUSTRIAL ROLLING RACK

The original garment center workhorse.
Base is all-welded construction with heavy steel angle iron.
Large 4" ball casters for easy mobility under heavy loads.

R504AO	\$24.36	1	Add on hangbar for R504 to create a lower level for hanging	8/8
--------	---------	---	---	-----



RACKS & MERCHANDISERS Floor Racks



DOUBLE BAR RACKS

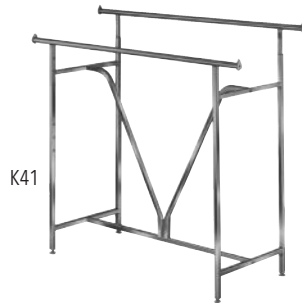

style #	\$	qty	description / size	wgt
K40	\$83.16	1	Chrome: 1" Square tubing 1 1/4" round hangrails 60"L x 22" W Height adjustable every 3" from 48-66"	38
K41	\$99.90	1	Same as K40 but with center V reinforcing	40



Both K40 and K41 pair with casters
WHEL and **TW10KIT**
(see details on page 80)

RACK ACCESSORIES

(for racks K40 /K41)

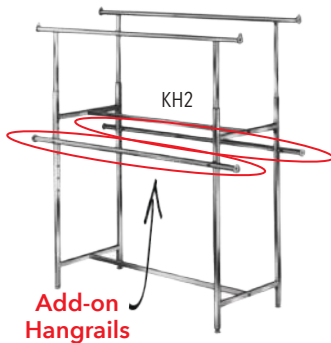

Add-on hangrail



2 per pack



Double-Bar Grid Clothing Rack Topper 1000034

KH1	\$29.16	2	Chrome: 60" add-on hangrail for K40 or K41 racks allows you to create 15' of continuous hangrails using only 2 racks	8
KH2	\$35.38	2	60" add-on hangrail for K40 or K41 racks allows you to create upper and lower hanging	8

1000034	\$81.99	1	Chrome grid topper 23"x54"x3" <i>Ships oversize UPS</i>	14/32
---------	---------	---	---	-------



FOLDING LINGERIE DISPLAYERS



K35	\$129.90	1	Chrome: 1" Square tubing 16-twist on 12" tubular arms 61" H	34
K36	\$129.90	1	1" Square tubing 16-twist on 1/2"x7/8"x12" rectangular arms 61" H	35

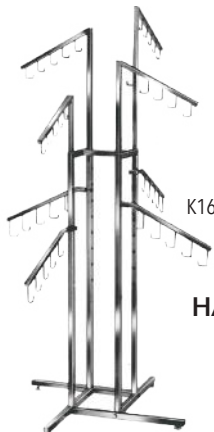

HANDBAG DISPLAYER

K16	\$129.90	1	Chrome: 1" Square tubing 8- 18" slant arms Total of 40 hooks	33
-----	----------	---	---	----

K16 pairs with a variety of casters -
CTM65, CTM75, TW12 & TW12LK (details on page 80)



Floor Racks RACKS & MERCHANDISERS

style #	\$	qty	description / size	wgt
K23	\$72.90	1	Chrome Rectangular tubing 2-16" straight arms. Adjust every 3" from 48-72" H	32
K24	\$72.90	1	Chrome Rectangular Tubing 2-18" slant arms. Adjust every 3" from 48-72" H	34
K21X	\$106.27	1	Chrome / 2-16" straight arms with X style base and 4 casters. Arms adjust every 3" from 48-72" H	27



CHROME 2-ARM RECTANGULAR TUBING RACKS



1/2" W x 1 1/2" H rectangular tubing arms:

B90	\$79.06	1	Straight arm is 16"	7/10
B91		1	Slant arm is 18"	7

Both racks are independently adjustable every 3", from 52" to 73" H

MATTE BLACK ADJUSTABLE 2-ARM RACKS



K20	\$59.90	1	1" square tubing 16" straight arm	18,6,5/8 (3 ctns)
K22	\$59.90	1	18" slant arm	23/33
K25	\$59.90	1	Arms adjust every 3" from 48-72" H	18,6,6/8 (3 ctns)



CHROME 2-ARM SQUARE TUBING RACKS

K39	\$49.90	1	Chrome - 45" H x 19 1/2" W Square tubing upright w/2 round tubing arms with disc ends	10/13
-----	---------	---	---	-------



CHROME BAG RACK

ARM13	\$7.39	1	16" Chrome straight arm for square tubing racks	6/8
-------	--------	---	---	-----



REPLACEMENT ARM

For Square tubing racks:

TV17	\$7.00	1	17" Chrome Rectangular tubing - for vertical 1" tubing /add-on twist-on arms for square tubing racks	
TV12	\$5.57	1	12" Chrome Square tubing For vertical 1" tubing	1/6
TV16	\$6.35	1	16" Chrome Square tubing For vertical 1" tubing	

Twist on Displays for 1" Square Tubing



ADD-ON DISPLAY BARS

RACKS & MERCHANDISERS Floor Racks

4-WAY GARMENT RACKS with Rectangular Tubing

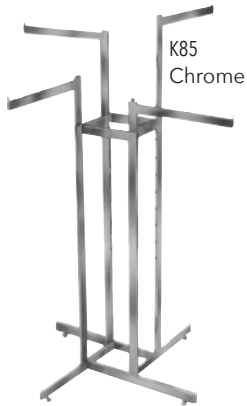

4-ARM SQUARE TUBING RACKS



1" Square
tubing



HIGH CAPACITY FLOOR RACKS



style #	\$	qty	description / size	wgt
K85	\$118.32	1	Chrome 4- 16" Straight arms Rectangular Tubing	33/35
B85	\$118.32	1	Black 4- 16" Straight Arms Rectangular Tubing	36

Racks K85 & B85 pair with caster style
CTM60 (details on page 80)



CTM60

B86	\$118.32	1	Black, 2- 16" Straight arms; 2- 18" Slant arms Rectangular Tubing	38
-----	----------	---	---	----

Rack B86 pairs with caster style
CTM60 (details on page 80)



CTM60

K10	\$79.90		1" square tubing 16" straight arm	
K12	\$79.90	1	18" slant arm Arms adjust every 3"	30
K15	\$79.90		from 48-72" H	

K10, K12 & K15 pair with casters from kit
TW10KIT (see details on page 80)



K80	\$145.02		Chrome, 4- 22" Straight arms; Rectangular tubing	34
B80	\$121.05	1	Black 4- 22" Straight arms Rectangular tubing	36
K80SC	\$172.63		Satin Chrome 4-22" Straight arms Rectangular tubing	38

The above 3 racks pair with caster style
CTM60 (details on page 80)



CTM60

All of the above racks listed on this page
adjust in height every 3" from 48" to 72" high

ARM85	\$18.01	1	16" Chrome Straight arm for rectangular tubing racks	6
-------	---------	---	--	---

For Rectangular tubing racks:

RV16	\$6.99	1	16" Chrome Rectangular tubing; For vertical 1/2" x 1 1/2"	2/6
RV22	\$6.99		22" Chrome Rectangular tubing; For vertical 1/2" x 1 1/2"	



ADD-ON DISPLAY BARS

Twist on
Displays
for Vertical
1/2" x 1 1/2"
Rectangular
Tubing



Round Racks RACKS & MERCHANDISERS

style #	\$	qty	description / size	wgt
K50	\$99.90	1	36" round chrome rack Ships oversize UPS	8/17, 26 (2 ctns)

Works with casters from kit
TW10KIT (see page 80 for details)

Racks adjust every 3" from 48" to 66"; uprights are 1" square tubing; round 1 1/4" hangrail; includes shelf supports.

K53	\$114.49	1	36" chrome round revolving rack; 34/90 Adjusts in height from 48-63"	
-----	----------	---	---	--

KH5	\$43.68	1	36" add on hangrail for K50/K52WD Ships oversize UPS	8/17 26 (2 ctns)
-----	---------	---	---	------------------------

KH7	\$27.09	4	Clamps to add a ring	4
-----	---------	---	----------------------	---

1000394	\$75.49	1	30" Chrome grid topper	9/31
---------	---------	---	------------------------	------

G30	\$99.90	2	2 pieces per carton 30" glass topper, 3/16" thick for use with 36" round racks	52
-----	---------	---	--	----

G36	\$50.49	1	1 piece per carton 36" glass topper, 1/4" thick for use with 42" round racks	30
-----	---------	---	--	----

G30/G36 ships UPS oversized - charges will apply

RTW30 RTB	\$45.23	1	30" round white topper 30" round black topper for use with 36" round racks	14
--------------	---------	---	--	----

SHP1	\$1.49	1 / each	Topper support *4 needed for each rack	1
------	--------	-------------	--	---

Racks with **WELDED CONSTRUCTION**
(allows for heavy loads)

K52WD	\$149.90	1	36" round chrome rack Ships truck	TRUCK 35/90
-------	----------	---	---	----------------

Works with **CTM60** caster style - (details on page 80)

K71WDSC	\$149.90	1	36" Satin chrome; adjusts from 48"-66" H Ships truck	TRUCK 39/90
---------	----------	---	---	----------------

K73WD	\$142.99	1	42" round chrome rack Ships truck	TRUCK 38/90
-------	----------	---	---	----------------

Works with **TW10KIT** casters - (details on page 80)

K73WDSC	\$179.90	1	42" round satin chrome rack Ships truck	TRUCK 38/90
---------	----------	---	--	----------------

Works with **CTM75** casters - (details on page 80)

KR57MAB	\$181.90	1	42" Black - same as K73 Ships truck	TRUCK 48/90
---------	----------	---	---	----------------

Works with **CTM75** casters - (details on page 80)

Racks adjust from 48" to 70" H; uprights are 1" square tubing; square tubing legs taper at bottom to allow casters to fit snugly; hangrail is made of 1" x 1 1/2" rectangular tubing; includes shelf supports

K62	\$126.96	1	43" half round rack; Adjusts in height every 3" from 49-73" / 1" sq. tubing / round hangrail	25/34
-----	----------	---	---	-------



ROUND GARMENT RACKS



K53
Cannot be used with casters

ROUND RACK ACCESSORIES



CHROME GRID (1000394)
attached to a K50 rack



GLASS OR MELAMINE ROUND TOPPERS



ROUND RACKS

Welded Construction
Can be used with casters



KR57MAB



HALF-ROUND RACK



K62

RACKS & MERCHANDISERS Accessories

REPLACEMENT WHEELS

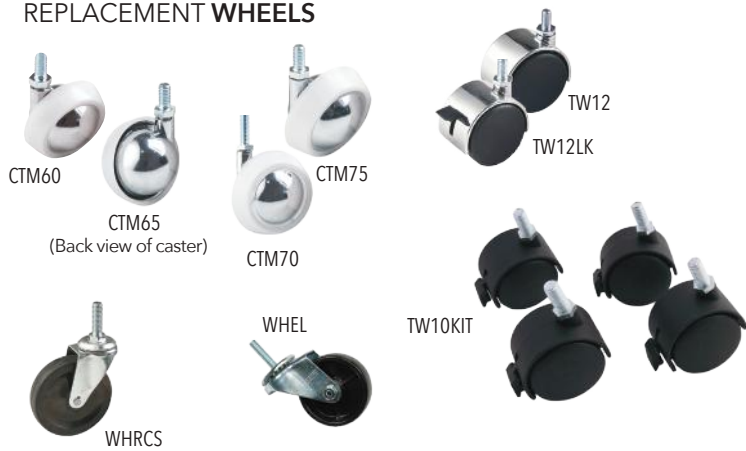

style #	\$	qty	description / size	wgt
CTM60	9.72		2" ball caster, 1" stem	
CTM65	9.07		2" ball caster, 5/8" stem	
CTM75	10.50	1	2 1/2" ball caster, 5/8" stem	1/3
TW12	5.44		2" twin wheel caster, 5/8" stem	
TW12LK	4.15		2" twin wheel caster, 5/8" stem w/ locking brake	
TW10KIT	8.81	1 set	set of (4) 2" wheels, 3/8" stem; (2) w/locking brakes; (2) w/out Works w/ racks: K73WD, K87, B87, K40, K41, K43, K10, K12, K15	2/2
WHRCS	36.81	4	Replacement casters - 4" for RCS-1, RCS2, RCS3	6
WHEL	37.32	4	Heavy duty replacement casters - 2 locking and 2 non-locking; 2 3/4" dia. K40 / K41 / K43	5

BLACK BEAUTY RACKS

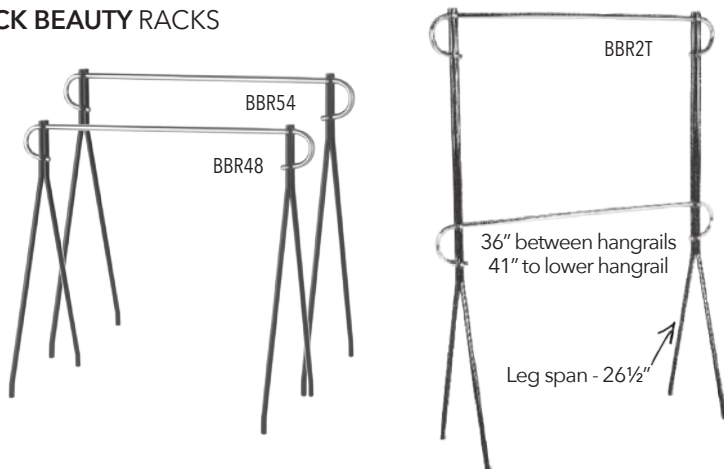

BBR2T	92.39		76" H x 5' L	26
BBR48	52.10	1	48" H x 5' L	14
BBR54	53.49		54" H x 5' L	16

Black with chrome hangrails

TIE & BELT DISPLAYERS



K56	99.90	1	60" H Chrome Upper ring 19" diameter w/ 20 - 3" hooks Lower ring 27" D w/ 28 - 3" hooks 18" diameter base	11,17,15 (3 ctns)
K58	97.90		52" H Chrome 19" diameter ring w/ 20 - 3" hooks 18" diameter base	23, 4/90 (2 ctns)

MANNEQUIN FORM NOTCHED COSTUMERS



K29	53.90	1	Chrome Spiral Costumer Spiral w/ 29 balls - 65" H round tubing, 18 1/2" base	26
VM504BR	79.90	2	Notched Costumer Satin Chrome Adjusts every 3" from 49 - 78" high	11, 15 (2 ctns)
VM504MTW	79.90	2	Notched Costumer Matte White Adjusts every 3" from 49 - 78" high	11, 14 (2 ctns)
VM504MAB	79.90	2	Notched Costumer Matte Black Adjusts every 3" from 49 - 78" high	11, 15 (2 ctns)

Pipeline RACKS & MERCHANDISERS

PIPELINE GARMENT RACKS

Racks have an anthracite grey or a gloss white finish, where noted.
Each garment rack includes 3" casters, two locking & two non-locking.



Non-adjustable Ballet Bar Rack
64" high; Base: 51"W x 23-3/8"D; 1 piece; 31 lbs.

Anthracite Grey - NHPSBB
Gloss White - NHPSBBWTE

\$141.13



Adjustable Ballet Bar Rack

Height adjusts from 48" to 72" high.
Base: 51"W x 23-3/8"D; 1 piece; 35 lbs.

Anthracite Grey - NHPSBBADJ **\$203.86**
Gloss White - NHPSBBADJWTE **\$180.14**



Add-On Hangbar

Only fits the adjustable ballet bar racks
NHPSBBADJ, NHPSBBCB1ADJ &
NHPSBBCB2ADJ; 1 piece; 6 lbs.

Anthracite Grey - NHPSAOH **\$56.76**
Gloss White - NHPSAOHWH **\$51.99**



60" Wide Ballet Bar Rack

64" high; Base: 60"W x 23-3/8"D; 1 piece; 31 lbs.

Anthracite Grey - NHPSBB60

\$160.19



60" Wide Adjustable Ballet Bar Rack

Height adjusts from 48" to 72" high.
Base: 60"W x 23-3/8"D; 1 piece; 38/46 lbs.

Anthracite Grey - NHPSBB60ADJ
Gloss White - NHPSBB60ADJWH

\$203.86

Double Tier Ballet Bar Rack

Top Bar height adjusts
from 63" - 78" high.

Lower Bar Height
adjusts from
45" - 60" high.

Tier step differen
measures 18".

Base: 49 5/8"W
x 23 1/4"D; 1 piece;

34/40 lbs.

Anthracite Grey - NHPSBBDTADJ **\$172.99**



Adjustable Double Ballet Bar Rack

Each 50" Long hangbar adjusts from 50" to 78" high.
Base: 50"W x 29"D; 1 piece; 61 lbs.

Anthracite Grey - NHPSBLLADJ **\$295.62**
Gloss White - NHPSBLLADJWH **\$258.99**

Double Ballet Bar Rack with Top

Frame Only -
NHPSBB2TS
48"W x 24"D x 52"H;
1 piece; 31 lbs.

\$288.99

NHPSBB2TS - MDF
Optional Top in Darkwood
measures
28" x 60" x 1.5";
1 piece; 51 lbs.

\$144.99



more PIPELINE →

RACKS & MERCHANDISERS Pipeline

PIPELINE GARMENT RACKS



Adjustable 4-Way Rack

16" long arms adjust from 48" to 72" h;
base measures 30"; 1 piece; 44 lbs.
Anthracite Grey - NHPSA4; \$204.64
Gloss White - NHPSA4WH; \$177.99



Double Bar Rack

48"L x 22"W; 60" Long Hangbars adjust from
53-1/2" to 80" high; 2 pieces; 2ctns. 52, 10 lbs.
Anthracite Grey - NHPSDBR; \$247.92
Gloss White - NHPSDBRWH; \$225.99



Adjustable 36" Round Rack

Adjusts from 45" to 67" h;
four (4) rubber tipped shelf supports
(takes 30" round toppers - see pg 30);
1 piece; 49/52 lbs.
Anthracite Grey - NHPSR36; \$198.99
Gloss White - NHPSR36WH; \$198.99



Adjustable Ballet Bar Rack

w/one crossbar
41"W x 22"D; 44-72" high;
13" faceouts;
1 piece; 36 lbs.
Anthracite Grey -
NHPS2CBADJ
\$168.99



Adjustable Ballet Bar Rack w/one crossbar

41"W x 22"D; 44-72" high; 13" faceouts; 1 piece; 37 lbs.
Anthracite Grey - NHPSBBCB1ADJ; \$184.99
Gloss White - NHPSBBCB1ADJWH; \$184.99



Adjustable Ballet Bar Rack w/two crossbars

41"W x 22"D; 44-72" high;
13" faceouts; 1 piece; 50 lbs.
Anthracite Grey - NHPSBBCB2ADJ
\$202.99



Adjustable 2-Way Rack

21"W x 21"D; 44-72" high; 13" faceouts;
2 pieces; 4,8 lbs. / 4,17 lbs. (2 ctns)
Anthracite Grey - NHPS2WADJ; \$112.99
Gloss White - NHPS2WADJWH; \$112.99



4-Leg Costumer

60"H x 21"W x 21"D w/ 6" faceout;
1 piece; 15 lbs.
Anthracite Grey - NHPSC2; \$95.99
Gloss White - NHPSC2WH; \$95.99



Replacement 2" Casters

Fits pipeline racks & costumers

NON-LOCKING	LOCKING
1 piece; 2/6 lbs NHCASPS	1 piece; 18 lbs NHCASPLK
\$6.99	\$6.99

Pipeline RACKS & MERCHANDISERS

PIPELINE OUTRIGGER AND WALL UNITS

Units and accessories have an anthracite grey or a gloss white finish, where noted.



Outrigger Wall Unit

Set of two 96"H slotted uprights (1/2" slots on 1" centers). Can be spaced 24" or 48" on Centers; 1 piece; 30 lbs.

Anthracite Grey - NHPSOR; **\$156.43** Gloss White - NHPSORWH; **\$151.89**



Freestanding Merchandiser

94" high x 20" deep x 48" wide. Slots (1/2" slots on 1" centers) are on each upright; 1 piece; 38, 28, 12 / 90, 90, 12 - 3 ctns.

Anthracite Grey - NHPFS96; **\$374.41**
Gloss White - NHPFS96WH; **\$375.99**

ACCESSORIES FOR OUTRIGGERS AND WALL UNITS



Extension Kits for Freestanding Merchandiser

Connect & stabilize two units together.
• Guarantees easy alignment for the 24" or 48" accessories between 2 units.
• Kits include 2 spacers. Can be used on top & bottom or along back.

Anthracite Grey - NHPFSFKT24 - 24"w 7 lbs; **\$34.99**
Gloss White - NHPFSFKT24WH - 24"w

Anthracite Grey - NHPFSFKT48 - 48"w 10 lbs; **\$47.95**
Gloss White - NHPFSFKT48WH - 48"w 10 lbs; **\$43.99**



Hangrails

Mounts on rear facing slots of uprights.
2 pieces/carton.

48" wide; 14lbs:
Anthracite Grey - NHPSORHB48 **\$100.57**
Gloss White - NHPSORHB48WH **\$82.99**

24" wide; 10 lbs:
Anthracite Grey - NHPSORHB24 **\$76.98**
Gloss White - NHPSORHB24WH **\$76.49**



Hangrail with 1 Faceout

Works on forward facing slots of uprights of Freestanding Merchandiser only.
24" wide w/12 3/4" faceout;
2 pieces/carton; 11/17 lbs.

Anthracite Grey - NHPSORFO24N **\$95.49**
Gloss White - NHPSORFO24NWH



Hangrail with 2 Faceouts

Works on forward facing slots of uprights of Freestanding Merchandiser only.
48" wide w/12 3/4" faceouts;
2 pieces/carton; 21/31lbs.

Anthracite Grey - NHPSORFO48N **\$162.26**
Gloss White - NHPSORFO48N WH **\$152.99**



Hangrail with 1 Faceout

Mounts on rear facing slots of uprights.
24"W with one 12" long faceout;
2 pieces/carton; 18/20 lbs.

Anthracite Grey - NHPSORFO24 **\$123.99**
Gloss White - NHPSORFO24WH



Hangrail with 2 Faceouts

Mounts on rear facing slots of uprights.
48"W with two 12 3/4" long faceouts;
2 pieces/carton; 29/37 lbs.

Anthracite Grey - NHPSORFO48 **\$161.87**
Gloss White - NHPSORFO48WH **\$152.99**



Add On Arms

3" Long 1 piece; 1 lb
Anthracite Grey - NHPSCLP03 **\$14.99**
Gloss White - NHPSCLP03WH

16" Long 2 pieces; 2 lbs
Anthracite Grey - NHPSF013 **\$52.75**
Gloss White - NHPSF013WH



Large Display Shelves

Bottom of shelf includes a slot for brackets to lock in to and metal support bar to handle heavy loads; 46 3/8"W x 15 3/4"D;
2 pcs/carton; 46 lbs.

Black Melamine - NHPSORSLF48-ML **\$147.74**
White Melamine - NHPSORSLF48MLWH **\$133.23**

Small Display Shelves

Bottom of shelf includes a slot for brackets to lock in to. 22 3/8"W x 15 3/4"D;
2 pcs/carton; 20 lbs.

Black Melamine - NHPSORSLF24-ML **\$60.99**
White Melamine - NHPSORSLF24MLWH



Shelf Brackets

Left & right (set) for use w/ shelves
2 set (4 pcs); 4 lbs.

Anthracite Grey - NHPSORKB **\$27.09**
Gloss White - NHPSORKBWH

RACKS & MERCHANDISERS Pipeline Accessories

ACRYLIC SIGN HOLDERS

Sign holder with swedge stem and C style clamp.
Fits pipeline racks & costumers.



5"H x 7"W
includes clamp; 1 piece; 1 lb.
Anthracite Grey - NHPSPJ57P24;
\$17.37
Gloss White - NHPSPJ57P24WH;
\$12.57



7"H x 11"W
includes clamp; 1 piece; 1lb.
Anthracite Grey - NHPSPJ711P24;
\$19.44
Gloss White - NHPSPJ711P24WH
\$14.99

WALL MOUNT FACEOUTS

SLATWALL FACEOUTS



4 1/2" Long
1 piece; 1 lb
Anthracite Grey - NHPSSW04 **\$9.70**
Gloss White - NHPSSW04WH
\$13.40



4 1/2" Long
1 piece; 1 lb
Anthracite Grey - NHPSSW04 **\$9.12**
Gloss White - NHPSSW04WH
\$8.52



10" Long
1 piece; 1 lb
Anthracite Grey - NHPSSL10
\$14.70
Gloss White - NHPSSL10WH
\$13.50



10" Long
1 piece; 1 lb
Anthracite Grey - NHPSSW10
\$11.16
Gloss White - NHPSSW10WH
\$10.56

PIPELINE TABLES & FLOOR DISPLAYERS



Large Nesting Table



Small Nesting Table

Table Topper



Display Table



Tower Table

Frame w/top 62"w 34"d 32"h;
1 pc; 18, 42 lbs (2 ctns);
Anthracite Grey - NHPSTLSET;
\$325.49
Gloss White - NHPSTLWHSET;
\$325.49

Frame w/top 48"w 24"d 24"h;
1 pc; 39, 41 lbs (2 ctns);
Anthracite Grey - NHPSTSET;
\$218.99
Gloss White - NHPSTSWHSET;
\$218.99

Frame w/top 54"w 14"d 13 1/2"h;
Dark Brown Melamine table top;
1 pc; 6, 29 lbs (2 ctns);
Anthracite Grey - NHPSTTOPSET
\$109.99

Frame w/top 28"w x 16"d x 18"h;
Dark Brown Melamine table top;
1 pc; 39, 17 lbs (2 ctns);
NHPSTSET **\$144.99**

Frame w/top 14"w x 14"d x 40"h;
Dark Brown Melamine table top;
1 pc; 36, 81 lbs (2 ctns);
NHPSTTSET **\$162.99**

Frame only 58"w 30"d 30 1/2"h;
1 pc; 22 lbs;
Anthracite Grey - NHPSTNL
\$151.99
Gloss White - NHPSTNLWH
\$151.99

Frame only 44"w 20"d 22 1/2"h;
1 pc; 18 lbs;
Anthracite Grey - NHPSTNS
\$122.99
Gloss White - NHPSTNSWH
\$122.99

Frame only 50"w 12"d 12"h;
1 pc; 6 lbs;
Anthracite Grey - NHPSTTOP
\$51.99

Frame only 27"w 15"d 17"h;
1 pc; 39 lbs;
NHPSTDT **\$122.99**

Frame only 13"w 13"d 39"h;
1 pc; 39 lbs;
NHPSTT **\$118.99**

Black Pipeline RACKS & MERCHANDISERS

BLACK ECONOMY PIPE RACKS A matte-black pipe rack collection for less



- 1 Ballet Bar Rack - black**
48" w x 23.5" d; 48-72" h adjustable; 1 piece; 34/37 lbs; **NHPLKBB \$132.32**
* Casters available
- 2 Round rack - black**
Round rail-36" dia; base-42" d; 46" h (not adjustable); includes casters; 1 piece;
20/44, 15 lbs (2 ctns); **NHPLRR \$303.00**
- 3 Half-round rack - black**
35" w / height adjustable from 54"; 1 piece; 20, 8/21 bs (2 ctns);
NHPLHR \$129.60
- 4 4-way pipe rack - black**
30" base; 16" arms; 48-72" h; 1 piece; 40, 19 lbs (2 ctns); **NHPLK4 \$206.97**
* Casters available
- 5 2-way pipe rack - black**
24.5" w x 18.5" d base; 16" arms; 48-72" h; 1 piece; 18, 4 lbs (2 ctns); **NHPLK2 \$96.81**
* Casters available
- 6 H rack - black**
48" w x 30" d base; height 48-72"; (Grid topper sold separately); 1 piece; 50,
17/21, 7 lbs (3 ctns); **NHPLKH \$209.43**
* Casters available
- 7 Outrigger pipe rack - black**
90" h; 1/2" slots on 1" center; stands 3.5" from wall; 2 pieces; 19 lbs;
NHPLKF5 \$131.80
- 8 Display rack with 3 wood trays - black**
24" L x 24" W x 52" H; (3) adjustable wood trays measure 17" L x 10" W x 3" h, are
finished in cinnamon melamine & rotate to a 45° or 90° angle; 1 piece; 39/70 lbs;
DTB242452BP \$347.72

BLACK ECONOMY PIPE RACK ACCESSORIES matte black finish



C Hangrail for Outrigger rack - black
24" w; 12" deep; 1 piece; 20/21lbs;
NHPL12CH \$18.53

3" Casters - black
3" casters, two with brakes and two
without; 4 pieces; 5 lbs;
NHPLCASTER \$46.66



NHPLCASTER



**12" Hangrail bracket for
Outrigger rack - black**
1 piece; 22 lbs; **NHPLCR12
\$7.26**



**12" Faceout w/ ball end for
Outrigger rack - black**
1 piece; 19 lbs;
NHPLRDW12 \$5.18



**3" Hangrail bracket for
Outrigger rack - black**
1 piece; 14 lbs;
NHPLCR3 \$5.18

RACKS & MERCHANDISERS Ladder Systems

BLACK LADDER SYSTEM

The extremely versatile Ladder System allows you to vary your merchandising techniques to suit any retail environment.

The black finish tower ladders measure 73"H and can be accessorized with specialized hangrails, shelves, face-outs and waterfalls (sold separately).

Ships truck.
Some assembly required.

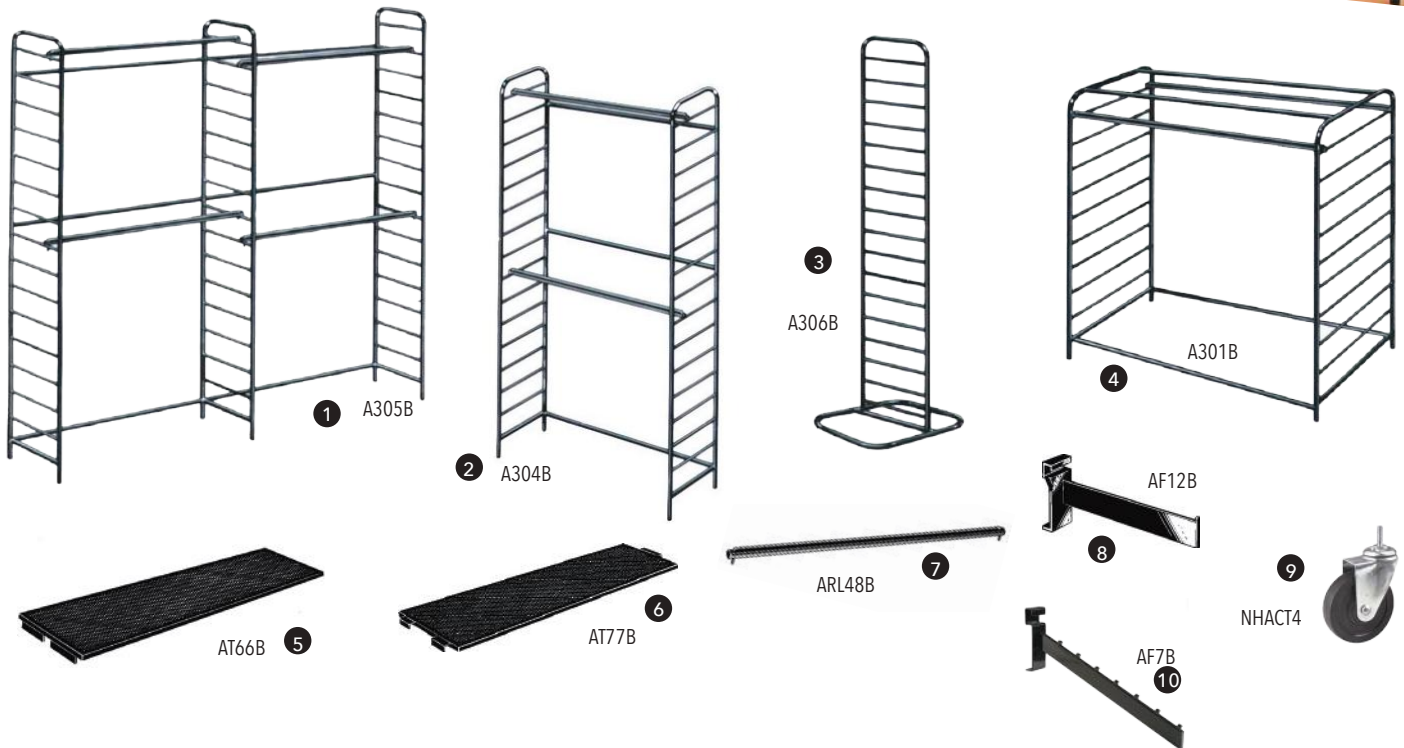
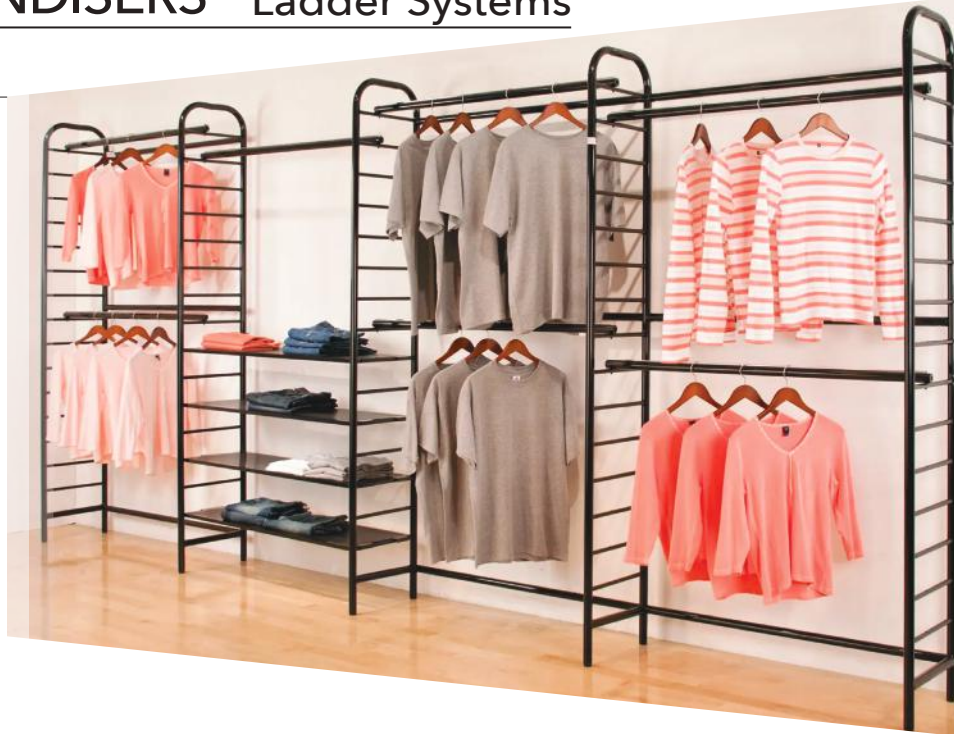

- 1 Double Two-Tier Wall Unit - black**
 16"W x 96"L x 88"H; 1 piece; 92 lbs; **must ship truck**; **A305B \$286.04**
- 2 Single Two-Tier Wall Unit - black**
 16"W x 48"L x 88"H; 1 piece; 58/90 lbs; **must ship truck**; **A304B \$185.85**
- 3 Tower Ladder - black**
 14"W x 73"H; 18" x 22" base; 1 piece; 23 lbs; **A306B \$126.23**
- 4 Double Center Floor Rack - black**
 28"W x 48"L x 58"H; 1 piece; 57 lbs; **must ship truck**; **A301B \$169.25**
- 5 Top Shelf - black** Fits A301B
 Epoxy coated perforated steel; 25" x 48"; 1 piece; 18/26 lbs; **AT66B \$101.99**
- 6 Interior Shelf - black** Fits all ladders
 Epoxy coated perforated steel; 14" x 45"; 1 piece; 11/15 lbs; **AT77B \$50.67**
- 7 Straight Hangrail - black**
 With attached 1/4" chrome wire protector; 48"; 1 piece; 4/5 lbs; **ARL48B \$15.29**
- 8 12" Faceout - black**
 Rectangular tubing; 1 piece; 2 lbs; **AF12B \$6.99**
- 9 Caster - black**
 4" caster w/ 1"L & 5/16" dia. stem; 150 lb. capacity; 1 piece; 2/2 lbs; **NHACT4 \$9.07**
- 10 7-Cube waterfall - black**
 16" L; 1/2" x 1 1/2" thick; 1 piece; **AF7B \$10.49**

Designer 400 RACKS & MERCHANDISERS

DESIGNER 400 SERIES

style # \$ qty description / size wgt

Chrome
 Attaches to rectangular or square tubing 1/2" on 1" center
 RV24 13.74 1 5/9

RV24 - A bracket made of rectangular tubing that supports DA224 (13" x 24") Duron shelves. The bracket has a clamp that attaches to an upright of a rectangular or square tubing rack. Tightening screws included.

TWIST ON SHELF SUPPORT
 Converts any 4 arm rack to display folded and hanging apparel



K410B 181.18 Black shelves
 K410AL 171.99 Almond shelves 9/11, 26 lbs
 K410GY 171.99 Grey shelves 2 ctns
 K410W 164.72 White shelves

57" H, 1" matte black square tubing frame; (8) 12" shelf brackets; (4) 13" x24" shelves; includes casters and one T-stand



K411B 279.99 Black shelves
 K411AL 285.99 Almond shelves 9/11, 9/11, 41 lbs
 K411GY 285.99 Grey shelves 3 ctns
 K411W 276.99 White shelves

54" H, 1" matte black square tubing frame; (16) 12" shelf brackets; (8) 13" x24" shelves; (2) 36" x 1 1/4" round hangrails



K400B 187.50 Black shelves
 K400AL 184.99 Almond shelves 9/11, 32 lbs
 K400GY 184.99 Grey shelves 2 ctns
 K400W 180.99 White shelves

57" H, 1" x 2" matte black rectangular tubing frame; (8) 12" shelf brackets; (4) 13" x24" shelves; includes casters; two 16" arms adjust to 70" H



RACKS & MERCHANDISERS Showcases

ECONOMY IMPORT SHOWCASES



FULL VISION SHOWCASES

Assembly required



SC



style #	\$	qty	description	size	wgt
Includes 2 glass shelves and shelf brackets:					
SC4B	224.08	1	Black	38"H x 18"D x 48"L	80/90, 30, 10, 10 lbs; (4 ctns)
SC4W			White		
SC4M			Maple		
SC6C			Cherry		
SC6B	317.91	1	Black	38"H x 18"D x 72"L	100, 30, 30, 20 lbs; (4 ctns)
SC6W			White		
SC6M			Maple		
SC6C			Cherry		

Standard LPL Finishes



White

Black

Maple Drop
Hardrock

Cherry

CORNER FILL-IN

Fill-in counters enable you to create various counter configurations and display merchandise.



Barnwood



Rustic Grey



Black



White



Maple

CFC20

CFC20	134.14	1	Corner fill-in - includes 2 glass shelves	38"H x 18"D x 18"L	36/75
-------	--------	---	---	-----------------------	-------

Specify Barnwood, Rustic Grey, Black, White or Maple for CFC20 above and SCPC18 below

PENTAGONAL FILL-IN



SCPC18



SCPC18	138.67	1	Pentagonal fill-in - includes 2 glass shelves	38"H x 18"D x 18"L	30, 18 lbs; (2 ctns)
--------	--------	---	---	-----------------------	----------------------------

REGISTER STAND

Perfect as a stand alone or with a wrap counter and corner fill-in unit.

Includes 1 (4"H) drawer & 1 wood shelf
Well Top (w/6" well):



RS24

RS24BW			Barnwood		
RS24RG			Rustic Grey		
RS24B	134.52	1	Black	38"H x 18"D x 24"L	81
RS24W			White		
RS24M			Maple		

Shelves RACKS & MERCHANDISERS

style #	\$	qty	description /size	wgt
W1224			White / 12"x24"	
B1224	88.99	8	Black / 12"x24"	45
M1224			Maple / 12"x24"	
W1248			White / 12"x48"	
B1248	99.99	4	Black / 12"x48"	45
M1248			Maple / 12"x48"	
W1448			White / 14"x48"	
B1448	110.99	4	Black / 14"x48"	50
M1448			Maple / 14"x48"	

MELAMINE SQUARE EDGE SHELVES



- Sturdy 3/4" thick
- Durable, easy to clean
- Finished on all 6 sides

Metal shelf signs

Ledge piece is 6" front to back;
sign holder piece is 6 1/2" across

NHSTCH	9.72		Metal	
NHSTV	7.00	1	High polished chrome	1

Accepts 6 1/2"W x 1 1/2"H paper inserts, (not included)

METAL SHELF OVERLAY RETAIL SIGNS w/framed front

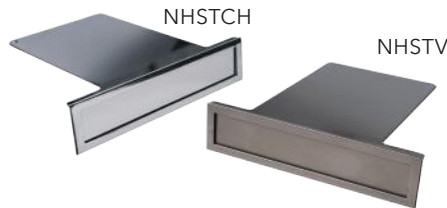

SHGL1048	98.49		10" x 48"	43
SHGL1224	49.25	5	12" x 24"	28
SHGL1248	88.20		12" x 48"	53
SHGL1448	99.14		14" x 48"	61

Ships truck

TEMPERED GLASS SHELVES 3/16" thick



All sizes packed 4 of one size and color per carton:

13" Shelves - to be used with 12" brackets:

OPEN BOTTOM

13" x 24"

DA224B	49.99		Black	
DA224G	60.49	4	Grey	9/11
DA224W	49.25		White	

13" x 48"

DA248B	90.85		Black	
DA248W	85.99	4	White	29
DA248G	123.99		Grey	

DURON BULLNOSE SHELVES

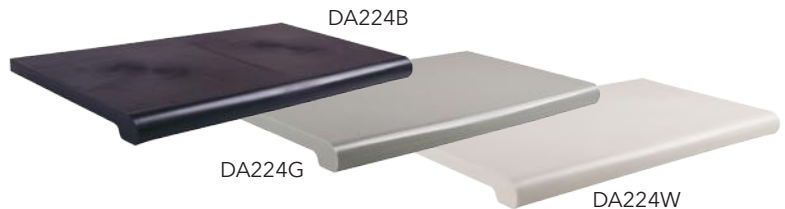

15" Shelves - to be used with 14" brackets:

OPEN BOTTOM

DA424W	94.35		15" x 24" (almond & grey n/a)	13/16
--------	-------	--	-------------------------------	-------

4

DA448B	112.99		15" x 48" (black only)	27/30
DA450B	166.40		15" x 50" (black only)	27

SPECIAL FINISHES

Min. order 12 pieces



Hard Rock Maple



Medium Oak



Walnut

follow style # by /B (for black) /W (for white) /G (for grey) /A (for almond)

How to order special finishes:

STYLE NO. FIN #3 /Surface coverage (woodgrain) on top, bullnose and sides.
Add \$10.90 for each shelf.

How to order:

- (1) Choose shelf desired;
- (2) Choose style or surface coverage desired (FIN #2 or FIN#3);
- (3) Choose woodgrain color desired;
- (4) **Min. order 12 shelves per finish;**
- (5) Cost of shelf and cost of woodgrain finish equals total cost.
Allow approx. 3-4 weeks.

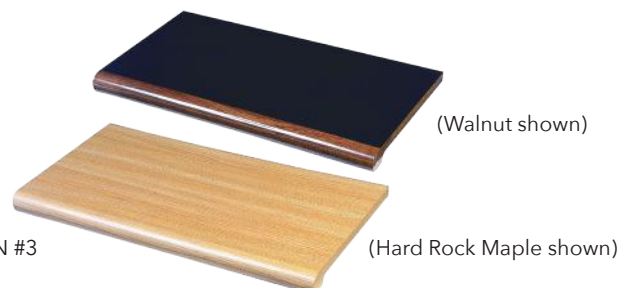

RACKS & MERCHANDISERS Displayers

DUMP BIN Adjustable base deck. Casters optional



chrome



white black

GTC48

4-TIER STACKING CHROME BASKETS
w/casters



DDB242143C



FOLDING SQUARE BASKET
BIN2



IMPULSE POSTS

Great for small or end of season clearance items near the register

IMPULSE41P



Holder for 8.5"x11" signs



WIRE SPINNER RACK

NHSDR

3-TIER BINS



DDB4518B



DDB4518W

DDB1947B



DDB1254B



4-TIER BINS

IMPULSE4W



style #	\$	qty	description / size	wgt
All styles measure 38" x 38" x 34 3/4"				
GTC48B	149.43		BLACK	80
GTC48W	149.43	1	WHITE	Ships UPS ground
GTC48C	199.90		CHROME	
DDB242143C	219.80	1	4 Stacking Chrome Baskets: 24"L x 21"W x 43"H; collapsible; w/4 black casters	40/122
BIN2	47.17	1	BLACK 30" x 18" x 1 8"	11/14
IMPULSE41P	119.49	1	Impulse Tower w/4 Bowls: Clear polycarbonate bowls with metal grey powdercoated base and pole. Acrylic signholder top included; 65 1/2" H; bowls: 12 1/8" dia; 6 1/8" depth base: 16" dia. signholder: 7" x 5 1/2"	22/27
NHSDR	84.94	1	Wire Spinner Rack 4 adjustable spinning tiers with 16 hooks; Black; Heavy duty plastic base and sign holder for signs 8 1/2 x 11" and 1mm thick; Dims: 24" footprint; 66" high; hook length 5"	14/24
DDB4518B	85.54	1	3-Tier Round Impulse Bin: 45"H x 18"W; w/ 3 round baskets each measuring 7"H x 18"W	23/23
DDB4518W			Black White	
DDB1947B	86.70	1	3-Tier Square Bin: Black; 19"W x 47"H; baskets - 6 1/2"H x 16"W each	30/30
DDB1254B	107.44	1	4-Tier Round Display Bin: Black; 54 1/2"H x 12"W; w/ 4 circular baskets measuring 6 1/2"H x 12"W	19/19
IMPULSE4W	115.99	1	Black floor display rack with 4 separate brushed chrome wire rotating baskets. Rack measures 66"H x 22"W; Each individual basket measures 21 3/4"W x 7"D	10/38

STANDARD SLATWALL PANELS

Laminated, 3/4" medium density fiber board.
 Optional inserts must be installed at time of manufacturing for an additional charge (see inserts on following page /92).
 4' high x 8' long panels. Each panel weighs between 80-100 lbs., and must ship via truck.
 Crate charge on 1-34 sheets is \$45.00.



Slatwall Orientation /Horizontal



Panels made in the USA

CALL or visit online CHAT at nahanco.com for more information.
 Our friendly Customer Service reps are based in the USA and ready to assist.

SOLIDS / MIRROR



WHITE
 SW48W
 \$88.99



BLACK
 SW48BK
 \$93.99



LIGHT GREY
 SW48LG
 \$90.99



DARK GREY
 SW48G
 \$90.99



MIRROR
 SW48MIR
 \$363.99

Actual colors may vary slightly from images

WOOD GRAINS



OAK
 SW48O
 \$91.99



MAHOGANY
 SW48M
 \$96.99



HARDROCK MAPLE
 SW48HM
 \$90.99



WEATHERED BARNWOOD
 SW48WB
 \$97.99



ASH BARNWOOD
 SW48AB
 \$97.99

• All prices are per panel with No Insert / NI

• Lead time is 2-3 weeks, with and with out inserts

WALL SYSTEMS Slatwall Panels



STANDARD SLATWALL PANELS

Actual colors may vary slightly from images

RUSTICS /textured



ASPEN OAK
SW48AO
\$97.99

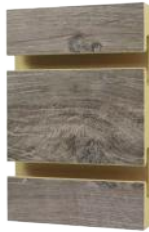

STORMY OAK
SW48SO
\$97.99



TIMBERCREEK OAK
SW48TCO
\$97.99



RECLAIMED BARNWOOD
SW48RB
\$97.99



CAMPFIRE ASH
SW48CA
\$97.99



WHITEWASHED FENCE
SW48WWF
\$97.99

SLATWALL INSERTS

Order slatwall panels with or without inserts. If inserts are desired, note that they levy an additional charge and must be installed at the time of manufacturing.

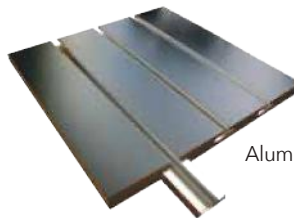

Metal inserts

Aluminum / AI

Black Aluminum / BAI



Black panel w/ Black Aluminum Inserts

Metal inserts add strength and enhance the appearance of slatwall panels.

NOTES:

All prices are per panel with No Insert / NI

Lead time is 2-3 weeks, with and with out inserts



White panel w/ No Inserts

Slatwall Accessories WALL SYSTEMS

style #	\$	qty	description	size	wgt
XT4	10.49		Chrome		
XT4B	8.99		Black	4"	2
XT4W	8.99		White		
XT6	10.49		Chrome		
XT6B	8.99		Black	6"	2
XT6W	8.99		White		
XT8	10.50		Chrome		
XT8B	9.07	12	Black	8"	3
XT8W	9.07		White		
XT10	10.50		Chrome		
XT10B	9.07		Black	10"	3
XT10W	9.07		White		
XT12	11.90		Chrome		
XT12B	10.50		Black	12"	4
XT12W	10.50		White		

Mounting plate width: 3/4" (for all hook styles listed above)

Hook widths: Chrome - 3/16" w; Black /White - 1/4" w

XTB	6.35		Black	1"W x 3	
XTW	6.35	12	White	1/4"H	2
XTH	7.91		Chrome		

SWFRC	1.99	1	Chrome	3"	1/2
-------	------	---	--------	----	-----

SW6	6.99		Chrome	6"	1/2
SW12	6.99	1	Chrome	12"	
SW12B	6.99		Black	12"	1/6
SW12W	6.99		White	12"	

HW5H	7.00	1	Chrome	16"	2/6
------	------	---	--------	-----	-----

RWA9	8.42	1	Chrome Rectangular tubing	Adjusts from 9" to 12" to 15" long	2
------	------	---	---------------------------------	--	---

RW12	5.18		Chrome	12"	1/6
EBLR3	4.67		Black	12"	
EWHR3	4.15	1	White	12"	
RW6	4.15		Chrome	6"	1/2

SW5HB	7.00		Black		
SW5H	6.22	1	Chrome	16"	2/6
SW5HW	7.00		White		

RW5HB	5.96	1	Black	17 1/4"	2/6
RW5H	7.00		Chrome		

SW6BC	4.54		Chrome		
SW6BB	4.15	1	Black	16 5/8"	2/6
SW6BW	4.15		White		

RW7B	15.99	1	Black	16 5/8"	2/6
RW7C			Chrome		

SWED6	2.07	1	CHROME	2 3/4"W x 4 1/2"L	1/5
-------	------	---	--------	----------------------	-----

J2387	33.17	1	CLEAR Holds 36 - 2" cards (not included)	12" W x 12 1/2" H	2/6
-------	-------	---	--	----------------------	-----

SW122	18.79	12	Brushed chrome	3 7/16"H x 2"L	2/5
-------	-------	----	----------------	-------------------	-----

HG100	50.67	100	White	2" clip	3
HG101	50.67	100	Black	2" clip	3

SLATWALL HOOKS



XTH

SWFRC

SLATWALL FACEOUTS

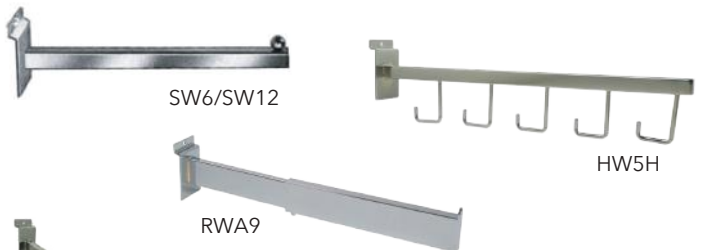

SW6/SW12

HW5H

RWA9

RECTANGULAR TUBING



RW12/EBL/EWH/RW6

Square Tubing
5 Hook Waterfall
SW5H

Rectangular Tubing
5 Hook Waterfall
RW5H

SLATWALL WATERFALLS



Square Tubing
6 Ball Waterfall
SW6C

Rectangular Tubing
7 Cube Waterfall
RW7C

SLATWALL JEWELRY DISPLAYERS



Slatwall Earring
Card Holder
SWED6

See page 130
for jewelry cards

Slatwall
Jewelry Card
Displayer
J2387

SLATWALL CLIPS



SW122

HG100 /
HG101

WALL SYSTEMS Slatwall Accessories



SHELF BRACKET
Chrome, black or white available

- See page 89 for shelving -



ADJUSTABLE SHELF BRACKET
12" - chrome
14" - chrome



SLATWALL SUPPORT ARMS
3380-76 for 8" & 10" brackets
3380-77 for 12" & 14" brackets
3380-78 for 12" rectangular tubing



3" & 12" RECTANGULAR HANGRAIL
Chrome, black or white available



ROUND HANGRAIL BRACKET

- See page 102 for tubing -



RECTANGULAR TUBING 'U' HANGRAIL



ROUND TUBING 'U' HANGRAIL



SCARECROW DISPLAYER

TUBULAR DISPLAY FORM
VM52



MILLINERY DISPLAYER
3" diameter



FOAM PAD
FPMC

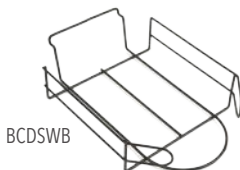

SLATWALL CAP MERCHANDISER
Holds 12 hats



REVOLVING BELT/TIE DISPLAY

SW500



SLATWALL WIRE MEDIA SHELF

style #	\$	qty	description	size	wgt
SW8KB	2.99		Chrome		
SW8KBB	2.99		Black	8"	2/7
SW8KBW	2.99		White		
SW10KB	3.29		Chrome		
SW10KBB	3.29		Black	10"	1/6
SW12KB	3.49	1	Chrome		
SW12KBB	3.49		Black	12"	1/6
SW12KBW	3.49		White		
SW14KB	3.99		Chrome		
SW14KBB	3.99		Black	14"	1/6
SW14KBW	3.99		White		
SWAJ12	4.15	1	CHROME	12"	1/6
SWAJ14	4.92			14"	1/6
3380-76	6.35			7 3/4"	
3380-77	6.35	1	CHROME	11 1/2"	1/3
3380-78	6.96			11 1/2"	
SWFB	5.57		CHROME	12"	2/7
SWFBB	5.57	1	BLACK	12"	2/7
SWR2	4.54		CHROME	3"	1/3
SW/RT	6.74	1	CHROME	12"	1/6
SWR81	20.22		CHROME	22"W x	
EMABR81	18.01	1	BLACK	11" D	5/21
EMTWR81	18.01		WHITE		
SW681C	18.01		CHROME	23"W x	
SW681B	17.37	1	BLACK	12" D	5/21
SW681W	17.37		WHITE		
SWT	20.22	1	CHROME	Adjusts	
EBLT	14.49		BLACK	20 1/2" to	4/21
VM52	24.36	1	CHROME	16" x 24"	3/21
SWML		1	CHROME		
SWMLB	5.44	1	BLACK	4 1/2" H x	1/3
SWMLW		1	WHITE	8" D	
FPMC	9.07	10	GREY	3"	1
BCDSW			CHROME	8 1/2"	
BCDSWB	5.44	1	BLACK	x 14" x 2"	2/6
BCDSWW			WHITE		
SW500	27.60	1	CHROME	11" x 17"	1/6
				12 - 4" hooks	
WVS45W	22.94	1	WHITE	48 x 6 1/2 x 7"	5/13

Slatwall Accessories WALL SYSTEMS

style #	\$	qty	description	size	wgt
NHPSSW04	9.07	1	Anthracite Grey	4 1/2" long	1
NHPSSW04WH	8.42	1	Gloss White	4 1/2" long	1
10" Faceouts:					
NHPSSW10	11.15	1	Anthracite Grey	10" long	1
NHPSSW10WH	10.50	1	Gloss White	10" long	1
Matte black faceout:					
SWP12B	11.15	1	Matte black faceout	12" long	2
Matte Black Waterfalls:					
SWP6NB16	16.85	1	6-ball	16 1/2" long	4
SWP5H16	18.27	1	5-hook	16 1/2" long	4
2326	29.90	1	1/8" ACRYLIC	8" W x 4" D	1/3
2240	2.99	1	1/8" ACRYLIC	2"	1/3
2035	8.99	1	1/8" ACRYLIC	7w x 11"h	2/7
2385	15.99	1	1/8" ACRYLIC	8" W x 10 1/4" H	2/7
850S	2.49	1	ACRYLIC	4" x 10" w/ 2" tall sign channel at front	2/3
2020S	4.49	1	ACRYLIC	4" x 10"	2/3
ACR988	19.90	1	ACRYLIC	24"L x 2"D x 4"H	3
2086	17.99	1	ACRYLIC	7" X 10"	1/2
2200S	4.49	1	ACRYLIC	45° downslant swivels 180°	1/3
2476	18.99	1	ACRYLIC	17" W x 7" H x 3 1/2"D	1
2486	4.99			1PAIR 3"L	2/6
2487	9.99	1	3/16" ACRYLIC	3 PAIRS 11 3/4"L	1/2
2488	18.49			6 PAIRS 23 3/4"L	5/11
ACR26SW	4.99	1	ACRYLIC	4 x 9"	2/3
ACR28SW	8.99			8 1/2 x 11"	1/3
ACR102	12.99	1	ACRYLIC	8 x 10"	1/7
ACR180	15.49	1	3/16" ACRYLIC	8"D x 12"W	2/7
ACR140	24.99	1	3/16" ACRYLIC	12"L x 9"W x 2"D	2/6

PIPELINE SLATWALL FIXTURES

Coordinates with other pipeline store fixtures (pages 81-84)

ANTHRACITE GREY & GLOSS WHITE FIXTURES

NHPSSW04



NHPSSW04WH



NHPSSW10

NHPSSW10WH

MATTE BLACK FIXTURES



SWP12B



SWP6NB16



SWP5H16

ACRYLIC SLATWALL FIXTURES



2326

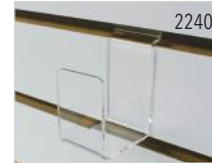

2240

JEWELRY DISPLAY BAR

DISPLAY HOOK

SIGN HOLDER

2035



JEWELRY CARD DISPLAYER

Holds twenty 2" cards

See page 130 for cards

2385

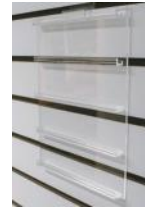

850S

SLATWALL SHOE SHELVES

2020S



ACR988 (w/tilt back)



MEDIA SHELVES

2200S



SLANTED SHOE DISPLAY

2086

SLATWALL HANGER

Extends 3" from wall

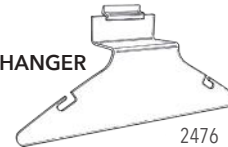

2476

ADJUSTABLE SHOE SWIVEL



ACR26SW



ACR28SW

BROCHURE HOLDERS

GLASSES DISPLAYS

For eyeglasses or sunglasses

2487

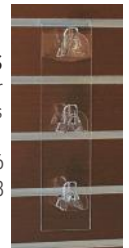

1pr/ 2486
6prs/ 2488

SLATWALL MIRROR

ACR102

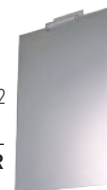

SLATWALL STRAIGH SHELF

ACR180

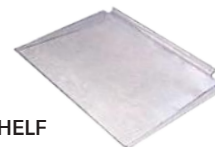

SLATWALL TRAY

ACR140



WALL SYSTEMS Grid Wall & Accessories

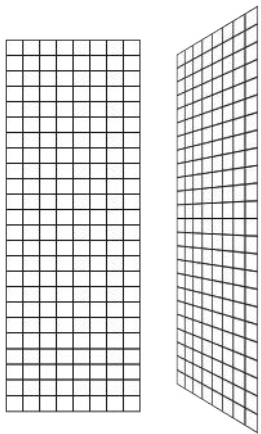

GRID WALL - 1/4" Wire
Uses grid wall accessories only

SLATGRID PANELS
Uses either grid wall or slatwall accessories **3 Panels per Carton**



Slatgrid - Chrome
STG

8' lengths must ship via truck or oversized UPS 

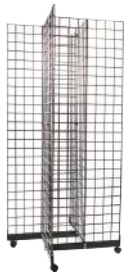

FOUR WAY BASE
Requires four panels and 12 grid-to-grid connectors.
Includes casters



TRIANGLE BASE
Requires three panels and nine grid-to-grid connectors.
Includes casters

GONDOLA BASE
Requires four panels and nine grid-to-grid connectors



LEGS FOR GRID



GL24



GRID-TO-GRID
For 1/4" wire. Connects grid panels at any required angle



CGW5

GRID TO SQUARE TUBING
Connects 1" square tubing to grid panel



WTEWB

WALL BRACKET
For mounting grid wall panels to the wall

style #	\$	qty	description	size	wgt
GW26	124.16	3	CHROME		
BLK26	99.14	3	BLACK	2'W x 6'H	55
WTE26	99.14	3	WHITE		
GW28	156.04	3	CHROME		Truck/UPS
BLK28	131.16	3	BLACK	2'W x 8'H	66/90
WTE28	131.16	3	WHITE		
STGC26	133.47	3	CHROME		
STGB26	111.44	3	BLACK	2'W x 6'H	47
STGW26	111.44	3	WHITE		
STGC28	164.27	3	CHROME		Truck/UPS
STGB28	145.14	3	BLACK	2'W x 8'H	52/90
STGW28	145.14	3	WHITE		
GW4BA	53.52		CHROME		
BLK4BA	49.90	1	BLACK	36 x 36"	11
WTE4BA	49.90		WHITE		
GW3TB	44.49		CHROME		
BLK3TB	40.56	1	BLACK	24"	10/11
WTE3TB	40.56		WHITE		
GWG48	41.99		CHROME		
BLKG48	38.99	1	BLACK	48 x 24"	12
WTEG48	38.99		WHITE		
GL24C	24.90		CHROME		
GL24B	22.94	1 pair	BLACK	24" H x 24" L	7
GL24W	22.94		WHITE		
CGW7	1.62		CHROME		
CBLK7	1.62	1	BLACK	N/A	1
CWTE7	1.62		WHITE		
CGW5	3.50		CHROME		
CWTE5	4.92	1	WHITE	N/A	1
GWWB	2.49		CHROME		
BLKW B	2.49	1	BLACK	3"	1
WTEWB	2.49		WHITE		

Grid Wall Accessories WALL SYSTEMS

style #	\$	qty	description	size	wgt
GWH4C	9.07		CHROME		
GWH4B	7.65		BLACK	4"	1/3
GWH4W	7.65		WHITE		
GWH6C	10.50		CHROME		
GWH6B	9.07		BLACK	6"	1/2
GWH6W	9.07	12	WHITE		
GWH8C	11.90		CHROME		
GWH8B	10.49		BLACK	8"	1/2
GWH8W	10.49		WHITE		
GWH10C	11.90		CHROME		
GWH10B	10.50		BLACK	10"	1/2
GWH10W	10.50		WHITE		
GW11	4.85		CHROME		
BLK11	3.88	1	BLACK	12"	3/6
WTE11	3.88		WHITE		
RG12	4.50		CHROME		
BLKR3	4.15	1	BLACK	12"	2/7
WTER3	4.15		WHITE		
GW12	4.92		CHROME		
BLK12	3.50	1	BLACK	12"	2/7
RG7B	7.00	1	CHROME	7 cube	2/6
RG5H	9.07	1	CHROME	5 hook	2/6
GW5H	4.99		CHROME		
BLK5H	5.31	1	BLACK	5 hook	2/6
WTE5H	5.31		WHITE		
GW7B	6.49		CHROME		
BLK7B	6.49	1	BLACK	7 ball	2/10
WTE7B	6.49		WHITE		
GWFRFC	5.44		CHROME		
GWFRB	5.44	1	BLACK	3"	1/3
GWML	4.02	1	CHROME	4 1/2" H	2/7
BLKML	3.76	1	BLACK	8" Deep	
FPMC	9.07	10	GREY	3"	1
KHG684	19.90	1	CHROME	52 1/4"	3/21
KHG681	18.01		CHROME		
BLHG681	17.37	1	BLACK	19 1/4 x 11"	3/21
GW12KB	3.89		CHROME	12"	
BLK12KB	3.24	1	BLACK	12"	2/7
WTE12KB	3.50		WHITE	12"	
GW14KB	4.15		CHROME	14"	
BLK14KB	3.50	1	BLACK	14"	2/6
HML4MAB	5.57	1	BLACK	4"	1/3
GWRT	7.00	1	CHROME	12"	2/7



WALL SYSTEMS Grid Wall Accessories



GRID WALL CAP MERCHANDISER
Holds approximately 12 hats

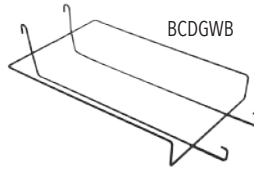

BCDGWB



GR7

GRID WALL BELT/TIE DISPLAY

GW122

GRID WALL CLIPS



HS101

TRIANGULAR SHELF

BLKS90

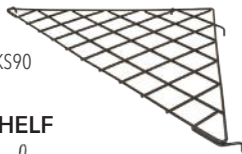

SLANT SHELF

BLKS91



STRAIGHT SHELF

GWS93



JGR410ST

INJECTION MOLDED SHOE SHELF



ACRYLIC SIGN HOLDER
HPSG

BROCHURE HOLDER

ACR26GW



MEDIA SHELVES

ACR988GW
(w/tilt back)

STANDARD BASKETS

Fits Slatwall, Grid Wall and Pegboard

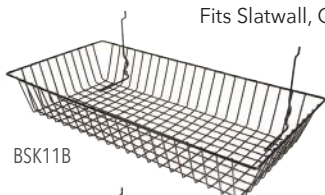

BSK11B

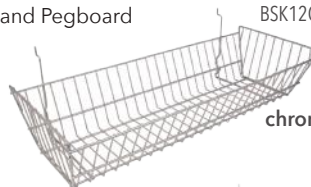

BSK12C

chrome



black



white

BSK14B



BSK15W

style #	\$	qty	description	size	wgt
BCDGW	6.35		CHROME	8 1/2 x 14	
BCDGWB	6.35	1	BLACK	x 2"	1/7
BCDGWW	6.35		WHITE		
GR7	21.38	1	CHROME	24" 7 - 5" hooks	3/12
GW122	25.66	12	BRUSHED CHROME	3 7/16" H	2/3
HS101	34.34	100	BLACK	2"	8
BLKS90	13.22	1	BLACK	24 x 24 x 34 1/2"	6/21
GWS93	24.36		CHROME		
BLKS93	21.51	1	BLACK	15 x 24"	6/21
WTES93	21.51		WHITE		
GWS91	22.29	1	CHROME	15 x 24"	6/21
BLKS91	21.51		BLACK		
JGR410ST	3.88	1	STYRENE	4 x 10"	1/3
HPSG57V	6.09			5 1/2w x 7"h	
HPSG811V	9.59		Vertical	8 1/2w x 11"h	1/2
HPSG114V	17.36			11w x 14"h	
HPSG57H	6.09	1	CLEAR	5 1/2h x 7"w	
HPSG711H	7.78		Horizontal	7h x 11"w	1/2
HPSG811H	11.99			8 1/2h x 11"w	
ACR26GW	4.92	1	ACRYLIC	4 x 9"	1/3
ACR988GW	25.01	1	ACRYLIC	24"L x 2"D x 4"H	2/4
ACR984GW	17.76	1			
BSK11B	15.99	1	Black	24w x 12d x 4"h shallow	4/12
BSK11C	15.94		Epoxy Chrome		
BSK11W	15.99		White		
BSK12B	18.01	1	Black	24w x 10d x 5"h double slope	4/12
BSK12C	19.44		Epoxy Chrome		
BSK12W	18.01		White		
BSK13B	9.72	1	Black	12w x 12d x 4"h small basket	3/10
BSK13C	9.72		Epoxy Chrome		
BSK13W	9.72		White		
BSK14C	11.79	1	Epoxy Chrome	12w x 12d x 8"h sloped front	3/10
BSK15B	14.64	1	Black	12w x 12d x 8"h deep basket	4/14
BSK15C	15.94		Epoxy Chrome		
BSK15W	14.64		White		

Slotted Standards WALL SYSTEMS

style #	\$	qty	description	size	wgt
Satin Zinc:					
Universal					
SS1048	54.82	10	Single	48"	11
SS1060	64.54		Single	60"	13/19
SS1072	75.69		Single	72"	1/9
SS1084	88.13		Single	84"	19
Heavy Duty					
SS1248	63.12	10	Single	48"	15
SS1260	72.84		Single	60"	2/8
SS1272	89.55		Single	72"	3/9
SS1284	102.00		Single	84"	3/11
SS2248	83.98	10	Double	48"	21
SS2272	132.45		Double	72"	4/9
SS2284	154.61		Double	84"	4/11
Extra Heavy Duty					
SS3048	100.57	10	Single	48"	29
SS3060	126.88		Single	60"	36
SS3072	149.17		Single	72"	43
SS3084	158.89		Single	84"	5/11

SLOTTED STANDARDS

Universal, Heavy Duty, Extra Heavy Duty

UNIVERSAL SLOTTED STANDARDS

Steel thickness: 1/16" (.062")
 Universal: 1/2" slots on 1" centers
 Countersunk mounting
 screw holes 9" apart



HEAVY DUTY SLOTTED STANDARDS

Steel thickness: 3/32" (.093") / (.062" at the recessed slots)
 Universal: 1/2" slots on 1" centers
 Countersunk mounting
 screw holes 9" apart



EXTRA HEAVY DUTY SLOTTED STANDARDS

Steel thickness: 1/8" (.125")
 1" slots on 2" centers
 Countersunk mounting
 screw holes 12" apart



* Screws not included

FACEOUT DISPLAYERS

To use on heavy duty slotted standards with 1/2" slots on 1" centers

TS12	4.15	1	CHROME	12"	2/6
TS5H	7.65		CHROME	18"	2/6
RS12	5.96	1	CHROME	12"	3/8
RS14	5.57		CHROME	14"	4/6
TS7B	6.35	1	CHROME	18"	2/6

STRAIGHT ARM

Square tubing



TS12

5-HOOK

Square tubing



TS5H

STRAIGHT ARM

Rectangular tubing



RS12/14



TS7B

7-BALL

Square tubing

FACEOUT DISPLAYERS

To use on extra heavy duty slotted standards with 1" slots on 2" centers

TR7B	2.46	1	CHROME	18"	2/6
RR12	7.52	1	CHROME	12"	2/6
RR14	7.65		CHROME	14"	2/6
RR7B	9.07		CHROME	18"	2/6



7-BALL

Square tubing

TR7B



RR12/14

7-CUBE

Rectangular tubing

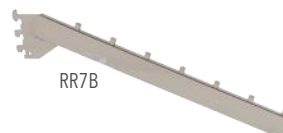

RR7B

STRAIGHT ARM

Rectangular tubing

WALL SYSTEMS Slotted Standard Brackets

HANGROD BRACKETS - to fit 1 1/4" tubing



12" or 14" BRACKETS
With nylon stabilizer. For slotted standards with 1/2" slots on 1" centers.

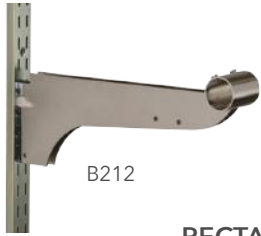

12" DOUBLE BRACKETS
For slotted standards with 1/2" slots on 1" centers.

style #	\$	qty	description	size	wgt
A212	7.49	1	CHROME	12"	2/6
A214	7.65		CHROME	14"	
B212	14.64	1	CHROME	12"	

RECTANGULAR TUBING BRACKETS

For use on slotted standards with 1/2" slots on 1" centers



3" BRACKET
Flat steel.



8" BRACKET
Rectangular tubing.



12" BRACKET
Rectangular tubing.



14" BRACKET
Rectangular tubing.

CR3	4.67	1	CHROME	3"	1/3
CR3B	3.63		BLACK	3"	
CR8	7.65	1	CHROME	8"	2/6
CR12	5.05	1	CHROME	12"	2/6
CR12B	4.92		BLACK	12"	
CR14	7.12	1	CHROME	14"	2/6

RECTANGULAR TUBING BRACKETS

For use on slotted standards with 1" slots on 2" centers



3" BRACKET
Flat steel.



8" BRACKET
Rectangular tubing.



12" BRACKET
Rectangular tubing.

GR3	4.14	1	CHROME	3"	1/3
GR3MAB	4.28		BLACK	3"	
GR8	7.20	1	CHROME	8"	2/6
GR12	3.99	1	CHROME	12"	2/6
GR12MAB	6.99		BLACK	12"	
GR14	7.64	1	CHROME	14"	2/6

- See page 89 for shelving -



TAP-IN SHELF BRACKET
Fits universal 1/2" slots on 1" centers. (.080" thick)



ADJUSTABLE SHELF BRACKETS
Fits universal 1/2" slots on 1" centers. Five positive spring loaded settings.



EXTRA HEAVY DUTY SHELF BRACKETS
Fits Extra Heavy Duty Standards. 1" slots on 2" centers. With tightening screw fit "imperial" (.125" thick). Accepts snap-on attachments for use with hangrails.



HEAVY DUTY SHELF BRACKETS w/ LIP
Fits universal extra heavy duty standards, 1" slots on 2" centers with tightening screw.

GA8	1.81	1	CHROME	8"	2/6
GA10	1.94		CHROME	10"	
GA12	2.00		CHROME	12"	
GA14	2.20		CHROME	14"	
GC12	3.11	1	CHROME	12"	2/6
G12	3.99	1	CHROME	12"	2/6
G14	7.26	1	CHROME	14"	
GSBL12	7.00	1	CHROME	12"	3/6
GSBL14	6.22	1	CHROME	14"	

Pegboard & Wall Mount WALL SYSTEMS

style #	\$	qty	description	size	wgt
STANDARD					
PHS4	7.00		4" long		
PHS6	7.65		6" long	1/8" D	1/3
PHS8	8.42		8" long		
HEAVY DUTY					
PHH6	9.07	12	6" long		1/3
PHH8	9.72		8" long	3/16" D	1/3
PHH10	11.15		10" long		2/6
PHH12	7.26		12" long		2/6
EXTRA HEAVY DUTY					
PHX6	11.79		6" long		1/3
PHX8	12.57		8" long	1/4"D	1/3
PHX10	13.87		10" long		2/6
PHX12	15.29		12" long		2/6
PB1C9	8.42	100	WHITE	ONE SIZE FITS ALL	1
SHP6	18.01	12	7 GAUGE	6"	3/7
SHP8	20.22			8" w/ 2" tab	
PB6B	4.28	1	CHROME	16 5/8"	1/6
PB5H	4.54	1	CHROME	16"	1/6
PBML	8.42	1	CHROME	8 x 4 1/4"	1/3
ACR28PB	12.83	1	ACRYLIC	8 1/2 x 11"	1/7
ACR984PB	20.74	1	ACRYLIC	24"L x 2"D x 4"H	2/5
TB12	4.41	1	CHROME	12"	2/6
RB12	6.35		CHROME	12"	
TB7B	7.78	1	CHROME	16 5/8" 7 BALL	2/6
TB5H	7.00	1	CHROME	16" 5 HOOK	2/6
FR3	7.00	1	CHROME	3"	1/3
ACR28WM	7.39	1	ACRYLIC	8 1/2 x 11"	1/7
ACR984WM	17.76	1	ACRYLIC	24"L x 2"D x 4"H	2/5
NHPSWL10WH	13.49	1	Gloss White	10"	14
NHPSWL10	14.64		Anthrocite Grey	10" long	

PEGBOARD ACCESSORIES

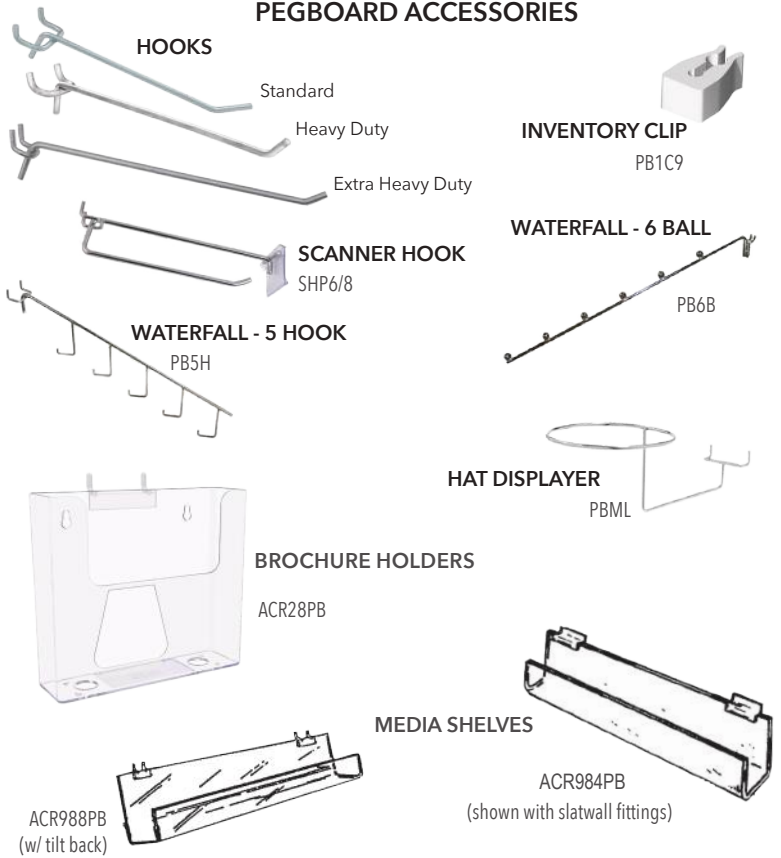

WALLMOUNT ACCESSORIES

* Note that screws are NOT included with wall mount accessories

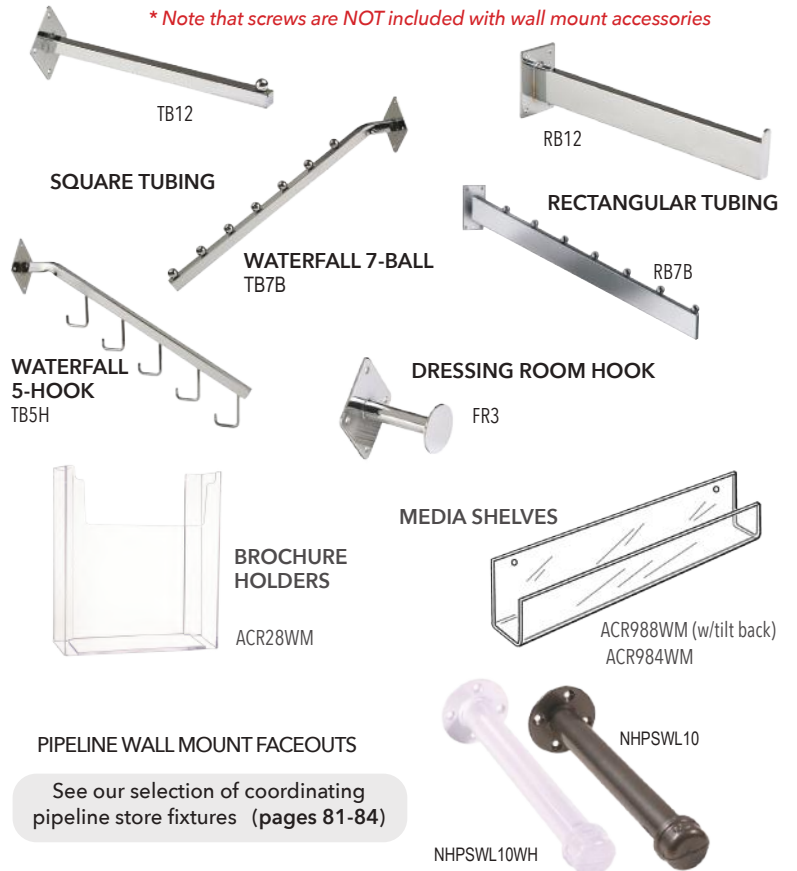

See our selection of coordinating pipeline store fixtures (pages 81-84)

WALL SYSTEMS Tubing & Accessories

ROUND TUBING & ACCESSORIES

ROUND TUBING
1 1/4" diameter, 14 gauge

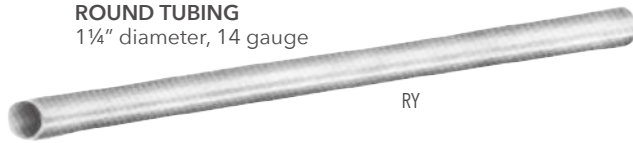

U FLANGE
For 1 1/4" and
1 5/16" round
tubing
UF9



O FLANGE
For 1 1/4" and
1 5/16" round tubing
OF7

SPLICER
For 1 1/4"
round tubing
RYSP



END CAP
For 1 1/4" and
1 5/16" tubing
EC2

style #	\$	qty	description	size	wgt
RY4	13.22		CHROME	4'	4/7
RY5	15.94		CHROME	5'	6
RY6	21.51	1	CHROME	6'	6/7
RY8	23.59		CHROME	8'	8
RY10	34.08		CHROME	10'	11
RY12	40.95		CHROME	12'	13
UF9	3.11		CHROME	UFLANGE	1
OF7	6.35		CHROME	OFLANGE	1
RYSP	2.01	1	CHROME	SPLICER	1/3
EC2	.95		CHROME	END CAP	1

RECTANGULAR TUBING & ACCESSORIES



RH7B	7.39		CHROME	14"	2/6
RH7BMAB	7.00		BLACK	14"	
RH5H	7.65		CHROME	17 3/4"	2
RH6	4.54	1	CHROME	6"	1/2
RH2C	3.89		CHROME	2"	1/3
RH12	6.35		CHROME	12"	2/6
RH12MAB	4.28		BLACK	12"	
H4	.78		CHROME	4"	
H6	1.17		CHROME	6"	1/3
H9	.91		CHROME	9"	
H12	1.68		CHROME	12"	

RECTANGULAR TUBING
1/2" x 1 1/2" x 17 gauge



RE2	3.99			2'	2
RE3	8.42		All sizes	3'	3
RE4	11.79		available in	4'	4/5
RE5	14.64		chrome except	5'	5
RE6	18.79	1	4' which is also	6'	6/10
RE8	22.29		available in	8'	6/12
RE10	34.08		black and white	10'	7
RE12	41.60			12'	9
REMA B4	11.79			4'	4/5

RECTANGULAR TUBING & ACCESSORIES

END CAPS



EC4 chrome plated
EC4MAB matte black

**EXTENDED
END CAPS**



EC5 chrome plated
EC5MAB matte black

SPLICER



RESP splicer for
rectangular tubing

EC4	.91		CHROME	TUBING	
EC4MAB	1.08		BLACK	1/2" x 1 1/2"	
EC5	1.44	1	CHROME	TUBING	
EC5MAB	1.49		BLACK	1/2" x 1 1/2" w/1" extension	1
RESP	2.85		CHROME	1/2" x 1 1/2"	

Open/Closed Signs SIGNAGE



Blue Retro NMSKBLO2

front



Open/Closed Sign Kits

Sturdy metal constructed, double-sided signs with two pre-drilled holes. Kits include one (1) black metal chain with two (2) black S hooks for hanging, and two (2) suction cups. Printed in the USA.

All signs are 12" w x 8" h; printed with an "open" message on the front and a "closed" message on the back; 5lbs.

24.36/kit



front

Blue Wash Tones NMSKBLO



back



front

Spanish NMSKABSE



back



front

Hiring - Black



back



front

Grey w/Dots NMSKGO



back



front

Hiring - Red



back



front

Red NMSKRO



back



front

Black



back



front

Black Awesome NMSKBOWA



back



front

Red Awesome NMSKROWA



back

SIGNAGE Card Stock Signs

Card Stock signs, available in 3 sizes and 9 designs.

Double sided. Printed on high quality 10 point card stock. Made in the USA.

Don't see the message you're looking for? Give us a call and let us know what you need. We can custom make it for you!

<p style="text-align: center;">small 5.5" w x 3.5" h \$1.93 /each \$9.50/5 pcs \$18.90 /10 pcs</p>	
<p style="text-align: center;">medium 7" w x 5.5" h \$2.19/each \$10.75/5 pcs \$20.35 /10 pcs</p>	
<p>ship weights: each - 1 lb 5-pack - 1 lb 10-pack - 1 lb</p>	<p style="text-align: center;">large 11" w x 7" h \$2.32/each \$11.20 /5 pcs \$21.64 /10 pcs</p>

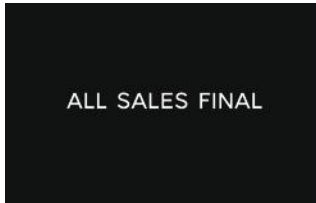
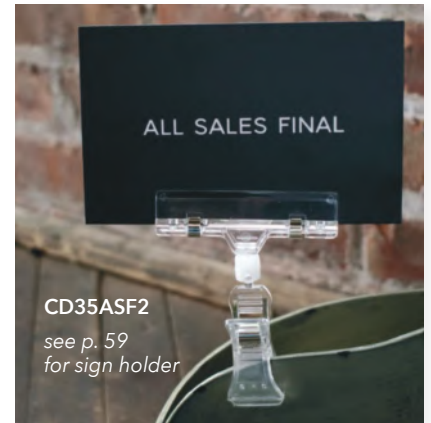

CD35ASF2 /small
CD57ASF2 /medium
CD711ASF2 /large



CD35ASF1 /small
CD57ASF1 /medium
CD711ASF1 /large



CD35S1 /small
CD57S1 /medium
CD711S1 /large



CD35S2 /small
CD57S2 /medium
CD711S2 /large



CD35S3 /small
CD57S3 /medium
CD711S3 /large



CD35S4 /small
CD57S4 /medium
CD711S4 /large

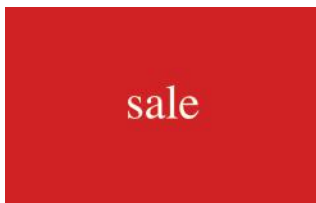

CD35S5 /small
CD57S5 /medium
CD711S5 /large



CD35NA2 /small
CD57NA2 /medium
CD711NA2 /large



CD35NA1 /small
CD57NA1 /medium
CD711NA1 /large



CD35SS /small
CD57SS /medium
CD711SS /large



SALEBANNER
Glossy red sale printed vinyl tags slip over the hook of a hanger. 2" w x 4" h; 5/16" dia. hole is 3/16" from top; 100 pcs; 1/3 lb.
27.73



RAH25



RAH007



RAH44

Plastic Display Cards
Red & White plastic card stock, slightly textured on front. Available in 3 styles. 7" w x 11" h; 1 pc; 1 lb. **3.89**

Sign Holders SIGNAGE

style #	\$	qty	description / size	wgt
BH28	41.90	1	Chrome, 22x28", 60" H <i>(holds graphics up to 3/16" thick, usable sign area 20 3/4" x 26 3/4")</i>	18
The following signs all hold graphics up to 1/4" thick:				
BH28BAW	116.51	1	Black, All Weather, 22x28", 60" H indoor/outdoor	18
BH22	59.49	1	Chrome, 14x22", 53" H	13
BH28MAB	52.99	1	Matte black, 22x28", 60" H	23
BH23	75.30	1	Chrome, extra heavy base, 14x22", 53" H	13
BH29	105.75	1	Chrome, weighted base, 22x28", 60" H	22
BH24	69.21	1	Chrome, rectangular tubing, 14x22", 56" H	7
<hr/>				
BH28SP	43.03	2	Acrylic Sign Protectors (2) crystal clear panels; each 22" w x 28" h x .04" thick <i>(works with BH28 - sold separately)</i>	4
BH28SP2	97.84	1 kit	"Sidewalk Sale" Sign Kit Kit includes (1) BH28 sign, (2) "Sidewalk Sale" poster signs, (2) sign protectors (BH28SP)	24
<hr/>				
BH30	79.57	1	Rect. tubing, 22x28", 56" H; Chrome <i>holds graphics up to 3/16" thick</i>	9,8 lbs; (2 ctns)
BH30MAB	62.73	1	Rect. tubing, 22x28", 56" H; Matte Black; <i>holds graphics up to 1/4" thick</i>	9,8 lbs; (2 ctns)
BH55	97.99	1	Double 22" x 28" sign holder; 56" H; Chrome; <i>holds graphics up to 3/16" thick</i>	9,8 lbs; (2 ctns)
BH55MAB	86.70	1	Double 22" x 28" sign holder; 56" H; Matte Black; <i>holds graphics up to 1/4" thick</i>	9,8 lbs; (2 ctns)
BH77	208.49	1	Triple 22" x 28" sign holder; 90" H; Chrome; <i>holds graphics up to 3/16" thick</i>	35/98, 10/25 lbs; (2 ctns)
BH77MAB	169.99	1	Triple 22" x 28" sign holder; 90" H; Matte Black; <i>holds graphics up to 1/4" thick</i>	
<hr/>				
MCW28V	36.81	1	22x28" frame with wall mount attachment	6/21
<hr/>				
Metal shelf signs Ledge piece is 6" front to back; sign holder piece is 6 1/2" across				
NHSTCH	9.72	1	High Polished Chrome	1
NHSTV	7.00		Metal	
Accepts 6 1/2"W x 1 1/2"H paper inserts, (not included)				



BH22/BH28
BH28MAB
Chrome or Black
10" x 14"
flat base

BH23/BH29
Chrome
Extra heavy weighted
10" x 14" base



BH28BAW
Black
All Weather
Sign Holder
10" x 14"
flat base

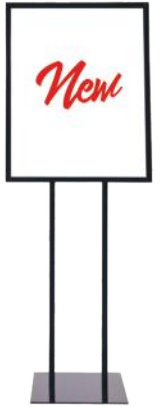

BH24
Chrome
Rectangular
tubing frame

ACRYLIC SIGN PROTECTORS

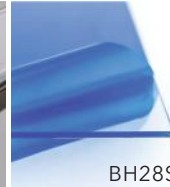

BH28SP



SIDEWALK SALE
SIGN KIT

BH28SP2



BH30
BH30MAB
Chrome or Black
Single sign holder.
Rectangular tubing
frame base - 15" x 24"



BH55
BH55MAB
Chrome or Black
Double sign holder.
Rectangular tubing
frame base -
15" x 24"



BH77
BH77MAB
Chrome or Black
Triple sign holder.
Rectangular tubing
frame base -
24" x 25"



WALL MOUNT SQUARE CORNER SIDE FRAME

MCW28V

METAL SHELF OVERLAY RETAILS SIGNS W/FRAMED FRONT

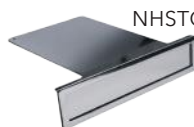

NHSTCH



NHSTV



SIGNAGE Sign Holders & Accessories



SQUARE CORNER CARD FRAMES

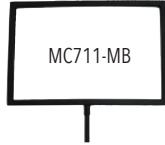

MVER114



MC57, MC711, MC114



MCP57, MCP711



ROUND CORNER CHROME FRAMES

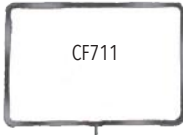

CF711

ALLIGATOR CLIP SIGN HOLDERS



WSAC2SN



WSAC5SN



WSAC6SN



WSAC7SN

ALLIGATOR SIGN CLIP HOLDERS

Satin Nickel / down position clip:

style #	\$	qty	description / size	wgt
MCP711-MB	10.50	1	7x11" Matte black mitre corner card frame w/double 4" stem 3/8x5" base	7/10
MC711-MB	7.49	1	7x11" Matte black square corner frame w/3" threaded stem attchd.	6/10
SC20-MB	8.90	1	Matte black magnetic clamp threaded	1
SC22-MB	1.99	1	Matte black all purpose clamp threaded	1
MVER114	89.90	6	11x14" chrome sign frame with 5 1/2x11" base	3/12
MC57	27.09	6	5 1/2x7" chrome frame w/ 3/8" fitting	2
MC711	27.90	6	7x11" chrome frame w/ 3/8" fitting	6/10
MC114	42.90	6	11x14" chrome frame w/ 3/8" fitting	6/10
MCP57	8.42	1	chrome, 5 1/2x7" card frame mitred Double 4" stem, 4x7" base	2/6
MCP711	9.72	1	chrome, 7x11" card frame mitred Double 4" stem, 4x7" base	2/6
SB57	10.25	1	10" H shovel base, 5 1/2x7"	2/6
SB711	10.50	1	10" H shovel base, 7x11"	2/6
CF711	8.42	6	7x11" frame w/ 3/8" fitting * while supplies last	6/7

WSAC1SN	18.01	1	12" H	3/6
WSAC2SN	19.44	1	24" H	3/11
WSAC4SN	20.22	1	42" H	4/21
WSAC5SN	3.95	1	Clear, 1"x1" square base; 4"H	0.5/1
WSAC6SN	4.82	1	Black, 1"x1" square base; 4"H	0.5/1
WSAC7SN	4.38	1	"S" design; stainless steel; 3 1/2"H	0.5/1

CHROME CLAMPS & STEMS



C5



C6



SC22



SC23



SC8



SC11



M3



M6



NS3



NS6

MAGNETIC CLAMPS



SC17



SC20



SC21

C5	20.22	6	1" Square w/3" stem - 3/8"	2/3
C6	17.37	6	1/2 x 1 1/2" rect. 2" stem - 3/8"	2/3
SC22	9.49	6	Universal all purpose clamp; Fits round, square & rect. tubing threaded	2/3
SC23	13.77	6	All purpose clamp for 3/8" swedge	2/3
SC8	14.64	6	Spring clamp for 1" sq. tubing w/ threaded 3/8" fitting	2/3
SC11	15.94	6	Spring clamp for rect. tubing w/ threaded 3/8" fitting	2/3
M3	4.92	6	3" threaded stem - 3/8"	2
M6	6.74	6	6" threaded stem - 3/8"	2
NS3	4.92	6	3" swedge stem - 3/8"	2
NS6	7.65	6	6" swedge stem - 3/8"	3
SC17	21.51	6	Magnetic clamp for 1/4 & 3/8" threaded stem	2
SC20	31.23	6	Magnetic clamp for 3/8" threaded stem	2/3
SC21	31.23	6	Magnetic clamp for 3/8" swedge stem	2/3

Sign Holders /Acrylic SIGNAGE

style #	\$	qty	description / size	wgt
Clear:				
POP1	18.01		Double clip sign holder 3½" long; clip - 0.75"W x 1.5" H	1/3
POP2	31.23		Clip on sign holder w/ spring loaded graphic holder; 4" long; clip - 3.2"W x 1"H	2/7
POP3	41.60	20	Clip on sign holder w/ spring loaded graphic holder; 6¼"L; clip - 3.2"Wx 1"H	2/7
POP4	24.36		Clip on sign holder w/ fixed graphic holder; 3 5/8" long; clip - 2.2"W x 0.88"H	2/7



CLIP-ON SIGN HOLDERS



PK57	11.15	1	5½x7" card holder w/ chrome double stem	2/3
PK711	15.03	1	7x11" card holder w/ chrome double stem	3/6
JPC57	45.99	6	5½x7½" frame w/ universal stem	2/3
JPC711	52.49	6	7x11" frame w/ universal stem	3/7
Horizontal, double-sided, bottom load sign holders:				
PG711	50.49	6	Straight 7x11" card holder	3/7
PJ711	42.99	6	Card holder, chrome channel 7x11" w/ 3/8" fitting	3
PJ57	29.81	6	Card holder chrome channel 5½x7" w/ 3/8" fitting	3/7
PH711	21.49	6	Slanted 7x11" card holder	7/10
PH57	17.99	6	Slanted 5½x7" card holder	3/7



ACRYLIC CARD HOLDERS



TOP & BOTTOM LOAD SIGN HOLDERS

Crystal clear sign holders

Top Load Styles

HPCT57H	4.92	1	TOP LOAD HORIZONTAL 5½"H x 7"W	2/3
HPCT57V	6.35	1	TOP LOAD VERTICAL 7"H x 5½"W	
HPCT711V	11.92	1	11"H x 7"W	2/3
HPCT811V	12.57	1	11"H x 8½"W	
HPCT114V	20.87	1	BOTTOM LOAD VERTICAL 14"H x 11"W	2/3
HPCT57HSB	2.99	1	SLANT BACK HORIZONTAL 5½"H x 7"W	2/3
HPCT57VSB	5.44	1	SLANT BACK VERTICAL 7"H x 5½"W	1/6
COUNTER BROCHURE HOLDER				
IMCT49	6.35	1	4" x 9" clear	1/3
IMCT811	9.59	1	8½" x 11" clear	2/6



SLANT BACK SIGN HOLDERS

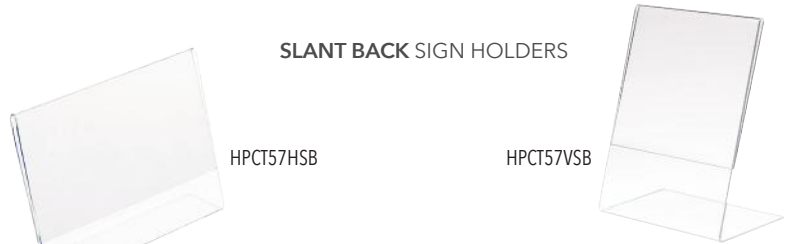

BROCHURE HOLDERS



SIGNAGE Sign Hanging & Accessories

CEILING ANCHORS



DISC MAGNETS



Spider Anchors

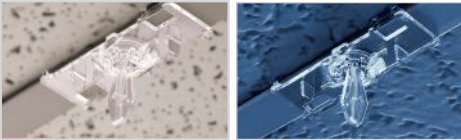

RAN1UP RAN1UP2

PINCH



CLEAR LOCKING HOOKS



2501006

Single Locking Hook

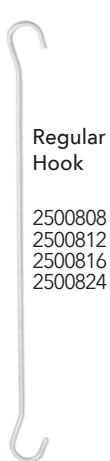

Regular Hook

2500808
2500812
2500816
2500824



Double Loop Cable (pairs)

DLC6
DLC12
DLC18
DLC24



S HOOKS

300100 300795 125309



06SC150H10

MIRACLE STICKS® ADHESIVE SIGN TABS

NHMS



style #	\$	qty	description / size	wgt
GCH02	17.37	10	1/4" swivel hook slot; rotates 360°; snaps on ceiling grids	5
GCH05	14.64	10	Clear hinged hook ceiling anchor	5
GCH06	13.87	10	7/8" loop ceiling anchor w/ 2" base; twist to connect	5
GCH04	34.08	10	Ceiling anchor w/ steel spring & 15/64" loop	5
RMB18	8.42		Plated steel magnet with hook: 1 1/2" dia - holds 18 lbs 2" dia - holds 20 lbs 2 1/2" dia - holds 38 lbs	
RMB20	13.87	1		
RMB38	17.37			
MCL1	1.10	1	Plated steel magnet in 2 sizes: 1" - holds 5 lbs 2" - holds 14 lbs	1
MCL2	1.94			
250145	12.96	1	White Gorilla magnet: holds up to 20 lbs	1
250026	75.69	50	White snail adhesive disk	1/3
DISCMAG10	13.87	10	1/2" x 1/8" disc magnet for signage; pull force: 7.36 lb	1/3
DISCMAG30	27.73	30		
ClearOne-Up™ Spider Anchors				
RAN1UP	7.52	10	use w/ hooks to hold signs perpendicular or parallel	1/3
RAN1UP2	8.29	10		
2 piece - use w/ hooks to hold signs perpendicular, parallel or 45°				
PINCH	4.15	10	Galvanized steel	1
Clear, Single locking hooks:				
2501006	32.66	50	6"	1/3
Galvanized Steel:				
300100	28.51	100	Long S Hook - 2 5/8"H	2/3
125309	8.42	100	Standard S Hook - 1"H	1
300795	11.15	50	Large S Hook - 1 5/8"H	
2500808	13.87	50	Regular Hook 8"	2/3
2500812	15.29	50	Regular Hook 12"	2
2500816	20.87	50	Regular Hook 16"	2/9
25008024	27.73	50	Regular Hook 24"	3/27
Double loop cable - sold in pairs; 1/32" uncoated stainless steel w/ 1/2" long loops; holds up to 50 lbs				
DLC6	9.72	2	6" Cable length	1/2
DLC12	11.15	2	12" Cable length	
DLC18	12.57	2	18" Cable length	
DLC24	13.87	2	24" Cable length	
06SC150H10	10.50	10	Suction cup - Clear with plated steel hook 1 3/4"	1/3
NHMS	22.29	500	Adhesive on both sides. Apply to back of signs to avoid messy taping. 3/8" x 1 5/8"	1



SIGN HANGING SYSTEMS & HANGING HARDWARE FOR GRAPHIC DISPLAYS

Featuring plastic gripper bar sets with snap closures, hanging dowel kits, sign clips that can be used for hanging signs - or simply turn them over to use as countertop displays. We have updated our ceiling anchors too, including magnets, hooks and cables. Easy to assemble and versatile for every season.

PLASTIC GRIPPER BAR SETS

Set includes a top and bottom bar, and feature snap grips that close easily. Strong with a rigid torque. Fits signs up to .070" thick. Each set includes two snap grips, two universal hanging clips and is available in three sizes.



GSHR - straight

Straight Sets

Available in 3 sizes and 3 colors (clear / black / silver):

GSH24R - (C/B/S)	24" long	11.79
GSH36R - (C/B/S)	36" long	15.29
GSH48R - (C/B/S)	48" long	19.44



GSHO - oval

Oval Sets

Available in 3 sizes and 2 colors (clear / silver):

GSH24O - (C/S)	24" long	20.87
GSH36O - (C/S)	36" long	24.36
GSH48O - (C/S)	48" long	31.88



Can be used 2 ways

RMB

Round magnetic base w/hook available on page 60



Mini size 1 1/4" w x 2" h

GSHC



2" w x 3" h

HANGING DOWEL KITS

Made for banners with a hem, top and bottom. Each kit includes (2) aluminum 1/2" diameter dowels, end caps and (1) diamond braided cord. Available in 3 sizes.

GDSH24	24" long	11.79
GDSH36	36" long	13.87
GDSH48	48" long	15.29

GDSH



SIGN HANGING & COUNTERTOP CLIP SETS

Solid aluminum alloy sign clips coated in a satin finish. Clips feature rubber grips, a binder spring and the ability to grip signs up to 1/2" in thickness.

Satin silver or black. Sold in sets of two, same size/color.

GSHCL	2"W x 3"H	39.53
GSHCLB		
GSHCS	1 1/4"W x 2"H (mini)	27.73
GSHCSB		



SIGNAGE Outdoor & Miscellaneous

FEATHER BANNER SWOOPER FLAG SIGN KITS



SALEFB CLEARANCEFB OPENFB OPENSFFB

15 FOOT HIGH FLAG SIGN KIT

Includes 1 flag (12' x 2.5'), 1 4-piece pole kit & 1 stake; stands 15' high when assembled; 1 kit/carton; 7 lbs. **\$97.07 /kit**

- | | |
|-------------|---------------------------------|
| SALEFB | Sale Sign kit |
| CLEARANCEFB | Clearance Sign kit |
| OPENFB | Open (blue/red) Sign kit |
| OPENSFFB | Open (stars & stripes) Sign kit |

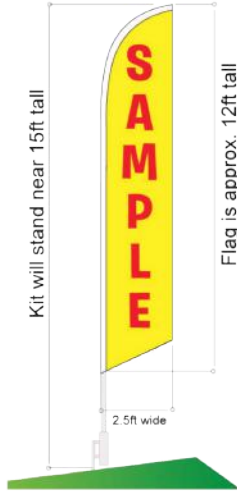

FLAGS



PFL00100



PFL00200

SALE & OPEN FLAGS

Large 3' x 5' flags. Lightweight and durable outdoor polyester material, double stitched on flying edges for extra durability, and two metal grommets for easy display. 1 /carton; 1 lb.

- | | |
|---------------|---------------------|
| SALE PFL00100 | \$13.87 each |
| OPEN PFL00200 | \$19.43 each |

PENNANTS



PNR100-OMC



PNR100-OPT

TRIANGLE PENNANTS

(48) 12" x 18" pennants on 100' of nylon rope. Please specify color: Red/White/Blue(OPT) or Multi-Colored(OMC).

- | |
|---------------------------|
| 1 /carton; 2/10 lbs. |
| PNR100-OPT \$26.49 |
| PNR100-OMC \$24.99 |



OPENHRB2

LED OPEN SIGN

LED red and blue open sign with black base for indoor use. Measures 13"H x 21 1/2"W x 1"D. Weight 3lbs. Lifetime of 10,000 hours. Low power consumption. No Flashing. Power supply and chain included; 18 5/8" w x 9 5/8" h. 1 /carton; 3/12 lbs. **\$55.34**



NHMBB03G

A-FRAME SIDEWALK CHALKBOARD

Features a mahogany finish. Can be used with chalk and liquid chalk markers (sold separately). It is double-sided and sits on rubber stoppers to prevent scratches and add stability. Can be used indoors and/or outdoors.

Closed Dimensions: 20 1/2" (w) x 39 1/2" (h) x 2" (d)
Open Dimensions: 20 1/2" (w) x 37 1/2" (h) x 27" (d)
Writable Area: 17 3/4" x 28 3/4"

1 /carton; 18/24 lbs. **\$116.51**



NHMBB03B

A-FRAME SIDEWALK MARKER BOARD

Features a mahogany finish and black marker board perfect for dry-erase or liquid chalk markers (sold separately). It is double-sided and sits on rubber stoppers to prevent scratched floors and added stability. Indoor use only.

Closed Dimensions: 20 1/2" (w) x 39 1/2" (h) x 2" (d)
Open Dimensions: 20 1/2" (w) x 37 1/2" (h) x 27" (d)
Writing Area: 17 3/4" x 58 3/4"

1 /carton; 18/24 lbs. **\$116.51**

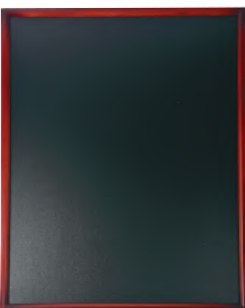

NHMBB10C

FRAMED SQUARE CHALKBOARD

Features a mahogany finish and can be used with chalk and liquid chalk markers (sold separately). It can be hung in portrait and landscape with the (2) hooks provided. Indoor use only.

Overall Size: 24" x 30" x 1"
Writable Area: 22 1/2" x 28 1/2"

1 /carton; 9/10 lbs. **\$68.04**



PFL00200KT

OPEN FLAG w/POLE KIT

Kit consists of one 3' x 5' OPEN flag and a 6' flag pole. The flag pole is white, painted steel and includes a mounting bracket and screws, rotating flag clips, and a gold plastic eagle mounted on the top.

1 kit /carton; 2/5 lbs. **\$42.76**

FLUORESCENT LIQUID CHALK MARKERS

Wipe away easily with a wet cloth. A set includes 8 markers: Blue, Green, Pink, Purple, Orange, Red, White, and Yellow.

w/ 1/8" SMALL BULLET TIP (8)

8 /carton; 1 lb. **\$25.66**

NHGEB06



w/ 5/8" LARGE FLAT TIP (8)

8 /carton; 1/2 lbs. **\$50.67**

NHGEB05

TRAFFIC CONTROL

Everyone experiences waiting in lines. Organized waiting feels shorter and less stressful. Visible queuing ensure customers understand where to check out. Choose from a range of stanchions for forming wait lines and guiding foot traffic.

RETRACTABLE BELT STANCHIONS

Economical steel posts and belts with slow-retracting brake available in three options.

40.5" tall; 10' black belt; 1/pack; 47/50 lbs./pair

PRBSBBK Black Post; 14" base \$57.49

PRBSS1BK Satin Steel Post; 14" base \$72.49

PRBPS1BK Polished Steel Post; 14" base \$69.49

**Price is per post / ships in pairs*

- Same day shipping on most orders.
- Ships knocked down.
- Easy assembly - no tools required.

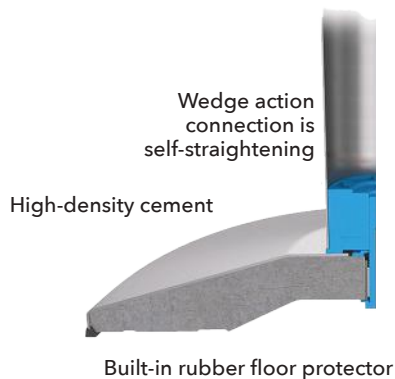

PRBSBBK
Smooth
Black



PRBSS1BK
Satin
Stainless
Steel

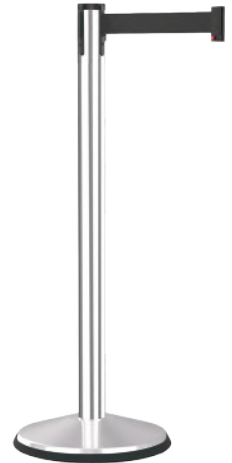

PRBPS1BK
Polished
Stainless
Steel

Economy accessories - page 113

WALL MOUNT BARRIERS

Wall mount barriers - Great for small spaces, closing off restrooms and other areas for cleaning. Great for micro physical inventories or cycle counts. Close off VIP areas for special customers. Economically priced and durable.

WALL MOUNT BARRIER

Wall mount barriers with 10' belts; 1/pack; 2.5/3 lbs. \$30.99

WALL MOUNT RECEIVING END

Receiving end; 1 lb. \$11.49

TLRE Black



WM100SBBK Black w/black belt



WM100PS1SB Chrome w/black belt

SECURITY Traffic Control

TENSABARRIER® 890 SERIES

Premium retail staple for stanchions. Military-grade fabric belt & high-grade premium posts. Added Safety: extra slow retracting and low edge base for people with mobility issues. Ships pre-assembled!

RETRACTABLE BELT STANCHIONS

40" h post; 7' long military-grade fabric belt - (0.89mm thick and 2" wide); 1 /pack; 20/26 lbs.

TENSABARRIER® accessories detailed on page 113



Polished chrome post w/ black belt
NH890PCB \$179.99



Satin chrome post w/ black belt
NH890SCB \$179.99



Black post w/ black belt
NH890BB \$165.99

POST & ROPE Style and durability for high-end retail and hospitality. Classic Post and Rope stanchions are professional quality at an economic price.

POSTS /STANCHIONS



Prices are for one post - but must be bought in pairs. 39.5 - 41.25" tall; 25 lbs.

FLAT TOP
Black
MLFTMB \$51.99

BALL TOP
Gold
MLBTPB \$78.99

URN TOP
Polished Stainless
MLUTPS \$62.99

ROPES



3 SNAP END FINISHES:

Black snap end

Chrome snap end

Gold snap end

Braided

Polypropylene:



Natural Hemp



Black



Black



PMS Cool Grey 9C
Pearl Grey



PMS 197
Light Pink



PMS 4725
Beige

Velour (w/cotton core) colors:

Pair posts with snap end ropes. 6' and 8' lengths; hemp or velour ropes; 3 choices of snap end finishes; 5 lbs.

BRAIDED/6 foot ropes \$72.99 /each

TRBLKB6 Black/black snap end
TRBLKG6 Black/gold snap end
TRBLKC6 Black/chrome snap end
TRHEMPB6 Natural/black snap end
TRHEMPG6 Natural/gold snap end
TRHEMPC6 Natural/chrome snap end

BRAIDED /8 foot ropes \$85.99 /each

TRBLKB8 Black/black snap end
TRBLKG8 Black/gold snap end
TRBLKC8 Black/chrome snap end
TRHEMPB8 Natural/black snap end
TRHEMPG8 Natural/gold snap end
TRHEMPC8 Natural/chrome snap end

VELOUR/6 foot ropes \$93.99 /each

VRBLKB6 Black/black snap end
VRBLKG6 Black/gold snap end
VRBLKC6 Black/chrome snap end
VRGRYB6 Grey/black snap end
VRGRYG6 Grey/gold snap end
VRGRYC6 Grey/chrome snap end
VRBGB6 Beige/black snap end
VRBGG6 Beige/gold snap end
VRBGC6 Beige/chrome snap end
VRPKB6 Pink/black snap end
VRPKG6 Pink/gold snap end
VRPKC6 Pink/chrome snap end

VELOUR /8 foot ropes \$112.99 /each

VRBLKB8 Black/black snap end
VRBLKG8 Black/gold snap end
VRBLKC8 Black/chrome snap end
VRGRYB8 Grey/black snap end
VRGRYG8 Grey/gold snap end
VRGRYC8 Grey/chrome snap end
VRBGB8 Beige/black snap end
VRBGG8 Beige/gold snap end
VRBGC8 Beige/chrome snap end
VRPKB8 Pink/black snap end
VRPKG8 Pink/gold snap end
VRPKC8 Pink/chrome snap end

TRAFFIC CONTROL ACCESSORIES

Guide customers with signs. Boost impulse sales by strategically merchandising your queue areas for waiting customers.

890 SERIES TENSABARRIER® SYSTEM *see page 112 for coordinating posts*

TENSABARRIER® SIGN BRACKET



Black plastic sign cone and slot for sign; The acrylic pocket allows you to use your own sign; Bracket can hold a hard backed ¼" thick

170133899HD 2/5 lbs. **\$49.99**

TENSABARRIER® IMPULSE BOWL



Bowl includes adapter that slides onto stanchion; Made from lightweight polycarbonate plastic; Heavy duty adapter for stability

NH890IB 3/5 lbs. **\$64.49**

ECONOMICAL POST & TENSION SYSTEMS *see page 111 for coordinating posts*

Pair stanchions with heavy duty sign frames or stock engraved messages signs.

HEAVY DUTY SIGN FRAMES

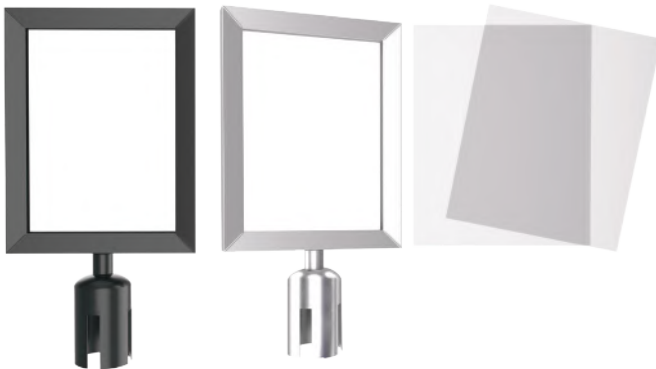

Display messages with premium post mount sign frames. 8.5x 11", durable steel construction, welded square corners and slotted top accepts up to ¼" thick insert material.

Frame includes adapter cone (works with 2.5" diameter posts) and 2 pieces of clear, non-glare acrylic inserts. Slotted cap for top loading.

TLSK1811MB matte black; 2.5/3 lbs. **\$36.49**

TLSK1811PC polished chrome; 2.5/3 lbs. **\$36.49**

ENGRAVED SIGNS



Universal Economy
7X11" engraved signs.
Single sided.

Custom message signs are available upon request.

PRENT please enter here; 3.5 lbs. **\$24.49**

PREX exit; 3.5 lbs. **\$24.49**

SIGN BRACKETS

Install a 7X11 engraved sign with a bracket. Universal post adapter. Works with 2.5" dia posts.

PRSBBS smooth black; 3.5/5 lbs. **\$43.49**

PRSBPC polished chrome 3.5/5 lbs. **\$43.49**



SECURITY Security Devices



COUNTERFEIT CASH DETECTOR

Counterfeit detector unit only; 2 3/4" x 4 1/2";
1 /pack; 1 lb; NHFT **\$56.99**
Includes AC adapter



3 TESTS:
watermark,
UV strip
& ink
detector



DETECTOR KIT /BATTERY

NHFTRB Detector kit w/battery;
both pieces 2 3/4" x 4 1/2";
1 kit /pack; 1 lb. **\$72.99**

NHFTRBADD Battery only.
rechargeable; 2 3/4" x 4 1/2";
1 /pack; 1 lb. **\$16.99**

PEN STYLE COUNTERFEIT DETECTOR

Each pen tests up to 5,000 bills.

K20020 Black Pen; 1/pack; 1 lb. **\$5.57**

K20020S Set of 3 Pens; 1/pack; 1 lb. **\$16.59**



WIRELESS ENTRY ALERT® CHIMES AND RECEIVER KITS

All kits feature: up to 500 ft. range; 64-88 dB at 1 foot; UL/cUL listed,
FCC and IC Compliant. 1/pack; 1 lb.

NH3360 Chime alert w/Receiver; 10 selectable chimes **\$52.99**

NH3350 Musical doorbell chime w/ Receiver; 10 selectable sounds **\$55.99**

NH3300 Doorbell extender w/ Receiver; 2 selectable sounds **\$55.99**

NH3610 Motion-activated chime w/ Receiver; 10 selectable chimes;
weather sealed **\$54.49**

Easy to install. No expensive wiring.

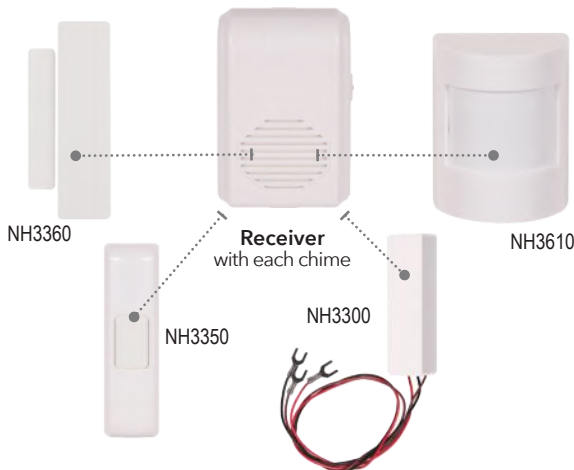

CA2

COMPACT MOTION DETECTOR

Self-contained indoor alarm. Motion detection activates a chime or alarm sound. Uses 9V battery (not included). Detects motion at a range of up to 32 feet. Fully automatic. No alignment required. Mount where you need it: ceiling, walls, etc. No wires. Easy install.

3x3x2 1/4"; 1/pack; 1 lb. **\$62.47**



SECURITY CHAIN KIT w/RING & LOCK

Economical and effective anti-theft. Feed chain through garment and secure to garment rack or display.

Kit includes 8" ring, 46" chain, lock and key; 1 /pack; 1/3 lbs; 606 **\$6.87**

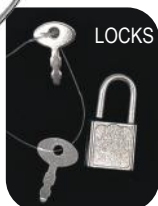

REPLACEMENT LOCKS
Standard replacement locks; 5 /pack; 1 lb;
LOCKS **\$3.11**



MG24



SD75

SD100

SD724

SECURELOCK - ANTI-THEFT APPARELL SECURITY

While Supplies Last

Adapters and cables sold separately.

main unit

MG24 24-slot arm w/key; 2/3 lbs. **\$46.49**

adapters

SD75 3/4" chrome tube; 2 lbs. **\$21.49**

SD100 1" square chrome tube; 1 lb. **\$8.49**

cables

SD7244 8 foot long chrome cable; 1 lb. **\$5.96**

DRESSING ROOM SUPPLIES

style #	\$	qty	description	size	wgt
NHBLB	24.36	1	Brass wire lint brush	9 1/4" long	2/3
NHCB	20.87	1	Horse hair coat brush, deluxe	14 1/4" long	2/3
NHNB	25.66	1	Lint & Nap brush - Brass wire center with outside row of horse hair bristles - excellent for suedes & sweaters	4 1/2"L x 2 1/2"W	2/3
NHFC	34.73	1	Fabric comb w/steel blade to remove pills from wool garments	6" wide; 7 1/4" long	2/3
NHSC	25.66	1	Sweater comb	6" long, 4 5/8" x 2 1/4" head	2/3
NHCSR	9.72	1	Janie® Dry Spot Commercial Stick Remover	.40 ounces	2/3
NHSR	6.49	1	Grandma's Secret Spot Remover	2 ounces	2/3
TS	54.17		White	Misses	2/3
TSJ	44.45	100	White thong	Junior	2/3
TCP1	77.99	1000	Natural	1 1/2x5"	3
LL30	3.50	1	8" Lint Roller w/ handle	30' roll	1/2
LLR	2.06		4" Refill		
1030A	30.99	1	One bottle Non-aerosol	8 oz	2
1061	20.49	1	One can Aerosol	12 oz	2
SG2000	95.99	1	Electric spot cleaning gun	Standard	5/6



NHBLB

BRASS WIRE LINT BRUSH



HORSE HAIR COAT BRUSH

NHCB



FABRIC COMB

NHFC

LINT & NAP BRUSH

NHNB

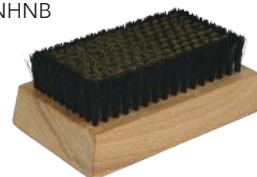

SWEATER COMB

NHSC

Janie® DRY STICK COMMERCIAL SPOT REMOVER

NHCSR



GRANDMA'S SECRET SPOT REMOVER

NHSR



TRY-ON PANTY
Excellent for bathing suits.
Each is packed individually.



TSJ

HYGIENIC LINER



TCP1

LINT ROLLER & Replacement Rolls



Ever Blum® COSMETIC STAIN REMOVER

POWDER SPOT REMOVER
For fine garments.

1030A

1061

LL30

LLR



SG2000

Albatross® ELECTRIC SPOT CLEANING GUN

DRESSING ROOM SUPPLIES

FITTING ROOM CHECKS

Color coded and notched to indicate number of items.



608 /608X



608-6B / 608-6W Numbers 1-6, printed both sides.



Numbers 1-6 plus 'guest'



LSB

PLASTIC SHOPPING BASKETS

Choose from two sizes: JSB (Jumbo) and LSB (Large).

Hot stamp printing is available for this item. Ask for details.

All baskets are drop ship only.

Basket stands sold separately (below).



BSJ



BASKET STAND

Black wire metal stand available in two sizes that correspond to shopping baskets above.



PGB-BLK

PULL & GO BASKETS

- Easy grip pick-up handle and ergonomic, antibacterial, lockable telescopic pull handle
- Smooth panel on the top rim can be used for logo branding
- Washable and 100% recyclable

style #	\$	qty	description	size	wgt
<i>25 pieces per color per kit:</i>					
608	41.47	100/ kit	Green, red, yellow, blue	4x4 1/2"	3
608X	54.17	150/ kit	Green, red, yellow, blue, white, black	4x4 1/2"	4
<i>25 pieces per size per kit:</i>					
608-6B	50.03	150	Black w/white print	4x4 1/2"	4
608-6W	50.03	150	White w/black print	4x4 1/2"	4
<i>25 pieces per size per kit:</i>					
M319	17.37	30/ kit	White: 4,5,6	2x5"	1/2
<i>10 pieces per size per kit:</i>					
M320	44.45	100/ kit	1,2,3, Guest	2x5"	3

Let us create Custom Kits for you!

Allow 5-10 business days to ship

JSB	101.22	12	SPECIFY color	19 1/8 x 13 1/4 x 10" (8 gallons/ 28 liters)	26/43
LSB	83.07	12	SPECIFY color	17 x 11 3/4 x 9" (6 gallons/ 22 liters)	20/29

Colors: Blue (BL), yellow (Y), red (R), black (BLK), grey (GY) and green (G). Note that other colors are available with a 60-90 day lead time.

BSJ	36.16	1	BLACK METAL	JUMBO	5/16
BSL	33.31	1	BLACK METAL	LARGE	3/14

PGB-BLK	206.71	6	Black	21"L x 15"W x 17"H (36"H W/ handle extended)	35/35
				43 liter capacity; max weight 55lbs	

DRESSING ROOM SUPPLIES

style #	\$	qty	description	size	wgt
NTEZ	9.59	1	EZ-Off Iron Cleaner	5.25 oz. tube	1/3
ZD100	27.60	1	1- 1 oz. tube of soleplate cleaner 1- application cloth 1- polish/finish cloth 1- set of instructions		1/3
NTHI450F	26.31	1	Replacement Resin Filter - for use w/gravity feed irons		1
NTTIS-NTP5N	41.60	1	Ironing shoe (for use with NTP5N iron)		1
834	6.87	5	White, 60"	60"	1
NTTMC	3.63	1	Crotch tape measure	60"	1/3
NTPCT	2.85	1	Pin cushion tomato	Red/Green	1/3
NTSR6	2.72	1	Large seam ripper		1
NTSR5	1.68	1	Small seam ripper		1
NT4	3.50	3	For all needle types	Gold	1
NTTCA/ NTTCAR	15.16 15.16	48	Tailor's chalk	White Red	1/3
NTZE	6.87	1	Zipper ease		1
NHBSK	18.79	1 kit	Singer® Beginner's Sewing Kit: scissors, needles, pins, thread, measuring tape, thimble, marking pencils, pin cushion, sew/knit gauge, seam ripper included		2/3
NHBT	7.65	1	Basting Tape	1/4" x 11 1/3" yds	2/3
NT301C	12.99	1	Thread clip	4 1/2"	1
NT2025	19.43	1	Scissors	5"	1/3
NT601	13.74	1	Lightweight threadclip	4 3/4"	1/2
NT690	22.16	1	Lightweight dressmaker	9"	1/2
NTTPIN24	15.16	1/2 lb.	T-pin	1 1/2"	1/3
NTX24SD	22.16	1 lb.	Dressmaker pin	1 1/2"	1/7
285	20.74	1 lb.	Straight pin	1"	1/3
NTX3SC	40.31	1440	Safety pin	2" #3	2/3
SBSP	10.63	100	black safety	1 1/2"	1
00	36.03	1440	brass safety	3/4"	1/2

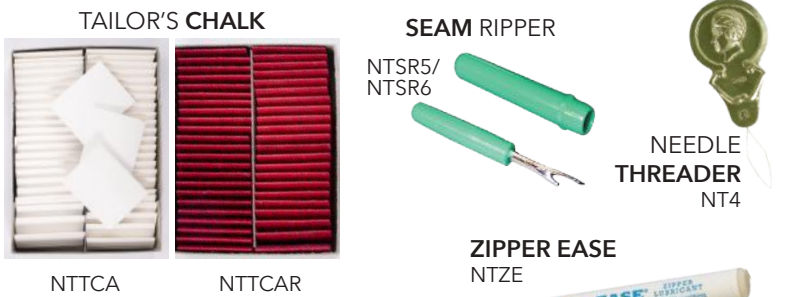

DRESSING ROOM SUPPLIES



J-2

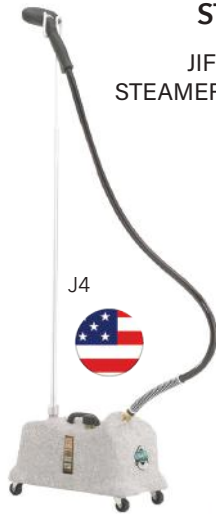

J4

STEAMERS

JIFFY CLOTHES STEAMERS & ACCESSORIES



J1



J6



JIFFY HANDHELD STEAMER



JC100

STEAM BUTLER ST500



style #	\$	qty	description	size	wgt
J-2	219.90	1	Standard 65" L Hose, 1 gal. water reservoir	1300 watts	18/21
J4	328.67	1	J4000 / Heavy Duty, 65" L Hose, 1 gal. water reservoir	1500 watts	25
J1	166.28	1	Hat Steamer 1 gal. water reservoir	1300 watts	14/21
#3	11.49	1	Replacement bottle for J-2	1 gallon	1/6
2A	81.99	1	Hose/Head replacement for J-2 & J4	65" L Hose	3/4
2C	37.99	1	Replacement head/handle for J1 /J-2/ J4		1/1
1030	45.49	1	Rod & nut set for J1 /J-2/ J4		3/3
J6	86.99	1	Plug In 8 oz. water reservoir	600 watts	3/7
0669	36.42	1	Water tank replacement for J6		1/1
0661	2.99	1	Inside O-ring replacement for J6		1/1
0662	2.99	1	Outside O-ring replacement for J6		1/1
0665	34.99	1	Right case half - J6		1/1
0666	24.99	1	Left case half - J6		1/1
0663	34.99	1	Steam cap w/face plate for J6		1
ST500	136.99	1	Grey Steam Butler 1 gallon water reservoir, snap on brush	1350 watts	19
JC100	12.57	1	Liquid Cleaner	10 oz	2/3
NTIRON	64.54	1	Iron has extra power & steam output; auto off; lifetime sole plate	8 ft. cord	4/10
NH2601	27.49	1 pair	Black Heat Gloves: steam /heat resistant; latex free; machine washable	size Large	1/3
NTP5N	211.51	1	Gravity Feed Iron Comes complete w/ water bottle, hoses, iron rest and filter	120 volt 5 lb.	10/13
VR8324U1	298.07	1	Steam Pro Iron	6.5 bar pump pressure w/ 350g/minute steam boost	10



STEAM IRON

NTIRON

15 MINUTE AUTO-OFF

30 SECOND AUTO-OFF

30 SECOND AUTO-OFF



NH2601



HEAT GLOVES

GRAVITY FEED IRON

Self-contained gravity feed iron system. The water tank gets installed above the iron (about 3 feet) and the gravity forces the water into the iron once the steam button is pushed.



NTP5N



STEAM PRO IRON

VR8324U1



Jersey Covered Forms BODY FORMS

PREMIUM JERSEY DISPLAY - Dressmaker Forms & Accessories

High-quality professional grade jersey covered forms for dimensional display. Professional, pinnable and long-lasting. Use for display, dressmaking, and tailoring. Create yours for a customized look.

Available in
2 classic colors
cream /CR &
black /BC

1 Select a Jersey Torso Form



Ladies Dress Torso

P26CR / P26BC

Size 8

91.99

7/8" Flange

10/47 lbs

Ladies Blouse Torso

P34CR / P34BC

Size 8

84.99

7/8" Flange

8/47 lbs

*Prices reflect torso only.
Complete forms shown for effect.*



Mens Shirt /Sweater Torso

P97CR / P97BC

Size 38

84.99

7/8" Flange

9/47 lbs

Mens Coat/Shirt Torso

P85CR / P85BC

Size 38

91.99

7/8" Flange

12/47 lbs

*Prices reflect torso only.
Complete forms shown for effect.*



Complete the Set: pair one of the Body Form torsos above with a neck block and a base (see p120)

BODY FORMS Jersey Forms /Components

PAIR COMPONENTS: body form torso (p72) + neck block + base

2 Add a Neck Block

WOOD styles

natural walnut mahogany

Wood Finial Neck Blocks 11.99
 Women's styles:
 NB301N / NB301S / NB301M
 Men's styles:
 NB302N / NB302S / NB302M
 (N=Natural / S=Walnut / M=Mahogany)

natural walnut mahogany

Neck Block Caps 11.99
 Women's styles:
 NDISK / WDISK / MDISK
 Men's styles:
 NDISKM / WDISKM / MDISKM
 (N=Natural / W=Walnut / M=Mahogany)

METAL styles

finial disk black metal

UNISEX NECK BLOCKS
Brushed Chrome:
 Finial / FSFSCFIN **45.99**
 Disk / FSFSC **11.99**
Black Metal: BKDISCM 11.99



Add a **HANGING LOOP (HL)** for **\$6.99**

3 Add a Base / Floor Standing

WOOD styles

Round or Tripod:
 42" Total Height
 (24" - Base / 18" - Chrome Pole)
 7/8" Flange compatible
 10/35lbs - 7/21lbs

mahogany mahogany
 natural natural walnut

Wood Bases - All Versions 50.99
 Round Base: WB172N7/8; WB172S7/8; WB172M7/8
 Tripod Base: WB212N7/8; WB212S7/8; WB212M7/8
 (N, Natural / S, Walnut / M, Mahogany)

METAL styles

Dressmaker Base:
 36" Upright Height
 7/8" Flange compatible
 36 lbs
 Includes casters

DMB1 Chrome **116.99** DMB2 Natural Metal **116.99**

DMU48C Replacement Upright
 48" height
 7/8" flange
 5 lbs.
11.79

DMU48C
**Upright only. For extra height, remove existing upright and insert the DMU48C. Dressmaker base (DMB1) must also be purchased. Available in chrome only.*

Jersey Form Sets BODY FORMS

BOUTIQUE DRESSMAKER FORMS /COMPLETE SETS



Includes: Cream pinnable form, acorn finial neck block and traditional style base with castors and decorative pedal in black or polished chrome.



NHZMMFBK



NHZMMFCH

Female Dress Sets

NHZMMFBK / **232.99**

Cream with Black

NHZMMFCH / **245.99**

Cream with Polished Chrome

Chest 36.5"
Waist 25.5"
Hip 36.5"
Height 30"
Adj. Height 63"-82"
Weight 22/50

Male Coat Sets

NHZMMMCK / **232.99**

Cream with Black

NHZMMMCH / **245.99**

Cream with Polished Chrome

Chest 40"
Waist 28"
Hip 39"
Height 29"
Adj. Height 60"-79"
Weight 22/50



NHZMMMCK



NHZMMMCH

JERSEY FORM SETS

Complete Sets - Budget Friendly - Professional Grade



NHBFFBM

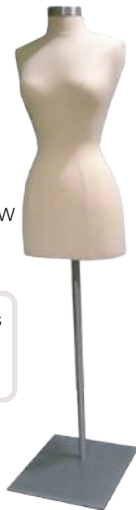

NHBFFOW

Metal bases have a 48" high pole

Female Dress Sets

92.99

Satin Chrome Stand and neck cap

Black Jersey NHBFFBM
 Cream Jersey NHBFFOW

Wood Stand and wood neck cap

Black Jersey w/black wood NHBFFBW
 Cream Jersey w/natural wood NHBFFCW

Size 8
Shoulder 15"
Chest 36"
Waist 25"
Hip 36"
Height 29"
Weight 15

Male Suit Sets

108.99

Satin Chrome Stand and neck cap

Black Jersey NHBFBM
 Cream Jersey NHBFCM

Wood Stand and wood neck cap

Black Jersey w/black wood NHBFBW
 Cream Jersey w/natural wood NHBFCW

Size 38
Shoulder 19"
Chest 38"
Waist 33"
Hip 39"
Height 33"
Weight 20



NHBFBM



NHBFCM



NHBFBW



NHBFBM



NHBFFBW



NHBFFCW

Wooden bases are 34.5" high

PIN-ON FLEXIBLE ARMS

Male / Female **43.99**

Pinnable flexible arms can be pinned to improved upper torso display. (Fills arms of garments)



FXA001R Female 23 1/4" long 2/12

FXA002R Male 26" long 3/12

BODY FORMS Jersey Forms & Accessories

LADIES & MENS 3/4 LENGTH FORMS

High Quality Jersey-Covered Forms. Versatile - leg mount or hang.
Easy to dress.



Best Sellers!



Hanging Loop (included)

Ladies 3/4 Torso

123.99

P27CR / P27BC
Cream / Black

Size 6
30" High
7/8" Flange
10/45

Mens 3/4 Torso

123.99

P86CR / P86BC
Cream / Black

Size 38
33" High
7/8" Flange
10/45

Price of form includes hanging loop and neck block of your choice:



Each preferred form comes complete with neck block. Specify: **N** (Natural); **W** (Walnut); **M** (Mahogany); **BC** (Brushed Chrome); or **BK** (Black metal).

Hanging Loop **HL** included in price

Bases are sold separately - see leg mount bases (pictured) below right

FLOOR STANDING NOTCHED COSTUMERS with adjustable height

Pairs with hanging jersey forms, full and half round body forms and display hangers.
Hanging loop included - can be easily removed.

see **page 80**
for more details

Notched costumers are also ideal for hanging display hangers



visit nahanco.com
for more details



VM504BR

Mannequin form not included

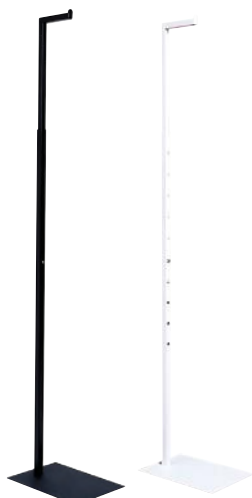

VM504MAB VM504MTW



VM504MAB



Forms shown hanging from notched costumers
(forms not included)

Sold in Sets of 2

VM504BR - Satin Chrome

105.99

VM504MAB - Matte Black

69.99

VM504MTW - Matte White

72.99

Adjusts every 3" from 51-78"

LEG MOUNT BASES

Leg only bases for use with 3/4 length forms - 7/8" flange compatible

61.99 /each

TFB/58
Matte Black / Center PoleBase/12x12"; 32" High

TFC/58
Brushed Chrome / Offset Pole Base/12x16"; 32" High

Ships in 2 cartons 4/6 actual, 10/13 billable



Mannequins BODY FORMS

PREMIUM FITNESS FORMS in matte white

Body forms in action, stretching or in yoga poses, are an effective way to bring dimensionality to clothing displays.

Standing form includes a heavy, brushed stainless steel base (15.75" x 15.75")



Male Stretch
498.99
NHFCP3MALE
74" High
41" Chest
32" Waist
39" Hips
43 /87lbs

Yoga Form
456.99
NHFCP4FEM
34" High
35" Chest
25" Waist
35" Hips
43 /79 lbs



Removable parts for easy dressing

Running forms include a heavy, brushed stainless steel base (23.5" x 15.75")



Male Runner
552.99
NHFCP4MALE
72" High
41" Chest
32" Waist
41" Hips
62 /96 lbs

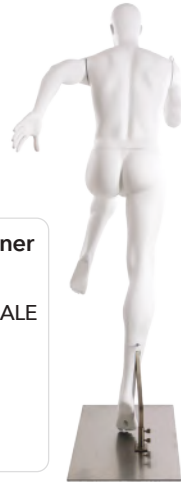

see nahanco.com for more info & additional forms

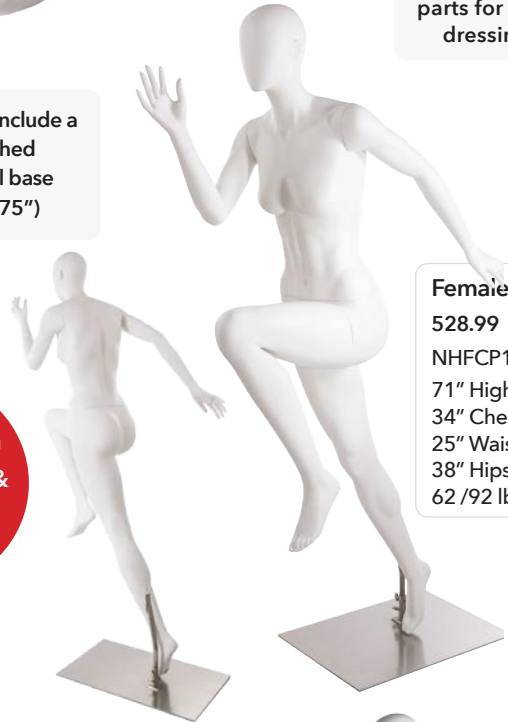

Female Runner
528.99
NHFCP1FEM
71" High
34" Chest
25" Waist
38" Hips
62 /92 lbs

PREMIUM KIDS FORMS

matte white fiberglass
Right sized, relaxed poses for kids apparel display (most include glass base)



head detail

4 year old
w/excited hands
296.99
NHKP1
43" High
22" Chest
19.75" Waist
24.25" Hips
10.5" Neck
23 /40 lbs



6 year old
seated
328.99
NHKP3
24.5" High
24" Chest
21" Waist
25" Hips
10.75" Neck
18 /53 lbs

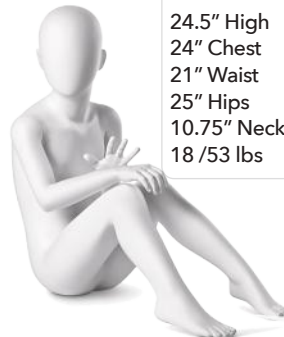

8 year old
with peace sign
343.99
NHKP4
51" High
25" Chest
21.5" Waist
27" Hips
10.75" Neck
43 /47 lbs

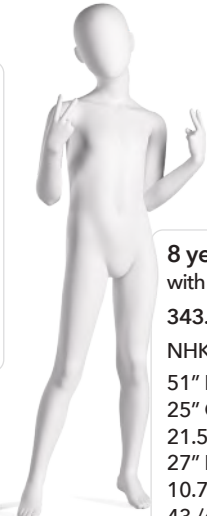

BODY FORMS Mannequins



WHITE MATTE MANNEQUIN FORMS - Stands included

Fiberglass mannequins provide a sculptured and realistic look for clothing display. Removeable parts for easy dressing. Headless forms keep the focus on the clothing.

ERICA SERIES

Height - 5'2" (ERICA5 - 3'2") / 28/57 lbs. **\$245.49** /each



ERICA1

Shoulder - 15 3/4"
Chest - 32 1/2"
Waist - 23 1/2"
Hip - 34 1/4"



ERICA2

ERICA3

Shoulder- 17 3/4"
Chest- 32 1/2"
Waist- 23 1/2"
Hip- 34 1/4"



ERICA4

Shoulder - 17 3/4"
Chest - 32 1/2"
Waist - 24"
Hip - 34"



ERICA5

Shoulder - 16"
Chest - 33"
Waist - 25 1/4"
Hip - 36 1/4"
(white seat included)



ERIC SERIES

Shoulder - 20 7/8"
Waist - 31"
Hip - 37 3/4"
31/57 lbs
\$251.99 /each



ERIC1
Height - 5'8"



ERIC2
Height - 5'8"



ERIC3
Height - 5'4"
Waist - 30 3/4"

JANET SERIES

Plus size
female
mannequins



JANET1W
Shoulder- 21 1/4"
Chest- 43"
Waist- 34"
Hip- 44"
Height- 5' 1/4"
30/94 lbs.
\$287.49 /each

JANET2W

Shoulder- 21 1/4"
Chest- 43"
Waist- 34"
Hip- 44"
Height- 6'
30/61 lbs.
\$309.49 /each



Due to their delicate nature and the fragility of mannequins and their components, all mannequin purchases are final. No returns are accepted, except if carton is unopened. Once a carton is opened and product removed, it cannot be re-sold.

Mannequins BODY FORMS

FIBERGLASS MANNEQUINS provide a sculptured and realistic look for clothing display. Removeable parts for easy dressing. Egghead styles focus the eye on the apparel.

Gloss
Fiberglass
Mannequins

Michelle 1-3

Gloss Fiberglass
shoulder - 15¼"
chest - 32½"
waist - 23½"
hips - 34¼"
height - 5'9"
28/61 lbs.

\$293.99 /each



MICHELLE1W



MICHELLE1B



MICHELLE2B



MICHELLE2W



MICHELLE3W



MICHELLE3B

Mike 1-3

Gloss Fiberglass
shoulder - 20 7/8"
chest - 37"
waist - 31"
hips - 37¾"
height - 6'2"
31/84 lbs.

\$299.99 /each



MIKE1B



MIKE1W



MIKE2W

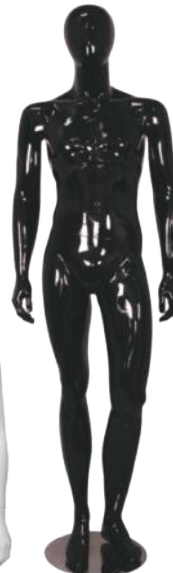

MIKE2B



MIKE3W



MIKE3B

BODY FORMS Polyethylene Forms

Milky White - Budget Unbreakable - Polyethylene Forms

Affordable and durable display. Color-infused polyethylene, difficult to break or chip, for long lasting display that doesn't need maintaining or replacing. Armless for easy dressing. Realistic display, full round.

FEMALE

Measurements: bust 34" / waist 24" / hip 35"
Order a form only **OR** a complete set for displaying

FEMALE TORSO FORM

NHLP4WH	NHLPH4M	NHLPF4M
Female Torso Form (form only)	Floor Standing Set Hanging base	Floor Standing Set Leg Mount base
Height 35"	Form Height 35" Upright: adjustable 43-74" Base: 14" x 14"	Form Height 35" Upright: 42" Base: 12" x 16"
8/46 lbs	23/60 lbs	24/66 lbs
100.49	155.49	158.99

FEMALE SHIRT FORM

NHLPB4WH	NHLPHB4M	NHLPFB4M
Female Shirt Form (form only)	Floor Standing Set Hanging base	Female Shirt Set Mount base/counter display
Height 24"	Form Height 24" Upright: adjustable 43-74" Base: 14" x 14"	Form Height 24" Upright: 26" Base: 10" x 10"
6/36 lbs	15/60 lbs	12/47 lbs
100.49	148.99	148.99

MALE

Measurements: Chest 39" / waist 32" / hip 37"
Order a form only **OR** a complete set for displaying

MALE SHIRT FORM

NHMPB5WH	NHMPHB5M	NHMPFB5M
Male Shirt Form (form only)	Floor Standing Set Hanging base	Male Shirt Set Mount base/counter display
Height 24"	Form Height 24" Upright: adjustable 43-74" Base: 14" x 14"	Form Height 24" Upright: 26" Base: 10" x 12"
8/36 lbs	20/60 lbs	15/47 lbs
100.49	148.99	141.49

MALE TORSO FORM

NHMP5WH	NHMPH5M	NHMPF5M
Male Torso Form (form only)	Floor Standing Set Hanging base	Floor Standing Set Leg Mount base
Height 40"	Form Height 40" Upright: adjustable 43-74" Base: 14" x 14"	Form Height 40" Upright: 42" Base: 12" x 16"
10/66 lbs	27/60 lbs	24/66 lbs
100.49	155.49	158.99

Display Forms BODY FORMS

INJECTED MODED HALF-ROUND FORMS - STYRENE
Heavy duty hook included. High quality, long lasting and reusable.

Best Seller!

LADIES
TORSO



LHR15



style #	\$	qty	description / size	wgt
LHR15B LHR15W	19.44	1	Ladies waist - 15" across; bust - 19"; hip - 18"; shoulder to shoulder - 16"; height - 31" w/out hook & 36" w/hook; back of form is hollow; matte finish Matte black Matte white	6/71

LHR35B LHR35W	12.99	1	Ladies Upper Torso 19 x 17 x 6" Matte black Matte white	4/22
------------------	-------	---	--	------

MHR26B MHR26W	26.31 22.29	1	Mens 35 x 20 x 6" Matte black Matte white	6/71
------------------	----------------	---	--	------

INJECTION MOLDED FORMS

Half-round forms feature high-quality, lightweight construction. The injection molding process ensures that these forms contain much thicker plastic (1/8" thick) than comparable vacuum formed forms.

LADIES UPPER
TORSO



LHR35



MHR26

MENS TORSO

Value Torso Forms

* While Supplies Last

FF15B FF15W FF15C	22.95 13.87 11.15	1	Girls Sizes 7-14 23 x 13 x 1" Black White Clear	2/21
-------------------------	-------------------------	---	---	------

FF37B	13.74	1	Maternity 30 1/2 x 17 1/2 x 8 1/2" (*Black - while supplies last)	5/63
-------	-------	---	---	------

FF27B	13.74	1	Ladies Shirt 21 x 19 1/2 x 4 3/4" (*Black only)	2/21
-------	-------	---	---	------

FF21B	20.22	1	Mens Shirt Sm. & Up, 14x15x1" (*Black - while supplies last)	2/21
-------	-------	---	--	------

HALF-ROUND VALUE TORSO FORMS



FF15W

FF15C

FF37

FF27B

FF21

BODY FORMS Heads & Hosiery Forms

Female Hip Torso



PEFHIPMW

Male Hip Torso



PEMHIPMW

style #	\$	qty	description / size	wgt
PEFHIPMW	63.24	1	Female hip torso milky white Hips are 36", waist measures 26" and the form stands at 14" H	6/20
PEMHIPMW	63.76	1	Male hip torso milky white Hips are 38", waist measures 33" and the form stands at 16"H	6/20

Made from Polyethylene - affordable and durable

3-D STYRO MANNEQUIN HEAD FORMS



77



804



2775

77	9.07	1	11 1/2" tall / White	1/10
804	19.31	1	20" tall / White	1/12

Mannequin heads above have a hole for mounting on wall

2775	14.64	1	Slatwall/ Pegboard head holder	1/2
------	-------	---	--------------------------------	-----

Universal Wall Mount - one bracket fits all

Women's Weighted, Self-Standing Hosiery Forms



HW0410 HW0400

HW0410	36.03	1	Beige: Calf high leg, 15 1/4" high	3/10
HW0400	34.60	1	Anklet, 10 5/8" high	2/3

Men's Weighted, Self-Stand Sock Display Forms



HM0340 HM0320 HM0310



MSDW MSDFT



			Men's sock display; magnetic/weighted for stability;	
			Beige:	
HM0340	44.32	1	Knee high leg, 17 3/4" high	3/10
HM0320	33.18	1	Calf high leg, 11 3/4" high	2/7
HM0310	30.46	1	Low calf high leg, 10" high	2/7
MSDW	27.99	1	White	
MSDFT	27.99	1	Beige fits sizes 10-13	1/2.1

Children and Infant Weighted, Self-Stand Sock Display Forms



HC021FL



HC0200



HC0210



HC0220



HC0230

			Beige:	
HC0230	34.60	1	Knee high leg, 15 1/2" high	
HC0220	34.60	1	Calf high leg, 12 5/8" high	2/16
HC0210	33.18	1	Crew leg, 8" high	
HC0200	33.18	1	Anklet leg, 6 1/8" high	2
HC021FL	36.03	1	"Walking" crew leg, 9" high	3/6

BURLAP JEWELRY DISPLAYS

Tightly wrapped burlap for durable, eco-chic displays with a beautiful natural woven linen look



NHNNE1

Narrow Necklaces Easel Back Stand

Thin easel stand; 4 1/4"W x 8 7/8"H; 1 piece; 1 lb. **\$5.99**

NHNNE2

Wide Necklaces Easel Back Stand

Displays 1 double-strand or 2 necklaces; 8 1/4"W x 12 1/2"H; 1 piece; 1 lb. **\$5.99**



NHNBD1

T-Bar Bracelet Display

Holds several bracelets; low profile bar is 1 5/8"D x 7 1/4"W x 5"H; 1 piece; 1 lb. **\$12.99**

8" Tall Double T-Bar Bracelet Display

10"W x 8"H; 1 piece; 1 lb. **\$25.99**



NHNDET

NHNND2

T-Bar Necklace Display

For necklaces and chains; 12"L x 3 1/2"W x 12"H; bar is 2" in diameter; 1 piece; 1 lb. **\$23.99**

Extra Tall T-Bar Necklace Display

T-Bar stand for necklace and chain displays; 14"W x 18"H; 1 piece; 1 lb. **\$28.99**

Displays 1 pair of earrings



T-Bar Earring Displays

T-stand for earring displays; 1 piece; 1 lb; available in 3 sizes:

- Small**
NHNEDS2 4 3/4"H; **\$4.99**
- Medium**
NHNEDTS 5 3/4"H; **\$6.49**
- Tall**
NHNEDS3 6 3/4"H; **\$6.99**

NHNEDS3

NHNEDTS

NHNEDS2



NHNRD5

NHNRD3

NHNRD5

Fixed Finger Ring Displays

Fixed fingers fit and display any ring; 1 piece; 1 lb.

- Single Finger**
NHNRD3 2 1/8"L x 2 1/8"W x 2 3/8"H; **\$3.99**
- Three Finger**
NHNRD5 4 7/8"L x 2 1/4"W x 2"H; **\$6.99**
- Five Finger**
NHNRD5 8"L x 2"W x 2 1/4"H; **\$11.99**



NHNBD3

Pillow Jewelry Display

Small burlap pillow for displaying bracelets, small pendants and pins; 3"L x 3"W; 1 piece; 1 lb. **\$3.99**



Earring & Pendant Display Stand

For 1 pair of earrings or a pendant; 2"W x 3"H; 1 piece; 1 lb. **\$3.99**

NHNEDFL

ECONOMY BLACK VELVET JEWELRY DISPLAYS

A range of displayers finished in a flocked, faux velvet. Attractive & affordable.



NHBFRD1

NHBFRD5

Finger Displays

Fixed fingers ring displayers; 1 piece; 1 lb.

- Single Finger**
NHBFRD1 2 1/4"L x 2 1/4"W x 2 1/4"H; **\$3.99**
- Five Finger**
NHBFRD5 8"L x 2"W x 2 1/2"H; **\$11.99**



NHBFPD1

Pillow Displays

Versatile displayers for bracelets, watches and pins; 1 piece; 1 lb.

Small about 3"L x 3"W **\$2.99**



252-3

Earring Display Tree

Accommodates 12 pairs of earrings on 3 display bars; 10 1/4"W x 8 1/2"H; 1 piece; 1 lb. **\$23.99**



NHBFNE1

Easel Necklace Stand

Single necklace or chain display; 3 3/4"L x 5 1/4"H; 1 piece; 1 lb. **\$4.15**



NHBFPND1

Padded Necklace Display with Easel Stand

6 1/2" x 7 7/8"H; 1 piece; 1 lb. **\$5.59**



NHBFPND2

Padded Necklace/Earring Combo Display with Easel Stand

Black velvet; 9 3/8"W x 9 1/2"H; 1 piece; 1 lb. **\$10.99**



NHBFPDB

Earring & Pendant Display

2"W x 3"H; 1 piece; 1 lb. **\$2.99**



NHBFB01

Single Bracelet / Watch Display Hump

1 3/8"W x 5"L x 2 1/2"H; 1 piece; 1 lb. **\$7.99**

DISPLAY FIXTURES Jewelry

JEWELRY DISPLAYERS

New

Pipe Jewelry Displayers

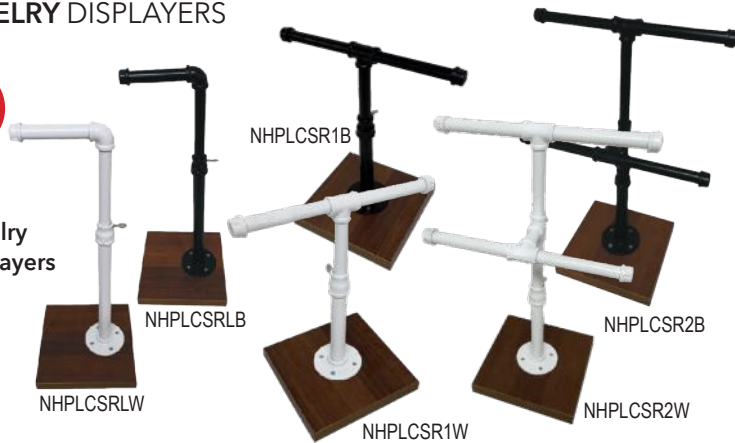

Rotating Jewelry Displayer

Acrylic T-Bar Jewelry Displayers



Jewelry Cards

Cards can also be used on displayers and peg hooks.

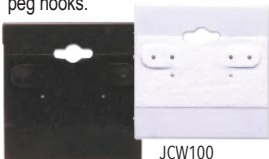

JCB100

JCW100

Counter Top Revolving Jewelry Display

Holds 108 two-inch cards.



856



JT1

JT2

JT3

JT4

Jewelry Tags

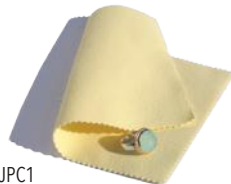

JPC1

Jewelry Polishing Cloth



A845

J1394

Watch Displayer

For slatwall or counter



style #	\$	qty	description	size	wgt
Black or White counter top jewelry displays w/adjustable heights and a 8" x 8" cherry wood base					
NHPLCSR1B			L-shaped hang bar:		
NHPLCSR1W	28.49	1	white	3 1/2" w bar;	2
NHPLCSR2B			black	21 -31" high	
NHPLCSR1B	28.49	1	Single T hang bar:		
NHPLCSR2W			white	12" w bar;	2
NHPLCSR2B	34.49	1	black	17-22" h	
NHPLCSR2W			Double T hang bar:		
NHPLCSR2B			white	12" w bars;	2/3
NHPLCSR2B			black	17-22" h	
NHAND2	10.50	1	Clear acrylic double T	4 1/4" / 8 3/4"	1/3
NHAND1	9.07	1	Clear acrylic single T	18 1/2" H	2/6
4-sided rotating display					
NHAED32	16.72	1	Holds 32 cards - 2"	5 x 5 x 12"	3/19
NHAED144	29.16	1	Holds 144 cards - 2"	10 1/2 x 10 1/2 x 19 1/2"	18/23
3-sided rotating display					
856	20.87	1	Clear acrylic w/ black	19 1/2" H	5/10
JCW100	11.79	100	White card	2" x 2"	1/2
JCB100			Black card		
JT1	18.79		White w/	1/2 x 7/8"	
JT2	18.01		red silk string	3/8 x 3/4"	
JT3	13.61	1000			1/3
JT4	13.74		White Adhesive	7/16 x 1 1/2"	
JPC1	8.68	1	Yellow	7 1/2"L x 5" W	1
A845	8.42	1 Set of three	CLEAR	3x3x3" 4x4x4" 5x5x5"	2/6
J1394	8.68	1	Clear CounterStand	13/4 x 23/4 x 3"	1
J2394	9.72	1	Clear Slatwall	2 1/8"	

Jewelry DISPLAY FIXTURES

style #	\$	qty	description	size	wgt
Q61014	63.12	1	CHROME oval mirror	10x14x22" 6" base	8/13
NHQ61016	67.26	1	CHROME rectangular mirror	10 x 12" H 3" base	8/13
A859	70.11	1	CLEAR ACRYLIC 2" or 3" D shelves	7"D x 15"W x 10"H	2/10
SUNGLASS36	114.49	1	Sunglass rack w/ 5" mirror - holds 36 pairs	28" H x 14" Dia	8/30
SUNGLASS44	105.99	1	Sunglass rack w/5" mirror - holds 44 pairs	32" H x 14" Dia	9/30
CAP3	51.32	1	BLACK METAL Holds 24 to 30 caps	24H x 9W x 13"D	6/12
CAP8	138.67	1	POWDER COATED wire tubing Silvervein: Holds 64 to 80 caps: 8 pocket tower	65H x 14W x 14"D	16/17
CAP16	202.56	1	Holds 128 to 160 caps 16 pocket, 2 sided	65H x 14W x 24"D	16/17 10/13 (2 ctns)
KREV26	163.04	1	CHROME Revolving	18x61 3/8" 14" sq. base	14 5 14 (4 ctns) 34 lbs
K26	144.99	1	CHROME Stationary	18x61 3/8" 14" sq. base	14 5 14 (3 ctns) 33 lbs
NHCSRHB	37.45	1	CHROME	17" - 31" H; 8" base	6/18
Q61814	42.38	1	CHROME	5/8 x 18"-36"H 6" base 16" hanger	7/19
Q61810	32.66	1	CHROME	5/8 x 18"-36"H 6" base	6/19
Q83010	65.97	1	CHROME	5/8 x 18"-36"H 8" base 14" dia.	8/13

Double Face Mirrors



NHQ61016



Q61014

A859



Reversible Counter Step Display

Sunglass Racks



CAP3

Countertop or Hanging Cap Display



SUNGLASS44



SUNGLASS36

Tower Cap Displayers



CAP8



CAP16

Deluxe Cap/Hat Trees

Revolving or stationary - 20 arms with foam caps



K26



Blouse Displayer

Complete w/ base and waist cincher
Q61814

Hook Stand Displayer

Q61810



Countertop Handbag Stand

NHCSRHB



Scarf Stand

Includes 100 white clips

Q83010

SHOE DISPLAYERS



MF0013

MF0040

Espadrille & Gladiator Forms

Profile of foot, with notched ridges for straps



1205

Z-Bend Shoe Rests

Heel Rest Shoe Risers



S1214/13

Beveled Edge Slant Shoe Risers



1230



1413

Shoe Rests



1210

G-Bend Shoe Risers



ZDB1210F1



Roll Up Boot Shapers

Inexpensive boot shapers are made out of a smooth natural plastic finish, easy to insert and remove, and they automatically adjust to fill the boot; in four sizes - 9", 13", 21" and 26"

Boot Shapers

Smooth plastic finish. Easy to insert and remove. Specify (M) Male or (F) Female



ZDB



MAR6121PR



Boot Weights

Drop into boots for a more stable display



ZSHOT060

style #	\$	qty	description / size	wgt
MF0040	4.67	1	Clear Plastic Espadrille Form, size 6-7	1/7
MF0013	4.15	1	Clear Plastic Gladiator Form, size 6-7, 13" tall	1/7
1205	31.88	1 set	Acrylic 3"W x 5"H 3"W x 6 1/2"H 3"W x 8"H 5mm thick bottom measures 5 1/2" deep Set includes all 3 sizes	10/17
S1213	4.92	1	Acrylic 1"W x 2 1/2"H x 2 1/2"D 3/32" thick	1
S1214	6.35		1 3/8"W x 4 1/4"H x 3"D	
1229A	8.42	1	Acrylic 3/16" thick	3
1229B	9.72	1	9 1/4"L x 4"W x 5"H	3
1229C	11.15	1	9 1/4"L x 4"W x 7"H	3/6
1230	22.29	1 set	9 1/4"L x 4"W x 9"H Set includes all 3 sizes	3/6
1413	8.29	1	Acrylic 1/8" thick Single Shoe Rest 4 3/4"H x 3"W x 3 3/4"D	1/2
See page 128 and 133-134 for our selection of foot & hosiery forms				
1210	40.18	1 set	Acrylic 4 mm thick, 7 1/2" D 3"W x 4 1/2"H 3"W x 6 1/2"H 3"W x 9 1/2"H Set includes all 3 sizes	3/10
Natural color in four sizes:				
ZDB109OF1	31.88		9" high	1/2
ZDB113OF1	34.73	12	13" high	2/6
ZDB1210F1	52.75		21" high	4
ZDB126OF1	58.32		26" high	4
ZDB1240	7.65		7" low top	1/2
ZDB1230	8.42	1	9" medium height	1/2
ZDB1020	9.72		14" high top tall	2/6
Specify M for male and F for female Note that male boot shapers are 1" wider than female shapers				
MAR6121PR	8.42	1 pair	14" Black plastic boot form	1/2
MAR6121	69.21	16 prs		11
ZSHOT060	3.50	1	Boot weight	1

SHOE DISPLAYERS

style #	\$	qty	description / size	wgt
710CH	94.35	100	Chrome w/ black rubber tips; 5" wide	10
JLP156	42.38	500	3 7/8" W x 3 7/8" H Natural	9/12
JLP156100	16.49	100		3/6
JLP256	42.38	500	Black	9/12
JLP256100	15.49	100		3/6
SH1	17.99	500	Black; 3 1/2" wide	2
SH1-100	5.99	100		1/2
SHOE1	82.56	500	Black; 7 1/4" W x 7 1/4" H	19/21
SHOE1100	18.01	100		4/6



KLGYMR			Men's Gray Sprinkle Right - size 8-9	
KLGYML			Men's Gray Sprinkle Left - size 8-9	
KLGYWR	15.29	1	Women's Gray Sprinkle Right - size 6-7	1/2
KLGYWL			Women's Gray Sprinkle Left - size 6-7	
KLGYR13			Children's Gray Sprinkle Right - size 13	
KLGYL13			Children's Gray Sprinkle Left - size 13	



Shoe Forms

Fits right or left shoe. Made from lightweight, natural plastic.



SHOEFORM10	.36		3 3/8" long, 3" wide	
SHOEFORM13	.71	1	4 1/4" long, 3 1/2" wide	1/2
SHOEFORMM	.47		4 7/8" long, 3" wide	
SHOEFORMW	.52		5 7/8" long, 3" wide	

Flexi-Form

Made from lightweight, unbreakable plastic.



All forms
fit right or
left shoe

FM7400B			Charcoal Men's, sizes 8-10	
FW7500B	4.15	1	Women's, sizes 4-10	1/2
FC7600B			Children's, sizes 10-13	

FRMDISWB	6.87		Women's Low-cut black Fits sizes 6-9	
FRMDISMB	6.87	1	Men's Low-cut black Fits sizes 8-11	1/2
FRMDISMHB	8.29		Men's High-top Black Fits sizes 8-11	
FRMDISWHB	8.29		Women's High-top Black Fits sizes 6-9	



SSUE	328.49	1	Chrome 56"H x 46"W x 25"D Ships Truck	25 20/25 20/25 (3 ctns)
------	--------	---	---	----------------------------------

Black Shoe Forms - womens/mens



8-Shelf Shoe Merchandiser

Includes 12" adjustable, tilt shelves.

Ships via truck only



SHOE DISPLAYERS

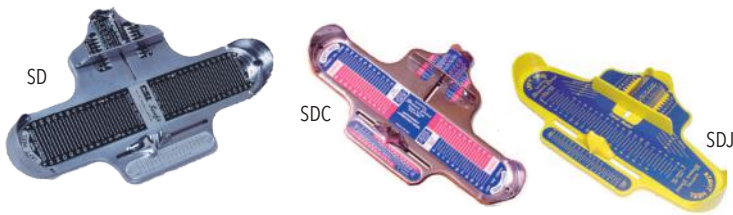

FOOT MEASURING DEVICES



24625

**Grey Tether with Split Ring/
Adhesive Backing**
For securing shoes on display.

T14915



06UPC02

Bronze Sign-Holder Clip
Clips small signs to the back
of footwear.

Try On Socks
Foot protectors



TOS1

SO1G

AS1

05010

**Best
Seller!**

Holder for
8.5"x11" signs

Spinning Sock Displayer

NHSDR



Disposable, Polyester/
Nylon Blend

style #	\$	qty	description	size	wgt
TOS1	8.29	144	BEIGE	ONE	1/3
SO1G	16.72	24	BLACK	SIZE FITS	1/3
AS1	23.59	50	WHITE	MOST	2/7
05010	13.87	48	BEIGE KNEE-HI		1/3

Shoe Horns

Call for color and
printing options



09059

SHOEBLA

NHSDR	110.15	1	Black Metal Rack; 4 spinning tiers w/16 hooks & sign holder; 66"H, 24" footprint, 5" long hooks	66"H, 24" footprint, 5" long hooks	14/24
09059	107.17	144		3"	7
09059/12	11.15	12	NICKEL PLATED	3"	1
SHOEBLA	31.88	144	BLACK	3 1/2"	7
SHOEBLAI	62.34	144	BLACK printed	3 1/2"	7

Shoe horns can be printed: Printing area is 2" x 1/2". \$75 plate charge, and a 3 gross minimum (342 pieces) for imprinting. Shoe horns also available in COLORS: 3 gross minimum (342 pieces). Green, Red, Yellow, Blue or White

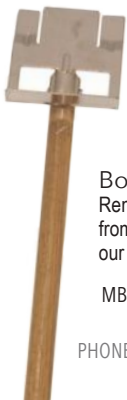

Box Reacher
Remove shoe boxes
from high shelves with
our 5-foot long tool.

MBR



MBR	37.45	1	Wood box reacher w/ metal end	60" L; 4" square metal plate, L-shaped	4/7
-----	-------	---	----------------------------------	---	-----

Kraft Shopping Bags PACKAGING



Available in 3 colors - White, Kraft, and Matte Black.
These bags are imprintable and a great way to advertise your store.
See page 136 for more details.



CUSTOM PRINTING: Custom printing applies to all style numbers below - see following page 89 for details

	style #	\$	qty	color	size	imprint area	wgt
1	SBCN1	51.99	250	White	8x4.75x10.5"	6x5"	24/30
2	SBCN1E	71.99	250	White Eco	8x4.75x10.5"	6x5"	24/30
	SBCN2E	59.99	250	Kraft Eco	8x4.75x10.5"	6x5"	24/30
3	SBCN7E	73.99	250	Kraft Eco	10X5X13"	7X8"	24/30
4	SBVN1	86.99	250	White	16x6x12.5"	10x7"	38/52
5	SBVN1E	68.99	250	White Eco	16x6x12.5"	10x7"	38/52
	SBVN2E	107.99	250	Kraft Eco	16x6x12.5"	10x7"	38/52
6	SBQN1	88.99	200	White	16x6x19"	10x11"	43
7	SBQN2E	89.99	200	Kraft Eco	16x6x19"	10x11"	42
8	KSB4E	60.99	250	White Eco	6x3.25x8.375"	3x4"	15
	KSB5E	73.99	250	Natural Eco	6x3.25x8.375"	3x4"	15
9	KSB6E	110.94	250	White Eco	10x7x13.5"	7x8"	43
	KSB7E	95.00	250	Natural Eco	10x7x13.5"	7x8"	43
10	KSB81	80.99	250	White	13x7x13.5"	9x8"	29
	KSB82E	63.99	250	Natural Eco	13x7x13.5"	9x8"	29
11	KSB91	92.99	250	White	13x7x17"	9x9"	44
	KSB92E	121.99	250	Natural Eco	13x7x17"	9x9"	44

A note about imprint areas and set-up fees:

2 different bag sizes will need 2 different set ups.
• check the imprint area specs on for more info

different size imprint areas will need different set ups



PACKAGING Custom Kraft Bags

CUSTOM BAG OPTIONS for our Natural, White or Black Kraft bags

Create walking billboards for your store



STEP 1

CHOOSE A BAG

Choose from any of our Natural, White or Black Kraft bags featured on [page 135](#)

STEP 2

DESIGN IT

(Choose from 2 print options below)

INK PRINT

A flexible plate is dipped in liquid ink and stamped onto the bag.

ADVANTAGES: Can print small details.

DISADVANTAGES: Ink color appearances may vary.

COST: \$0.24 per side, per bag /\$.48 for both sides



HOT STAMP

Foils are pressed and transferred through heat onto the bag.

ADVANTAGES: Produces a true, even color.

DISADVANTAGES: Doesn't allow for small details.

COST: \$0.45 per side, per bag /\$.90 for both sides



STEP 3

SET IT UP & PLACE YOUR ORDER

ARTWORK

Vector files are preferred - Illustrator (.ai) files are best. (.docx files will not be accepted)

If artwork quality is not acceptable, art fees may apply.

Please call us (1-800-426-4377) for assistance

SET-UP FEES

Ink Printing and Hot Stamp
Set up fees are per bag size, per order
Please call for set-up fees

ORDERING

Call it in:
1.800.426.4377 and speak with one of our Customer Reps
You can also connect with us via email (mail@nahanco.com)

Shopping Bags PACKAGING

style #	\$	qty	description	size	wgt
---------	----	-----	-------------	------	-----

ECO NATURAL KRAFT EURO SHOPPERS/BAGS

NHK19616	171.99	100	XX-Large Shopper	19 x 6 x 16"	48/49
NHK1010	145.99	200	X-Large Shopper	10½ x 10 x 10"	30/31
NHK1048	94.99	200	Large Shopper	10 x 4 x 8"	23/24
NHSN513	46.99	250	Tall Wine/Gift Bag w/Serrated Edge	5¼ x 3½ x 13"	19/21

Eco friendly, reusable, recyclable and compostable, these bags are made of 80% recycled fibers and 80% post-consumer content

CARNIVAL GROOVE EUROTOTES

KE9NH	96.49	200	Kraft w/ natural	9x3½x7"	20
KE13	145.99	200	cotton handles; top &	13x5x10"	33
KE16NH	94.99	100	bottom board inserts	16x5x13"	23

LUXE GLOSS EUROTOTES

GE6B	49.99	100	BLACK	6x3x8"	9
GE6W	49.99		WHITE		
GE8B	70.76	100	BLACK	8x4x10"	14
GE8W	70.76		WHITE		
GE16B	114.49	100	BLACK	16x6x12"	29
GE16W	114.49		WHITE		

THANK YOU DIE CUT BAGS

NHFO15THA	95.40	500	Medium	15x18x4"	24
NHFO20THA	126.99	500	Large	20x20x5"	35

SUPER GLOSS BAGS

NHSG9WH	55.49	1000	White - small	9 x 12"	11
NHSG9CLE			Clear - small	1.25 mil.	
NHSG12WH	76.49	1000	White - medium	12 x 15"	16
NHSG12CLE			Clear - medium	1.25 mil.	

PLASTIC MERCHANDISE BAGS

TSB3-30	27.09	1000	Thank You <i>Type style & color may vary</i>	11½x6½x21" .75 mil	13
BGA2-1	51.99	1000	White	12x15"	10

ECO KRAFT EURO SHOPPERS/BAGS



CARNIVAL GROOVE EUROTOTES (KE)



LUXE GLOSS EUROTOTES (GE)

Gloss laminated bags w/gromets, knotted macrame handle, top and bottom boards



REINFORCED DIE CUT THANK YOU BAGS

SUPER GLOSS MERCHANDISING BAGS

In 2 sizes and 2 colors

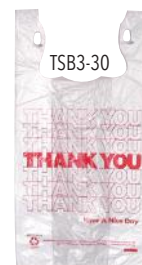

PLASTIC MERCHANDISE BAGS

Economy, high density plastic



Type style and color may vary

Cannot be imprinted

PACKAGING Tissue & Boxes



WHITE TISSUE



BLACK TISSUE



KRAFT TISSUE

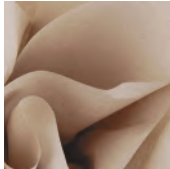

NEWSPAPER PRINT TISSUE

WHITE APPAREL BOXES
with light gray interior



AB 2/3/4



KAB 2 / 4

NATURAL APPAREL BOXES
with kraft interior



CORRUGATED E-COMMERCE BOXES
available in four sizes



NH1293BLA



NH883NAT



NH994WHI

COTTON FILLED JEWELRY BOXES

JB 1/2/3/4



JB 1/2/3N



style #	\$	qty	description	size	wgt
TP1	36.99	1000	WHITE	18 x 24"	10/14
TP2	49.99	sheets	Tissue Paper	20 x 30"	15/22
TP3	58.32	500	WHITE Tissue Paper	24 x 36"	?
TP25	47.28	480	BLACK Tissue Paper		7
NH11018	24.49	sheets	Solid Recycled KRAFT Tissue Paper	20 x30"	9
TIKNP	50.99	2400	NEWSPRINT Heavy Tissue Paper for bulky items	20 x30"	50

WHITE:					
AB2	82.49	100	Shirts	15x9 $\frac{1}{2}$ x2"	29
AB3	63.49	50	Sweaters	17x11x2 $\frac{1}{2}$ "	20/21
AB4	68.99	25	Coats	24x14x4"	21/28
KRAFT:					
KAB2	78.99	100	Shirts	15x9 $\frac{1}{2}$ x2"	27/29
KAB4	61.99	25	Coats	24x14x4"	23

CORRUGATED BOXES

NH1293BLA	96.49		Black		
NH1293NAT	67.99	24	Natural	3" h x 12" l x 9" w	16
NH1293WHI	96.99		White		
NH883BLA	125.99		Black		
NH883NAT	103.99	48	Natural	3" h x 8" l x 8" w	22
NH883WHI	125.99		White		
NH994BLA	178.49		Black		
NH994NAT	119.49	48	Natural	4" h x 9" l x 9" w	30
NH994WHI	178.49		White		

WHITE

JB1	26.99	100	Earring	2 $\frac{1}{2}$ x1 $\frac{1}{2}$ x 7/8"	4/6
JB2	36.49	100	Bracelet	3 $\frac{1}{2}$ x3 $\frac{1}{2}$ x1"	12/14
JB3	46.99	100	Necklace	8x2x 7/8"	10/15
JB4	40.99	100	Large pin	5 $\frac{1}{2}$ x3 $\frac{3}{4}$ x 7/8"	10/19

KRAFT

JB1N	22.49	100	Earring	2 $\frac{1}{2}$ x1 $\frac{1}{2}$ x 7/8"	4/6
JB2N	31.49	100	Bracelet	3 $\frac{1}{2}$ x3 $\frac{1}{2}$ x1"	12/14
JB3N	48.99	100	Necklace	8x2x 7/8"	10/15

index

Acrylic sign holders	95, 98, 107	Foot/Leg forms	128, 133-134	Needles (replacement)	65-66	Size dividers & markers	50-54
Alteration tags	28, 70	Foot measuring device	134	Non slip attachments	14, 60	Slatwall & accessories	91-95
Bagging Jack	71	Garment bags	27, 71-72	Package hangers	59	Slatwall panels	91-92
Bags	135-137	Glass toppers (round racks)	79	Packaging	135-138	Sleeping bag hangers	37
Baskets	90, 98, 116	Glove hangers	37	Pegboard accessories	101	Sock hangers	58
Bedsread hangers	37	Grabber	61	Pennants	110	Stain Remover	115
Belt hanger	58	Grid wall & accessories	96-98	Pipeline Series	81-85, 95	Standards & accessories	99-100
Belt racks	80, 94	Handbag racks.....	77, 131	Pins	117	Steamers	118
Bikini hangers	33	Hang all clips	56-57	Pin tickets	70	Storage tray	54
Body forms	119-128	Hanger accessories	14, 60	Plastic hangers ..	28, 29, 32, 35, 40-49	Suction cups	108
Boot hanger	133	Hanger collection racks	62-63	Polybag rolls & dispensers	71	Suit covers	71-72
Boot shapers & weights	132	Hangers (garment)	10-49	Pricing Supplies	65-70	Sunglass racks	131
Boxes (gift, apparel, jewelry)	138	Hanger stackers	63	Rack cover	73-74	Swimwear hangers.....	33
Boxes (storage)	61	Hanger storage	62	Racks (garment)	73-87	Tables	84
Box reacher	61, 134	Hanger strips, connectors	60	Reaching hook	61	Tacking hooks	59, 67
Bridal bags	27, 72	Hat hangers	37	Register Stands	88	Tagging tools	65-67
Bulletin sign holders	105	Head forms	128	Repair tags	70	Tags	69-70
Cap Racks	131	Hosiery forms	128	Rolling racks	73-76, 81-82	Tailor supplies	117
Card frames	105, 106	Hotel hangers	39	S Hooks	56, 108	Tie hanger	58
Cards /stock signs	104	Intimate apparel hangers	34-35	Safety pins	117	Tie racks	80
Casters (racks). 72-76, 78, 80-82, 85-86		Irons & Accessories.....	117-118	Sandal forms	132-133	Tissue paper	138
Chalkboards	110	Jean hooks	56	Sandal hangers	133	Traffic control	111-113
Circle fasteners	67	Jersey Forms.....	119-122	Satin hangers	34	Try-on protectors	115
Clamps (sign holders)	84, 106	Jewelry displays	128-130	Scarf racks	131	Tubing & accessories	102
Cleaning gun & solvent	115	Jewelry tags & cards	130	Scarf rings, scarf hangers	55, 58	Tubular hangers	49
Clips	55-57	Kraft bags	135-137	Scissors	117	Twist on arms (racks)	78
Clothing racks	73-87	Kraft tags	70	Seam ripper	117	Utility Racks/Storage	75
Coordinate strips	60	Kraft tissue	138	Secure lock system	114	VICS hangers	48
Counterfeit detector pen	114	Labels (pricing)	70	Security devices	114	Wall mount accessories	107
Counterfeit cash detector kit	114	Labels (sizing)	54	Shelves	89	Wooden hangers	10-26, 33-34, 39
Display bins	90	Ladder systems	86	Shoe accessories	132-134	Workstations	64
Display hangers	13, 23, 32-34	Layaway tags	70	Shoe forms	132-133	Z-racks	74
Door alarms	114	LED sign	110	Shoe horns	134		
Dressing room supplies	115-118	Leggings hangers	55, 58	Shoe merchandisers	132-133		
Dry cleaning hangers	49	Lint rollers	115	Shoe risers	132		
Dump bins	90	Literature holders	95, 98, 101, 107	Shopping baskets	116		
Fabric brushes.....	115	Mannequin forms	123-126	Shopping bags	135-137		
Fasteners	65-67	Markers	110	Shoulder covers	72		
Fitting room checks	116	Marking tools	67-68	Showcases	88		
Fitting clips	57	Measuring tape	117	Sidewalk signs	110		
Flags	110	Message boards	110	Sign kits	103-105, 110, 113		
Flocked hangers	31	Metal Hangers	35, 36-38, 39	Sign holders	105-107, 110, 113		
Foam hanger covers	60	Millinery display	94, 131	Sign hanging systems	108-109		
Folding boards	64	Mirrors (counter)	131	Signs	103-105, 113		

More Ways to Pay

Terms: Net 30 days credit. Sorry, no CODs.

Credit Cards:



Prepayment: prepay by ACH or wire payment in advance.

Pricing

Prices are subject to change without notice.

Shipping Information

Shipments are made F.O.B. our warehouse or point of origin. Small orders ship via UPS. Some packages bill as oversized by UPS. When orders exceed UPS limits, we ship via common carrier.

Returns

If you're not satisfied with your purchase, please contact us, explain the problem and we'll take the necessary steps to resolve the problem to your satisfaction. At times there may be a 25% restocking charge for items returned plus freight costs. Customer service will advise you of these charges should they apply to you. Sorry...**No Returns after 30 days.**

Carrier Damage

Our products are inspected prior to shipment and any customer claims for visible or concealed damage must be made with the delivering carrier. Our responsibility ceases when the merchandise is turned over to the carrier.

Backorders

Unfortunately, on occasion we may have to backorder an item. As soon as the item is available, we will ship it - unless otherwise requested not to. If an item is out of stock for more than 30 days, we will notify you.

Please note that we are not responsible for typographical errors.



NATIONAL HANGER COMPANY
 P.O. Box 818, 276 Water St
 North Bennington, VT 05257

2025



a USA manufacturer!

Everyday Value Items

Items you need every day. In stock. Ready to ship. Low industry prices.



1507

middle weight hanger
\$30.99

rolling rack
\$41.90

RCS2

101
 hanger stacker
\$12.90



J11S

\$7.90



K31

\$69.90



made in USA 

\$30.99

2507BH



BH28

\$41.90



\$199.90

J-2



\$79.90

81-17



Order online at nahanco.com EMAIL sign up for our emails at nahanco.com
 Call toll-free **800.426.4377** (800-hangers) ACCOUNT set up an account at nahanco.com