

XCT7™

# VRF System



Turn to the experts



2022 - 2023



Turn to the experts



<b>OUR LEGACY</b> .....	004
<b>VRF SYSTEMS</b> .....	010
<b>VRF TRAINING CENTRES IN EUROPE</b> .....	018
<b>VIRTUAL CARRIER EXPERT CENTER</b> .....	019
<b>PRODUCT LINEUP</b> .....	020
OUTDOOR UNITS LINEUP .....	020
INDOOR UNITS LINEUP .....	022
CONTROLLER UNITS LINEUP .....	024
<b>OUTDOOR UNITS</b> .....	027
SIDE DISCHARGE HEAT PUMP .....	028
TOP DISCHARGE HEAT PUMP .....	048
TOP DISCHARGE HEAT RECOVERY .....	066
<b>INDOOR UNITS</b> .....	084
ONE-WAY CASSETTE .....	086
TWO-WAY CASSETTE .....	090
COMPACT FOUR-WAY CASSETTE .....	094
ROUND-WAY CASSETTE .....	098
SLIM DUCT (0/30PA) .....	104
STANDARD STATIC DUCT (20/200PA) .....	108
HIGH STATIC DUCT(0/250PA) .....	112
HIGH WALL .....	118
TWO-WAY CONSOLE .....	122
CONSOLE-RECESSED .....	126
FLEX CEILING FLOOR (DC MOTOR) .....	128
HRV .....	134

<b>AIR HANDLING UNIT DX KIT</b> .....	139
VRF AHU SOLUTION .....	140
TA CONTROL TYPE .....	142
DDC CONTROL TYPE.....	144
<b>CONTROLLER</b> .....	149
INDIVIDUAL CONTROLLER .....	154
CENTRALIZED CONTROLLER .....	156
BMS .....	160
<b>ACCESSORIES</b> .....	172
HEAT PUMP - ODU PIPING CONNECTION ACCESSORIES .....	174
HEAT PUMP - IDU PIPING CONNECTION ACCESSORIES .....	176
HEAT RECOVERY - ODU PIPING CONNECTION ACCESSORIES .....	178
HEAT RECOVERY - IDU PIPING CONNECTION ACCESSORIES .....	180
HEAT RECOVERY - VALVE BOX .....	182



Turn to the experts

# Carrier's Heritage: The Invention that Changed the World

On July 17, 1902, Willis Carrier designed the first modern air-conditioning system to solve a production problem at the Sackett & Wilhelms printing plant in Brooklyn, New York, launching an industry that would fundamentally improve the way we live, work and play.



Willis Carrier applied for a patent on his invention, an "Apparatus for Treating Air." He had invented the world's first spray-type air conditioning equipment, capable of both washing and humidifying or dehumidifying air. Modern air conditioning then got its building block.



Carrier hires America's first female air-conditioning engineer right around the time the decision to allow American women to vote was being debated by lawmakers.

1904

1917

1911

1922

Willis Carrier's Rational Psychrometric Formulae brought science to what had previously been the often hit-or-miss design of air-conditioning systems, and in the process made Carrier an international name.

Carrier unveiled the first centrifugal chiller which opened the door to large-scale comfort air-conditioning.





Carrier introduces the first home air conditioner.

1926

Willis Carrier is named among Time magazine's 100 Most Influential People of the Century.

1998

Carrier becomes an independent, publicly traded company, and begins trading on the New York Stock Exchange.

2020

1931

The M.V. Victoria became the first vessel to make its maiden voyage equipped with Carrier air conditioning.



2016

Construction began on the Center for Intelligent Buildings Carrier Global Corporation Headquarters.



Turn to the experts

Carrier is the leading global provider of healthy, safe, sustainable and intelligent building and cold chain solutions.

We constantly build on our legacy with innovative products and services that improve global comfort and efficiency.

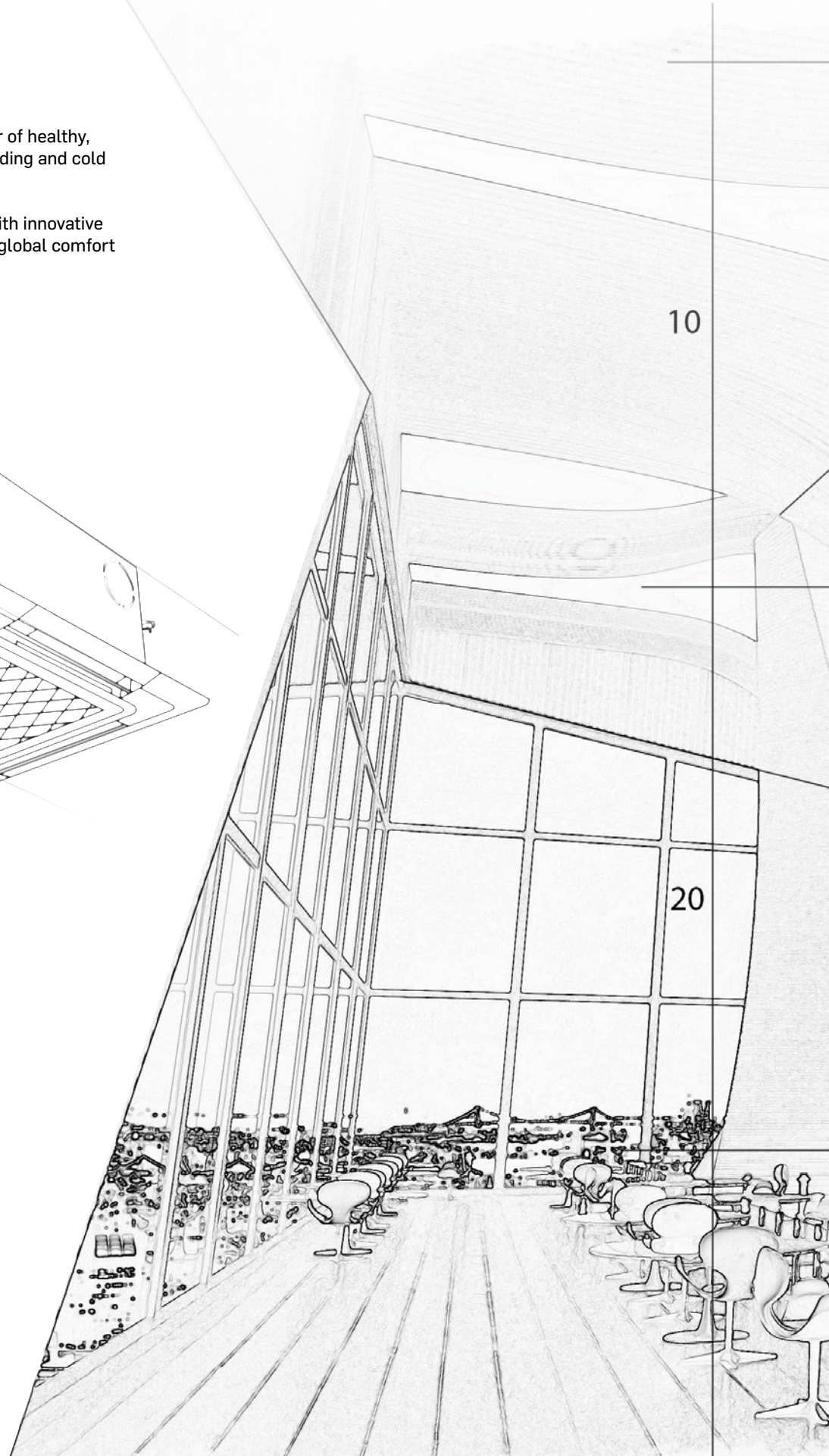
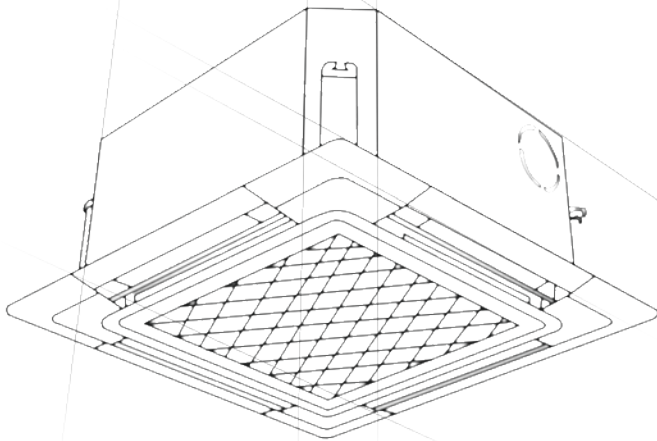

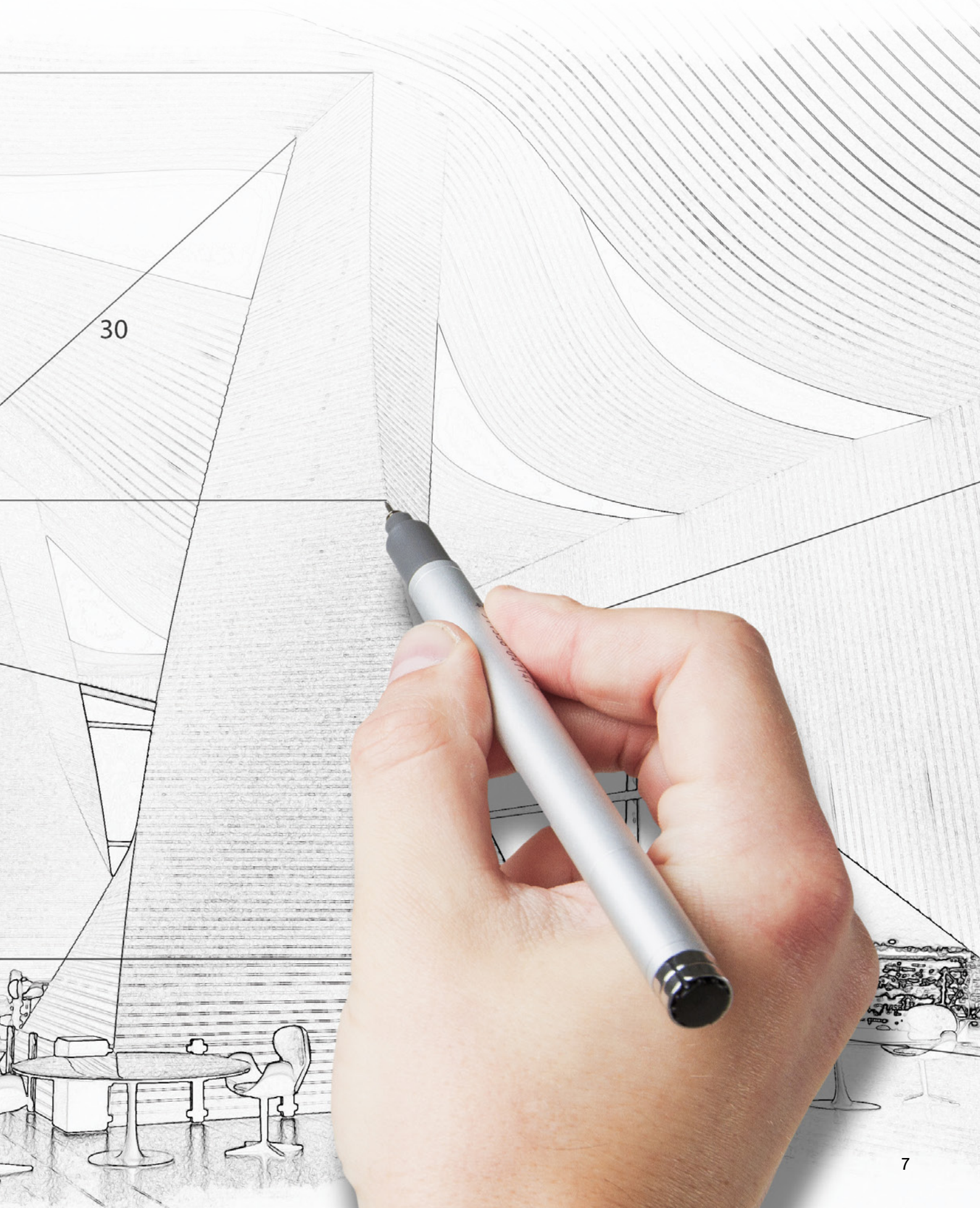



Turn to the experts

# Innovation

## A Leading Legacy

Carrier was built on a legacy of innovation, beginning with our founders. We are innovators at heart and inventors by heritage. Right from the start, we've pioneered new technologies and enabled entirely new industries that have changed the world. Today, building on our legacy of innovations, we're boldly advancing the industries we created to make a difference in people's lives.

## Innovating Everywhere

Our industry-leading solutions and services are keeping buildings and homes across the globe comfortable, safe, and secure.

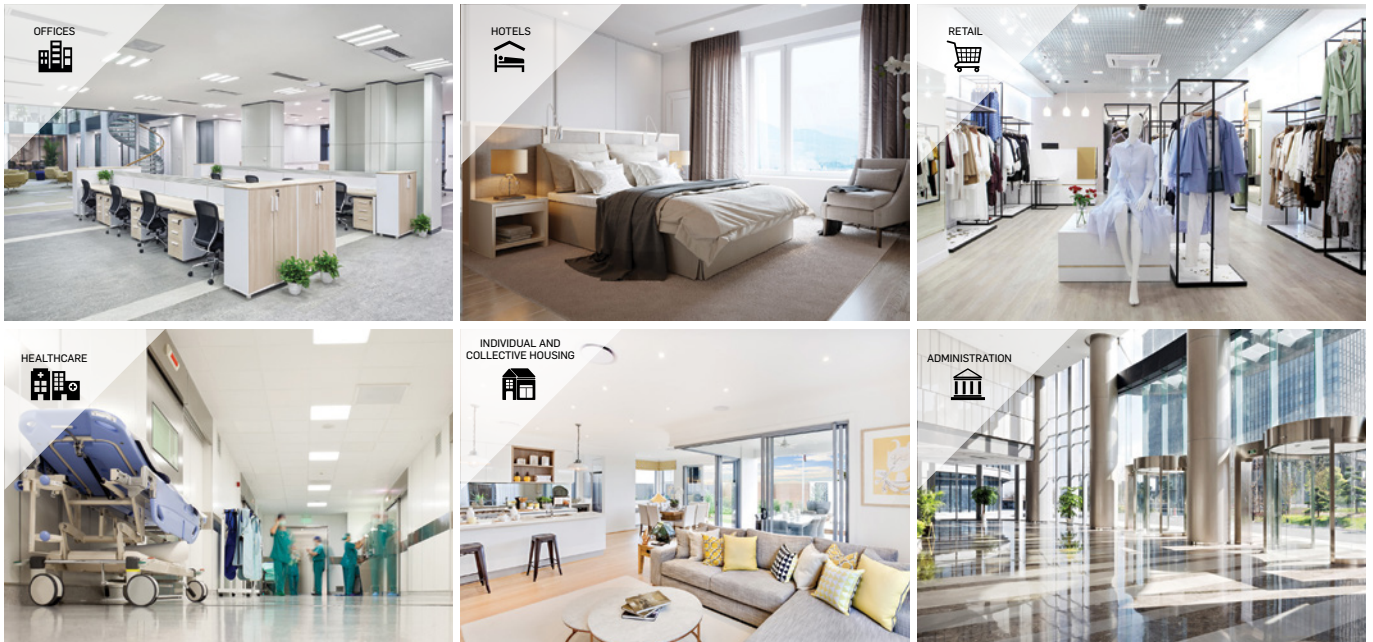



# Carrier: Meeting the challenge of regulatory changes

Carrier is committed to limiting the environmental impact of its products and reducing energy consumption.

This energy efficiency target strongly influences the HVAC market. Indeed, buildings are the largest consumers of energy today, and of these, HVAC systems account for considerably more than other equipment. Providing customers with energy efficient solutions is therefore a key sustainable development opportunity for the HVAC industry.

## New metrics because seasonal efficiency matters

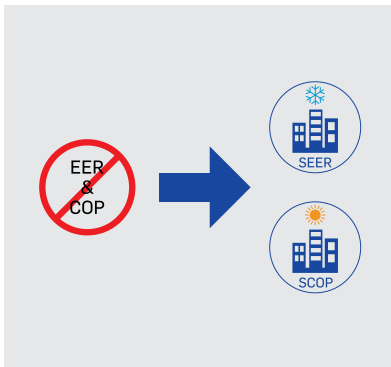

EER & COP belong to the past. To compare the energy efficiency of products using different sources of energy, the Ecodesign regulation introduces a measurement expressed in primary energy:  $\eta_{S,C}$  is the equivalent of SEER for comfort cooling applications and  $\eta_{S,H}$  is the equivalent of SCOP for space heating.

This is a more accurate indicator as it considers performance during cold seasons with temperature variations on many measurement points. This will maximize the entire VRF system's energy consumption.

Seasonal efficiency coefficient calculation:

$$\eta_{S,H} = \frac{\text{Annual heating demand}}{\text{Annual energy consumption}}$$

$$\eta_{S,C} = \frac{\text{Annual cooling demand}}{\text{Annual energy consumption}}$$

$$\text{SEER} : 2.5 * \eta_{S,C} ; \text{SCOP} : 2.5 * \eta_{S,H}$$

Carrier display SEER, SCOP,  $\eta_{S,H}$ ,  $\eta_{S,C}$  in all catalogues to facilitate product selection.

## Carrier subscribes to the Eurovent Certita Certification program

With this certification program, all manufacturers can easily benchmark competitors' products using Eurovent's common database.

Design offices and customers do not have to organize manufacturing testing and performances check when they select certified products as all data are already compiled.



This certification guarantees the accuracy of products' data.

For detailed information, please visit [www.eurovent-certification.com](http://www.eurovent-certification.com)



Turn to the experts

# Understanding VRF Systems

## SETTING THE STANDARD FOR FLEXIBILITY, EFFICIENCY & PERFORMANCE

Variable Refrigerant Flow (VRF) systems are large-scale ductless HVAC systems performing at high capacity. VRF technology has the unmatched capacity that allows for multiple indoor units or zones to operate on the same outdoor system.

They constitute a multi-outdoor-unit solution that carefully computes the precise amount of refrigerant required by each indoor unit to achieve individualized temperature control for each comfort zone.

Thanks to its flexibility, VRF systems can be customized to meet the specific demands of any project. They control the refrigerant flow according to the heat load requirement to effectively avoid over cooling or heating.

## Why Choose VRF Systems?



### FLEXIBILITY

Whether you're looking to maximize comfort in a new building or retrofit an existing one, VRF systems match design flexibility with potential energy savings.



### EFFICIENCY

VRF systems use minimal ductwork, and sometimes, none at all (depending on the application). This makes installation and maintenance far easier. They also precisely match power requirements to eliminate the energy wastage associated with central duct systems.



### PERFORMANCE

System performance is significantly enhanced because of the heat transfer properties of refrigerant over other mediums, while the zone temperature control provides the ideal level of comfort.

## **A TOTAL SYSTEM SOLUTION**

Unlike other HVAC solutions, VRF is a closed-loop system - not merely components. This means components. This means you get a holistic solution from the start with the assurance that everything will work together seamlessly.

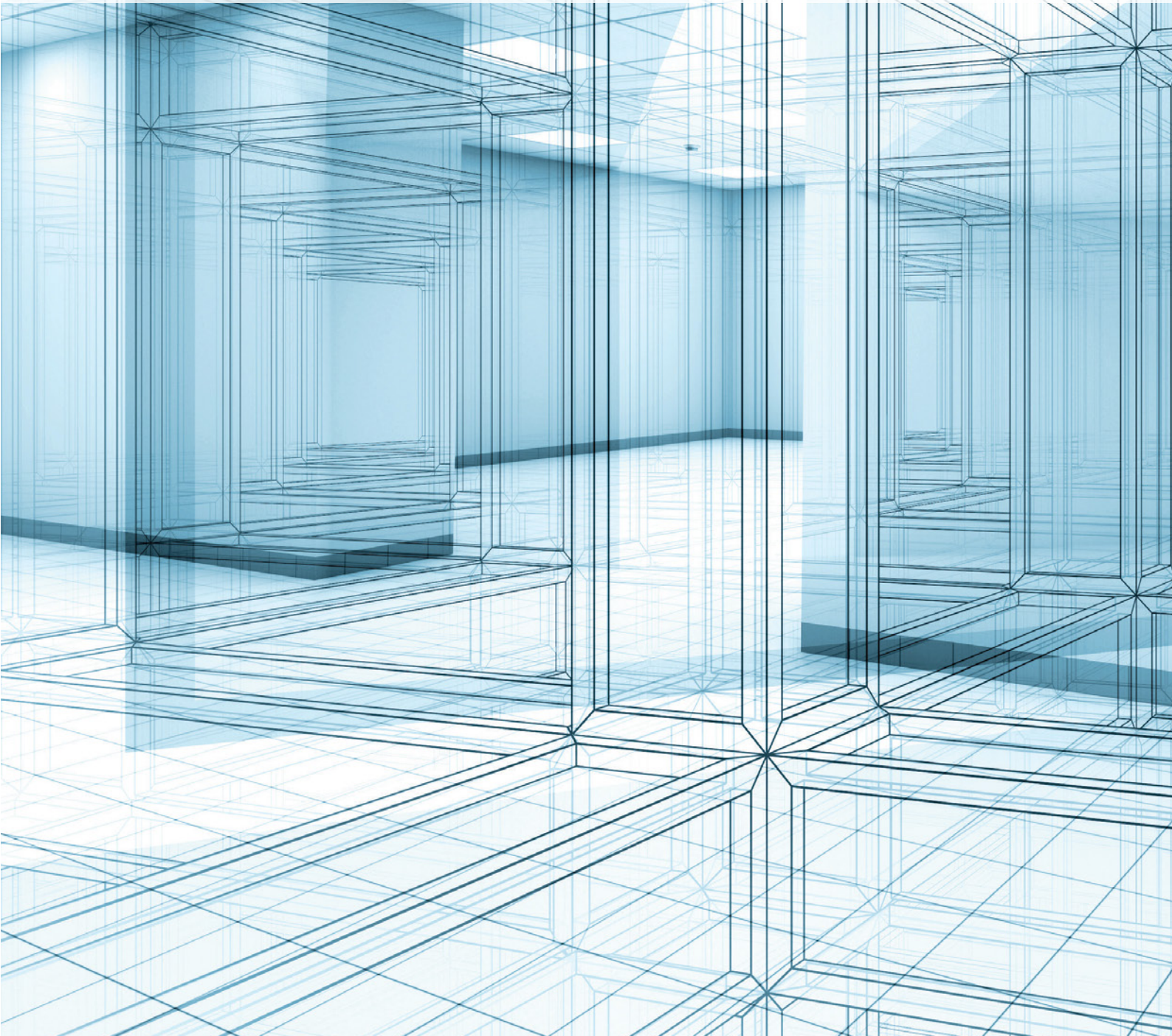



Turn to the experts



# What is Carrier XCT7?

XCT7 is the 7th generation of our VRF system that proudly represents Carrier's world leading innovation, technology and unyielding commitment to energy efficiency.

Carrying forth the legacy that shaped the climate control industry, Carrier's VRF systems have always delivered optimal comfort and performance that can be scaled up to meet climate control requirements, all the way from a small single-family residence to a commercial high-rise building. We're determined to make a global impact once again with the XCT7 – a VRF system that provides unmatched advantages such as strong reliability, peak performance, enhanced efficiency, longer lifespan, optimal user experience and easy operation.



Ultimate Reliability



Enhanced System Performance



High-Efficiency



Large Operating Range



Easy Installation



Incredible Flexibility



Wide Range of Options



Turn to the experts



# Black-coated fin

Carrier VRF black-coated fin has enhanced corrosion resistance and provides stronger protection from air pollution and salt contamination.



### Longer resistance to neutral salt spray

Standard model heat exchanger anticorrosion protection test for the black-coated fin is **1500 hours under 5% salt spray**, compared to the ordinary coated fin tested within just 500 hours.



### Better corrosion-resistant performance

The corrosion-resistant coating of the black-coated fin is **2.4-2.8g/m<sup>2</sup>** and the hydrophilic coating is 0.3-0.5g/m<sup>2</sup>, whereas the normal coated fin's coating is only 0.9-1.8g/m<sup>2</sup>, indicating the former's highly advanced corrosion-resistant performance and the heat exchanger's enhanced lifespan.

### Structure diagram of the hydrophilic aluminum foil

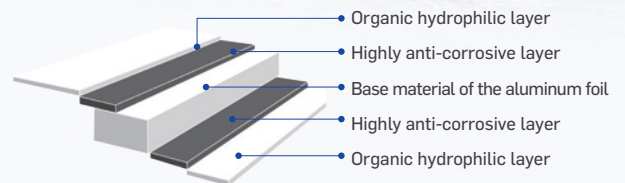

### Higher alkali and oil resistance



**black-coated fin**  
alkali resistance: √ 5min  
oil resistance: √ 48h

• **Higher alkali resistance**

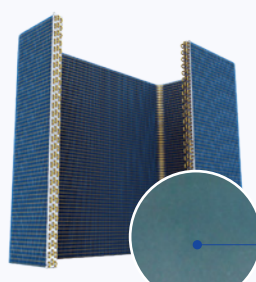

**General hydrophilic aluminum fin**  
alkali resistance: √ 3min  
oil resistance: √ 24h

• **Conventional alkali and oil resistance**

# Why Choose Carrier VRF?

Your choice makes a difference. When you invest in Carrier VRF, you create a system that delivers on the promises of comfort, performance, and reliability - the backbone of the Carrier confidence.



## Ultimate Reliability

**Reliability is at the heart of the XCT7 conception which provides customers with complete peace of mind.**

- Outdoor condenser with advanced black-coated fin technology for enhanced corrosion resistance
- Reduced liquid shock failure rate owing to the anti-liquid shock technology of the compressor



## Enhanced System Performance

**The enhanced system efficiency relies on the combination of the following features:**

- Improved refrigerant distribution balance owing to the centrifugal oil separator
- Smooth supply of lubricant with 10-stage oil return technology which protects the compressor and the system



## High Efficiency

**Carrier VRF achieves high efficiency in cooling and heating by utilizing:**

- Highly efficient DC fan
- Advanced DC compressor



## Large Operating Range

**XCT7 units deliver comfort solutions for any indoor space, at any time of the year.**

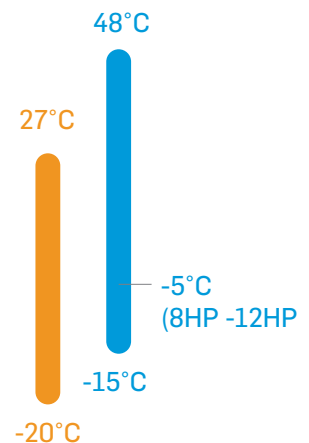

HEATING



COOLING



Turn to the experts

# Why Choose Carrier VRF?



## Easy Installation

**By design, Carrier VRF systems are user-friendly, providing easy installation and maintenance.**

- Easy to open the front panel
- Easy access to the internal system components
- Branching kit designed to fit your requirements
- One button trial operation :
  - Saves 10% of the test operation time
  - Tests all units in one go



## Incredible Flexibility

**XCT7 units accommodate almost all building requirements.**

- Compact solution, perfect for limited space applications
- Up to 110 Pa of the external static pressure available
- Easily serves high-rise buildings up to 110 m
- Flexible piping layout



## Wide Range of Options

**XCT7 units are designed to satisfy your needs. No matter the building, application, or project specifications, Carrier has a VRF solution for you.**

- Single module from 4 to 26 HP
- 4-module combinations, up to 104 HP
- IDU solutions for every scenario
- Up to 64 indoor units per outdoor system
- User friendly controller solutions

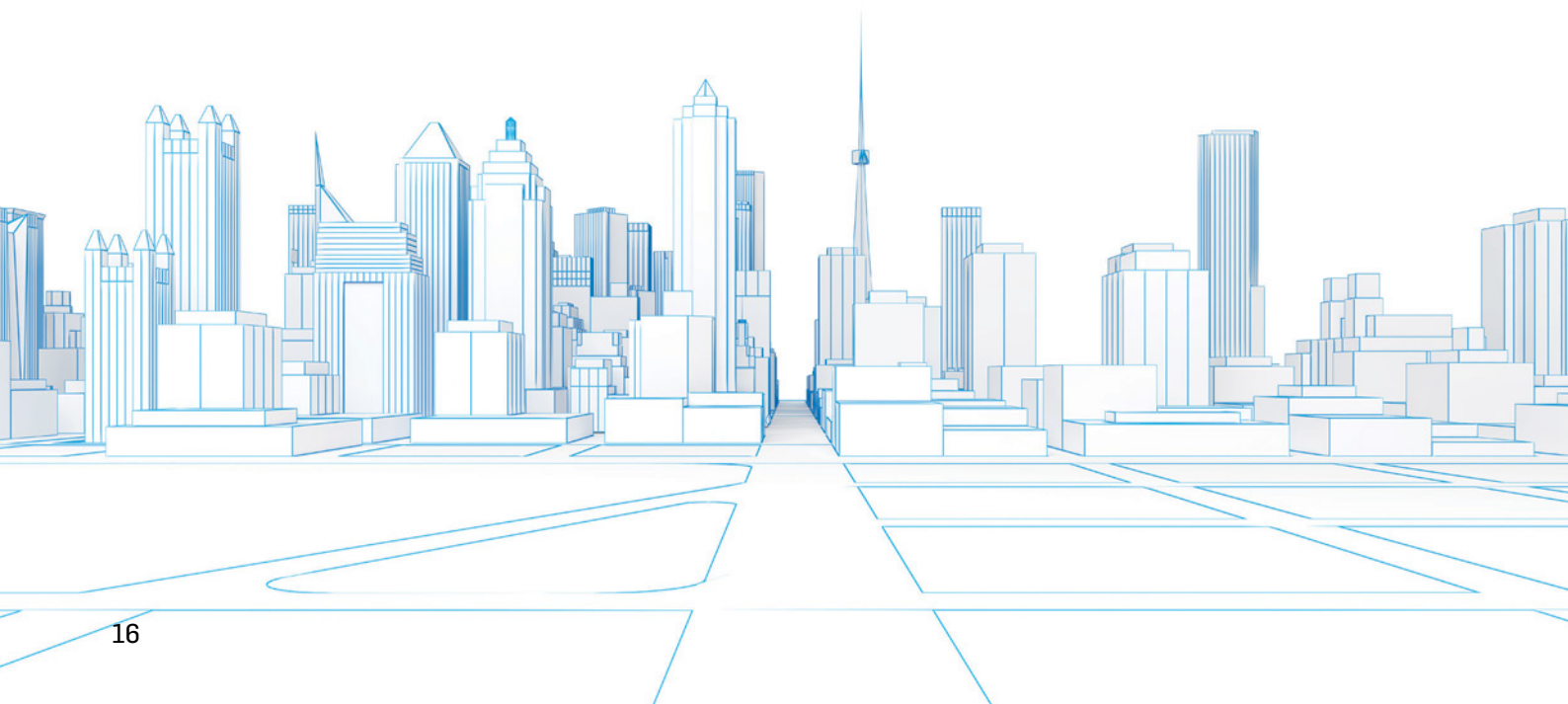



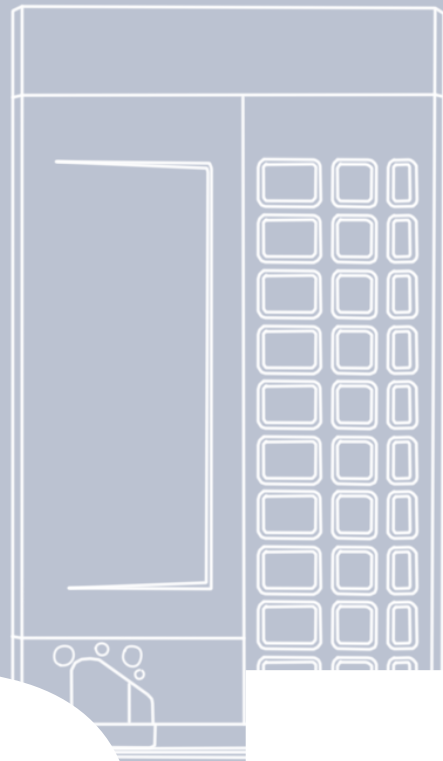
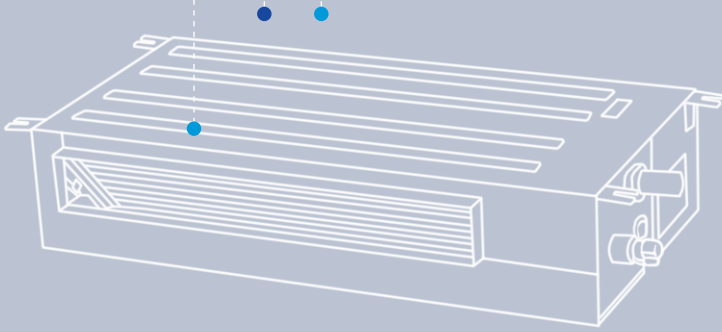

# V R F

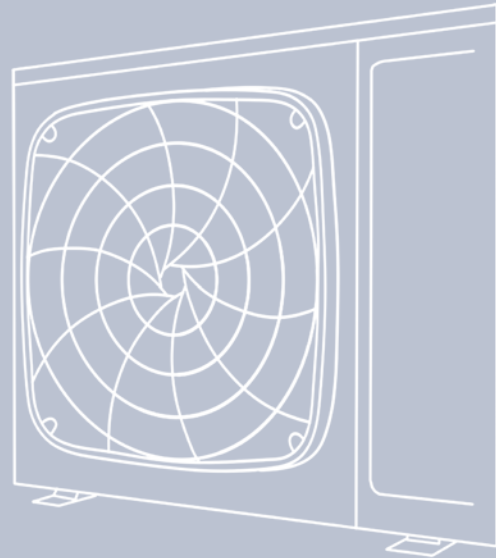
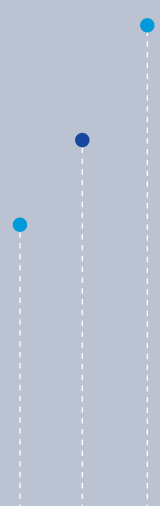
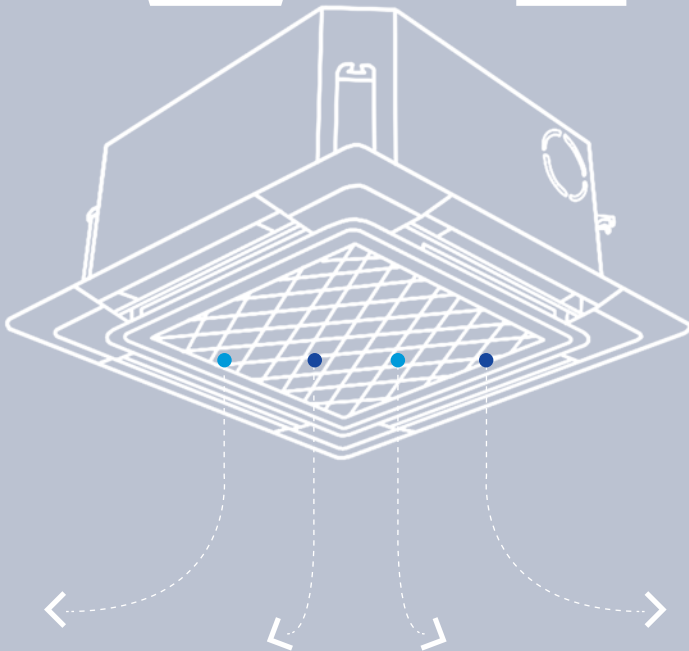



Turn to the experts

# VRF Training centers in Europe

We would be happy to show you our VRF in operation! Get in touch to arrange a joint visit.

**Manchester**  
United Kingdom



**Duisburg**  
Germany



**Lisbon**  
Portugal



**Madrid**  
Spain



**Montluel**  
France



**Milan**  
Italy













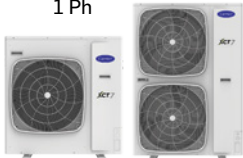

# Interact and engage with our VRF products in the virtual Carrier Expert Center. Anytime. Anywhere.









Learn more about XCT7 - our latest VRF system at [www.ecec.carrier.com](http://www.ecec.carrier.com)

- With the virtual Carrier Expert Center, VRF products are now just a click away.
- Enjoy Carrier's new online experience with a user-friendly and intuitive interface
- With this immersive and realistic 3D visual experience, you can discover all VRF product features, exploded, and 360° views.



# OUTDOOR UNITS LINEUP

Lineup (HP)	4										5						6							
kW	12,1										14,0						15,5							
<b>Side Discharge Heat Pump</b> 38VS*	1 Ph 										1&3 Ph 						1&3 Ph 							
Lineup (HP)	8	10	12	14	16	18	20	22	24	26	28	30	32	34	36	38	40	42	44	46	48	50	52	
kW	25,2	28	33,5	40	45	50,4	56	61,5	68	73,5	80	85	90	95,4	100,8	106,4	112	117,5	123	129,5	136	141,5	147	
<b>Top Discharge Heat Pump up to 104HP</b> 38VT*73H																								
Lineup (HP)	8	10	12	14	16	18	20	22	24	26	28	30	32	34	36	38	40	42	44					
kW	22,4	28	33,5	40	45	50	56	60	67	73,5	80	85	90	95	100	106	112	116	120					
<b>Top Discharge Heat Recovery up to 88HP</b> 38VT*73R																								





8						10						12														
22,6						28,0						31,5														
3 Ph						3 Ph						3 Ph														
																										
54	56	58	60	62	64	66	68	70	72	74	76	78	80	82	84	86	88	90	92	94	96	98	100	102	104	
151,2	156,8	162,4	168	173,5	179	184,5	191	197,5	204	209,5	215	220,5	224	229,5	235	240,5	246	252,5	259	265,5	272	277,5	283	288,5	294	
																										
46						48	50	52	54	56	58	60	62	64	66	68	70	72	74	76	78	80	82	84	86	88
130						135	140	145	150	156	162	168	172	176	180	190	195	200	206	212	218	224	228	232	236	240
																										

















Turn to the experts

# INDOOR UNITS LINEUP

Capacity kW/kBTU/h	ONE-WAY CASSETTE	TWO-WAY CASSETTE	COMPACT FOUR-WAY CASSETTE	ROUND-WAY CASSETTE	SLIM DUCT	STANDARD STATIC DUCT 20/200 Pa
	 40VU*1-7E	 40VU*2-7G	 40VU*C-7S	 40VU*R-7E	 40VD*L-7E	 40VD*S-7S
Fan Motor Type	DC	AC	DC	DC	DC	DC
1.5/5	●		●		●	●
2.2/7	●	●	●	●	●	●
2.8/9	●	●	●	●	●	●
3.6/12	●	●	●	●	●	●
4.5/16		●	●	●	●	●
5.6/18		●	●	●	●	●
7.1/24				●	●	●
8.0/28				●		●
9.0/30				●		●
11.2/38				●		●
14.0/48				●		●
16.0/54				●		●
22.4/72						
28.0/96						

Capacity kW/kBTU/h	HIGH STATIC DUCT 0/250 Pa  40VD*H-7S	HIGH WALL  40VK*S-7S2	TWO-WAY CONSOLE  40VL*B-7E	CONSOLE - RECESSED  40VL*R-7G	FLEX CEILING FLOOR  40VC*F-7S
	Fan Motor Type	DC	DC	DC	AC
1.5/5		●	●		
2.2/7	●	●	●	●	
2.8/9	●	●	●	●	●
3.6/12	●	●	●	●	●
4.5/16	●	●			●
5.6/18	●	●	●		●
7.1/24	●	●			●
8.0/28	●	●			●
9.0/30	●	●			●
11.2/38	●				●
14.0/48	●				●
16.0/54	●				●
22.4/72	●				
28.0/96	●				

# CONTROLLER UNITS LINEUP

<b>INDIVIDUAL CONTROLLER</b>	Remote Controller	 <b>Wireless Controller</b> 40VCI67FQEE	 <b>Receiver (Duct unit)</b> 40VCIR7FQEE			
	Wired Controller	 <b>Simple Wired Controller</b> 40VCW117FQEE	 <b>Wired Controller</b> 40VCW217FQEE	 <b>Wired Weekly Timer</b> 40VCW317FQEE		
<b>CENTRALIZED CONTROLLER</b>		 <b>Group Controller up to 32 IDU</b> 40VCC837FQEE	 <b>Touchscreen up to 256 IDU</b> 40VCC617FQEE	 <b>Touchscreen up to 800 IDU</b> 40VCC727FQEE		
<b>ADAPTER</b>		 <b>Protocol Adapter Modbus to RS485</b> 40VCCR17FQEE	 <b>Protocol Adapter &amp; Electricity Data Collection</b> 40VCBM17FQEE	 <b>Protocol Adapter for Touchscreen</b> 40VCCX17FQEE		
<b>BMS</b>		 <b>Remote monitoring BACnet® / Modbus IP</b> 40VCB217FQEE	 <b>Local PC control RS485 to USB</b> 40VCB117FQEE	 <b>Lonworks™ Gateway</b> 40VCBL17FQEE	 <b>KNX® Gateway</b> 40VCBK17FQEE 40VCBK27FQEE 40VCBK37FQEE	 <b>BACnet® Gateway</b> 40VCBB17FQEE







Turn to the experts

HOUSING



HOTEL



RETAIL



HEALTHCARE



ADMINISTRATIONS



OFFICES



RETAIL



ADMINISTRATIONS



HOTELS



HEALTHCARE



HOUSING

## OUTDOOR UNITS

- 028 SIDE DISCHARGE HEAT PUMP
- 048 TOP DISCHARGE HEAT PUMP
- 066 TOP DISCHARGE HEAT RECOVERY





Turn to the experts

OUTDOOR





# SIDE DISCHARGE

Compact design for flexible application in small or narrow spaces





Turn to the experts

# Carrier Product Benefits 4/5 HP



OUTDOOR

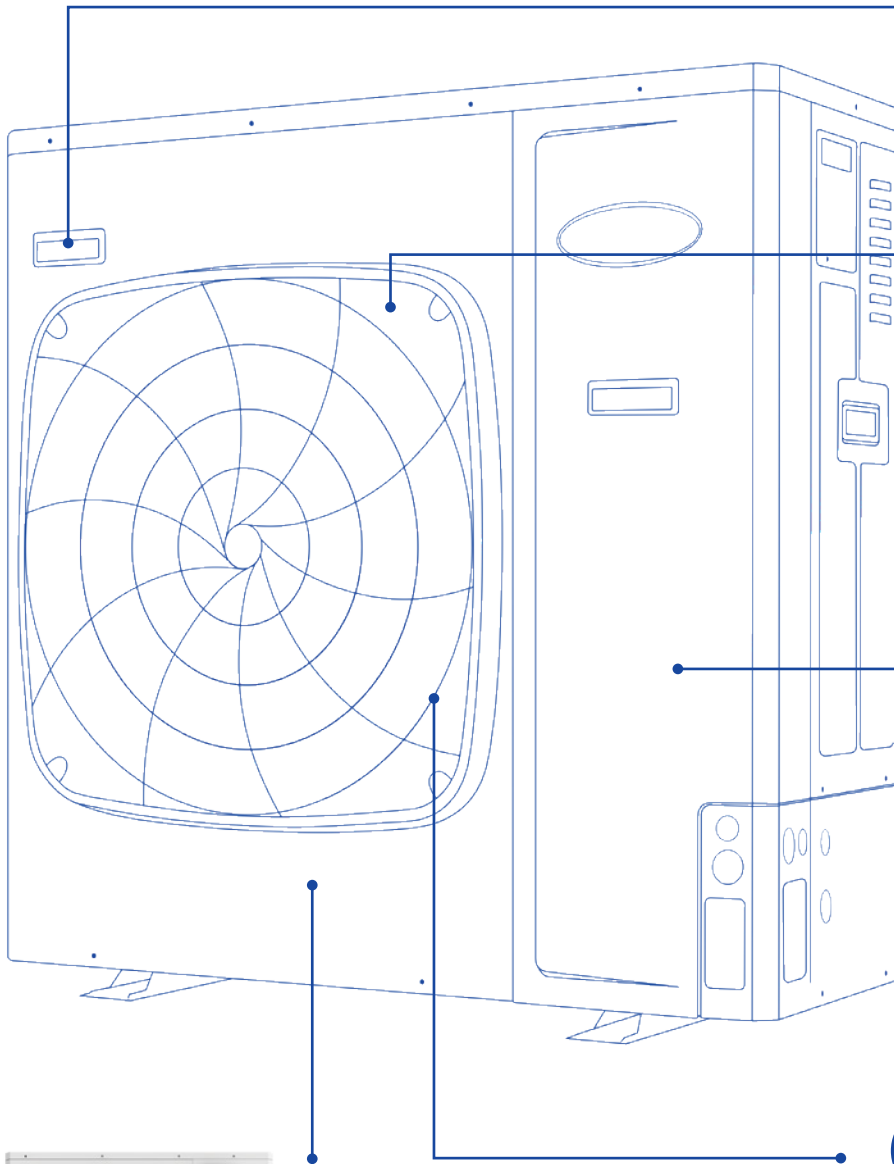

### Compact design

- Lower to 90 kg net weight
- Compact design with only 0.35 m<sup>2</sup> footprint
- Limited refrigerant charge with 3.3 kg



### Superior Comfort

**New aerodynamic fan**  
550 mm super big diameter aerospace helix fan lowers sound level by 3 dB(A)



### Easy Installation

- 1 **Double side '4' handles**  
Easy to carry
- 2 **'888' test panel**  
All running data and error codes can be checked from '888' screen, which makes it convenient for install
- 3 **Four-way pipe connection**  
Four-way (front, back, left and right) pipe connection, easy to design and install

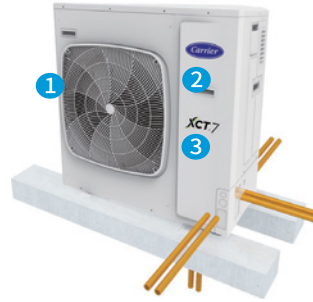

### DC Fan and Motor

#### DC power brings higher efficiency to running partial load

- 16-stage speed control; high-efficiency running especially in low speed
- 45% higher efficiency than AC motors
- Lower power input

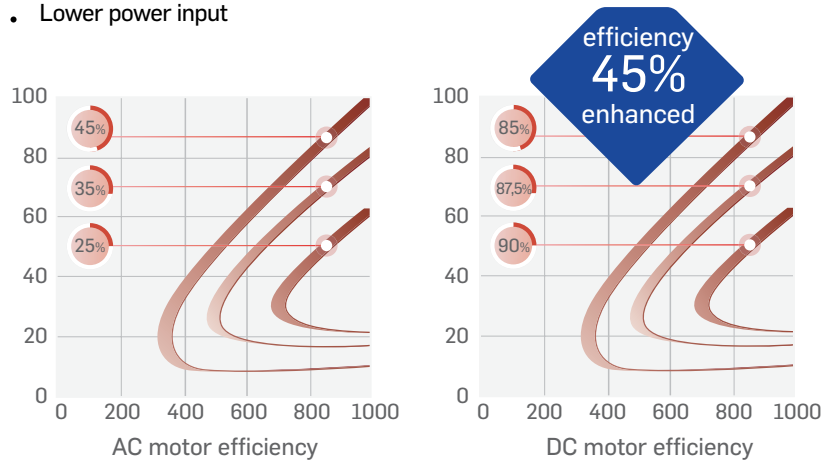

- **Large diameter fan**

The large fan of 550 mm diameter allows for greater airflow and hence, higher efficiency



DC motor



ø550mm fan

- **New DC inverter with twin rotary compressor**

Small torque changes & good dynamic balance allows the system to run smoothly, with low vibration, low noise and higher efficiency when running partial load

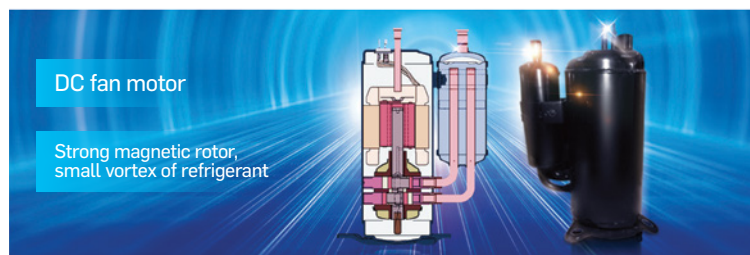

OUTDOOR



Turn to the experts

# Carrier Product Benefits

4/5/6 HP



OUTDOOR

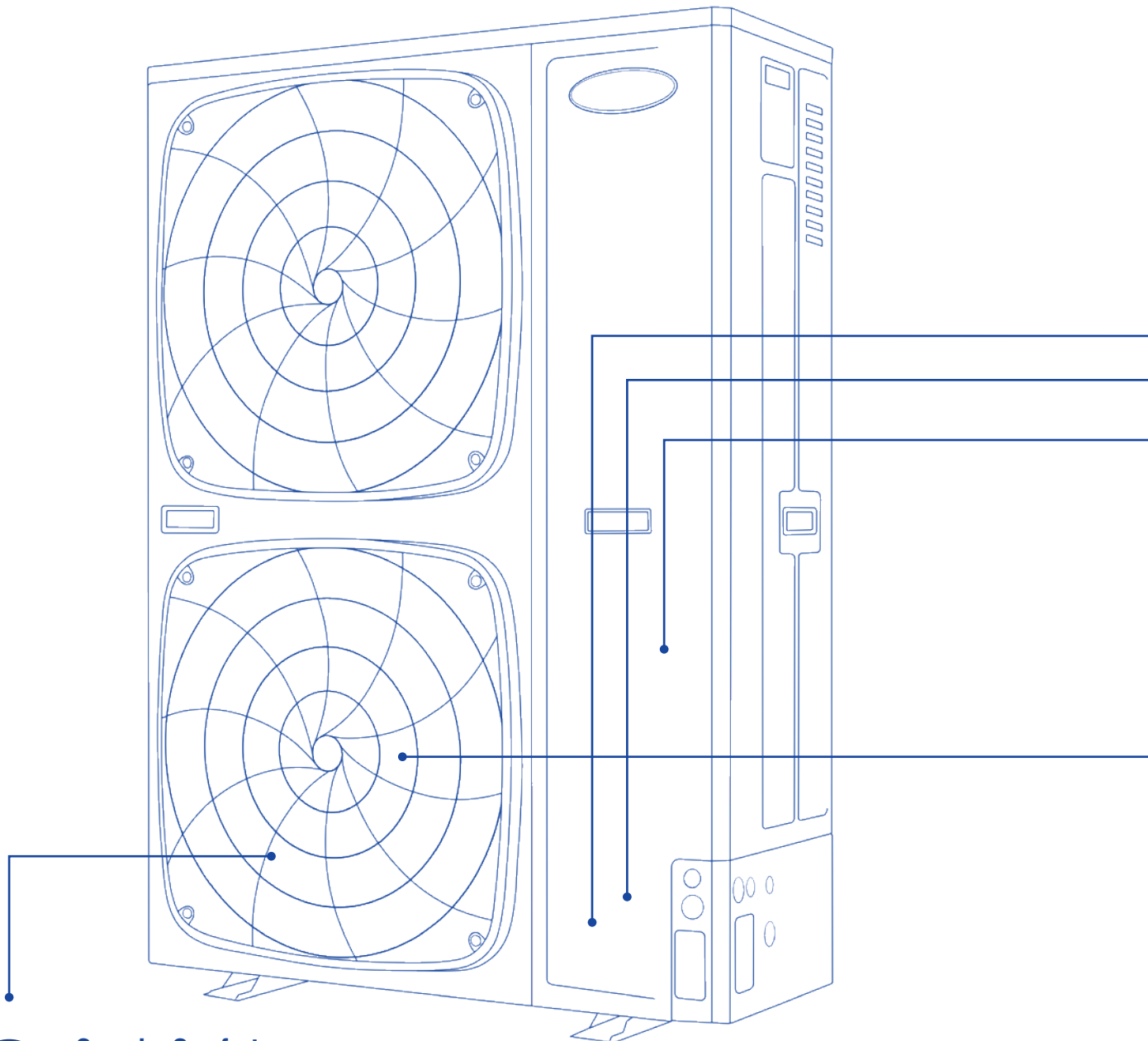

### Superior Comfort

#### New aerodynamics fan

550 mm super big diameter aerospace helix fan lowers sound level by 3 dB(A)





### Leadership in Advanced Technology

#### Two-stage Sub-cooling Cycle Technology

Increases unit efficiency by 9%.

#### Maximize 30°C Sub-cooling

Increases unit cooling capacity by 46%

#### Adding of the Sub-cooler at the Bottom of the Outdoor Exchanger

Increases the efficiency of the system sub-cooling to achieve deep sub-cooling

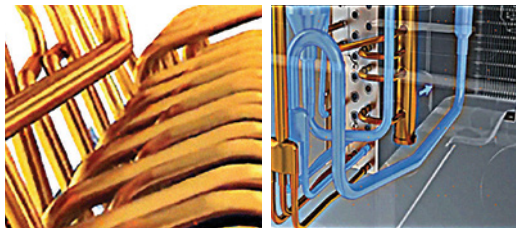

### More Powerful Heating Capacity by Enthalpy Injection

In low ambient conditions, condenser heat rejection is weakened. The amount of hot gas returning to the compressor is greatly reduced. However, the indoor units have the capacity to receive more heat due to the residual enthalpy injection from the 2<sup>nd</sup> stage subcooling.

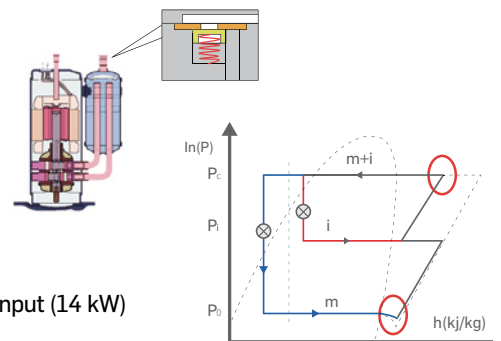

### High-Efficiency

- **DC Inverter Compressor**

Carrier XCT7 unit uses DC inverter compressors, with 5% lower power input (14 kW)

- **Large 550 mm DC powered fan**

38% lower power input, 8% higher airflow

- **Larger heat exchanger**

Heat exchange area increased by 10%

- **Charge valve**

Built-in charge valve enables safer and easier maintenance

- **Low standby power**

New PCB program reduces 20% standby power consumption



### DC Fan and Motor

#### DC power brings higher efficiency to running partial load

- 16-stage speed control; high-efficiency running especially in low speed
- 45% higher efficiency than AC motors
- Lower power input

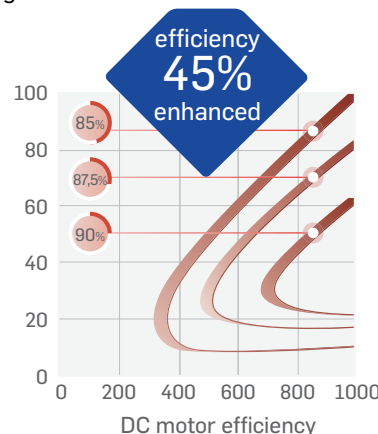
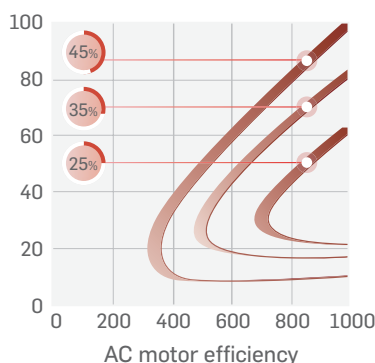

### Large diameter fan

The large fan of 550 mm diameter allows for greater airflow and hence, higher efficiency



DC motor



ø550mm fan



Turn to the experts

# Carrier Product Benefits

4/5/6 HP

8/10/12 HP



OUTDOOR

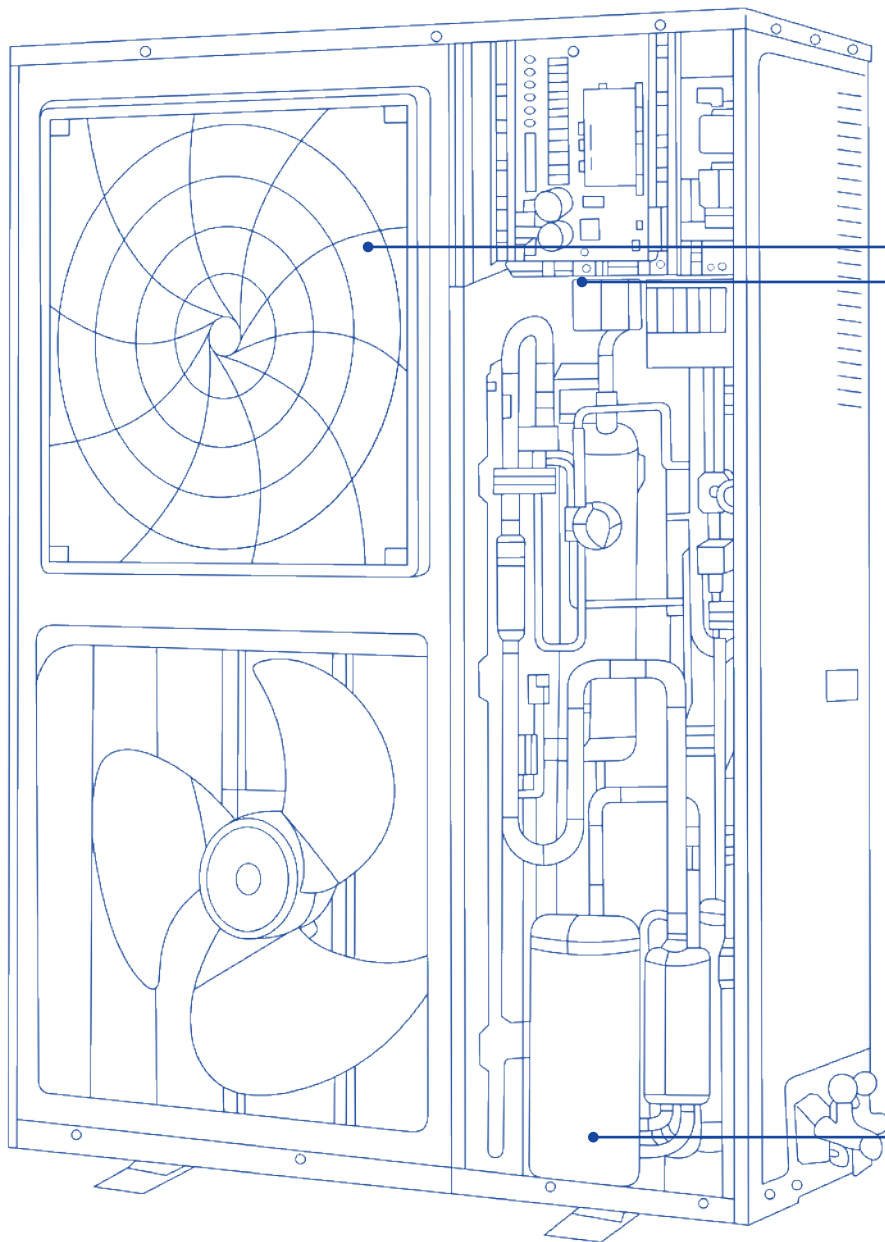



### High Efficiency

- **DC Inverter Compressor**  
Carrier XCT7 uses DC INV. compressors, with 5% lower power input (14 kW)
- **Larger heat exchanger**  
Heat exchange area increased by 10%
- **Charge valve**  
Built-in charge valve to enable safer and easier maintenance
- **Low standby power**  
New PCB program to reduce 20% standby power consumption

### New DC inverter with twin rotary compressor

Small torque changes & good dynamic balance allows the system to run smoothly, with low vibration, low sound and higher efficiency when running partial load

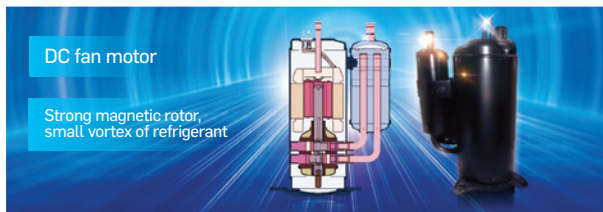

### Low Noise Level

- **Night mode function**  
Quiet Night Mode (-8 dB(A)) is also available by setting PCB. The sound can be reduced to 50 dB(A)

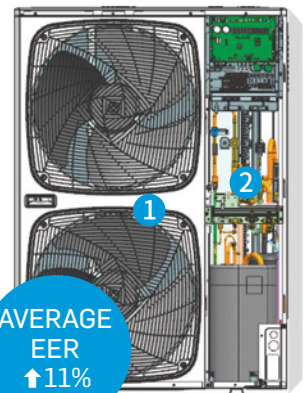
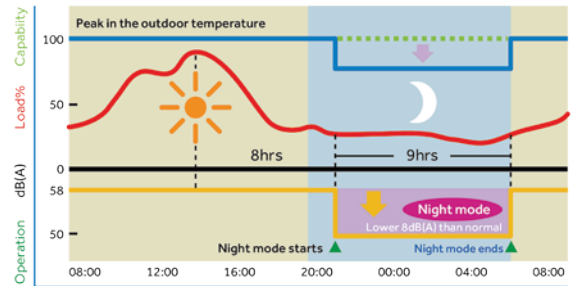

### Super Comfort

- 1 **Enlarged air inlet path and spiral air outlet**  
Air flow follows the grill direction to lower sound level by 2-4 dB(A)
- 2 **Automatic sound-reducing function**  
Night mode set by PCB to lower the sound level by 8dB (A)

### Precise Vector Inverter Control

#### DC fan motor bracket & non-resonance structure

Ensures smooth running of the motor to reduce noise

#### DC inverter twin rotary compressor

Smooth operation as there is no need to frequently start the compressor thereby effectively reducing the outdoor noise

#### Big diameter fan

Designed according to the functionally silent aircraft principle





Turn to the experts

# Carrier Product Benefits

4/5/6 HP

8/10/12 HP



OUTDOOR

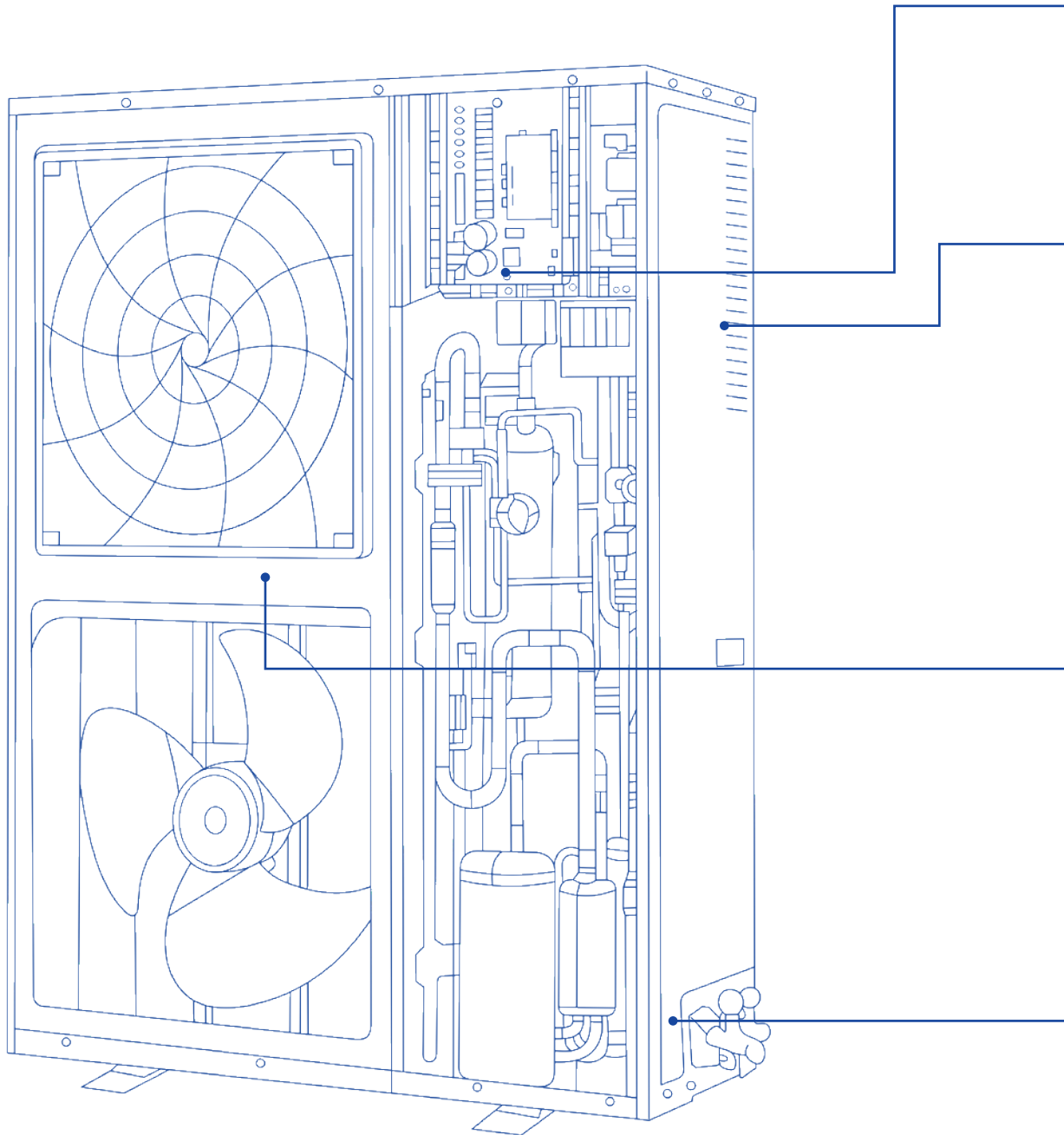



### Easy Maintenance for Control

#### Front-facing, hinge design control box

Reserving space by 108 mm between control box and top panel, the easy-to-open unit allows for maintenance from the top



#### Parameter display panel (Available only on 4-6 HP)

The first original parameter display panel is on the side. The parameter can be observed directly by opening the protective cover. without removing the repair board

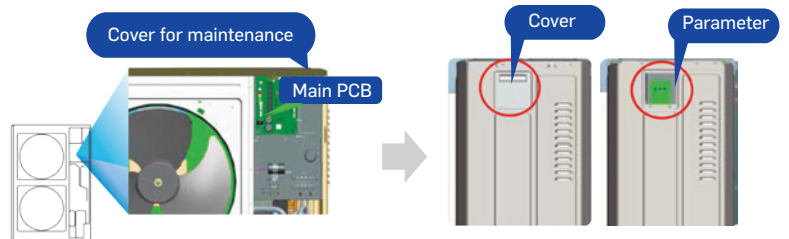

#### Compact Discharge Design

Large capacity, small footprint with only 0.42 m<sup>2</sup>, to reduce floor area by as much as 43%. No need for an additional ventilation hood unlike the top discharge unit.



### Easy Installation

- 1 **Double side '4' handles**  
Easy to carry
- 2 **'888' test panel**  
All running data and error codes can be checked from '888' screen, which makes it convenient for installers
- 3 **Four-way pipe connection**  
Four-way (front, back, left, and right) pipe connection, easy to design and install





Turn to the experts

# Carrier Product Benefits

4/5/6 HP

8/10/12 HP



OUTDOOR

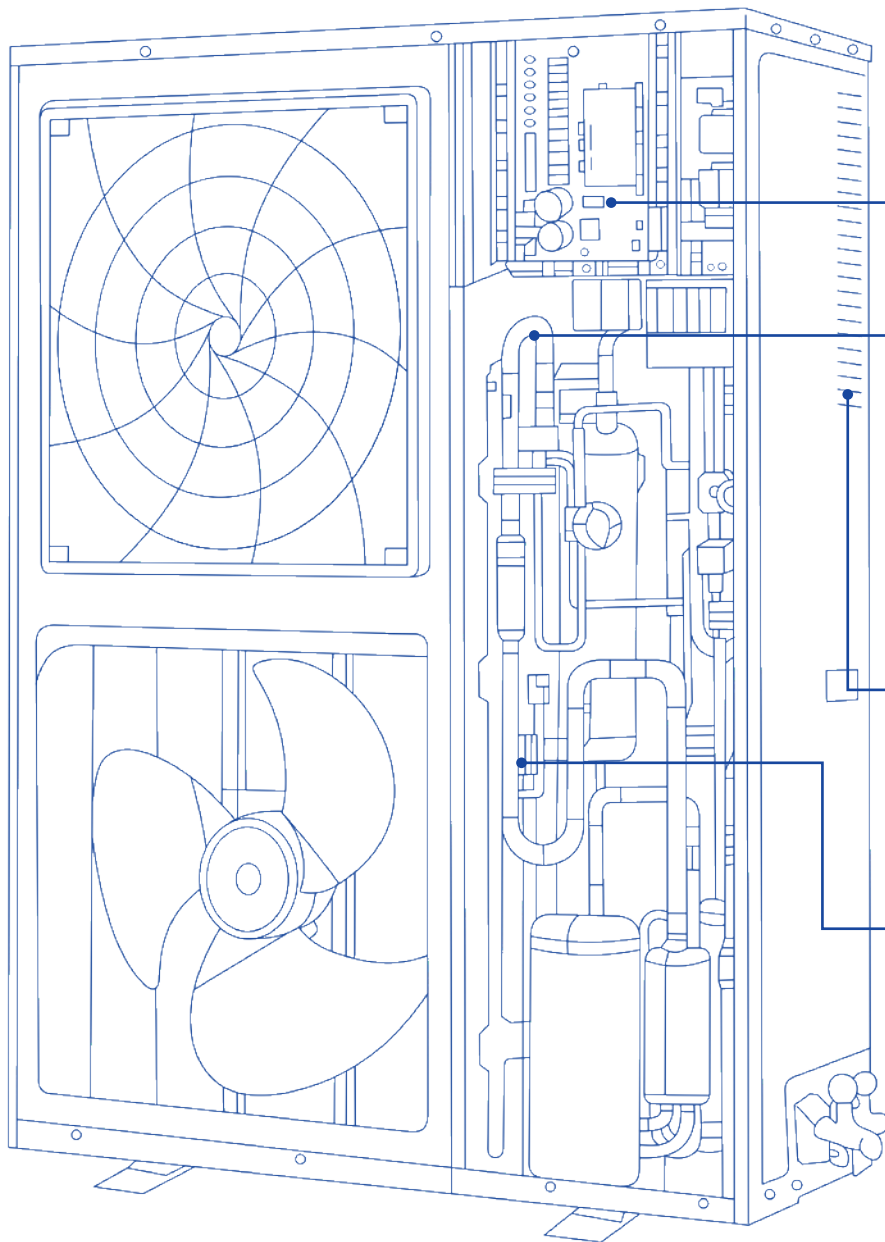



### Easy Maintenance for Control

The control box is in front, reserving 108 mm between the control box and top panel, which and along with the hinge design, allows for easy maintenance from the top

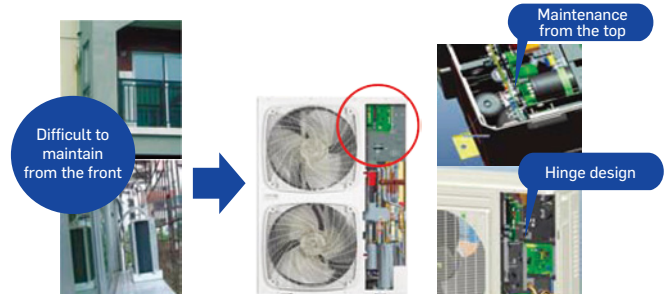

### High Reliability

- **Refrigerant control technology**  
Refrigerant control technology reduces the refrigerant volume and enhances the running efficiency without high pressure accumulator

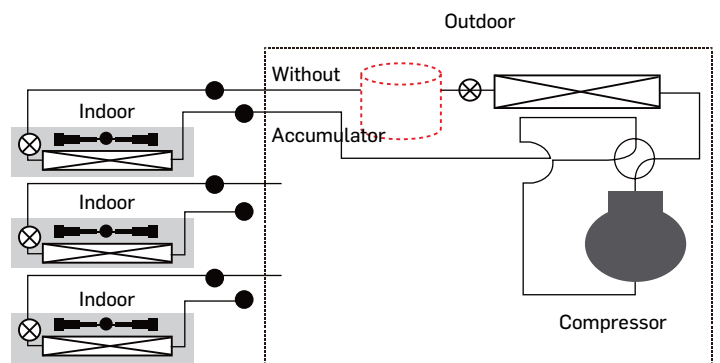

- **Air inlet grill design on right side panel**  
This is to effectively reduce the module temperature and avoid air dust entering the air conditioner

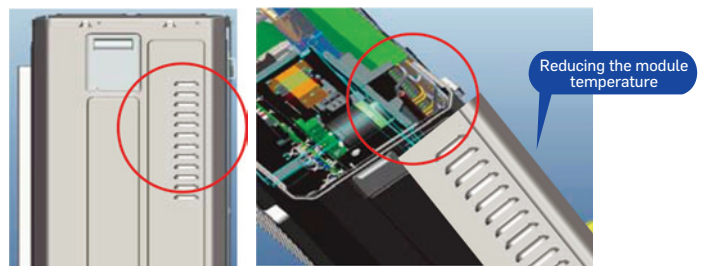

- **High and low double pressure sensor**  
Double pressure sensors with PID control technology and high speed communication both allow immediate start of compressor with more precise control. The temperature can be controlled  $\pm 0.5^\circ \text{C}$

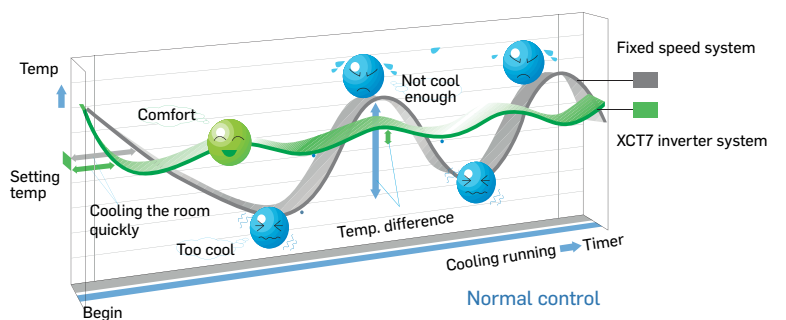
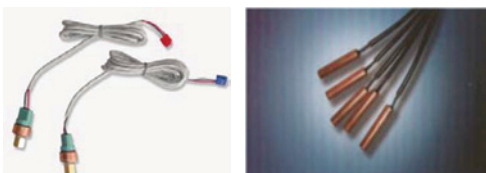



# Specifications Side Discharge Heat Pump 4-5 HP

Model			38VS125C7SHQEE	38VS140C7SHQEE
Capacity <sup>(1)</sup>	Capacity range	HP	4	5
	Cooling	kW	12.1	14.0
	Heating	kW	12.1	14.0
	Heating (Max)	kW	14.0	15.5
Cooling Efficiency <sup>(1)</sup>	EER	W/W	2.85	2.80
	SEER	/	4.90	4.85
	ηs	%	193	191
	Running current	A	20.3	23.9
Heating Efficiency <sup>(1)</sup>	COP	W/W	2.95	2.90
	SCOP <sup>(1)</sup>	/	3.5	3.55
	ηs	%	137	139
	Running current	A	19.6	23.1
Electrical Parameters	Power supply	Ph/V/Hz	1/220-240/50/60	1/220-240/50/60
	Rated power input (Cooling)	kW	4,25	5,00
	Rated power input (Heating)	kW	4,10	4,83
	Max. current	A	28.30	29.30
Dimensions (H/W/D)	External (H/W/D)	mm	965/950/370	965/950/370
	Shipping (H/W/D)	mm	1010/990/458	1010/990/458
Weight	Net/Shipping weight	kg	90/97	90/97
Compressor	Compressor type	/	Rotary	Rotary
	Motor power	W	4130	4130
	Compressor quantity	/	1	1
Fan	Air flow (H)	m <sup>3</sup> /h	5400	5400
Pressure Sound Level	Cooling	dB(A)	58	60
	Heating	dB(A)	60	62
Power Sound Level	Cooling	dB(A)	75	77
	Heating	dB(A)	77	79
Refrigerant	Type	/	R410A	R410A
	Charge	kg	3,3	3,3
Piping	Refrigerant liquid pipe (Ø)	mm	9.52	9.52
	Refrigerant gas pipe (Ø)	mm	15.88	15.88
	Total pipe length	m	120	120
	Max. pipe length (Equivalent/Actual)	m	70/60	70/60
	Max. drop between I.U. & O.U. (ODU above / below)	m	30/20	30/20
	Max. drop between I.U. & I.U.	m	10	10
Connection Ratio	Connectable indoor unit ratio <sup>(2)</sup>	%	50-130	50-130
	Maxi. number of indoor units	/	7	8
Working Temp.	Cooling	°C	-5-52	-5-52
	Heating	°C	-15-21	-15-21

OUTDOOR

HEATING

COOLING



(1) CARRIER participates in the ECP program for Comfort Air Conditioners (AC) Check ongoing validity of certificate : [www.eurovent-certification.com](http://www.eurovent-certification.com)  
 Cooling capacity tested conditions : Indoor air temperature of 27°C DB / 19°C WB and outdoor air temperature of 35° DB / 24°C WB  
 Heating capacity tested conditions : Indoor air temperature of 20°C DB and outdoor air temperature of 7°DB / 6°C WB

(2) The indoor and outdoor capacity ratio should be limited within 100% when all the indoor units are in operation to ensure the system cooling/heating performance.





## Side Discharge Heat Pump 4-5-6 HP

1-Ph

OUTDOOR

Model			38VS12117SHQEE	38VS14017SHQEE	38VS15517SHQEE
Capacity <sup>(1)</sup>	Capacity range	HP	4	5	6
	Cooling	kW	12.1	14.0	15.5
	Heating	kW	12.1	14.0	15.5
	Heating (Max)	kW	14.2	16.0	18.0
Cooling Efficiency <sup>(1)</sup>	EER	W/W	3.35	3.23	3.00
	SEER		6.82	6.65	6.80
	ηs	%	270	263	269
	Running current	A	17.8	21.4	25.5
Heating Efficiency <sup>(1)</sup>	COP	W/W	3.75	3.72	3.10
	SCOP <sup>(1)</sup>	/	4.05	4.11	4.05
	ηs	%	159	161	159
	Running current	A	15.9	18.4	21.7
Electrical Parameters	Power supply	Ph/V/Hz	1/220-240/50/60	1/220-240/50/60	1/220-240/50/60
	Rated Power input (Cooling)	kW	3.61	4.33	5.17
	Rated Power input (Heating)	kW	3.23	3.72	4.39
	Max. current	A	34.1	35.5	36.9
Dimensions (H/W/D)	External (H/W/D)	mm	1340/950/370	1340/950/370	1340/950/370
	Shipping (H/W/D)	mm	1420/1023/471	1420/1023/471	1420/1023/471
Weight	Net/Shipping weight	kg	108/123	108/123	108/123
Compressor	Compressor type	/	Rotary	Rotary	Rotary
	Motor Power	W	4130	4130	4130
	Compressor quantity	/	1	1	1
Fan	Air flow (H)	m <sup>3</sup> /h	7200	7200	7200
Maximum external static pressure		Pa	30	30	30
Pressure Sound Level	Cooling	dB(A)	55	56	57
	Heating	dB(A)	57	58	59
Power Sound Level	Cooling	dB(A)	69	71	73
	Heating	dB(A)	71	73	75
Refrigerant	Type	/	R410A	R410A	R410A
	Charge	kg	4	4	4
Piping	Refrigerant liquid pipe (Ø)	mm	9.52	9.52	9.52
	Refrigerant gas pipe (Ø)	mm	15.88	15.88	15.88
	Total pipe length	m	300	300	300
	Max. pipe length (equivalent/actual)	m	175/150	175/150	175/150
	Max. drop between I.U.& O.U. (ODU above / below)	m	50/40	50/40	50/40
	Max. drop between I.U.&I.U	m	15	15	15
Connection Ratio	Connectable indoor unit ratio <sup>(2)</sup>	%	50-130	50-130	50-130
	Max. number of indoor units	/	8	10	13
Working Temp.	Cooling	°C	-15-48	-15-48	-15-48
	Heating	°C	-20-27	-20-27	-20-27



HEATING



COOLING



(1) CARRIER participates in the ECP program for Comfort Air Conditioners (AC) Check ongoing validity of certificate : [www.eurovent-certification.com](http://www.eurovent-certification.com)  
Cooling capacity tested conditions : Indoor air temperature of 27°C DB / 19°C WB and outdoor air temperature of 35° DB / 24°C WB  
Heating capacity tested conditions : Indoor air temperature of 20°C DB and outdoor air temperature of 7°DB / 6°C WB

(2) The indoor and outdoor capacity ratio should be limited within 100% when all the indoor units are in operation to ensure the system cooling/heating performance.



# Specifications Side Discharge Heat Pump 4-5-6 HP

3-Ph

Model			38VS121173HQEE	38VS140173HQEE	38VS155173HQEE
Capacity <sup>(1)</sup>	Capacity range	HP	4	5	6
	Cooling	kW	12.1	14.0	15.5
	Heating	kW	12.1	14.0	15.5
	Heating (Max)	kW	14.2	16.0	18.0
Cooling Efficiency <sup>(1)</sup>	EER	W/W	3.35	3.23	3.00
	SEER		6.82	6.65	6.80
	ηs	%	270	263	269
	Running current	A	5.8	6.9	8.3
Heating Efficiency <sup>(1)</sup>	COP	W/W	3.75	3.72	3.10
	SCOP <sup>(1)</sup>	/	4.05	4.11	4.05
	ηs	%	159	161	159
	Running current	A	5.1	5.9	7.0
Electrical Parameters	Power supply	Ph/V/Hz	3/380-415/50/60	3/380-415/50/60	3/380-415/50/60
	Rated Power input (Cooling)	kW	3.61	4.33	5.17
	Rated Power input (Heating)	kW	3.18	3.72	4.39
	Max. current	A	11.4	11.9	12.3
Dimensions (H/W/D)	External (H/W/D)	mm	1340/950/370	1340/950/370	1340/950/370
	Shipping (H/W/D)	mm	1420/1023/471	1420/1023/471	1420/1023/471
Weight	Net/Shipping weight	kg	108/123	108/123	108/123
Compressor	Compressor type	/	Rotary	Rotary	Rotary
	Motor Power	W	4060	4060	4060
	Compressor quantity	/	1	1	1
Fan	Air flow (H)	m <sup>3</sup> /h	7200	7200	7200
Maximum external static pressure		Pa	30	30	30
Pressure Sound Level	Cooling	dB(A)	55	56	57
	Heating	dB(A)	57	58	59
Power Sound Level	Cooling	dB(A)	69	71	73
	Heating	dB(A)	71	73	75
Refrigerant	Type	/	R410A	R410A	R410A
	Charge	kg	4	4	4
Piping	Refrigerant liquid pipe (Ø)	mm	9.52	9.52	9.52
	Refrigerant gas pipe (Ø)	mm	15.88	15.88	15.88
	Total pipe length	m	300	300	300
	Max. pipe length (equivalent/actual)	m	175/150	175/150	175/150
	Max. drop between I.U. & O.U. (ODU above / below)	m	50/40	50/40	50/40
	Max. drop between I.U. & I.U.	m	15	15	15
Connection Ratio	Connectable indoor unit ratio <sup>(2)</sup>	%	50-130	50-130	50-130
	Max. number of indoor units	/	8	10	13
Working Temp.	Cooling	°C	-15-48	-15-48	-15-48
	Heating	°C	-20-27	-20-27	-20-27

OUTDOOR

HEATING

COOLING



(1) CARRIER participates in the ECP program for Comfort Air Conditioners (AC) Check ongoing validity of certificate : [www.eurovent-certification.com](http://www.eurovent-certification.com)  
 Cooling capacity tested conditions : Indoor air temperature of 27°C DB / 19°C WB and outdoor air temperature of 35° DB / 24°C WB  
 Heating capacity tested conditions : Indoor air temperature of 20°C DB and outdoor air temperature of 7°DB / 6°C WB

(2) The indoor and outdoor capacity ratio should be limited within 100% when all the indoor units are in operation to ensure the system cooling/heating performance.



## Side Discharge Heat Pump 8-10-12 HP

Model			38VS226174HQEE	38VS280174HQEE	38VS335174HQEE
Capacity <sup>(1)</sup>	Capacity range	HP	8	10	12
	Cooling	kW	22.6	28.0	31.5
	Heating	kW	22.6	30.5	31.5
	Heating (Max)	kW	25.0	32.0	35.0
Cooling Efficiency <sup>(1)</sup>	EER	W/W	3.25	3.23	2.73
	SEER		7.67	7.65	7.47
	ηs	%	304	303	296
	Running current	A	11.5	14.3	19.0
Heating Efficiency <sup>(1)</sup>	COP	W/W	3.90	3.80	3.71
	SCOP <sup>(1)</sup>	/	4.05	4.16	4.21
	ηs	%	159	163	165
	Running current	A	9.6	13.3	14.0
Electrical Parameters	Power supply	Ph/V/Hz	3/380-415/50/60	3/380-415/50/60	3/380-415/50/60
	Rated Power input (Cooling)	kW	6.95	8.67	11.52
	Rated Power input (Heating)	kW	5.79	8.03	8.49
	Max. current	A	18.99	23.78	25.43
Dimensions (H/W/D)	External (H/W/D)	mm	1636/1050/400	1636/1050/400	1636/1050/400
	Shipping (H/W/D)	mm	1790/1150/510	1790/1150/510	1790/1150/510
Weight	Net/Shipping weight	kg	149/168	149/168	149/168
Compressor	Compressor type	/	Inverter Twin Rotary	Inverter Twin Rotary	Inverter Twin Rotary
	Motor Power	W	6270	6270	6270
	Compressor quantity	/	1	1	1
Fan	Air flow (H)	m <sup>3</sup> /h	10000	10000	10000
Maximum external static pressure		Pa	30	30	30
Pressure Sound Level	Cooling	dB(A)	63	64	65
	Heating	dB(A)	65	66	67
Power Sound Level	Cooling	dB(A)	81	83	85
	Heating	dB(A)	83	85	87
Refrigerant	Type	/	R410A	R410A	R410A
	Charge	kg	5.1	5.1	5.1
Piping	Refrigerant liquid pipe (Ø)	mm	9.52	9.52	12.7
	Refrigerant gas pipe (Ø)	mm	19.05	22.22	25.4
	Total pipe length	m	300	300	300
	Max. pipe length (equivalent/actual)	m	175/150	175/150	175/150
	Max. drop between I.U. & O.U. (ODU above / below)	m	50/40	50/40	50/40
	Max. drop between I.U. & I.U.	m	15	15	15
Connection Ratio	Connectable indoor unit ratio <sup>(2)</sup>	%	50-130	50-130	50-130
	Max. number of indoor units	/	13	16	19
Working Temp.	Cooling	°C	-5-48	-5-48	-5-48
	Heating	°C	-20-27	-20-27	-20-27



Turn to the experts



### Dimensions (4-6HP)

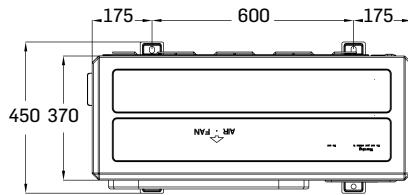
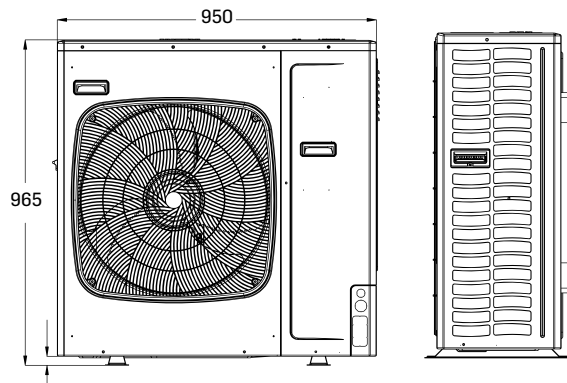

### 4/5/6 HP Dual Fan Side Discharge

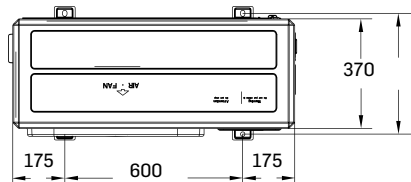
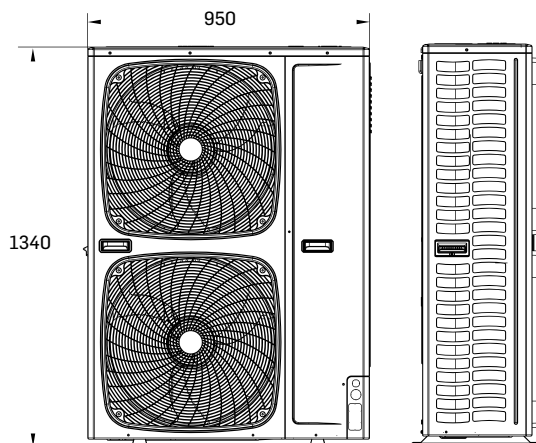

OUTDOOR



### Dimensions (8-12HP)

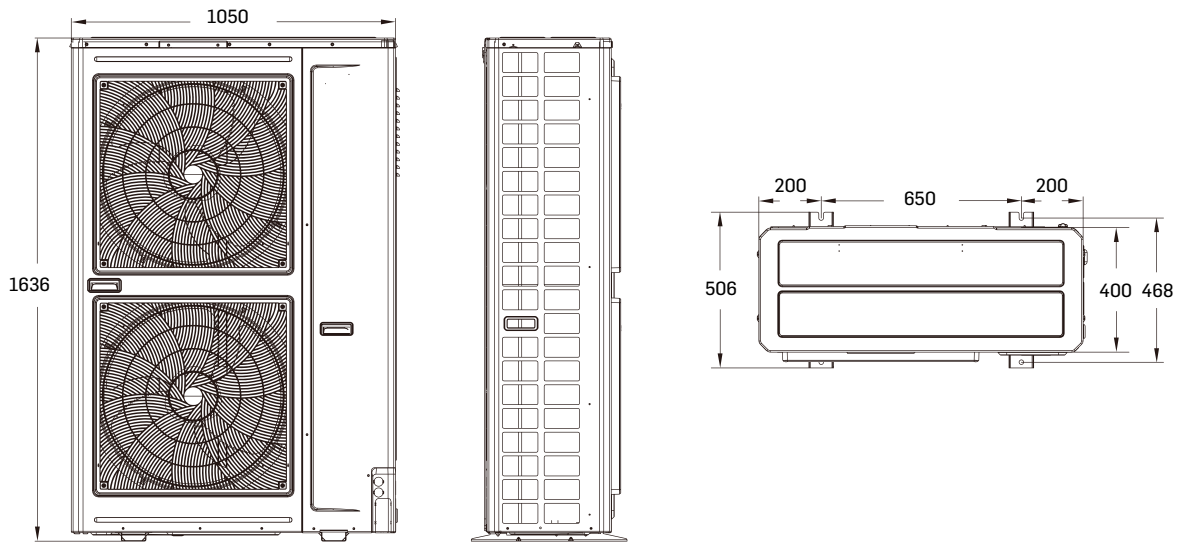

OUTDOOR

### Installation and Maintenance Space

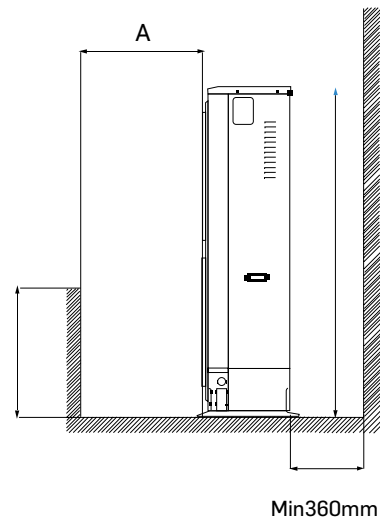
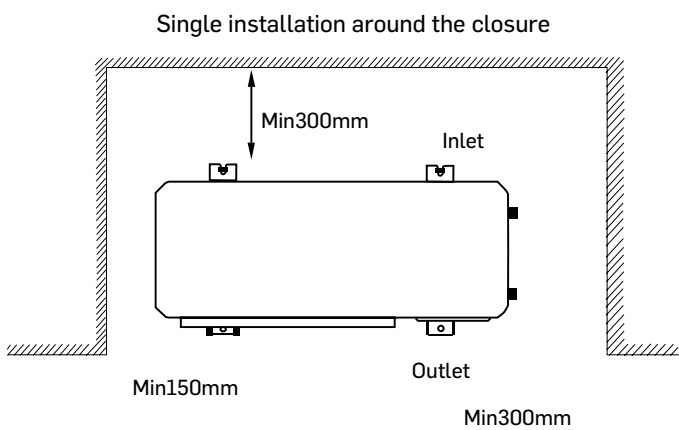

**Note:**  
For more details, please refer to the instruction manual.



### Piping rules (4-5HP)

Permissible pipe length and height difference

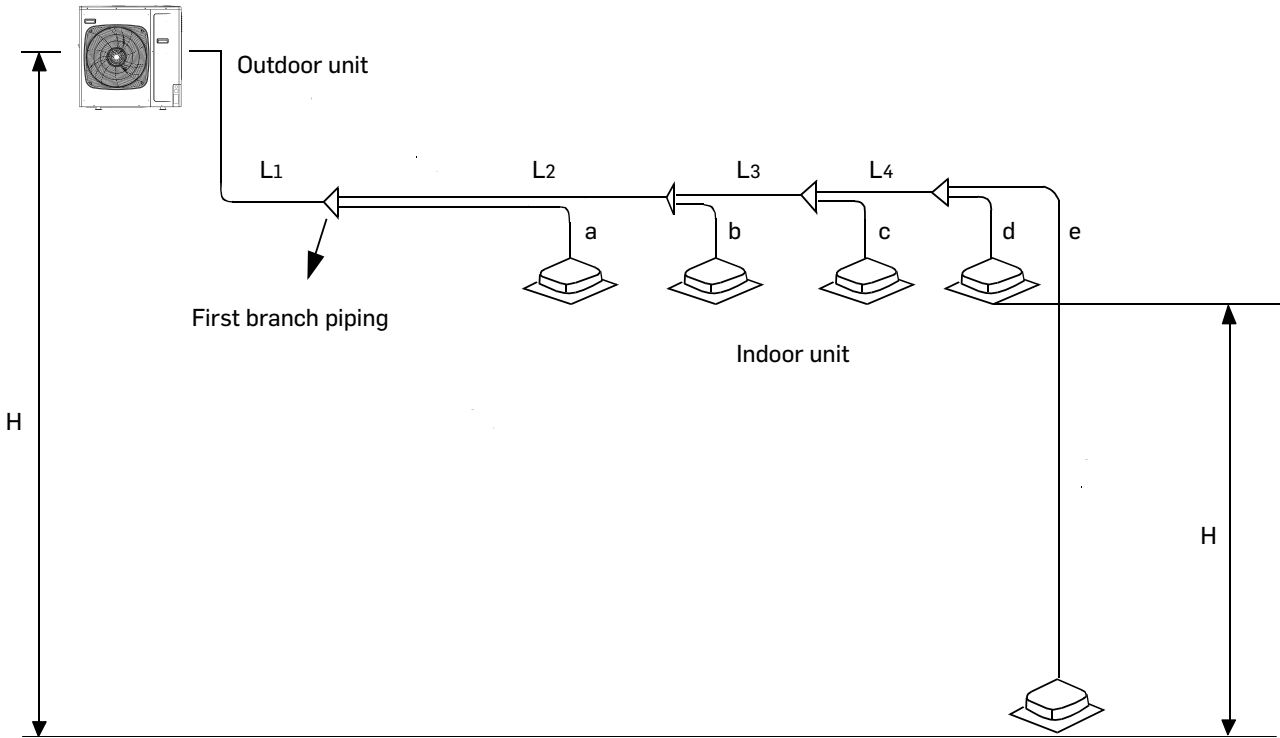

OUTDOOR

		Permissible value	Piping part
<b>Piping length</b>	Total length of piping (actual length)		120m
	Longest piping L	Actual /Equivalent length	60/70m
	The distance between the nearest indoor unit and the farthest indoor		40m
	Pipe length between the indoor unit & the nearest branch length		10m
	Piping length of indoor unit which is furthest to the first branch piping L (*)		40m
<b>Drop height</b>	Drop height between indoor and outdoor unit H	Outdoor above	30m
		Outdoor below	20m
	Drop height between indoor units H		10m



### Piping rules (4-12HP)

Permissible pipe length and height difference

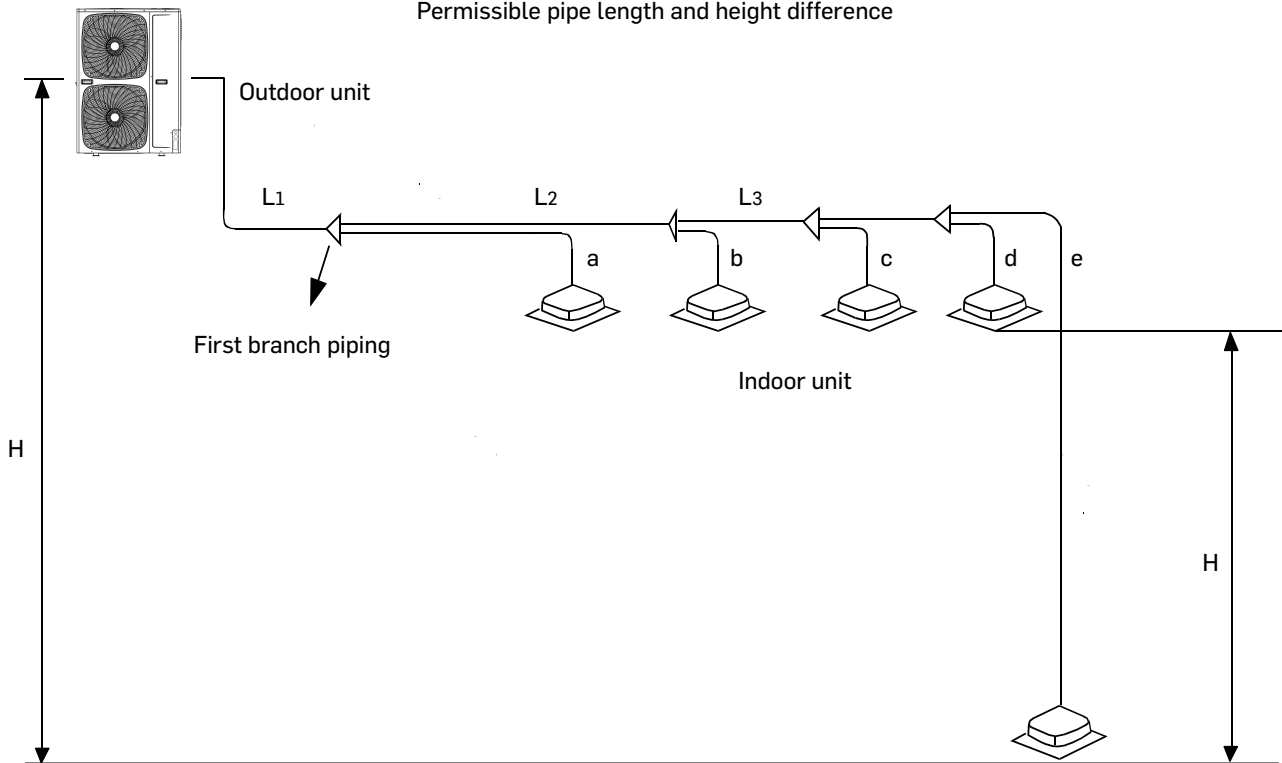

OUTDOOR

Maximal length and drop height permissible of refrigerant piping

		Permissible value	Piping part	
<b>Piping length</b>	Total length of piping (actual length)		300m	$L1+L2+L3+L4+a+b+c+d+e$
	Longest piping L	Actual length	150m	$L1+L2+L3+L4+e$
	Piping length of indoor unit which is furthest to the first branch piping L (*)		40m	$L2+L3+L4+e$
	The distance between the nearest indoor unit and the farthest indoor		40m	$L2+L3+L4+e-a$
	Pipe length between the indoor unit & the nearest branch length		10m	a,b,c,d,e
<b>Drop height</b>	Drop height between indoor and outdoor unit H	Outdoor above	50m	—
		Outdoor below	40m	—
	Drop height between indoor units H		15m	—

Note:

When the single way pipe length is over 30m, the main pipe should be of the enlarged diameter.



Turn to the experts

OUTDOOR







# TOP DISCHARGE

Handles heating and cooling with incredible efficiency and ensures continuous comfort indoors



Turn to the experts

## XCT7 Unit Special Features

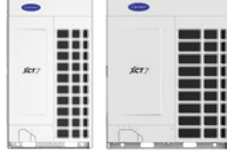

OUTDOOR

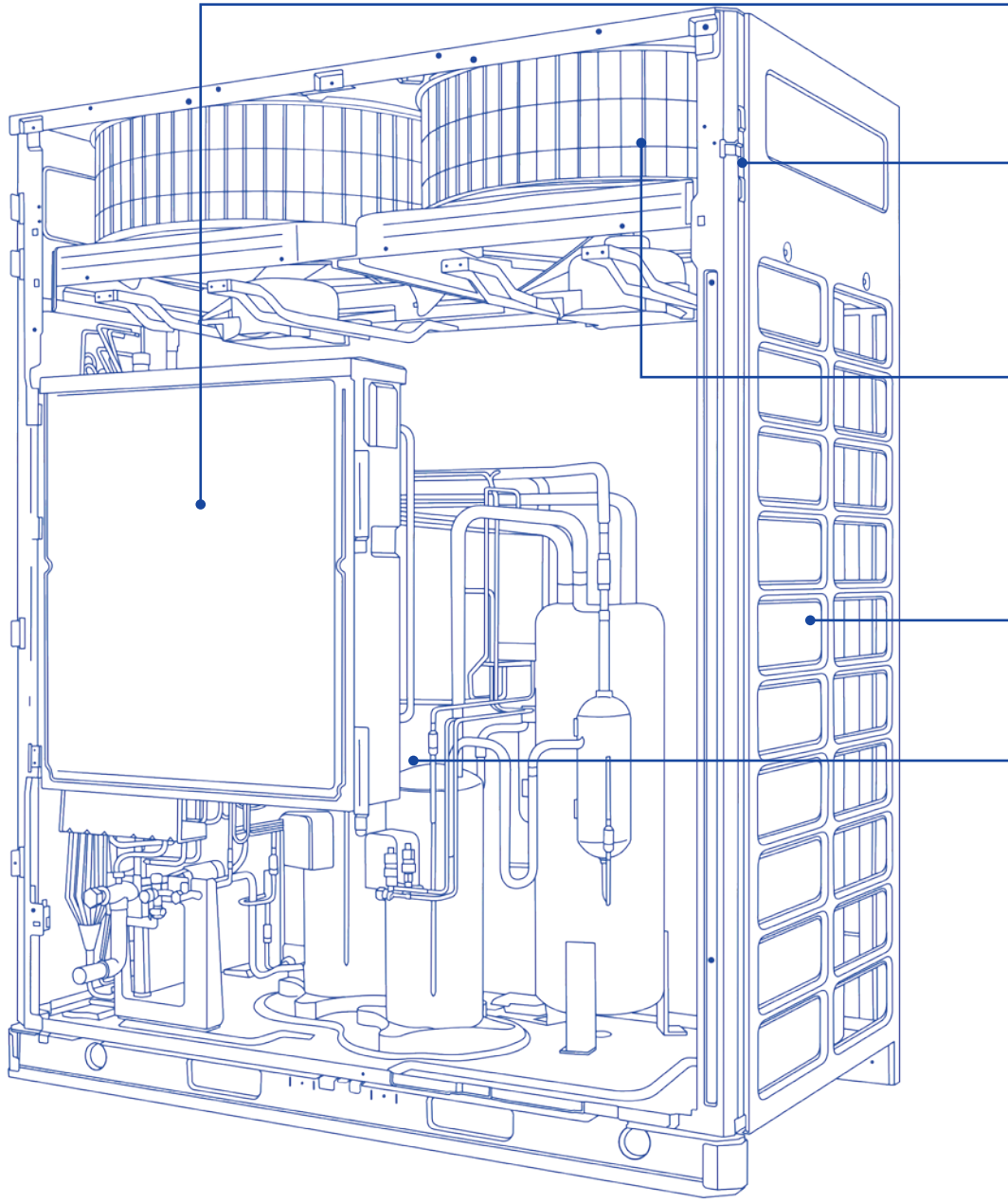



### One Button Trial Operation

You only need to press the outdoor PCB button once to initiate the trial operation mode instead of starting indoor units one by one.

Save up to 10% of trial operation time with this unique function for both cooling and heating modes.



### Less Brazing Refrigerant Accessories

The refrigerant piping accessories are pre-fitted with multiple diameters allowing easy cutting depending on your needs.

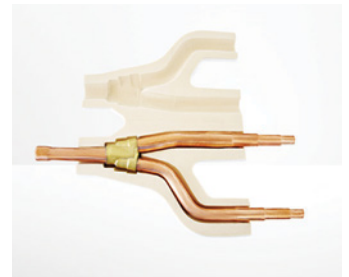

### High Efficiency Outdoor Fan & Dc Inverter Stepless Fan Motor

The fan adopts an aerodynamic design for compressed noise and higher efficiency. The outdoor fan motor adopts unique stepless inverter regulation technology, which coordinates with the stepless inverter compressor.



### Advanced black-coated fin Technology

The unique, advanced, black-coated fin technology on the outdoor condenser enhances the resistance to corrosion and provides stronger protection from air pollution and salt contamination to achieve maximum system reliability.



### Longer resistance to neutral salt spray



### Better corrosion-resistant performance

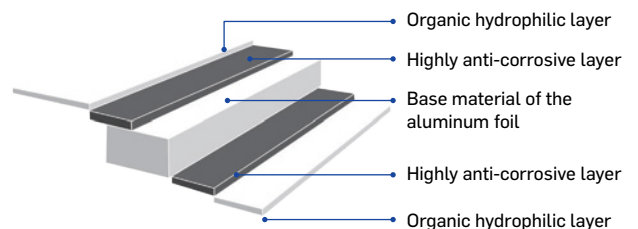
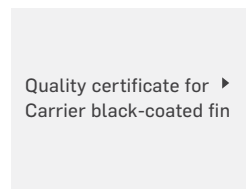

### Advanced Separator

Our advanced separator enhances heat exchanger performance, improves refrigerant distribution balance, and increases overall system efficiency.



OUTDOOR



Turn to the experts

## XCT7 Unit Special Features



OUTDOOR

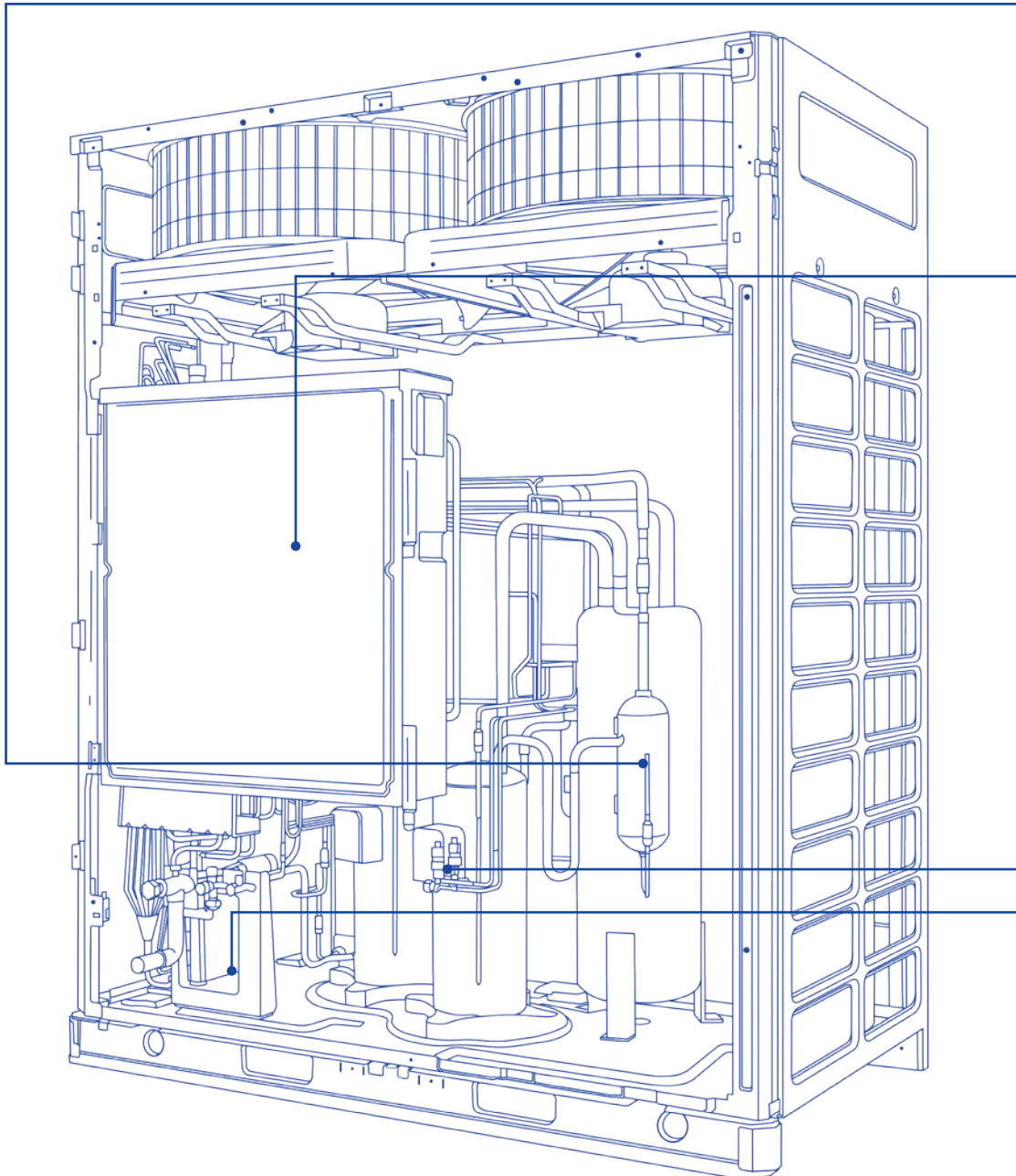

### Optimized performance with automatic dust removal

After 60 days of continuous operation of the unit, the outdoor fan is forced into reverse mode at max. speed for 3 minutes to eject dust from the condenser.



### Reliable Multi-layer Oil Return Technology

Our 10-stage oil return technology, as compared to the industry average of 5, ensures smooth lubricant oil supply to protect the compressor and system.

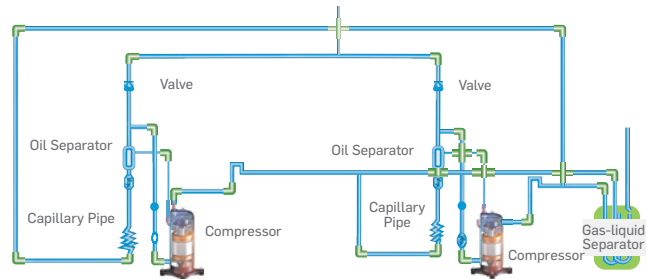

### Easy Access

The design of the ODU is optimized to open to 120°, allowing complete access to internal system components.



### Advanced Compressor Anti-liquid shock Technology

With a soft scroll design, the anti-liquid shock technology ensures an effective unloading when the compressor's internal pressure is too large. It also assures reliable and efficient operation of the compressor by reducing friction and leakage and by halving the liquid shock failure rate.

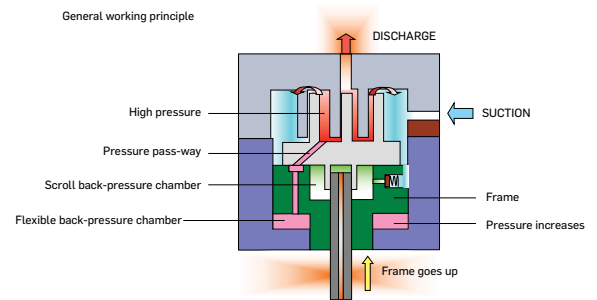

### Flexible Long Piping Length

The piping can go up to 1000 m in length and a maximum of 110 m in height, thereby allowing you to easy service in high rise buildings.

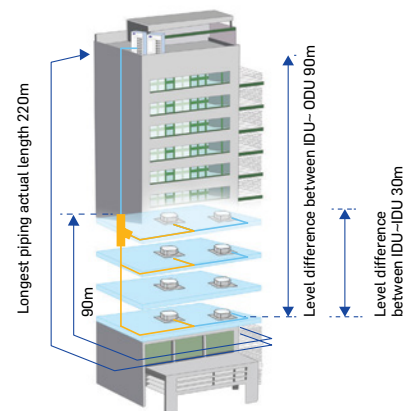

### Top Discharge Outdoor Unit with Built-In RS485 Protocol

Top discharge outdoor unit with built-in RS485 protocol can be directly connected to the building automation system (BMS) without adapters



# Specifications Top Discharge Heat Pump 8-26 HP

OUTDOOR

Model			38VT008173HQEE	38VT010173HQEE	38VT012173HQEE	38VT014173HQEE	38VT016173HQEE
Capacity <sup>(1)</sup>	Capacity range	HP	8	10	12	14	16
	Cooling	kW	25.2	28.0	33.5	40.0	45.0
	Heating	kW	25.2	28.0	33.5	40.0	45.0
	Heating (Max)	kW	28.0	31.5	37.5	45.0	50.0
Cooling Efficiency <sup>(1)</sup>	EER	W/W	4.04	3.80	3.30	3.35	3.40
	SEER		7.25	7.09	6.69	6.60	6.36
	ηs	%	287	281	265	261	251
	Running current	A	10.5	12.4	17.1	20.2	22.3
Heating Efficiency <sup>(1)</sup>	COP	W/W	4.40	4.30	3.90	4.00	4.00
	SCOP <sup>(1)</sup>	/	4.41	4.31	4.31	4.12	4.05
	ηs	%	173	169	169	161	159
	Running current	A	9.67	10.99	14.52	16.88	18.99
Electrical Parameters	Power supply	Ph/V/Hz	3/380-415/50/60	3/380-415/50/60	3/380-415/50/60	3/380-415/50/60	3/380-415/50/60
	Rated Power input (Cooling)	kW	6.24	7.37	10.15	11.94	13.24
	Rated Power input (Heating)	kW	5.73	6.51	8.59	10.00	11.25
	Max. current	A	17.02	19.52	23.30	27.69	32.41
Dimensions (H/W/D)	External (H/W/D)	mm	1690/980/750	1690/980/750	1690/980/750	1690/980/750	1690/980/750
	Shipping (H/W/D)	mm	1838/1070/850	1838/1070/850	1838/1070/850	1838/1070/850	1838/1070/850
Weight	Net/Shipping weight	kg	224/250	224/250	224/250	244/270	244/270
Compressor	Compressor type	/	DC INV. SCROLL	DC INV. SCROLL	DC INV. SCROLL	DC INV. SCROLL	DC INV. SCROLL
	Motor Power	W	6500	6500	6500	6500	7640
	Compressor quantity	/	1	1	1	1	1
Fan	Air flow (H)	m <sup>3</sup> /h	11000	11000	12000	13500	13500
Maximum external static pressure		Pa	110	110	110	110	110
Pressure Sound Level	Cooling	dB(A)	56	56	59	59	60
	Heating	dB(A)	56	56	59	59	60
Power Sound Level	Cooling	dB(A)	81	82	88	88	88
	Heating	dB(A)	81	82	88	88	88
Refrigerant	Type	/	R410A	R410A	R410A	R410A	R410A
	Charge	kg	8.5	8.5	8.5	10	10
Piping	Refrigerant liquid pipe (Ø)	mm	9.52	9.52	12.7	12.7	12.7
	Refrigerant gas pipe (Ø)	mm	19.05	22.22	25.4	25.4	28.58
	Total pipe length	m	1000	1000	1000	1000	1000
	Max. pipe length (equivalent/actual)	m	260/220	260/220	260/220	260/220	260/220
	Max. drop between I.U. & O.U. (ODU above/below)	m	110/90	110/90	110/90	110/90	110/90
	Max. drop between I.U. & I.U.	m	30	30	30	30	30
Connection Ratio	Connectable indoor unit ratio <sup>(2)</sup>	%	50-130	50-130	50-130	50-130	50-130
	Max. number of indoor units	/	13	16	20	24	27
Working Temp.	Cooling	°C	-5-50	-5-50	-5-50	-5-50	-5-50
	Heating	°C	-23-21	-23-21	-23-21	-23-21	-23-21

HEATING  
COOLING



(1) CARRIER participates in the ECP program for Comfort Air Conditioners (AC) Check ongoing validity of certificate : [www.eurovent-certification.com](http://www.eurovent-certification.com)  
 Cooling capacity tested conditions : Indoor air temperature of 27°C DB / 19°C WB and outdoor air temperature of 35° DB / 24°C WB  
 Heating capacity tested conditions : Indoor air temperature of 20°C DB and outdoor air temperature of 7°DB / 6°C WB

(2) The indoor and outdoor capacity ratio should be limited within 100% when all the indoor units are in operation to ensure the system cooling/heating performance.



## Top Discharge Heat Pump 8-26 HP

Model			38VT018173HQEE	38VT020173HQEE	38VT022173HQEE	38VT024173HQEE	38VT026173HQEE
Capacity <sup>(1)</sup>	Capacity range	HP	18	20	22	24	26
	Cooling	kW	50.4	56.0	61.5	68.0	73.5
	Heating	kW	50.4	56.0	61.5	68.0	73.5
	Heating (Max)	kW	56.5	61.5	69.0	73.0	82.5
Cooling Efficiency <sup>(1)</sup>	EER	W/W	3.23	3.37	3.05	3.00	2.00
	SEER		6.78	6.75	6.54	5.83	4.90
	ηs	%	268	267	259	230	193
	Running current	A	26.3	28.1	34.1	38.3	59.2
Heating Efficiency <sup>(1)</sup>	COP	W/W	3.82	3.82	3.30	3.50	2.80
	SCOP <sup>(1)</sup>	/	4.15	4.2	4.21	4.17	3.5
	ηs	%	163	165	165	164	137
	Running current	A	22.27	24.75	31.49	32.80	45.68
Electrical Parameters	Power supply	Ph/V/Hz	3/380-415/50/60	3/380-415/50/60	3/380-415/50/60	3/380-415/50/60	3/380-415/50/60
	Rated Power input (Cooling)	kW	15.60	16.62	20.16	22.67	36.75
	Rated Power input (Heating)	kW	13.19	14.66	18.64	19.43	26.25
	Max. current	A	36.13	42.37	48.11	49.13	61.91
Dimensions (H/W/D)	External (H/W/D)	mm	1690/1410/750	1690/1410/750	1690/1410/750	1690/1410/750	1690/1410/750
	Shipping (H/W/D)	mm	1838/1515/850	1838/1515/850	1838/1515/850	1838/1515/850	1838/1515/850
Weight	Net/Shipping weight	kg	287/317	370/400	370/400	370/400	370/400
Compressor	Compressor type	/	DC INV. SCROLL	DC INV. SCROLL	DC INV. SCROLL	DC INV. SCROLL	DC INV. SCROLL
	Motor Power	W	8500	5250*2	6500*2	6500*2	7640*2
	Compressor quantity	/	1	2	2	2	2
Fan	Air flow (H)	m <sup>3</sup> /h	17000	17000	18000	18000	19000
Maximum external static pressure		Pa	110	110	110	110	110
Pressure Sound Level	Cooling	dB(A)	61	61	61	62	62
	Heating	dB(A)	61	61	61	62	62
Power Sound Level	Cooling	dB(A)	88	88	90	90	90
	Heating	dB(A)	88	88	90	90	90
Refrigerant	Type	/	R410A	R410A	R410A	R410A	R410A
	Charge	kg	10	10	10	10	10
Piping	Refrigerant liquid pipe (Ø)	mm	15.88	15.88	15.88	15.88	15.88
	Refrigerant gas pipe (Ø)	mm	28.58	28.58	28.58	28.58	28.58
	Total pipe length	m	1000	1000	1000	1000	1000
	Max. pipe length (Equivalent/Actual)	m	260/220	260/220	260/220	260/220	260/220
	Max. drop between I.U. & O.U. (ODU above/below)	m	110/90	110/90	110/90	110/90	110/90
	Max. drop between I.U. & I.U.	m	30	30	30	30	30
Connection Ratio	Connectable indoor unit ratio <sup>(2)</sup>	%	50-130	50-130	50-130	50-130	50-130
	Max. number of indoor units	/	30	33	36	40	43
Working Temp.	Cooling	°C	-5-50	-5-50	-5-50	-5-50	-5-50
	Heating	°C	-23-21	-23-21	-23-21	-23-21	-23-21



(1) CARRIER participates in the ECP program for Comfort Air Conditioners (AC) Check ongoing validity of certificate : [www.eurovent-certification.com](http://www.eurovent-certification.com)  
 Cooling capacity tested conditions : Indoor air temperature of 27°C DB / 19°C WB and outdoor air temperature of 35° DB / 24°C WB  
 Heating capacity tested conditions : Indoor air temperature of 20°C DB and outdoor air temperature of 7°DB / 6°C WB

(2) The indoor and outdoor capacity ratio should be limited within 100% when all the indoor units are in operation to ensure the system cooling/heating performance.



Turn to the experts



# Specifications Top Discharge Heat Pump 28-40 HP

OUTDOOR

Model			38VT028S73HQEE	38VT030S73HQEE	38VT032S73HQEE	38VT034S73HQEE	38VT036S73HQEE	38VT038S73HQEE	38VT040S73HQEE
Combination			38VT014173HQEE 38VT014173HQEE	38VT014173HQEE 38VT016173HQEE	38VT016173HQEE 38VT016173HQEE	38VT016173HQEE 38VT018173HQEE	38VT018173HQEE 38VT018173HQEE	38VT018173HQEE 38VT020173HQEE	38VT020173HQEE 38VT020173HQEE
Capacity	Capacity range	HP	28	30	32	34	36	38	40
	Cooling	kW	80.0	85.0	90.0	95.4	100.8	106.4	112.0
	Heating	kW	80.0	85.0	90.0	95.4	100.8	106.4	112.0
	Heating (Max)	kW	90.0	95.0	100.0	106.5	113.0	118.0	123.0
Cooling Efficiency <sup>(1)</sup>	EER	W/W	3.35	3.38	3.40	3.31	3.23	3.30	3.37
	SEER		6.60	6.36	6.36	6.36	6.78	6.75	6.75
	ηs	%	261	251.4	251.4	251.4	268.2	267	267
	Running current	A	40.3	42.5	44.7	48.7	52.7	54.4	56.1
Heating Efficiency <sup>(1)</sup>	COP	W/W	4.00	4.00	4.00	3.90	3.82	3.82	3.82
	SCOP <sup>(1)</sup>	/	4.12	4.05	4.05	4.05	4.15	4.15	4.2
	ηs	%	161.8	159	159	159	163	163	165
	Running current	A	33.8	35.9	38.0	41.3	44.5	47.0	49.5
Electrical Parameters	Power supply	Ph/V/Hz	3/380-415/50/60	3/380-415/50/60	3/380-415/50/60	3/380-415/50/60	3/380-415/50/60	3/380-415/50/60	3/380-415/50/60
	Rated Power input (Cooling)	kW	23.88	25.18	26.47	28.84	31.21	32.22	33.23
	Rated Power input (Heating)	kW	20.00	21.25	22.50	24.44	26.39	27.85	29.32
	Max. current	A	55.37	60.10	64.83	68.54	72.26	78.50	84.75
Dimensions (H/W/D)	External (H/W/D)	mm	1690/980/750 + 1690/980/750			1690/980/750 + 1690/1410/750	1690/1410/750 + 1690/1410/750		
	Shipping (H/W/D)	mm	1838/1070/850 + 1838/1070/850			1838/1070/850 + 1838/1515/850	1838/1515/850 + 1838/1515/850		
Weight	Net/Shipping weight	kg	488/540	488/540	488/540	531/587	574/634	657/717	740/800
Compressor	Compressor type	/	DC INV. SCROLL	DC INV. SCROLL	DC INV. SCROLL	DC INV. SCROLL	DC INV. SCROLL	DC INV. SCROLL	DC INV. SCROLL
	Motor Power	W	6500+6500	6500+7640	7640+7640	7640+8500	8500+8500	8500+5250*2	5250*2+5250*2
	Compressor quantity	/	2	2	2	2	2	3	4
Fan	Air flow (H)	m <sup>3</sup> /h	27000	27000	27000	30500	34000	34000	34000
Maximum external static pressure		Pa	110	110	110	110	110	110	110
Pressure Sound Level	Cooling	dB(A)	62	63	63	64	64	64	64
	Heating	dB(A)	62	63	63	64	64	64	64
Power Sound Level	Cooling	dB(A)	91	91	91	91	91	91	91
	Heating	dB(A)	91	91	91	91	91	91	91
Refrigerant	Type	/	R410A	R410A	R410A	R410A	R410A	R410A	R410A
	Charge	kg	20	20	20	20	20	20	20
Piping	Refrigerant liquid pipe (Ø)	mm	15.88	19.05	19.05	19.05	19.05	19.05	19.05
	Refrigerant gas pipe (Ø)	mm	28.58	31.8	31.8	31.8	38.1	38.1	38.1
	Total pipe length	m	1000	1000	1000	1000	1000	1000	1000
	Max. pipe length (equivalent/actual)	m	260/220	260/220	260/220	260/220	260/220	260/220	260/220
	Max. drop between I.U. & O.U. (ODU above/below)	m	110/90	110/90	110/90	110/90	110/90	110/90	110/90
Connection Ratio	Connectable indoor unit ratio <sup>(2)</sup>	%	50-130	50-130	50-130	50-130	50-130	50-130	50-130
	Max. number of indoor units	/	47	50	53	56	59	63	64
Working Temp.	Cooling	°C	-5-50 DB	-5-50 DB	-5-50 DB	-5-50 DB	-5-50 DB	-5-50 DB	-5-50 DB
	Heating	°C	-23-21 WB	-23-21 WB	-23-21 WB	-23-21 WB	-23-21 WB	-23-21 WB	-23-21 WB

The indoor and outdoor capacity ratio should be limited within 100% when all the indoor units are in operation to ensure the system cooling/heating performance.

HEATING  
COOLING





## Top Discharge Heat Pump 42-52 HP

Model			38VT042S73HQEE	38VT044S73HQEE	38VT046S73HQEE	38VT048S73HQEE	38VT050S73HQEE	38VT052S73HQEE
Combination			38VT020173HQEE 38VT022173HQEE	38VT022173HQEE 38VT022173HQEE	38VT022173HQEE 38VT024173HQEE	38VT024173HQEE 38VT024173HQEE	38VT024173HQEE 38VT026173HQEE	38VT026173HQEE 38VT026173HQEE
Capacity	Capacity range	HP	42	44	46	48	50	52
	Cooling	kW	117.5	123.0	129.5	136.0	141.5	147.0
	Heating	kW	117.5	123.0	129.5	136.0	141.5	147.0
	Heating (Max)	kW	130.5	138.0	142.0	146.0	155.5	165.0
Cooling Efficiency <sup>(1)</sup>	EER	W/W	3.19	3.05	3.02	3.00	2.38	2.00
	SEER		6.54	6.54	5.83	5.83	4.90	4.90
	ηs	%	258.6	258.6	230.2	230.2	193	193
	Running current	A	62.1	68.1	72.3	76.6	97.5	118.5
Heating Efficiency <sup>(1)</sup>	COP	W/W	3.53	3.30	3.40	3.50	3.10	2.80
	SCOP <sup>(1)</sup>	/	4.2	4.21	4.17	4.17	3.48	3.48
	ηs	%	165	165.4	163.8	163.8	136.2	136.2
	Running current	A	56.2	63.0	64.3	65.6	78.5	91.4
Electrical Parameters	Power supply	Ph/V/Hz	3/380-415/50/60	3/380-415/50/60	3/380-415/50/60	3/380-415/50/60	3/380-415/50/60	3/380-415/50/60
	Rated Power input (Cooling)	kW	36.78	40.32	42.83	45.34	59.42	73.50
	Rated Power input (Heating)	kW	33.30	37.28	38.07	38.86	45.68	52.50
	Max. current	A	90.49	96.23	97.24	98.25	111.04	123.82
Dimensions (H/W/D)	External (H/W/D)	mm	1690/1410/750 + 1690/1410/750					
	Shipping (H/W/D)	mm	1838/1515/850 + 1838/1515/850					
Weight	Net/Shipping weight	kg	740/800	740/800	740/800	740/800	740/800	740/800
Compressor	Compressor type	/	DC INV. SCROLL	DC INV. SCROLL	DC INV. SCROLL	DC INV. SCROLL	DC INV. SCROLL	DC INV. SCROLL
	Motor Power	W	5250*2 + 6500*2	6500*2 + 6500*2	6500*2 + 6500*2	6500*2 + 6500*2	6500*2 + 7640*2	7640*2 + 7640*2
	Compressor quantity	/	4	4	4	4	4	4
Fan	Air flow (H)	m <sup>3</sup> /h	35000	36000	36000	36000	37000	38000
	Maximum external static pressure	Pa	110	110	110	110	110	110
Pressure Sound Level	Cooling	dB(A)	64	64	65	65	65	65
	Heating	dB(A)	64	64	65	65	65	65
Power Sound Level	Cooling	dB(A)	92	93	93	93	93	93
	Heating	dB(A)	92	93	93	93	93	93
Refrigerant	Type	/	R410A	R410A	R410A	R410A	R410A	R410A
	Charge	kg	20	20	20	20	20	20
Piping	Refrigerant liquid pipe (Ø)	mm	19.05	19.05	19.05	19.05	19.05	19.05
	Refrigerant gas pipe (Ø)	mm	38.1	38.1	38.1	38.1	38.1	38.1
	Total pipe length	m	1000	1000	1000	1000	1000	1000
	Max. pipe length (equivalent/actual)	m	260/220	260/220	260/220	260/220	260/220	260/220
	Max. drop between I.U. & O.U. (ODU above / below)	m	110/90	110/90	110/90	110/90	110/90	110/90
	Max. drop between I.U. & I.U.	m	30	30	30	30	30	30
Connection Ratio	Connectable indoor unit ratio <sup>(2)</sup>	%	50-130	50-130	50-130	50-130	50-130	50-130
	Max. number of indoor units	/	64	64	64	64	64	64
Working Temp.	Cooling	°C	-5-50 DB	-5-50 DB	-5-50 DB	-5-50 DB	-5-50 DB	-5-50 DB
	Heating	°C	-23-21 WB	-23-21 WB	-23-21 WB	-23-21 WB	-23-21 WB	-23-21 WB

The indoor and outdoor capacity ratio should be limited within 100% when all the indoor units are in operation to ensure the system cooling/heating performance.



Turn to the experts



# Specifications Top Discharge Heat Pump 54-66 HP

OUTDOOR

Model			38VT054S73HQEE	38VT056S73HQEE	38VT058S73HQEE	38VT060S73HQEE	38VT062S73HQEE	38VT064S73HQEE	38VT066S73HQEE
Combination			38VT018173HQEE 38VT018173HQEE 38VT018173HQEE	38VT018173HQEE 38VT018173HQEE 38VT020173HQEE	38VT018173HQEE 38VT020173HQEE 38VT020173HQEE	38VT020173HQEE 38VT020173HQEE 38VT020173HQEE	38VT022173HQEE 38VT020173HQEE 38VT020173HQEE	38VT022173HQEE 38VT022173HQEE 38VT020173HQEE	38VT022173HQEE 38VT022173HQEE 38VT022173HQEE
Capacity	Capacity range	HP	54	56	58	60	62	64	66
	Cooling	kW	151.2	156.8	162.4	168.0	173.5	179.0	184.5
	Heating	kW	151.2	156.8	162.4	168.0	173.5	179.0	184.5
	Heating (Max)	kW	169.5	174.5	179.5	184.5	192.0	199.5	207.0
Cooling Efficiency <sup>(1)</sup>	EER	W/W	3.23	3.28	3.33	3.37	3.25	3.14	3.05
	SEER		6.78	6.75	6.75	6.75	6.54	6.54	6.54
	ηs	%	268.2	267	267	267	258.6	258.6	258.6
	Running current	A	79.0	80.7	82.4	84.2	90.2	96.2	102.2
Heating Efficiency <sup>(1)</sup>	COP	W/W	3.82	3.82	3.82	3.82	3.62	3.45	3.30
	SCOP <sup>(1)</sup>	/	4.15	4.15	4.15	4.2	4.2	4.2	4.21
	ηs	%	163	163	163	165	165	165	165.4
	Running current	A	66.8	69.3	71.8	74.2	81.0	87.7	94.5
Electrical Parameters	Power supply	Ph/V/Hz	3/380-415/50/60	3/380-415/50/60	3/380-415/50/60	3/380-415/50/60	3/380-415/50/60	3/380-415/50/60	3/380-415/50/60
	Rated Power input (Cooling)	kW	46.81	47.82	48.84	49.85	53.39	56.94	60.48
	Rated Power input (Heating)	kW	39.58	41.05	42.51	43.98	47.96	51.94	55.92
	Max. current	A	108.38	114.63	120.88	127.12	132.86	138.60	144.34
Dimensions (H/W/D)	External (H/W/D)	mm	1690/1410/750 + 1690/1410/750 + 1690/1410/750						
	Shipping (H/W/D)	mm	1838/1515/850 + 1838/1515/850 + 1838/1515/850						
Weight	Net/Shipping weight	kg	861/951	944/1034	1027/1117	1110/1200	1110/1200	1110/1200	1110/1200
Compressor	Compressor type	/	DC INV. SCROLL	DC INV. SCROLL	DC INV. SCROLL	DC INV. SCROLL	DC INV. SCROLL	DC INV. SCROLL	DC INV. SCROLL
	Motor Power	W	8500 + 8500 + 8500	8500 + 8500 + 5250*2	8500 + 5250*2 + 5250*2	5250*2 + 5250*2 + 5250*2	5250*2 + 5250*2 + 6500*2	5250*2 + 6500*2 + 6500*2	6500*2 + 6500*2 + 6500*2
	Compressor quantity	/	3	4	5	6	6	6	6
Fan	Air flow (H)	m <sup>3</sup> /h	51000	51000	51000	51000	52000	53000	54000
Maximum external static pressure		Pa	110	110	110	110	110	110	110
Pressure Sound Level	Cooling	dB(A)	66	66	66	66	66	66	66
	Heating	dB(A)	66	66	66	66	66	66	66
Power Sound Level	Cooling	dB(A)	93	93	93	93	94	94	95
	Heating	dB(A)	93	93	93	93	94	94	95
Refrigerant	Type	/	R410A	R410A	R410A	R410A	R410A	R410A	R410A
	Charge	kg	30	30	30	30	30	30	30
Piping	Refrigerant liquid pipe (Ø)	mm	19.05	19.05	19.05	19.05	19.05	19.05	19.05
	Refrigerant gas pipe (Ø)	mm	38.1	38.1	41.3	41.3	41.3	41.3	41.3
	Total pipe length	m	1000	1000	1000	1000	1000	1000	1000
	Max. pipe length (equivalent/actual)	m	260/220	260/220	260/220	260/220	260/220	260/220	260/220
	Max. drop between I.U. & O.U. (ODU above / below)	m	110/90	110/90	110/90	110/90	110/90	110/90	110/90
Connection Ratio	Connectable indoor unit ratio <sup>(2)</sup>	%	50-130	50-130	50-130	50-130	50-130	50-130	50-130
	Max. number of indoor units	/	64	64	64	64	64	64	64
Working Temp.	Cooling	°C	-5-50 DB	-5-50 DB	-5-50 DB	-5-50 DB	-5-50 DB	-5-50 DB	-5-50 DB
	Heating	°C	-23-21 WB	-23-21 WB	-23-21 WB	-23-21 WB	-23-21 WB	-23-21 WB	-23-21 WB

The indoor and outdoor capacity ratio should be limited within 100% when all the indoor units are in operation to ensure the system cooling/heating performance.

HEATING  
COOLING



## Top Discharge Heat Pump 68-78 HP

Model			38VT068S73HQEE	38VT070S73HQEE	38VT072S73HQEE	38VT074S73HQEE	38VT076S73HQEE	38VT078S73HQEE
Combination			38VT022173HQEE 38VT022173HQEE 38VT024173HQEE	38VT022173HQEE 38VT024173HQEE 38VT024173HQEE	38VT024173HQEE 38VT024173HQEE 38VT024173HQEE	38VT026173HQEE 38VT024173HQEE 38VT024173HQEE	38VT026173HQEE 38VT026173HQEE 38VT024173HQEE	38VT026173HQEE 38VT026173HQEE 38VT026173HQEE
Capacity	Capacity range	HP	68	70	72	74	76	78
	Cooling	kW	191.0	197.5	204.0	209.5	215.0	220.5
	Heating	kW	191.0	197.5	204.0	209.5	215.0	220.5
	Heating (Max)	kW	211.0	215.0	219.0	228.5	238.0	247.5
Cooling Efficiency <sup>(1)</sup>	EER	W/W	3.03	3.02	3.00	2.55	2.24	2.00
	SEER		5.83	5.83	5.83	4.90	4.90	4.90
	ηs	%	230.2	230.2	230.2	193	193	193
	Running current	A	106.4	110.6	114.8	135.8	156.8	177.7
Heating Efficiency <sup>(1)</sup>	COP	W/W	3.37	3.43	3.50	3.22	2.99	2.80
	SCOP <sup>(1)</sup>	/	4.17	4.17	4.17	3.48	3.48	3.48
	ηs	%	163.8	163.8	163.8	136.2	136.2	136.2
	Running current	A	95.8	97.1	98.4	111.3	124.2	137.0
Electrical Parameters	Power supply	Ph/V/Hz	3/380-415/50/60	3/380-415/50/60	3/380-415/50/60	3/380-415/50/60	3/380-415/50/60	3/380-415/50/60
	Rated Power input (Cooling)	kW	62.99	65.50	68.01	82.09	96.17	110.25
	Rated Power input (Heating)	kW	56.71	57.50	58.29	65.11	71.93	78.75
	Max. current	A	145.35	146.37	147.38	160.16	172.95	185.73
Dimensions (H/W/D)	External (H/W/D)	mm	1690/1410/750 + 1690/1410/750 + 1690/1410/750					
	Shipping (H/W/D)	mm	1838/1515/850 + 1838/1515/850 + 1838/1515/850					
Weight	Net/Shipping weight	kg	1110/1200	1110/1200	1110/1200	1110/1200	1110/1200	1110/1200
Compressor	Compressor type	/	DC INV. SCROLL	DC INV. SCROLL	DC INV. SCROLL	DC INV. SCROLL	DC INV. SCROLL	DC INV. SCROLL
	Motor Power	W	6500*2 + 6500*2 + 6500*2	6500*2 + 6500*2 + 6500*2	6500*2 + 6500*2 + 6500*2	6500*2 + 6500*2 + 7640*2	6500*2 + 7640*2 + 7640*2	7640*2 + 7640*2 + 7640*2
	Compressor quantity	/	6	6	6	6	6	6
Fan	Air flow (H)	m <sup>3</sup> /h	54000	54000	54000	55000	56000	57000
Maximum external static pressure		Pa	110	110	110	110	110	110
Pressure Sound Level	Cooling	dB(A)	66	66	67	67	67	67
	Heating	dB(A)	66	66	67	67	67	67
Power Sound Level	Cooling	dB(A)	95	95	95	95	95	95
	Heating	dB(A)	95	95	95	95	95	95
Refrigerant	Type	/	R410A	R410A	R410A	R410A	R410A	R410A
	Charge	kg	30	30	30	30	30	30
Piping	Refrigerant liquid pipe (Ø)	mm	22.2	22.2	22.2	22.2	22.2	22.2
	Refrigerant gas pipe (Ø)	mm	44.5	44.5	44.5	44.5	44.5	44.5
	Total pipe length	m	1000	1000	1000	1000	1000	1000
	Max. pipe length (equivalent/actual)	m	260/220	260/220	260/220	260/220	260/220	260/220
	Max. drop between I.U. & O.U. (ODU above / below)	m	110/90	110/90	110/90	110/90	110/90	110/90
Connection Ratio	Max drop between I.U. & I.U.	m	30	30	30	30	30	30
	Connectable indoor unit ratio <sup>(2)</sup>	%	50-130	50-130	50-130	50-130	50-130	50-130
Working Temp.	Max. number of indoor units	/	64	64	64	64	64	64
	Cooling	°C	-5-50 DB	-5-50 DB	-5-50 DB	-5-50 DB	-5-50 DB	-5-50 DB
	Heating	°C	-23-21 WB	-23-21 WB	-23-21 WB	-23-21 WB	-23-21 WB	-23-21 WB

The indoor and outdoor capacity ratio should be limited within 100% when all the indoor units are in operation to ensure the system cooling/heating performance.



Turn to the experts



# Specifications Top Discharge Heat Pump 80-92 HP

OUTDOOR

Model			38VT080S73HQEE	38VT082S73HQEE	38VT084S73HQEE	38VT086S73HQEE	38VT088S73HQEE	38VT090S73HQEE	38VT092S73HQEE
Combination			38VT020173HQEE 38VT020173HQEE 38VT020173HQEE 38VT020173HQEE	38VT020173HQEE 38VT020173HQEE 38VT020173HQEE 38VT022173HQEE	38VT020173HQEE 38VT020173HQEE 38VT020173HQEE 38VT022173HQEE	38VT020173HQEE 38VT022173HQEE 38VT022173HQEE 38VT022173HQEE	38VT022173HQEE 38VT022173HQEE 38VT022173HQEE 38VT022173HQEE	38VT024173HQEE 38VT022173HQEE 38VT022173HQEE 38VT022173HQEE	38VT024173HQEE 38VT024173HQEE 38VT022173HQEE 38VT022173HQEE
Capacity	Capacity range	HP	80	82	84	86	88	90	92
	Cooling	kW	224.0	229.5	235.0	240.5	246.0	252.5	259.0
	Heating	kW	224.0	229.5	235.0	240.5	246.0	252.5	259.0
	Heating (Max)	kW	246.0	253.5	261.0	268.5	276.0	280.0	284.0
Cooling Efficiency <sup>(1)</sup>	EER	W/W	3.37	3.28	3.19	3.12	3.05	3.04	3.02
	SEER		6.75	6.54	6.54	6.54	6.54	5.83	5.83
	ηs	%	267	258.6	258.6	258.6	258.6	230.2	230.2
	Running current	A	112.2	118.2	124.2	130.2	136.2	140.5	144.7
Heating Efficiency <sup>(1)</sup>	COP	W/W	3.82	3.67	3.53	3.41	3.30	3.35	3.40
	SCOP <sup>(1)</sup>	/	4.2	4.2	4.2	4.2	4.21	4.17	4.17
	ηs	%	165	165	165	165	165.4	163.8	163.8
	Running current	A	99.0	105.7	112.5	119.2	126.0	127.3	128.6
Electrical Parameters	Power supply	Ph/V/Hz	3/380-415/50/60	3/380-415/50/60	3/380-415/50/60	3/380-415/50/60	3/380-415/50/60	3/380-415/50/60	3/380-415/50/60
	Rated Power input (Cooling)	kW	66.47	70.01	73.55	77.10	80.64	83.15	85.66
	Rated Power input (Heating)	kW	58.64	62.62	66.60	70.58	74.56	75.35	76.14
	Max. current	A	169.50	175.24	180.98	186.72	192.46	193.47	194.48
Dimensions (H/W/D)	External (H/W/D)	mm	1690/1410/750+1690/1410/750+1690/1410/750+1690/1410/750						
	Shipping (H/W/D)	mm	1838/1515/850+1838/1515/850+1838/1515/850+1838/1515/850						
Weight	Net/Shipping weight	kg	1480/1600	1480/1600	1480/1600	1480/1600	1480/1600	1480/1600	1480/1600
Compressor	Compressor type	/	DC INV. SCROLL	DC INV. SCROLL	DC INV. SCROLL	DC INV. SCROLL	DC INV. SCROLL	DC INV. SCROLL	DC INV. SCROLL
	Motor Power	W	5250*2 + 5250*2 + 5250*2	5250*2 + 5250*2 + 5250*2 + 6500*2	5250*2 + 5250*2 + 6500*2 + 6500*2	5250*2 + 6500*2 + 6500*2 + 6500*2	6500*2 + 6500*2 + 6500*2 + 6500*2	6500*2 + 6500*2 + 6500*2 + 6500*2	6500*2 + 6500*2 + 6500*2 + 6500*2
	Compressor quantity	/	8	8	8	8	8	8	8
Fan	Air flow (H)	m <sup>3</sup> /h	68000	69000	70000	71000	72000	72000	72000
Maximum external static pressure		Pa	110	110	110	110	110	110	110
Pressure Sound Level	Cooling	dB(A)	67	67	67	67	67	67	68
	Heating	dB(A)	67	67	67	67	67	67	68
Power Sound Level	Cooling	dB(A)	94	95	95	96	96	96	96
	Heating	dB(A)	94	95	95	96	96	96	96
Refrigerant	Type	/	R410A	R410A	R410A	R410A	R410A	R410A	R410A
	Charge	kg	40	40	40	40	40	40	40
Piping	Refrigerant liquid pipe (Ø)	mm	22.2	22.2	22.2	25.4	25.4	25.4	25.4
	Refrigerant gas pipe (Ø)	mm	44.5	44.5	44.5	50.8	50.8	50.8	50.8
	Total pipe length	m	1000	1000	1000	1000	1000	1000	1000
	Max. pipe length (equivalent/actual)	m	260/220	260/220	260/220	260/220	260/220	260/220	260/220
	Max. drop between I.U. & O.U. (ODU above / below)	m	110/90	110/90	110/90	110/90	110/90	110/90	110/90
	Max drop between I.U. & I.U.	m	30	30	30	30	30	30	30
Connection Ratio	Connectable indoor unit ratio <sup>(2)</sup>	%	50-130	50-130	50-130	50-130	50-130	50-130	50-130
	Max. number of indoor units	/	64	64	64	64	64	64	64
Working Temp.	Cooling	°C	-5-50 DB	-5-50 DB	-5-50 DB	-5-50 DB	-5-50 DB	-5-50 DB	-5-50 DB
	Heating	°C	-23-21 WB	-23-21 WB	-23-21 WB	-23-21 WB	-23-21 WB	-23-21 WB	-23-21 WB

The indoor and outdoor capacity ratio should be limited within 100% when all the indoor units are in operation to ensure the system cooling/heating performance.





## Top Discharge Heat Pump 94-104 HP

Model			38VT068S73HQEE	38VT070S73HQEE	38VT072S73HQEE	38VT074S73HQEE	38VT076S73HQEE	38VT078S73HQEE
Combination			38VT024173HQEE 38VT024173HQEE 38VT024173HQEE 38VT022173HQEE	38VT024173HQEE 38VT024173HQEE 38VT024173HQEE 38VT024173HQEE	38VT026173HQEE 38VT024173HQEE 38VT024173HQEE 38VT024173HQEE	38VT026173HQEE 38VT026173HQEE 38VT024173HQEE 38VT024173HQEE	38VT026173HQEE 38VT026173HQEE 38VT026173HQEE 38VT024173HQEE	38VT026173HQEE 38VT026173HQEE 38VT026173HQEE 38VT026173HQEE
Capacity	Capacity range	HP	94	96	98	100	102	104
	Cooling	kW	265.5	272.0	277.5	283.0	288.5	294.0
	Heating	kW	265.5	272.0	277.5	283.0	288.5	294.0
	Heating (Max)	kW	288.0	292.0	301.5	311.0	320.5	330.0
Cooling Efficiency <sup>(1)</sup>	EER	W/W	3.01	3.00	2.65	2.38	2.17	2.00
	SEER		5.83	5.83	4.90	4.90	4.90	4.90
	ηs	%	230.2	230.2	193	193	193	193
	Running current	A	148.9	153.1	174.1	195.0	216.0	237.0
Heating Efficiency <sup>(1)</sup>	COP	W/W	3.45	3.50	3.28	3.10	2.94	2.80
	SCOP <sup>(1)</sup>	/	4.17	4.17	3.48	3.48	3.48	3.48
	ηs	%	163.8	163.8	136.2	136.2	136.2	136.2
	Running current	A	129.9	131.2	144.1	157.0	169.8	182.7
Electrical Parameters	Power supply	Ph/V/Hz	3/380-415/50/60	3/380-415/50/60	3/380-415/50/60	3/380-415/50/60	3/380-415/50/60	3/380-415/50/60
	Rated Power input (Cooling)	kW	88.17	90.68	104.76	118.84	132.92	147.00
	Rated Power input (Heating)	kW	76.93	77.71	84.54	91.36	98.18	105.00
	Max. current	A	195.49	196.51	209.29	222.07	234.86	247.64
Dimensions (H/W/D)	External (H/W/D)	mm	1690/1410/750+1690/1410/750+1690/1410/750+1690/1410/750					
	Shipping (H/W/D)	mm	1838/1515/850+1838/1515/850+1838/1515/850+1838/1515/850					
Weight	Net/Shipping weight	kg	1480/1600	1480/1600	1480/1600	1480/1600	1480/1600	1480/1600
Compressor	Compressor type	/	DC INV. SCROLL	DC INV. SCROLL	DC INV. SCROLL	DC INV. SCROLL	DC INV. SCROLL	DC INV. SCROLL
	Motor Power	W	6500*2 + 6500*2 + 6500*2	6500*2 + 6500*2 + 6500*2	6500*2 + 6500*2 + 6500*2	6500*2 + 6500*2 + 7640*2	6500*2 + 7640*2 + 7640*2	7640*2 + 7640*2 + 7640*2
	Compressor quantity	/	8	8	8	8	8	8
Fan	Air flow (H)	m <sup>3</sup> /h	72000	72000	73000	74000	75000	76000
Maximum external static pressure		Pa	110	110	110	110	110	110
Pressure Sound Level	Cooling	dB(A)	68	67	67	68	68	68
	Heating	dB(A)	68	67	67	68	68	68
Power Sound Level	Cooling	dB(A)	96	96	96	96	96	96
	Heating	dB(A)	96	96	96	96	96	96
Refrigerant	Type	/	R410A	R410A	R410A	R410A	R410A	R410A
	Charge	kg	40	40	40	40	40	40
Piping	Refrigerant liquid pipe (Ø)	mm	25.4	25.4	25.4	25.4	25.4	25.4
	Refrigerant gas pipe (Ø)	mm	50.8	50.8	54.1	54.1	54.1	54.1
	Total pipe length	m	1000	1000	1000	1000	1000	1000
	Max. pipe length (equivalent/actual)	m	260/220	260/220	260/220	260/220	260/220	260/220
	Max. drop between I.U. & O.U. (ODU above / below)	m	110/90	110/90	110/90	110/90	110/90	110/90
	Max. drop between I.U. & I.U.	m	30	30	30	30	30	30
Connection Ratio	Connectable indoor unit ratio <sup>(2)</sup>	%	50-130	50-130	50-130	50-130	50-130	50-130
	Max. number of indoor units	/	64	64	64	64	64	64
Working Temp.	Cooling	°C	-5-50 DB	-5-50 DB	-5-50 DB	-5-50 DB	-5-50 DB	-5-50 DB
	Heating	°C	-23-21 WB	-23-21 WB	-23-21 WB	-23-21 WB	-23-21 WB	-23-21 WB

The indoor and outdoor capacity ratio should be limited within 100% when all the indoor units are in operation to ensure the system cooling/heating performance.



**Dimensions (for all Top Discharge units)**

Single Fan Heat Pump (8-16HP)  
Single Fan Heat Recovery (8-14HP)

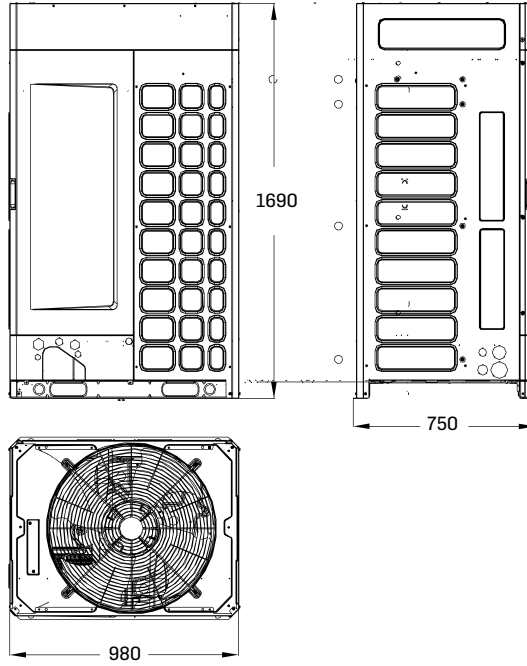

Dual Fan Heat Pump (18-26HP)  
Dual Fan Heat Recovery (16-22HP)

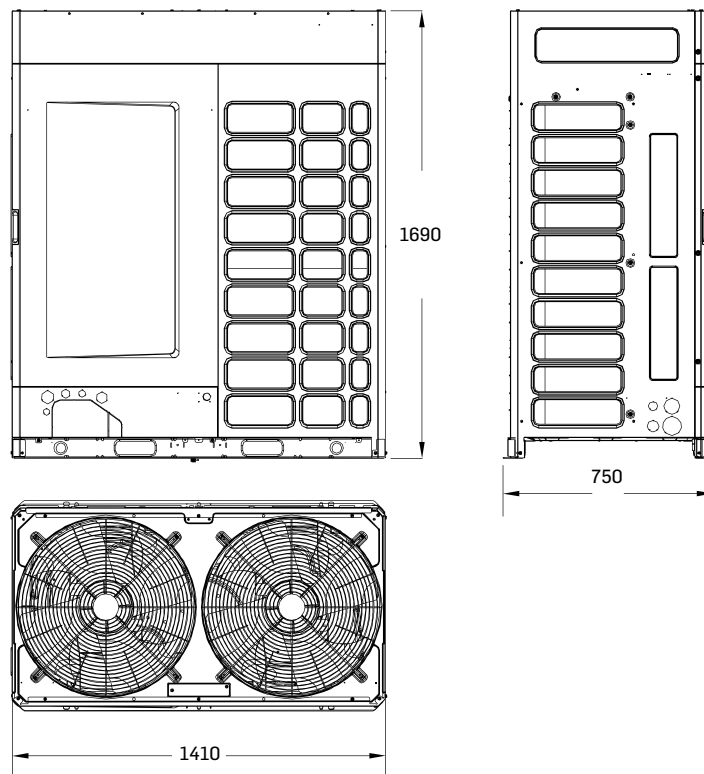

OUTDOOR



### Combination Installation Dimensions

There should be no obstacles within 2000 mm above the outdoor unit.

Obstacles around the outdoor unit should be less than 900 mm to the bottom of unit.

When multiple modules are installed, the outdoor unit should be ranked according to capacity, with the larger capacity closer to the main pipe.

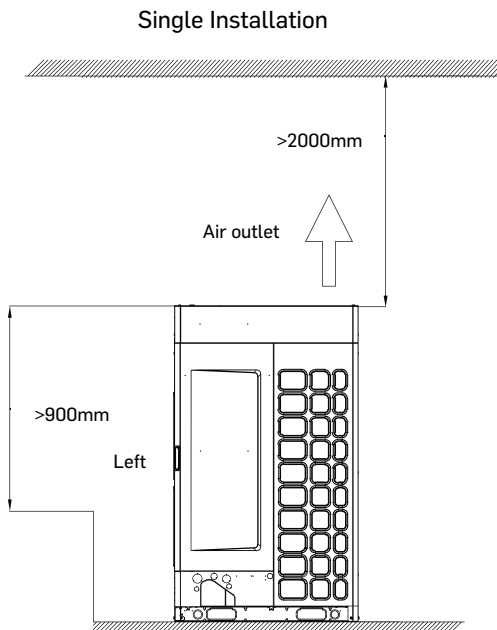

### Single Fan Top Discharge

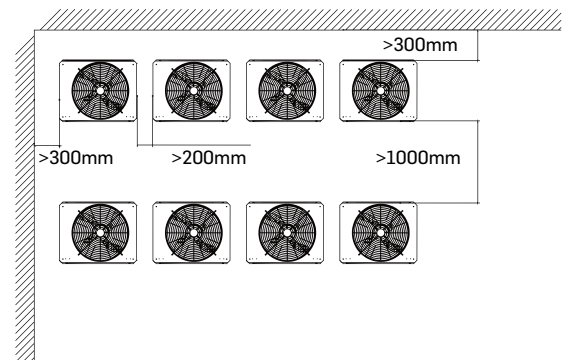
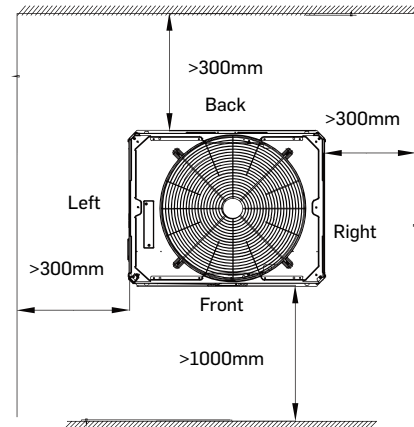

### Combination Installation

Unit can be installed facing the same or opposite direction

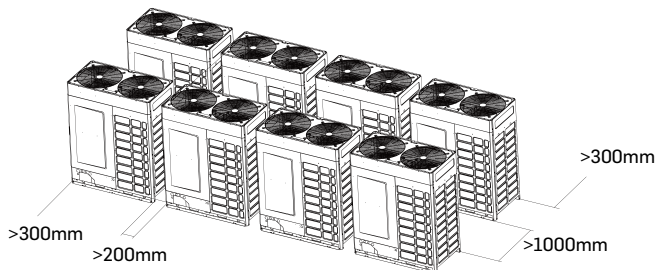

### Wall Higher Than the Outdoor Condensers

Place with air inlet hole

#### Notes:

- Fan speed  $V_s$  at air inlet is 1.5 m/s or below.
- Air outlet height  $HD = H - h$  and below 1 m.

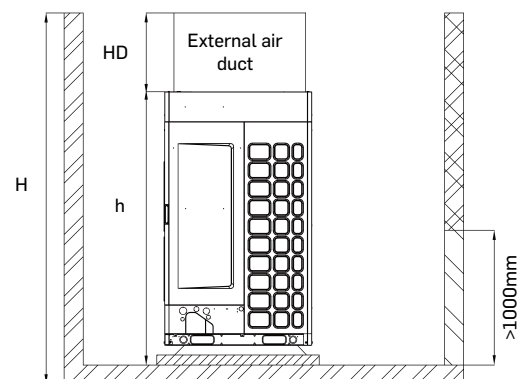



### Piping rules

Permissible pipe length and height difference

OUTDOOR

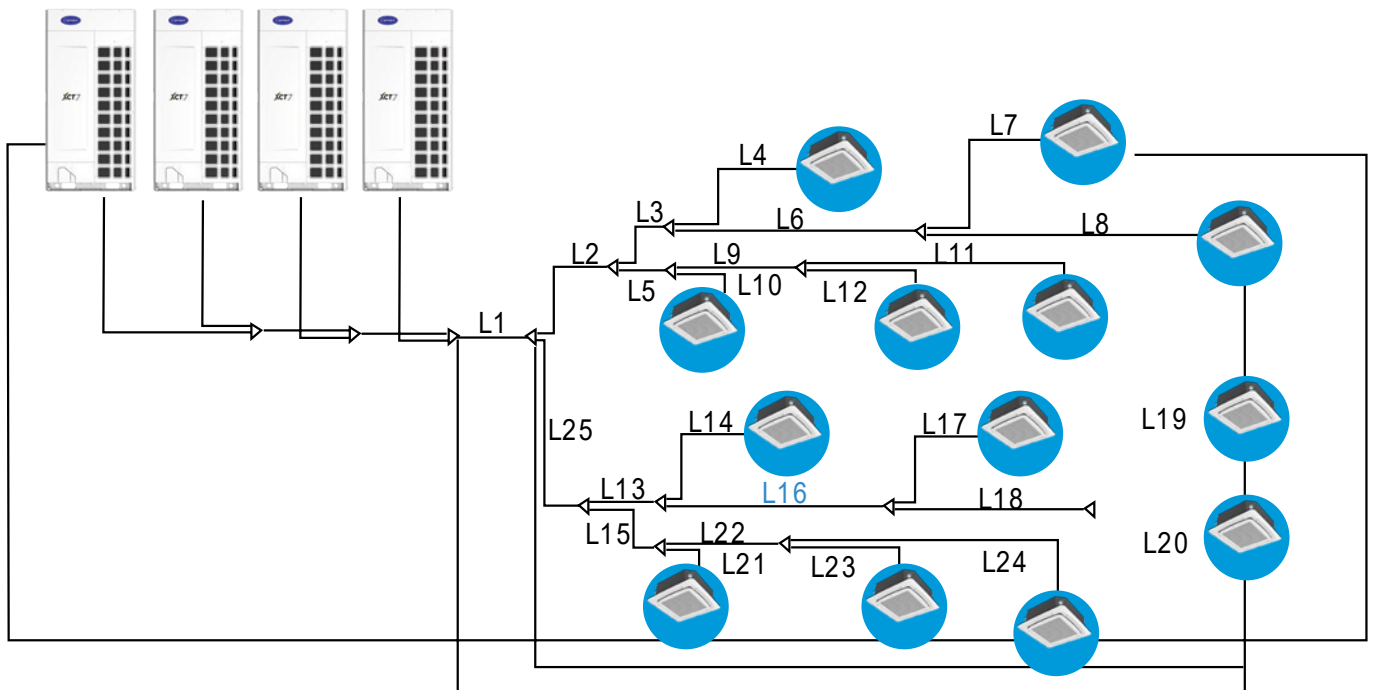

### Piping Limitations

If the height drop between outdoor(below) and indoor units(above) is bigger than 40m and smaller than 110m, or the height drop between outdoor(above) and indoor units(below) bigger than 50m and smaller than 90m:

- 1) The system performance will be influenced if more than 100% indoor units operate at the same time.
- 2) The pipe size should be enlarged by one size.
- 3) The outdoor dip switch should be changed to long pipe installation method.
- 4) If pipe length is bigger than 500m -single way pipe length, add 0.3L compressor oil per 100m.

**Note:**

- 1) If the height drop between indoor and outdoor units is more than 70 m and less than 500 m of the total piping length, please check with Tech. dept. for reference.
- 2) For more details regarding top discharge systems and side discharge systems, please refer to the corresponding technical manual.





Piping Guidelines		Max. length	Details
Single way total pipe length (is equal to total liquid pipe length)		1100m	L1+L2+L3+L4+L5+L6+L7+L8+L9 +L10+L11+L12+L13+L14+L15+... ..+L24
Single way max. pipe length (max. length between outdoor & indoor units) actual length /equivalent length		220m/260m	L1+ L2+L3+ L6+ L8
Main pipe actual length (length between outdoor unit with first branch pipe)		130m	L1
Pipe length after first branch pipe (length between first branch & farthest indoor unit)		90	L2+L3+L6+L8
The distance between the nearest indoor unit and the farthest indoor unit		40	L8+L6+L3-L5-L10
Pipe length among outdoor units (length between first gather pipe & farthest outdoor unit)		10m	La+Le+Lf
Height difference between indoor units		30m	h2
Height difference between outdoor units		5m	h1
Height difference between IDU & ODU	IDU below ODU (between highest outdoor unit & lowest indoor unit)	90m*	H1
	IDU below ODU (between lowest outdoor unit & highest indoor unit)	110m*	H2
The distance between the indoor unit and the nearest branch pipe		40	/

OUTDOOR



Turn to the experts



# TOP DISCHARGE HEAT RECOVERY

OUTDOOR





# System Introduction



## What are Heat Recovery VRF Units?

For the heat pump series, the units within one system can only work in the same mode. Carrier heat recovery series, due to heat recovery pipeline design of outdoor unit and the new valve box, can now achieve cooling and heating simultaneously in one system. In addition, multiple types of indoor units are provided to meet various project demands.

### 2-pipe system: Top Discharge Heat Pump

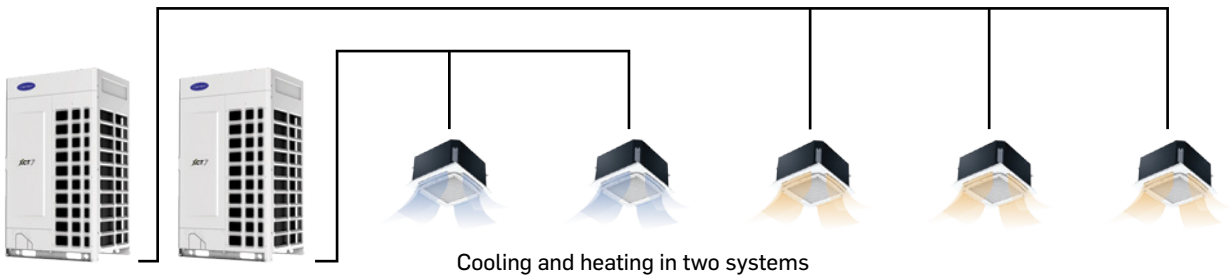

### 3-pipe system: Top Discharge Heat Recovery

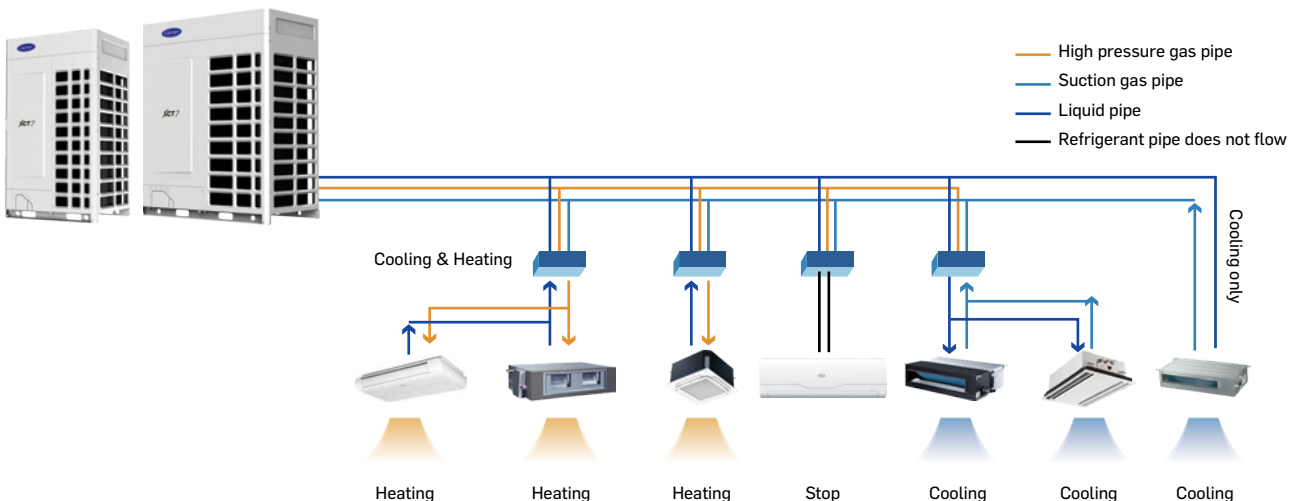
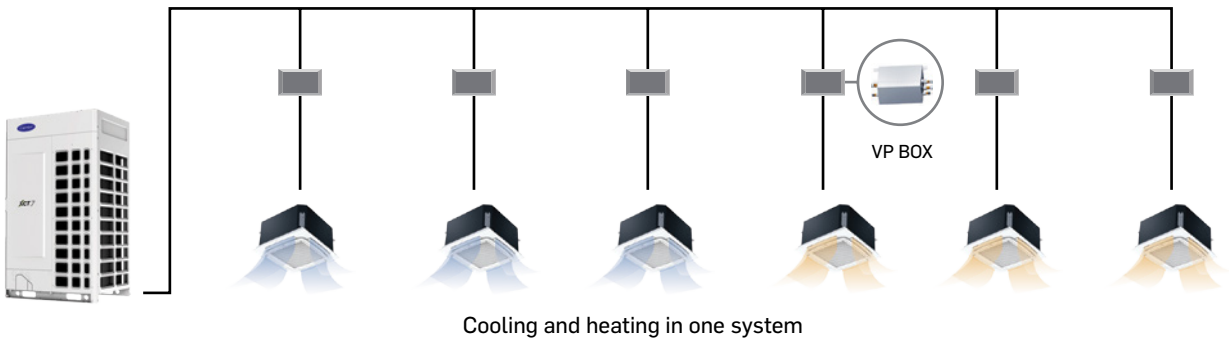

OUTDOOR



# Specifications Top Discharge Heat Recovery 8-22 HP

OUTDOOR

Model			38VT008173RQEE	38VT010173RQEE	38VT012173RQEE	38VT014173RQEE
Capacity <sup>(1)</sup>	Capacity range	HP	8	10	12	14
	Cooling	kW	22.4	28.0	33.5	40.0
	Heating	kW	22.4	28.0	33.5	40.0
	Heating (Max)	kW	25.0	31.5	37.5	45.0
Cooling Efficiency <sup>(1)</sup>	EER	W/W	3.84	3.65	3.37	3.25
	SEER		6.12	6.68	6.46	6.37
	ηs	%	242	264	255	252
	Running current	A	9.6	12.7	16.4	20.3
Heating Efficiency <sup>(1)</sup>	COP	W/W	4.16	4.20	3.82	3.80
	SCOP <sup>(1)</sup>	/	3.82	3.94	3.99	3.86
	ηs	%	150	155	157	151
	Running current	A	8.9	11.0	14.5	17.4
Electrical Parameters	Power supply	Ph/V/Hz	3/380-415/50/60	3/380-415/50/60	3/380-415/50/60	3/380-415/50/60
	Rated Power input (Cooling)	kW	5.83	7.67	9.94	12.31
	Rated Power input (Heating)	kW	5.38	6.67	8.77	10.53
	Max. current	A	21.14	22.79	30.06	31.71
Dimensions (H/W/D)	External (H/W/D)	mm	1690/980/750	1690/980/750	1690/980/750	1690/980/750
	Shipping (H/W/D)	mm	1838/1070/850	1838/1070/850	1838/1070/850	1838/1070/850
Weight	Net/Shipping weight	kg	246/271	246/271	257/282	257/282
Compressor	Compressor type	/	DC INV. SCROLL	DC INV. SCROLL	DC INV. SCROLL	DC INV. SCROLL
	Motor Power	W	6500	6500	7640	7640
	Compressor quantity	/	1	1	1	1
Fan	Air flow (H)	m³/h	12000	12000	13500	13500
Maximum external static pressure		Pa	110	110	110	110
Pressure Sound Level	Cooling	dB(A)	57	58	60	61
	Heating	dB(A)	57	58	60	61
Power Sound Level	Cooling	dB(A)	81	82	88	88
	Heating	dB(A)	81	82	88	88
Refrigerant	Type	/	R410A	R410A	R410A	R410A
	Charge	kg	10	10	10	10
Piping	Refrigerant liquid pipe (Ø)	mm	9.52	9.52	12.7	12.7
	Refrigerant gas pipe (Ø)	mm	19.05	22.22	25.4	25.4
	Refrigerant high gas pipe	mm	19.05	19.05	22.22	22.22
	Total pipe length	m	1000	1000	1000	1000
	Max. pipe length (equivalent/actual)	m	260/220	260/220	260/220	260/220
	Max. drop between I.U. & O.U. (ODU above/below)	m	110/90	110/90	110/90	110/90
Connection Ratio	Max. drop between I.U. & I.U.	m	30	30	30	30
	Connectable indoor unit ratio <sup>(2)</sup>	%	50-130	50-130	50-130	50-130
Working Temp.	Max. number of indoor units	/	13	16	20	24
	Cooling	°C	-5-50	-5-50	-5-50	-5-50
	Heating	°C	-23-21	-23-21	-23-21	-23-21

HEATING  
COOLING



(1) CARRIER participates in the ECP program for Comfort Air Conditioners (AC) Check ongoing validity of certificate : [www.eurovent-certification.com](http://www.eurovent-certification.com)  
 Cooling capacity tested conditions : Indoor air temperature of 27°C DB / 19°C WB and outdoor air temperature of 35° DB / 24°C WB  
 Heating capacity tested conditions : Indoor air temperature of 20°C DB and outdoor air temperature of 7°DB / 6°C WB

(2) The indoor and outdoor capacity ratio should be limited within 100% when all the indoor units are in operation to ensure the system cooling/heating performance.



## Top Discharge Heat Recovery 8-22 HP

Model			38VT016173RQEE	38VT018173RQEE	38VT020173RQEE	38VT022173RQEE
Capacity <sup>(1)</sup>	Capacity range	HP	16	18	20	22
	Cooling	kW	45.0	50.0	56.0	60.0
	Heating	kW	45.0	50.0	56.0	60.0
	Heating (Max)	kW	50.0	56.0	61.5	69.0
Cooling Efficiency <sup>(1)</sup>	EER	W/W	3.23	3.10	3.25	3.00
	SEER		6.86	6.48	5.90	5.63
	ηs	%	271	256	233	222
	Running current	A	23.0	26.6	28.5	33.0
Heating Efficiency <sup>(1)</sup>	COP	W/W	3.95	3.65	3.55	3.35
	SCOP <sup>(1)</sup>	/	4.21	3.99	3.93	3.5
	ηs	%	165	157	154	137
	Running current	A	18.8	22.6	26.1	29.6
Electrical Parameters	Power supply	Ph/V/Hz	3/380-415/50/60	3/380-415/50/60	3/380-415/50/60	3/380-415/50/60
	Rated Power input (Cooling)	kW	13.93	16.13	17.23	20.00
	Rated Power input (Heating)	kW	11.39	13.70	15.77	17.91
	Max. current	A	41.45	47.07	52.85	54.50
Dimensions (H/W/D)	External (H/W/D)	mm	1690/1410/750	1690/1410/750	1690/1410/750	1690/1410/750
	Shipping (H/W/D)	mm	1838/1515/850	1838/1515/850	1838/1515/850	1838/1515/850
Weight	Net/Shipping weight	kg	366/395	366/395	375/404	375/404
Compressor	Compressor type	/	DC INV. SCROLL	DC INV. SCROLL	DC INV. SCROLL	DC INV. SCROLL
	Motor Power	W	10500	10500	15280	15280
	Compressor quantity	/	2	2	2	2
Fan	Air flow (H)	m <sup>3</sup> /h	17000	17000	19000	19000
Maximum external static pressure		Pa	110	110	110	110
Pressure Sound Level	Cooling	dB(A)	62	63	63	64
	Heating	dB(A)	62	63	63	64
Power Sound Level	Cooling	dB(A)	88	88	88	90
	Heating	dB(A)	88	88	88	90
Refrigerant	Type	/	R410A	R410A	R410A	R410A
	Charge	kg	10	10	10	10
Piping	Refrigerant liquid pipe (Ø)	mm	12.7	15.88	15.88	15.88
	Refrigerant gas pipe (Ø)	mm	28.58	28.58	28.58	28.58
	Refrigerant high gas pipe	mm	25.4	25.4	25.4	25.4
	Total pipe length	m	1000	1000	1000	1000
	Max. pipe length (equivalent/actual)	m	260/220	260/220	260/220	260/220
	Max. drop between I.U. & O.U. (ODU above/below)	m	110/90	110/90	110/90	110/90
Max. drop between I.U. & I.U.		m	30	30	30	30
Connection Ratio	Connectable indoor unit ratio <sup>(2)</sup>	%	50-130	50-130	50-130	50-130
	Max. number of indoor units	/	27	30	33	36
Working Temp.	Cooling	°C	-5-50	-5-50	-5-50	-5-50
	Heating	°C	-23-21	-23-21	-23-21	-23-21



(1) CARRIER participates in the ECP program for Comfort Air Conditioners (AC) Check ongoing validity of certificate : [www.eurovent-certification.com](http://www.eurovent-certification.com)  
 Cooling capacity tested conditions : Indoor air temperature of 27°C DB / 19°C WB and outdoor air temperature of 35° DB / 24°C WB  
 Heating capacity tested conditions : Indoor air temperature of 20°C DB and outdoor air temperature of 7°DB / 6°C WB

(2) The indoor and outdoor capacity ratio should be limited within 100% when all the indoor units are in operation to ensure the system cooling/heating performance.



Turn to the experts



# Specifications Top Discharge Heat Recovery 24-34 HP

OUTDOOR

Model			38VT024S73RQEE	38VT026S73RQEE	38VT028S73RQEE	38VT030S73RQEE	38VT032S73RQEE	38VT034S73RQEE
Combination			38VT012173RQEE 38VT012173RQEE	38VT012173RQEE 38VT014173RQEE	38VT014173RQEE 38VT014173RQEE	38VT014173RQEE 38VT016173RQEE	38VT016173RQEE 38VT016173RQEE	38VT016173RQEE 38VT018173RQEE
Capacity	Capacity range	HP	24	26	28	30	32	34
	Cooling	kW	67.0	73.5	80.0	85.0	90.0	95.0
	Heating	kW	67.0	73.5	80.0	85.0	90.0	95.0
	Heating (Max)	kW	75.0	82.5	90.0	95.0	100.0	106.0
Cooling Efficiency <sup>(1)</sup>	EER	W/W	3.37	3.30	3.25	3.24	3.23	3.16
	SEER		6.46	6.37	6.37	6.37	6.86	6.48
	ηs	%	255.40	251.80	251.80	251.80	271.40	256.20
	Running current	A	32.8	36.7	40.7	43.3	46.0	49.6
Heating Efficiency <sup>(1)</sup>	COP	W/W	3.82	3.81	3.80	3.88	3.95	3.79
	SCOP <sup>(1)</sup>	/	3.99	3.86	3.86	3.86	4.21	3.99
	ηs	%	156.60	151.40	151.40	151.40	165.40	156.60
	Running current	A	29.0	31.9	34.8	36.2	37.6	41.4
Electrical Parameters	Power supply	Ph/V/Hz	3/380-415/50/60	3/380-415/50/60	3/380-415/50/60	3/380-415/50/60	3/380-415/50/60	3/380-415/50/60
	Rated Power input (Cooling)	kW	19.88	22.25	24.62	26.24	27.86	30.06
	Rated Power input (Heating)	kW	17.54	19.30	21.05	21.92	22.78	25.09
	Max. current	A	60.11	61.77	63.42	73.16	82.91	88.52
Dimensions (H/W/D)	External (H/W/D)	mm	1690/980/750 + 1690/980/750	1690/980/750 + 1690/980/750	1690/980/750 + 1690/980/750	1690/980/750 + 1690/1410/750	1690/1410/750 + 1690/1410/750	1690/1410/750 + 1690/1410/750
	Shipping (H/W/D)	mm	1838/1070/850 + 1838/1070/850	1838/1070/850 + 1838/1070/850	1838/1070/850 + 1838/1070/850	1838/1070/850 + 1838/1515/850	1838/1515/850 + 1838/1515/850	1838/1515/850 + 1838/1515/850
Weight	Net/Shipping weight	kg	514/564	514/564	514/564	623/677	732/790	732/790
Compressor	Compressor type	/	DC INV. SCROLL	DC INV. SCROLL	DC INV. SCROLL	DC INV. SCROLL	DC INV. SCROLL	DC INV. SCROLL
	Motor Power	W	7640+7640	7640+7640	7640+7640	7640+10500	10500+10500	10500+10500
	Compressor quantity	/	2	2	2	3	4	4
Fan	Air flow (H)	m <sup>3</sup> /h	27000	27000	27000	30500	34000	34000
Maximum external static pressure		Pa	110	110	110	110	110	110
Pressure Sound Level	Cooling	dB(A)	63	64	64	65	65	66
	Heating	dB(A)	63	64	64	65	65	66
Power Sound Level	Cooling	dB(A)	91	91	91	91	91	91
	Heating	dB(A)	91	91	91	91	91	91
Refrigerant	Type	/	R410A	R410A	R410A	R410A	R410A	R410A
	Charge	kg	10	10	10	10	10	10
Piping	Refrigerant liquid pipe (Ø)	mm	15.88	15.88	15.88	19.05	19.05	19.05
	Refrigerant gas pipe (Ø)	mm	28.58	28.58	28.58	31.8	31.8	31.8
	Refrigerant high gas pipe	mm	25.4	25.4	25.4	28.58	28.58	28.58
	Total pipe length	m	1000	1000	1000	1000	1000	1000
	Max. pipe length (equivalent/actual)	m	260/220	260/220	260/220	260/220	260/220	260/220
	Max. drop between I.U. & O.U. (ODU above / below)	m	110/90	110/90	110/90	110/90	110/90	110/90
Max. drop between I.U. & I.U.		m	30					
Connection Ratio	Connectable indoor unit ratio <sup>(2)</sup>	%	50-130	50-130	50-130	50-130	50-130	50-130
	Max. number of indoor units	/	40	43	46	50	53	57
Working Temp.	Cooling	°C	-5-50 DB	-5-50 DB	-5-50 DB	-5-50 DB	-5-50 DB	-5-50 DB
	Heating	°C	-23-21 WB	-23-21 WB	-23-21 WB	-23-21 WB	-23-21 WB	-23-21 WB

HEATING  
COOLING

The indoor and outdoor capacity ratio should be limited within 100% when all the indoor units are in operation to ensure the system cooling/heating performance.



## Top Discharge Heat Recovery 36-44 HP

Model			38VT036S73RQEE	38VT038S73RQEE	38VT040S73RQEE	38VT042S73RQEE	38VT044S73RQEE
Combination			38VT018173RQEE 38VT018173RQEE	38VT018173RQEE 38VT020173RQEE	38VT020173RQEE 38VT020173RQEE	38VT020173RQEE 38VT022173RQEE	38VT022173RQEE 38VT022173RQEE
Capacity	Capacity range	HP	36	38	40	42	44
	Cooling	kW	100.0	106.0	112.0	116.0	120.0
	Heating	kW	100.0	106.0	112.0	116.0	120.0
	Heating (Max)	kW	112.0	117.5	123.0	130.5	138.0
Cooling Efficiency <sup>(1)</sup>	EER	W/W	3.10	3.18	3.25	3.12	3.00
	SEER		6.48	5.90	5.90	5.63	5.63
	ηs	%	256.20	233.00	233.00	222.20	222.20
	Running current	A	53.3	55.1	56.9	61.5	66.1
Heating Efficiency <sup>(1)</sup>	COP	W/W	3.65	3.60	3.55	3.44	3.35
	SCOP <sup>(1)</sup>	/	3.99	3.93	3.93	3.50	3.50
	ηs	%	156.60	154.20	154.20	137.00	137.00
	Running current	A	45.2	48.7	52.1	55.6	59.2
Electrical Parameters	Power supply	Ph/V/Hz	3/380-415/50/60	3/380-415/50/60	3/380-415/50/60	3/380-415/50/60	3/380-415/50/60
	Rated Power input (Cooling)	kW	32.26	33.36	34.46	37.23	40.00
	Rated Power input (Heating)	kW	27.40	29.47	31.54	33.68	35.82
	Max. current	A	94.14	99.92	105.70	107.35	109.00
Dimensions (H/W/D)	External (H/W/D)	mm	1690/1410/750 + 1690/1410/750	1690/1410/750 + 1690/1410/750	1690/1410/750 + 1690/1410/750	1690/1410/750 + 1690/1410/750	1690/1410/750 + 1690/1410/750
	Shipping (H/W/D)	mm	1838/1515/850 + 1838/1515/850	1838/1515/850 + 1838/1515/850	1838/1515/850 + 1838/1515/850	1838/1515/850 + 1838/1515/850	1838/1515/850 + 1838/1515/850
Weight	Net/Shipping weight	kg	732/790	741/799	750/808	750/808	750/808
Compressor	Compressor type	/	DC INV. SCROLL	DC INV. SCROLL	DC INV. SCROLL	DC INV. SCROLL	DC INV. SCROLL
	Motor Power	W	10500+10500	10500+15280	15280+15280	15280+15280	15280+15280
	Compressor quantity	/	4	4	4	4	4
Fan	Air flow (H)	m <sup>3</sup> /h	34000	36000	38000	38000	38000
Maximum external static pressure		Pa	110	110	110	110	110
Pressure Sound Level	Cooling	dB(A)	66	66	66	67	67
	Heating	dB(A)	66	66	66	67	67
Power Sound Level	Cooling	dB(A)	91	91	91	92	93
	Heating	dB(A)	91	91	91	92	93
Refrigerant	Type	/	R410A	R410A	R410A	R410A	R410A
	Charge	kg	10	10	10	10	10
Piping	Refrigerant liquid pipe (Ø)	mm	19.05	19.05	19.05	19.05	19.05
	Refrigerant gas pipe (Ø)	mm	38.1	38.1	38.1	38.1	38.1
	Refrigerant high gas pipe	mm	34.9	34.9	34.9	34.9	34.9
	Total pipe length	m	1000	1000	1000	1000	1000
	Max. pipe length (Equivalent/Actual)	m	260/220	260/220	260/220	260/220	260/220
	Max. drop between I.U.&O.U (ODU above / below)	m	110/90	110/90	110/90	110/90	110/90
Connection Ratio	Max. drop between I.U. & I.U.	m					
	Connectable indoor unit ratio <sup>(2)</sup>	%	50-130	50-130	50-130	50-130	50-130
Working Temp.	Max. number of indoor units	/	60	64	64	64	64
	Cooling	°C	-5-50 DB	-5-50 DB	-5-50 DB	-5-50 DB	-5-50 DB
	Heating	°C	-23-21 WB	-23-21 WB	-23-21 WB	-23-21 WB	-23-21 WB

The indoor and outdoor capacity ratio should be limited within 100% when all the indoor units are in operation to ensure the system cooling/heating performance.



Turn to the experts



# Specifications Top Discharge Heat Recovery 46-56 HP

OUTDOOR

Model			38VT046S73RQEE	38VT048S73RQEE	38VT050S73RQEE	38VT052S73RQEE	38VT054S73RQEE	38VT056S73RQEE
Combination			38VT014173RQEE 38VT016173RQEE 38VT016173RQEE	38VT016173RQEE 38VT016173RQEE 38VT016173RQEE	38VT016173RQEE 38VT016173RQEE 38VT016173RQEE	38VT016173RQEE 38VT018173RQEE 38VT018173RQEE	38VT018173RQEE 38VT018173RQEE 38VT018173RQEE	38VT018173RQEE 38VT018173RQEE 38VT020173RQEE
Capacity	Capacity range	HP	46	48	50	52	54	56
	Cooling	kW	130.0	135.0	140.0	145.0	150.0	156.0
	Heating	kW	130.0	135.0	140.0	145.0	150.0	156.0
	Heating (Max)	kW	145.0	150.0	156.0	162.0	168.0	173.5
Cooling Efficiency <sup>(1)</sup>	EER	W/W	3.24	3.23	3.18	3.14	3.10	3.15
	SEER		6.37	6.86	6.48	6.48	6.48	5.90
	ηs	%	251.80	271.40	256.20	256.20	256.20	233.00
	Running current	A	66.3	69.0	72.7	76.3	79.9	81.7
Heating Efficiency <sup>(1)</sup>	COP	W/W	3.90	3.95	3.84	3.74	3.65	3.61
	SCOP <sup>(1)</sup>	/	3.86	4.21	3.99	3.99	3.99	3.93
	ηs	%	151.40	165.40	156.60	156.60	156.60	154.20
	Running current	A	55.0	56.4	60.3	64.1	67.9	71.3
Electrical Parameters	Power supply	Ph/V/Hz	3/380-415/50/60	3/380-415/50/60	3/380-415/50/60	3/380-415/50/60	3/380-415/50/60	3/380-415/50/60
	Rated Power input (Cooling)	kW	40.17	41.80	43.99	46.19	48.39	49.49
	Rated Power input (Heating)	kW	33.31	34.18	36.48	38.79	41.10	43.17
	Max. current	A	114.61	124.36	129.97	135.59	141.20	146.98
Dimensions (H/W/D)	External (H/W/D)	mm	1690/980/750 + 1690/1410/750 + 1690/1410/750	1690/1410/750 + 1690/1410/750 + 1690/1410/750	1690/1410/750 + 1690/1410/750 + 1690/1410/750	1690/1410/750 + 1690/1410/750 + 1690/1410/750	1690/1410/750 + 1690/1410/750 + 1690/1410/750	1690/1410/750 + 1690/1410/750 + 1690/1410/750
	Shipping (H/W/D)	mm	1838/1070/850 + 1838/1515/850 + 1838/1515/850	1838/1515/850 + 1838/1515/850 + 1838/1515/850	1838/1515/850 + 1838/1515/850 + 1838/1515/850	1838/1515/850 + 1838/1515/850 + 1838/1515/850	1838/1515/850 + 1838/1515/850 + 1838/1515/850	1838/1515/850 + 1838/1515/850 + 1838/1515/850
Weight	Net/Shipping weight	kg	989/1072	1098/1185	1098/1185	1098/1185	1098/1185	1107/1194
Compressor	Compressor type	/	DC INV. SCROLL	DC INV. SCROLL	DC INV. SCROLL	DC INV. SCROLL	DC INV. SCROLL	DC INV. SCROLL
	Motor Power	W	7640+10500+10500	10500+10500+10500	10500+10500+10500	10500+10500+10500	10500+10500+10500	10500+10500+15280
	Compressor quantity	/	5	6	6	6	6	6
Fan	Air flow (H)	m³/h	47500	51000	51000	51000	51000	53000
Maximum external static pressure		Pa	110	110	110	110	110	110
Pressure Sound Level	Cooling	dB(A)	66	67	67	67	68	68
	Heating	dB(A)	66	67	67	67	68	68
Power Sound Level	Cooling	dB(A)	93	93	93	93	93	93
	Heating	dB(A)	93	93	93	93	93	93
Refrigerant	Type	/	R410A	R410A	R410A	R410A	R410A	R410A
	Charge	kg	10	10	10	10	10	10
Piping	Refrigerant liquid pipe (Ø)	mm	19.05	19.05	19.05	19.05	19.05	19.05
	Refrigerant gas pipe (Ø)	mm	38.1	38.1	38.1	38.1	38.1	38.1
	Refrigerant high gas pipe	mm	34.9	34.9	34.9	34.9	34.9	34.9
	Total pipe length	m	1000	1000	1000	1000	1000	1000
	Max. pipe length (equivalent/actual)	m	260/220	260/220	260/220	260/220	260/220	260/220
	Max. drop between I.U. & O.U. (ODU above / below)	m	110/90	110/90	110/90	110/90	110/90	110/90
Connection Ratio	Connectable indoor unit ratio <sup>(2)</sup>	%	50-130	50-130	50-130	50-130	50-130	50-130
	Max. number of indoor units	/	64	64	64	64	64	64
Working Temp.	Cooling	°C	-5-50 DB	-5-50 DB	-5-50 DB	-5-50 DB	-5-50 DB	-5-50 DB
	Heating	°C	-23-21 WB	-23-21 WB	-23-21 WB	-23-21 WB	-23-21 WB	-23-21 WB

The indoor and outdoor capacity ratio should be limited within 100% when all the indoor units are in operation to ensure the system cooling/heating performance.







## Top Discharge Heat Recovery 58-66 HP

Model			38VT058S73RQEE	38VT060S73RQEE	38VT062S73RQEE	38VT064S73RQEE	38VT066S73RQEE
Combination			38VT018173RQEE 38VT020173RQEE 38VT020173RQEE	38VT020173RQEE 38VT020173RQEE 38VT020173RQEE	38VT020173RQEE 38VT020173RQEE 38VT020173RQEE	38VT020173RQEE 38VT022173RQEE 38VT022173RQEE	38VT022173RQEE 38VT022173RQEE 38VT022173RQEE
Capacity	Capacity range	HP	58	60	62	64	66
	Cooling	kW	162.0	168.0	172.0	176.0	180.0
	Heating	kW	162.0	168.0	172.0	176.0	180.0
	Heating (Max)	kW	179.0	184.5	192.0	199.5	207.0
Cooling Efficiency <sup>(1)</sup>	EER	W/W	3.20	3.25	3.16	3.08	3.00
	SEER		5.90	5.90	5.63	5.63	5.63
	ηs	%	233.00	233.00	222.20	222.20	222.20
	Running current	A	83.6	85.4	89.9	94.5	99.1
Heating Efficiency <sup>(1)</sup>	COP	W/W	3.58	3.55	3.48	3.41	3.35
	SCOP <sup>(1)</sup>	/	3.93	3.93	3.50	3.50	3.50
	ηs	%	154.20	154.20	137.00	137.00	137.00
	Running current	A	74.7	78.1	81.7	85.2	88.7
Electrical Parameters	Power supply	Ph/V/Hz	3/380-415/50/60	3/380-415/50/60	3/380-415/50/60	3/380-415/50/60	3/380-415/50/60
	Rated Power input (Cooling)	kW	50.59	51.69	54.46	57.23	60.00
	Rated Power input (Heating)	kW	45.24	47.31	49.45	51.59	53.73
	Max. current	A	152.76	158.54	160.20	161.85	163.50
Dimensions (H/W/D)	External (H/W/D)	mm	1690/1410/750 + 1690/1410/750 + 1690/1410/750	1690/1410/750 + 1690/1410/750 + 1690/1410/750	1690/1410/750 + 1690/1410/750 + 1690/1410/750	1690/1410/750 + 1690/1410/750 + 1690/1410/750	1690/1410/750 + 1690/1410/750 + 1690/1410/750
	Shipping (H/W/D)	mm	1838/1515/850 + 1838/1515/850 + 1838/1515/850	1838/1515/850 + 1838/1515/850 + 1838/1515/850	1838/1515/850 + 1838/1515/850 + 1838/1515/850	1838/1515/850 + 1838/1515/850 + 1838/1515/850	1838/1515/850 + 1838/1515/850 + 1838/1515/850
Weight	Net/Shipping weight	kg	1116/1203	1125/1212	1125/1212	1125/1212	1125/1212
Compressor	Compressor type	/	DC INV. SCROLL	DC INV. SCROLL	DC INV. SCROLL	DC INV. SCROLL	DC INV. SCROLL
	Motor Power	W	10500+15280+15280	15280+15280+15280	15280+15280+15280	15280+15280+15280	15280+15280+15280
	Compressor quantity	/	6	6	6	6	6
Fan	Air flow (H)	m <sup>3</sup> /h	55000	57000	57000	57000	57000
Maximum external static pressure		Pa	110	110	110	110	110
Pressure Sound Level	Cooling	dB(A)	68	68	68	68	69
	Heating	dB(A)	68	68	68	68	69
Power Sound Level	Cooling	dB(A)	93	93	94	94	95
	Heating	dB(A)	93	93	94	94	95
Refrigerant	Type	/	R410A	R410A	R410A	R410A	R410A
	Charge	kg	10	10	10	10	10
Piping	Refrigerant liquid pipe (Ø)	mm	19.05	19.05	19.05	19.05	19.05
	Refrigerant gas pipe (Ø)	mm	41.3	41.3	41.3	41.3	41.3
	Refrigerant high gas pipe	mm	38.1	38.1	38.1	38.1	38.1
	Total pipe length	m	1000	1000	1000	1000	1000
	Max. pipe length (equivalent/actual)	m	260/220	260/220	260/220	260/220	260/220
	Max. drop between I.U. & O.U. (ODU above / below)	m	110/90	110/90	110/90	110/90	110/90
Connection Ratio	Connectable indoor unit ratio <sup>(2)</sup>	%	50-130	50-130	50-130	50-130	50-130
	Max. number of indoor units	/	64	64	64	64	64
Working Temp.	Cooling	°C	-5-50 DB	-5-50 DB	-5-50 DB	-5-50 DB	-5-50 DB
	Heating	°C	-23-21 WB	-23-21 WB	-23-21 WB	-23-21 WB	-23-21 WB

OUTDOOR

HEATING

COOLING

The indoor and outdoor capacity ratio should be limited within 100% when all the indoor units are in operation to ensure the system cooling/heating performance.



Turn to the experts



# Specifications Top Discharge Heat Recovery 68-78 HP

OUTDOOR

Model			38VT068S73RQEE	38VT070S73RQEE	38VT072S73RQEE	38VT074S73RQEE	38VT076S73RQEE	38VT078S73RQEE
Combination			38VT016173RQEE 38VT016173RQEE 38VT018173RQEE 38VT018173RQEE	38VT016173RQEE 38VT018173RQEE 38VT018173RQEE 38VT018173RQEE	38VT018173RQEE 38VT018173RQEE 38VT018173RQEE 38VT018173RQEE	38VT018173RQEE 38VT018173RQEE 38VT018173RQEE 38VT020173RQEE	38VT018173RQEE 38VT018173RQEE 38VT020173RQEE 38VT020173RQEE	38VT018173RQEE 38VT020173RQEE 38VT020173RQEE 38VT020173RQEE
Capacity	Capacity range	HP	68	70	72	74	76	78
	Cooling	kW	190.0	195.0	200.0	206.0	212.0	218.0
	Heating	kW	190.0	195.0	200.0	206.0	212.0	218.0
	Heating (Max)	kW	212.0	218.0	224.0	229.5	235.0	240.5
Cooling Efficiency <sup>(1)</sup>	EER	W/W	3.16	3.13	3.10	3.14	3.18	3.21
	SEER		6.48	6.48	6.48	5.90	5.90	5.90
	ηs	%	256.20	256.20	256.20	233.00	233.00	233.00
	Running current	A	99.3	102.9	106.5	108.4	110.2	112.0
Heating Efficiency <sup>(1)</sup>	COP	W/W	3.79	3.72	3.65	3.62	3.60	3.57
	SCOP <sup>(2)</sup>	/	3.99	3.99	3.99	3.93	3.93	3.93
	ηs	%	156.60	156.60	156.60	154.20	154.20	154.20
	Running current	A	82.9	86.7	90.5	93.9	97.3	100.8
Electrical Parameters	Power supply	Ph/V/Hz	3/380-415/50/60	3/380-415/50/60	3/380-415/50/60	3/380-415/50/60	3/380-415/50/60	3/380-415/50/60
	Rated Power input (Cooling)	kW	60.12	62.32	64.52	65.62	66.72	67.82
	Rated Power input (Heating)	kW	50.18	52.49	54.79	56.87	58.94	61.01
	Max. current	A	177.04	182.66	188.27	194.05	199.83	205.61
Dimensions (H/W/D)	External (H/W/D)	mm	1690/1410/750 + 1690/1410/750 + 1690/1410/750 + 1690/1410/750	1690/1410/750 + 1690/1410/750 + 1690/1410/750 + 1690/1410/750	1690/1410/750 + 1690/1410/750 + 1690/1410/750 + 1690/1410/750	1690/1410/750 + 1690/1410/750 + 1690/1410/750 + 1690/1410/750	1690/1410/750 + 1690/1410/750 + 1690/1410/750 + 1690/1410/750	1690/1410/750 + 1690/1410/750 + 1690/1410/750 + 1690/1410/750
	Shipping (H/W/D)	mm	1838/1515/850 + 1838/1515/850 + 1838/1515/850 + 1838/1515/850	1838/1515/850 + 1838/1515/850 + 1838/1515/850 + 1838/1515/850	1838/1515/850 + 1838/1515/850 + 1838/1515/850 + 1838/1515/850	1838/1515/850 + 1838/1515/850 + 1838/1515/850 + 1838/1515/850	1838/1515/850 + 1838/1515/850 + 1838/1515/850 + 1838/1515/850	1838/1515/850 + 1838/1515/850 + 1838/1515/850 + 1838/1515/850
Weight	Net/Shipping weight	kg	1464/1580	1464/1580	1464/1580	1473/1589	1482/1598	1491/1607
Compressor	Compressor type	/	DC INV. SCROLL	DC INV. SCROLL	DC INV. SCROLL	DC INV. SCROLL	DC INV. SCROLL	DC INV. SCROLL
	Motor Power	W	10500 + 10500 + 10500 + 10500	10500 + 10500 + 10500 + 10500	10500 + 10500 + 10500 + 10500	10500 + 10500 + 10500 + 15280	10500 + 10500 + 15280 + 15280	10500 + 15280 + 15280 + 15280
	Compressor quantity	/	8	8	8	8	8	8
Fan	Air flow (H)	m <sup>3</sup> /h	68000	68000	68000	70000	72000	74000
Maximum external static pressure		Pa	110	110	110	110	110	110
Pressure Sound Level	Cooling	dB(A)	69	69	69	69	69	69
	Heating	dB(A)	69	69	69	69	69	69
Power Sound Level	Cooling	dB(A)	94	94	94	94	94	94
	Heating	dB(A)	94	94	94	94	94	94
Refrigerant	Type	/	R410A	R410A	R410A	R410A	R410A	R410A
	Charge	kg	10	10	10	10	10	10
Piping	Refrigerant liquid pipe (Ø)	mm	22.2	22.2	22.2	22.2	22.2	22.2
	Refrigerant gas pipe (Ø)	mm	44.5	44.5	44.5	44.5	44.5	44.5
	Refrigerant high gas pipe	mm	41.3	41.3	41.3	41.3	41.3	41.3
	Total pipe length	m	1000	1000	1000	1000	1000	1000
	Max. pipe length (equivalent/actual)	m	260/220	260/220	260/220	260/220	260/220	260/220
	Max. drop between I.U. & O.U. (ODU above / below)	m	110/90	110/90	110/90	110/90	110/90	110/90
Connection Ratio	Connectable indoor unit ratio <sup>(2)</sup>	%	50-130	50-130	50-130	50-130	50-130	50-130
	Max. number of indoor units	/	64	64	64	64	64	64
Working Temp.	Cooling	°C	-5-50 DB	-5-50 DB	-5-50 DB	-5-50 DB	-5-50 DB	-5-50 DB
	Heating	°C	-23-21 WB	-23-21 WB	-23-21 WB	-23-21 WB	-23-21 WB	-23-21 WB

The indoor and outdoor capacity ratio should be limited within 100% when all the indoor units are in operation to ensure the system cooling/heating performance.

HEATING  
COOLING



## Top Discharge Heat Recovery 80-88 HP

Model			38VT080S73RQEE	38VT082S73RQEE	38VT084S73RQEE	38VT086S73RQEE	38VT088S73RQEE
Combination			38VT020173RQEE 38VT020173RQEE 38VT020173RQEE 38VT020173RQEE	38VT020173RQEE 38VT020173RQEE 38VT020173RQEE 38VT022173RQEE	38VT020173RQEE 38VT020173RQEE 38VT022173RQEE 38VT022173RQEE	38VT020173RQEE 38VT022173RQEE 38VT022173RQEE 38VT022173RQEE	38VT022173RQEE 38VT022173RQEE 38VT022173RQEE 38VT022173RQEE
Capacity	Capacity range	HP	80	82	84	86	88
	Cooling	kW	224.0	228.0	232.0	236.0	240.0
	Heating	kW	224.0	228.0	232.0	236.0	240.0
	Heating (Max)	kW	246.0	253.5	261.0	268.5	276.0
Cooling Efficiency <sup>(1)</sup>	EER	W/W	3.25	3.18	3.12	3.06	3.00
	SEER		5.90	5.63	5.63	5.63	5.63
	ηs	%	233.00	222.20	222.20	222.20	222.20
	Running current	A	113.8	118.4	123.0	127.5	132.1
Heating Efficiency <sup>(1)</sup>	COP	W/W	3.55	3.50	3.44	3.40	3.35
	SCOP <sup>(1)</sup>	/	3.93	3.50	3.50	3.50	3.50
	ηs	%	154.20	137.00	137.00	137.00	137.00
	Running current	A	104.2	107.7	111.2	114.8	118.3
Electrical Parameters	Power supply	Ph/V/Hz	3/380-415/50/60	3/380-415/50/60	3/380-415/50/60	3/380-415/50/60	3/380-415/50/60
	Rated Power input (Cooling)	kW	68.92	71.69	74.46	77.23	80.00
	Rated Power input (Heating)	kW	63.08	65.22	67.36	69.50	71.64
	Max. current	A	211.39	213.04	214.70	216.35	218.00
Dimensions (H/W/D)	External (H/W/D)	mm	1690/1410/750 + 1690/1410/750 + 1690/1410/750 + 1690/1410/750	1690/1410/750 + 1690/1410/750 + 1690/1410/750 + 1690/1410/750	1690/1410/750 + 1690/1410/750 + 1690/1410/750 + 1690/1410/750	1690/1410/750 + 1690/1410/750 + 1690/1410/750 + 1690/1410/750	1690/1410/750 + 1690/1410/750 + 1690/1410/750 + 1690/1410/750
	Shipping (H/W/D)	mm	1838/1515/850 + 1838/1515/850 + 1838/1515/850 + 1838/1515/850	1838/1515/850 + 1838/1515/850 + 1838/1515/850 + 1838/1515/850	1838/1515/850 + 1838/1515/850 + 1838/1515/850 + 1838/1515/850	1838/1515/850 + 1838/1515/850 + 1838/1515/850 + 1838/1515/850	1838/1515/850 + 1838/1515/850 + 1838/1515/850 + 1838/1515/850
Weight	Net/Shipping weight	kg	1500/1616	1500/1616	1500/1616	1500/1616	1500/1616
Compressor	Compressor type	/	DC INV. SCROLL	DC INV. SCROLL	DC INV. SCROLL	DC INV. SCROLL	DC INV. SCROLL
	Motor Power	W	15280 + 15280 + 15280 + 15280	15280 + 15280 + 15280 + 15280	15280 + 15280 + 15280 + 15280	15280 + 15280 + 15280 + 15280	15280 + 15280 + 15280 + 15280
	Compressor quantity	/	8	8	8	8	8
Fan	Air flow (H)	m <sup>3</sup> /h	836000	76000	76000	76000	76000
Maximum external static pressure		Pa	110	110	110	110	110
Pressure Sound Level	Cooling	dB(A)	69	69	70	70	70
	Heating	dB(A)	69	69	70	70	70
Power Sound Level	Cooling	dB(A)	94	95	95	96	96
	Heating	dB(A)	94	95	95	96	96
Refrigerant	Type	/	R410A	R410A	R410A	R410A	R410A
	Charge	kg	10	10	10	10	10
Piping	Refrigerant liquid pipe (Ø)	mm	22.2	22.2	22.2	25.4	25.4
	Refrigerant gas pipe (Ø)	mm	44.5	44.5	44.5	50.8	50.8
	Refrigerant high gas pipe	mm	41.3	41.3	41.3	44.5	44.5
	Total pipe length	m	1000	1000	1000	1000	1000
	Max. pipe length (Equivalent/Actual)	m	260/220	260/220	260/220	260/220	260/220
	Max. drop between I.U. & O.U. (ODU above / below)	m	110/90	110/90	110/90	110/90	110/90
Connection Ratio	Max. drop between I.U. & I.U.	m					
	Connectable indoor unit ratio <sup>(2)</sup>	%	50-130	50-130	50-130	50-130	50-130
Working Temp.	Max. number of indoor units	/	64	64	64	64	64
	Cooling	°C	-5-50 DB	-5-50 DB	-5-50 DB	-5-50 DB	-5-50 DB
	Heating	°C	-23-21 WB	-23-21 WB	-23-21 WB	-23-21 WB	-23-21 WB

The indoor and outdoor capacity ratio should be limited within 100% when all the indoor units are in operation to ensure the system cooling/heating performance.



Turn to the experts



### Dimensions (for all Top Discharge units)

Single Fan Heat Pump (8-16HP)  
Single Fan Heat Recovery (8-14HP)

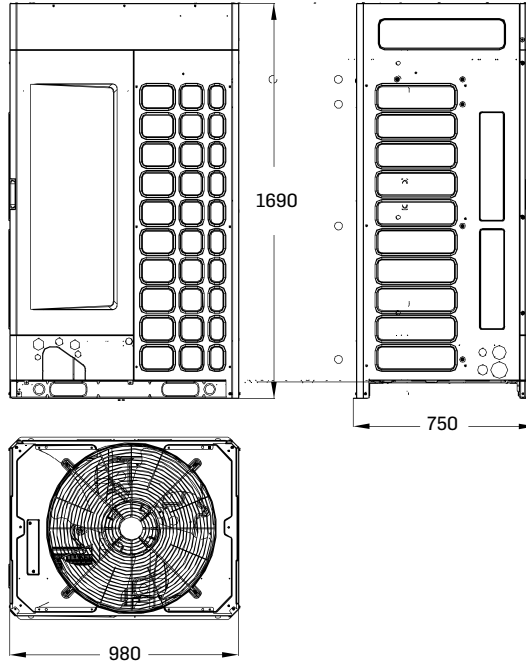

Dual Fan Heat Pump (18-26HP)  
Dual Fan Heat Recovery (16-22HP)

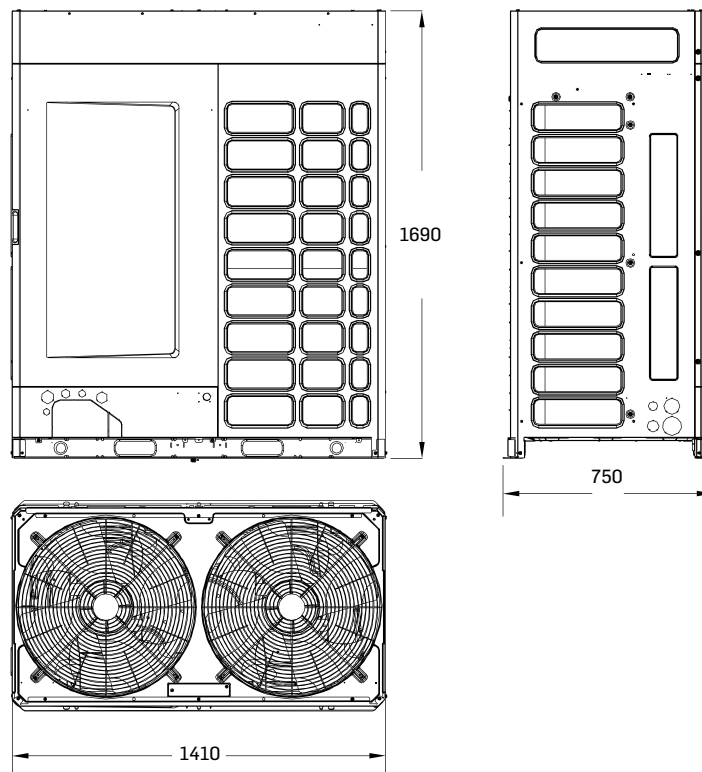

OUTDOOR



### Combination Installation Dimensions

There should be no obstacles within 2000 mm above the outdoor unit.

Obstacles around the outdoor unit should be less than 900 mm to the bottom of unit.

When multiple modules are installed, the outdoor unit should be installed according to capacity, with the larger capacity closer to the main pipe.

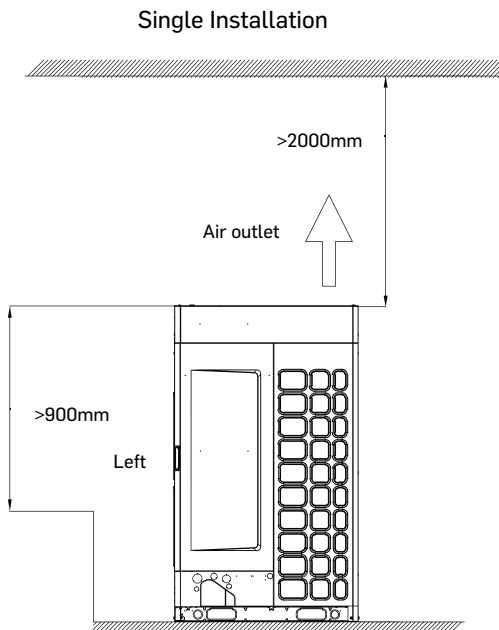

### Single Fan Top Discharge

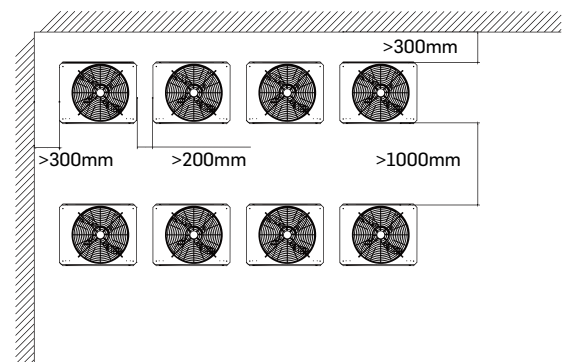
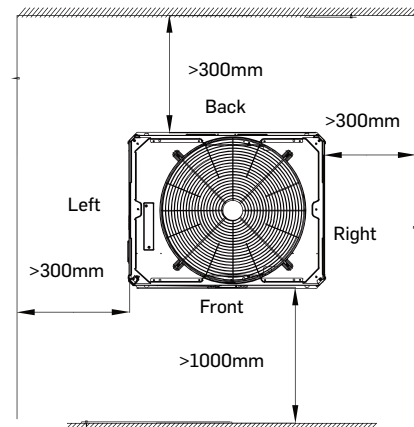

### Combination Installation

Unit can be installed facing the same or opposite direction

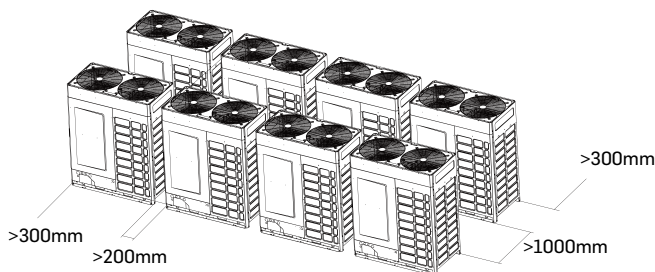

### Wall Higher Than the Outdoor Condensers

Place with air inlet hole

#### Notes:

- Fan speed  $V_s$  at air inlet is 1.5 m/s or below.
- Air outlet height  $HD = H - h$  and below 1 m.

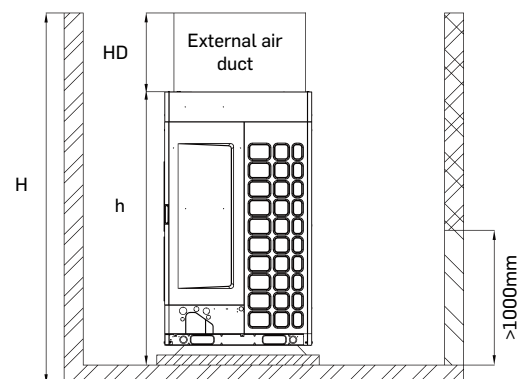



### Piping rules

Permissible pipe length and height difference

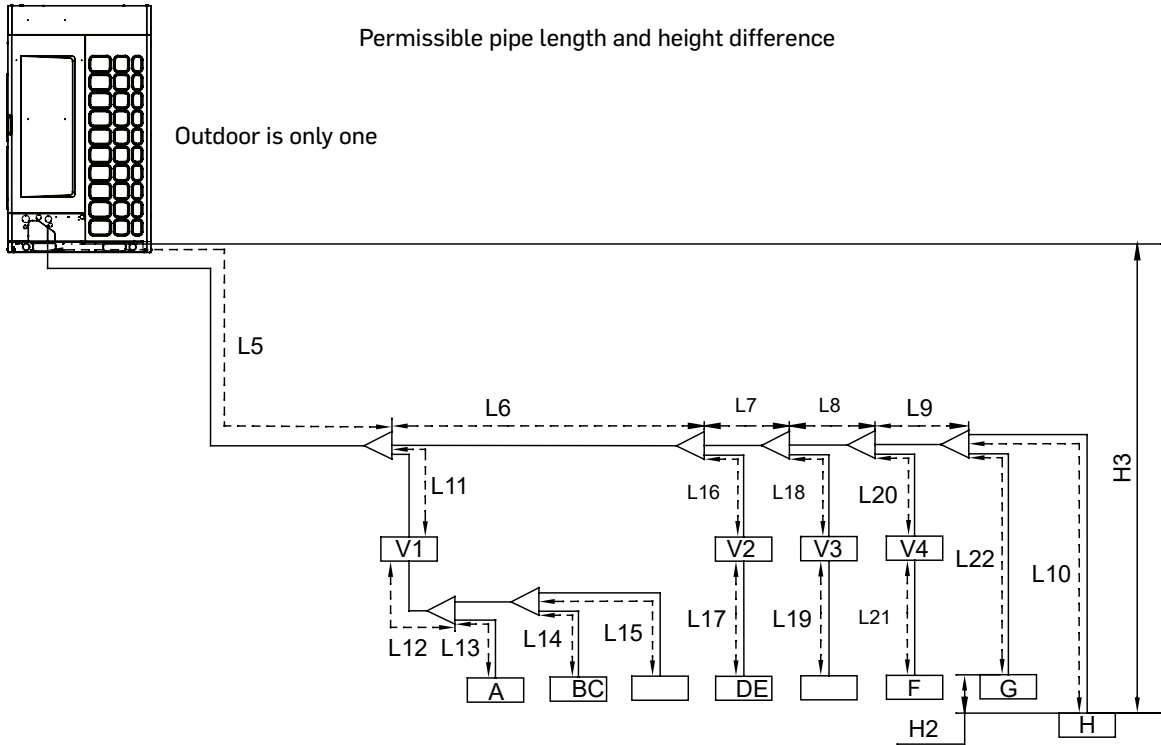

Outdoor 1

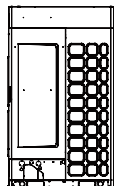

The outdoor is more than one unit

When the distance between outdoors (L1, L3) is over 2m, the oil trap must be set as indicated in the diagram (upright projecting pipe, 200 mm high):

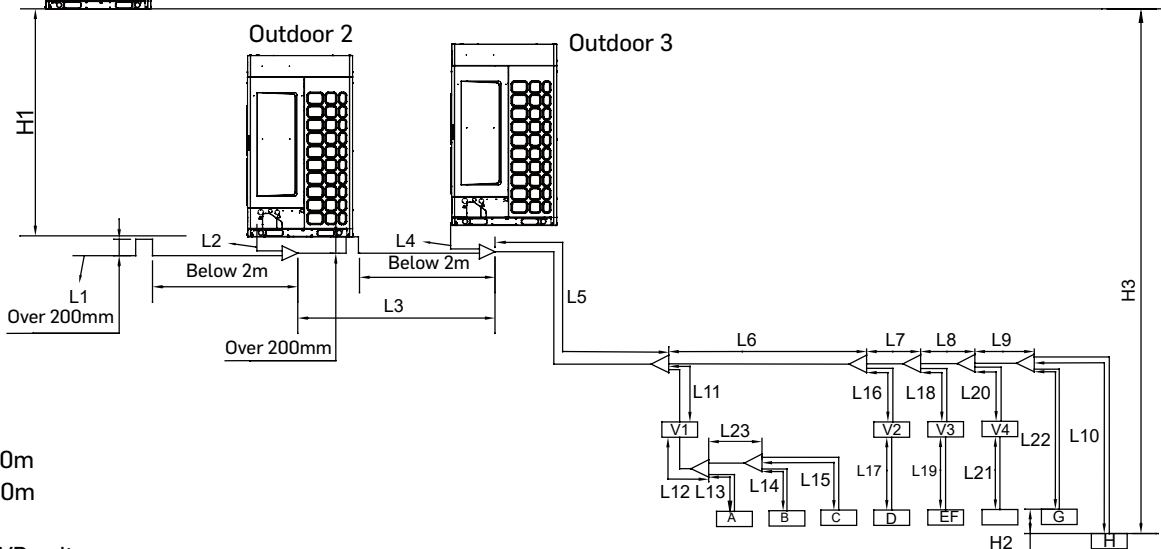

- L3 < 10m
- L1 + L3 < 10m
- L2 + L3 < 10m

Note:

V1---V4: VP unit

A---F: indoors (cooling / heating selection possible)

G---H: indoors (cooling only)



Item Model		All Outdoors	Pipe in above figure
Single way total pipe length		1000 m	$L5+2\times(L6+L7+L8+L9+L11+L12+L23)+L10+L16+L17+L18+L19+L20+L21+L22+L13+L14+L15$
Single way pipe length		Max. 220/260 (equivalent length)	$L1+L3+L5+L6+L7+L8+L9+L10$
Main pipe between outdoor to 1st branch		Max.130	L5
Height difference between indoor and outdoor	Outdoor is upper	Max. 90m	H3
	Outdoor is lower	Max. 110m	H3
Height difference between outdoors (in the same system)		Within 5 m (better be horizontal)	H1
Max. pipe length from 1st branch pipe to indoor		Max. 90m	$L6+L7+L8+L9+L10$
Height difference between indoors		Max.30m	H2
Max.pipe length between indoors and the nearest branch pipe		Max. 30m	/
The distance between the nearest indoor unit and the farthest indoor		40m	/
Pipe length among outdoor units (length between first gather pipe & farthest outdoor unit)		10m	/
When outdoor is only one, Single way max. pipe length = $L5+L6+L7+L8+L9+L10 \leq 260\text{m}$ ; Single way total pipe length = $L5+L6+\dots+L22$			

When the pipe between the outdoor unit and its furthest indoor unit is longer than 90m, the specification of master pipe (Gas pipe/ Liquid pipe) between outdoor unit and the first Y joint should be upgraded for one level. For more details, please refer to "Outdoor pipe selection table"

When the pipe between the first Y joint and its furthest indoor unit is longer than 40m,

1. The specification of the master pipe ( Gas pipe/ Liquid pipe) between the first Y joint and its furthest indoor unit should be upgraded for one level.
2. The distance between the furthest indoor unit and the nearest one should be less than 40 m.



Turn to the experts

HEALTHCARE



HOTELS



RETAIL



HOUSING



ADMINISTRATIONS



OFFICES



RETAIL



ADMINISTRATIONS



HOTELS



HEALTHCARE



HOUSING





## INDOOR UNITS





086	ONE-WAY CASSETTE	118	HIGH WALL
090	TWO-WAY CASSETTE	122	TWO-WAY CONSOLE
094	COMPACT FOUR-WAY CASSETTE	126	CONSOLE-RECESSED
098	ROUND-WAY CASSETTE	128	FLEX CEILING FLOOR (DC MOTOR)
104	SLIM DUCT	134	HRV
108	STANDARD STATIC DUCT (20/200PA)		
112	HIGH STATIC DUCT(0/200PA)		



## Benefits Overview

		CASSETTE				DUCT	
Features		ONE-WAY CASSETTE	TWO-WAY CASSETTE	COMPACT FOUR-WAY CASSETTE	ROUND-WAY CASSETTE	SLIM DUCT	STANDARD STATIC DUCT (20-200PA)
		40VU*1-7E	40VU*2-7G	40VU*C-7S	40VU*R-7E	40VD*L-7E	40VD*S-7S
Comfortable	Washable filter included: <ul style="list-style-type: none"> <li>Ensures clean air</li> <li>Extends the life of the fan</li> </ul>	●	●	●	●	●	●
	Independent control of the air flow directions: <ul style="list-style-type: none"> <li>Flexible controls for different needs</li> <li>Ensures a comfortable environment</li> </ul>				●		
	Multi-gear air speed selection: <ul style="list-style-type: none"> <li>Meets different requirements of installation &amp; usage</li> </ul>	●	●	●	●	●	●
	Presence sensor (optional): <ul style="list-style-type: none"> <li>Automatically switches on &amp; off when people enter &amp; leave</li> <li>Energy conservation</li> </ul>				● (Optional)		
	<ul style="list-style-type: none"> <li>Brushless DC motor:</li> <li>Operation noise is reduced</li> </ul>	●		●	●	●	●
Aesthetic	<ul style="list-style-type: none"> <li>Streamlined design</li> <li>Easily fits in with different interior designs</li> </ul>	●	●		●		
	<ul style="list-style-type: none"> <li>Ultra-thin &amp; compact design</li> <li>Save ceiling space</li> </ul>	●	●	●	●	●	●
Convenient	<ul style="list-style-type: none"> <li>Optional location of air return vent (front &amp; back)</li> <li>Friendly installation</li> </ul>					●	●
	Easy disassembly of the maintenance panel	●	●		●		
	<ul style="list-style-type: none"> <li>Adjustable static pressure</li> <li>Flexible selection according to the actual installation</li> </ul>					●	●
	<ul style="list-style-type: none"> <li>Standard drain pump</li> <li>Drain water is discharged easily</li> </ul>	●	●	●	●	●	●
	Reserved fresh air inlet			●	●		●
Intelligent	Compatible with centralized control	●	●	●	●	●	●
	Room card	●	●	●	●	●	●
	Reminder to clean the washable filter	●	●	●	●	●	●

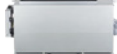

		DUCT	WALL MOUNTED UNIT	FLOOR STANDING UNITS			VENTILATION
Features		HIGH STATIC DUCT (0/250 PA) 	HIGH WALL 	TWO-WAY CONSOLE 	CONSOLE - RECESSED 	FLEX CEILING FLOOR DC FAN 	HRV 
		40VD*H-7S	40VK*S-7S2	40VL*B-7E	40VL*R-7G	40VC*F-7S	40VH*A-7G
Comfortable	Washable filter included: • Ensures clean air • Extends the life of the fan	● 72/96 not included	●	●	●	●	●
	Independent control of the air flow directions: • Flexible controls for different needs • Ensures a comfortable environment		●			●	
	Multi-gear air speed selection: • Meets different requirements of installation & usage	●	●	●	●	●	●
	Presence sensor (optional): • Automatically switches on & off when people enter & leave • Energy conservation						
	• Brushless DC motor: • Operation noise is reduced	●	●	●		●	
Aesthetic	• Streamlined design • Easily fits in with different interior designs		●	●		●	
	• Ultra-thin & compact design • Save ceiling space	●					
Convenient	• Optional location of air return vent (front & back) • Friendly installation						
	Easy disassembly of the maintenance panel			●		●	
	• Adjustable static pressure • Flexible selection according to the actual installation	●					
	• Standard drain pump • Drain water is discharged easily	● 72/96 not included					
	Reserved fresh air inlet	● 72/96 not included				●	
Intelligent	Compatible with centralized control	●	●	●	●	●	●
	Room card	●	●	●	●	●	
	Reminder to clean the washable filter	● 72/96 not included	●	●	●	●	



Turn to the experts

INDOOR





**INDOOR**



Turn to the experts



## ONE-WAY CASSETTE (DC MOTOR) 40VU\*1-7E

- Slim & elegant design in just 185 mm height  
(When not in use, it closes completely and is only slightly noticeable, 40VPU01217EQEE making it appear uniform with ceiling)
- DC powered fan with noise levels down as low as 25dB(A)
- Return air panel serves as a service port to maintain the unit
- Built-in drain pump (600 mm)
- Unique ceiling anti-fouling design



Optional Panel: 40VPU01217EQEE



Wired Controller  
40VCW217FQEE



Simple Wired  
Controller  
40VCW117FQEE



Wired Weekly  
Timer  
40VCW317FQEE



Wireless Controller  
40VCI67FQEE



## Specifications



Model Code	Item	Unit	40VU0051-7E-QEE	40VU0071-7E-QEE	40VU0091-7E-QEE	40VU0121-7E-QEE
Capacity	Model capacity	HP	0,5	0,8	1,0	1,25
	Cooling	kW	1,5	2,2	2,8	3,6
	Heating	kW	1,7	2,5	3,2	4,0
Electrical Parameters	Power supply	Ph/V/Hz	1/220-230/50/60	1/220-230/50/60	1/220-230/50/60	1/220-230/50/60
	Power consumption	W	21	21	21	23
Dimensions (W/D/H)	Net Product	mm	875/505/185	875/505/185	875/505/185	875/505/185
	Shipping Product	mm	1028/581/270	1028/581/270	1028/581/270	1028/581/270
	Net Panel	mm	1050/560/122	1050/560/122	1050/560/122	1050/560/122
	Shipping Panel	mm	1133/623/197	1133/623/197	1133/623/197	1133/623/197
Weight	Product Net/Shipping	kg	15.3/17.9	15.3/17.9	15.3/17.9	15.3/17.9
	Panel Net/Shipping	kg	5.3/8.3	5.3/8.3	5.3/8.3	5.3/8.3
Fan	Air flow (H/M/L)	m <sup>3</sup> /h	530/490/450	530/490/450	530/490/450	550/530/490
Pressure sound level	Cooling (H/M/L)	dB(A)	32/29/24	32/29/24	32/29/24	34/30/25
	Heating (H/M/L)	dB(A)	32/29/24	32/29/24	32/29/24	34/30/25
Piping	Refrigerant liquid pipe (Ø)	mm	6,35	6,35	6,35	6,35
	Refrigerant gas pipe (Ø)	mm	9,52	9,52	9,52	12,7
	Drain port diameter	mm	32	32	32	32
Drain pump	O-optional, S-standard, N-not incl.	/	S	S	S	S
Accessories (Optional)	Panel Model Code	/	40VPU01217EQEE	40VPU01217EQEE	40VPU01217EQEE	40VPU01217EQEE

INDOOR

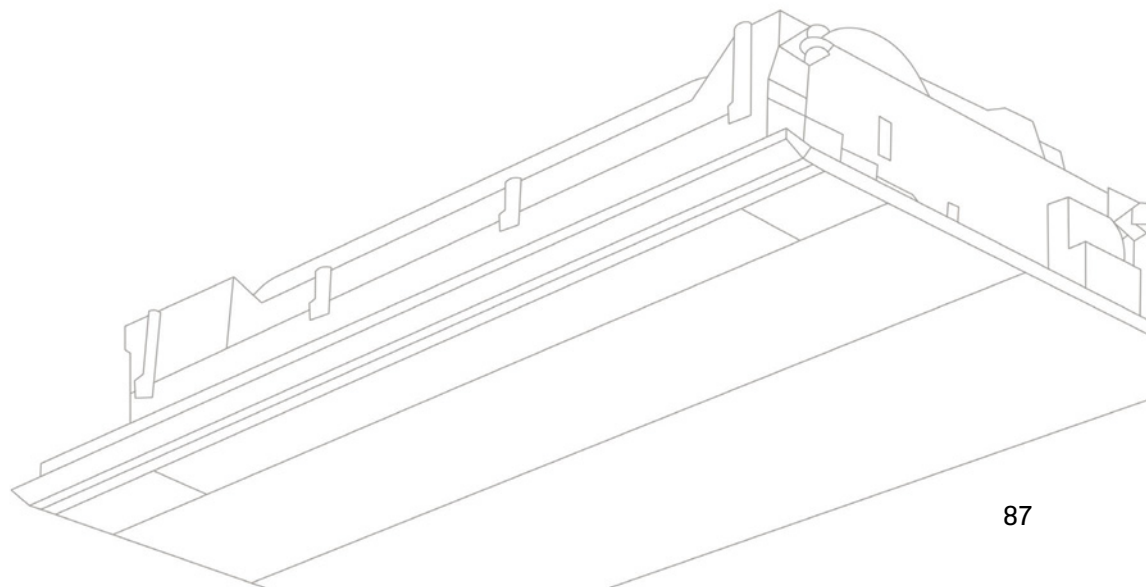



## ONE-WAY CASSETTE (DC MOTOR)



### Easy - Servicing & Maintenance

- Easy removal of air filters for cleaning
- Easy access to indoor unit components

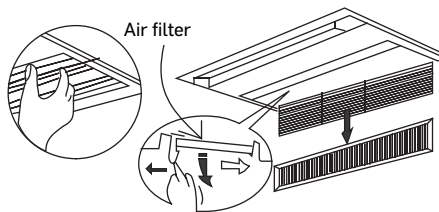

### Built-in Drain Pump

- Standard built-in drain pump with 600 mm
- Pumphead and slim body makes the installation flexible to storey height limitations.

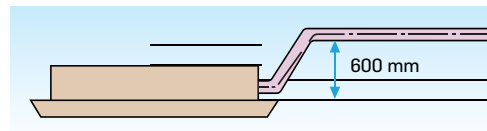

### 185 mm height Only

Compact design, slim body with a min. height of 185 mm, especially suitable for spaces with narrow ceilings, such as lobbies, small-sized meeting rooms, mansions, restaurants, etc.

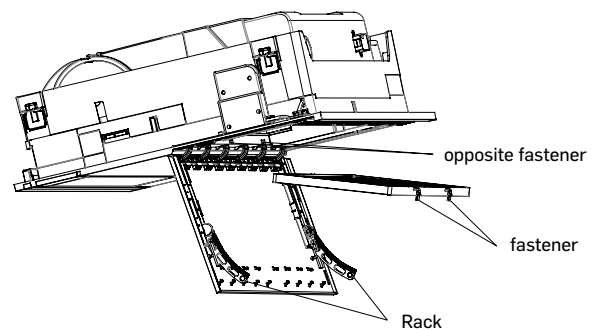
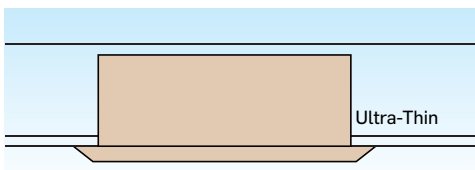





## Dimensions

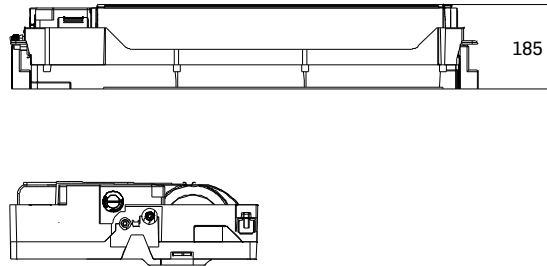
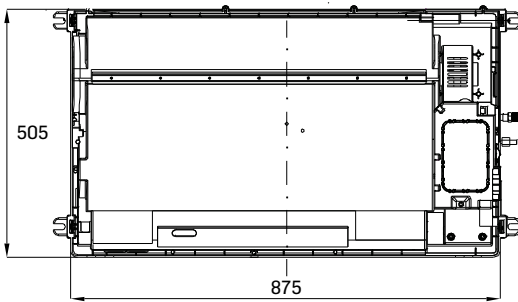

## Installation & Service

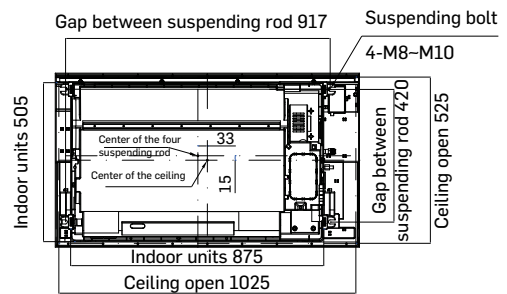
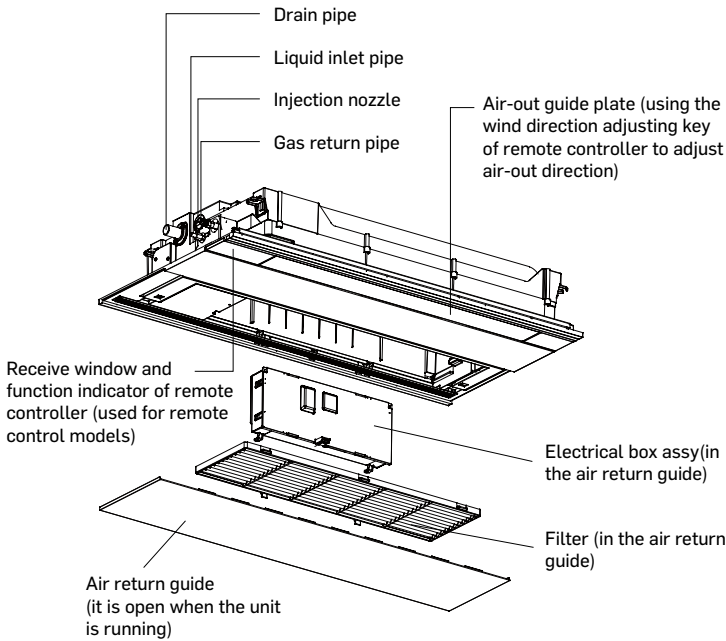

### Installation space

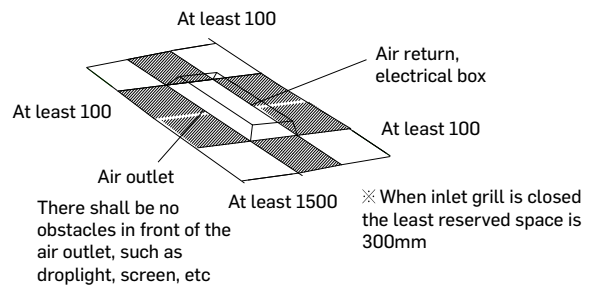





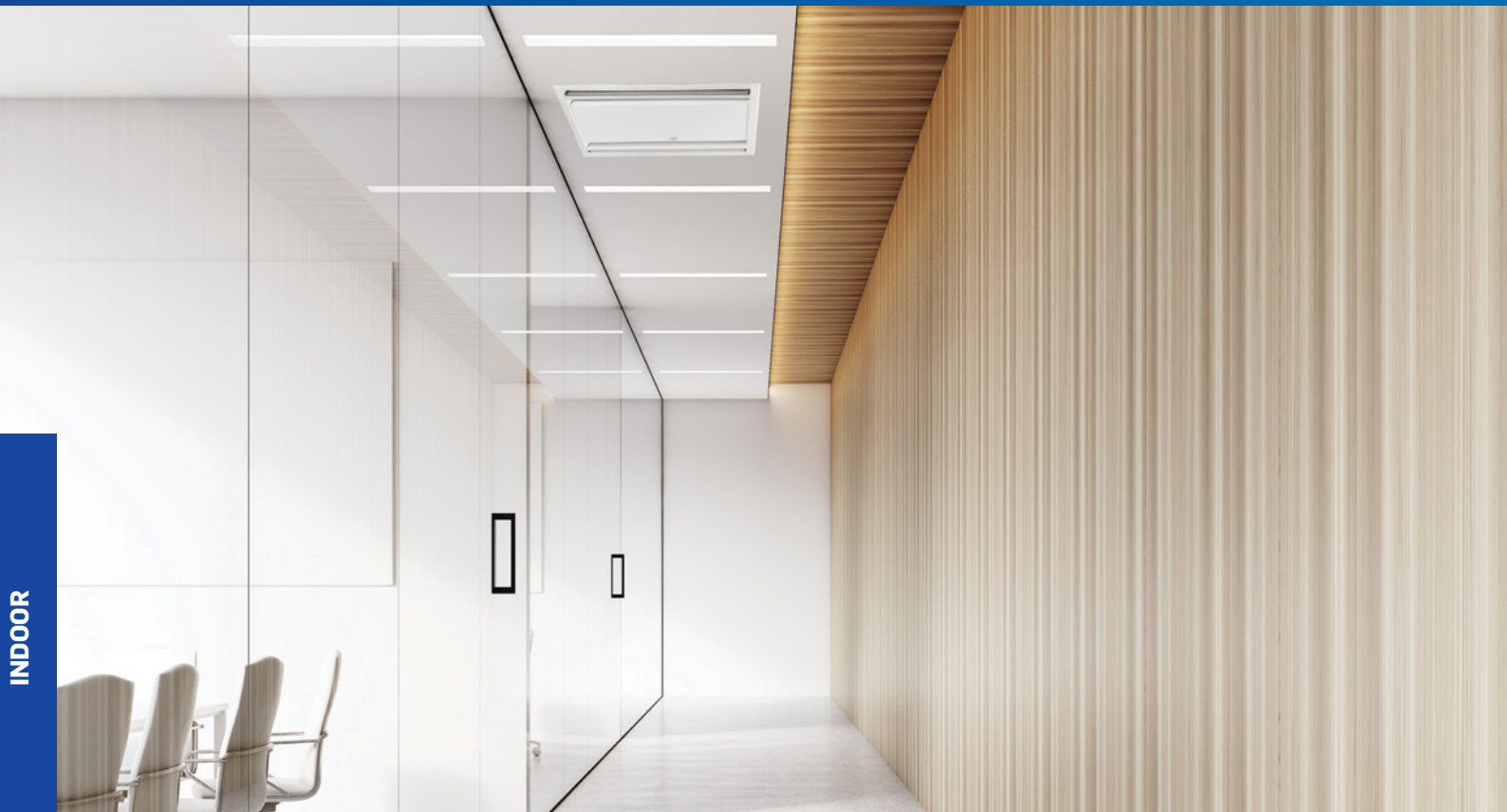

Turn to the experts



INDOOR

## TWO-WAY CASSETTE (AC MOTOR) 40VU\*2-7G

- 
 Compact design: only 220 mm in height  
(When not in use, it closes completely making it appear uniform with the ceiling)
- 
 Built-in drain pump (750 mm)
- 
 Unique ceiling anti-fouling design
- 
 Dual air supply to distribute air in two directions silently



Optional Panel: 40VPU01827GQEE

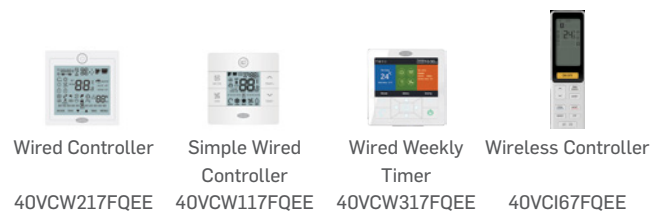



## Specifications



Model Code	Item	Unit	40VU0072-7G-QEE	40VU0092-7G-QEE	40VU0122-7G-QEE	40VU0162-7G-QEE	40VU0182-7G-QEE
Capacity	Model capacity	HP	0,8	1,0	1,25	1,7	2,0
	Cooling	kW	2,2	2,8	3,6	4,5	5,6
	Heating	kW	2,5	3,2	4,0	5,0	6,3
Electrical parameters	Power supply	Ph/V/Hz	1/220-230/50/60	1/220-230/50/60	1/220-230/50/60	1/220-230/50/60	1/220-230/50/60
	Power consumption	W	90	90	90	110	110
Dimensions (W/D/H)	Net Product	mm	817/620/220	817/620/220	817/620/220	817/620/220	817/620/220
	Shipping Product	mm	1015/695/260	1015/695/260	1015/695/260	1015/695/260	1015/695/260
	Net Panel	mm	1055/680/68	1055/680/68	1055/680/68	1055/680/68	1055/680/68
	Shipping Panel	mm	1110/720/160	1110/720/160	1110/720/160	1110/720/160	1110/720/160
Weight	Product Net/Shipping	kg	21/23	21/23	21/23	21/23	21/23
	Panel Net/Shipping	kg	7/8	7/8	7/8	7/8	7/8
Fan	Air flow (H/M/L)	m <sup>3</sup> /h	840/700/550	840/700/550	840/700/550	840/700/550	840/700/550
Pressure sound level	Cooling (H/M/L)	dB(A)	42/37/33	42/37/33	42/37/33	44/39/34	44/39/34
	Heating (H/M/L)	dB(A)	42/37/33	42/37/33	42/37/33	44/39/34	44/39/34
Piping	Refrigerant liquid pipe (Ø)	mm	6,35	6,35	6,35	6,35	6,35
	Refrigerant gas pipe (Ø)	mm	9,52	9,52	12,7	12,7	12,7
	Drain port diameter	mm	32	32	32	32	32
Drain pump	O=optional, S=standard, N=not incl.	/	S	S	S	S	S
Accessories (optional)	Panel model code	/	40VPU01827GQEE	40VPU01827GQEE	40VPU01827GQEE	40VPU01827GQEE	40VPU01827GQEE

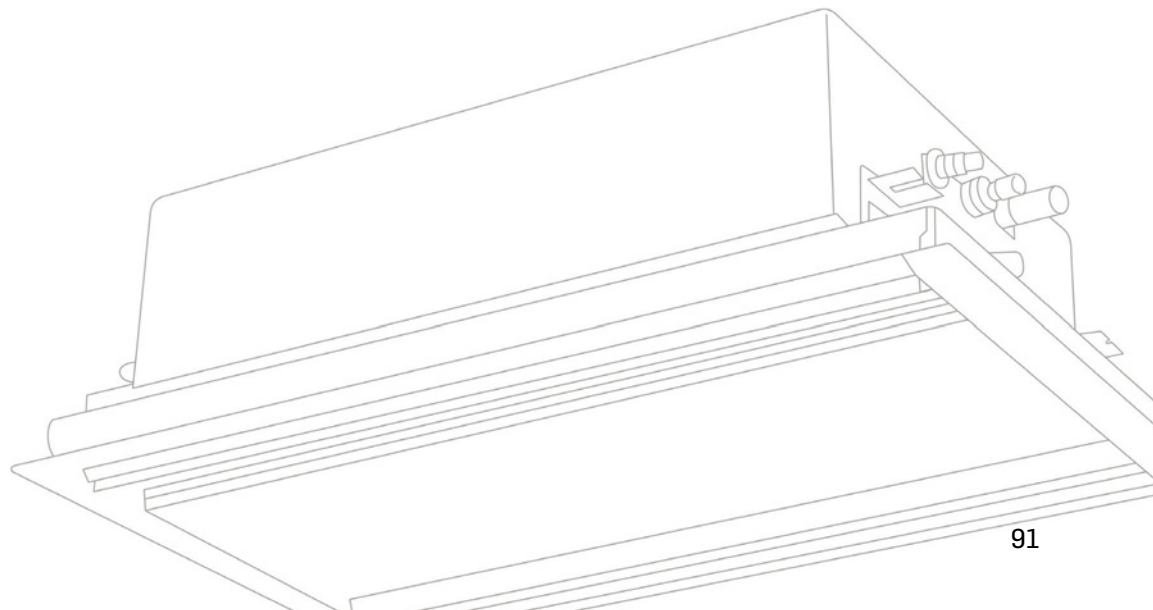



Turn to the experts

INDOOR



## TWO-WAY CASSETTE (AC MOTOR)



### Stylish Design & Slim Body

The stylish appearance and slim body makes the unit blend in harmoniously with the room decor. The sleek body with only 220 mm height, requires minimum ceiling space to be suspended from. Installation being free of storey height, limitations makes the design and decoration much more flexible.

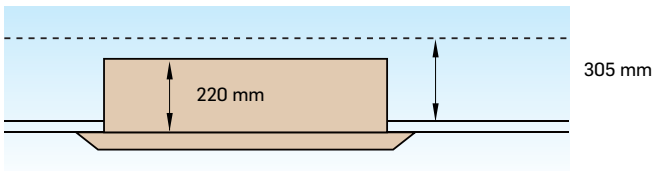

### Standard Built-in Drain Pump

Standard built-in drain pump with 750 mm pump head. Flat-type suction grille design allows ease of maintenance.

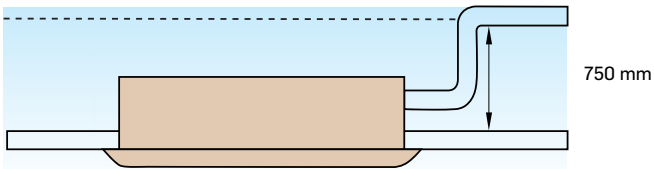





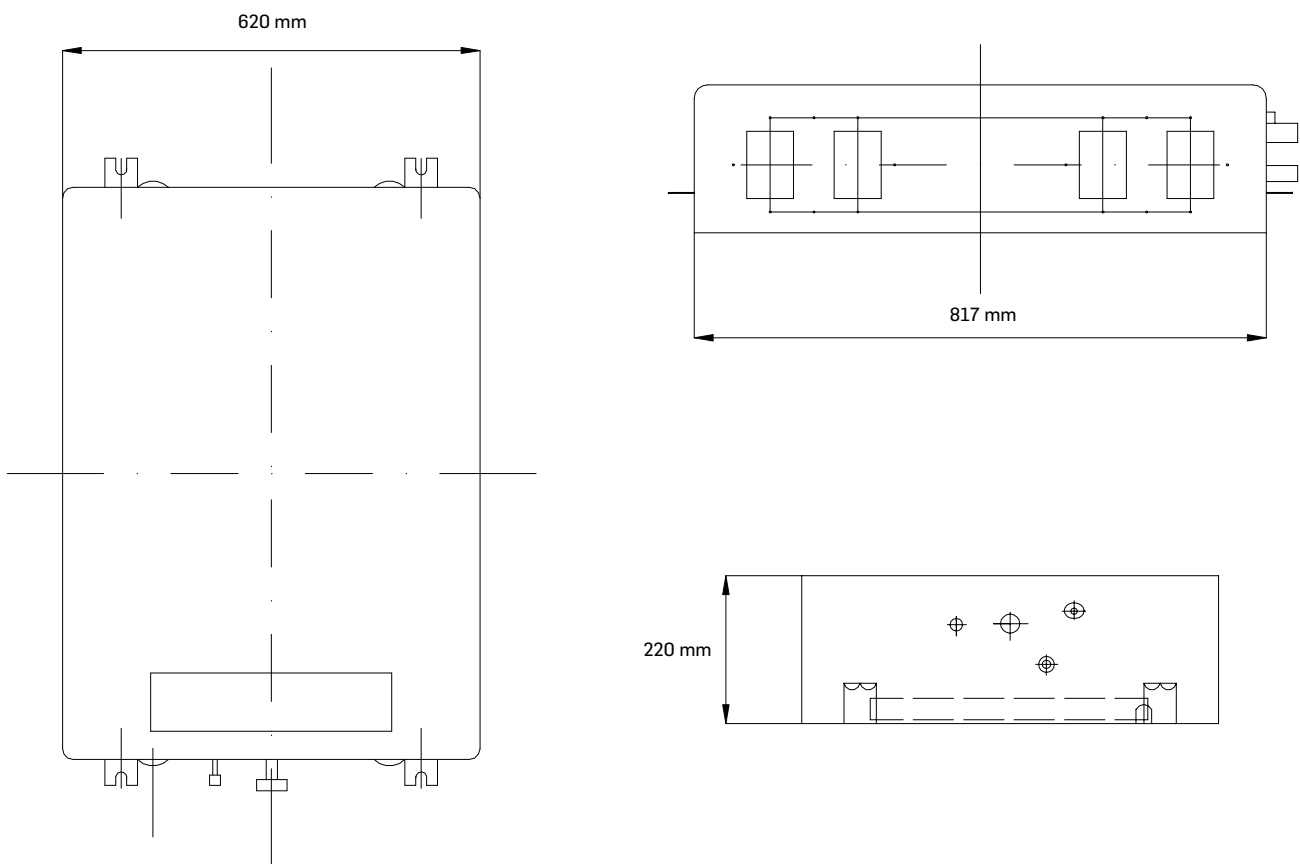

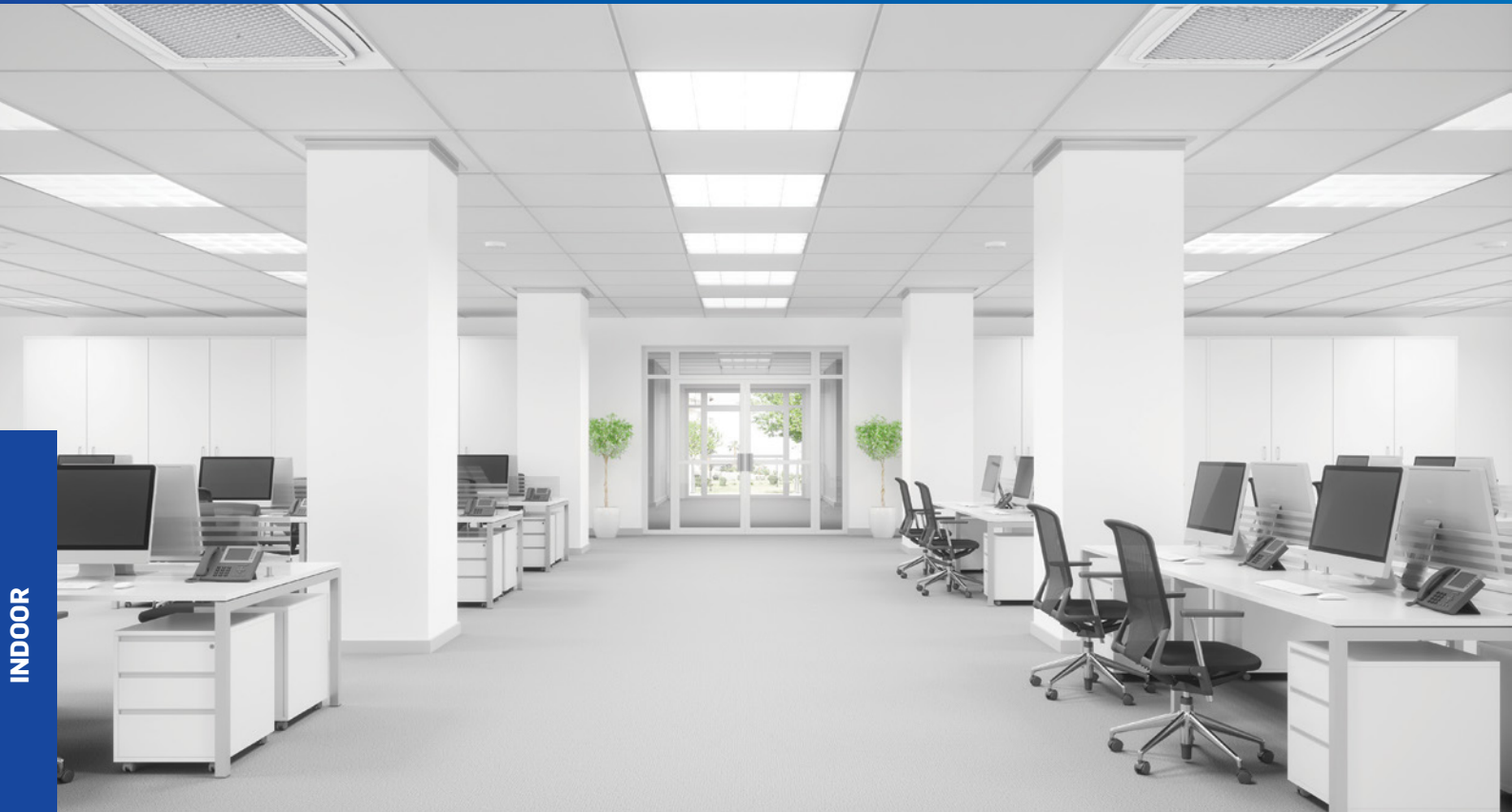

## Dimensions





INDOOR

## COMPACT FOUR-WAY CASSETTE (DC MOTOR) 40VU\*C-7S

- 
**Compact design:** installation restrictions reduced to enable high flexibility  
 Ideal for standard ceiling tiles and small rooms: 570\*570 mm body size and 620\*620 mm panel size
- 
**Built-in drain pump** (600 mm)
- 
**Low sound, high efficiency and comfort**
- 
**Knockout hole for outside air**
- 
**Innovative four-way independent airflow**
- 
**Unit body is insulated from 4 sides to avoid cold bridge effect**



Optional Panel: 40VPU018C7SQEE





## Specifications



Model Code	Item	Unit	40VU005C-7S-QEE	40VU007C-7S-QEE	40VU009C-7S-QEE	40VU012C-7S-QEE	40VU016C-7S-QEE	40VU018C-7S-QEE
Capacity	Model capacity	HP	0,5	0,8	1,0	1,25	1,7	2,0
	Cooling	kW	1,5	2,2	2,8	3,6	4,5	5,6
	Heating	kW	1,7	2,5	3,2	4,0	5,0	6,3
Electrical parameters	Power supply	Ph/V/Hz	1/220-240/50/60	1/220-240/50/60	1/220-240/50/60	1/220-240/50/60	1/220-240/50/60	1/220-240/50/60
	Power consumption	W	17	17	17	18	26	35
Dimensions (W/D/H)	Net Product	mm	570/570/260	570/570/260	570/570/260	570/570/260	570/570/260	570/570/260
	Shipping Product	mm	718/680/380	718/680/380	718/680/380	718/680/380	718/680/380	718/680/380
	Net Panel	mm	620/620/60	620/620/60	620/620/60	620/620/60	620/620/60	620/620/60
	Shipping Panel	mm	660/660/115	660/660/115	660/660/115	660/660/115	660/660/115	660/660/115
Weight	Product Net/Shipping	kg	16/19	16/19	16/19	19/22	19/22	19/22
	Panel Net/Shipping	kg	2,8/4,5	2,8/4,5	2,8/4,5	2,8/4,5	2,8/4,5	2,8/4,5
Fan	Air flow (H/M/L)	m <sup>3</sup> /h	520/450/400	520/450/400	520/450/400	520/450/400	650/520/450	760/650/520
Pressure sound level	Cooling (H/M/L)	dB(A)	32/30/29	32/30/29	32/30/29	33/30/29	33/30/29	34/32/30
	Heating (H/M/L)	dB(A)	32/30/29	32/30/29	32/30/29	33/30/29	33/30/29	34/32/30
Piping	Refrigerant liquid pipe (Ø)	mm	6,35	6,35	6,35	6,35	6,35	6,35
	Refrigerant gas pipe (Ø)	mm	9,52	9,52	9,52	12,7	12,7	12,7
	Drain port diameter	mm	32	32	32	32	32	32
Drain pump	O-optional, S-standard, N-not incl.	/	S	S	S	S	S	S
Accessories (optional)	Panel model code	/	40VPU018C7SQEE	40VPU018C7SQEE	40VPU018C7SQEE	40VPU018C7SQEE	40VPU018C7SQEE	40VPU018C7SQEE

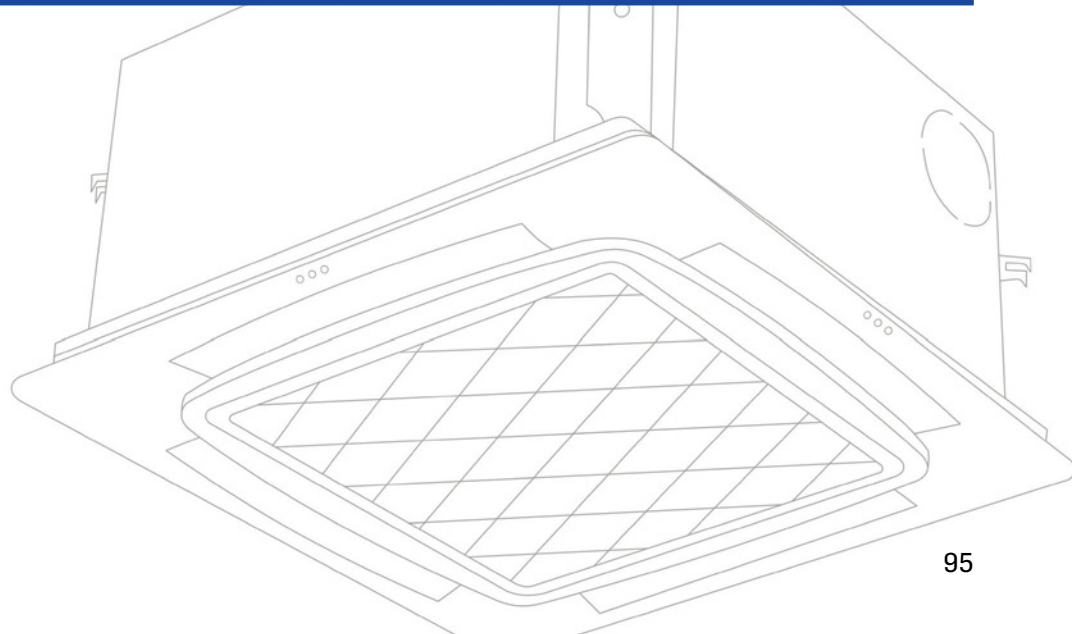



## COMPACT FOUR-WAY CASSETTE (DC MOTOR)

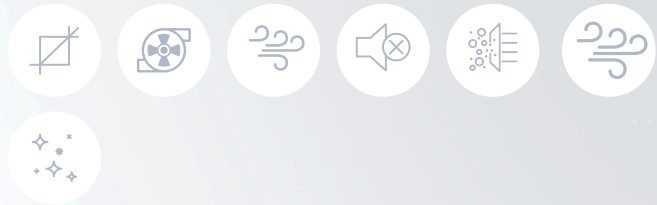

INDOOR

### Compact Design, Easy Installation, Servicing & Maintenance

Extremely compact casing (570 mm in width and 260 mm in depth) makes it match perfectly with the ambience and decor.

Minimum space is required for installation on a shallow ceiling. Due to their compact body and light weight, all models can be installed without a hoist.

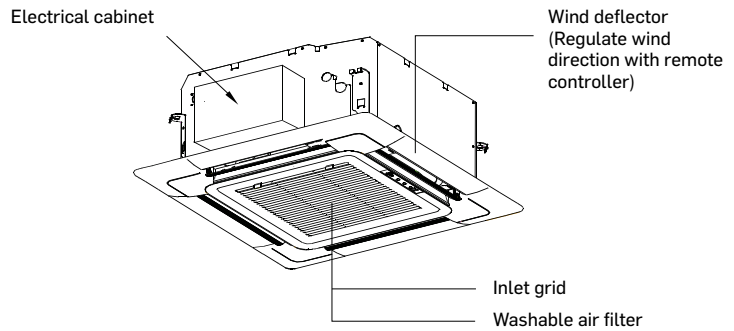
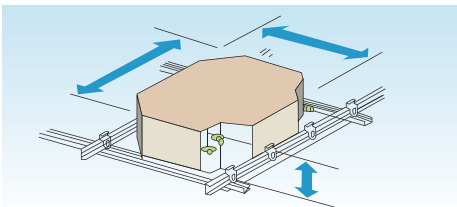

### Easy Servicing & Maintenance

- Easy removal of air filters for cleaning
- Easy access to indoor unit components

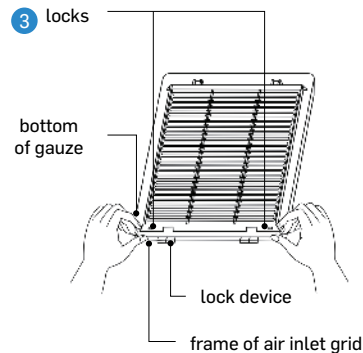
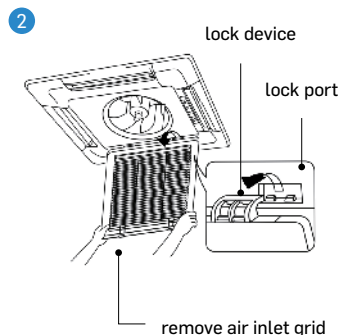
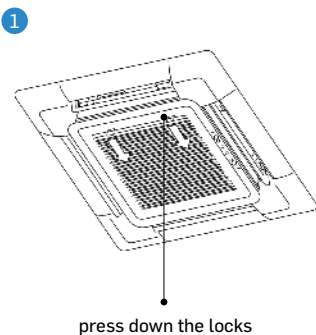





### Standard Built-in Drain Pump

Standard fitting drain pump with 600 mm pump head

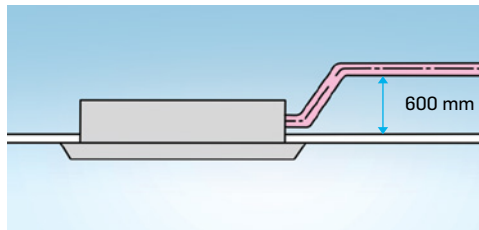

INDOOR

### Dimensions

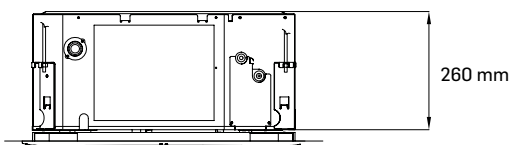
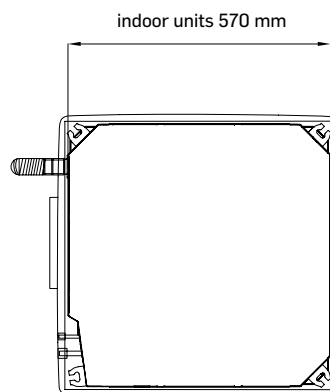
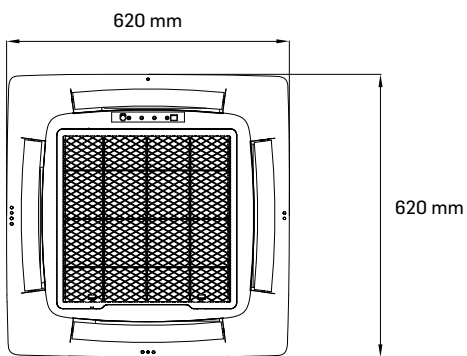

# ROUND-WAY CASSETTE (DC MOTOR) 40VU\*R-7E

- Round corner design. Unique round-way air outlet and air distribution to reduce blind spots
- DC powered fan with low sound and high efficiency
- Built-in drain pump (600 mm)
- Innovative four-way independent airflow control, 6 adjustable lower positions and 1296 air flow combinations
- Upto 4.2 m ceiling height with a large capacity
- Automatic display of fault codes and setpoint temperature
- T-shaped lifting eye with adjustable width and length direction for your convenience
- Fresh air inlet
- The unit body is insulated on 4 sides to avoid cold bridge effect



Optional Panel: 40VPU054R7EQEE

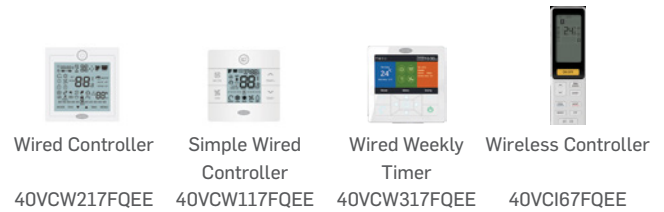

INDOOR

## Specifications



Model Code	Item	Unit	40VU007R-7E-QEE	40VU009R-7E-QEE	40VU012R-7E-QEE	40VU016R-7E-QEE	40VU018R-7E-QEE	40VU024R-7E-QEE
Capacity	Model capacity	HP	0,8	1,0	1,25	1,7	2,0	2,5
	Cooling	kW	2,2	2,8	3,6	4,5	5,6	7,1
	Heating	kW	2,5	3,2	4,0	5,0	6,3	8,0
Electrical parameters	Power supply	Ph/V/Hz	1/220-230/50/60	1/220-230/50/60	1/220-230/50/60	1/220-230/50/60	1/220-230/50/60	1/220-230/50/60
	Power consumption	W	30	30	30	30	30	50
Dimensions (W/D/H)	Net Product	mm	840/840/183	840/840/183	840/840/183	840/840/183	840/840/183	840/840/204
	Shipping Product	mm	983/983/268	983/983/268	983/983/268	983/983/268	983/983/268	983/983/290
	Net Panel	mm	950/950/50	950/950/50	950/950/50	950/950/50	950/950/50	950/950/50
	Shipping Panel	mm	1013/1025/123	1013/1025/123	1013/1025/123	1013/1025/123	1013/1025/123	1013/1025/123
Weight	Product Net/Shipping	kg	25/28	25/28	25/28	25/28	25/28	27/30
	Panel Net/Shipping	kg	6,5/9	6,5/9	6,5/9	6,5/9	6,5/9	6,5/9
Fan	Air flow (H/M/L)	m³/h	1000/810/620	1000/810/620	1000/810/620	1000/810/620	1000/810/620	1380/1190/1000
	Pressure sound level							
Pressure sound level	Cooling (H/M/L)	dB(A)	30/27/25	30/27/25	30/27/25	32/29/27	33/30/29	35/34/31
	Heating (H/M/L)	dB(A)	30/27/25	30/27/25	30/27/25	32/29/27	33/30/29	35/34/31
Piping	Refrigerant liquid pipe (Ø)	mm	6,35	6,35	6,35	6,35	6,35	9,52
	Refrigerant gas pipe (Ø)	mm	9,52	9,52	12,7	12,7	12,7	15,88
	Drain port diameter	mm	25	25	25	25	25	25
Drain pump	O-optional, S-standard, N-not incl.	/	S	S	S	S	S	S
Accessories (optional)	Panel Model Code - Standard	/	40VPU054R7EQEE	40VPU054R7EQEE	40VPU054R7EQEE	40VPU054R7EQEE	40VPU054R7EQEE	40VPU054R7EQEE
	Panel Model Code with Presence Sensor	Additional Feature	40VPU054A7EQEE	40VPU054A7EQEE	40VPU054A7EQEE	40VPU054A7EQEE	40VPU054A7EQEE	40VPU054A7EQEE



## Specifications

**HEATING**

**COOLING**

Model Code	Item	Unit	40VU028R-7E-QEE	40VU030R-7E-QEE	40VU038R-7E-QEE	40VU048R-7E-QEE	40VU054R-7E-QEE
Capacity	Model capacity	HP	3,0	3,2	4,0	5,0	6,0
	Cooling	kW	8,0	9,0	11,2	14,0	16,0
	Heating	kW	9,0	10,0	12,5	16,0	18,0
Electrical parameters	Power supply	Ph/V/Hz	1/220~230/50/60	1/220~230/50/60	1/220~230/50/60	1/220~230/50/60	1/220~230/50/60
	Power consumption	W	50	90	90	110	110
Dimensions (W/D/H)	Net Product	mm	840/840/204	840/840/246	840/840/246	840/840/288	840/840/288
	Shipping Product	mm	983/983/290	983/983/331	983/983/331	983/983/373	983/983/373
	Net Panel	mm	950/950/50	950/950/50	950/950/50	950/950/50	950/950/50
	Shipping Panel	mm	1013/1025/123	1013/1025/123	1013/1025/123	1013/1025/123	1013/1025/123
Weight	Product Net/Shipping	kg	27/30	31/36	31/36	33/38	33/38
	Panel Net/Shipping	kg	6.5/9	6.5/9	6.5/9	6.5/9	6.5/9
Fan	Air flow (H/M/L)	m³/h	1380/1190/1000	2050/1860/1670	2050/1860/1670	2100/1910/1720	2100/1910/1720
Pressure sound level	Cooling (H/M/L)	dB(A)	37/35/31	37/35/31	37/35/31	44/40/36	44/40/36
	Heating (H/M/L)	dB(A)	37/35/31	37/35/31	37/35/31	44/40/36	44/40/36
Piping	Refrigerant liquid pipe (Ø)	mm	9,52	9,52	9,52	9,52	9,52
	Refrigerant gas pipe (Ø)	mm	15,88	15,88	15,88	15,88	15,88
	Drain port diameter	mm	25	25	25	25	25
Drain pump	O-optional, S-standard, N-not incl.	/	S	S	S	S	S
Accessories (optional)	Panel Model Code - Standard	/	40VPU054R7EQEE	40VPU054R7EQEE	40VPU054R7EQEE	40VPU054R7EQEE	40VPU054R7EQEE
	Panel Model Code with Presence Sensor	Additional Feature	40VPU054A7EQEE	40VPU054A7EQEE	40VPU054A7EQEE	40VPU054A7EQEE	40VPU054A7EQEE



## ROUND-WAY CASSETTE (DC MOTOR)



### Standard Built-in Drain Pump

Standard built-in drain pump can take the condensed water up to 600 mm which allows easier installation of the drain pipe system.

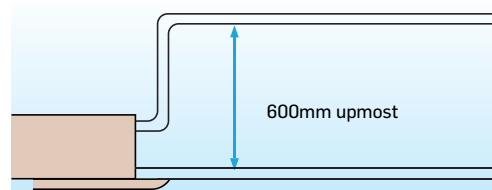

### Smart Self Diagnostic Function

By adding digital tube displayer on the display board, the error codes can be displayed directly for trouble shooting.



### Save Energy

Optional panel with presence sensor

- IDU automatically turns on when it detects human presence
- automatically switches off when no human presence is detected

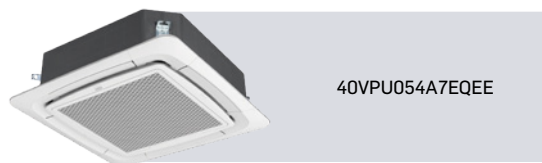

### Easy Servicing & Maintenance

- Easy removal of air filter for cleaning
- Remote on/off function and alarm function
- Easy access to indoor unit components

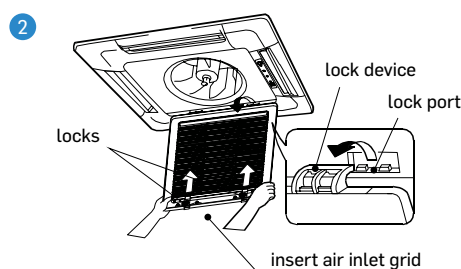
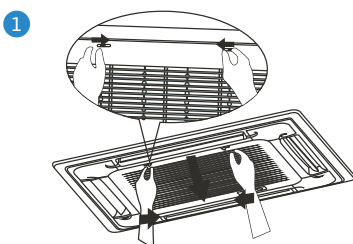

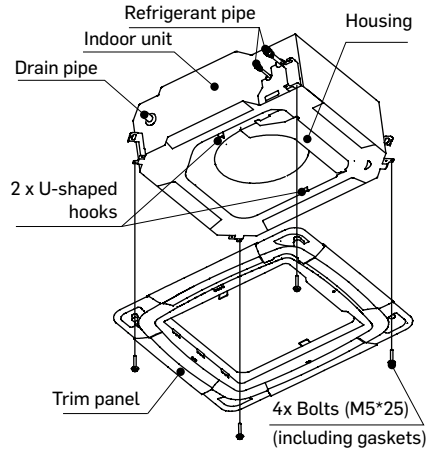
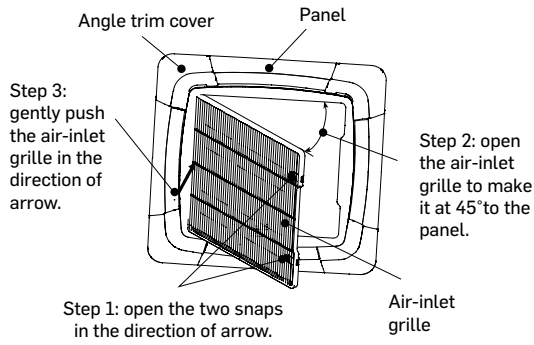

## Dimensions

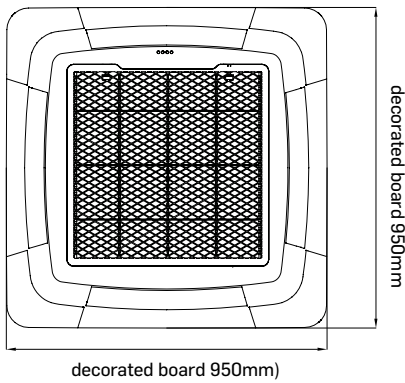
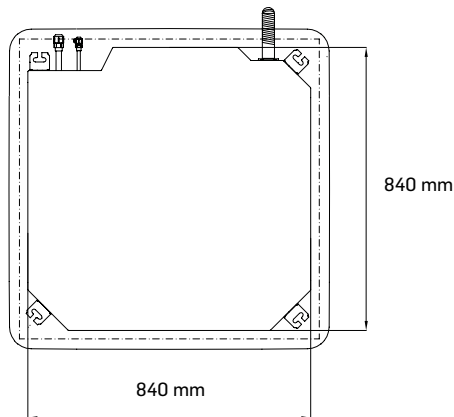

40VU007/009/012/016/018R-7E-QEE

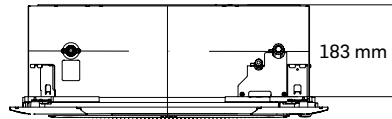

40VU024/028R-7E-QEE

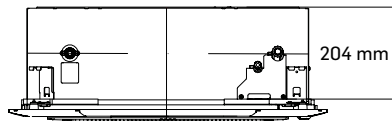

40VU030/038R-7E-QEE

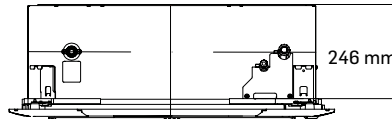

40VU048/054R-7E-QEE

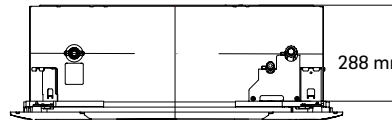



Turn to the experts

INDOOR

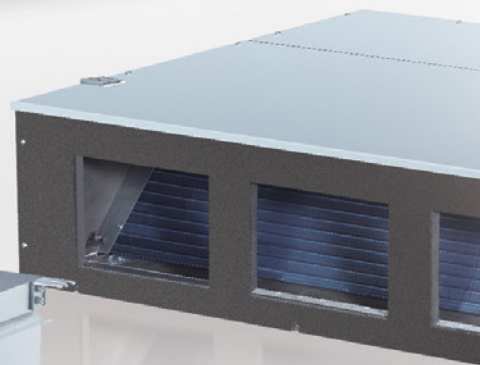

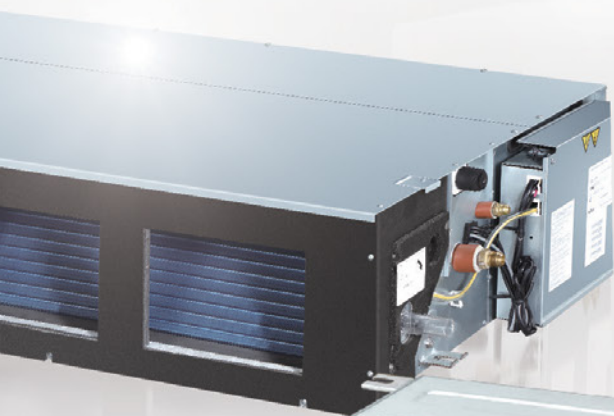

INDOOR

# SLIM DUCT

## (DC MOTOR 0/15/30 PA) 40VD\*L-7E

- Ultra-thin design: 185 mm height to accommodate in limited space
- DC motor with six fan speed settings provides comfort control according to convenience
- Built-in drain pump
- Bottom or rear air return
- Static pressure setting 0/30 Pa
- Can be installed with or without discharge & return plenum
- Drainage connection available on both sides to adapt to any building configuration
- Optional panel available

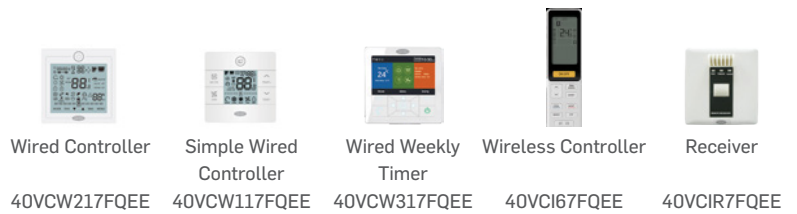

INDOOR

### Specifications



Model Code	Item	Unit	40VD005L-7E-QEE	40VD007L-7E-QEE	40VD009L-7E-QEE	40VD012L-7E-QEE
Capacity	Model capacity	HP	0,5	0,8	1,0	1,25
	Cooling	kW	1,5	2,2	2,8	3,6
	Heating	kW	1,7	2,5	3,2	4,0
Electrical parameters	Power supply	Ph/V/Hz	1/220-230/50/60	1/220-230/50/60	1/220-230/50/60	1/220-230/50/60
	Power consumption	W	18	18	18	31
Dimensions (W/D/H)	Net Product	mm	850/420/185	850/420/185	850/420/185	850/420/185
	Shipping Product	mm	1045/540/270	1045/540/270	1045/540/270	1045/540/270
	Net Panel	mm	890/190/100 (outlet panel) 890/290.5/32.4 (inlet panel)	890/190/100 (outlet panel) 890/290.5/32.4 (inlet panel)	890/190/100 (outlet panel) 890/290.5/32.4 (inlet panel)	890/190/100 (outlet panel) 890/290.5/32.4 (inlet panel)
	Shipping Panel (inlet/outlet)	mm	938/335/220	938/335/220	938/335/220	938/335/220
Weight	Product Net/Shipping	kg	16.5/21.5	17.5/22.5	17.5/22.5	17.5/22.5
	Panel Net (In-Out)/Shipping (In-Out)	kg	4/5	4/5	4/5	4/5
External static pressure	Standard	Pa	15	15	15	15
	Maximum	Pa	30	30	30	30
Fan	Air flow (H/M/L)	m³/h	430/370/310	480/420/360	480/420/360	550/430/370
Pressure sound level	Cooling (H/M/L)	dB(A)	26/22/19	27/23/20	27/23/20	30/27/24
	Heating (H/M/L)	dB(A)	26/22/19	27/23/20	27/23/20	30/27/24
Piping	Refrigerant liquid pipe (Ø)	mm	6,35	6,35	6,35	6,35
	Refrigerant gas pipe (Ø)	mm	9,52	9,52	9,52	12,7
	Drain port diameter	mm	25	25	25	25
Drain pump	O-optional, S-standard, N-not incl.	/	S	S	S	S
Accessories (optional)	Panel model code	/	40VPD016L7EQEE	40VPD016L7EQEE	40VPD016L7EQEE	40VPD016L7EQEE





INDOOR

## Specifications



HEATING



COOLING

Model Code	Item	Unit	40VD016L-7E-QEE	40VD018L-7E-QEE	40VD024L-7E-QEE
Capacity	Model capacity	HP	1,7	2,0	3,0
	Cooling	kW	4,5	5,6	7,1
	Heating	kW	5,0	6,3	8,0
Electrical parameters	Power supply	Ph/V/Hz	1/220~230/50/60	1/220~230/50/60	1/220~230/50/60
	Power consumption	W	35	40	50
Dimensions (W/D/H)	Net Product	mm	850/420/185	1170/420/185	1170/420/185
	Shipping Product	mm	1045/540/270	1365/540/270	1365/540/270
	Net Panel	mm	890/190/100 (outlet panel) 890/290.5/32.4 (inlet panel)	1210/190/100 (outlet panel) 1210/290.5/32.4 (inlet panel)	1210/190/100 (outlet panel) 1210/290.5/32.4 (inlet panel)
	Shipping Panel (inlet/outlet)	mm	938/335/220	1258/335/220	1258/335/220
Weight	Product Net/Shipping	kg	18.5/23.5	22.2/28.2	24/30
	Panel Net (In-Out)/Shipping (In-Out)	kg	4/5	5/6	5/6
External static pressure	Standard	Pa	15	15	15
	Maximum	Pa	30	30	30
Fan	Air flow (H/M/L)	m <sup>3</sup> /h	600/540/460	800/690/580	930/850/750
Pressure sound level	Cooling (H/M/L)	dB(A)	32/29/26	33/30/27	36/33/30
	Heating (H/M/L)	dB(A)	32/29/26	33/30/27	36/33/30
Piping	Refrigerant liquid pipe (Ø)	mm	6,35	6,35	9,52
	Refrigerant gas pipe (Ø)	mm	12,7	12,7	15,88
	Drain port diameter	mm	25	25	25
Drain pump	O-optional, S-standard, N-not incl.	/	S	S	S
Accessories (optional)	Panel model code	/	40VPD016L7EQEE	40VPD024L7EQEE	40VPD024L7EQEE



## SLIM DUCT (DC MOTOR – 0/15-30 Pa)



INDOOR

### Slim, Light Weight & Compact

The compact design is 185mm in height and is ideal for installation where space above the ceiling is limited.

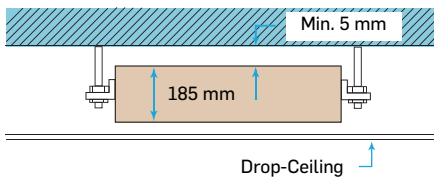

### Built-in Drain Pump

Built-in drain pump (600 mm pump head)

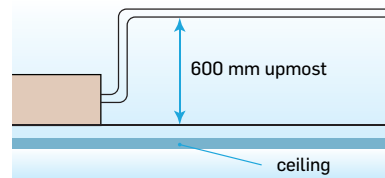

### Easy Installation

Optional outlet & inlet panels are available



Model Codes	Outlet Panel Dimensions (WxHxD)	Inlet Panel Dimensions (WxHxD)	Shipping Panel (inlet - Outlet)
Up to 40VPD016L7EQEE	890x190x100 mm	890x291x32 mm	938x335x220 mm
40VPD018-024L7EQEE	1210x190x100 mm	1210x291x32 mm	1258x335x220 mm



## Installation Modes

This series of air conditioners can be arranged in two air return modes:

1. Backward air return (factory default);
2. Downward air return (can be adjusted on site. See the following figures.)

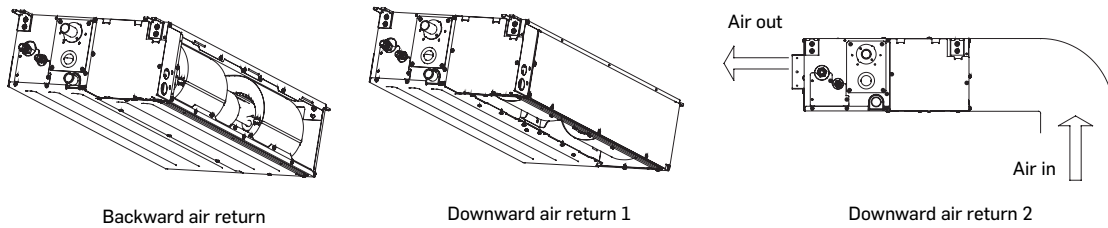

Note: the downward air return mode would increase noise to 3-5 dB(A). It is recommended to install the air conditioner in downward air return mode 2 if enough space is available.

## Dimensions

40VD005/007/009/012/016L-7E-QEE

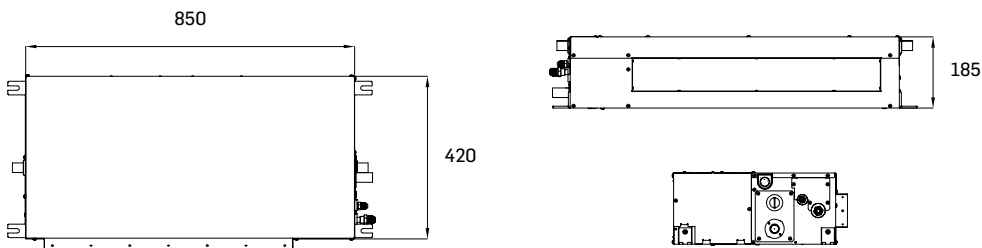

40VD018/024L-7E-QEE

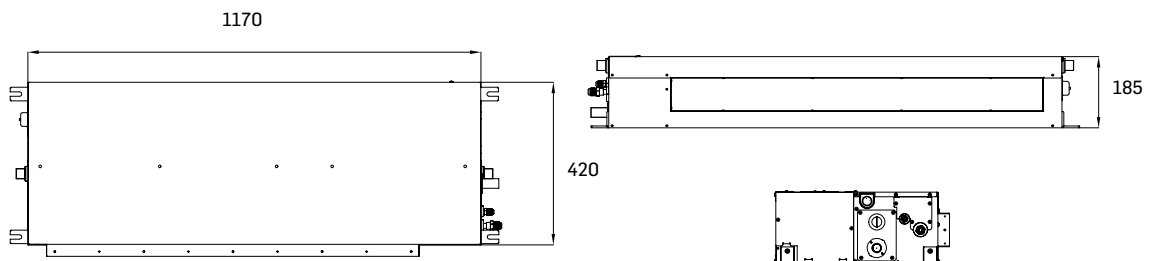

# STANDARD STATIC DUCT (DC MOTOR 20/200 Pa) 40VD\*S-7S



- Elegant slim design with T-shaped lifting eye with adjustable width and length in direction for your convenience
- Hidden installation for a clean and sophisticated appearance
- Standard draining pump with maximum 700 mm lift
- Reserve outside air inlet that helps improve indoor air quality
- High-quality sealing pipe liner made of heat-retaining EPS material
- Installation markers for easy installation



Wired Controller  
40VCW217FQEE



Simple Wired Controller  
40VCW117FQEE



Wired Weekly Timer  
40VCW317FQEE



Wireless Controller  
40VCI67FQEE



Receiver  
40VICR7FQEE

INDOOR

## Specifications



HEATING



COOLING

Model Code	Item	Unit	40VD005S-7S-QEE	40VD007S-7S-QEE	40VD009S-7S-QEE	40VD012S-7S-QEE	40VD016S-7S-QEE	40VD018S-7S-QEE
Capacity	Model capacity	HP	0.5	0.8	1.0	1.25	1.7	2.0
	Cooling	kW	1.5	2.2	2.8	3.6	4.5	5.6
	Heating	kW	1.7	2.5	3.2	4.0	5.0	6.3
Electrical parameters	Power supply	Ph/V/Hz	1/220-240/50/60	1/220-240/50/60	1/220-240/50/60	1/220-240/50/60	1/220-240/50/60	1/220-240/50/60
	Power consumption	W	27	29	29	31	50	37
Dimensions (W/D/H)	Net Product	mm	700/700/248	700/700/248	700/700/248	700/700/248	700/700/248	1100/700/248
	Shipping Product	mm	932/835/280	932/835/280	932/835/280	932/835/280	932/835/280	1332/835/280
Weight	Product Net/Shipping	kg	27/32	27/32	27/32	27/32	28.5/33.5	36.8/43.4
External static pressure	Standard	Pa	20	20	20	20	20	20
	Maximum	Pa	200	200	200	200	200	200
Fan	Air flow (H/M/L)	m <sup>3</sup> /h	515/440/390	545/470/390	545/470/390	570/495/420	700/625/550	915/765/640
Pressure sound level	Cooling (H/M/L)	dB(A)	29/27/25	30/28/25	30/28/25	31/29/27	32/30/28	33/31/29
	Heating (H/M/L)	dB(A)	29/27/25	30/28/25	30/28/25	31/29/27	32/30/28	33/31/29
Piping	Refrigerant liquid pipe (Ø)	mm	6.35	6.35	6.35	6.35	6.35	6.35
	Refrigerant gas pipe (Ø)	mm	9.52	9.52	9.52	12.7	12.7	12.7
	Drain port diameter	mm	25	25	25	25	25	25
Drain pump	O-optional, S-standard, N-not incl.	/	S	S	S	S	S	S

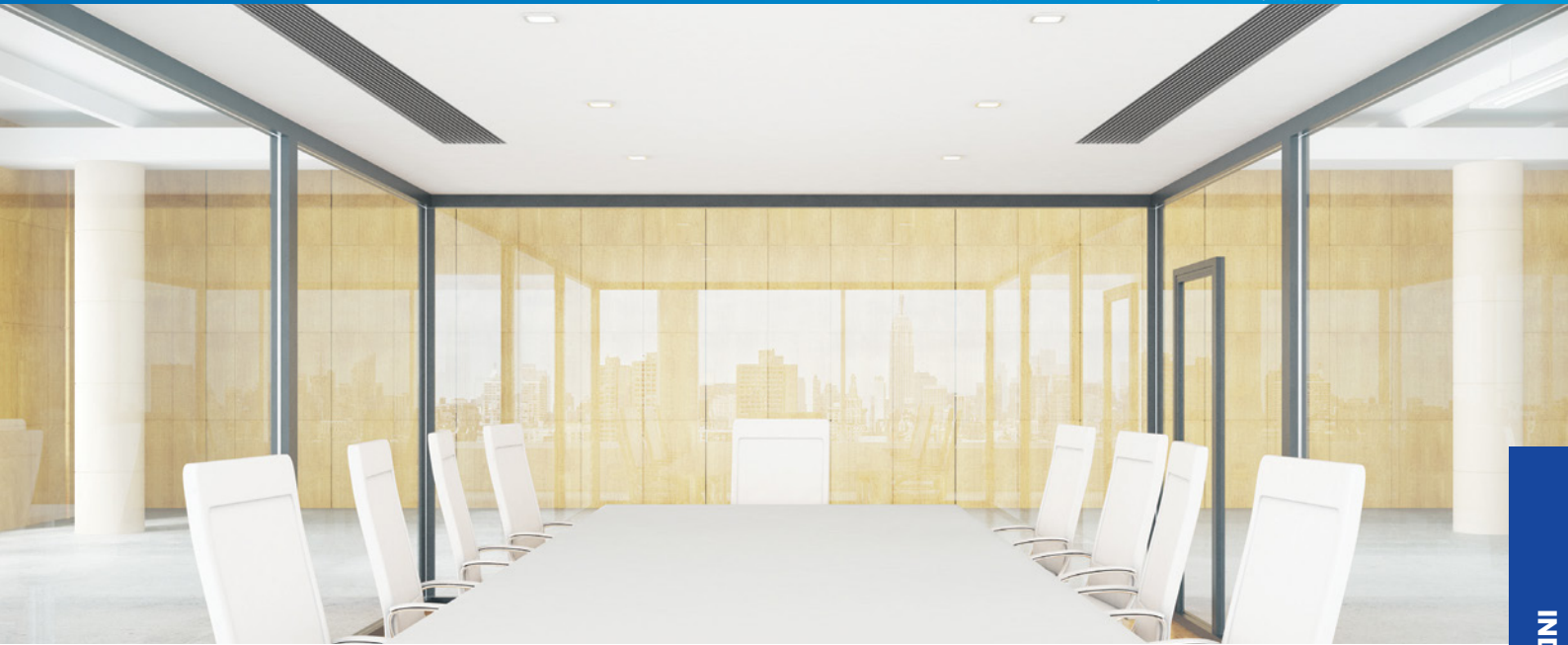

## Specifications

**HEATING**

**COOLING**

Model Code	Item	Unit	40VD024S-7S-QEE	40VD028S-7S-QEE	40VD030S-7S-QEE	40VD038S-7S-QEE	40VD048S-7S-QEE	40VD054S-7S-QEE
Capacity	Model capacity	HP	2.5	3.0	3.2	4.0	5.0	6.0
	Cooling	kW	7.1	8.0	9.0	11.2	14.0	16.0
	Heating	kW	8.0	9.0	10.0	13.0	16.3	18.0
Electrical parameters	Power supply	Ph/V/Hz	1/220-240/50/60	1/220-240/50/60	1/220-240/50/60	1/220-240/50/60	1/220-240/50/60	1/220-240/50/60
	Power consumption	W	68	68	94	124	156	194
Dimensions (W/D/H)	Net Product	mm	1100/700/248	1100/700/248	1100/700/248	1500/700/248	1500/700/248	1500/700/248
	Shipping Product	mm	1332/835/280	1332/835/280	1332/835/280	1698/857/305	1698/857/305	1698/857/305
Weight	Product Net/Shipping	kg	36.8/43.4	36.8/43.4	39.4/45.4	48.3/56.5	51.3/59.5	51.3/59.5
External static pressure	Standard	Pa	20	20	20	20	20	20
	Maximum	Pa	200	200	180	180	180	180
Fan	Air flow (H/M/L)	m <sup>3</sup> /h	1275/1050/875	1275/1050/875	1450/1200/1000	2000/1700/1400	2150/1750/1400	2350/1950/1600
Pressure sound level	Cooling (H/M/L)	dB(A)	34/31/29	35/33/30	36/33/30	38/35/32	40/36/32	42/38/34
	Heating (H/M/L)	dB(A)	34/31/29	35/33/30	36/33/30	38/35/32	40/36/32	42/38/34
Piping	Refrigerant liquid pipe (Ø)	mm	9,52	9,52	9,52	9,52	9,52	9,52
	Refrigerant gas pipe (Ø)	mm	15,88	15,88	15,88	15,88	15,88	15,88
	Drain port diameter	mm	25	25	25	25	25	25
Drain pump	O-optional, S-standard, N-not incl.	/	S	S	S	S	S	S



## STANDARD STATIC DUCT (DC MOTOR – 20/200 Pa)



### Slim & Compact Design

The compact design is 248 mm in height and is ideal for installation where space above the ceiling is limited.

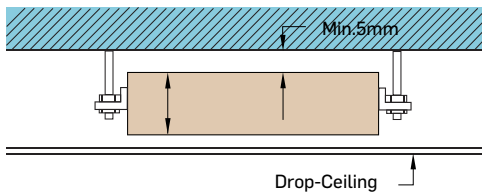

### Built-in Drain Pump

Built-in drain pump (700mm pump head)

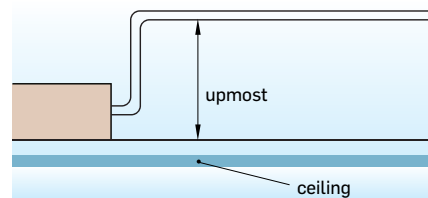

### Standard Static Duct

- Flexible Bottom or Rear Air Return

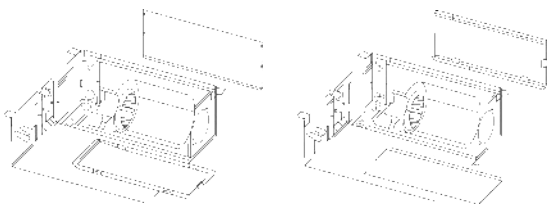

Back air return opening

Below air return opening

- Fixation adjustment  
Width and length direction can be adjusted for more convenience

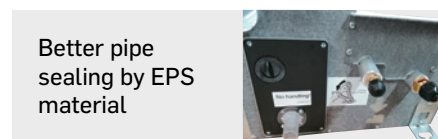
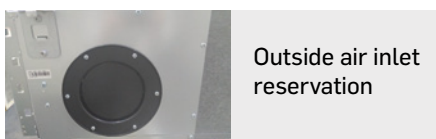



## Dimensions

40VD005S-7S-QEE/40VD007S-7S-QEE/40VD009S-7S-QEE/40VD012S-7S-QEE/40VD016S-7S-QEE

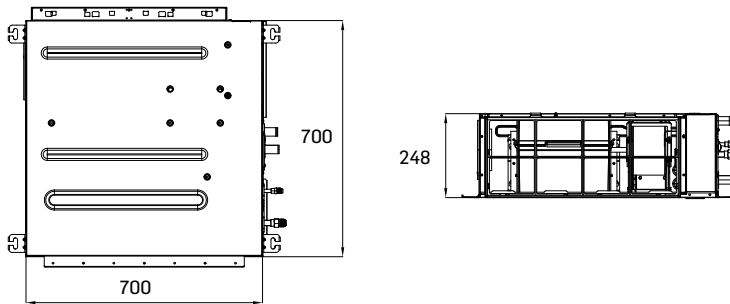

40VD018S-7S-QEE/40VD024S-7S-QEE/40VD028S-7S-QEE/40VD030S-7S-QEE

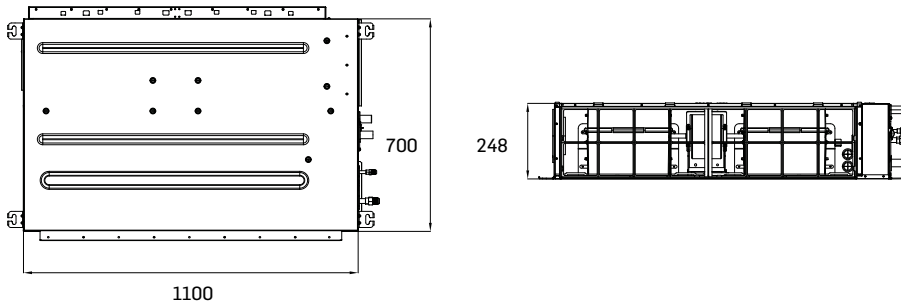

40VD038S-7S-QEE/40VD048S-7S-QEE/40VD054S-7S-QEE

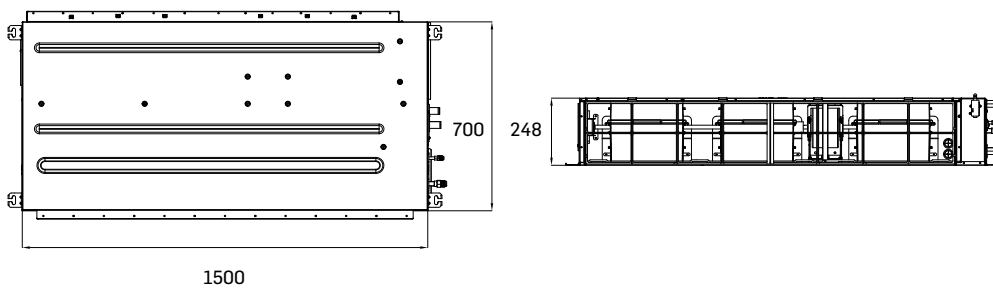

# HIGH STATIC DUCT (DC MOTOR 0/250 PA) 40VD\*H-7S

- Wide range of capacities covered from 2.2 kW to 28 kW with compact 280 mm height
- High-efficiency, low energy consumption DC motor
- 6.35 mm coil copper pipe to ensure precise & efficient refrigerant distribution
- Top-performing composite material fan wheel blower with light air resistance
- ESP can be changed according to requirements to minimize the noise
- Installer-friendly buckle design of electric box & pull-out fan motor design
- Built-in drain pump (for models up to 6 HP)
- Up to 250 Pa ESP

40VD007H/054H-7S-QEE

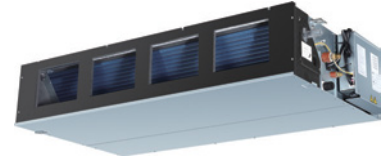

40VD072H/096H-7S-QEE



Wired Controller

40VCW217FQEE



Simple Wired Controller

40VCW117FQEE



Wired Weekly Timer

40VCW317FQEE



Wireless Controller

40VCI67FQEE



Receiver

40VCIR7FQEE

## Specifications



Model Code	Item	Unit	40VD007H-7S-QEE	40VD009H-7S-QEE	40VD012H-7S-QEE	40VD015H-7S-QEE	40VD018H-7S-QEE	40VD024H-7S-QEE	40VD028H-7S-QEE
Capacity	Model capacity	HP	0,8	1,0	1,25	1,7	2,0	2,5	3,0
	Cooling	kW	2,2	2,8	3,6	4,5	5,6	7,1	8,0
	Heating	kW	2,5	3,2	4,0	5,0	6,3	8,0	9,0
Electrical parameters	Power supply	Ph/V/Hz	1/220-240/50(60)	1/220-240/50(60)	1/220-240/50(60)	1/220-240/50(60)	1/220-240/50(60)	1/220-240/50(60)	1/220-240/50(60)
	Power consumption	W	120	120	181	181	181	252.3	259.3
Dimensions (W/D/H)	Net Product	mm	750/635/280	750/635/280	750/635/280	750/635/280	750/635/280	950/635/280	950/635/280
	Shipping Product	mm	980/740/335	980/740/335	980/740/335	980/740/335	980/740/335	1180/740/335	1180/740/335
Weight	Product Net/Shipping	kg	29/35	29/35	29/35	29/35	29/35	34/41	34/41
External static pressure	Standard	Pa	0-200	0-200	0-200	0-200	0-200	0-200	0-200
	Maximum	Pa	200	200	200	200	200	200	200
Fan	Air flow (H/M/L)	m <sup>3</sup> /h	500/410/360	600/510/450	700/580/500	780/680/600	900/780/600	1100/1020/920	1500/1320/1220
Pressure sound level	Cooling (H/M/L)	dB(A)	30/25/23	30/25/23	32/29/26	32/29/26	32/29/26	33/29/25	33/29/25
	Heating (H/M/L)	dB(A)	30/25/23	30/25/23	32/29/26	32/29/26	32/29/26	33/29/25	33/29/25
Piping	Refrigerant liquid pipe (Ø)	mm	6,35	6,35	6,35	6,35	6,35	9,52	9,52
	Refrigerant gas pipe (Ø)	mm	9,52	9,52	12,7	12,7	12,7	15,88	15,88
	Drain port diameter	mm	31,5	31,5	31,5	31,5	31,5	31,5	31,5
Drain pump	O-optional, S-standard, N-not incl.	/	S	S	S	S	S	S	S





INDOOR

## Specifications



HEATING



COOLING

Model Code	Item	Unit	40VD030H-7S-QEE	40VD036H-7S-QEE	40VD048H-7S-QEE	40VD054H-7S-QEE	40VD072H-7S-QEE	40VD096H-7S-QEE
Capacity	Model capacity	HP	3,2	4,0	5,0	6,0	8	10
	Cooling	kW	9,0	11,2	14,0	16,0	22,4	28
	Heating	kW	10,0	12,5	16,0	18,0	25	31
Electrical parameters	Power supply	Ph/V/Hz	1/220-240/50(60)	1/220-240/50(60)	1/220-240/50(60)	1/220-240/50(60)	1/220-240/50(60)	1/220-240/50(60)
	Power consumption	W	259.3	315.6	366.8	366.8	645	950
Dimensions (W/D/H)	Net Product	mm	950/635/280	1370/740/280	1370/740/280	1370/740/280	1330/895/500	1330/895/500
	Shipping Product	mm	1180/740/335	1555/839/380	1555/839/380	1555/839/380	1590/1087/690	1590/1087/690
Weight	Product Net/Shipping	kg	34/41	54/68	54/68	54/68	103/146	103/146
External static pressure	Standard	Pa	0-200	0-200	0-200	0-200	100	100
	Maximum	Pa	200	200	200	200	250	250
Fan	Air flow (H/M/L)	m <sup>3</sup> /h	1500/1320/1220	1700/1510/1400	2280/1920/1780	2280/1920/1780	4200/3500/2900	5200/4300/3500
Pressure sound level	Cooling (H/M/L)	dB(A)	33/29/25	38/36/30	40/34/29	40/34/29	55/51/47	62/58/54
	Heating (H/M/L)	dB(A)	33/29/25	38/36/30	40/34/29	40/34/29	55/51/47	62/58/54
Piping	Refrigerant liquid pipe (Ø)	mm	9,52	9,52	9,52	9,52	12,7	12,7
	Refrigerant gas pipe (Ø)	mm	15,88	15,88	15,88	15,88	22,22	22,22
	Drain port diameter	mm	31,5	31,5	31,5	31,5	25	25
Drain pump	O-optional, S-standard, N-not incl.	/	S	S	S	S	N	N



## HIGH STATIC DUCT (DC MOTOR – 0/250 Pa)



INDOOR

### Slim, Light Weight & Compact Design

Uniform 280 mm in height. Compact design for easy installation where space over ceiling is limited.

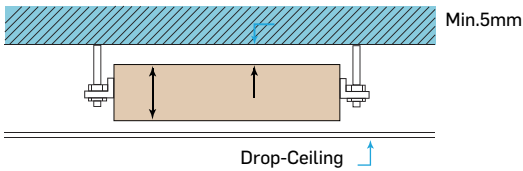

### Built-in Drain Pump

Built-in drain pump  
(600 mm pump head).

\*Drain pump is only for casing up to 6 HP

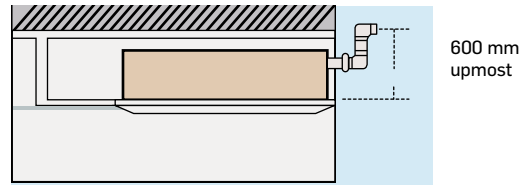

### Energy Saving

- High-efficiency DC fan motor
- 6.35 mm heat exchange tube ensures more precise refrigerant distribution and higher efficiency
- High performance composite material wind wheel, light and small air resistance

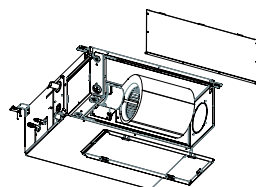
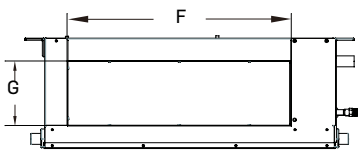

Back air return opening

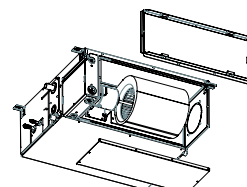

Below air return opening



## Dimensions

40VD007/009/012/015/018H-7S-QEE

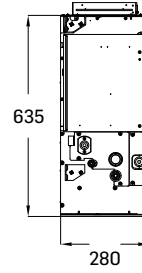
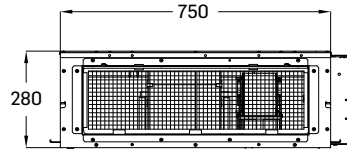
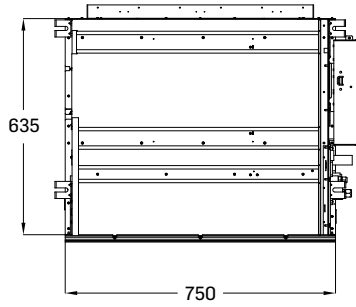

40VD024/028/030H-7S-QEE

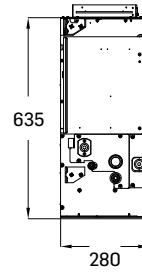
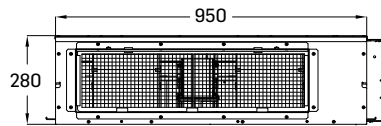
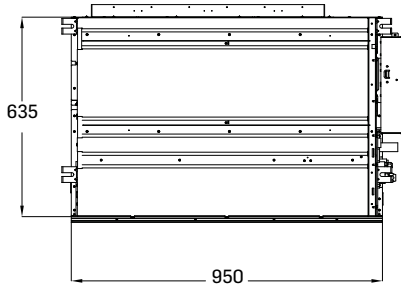

40VD036/048/054H-7S-QEE

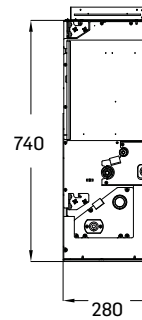
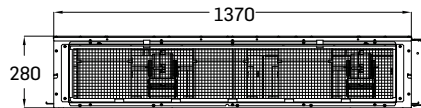
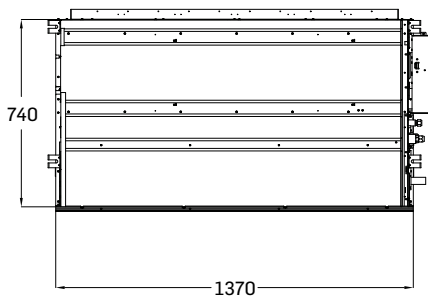

40VD072H/096H-7S-QEE

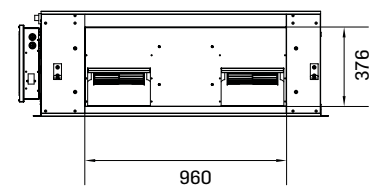
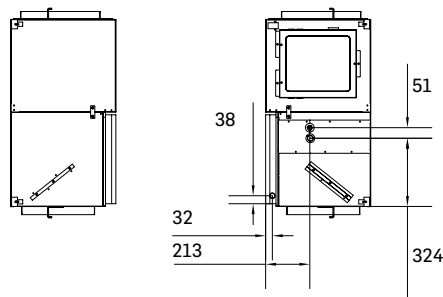
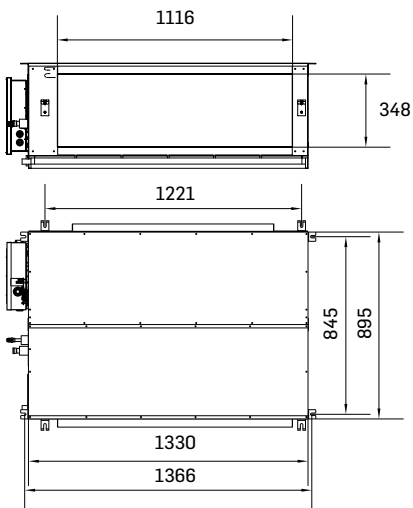



Turn to the experts

INDOOR





INDOOR

# HIGH WALL

## (DC MOTOR) 40VK\*S-7S2



- Stylish & exclusive design with LED display cover panel uses ABS-material to improve surface brightness and durability
- Easy-support clip to enable simple installation
- High-efficiency DC powered fan
- PCB integrated design, flexible piping direction arrangement
- PM 2.5 filter available (optional)
- Strong anti-electromagnetic interference to deliver trouble-free performance (EMC test). Suitable for data center application.

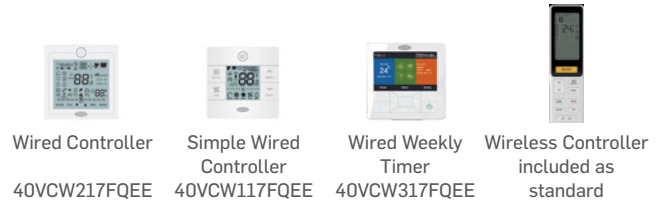

INDOOR

### Specifications



Model Code	Item	Unit	40VK005S-7S2-QEE	40VK007S-7S2-QEE	40VK009S-7S2-QEE	40VK012S-7S2-QEE	40VK016S-7S2-QEE
Capacity	Model capacity	HP	0,5	0,8	1,0	1,25	1,7
	Cooling	kW	1,5	2,2	2,8	3,6	4,5
	Heating	kW	1,7	2,5	3,2	4,0	5,0
Electrical parameters	Power supply	Ph/V/Hz	1/220~240/50/60	1/220~240/50/60	1/220~240/50/60	1/220~240/50/60	1/220~240/50/60
	Power consumption	W	38	38	38	38	52
Dimensions (W/D/H)	Net Product	mm	855/208/280	855/208/280	855/208/280	855/208/280	1115/243/336
	Shipping Product	mm	954/279/355	954/279/355	954/279/355	954/279/355	1206/342/418
Weight	Product Net/Shipping	kg	9.9/12	9.9/12	9.9/12	9.9/12	15.8/18.9
Fan	Air flow (H/M/L)	m³/h	500/430/370	550/480/420	600/530/470	630/560/500	800/720/650
Pressure sound level	Cooling (H/M/L)	dB(A)	33/31/29	35/31/29	36/31/29	37/33/29	39/36/34
	Heating (H/M/L)	dB(A)	33/31/29	35/31/29	36/31/29	37/33/29	39/36/34
Piping	Refrigerant liquid pipe (Ø)	mm	6,35	6,35	6,35	6,35	6,35
	Refrigerant gas pipe (Ø)	mm	9,52	9,52	9,52	12,7	12,7
	Drain port diameter	mm	16,8	16,8	16,8	16,8	16,8
Drain pump	O-optional, S-standard, N-not incl.	/	N	N	N	N	N
Accessories (optional)	PM2.5 Filter	/	40VFK030S7-QEE	40VFK030S7-QEE	40VFK030S7-QEE	40VFK030S7-QEE	40VFK030S7-QEE



## Specifications

**HEATING**

**COOLING**

Model Code	Item	Unit	40VK018S-7S2-QEE	40VK024S-7S2-QEE	40VK028S-7S2-QEE	40VK030S-7S2-QEE
Capacity	Model capacity	HP	2,0	2,5	3,0	4,0
	Cooling	kW	5,6	7,1	8,0	9,0
	Heating	kW	6,3	8,0	9,0	10,0
Electrical parameters	Power supply	Ph/V/Hz	1/220-240/50/60	1/220-240/50/60	1/220-240/50/60	1/220-240/50/60
	Power consumption	W	52	52	94	94
Dimensions (W/D/H)	Net Product	mm	1115/243/336	1115/243/336	1316/270/365	1316/270/365
	Shipping Product	mm	1206/342/418	1206/342/418	1403/384/463	1403/384/463
Weight	Product Net/Shipping	kg	15.8/18.9	15.8/18.9	21.8/26.3	21.8/26.3
Fan	Air flow (H/M/L)	m <sup>3</sup> /h	920/800/720	1010/920/800	1500/1400/1300	1600/1500/1400
Pressure sound level	Cooling (H/M/L)	dB(A)	40/39/35	44/40/36	48/43/40	49/44/41
	Heating (H/M/L)	dB(A)	40/39/35	44/40/36	48/43/40	49/44/41
Piping	Refrigerant liquid pipe (Ø)	mm	6,35	9,52	9,52	9,52
	Refrigerant gas pipe (Ø)	mm	12,7	15,88	15,88	15,88
	Drain port diameter	mm	16,8	16,8	16,8	16,8
Drain pump	O-optional, S-standard, N-not incl.	/	N	N	N	N
Accessories (optional)	PM2.5 Filter	/	40VFK030S7-QEE	40VFK030S7-QEE	40VFK030S7-QEE	40VFK030S7-QEE



CASING FOR SIZES 0.5HP TO 2.5HP



CASING FOR SIZES 3.0HP TO 4.0HP

## HIGH WALL (DC MOTOR)



INDOOR

### Dimensions

MODEL	A	B	C
40VK005/007/009/012S-72S-QEE	855	208	280
40VK016/018/024S-7S2-QEE	1115	243	336
40VK028/030S-7S2-QEE	1316	220	365

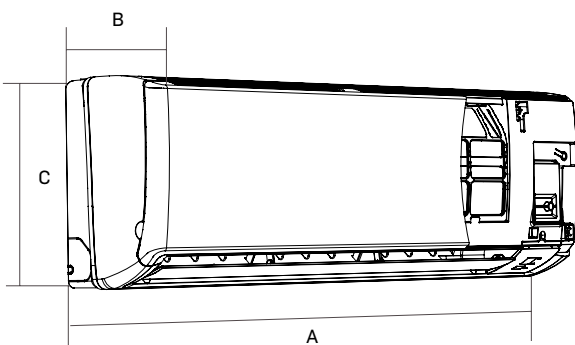

PM 2.5 FILTER (OPTIONAL)

FILTER CODE	DIMENSIONS
40VFK030S7-QEE	225*50*5 MM





### Easy Servicing & Maintenance

- Easy removal of air filters for cleaning
- Remote on/off function and alarm function
- Easy access to indoor unit components

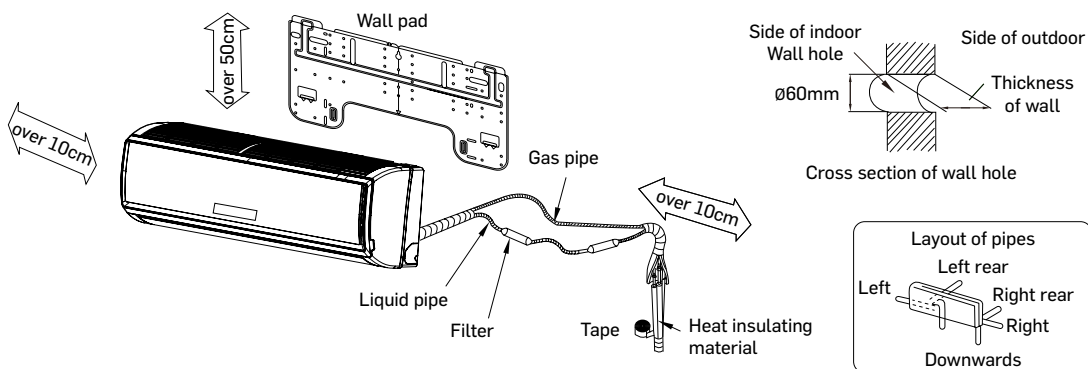
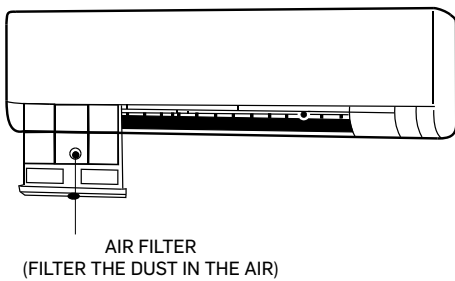





Turn to the experts



INDOOR

## TWO-WAY CONSOLE (DC MOTOR) 40VL\*B-7E

-  Compact design makes installation flexible and easy on the floor or against the wall
-  Five fan speeds and two-way airflow modes that automatically adjust for extra comfort and flexibility  
Automatic adjusting to carpet airflow when switched to two-way airflow mode
-  Stylish & elegant design



Wired Controller  
40VCW217FQEE



Simple Wired Controller  
40VCW117FQEE



Wired Weekly  
Timer  
40VCW317FQEE



Wireless Controller  
40VCI67FQEE



## Specifications



Model Code	Item	Unit	40VL005B-7E-QEE	40VL007B-7E-QEE	40VL009B-7E-QEE	40VL012B-7E-QEE	40VL018B-7E-QEE
Capacity	Model capacity	HP	0,50	0,80	1,0	1,25	2,0
	Cooling	kW	1,5	2,2	2,8	3,6	5,0
	Heating	kW	1,7	2,6	3,2	4,0	5,5
Electrical parameters	Power supply	Ph/V/Hz	1,220-230V,50/60HZ	1,220-230V,50/60HZ	1,220-230V,50/60HZ	1,220-230V,50/60HZ	1,220-230V,50/60HZ
	Power consumption	W	31	31	31	34	36
Dimensions (W/D/H)	Net Product	mm	700/210/600	700/210/600	700/210/600	700/210/600	700/210/600
	Shipping Product	mm	783/303/695	783/303/695	783/303/695	783/303/695	783/303/695
Weight	Product Net/Shipping	kg	15.2/18.7	15.2/18.7	15.2/18.7	15.2/18.7	15.2/18.7
Fan	Air flow (H/M/L)	m <sup>3</sup> /h	540/460/390/310/270	540/460/390/310/270	540/460/390/310/270	580/500/420/350/270	620/540/460/390/270
Pressure sound level	Cooling (H/M/L)	dB(A)	45/42/38/33/30	45/42/38/33/30	45/42/38/33/30	47/44/40/36/30	48/45/42/38/30
	Heating (H/M/L)	dB(A)	45/42/38/33/30	45/42/38/33/30	45/42/38/33/30	47/44/40/36/30	48/45/42/38/30
Piping	Refrigerant liquid pipe (Ø)	mm	6,35	6,35	6,35	6,35	6,35
	Refrigerant gas pipe (Ø)	mm	12,7	12,7	12,7	12,7	12,7
	Drain port diameter	mm	16	16	16	16	16
Drain pump	O-optional, S-standard, N-not incl.	/	N	N	N	N	N

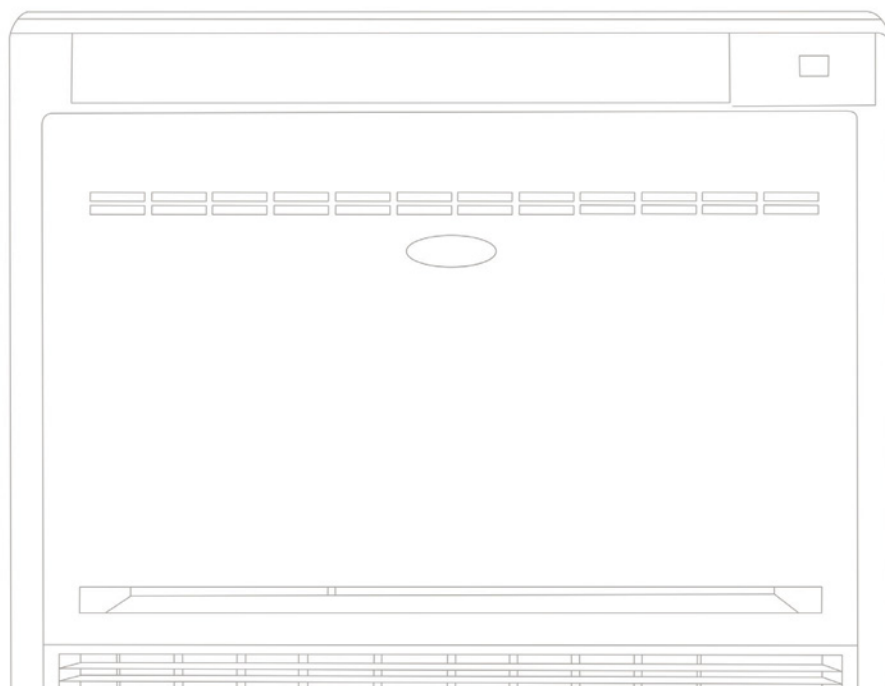



## TWO-WAY CONSOLE (DC MOTOR)



### Easy Installation

- The indoor units can be installed on the floor or on the wall. It's flexibility allows for easy installation.

### Compact Unit, Save Space

- The console indoor unit is very slim and blend in harmoniously in any room. It can be placed at the corner which allows space saving.

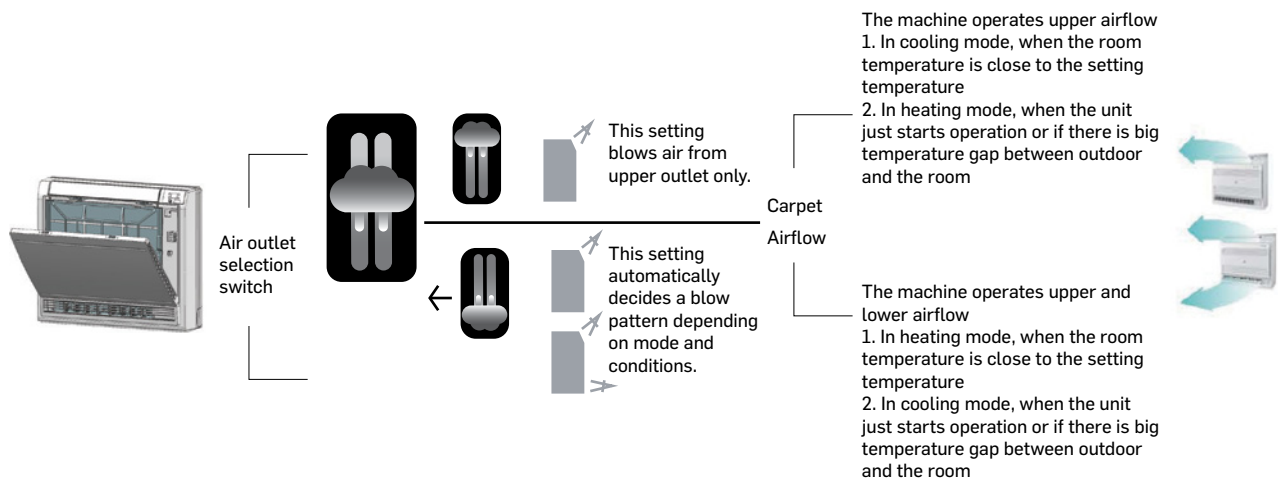



## Dimensions

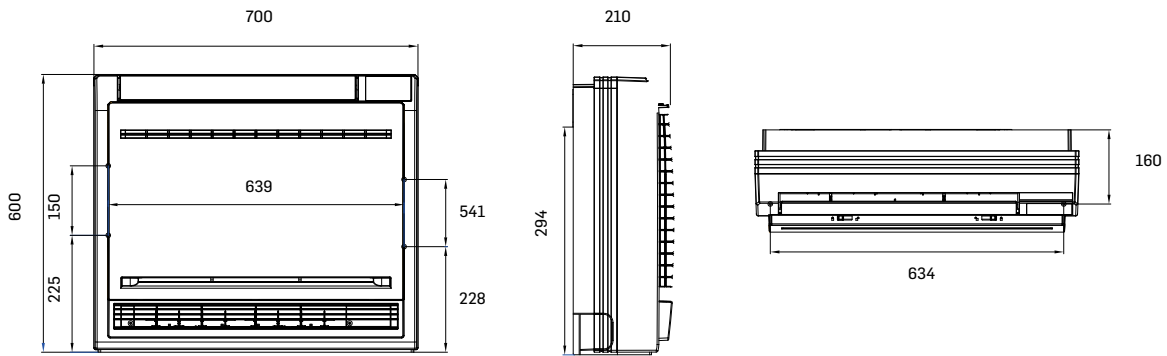

## Installation & Servicing

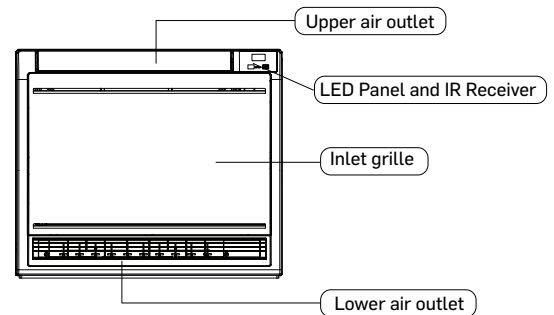
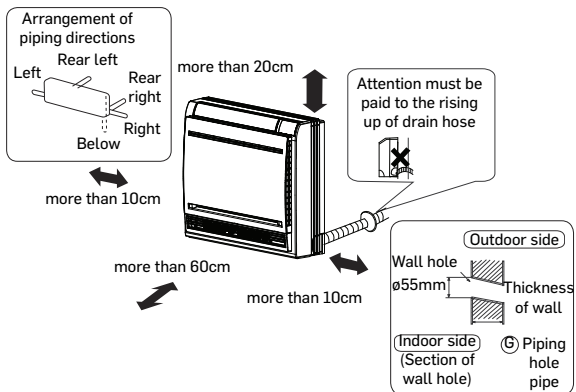

- Hold the front panel by the tabs on both sides and lift it until it stops with a click.

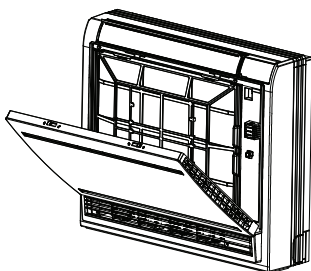

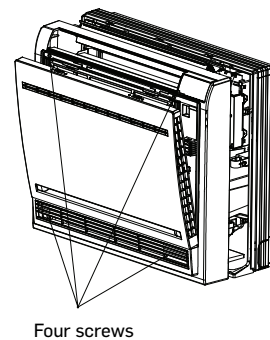

- Loosen the four screws marked here and open the grille.





## CONSOLE - RECESSED (AC MOTOR) 40VL\*R-7G

-  Compact design suitable for installation space as little as 221 mm
-  Good solution for installation beneath a window. Washable filter fitted as standard
-  30 Pa available static pressure for small ducting or higher efficiency filter

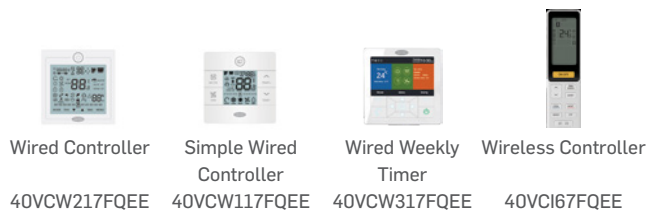



## Specifications



HEATING



COOLING

Model Code	Item	Unit	40VL007R-7G-QEE	40VL009R-7G-QEE	40VL012R-7G-QEE
Capacity	Model capacity	HP	0,8	1,0	1,25
	Cooling	kW	2,2	2,8	3,6
	Heating	kW	2,5	3,2	4,0
Electrical parameters	Power supply	Ph/V/Hz	1/220-230/50/60	1/220-230/50/60	1/220-230/50/60
	Power consumption	W	110	110	110
Dimensions (W/D/H)	Net Product	mm	1116/221/624	1116/221/624	1116/221/624
	Shipping Product	mm	1198/295/707	1198/295/707	1198/295/707
Weight	Product Net/Shipping	kg	29/37	29/37	29/37
External static pressure	Standard	Pa	0	0	0
	Maximum	Pa	30	30	30
Fan	Air flow (H/M/L)	m <sup>3</sup> /h	750/650/550	750/650/550	750/650/550
Pressure sound level	Cooling (H/M/L)	dB(A)	38/35/33	38/35/33	40/37/35
	Heating (H/M/L)	dB(A)	38/35/33	38/35/33	40/37/35
Piping	Refrigerant liquid pipe (Ø)	mm	6,35	6,35	6,35
	Refrigerant gas pipe (Ø)	mm	9,52	9,52	12,7
	Drain port diameter	mm	20	20	20
Drain pump	O-optional, S-standard, N-not incl.	/	N	N	N

INDOOR

## Dimensions

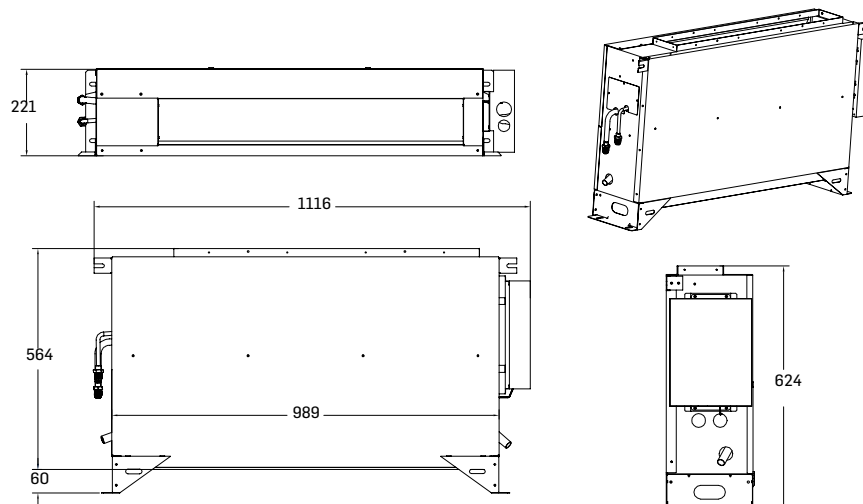

# FLEX CEILING FLOOR (DC MOTOR) 40VC\*F-7S



- Ultra-compact design (230 mm), elegant balance of flexibility and simplicity
- Appealing, even without screen cover
- Easy installation and maintenance. Easy access to PCB
- Simultaneous left and right swing control for optional freestyle airflow
- PM 2.5 filter (optional)
- Automatic display of fault codes and setpoint temperature
- Fresh air inlet
- Slightly retractable into ceiling

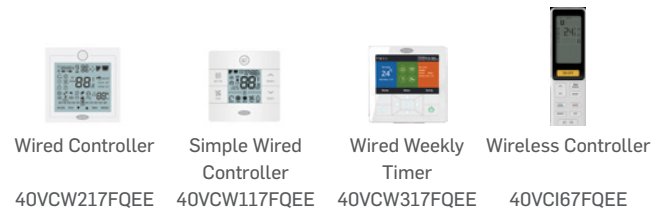

INDOOR

## Specifications



Model Code	Item	Unit	40VC009F-7S-QEE	40VC012F-7S-QEE	40VC016F-7S-QEE	40VC018F-7S-QEE	40VC024F-7S-QEE
Capacity	Model capacity	HP	1,0	1,25	1,7	2,0	2,5
	Cooling	kW	2,8	3,6	4,5	5,6	7,1
	Heating	kW	3,2	4,0	5,0	6,3	8,0
Electrical parameters	Power supply	Ph/V/Hz	1,220~230,50/60	1,220~230,50/60	1,220~230,50/60	1,220~230,50/60	1,220~230,50/60
	Power consumption	W	35	35	45	45	80
Dimensions (W/D/H)	Net Product	mm	1000*230*680	1000*230*680	1000*230*680	1000*230*680	1330*230*680
	Shipping Product	mm	1100*305*779	1100*305*779	1100*305*779	1100*305*779	1425*305*779
Weight	Product Net/Shipping	kg	27.9/33.6	27.9/33.6	27.9/33.6	27.9/33.6	35.8/42.1
Fan	Air flow (H/M/L)	m³/h	820/750/690	820/750/690	950/820/690	950/820/690	1420/1270/1240
Pressure sound level	Cooling (H/M/L)	dB(A)	38/36/34	38/36/34	42/38/35	42/38/35	46/44/41
	Heating (H/M/L)	dB(A)	38/36/34	38/36/34	42/38/35	42/38/35	46/44/41
Piping	Refrigerant liquid pipe (Ø)	mm	6,35	6,35	6,35	6,35	9,52
	Refrigerant gas pipe (Ø)	mm	9,52	12,7	12,7	12,7	15,88
	Drain port diameter	mm	20	20	20	20	20
Drain pump	O-optional, S-standard, N-not incl.	/	N	N	N	N	N
Accessories (optional)	PM2.5 Filter	/	40VFC018F7-QEE	40VFC018F7-QEE	40VFC018F7-QEE	40VFC018F7-QEE	40VFC054F7-QEE





INDOOR

## Specifications



HEATING



COOLING

Model Code	Item	Unit	40VC028F-7S-QEE	40VC030F-7S-QEE	40VC038F-7S-QEE	40VC048F-7S-QEE	40VC054F-7S-QEE
Capacity	Model capacity	HP	3,0	3,2	4,0	5,0	6,0
	Cooling	kW	8,0	9,0	11,2	14,0	16,0
	Heating	kW	9,0	10,0	12,5	16,0	18,0
Electrical parameters	Power supply	Ph/V/Hz	1,220~230,50/60	1,220~230,50/60	1,220~230,50/60	1,220~230,50/60	1,220~230,50/60
	Power consumption	W	105	105	126	126	126,0
Dimensions (W/D/H)	Net Product	mm	1330*230*680	1330*230*680	1650*230*680	1650*230*680	1650*230*680
	Shipping Product	mm	1425*305*779	1425*305*779	1750*305*779	1750*305*779	1750*305*779
Weight	Product Net/Shipping	kg	35.8/42.1	35.8/42.1	43.5/50.5	43.5/50.5	43.5/50.5
Fan	Air flow (H/M/L)	m <sup>3</sup> /h	1570/1420/1240	1570/1420/1240	2110/1990/1750	2110/1990/1750	2110/1990/1750
Pressure sound level	Cooling (H/M/L)	dB(A)	47/44/41	47/44/41	50/46/43	50/46/43	50/46/43
	Heating (H/M/L)	dB(A)	47/44/41	47/44/41	50/46/43	50/46/43	50/46/43
Piping	Refrigerant liquid pipe (Ø)	mm	9,52	9,52	9,52	9,52	9,52
	Refrigerant gas pipe (Ø)	mm	15,88	15,88	15,88	15,88	15,88
	Drain port diameter	mm	20	20	20	20	20
Drain pump	O-optional, S-standard, N-not incl.	/	N	N	N	N	N
Accessories (optional)	PM2.5 Filter	/	40VFC054F7-QEE	40VFC054F7-QEE	2 x 40VFC054F7-QEE	2 x 40VFC054F7-QEE	2 x 40VFC054F7-QEE



## FLEX CEILING FLOOR (DC MOTOR)



### Easy Servicing & Maintenance

- Easy removal of air filters for cleaning
- Easy access to indoor unit components
- Remote on/off function and alarm function

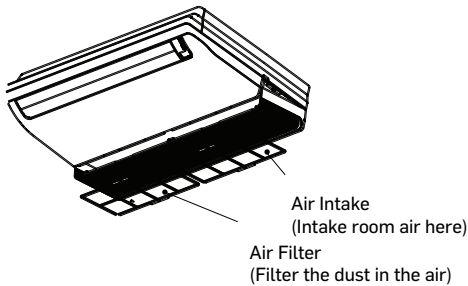

### Design Aesthetics

- The visually ultra-thin body features wave-shaped vents on both sides that embody multiple levels of design



- Visually screw-free, yet easy to maintain



### PM 2.5 Filter (Optional)

UNIT MODEL	FILTER MODEL NAME	FILTER SIZE	FILTER PIC
40VC009/012/016/018F-7S-QEE	40VFC018F7-QEE	133*52*10	
40VC024/028/030F-7S-QEE	40VFC054F7-QEE	224*69.3*10	
40VC038/048/054F-7S-QEE	2*40VFC054F7-QEE	2*224*69.3*10	

### Multiple Air Distribution Directions

On pressing the SWING button, the flap changes between the following positions:

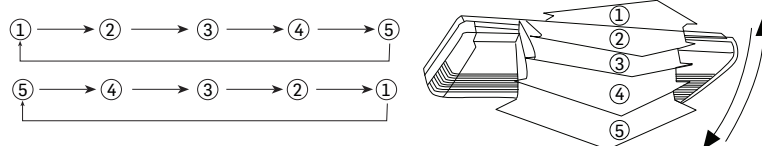



## Dimensions

40VC009/012/016/018F-7S-QEE

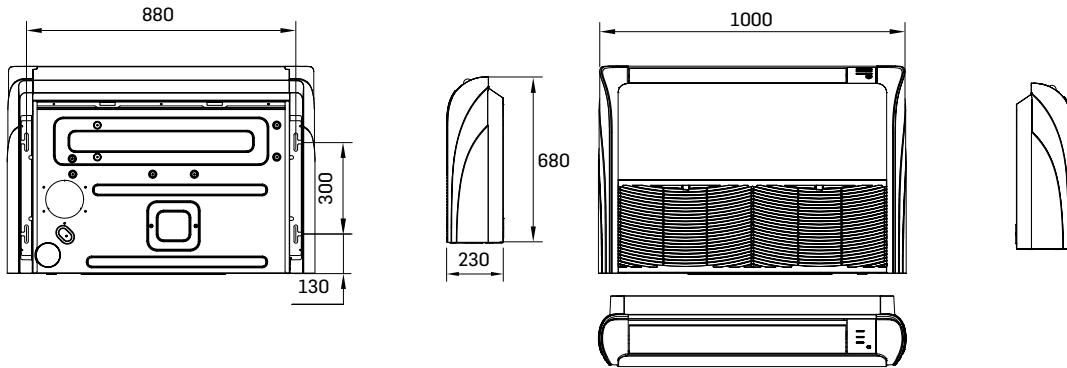

40VC024/028/030F-7S-QEE

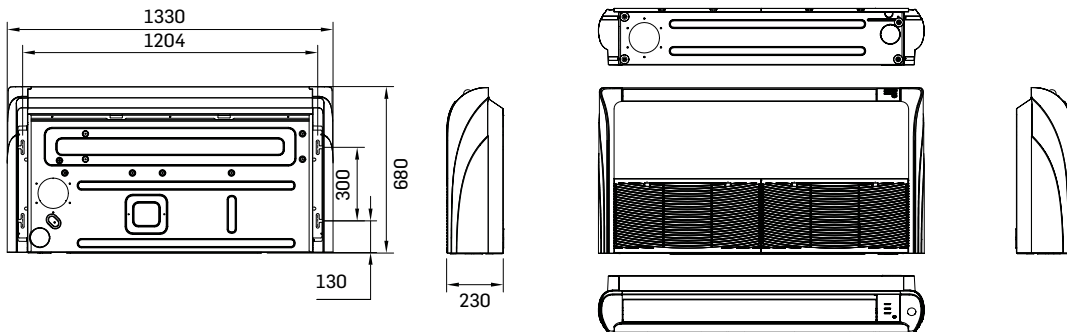

40VC038/048/054F-7S-QEE

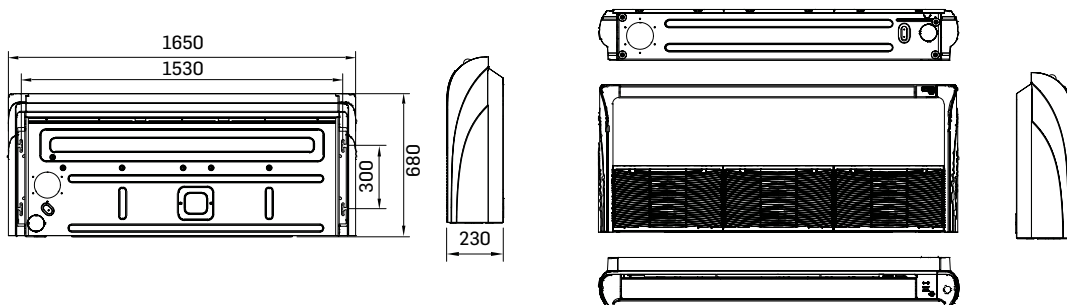



Turn to the experts

INDOOR





**INDOOR**





Turn to the experts



## HRV

### (AC Motor) 40VH\*A-7G

-  Efficiency up to 78% on temperature exchanger & 65% on enthalpy (cooling)
-  Independent 220V power supply
-  Can run in slight over-pressure or under-pressure mode  
Efficient heat recovery air processing

Note: This unit doesn't require refrigerant connection





## Specifications

Model/indoor unit	Item	Unit	40VH015A-7G-QEE	40VH026A-7G-QEE
Electrical parameters	Power supply	Ph/V/Hz	1/220-230/50/60	1/220-230/50/60
	Power consumption	W	100	120
Dimensions (W/D/H)	Net Product	mm	813/553/276	813/553/276
	Shipping Product	mm	1000/760/320	1000/760/320
Weight	Product Net/Shipping	kg	28.7/31.2	28.7/31.2
External static pressure	Standard	Pa	80	60
	Maximum	Pa	80	60
Fan	Maximum	m <sup>3</sup> /h	150	260
Sound level	Sound pressure level (H/L)	dB(A)	44/43	44/43
	Sound power level (H/L)	dB(A)	55/54	55/54
Controller	Wired (Standard)	Specific	S	S

INDOOR

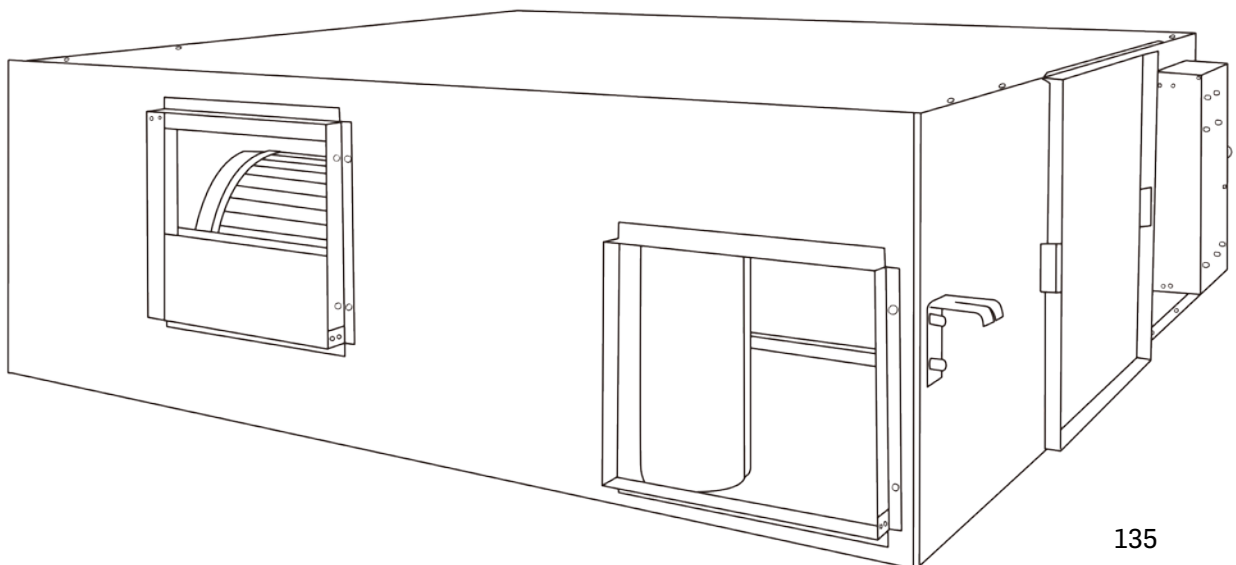



Turn to the experts



## HRV (AC MOTOR)



INDOOR

### Dimensions

40VH015/026A-7G-QEE

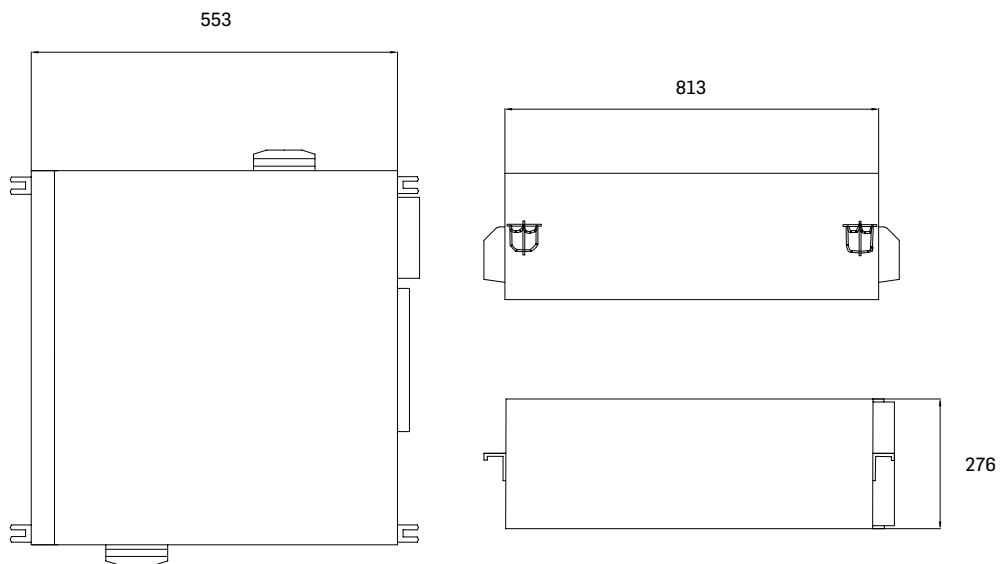





## Dimensions

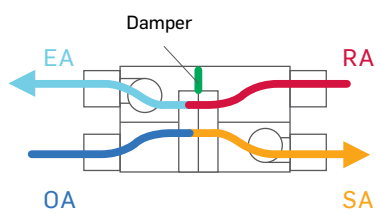

### Air to Air Heat Exchanger Process Patterns

#### Heating Mode

Outdoor cold air and hot return air cross through the heat recovery element. The unit blows the warmer air from inside the ducts to the room.

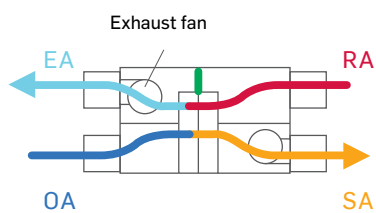

#### Cooling Mode

Outdoor hot air and cold return air cross through the heat recovery element. The unit blows the cooler air from inside the ducts to the room.

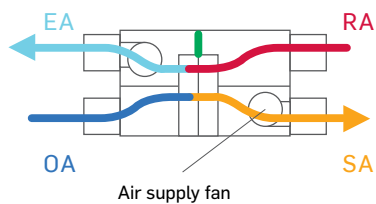

#### Free Cooling Mode

Outdoor air passes without heat recovery treatment.



Turn to the experts

ADMINISTRATIONS



HOTELS



HEALTHCARE



RETAIL



OFFICES



RETAIL



ADMINISTRATIONS



HOTELS



HEALTHCARE



## AIR HANDLING UNIT DX KITS

140 VRF AHU SOLUTION

142 TA CONTROL TYPE

144 DDC CONTROL TYPE



Turn to the experts



## VRF AHU SOLUTION

Carrier offers a vast range of kits to connect XCT7 systems to 3rd party DX Air Handling Units. This enables VRF to explore more possibilities for applications in various architectures.

### VRF SYSTEM BENEFITS

- High Efficiency
  - Seasonal efficiency (high SEER and SCOP)
  - Effective heating/cooling mode switch
- Easy Installation
  - Easy to install with reduced pipe size: minimal space required
- Incredible Flexibility
  - Ideal for renovation projects

### VRF SYSTEM WITH AHU DX KIT BENEFITS

- Wide range from 3HP to 26HP
- Easy maintenance and servicing
- Covers large & high ceiling applications
- Flexible control
- Touch-screen controller for centralized control
- Can be combined with other types of VRF indoor units

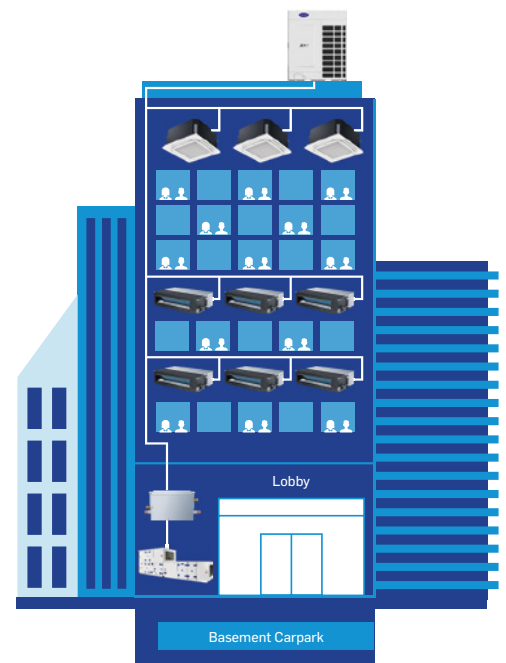

VRF AHU System

## Operating Conditions

Cooling mode mixed air temperature (before coil),Min/Max.	Cooling : 14/43°C DB
Heating mode mixed air temperature (before coil),Min/Max.	Heating : 5/28°C DB

## PIPING RULES

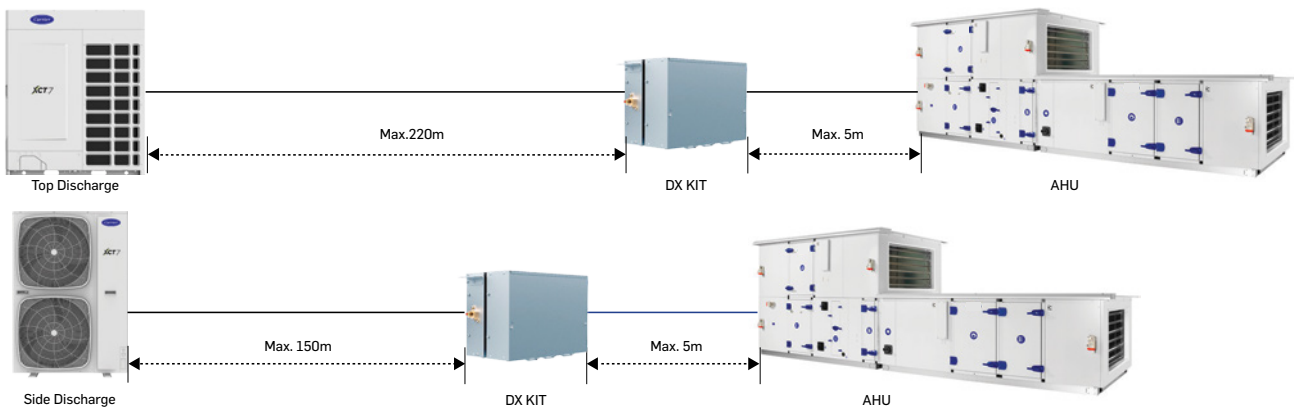

### Note

1. Non-mixing connection: AHU connection rate 90- 110%
2. When mixing with VRF IDUs, total indoor unit(including AHU) connection rate should be 50 ~110%, whose IDU share is not less than 50% & AHU ≤ 30% ODU capacity
3. Height difference between outdoor unit and AHU DX kit: Top Discharge up to 110m, Side Discharge up to 50m

For more information, or for different configurations, please contact the sales representative



# Air Handling Unit DX Coil kit (TA TYPE)

## TA TYPE DX Kits Connection

### 1 TO 1 CONNECTION

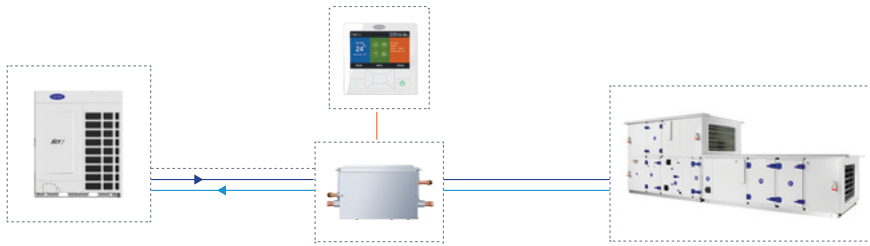

### COMBINE WITH VRF INDOOR UNITS

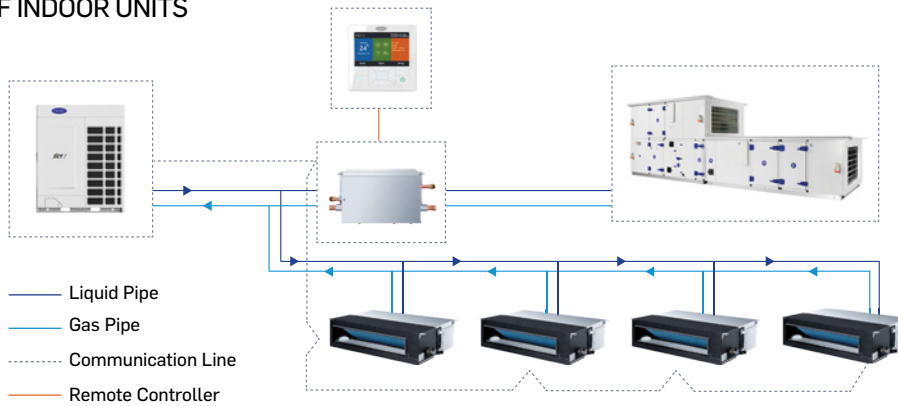

VRF IDU controls omitted

## TA TYPE DX Kit Control Connection

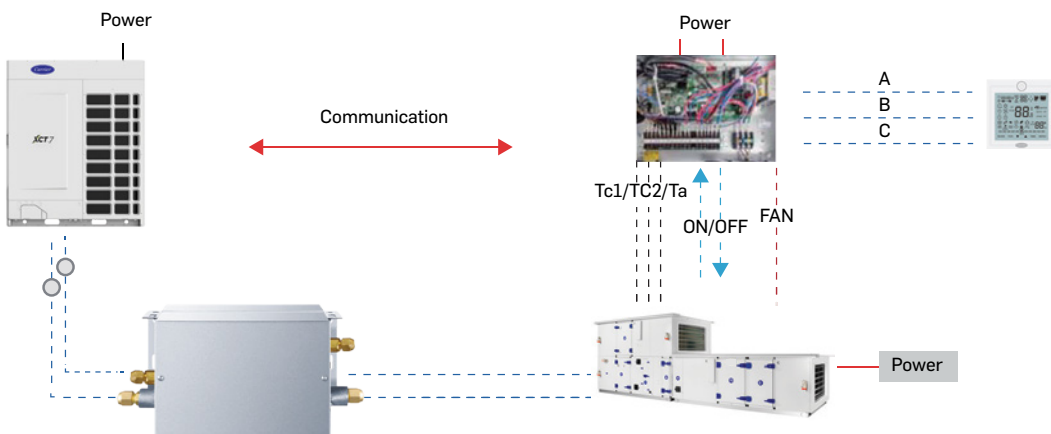

## Specification (TA TYPE)

Model	Unit	40VA010T7FAQEE	40VA020T7FAQEE
Connected AHU Capacity		14 ≤ x ≤ 28 kW (5-10 HP)	28 < x ≤ 56kW (10-20 HP)
Power Supply (Ph/V/Hz)		1/220~240/50/60	1/220~240/50/60
Dimensions(L x H x W)	mm	350 x 226 x 155	433 x 296 x 193
Weight	kg	6	8
Liquid Pipe	mm	9.52 (main) / 12.7	12.7 (main) / 15.88
	inch	0.375 (main) / 0.5	0.5 (main) / 0.625
Gas Pipe	mm	25.4 (main) / 22.2 / 19.05	28.58 (main) / 25.4 / 22.22
	inch	1 (main) / 0.875 / 0.75	0.125 (main) / 1 / 0.875
Airflow Min./Max.	m <sup>3</sup> /h	1800 / 8250	2600 / 16500
Internal Volume Min./Max.	L	3.68 / 8.80	4.53 / 16.13
Kit Composition			



## ODU COMPATIBILITY (TA TYPE)

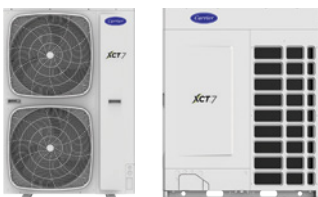

### Compatibility

- Top Discharge Heat Pump XCT7 (up to 60HP)
- Side Discharge Heat Pump XCT7 (8 to 12HP)

ODU Compatible	AHU DX KIT	AHU Coil Capacity (kW)
8-10HP	40VA010T7FAQEE	14kW < x ≤ 28kW
10-20HP	40VA020T7FAQEE	28kW < x ≤ 56kW
20-30HP	40VA020T7FAQEE+40VA010T7FAQEE	56kW < x ≤ 84kW
30-40HP	40VA020T7FAQEE+40VA020T7FAQEE	84kW < x ≤ 112kW
40-50HP	40VA020T7FAQEE+40VA020T7FAQEE+40VA010T7FAQEE	112kW < x ≤ 140kW
50-60HP	40VA020T7FAQEE+40VA020T7FAQEE+40VA020T7FAQEE	140kW < x ≤ 168kW

## COMBINATION RULES (TA TYPE)

- Non-mixing connection: AHU connection rate 90 ~ 110%
- When mixing total indoor unit connection rate is 50 ~ 110%, of which IDU share is not less than 50% and AHU < 30% of total ODU capacity



## Air Handling Unit DX Coil kit (DDC TYPE)

### DDC Type DX Kits Connection

#### 1 TO 1 CONNECTION

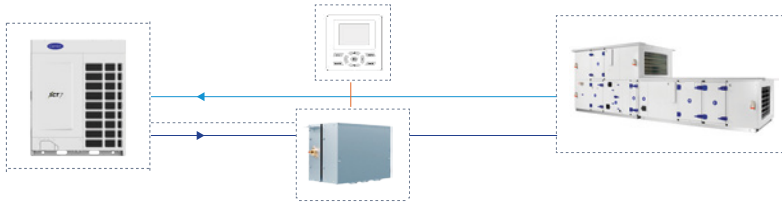

#### 1 TO MULTIPLE AHU

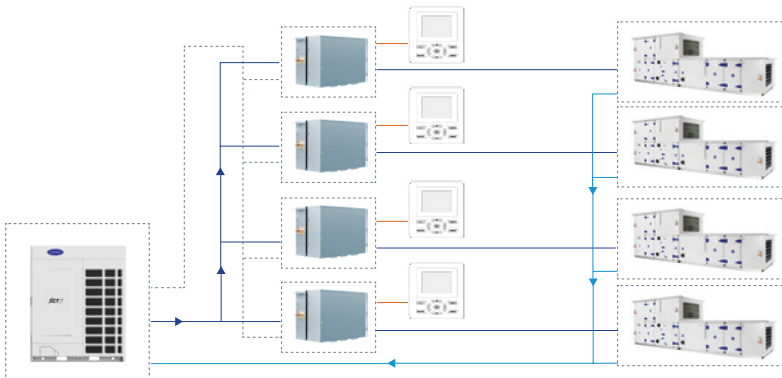

#### COMBINE WITH VRF INDOOR UNITS

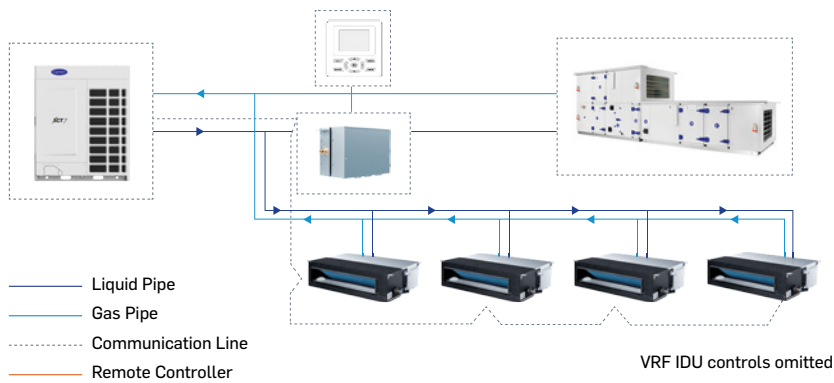

### DDC Type DX Kit Control Connection

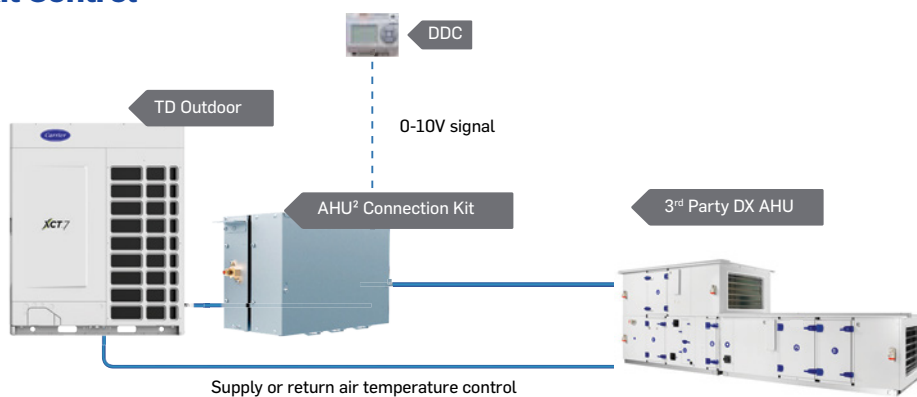

AHU KITS



## Specification (DDC Type)

Model	Unit	40VA003D7FAQEE	40VA005D7FAQEE	40VA010D7FAQEE	40VA020D7FAQEE	40VA026D7FAQEE
Connected AHU Capacity		3.5 ≤ x ≤ 7 kW (1-3HP)	7 < x ≤ 14 kW (3-5HP)	14 ≤ x ≤ 28 kW (5-10HP)	28 < x ≤ 56 kW (10-20HP)	56 < x ≤ 73 kW (20-26HP)
Power Supply (Ph/V/Hz)		1/220-230/50/60				
Dimensions (L x H x W)	mm	420 x 260 x 165				
Weight	kg	5.5			6.5	
Liquid Pipe	mm inch	9.52 (main) / 6.35 0.375 (main) / 0.25			12.7 (main) / 15.88 0.5 (main) / 0.625	
Airflow Min./Max.	m <sup>3</sup> /h	520 / 1950	720 / 3750	1200 / 8250	2600 / 16500	4800 / 2100
Internal Volume Min./Max.	L	1.01 / 2.16	1.51 / 4.32	2.28 / 8.80	4.53 / 16.13	8.18 / 20.16
Kit Composition						



## ODU COMPATIBILITY (DDC Type)



### Compatibility

- Top Discharge Heat Pump XCT7 (up to 104HP)
- Side Discharge Heat Pump XCT7 (2 Fans: 4 to 12HP)

ODU Compatible	ODU Compatible	AHU Coil Capacity (kW)
1-3HP	40VA003D7FAQEE	3 ≤ x ≤ 7kW
3-5HP	40VA005D7FAQEE	7 < x ≤ 14kW
5-10HP	40VA010D7FAQEE	14 < x ≤ 28kW
10-20HP	40VA020D7FAQEE	28 < x ≤ 56kW
20-26HP	40VA026D7FAQEE	56 < x ≤ 73kW
28-40HP	2x40VA020D7FAQEE	73 < x ≤ 112kW
42-52HP	2x40VA026D7FAQEE	112 < x ≤ 146kW
52-60HP	3x40VA020D7FAQEE	146 < x ≤ 168kW
62-78HP	3x40VA026D7FAQEE	168 < x ≤ 219kW
80HP	4x40VA020D7FAQEE	219 < x ≤ 224kW
82-104HP	4x40VA026D7FAQEE	224 < x ≤ 292kW

## Combination Rules (DDC TYPE)

- Non-mixing connection: AHU connection rate 90 ~ 110%
- When mixing total indoor unit connection rate is 50 ~ 110%, of which IDU share is not less than 50% & AHU < 30% total ODU capacity



## VRF AHU DX KITS CONTROL SOLUTION (DDC TYPE)

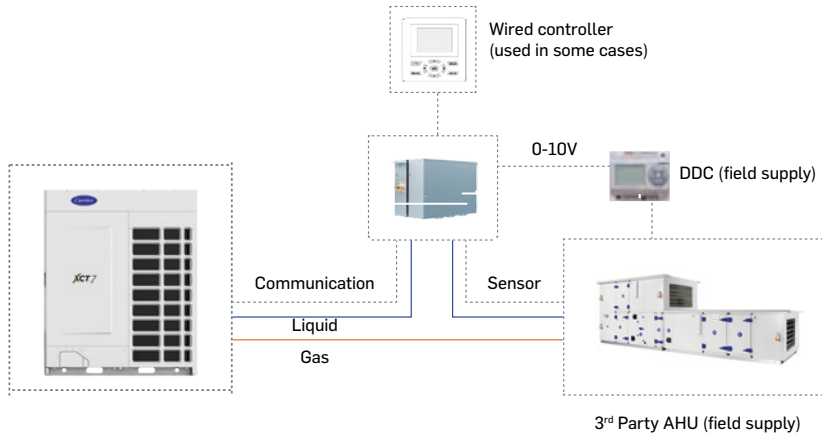

### Control method A

0-10V signal output from 3<sup>rd</sup> party DDC controller AHU kit receives 0-10V signal to adjust the ODU capacity

### Control method B

Control temperature via 3<sup>rd</sup> party DDC 0-10V signal output from 3<sup>rd</sup> party DDC AHU kit receives 0-10V signal to adjust set-point temperature

Simple DDC Volt. Range (Vdc)		Capacity Output	Target Pressure-Cooling (Mpa)	Target Pressure-Heating (Mpa)
0	1.0	0% OFF		
1.1	1.5	10%	0.9	1.9
1.6	2.5	20%	0.87	2.0
2.6	3.5	30%	0.84	2.1
3.6	4.5	40%	0.81	2.2
4.6	5.5	50%	0.78	2.3
5.6	6.5	60%	0.76	2.4
6.6	7.5	70%	0.73	2.5
7.6	8.5	80%	0.7	2.6
8.6	9.6	90%	0.67	2.7
9.6	10	100%	0.64	2.8

Simple DDC Voltage Range(V) (Vdc)		Set Temperature (°C) -Cooling	Set Temperature (°C) -Heating
0	1	16	16
1.1	1.7	17	17
1.8	2.3	18	18
2.4	2.9	19	19
3	3.5	20	20
3.6	4.1	21	21
4.2	4.7	22	22
4.8	5.3	23	23
5.4	5.9	24	24
6	6.5	25	25
6.6	7.1	26	26
7.2	7.7	27	27
7.8	8.3	28	28
8.4	8.9	29	29
9	10	30	30



## VRF AHU DX KITS CONTROL SOLUTION (DDC TYPE)

### Control method C (special application)

- Without DDC controller
- Dedicated wired controller is necessary for initial set-up but not required for operation
- Third party thermostat provides ON/Off signal to AHU kit when set point temperature is reached.
- Applicable for some cases with constant cooling or heating demands and not sensitive to comfort demands.

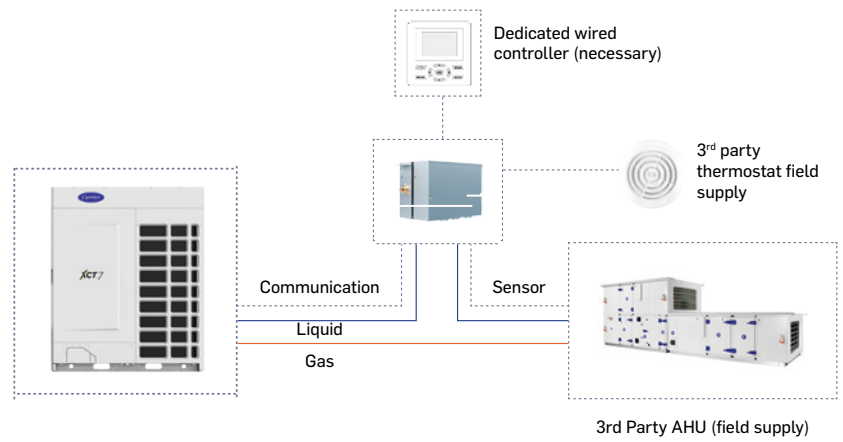

### Control method D

- TA control type
- Control of AHU same as VRF IDU
- Return/Room temperature control only
- Dedicated AHU wired controller is used to operate the AHU DX kit
- Control method for combination VRF indoor units and 3<sup>rd</sup> party AHU system

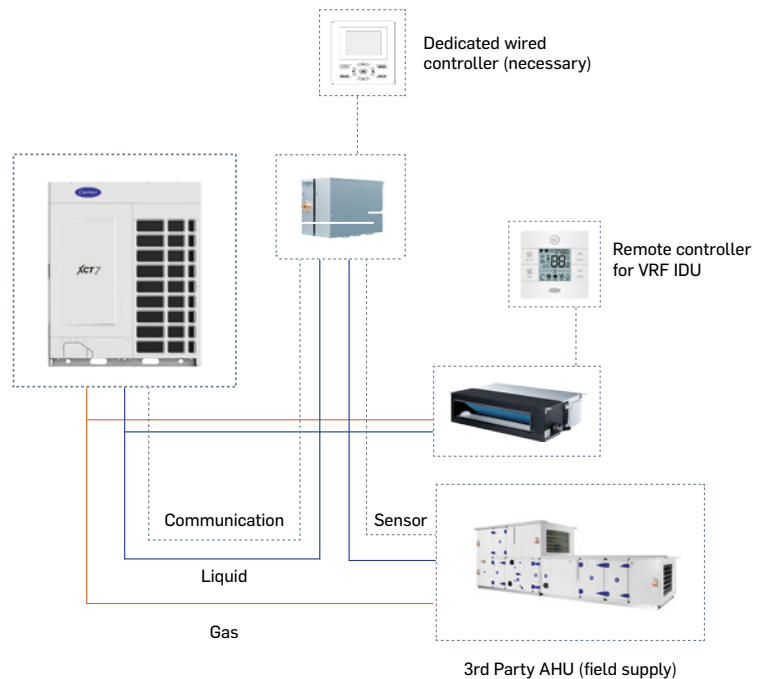



OFFICES



RETAIL



ADMINISTRATIONS



HOTELS



HEALTHCARE



HOUSING



## **CONTROLLER**

- 154      **INDIVIDUAL CONTROLLER**
  
- 156      **CENTRALIZED CONTROLLER**
  
- 160      **BMS**

## Individual Controller Features





Item	Infrared Controller	Wired Controller	Wired Weekly Time Controller	Wired Simple Controller	Remarks	
Model	40VCI67FQEE	40VCW217FQEE	40VCW317FQEE	40VCW117FQEE		
Picture						
Dimensions (W*H*D) mm	200 x 57x 29	86 x 86 x 13.07	120 x 120 x 17.8	86 x 86 x 15.8		
Power Supply	Battery	12 V AC	12 V AC	12 V AC		
Connectivity	Max. IDUs Controllable	1	16	16		
	Max. Groups Controllable	1	1	1		
Basic Control Function	On/Off	●	●	●		
	Mode Setting (Auto-Heat-Cool-Fan-Dry)	●	●	●		
	Fan Speed Adjustment	●	●	●		
	Temperature Setting	●	●	●		
	Airflow Direction — Up & Down	●	●	●		
	Airflow Direction — Left & Right	●	●	●	Whether the function is available applicable upon Indoor units.	
	Precise Temp. Control	+/-0.5°C	+/-0.5°C	+/-0.5°C	+/-0.5°C	
	°F/°C	●	●	●	●	
Display	Set-point Temp. Display	●	●	●	●	
	Real Time Clock	●	●	●	/	
	Day	/	/	●	/	
	IDU Status Display, Including Qty Online, Standby or Running	/	/	●	/	
	Backlight	●	●	●	●	
Advanced Function	Sleep	●	●	●	/	
	Child Lock	●	●	●	●	
	Quiet	●	●	●	/	
	Turbo	●	●	●	/	
	Round-Way Cassette Blade Adjustment	●	●	●	/	
	Human Sensor Function	●	●	●	/	
	Electric Heater	/	●	●	/	
	Control Lock (under central controller)	/	●	●	●	
	Temp. Range Limitation (For Energy Saving)	/	●	●	●	
	Temp. Compensation	/	●	●	●	
	Forced Cooling/Heating	/	●	/	●	
	Screen Saving	/	●	●	●	
	Screen Brightness Adjustment	/	/	●	/	
	10°C Heating	/	●	●	/	
Schedule/Timer	Timer On/Off	●	●	●	/	
	Weekly Schedule	/	/	●	/	
Installer Info.	Forced Defrost	/	●	●	/	
	Error Code	/	●	●	●	
	Filter Clean Indicator	/	●	●	●	
	ESP Grades Adjustment	/	●	●	/	
	Installer Setting	/	●	●	/	
	Service Help	/	/	●	/	
	Password	/	/	●	/	
	Parameter Check	/	●	●	●	
	Unit No. Setting	/	●	●	●	
	Non-volatile Memory (Power Off Memory)	/	●	●	●	
Sensor Error Display	/	●	●	●		

CONTROLLER

## Centralized Controller & Local BMS Features

Item	Group Controller	Touchscreen Controller	Touchscreen Controller	Local Control	Remote Monitoring	
Model	40VCC837FQEE	40VCC727FQEE	40VCC617FQEE	40VCB117FQEE	40VCB217FQEE	
Picture						
Dimensions (W*H*D) mm	133 x103 x 17	302.5 x 187.7 x 25	190 x 130 x 20		137.25 x 260.5 x 69.2	
Power Supply	12 V DC	12 V DC	12 V DC	/	AC 110-240	
Connectivity	Max. Controllable IDUs	64	800	256	400	
	Max. ODUs System (max. Gateway Qty)	32	32 x 2	32	32	20 x 4
Screen	Screen Type	TFT LCD	TFT LCD	TFT LCD	/	/
	Screen Dimension	5	12.5	7"	/	/
	Button Type	Full Touchscreen	Touch Button	Touch Button	/	/
	Backlight	●	●	●	/	/
	Screen Saver	●	●	●	/	/
	Screen Brightness Adjustment	●	●	●	/	/
Display	Indoor Temperature	●	●	●	●	●
	Clock and Day	●	●	●	●	●
	°C/°F Switch	●	●	●	●	/
Standard Control Function	General IDU Status Statistics Display	●	●	●	/	/
	On/Off	●	●	●	●	●
	Mode (Auto-Cool-Dry-Heat-Fan-Auto)	●	●	●	●	●
	Temperature Setting	●	●	●	●	●
Central Control	Precise Temp. Control 1°C/0.5°C	±1°C	±1°C/±1°F	±1°C	±1°C/±1°F	±1°C/±1°F
	Fan Speed (Auto-Low-Mid-High)	●	●	●	●	●
	Group (Zone) Control	●	●	●	●	●
	One Button for all On/Off	●	●	●	●	●
Schedule	Group (Zone) Name Setting	●	●	●	●	●
	Group (Zone) Name Display	●	●	●	●	●
	Daily	●	●	●	●	●
	Weekly	●	●	●	●	●
Electricity Data Management	Special Day	●	●	●	●	●
	Schedule Programs Qty	32	100	32	No Limit	No Limit
	Electricity Bill	/	/	/	●	●
	Historical Electricity Data	/	/	/	/	●
Advanced Function	Historical Electricity Data Curve	/	/	/	/	●
	Child Lock	●	/	●	/	/
	Control Mode (LIFI/Central/Lock)	●	●	●	●	●
	ECD (Set temp. Range Limit)	●	●	●	●	/
	Unit/Groups Setting	●	●	●	●	●
	IDU No. Display	●	●	●	●	●
	Unit Running Time Display	●	/	●	●	●
	Unit Running Curve	/	/	/	/	●
	IDU Parameter Display	●	●	●	●	●
Working Mode (Cool Only/Heat Only/No Limit)	●	●	●	●	●	
HRV Control	Floor Layout (Floor Navigation)	●	●	/	●	●
	HRV ON/OFF	●	/	●	/	/
Installer Info.	HRV Fan (Low Air Exchange-High Air Exchange-Low-High)	●	/	●	/	/
	Password	●	●	●	●	●
	Error Code	●	●	●	●	●
	Error Record Check	●	●	●	●	●
	Parameter Inquiry	●	●	●	●	●
	Reset	●	●	●	●	●
User Account Management	Detailed IDU Parameters Display	/	●	/	●	●
	User Info.	/	●	/	●	●
Control Type	User Account Management Level	/	●	/	●	●
	Local Control Panel	●	●	●	●	●
Communication	PC Version	/	●	/	●	●
	Input	RS-485 1CH	RS-485 5CH	RS-485 1CH	RS-485 1CH	RS-485 4CH
	Output	RS-485 1CH	RS-485 1CH	RS-485 1CH	RS-485 1CH	TCP IP
Protocol	Modbus RTU	Modbus RTU	Modbus RTU	Modbus RTU	Modbus IP or BACnet IP	
	Fire Alarm Linkage	●	●	●	/	/

## Adapters & BMS Gateway Features

Item		Protocol Adapter & Electricity Data	Protocol Adapter	LonWorks™ Gateway	KNX® Gateway	BACnet® Gateway
Model		40VCBM17FQEE	40VCCR17FQEE	40VCBL17FQEE	40VCBK17FQEE 40VCBK27FQEE 40VCBK37FQEE	40VCBB17FQEE
Protocol		Modbus RTU	Modbus RTU	LonWorks™	KNX®	BACnet® IP
Picture						
Power Supply		220 V AC	With 12 V DC trans former	24 V DC	29 V DC	AC and DC rated voltage 24 V, working range 12 V to 24 V
Dimensions (W*H*D) mm		200 x 130 x 43	125 x 120 x 40	90 x 70 x 22	70 x 70 x 28	142 x 91 x 35
Communication Port-Input	AC Port (PQ Connection)	1	1			
	RS485			1ch	1ch	2ch
	Pulse Port	1				
Communication Port-Output	RS485	1ch (3rd party Or 40VCB117FQEE, 40VCB217FQEE)	RS485 2ch (for central controller or 3rd party 1ch; for 40VCB117FQEE, 40VCB217FQEE)			
	RS485 For LonWorks Protocol Device			1ch		
	BACnet IP					1
	KNX				KNX port plug-in terminal block(2 poles)	
Operation Temp.		-30-52°C	-20-70°C	-20-70°C	0-60°C	-20-70°C
Stock Temp.		-30-52°C	-40-85°C	-40-85°C	-20-85°C	-40-85°C
Operational Humidity		10%-85%	5-90% (non-condensing)	5-90% (non-condensing)	<90%, RH, non-condensing	5-90% (non-condensing)
Stock Humidity		10%-85%	5-95% (non-condensing)	5-95% (non-condensing)	<90%, RH, non-condensing	5-95% (non-condensing)
Function Description		Embedded in TD ODU Converter HomeBus to Modbus and Electricity collection and distribution function must connect this adapter.	Converter HomeBus to Modbus For SD ODU	For SD ODU Works with 40VCCR17FQEE to converter Modbus to LonWorks™	For SD ODU Works with 40VCCR17FQEE to converter Modbus to KNX®	For SD ODU Works with 40VCCR17FQEE to converter Modbus to BACnet® IP

CONTROLLER





CONTROLLER

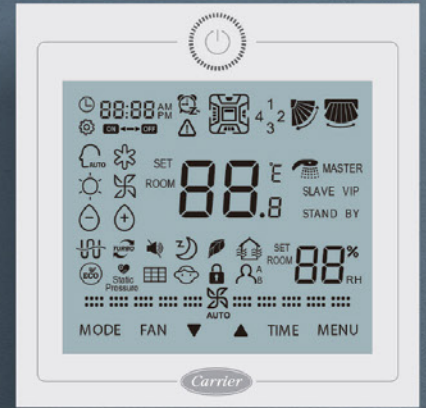

## INDIVIDUAL CONTROLLER



### 40VC167FQEE Wireless Remote Controller

- Basic functions: on/off mode, fan speed, temperature setting, swing
- Turbo, quiet
- Individual louver control for compact four-way cassette & round-way cassette
- Clock & timer
- Follow/evade function (optional)
- Celsius to Fahrenheit



### 40VCW117FQEE Simple Wired Controller

- Basic functions: on/off mode, 3 fan speed, temperature
- Individual & group controller (max. 16 indoor units)
- Simple and smart design, 86\*86\*15.80mm



### 40VCIR7FQEE Infrared Receiver

- For duct units



### 40VCW217FQEE Standard Wired Controller

- Basic functions: on/off mode, 5 fan speed, temperature setting, swing
- Individual & group control (max. 16 indoor units)
- Simple and smart design, 86\*86\*13.05 mm
- Touch button with back light
- Timer/clock
- Easy installation



### 40VCW317FQEE Wired Weekly Timer

- Colorful screen: 120mm X 120mm X 17.8 mm
- Basic functions: on/off mode, fan speed, temperature setting, swing
- Individual & group control (max. 16 indoor units)
- Fahrenheit/ Celsius selectable; sensitivity  $\pm 0.5^{\circ}\text{C}$
- Weekly timer
- Individual louver control for round-way cassette
- Static pressure setting



Turn to the experts

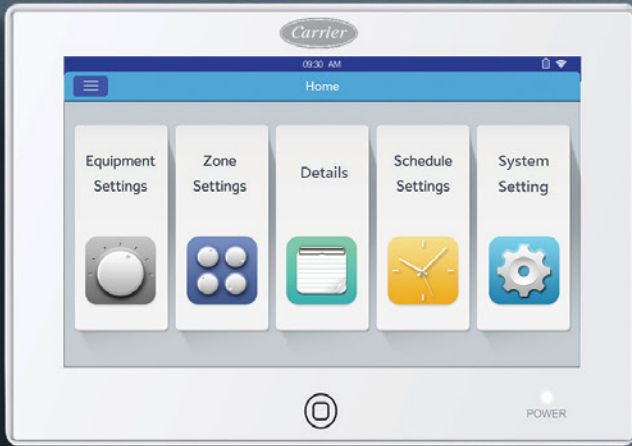

CONTROLLER



## CENTRALIZED CONTROLLER



### 40VCC837FQEE Group Controller Touchscreen

- Individual control, group control & central control
- Max. 32 systems, max. 64 indoor units
- Schedule : daily/weekly/special day
- Flexible group management
- Energy saving : temperature limitation
- HRV control & monitoring
- Fire alarm interlocking
- Modbus RTU protocol for 3<sup>rd</sup> party BMS
- XCT7 Top Discharge system can connect directly; other Side Discharge systems require 40VCCR17FQEE



### 40VCC617FQEE Touchscreen Controller

- Individual control, group control & central control (max. 256 indoor units)
- 7-inch TFT LCD touch screen with back light
- Weekly timer
- Indoor units' information editable
- Error display
- XCT7 Top Discharge system can connect directly; other Side Discharge systems require 40VCCR17FQEE



**40VCC617FQEE**  
System

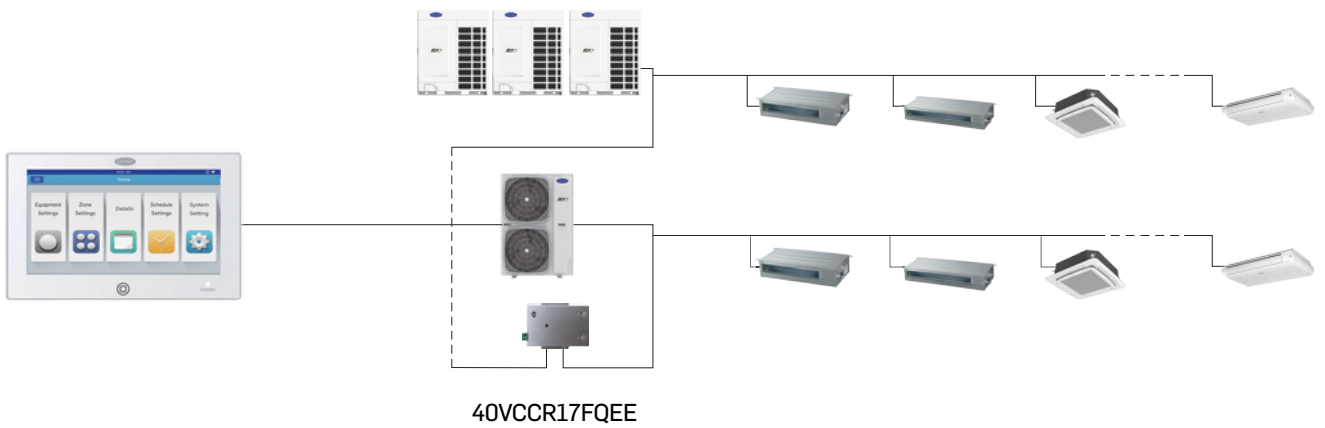



Turn to the experts



CONTROLLER



## CENTRALIZED CONTROLLER



### 40VCC727FQEE Touchscreen Controller

- Individual control, group control & central control (max 800 indoor units)
- 12.5 inch TFT LCD touch screen
- Web access & e-mail alarm
- Weekly schedule & special day setting
- Floor plan layout view
- Can integrate 3<sup>rd</sup> party devices like fire alarm, fan, lighting, other than XCT7 indoor units
- \* Must be used in combination with a 40VCCX17FQEE for each XCT7 system (max. 64 indoor units)



CONTROLLER

## 40VCC727FQEE

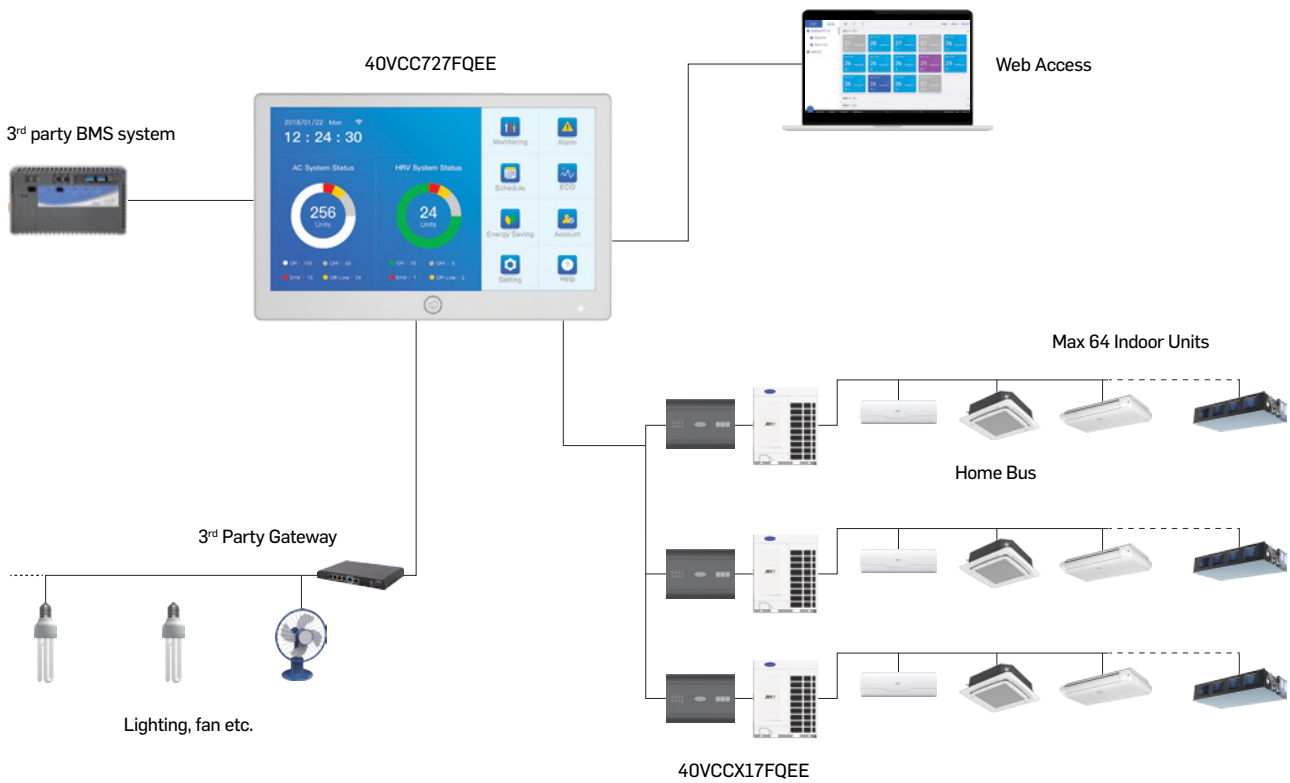

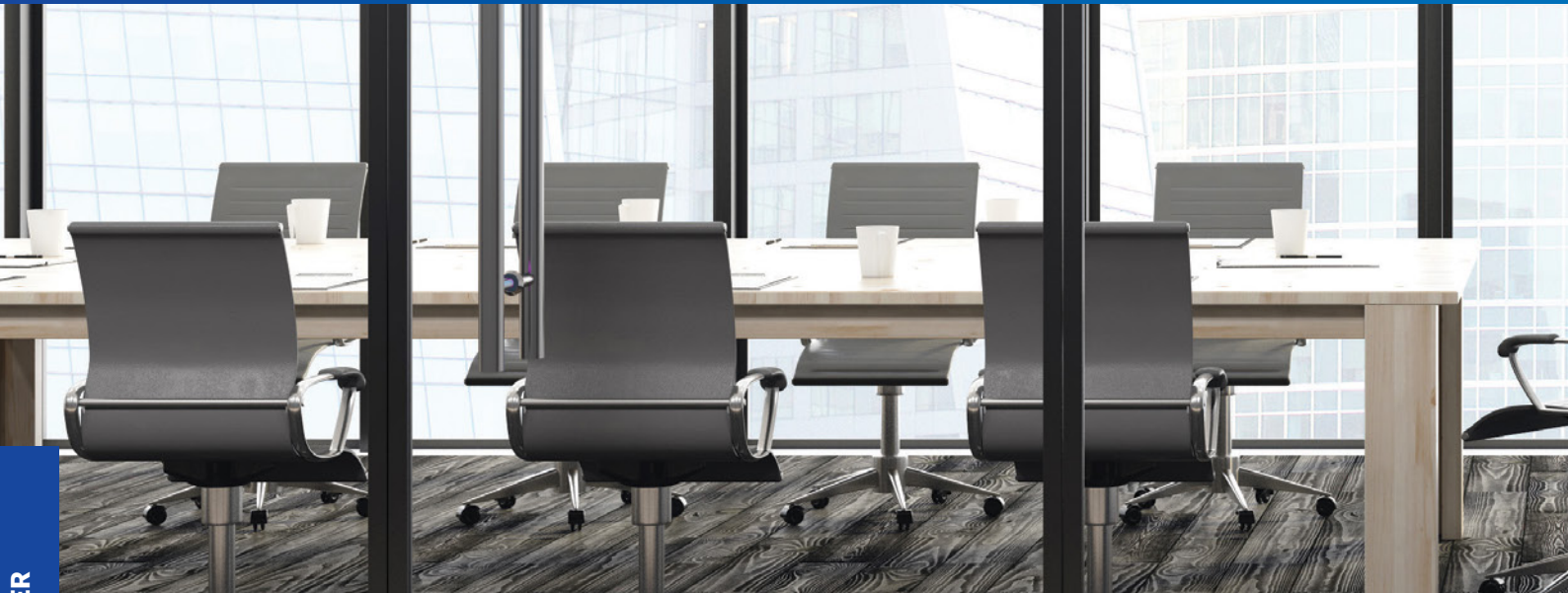

CONTROLLER



## BMS - LOCAL CONTROL



### 40VCB117FQEE

- Local version or PC version; Convert RS-485 to USB
- Max. 400 indoor units can be controlled
- Modbus RTU interface, also supports 3rd party interface
- Win 7 32bits/64bits, Win 8 Pro, Win 10 Pro
- Max. 32 systems
- Each Side Discharge system requires one 40VCCR17FQEE
- Schedule setting
- Power consumption report (must use 40VCBM17FQEE)
- Data monitoring & control functions

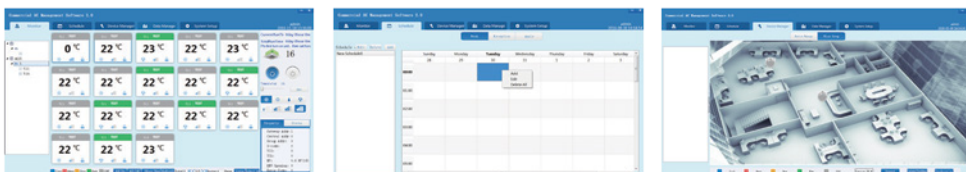



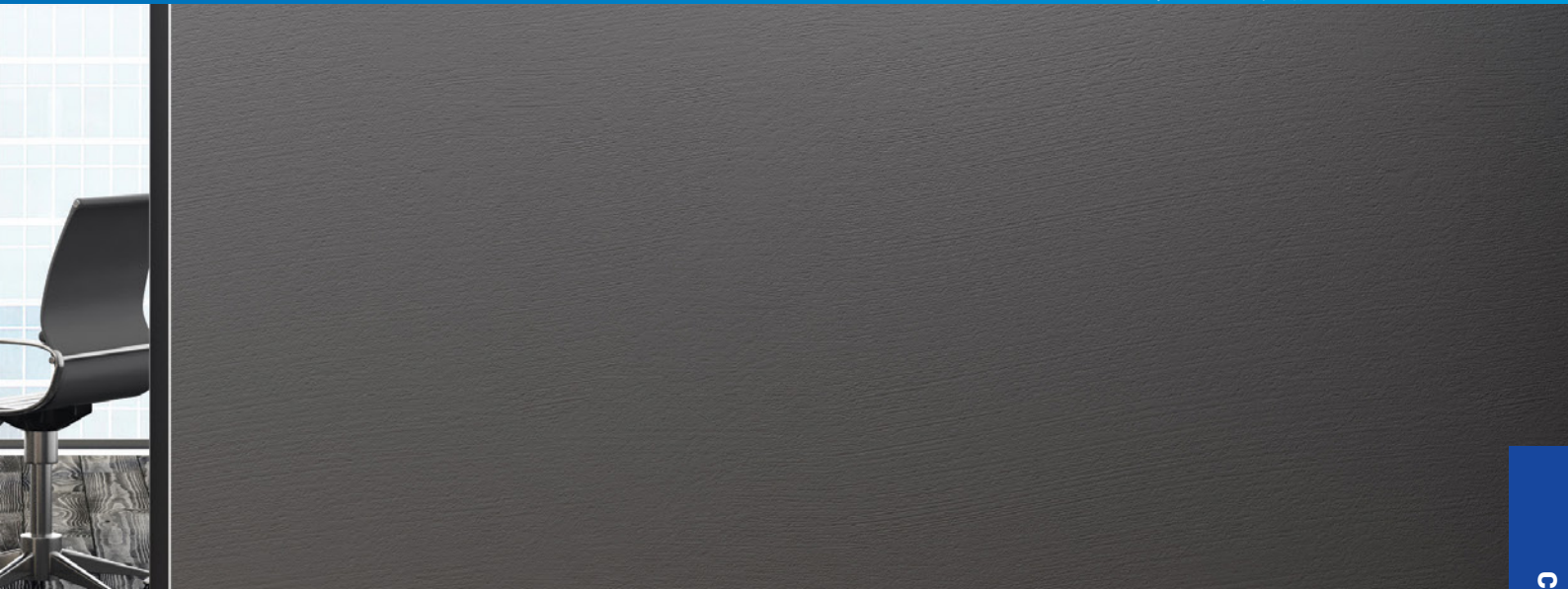

### 40VCB117FQEE System

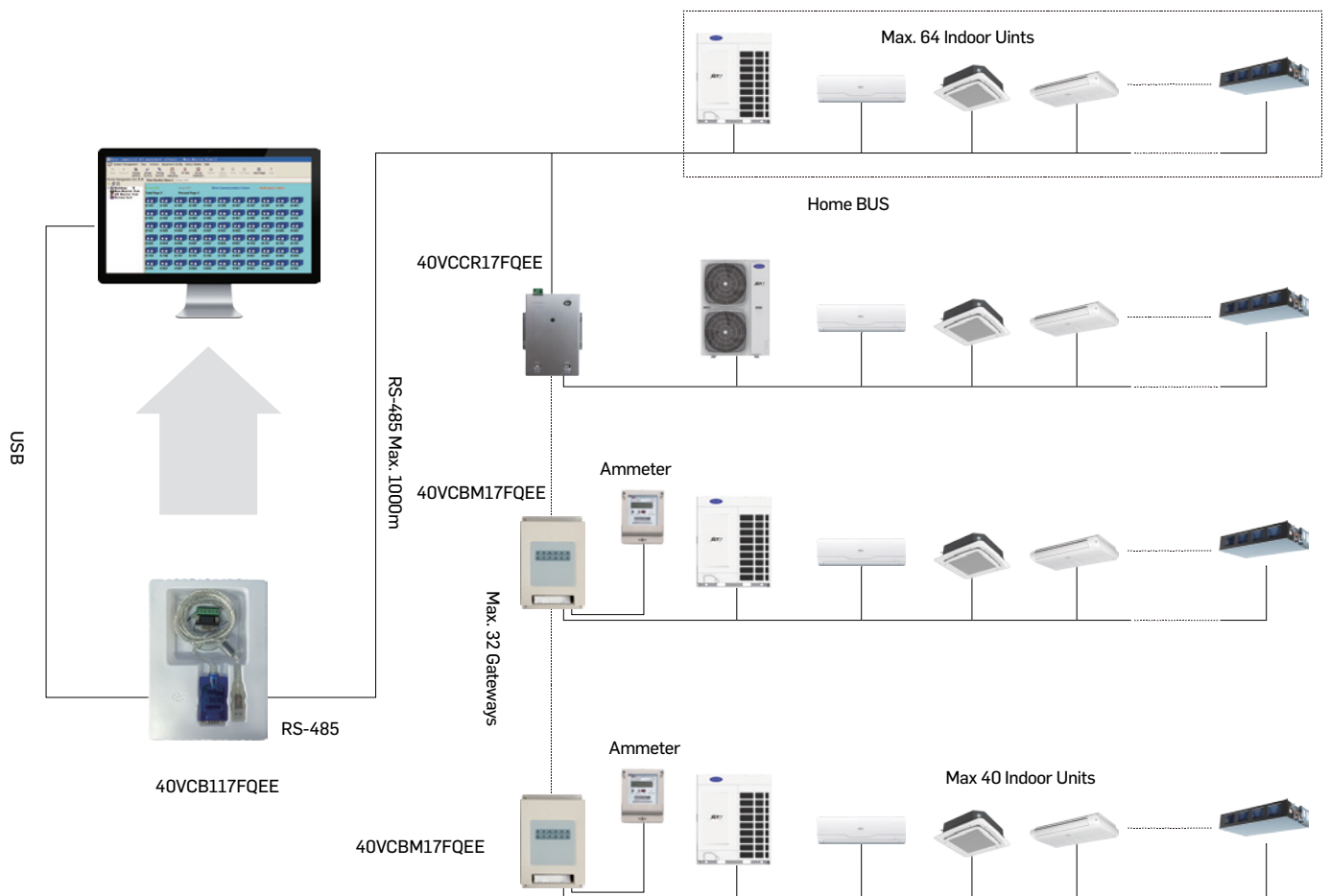



BMS

## BMS - REMOTE MONITORING



### 40VCB217FQEE

- Remote monitoring version also supports third party interface: BACnet IP/Modbus IP/Modbus RTU
- Max. 1500 indoor units can be controlled
- Max. 4 groups. Each group can connect 20 systems. For Top Discharge outdoor units, additional adapter is not required. For Side Discharge outdoor units, 40VCCR17FQEE is needed.
- Operation status setting & monitoring
- Schedule setting
- Multi-user management with different authorized levels
- Operation and error history log
- Web interface access
- Power consumption data & report only available if using 40VCBM17FQEE + Ammeter

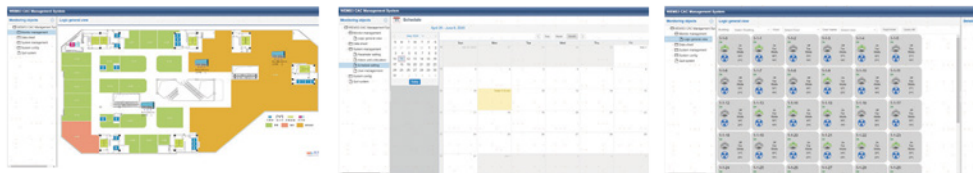



CONTROLLER

### 40VCB217FQEE System

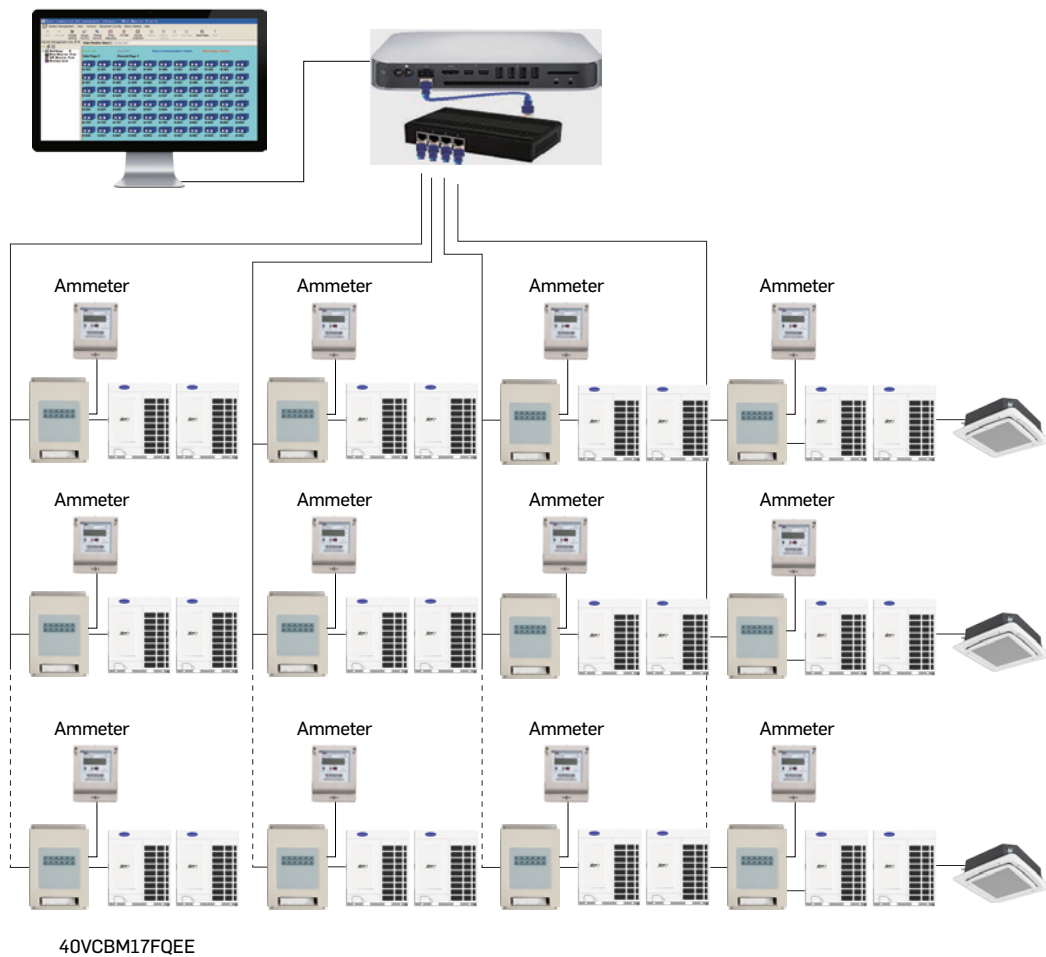

BMS

## BMS GATEWAYS



### 40VCBL17FQEE

- 40VCBL17FQEE, convert ModBus RTU to LonWorks™
- Each system requires one adapter 40VCBL17FQEE (combine with 40VCCR17FQEE if outdoor unit is XCT7)
- Max. 32 indoor units can be connected in one system
- External 24 V DC power supply is needed



### 40VCBB17FQEE

- Protocol adapter, convert Modbus RTU to BACnet® Gateway
- Max. 128 indoor units/ 4 systems can be controlled
- Operation status setting & monitoring
- Schedule setting
- Multi-user management
- 40VCCR17FQEE is required for Side Discharge outdoor units



LonWorks System

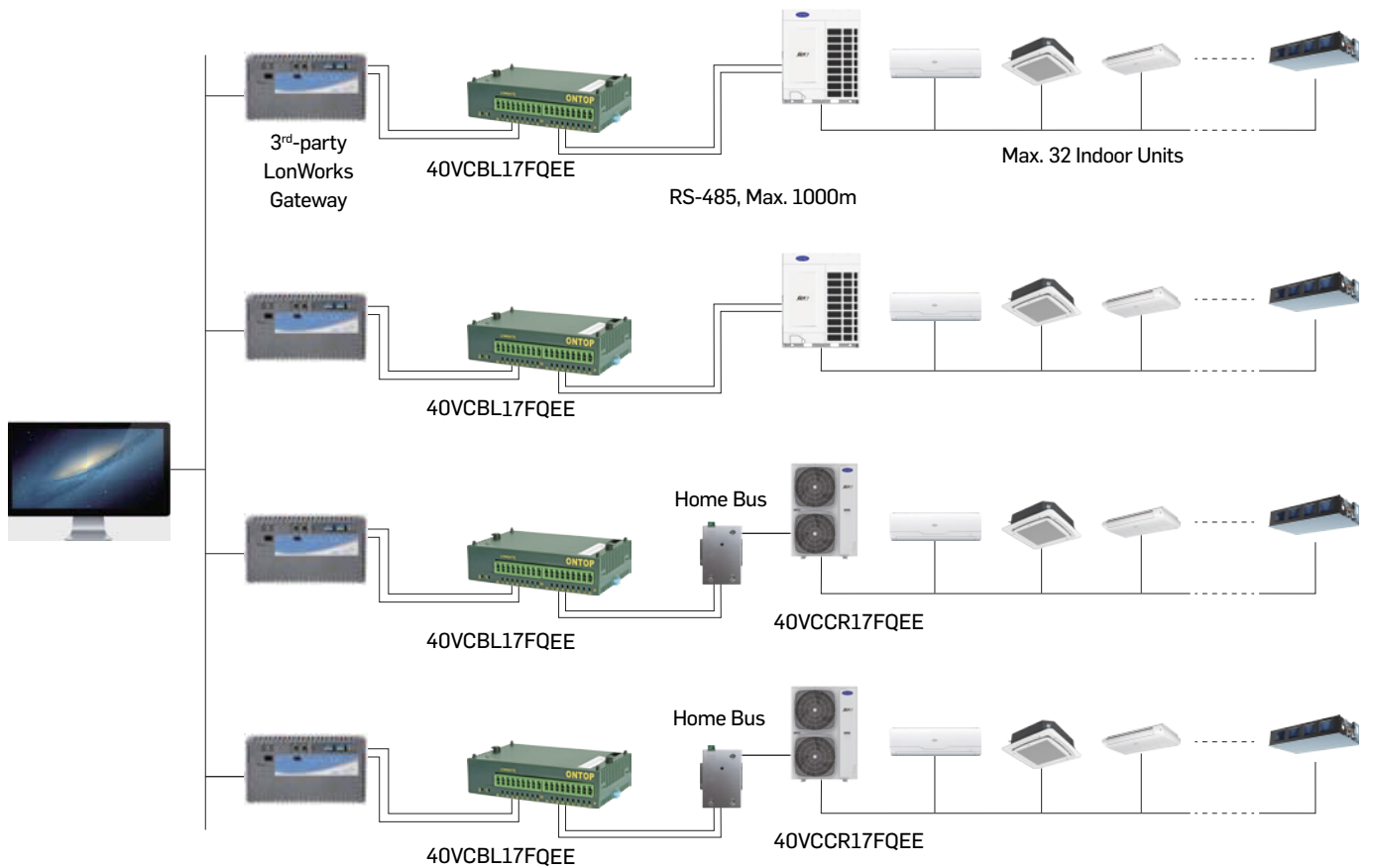



## BMS PROTOCOL ADAPTERS



40VCBK17FQEE(8 IDU)      40VCBK27FQEE(16 IDU)  
40VCBK37FQEE(64 IDU)

- KNX® gateway
- Convert Modbus RTU to KNX®
- Each side discharge ODU requires one KNX® gateway + 40VCCR17FQEE
- Max.8/16/64 indoor units can be connected to one system



40VCCR17FQEE

- Protocol adapter, convert Home Bus to RS-485
- Gateway: ModBus RTU
- Max. 64 indoor units can be connected with one 40VCCR17FQEE
- Side discharge XCT7 requires one 40VCCR17FQEE when connecting with centralized controller or BMS system

Modbus model No.	No. of I.U. controllable	Installation Method	Compatible O.U. Type
40VCCR17FQEE	64	Outside the O.U.	Side and Top discharge O.U.



40VCBM17FQEE

- Protocol adapter, convert Home Bus to ModBus
- Power consumption data collection, and storage (requires 3<sup>rd</sup> party ammeter)
- Match with local BMS (40VCB117FQEE,40VCB217FQEE), each system requires one adapter
- Max. 40 indoor units can be connected with one 40VCBM17FQEE Gateway



### Controllers Match Table for Indoor Units

Outlook	Series	 40VCI67FQEE	 40VCW217FQEE	 40VCW317FQEE	 40VCW117FQEE
	ONE-WAY CASSETTE	●	●	●	●
	TWO-WAY CASSETTE	●	●	●	●
	COMPACT FOUR-WAY CASSETTE	●	●	●	●
	ROUND-WAY CASSETTE	●	●	●	●
	SLIM DUCT	●	●	●	●
	STANDARD STATIC DUCT 20/200 Pa	●	●	●	●
	HIGH STATIC DUCT 0/250 Pa	●	●	●	●
	HIGH WALL	●	●	●	●
	TWO-WAY CONSOLE	●	●	●	●
	CONSOLE-RECESSED	●	●	●	●
	FLEX CEILING FLOOR DC	●	●	●	●

CONTROLLER

● Controllers match with the indoor unit



Turn to the experts



# Control Systems

CONTROLLER

3<sup>rd</sup> Party BMS or HEMS

Central Control



Web Access



40VCC617FQEE

40VCC837FQEE



40VCC727FQEE

40VCCX17FQEE

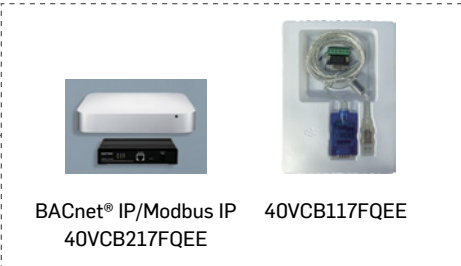

BACnet® IP/Modbus IP  
40VCB217FQEE

40VCB117FQEE



3<sup>rd</sup> Party Integrator Program

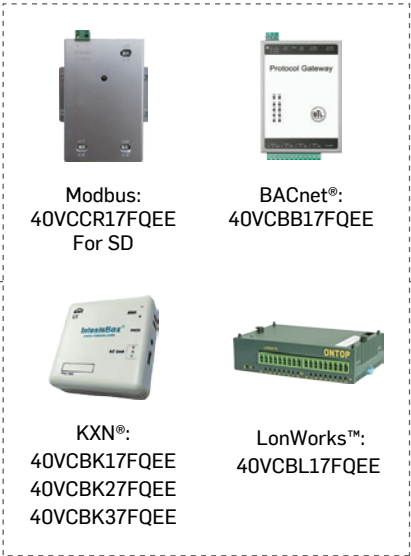

Modbus:  
40VCCR17FQEE  
For SD

BACnet®:  
40VCBB17FQEE

KXN®:  
40VCBK17FQEE  
40VCBK27FQEE  
40VCBK37FQEE

LonWorks™:  
40VCBL17FQEE





Individual Control



40VCI67FQEE

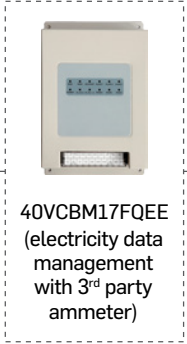
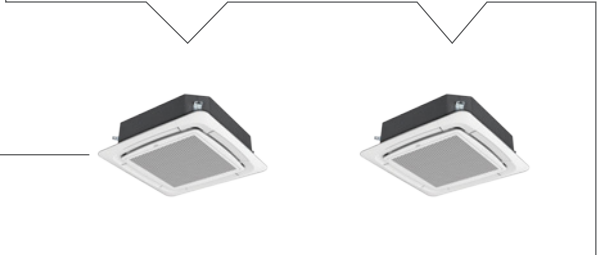
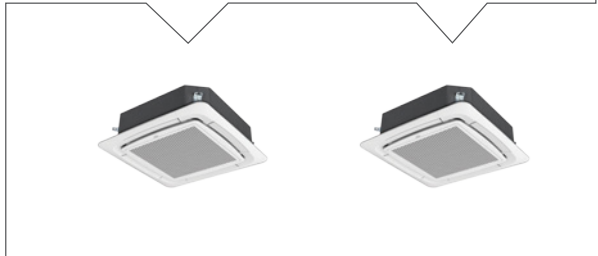
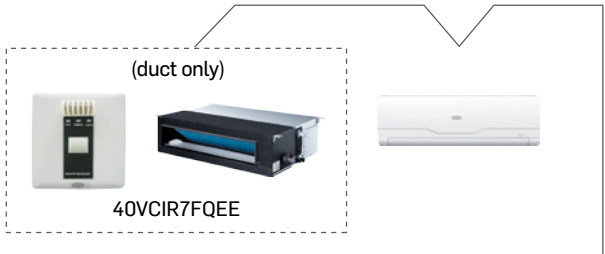

40VCW117FQEE



40VCW217FQEE



40VCW317FQEE

CONTROLLER



## **Service, Support & Product Training**

## **Customer Focus**

As your preferred service provider, Carrier designs tailored service programs to meet your goals and optimize your business performance.

## **Proximity & Responsiveness**

Our expert technicians are there to respond quickly. The comprehensive and highly efficient maintenance processes practiced by Carrier aids in prompt action to get your equipment functioning smoothly again.

## **Expertise & Consultancy**

Your Carrier experts can help you with energy efficiency and optimize your investment with our wide choice of technologies and solutions. With the commendable expertise of our internal team, we can offer you the best consultancy.



Turn to the experts



ACCESSORIES



## ACCESSORIES

- 174 HEAT PUMP - ODU PIPING CONNECTION ACCESSORIES
- 176 HEAT PUMP - IDU PIPING CONNECTION ACCESSORIES
- 178 HEAT RECOVERY – ODU PIPING CONNECTION ACCESSORIES
- 180 HEAT RECOVERY – IDU PIPING CONNECTION ACCESSORIES
- 182 HEAT RECOVERY – VALVE BOX







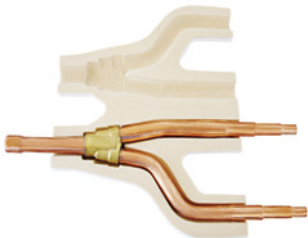
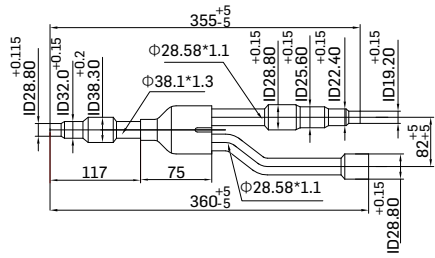
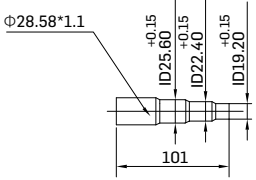
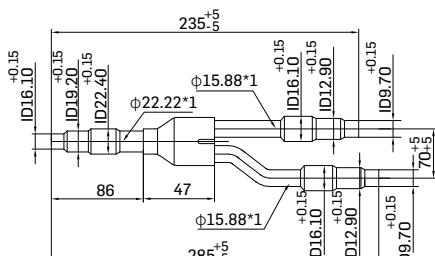
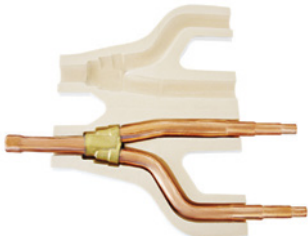
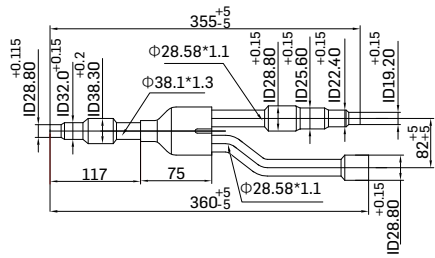
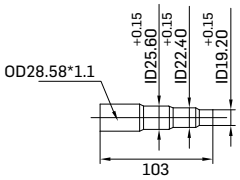
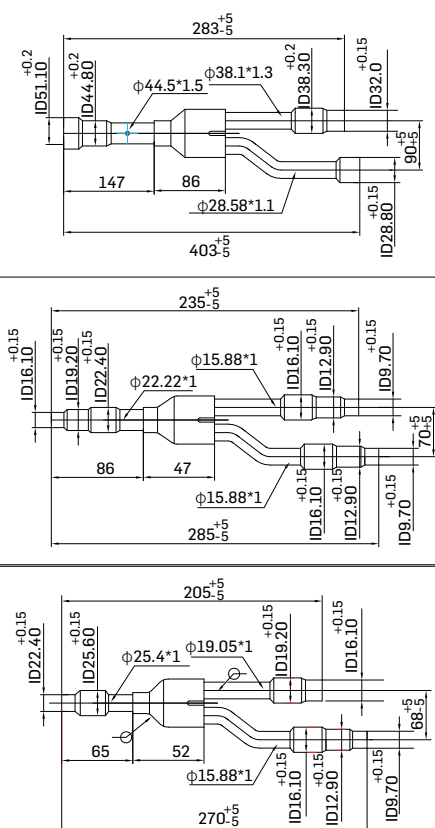
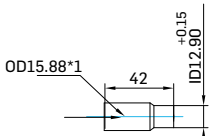

## Accessories

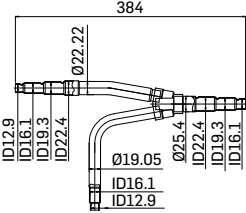
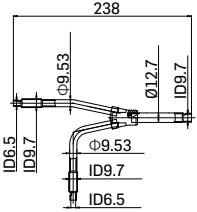
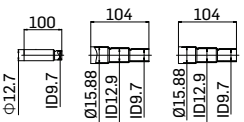
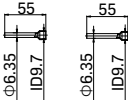
Shape	Model	Description
Piping accessory for Heat Pump outdoor unit combination connection		
	40VJ052G7-HQEE	For two outdoor units' combination at installation location
	40VJ078G7-HQEE	For three outdoor units' combination at installation location
	40VJ078G7-HQEE +40VJ072M7-HQEE	For four outdoor units' combination at installation location
Piping accessory for Indoor unit and Heat Pump outdoor unit connection		
	40VJ012M7-HQEE	< 33.5 kW
	40VJ018M7-HQEE	33.5 < < 50.6kW
	40VJ026M7-HQEE	50.6 < < 73kW
	40VJ048M7-HQEE	73 < < 135kW
	40VJ072M7-HQEE	135 < < 204kW

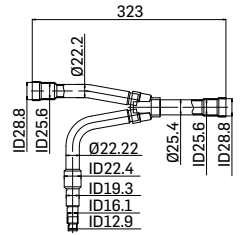
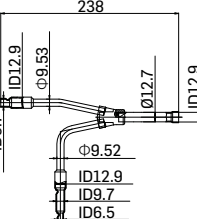
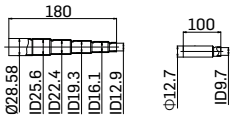
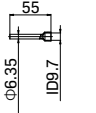
## Piping accessory for Heat Pump outdoor unit combination connection

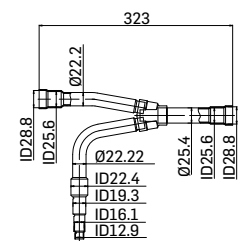
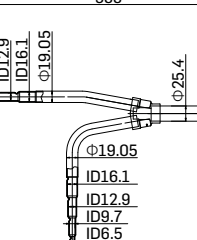
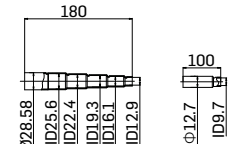
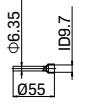
ACCESSORIES

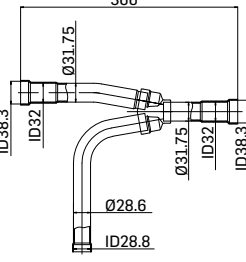
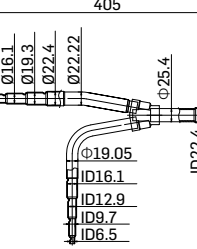
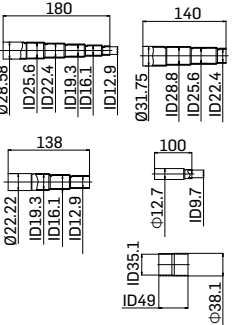
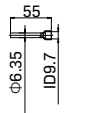
Model Name	Side	Gather Pipe	Connection of Gather Pipe
<p>40VJ052G7-HQEE</p> 	Suction gas side		
	Liquid side		
<p>40VJ078G7-HQEE</p> 	Suction gas side		 <p>double</p>
	Liquid side		 <p>double</p>

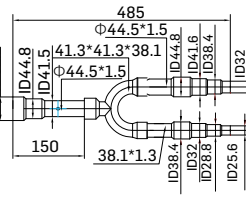
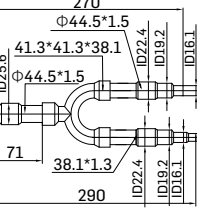
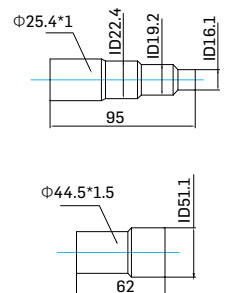
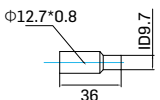
Model	Gas Side Branch Pipe	Liquid Side Branch Pipe	Gas Side Connection of Branch Pipe	Liquid Side Connection of Branch Pipe
 <p>40VJ012M7-HQEE</p>	 <p>384 Ø22.22 ID12.9 ID16.1 ID19.3 ID22.4 Ø19.05 Ø25.4 ID22.4 ID19.3 ID16.1 ID12.9</p>	 <p>238 Ø9.53 Ø12.7 ID9.7 ID6.5 ID9.7 ID6.5</p>	 <p>100 104 104 Φ12.7 ID9.7 Ø15.88 ID12.9 ID9.7 Ø15.88 ID12.9 ID9.7</p>	 <p>55 55 Φ6.35 ID9.7 Φ6.35 ID9.7</p>
 <p>40VJ018M7-HQEE</p>	 <p>323 Ø22.2 ID28.8 ID25.6 Ø22.22 ID22.4 Ø25.4 ID25.6 ID28.8 ID16.1 ID12.9</p>	 <p>238 ID12.9 Ø9.53 Ø12.7 ID9.7 ID12.9 Ø9.52 ID12.9 ID9.7 ID6.5</p>	 <p>180 100 Ø28.58 ID25.6 ID22.4 ID19.3 ID16.1 ID12.9 Φ12.7 ID9.7</p>	 <p>55 Φ6.35 ID9.7</p>
 <p>40VJ026M7-HQEE</p>	 <p>323 Ø22.2 ID28.8 ID25.6 Ø22.22 ID22.4 Ø25.4 ID25.6 ID28.8 ID16.1 ID12.9</p>	 <p>388 ID12.9 ID16.1 Ø19.05 Ø25.4 ID9.7 Φ19.05 ID16.1 ID12.9 ID9.7 ID6.5 ID16.1</p>	 <p>180 100 Ø28.58 ID25.6 ID22.4 ID19.3 ID16.1 ID12.9 Φ12.7 ID9.7</p>	 <p>Φ6.35 ID9.7 55</p>
 <p>40VJ048M7-HQEE</p>	 <p>366 Ø31.75 ID38.3 ID32 Ø31.75 ID32 ID38.3 Ø28.6 ID28.8</p>	 <p>405 ID12.9 ID16.1 ID19.3 Ø22.4 Ø22.22 Ø25.4 ID9.7 Φ19.05 ID16.1 ID12.9 ID9.7 ID6.5 ID22.4 ID19.3</p>	 <p>180 140 138 100 Ø28.58 ID25.6 ID22.4 ID19.3 ID16.1 ID12.9 Ø31.75 ID28.8 ID25.6 ID22.4 ID35.1 ID38.1 ID49 Φ12.7 ID9.7</p>	 <p>55 Φ6.35 ID9.7</p>
 <p>40VJ072M7-HQEE</p>	 <p>485 Ø44.5*1.5 ID51.1 ID44.8 ID41.5 41.3*41.3*38.1 Ø44.5*1.5 ID44.8 ID41.6 ID38.4 ID32 ID28.8 ID25.6 ID32 130 150 38.1*1.3</p>	 <p>270 Ø44.5*1.5 ID25.6 ID16.1 ID19.3 Ø22.4 ID22.4 ID19.2 ID16.1 ID12.9 70 71 38.1*1.3 290 ID22.4 ID19.2 ID16.1 ID12.9</p>	 <p>Φ25.4*1 ID22.4 ID19.2 ID16.1 95 Φ44.5*1.5 ID51.1 62</p>	 <p>Φ12.7*0.8 36 ID9.7</p>

### Piping accessory for Heat Recovery outdoor unit combination connection

24-44 HP

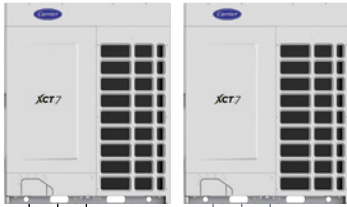

40VJ044G7-RQEE

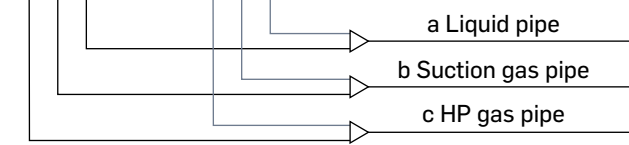

46-66 HP



40VJ066G7-RQEE

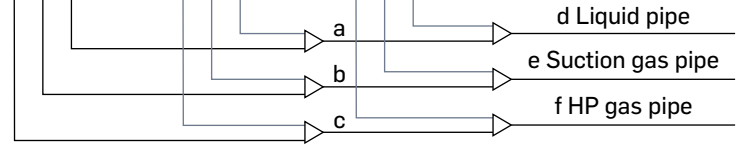

ACCESSORIES

	Side	Mark	Manifold Pipe	Insulation Material
40VJ044G7-RQEE	Suction gas side	A		
	HP gas side	B		
	Liquid side	C		



	Side	Mark	Manifold Pipe	Insulation Material
40VJ066G7-RQEE	Suction gas side	D		
		E		
	HP gas side	F		
		G		
	Liquid side	H		
		I		

## Piping accessory for Heat Recovery outdoor unit combination connection

68-88 HP

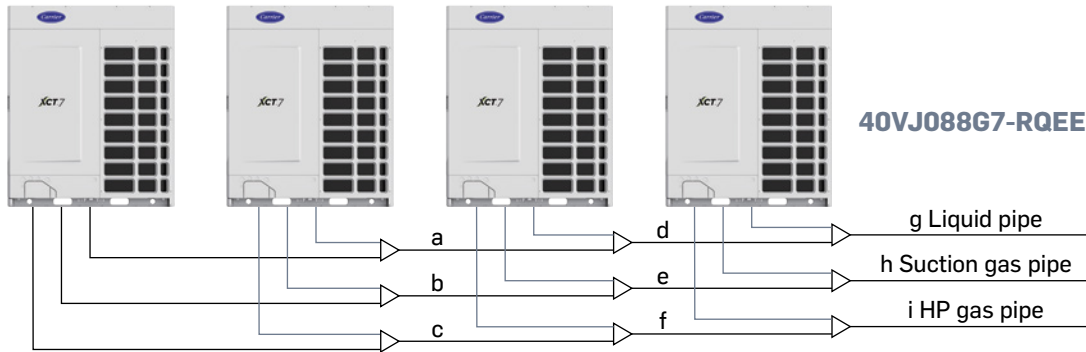









ACCESSORIES

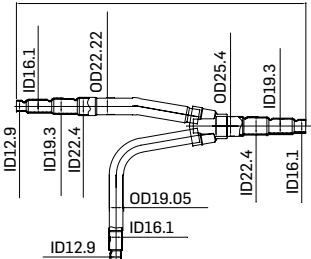
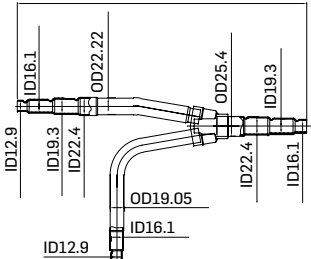
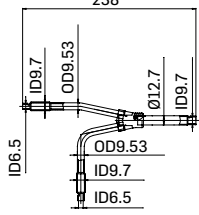

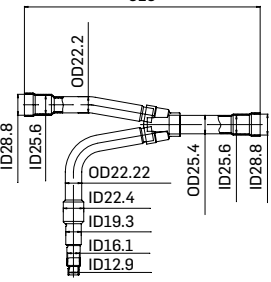
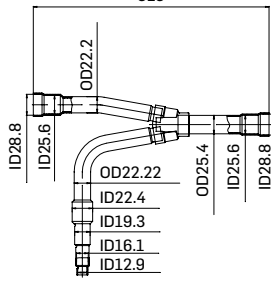
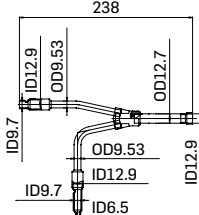

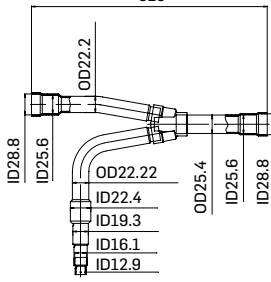
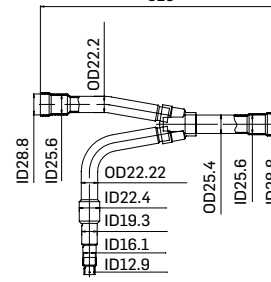
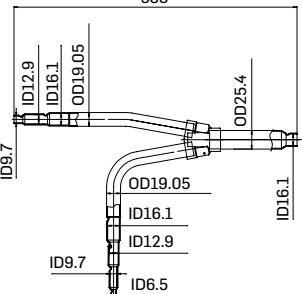

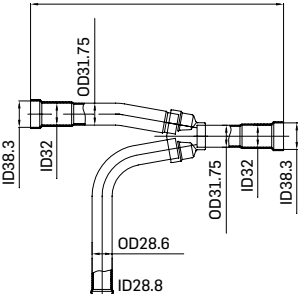
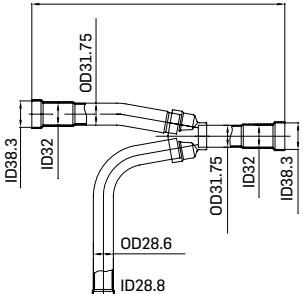
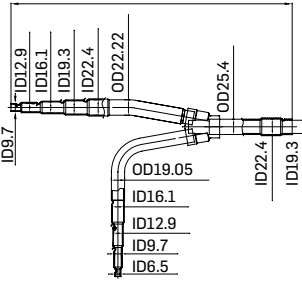

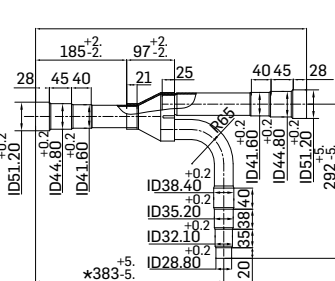
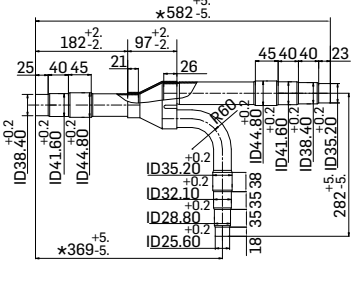
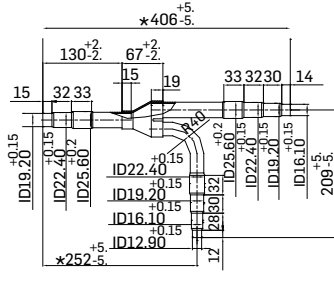
	Side	Mark	Manifold Pipe	Insulation Material
40VJ088G7-RQEE	Liquid side	P		
		Q		
		R		

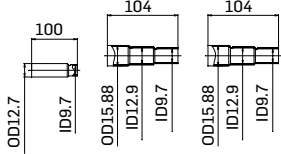
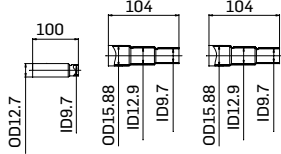
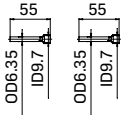
	Side	Mark	Manifold Pipe	Insulation Material
40VJ088G7-RQEE	Suction gas side	J		
		K		
		L		
40VJ088G7-RQEE	HP gas side	M		
		N		
		O		

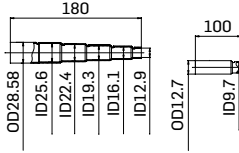
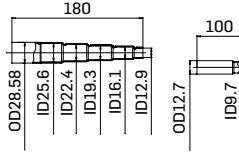
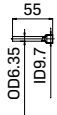
## Piping accessory for Indoor unit and Heat Recovery outdoor unit connection

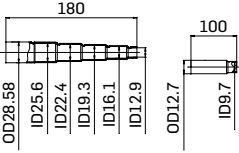
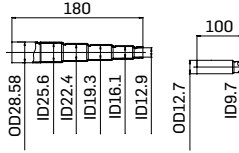
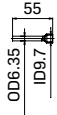
ACCESSORIES

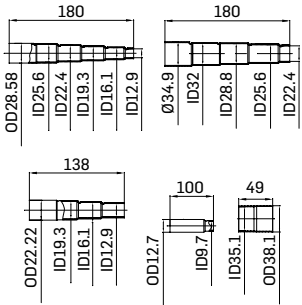
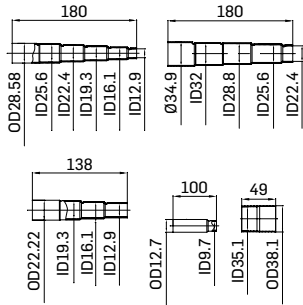
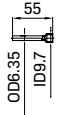
Model	Suction Gas Branch Pipe	HP Gas Branch Pipe	Liquid Branch Pipe
<p>40VJ012M7-RQEE</p> 	<p>384</p> 	<p>384</p> 	<p>238</p> 
<p>40VJ018M7-RQEE</p> 	<p>323</p> 	<p>323</p> 	<p>238</p> 
<p>40VJ026M7-RQEE</p> 	<p>323</p> 	<p>323</p> 	<p>388</p> 
<p>40VJ048M7-RQEE</p> 	<p>366</p> 	<p>366</p> 	<p>405</p> 
<p>40VJ072M7-RQEE</p> 			

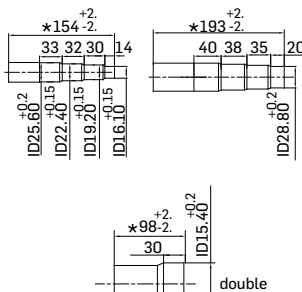
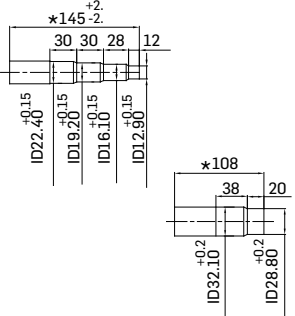
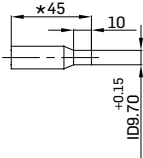
Model	Suction Gas Branch Pipe	HP Gas Branch Pipe	Liquid Branch Pipe
<p>40VJ012M7-RQEE</p> 	 <p>100, 104, 104</p> <p>OD12.7, ID9.7, OD15.88, ID12.9, ID9.7, OD15.88, ID12.9, ID9.7</p>	 <p>100, 104, 104</p> <p>OD12.7, ID9.7, OD15.88, ID12.9, ID9.7, OD15.88, ID12.9, ID9.7</p>	 <p>55, 55</p> <p>OD6.35, ID9.7, OD6.35, ID9.7</p>
<p>40VJ018M7-RQEE</p> 	 <p>180, 100</p> <p>OD28.58, ID25.6, ID22.4, ID19.3, ID16.1, ID12.9, OD12.7, ID9.7</p>	 <p>180, 100</p> <p>OD28.58, ID25.6, ID22.4, ID19.3, ID16.1, ID12.9, OD12.7, ID9.7</p>	 <p>55</p> <p>OD6.35, ID9.7</p>
<p>40VJ026M7-RQEE</p> 	 <p>180, 100</p> <p>OD28.58, ID25.6, ID22.4, ID19.3, ID16.1, ID12.9, OD12.7, ID9.7</p>	 <p>180, 100</p> <p>OD28.58, ID25.6, ID22.4, ID19.3, ID16.1, ID12.9, OD12.7, ID9.7</p>	 <p>55</p> <p>OD6.35, ID9.7</p>
<p>40VJ048M7-RQEE</p> 	 <p>180, 180, 138, 100, 49</p> <p>OD28.58, ID25.6, ID22.4, ID19.3, ID16.1, ID12.9, Ø34.9, ID32, ID28.8, ID25.6, ID22.4, OD22.22, ID19.3, ID16.1, ID12.9, OD12.7, ID9.7, ID35.1, OD38.1</p>	 <p>180, 180, 138, 100, 49</p> <p>OD28.58, ID25.6, ID22.4, ID19.3, ID16.1, ID12.9, Ø34.9, ID32, ID28.8, ID25.6, ID22.4, OD22.22, ID19.3, ID16.1, ID12.9, OD12.7, ID9.7, ID35.1, OD38.1</p>	 <p>55</p> <p>OD6.35, ID9.7</p>
<p>40VJ072M7-RQEE</p> 	 <p>*154<sup>+2</sup>/<sub>-2</sub>, 33, 32, 30, 14, *193<sup>+2</sup>/<sub>-2</sub>, 40, 38, 35, 20, ID25.60<sup>+0.2</sup>, ID22.40<sup>+0.15</sup>, ID19.30<sup>+0.15</sup>, ID16.10<sup>+0.15</sup>, ID12.90<sup>+0.15</sup>, ID28.80<sup>+0.2</sup>, *98<sup>+5</sup>/<sub>-2</sub>, 30, ID15.40<sup>+0.2</sup>, double</p>	 <p>*145<sup>+2</sup>/<sub>-2</sub>, 30, 30, 28, 12, ID22.40<sup>+0.15</sup>, ID19.30<sup>+0.15</sup>, ID16.10<sup>+0.15</sup>, ID12.90<sup>+0.15</sup>, *108, ID32.10<sup>+0.2</sup>, 38, 20, ID28.80<sup>+0.2</sup></p>	 <p>*45, 10, +0.15, ID9.70</p>

## Accessories Line-up – Valve box for 3 pipe Heat Recovery outdoor unit

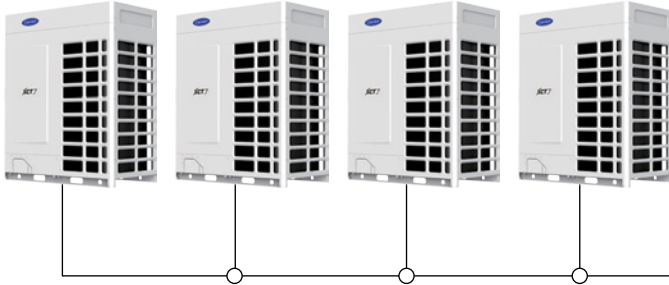

Different mode for refrigerant piping connection according to Valve box connection rules :

1. Multi 4 port valve box installed in a line
2. Less than 4 IDUs connected to 4 port VB
3. More than 4 IDU on a 4 port Valve box
4. More IDU connected to a 1 port Valve box
5. IDU connected without Valve box

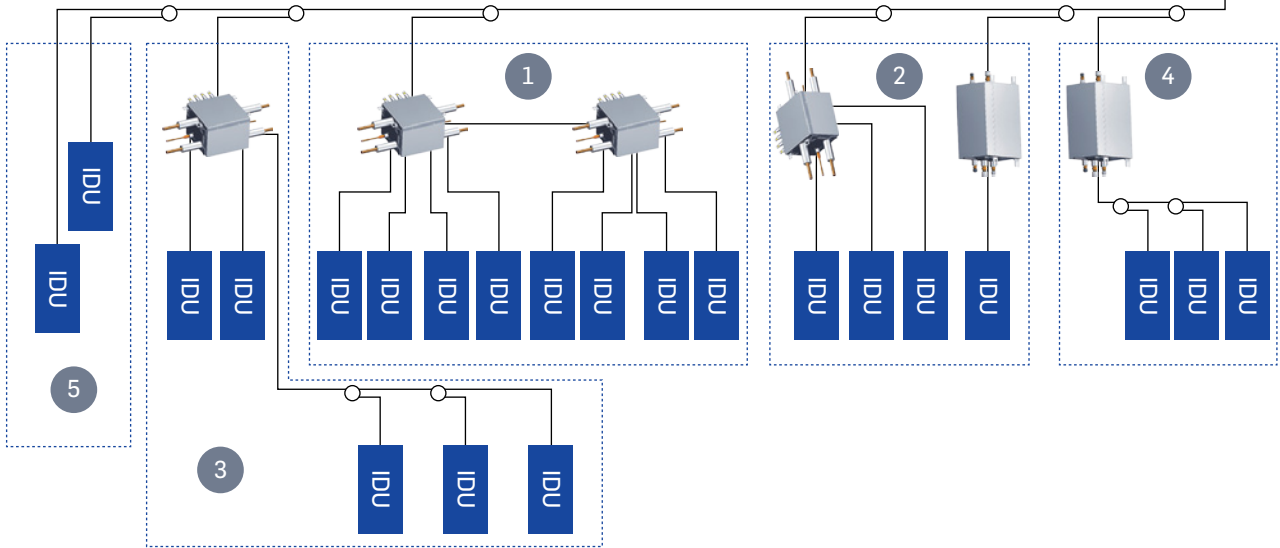

ACCESSORIES

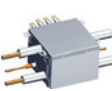
EXV Type	Model Code	40VX	00417FRQEE	00717FRQEE	01017FRQEE	01647FRQEE
1 Port 	Power Supply	Ph/V/Hz	1/220~240/50/60			
	Number of Ports		1			4
4 Ports 	Maximum Indoor Units		5	8	8	20
	Max IDU Capacity	kW	≤ 11.2	11.2 < ≤ 18	18 < ≤ 28	≤ 45
	External Dimension (LxWxH)	mm	388 x 200 x 276			405 x 300 x 421
	Net Weight	kg	8.6			9.3



Type	Product Family Name	Carrier Model Code	Page
<b>Outdoor Units</b>	Side Discharge Heat Pump Single Fan 4-5 HP	38VS*C7SH	40
	Side Discharge Heat Pump Dual Fan 4-5-6 HP	38VS*17S/3H	41
	Side Discharge Heat Pump Dual Fan 8-10-12 HP	38VS*174H	43
	Top Discharge Heat Pump	38VT*173H	54
	Top Discharge Heat Recovery	38VT*173R	68
<b>Indoor Units</b>	One-Way Cassette	40VU*1-7E	87
	Two-Way Cassette	40VU*2-7G	91
	Compact Four-Way Cassette	40VU*C-7S	95
	Round-Way Cassette	40VU*R-7E	98
	Slim Duct	40VD*L-7E	104
	Standard Static Duct 20-200 Pa	40VD*S-7S	108
	High Static Duct 0-250 Pa	40VD*H-7S	112
	High Wall	40VK*S-7S2	118
	Two-Way Console	40VL*B-7E	123
	Console Recessed	40VL*R-7G	127
	Flex Ceiling Floor (DC Fan)	40VC*F-7S	128
	Heat Reclaim Ventilation	40VH*A-7G	135
<b>AHU DX KIT</b>		40VA	143
<b>Controls</b>		40VC	150
<b>Accessories</b>		40VJ	173
		40VX	182



## ICON LIST

- |   |  |                                   |  |
|---|--|-----------------------------------|--|
| High reliability                                  | Easy installation & access & fix & maintenance   | Advanced technology               | AHU DX coil kit (TA Control)                                 |
| Enhanced performance                              | One button trial operation                       | Brazing refrigerant               | Unit structure   |
| High efficiency                                   | Powerful heating                                 | Advanced separator                | Individual controller  |
| Compact design & ultra-thin design & space saving | Knockout hole for outside fresh air              | Fan motor.                        | Centralized controller                                       |
| Wide range of capacity                            | Large operating range                            | Built-in drain pump               | BMS - Local control  |
| Wide range of options                             | Bottom or rear air return                        | Administrations                   | BMS gateways   |
| Superior comfort                                  | Independent or flexible control of the air flow  | Offices                           | Control systems  |
| Low sound level                                   | Static pressure setting                          | Hotels                            | Can be installed with or without discharge & return plenum   |
| Effective control of the temperature              | Light air resistance                             | Retail                            | Hidden installation for a clean and sophisticated appearance |
| Independent 220v power                            | PM 2.5 filter available                          | Healthcare                        | Flexible discharge duct connection                           |
| Automatic display of fault codes                  | Advanced black-coated fin technology             | Individual and collective housing | Multiple direction for connection pipe setting               |
| Unique design                                     | Reliable multi-layer oil return technology       | Pipe liner                        | Cooling  |
| Round corner design                               | Advanced compressor anti-liquid-shock technology | Rear & bottom inlet               | Heating  |

## Your VRF System of Choice



### AHI CARRIER EUROPE

#### GREECE

##### AHI CARRIER S.E. EUROPE SINGLE MEMBER S.A.

###### Headquarters

18, Kifissou Ave.  
104 42 - Athens  
Tel.: +30 210 6796300

###### Thessaloniki Branch

5, Ag. Georgioy str., Cosmos Offices  
570 01 - Patriarhiko Pileas Thessaloniki  
Tel.: +30 231 3080430

[grinfo@ahi-carrier.eu](mailto:grinfo@ahi-carrier.eu)

[www.ahi-carrier.gr](http://www.ahi-carrier.gr)

[www.toshiba-aircon.gr](http://www.toshiba-aircon.gr)

#### BULGARIA

##### AHI CARRIER HVAC BULGARIA EOOD

Trade Center Europe Building 6,  
floor 3, office 6  
7 Iskarsko Shose Blvd., Sofia 1528  
Tel.: +35 929483960

[bginfo@ahi-carrier.com](mailto:bginfo@ahi-carrier.com)

[www.ahi-carrier.bg](http://www.ahi-carrier.bg)

[www.toshiba-aircon.bg](http://www.toshiba-aircon.bg)

#### ROMANIA

##### AHI CARRIER ROMANIA SRL

Intrarea Nestorei 1, Corp B, Et. 5, Sector 4  
Cladirea River Plaza, RO-040295 Bucuresti  
Tel.: +40 214 050751

[roinfo@ahi-carrier.eu](mailto:roinfo@ahi-carrier.eu)

[www.ahi-carrier.ro](http://www.ahi-carrier.ro)

[www.toshiba-aircon.ro](http://www.toshiba-aircon.ro)

#### AUSTRIA

##### AHI CARRIER GMBH

Andromeda Tower, Donau-City Str. 6/9  
1220 Wien, Österreich  
Tel.: +43 1 269 969 710

[info@ahi-carrier.at](mailto:info@ahi-carrier.at)

[www.ahi-carrier.at](http://www.ahi-carrier.at)

#### CZECH REPUBLIC

##### AHI CARRIER CZ S.R.O.

Styblova 253/13,  
14900 Praha 5, Chodov  
Tel.: +420 212 812 030

[info@ahi-carrier.cz](mailto:info@ahi-carrier.cz)

[www.ahi-carrier.cz](http://www.ahi-carrier.cz)