

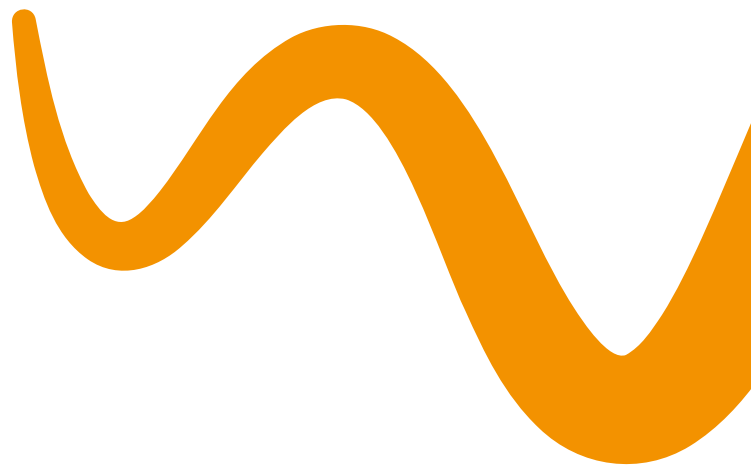

CLOSE TO YOU

2024 GENERAL CATALOGUE

Think BIC



YOU JUST IMAGINE,
WE MAKE IT REAL.



THINK BIC

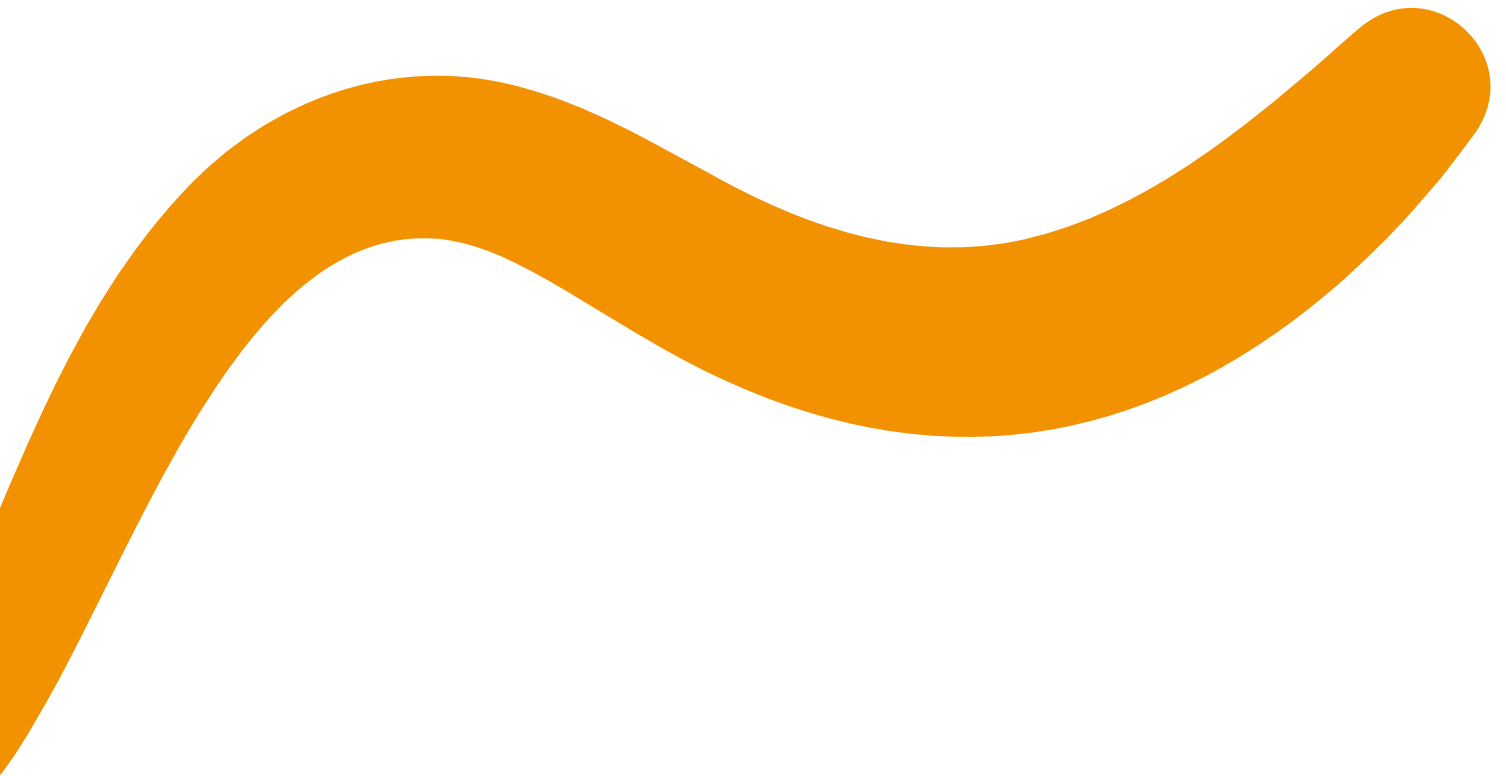

CLOSE TO YOU

We were there beside you as you took your first steps in this world. From the moment your doodling became words to the time you lit those special birthday candles, BIC has shared your journey, filling your everyday moments with joy, creativity, and sustainability. As life moves forward, we innovate to remain your trustworthy daily life companion.

Our commitment to innovation leads the way with each step forward in life. We're constantly seeking new ways to simplify your daily routines and add more joy to your journey. Sustainability is our legacy. We're committed to protecting our planet for future generations while considering your values.

This philosophy forms the foundation of everything we do at BIC Graphic. We've forged strong bonds with every person and company we engage with. Our local teams understand your unique needs, crafting high-quality products tailored just for you. We're not just a brand; we're your dedicated partner.

Close to you signifies our dedication to delivering quality and sustainability tailored to your needs through our European-made solutions, predominantly sourced from France and Spain. Our local production guarantees both proximity and accessibility, fostering an interconnected network.

Let's continue building this strong partnership where innovation, iconic simplicity and sustainability thrive while reflecting your uniqueness.





BIC GRAPHIC

6

Our Values	6	Sustainable Actions	24
Our Legacy	8	Sustainable Products	30
Olympic Games	12	Corporate Social Responsibility	34
Your trusted companion	14	Novelties 2024	36
Iconic	16	Printing Techniques	38
Innovative	18	Full Colour britepix™ Digital Range	40
Sustainability	20	Bic® Collection boxes	42

BIC® WRITING INSTRUMENTS

44

BALLPENS

BIC® Style	46	BIC® 4 Colours® Flags Collection	136
BIC® Round Stic®	50	BIC® 4 Colours® 3+1 ^{HB}	138
BIC® M10® Clic	56	METALLIC PENS	
BIC® Media Clic	58	BIC® Metal Pro	140
BIC® Media Clic Grip	63	BIC® Cristal® Re'New™	145
BIC® Media Clic BGuard™ antibacterial	67	ROLLERS AND GELS	
BIC® Media Clic BGuard™ antimicrobial Ecolutions®	70	BIC® Grip Roller	150
BIC® Media Clic Biobased Ecolutions®	72	BIC® XS Finestyle	152
BIC® Media Clic Biobased BGuard™ antibacterial	75	BIC® Intensity® Gel Clic	154
BIC® Media Clic Shine	77	HIGHLIGHTERS AND MARKERS	
BIC® Media Clic Glacé	78	BIC® Brite Liner® Grip	158
BIC® Clic Stic	80	BIC® Velleda® White Board Marker Fine	160
BIC® Clic Stic Stylus	84	BIC® Velleda® White Board Marker Grip	161
BIC® Clic Stic Mini	84	BIC® Mark-It Permanent Marker	162
BIC® Super Clip	88	BIC® Permanent Marker Ecolutions®	163
BIC® Super Clip Advance	94	MECHANICAL PENCILS	
BIC® Super Clip Glacé	98	BIC® Matic®	166
BIC® Super Clip Glacé Advance	98	BIC® Media Clic Mechanical pencil	168
BIC® Super Clip Soft	100	BIC® Media Clic Grip Mechanical pencil	169
BIC® Super Clip Soft Advance	100	PENCILS	
BIC® Super Clip Origin	102	BIC® Evolution® Ecolutions®	174
BIC® Wide Body™	104	Sprout™ Graphite pencil	178
BIC® 4 Colours®	112		
BIC® 4 Colours® Bicolor	114		
BIC® 4 Colours® Gradient	116		
BIC® 4 Colours® Pastel	118		
BIC® 4 Colours® Fashion	120		
BIC® 4 Colours® Sun	122		
BIC® 4 Colours® Fine	124		
BIC® 4 Colours® Fluo	126		
BIC® 4 Colours® Shine	128		
BIC® 4 Colours® Glacé	130		
BIC® 4 Colours® Soft	132		
BIC® 4 Colours® Wood Style	134		

OTHER WRITING INSTRUMENTS **180**

PLASTIC PENS

Basic Pen	182
Click Pen	184
Striped Grip Pen	186

STYLUS PENS

Sleek Stylus Pen	188
------------------	-----

NOTEBOOKS **190**

ROCKETBOOK®

Rocketbook® Core Executive A5	194
Rocketbook® Fusion Executive A5	196
Rocketbook® Core Mini A6	198

BIC®/DJEET® LIGHTERS AND BIC® CASES **200**

LIGHTERS

BIC® J25 Lighter	206
BIC® J23 Lighter	210
BIC® J26 Lighter	214
BIC® J38 Lighter	218

BIC® Clip Case	225
BIC® 3D Case	226

OTHER PRODUCTS

BIC® Pocket Ashtray	228
---------------------	-----

LIGHTER CASES

BIC® Styl'it Luxury Case	222
BIC® Aluminium Flat Case	224

DJEET® LIGHTERS

DJEET® D1 Lighter	236
-------------------	-----

BIC® PACKAGING **238**

BIC® Packaging Ecolutions®	240
BIC® Packaging	242

GENERAL INFORMATION **246**

Make it simple!	248
Symbols and abbreviations	250
General information	252

Product index	253
Colour table	254

OUR VALUES

An enduring partnership that remains strong thanks to the principles we share.

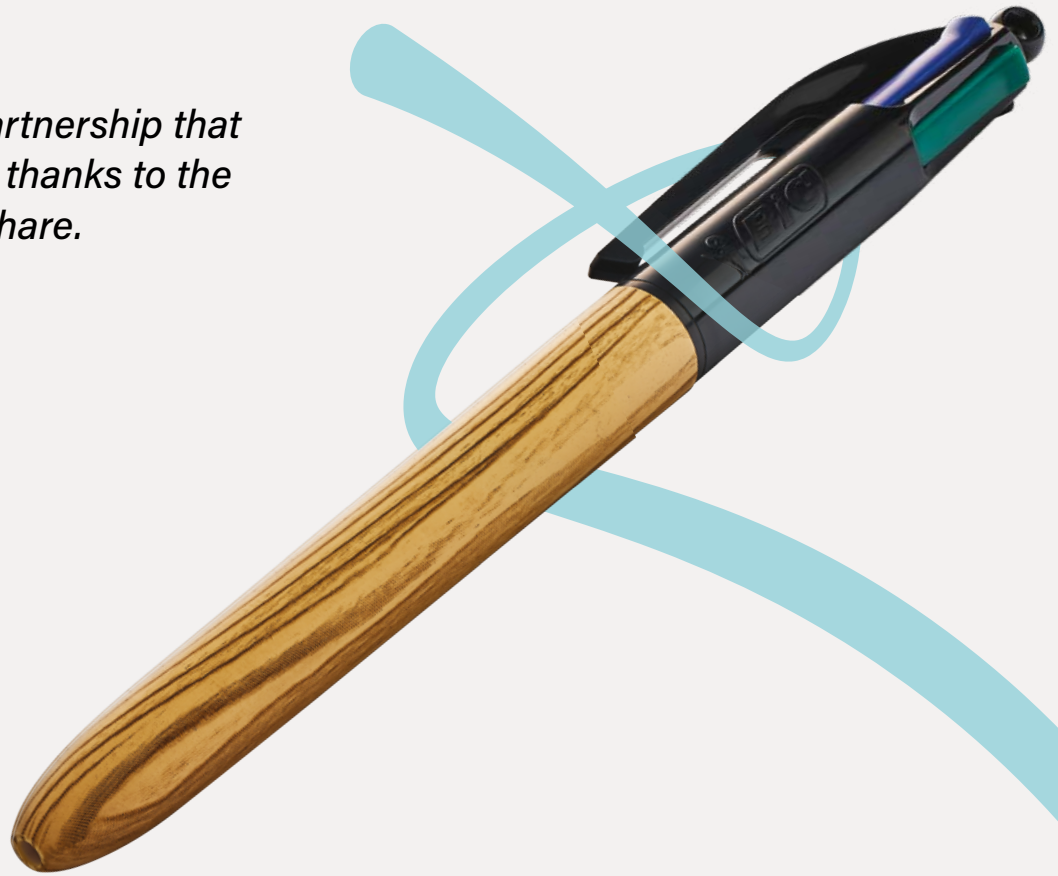

Certifications



ISO CERTIFIED
ISO 9001 - ISO 14001



GOLD
RATING



CO₂ NEUTRAL
WEBSITE



AUDITED BY
COCA-COLA



IMPRIM'VERT
LABEL



MEMBERS OF THE
UN GLOBAL
COMPACT



AUDITED BY WCA



AMFORI MEMBERS AND
AUDITED BY BSCI



SEDEX MEMBERS AND
AUDITED BY SMETA



Iconic and innovative

This constant vocation for innovation is manifested in the implementation of new product personalisation techniques, the launch of more sustainable and better quality products, and new special and trend-setting finishes for the most iconic products. A globally recognisable brand and an icon on the cutting edge for its innovative spirit.



Trusted

The brand is also a benchmark in terms of its compliance with the highest quality and safety standards, not to mention its social, environmental and ethical commitment.



Close to you

Local production, closer to you, to reduce the carbon footprint. We're close by and anticipate your needs by offering the maximum level of product personalisation, along with digital tools to make personalisation configuration as convenient as possible.

A JOURNEY WITH YOU



Explore our shared journey over the years, in which our European heritage has shaped a legacy. Discover how tradition and innovation have joined forces to create products that have accompanied you every step of the way.

1950s

1950

The BIC® brand is born. Launch of BIC® Cristal® in France.



1951

First exports to Belgium.

1952

First ad campaigns by Raymond Savignac, premiered at Tour de France.

A BIC for every company! BIC® pens adapt to suit all tastes and are used for promotional purposes. Opposite, an ad for the launch of the Promotional Products business in France in the 1970s.

1954

BIC® enters Italy, as a licensed manufacturing unit opens in Spain to serve the Iberian Peninsula.

1955

First steps in Switzerland, as well as in Dutch, German and Austrian markets.

1956

Creation of BIC Lugano, a distribution society for Switzerland, and first steps in the Netherlands and Austria.

1957

Acquisition of British group Biro Swan, paving the way to sterling area markets for BIC®.

1959

BIC® enters Nordic markets: Sweden, Norway, Finland, and Denmark.

1960s

1967

BIC® becomes the sponsor of a European cycling team and Spain's Luis Ocaña wins the Tour de France.

NOUVELLE BILLE



The BIC® Boy, an ad for the New Ballpoint campaign, designed by Raymond Savignac, 1961.

1970s

1970

The jingle "BIC Naranja y BIC Cristal" makes a huge splash to become part of Spanish pop culture.

1972

Société BIC is listed on the Paris Stock Exchange.

1976

Launch of the slogan "Si c'est BIC®, c'est bon" for BIC® Lighters in the Belgian market.



**Ce sont des gens de goût...
...puisqu'ils sont vos clients!**

Adressez-leur un ambassadeur digne de votre firme, un cadeau de marque connue, dont le renom viendra s'ajouter au vôtre.

Pour une clientèle nombreuse et variée le BIC-Cristal ou le BIC-Opaque.

Pour une clientèle aux goûts classiques le BIC-Poche M.3, ou le BIC-Poche M.4.

Pour une clientèle jeune et dynamique le BIC-Amortisseur ou le BIC-Clic.

Pour ceux qui "ont la signature", le Super-BIC, le plus racé des stylos à bille.

1978

"4 francs, 7 BIC razors. The economy counts", says Raymond Poulidor in a humorous commercial for the French market.

1990s

1991

"La machine à écrire", advertising for Belgian market.

1995

Expansion of BIC Graphic's advertising printing business in Europe, centralising all its customisation operations for writing instruments and lighters in Tarragona, Spain. Consolidation of Eastern and Central European market



1997

BIC® appears in Formula 1 by sponsoring Alain Prost.

BIC® launches a campaign in Greece with pictures by Oliviero Toscani.

2010s

2011

Partnership in Europe with Terracycle for collecting used writing instruments.



2020s

2020

Acquisition of Rocketbook®, a brand of smart reusable notebooks. Acquisition of DJEEP®, a French brand of lighters.



The BIC ballpoint turns and turns, designed by Savignac, 1952.



BALL POINT PENS

GUARANTEED TO WRITE FIRST TIME - EVERY TIME!

No Skip



No Smear



No Clog



Less Cost

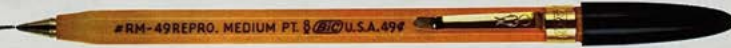

**WORLD'S
LARGEST
PEN
MANUFACTURER!**

Form S-463

American advertisement for BIC® products, early 1960s.



We've always been with you during major events, so we're delighted to have been chosen by Paris 2024 to create a range of officially licensed products. Nine exclusive designs of the BIC® 4 Colours® ballpen are now available in stores. We have shared so much, and we have so much left to share.



PRODUIT
OFFICIEL
SOUS
LICENCE



CLOSE TO WHERE HISTORY OCCURS



ALWAYS BY YOUR SIDE

92 %

of our products are
manufactured by the BIC Group

24

factories on 4 continents

15,898

Employees worldwide

100 %

Of our writing instruments
are printed at BIC Graphic
Europe, in Tarragona, Spain

29 M.

BIC® products are chosen every
day throughout the world

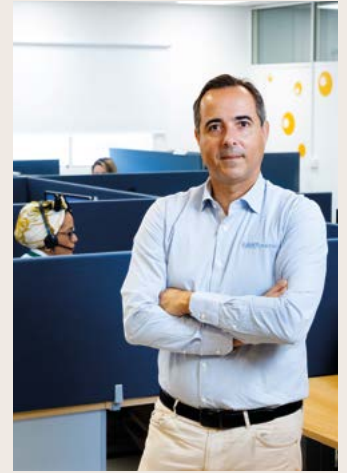
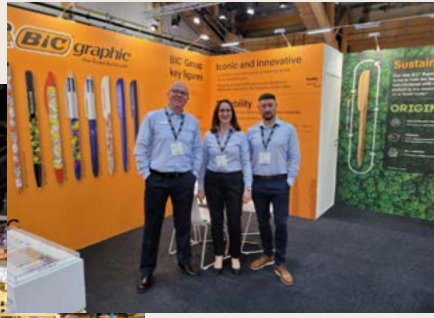

Think of us as your reliable daily companion. Discover how our products instil trust and reliability, supported by our dedicated local customer care and sales team. From capturing your thoughts to igniting your path, we've been there for you at every major moment.



WE'VE BEEN TOGETHER OUR ENTIRE LIVES

In fact, we've been together with you and with so many other people around the world. Our products are known everywhere, and it probably has a certain relationship with our commitment to innovation and with the launch of special products and finishes for our most iconic products. One life together, and we still have a lot left.



MoMA

2001 - BIC® CRISTAL® IS INCLUDED IN THE MUSEUM OF MODERN ART (MOMA), NEW YORK.



Centre Pompidou

2006 - BIC IS INCLUDED IN THE COLLECTION OF THE MUSÉE NATIONAL D'ART MODERNE, PARIS.



1973

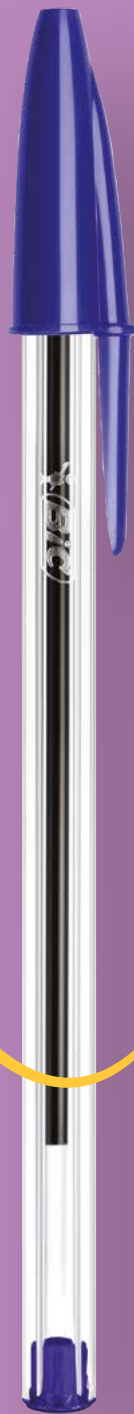

1950

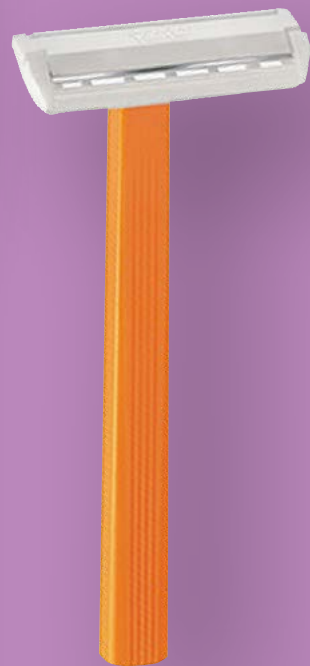

1975

THE ECO- DESIGN REVOLUTION





Welcome to a new era in which eco-design is at the forefront of innovation. Allow us then to show you the development of sustainable production technologies that help to reduce the carbon footprint, solutions for creating long-lasting products and functional features that contribute to design excellence. Are you ready to accompany us?

A new era lies in your hands

This is a ballpen, but it is also the symbol of a new era: the BIC® Super Clip Origin biobased ballpen! Our latest BIC® Super Clip is crafted from biobased materials made with natural ingredients, free from petroleum or fossil fuels. *

*Refers to barrel and clip.

PIONEERING SUSTAINABILITY FOR A BETTER FUTURE



Although seemingly an overstatement, we've been working towards a better future for decades now, well before it became a trend. Our efforts include fostering product innovation, like the biobased materials used in our Origin or recycled materials in the Ecolutions® line, acting against climate change and preserving the environment.

So, yes, we can confidently state that we're geared towards sustainability, and this marks the beginning of our pledge for a better future.

**And we can strive towards this goal together.
Are you with us?**





ORIGIN
BIOBASED

BIOBASED

SUSTAINABILITY BEGINS WITH THE LETTER R



That's right, because BIC's goal of being more sustainable begins with a plan that is based on the letter R. In other words, the 9 Rs of the circular economy. Each R has significant environmental value, and it enhances a product's longevity and creates added value when working in synergy with the others.

9Rs

When the phrase “committed to the planet” is more than JUST WORDS.

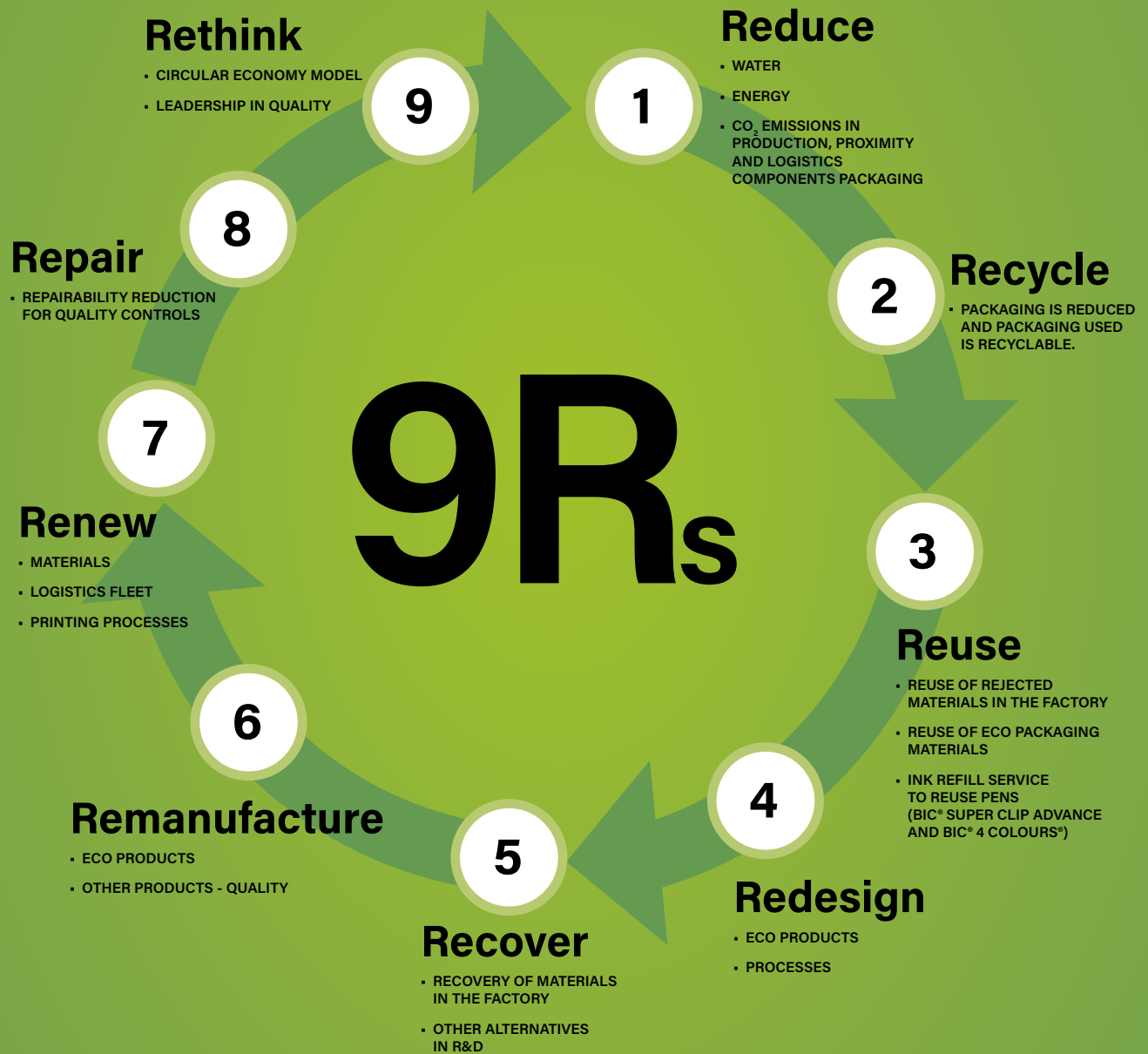

EMPOWERING CHANGE



It's through action that we achieve real impact. Our sustainable development initiative, «Writing the Future Together,» embodies this commitment. The plan extends until 2025, and we are continuously measuring its goals.

**Want to know more about our plan?
These are its 5 lines of action:**

1 DRIVE SUSTAINABLE INNOVATION

Our journey is guided by the sustainable development of new products and processes.

2 TAKE ACTION ON CLIMATE CHANGE

Electricity from 100 % renewable sources, to reduce greenhouse gas emissions, transforming our use of plastics, adhering to the United Nations Global Compact, renewing our climate commitment, and aligning with the TCFD, the working group created at the request of G20 leaders.

3 COMMITMENT TO SAFETY AT WORK

Our commitment to safety extends throughout every facet of our operations, ensuring the well-being of our team members and the communities we serve.

4 PROACTIVELY ENGAGE SUPPLIERS

We proactively seek out partnerships and collaborations with suppliers who align with our core principles and values. Our goal is to work hand in hand with providers, collectively advancing towards a more responsible and impactful future.

5 WORK TOWARDS A BETTER LIFE THROUGH EDUCATION

More than 187 million children have benefited from direct actions such as donating school supplies, organising school workshops, developing educational tools for teachers, and providing financial support.



CIRCULAR ECONOMY LIGHTER MODEL



After dedicating over seven years to cutting-edge technology development, we've perfected the art of disassembling and recycling every component of a used lighter.

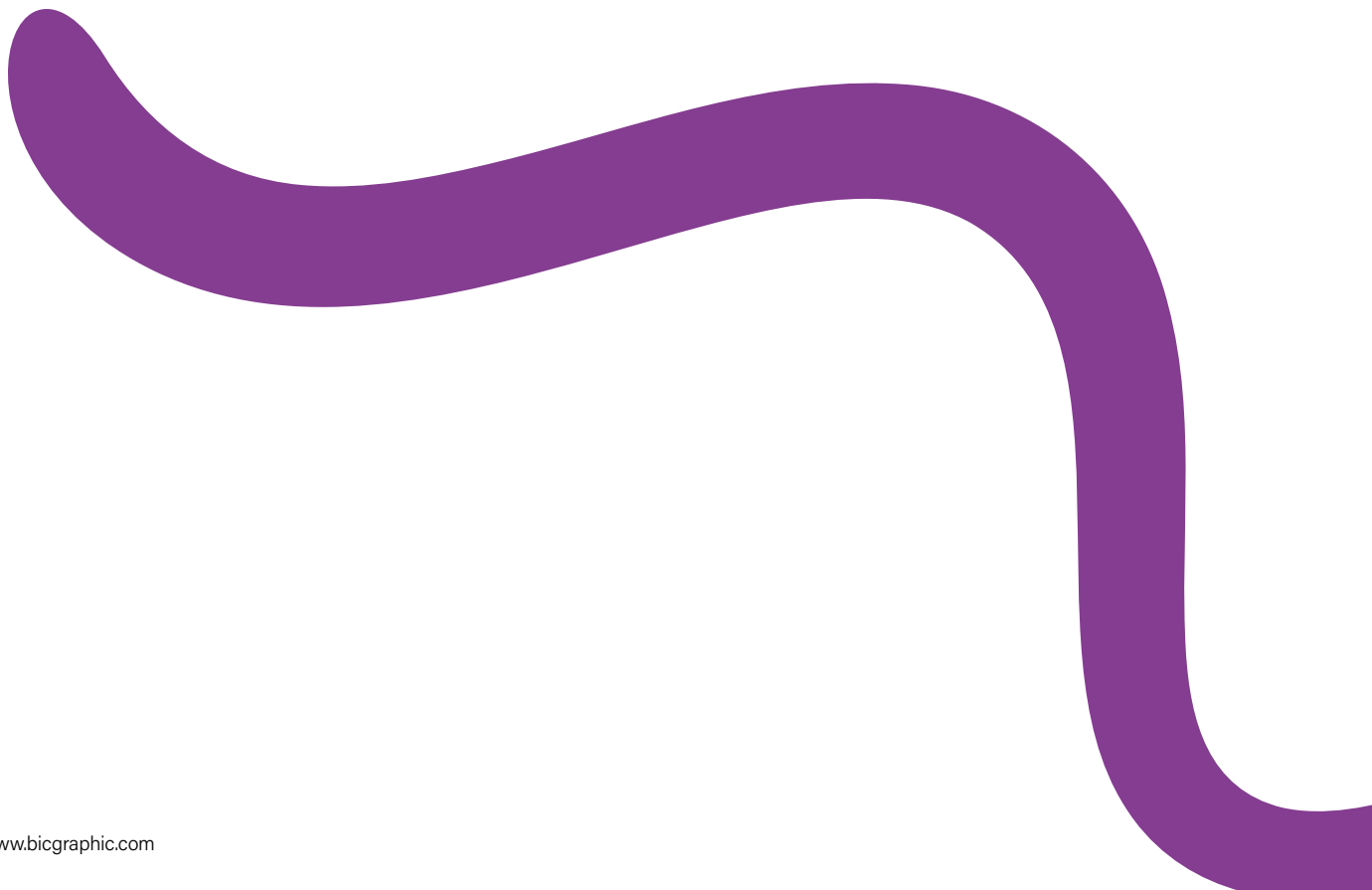

Today, BIC pioneers a circular economy model for the lighter industry

BIC® LIGHTERS

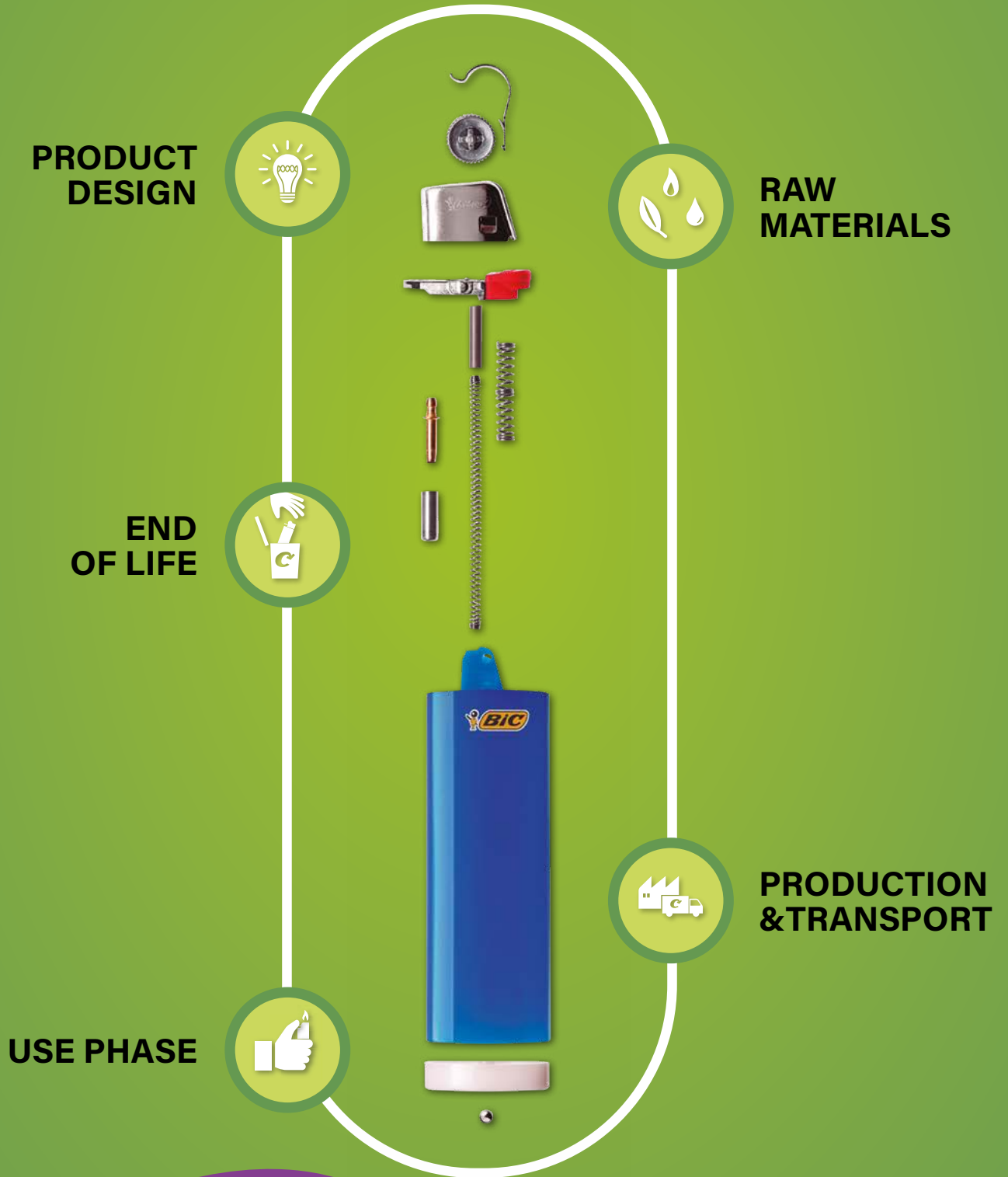



Refill service on request



BIC® SUPER CLIP ADVANCE



BIC® 4 COLOURS®

REFILL SERVICE FOR YOUR PEN



Think of the pleasant feeling of holding the pen that's just right for you.

You use it so much that it eventually runs out of ink. Now you can extend the life of your BIC® 4 Colours® or even your BIC® Super Clip Advance with our refill service. If you think about it, it's a sustainable solution that's consistent with our way of thinking.

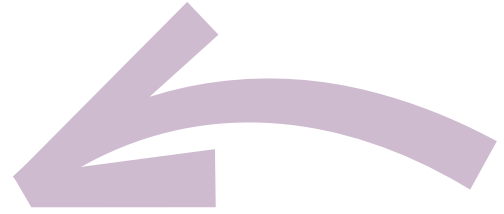

Let's start from the source

When addressing the challenge of sustainability, one of the most important points to consider is the source of the material used in our products. Some of them may surprise you, but when you're committed to a goal you have to think out of the box when it comes to innovation.

Presenting them below:

- Made from scrap fruit and vegetables trays

- Made from pharmaceutical waste
- Made from scrap plastic car parts

Our Ecolutions® range is made from sustainable materials

- Recycled and recyclable materials
- Biobased materials
- Paper from sustainable forests (FSC)
- Packaging made of recycled paper



Made from biobased material.

**BIC® SUPER CLIP
ORIGIN**



Made from scrap fruit and vegetables trays.

**BIC® WIDE BODY™
ECOLUTIONS®**

**BIC® CLIC STIC
ECOLUTIONS®**

**BIC® ROUND STIC®
ECOLUTIONS®**





Made from scrap plastic car parts.

**BIC® MEDIA CLIC
GRIP ECOLUTIONS®**

**BIC® MEDIA CLIC
ECOLUTIONS®**

**BIC® SUPER CLIP
ECOLUTIONS®**



Made from sugar cane.

**BIC® MEDIA CLIC
BIOBASED
ECOLUTIONS®**



FSC and recyclable cardboard.

**SPROUT™
GRAPHITE PENCIL**



Made from recycled fridges and yogurt pots.

**BIC® EVOLUTION®
ECOLUTIONS®**



Made from pharmaceutical waste.

**BIC® PERMANENT
MARKER
ECOLUTIONS®**

**BIC® MATIC®
ECOLUTIONS®**



 ROCKETBOOK

*Save Your
Notes.
Save the
Planet*



EMPOWERING CHANGE

In every school, office and home, we help reduce the environmental footprint from start to finish.



The average person will consume 10,000 sheets of paper/year



Equivalent to 1 worker = 1.2 trees per year



Paper is 70% of office waste and 16% of landfill solid waste



4 billion trees are cut down for paper/year



Our manufacturing process reuses 40% of wastewater from the page making process

The re-usable notebook is more eco-sustainable than the traditional notebook, as it presents a dramatically reduced waste of paper, use of water, and environmental footprint.



Rocketbook® is made of recycled PET and HDPE



**Corporate
Foundation**
We Give to Create



DEEDS BEFORE WORDS



CSR plays a pivotal role in our sustainable development plan. The BIC Corporate Foundation was therefore set up in 2016 to support educational initiatives throughout the world, primarily through three types of actions: providing grants and product donations, volunteering in our communities and forming global partnerships.

And you know what?

The annual BIC Global Education Week ranks as one of the most significant ventures in recent times. It is there that team members actively labour for a week to improve learning conditions worldwide through specific volunteer activities.

BIC® 4 Colours® Gradient
The most summery vibes



A pen for every side of you

Presenting the even more versatile BIC® 4 Colours®.
So that it suits you, and all your sides.



BIC® 4 Colours® Bicolor
A metallic look with an artistic touch



BIC® 4 Colours® Pastel
Vintage colours, dreamy imagery
*Available as of April 2024

NEW!

The new clip and push button on our iconic BIC® 4 Colours® pen enable us to reduce the weight of the product's upper part by **13.1%**, which represents a total of **44 tonnes** less plastic and dyes per year. **Because small changes can make a big difference.**

New and old clip will co-exist from June 2023 to June 2024. Within one order, the clip will always be the same type.



New printing area for all BIC® 4 Colours® white upper parts

Our printing techniques

Our product customisation process is regulated by strict quality controls, is in accordance with all EU regulations and passes 5 different quality tests:

- Adhesion test
- Scratch test (ISO 12137:11)
- Abrasion test
- Tumble test
- Exposure to artificial perspiration test

QUALITY CONTROL TESTS

Every imprinted order passes 4 different quality controls:

- Cosmetic appearance control
- Imprint colour control
- Imprint adherence control
- Resistance to scratching



Screen printing

Perfect technique for creating high-quality prints and exact colour matches.

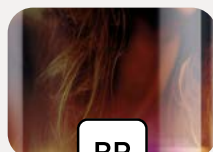

Brilliant

Choose the brilliant finish for a dazzling final effect.



Matt

Use the matt finish to add a touch of elegance to your design.



Metallic

Create great effects! Metallic effects in text, images and backgrounds.

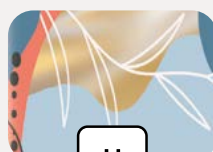

Holographic

Stand out from the crowd! Play with gold or silver reflections in your design.



Puffy

Highlighted personalisation that gives a relief effect to your logo.



With more than 50 years of experience as a guarantee!



PG

Puffy Glitter

Embellish your designs with the shimmering effect of glitter. See and feel its coloured glitter texture.



BP

BritePix™ Digital

The solution for full-colour communication. Now on coloured barrels!



LE

Laser

Laser engraving brings elegance to your communication. Use it to make a lasting impression.



BP

BritePix™ Texture

BritePix™ Texture is a fresh addition to our britePix™ concept: now you don't just see the full colour – you can feel it!



UV

UV

Highlight your brand with a high-gloss finish! Combine a matt and gloss finish to highlight contrasts.



BP

BritePix™ Personalisation

BritePix™ personalisation. Personalise each unit within the same britePix™ order.

britepix™

**BIC GRAPHIC EUROPE
THE PIONEER IN DIGITAL PRINTING**



BIC® Evolution® Ecolutions®



BIC® Super Clip Advance



BIC® Round Stic®



BIC® Clic Stic Stylus



BIC® Wide Body™



BIC® 4 Colours®



BIC® Media Clic



BIC® XS Finestyle

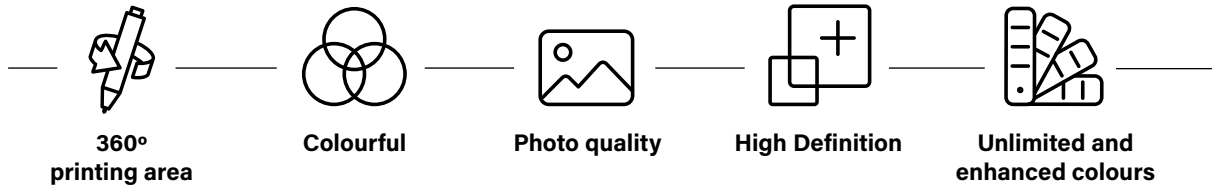

Your most Colourful solution



BritePix™ DIGITAL

The solution for full colour communication, with photographic excellence, producing a durable imprint that ensures lasting impressions of your logo. Now on coloured barrels!



BritePix™ TEXTURE

BritePix™ Texture is a fresh addition to our britePix™ concept: now you don't just see the full colour – you can feel it!



BritePix™ PERSONALISATION

Personalise each unit within the same britePix™ order.



BIC® COLLECTION
BOX 1 UNIT
991212

BIC® COLLECTION
BOX 2 UNITS
991213

BIC® COLLECTION
BOX 3 UNITS
991214

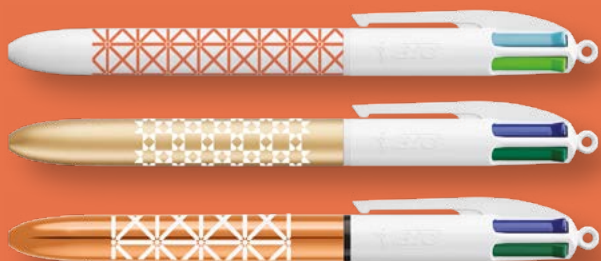

A set of BIC® products in customisable boxes

You can go even further in customisation with our FSC cardboard box, customisable on each side. Perfect for combining our iconic BIC® products as a set. In fact, more than just boxes, they are a great way to maximise your sales.

SPECIAL PACKAGING FOR:

BIC® 4 COLOURS®
BIC® WIDE BODY™
BIC® SUPER CLIP
BIC® BRITE LINER® GRIP
BIC® GRIP ROLLER



FSC and recyclable cardboard



Made in Europe

Contents

01

BIC®

WRITING

INSTRUMENTS

BALLPENS

BIC® Style	46
BIC® Round Stic®	50
BIC® M10® Clic	56
BIC® Media Clic	58
BIC® Media Clic Grip	63
BIC® Media Clic BGuard™ antibacterial	67
BIC® Media Clic BGuard™ antimicrobial Ecolutions®	70
BIC® Media Clic Biobased Ecolutions®	72
BIC® Media Clic Biobased BGuard™ antibacterial	75
BIC® Media Clic Shine	77
BIC® Media Clic Glacé	78
BIC® Clic Stic	80
BIC® Clic Stic Stylus	84
BIC® Clic Stic Mini	84
BIC® Super Clip	88
BIC® Super Clip Advance	94
BIC® Super Clip Glacé	98
BIC® Super Clip Glacé Advance	98
BIC® Super Clip Soft	100
BIC® Super Clip Soft Advance	100
BIC® Super Clip Origin	102
BIC® Wide Body™	104
BIC® 4 Colours®	112
BIC® 4 Colours® Bicolor	114
BIC® 4 Colours® Gradient	116
BIC® 4 Colours® Pastel	118
BIC® 4 Colours® Fashion	120
BIC® 4 Colours® Sun	122
BIC® 4 Colours® Fine	124
BIC® 4 Colours® Fluo	126
BIC® 4 Colours® Shine	128
BIC® 4 Colours® Glacé	130
BIC® 4 Colours® Soft	132
BIC® 4 Colours® Wood Style	134
BIC® 4 Colours® Flags Collection	136
BIC® 4 Colours® 3+1 ^{HB}	138

METALLIC PENS

BIC® Metal Pro	140
BIC® Cristal® Re'New™	145

ROLLERS AND GELS

BIC® Grip Roller	150
BIC® XS Finestyle	152
BIC® Intensity® Gel Clic	154

HIGHLIGHTERS AND MARKERS

BIC® Brite Liner® Grip	158
BIC® Velleda® White Board Marker Fine	160
BIC® Velleda® White Board Marker Grip	161
BIC® Mark-It Permanent Marker	162
BIC® Permanent Marker Ecolutions®	163

MECHANICAL PENCILS

BIC® Matic®	166
BIC® Media Clic Mechanical pencil	168
BIC® Media Clic Grip Mechanical pencil	169

PENCILS

BIC® Evolution® Ecolutions®	174
Sprout™ Graphite pencil	178

BIC® STYLE

**Globally renowned
BIC® cap design.**

The BIC® Style
offers excellent
value for money.



BIC® STYLE

1610 Opaque

Colour ink



01/01

01/03

01/04

01/02

02/02

04

10

100%

●
Only available
in black ink

●
Only available
in blue ink

●
Only available
in black ink

MANUFACTURED AND PRINTED IN BIC FACTORIES

REGULATORY COMPLIANCE

ISO certified

IMPRIM'VERT®

UBIQUITY™ PROGRAM
ALLOWS RECYCLING
BIC WRITING INSTRUMENTS

100% ELECTRICITY COMING FROM RENEWABLE SOURCES

WRITING MODES

BALLPEN M
0.1 MM

PRINTING TECHNIQUES

SP
SCREEN PRINTING

See page 250 for a detailed explanation of the icons

BIC® STYLE

1610 Clear

Colour ink



Decoration

BIC® STYLE

1610 Opaque
A SP: max. 1 col.

BIC® STYLE

1610 Clear
B SP: max. 1 col.

MOQ 500 units

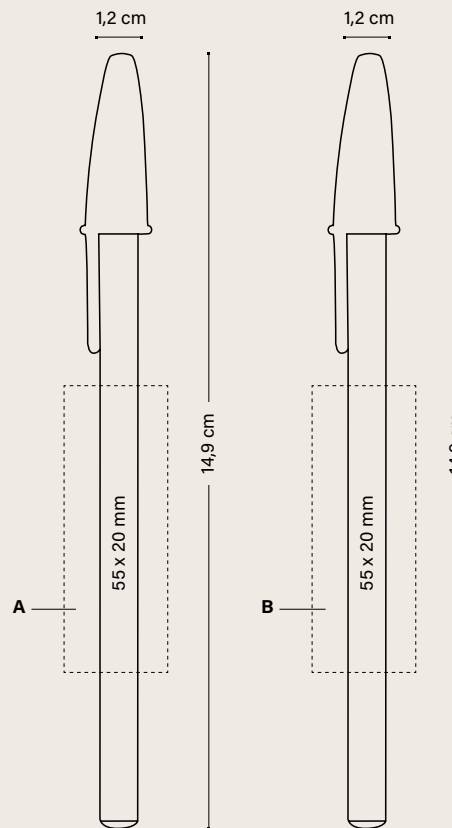

OPTIONAL SPECIAL PACKAGING



PLASTIC
POUCH

+ INFO PAGES 240 TO 245

EXTERNAL PACKAGING



500 ± 3,5 KG



MANUFACTURED
AND PRINTED IN
BIC FACTORIES



REGULATORY
COMPLIANCE



ISO
certified



IMPRIM'VERT®



UBICITY™ PROGRAM
ALLOWS RECYCLING
BIC WRITING INSTRUMENTS



100% ELECTRICITY
COMING FROM
RENEWABLE SOURCES

**WRITING
MODES**



BALLPEN M
Ø 1 MM

**PRINTING
TECHNIQUES**



SCREEN PRINTING

BIC® ROUND STIC®

**The iconic BIC® Round Stic®
offers a timeless style and high
quality.**

Its classic design is easy to identify
and symbolises long-term reliability.





Embossed
iconic BIC® brand!

BIC® ROUND STIC®

1010 Opaque

Colour ink



Red Ink available under request



12



05



07



18



02



03



100%

360°
Printing

Only available
on white barrel



MIX &
MATCH



PERSONALIZED
COLOURS



MANUFACTURED
AND PRINTED IN
BIC FACTORIES



MADE
IN SPAIN



REGULATORY
COMPLIANCE



ISO
certified



IMPRIM'VERT®



UBICITY™ PROGRAM
ALLOWS RECYCLING
BIC WRITING INSTRUMENTS



100% ELECTRICITY COMING
FROM RENEWABLE SOURCES

WRITING
MODES



BALLPEN M
Ø 1 MM

PRINTING
TECHNIQUES



SCREEN PRINTING



DIGITAL

BIC® ROUND STIC®

1010 Frosted

Colour ink



Red Ink available under request



ECO version and standard at the same price!

ecolutions®
MADE FROM 94% RECYCLED MATERIAL*



MIX & MATCH



PERSONALIZED COLOURS



MANUFACTURED AND PRINTED IN BIC FACTORIES



MADE IN SPAIN



REGULATORY COMPLIANCE



ISO certified



IMPRIM'VERT®



FRUIT AND VEGETABLE TRAYS



LIBICITY™ PROGRAM ALLOWS RECYCLING BIC WRITING INSTRUMENTS



100% ELECTRICITY COMING FROM RENEWABLE SOURCES

WRITING MODES



BALLPEN M Ø 1 MM

PRINTING TECHNIQUES



SP SCREEN PRINTING



DG DIGITAL

See page 250 for a detailed explanation of the icons

BIC® ROUND STIC®

1E10 Opaque

Colour ink



Red Ink available under request



1E/8E

1E/7E

1E/3E



360° Printing

100%

Only available on white barrel



BIC® ROUND STIC®

1E10 Frosted

Colour ink



Red Ink available under request



2E/8E

2E/7E

2E/3E

2E/10E

100%

*The percentage is calculated based on total weight of the barrel. Due to the recycled content of the raw materials used to make the product, we cannot guarantee that the colours shown in the catalogue or colours customised to order will always have the same colour and appearance.

BIC® ROUND STIC®



No extra charge

BIC® ROUND STIC®

1010 / **ecolutions®** 1E10 Opaque
1010 / **ecolutions®** 1E10 Frosted

MOQ 500 units.
Standard colours combination

ecolutions®



FRUIT AND
VEGETABLE
TRAYS

Standard colours
combination*

Plug

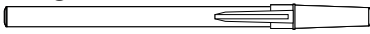

Cap

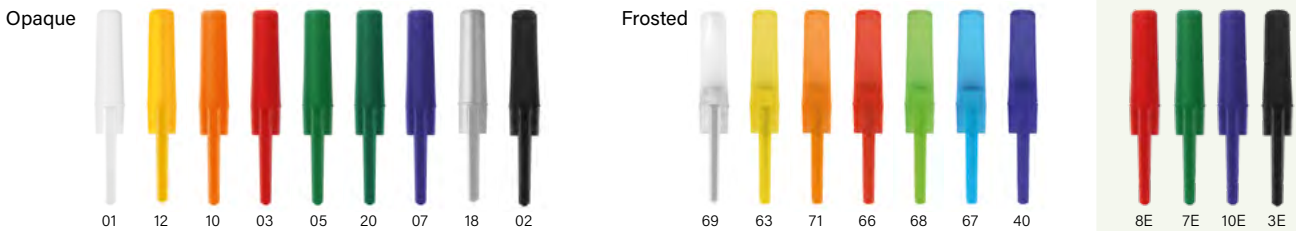
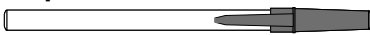

Section

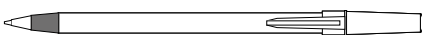

Barrel



Exact colour match: $\geq 10,000$ units



Add the Möbius loop to your artwork at no additional charge. Please specify it on your order. (Möbius loop imprint defaults to left-hand corner.)

Decoration

BIC® ROUND STIC®

1010

ecolutions® 1E10

A SP: max. 3 col.

B SP: max. 1 col.

C SP: max. 1 col.

D DG: full-colour

(Only available on white barrel)

MOQ 500 units.

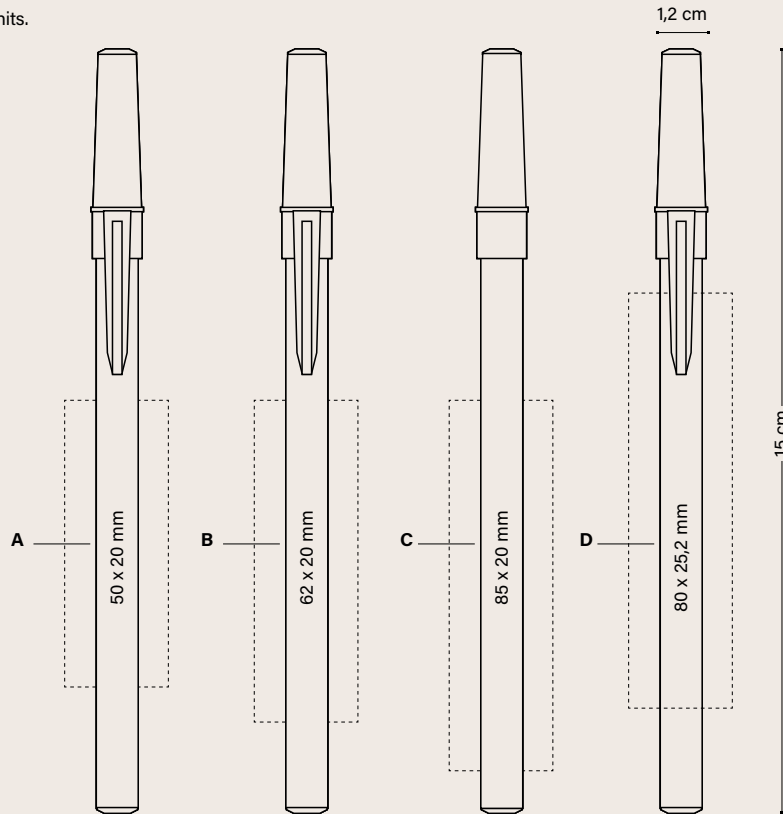

OPTIONAL SPECIAL PACKAGING



PLASTIC
POUCH

+ INFO PAGES 240 TO 245

EXTERNAL PACKAGING



500 ± 2,5 KG



PERSONALIZED
COLOURS



MANUFACTURED
AND PRINTED IN
BIC FACTORIES



MADE
IN SPAIN



REGULATORY
COMPLIANCE



IMPRIM'VERT®

ecolutions®



FRUIT AND
VEGETABLE TRAYS



UBICITY™ PROGRAM
ALLOWS RECYCLING
BIC WRITING INSTRUMENTS



100% ELECTRICITY COMING
FROM RENEWABLE SOURCES

**WRITING
MODES**



BALLPEN **M**
Ø 1 MM

**PRINTING
TECHNIQUES**



SCREEN PRINTING



DIGITAL

See page 250 for a detailed explanation of the icons



*Embossed
iconic BIC® brand!*

BIC® M10® CLIC

1590

Colour ink



01

8G

10

14

59

04

02

3D

100%

●
Only available
in black ink

Decoration

BIC® M10® CLIC
1590

A SP: max. 2 col.

MOQ 500 units

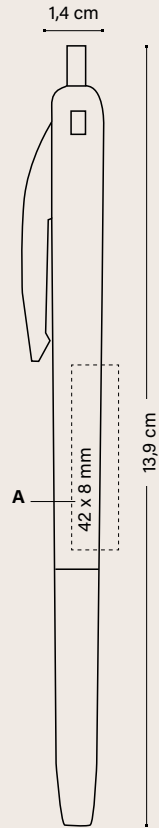

OPTIONAL SPECIAL PACKAGING



+ INFO PAGES 240 TO 245

EXTERNAL PACKAGING



MANUFACTURED
AND PRINTED IN
BIC FACTORIES



MADE IN FRANCE



WHITE COLOUR
MANUFACTURED IN SAF



REGULATORY
COMPLIANCE



UBICITY™ PROGRAM
ALLOWS RECYCLING
BIC WRITING INSTRUMENTS



100% ELECTRICITY COMING
FROM RENEWABLE SOURCES

WRITING
MODES



BALLPEN M
Ø 1 MM

PRINTING
TECHNIQUES



SCREEN PRINTING



CHECK OUT THE
VIDEO

See page 250 for a detailed explanation of the icons





BIC[®] MEDIA CLIC

One of the best sellers in the industry, a functional and widely recognized design, our BIC[®] Media Clic is a lasting product available in different materials. Choose between the Standard, Recycled, Biobased, Antibacterial and premium finishes. Be inspired with the wide range of finishes and colours, and match them to enhance your brand.

ECOLUTIONS[®]

GRIP

GRIP ECOLUTIONS[®]

BGUARD[™] ANTIBACTERIAL

BGUARD[™]

ANTIMICROBIAL

BIOBASED

BIOBASED BGUARD[™] ANTIBACTERIAL

SHINE

GLACÉ



Embossed
iconic BIC® brand!



Also in
Mechanical pencil

BIC® MEDIA CLIC

1025 Ballpen / 1028 Mechanical pencil (see page 168)

Opaque

Colour ink



Red Ink available under request



ECO version and standard at the same price!

ecolutions®

MADE FROM 92% RECYCLED MATERIAL*

PLASTIC CAR PARTS

BIC® MEDIA CLIC

1E25 Ballpen

Opaque

Colour ink



MIX & MATCH



PERSONALIZED COLOURS



MANUFACTURED AND PRINTED IN BIC FACTORIES



MADE IN SPAIN



REGULATORY COMPLIANCE



ISO certified



IMPRIM'VEERT®

ecolutions®



PLASTIC CAR PARTS



UBICUITY™ PROGRAM ALLOWS RECYCLING BIC WRITING INSTRUMENTS



100% ELECTRICITY COMING FROM RENEWABLE SOURCES

WRITING MODES



BALLPEN M Ø 1 MM

PRINTING TECHNIQUES



SCREEN PRINTING



DIGITAL

See page 250 for a detailed explanation of the icons

*The percentage is calculated based on total weight of the barrel. Due to the recycled content of the raw materials used to make the product, we cannot guarantee that the colours shown in the catalogue or colours customised to order will always have the same colour and appearance.



Also in
Mechanical pencil

BIC® MEDIA CLIC

1025 Ballpen / 1028 Mechanical pencil (see page 168)

Frosted

Colour ink



Red Ink available under request



BIC® MEDIA CLIC

1025 Ballpen

Clear

Colour ink



4D



92



93

100%



Also in
Mechanical pencil

BIC® MEDIA CLIC GRIP

1020 Ballpen

1021 Mechanical pencil (see page 169)

Opaque

Colour ink



01/12

100%

360°
Printing



Only available
on white barrel



PERSONALIZED
COLOURS



MANUFACTURED
AND PRINTED IN
BIC FACTORIES



MADE
IN SPAIN



REGULATORY
COMPLIANCE



ISO
certified



IMPRIM'VERT®



UBICUITY™ PROGRAM
ALLOWS RECYCLING
BIC WRITING INSTRUMENTS



100% ELECTRICITY COMING
FROM RENEWABLE SOURCES

WRITING
MODES



BALLPEN M
Ø 1 MM

PRINTING
TECHNIQUES



SCREEN PRINTING



DIGITAL

BIC® MEDIA CLIC / BIC® MEDIA CLIC GRIP

MIX & MATCH



PERSONALIZED COLOURS



MANUFACTURED AND PRINTED IN BIC FACTORIES



MADE IN SPAIN



REGULATORY COMPLIANCE



ISO certified



IMPRIM'VERT®



ecolutions®



PLASTIC CAR PARTS



UBICUITY™ PROGRAM ALLOWS RECYCLING BIC WRITING INSTRUMENTS



100% ELECTRICITY COMING FROM RENEWABLE SOURCES

WRITING MODES



BALLPEN M 0.1 MM

PRINTING TECHNIQUES



SCREEN PRINTING



DIGITAL



Also in Mechanical pencil

BIC® MEDIA CLIC GRIP

1020 Ballpen

1021 Mechanical pencil (see page 169)

Frosted

Colour ink



01/69

71/69

82/69

40/69



Also in Mechanical pencil

ECO version and standard at the same price!

ecolutions®

MADE FROM 92% RECYCLED MATERIAL*



PLASTIC CAR PARTS

BIC® MEDIA CLIC GRIP

1E20 Ballpen

1E21 Mechanical pencil (see page 169)

Opaque

Colour ink



01/03

01/05

01/02

01/07

BIC® MEDIA CLIC / BIC® MEDIA CLIC GRIP

BIC® MEDIA CLIC
1025 Ballpen / **ecolutions®** 1E25 Ballpen

BIC® MEDIA CLIC GRIP
1020 Ballpen / **ecolutions®** 1E20 Ballpen

MOQ 500 units
ecolutions® Standard colours combination

MIX & MATCH
No extra charge

Plug

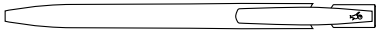

Opaque 01 12 10 03 5C 2D 13 5G 05 3D 04 07 18 02 Frosted 69

Clip

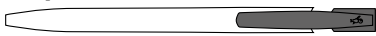

Opaque 01 12 10 03 5C 2D 13 5G 05 3D 04 07 18 02 Frosted 69

Barrel



Opaque 01 12 10 03 5C 2D 13 5G 05 3D 04 07 3C 18 02 83 8D 01/12

Frosted 69 63 71 66 68 82 67 40 4B

Clear 4D 92 93

Barrel & Grip

Barrel & Grip

01/69 71/69 82/69 40/69

Exact colour match: \geq 10,000 units 1025/1E25
Exact colour match: \geq 20,000 units 1020/1E20



PERSONALIZED COLOURS

MANUFACTURED AND PRINTED IN BIC FACTORIES

MIX & MATCH
ecolutions®

PLASTIC CAR PARTS

UBIQUITY™ PROGRAM
ALLOWS RECYCLING
BIC WRITING INSTRUMENTS

WRITING MODES

BALLPEN M
Ø 1 MM

PRINTING TECHNIQUES

SP

SCREEN PRINTING

DG

DIGITAL

*Due to the recycled content of the raw materials used to make the product, we cannot guarantee that the colours shown in the catalogue or colours customised to order will always have the same colour and appearance.

www.bicgraphic.com

65

See page 250 for a detailed explanation of the icons

BIC® WRITING INSTRUMENTS | BALLPENS

BIC® MEDIA CLIC / BIC® MEDIA CLIC GRIP

Decoration

BIC® MEDIA CLIC

1025 Ballpen
1028 Mechanical pencil (see page 168)
eColutions® 1E25 Ballpen

A SP: max. 4 col.
B SP: max. 2 col.
C DG: full-colour

MOQ 500 units.

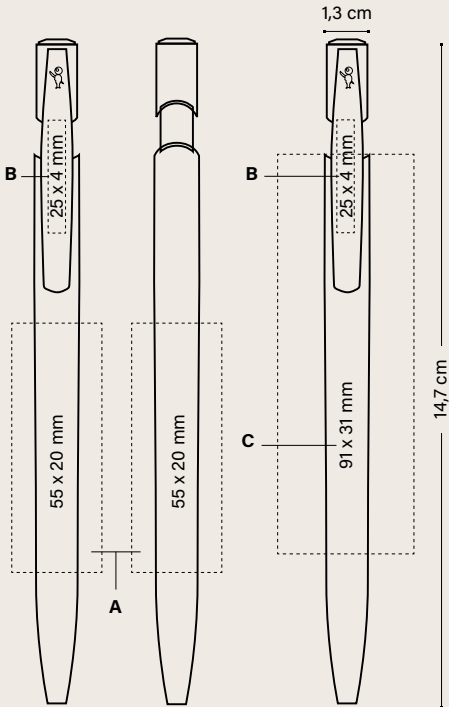

Decoration

BIC® MEDIA CLIC GRIP

1020 Ballpen
1021 Mechanical pencil (see page 169)
eColutions® 1E20 Ballpen
eColutions® 1E21 Mechanical pencil (see page 169)

D SP: max. 4 col.
E SP: max. 2 col.
F DG: full-colour

MOQ 500 units.

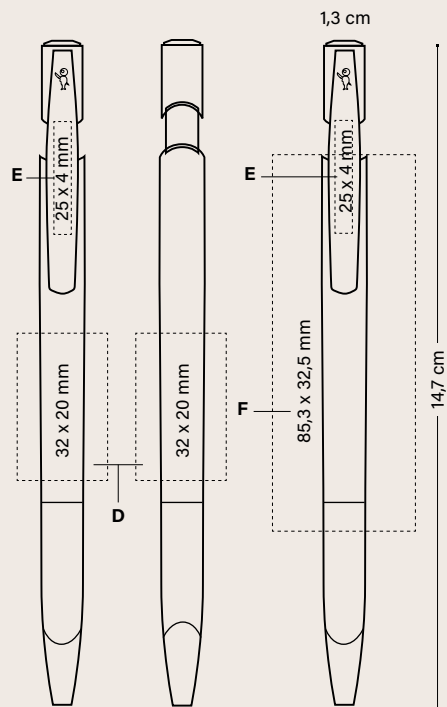

OPTIONAL SPECIAL PACKAGING



+ INFO PAGES 240 TO 245

EXTERNAL PACKAGING



500 ± 4,1 KG

OPTIONAL SPECIAL PACKAGING



+ INFO PAGES 240 TO 245

EXTERNAL PACKAGING



500 ± 4,3 KG



UBICITY™ PROGRAM
ALLOWS RECYCLING
BIC WRITING INSTRUMENTS

WRITING MODES



PRINTING TECHNIQUES



BIC® MEDIA CLIC Antibacterial



Bacteria
elimination



Entire pen
protection



Timeless
protection



Antibacterial
Test protocol



1E27

1026

BIC® MEDIA CLIC BGUARD™ ANTIBACTERIAL

BGUARD™



Bacteria elimination



Entire pen protection



Timeless protection



Antibacterial Test protocol

britePix DIGITAL THE SOLUTION FOR FULL COLOUR COMMUNICATION!

BIC® MEDIA CLIC BGUARD™ ANTIBACTERIAL

1026: antibacterial logo

1027: SARS-CoV-2 logo

Opaque

Colour ink



Red Ink available under request



MIX & MATCH

No extra charge

BIC® MEDIA CLIC BGUARD™ ANTIBACTERIAL

1026: antibacterial logo

1027: SARS-CoV-2 logo

Opaque

MOQ 500 units

Standard colours combination

Plug

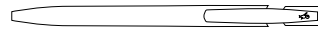

Opaque

1BG 7BG 2BG

Clip

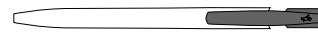

Opaque



1BG 2BG

Barrel



Opaque



1BG 2BG

Exact colour match: ≥ 10.000 units



Iconic BIC® Boy and Antibacterial logo always visible!

ANTIBACTERIAL™

Decoration:

**BIC® MEDIA CLIC BGUARD™
ANTIBACTERIAL**

1026: antibacterial logo
1027: SARS-CoV-2 logo

A **SP**: max. 2 col.
B **SP**: max. 1 col.
C **DG**: full-colour

MOQ 500 units.

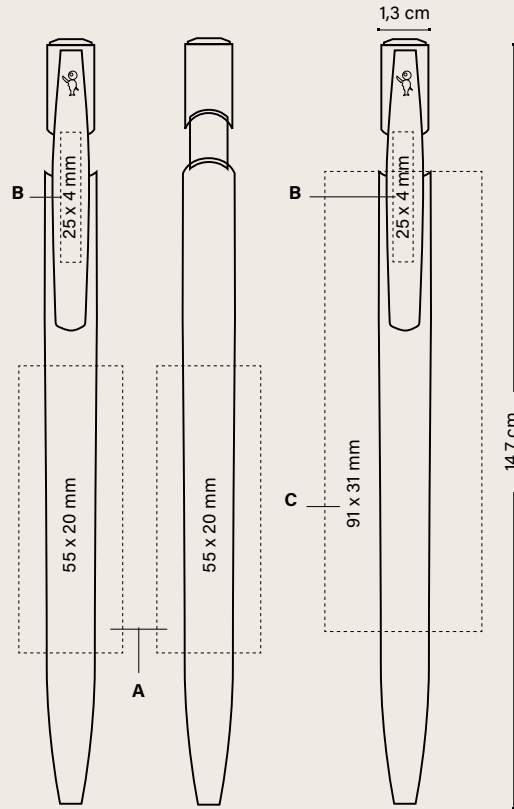

OPTIONAL SPECIAL PACKAGING



ECO SLEEVE



PLASTIC POUCH



WINDOW BOX

+ INFO PAGES 240 TO 245

EXTERNAL PACKAGING



500 ± 4,1 KG

**MIX &
MATCH**



PERSONALIZED
COLOURS



MANUFACTURED
AND PRINTED IN
BIC FACTORIES



MADE
IN SPAIN



REGULATORY
COMPLIANCE



ISO
certified



IMPRIM'VERT®



UBICITY™ PROGRAM
ALLOWS RECYCLING
BIC WRITING INSTRUMENTS



100% ELECTRICITY COMING
FROM RENEWABLE SOURCES

**WRITING
MODES**



BALLPEN M
Ø 1 MM

**PRINTING
TECHNIQUES**



SCREEN PRINTING



DIGITAL

See page 250 for a detailed explanation of the icons

BIC® MEDIA CLIC BGUARD™ ANTIMICROBIAL ECOLUTIONS®



ANTIMICROBIAL™* =



Bacteria elimination
99% en 24h

+



Viral reduction
93% in 24 h

+



Fungal inhibition
for 24 h

BGUARD™ **ecolutions®**

**MIX &
MATCH**

No extra charge

ecolutions®



MADE FROM 86%
RECYCLED MATERIAL**

PLASTIC
CAR PARTS



BIC® MEDIA CLIC BGUARD™ ANTIMICROBIAL ECOLUTIONS®

ecolutions® 1E26: antimicrobial logo

ecolutions® 1E27: SARS-CoV-2 logo

Opaque

Colour ink



Red Ink available under request



ecolutions®

PLASTIC
CAR PARTS



BIC® MEDIA CLIC BGUARD™ ANTIMICROBIAL ECOLUTIONS®

ecolutions® 1E26 / ecolutions® 1E27



Add the Möbius loop to your artwork at no additional charge. Please specify it on your order. (Möbius loop imprint defaults to left-hand corner.)

MOQ 500 units

Standard colours combination

Plug



Opaque

1BG 7BG 2BG

Clip

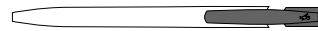

Opaque



1BG 2BG

Barrel



Opaque



1E 3E

Exact colour match: ≥ 10.000 units



You can also choose to print the SARS-CoV-2 reduction logo.
Ask your Customer Service representative for more information.

*99.9% of bacteria is eliminated from the surface in 24 hours (and more than 30% in 2 hours).

Tested under ISO 22196 protocol adapted to real usage of the pen.

93% of viruses, Sars-Cov-2 Coronavirus causing Covid-19 disease, are eliminated from the surface in 24 hours, (and around 50% in 2 hours).

Tested under ISO 22196 protocol adapted to real usage of the pen.

Fungi present on the surface is inhibited within 24 hours.

Tested under ISO 22196 protocol adapted to fungi and to real usage of the pen.



Entire pen protection



Timeless protection



Antibacterial Test protocol



Adapted to fungus test protocol



Antiviral test protocol

Decoration

**BIC® MEDIA CLIC Bguard™
ANTIMICROBIAL ECOLUTIONS®**

ecolutions® 1E26: antimicrobial logo

ecolutions® 1E27: SARS-CoV-2 logo

A SP: max. 2 col.

B SP: max. 2 col.

MOQ 500 units.

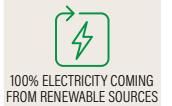
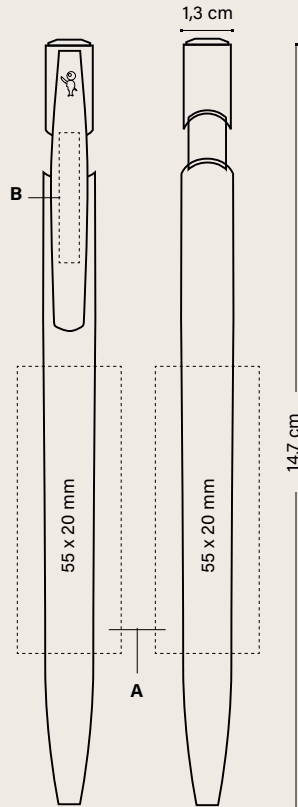

WRITING MODES



PRINTING TECHNIQUES



SCREEN PRINTING

OPTIONAL SPECIAL PACKAGING



ECO SLEEVE



PLASTIC POUCH



WINDOW BOX

+ INFO PAGES 240 TO 245

EXTERNAL PACKAGING



500 ± 4,1 KG

Available in selected countries, please ask your customer service representative.

**The percentage is calculated based on total weight of the barrel. Due to the recycled content of the raw materials used to make the product, we cannot guarantee that the colours shown in the catalogue or colours customised to order will always have the same colour and appearance.

BIC® MEDIA CLIC
BIOBASED ECOLUTIONS®

The top priority
of the ballpen life cycle
is sustainability.

ecolutions®

BIOBASED

Made to last:

- More than 10,000 clicks
- Increased visibility for your brand
- Break resistant clip



BIOBASED PEN

There's no more ink in the pen?
No problem, now you can compost it*.

The barrel is made of **biobased material**.



Electricity 100% produced by renewable sources

Produced in our factory and printing
facilities which are both powered by
electricity **100% produced using
renewable sources**.



Low transport impact:

Production, printing and even
raw material.



**100%
Recyclable**
Ubicuity™

**70%
Biobased
MATERIAL****

**100%
Biobased
COLORANTS**

BIOBASED **ecolutions**®

BIOBASED **ecolutions**®

MADE FROM 70% BIO-SOURCED* & 100% INDUSTRIALLY COMPOSTABLE MATERIAL



SUGAR CANE

BIC® MEDIA CLIC BIOBASED ECOLUTIONS®

1972 Ballpen
 Opaque
 Colour ink
 ● ● ●
 Red Ink available under request



Available on white barrel



MIX & MATCH



PERSONALIZED COLOURS



MANUFACTURED AND PRINTED IN BIC FACTORIES



MADE IN SPAIN



REGULATORY COMPLIANCE



ISO certified



IMPRIM'VERT® ecolutions®



SUGAR CANE



UBICITY™ PROGRAM ALLOWS RECYCLING BIC WRITING INSTRUMENTS



100% ELECTRICITY COMING FROM RENEWABLE SOURCES

WRITING MODES



BALLPEN M Ø1 MM

PRINTING TECHNIQUES



SCREEN PRINTING



DIGITAL

See page 250 for a detailed explanation of the icons

*The percentage is calculated based on total weight of the barrel. Due to the natural content of the raw materials used to make the product, we cannot guarantee that the colours shown in the catalogue or colours customised to order will always have the same colour and appearance.

BIC® MEDIA CLIC BIOBASED ECOLUTIONS®



BIC® MEDIA CLIC BIOBASED ECOLUTIONS®

1972 Ballpen Opaque

MOQ 500 units
Standard colours combination

Plug



Clip

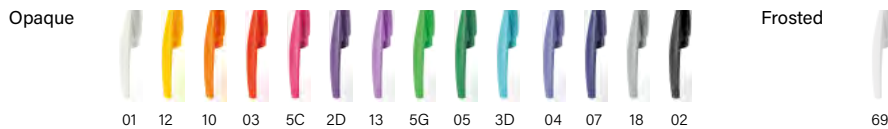

Barrel

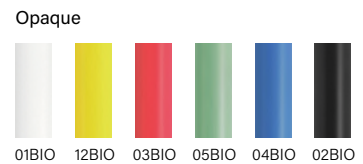

Exact colour match:
≥ 10.000 units



MANUFACTURED AND PRINTED IN BIC FACTORIES



MADE IN SPAIN



SUGAR CANE



UBICITY™ PROGRAM
ALLOWS RECYCLING
BIC WRITING INSTRUMENTS

WRITING MODES



BALLPEN M
Ø 1 MM

PRINTING TECHNIQUES



SCREEN PRINTING



DIGITAL

Decoration

BIC® MEDIA CLIC BIOBASED ECOLUTIONS®

1972

A SP: max. 2 col.

B SP: max. 2 col.

C DG: full-colour

MOQ 500 units.

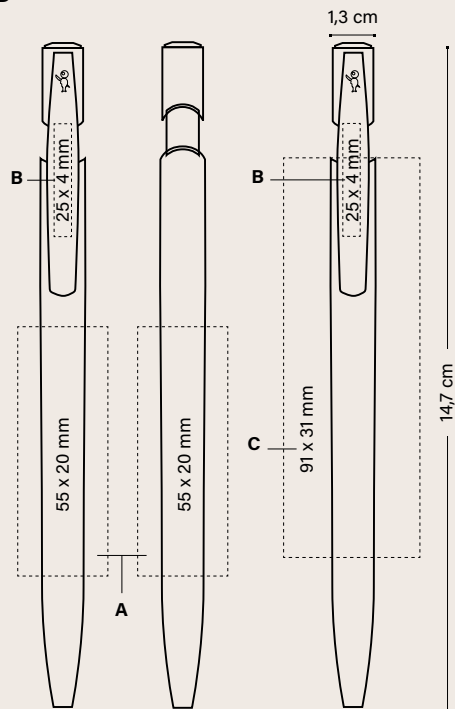

OPTIONAL SPECIAL PACKAGING



+ INFO PAGES 240 TO 245

EXTERNAL PACKAGING



500 ± 4,3KG

See page 250 for a detailed explanation of the icons

*Due to the natural content of the raw materials used to make the product, we cannot guarantee that the colours shown in the catalogue or colours customised to order will always have the same colour and appearance.

BIC® MEDIA CLIC BIOBASED BGUARD™ ANTIBACTERIAL

BGUARD™



Bacteria elimination



Entire pen protection



Timeless protection



Antibacterial Test protocol

BIOBASED



SUGAR CANE

MADE FROM 70% BIO-SOURCED*
& 100% INDUSTRIALLY
COMPOSTABLE MATERIAL

BIC® MEDIA CLIC BIOBASED BGUARD™ ANTIBACTERIAL

1973 Ballpen

Opaque

Colour ink



Red Ink available under request



02



360°
Printing

100%

01

Available on
white barrel



MIX & MATCH



PERSONALIZED COLOURS



MANUFACTURED AND PRINTED IN BIC FACTORIES



MADE IN SPAIN



REGULATORY COMPLIANCE



ISO certified



IMPRIM'VERT®



SUGAR CANE



UBICITY™ PROGRAM
ALLOWS RECYCLING
BIC WRITING INSTRUMENTS



100% ELECTRICITY COMING
FROM RENEWABLE SOURCES

WRITING
MODES



BALLPEN M
Ø 1 MM

PRINTING
TECHNIQUES



SCREEN PRINTING



DIGITAL

See page 250 for a detailed explanation of the icons

*The percentage is calculated based on total weight of the barrel. Due to the natural content of the raw materials used to make the product, we cannot guarantee that the colours shown in the catalogue or colours customised to order will always have the same colour and appearance.

BIC® MEDIA CLIC BIOBASED BGUARD™ ANTIBACTERIAL



No extra charge

BIC® MEDIA CLIC BIOBASED BGUARD™ ANTIBACTERIAL

1973 Ballpen Opaque

MOQ 500 units. Standard colours combination.

Plug

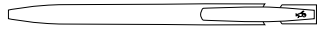

Opaque

01BG 07BG 02BG

Clip



Opaque



01BG 02BG

Barrel



Opaque



01 02

Exact colour match: ≥ 10.000 units



PERSONALIZED COLOURS



MANUFACTURED AND PRINTED IN BIC FACTORIES



MADE IN SPAIN



SUGAR CANE



UBICITY™ PROGRAM ALLOWS RECYCLING BIC WRITING INSTRUMENTS

WRITING MODES



BALLPEN M
Ø 1 MM

PRINTING TECHNIQUES



SCREEN PRINTING



DIGITAL

Decoration

BIC® MEDIA CLIC BIOBASED BGUARD™ ANTIBACTERIAL

1973

A SP: max. 2 col.

B SP: max. 2 col.

C DG: full-colour

MOQ 500 units.

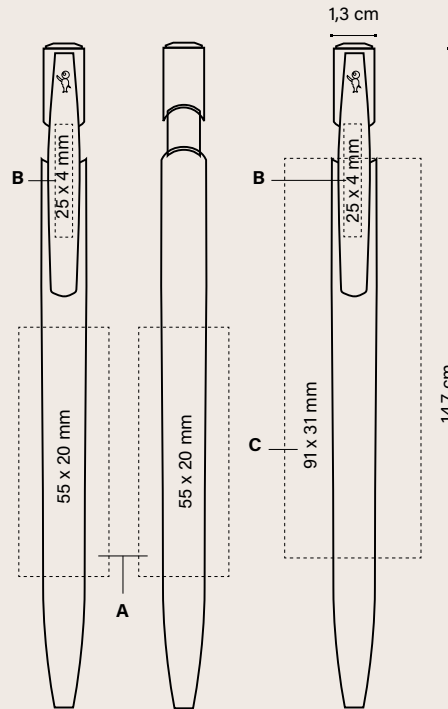

OPTIONAL SPECIAL PACKAGING



ECO SLEEVE



PLASTIC POUCH



WINDOW BOX

+ INFO PAGES 240 TO 245

EXTERNAL PACKAGING



250 ± 4,3 KG

BIC® MEDIA CLIC SHINE



BIC® MEDIA CLIC SHINE 1975 Ballpen Opaque

MOQ 500 units. Standard colours combination.

Plug

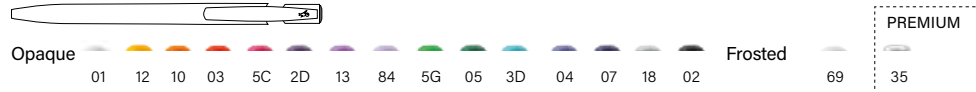

Clip

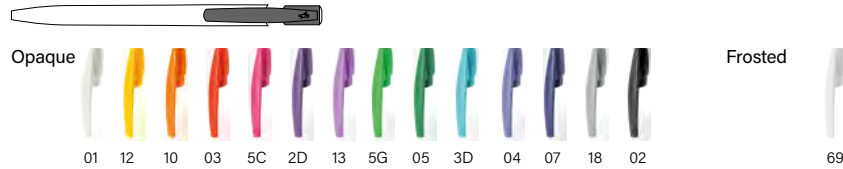

Barrel

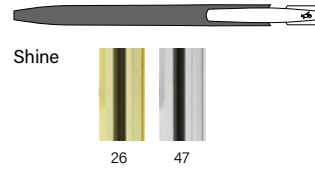

BIC® MEDIA CLIC SHINE

1975 Ballpen
Opaque

Colour ink
● ● ●

Red Ink available under request



47



26

100%

BIC® MEDIA CLIC SHINE

1975

A SP: max. 2 col.

B SP: max. 2 col.

MOQ 500 units.

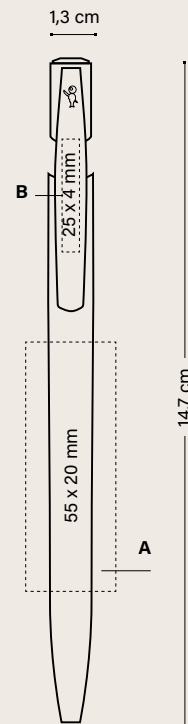

OPTIONAL SPECIAL PACKAGING



+ INFO PAGES 240 TO 245

EXTERNAL PACKAGING



500 ± 4,1 KG



PERSONALIZED COLOURS



MANUFACTURED AND PRINTED IN BIC FACTORIES



MADE IN SPAIN



REGULATORY COMPLIANCE



ISO certified



IMPRIM'VERT®



UBICITY™ PROGRAM
ALLOWS RECYCLING
BIC WRITING INSTRUMENTS



100% ELECTRICITY COMING
FROM RENEWABLE SOURCES

WRITING MODES



BALLPEN M
0.1 MM

PRINTING TECHNIQUES



SCREEN PRINTING

See page 250 for a detailed explanation of the icons

BIC® MEDIA CLIC GLACÉ

Our best seller in elegant colours.

BIC® MEDIA CLIC GLACÉ
1030 Opaque
Colour ink
● ● ●
Red Ink available under request



47G



76



03G



05G



04G



14G

BIC® MEDIA CLIC GLACÉ



BIC® MEDIA CLIC GLACÉ 1030 Ballpen Opaque

MOQ 500 units
Standard colours combination

Plug



Clip

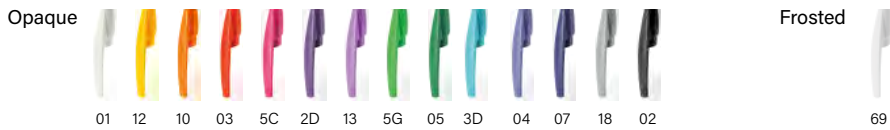

Barrel

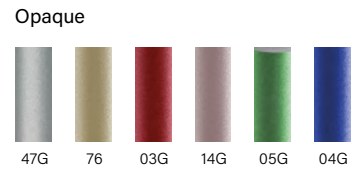

Decoration

BIC® MEDIA CLIC GLACÉ

1030

A SP: max. 2 col.

B SP: max. 2 col.

MOQ 500 units.

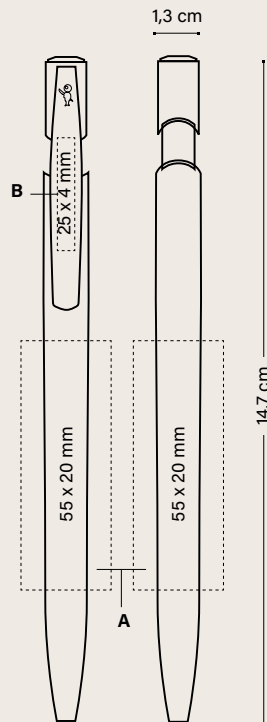

OPTIONAL SPECIAL PACKAGING



+ INFO PAGES 240 TO 245

EXTERNAL PACKAGING



MANUFACTURED AND PRINTED IN BIC FACTORIES



MADE IN SPAIN



REGULATORY COMPLIANCE



ISO certified



IMPRIM'VERT®



UBICITY™ PROGRAM
ALLOWS RECYCLING
BIC WRITING INSTRUMENTS



100% ELECTRICITY COMING
FROM RENEWABLE SOURCES

WRITING MODES



BALLPEN M
Ø 1 MM

PRINTING TECHNIQUES



SCREEN PRINTING

See page 250 for a detailed explanation of the icons

BIC® CLIC STIC

**Modern, flexible,
reliable. That's how
BIC® Clic Stic is!**

A large variety of finishes such
as Digital, Stylus or Softfeel®,
Mini.



*Thousands of colour
combinations!*

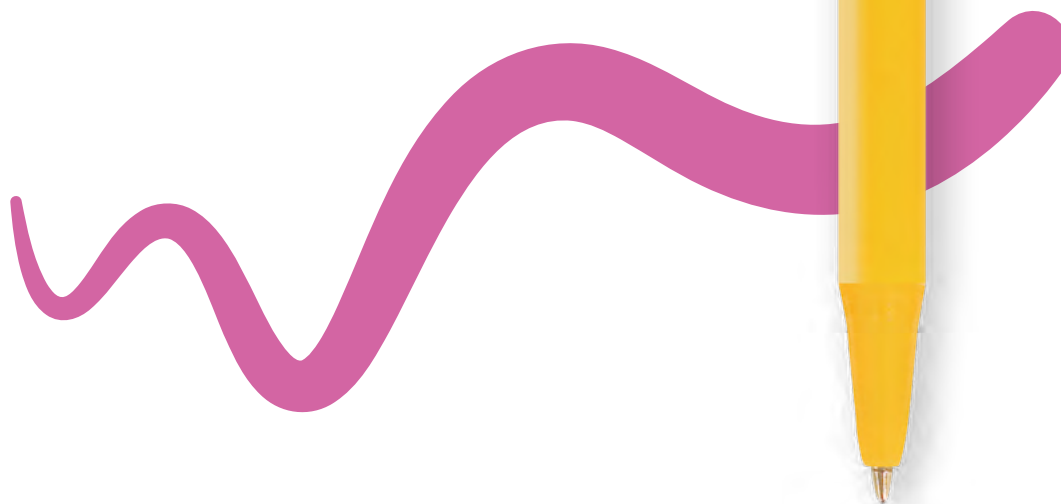



BIC® CLIC STIC
1000 Opaque
Colour ink
● ● ●

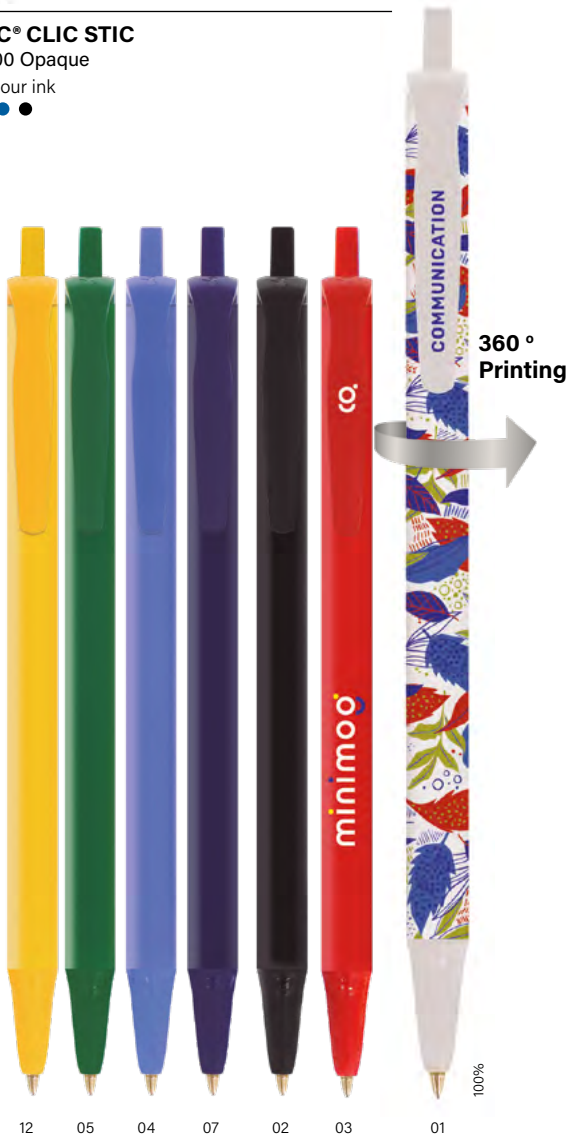

Available on white barrel



ECO version and standard at the same price!

ecolutions® FRUIT AND VEGETABLE TRAYS

MADE FROM 78% RECYCLED MATERIAL*

BIC® CLIC STIC
1E00 Opaque
Colour ink
● ● ●



Available on white barrel



PERSONALIZED COLOURS



MANUFACTURED AND PRINTED IN BIC FACTORIES



MADE IN SPAIN



REGULATORY COMPLIANCE



ISO certified



IMPRIM'VERT®



FRUIT AND VEGETABLE TRAYS



UBICITY™ PROGRAM ALLOWS RECYCLING BIC WRITING INSTRUMENTS



100% ELECTRICITY COMING FROM RENEWABLE SOURCES

WRITING MODES



BALLPEN M 0.1 MM

PRINTING TECHNIQUES



SCREEN PRINTING



DIGITAL

*The percentage is calculated based on total weight of the barrel. Due to the recycled content of the raw materials used to make the product, we cannot guarantee that the colours shown in the catalogue or colours customised to order will always have the same colour and appearance.

ECO version and standard at the same price!

ecolutions®
 **MADE FROM 78% RECYCLED MATERIAL***

 **FRUIT AND VEGETABLE TRAYS**

BIC® CLIC STIC

1000 Frosted

Colour ink



Red Ink available under request



69

63

71

66

68

40

67

100%

BIC® CLIC STIC

1E00 Frosted

Colour ink



Red Ink available under request



2E/8E

2E/10E

2E/3E

2E/7E

100%

*The percentage is calculated based on total weight of the barrel. Due to the recycled content of the raw materials used to make the product, we cannot guarantee that the colours shown in the catalogue or colours customised to order will always have the same colour and appearance.

**BIC® CLIC STIC
SOFTFEEL®**
1005 Opaque
Colour ink
● ● ●
*Red Ink available
under request*



20



07



02

100%

**BIC® CLIC STIC
SOFTFEEL®**
1005 Frosted
Colour ink
● ● ●
*Red Ink available
under request*



40

100%

**MIX &
MATCH**



PERSONALIZED
COLOURS



MANUFACTURED
AND PRINTED IN
BIC FACTORIES



MADE IN SPAIN



REGULATORY
COMPLIANCE



ISO
certified



IMPRIM'VERT®

ecolutions®



FRUIT AND
VEGETABLE TRAYS



UBICITY™ PROGRAM
ALLOWS RECYCLING
BIC WRITING INSTRUMENTS



100% ELECTRICITY COMING
FROM RENEWABLE SOURCES

**WRITING
MODES**



BALLPEN M
Ø 1 MM

**PRINTING
TECHNIQUES**



SP
SCREEN PRINTING



DG
DIGITAL

See page 250 for a detailed explanation of the icons

MIX & MATCH



PERSONALIZED COLOURS



MANUFACTURED AND PRINTED IN BIC FACTORIES



MADE IN SPAIN



REGULATORY COMPLIANCE



ISO certified



IMPRIM'VERT®



FRUIT AND VEGETABLE TRAYS



UBIQUITY™ PROGRAM ALLOWS RECYCLING BIC WRITING INSTRUMENTS



100% ELECTRICITY COMING FROM RENEWABLE SOURCES

WRITING MODES



BALLPEN M 0.1 MM

PRINTING TECHNIQUES



SCREEN PRINTING



DIGITAL

ECO version and standard at the same price!

ecolutions®
MADE FROM 78% RECYCLED MATERIAL*



FRUIT AND VEGETABLE TRAYS

BIC® CLIC STIC STYLUS

1847 Opaque

Colour ink

● ● ●

Red Ink available under request



BIC® CLIC STIC STYLUS

1846 Opaque

Colour ink

● ● ●

Red Ink available under request



*The percentage is calculated based on total weight of the barrel. Due to the recycled content of the raw materials used to make the product, we cannot guarantee that the colours shown in the catalogue or colours customised to order will always have the same colour and appearance.

BIC® CLIC STIC

1000 Opaque / **ecolutions**® 1E00 Opaque

1000 Frosted / **ecolutions**® 1E00 Frosted

1005 Opaque / Frosted

MOQ 500 units. Standard colours combination

BIC® CLIC STIC STYLUS

1846 / 1847 Opaque



Plug

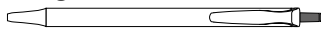

Opaque



Frosted

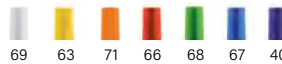

Clip

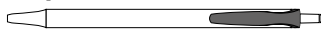

Opaque



Frosted

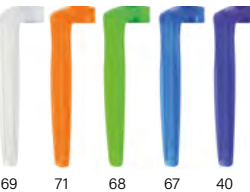

Section

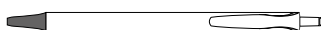

Opaque



Frosted

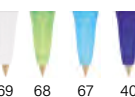

Stylus

Opaque



Barrel



Opaque

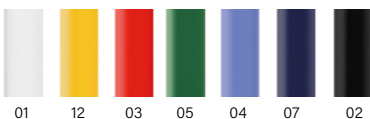

Stylus

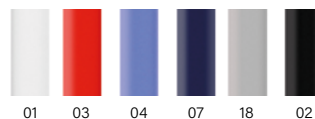

Softfeel®

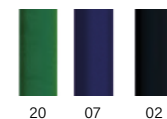

Mini



Frosted

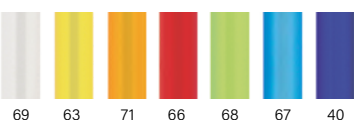

Exact colour match: ≥ 10.000 units



MOQ 500 units

ecolutions® Standard colours combination*



Add the Möbius loop to your artwork at no additional charge. Please specify it on your order. (Möbius loop imprint defaults to left-hand corner.)

FRUIT AND VEGETABLE TRAYS



Plug



Opaque



Section



Opaque

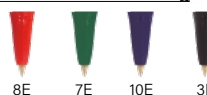

Stylus

Opaque



Clip



Opaque

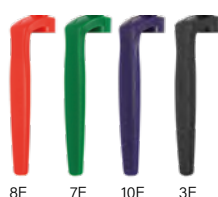

Barrel



Opaque



Stylus

Opaque



Exact colour match: ≥ 10.000 units

*Due to the recycled content of the raw materials used to make the product, we cannot guarantee that the colours shown in the catalogue or colours customised to order will always have the same colour and appearance.



PERSONALIZED COLOURS



MANUFACTURED AND PRINTED IN BIC FACTORIES



MADE IN SPAIN



REGULATORY COMPLIANCE



FRUIT AND VEGETABLE TRAYS



UBICITY™ PROGRAM ALLOWS RECYCLING BIC WRITING INSTRUMENTS



100% ELECTRICITY COMING FROM RENEWABLE SOURCES

WRITING MODES



BALLPEN M
Ø 1 MM

PRINTING TECHNIQUES



SCREEN PRINTING



DIGITAL

Decoration

BIC® CLIC STIC

1000 / eColutions® 1E00

BIC® CLIC STIC STYLUS

1847 / eColutions® 1846

A SP: max. 3 col.

B SP: max. 1 col.

C SP: max. 2 col.

D DG: full-colour (area for text)
(Only available on white barrel)

MOQ 500 units.

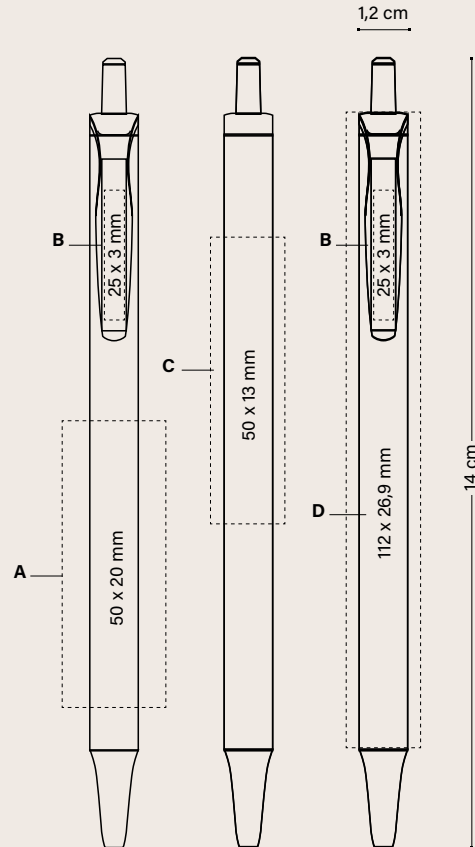

OPTIONAL SPECIAL PACKAGING



ECO SLEEVE



PLASTIC POUCH

+ INFO PAGES 240 TO 245

EXTERNAL PACKAGING



500 ± 2,9 KG

Decoration

BIC® CLIC STIC SOFTFEEL®
1005

A/B SP: max. 1 col.

MOQ 500 units.

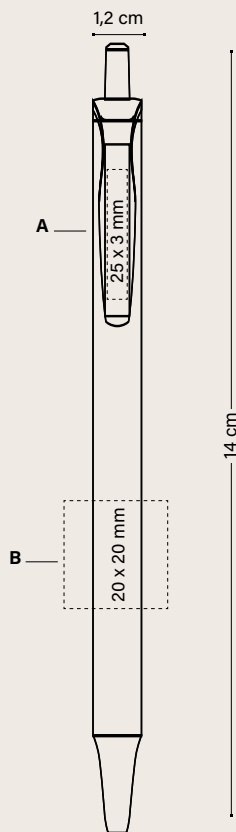

OPTIONAL SPECIAL PACKAGING



+ INFO PAGES 240 TO 245

EXTERNAL PACKAGING



Decoration

BIC® CLIC STIC MINI
1892

A SP: max. 1 col.

B SP: max. 1 col.

C DG: full-colour (area for text)
(Only available on white barrel)

MOQ 500 units.

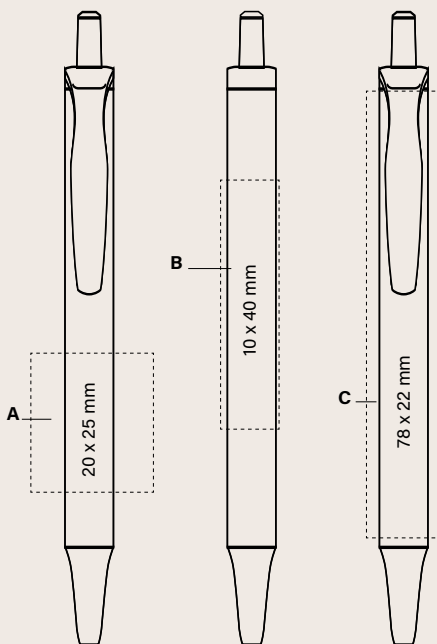

OPTIONAL SPECIAL PACKAGING



+ INFO PAGES 240 TO 245

EXTERNAL PACKAGING



MIX &
MATCH



PERSONALIZED
COLOURS



MANUFACTURED
AND PRINTED IN
BIC FACTORIES



MADE IN SPAIN



REGULATORY
COMPLIANCE



ISO
certified



IMPRIM'VERT®



UBICITY™ PROGRAM
ALLOWS RECYCLING
BIC WRITING INSTRUMENTS



100% ELECTRICITY COMING
FROM RENEWABLE SOURCES

WRITING
MODES



BALLPEN M
0.1 MM

PRINTING
TECHNIQUES



SCREEN PRINTING



DIGITAL





BIC[®] SUPER CLIP

Discover the eye-catching clip and its gentle twist mechanism. Large printing areas offer a wide range of personalisation possibilities in the standard and advance versions. Now also available in soft and glacé versions. In addition, the Super Clip Origin, a more innovative and sustainable pen.
Welcome to the future!

ECOLUTIONS[®]
ADVANCE
GLACÉ
GLACÉ ADVANCE
SOFT
SOFT ADVANCE
ORIGIN

BIC® SUPER CLIP

BIC® SUPER CLIP
1039 Opaque
Colour ink
● ●



Large
printing
areas!

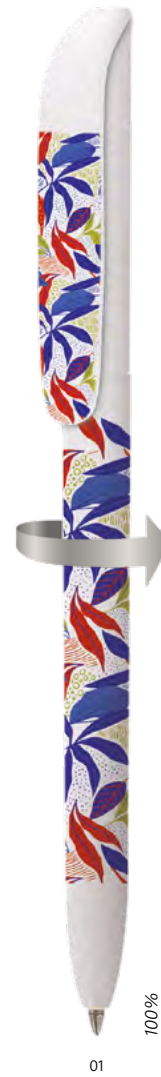

Gentle twist
mechanism!

360°
Printing

Available on
white barrel



ECO version and standard at the same price!

ecolutions®
 **MADE FROM 78% RECYCLED MATERIAL***
 **PLASTIC CAR PARTS**

BIC® SUPER CLIP
 1E50 Opaque
 Colour ink
 ● ●



BIC® SUPER CLIP
 1039 Clear
 Colour ink
 ● ●



MIX & MATCH



PERSONALIZED COLOURS



MANUFACTURED AND PRINTED IN BIC FACTORIES



MADE IN SPAIN



REGULATORY COMPLIANCE



ISO certified



IMPRIM'VERT®
 ecolutions®



PLASTIC CAR PARTS



UBICITY™ PROGRAM
 ALLOWS RECYCLING
 BIC WRITING INSTRUMENTS



100% ELECTRICITY COMING
 FROM RENEWABLE SOURCES



WRITING MODES
 BALLPEN M
 Ø 1 MM



PRINTING TECHNIQUES
 SP



SCREEN PRINTING



DIGITAL



BRITEPIX™
 BRITEPIX™ TEXTURE
 BRITEPIX™ PERSONALISATION

*The percentage is calculated based on total weight of the barrel. Due to the recycled content of the raw materials used to make the product, we cannot guarantee that the colours shown in the catalogue or colours customised to order will always have the same colour and appearance.

BIC® SUPER CLIP

BIC® SUPER CLIP

1039 Opaque

ecolutions® 1E50 Opaque

1039 Clear

MOQ 250 units

Standard colours combination

**MIX &
MATCH**

No extra charge

Clip



Opaque

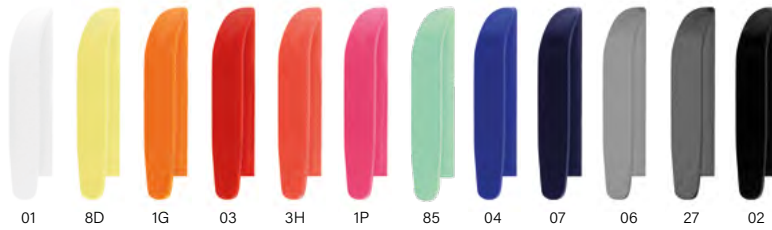

Clear

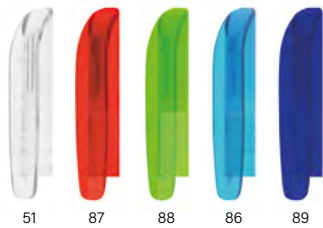

ecolutions®



Standard colours combination*



1E 1E



Add the Möbius loop to your artwork at no additional charge. Please specify it on your order. (Möbius loop imprint defaults to left-hand hand corner.)

Barrel



Opaque

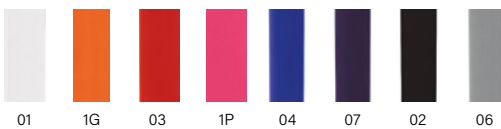

Clear

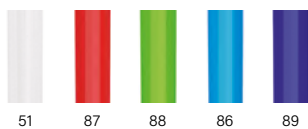

Exact colour match: ≥ 10.000 units



*Due to the recycled content of the raw materials used to make the product, we cannot guarantee that the colours shown in the catalogue or colours customised to order will always have the same colour and appearance.

Decoration

BIC® SUPER CLIP

1039

ecolutions® 1E50

A SP: max. 2 col.

B SP: max. 1 col.

C DG: full-colour

D BP: full-colour

BP Texture: full-colour

MOQ 250 units.

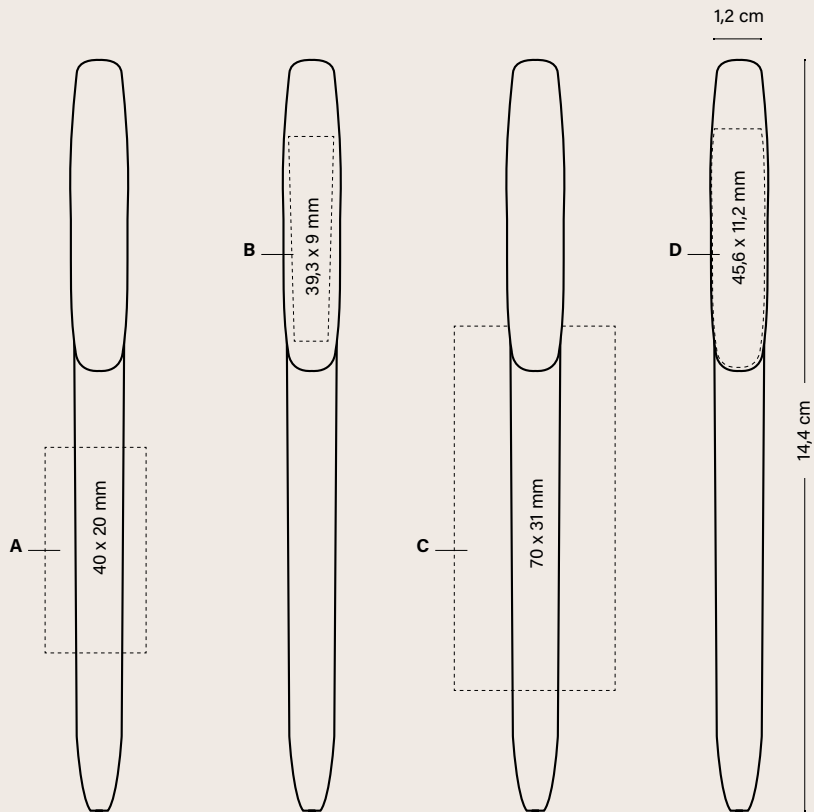

OPTIONAL SPECIAL PACKAGING



+ INFO PAGES 240 TO 245

EXTERNAL PACKAGING



250 ± 2,6 KG

Collection Box
(1, 2 & 3 units)



PERSONALIZED COLOURS



MANUFACTURED AND PRINTED IN BIC FACTORIES



MADE IN SPAIN



REGULATORY COMPLIANCE



ISO certified



IMPRIM'VERT®



ecolutions®



PLASTIC CAR PARTS



UBICITY™ PROGRAM
ALLOWS RECYCLING
BIC WRITING INSTRUMENTS



100% ELECTRICITY COMING
FROM RENEWABLE SOURCES

WRITING MODES



BALLPEN M
Ø 1 MM

PRINTING TECHNIQUES



SCREEN PRINTING



DIGITAL



BRITEPIX™
BRITEPIX™ TEXTURE
BRITEPIX™ PERSONALISATION

See page 250 for a detailed explanation of the icons

BIC® SUPER CLIP ADVANCE

BIC® SUPER CLIP ADVANCE

1073 Opaque

Colour ink

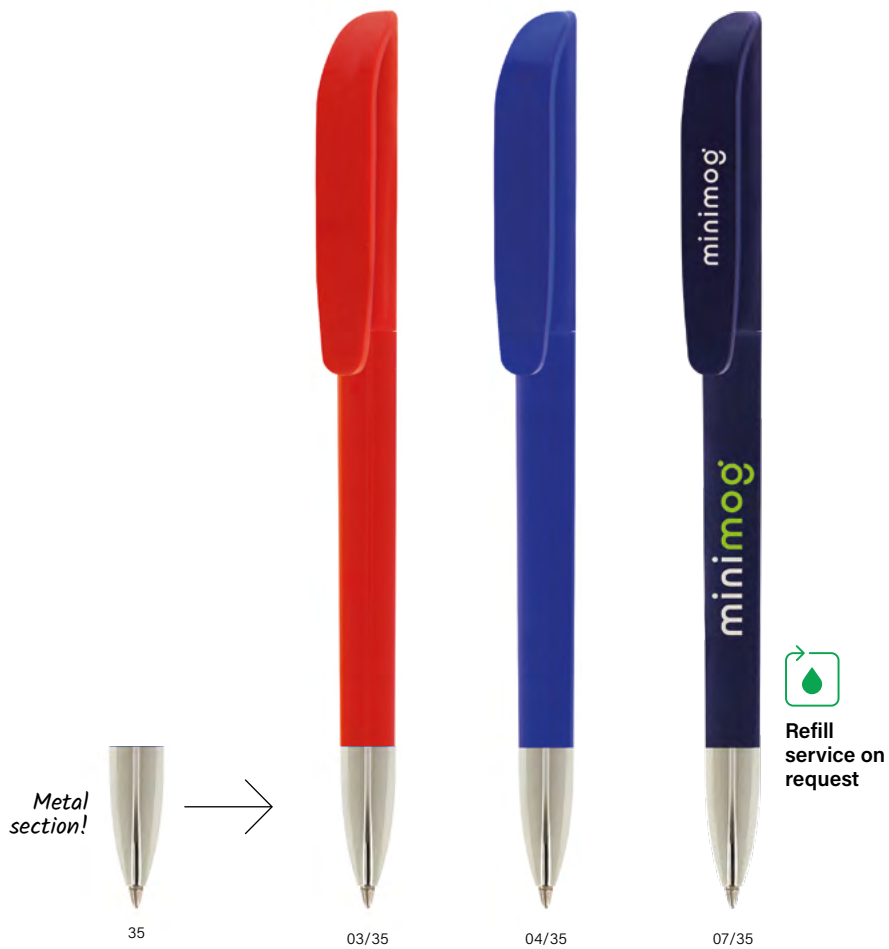



Available on white barrel



MIX & MATCH



PERSONALIZED COLOURS



MANUFACTURED AND PRINTED IN BIC FACTORIES



MADE IN SPAIN



REGULATORY COMPLIANCE



ISO certified



IMPRIM'VERT®



UBICITY™ PROGRAM
ALLOWS RECYCLING
BIC WRITING INSTRUMENTS



100% ELECTRICITY COMING
FROM RENEWABLE SOURCES

WRITING MODES



BALLPEN M
Ø 1 MM

PRINTING TECHNIQUES



SCREEN PRINTING



DIGITAL



BRITEPIX™
BRITEPIX™ TEXTURE
BRITEPIX™ PERSONALISATION

See page 250 for a detailed explanation of the icons

BIC® SUPER CLIP ADVANCE

BIC® SUPER CLIP ADVANCE
1073 Opaque

MOQ 250 units
Standard colours combination

**MIX &
MATCH**

No extra charge

Clip



Opaque

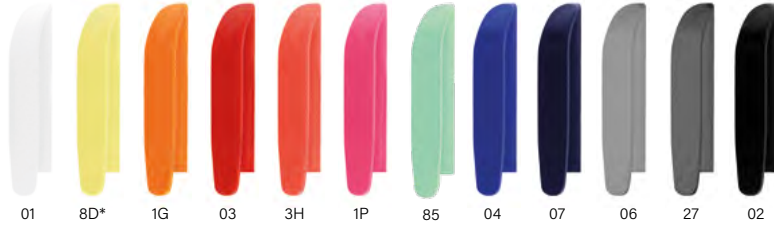

Clear

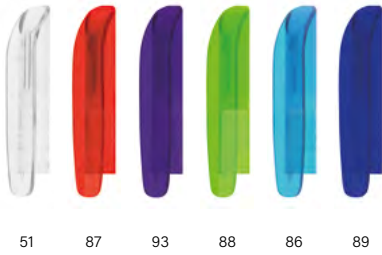

Barrel



Opaque

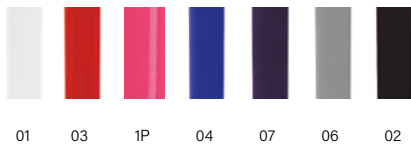

Section



35

Exact colour match: ≥ 10.000 units



Decoration

BIC® SUPER CLIP ADVANCE

1073

A SP: max. 2 col.

B SP: max. 1 col.

C DG: full-colour

D BP: full-colour

BP Texture: full-colour

MOQ 250 units.

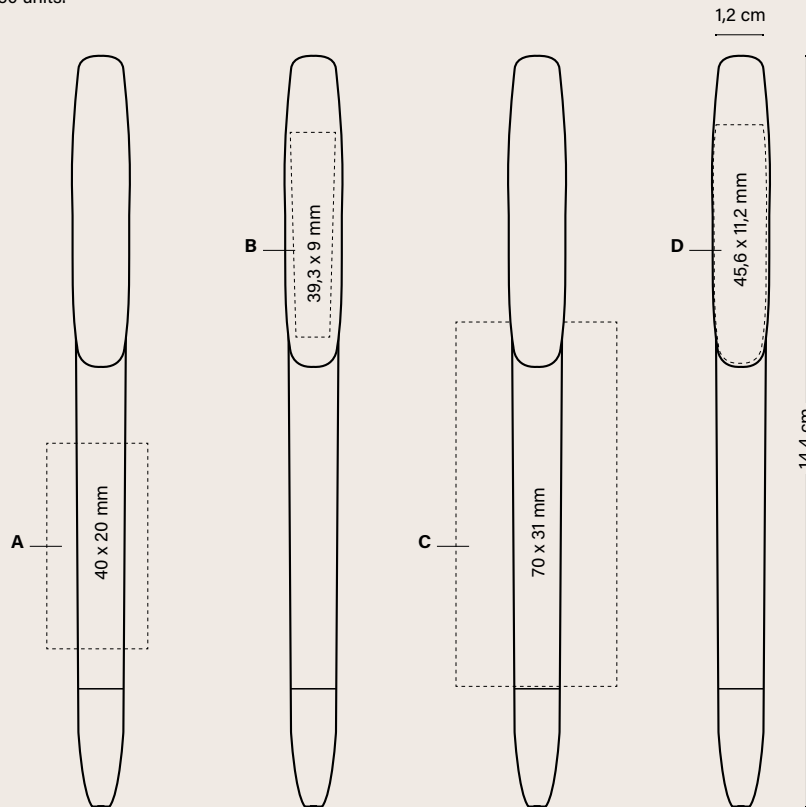

OPTIONAL SPECIAL PACKAGING



ECO SLEEVE



PLASTIC POUCH



WINDOW BOX

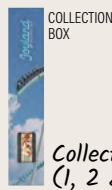

COLLECTION BOX

Collection Box (1, 2 & 3 units)



250 ± 2,6 KG

+ INFO PAGES 240 TO 245

EXTERNAL PACKAGING



PERSONALIZED COLOURS



MANUFACTURED AND PRINTED IN BIC FACTORIES



MADE IN SPAIN



REGULATORY COMPLIANCE



ISO certified



IMPRIM'VERT®



UBICITY™ PROGRAM ALLOWS RECYCLING BIC WRITING INSTRUMENTS



100% ELECTRICITY COMING FROM RENEWABLE SOURCES

WRITING MODES



BALLPEN M Ø 1 MM

PRINTING TECHNIQUES



SCREEN PRINTING



DIGITAL



BRITEPIX™ BRITEPIX™ TEXTURE BRITEPIX™ PERSONALISATION

See page 250 for a detailed explanation of the icons

BIC® SUPER CLIP GLACÉ & ADVANCE

Discover the BIC® Super Clip in a new glamorous version.

BIC® SUPER CLIP GLACÉ

1082

Colour ink



47G

76

014G

03G

04G

05G

100%

BIC® SUPER CLIP GLACÉ ADVANCE

1084

Colour ink



47G/35

05G/35

014G/35

03G/35

04G/35

76/35

100%



Refill
service on
request

BIC® SUPER CLIP GLACÉ & ADVANCE

Section

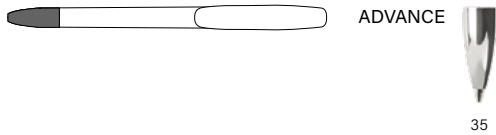

Decoration

BIC® SUPER CLIP GLACÉ
1082

**BIC® SUPER CLIP GLACÉ
ADVANCE**
1084

A SP: max. 1 col.
B SP: max. 1 col.

MOQ 250 units
Standard colours combination

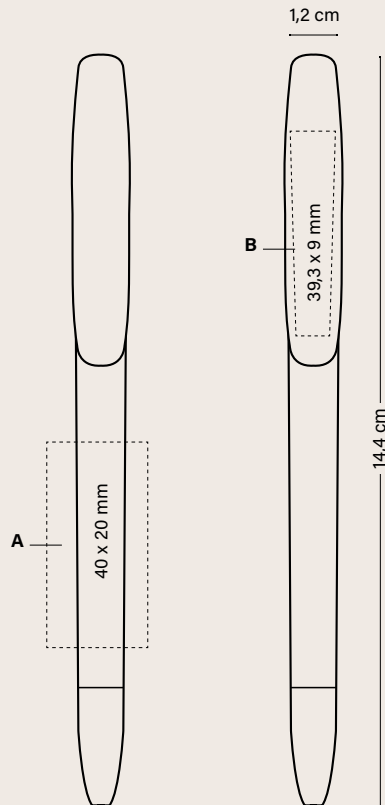

PERSONALIZED
COLOURS



MANUFACTURED
AND PRINTED IN
BIC FACTORIES



MADE IN SPAIN



REGULATORY
COMPLIANCE



ISO
certified



IMPRIM'VERT®



UBICITY™ PROGRAM
ALLOWS RECYCLING
BIC WRITING INSTRUMENTS



100% ELECTRICITY COMING
FROM RENEWABLE SOURCES

WRITING MODES



BALLPEN M
Ø 1 MM

PRINTING TECHNIQUES



SCREEN PRINTING

OPTIONAL SPECIAL PACKAGING



+ INFO PAGES 240 TO 245

EXTERNAL PACKAGING



250 ± 2,6 KG

Collection Box
(1, 2 & 3 units)



CHECK OUT THE VIDEO

See page 250 for a detailed explanation of the icons

BIC® SUPER CLIP SOFT & ADVANCE

Feel the incredible softness of our BIC® Super Clip version with twist mechanism.



BIC® SUPER CLIP SOFT

1083

Colour ink



02F

03F

07F

100%

BIC® SUPER CLIP SOFT ADVANCE

1085

Colour ink



02F/35

03F/35

07F/35

100%



Refill
service on
request

BIC® SUPER CLIP SOFT & ADVANCE

Section

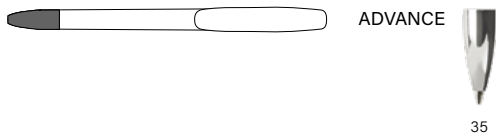

Decoration

BIC® SUPER CLIP SOFT
1083

**BIC® SUPER CLIP SOFT
ADVANCE**
1085

A SP: max. 1 col.

MOQ 250 units
Standard colours combination

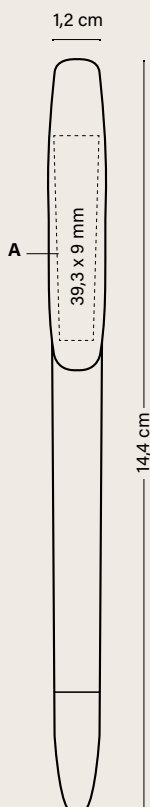

MANUFACTURED
AND PRINTED IN
BIC FACTORIES



MADE IN SPAIN



REGULATORY
COMPLIANCE



ISO
certified



IMPRIM'VERT®



UBIQUITY™ PROGRAM
ALLOWS RECYCLING
BIC WRITING INSTRUMENTS



100% ELECTRICITY COMING
FROM RENEWABLE SOURCES

WRITING MODES



BALLPEN M
Ø 1 MM

PRINTING TECHNIQUES



SCREEN PRINTING

OPTIONAL SPECIAL PACKAGING



ECO
SLEEVE



PLASTIC
POUCH



WINDOW
BOX

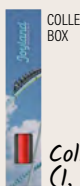

COLLECTION
BOX

Collection Box
(1, 2 & 3 units)

EXTERNAL PACKAGING



250 ± 2,6 KG

+ INFO PAGES 240 TO 245



CHECK OUT THE VIDEO

See page 250 for a detailed explanation of the icons

BIC® SUPER CLIP ORIGIN

Our new BIC® Super Clip is made from natural ingredients*.

NEW!

ecolutions® MADE WITH A BIOBASED MATERIAL

BIC® SUPER CLIP ORIGIN

1038

Colour ink



Gentle twist mechanism!

ORIGIN
BIOBASED

BIC® Super Clip Origin is made from biobased material manufactured with natural polymers excluding any source of petroleum or fossil fuels*.



Made with castor oil and other ingredients of vegetal origin.*

Due to the use of natural materials, our pens feature unique variations in color, highlighting the authentic and distinctive nature of each piece. Embrace the natural charm!



Manufactured and printed in factories 100% powered by electricity produced using renewable sources.



Barrel and clip are 100% biosourced.



The Ubicuity program, developed by BIC in partnership with Terracycle, enables the recycling of BIC's ballpoint pens.



60

70

6CO

BIC® SUPER CLIP ORIGIN

Decoration

BIC® SUPER CLIP ORIGIN

1038

A SP: max. 1 col.

MOQ 250 units
Standard colours combination

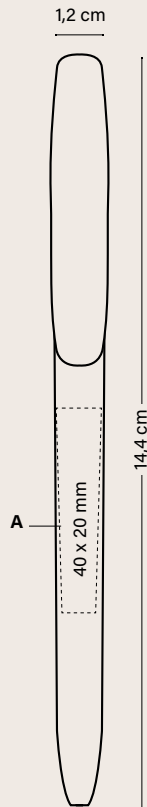

PERSONALIZED COLOURS



MANUFACTURED AND PRINTED IN BIC FACTORIES



MADE IN SPAIN



REGULATORY COMPLIANCE



ISO certified



IMPRIM'VERT®

ORIGIN
BIOBASED



UBICUITY™ PROGRAM
ALLOWS RECYCLING
BIC WRITING INSTRUMENTS



100% ELECTRICITY COMING
FROM RENEWABLE SOURCES

PRINTING
TECHNIQUES



SCREEN PRINTING

OPTIONAL SPECIAL PACKAGING



ECO SLEEVE



PLASTIC POUCH



WINDOW BOX



COLLECTION BOX

+ INFO PAGES 240 TO 245

*Can be used
as bookmark*

EXTERNAL PACKAGING



250 ± 2,6 KG

*Collection Box
(1, 2 & 3 units)*

See page 250 for a detailed explanation of the icons

BIC® WIDE BODY™

The right size to show the true value of your brand!

Wide profile and wide variety of
possibilities to maximise your
message.



BIC® WIDE BODY™



Iconic BIC® Boy is embossed

BIC® WIDE BODY™

1080 Opaque

Colour ink



Red Ink available under request

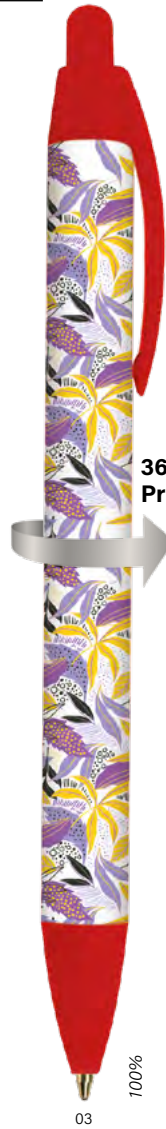

BIC® WIDE BODY™

ecolutions® 1E80 Opaque

Colour ink



Red Ink available under request



360° Printing

360° Printing

Available on white barrel



Available on white barrel



ECO version and standard at the same price!

ecolutions®

MADE FROM 94% RECYCLED MATERIAL*

FRUIT AND VEGETABLE TRAYS

MIX & MATCH



PERSONALIZED COLOURS



MANUFACTURED AND PRINTED IN BIC FACTORIES



MADE IN SPAIN



REGULATORY COMPLIANCE



ISO certified



IMPRIM'VERT®



FRUIT AND VEGETABLE TRAYS



UBICITY™ PROGRAM ALLOWS RECYCLING BIC WRITING INSTRUMENTS



100% ELECTRICITY COMING FROM RENEWABLE SOURCES



WRITING MODES



BALLPEN M Ø 1 MM



PRINTING TECHNIQUES



SCREEN PRINTING



DIGITAL

See page 250 for a detailed explanation of the icons

*The percentage is calculated based on total weight of the barrel. Due to the recycled content of the raw materials used to make the product, we cannot guarantee that the colours shown in the catalogue or colours customised to order will always have the same colour and appearance.

BIC® WIDE BODY™

1080 Frosted

Colour ink



40

63

67

68

69

66

71

100%

Large printing areas!



BIC® WIDE BODY™

MINI DIGITAL

1893 Opaque

1896 Chrome Opaque

Colour ink



01

01

100%

360° Printing

Available on white barrel



BIC® WIDE BODY™
 1080 Opaque
 ecolutions® 1E80 Opaque
 1080 Frosted

BIC® WIDE BODY™ MINI DIGITAL
 1893 Opaque
 1896 Chrome Opaque

MOQ 250 units
 Standard colours combination

MIX & MATCH

No extra charge

Plug



Opaque



Frosted



Chrome



Clip

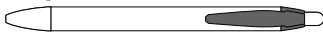

Opaque

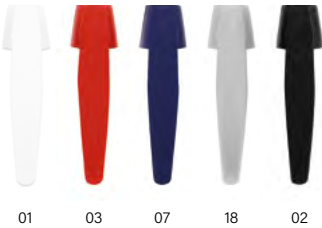

Frosted

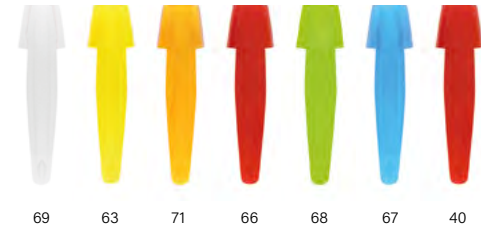

Barrel



Opaque



Frosted

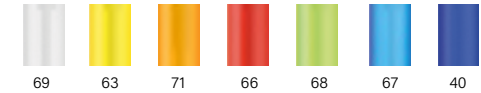

Opaque



ecolutions® **



Add the Möbius loop to your artwork at no additional charge. Please specify "Print the Möbius loop" on your order. (Möbius loop imprint defaults to left-hand corner.)



FRUIT AND VEGETABLE TRAYS

Section



Opaque

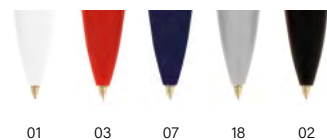

Frosted



Chrome



Exact colour match: ≥ 10.000 units



MIX & MATCH



PERSONALIZED COLOURS



MANUFACTURED AND PRINTED IN BIC FACTORIES



MADE IN SPAIN



REGULATORY COMPLIANCE



ISO certified



IMPRIM'VERT®

ecolutions®



FRUIT AND VEGETABLE TRAYS



UBICITY™ PROGRAM ALLOWS RECYCLING BIC WRITING INSTRUMENTS



100% ELECTRICITY COMING FROM RENEWABLE SOURCES

WRITING MODES



BALLPEN M 0.1 MM

PRINTING TECHNIQUES



SCREEN PRINTING



DIGITAL

*While stocks last.

**Due to the recycled content of the raw materials used to make the product, we cannot guarantee that the colours shown in the catalogue or colours customised to order will always have the same colour and appearance.

BIC® WIDE BODY™

BIC® WIDE BODY™

1080 Opaque

ecolutions® 1E80

A/C SP: max. 2 col.

B/F SP: max. 1 col.

D DG: full-colour (area for images)

E DG: full-colour (area for text)

MOQ 250 units (SP)

MOQ 500 units (DG)

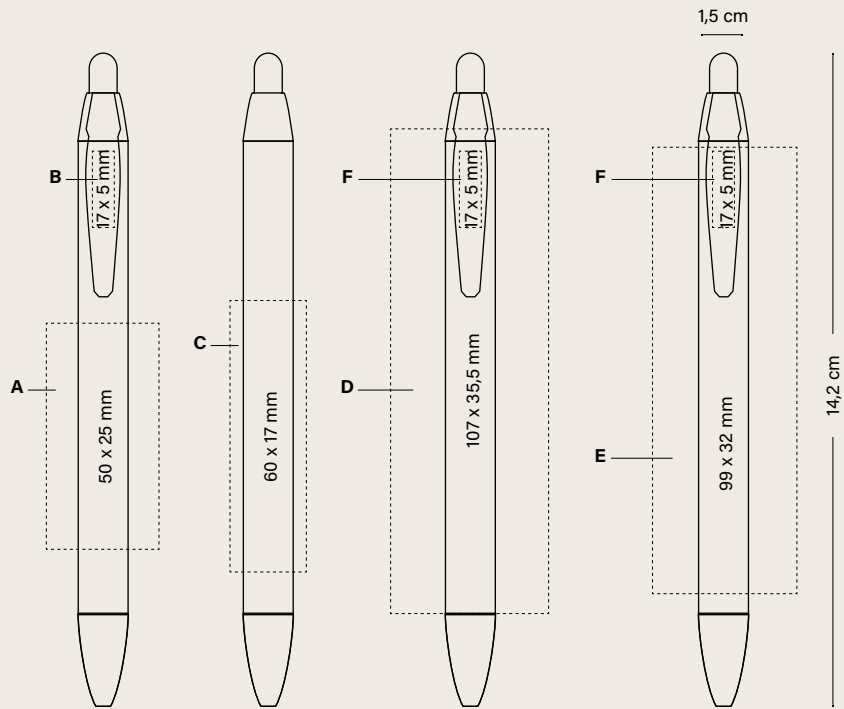

OPTIONAL SPECIAL PACKAGING



+ INFO PAGES 240 TO 245

EXTERNAL PACKAGING



250 ± 2,6KG

Collection Box
(1, 2 & 3 units)

**BIC® WIDE BODY™
MINI DIGITAL**

1893

**BIC® WIDE BODY™
MINI CHROME DIGITAL**

1896

A DG: full-colour (area for images)

B DG: full-colour (area for text)

MOQ 500 units (DG)

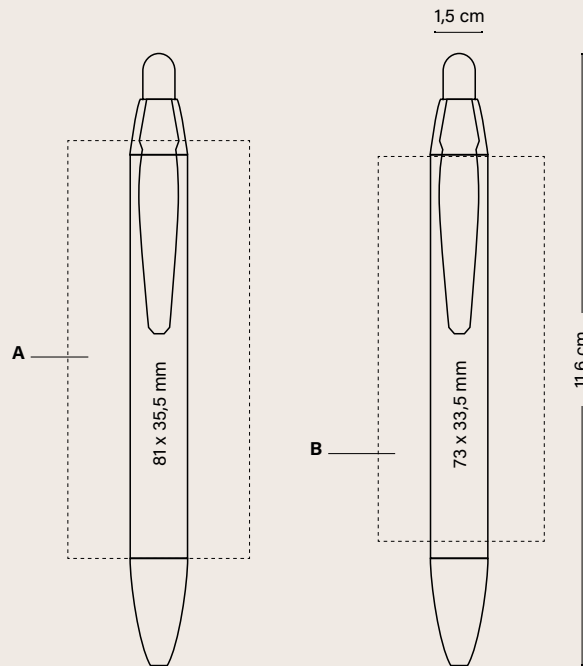

OPTIONAL SPECIAL PACKAGING



ECO SLEEVE



PLASTIC POUCH



WINDOW BOX



COLLECTION BOX

EXTERNAL PACKAGING



250 ± 2,6KG

Collection Box
(1, 2 & 3 units)

+ INFO PAGES 240 TO 245



PERSONALIZED COLOURS



MANUFACTURED AND PRINTED IN BIC FACTORIES



MADE IN SPAIN



REGULATORY COMPLIANCE



ISO certified



IMPRIM'VERT®
eColutions®



FRUIT AND VEGETABLE TRAYS



UBICITY™ PROGRAM
ALLOWS RECYCLING
BIC WRITING INSTRUMENTS



100% ELECTRICITY COMING
FROM RENEWABLE SOURCES

WRITING MODES



BALLPEN M
Ø 1 MM

PRINTING TECHNIQUES



SCREEN PRINTING



DG
DIGITAL

See page 250 for a detailed explanation of the icons





BIC® 4 COLOURS®

The world-renowned BIC® 4 Colours® ballpen gives you the convenience of four different ink colours in one ballpoint pen, making it a great choice to organise notes and record data in different colours. This versatile pen has a 1.0 mm medium point and is filled with long-lasting ink. For added convenience, it has a lanyard hole, so you can take it with you anywhere.

Discover all the versions: Classic, Fashion, Sun, Fine, Shine, Fluo, 3+1^{HB} (with mechanical pencil), Glacé, Soft, Wood Style and the latest versions Pastel, Bicolor, Gradient and Flags Collection.

Don't wait...start your collection today!

**BICOLOR
GRADIENT
PASTEL
FASHION
SUN
FINE
FLUO**

**SHINE
GLACÉ
SOFT
WOOD STYLE
FLAGS COLLECTION
3+1^{HB}**

BIC® 4 COLOURS®

Always an icon.



THE SOLUTION FOR FULL COLOUR COMMUNICATION!

Now in coloured barrels

BIC® 4 COLOURS®

1100 Opaque
1101 With lanyard
Colour ink
●●●●



NEW!



New printing area

360° Printing



Refill service on request

Decoration

BIC® 4 COLOURS®

1100/1101

A SP: max. 4 col.

B DG: Digital print (area for images)

C BP: full-colour

D SP: 1 col. (only for white upper parts)

MOQ 250 units (SP, DG)

MOQ 100 units (BP)

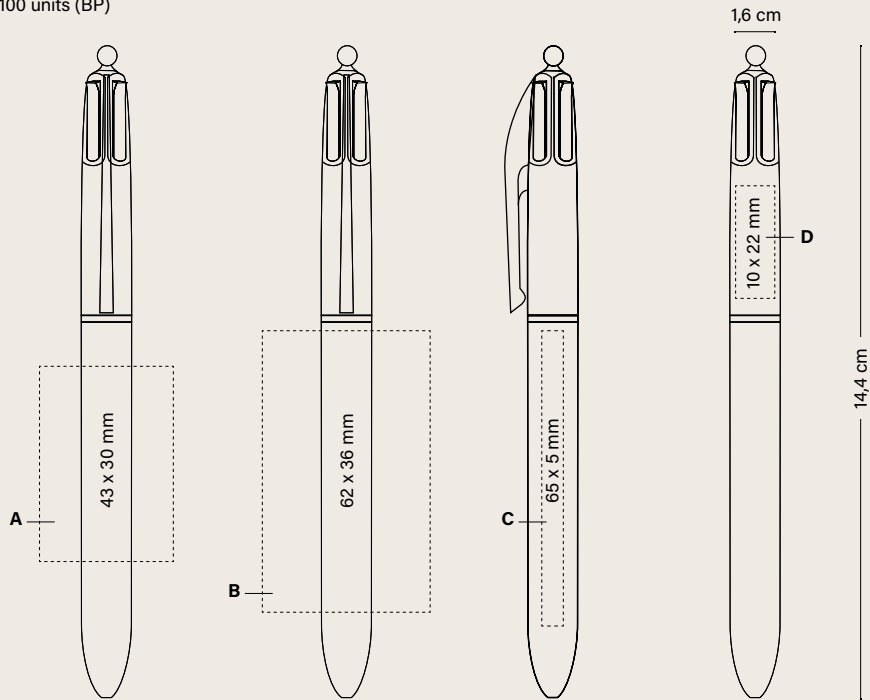

OPTIONAL SPECIAL PACKAGING



+ INFO PAGES 240 TO 245

EXTERNAL PACKAGING



250 ± 3,2KG

Collection Box
(1, 2 & 3 units)



PERSONALIZED
COLOURS



MANUFACTURED
AND PRINTED IN
BIC FACTORIES



MADE IN FRANCE



REGULATORY
COMPLIANCE



ISO
certified



UBICITY™ PROGRAM
ALLOWS RECYCLING
BIC WRITING INSTRUMENTS



100% ELECTRICITY COMING
FROM RENEWABLE SOURCES

**WRITING
SMODES**



BALLPEN M
Ø 1 MM

**PRINTING
TECHNIQUES**



SCREEN PRINTING



DIGITAL



BRITPIX™

BIC® 4 COLOURS® BICOLOR Metallic aesthetics with an artistic touch.

BIC® 4 COLOURS® BICOLOR

1069 Opaque
1076 With Lanyard
Colour ink



01/04G/47



01/05G/47



01/80/47



01/4R/47

NEW!

New
printing area



Refill
service on
request

Decoration

BIC® 4 COLOURS® BICOLOR

1069/1076

A SP: max. 2 col.

B SP: max. 1 col.

MOQ 250 units

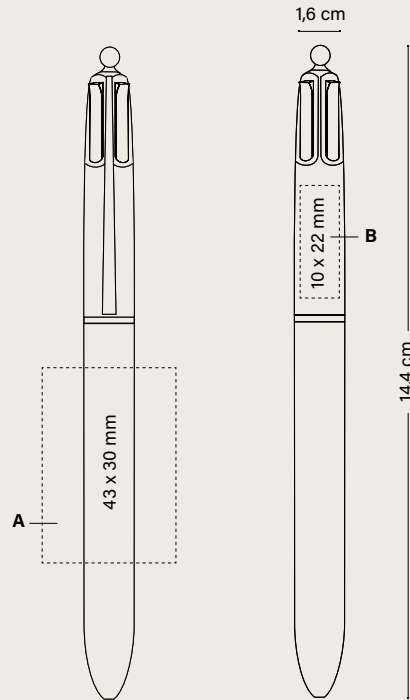

PERSONALIZED
COLOURS



MANUFACTURED
AND PRINTED IN
BIC FACTORIES



FABRIQU 
EN FRANCE

MADE IN FRANCE



REGULATORY
COMPLIANCE



ISO
certified



IMPRIM'VERT®



UBICITY™ PROGRAM
ALLOWS RECYCLING
BIC WRITING INSTRUMENTS



100% ELECTRICITY COMING
FROM RENEWABLE SOURCES

WRITING
MODES



BALLPEN M
Ø 1 MM

PRINTING
TECHNIQUES



SCREEN PRINTING

OPTIONAL SPECIAL PACKAGING



ECO
SLEEVE



PLASTIC
POUCH



WINDOW
BOX

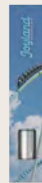

COLLECTION
BOX



250 ± 3,2KG

Collection Box
(1, 2 & 3 units)

+ INFO PAGES 240 TO 245

EXTERNAL PACKAGING

BIC® 4 COLOURS® GRADIENT

The most summery vibes.

BIC® 4 COLOURS® GRADIENT

1074 Opaque
1075 With Lanyard

Colour ink



NEW!

New
printing area



Refill
service on
request

01/3G/8D/4R

Decoration

BIC® 4 COLOURS® GRADIENT

1074/1075

A SP: max. 2 col.

B SP: max. 1 col.

MOQ 250 units

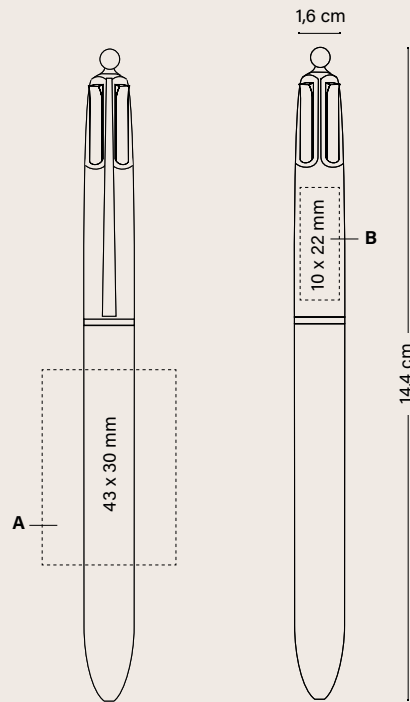

PERSONALIZED COLOURS



MANUFACTURED AND PRINTED IN BIC FACTORIES



MADE IN FRANCE



REGULATORY COMPLIANCE



ISO certified



IMPRIM'VERT®



UBICITY™ PROGRAM
ALLOWS RECYCLING
BIC WRITING INSTRUMENTS



100% ELECTRICITY COMING
FROM RENEWABLE SOURCES

WRITING MODES



BALLPEN M
Ø 1 MM

PRINTING TECHNIQUES



SCREEN PRINTING

OPTIONAL SPECIAL PACKAGING



ECO SLEEVE



PLASTIC POUCH



WINDOW BOX



COLLECTION BOX



250 ± 3,2KG

Collection Box
(1, 2 & 3 units)

+ INFO PAGES 240 TO 245

EXTERNAL PACKAGING

BIC® 4 COLOURS® PASTEL

Vintage colours, dreamy imagery.

NEW!

BIC® 4 COLOURS® PASTEL

1071 Opaque
1072 With Lanyard

Colour ink



84

8D



83



Refill
service on
request

Decoration

BIC® 4 COLOURS® PASTEL

1071/1072

A SP: max. 4 col.

MOQ 250 units

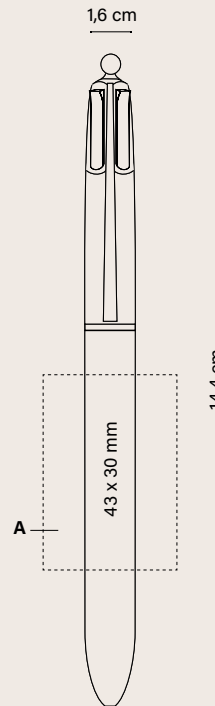

PERSONALIZED COLOURS



MANUFACTURED AND PRINTED IN BIC FACTORIES



MADE IN FRANCE



REGULATORY COMPLIANCE



ISO certified



IMPRIM'VERT®



UBICITY™ PROGRAM
ALLOWS RECYCLING
BIC WRITING INSTRUMENTS



100% ELECTRICITY COMING
FROM RENEWABLE SOURCES

WRITING MODES



BALLPEN M
Ø 1 MM

PRINTING TECHNIQUES



SCREEN PRINTING

OPTIONAL SPECIAL PACKAGING

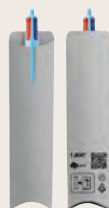

ECO SLEEVE



PLASTIC POUCH



WINDOW BOX



COLLECTION BOX



250 ± 3,2KG

+ INFO PAGES 240 TO 245

Collection Box
(1, 2 & 3 units)

EXTERNAL PACKAGING



THE SOLUTION
FOR FULL COLOUR
COMMUNICATION!

Now on
coloured barrels

4 COLOURS® FASHION

- 1102 Opaque
- 1108 With Lanyard
- Colour ink



Decoration

BIC® 4 COLOURS® FASHION
1102/1108

- A SP:** max. 4 col.
- B DG:** Digital print (area for images)
- C BP:** full-colour
- D SP:** max. 1 col.

MOQ 250 units (SP, DG)
MOQ 100 units (BP)

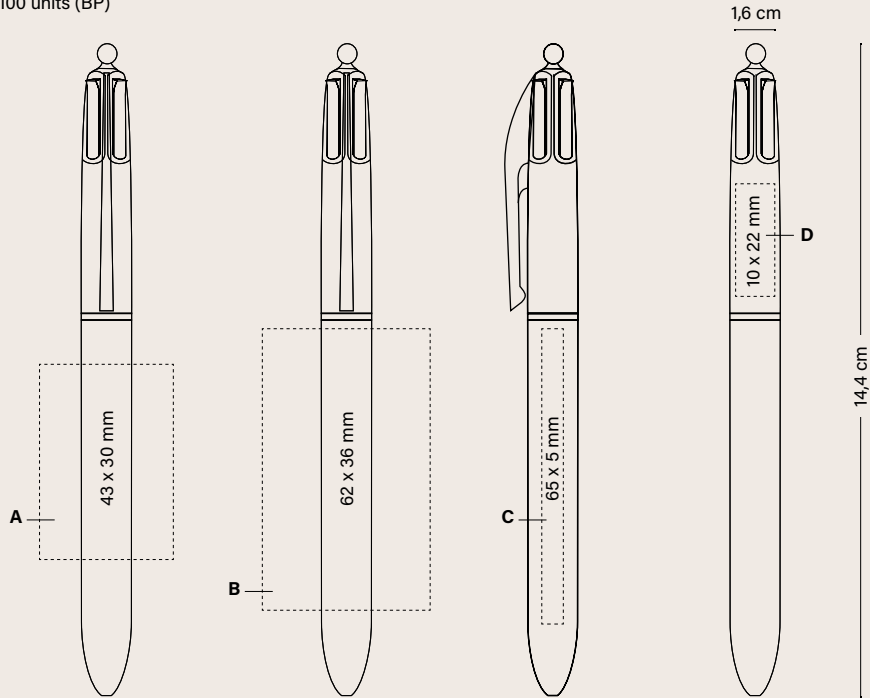

PERSONALIZED COLOURS



MANUFACTURED AND PRINTED IN BIC FACTORIES



MADE IN FRANCE



REGULATORY COMPLIANCE



ISO certified
IMPRIM'VERT®



UBICITY™ PROGRAM ALLOWS RECYCLING BIC WRITING INSTRUMENTS



100% ELECTRICITY COMING FROM RENEWABLE SOURCES

WRITING MODES



BALLPEN M 0.1 MM

PRINTING TECHNIQUES



SCREEN PRINTING



BRITEPIX™
BRITEPIX™ TEXTURE
BRITEPIX™ PERSONALISATION

OPTIONAL SPECIAL PACKAGING



ECO SLEEVE



PLASTIC POUCH



WINDOW BOX



COLLECTION BOX



250 ± 3,2KG

Collection Box (1, 2 & 3 units)

+ INFO PAGES 240 TO 245

See page 250 for a detailed explanation of the icons



THE SOLUTION
FOR FULL COLOUR
COMMUNICATION!

BIC® 4 COLOURS® SUN

- 1097 Opaque
- 1098 With Lanyard
- Colour ink



Decoration

BIC® 4 COLOURS® SUN

1097/1098

A SP: max. 4 col.

B DG: Digital print (area for images)

C BP: full-colour

D SP: max. 1 col.

MOQ 250 units (SP, DG)

MOQ 100 units (BP)

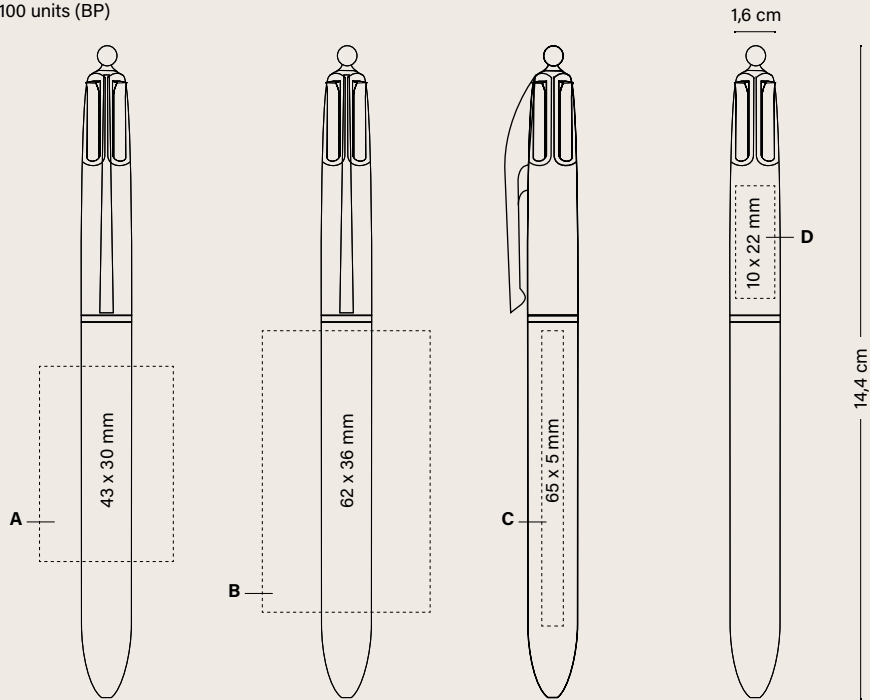

OPTIONAL SPECIAL PACKAGING



ECO SLEEVE



PLASTIC POUCH



WINDOW BOX



COLLECTION BOX



250 ± 3,2KG

Collection Box (1, 2 & 3 units)

+ INFO PAGES 240 TO 245

EXTERNAL PACKAGING



PERSONALIZED COLOURS



MANUFACTURED AND PRINTED IN BIC FACTORIES



MADE IN FRANCE



REGULATORY COMPLIANCE



ISO certified



UBIQUITY™ PROGRAM ALLOWS RECYCLING BIC WRITING INSTRUMENTS



100% ELECTRICITY COMING FROM RENEWABLE SOURCES

WRITING MODES



BALLPEN M Ø 1 MM

PRINTING TECHNIQUES



SCREEN PRINTING



DIGITAL



BRITEPIX™ BRITEPIX™ TEXTURE BRITEPIX™ PERSONALISATION

See page 250 for a detailed explanation of the icons

britePix
DIGITAL

THE SOLUTION
FOR FULL COLOUR
COMMUNICATION!

BIC® 4 COLOURS® FINE

- 1109 Opaque
 - 1111 With Lanyard
 - Colour ink
-



Decoration

BIC® 4 COLOURS® FINE

1109/1111

A SP: max. 4 col.

B DG: Digital print

C BP: full-colour

D SP: max. 1 col.

MOQ 250 units (SP, DG)

MOQ 100 units (BP)

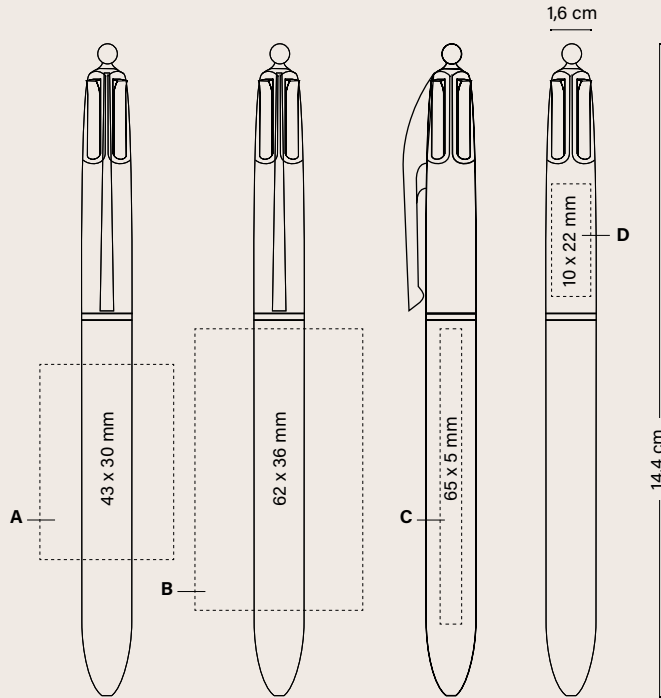

OPTIONAL SPECIAL PACKAGING



ECO SLEEVE



PLASTIC POUCH



WINDOW BOX



Collection Box
(1, 2 & 3 units)

EXTERNAL PACKAGING



250 ± 3,2KG

+ INFO PAGES 240 TO 245



PERSONALIZED COLOURS



MANUFACTURED AND PRINTED IN BIC FACTORIES



FABRIQU  EN FRANCE
MADE IN FRANCE



REGULATORY COMPLIANCE



ISO certified



IMPRIM'VERT®



UBICITY™ PROGRAM
ALLOWS RECYCLING
BIC WRITING INSTRUMENTS



100% ELECTRICITY COMING
FROM RENEWABLE SOURCES

WRITING MODES



BALLPEN 0,8 MM

PRINTING TECHNIQUES



SCREEN PRINTING



DIGITAL



BRITEPIX™
BRITEPIX™ TEXTURE
BRITEPIX™ PERSONALISATION

See page 250 for a detailed explanation of the icons

BIC® 4 COLOURS® FLUO

1114 Opaque
1116 With Lanyard
Colour ink
●●●●



Decoration

BIC® 4 COLOURS® FLUO

1114/1116

A SP: max. 4 col.

B BP: full-colour

C SP: max. 1 col.

MOQ 250 units (SP, DG)

MOQ 100 units (BP)

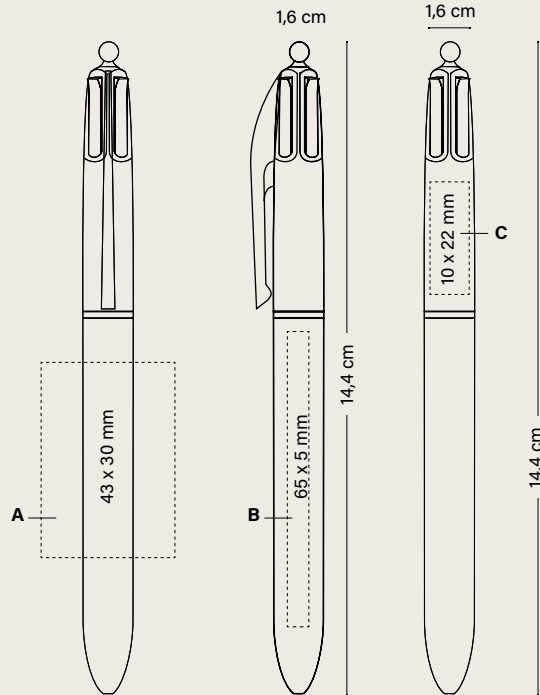

OPTIONAL SPECIAL PACKAGING



ECO SLEEVE



PLASTIC POUCH



WINDOW BOX



COLLECTION BOX



250 ± 3,2KG

Collection Box
(1, 2 & 3 units)

+ INFO PAGES 240 TO 245



PERSONALIZED COLOURS



MANUFACTURED AND PRINTED IN BIC FACTORIES



MADE IN FRANCE



REGULATORY COMPLIANCE



ISO certified



IMPRIM'VERT®



UBICITY™ PROGRAM
ALLOWS RECYCLING
BIC WRITING INSTRUMENTS



100% ELECTRICITY COMING
FROM RENEWABLE SOURCES

WRITING MODES



BALLPEN M
Ø 1 MM

PRINTING TECHNIQUES



SCREEN PRINTING



DIGITAL



BRITEPIX™
BRITEPIX™ TEXTURE
BRITEPIX™ PERSONALISATION

See page 250 for a detailed explanation of the icons

BIC® 4 COLOURS® SHINE

1106 Opaque

1107 With Lanyard

Colour ink



01/75



01/26



01/7G



01/34



01/97

New printing area

Super Shiny barrels!



Refill service on request

100%

BIC® 4 COLOURS® SHINE

Decoration

BIC® 4 COLOURS® SHINE

1106/1107

A SP: max. 2 col.

B LE

C LE

D LE: 360°

E SP: max. 1 col.

MOQ 250 units

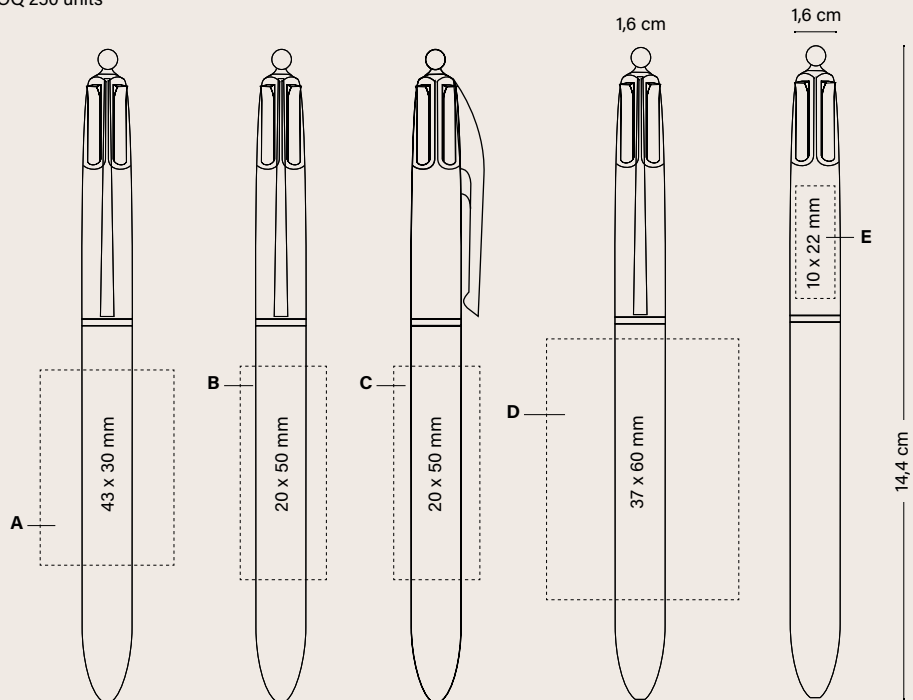

PERSONALIZED
COLOURS



MANUFACTURED
AND PRINTED IN
BIC FACTORIES



FABRIQU 
EN FRANCE

MADE IN FRANCE



REGULATORY
COMPLIANCE



ISO
certified



IMPRIM'VERT®



UBICITY™ PROGRAM
ALLOWS RECYCLING
BIC WRITING INSTRUMENTS



100% ELECTRICITY COMING
FROM RENEWABLE SOURCES

WRITING MODES



BALLPEN M
Ø 1 MM

PRINTING TECHNIQUES



SCREEN PRINTING



LASER

OPTIONAL SPECIAL PACKAGING

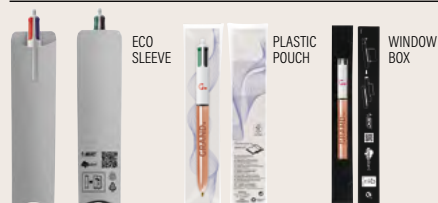

+ INFO PAGES 240 TO 245

EXTERNAL PACKAGING



See page 250 for a detailed explanation of the icons

BIC® 4 COLOURS® GLACÉ

Our classic pen dressed up.

BIC® 4 COLOURS® GLACÉ
1057 Opaque
1058 With Lanyard
Colour ink
●●●●

NEW!



01/76 01/47G 01/03G 01/05G 01/04G 02/47G 02/76 01/14G



New printing area



Refill service on request

BIC® 4 COLOURS® GLACÉ

Decoration

BIC® 4 COLOURS® GLACÉ

1057/1058

A SP: max. 2 col.

B SP: max. 1 col. (only for white upper parts)

MOQ 250 units

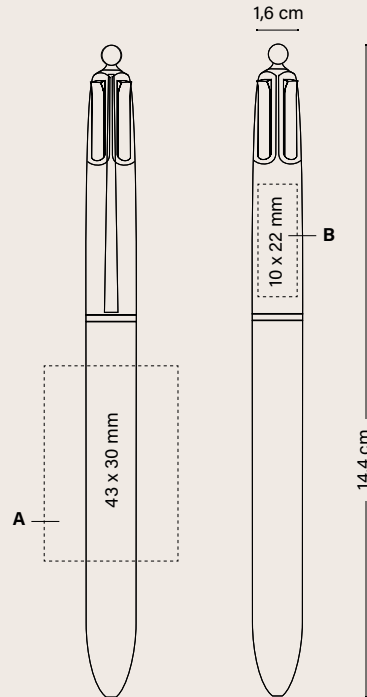

PERSONALIZED
COLOURS



MANUFACTURED
AND PRINTED IN
BIC FACTORIES



MADE IN FRANCE



REGULATORY
COMPLIANCE



ISO
certified



IMPRIM'VERT®



UBICITY™ PROGRAM
ALLOWS RECYCLING
BIC WRITING INSTRUMENTS



100% ELECTRICITY COMING
FROM RENEWABLE SOURCES

WRITING MODES



BALLPEN M
Ø 1 MM

PRINTING TECHNIQUES



SCREEN PRINTING

OPTIONAL SPECIAL PACKAGING



+ INFO PAGES 240 TO 245

EXTERNAL PACKAGING



250 ± 3,2KG

Collection Box
(1, 2 & 3 units)

See page 250 for a detailed explanation of the icons

BIC® 4 COLOURS® SOFT

A soft touch you won't want to put down!



BIC® 4 COLOURS® SOFT

- 1060 Opaque
 - 1063 With Lanyard
 - Colour ink
- ● ● ●

NEW!



01/03F



01/02F



02/02F



01/07F

New printing area

Feel the softness in your hands



Refill service on request

BIC® 4 COLOURS® SOFT

Decoration

BIC® 4 COLOURS® SOFT

1060/1063

A SP: max. 1 col.

B SP: max. 1 col. (only for white upper parts)

MOQ 250 units

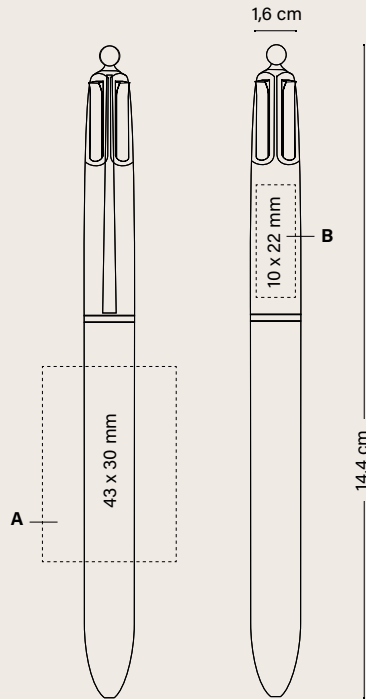

PERSONALIZED
COLOURS



MANUFACTURED
AND PRINTED IN
BIC FACTORIES



FABRIQU 
EN FRANCE

MADE IN FRANCE



REGULATORY
COMPLIANCE



ISO
certified



IMPRIM'VERT®



UBICITY™ PROGRAM
ALLOWS RECYCLING
BIC WRITING INSTRUMENTS



100% ELECTRICITY COMING
FROM RENEWABLE SOURCES

WRITING MODES



BALLPEN M
Ø 1 MM

PRINTING TECHNIQUES



SCREEN PRINTING

OPTIONAL SPECIAL PACKAGING



ECO
SLEEVE



PLASTIC
POUCH



WINDOW
BOX



COLLECTION
BOX

Collection Box
(1, 2 & 3 units)

+ INFO PAGES 240 TO 245

EXTERNAL PACKAGING



250 ± 3,2KG

See page 250 for a detailed explanation of the icons

BIC® 4 COLOURS® WOOD STYLE

Be impressed with the spectacular wood finish!



BIC® 4 COLOURS® WOOD STYLE

1061 Opaque
1064 With Lanyard

Colour ink
●●●●

NEW!



01/6AW

01/05W

01/02W

02/6AW

01/12W

New
printing area

Bring warmth to your
brand

Refill
service on
request

Decoration

BIC® 4 COLOURS® WOOD STYLE

1061/1064

A SP: max. 2 col.

B SP: max. 1 col. (only for white upper parts)

MOQ 250 units

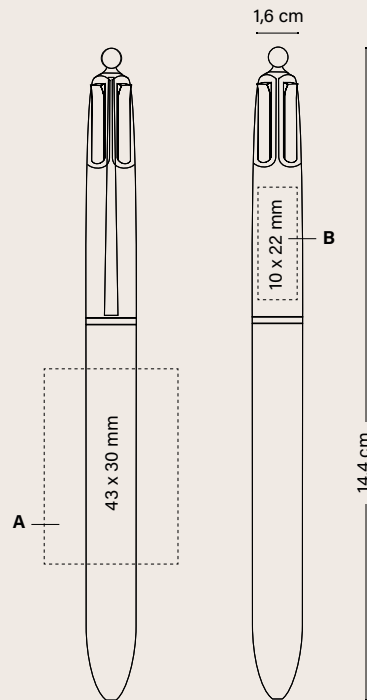

PERSONALIZED COLOURS



MANUFACTURED AND PRINTED IN BIC FACTORIES



MADE IN FRANCE



REGULATORY COMPLIANCE



ISO certified



IMPRIM'VERT®



UBICITY™ PROGRAM
ALLOWS RECYCLING
BIC WRITING INSTRUMENTS



100% ELECTRICITY COMING
FROM RENEWABLE SOURCES

WRITING MODES



BALLPEN M
Ø 1 MM

PRINTING TECHNIQUES



SCREEN PRINTING

OPTIONAL SPECIAL PACKAGING



ECO SLEEVE



PLASTIC POUCH



WINDOW BOX



COLLECTION BOX

Collection Box
(1, 2 & 3 units)

EXTERNAL PACKAGING



250 ± 3,2KG

+ INFO PAGES 240 TO 245

See page 250 for a detailed explanation of the icons

BIC® 4 COLOURS® FLAGS COLLECTION

Celebrate heritage

BIC® 4 COLOURS® FLAGS COLLECTION

1067
1068 With Lanyard

Colour ink
●●●●



01/03/47/05



01/02/03/12



01/03/47/04



01/03/12/03

NEW!

New printing area



Refill service on request

BIC® 4 COLOURS® FLAGS COLLECTION

Decoration

BIC® 4 COLOURS® FLAGS COLLECTION

1067/1068

A SP: max. 2 col.

B SP: max. 1 col.

MOQ 250 units

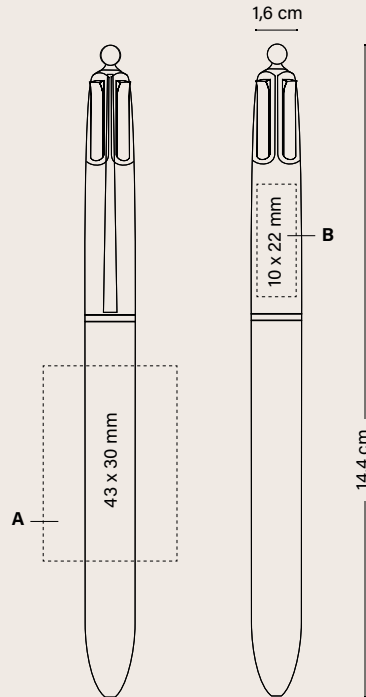

PERSONALIZED
COLOURS



MANUFACTURED
AND PRINTED IN
BIC FACTORIES



FABRIQU 
EN FRANCE

MADE IN FRANCE



REGULATORY
COMPLIANCE



ISO
certified



IMPRIM'VERT®



UBICITY™ PROGRAM
ALLOWS RECYCLING
BIC WRITING INSTRUMENTS



100% ELECTRICITY COMING
FROM RENEWABLE SOURCES

WRITING MODES



BALLPEN M
Ø 1 MM

PRINTING TECHNIQUES



SCREEN PRINTING

OPTIONAL SPECIAL PACKAGING



ECO
SLEEVE



PLASTIC
POUCH



WINDOW
BOX



COLLECTION
BOX

Collection Box
(1, 2 & 3 units)



250 ± 3,2KG

+ INFO PAGES 240 TO 245

See page 250 for a detailed explanation of the icons

BIC® 4 COLOURS® 3+1^{HB}
1099 Opaque
Colour ink
●●●●

3 ballpens +
1 mechanical pencil.



Refill
service on
request



Decoration

BIC® 4 COLOURS® 3+1^{HB}

1099 Opaque

A/B LE

MOQ 250 units

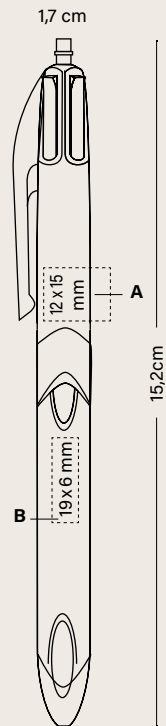

PERSONALIZED COLOURS



MANUFACTURED AND PRINTED IN BIC FACTORIES



REGULATORY COMPLIANCE



ISO certified



IMPRIM'VERT®



UBICITY™ PROGRAM
ALLOWS RECYCLING
BIC WRITING INSTRUMENTS



100% ELECTRICITY COMING
FROM RENEWABLE SOURCES

WRITING MODES



BALLPEN M
Ø 1 MM



MECHANICAL PENCIL
MP Ø 0,7MM

PRINTING TECHNIQUES



LASER

OPTIONAL SPECIAL PACKAGING



PLASTIC
POUCH



COLLECTION
BOX

Collection Box
(1, 2 & 3 units)

+ INFO PAGES 240 TO 245

EXTERNAL PACKAGING



250 ± 3,5 KG



CHECK OUT THE
VIDEO

See page 250 for a detailed explanation of the icons

BIC® METAL PRO

Metal accents, modern design
with a large selection of
colours and finishes.

BIC® METAL PRO

1290 Soft
Colour ink



01F



02F



04F

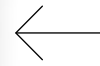

*Maximum writing
comfort*

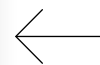

*German ink for
writing up to 8 km.*

BIC® METAL PRO

1290 Polished

Colour ink



01E



02E



04E



05E



06P

100%



WRITING MODES



PRINTING TECHNIQUES



See page 250 for a detailed explanation of the icons.

BIC® METAL PRO

1290 Matt

Colour ink



01D



02D



04D

100%

Decoration

BIC® METAL PRO

1290

A SP: max. 2 col.
(Not available in soft finish)

B LE/SP: max. 1 col.

C LE 360°

MOQ 50 units

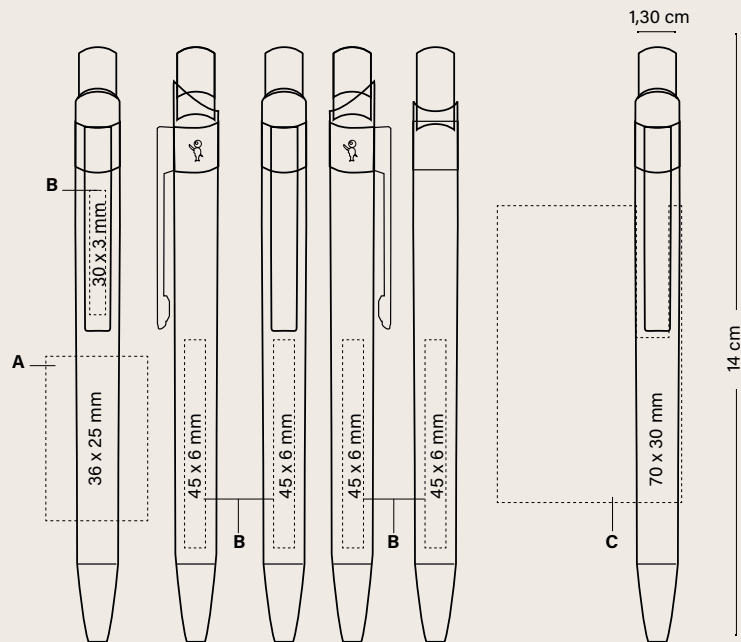

OPTIONAL SPECIAL PACKAGING



+ INFO PAGES 240 TO 245

EXTERNAL PACKAGING



150 ± 2,5KG



WRITING MODES



PRINTING TECHNIQUES



See page 250 for a detailed explanation of the icons.

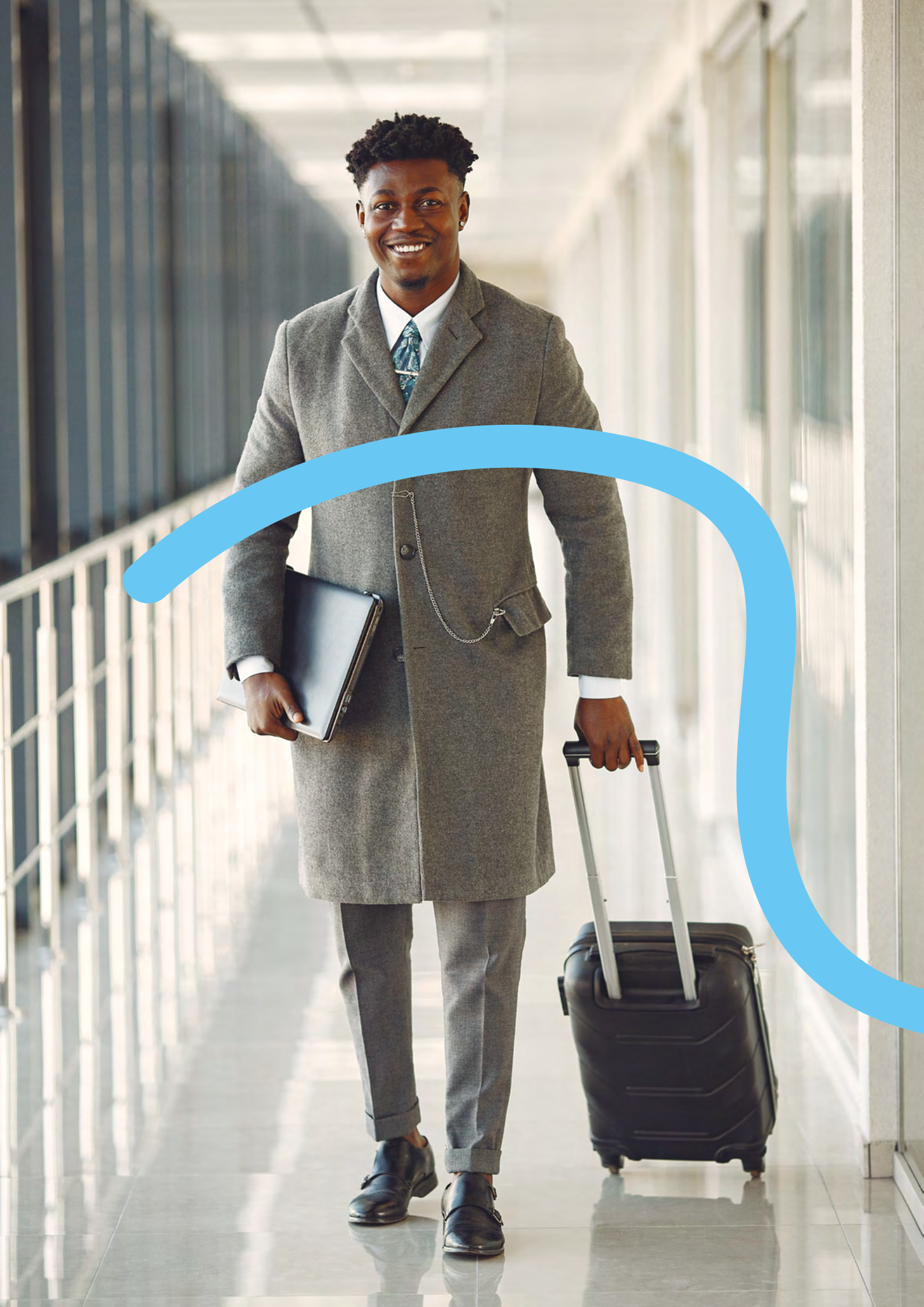

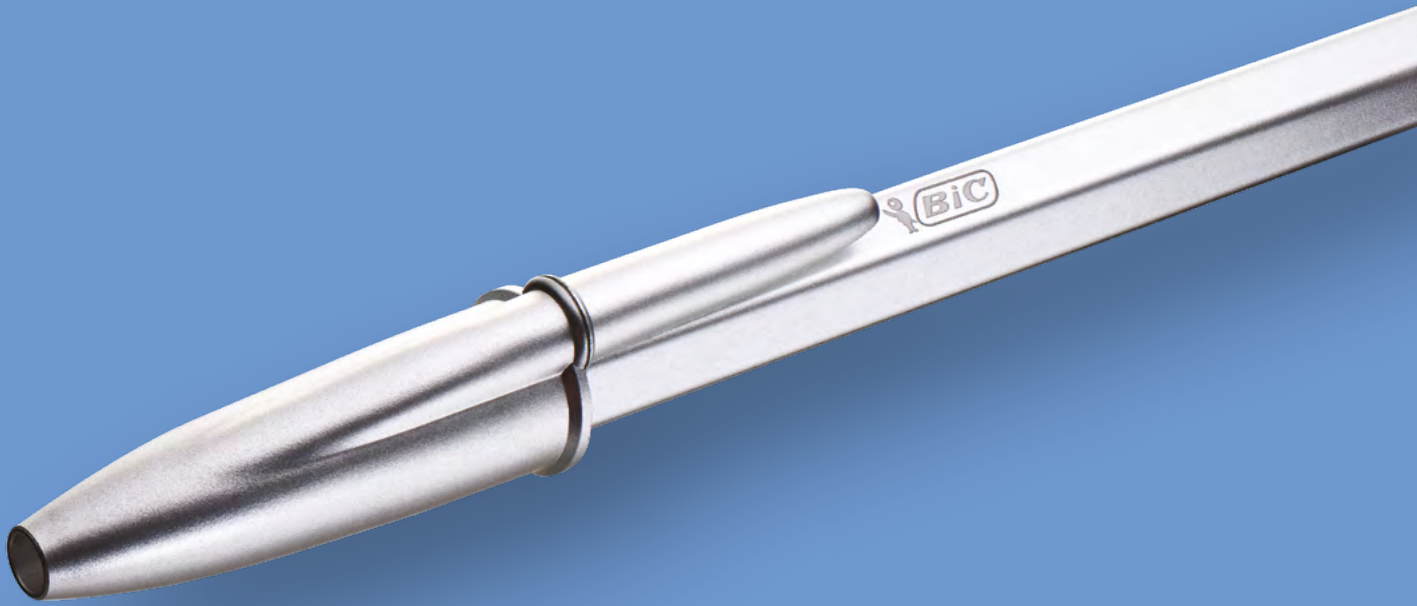

BIC[®] CRISTAL[®] RE'NEW[™]

The iconic BIC[®] Cristal[®] in a metal version. The BIC[®] Cristal[®] Re'New[™] adds to the iconic BIC[®] Cristal[®] original, attaching a sense of modernity to its aluminum matt barrel and the laser engraved BIC[®] logo. The cap has been also redesigned; it's matt grey and manufactured from 96% recycled plastic. Refillable with blue or black inks. Includes 2 cartridges. The same ingenious hexagonal shape as the original BIC[®] Cristal[®] for controlled grip and comfort. Sustainable design, trusted quality, and timeless value. The product comes with BIC[®] Window Box packaging.

BIC® CRISTAL® RE'NEW™

Elegance dressed in metal

BIC® CRISTAL®
RE'NEW™

1090

Colour ink



BIC® WINDOW BOX

1 pen + 2 refills



*Your Cristal® Re'New™
comes with this packaging!*

(Included in the price)

Decoration

BIC® CRISTAL® RE'NEW™
1090

A LE: max. 1 col.

MOQ 25 units

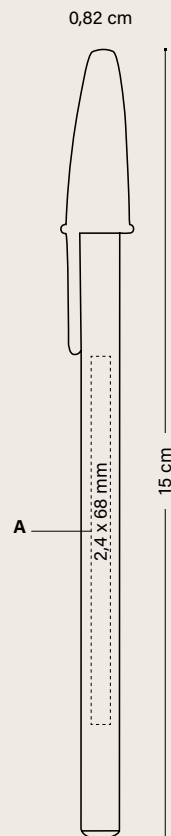

EXTERNAL PACKAGING



44 ± 1KG



MANUFACTURED
AND PRINTED IN
BIC FACTORIES



REGULATORY
COMPLIANCE



ISO
certified



IMPRIM'VERT®



UBICITY™ PROGRAM
ALLOWS RECYCLING
BIC WRITING INSTRUMENTS

WRITING
MODES



BALLPEN M
Ø 1 MM

PRINTING
TECHNIQUES



LE
LASER



REFILLABLE

See page 250 for a detailed explanation of the icons.



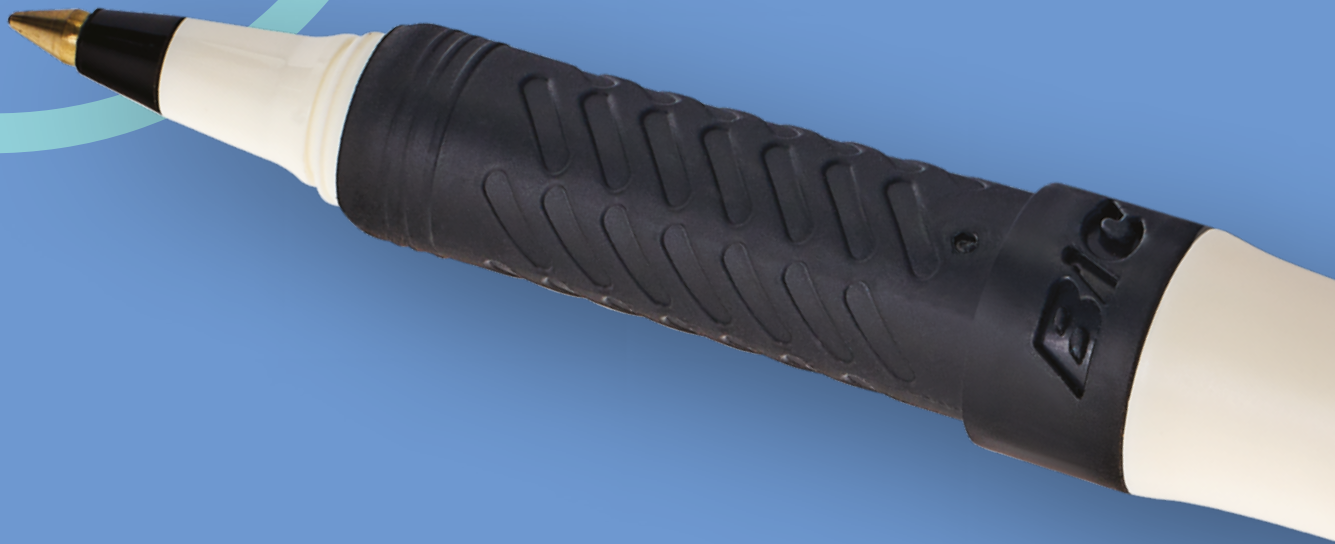

BIC[®] ROLLERS AND GELS

Enjoy a smooth writing experience. Glide across the paper easily without smudging thanks to the quick-drying ink, ideal for both left and right-handed people.

BIC[®] GRIP ROLLER

BIC[®] XS FINESTYLE

BIC[®] INTENSITY[®] GEL CLIC

BIC® GRIP ROLLER



MEDIUM WRITING
Ø 0,7 MM

*High quality medium point liquid ink roller
pen for smooth and fluid writing*

BIC® GRIP ROLLER

1187

Colour ink



01/35

●
Also available
in blue ink



12/35



10/35



03/35



59/35



24/35



07/35

●
Also available
in blue ink



06/35



27/35



02/35

●
Also available
in blue ink



14/35

100%

Decoration

BIC® GRIP ROLLER

1187

A/B SP: max. 3 col.

MOQ 250 units

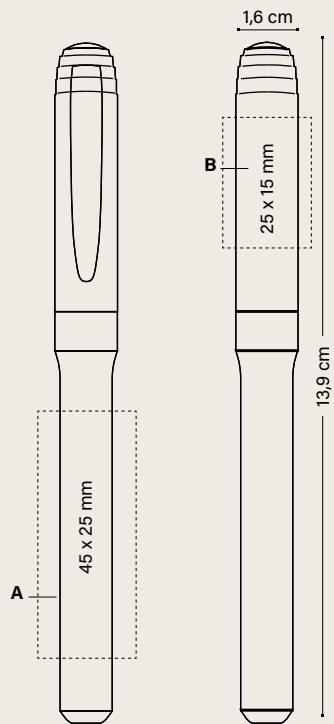

MANUFACTURED AND PRINTED IN BIC FACTORIES



REGULATORY COMPLIANCE



ISO certified



IMPRIM'VERT®



UBUCITY™ PROGRAM
ALLOWS RECYCLING
BIC WRITING INSTRUMENTS

WRITING MODES



ROLLER R
Ø 0,7 MM

PRINTING TECHNIQUES



SCREEN PRINTING

OPTIONAL SPECIAL PACKAGING



ECO SLEEVE

PLASTIC POUCH

WINDOW BOX

MARKING SET

COLLECTION BOX

+ INFO PAGES 240 TO 245

EXTERNAL PACKAGING



250 ± 3 KG

Collection Box
(1, 2 & 3 units)

See page 250 for a detailed explanation of the icons.

BIC® XS FINESTYLE
1851 Opaque
Colour ink



01/03

01/25

●
Only available
in black ink



01/06

BIC® XS FINESTYLE
1851 Clear
Colour ink



89/01

100%

Decoration

BIC® XS FINESTYLE

1851

A PD: max. 2 col.

B SP: max. 2 col.

C BP: full-colour

MOQ 250 units

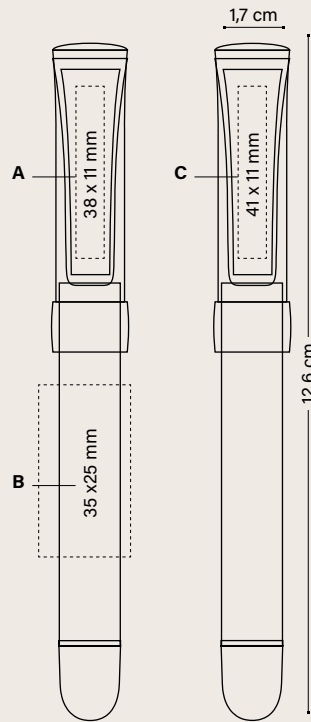

OPTIONAL SPECIAL PACKAGING



ECO SLEEVE



PLASTIC POUCH

+ INFO PAGES 240 TO 245

EXTERNAL PACKAGING



250 ± 2,8KG



MANUFACTURED AND PRINTED IN BIC FACTORIES



MADE IN SPAIN



REGULATORY COMPLIANCE



ISO certified



IMPRIM'VERT®



UBICITY™ PROGRAM ALLOWS RECYCLING BIC WRITING INSTRUMENTS



100% ELECTRICITY COMING FROM RENEWABLE SOURCES

WRITING MODES



FINESTYLE
Ø 0,7 MM

PRINTING TECHNIQUES



SCREEN PRINTING



PAD PRINTING



BRITEPIX™
BRITEPIX™
TEXTURE
BRITEPIX™
PERSONALISATION

See page 250 for a detailed explanation of the icons.



*Iconic BIC® Boy
is embossed*

**BIC® INTENSITY®
GEL CLIC**

1196 Opaque
Colour ink



01



02

100%

**BIC® INTENSITY®
GEL CLIC**

1196 Clear
Colour ink



92



88



86

100%

Decoration

BIC® INTENSITY® GEL CLIC

1196

A SP: max. 2 col.

B SP: max. 4 col.

MOQ 250 units

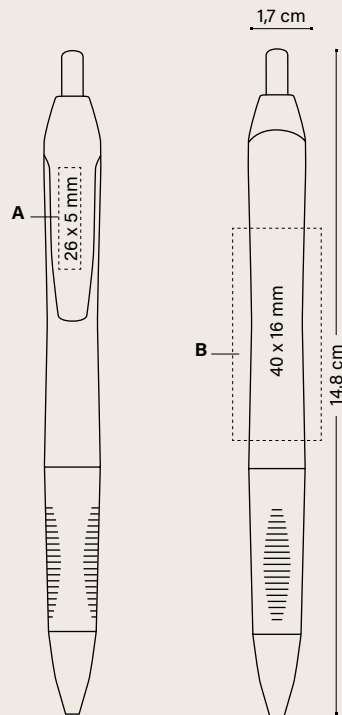

OPTIONAL SPECIAL PACKAGING



+ INFO PAGES 240 TO 245

EXTERNAL PACKAGING



MANUFACTURED AND PRINTED IN BIC FACTORIES



REGULATORY COMPLIANCE



ISO certified



IMPRIM'VERT®



UBICITY™ PROGRAM
ALLOWS RECYCLING
BIC WRITING INSTRUMENTS

WRITING MODES



GEL G
Ø 0,7 MM

PRINTING TECHNIQUES



SCREEN PRINTING

See page 250 for a detailed explanation of the icons.



Ideas

BIC[®] HIGHLIGHTERS AND MARKERS

BIC[®] Markers offer you products specifically designed to write in a highly visible way and mark on surfaces or material that other writing instruments cannot mark on. Make your ideas visible and express yourself whatever the surface with BIC[®] Markers.

BIC[®] BRITE LINER[®] GRIP

BIC[®] VELLEDA[®] WHITE BOARD MARKER FINE

BIC[®] VELLEDA[®] WHITE BOARD MARKER GRIP

BIC[®] MARK-IT PERMANENT MARKER

BIC[®] PERMANENT MARKER ECOLUTIONS[®]



BIC® BRITE LINER® GRIP

BIC® BRITE LINER® GRIP 1192



Decoration

BIC® BRITE LINER® GRIP

1192

A/B SP: max. 3 col.

MOQ 250 units

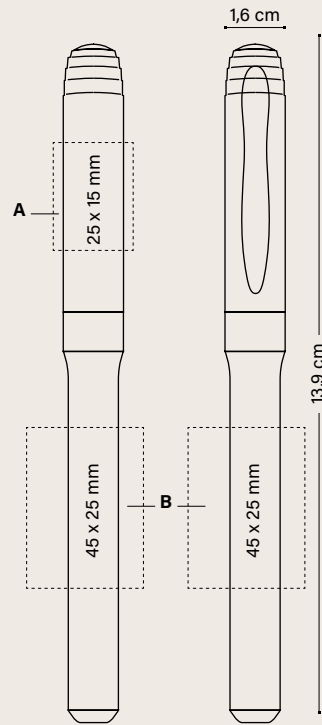

OPTIONAL SPECIAL PACKAGING



MARKING SET



COLLECTION BOX

Collection Box (1, 2 & 3 units)

+ INFO PAGES 240 TO 245

EXTERNAL PACKAGING



250 ± 2,8KG



MANUFACTURED AND PRINTED IN BIC FACTORIES



REGULATORY COMPLIANCE



ISO certified



IMPRIM'VERT®



UBIQUITY™ PROGRAM
ALLOWS RECYCLING
BIC WRITING INSTRUMENTS



WILL NOT DRY OUT IN 24H

WRITING MODES



HIGHLIGHTER HL

PRINTING TECHNIQUES



SCREEN PRINTING

SUITABLE FOR



FAXES



PHOTOCOPIES



PRINTERS



PAPER

See page 250 for a detailed explanation of the icons

BIC® VELLEDA® WHITE BOARD MARKER FINE

Velleda®

BIC® VELLEDA® WHITE BOARD MARKER FINE
1651



01/04

Colour ink



100%

01/02

Colour ink

Decoration

BIC® VELLEDA® WHITE BOARD MARKER FINE
1651

A SP: max. 1 col.

MOQ 500 units

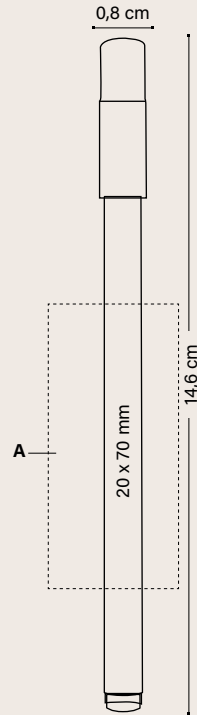

OPTIONAL SPECIAL PACKAGING



MARKING SET

Now you can have it as a set!

+ INFO PAGES 240 TO 245

EXTERNAL PACKAGING



500 ± 3,2KG



MANUFACTURED AND PRINTED IN BIC FACTORIES

FABRIQUÉ EN FRANCE

MADE IN FRANCE



REGULATORY COMPLIANCE



ISO certified



IMPRIM'VERT®



UBICITY™ PROGRAM
ALLOWS RECYCLING
BIC WRITING INSTRUMENTS



RESISTANT TIP

WRITING MODES



MARKER
MK

PRINTING TECHNIQUES



SCREEN PRINTING

BIC® VELLEDA® WHITE BOARD MARKER GRIP



BIC® VELLEDA® WHITE BOARD MARKER GRIP 1213



→
Textured rubberised grip for more precision and control

01/02
●
Colour ink

100%

Decoration

BIC® VELLEDA® WHITE BOARD MARKER GRIP 1213

A/B SP: max. 3 col.

MOQ 250 units

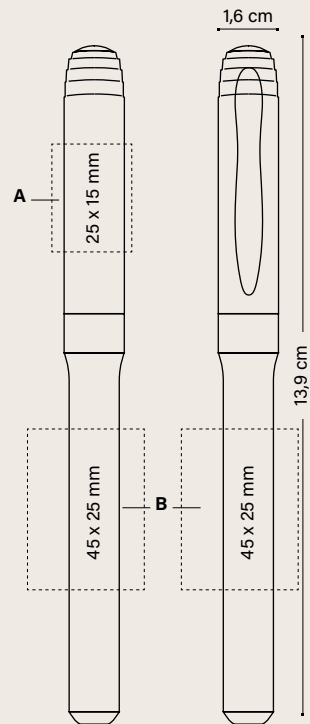

OPTIONAL SPECIAL PACKAGING



MARKING SET

Now you can have it as a set!

+ INFO PAGES 240 TO 245

EXTERNAL PACKAGING



250 ± 2,7KG



MANUFACTURED AND PRINTED IN BIC FACTORIES



REGULATORY COMPLIANCE



ISO certified



IMPRIM'VERT®



UBICITY™ PROGRAM
ALLOWS RECYCLING
BIC WRITING INSTRUMENTS



RESISTANT TIP

WRITING MODES



MARKER MK

PRINTING TECHNIQUES



SCREEN PRINTING

BIC® MARK-IT PERMANENT MARKER

**BIC® MARK-IT
PERMANENT
MARKER**
1214



01/02
●
Colour ink

01/04
●
Colour ink

←
*Textured rubberised
grip for more
precision and control*

Decoration

**BIC® MARK-IT
PERMANENT MARKER**
1214

A/B SP: max. 3 col.

MOQ 250 units

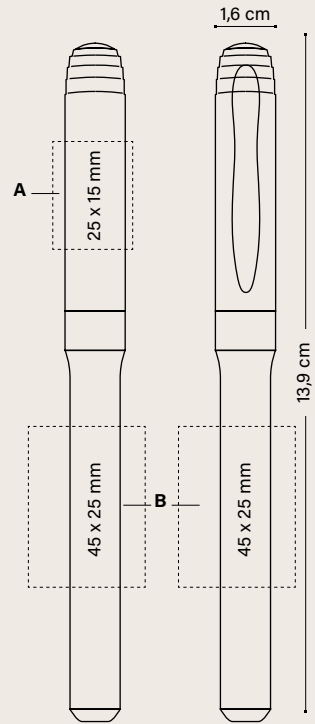

OPTIONAL SPECIAL PACKAGING



MARKING
SET

*You can have
it as a set!*

+ INFO PAGES 240 TO 245

EXTERNAL PACKAGING



250 ± 2,8KG



MANUFACTURED AND
PRINTED IN BIC FACTORIES



REGULATORY
COMPLIANCE



UBICITY™ PROGRAM
ALLOWS RECYCLING
BIC WRITING INSTRUMENTS



RESISTANT
TIP



MARKER
MK



SCREEN PRINTING

BIC® PERMANENT MARKER ECOLUTIONS®



MADE FROM
51% RECYCLED MATERIAL*

Add the Möbius loop to your artwork at no additional charge. Please specify "Print the Möbius loop" on your order. (Möbius loop imprint defaults to left-hand hand corner.)



PHARMACEUTICAL
WASTE

BIC® PERMANENT MARKER ecolutions® 1210



02

●
Colour ink

02

●
Colour ink

Decoration

BIC® PERMANENT MARKER ecolutions® 1210

A SP: max. 1 col.

MOQ 250 units

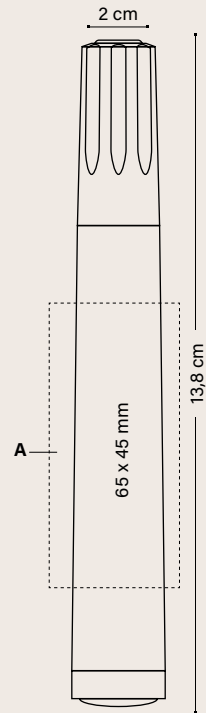

EXTERNAL PACKAGING



250 ± 2,6KG



MANUFACTURED AND
PRINTED IN BIC FACTORIES

FABRIQUÉ
EN FRANCE



MADE IN
FRANCE



REGULATORY
COMPLIANCE



PHARMACEUTICAL
WASTE



RESISTANT
TIP

WRITING MODES



MARKER
MK

PRINTING TECHNIQUES



SCREEN PRINTING

*The percentage is calculated on total weight of product excluding ink system. Due to the recycled content of the raw materials used to make the product, we cannot guarantee that the colours shown in the catalogue or colours customised to order will always have the same colour and appearance. See page 250 for a detailed explanation of the icons



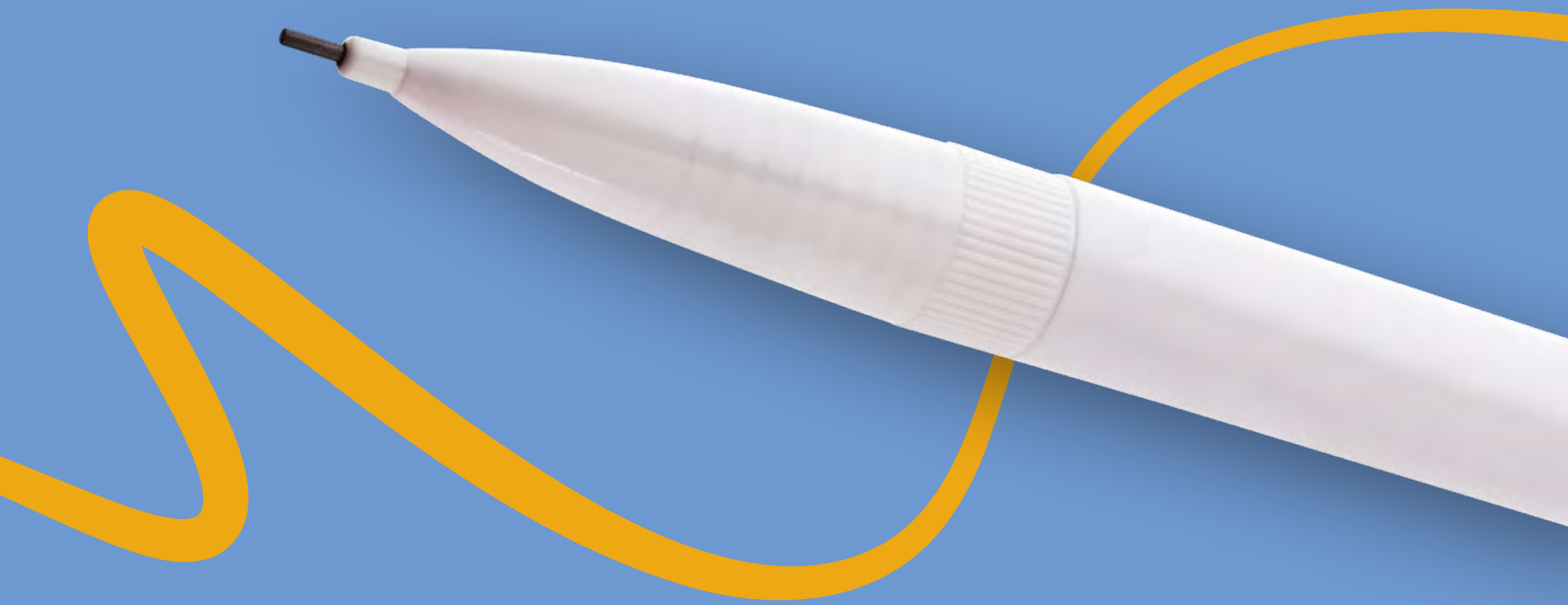

BIC[®] MECHANICAL PENCILS

A reference since 1993. Stay sharp with this first-class mechanical pencil!

It is solid and resistant, never needs sharpening and writes smoother and darker than ever!

BIC[®] MATIC[®]

BIC[®] MEDIA CLIC MECHANICAL PENCIL

BIC[®] MEDIA CLIC GRIP MECHANICAL PENCIL

ECO version and standard at the same price!

ecolutions®



MADE FROM 65% RECYCLED MATERIAL*

Add the Möbius loop to your artwork at no additional charge. Please specify it on your order. (Möbius loop imprint defaults to left-hand corner.)



PHARMACEUTICAL WASTE

BIC® MATIC®
1120 Opaque



BIC® MATIC®
ecolutions® 1E40 Opaque



*The percentage is calculated based on total weight of the product. Due to the recycled content of the raw materials used to make the product, we cannot guarantee that the colours shown in the catalogue or colours customised to order will always have the same colour and appearance.

Decoration

BIC® MATIC®
1120
ecolutions® 1E40
MOQ 500 units

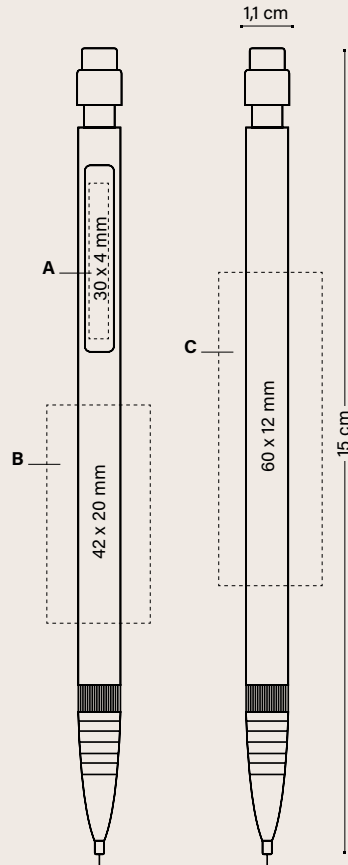

OPTIONAL SPECIAL PACKAGING



PLASTIC POUCH

+ INFO PAGES 240 TO 245

EXTERNAL PACKAGING



500 ± 3,1 KG



MANUFACTURED AND PRINTED IN BIC FACTORIES



FABRIQUÉ EN FRANCE
MADE IN FRANCE



REGULATORY COMPLIANCE



IMPRIM'VERT®

ecolutions®



PHARMACEUTICAL WASTE



RECYCLABLE



SMOOTHER AND DARKER WRITING



EASY TO USE AND ERASE



2 LEADS 9 CM

WRITING MODES



MECHANICAL PENCIL MP
Ø 0,7 MM

PRINTING TECHNIQUES



SCREEN PRINTING

See page 250 for a detailed explanation of the icons.

BIC® MEDIA CLIC MECHANICAL PENCIL



Embossed
iconic BIC® brand!

BIC® MEDIA CLIC
1028 Mechanical pencil
Opaque



BIC® MEDIA CLIC
1028 Mechanical pencil
Frosted

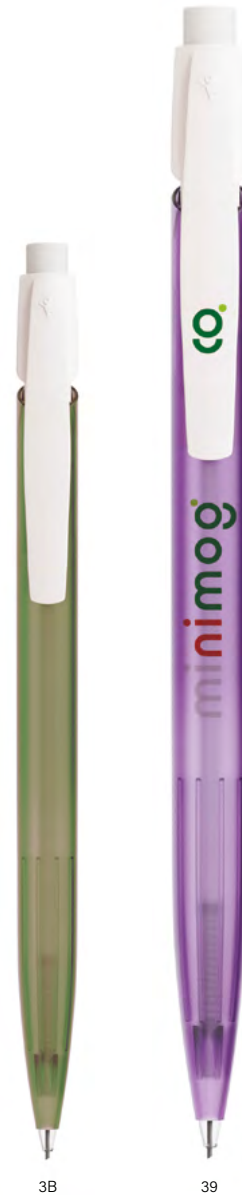

BIC® MEDIA CLIC GRIP MECHANICAL PENCIL

ECO version and standard at the same price!

ecolutions®
 MADE FROM 92%
 RECYCLED MATERIAL*



PLASTIC
 CAR PARTS

BIC® MEDIA CLIC GRIP
 1021 Mechanical pencil
 Opaque



BIC® MEDIA CLIC GRIP
 1021 Mechanical pencil
 Frosted



BIC® MEDIA CLIC GRIP
 1E21 Mechanical pencil
 Opaque



Only available
 on white barrel



*The percentage is calculated based on total weight of the product. Due to the recycled content of the raw materials used to make the product, we cannot guarantee that the colours shown in the catalogue or colours customised to order will always have the same colour and appearance.

BIC® MEDIA CLIC MECHANICAL PENCIL

BIC® MEDIA CLIC
1028 Mechanical pencil

BIC® MEDIA CLIC GRIP
1021 Mechanical pencil / **ecolutions®** 1E21 Mechanical pencil

MOQ 500 units
Standard colours combination

MIX & MATCH

No extra charge

Clip

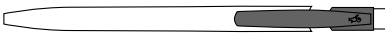

Opaque

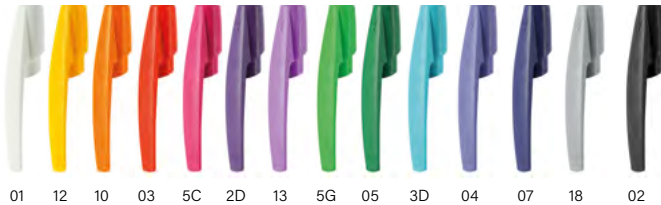

Frosted



01 12 10 03 5C 2D 13 5G 05 3D 04 07 18 02 69

Barrel



Opaque

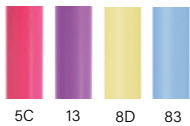

5C 13 8D 83

Frosted



39 3B

Barrel & Grip



01/12

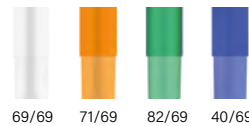

69/69 71/69 82/69 40/69



THE SOLUTION FOR
**FULL COLOUR
COMMUNICATION!**

ecolutions®



PLASTIC
CAR PARTS

Standard colours
combination*

Barrel & Grip

Opaque



01/
03 01/
05 01/
07 01/
02



Add the Möbius loop to
your artwork at no
additional charge. Please
specify "Print the Möbius
loop" on your order.
(Möbius loop imprint
defaults to left-hand
corner.)

All colour range available in Digital britePix™

Exact colour match: ≥ 10.000 units 1028

Exact colour match: ≥ 20.000 units 1021 / 1E21



PERSONALIZED
COLOURS



MANUFACTURED
AND PRINTED IN
BIC FACTORIES

**MIX &
MATCH**
ecolutions®



PLASTIC
CAR PARTS



RECYCLABLE

WRITING MODES



MECHANICAL
PENCIL MP

PRINTING TECHNIQUES



SP
SCREEN
PRINTING



DG
DIGITAL

BIC® MEDIA CLIC / BIC® MEDIA CLIC GRIP MECHANICAL PENCIL

BIC® MEDIA CLIC

1028 Mechanical pencil

A SP: max. 4 col.

B SP: max. 2 col.

C DG: full-colour

MOQ 500 units.

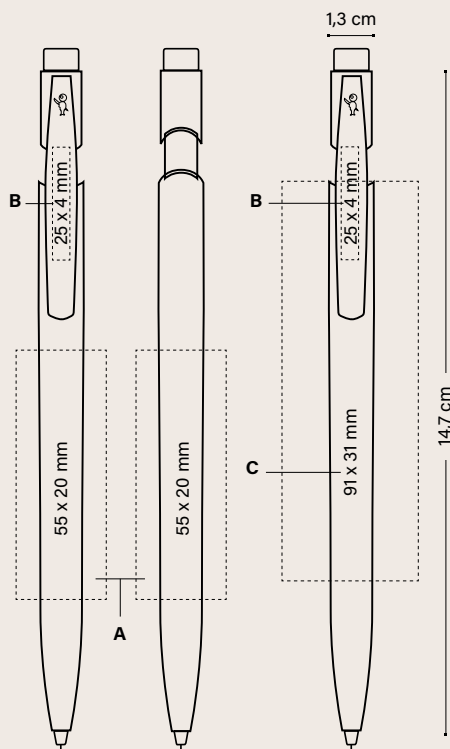

OPTIONAL SPECIAL PACKAGING



ECO SLEEVE

PLASTIC POUCH

WINDOW BOX

+ INFO PAGES 240 TO 245

EXTERNAL PACKAGING



500 ± 4,1 KG

BIC® MEDIA CLIC GRIP

1021 Mechanical pencil

ecolutions® 1E21 Mechanical pencil

D SP: max. 4 col.

E SP: max. 2 col.

F DG: full-colour

MOQ 500 units.

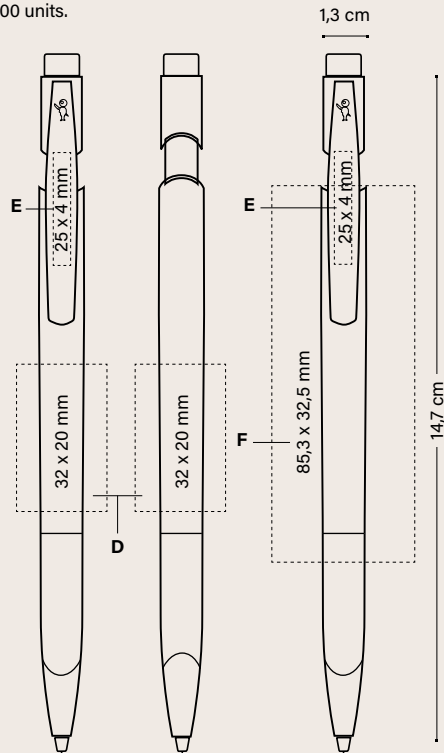

OPTIONAL SPECIAL PACKAGING



ECO SLEEVE

PLASTIC POUCH

WINDOW BOX

+ INFO PAGES 240 TO 245

EXTERNAL PACKAGING



500 ± 4,3 KG



WRITING MODES



MECHANICAL PENCIL MP

PRINTING TECHNIQUES



SCREEN PRINTING



DIGITAL



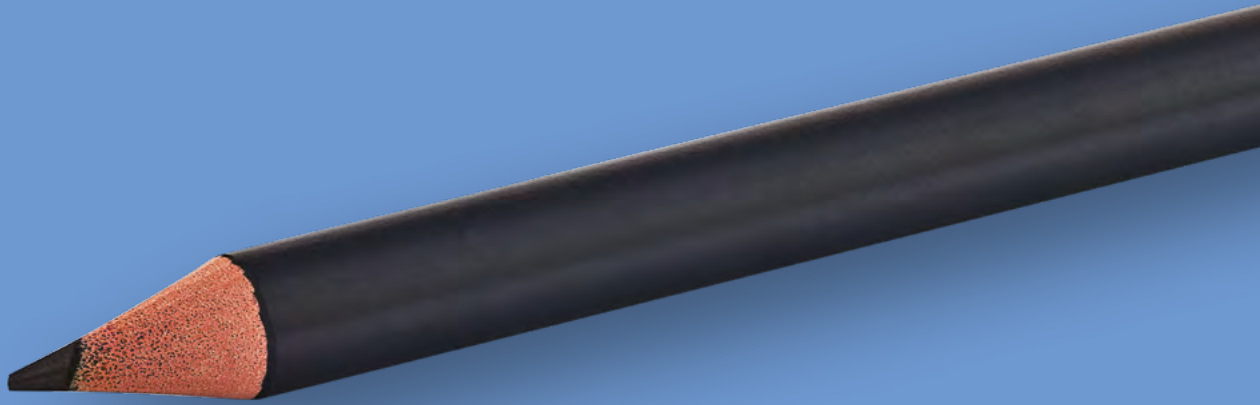

BIC[®] PENCILS

—

A reference since 1993. Wood-free pencil made with recycled synthetic resin material, that will not splinter in the event of breaking. Ultra-resistant HB graphite lead.

EVOLUTION[®] ECOLUTIONS[®]



THE SOLUTION FOR FULL COLOUR COMMUNICATION!



THE SOLUTION FOR FULL COLOUR COMMUNICATION!



Embossed iconic BIC® brand!

ecolutions®



MADE FROM 60% RECYCLED MATERIAL*



FRIDGES AND YOGURT POTS

ecolutions®



MADE FROM 52,7% RECYCLED MATERIAL*



FRIDGES AND YOGURT POTS

GRAPHITE PENCIL CUT END ecolutions® 1150

GRAPHITE PENCIL WITH ERASER ecolutions® 1151



Protective sheath

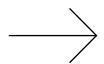

20



02



03



ARROW

100%



100%

360° Printing



20



02



03



COMMUNICATION

100%



100%

360° Printing



*The percentage is calculated based on total weight of the product. Due to the recycled content of the raw materials used to make the product, we cannot guarantee that the colours shown in the catalogue or colours customised to order will always have the same colour and appearance.

ecolutions®
 MADE FROM
 60% RECYCLED MATERIAL*



Add the Möbius loop to your artwork at no additional charge. Please specify it on your order. (Möbius loop imprint defaults to left-hand hand corner.)

GRAPHITE PENCIL

1150/1151

MOQ 500 units
 Standard colours combination



No extra charge

Eraser

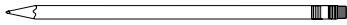

Opaque



Ferrule

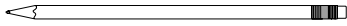

Opaque



Barrel



Opaque

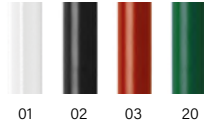

MANUFACTURED AND PRINTED IN BIC FACTORIES



MADE IN FRANCE



REGULATORY COMPLIANCE



ecolutions®



RECYCLABLE



RESISTANT TIP



NO SPLINTER



PROTECTIVE SHEATH



EASY TO USE AND ERASE

WRITING MODES



PENCIL PC HB
 Ø 2,3MM

PRINTING TECHNIQUES



SCREEN PRINTING



DIGITAL

See page 250 for a detailed explanation of the icons.



Decoration

BIC® EVOLUTION® ECOLUTIONS®
eColutions® 1150 (Pencil cut end)

A SP: max. 1 col.

MOQ 500 units

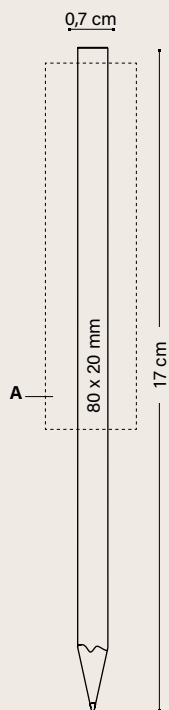

Decoration

BIC® EVOLUTION® ECOLUTIONS®
eColutions® 1151 (Pencil with eraser)

MOQ 500 units

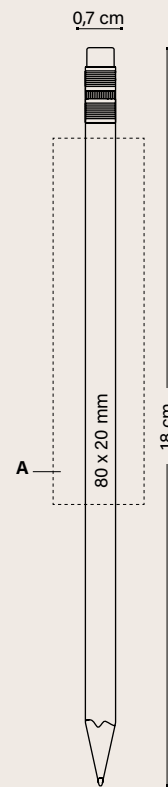

OPTIONAL SPECIAL PACKAGING



PLASTIC
POUCH
(x3 UNITS)

*Now you can
have it as a set!*

+ INFO PAGES 240 TO 245

EXTERNAL PACKAGING



500 ± 3,5 KG

Decoration

BIC® EVOLUTION® ECOLUTIONS®
ecolutions® 1150 (Pencil cut end Digital)

A DG: full-colour (area for images)

MOQ 500 units

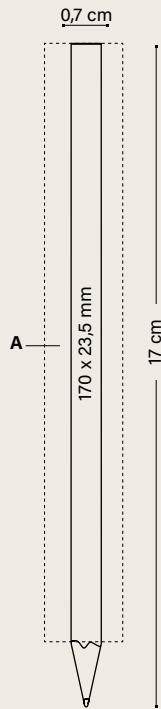

Decoration

BIC® EVOLUTION® ECOLUTIONS®
ecolutions® 1151 (Pencil with eraser Digital)

MOQ 500 units

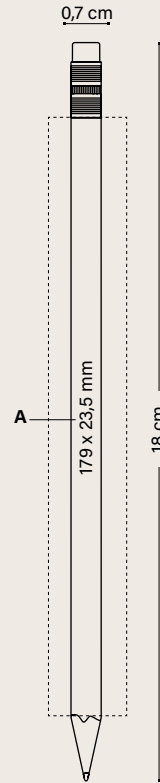

OPTIONAL SPECIAL PACKAGING



PLASTIC
POUCH
(X 3 UNITS)

*Now you can
have it as a set!*

+ INFO PAGES 240 TO 245

EXTERNAL PACKAGING



500 ± 3,5 KG



MANUFACTURED
AND PRINTED IN
BIC FACTORIES



MADE IN FRANCE



REGULATORY
COMPLIANCE



FRIGIDES AND
YOGURT POTS



RECYCLABLE



RESISTANT TIP



NO
SPLINTER



PROTECTIVE
SHEATH



EASY TO
USE AND ERASE

**WRITING
MODES**



PENCIL **PC** HB
Ø 2,3MM

**PRINTING
TECHNIQUES**



SCREEN PRINTING



DIGITAL

See page 250 for a detailed explanation of the icons.

SPROUT™ GRAPHITE PENCIL



This pen enables you to convey a meaningful message and sets the foundation for a lasting relationship. The sustainable pencil that you can plant after use and grow into herbs, vegetables or flowers.

SPROUT™ GRAPHITE PENCIL
53062

With seeds
→



Standard barrel

Customised barrels

Standard cardboard!



Standard cardboard packaging

Customisable cardboard!

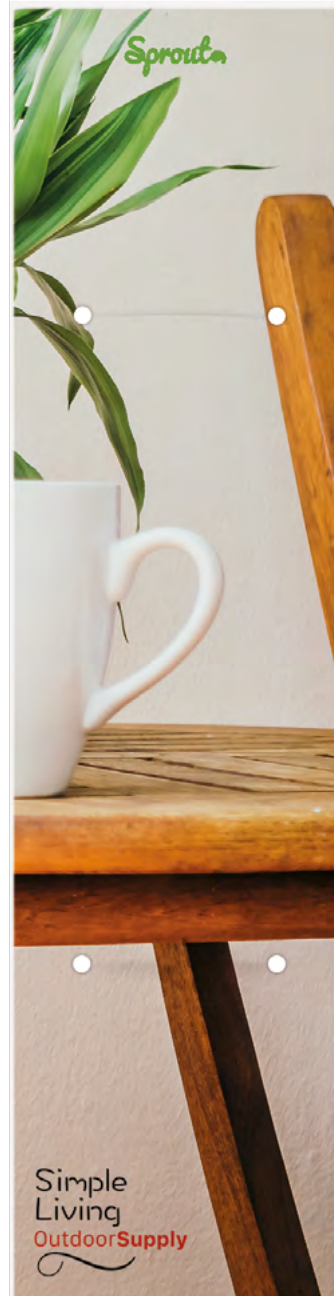

Personalised cardboard packaging



Rear side



Graphite Lead

Once the pencil is too short to write with, plant the stub and watch your message turn into a pot of beautiful herbs, flowers or vegetables.

Choose between 8 different seeds!

- | | |
|------------------|------------------|
| 1. Spruce | 5. Basil |
| 2. Sunflower | 6. Thyme |
| 3. Daisy | 7. Sage |
| 4. Forget me not | 8. Cherry tomato |

Decoration

SPROUT™ GRAPHITE PENCIL
53062

A LE
B DG

MOQ 100 units

Pencil sharpening is offered at an extra charge

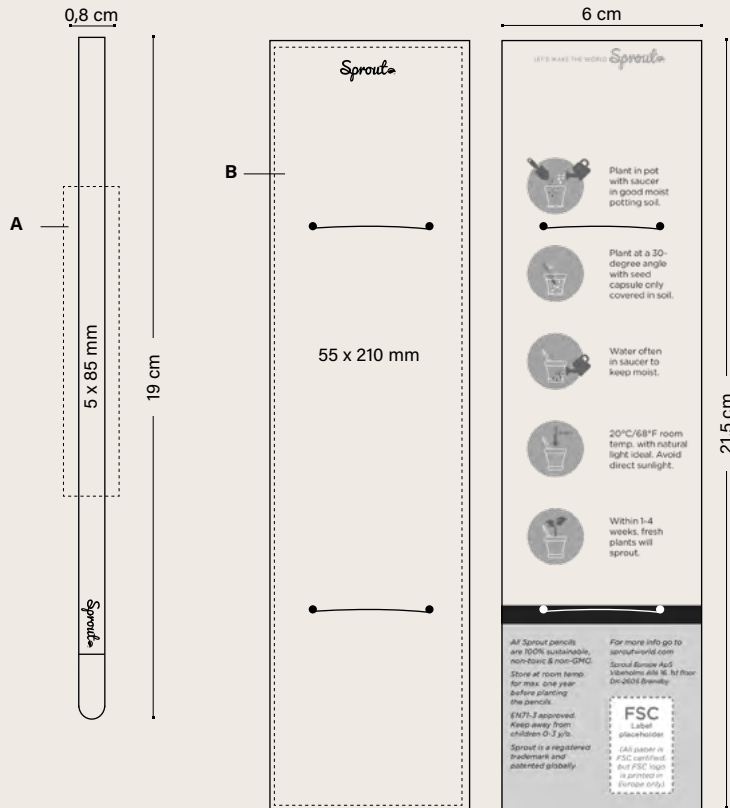

Planting instructions included on the rear side. For customised cardboard, you can change the font and colours!

EXTERNAL PACKAGING



500 ± 2,5 KG (ONLY PENCIL)
± 5 KG (WITH CARDBOARD PACKAGING)

PACKAGING



Sprout



FSC AND
RECYCLABLE CARDBOARD



RECYCLABLE

WRITING MODES



PENCIL PC HB
0,2,3MM

PRINTING TECHNIQUES



LASER



DIGITAL



CHECK OUT THE VIDEO

See page 250 for a detailed explanation of the icons.

Contents

02

OTHER WRITING INSTRUMENTS

PLASTIC PENS

Basic Pen	182
Click Pen	184
Striped Grip Pen	186

STYLUS PENS

Sleek Stylus Pen	188
------------------	-----

BASIC PEN

BASIC PEN

12010

Colour ink



Decoration

BASIC PEN

12010

A/B SP: max. 1 col.

MOQ 500 units

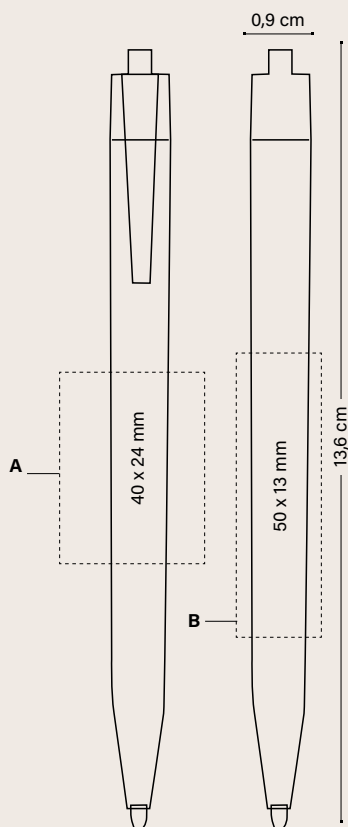

EXTERNAL PACKAGING



1000 ± 12,5 KG



PRINTED IN
BIC FACTORIES



QUALITY & SAFETY
APPROVED



REGULATORY
COMPLIANCE



ISO
certified



IMPRIM'VERT®

WRITING
MODES



BALLPEN M
Ø 1 MM

PRINTING
TECHNIQUES



SCREEN PRINTING

See page 250 for a detailed explanation of the icons.

CLICK PEN

CLICK PEN

11748

Colour ink



Decoration

CLICK PEN

11748

A/B SP: max. 4 col.
C/D PD: max. 4 col.

MOQ 500 units

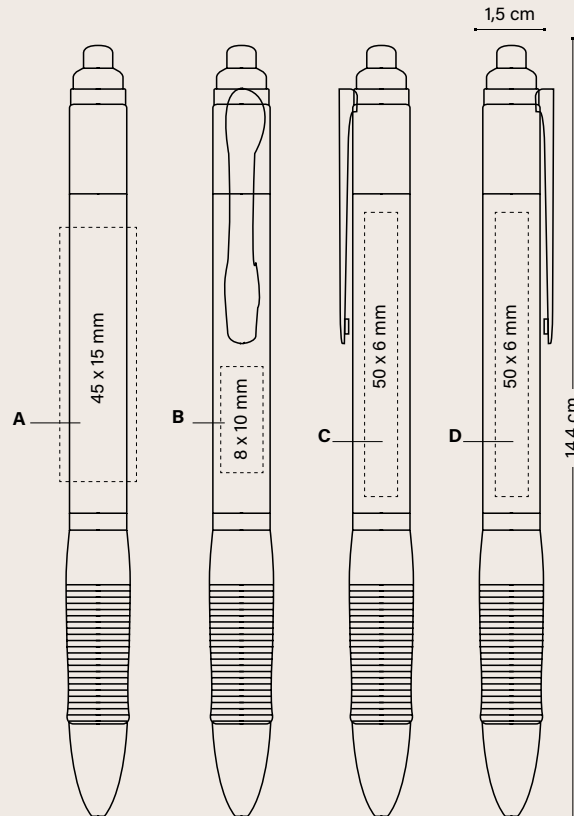

EXTERNAL PACKAGING



WRITING MODES



PRINTING TECHNIQUES



See page 250 for a detailed explanation of the icons.

STRIPED GRIP PEN

STRIPED GRIP PEN

11243

Colour ink



10



03



24



8C



04

100%

Decoration

STRIPED GRIP PEN

11243

A SP: max. 2 col.

B PD: max. 1 col.

MOQ 500 units

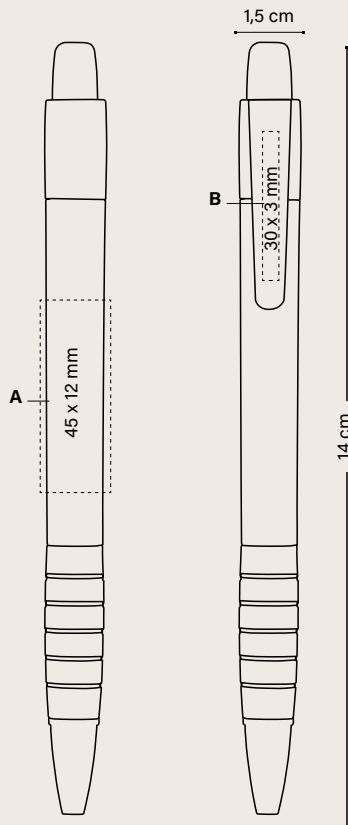

EXTERNAL PACKAGING



WRITING MODES



PRINTING TECHNIQUES



See page 250 for a detailed explanation of the icons.

SLEEK STYLUS PEN

SLEEK STYLUS PEN

11666
Colour ink
●



01

SLEEK STYLUS MATT PEN

11747
Colour ink
●



47



04

SLEEK STYLUS EXECUTIVE PEN

11976



26

●
Available in
blue ink



2N

●
Available in
black ink

Decoration

SLEEK STYLUS PEN

11666

SLEEK STYLUS MATT PEN

11747

SLEEK STYLUS EXECUTIVE PEN

11976

A SP: max. 1 col.

B SP: max. 2 col.

C LE

MOQ 500 units (SP)

MOQ 100 units (LE)

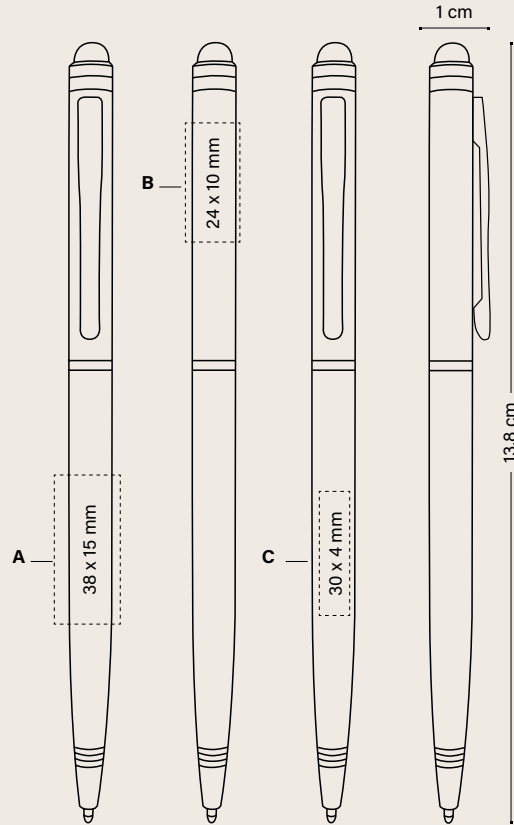

EXTERNAL PACKAGING



(11666)
900 ± 12,4 KG



(11747 / 11976)
800 ± 13 KG



WRITING MODES



BALLPEN M
Ø 1 MM

PRINTING TECHNIQUES



SCREEN PRINTING



LASER

See page 250 for a detailed explanation of the icons.

Contents

03

NOTEBOOKS

ROCKETBOOK®

Rocketbook® Core Executive A5	194
Rocketbook® Fusion Executive A5	196
Rocketbook® Core Mini A6	198



ROCKETBOOK®

Rocketbook® combines the freedom of a traditional pen and paper notebook with its app technology to send handwritten notes quickly and securely to the cloud folder of your choice. It is designed to be the last notebook you'll ever need. Follow the instructions included for a clean page that can be used endlessly. You can choose the Core for taking notes, making graphs and sketching, or go one step further with the Fusion for planning, making lists and setting goals.

ROCKETBOOK® CORE EXECUTIVE A5

ROCKETBOOK® FUSION EXECUTIVE A5

ROCKETBOOK® CORE MINI A6



ROCKETBOOK® CORE EXECUTIVE A5

NEW!

NEW IMPROVED MOQ 25 UNITS!



ROCKETBOOK® CORE EXECUTIVE A5
3728



07
●
Navy Blue



01
○
White



02
●
Black

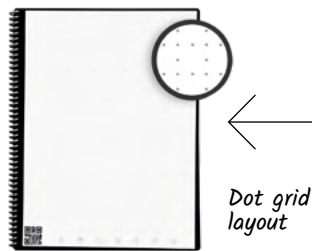
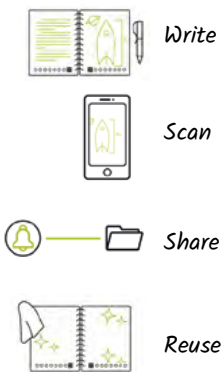

- The box always includes:
- Notebook
 - Pen
 - Cloth
 - Instructions

ROCKETBOOK® FUSION EXECUTIVE A5

NEW!

NEW IMPROVED MOQ 25 UNITS!



ROCKETBOOK® FUSION EXECUTIVE A5
3726



01
○
White



02
●
Black

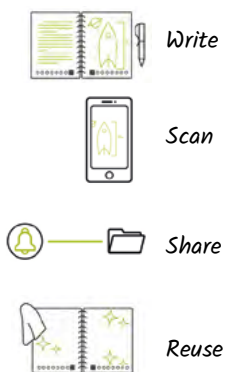

Seven page styles

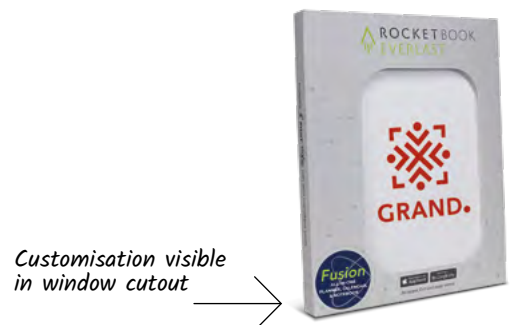
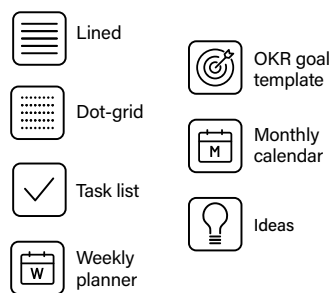

Customisation visible in window cutout

- The box always includes:
- Notebook
 - Pen
 - Cloth
 - Instructions

Decoration

ROCKETBOOK® FUSION EXECUTIVE A5

3726

A SP: max. 1 col.

B BP: full-colour

C HS: max. 1 col.

42 pages

MOQ 25 units

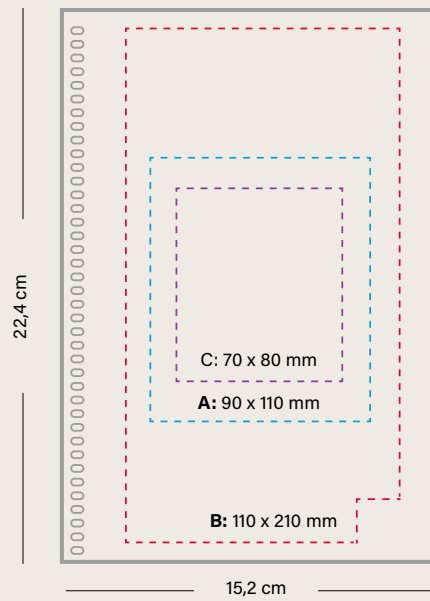

PRINTED
IN BIC
FACTORIES



REGULATORY
COMPLIANCE



IMPRIM'VERT®

ROCKETBOOK®
APP AVAILABLE
IN:



PRINTING
TECHNIQUES



SCREEN PRINTING



BRITEPIX™



HOT STAMPING

SPECIAL PACKAGING ALWAYS INCLUDED



GIFT BOX
FUSION A5

EXTERNAL PACKAGING



50 ± 5,8 KG



DOWNLOAD THE APP



HOW IT WORKS

See page 250 for a detailed explanation of the icons.

ROCKETBOOK® CORE MINI A6

NEW!

NEW IMPROVED MOQ 25 UNITS!



ROCKETBOOK® CORE MINI A6
3727



01
○
White



02
●
Black

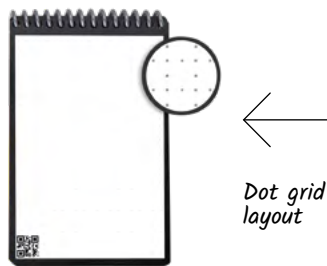
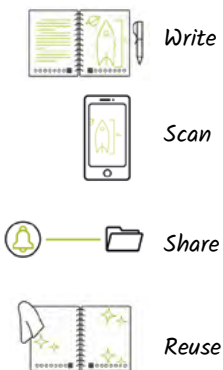

- The box always includes:
- Notebook
 - Pen
 - Cloth
 - Instructions

Decoration

**ROCKETBOOK® CORE
MINI A6**

3727

A SP: max. 1 col.

B BP: full-colour

C HS: max. 1 col.

48 pages

MOQ 25 units

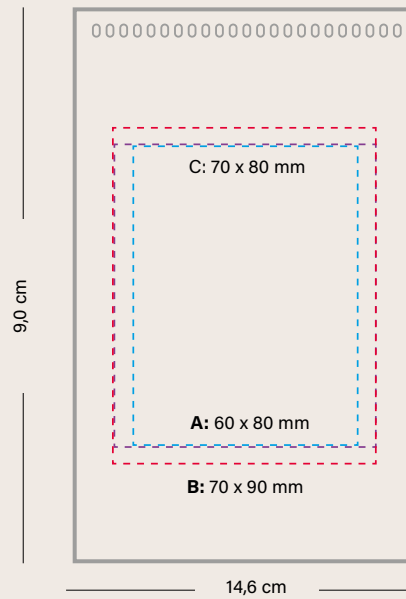

**ROCKETBOOK®
APP AVAILABLE
IN:**



**PRINTING
TECHNIQUES**



SCREEN PRINTING



BRITEPIX™



HOT STAMPING

SPECIAL PACKAGING ALWAYS INCLUDED



GIFT BOX
CORE A6

EXTERNAL PACKAGING



50 ± 2,6 KG



DOWNLOAD THE APP



HOW IT WORKS

See page 250 for a detailed explanation of the icons.

Contents

04

BIC®/DJEEP® LIGHTERS AND BIC® CASES

BIC® LIGHTERS

BIC® J25 Lighter	206
BIC® J23 Lighter	210
BIC® J26 Lighter	214
BIC® J38 Lighter	218

BIC® LIGHTER CASES

BIC® Styl'it Luxury Case	222
BIC® Aluminium Flat Case	224
BIC® Clip Case	225
BIC® 3D Case	226

OTHER PRODUCTS

BIC® Pocket Ashtray	228
---------------------	-----

DJEEP® LIGHTERS

DJEEP® D1 Lighter	230
-------------------	-----

BIC® lighters. Our quality, your safety.

All BIC® pocket lighters meet or exceed international standards and regulations requirements (ISO 9994, EN 13869, ASTM F400, US CPSC).
Don't risk it, buy BIC®!



BIC® is number one
worldwide for
branded lighters.



100% of pocket lighters are manufactured
by BIC in Europe. All BIC® Pocket Lighters
are made in BIC® factories.
This is the starting block of the BIC® lighter
safety guarantee.

50 YEARS

BIC® has acquired 50 years
of incredible manufacturing expertise to
guarantee the safety and quality of its
products.

50 CHECKS

Before leaving the factory, every BIC®
Lighter undergoes more than 50
automatic quality and security checks.

CHOOSE WISELY! BIC® Pocket Lighters



BIC® J25
Digital lighter

UP TO
1450



BIC® J23
Digital lighter

UP TO
1800



BIC® J26
Digital lighter

UP TO
3000



BIC® J38
Digital lighter

UP TO
1800

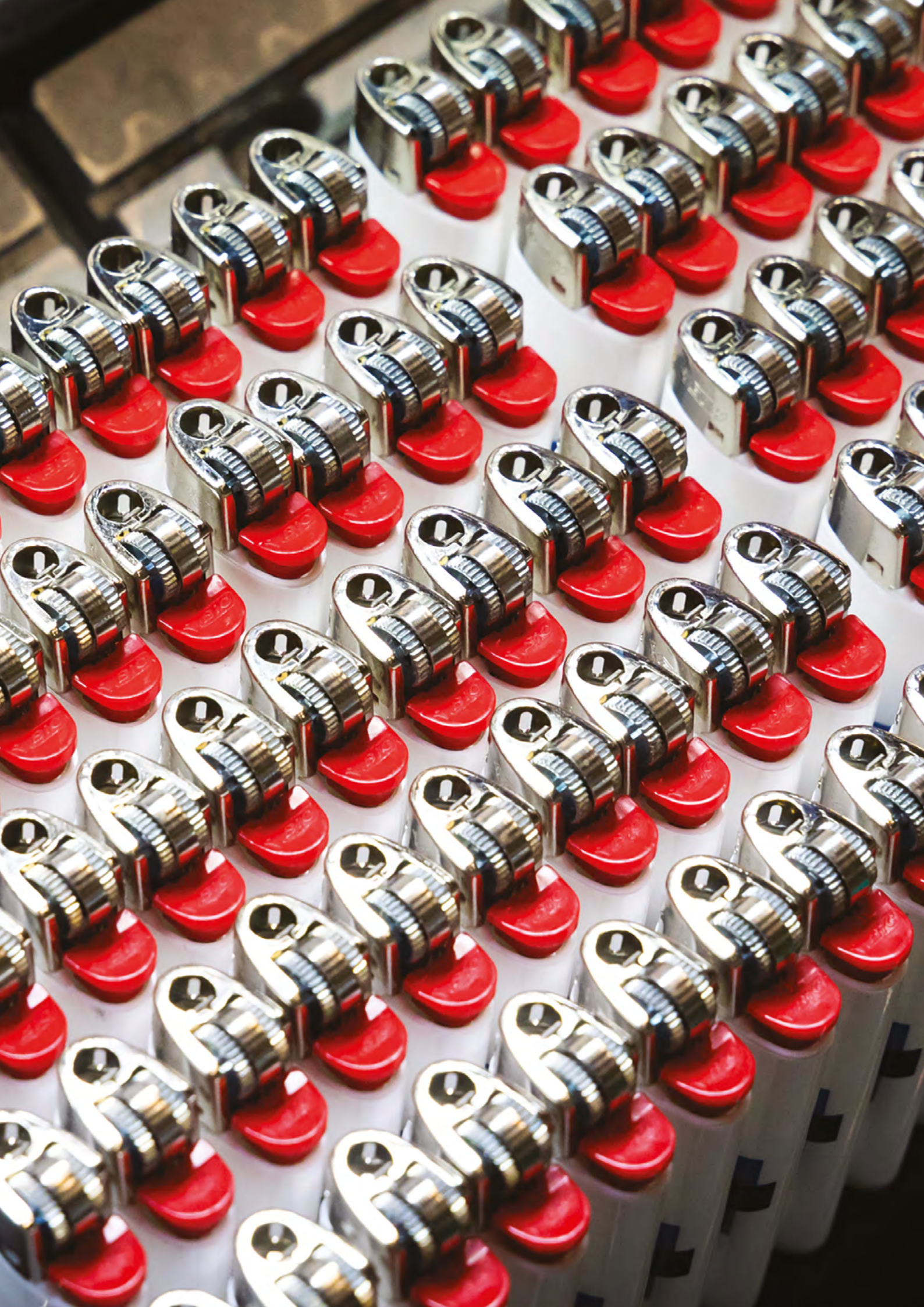



BIC® LIGHTERS

The iconic, well-loved and time-honoured shapes of BIC® pocket lighters remain on trend!
Four different sizes and a wide range of colour combinations.

BIC® J25 LIGHTER

BIC® J23 LIGHTER

BIC® J26 LIGHTER

BIC® J38 LIGHTER

BIC® STYL'IT LUXURY CASE

BIC® ALUMINIUM FLAT CASE

BIC® CLIP CASE

BIC® 3D CASE

BIC® POCKET ASHTRAY



BIC® J25 LIGHTER

Perfect for your pocket!



Iconic BIC® Boy and BIC® logo engraved!

BIC® J25 LIGHTER

2360

2364 All Black



01

57

57

8G

03

11

59

24

04



25

25

6W

90

02

02

02

02

100%

Decoration

BIC® J25 LIGHTER

2360/2364

A/C SP: max. 4 col.

MOQ 300 units



BIC® J25 LIGHTER BRIPEPIX™

2360 / 2364

A/C BP: full-colour

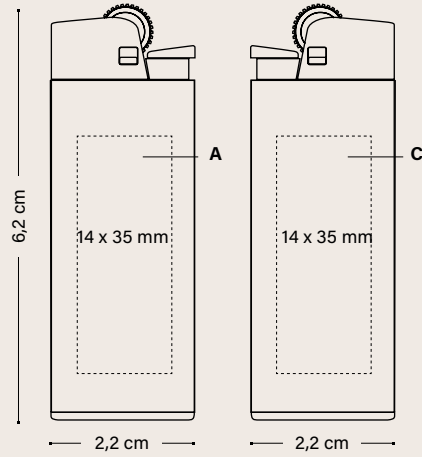
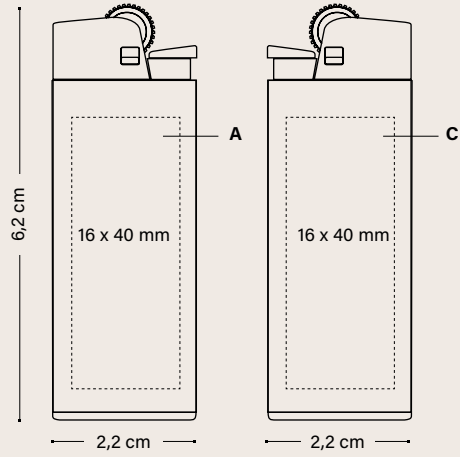

PACKAGING



100% recycled!

STANDARD PACKAGING:
IN TRAY OF 50 UNITS

EXTERNAL PACKAGING



600 ± 7,6 KG



FSC AND
RECYCLABLE
CARDBOARD



MANUFACTURED
AND PRINTED
IN BIC FACTORIES



MADE IN SPAIN



PASTEL
MADE IN FRANCE



REGULATORY COMPLIANCE



UP TO 1.450



100% OF ELECTRICITY
PRODUCED USING
RENEWABLE SOURCES

**PRINTING
TECHNIQUES**



SCREEN PRINTING



BRIPEPIX™

See page 250 for a detailed explanation of the icons.

DIGITAL FINISHES



BR BRILLIANT



MT MATT

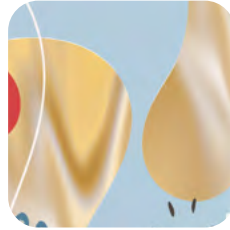

H HOLOGRAPHIC



P PUFFY



M METALLIC



UV UV



PG PUFFY GLITTER

BIC® J25 DIGITAL LIGHTER 2360



MT MATT

P PUFFY



PG PUFFY GLITTER



MT MATT

M METALLIC

Decoration

BIC® J25 DIGITAL LIGHTER

2360

A DG: full-colour

MOQ 600 units

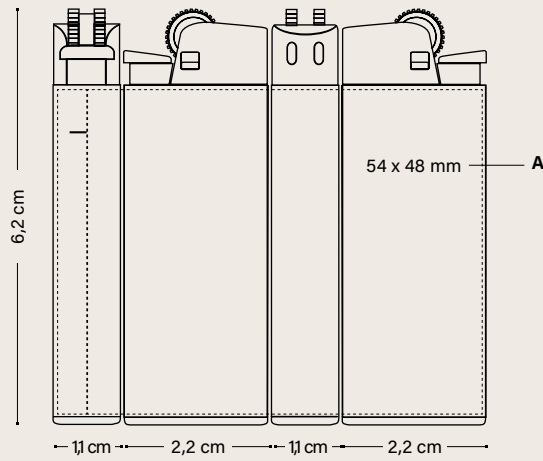

MANUFACTURED AND PRINTED IN BIC FACTORIES



MADE IN SPAIN



PASTEL
MADE IN FRANCE



REGULATORY COMPLIANCE



UP TO 1.450

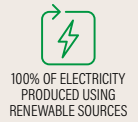

PRINTING TECHNIQUES



PACKAGING



STANDARD PACKAGING:
IN TRAY OF 50 UNITS

100% recycled!



EXTERNAL PACKAGING



600 ± 7,6 KG



FSC AND RECYCLABLE CARDBOARD

See page 250 for a detailed explanation of the icons.

BIC® J23 LIGHTER



Iconic BIC® Boy
and BIC® logo
engraved!

BIC® J23 LIGHTER 2340



57



12



03



10

*Slim and fits
everywhere!*



05



04



25



02

Decoration

BIC® J23 LIGHTER

2340

A/C SP: max. 4 col.

MOQ 300 units

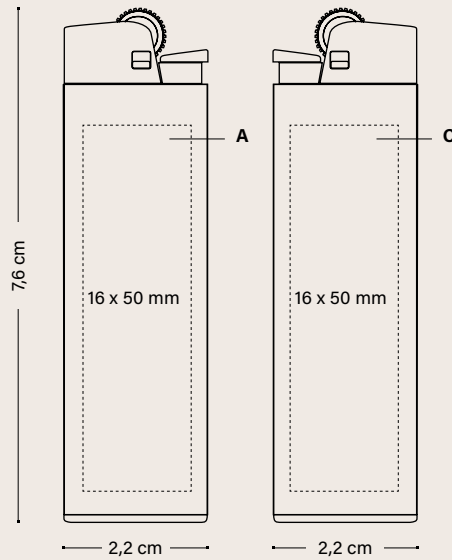

PACKAGING



100% recycled!

STANDARD PACKAGING:
IN TRAY OF 50 UNITS

EXTERNAL PACKAGING



600 ± 9,5 KG



FSC AND
RECYCLABLE
CARDBOARD



MANUFACTURED
AND PRINTED
IN BIC FACTORIES



MADE IN FRANCE



REGULATORY
COMPLIANCE



UP TO 1.800



PRINTING
TECHNIQUES



SCREEN PRINTING

See page 250 for a detailed explanation of the icons.

DIGITAL FINISHES



BR BRILLIANT



MT MATT

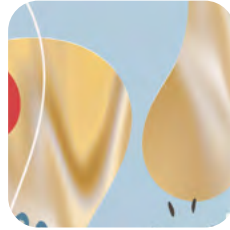

H HOLOGRAPHIC



P PUFFY



M METALLIC



UV UV



PG PUFFY GLITTER

BIC® J23 DIGITAL LIGHTER
2340



MT MATT



PG PUFFY GLITTER



BR BRILLIANT

H HOLOGRAPHIC GOLD

Decoration

BIC® J23 DIGITAL LIGHTER

2340

A DG: full-colour

MOQ 600 units

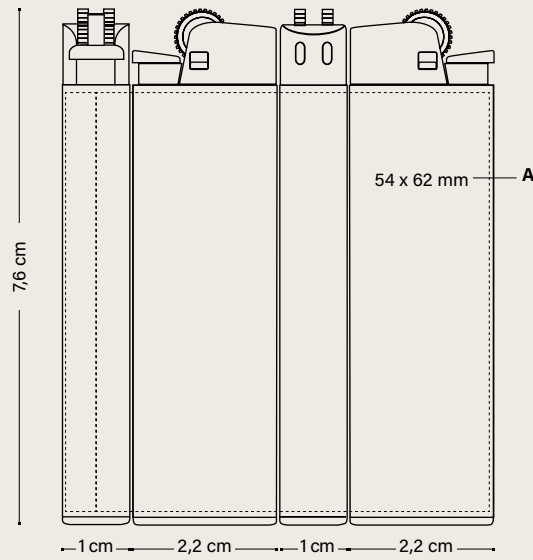

MANUFACTURED
AND PRINTED
IN BIC FACTORIES



MADE IN FRANCE



REGULATORY
COMPLIANCE



UP TO 1.800



PRINTING
TECHNIQUES



DIGITAL

PACKAGING



STANDARD PACKAGING:
IN TRAY OF 50 UNITS

100% recycled!



EXTERNAL PACKAGING



600 ± 9,5 KG



FSC AND
RECYCLABLE
CARDBOARD

See page 250 for a detailed explanation of the icons.

BIC® J26 LIGHTER

The flame that lasts.



Iconic BIC® Boy
and BIC® logo
engraved!

BIC® J26 LIGHTER
2320



01



57



8G



10



6W

Extra long-
lasting: up to
3.000 lights!



59



24



25



02



03

Decoration

BIC® J26 LIGHTER

2320

A/C SP: max. 4 col.

MOQ 300 units

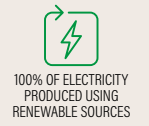
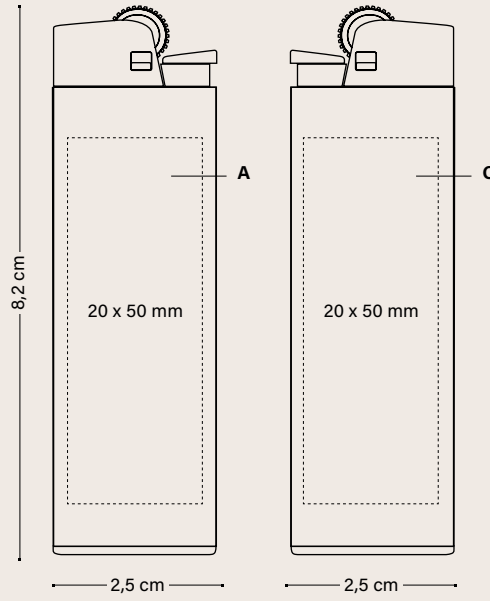

PACKAGING



100% recycled!

EXTERNAL PACKAGING



See page 250 for a detailed explanation of the icons.

DIGITAL FINISHES



BR BRILLIANT



MT MATT

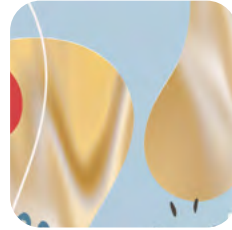

H HOLOGRAPHIC



P PUFFY



M METALLIC



UV UV



PG PUFFY GLITTER

BIC® J26 DIGITAL LIGHTER 2320



MT MATT



BR BRILLIANT



360°
Printing

MT MATT

100%

H HOLOGRAPHIC
SILVER

Decoration

BIC® J26 DIGITAL LIGHTER

2320

A DG: full-colour

MOQ 600 units

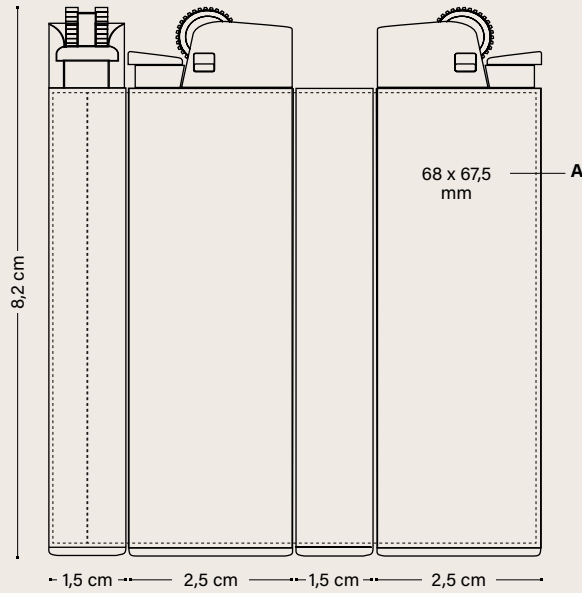

MANUFACTURED AND PRINTED IN BIC FACTORIES



MADE IN SPAIN



REGULATORY COMPLIANCE



UP TO 3.000

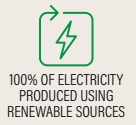

PRINTING TECHNIQUES



DIGITAL

PACKAGING



STANDARD PACKAGING:
IN TRAY OF 50 UNITS

100% recycled!



EXTERNAL PACKAGING



600 ± 15,1 KG



FSC AND RECYCLABLE CARDBOARD

See page 250 for a detailed explanation of the icons.

BIC® J38 LIGHTER



*Iconic BIC® Boy
and BIC® logo
engraved!*

BIC® J38 LIGHTER 2452



57



25



02



03

100%

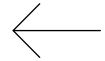

*Elegant and
comfortable
lighting!*

Decoration

BIC® J38 LIGHTER

2452

A/C SP: max. 4 col.

MOQ 300 units

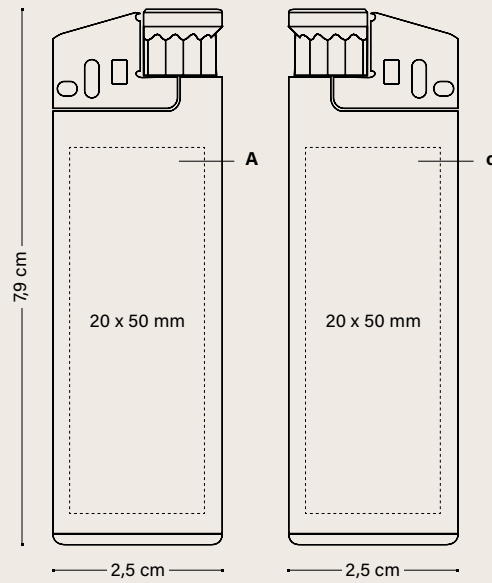

MANUFACTURED AND PRINTED IN BIC FACTORIES



MADE IN SPAIN



REGULATORY COMPLIANCE



UP TO 1.800

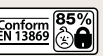

100% OF ELECTRICITY PRODUCED USING RENEWABLE SOURCES

PRINTING TECHNIQUES



SCREEN PRINTING

PACKAGING



STANDARD PACKAGING: IN TRAY OF 50 UNITS

100% recycled!

EXTERNAL PACKAGING



600 ± 13,2 KG



FSC AND RECYCLABLE CARDBOARD

See page 250 for a detailed explanation of the icons.

FINISHES



BR BRILLIANT



MT MATT

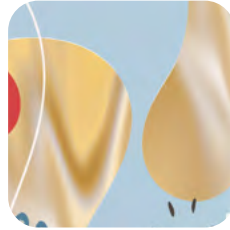

H HOLOGRAPHIC



P PUFFY



M METALLIC



UV UV



PG PUFFY GLITTER

BIC® J38 DIGITAL LIGHTER
2452



57

BR BRILLIANT



57

MT MATT



57

MT MATT

H HOLOGRAPHIC GOLD

360°
Printing

100%

Decoration

BIC® J38 DIGITAL LIGHTER

2452

A DG: full-colour

MOQ 600 units

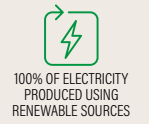
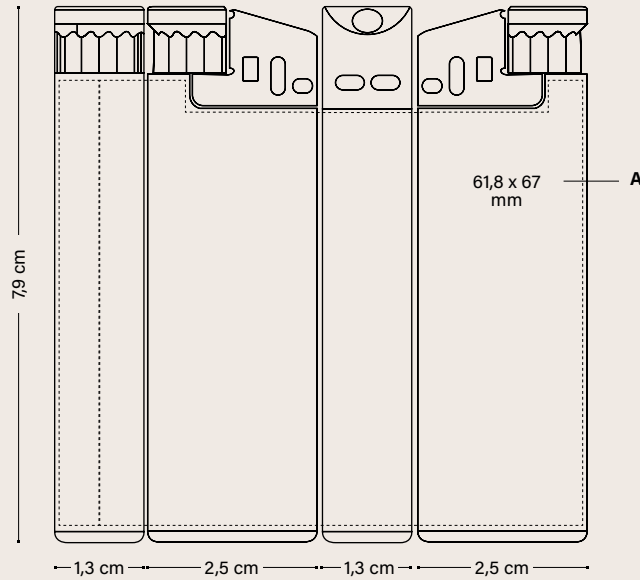

PRINTING TECHNIQUES



PACKAGING



100% recycled!

EXTERNAL PACKAGING



600 ± 13,2 KG



See page 250 for a detailed explanation of the icons.

BIC® STYL'IT LUXURY CASE

BIC® STYL'IT LUXURY CASE 2386 Neon



All cases are delivered with a white BIC® 12S lighter!



59



1G



5C

100%

Decoration

BIC® STYL'IT LUXURY CASE 2386

MOQ 100 units
A/C LE

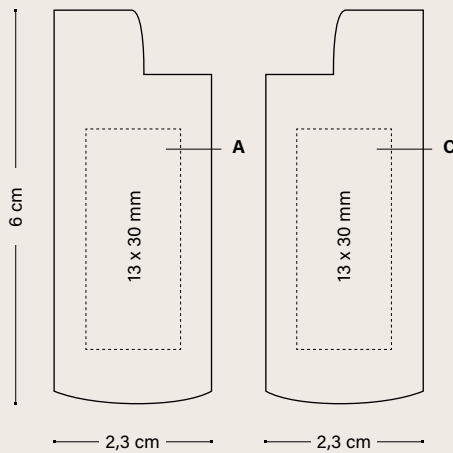

MOQ 100 units
A/C PD

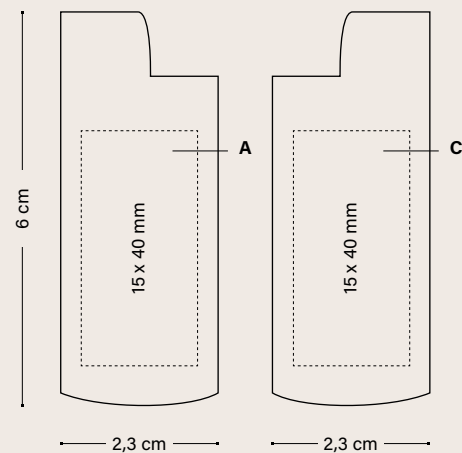

PACKAGING



STANDARD PACKAGING:
BOX FOR 10 UNITS

EXTERNAL PACKAGING



300 ± 6,1 KG



FSC AND
RECYCLABLE
CARDBOARD



PRINTED IN BIC
FACTORIES



REGULATORY
COMPLIANCE



PRINTING TECHNIQUES



PAD PRINTING



LASER

BIC® STYL'IT LUXURY CASE
2153 Soft



All cases are delivered with a white BIC® J25 lighter!



47

Decoration

BIC® STYL'IT LUXURY CASE

2153

A/C LE

MOQ 100 units

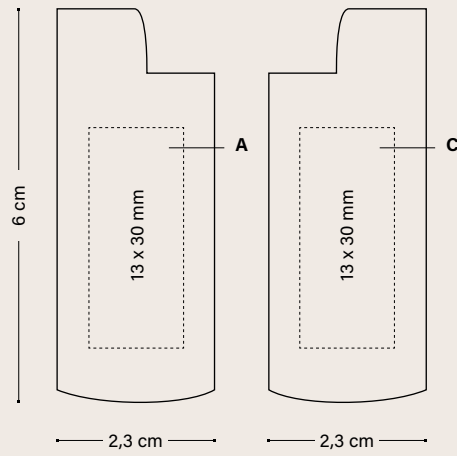

PACKAGING



STANDARD PACKAGING:
BOX FOR 10 UNITS

EXTERNAL PACKAGING



300 ± 6,1 KG



FSC AND
RECYCLABLE
CARDBOARD



PRINTED IN BIC
FACTORIES



REGULATORY
COMPLIANCE



PRINTING TECHNIQUES



LASER

BIC® ALUMINIUM FLAT CASE

BIC® ALUMINIUM FLAT CASE 2156

3 customisable sides!



All cases are delivered with a white BIC® J25 lighter!



47

Decoration

BIC® ALUMINIUM FLAT CASE 2156

MOQ 100 units
A/C PD: max. 1 col.

MOQ 100 units
A/B/C BP: full-colour

MOQ 100 units
A/B/C LE

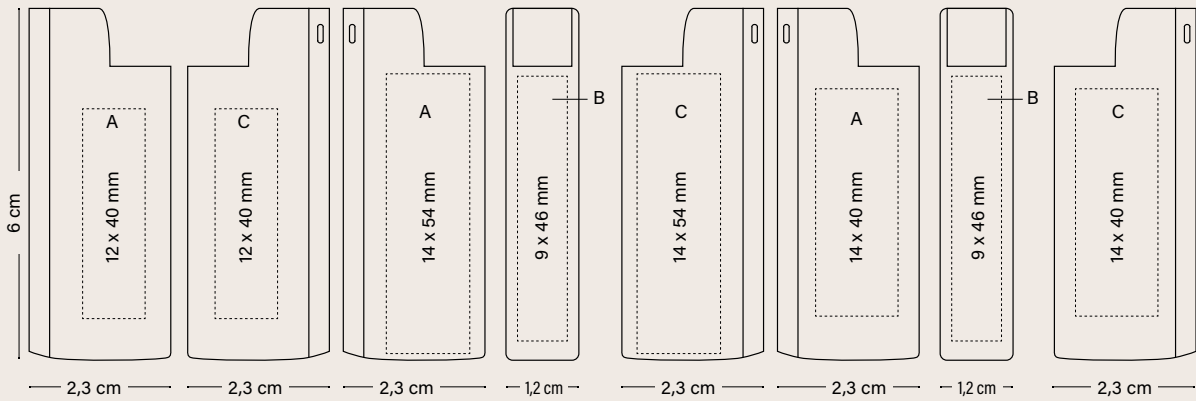

PACKAGING



STANDARD PACKAGING:
BOX FOR 50 UNITS

EXTERNAL PACKAGING



300 ± 6,9 KG



FSC AND
RECYCLABLE
CARDBOARD



PRINTED IN
BIC FACTORIES



REGULATORY
COMPLIANCE



PRINTING TECHNIQUES



PAD PRINTING



LASER



BRITEPIX™
BRITEPIX™ PERSONALISATION

BIC® CLIP CASE 2398



All cases are delivered with a white BIC® J25 lighter!



03



02

100%



Decoration

BIC® CLIP CASE 2398

MOQ 100 units
A/C PD: max. 1 col.

MOQ 100 units
A/C BP: full-colour
BP Texture: full-colour

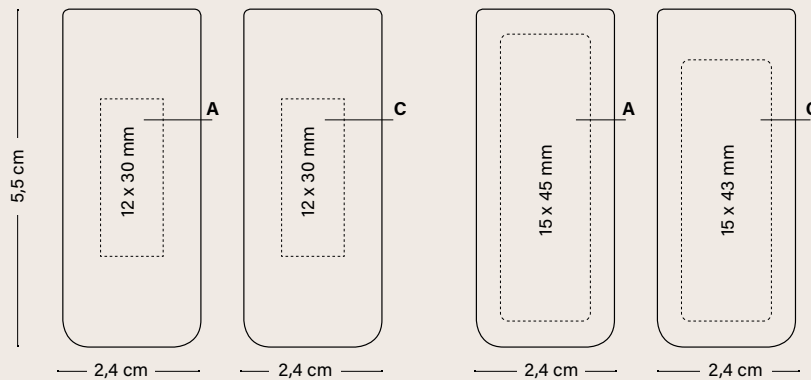

PACKAGING



STANDARD PACKAGING:
BOX FOR 50 UNITS

EXTERNAL PACKAGING



300 ± 7,5 KG



FSC AND
RECYCLABLE
CARDBOARD

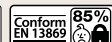

PRINTING TECHNIQUES

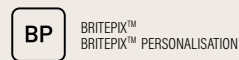

BIC® 3D CASE 2395



Decoration

BIC® 3D CASE

2395

A/C 3D: max. 6 col.

MOQ 1.200 units

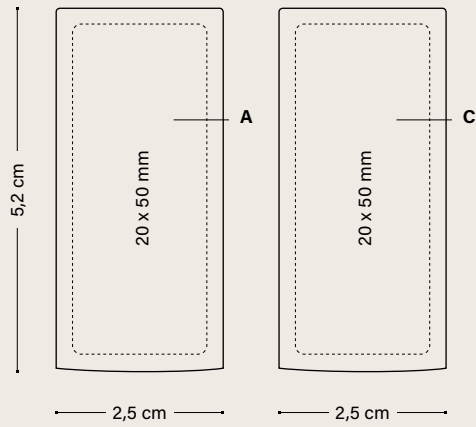

PACKAGING



STANDARD PACKAGING:
BOX FOR 50 UNITS

EXTERNAL PACKAGING



300 ± 7,5 KG



FSC AND
RECYCLABLE
CARDBOARD



REGULATORY
COMPLIANCE

Conform
ISO 9994



PRINTING
TECHNIQUES

3D

EMBOSSING

See page 250 for a detailed explanation of the icons.

BIC® POCKET ASHTRAY

BIC® POCKET ASHTRAY
3850

*6 different
flap shapes
available!*

*Reusable and
hermetic!*



Decoration

BIC® POCKET ASHTRAY
3850

A SP: max. 5 col. (max. 2 col.
for orders under 20.000 pcs.)

MOQ 5.000 units

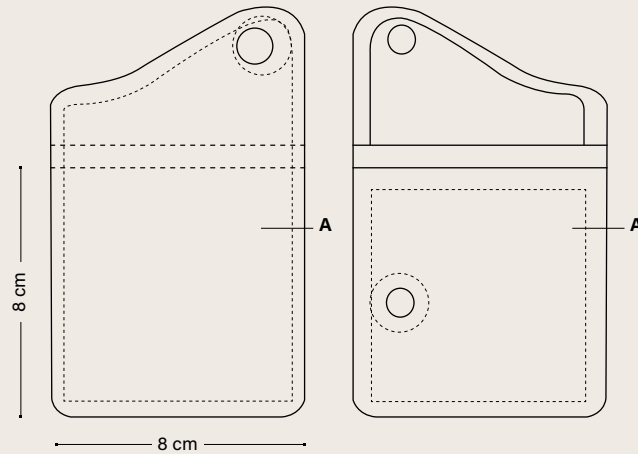

PACKAGING



BOX FOR 10 UNITS EACH
BIC® POCKET ASHTRAY
COMES IN AN INDIVIDUAL
CELLOPHANE PACKAGING

EXTERNAL PACKAGING



500 ± 5,5 KG

SPECIFICATIONS



REGULATORY
COMPLIANCE

PRINTING TECHNIQUES



SCREEN PRINTING

BIC® POCKET ASHTRAY
3851 Kraft

Environmentally friendly image



100%

6F

Decoration

BIC® POCKET ASHTRAY KRAFT

3851 Kraft

A SP: max. 2 col.

MOQ 10.000 units

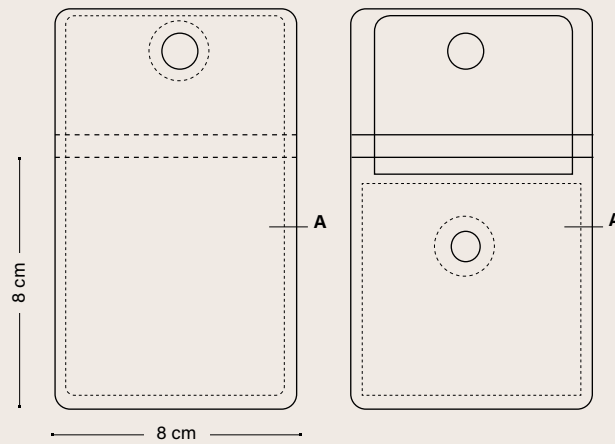

PACKAGING



BOX FOR 10 UNITS EACH BIC® POCKET ASHTRAY COMES IN AN INDIVIDUAL CELLOPHANE PACKAGING.

EXTERNAL PACKAGING



500 ± 5,5 KG

SPECIFICATIONS



REGULATORY COMPLIANCE

PRINTING TECHNIQUES



SCREEN PRINTING



DJEEP® LIGHTERS

Long-lasting and designed with style. DJEEP® is crafted to function perfectly. Each lighter is fully tested to ensure it meets our top-quality criteria.

DJEEP® D1 LIGHTER



NEW!



**Ignite your
mark.**

A good flame is reliable and flexible. But this flame shines a light on what you stand for. This flame brings colours to life and shows us the way to a brighter tomorrow. This flame is premium, original, creative and engaged.

ABOUT DJEEP®

We are **premium**

We have a taste for the qualitative, the authentic, the iconic. And so, we value long life and quality. That's why we offer up to 3500 flames.

We are **singular**

We have our own philosophy and our own vision of the energy of life. We stand firm on our conviction to stand out. That's why we have a unique tank shape.



We are **engaged**

We support everyone that moves for the greater good and triggers its energy with positivity and unicity. That's why we pledge to be accessible and inclusive.

We are **creative**

Triggering energy to create movement is about being an adventurer, to keep searching for new horizons, to always cast a new light on what is around us. That's why we shape a large collection of distinctive decors with different printing finishes.

DJEEP® D1 LIGHTER

Long-lasting and designed with style. DJEEP® is crafted to function perfectly. Each lighter is fully tested to ensure it meets our top-quality criteria.



STABLE FLAME
thanks to pure isobutane fuel



A LONG-LASTING LIGHTER
thanks to triple-tank technology



HIGH RESISTANCE
reservoir made of high mechanical resistance resin



LARGER PUSHER
for a better comfort of use



HIGH-END EFFECTS
QUALITY MADE
compliant with international safety standards
Made in France



UNIQUE RECTANGULAR SHAPE
to offer comfort in hand and a large surface of expression

CHILD-RESISTANT SAFETY GUARD
compliant with EN 13869 Standard



NEW!

360° Digital Decoration

DJEEP® offers a wide variety of digital printing effects; select from touch & feel, glossy & matt mix, etched, Holographik®, ... to elevate each lighter.



01. Base. Select between:
 WM WHITE MEDIUM M METALLIC SILVER H HOLOGRAPHIC

03. Finish. Select between:
 G GLOSSY MT MATT ST DJEEP SOFT TOUCH®

02. Printing: We select the best option for you (digital, offset, flexo, silk screen ...) depending on quantity and design options.

04. Decoration options. Select up to 2 different decoration options between: GRANITE, FABRIC, DJEEP® SOFT TOUCH®, RESIN CHIP, TOUCH&FEEL, GLOSSY & MATT MIX, BLACK LIGHT, HAMMERED METAL, GLITTERING, FRAGRANT INK, GLOW IN THE DARK, ETCHED, QR CODE, HOLOGRAPHIK®, PEARLESCENT.

DECORATION POSSIBILITIES



ST

DJEEP® SOFT TOUCH®

Provide a unique smooth sensation!
 Deep tones and a soft surface for an exclusive experience.



GT

GLITTERING

Add a sparkling effect to your design!
 Make your colours vibrant!



HM

HAMMERED METAL

A metallic background with a puffy effect pattern.
 A premium look and feel that stands out!



TF

TOUCH & FEEL

Give an embossed effect to your design!



ET

ETCHED

Gives an etched or engraved effect to the lighter!
Create patterns and convert your idea into an elegant design.



GM

GLOSSY & MATT MIX

Choose this finish to create distinctions between matt or DJEEP® Soft Touch® and the UV varnish that produces vivid colours.



FI

FRAGRANT INK

Rub the label and enjoy the fragrance!
Available fragrances: Mint, Red Fruits, Mojito, Lime and Pineapple.



OR

QR CODE

Redirect your customer to a website, phone number or message. Create interactivity between the lighter and your message!



BL

BLACK LIGHT

Under a black light the fluor colours appear.
You can have light blue, red, green or yellow.



FA

FABRIC

Give it the look and feel of fabric with a relief effect and matt finish!



RC

RESIN CHIP

Add volume to your design!
Give the lighter a third dimension!



GR

GRANITE

Add a granular feel to the lighter!



GD

GLOW IN THE DARK

Expose the DJEEP® lighter to a light bulb or direct sunlight and observe the photoluminescent powder in dark places!



H

HOLOGRAPHIK®

A reflective silvery surface to show high quality and innovation!



PE

PEARLESCENT

Pearly and subtle shine that transmits elegance and delicacy!

DJEEP® D1 LIGHTER
08D1

MOQ 10.000 units
Standard colours combination



**MIX &
MATCH**
No extra charge

Hood

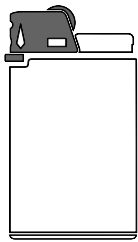

Pusher

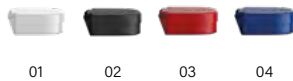
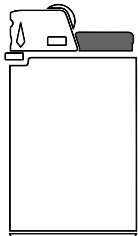

Reservoir

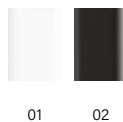
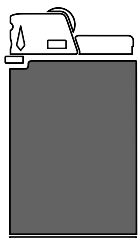

Decoration

DJEEP® D1 LIGHTER

08D1

A DG: full-colour

MOQ 10000 units

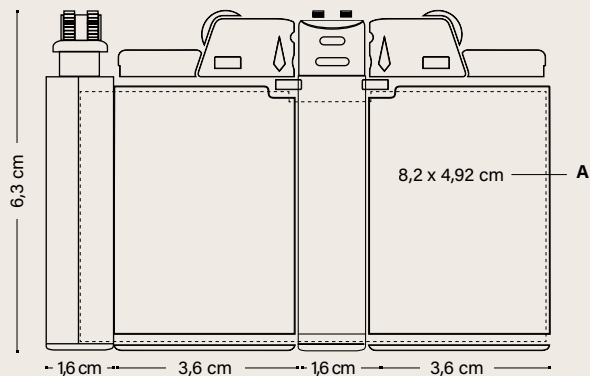

MANUFACTURED AND PRINTED IN DJEEP FACTORIES



MADE IN FRANCE



REGULATORY COMPLIANCE



UP TO 3.500



DJEEP FACTORY POWERED WITH 100% ELECTRICITY COMING FROM RENEWABLE SOURCES

PRINTING TECHNIQUES



DIGITAL

PACKAGING



STANDARD PACKAGING:
IN TRAY OF 10 UNITS

EXTERNAL PACKAGING



600 ± 20 KG



FSC AND RECYCLABLE CARDBOARD

Contents

05

BIC® PACKAGING

BIC® Packaging Ecolutions®	240
BIC® Packaging	242

BIC® PACKAGING ECOLUTIONS®



BIC® COLLECTION BOX

FSC cardboard box, customisable on each side and offering large communication surfaces. Ideal for offering our iconic BIC® products as a collection. More than a box, a great way to optimise your sales.

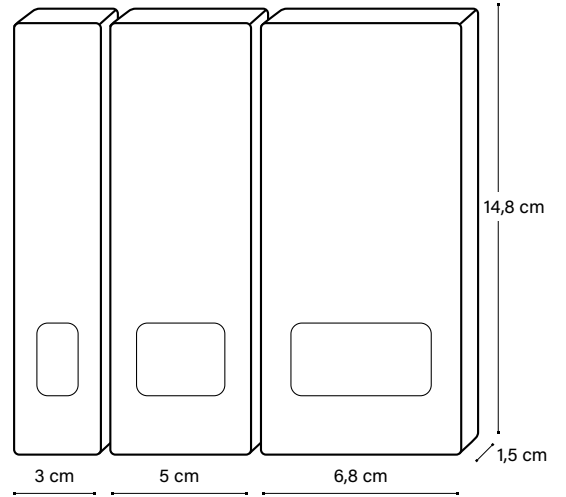

Special packaging for:



- BIC® 4 COLOURS®**
- BIC® WIDE BODY™**
- BIC® SUPER CLIP**
- BIC® BRITE LINER® GRIP**
- BIC® GRIP ROLLER**



FSC AND RECYCLABLE CARDBOARD

BIC® ECO SLEEVE

985240

Special recycled sleeve for all BIC® writing instruments except graphite pencils.



RECYCLED CARDBOARD



Special packaging for pens with clip printed:



- BIC® MEDIA CLIC**
- BIC® CLIC STIC**
- BIC® SUPER CLIP**
- BIC® WIDE BODY™**
- BIC® INTENSITY® GEL CLIC**
- BIC® XS FINE STYLE**

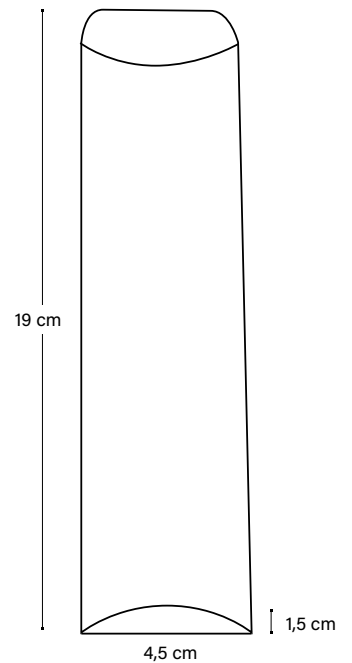

BIC® WINDOW BOX

985241

Premium design packaging for all BIC® writing instruments except graphite pencils.



FSC AND RECYCLABLE CARDBOARD

2,2 cm

2,2 cm

18,7 cm

Special packaging for:



BIC® METAL PENS

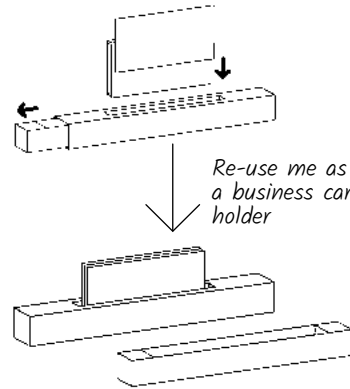

Re-use me as a business card holder

BIC® PLASTIC POUCH

985242

Special design for this packaging which fits any writing instrument or 3 graphite pencils.



FSC AND RECYCLABLE CARDBOARD



RECYCLABLE PLASTIC



Use me as a bookmark



19,6 cm

4,6 cm

BIC® MARKING SET

985243

Packaging designed for all types of marker products.



FSC AND RECYCLABLE CARDBOARD



RECYCLABLE PLASTIC



16 cm

6,3 cm

Special packaging for:



3 BIC® BRITE LINER® GRIP
3 BIC® MARK-IT



3 BIC® VELLEDA® GRIP
3 BIC® VELLEDA® FINE

Use me as a bookmark



MADE IN SPAIN



REGULATORY COMPLIANCE



ISO certified

ecolutions®

BIC® CELLO WRAP

971634 / 971635 / 971636 / 971637

Packaging to wrap in a tough and transparent plastic material.



Cello wrap 1 unit



Cello wrap 2 units

BIC® BLACK VELVET POUCH 1 ITEM

974216

Velvet exclusive packaging for 1 writing instrument.

Especially suitable for metal pens.

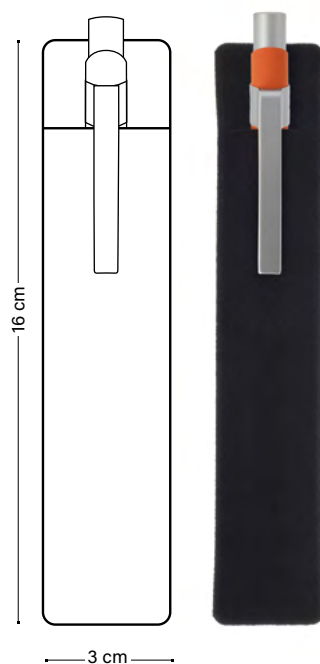

**BIC® CARTON BLACK&SILVER
COLOUR GIFT BOX**

974218

Box for all writing instruments, except graphite pencils.

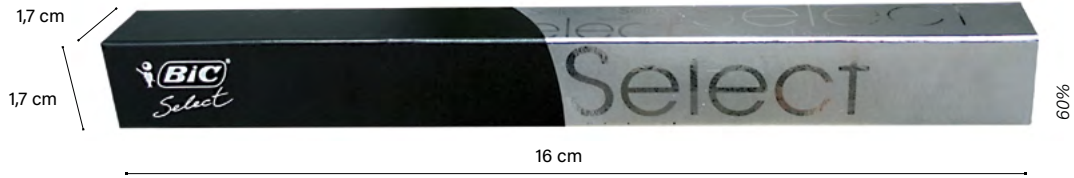

BIC® FROSTED POUCH (FOR 1 OR 2 ITEMS)

971640

Transparent packaging for 2 writing instruments.

A SP: max. 1 col.

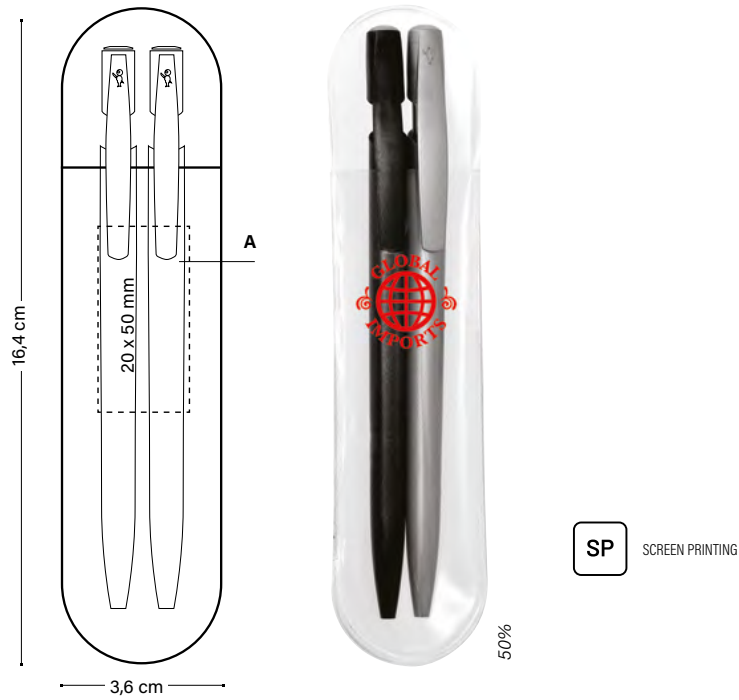

**BIC® SEE-THROUGH GIFT BOX
(FOR 1 OR 2 ITEMS)**

974599

Box for all writing instruments, except graphite pencils,
with special window.

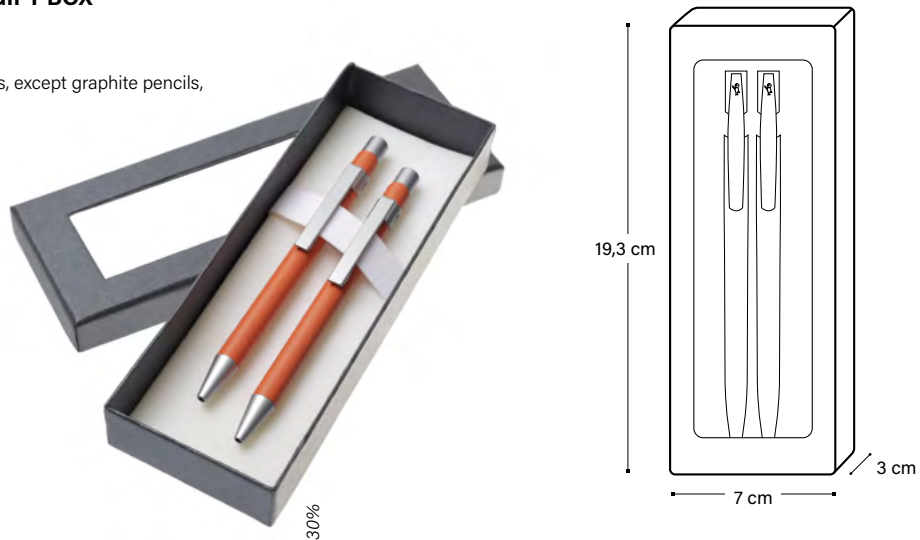

COUNT BOX

Small (for 25 BIC® Clic Stic) - 6 x 6,2 x 14 cm
971639

Medium (for 50 BIC® Media Clic or writing instruments of similar size) - 7,5 x 7,5 x 15,2 cm
971638

Large (only for 100 BIC® Evolution® Ecolutions®) - 7,5 x 7,5 x 19 cm
971672



PLASTIC BAG

Small (for 25 BIC® Media Clic or writing instruments of similar size)
971644 - 12 x 18 cm

Medium (for 50 BIC® Media Clic or writing instruments of similar size)
971643 - 15 x 22 cm

Large (for 100 BIC® Media Clic or writing instruments of similar size)
971642 - 30 x 40 cm



TRAY OF 10 WRITING INSTRUMENTS

974590

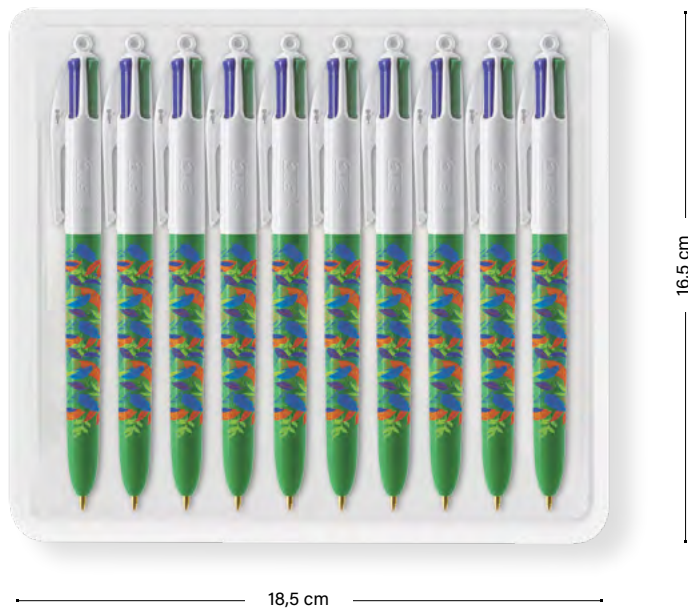

COUNT BOX 10U. CASES
976382



COUNT BOX 10U. CASES CHILD RESISTANT
976403



COUNT BOX 10U. J25 CHILD RESISTANT
974635



BOX OF 50U. METAL STYL'IT CASE
977852



TRAY OF 50 BIC® LIGHTERS



TRAY OF 10 DJEEP® LIGHTERS

RECYCLABLE
CARDBOARD



BIC® OUTER BOXES

Special design for all the outer boxes for all writing instruments.



FSC AND RECYCLABLE CARDBOARD



MADE IN SPAIN



FSC AND RECYCLABLE CARDBOARD



MADE IN SPAIN



FSC AND RECYCLABLE CARDBOARD



MADE IN FRANCE



Contents

GENERAL INFORMATION

Make it simple!	248
Symbols and abbreviations	250
General information	252
Product index	253
Colour table	254

SAVE TIME WHEN CALCULATING YOUR FINAL PRICE

LOOK AT THE QUANTITY COLUMN FOR THE PRICE AND THAT'S IT!

NO SET UP OR SCREEN CHARGES

PERSONALISATION INCLUDED

Price includes personalisation in one position.

CUSTOM MADE COLOURS FOR TRIM

- An "unlimited" choice of barrel and trim colours for orders over 10.000 units.
- A completely personalised pen in any colour you want.
- Available on an extensive range of products.
- A value added service with only a short additional lead time.
- Available for barrel and trims of: BIC® Round Stic®, BIC® Media Clic, BIC® Media Clic Grip*, BIC® Clic Stic, BIC® Super Clip, BIC® Wide Body™, BIC® XS Finestyle

*For personalised barrel and grip MOQ is 20.000 units

Set up charge per trim

Set up charge per trim (repeat orders)

Set up charge per trim from 100.000 units

OTHER CHARGES

PRE-PRODUCTION ORDER (TRANSPORT NOT INCLUDED)

- › Available for BIC® Writing Instruments (10 units), BIC® Lighters (10 units)
- › Ink cartridge change when available (handling charge, cartridge not included)
- › Cancellations or changes to orders after artwork approval (Subject to BIC GRAPHIC EUROPE, S.A. acceptance).
- › Fixed cost per change (extra costs such as tooling, components or finished product to be added)
- › britePix™ individual personalisation

OTHER CHARGES

*Not available for digital lighters with Puffy, Puffy Glitter, Metallic, Holographic and UV finishes.

**britePix™ individual personalisation allows you to change the texts and images of your artwork, giving you a personalised imprint for each of the products in your order. Both texts and information regarding image changes should be provided in an Excel file. Should you also require changes in the positioning of the texts and images there will be an additional charge.

Terms and conditions of sale apply, please refer to www.bicgraphic.com

FILE INFORMATION

Please submit your artwork in one of the following formats:

- Electronic file with the graphic design (artwork).
- Separate file for the text. For individual laser engraving please provide texts only in Excel® format (.xls)

ARTWORKS FEATURES

Please submit your artwork in one of the following formats:

- JPG / 350 dpi not compressed (only for images, no texts)
- PDF / outlined
- Illustrator® CC / outlined
- Photoshop® CC / with layers
- ZIP files

In order to facilitate a fluid order process and obtain an appropriate final result, it is important to provide us the information in one of the above listed formats. Should the customer's design not fit into our imprint area, we will modify it accordingly.

TYPEFACES:

All the typefaces must be converted to an artwork. Verify the minimum type sizes & line weights. Please, contact Customer Service for further information.

SPECIAL FOR WRITING PRODUCTS

SCREEN PRINTING

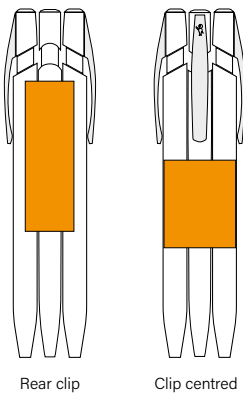

Available imprint area depends on required printing technique.



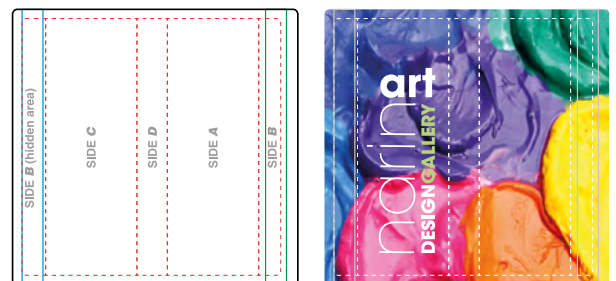











SPECIAL FOR DIGITAL LIGHTERS (J25, J23, J26 & J38)























If a direct exact colour is desired a fifth colour may be chosen from the aforementioned Guide for an additional charge. For more information on achieving the closest colour match for imprints on different products within our catalogue please contact our Customer Service Department

Symbols and abbreviations













PRINTING TECHNIQUES SYMBOLS

	PG Puffy glitter Coloured glitter texture.
	P Puffy Highlighted personalisation giving a relief effect to your logo.
	BR Brilliant Brilliant finish.
	M Metallic Create metallic effects on images and backgrounds.
	H Holografic Create attractive gold or silver effects.
	MT Matt Matt finish.
	UV UV High gloss finish.
	HS Hot Stamping Tactile embossing
	Print 360° ballpen
	Print 360° lighter
	Digital High-definition 4-colour process. 360° degrees and full length of the barrel/body.
	britePix™ Digital The solution for full colour communication. Now on coloured barrels!
	britePix™ Texture britePix™ Texture is a fresh addition to our britePix™ concept: now you don't just see the full colour – you can feel it!
	britePix™ personalisation Personalise each unit within the same britePix™ order.

















	SP Screen printing
	LE Laser
	PD Pad printing
	DG Digital

	BP britePix™
	3D Embossing
	TF Touch & feel
	ET Etched
	GM Glossy & matt mix
	FI Fragrant ink
	QR QR code
	BL Black light
	FA Fabric
	RC Resin chip
	GR Granite
	GD Glow in the dark
	H Holographik®
	PE Pearlescent
	ST Djeeep® soft touch®
	GT Glittering
	HM Hammered metal





































INK COLOURS

	Black		Light Green
	Light Blue		Apple Green
	Dark Blue		Green Dark
	Red		Fluo
	Orange		Pink
	Yellow		Purple

WRITING MODES

	Ballpen M Medium 1 mm F Fine
	Mechanical Pencil MP
	Pencil PC
	Roller Ball R
	Highlighter HL
	Stylus Pen SP
	Finestyle 0,7mm FS
	Gel G
	Marker MK
	Resistant tip
	No splinter
	Easy to use and erase
	Smoother and darker writing
	Smoother, more flowing writing
	Shock resistant
	Will not dry out
	Protective sheath
	2 leads

OTHER SYMBOLS

	New			Viral reduction 93% in 24 h	
	Mix&Match Hundreds of colours of components in stock of writing instruments for full personalisation.		FSC and recyclable cardboard Certification to promote the appropriate environmental management		Entire pen protection
	Custom colours Choose the exact PMS colour that suits your logo.		Pharmaceutical waste		Timeless protection
	Manufactured and printed in BIC factories		Fruit and vegetable trays		Bacteria elimination
	Manufactured in BIC factories		Fridges and yogurt pots		Fungal inhibition for 24 h
	Printed in BIC factories		Sugar cane		Regulatory compliance
	Assembled and printed in DJEEP factories		Ubicuity Program All BIC writing instruments are recyclable through our Ubicuity program, a partnership with Terracycle. For details, visit Terracycle at https://www.terracycle.com		EN 13869 European Child Resistant Regulation for lighters.
	Assembled and printed in BIC factories		Plastic car parts		ISO Certified
	Quality & safety approved		100% renewable electricity The BIC Graphic Europe factory is powered by 100% renewable energy. Hence, products are made with 100% renewable electricity.		ISO International safety standards
	Country of Origin		Imprim'vert		Number of flames
	Made in France		Möbius Loop Product contains recycled material.		QR code Scan QR code
	Made in Spain		Refill Service		Packaging Information 250 ± 3,5 KG
					DIMENSIONS: Dimensions published of each product correspond to its maximum size, regardless of the drawing position.

General Information

TECHNICAL PARAMETERS FOR EACH TYPE OF PRINTING

	DIGITAL / DIGITAL TRANSFER	
Minimum positive text	4 pt (1.4 mm)	<small>4 Point text</small>
Minimum negative text	7 pt (2.4 mm)	7 Point text
Minimum text for half tone	1.5 pt (0.5 mm)	7 Point text
Minimum thickness for positive lines	0.25 pt (0.08 mm)	—————
Minimum thickness for negative lines	0.5 pt (0.17 mm)	—————
Minimum thickness for lines in half tone	0.5 pt (0.17 mm)	—————
Minimum half tone values	C: 8% / M: 8% / Y: 12% / K: 8% 	

	britePix™	
Minimum positive text	6 pt (2.1 mm)	<small>6 Point text</small>
Minimum negative text	7 pt (2.4 mm)	7 Point text
Minimum thickness for positive lines	0.4 pt (0.14 mm)	—————
Minimum thickness for negative lines	0.5 pt (0.17 mm)	—————
Minimum thickness for half tones	1 pt (0.35 mm)	—————
Percentage half tone		

	SCREEN PRINTING/ PAD PRINTING	HOT STAMPING / DEBOSSING	LASER ENGRAVING
Minimum positive text	6 pt (2.1 mm) <small>6 Point text</small>	10 pt (3.5 mm) 10 Point text	6 pt (2.1 mm) <small>6 Point text</small>
Minimum negative text	9 pt (3.1 mm) 9 Point text	15 pt (5.25 mm) 15 Point	NOT RECOMENDED
Minimum thickness for positive lines	0.4 pt (0.14 mm) —————	1.5 pt (0.5 mm) —————	0.3 pt (0.1 mm) —————
Minimum thickness for negative lines	0.5 pt (0.176 mm) —————	2 pt (0.706 mm) —————	0.5 pt (0.17 mm) —————
Minimum thickness for half tones	1.5 pt (0.5 mm) —————	NOT POSSIBLE	NOT POSSIBLE
Percentage half tone	50% —————		

Product Index

BIC® WRITING INSTRUMENTS

BIC® Style _____	46
BIC® Round Stic® _____	50
BIC® M10® Clic _____	56
BIC® Media Clic _____	58
BIC® Media Clic Grip _____	63
BIC® Media Clic BGuard™ antibacterial _____	67
BIC® Media Clic BGuard™ antimicrobial Ecolutions® _____	70
BIC® Media Clic Biobased Ecolutions® _____	72
BIC® Media Clic Biobased BGuard™ antibacterial _____	75
BIC® Media Clic Shine _____	77
BIC® Media Clic Glacé _____	78
BIC® Clic Stic _____	80
BIC® Clic Stic Stylus _____	84
BIC® Clic Stic Mini _____	84
BIC® Super Clip _____	88
BIC® Super Clip Advance _____	94
BIC® Super Clip Glacé _____	98
BIC® Super Clip Glacé Advance _____	98
BIC® Super Clip Soft _____	100
BIC® Super Clip Soft Advance _____	100
BIC® Super Clip Origin _____	102
BIC® Wide Body™ _____	104
BIC® 4 Colours® _____	112
BIC® 4 Colours® Bicolor _____	114
BIC® 4 Colours® Gradient _____	116
BIC® 4 Colours® Pastel _____	118
BIC® 4 Colours® Fashion _____	120
BIC® 4 Colours® Sun _____	122
BIC® 4 Colours® Fine _____	124
BIC® 4 Colours® Fluo _____	126
BIC® 4 Colours® Shine _____	128
BIC® 4 Colours® Glacé _____	130
BIC® 4 Colours® Soft _____	132
BIC® 4 Colours® Wood Style _____	134
BIC® 4 Colours® Flags Collection _____	136
BIC® 4 Colours® 3+1 ^{HB} _____	138
BIC® Metal Pro _____	140
BIC® Cristal® Re'New™ _____	145
BIC® Grip Roller _____	150
BIC® XS Finestyle _____	152
BIC® Intensity® Gel Clic _____	154
BIC® Brite Liner® Grip _____	158
BIC® Velleda® White Board Marker Fine _____	160
BIC® Velleda® White Board Marker Grip _____	161
BIC® Mark-It Permanent Marker _____	162
BIC® Permanent Marker Ecolutions® _____	163
BIC® Matic® _____	166
BIC® Media Clic Mechanical pencil _____	168
BIC® Media Clic Grip Mechanical pencil _____	169
BIC® Evolution® Ecolutions® _____	174
Sprout™ Graphite pencil _____	178

OTHER WRITING INSTRUMENTS

Basic Pen _____	182
Click Pen _____	184
Striped Grip Pen _____	186
Sleek Stylus Pen _____	188

NOTEBOOKS

Rocketbook® Core Executive A5 _____	194
Rocketbook® Fusion Executive A5 _____	196
Rocketbook® Core Mini A6 _____	198

BIC® LIGHTERS AND CASES

BIC® J25 Lighter _____	206
BIC® J23 Lighter _____	210
BIC® J26 Lighter _____	214
BIC® J38 Lighter _____	218
BIC® Styl'it Luxury Case _____	222
BIC® Aluminium Flat Case _____	224
BIC® Clip Case _____	225
BIC® 3D Case _____	226
BIC® Pocket Ashtray _____	228

DJEEP® LIGHTERS

DJEEP® D1 Lighter _____	230
-------------------------	-----

BIC® PACKAGING

BIC® Packaging Ecolutions® _____	240
BIC® Packaging _____	242

Colour table

 01 White	 1E White recycled	 57 Opaque white	 3C White pearl	 01BIO BIO white	 1T White polished	 51 Transparent	 69 Frosted white	 2E Frosted white recycled		
 8D Yellow pastel	 8G Light yellow	 12 Yellow	 12W Yellow wood	 63 Frosted yellow	 6AW Natural wood	 012BIO BIO yellow	 4D Clear yellow	 6F Light brown	 60 Natural	
 26 Gold	 76 Gold glacé	 1G Acid orange	 10 Orange	 90 Orange pastel	 71 Frosted orange	 92 Clear orange				
 03 Red	 03G Red glacé	 03F Red soft	 8E Red recycled	 87 Clear red	 03BIO BIO red	 66 Frosted red	 08 Burgundy			
 14 Pink	 5C Pink fizz	 1P Acid pink	 014G Pink glacé	 07 Gold Pink	 11 Pink	 80 Pink	 97 Rose Gold			
 84 Purple pastel	 13 Violet	 39 Frosted Dark Purple	 7G Metallic purple	 2D Purple	 93 Clear Purple	 4B Frosted Purple				
 8C Lime	 68 Frosted green	 6C Grass green	 88 Clear light green	 59 Apple green	 82 Frosted dark green	 72 Clear green	 5G Light green	 05G Green glacé		
 05 Green	 05W Green wood	 20 Dark green	 7E Dark green recycled	 88 Clear dark green	 05BIO BIO green	 3B Frosted jungle				
 83 Blue pastel	 3D Caribbean blue	 86 Clear blue	 67 Frosted blue	 24 Light blue	 04BIO BIO blue	 04 Blue	 04G Blue glacé	 40 Frosted dark blue	 4R Blue turquoise	
 34 Metallic Blue	 89 Clear dark blue	 25 Dark blue	 07 Navy blue	 07F Navy blue soft	 10E Navy blue recycled					
 35 Chrome	 47 Silver	 47G Silver glacé	 75 Metallic silver	 18 Metal	 06 Grey	 27 Dark grey	 8H Clear dark grey			
 02BIO BIO black	 02W Black wood	 02F Black soft	 02 Black	 3E Black recycled	 2N Black matt					

CLOSE TO YOU



Interior paper:
From sustainable forests with PEFC chain of custody.



www.bicgraphic.com