

# 2025

## ATHLETIC EQUIPMENT CATALOG

[trigonsports.com](http://trigonsports.com)

**tsi** TRIGON  
SPORTS®

MAKE WINNING POSSIBLE.®





As a family-owned and operated business with over 60 years of combined experience in the sporting goods industry, Trigon Sports provides high-quality sports equipment for high school, collegiate, and professional programs. Our goal was not to change the sporting goods industry, but simply make it better. Even as our reputation for providing quality sports equipment grew, our reputation for great customer service grew faster.

Through our trademarked brand of sports equipment, ProCage™ and Practice Partner®, we have expanded our product line from baseball and softball, to football, lacrosse, soccer, and more. Our business model is simple: Focus on the customer, provide them with high quality sports equipment, and perhaps most important, love what we do. Here at TSI, we love what we do, and it shows from the moment you call us. We are proud to serve our loyal customers, and even more proud that we help them **“Make Winning Possible®”**.

We want to say thank you to all of our local team dealers, team catalog sales reps and loyal customers who use our products every day!

We appreciate you choosing Trigon Sports and we look forward to the opportunity to continue to build relationships with you in the years to come.

**It is our pleasure to serve around the globe and help  
MAKE WINNING POSSIBLE.®**



2019  
Local Champion



Official Field  
Equipment Supplier



Official Field  
Equipment Supplier

**888-313-1303 • sales@trigonsports.com**



# CONTENTS

## 2 PRACTICE PARTNER

Our line of at-home practice equipment to ensure you Make Winning Possible.

## 4 BASEBALL/SOFTBALL

- 4 Rollaway Batting Cages
- 5 Indoor Electric Batting Cages
- 6 Poly Tunnel Nets & Frames
- 7 Cantilever Batting Cage Frames
- 8 Custom Netting
- 9 Protective Screens
- 13 Ball Caddies
- 14 Training Aids
- 16 Pitching Machines
- 17 Foul Poles
- 18 Halo Kits
- 19 Turf Mats
- 20 Custom Turf
- 21 Pitcher's Mounds
- 25 Pitching Rubbers
- 26 Base Sets
- 28 Field Dirt Products
- 28 Field Maintenance
- 31 Drag Mats
- 32 Dry Liner Markers/Templates

- 33 Field Marking
- 34 Irrigation
- 35 Field Covers & Protectors
- 39 Temporary Fencing
- 41 Fence Protectors
- 42 Fence Screens
- 43 Rail Padding
- 44 Stadium Padding
- 45 Facility Solutions/Indoor Padding

## 48 BASKETBALL

- 48 Scoreboards
- 49 Ball Carts
- 50 Rims
- 51 Backboards

## 52 TRAINING

- 52 Sports Speed & Agility

## 53 FOOTBALL

- 53 Training Aids
- 54 Equipment Storage
- 55 Gameday Field Layout/Equipment
- 56 Sideline Protectors
- 57 Goal Posts
- 58 Dummies/Pads

## 59 LACROSSE

- 59 Goals

## 62 SOCCER

- 62 Gameday Field Equipment
- 63 Goals

## 65 HOCKEY

- 65 Goals/Shooting Target

## 66 VOLLEYBALL

- 66 Net Systems/Nets
- 67 Rollaway Standards/Training Aids

## 68 BANNERS

- 68 Sports Banners/Flags
- 69 Bleacher Enclosures

## 70 BLEACHERS

- 70 Standard Aluminum
- 71 Low-Rise/Tip & Roll
- 72 Supreme Series/ADA Compliant
- 73 Team Benches



# PRACTICE PARTNER®

## FROM THE FIELD TO THE BACKYARD.

Practice Partner was founded in 1982 by Joseph Rajacich, a father of two little league ballplayers, who saw the need for a better way to practice at home. Under the leadership of Rajacich's sons, Alex and Andrew, the Practice Partner group of products expanded into a full line of team sports training aids.

Trigon Sports acquired the Practice Partner name and product line in 2021. The acquisition of Practice Partner allows Trigon Sports the ability to offer quality practice equipment to athletes at all levels of play.

## BASEBALL

### BASEBALL PRO REBOUNDER

Constructed of 1.5" hammered grey powder-coated steel tubing. Swaged joints for easy assembly. Heavy duty polyethylene netting with bungee cords for attachment.



Practice Partner® Pro Baseball Rebounder

**PROREB**

## LACROSSE

### LACROSSE WALL REBOUNDER

Constructed of 1.5" 18-gauge steel tubing with 4' x 3' rebounding surface.

**Size:** 84"T x 36"W



Practice Partner® Lacrosse Wall Rebounder

**LPBT**

### CANVAS CATCHER THROWING TARGET

Canvas Catcher is made from vinyl and measures 48"W x 75"H. The 2 sided design can be used to practice pitching baseballs, or reversed for practicing your football passes.

Canvas Catcher Throwing Target

**BDUSPORT**



**FRONT**

**NEW!**

**BACK**



## LACROSSE GOAL



Official size lacrosse goal. Formed from 18-gauge, 1.5" powder-coated steel tubing. Includes 3mm, heavy-duty weatherized netting.

**Size:** 72"W x 72"H x 84"D

Practice Partner®  
Lacrosse Goal

**LGPRAC**

## SILVERLINE PRACTICE LACROSSE GOAL



1.5" powder-coated orange galvanized steel frame. Net laces around frame face and ground supports. 4mm net and lacing cord.

**SOLD INDIVIDUALLY.**

Practice Partner® Silverline  
Lacrosse Goal

**SLVLG**

## SOCCER

### SILVERLINE SOCCER GOALS



Practice Partner® Silverline  
Soccer Goal 6x9

**SLVSG9**

Practice Partner® Silverline  
Soccer Goal 6x12

**SLVSG12**

Practice Partner® 6'x9'  
Replacement Soccer Net

**SOCNET9**

Practice Partner® 6'x12'  
Replacement Soccer Net

**SOCNET12**

### 6X9 SOCCER REBOUNDER



Assembles to 6'H x 9'W. Precision-fit locking pins for easy assembly. Constructed of 1.5", 18-gauge heavy-duty steel tubing.

Practice Partner®  
Soccer Rebounder

**SOCREB**

### 4X8 FOLDING SOCCER GOAL



Foldable goal features push-button assembly and all-weather net. Perfect portable goal for practice.

**Size:** 4'H x 6'W x 3'D

Practice Partner® Folding  
Soccer Goal

**FOLD95**

## HOCKEY

### HOCKEY GOAL



2" galvanized steel tubing with weather-treated red powder coat. Pro style round back frame. Doubled welded net attachment system. 4mm heavy duty weatherized netting.

Practice Partner® Hockey Goal

**RHX2**

### SILVERLINE HOCKEY GOAL



15/8" 18-gauge steel tubing with weather-treated red powder coating. Pro style round back frame. 4mm heavy duty weatherized netting.

**Size:** 72"W x 48"H x 36"D

Practice Partner®  
Silverline Hockey Goal

**SLVRHR**





**ROLLAWAY BATTING CAGE**  
BPCAGE

**STANDARD FEATURES**

- Overall dimensions: 22'D x 18'W x 12'H
- Collapsed storage height is 5'
- Rear dolly assembly easily lifts & maneuvers cage
- Dual, fold-out coaches platforms at rear of cage allow for raised viewing of batter
- Complete Rollaway Cage includes: Net, Heavy-duty vinyl skirt & thud pad
- Frame structure is 2" O.D. heavy wall aluminum tubing
- Large 10' x 10' baffle net to protect rear of cage
- Heavy-duty weather-treated knot-less netting - replacement net
- Replacement heavy-duty vinyl skirt (Black)
- Outer wheels turn 180 degrees and feature locking hubs with oversized turf tires

Rollaway Batting Cage **BPCAGE**

**UPGRADES**

- Replacement Heavy-Duty Vinyl Skirt (Black) **BPCAGESKT**
- Replacement Thud Pad (Black) **BPCAGEPAD**
- Replacement Net **BPCAGEN**

***SHIPS FREIGHT. UNIT NOT DESIGNED FOR TOWING.***

**SKIRT & PAD WRAP COLOR KITS**



COLOR	SKIRT	PAD WRAP COLOR KIT
Dark Green	<b>BCSKTDG</b>	<b>BCPADDG</b>
Purple	<b>BCSKTPU</b>	<b>BCPADPU</b>
Navy Blue	<b>BCSKTNA</b>	<b>BCPADNA</b>
Royal Blue	<b>BCSKTRO</b>	<b>BCPADRO</b>
Red	<b>BCSKTRD</b>	<b>BCPADRD</b>

Dual Fold-Out Coaches Platforms At Rear Of Cage



Color Skirt and Pad Wrap Kits Available





## INDOOR CEILING SUSPENSION KIT

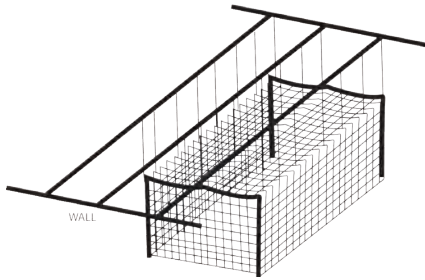

### KIT INCLUDES:

- (3) 3/16" x 100' Galvanized Steel Wire Cables
- (30) 3/16" x 30' Galvanized Steel Wire Cables
- (66) Wire Rope Clamps
- (6) Hook & Eye Turnbuckles
- (6) 1/2" x 12" Eye-bolts
- (60) Snap Links

ProCage™ Indoor Ceiling Suspension Kit

**B50015**

## 1/4" SPRING CLIPS



1/4" Spring Clips, 42ct

**SNAP42**

## INDOOR ELECTRIC MULTI-SPORT BATTING CAGE



Our Indoor Electric Multi-Sport Batting Cage is conveniently suspended from the ceiling structure and electrically operated. Our team will provide cut sheets to build to your specific dimensions. The drive shaft raises and lowers the system, powered by our curtain hoist. This Indoor Electric Batting Cage also comes with a 1-Year Limited Warranty. Ship time is dependent upon receipt of gymnasium dimension verification. This item includes custom-size ceiling structure only. Batting Tunnel net is NOT included. Please call for further details.

55' Custom Cage

**B51055**

70' Custom Cage

**B51070**

\*\*\*Pricing may vary depending on building structure\*\*\*

## BATTING CAGE SUSPENSION/INSTALLATION KIT

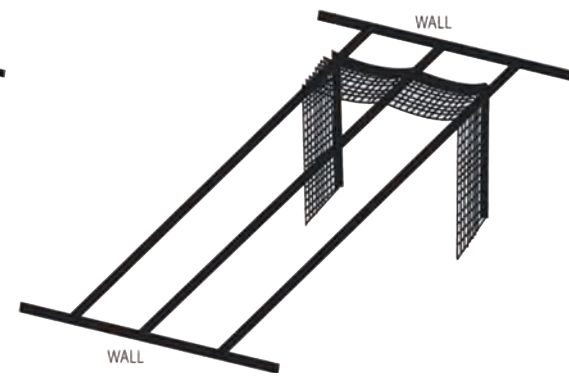
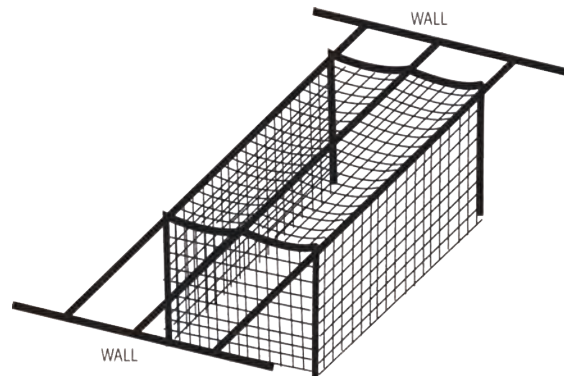

### KIT INCLUDES:

- (3) 3/16" x 100' Galvanized Steel Wire Cables
- (6) Hook & Eye Turnbuckles
- (6) 1/2" x 12" Eye-bolts
- (6) Wire Rope Clamps
- (42) Snap Links

ProCage™ Batting Cage Installation Kit

**B50010**

Can be used for indoor suspension kit or outdoors as installation hardware for your existing frame.

CALL FOR PRICING 888-313-1303

# POLY BATTING TUNNEL NETS



**AVAILABLE IN BOTH #42 THREAD WITH A 5-YEAR WARRANTY AND #24 THREAD WITH A 2-YEAR WARRANTY.**

Constructed of heavy-synthetic HDPE fiber, extruded with permanent black color and sunlight/UV inhibitors throughout each filament. 1-3/4" mesh size. High abrasion resistant twisted-knotted netting, strongest form of netting in commercial use. 100% waterproof and low-stretch = no sagging. Heavy-Duty rope reinforcement on all edges, corners and top hanging ropes.



**#42 THREAD**  
2.5mm diameter,  
#60 (380d/60) denier



**#24 THREAD**  
2.18mm diameter,  
#42 (380d/42) denier

NET SIZE	WEIGHT	ITEM#
75'Lx15'Wx12'H	130 lbs.	<b>B427515</b>
70'Lx24'Wx12'H	200 lbs.	<b>B427024</b>
70'Lx14'Wx14'H	125 lbs.	<b>B427044</b>
70'Lx14'Wx12'H	120 lbs.	<b>B427014</b>
70'Lx12'Wx12'H	115 lbs.	<b>B427012</b>
55'Lx14'Wx14'H	105 lbs.	<b>B425544</b>
55'Lx14'Wx12'H	100 lbs.	<b>B425514</b>
55'Lx12'Wx12'H	95 lbs.	<b>B425512</b>

**INCLUDES ENTRY DOOR W/ BAFFLE**

70'Lx14'Wx12'H	125 lbs.	<b>B427014F</b>
55'Lx14'Wx12'H	105 lbs.	<b>B425514F</b>

U.S. twine size as standardized by American manufacturers and the American Cordage Institute.

Do not be confused by those that refer to the thread count as U.S. twine size.

NET SIZE	WEIGHT	ITEM#
70'Lx14'Wx12'H	75 lbs.	<b>B247014</b>
70'Lx12'Wx12'H	70 lbs.	<b>B247012</b>
55'Lx14'Wx12'H	70 lbs.	<b>B245514</b>
55'Lx12'Wx12'H	65 lbs.	<b>B245512</b>
35'Lx14'Wx12'H	46 lbs.	<b>B243514</b>

## DIVIDER NETTING

#42 Polyethylene thread with a rope border on all four sides. Attach behind batting & pitching areas to prolong net life, or hang in middle of tunnel for 2 hitting stations.



14'x12' Baffle Netting **B421412**

## BATTING CAGE ZIP DOOR



Add a door entry to any batting cage in minutes. Marine-grade vinyl that attaches using super stick Velcro & snaps. Simply cut an opening and attach.  
**Size:** 70"H x 24"W with a 64" zipper door opening.  
(Patent Pending)

Batting Cage Zip Door **BPZIPD**

## TUNNEL CAGE SAVERS

**BEST SELLER!**

Made of tough vinyl, lengthen the life of your batting cage nets with our cage savers. Includes brightly colored strike zone and comes with brass grommets and poly rope in corners for attachment.

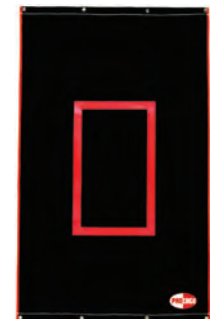

Heavy-Duty 22 oz. Vinyl, 4'x6' **BSVR22**  
Heavy-Duty 30 oz. Vinyl, 5'x7' **BSVR30**

**Color Options:** 22oz. Vinyl - Black with Red Strike Zone, 30oz Vinyl - Blue with Yellow Strike Zone, Black with Orange Strike Zone





# CANTILEVER BATTING CAGE FRAME

INDIVIDUAL  
POLES OR  
CUSTOM  
SET-UPS  
AVAILABLE

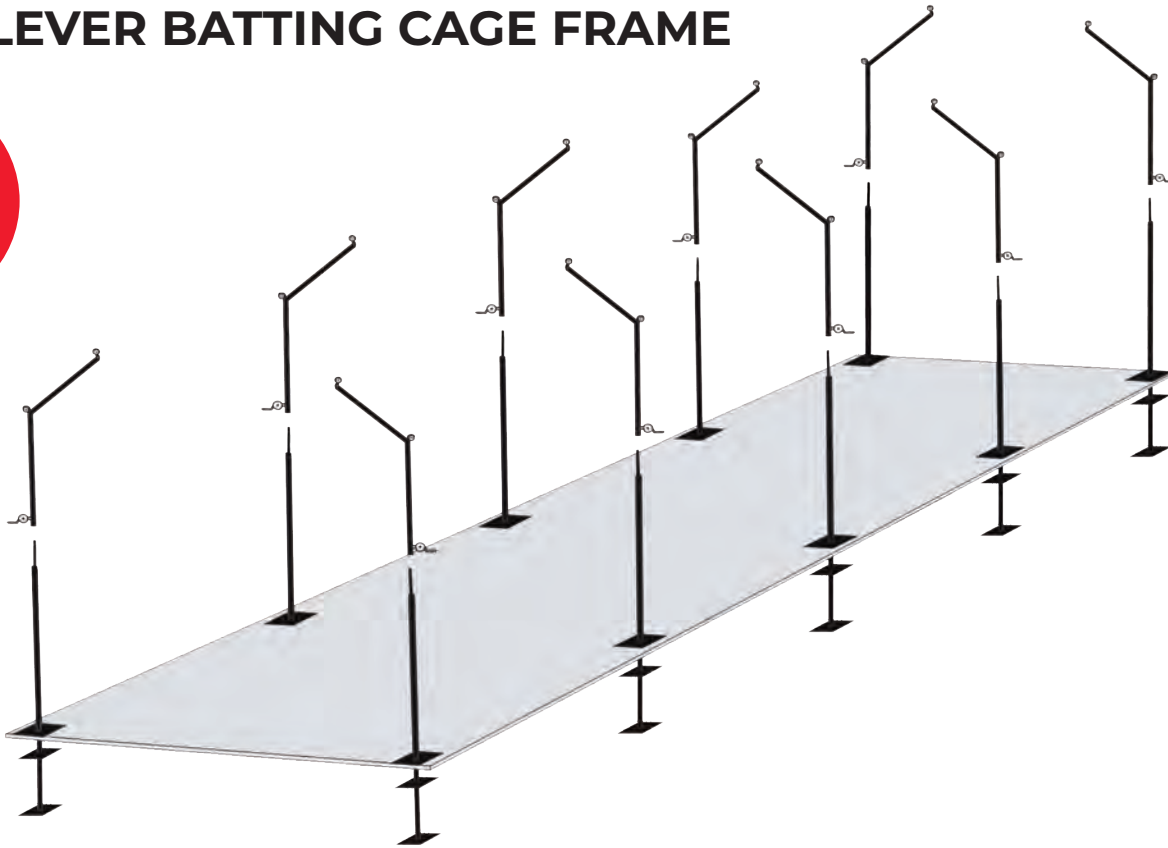

**14' W x 14' H TUNNEL NET IS RECOMMENDED FOR ALL CANTILEVER CAGES.**

Call us today and see how we can make this frame meet your needs.

- 8-Poles & Ground Sleeves with Hardware Kit **BCFRM55**
- 10-Poles & Ground Sleeves with Hardware Kit **BCFRM70**
- Single Pole & Ground Sleeves with Hardware Kit **BCFRM**
- 1/4" Spring Clips, 42ct **SNAP42**

New design, features 2-piece pole assembly with cantilever top and individual winch on each pole makes net set up and take down quick and easy! **NO LADDERS NEEDED!**



## PRE-CUT BARRIER NETTING



Made of Black #42 knotted thread that is weather and UV treated. 1 3/4" square mesh with a sewn rope border on all sides. Perfect for use as a barrier net for baseball or softball.

14'x50' Pre-Cut Netting

**BN1450**

14'x100' Pre-Cut Netting

**BN14100**

# CUSTOM NETTING



Custom nets are made to your specification to cover any sport or application. We offer nets hung on the diamond or on the square and your choice of rope borders or vinyl tape with grommets. Please contact us with your measurements and application. Netting is our specialty!

**DYNEEMA**



ITEM NUMBER	CN250	CN21	CN371	CN504	CN42	CN361	CN60	CN96	CND18
<b>Mesh Size</b>	1"	1-3/4"	3/4"	4"	1-3/4"	1-3/4"	1-3/4"	1-3/4"	1-3/4"
<b>Colors Available</b>	Black	Black	Black, Blue	Black, White	Black	Black	Black	Black	Black
<b>Cord Diameter (mm)</b>	1.8	1.8	2.3	2.3	2.7	2.5	3.0	4.0	1.7
<b>Applications</b>									
Baseball Backstop					✓	✓	✓	✓	✓
Basketball Court Netting	✓	✓	✓	✓	✓	✓	✓	✓	✓
Batting Cage/Tunnel					✓	✓	✓	✓	✓
Discus Cage Netting					✓	✓	✓	✓	✓
Football Field Netting				✓	✓	✓	✓	✓	✓
Foul Ball Barrier		✓			✓	✓	✓	✓	✓
Golf Perimeter Net	✓		✓						
Golf Practice Panel/Tunnel			✓						
Hockey Barrier							✓	✓	
Indoor Baseball Facilities		✓			✓	✓	✓	✓	✓
Indoor Soccer Facilities		✓		✓	✓	✓	✓	✓	✓
L-Screen					✓	✓	✓	✓	
Lacrosse Barrier Net			✓		✓	✓	✓	✓	✓
Racquet Ball Barrier	✓	✓	✓						
Soccer Barrier		✓		✓	✓	✓	✓	✓	
Soccer Goals		✓			✓	✓	✓	✓	
Tennis Barrier/Divider	✓	✓			✓	✓	✓	✓	





# PRO SCREENS

## ALL PRO SCREENS FEATURE:

- Heavy-duty 4.0mm #96 thread knotted pillowcase style net
- Heavy-gauge 2" galvanized steel frame
- Heavy-duty wheel kit with no-flat turf tires
- Heavy-duty wheel protectors

## 8-10' FRAME PADDING KIT

3 8' Sections Vinyl w/ Lacing Twine

### RECOMMENDED ON ALL SCREENS

- 8' Black Frame Padding Kit **BPROPAD**
- Green Frame Padding Kit **BPROPADGR**
- Red Frame Padding Kit **BPROPADR**
- Blue Frame Padding Kit **BPROPADBL**



## PROCAGE™ "OLE 96ER" PRO L-SCREEN

8'x8'



Complete L-Screen **BLPRO96**  
Replacement L-Screen Net **BLPRO96N**

## PROCAGE™ "OLE 96ER" FUNGO SCREEN

8'x8'



### FRAME PADDING KIT RECOMMENDED

Fits 8'-10' frame padding kits

Complete Fungo Screen **BFPRO96**  
Replacement Fungo Net **BFPRO96N**

## PROCAGE™ PROFESSIONAL 10'X10' PROTECTIVE SCREEN

10'x10'

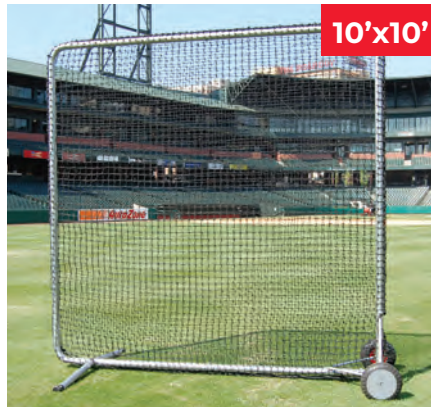

### FRAME PADDING KIT RECOMMENDED

Fits 8'-10' frame padding kits

Complete 10'x10' Screen **BFPRO10**  
Replacement 10'x10' Net **BFPRO10N**

## PROCAGE™ MINI PRO L-SCREEN

BEST SELLER!



### FEATURES:

- Size: 5'W x 7'H
- Heavy-duty 4.0mm thread knotted pillowcase style net
- Heavy-gauge 2" galvanized steel frame
- Heavy-duty wheel kit with no-flat turf tires
- Heavy-duty fabric wrapped foam encases entire frame
- Heavy-duty wheel protectors

Complete Padded Mini L-Screen **BLPRO57**  
Replacement Mini L-Screen Net **BLPRO57N**

## PROCAGE™ PRO #96 DOUBLE L-SCREEN W/ HOOD

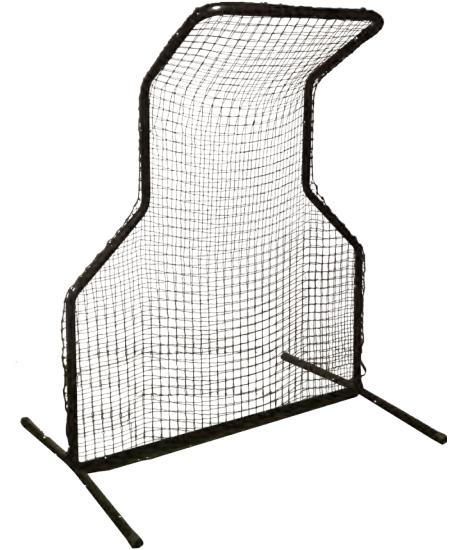

### FEATURES:

- Size: 6' x 94" (42"W at top)
- 2' deep slanted protective hood
- Heavy duty 2" steel frame
- Heavy-duty 4.0mm thread knotted pillowcase style net
- Fully padded

Complete Double L-Screen w/ Hood

**BLPRODB**

## NET REPAIR KIT

Net repair/lacing kit. Includes 1lb spool of black #36 tarred nylon twine and net repair lacing needle.



Net Repair/Lacing Kit

**BNETREP**

CALL FOR PRICING 888-313-1303





## SUPREME SCREENS

### ALL SUPREME SCREENS FEATURE:

- Double 3.0mm knotted netting
- 1.5mm heavy wall steel tubing
- 1-1/2" round hammer powder coat finish
- Push-button assembly
- Detachable legs for easy storage

### 7' FRAME PADDING KIT

3-7' Sections Vinyl w/ Lacing Twine

#### **RECOMMENDED ON ALL SCREENS**

- 7' Black Frame Padding Kit **B77PAD**
- Green Frame Padding Kit **B77PADGR**
- Red Frame Padding Kit **B77PADRD**
- Blue Frame Padding Kit **B77PADBL**



### PITCHER'S L-SCREEN PROTECTIVE SCREEN

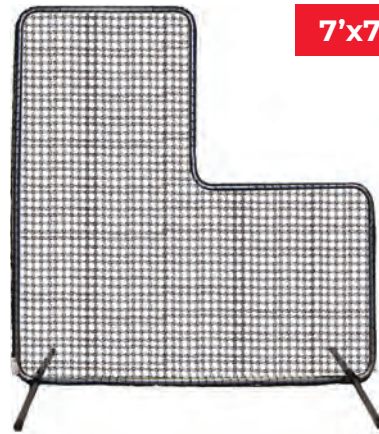

7'x7'

#### **FRAME PADDING KIT RECOMMENDED**

Fits 7' frame padding kits

Complete Pitcher's L-Screen **B607744**

Replacement L-Screen Net **B607744N**

### FIRST BASE FUNGO PROTECTIVE SCREEN



7'x7'  
#60 NETTING

#### **FRAME PADDING KIT RECOMMENDED**

Fits 7' frame padding kits

First Base Fungo Screen **B607720**

Replacement Screen Net **B607720N**

### Z-SCREEN PROTECTIVE PITCHING SCREEN



7'x5'

#### **FRAME PADDING KIT RECOMMENDED**

Fits 7' frame padding kits (as Shown)

Complete Z-Screen **B6075Z**

### NET REPAIR KIT

Net repair/lacing kit. Includes 1lb spool of black #36 tarred nylon twine and net repair lacing needle.



Net Repair/Lacing Kit

**BNETREP**

### PROCAGE™ UNIVERSAL WHEEL KIT



Add this wheel kit to any round or square tube screen for additional mobility on and off the field!

***FITS ALL SQUARE AND ROUND TUBE FRAMES UP TO 1-3/4".***

#### **FEATURES:**

- Heavy-duty steel construction
- Large turf-type wheels
- Dual clamps for secure attachment

ProCage™ Universal Wheel Kit

**BWHLKIT**



# PREMIUM SCREENS

## ALL PREMIUM SCREENS FEATURE:

- Double 2.5mm #42 pillowcase style net
- Constructed of 1-3/4" galvanized square steel frame
- Swaged joints and push-button assembly
- Detachable legs for storage

**FRAME PADDING KIT RECOMMENDED**

## 7' FRAME PADDING KIT

3-7' Sections Vinyl w/ Lacing Twine

**RECOMMENDED ON ALL SCREENS**

- 7' Black Frame Padding Kit **B77PAD**
- Green Frame Padding Kit **B77PADGR**
- Red Frame Padding Kit **B77PADRD**
- Blue Frame Padding Kit **B77PADBL**



## PITCHER'S PROTECTIVE L-SCREEN



**FRAME PADDING KIT RECOMMENDED**

Fits 7' frame padding kits

- Complete L-Screen **B427744**
- Replacement Screen Net **B427744N**

## PROCAGE™ MINI FUNGO SCREEN



- Complete Mini Fungo Screen **BSQ4274**
- Replacement Mini Fungo Net **BSQ4274N**
- Mini Fungo Screen Padding Kit (8 Sections vinyl w/lacing twine) **BSQ4274P**

## SOFTBALL PITCHER'S PROTECTIVE SCREEN



**FRAME PADDING KIT RECOMMENDED**

Fits 7' frame padding kits

- Softball Pitcher's Screen **B427780**
- Replacement Screen Net **B427780N**

## SOFTBALL PITCHER'S C-SCREEN



**FRAME PADDING KIT RECOMMENDED**

Fits 7' frame padding kits

- Softball Pitcher's C-Screen **B427790**
- Replacement C-Screen Net **B427790N**

## FIRST BASE FUNGO PROTECTIVE SCREEN



**FRAME PADDING KIT RECOMMENDED**

Fits 7' frame padding kits

- First Base Fungo Screen **B427720**
- Replacement Screen Net **B427720N**

## SOFT TOSS SOCK NET SCREEN



**FRAME PADDING KIT RECOMMENDED**

Fits 7' frame padding kits

- Soft Toss Sock Net Screen **B427700**
- Replacement Soft Toss Sock Net **B427700N**

## FRAME PADDING KITS RECOMMENDED FOR ALL SCREENS



Heavy duty vinyl wrapped foam padding with grommets. Lacing twine is included to securely attach to square or round tube frames.



- 8'-10' Padding Kit Black **BPPROPAD**
- Green **BPPROPADGR**
- Red **BPPROPARD**
- Blue **BPPROPADBL**
- 7' Padding Kit Black **B77PAD**
- Green **B77PADGR**
- Red **B77PADRD**
- Blue **B77PADBL**
- Mini Fungo Padding Kit **BSQ4274P**

**CALL FOR PRICING 888-313-1303**





# BLACK SERIES SCREENS

## PITCHER'S PROTECTIVE L-SCREEN

**7'X7'**  
WITH 3.5'X3.5'  
CUTOUT



**FRAME PADDING KIT RECOMMENDED**

Fits 7' frame padding kits

Complete L-Screen **BSL77P**  
Replacement Screen Net **B427744N**

## 7'X7' FIRST BASE FUNGO SCREEN

**7'X7'**  
#42 NETTING



**FRAME PADDING KIT RECOMMENDED**

Fits 7' frame padding kits

7'x7' First Base Fungo Screen **BSL77F**  
Replacement Screen Net **B427720N**

### ALL BLACK SERIES SCREENS FEATURE:

- Waterproof double-pillowcase netting
- Sturdy 18-gauge powder-coated 1-1/2" round steel frame
- Push-button for easy assembly
- Screen is retail packaged with UPC barcode
- Detachable legs for storage

## 10'X10' FIRST BASE FUNGO SCREEN

**10'X10'**  
#42 NETTING



**FRAME PADDING KIT RECOMMENDED**

Fits 8'-10' frame padding kits

10'x10' First Base Fungo Screen **BSL10F**  
Replacement Screen Net **BSL10FN**

## SOFTBALL PITCHER'S PROTECTIVE SCREEN

**7'X7'**  
WITH 24"X20"  
CUTOUT



**FRAME PADDING KIT RECOMMENDED**

Fits 7' frame padding kits

7'x7' First Base Fungo Screen **BSL77SB**  
Replacement Screen Net **B427780N**

## SOFT TOSS SOCK NET PROTECTIVE SCREEN

**7'X7'**  
WITH 4'X4'  
SOCK OPENING



**FRAME PADDING KIT RECOMMENDED**

Fits 7' frame padding kits

7'x7' First Base Fungo Screen **BSL77S**  
Replacement Screen Net **B427700N**

## FRAME PADDING KITS RECOMMENDED FOR ALL SCREENS



Heavy duty vinyl wrapped foam padding with grommets. Lacing twine is included to securely attach to square or round tube frames.



8'-10' Padding Kit Black	<b>BPPROPAD</b>
Green	<b>BPPROPADGR</b>
Red	<b>BPPROPADR</b>
Blue	<b>BPPROPADBL</b>
7' Padding Kit Black	<b>B77PAD</b>
Green	<b>B77PADGR</b>
Red	<b>B77PADRD</b>
Blue	<b>B77PADBL</b>
Mini Fungo Padding Kit	<b>BSQ4274P</b>



## TRI-FOLD PROTECTIVE SCREEN



### FEATURES:

- Main panel is 8'x8' with (2) 8'x4' wings.
- Includes wheels & ground anchor stakes
- New design features four legs for added stability

### OVERALL SIZE:

Our ProCage™ Tri-Fold Screen features a 1½ inch powder coated steel frame with waterproof pillowcase netting. Screen includes wheels for transport and ground anchor stakes for added stability.

Tri-Fold Protective Screen **BTRIFLD**  
 Replacement Tri-Fold Screen Net **BTRINET**

## TRI-FOLD 3-IN-1 NET KIT

### FEATURES:

- 8'x8' sock net
- 8'x4' pitchback
- 8'x4' three-pocket catch net

### OVERALL SIZE:

Main panel is 8'x8' with (2) 8'x4' wings.

Transform your tri-fold screen into a multi-purpose practice station with the Tri-fold 3-in-1 net kit. Each panel is made with a durable waterproof #42 pillowcase style netting.

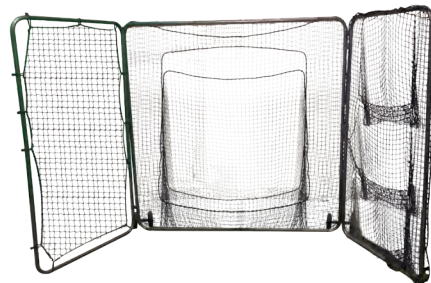

Tri-Fold Multi Purpose Net Kit **BT3N1**

***INCLUDES NET ONLY,  
 FRAME SOLD SEPARATELY.***

## BATTING PRACTICE BALL CADDY



Caddy can be used while sitting or standing by easily adjusting leg height. Legs adjust to 24", 30" and 36" heights. Comes with wheels for easy transport on and off the field. Holds up to 60 baseballs or 36 softballs.

Batting Practice Ball Caddy **BPCAD**  
 Replacement Bag **BPCADMB**

## PROCAGE PROFESSIONAL BALL CART

**PRO'S CHOICE**



HD powder-coated steel frame with a premium mesh netted ball basket. Sturdy and durable with no-flat turf tires. NEW wheel protectors. Push-button assembly. Dolly-style design for easy transport. Holds 300 baseballs and approximately 150 softballs. Great for all levels of play.

ProCage Professional Ball Cart **BPCADP**  
 Replacement Net **BPCADPN**

# TRAINING AIDS

## THE DESIGNATED HITTER



Life-like, silhouette figure of a batter stands in at the plate in place of a real batter, adding the element of a more game-like setting to pitching practice.

Available in: Red, Blue and Gray

Designated Hitter Pro Model

**DHPRO**



## STANDARD BATTING TEE



Mounted on an official rubber home plate. Molded rubber design with inner steel support tube. Inner sleeve adjusts from 22" to 47" to accommodate batters of all sizes.

Standard Batting Tee

**BBTEE**

## DELUXE BATTING TEE



Mounted on an official rubber home plate. Features a reinforced tube base. Inner sleeve adjusts from 22" to 47" to accommodate batters of all sizes. Molded rubber design features a built-in carry handle.

Deluxe Batting Tee

**BDTEE**

## FOLDING BATTING TEE



Molded rubber design. Adjustable height from 30"-46". Folding base makes it travel easy.

Folding Batting Tee

**BFTEE**

## HANGING BALL HOLDERS

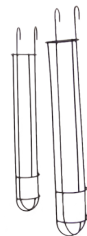

Features an all steel, welded construction powder-coated black for maximum protection. Holders store up to 10 balls.

Baseball Holder

**BBHLD**

Softball Holder

**SBHLD**

## HANGING BAT RACK



All steel construction, powder-coated black for maximum protection. Hanging arms swivel for easy use and storage. Rack holds 10 bats.

Size: 30" wide

Hanging Bat Rack

**BHRACK**



## 9-HOLE PITCHING TARGET TRAINER

**BEST SELLER!**



### FEATURES:

- Size: 46"H x 36"W
- Target zone: 42"H x 36"W
- 2" steel frame
- Knotless nylon netting with nine netting pockets
- Vinyl padding with yellow target zone

9-Hole Pitching Trainer  
9-Hole Pitching Trainer  
Replacement Net

**BPTRAIN9**  
**BPTRAIN9N**

## PRO ADJUSTABLE 9-HOLE TARGET



### FEATURES:

- Target zone: 30"H x 26"W
- 2" steel frame
- Adjusts to three height settings up to 4'
- Knotless nylon netting with nine netting pockets
- Vinyl padding with yellow target zone
- Ideal for evaluating pitcher accuracy at all skill levels

Pro Adjustable 9-Hole Target Pitch Trainer

**BPTRAIN9PRO**

## MULTI-SPORT PITCH BACK REBOUNDER

**BEST SELLER!**



1<sup>1</sup>/<sub>4</sub>" hammered grey powder coated steel tubing. Swaged joints with thumb snaps for easy assembly. Adjustable to multiple angles for play on both sides. Heavy-duty polyethylene netting with bungee cords for attachment. Includes a 1" red target interlaced into netting.

**Size:** 72"T x 42"W

Multi-Sport Pitch Back Rebounder  
Multi-Sport Pitch Back Rebounder  
Replacement net

**MSPB427**

**MSPB427N**

**PRACTICE PARTNER®**

## BASEBALL PRO REBOUNDER



Constructed of 1.5" hammered grey powder-coated steel tubing. Swaged joints for easy assembly. Heavy duty polyethylene netting with bungee cords for attachment.

Practice Partner® Pro  
Baseball Rebounder

**PROREB**

**BASEBALL/ SOFTBALL**



## I-HACK ATTACK BASEBALL PITCHING MACHINE



### TOUCH SCREEN INTERFACE:

With the familiar look and feel of a personal tablet, the machine interface is a customized touch screen through which you can control and select pitch type, speed and spin as well as access saved favorite pitches and sequences.

### ADVANCED SOFTWARE PROGRAM:

Using touch screen, quickly go between eight different pre-set pitches as well as pre-set defensive drills.

All pitches can be modified as desired by making finite adjustments to each motor individually.

### FEATURES:

- Great for all levels of baseball.
- Throws fastballs, curves, sliders, split fingers and Knuckleballs.
- Pivots instantly for pop-ups, flyballs, grounders and catcher's pop-ups.

I-Hack Attack Baseball Pitching Machine **BIHACK**

## HACK ATTACK PITCHING MACHINE



The exclusive three-wheel design of the Hack Attack Baseball Pitching Machine allows the hitter to see the ball clearly all the way through the feeding motion, acceleration and release, just like with a live pitcher.

### FEATURES:

- Can be used for all levels of baseball.
- Throws fastballs, curves, sliders, split fingers and Knuckleballs.
- Pivots instantly for pop-ups, flyballs, grounders and catcher's pop-ups.
- Can be converted to softball.

Hack Attack Baseball Pitching Machine **BHABSBL**

## JUNIOR HACK ATTACK PITCHING MACHINE



The Junior Hack Attack Baseball Pitching Machine is the major-league quality training tool designed to develop serious young players.

### FEATURES:

- Great for all levels of baseball or softball.
- Throws fastballs, curves, sliders, split fingers and Knuckleballs.
- Pivots instantly for pop-ups, flyballs, grounders and catcher's pop-ups.

Junior Hack Attack Baseball Pitching Machine **BHAJRBB**

Junior Hack Attack Softball Pitching Machine **BHAJRSB**



# FOUL POLES

## 20' TWO-PIECE DESIGN FOUL POLES

**BEST SELLER!**

### Complies with NCAA Rule 2.12 for Softball Foul Poles.

Heavy-duty foul pole constructed of 3.5" OD powder-coated steel. Expanded metal wing panels are 1 1/2' x 12'. 24' poles are placed 4' into the ground. Optional galvanized steel ground sleeves available.

White 20' Two-Piece Design Foul Pole	<b>BFPOLE20CW</b>
Yellow 20' Two-Piece Design Foul Pole	<b>BFPOLE20C</b>
4' Ground Sleeve	<b>BFPSLVE20</b>



**20' WHITE**



**20' YELLOW**



**4' GROUND SLEEVE**

# CUSTOM FOUL POLE BANNERS

Spruce up your field with custom foul pole banners designed to fit your existing foul pole wings. Sold in 14 oz promesh windscreens with full graphics included.

**SOLD IN PAIRS.**

**Size:** 18" x 12'

Foul Pole Banners (Pair)

**BFLBANNER**



BASEBALL/ SOFTBALL

# FIELD BANNERS



- Outfield distance markers and other field banners are printed digitally with 14 oz. reinforced vinyl fabric.
- Available with numerals and background colors of your choice.
- Specify distances when ordering!

56" H x 20" L (12" Numerals) **BVDB12**

27" H x 36" L (14" Numerals) **BVDB14**

38" H x 56" L (24" Numerals) **BVDB24**



**CALL FOR PRICING 888-313-1303**

# HALO KITS



Turf halo kits are used on baseball and softball fields, to outline the area behind home-plate. A top-of-the-line protective halo kit will keep this area from being worn out from foot traffic and save money on grass maintenance. Halo kits are also an interesting way to display logos, team or event names, sponsors or memorials.

**FEATURES:**

- High-grade, spike resistant durable turf
- Designed to fit 36' diameter home plate areas
- Available in 5' or 10' widths and come with unitary (without shock pads) or 5mm foam backing for shock absorption.
- Extension wings available in 5' or 10' lengths.
- Available in standard green or a variety of other colors.
- All custom artwork is inlaid with colored turf.

Halos require a concrete or asphalt slab that should cure for no less than 2 weeks prior to installation

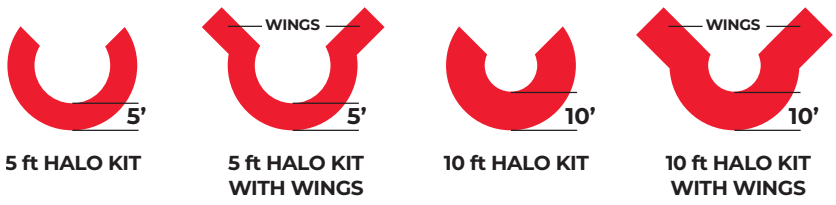

KIT	NO WINGS	WINGS
5' Home Plate Halo Kit	<b>BTHAL05</b>	<b>BTHAL05W</b>
5' Home Plate Halo Kit & Padding	<b>BTHAL05F</b>	<b>BTHAL05FW</b>
10' Home Plate Halo Kit	<b>BTHAL010</b>	<b>BTHAL010W</b>
10' Home Plate Halo Kit & Padding	<b>BTHAL010F</b>	<b>BTHAL010FW</b>
Solid Color Lettering - 5' Halo	<b>BTHCOL5</b>	
Solid Color Lettering - 10' Halo	<b>BTHCOL10</b>	
Two-Color Lettering - 5' Halo	<b>BTHLT5</b>	
Two-Color Lettering - 10' Halo	<b>BTHLT10</b>	

## TURF CLAW FB TURF ADHESIVE



Turf Claw FB is solvent-free, low odor and designed for the permanent installation of rubber backed and urethane backed carpets, underlayment and flooring.

Four-Gallon Bucket, **BTADH**  
Turf Claw FB Turf Adhesive

## OXYTURF CLEANER & DISINFECTANT



A one-step, non-acid, ready-to-use, non-abrasive, synthetic turf cleaner & disinfectant. Removes grease & grime. Kills 99.9% of germs, viruses, & bacteria. Patented stabilized Hydrogen Peroxide Technology. Oxygenated cleaning & deodorizing. Good for 4+ years of shelf life. **55 GALLONS WILL CLEAN A WHOLE FOOTBALL FIELD!**

One-Gallon Jug with Battery Powered Sprayer **TCOT001BPS**  
Six Gallon Pail **TCOT006**  
55-Gallon Drum **TCOT0055**



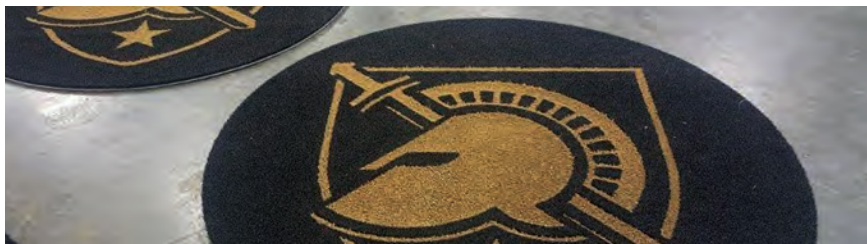

## PRO TURF MATS

Looking to step up your game with some Pro Turf? Look no further than Trigon Sports. We offer a range of bat mats to suit your needs, including home plate mats, on-deck circles and batter's box mats. Or, if you need Pro Turf for pitchers, check out our pitcher's mats. To fill a larger space, there's turf by the roll as well.

All Pro Turf mats are constructed of top quality spike-proof turf with a 5mm shock absorbing cushion.

### TURF ON DECK CIRCLES



Made of spike-proof turf with a 5mm shock absorbing cushion, our top-of-the-line on-deck circles give the upcoming batter their specific space to warm up. Mats can be customized with team logos or sponsors to help your team and field look and play like the pros.

Available in a variety of colors, or you can send your custom artwork to [sales@trigonsports.com](mailto:sales@trigonsports.com) for a quote.



- Green 6' Diameter **BTMOD6**
- Clay 6' Diameter **BTMOD6CL**
- Green 4' Diameter **BTMOD4**
- Clay 4' Diameter **BTMOD4C**
- Custom Color 6' Diameter **BTMOD4CC**
- Custom Color 6' Diameter **BTMOD6CC**

### PRO-DECK DIGITAL PRINT ON DECK CIRCLES



Constructed using an all-weather memory foam and super thick spike resistant PVC surface.

60" Pro-Deck Circle **PDODC60**

## HOME PLATE MATS

### PRO'S CHOICE



Give pitchers a clear reference with a turf home plate mat. Protect your batters box and home plate area. Available in a variety of colors to customize your practice space.

- 6'x12' Green Home Plate Mat **BTM612**
- 7'x12' Green Home Plate Mat **BTM712**

- 6'x12' Clay Home Plate Mat **BTM612C**
- 7'x12' Clay Home Plate Mat **BTM712C**
- 6'x12' Brown Home Plate Mat **BTM612BR**
- 6'x12' Black Home Plate Mat **BTM612BK**

### BATTER'S BOX MATS



Protect and prevent digouts quickly and economically with a turf batter's box mat.

- 4'x6' Baseball Batter's Box Mat **BTMB46**
- 3'x7' Softball Batter's Box Mat **BTMB37**
- 12'x12' Batting Mat - Includes two throw-down home plates **BTBM12**

### PITCHER'S MATS



Prevent time-consuming mound maintenance by covering it with a turf pitching mat during pitching practice.



- 4'x12' Pitching Mat **BTMP412**
- 6'x12' Pitching Mat **BTMB37**



# CUSTOM TURF

Pro Turf is perfect for a variety of surfaces including indoor sports facilities, outdoor sports fields, and batting cages and stands up to light steel cleat traffic. The synthetic option offers years of play, low maintenance and performance of the best kept grasses. Urethane and foam backed turf can be glued down for permanent installations on concrete or asphalt. Foam backing gives excellent shock absorbency & durability. Our proven synthetic turf surfaces are ideal for indoor and outdoor soccer fields, football fields, baseball fields, multi-purpose fields, lacrosse, and more!

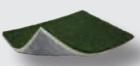
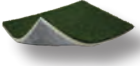
**MINIMUM ORDER OF 180 SQUARE FEET (15' X 12'). COLORS & STYLES MAY VARY**

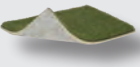
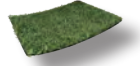
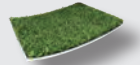
TURF STYLE	ITEM #	FACE WEIGHT	PILE HEIGHT	WIDTH	BACKING	SUGGESTED USE
	<b>BTPL357U</b>	24 oz.	1/4"	15'	Urethane	Medium-use turf.
 Standard	<b>BTPL357S</b>	24 oz.	1/4"	15'	5mm Foam	Withstands light steel cleat traffic.
	<b>BTPL3573</b>	24 oz.	1/4"	15'	3mm Foam	<b><i>MOST POPULAR TURF FOR INDOOR FACILITIES</i></b>
 Supreme	<b>BTPL705U</b>	36 oz.	9/16"	15'	Urethane	<b><i>MOST POPULAR TURF FOR OUTDOOR BATTING CAGES</i></b>
	<b>BTPL705S</b>	36 oz.	9/16"	15'	5mm Foam	High quality, durable turf. Ideal for batting cages, bullpens & dugouts. Withstands steel cleats.
 Premier	<b>BTAT740U</b>	40 oz.	3/4"	15'	Urethane	Most popular turf for sports fields and arenas. Most durable turf. Stands up to heavy steel cleat traffic.
	<b>BTAT740S</b>	40 oz.	3/4"	15'	5mm Foam	

\*Turf home plate & pitching mats should be used in high traffic & batting areas to prolong turf life. Actual colors of turf may vary from images above. All turf ships truck freight.

## TURF CLAW FB TURF ADHESIVE



Turf Claw FB is solvent-free, low odor and designed for the permanent installation of rubber backed and urethane backed carpets, underlayment and flooring.

Four-Gallon Bucket, Turf Claw FB Turf Adhesive

**BTADH**

## OXYTURF CLEANER & DISINFECTANT



A one-step, non-acid, ready-to-use, non-abrasive, synthetic turf cleaner & disinfectant. Removes grease & grime. Kills 99.9% of germs, viruses, & bacteria. Patented stabilized Hydrogen Peroxide Technology. Oxygenated cleaning & deodorizing. Good for 4+ years of shelf life. ***55 GALLONS WILL CLEAN A WHOLE FOOTBALL FIELD!***

One-Gallon Jug with Battery Powered Sprayer

**TCOT001BPS**

Six Gallon Pail

**TCOT006**

55-Gallon Drum

**TCOT005S**



# PORTABLE PITCHER'S MOUNDS

## PREP GAME MOUND



### FEATURES:

- Size: 9'L x 4'W x 6"H
- Spike-proof artificial turf with 1-Year limited warranty
- Non-slip, non-marking, rubber backing
- Lightweight, portable, high strength construction
- Shock absorbing landing area
- For pitching distances of 54' or less

Green Prep Game Mound **B417000**  
Clay Prep Game Mound **B418000**

## TAPERED PREP MOUND



### FEATURES:

- Size: 9'L x 4'W x 6"H
- Spike-proof artificial turf with 1-Year limited warranty
- Non-slip, non-marking, rubber backing
- Lightweight, portable, high-strength construction
- Shock absorbing landing area
- For pitching distances of 54' or less
- Tapered sides allow pitcher's to throw to all bases

Green Tapered Prep Mound **B817000TC**  
Clay Tapered Prep Mound **B818000TC**

## COLLEGIATE PREP PITCHER'S MOUND



### FEATURES:

- Size: 9'6"L x 4'W x 10"H
- Spike-proof artificial turf with 1-Year limited warranty
- Non-slip, non-marking, rubber backing
- Lightweight, portable, high strength construction
- Shock absorbing landing area

Green Collegiate Prep Mound **B417002**  
Clay Collegiate Prep Mound **B418002**

## PRO PRACTICE PITCHER'S MOUND

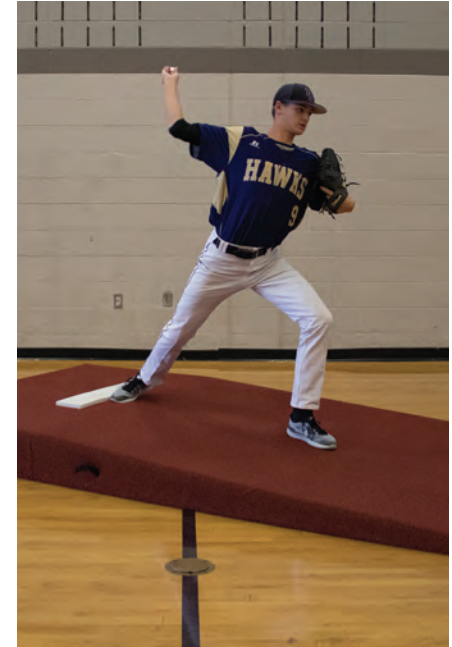

### FEATURES:

- Size: 9'6"L x 5'4"W x 10"H
- Spike-proof artificial turf with 1-Year limited warranty
- Non-slip, non-marking, rubber backing
- Lightweight, portable, high strength construction
- Shock absorbing landing area

Green Pro Practice Mound **B417003**  
Clay Pro Practice Mound **B418003**

## JUNIOR GAME MOUND



### FEATURES:

- **Size:** 9'L x 5'4"W x 6"H
- Spike-proof artificial turf with 1-Year limited warranty
- Non-slip, non-marking, rubber backing
- Lightweight, portable, high strength construction
- Shock absorbing landing area
- For pitching distances of 54' or less

Green Junior Game Mound **B417001**  
 Clay Junior Game Mound **B418001**

## TAPERED JUNIOR GAME MOUND



### FEATURES:

- **Size:** 9'L x 5'4"W x 6"H
- Spike-proof artificial turf with 1-Year limited warranty
- Non-slip, non-marking, rubber backing
- Lightweight, portable, high strength construction
- Shock absorbing landing area
- For pitching distances of 54' or less
- Tapered sides allow pitchers to throw to all bases

Green Junior Game Mound **B817001TG**  
 Clay Junior Game Mound **B818001TC**

## PRO PITCHER'S GAME MOUND



### FEATURES:

- **Size:** 11'6"L x 8'3"W
- Spike-proof artificial turf with 1-Year limited warranty
- Non-slip, non-marking, rubber backing
- Lightweight, portable, high strength construction
- Shock absorbing landing area
- For pitching distances of 60'6"

Green 8" Pro Game Mound **B817004**  
 Clay 8" Pro Game Mound **B818004**  
 Green 10" Pro Game Mound **B417004**  
 Clay 10" Pro Game Mound **B418004**

## TAPERED PRO GAME MOUND



### FEATURES:

- **Size:** 11'6"L x 8'3"W
- Spike-proof artificial turf with 1-Year limited warranty
- Non-slip, non-marking, rubber backing
- Lightweight, portable, high strength construction
- Tapered sides allow pitchers to throw to all bases

Green 8" Tapered Pro Game Mound **B807004**  
 Clay 8" Tapered Pro Game Mound **B808004**  
 Green 10" Tapered Pro Game Mound **B107004**  
 Clay 10" Tapered Pro Game Mound **B108004**

All Mounds Ship Freight.



## BATTING PRACTICE PITCHING PLATFORM



### FEATURES:

- **Size:** 7'L x 4'W
- Spike-proof artificial turf with 1-Year limited warranty
- Lightweight, portable, high strength construction
- Shock absorbing landing area
- Wheels for easy transportation on & off field

Batting Practice Pitching Platform

**B417016**

## PONY PITCHING MOUND



### FEATURES:

- **Size:** 54"L x 49"W x 6"H
- Weighs 50 lbs.
- Easy to move & store
- Fully turfed with regulation pitching rubber
- Tapered sides allow pitchers to throw to first and third base

Green Pony Pitching Mound **B417020**

Clay Pony Pitching Mound **B418020**

## JUNIOR TRAINING PITCHING MOUND



### FEATURES:

- **Size:** 42"L x 42"W x 4"H
- Great for working on mechanics & pickoffs
- Portable, lightweight design for transport anywhere

Green Junior Training Mound **B419005**

Clay Junior Training Mound **B419006**

## 2-PIECE INDOOR PITCHING MOUND



### FEATURES:

- **Size:** Collegiate - 9'6"L x 4'W x 10"H  
Pro - 9'6"L x 5'4"W x 10"H
- Two-piece design for easy moving & storage
- Interlocking sections allow bottom piece to be offset
- Will not damage or scratch gym floors

Green Collegiate 2-Piece Mound **B417030**

Clay Collegiate 2-Piece Mound **B418030**

Green Pro 2-Piece Mound **B417032**

Clay Pro 2-Piece Mound **B418032**

## JUNIOR PRO MOUND



### FEATURES:

- **Size:** 6'L x 42"W x 6"H
- Great for working on mechanics & pickoffs
- Portable, lightweight design for transport anywhere

Green Junior Pro Mound **B419002**  
Clay Junior Pro Mound **B419003**

## TAPERED JUNIOR PRO MOUND



### FEATURES:

- **Size:** 6'L x 42"W x 6"H
- Great for working on mechanics & pickoffs
- Portable, lightweight design for transport anywhere

Green Tapered Junior Pro Mound **B819002TC**  
Clay Tapered Junior Pro Mound **B819003TC**

## FOLD 'N' ROLL MOUND



### FEATURES:

- **Size:** Collegiate - 9'6"L x 4'W x 10"H  
Pro - 9'6"L x 5'4"W x 10"H
- Lightweight, portable design with spike-proof artificial turf
- Non-slip, non-marking, rubber backing
- Regulation slope for learning proper mechanics
- Folds up & rolls away in seconds

Green Collegiate Fold 'n' Roll Mound **B417002F**  
Clay Collegiate Fold 'n' Roll Mound **B418002F**  
Green Pro Fold 'n' Roll Mound **B417003F**  
Clay Collegiate Fold 'n' Roll Mound **B418003F**

## SOFTBALL PITCHING MATS



### FEATURES:

- **Sizes:** 3'W x 10'L & 3' x 3'
- Spike-proof artificial turf
- Non-slip, non-marking, rubber backing
- Permanent pitching rubber

3' x 3' Mini Pitching Mat **B417026**  
3' x 10' Pitching Mat with Stride Line **B417010**  
3'x10' Pitching Mat without Stride Line **SBPM310**



# HOME PLATES & PITCHING RUBBERS

## MAJOR LEAGUE HOME PLATE

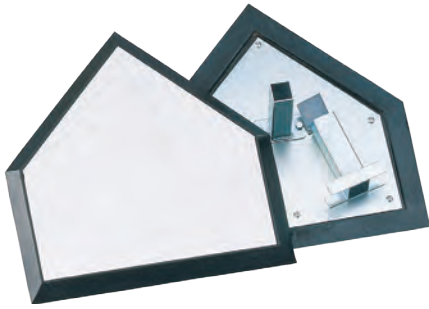

Professional anchor-style home plate. Includes ground anchor.

Major League Home Plate **BHPML**

## MOLDED RUBBER HOME PLATE



Professional anchor-style home plate. Includes ground anchor.

Molded Rubber Home Plate **BHPMR**

## LOW PROFILE HOME PLATE

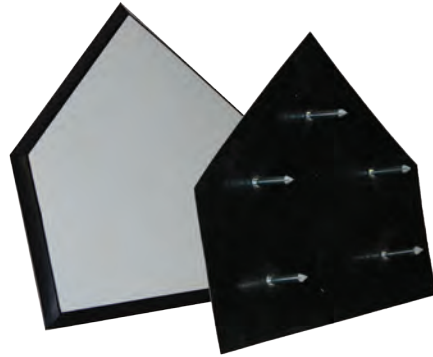

Low-profile home plate sold with ground spikes for in-ground system. Includes ground spikes.

Low Profile Home Plate **BHPSL**

## WAFFLE BOTTOM HOME PLATE

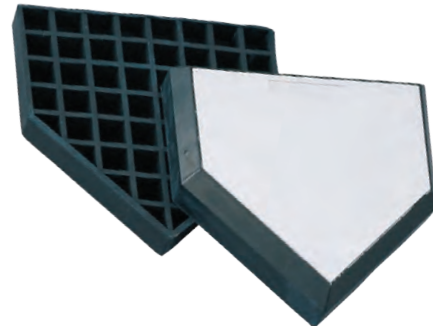

Professional bury-all home plate with waffle bottom.

Waffle Bottom Home Plate **BWBHP**

## WOOD BOTTOM HOME PLATE

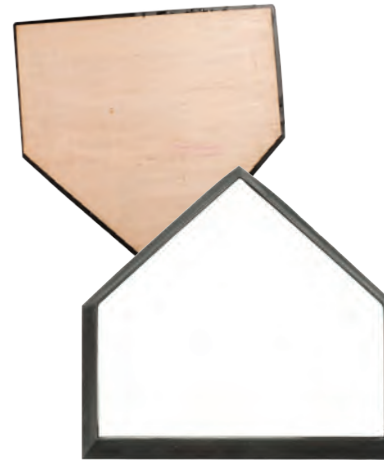

Solid wood filling with beveled outer edge.

Wood Bottom Home Plate **BHPWD**

## THROW DOWN HOME PLATE



Heavy-duty rubber home plate with waffle bottom and beveled edges.

Throw Down Home Plate **BTDHPW**

## STRIKE ZONE HOME PLATE



Heavy-duty rubber home plate with painted strike zones.

Strike Zone Home Plate **BSTRKHP**

## THROW DOWN CLEAT CLEANER

**PRO'S CHOICE**



Features 88 tough rubber bristles that quickly & easily remove dirt & debris from cleats. Holes in each corner for stake-down option.

12" x 11" Throw Down Cleat Cleaner **BHDRCC**

CALL FOR PRICING 888-313-1303

## STEP DOWN PITCHING RUBBER



Official size with solid wooden core and molded rubber cover.

6" x 24" Step Down Pitching Rubber  
4" x 18" Youth Step Down Pitching Rubber

**BPPSD**  
**BPPSDJ**

## 4-WAY PITCHING RUBBERS



Heavy-duty rubber with a hard inner support tube. Pitching rubber can be rotated for use on all four sides.

6" x 24" 4-Way Pitching Rubber  
4" x 18" Youth 4-Way Pitching Rubber

**BPP4W**  
**BPP4WJ**

## IN-GROUND ANCHOR POST



Removable in-ground anchor system for pitching plate.

***PITCHING PLATE SOLD SEPARATELY!***

Official Size In-Ground Anchor  
Youth In-Ground Anchor Post

**BIGPPAP**  
**BIGPPAPJ**

## PITCHING PLATE

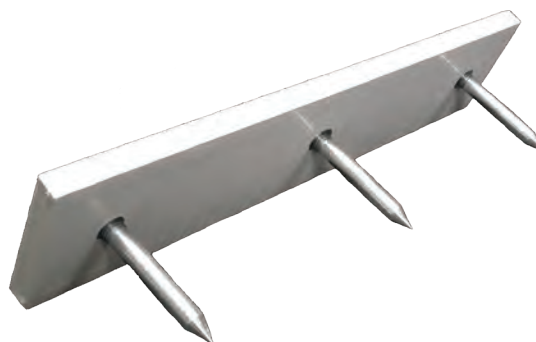

Pitcher's plate sold with ground spikes for in-ground system.

***PITCHER'S PLATE & ANCHOR SYSTEM SOLD SEPARATELY!***

6" x 24" Pitching Plate  
4" x 18" Youth Pitching Plate

**BIGPP**  
**BIGPPJ**

## BASE SETS

### HOLLYWOOD STYLE BASE SET

**BEST SELLER!**



Hollywood style professional anchored 3-base set.

**SET INCLUDES:**

- 3 Bases
- 3 Anchors
- 3 Plugs

Hollywood Style Base Set

**BMLBS**

### 18" PRO MAJOR LEAGUE BASE SET



18" Professional Major league style anchored 3-base set.

**SET INCLUDES:**

- 3 Bases
- 3 Anchors
- 3 Plugs

18" PRO Major League Base Set

**BMLBS18**



## MOLDED RUBBER BASE SET

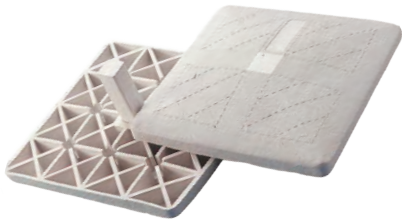

15" x 15" x 2" molded rubber bases.

### SET INCLUDES:

- 3 Bases
- 3 Anchors
- 3 Plugs

Molded Rubber Base Set

**BMRBS**

## MAGNETIC BREAK-FREE BASE

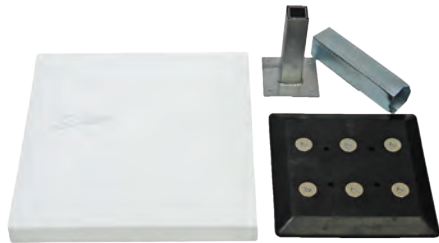

Each base includes molded rubber cover, stanchion, ground anchor with magnetic fixture and three galvanized steel plates for different resistance.

**PRICED AND SOLD PER BASE!**

Magnetic Break-Free Base

**BBMAC**

## GROUND ANCHORS

1 1/2" (Female opening) x 8" long. For all bases & plates that utilize a 1 1/2" anchor system. Sold in Sets of 3.



Ground Anchors (Set of 3)

**BMLANCH**

## PRO DOUBLE FIRST BASE



Professional Double First Base features one-piece molded rubber construction. Comes complete with ground anchors and plugs.

**Size:** 30" x 15" x 2.5"

Pro Double First Base

**BDFBML**

## THROW DOWN BASE SET



Heavy-duty rubber bases with a waffle bottom and beveled edges. Set includes 3 bases.

Throw Down Base Set

**BWBBS**

## DIGOUT TOOL



Features steel construction with wooden handle. Easily cleans dirt from ground anchors.

Digout Tool

**BDOUT**

## BASE CADDY



**NEW!**

Heavy duty transport caddy for 1 set of bases and dig out tool. Constructed of all steel components and no flat wheels. Will be able to transport bases up to 18" square that use square hollow stem. Bases not included.

Base Caddy

**BBCAD**

## FLAT RUBBER THROW DOWN BASE SET



Durable flat rubber base set. Set includes 3 bases, pitching rubber and home plate.

Flat Rubber Throw Down Base Set

**BTDSO**

## FEATHERED BASE PLUGS



Big league base plugs fit snug to keep dirt & debris out of your base anchors. Feathered design allows drags to be pulled directly over plugs without damage.

Feathered Base Plugs  
(Set of 4)

**BFPLUGN**

## RUBBER BASE PLUGS

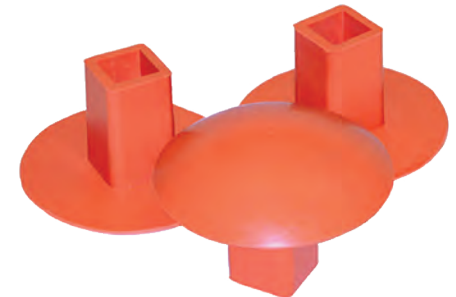

Rubber base plugs fit snug to keep dirt & debris out of your base anchors.

**PRICED AND SOLD PER PLUG!**

Rubber Base Plug

**BDPLUG**

# DIRT PRODUCTS

10 BAG MINIMUM ON ALL DIRT - MIX AND MATCH

## MOUND CLAY



High-density red clay material used in high wear areas on the mound (toe and landing areas) or in the batter's boxes. Screened at 1/2" to remove debris and "sift" the material. Available in 50 lb. bags or bulk. Please call for bulk pricing.

Mound Clay **MCLAY**

## ATHLETIC FIELD SURE DRY



Calcined clay material native to the North Mississippi area. Absorbs moisture and helps reduce slick spots on the mound, plate areas or around the bases. Available in 50 lb. bags or bulk. Please call for bulk pricing.

Sure Dry **SUREDRY**

## ALL PRO PLUS CHALK



High-quality marble dust for marking athletic fields. Complies with the "Safe Use" requirements of the Consumer Safety Act and NCAA rules for athletic marking materials. Available in 50 lb. bags.

All Pro Plus Chalk **CHALK**



# FIELD CONDITIONERS

## FIELD CONDITIONER APPLICATION FOR SKINNED AREAS

Field Size	Infield Type	Quantity
<b>Baseball</b>		
95 Foot Radius	Grass Infield Only	40-80 Bags
95 Foot Radius	Grass Infield (6' Baseline)	60-80 Bags
<b>Softball</b>		
65 Foot Radius	Skinned w/ Grass Apron	40-80 Bags
65 Foot Radius	All Skinned	80-120 Bags
<b>Youth</b>		
50 Foot Radius	Grass Infield Only	40 Bags
50 Foot Radius	Grass Infield - 4' Baseline	50 Bags
50 Foot Radius	All Skinned	80-120 Bags

Field conditioner absorbs excess moisture to keep field consistently playable. Field conditioners can be used to help reduce compaction in high traffic areas in your turf grass or as a top dressing material for your football, soccer, and outfield turf grass. Available in two particle sizes, 516 and 816. Available in 50 lb. bags or bulk.

Mule Mix 516 Conditioner **MULE516**  
 Mule Mix 816 Conditioner **MULE816**



## PUDDLE PILLOW



Remove small puddles on your field quickly. Place pillows in standing water and when pillows are saturated, squeeze out absorbed water. Can be reused multiple times! 10 pillows per case. Each pillow can absorb up to 3.5 liters of water.

Puddle Pillow **PILLOW**



# FIELD MAINTENANCE

## PRO FIELD RAKE

**BEST SELLER!**



All aluminum construction designed for institutional use. Durable and lightweight with oversized teeth. Use one side to rake and the other side to level.

- 24" Head-width Pro Field Rake **BRAKE24**
- 36" Head-width Pro Field Rake **BRAKE36**
- 48" Head-width Pro Field Rake **BRAKE48**

## DUAL PURPOSE RAKE



Features two teeth designs. Short teeth for breaking up hard clay, while the long teeth are for wet clay and general raking. 66" powder-coated aluminum handle with 6" non-slip vinyl grip provides extra comfort.

- 24" Head-width Dual Purpose Rake **BRAKE24DP**
- 36" Head-width Dual Purpose Rake **BRAKE36DP**

## PRO TURF LUTE RAKE



Lightweight design is perfect for spreading dirt, gravel or for grading soil. Comes with 82" powder-coated aluminum handle in 24" or 36" head widths.

- 24" Head-width Pro Turf Lute Rake **BRAKELT24**
- 36" Head-width Pro Turf Lute Rake **BRAKELT36**

## INFIELD LIP BROOM



Heavy-duty 28" head with scarifying edge and two rows of removable bristles. Powder-coated aluminum handle is bent to reduce back strain.

- Infield Lip Broom **BLPBROOM**

## 7' DOUBLE PLAY MONSTER DRAG BROOM



7' head with A-frame padded handle with hooks for hanging. Short teeth for breaking up hard, dry clay.

- 2 Rows of Bristles w/ Scarifying Teeth **BMBROOM2**
- 3 Rows of Bristles **BMBROOM3**

## COCOA/MOUND MOP



High-quality 1" thick cocoa material with a heavy-duty vinyl backing. Excellent for mounds and areas that require tight maneuvering.

- 24" x 16" Cocoa Mound Mop **BCMOP24**

### STEEL FLEX DRAG MOP

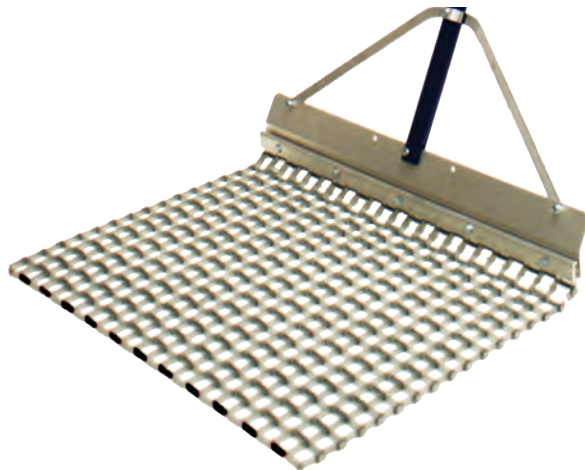

Designed to finish grooming small areas. Powder-coated aluminum handle is 66" long with aluminum head and wrap around bracing.

24" x 18" Steel Flex Drag Mop **BSFDM**

### FINISHER MOP

**NEW!**



All rubber finishing mop for mounds and other areas that require tight maneuvering.

24" x 18" Finisher Mop **BFINMOP**

### NON-ABSORBENT ROLLER SQUEEGEE



GREAT FOR TENNIS

36" head with 60" aluminum handle. Great for pushing water off of hard surfaces.

Roller Squeegee **TNRLR36**  
Replacement Roller **TNRLR36R**

### DIRT TAMP



Designed for rugged use. No more broken handles with our solid welded steel construction. 48" Handle with 12" solid vinyl grip.

Dirt Tamp **BTAMP10**

### LOOP HOE



Double knife edge rocks back and forth with a push/pull motion. Fiberglass handle.

Loop Hoe **BLPHOE**

### SIFTING SCOOP



Designed to finish grooming small areas. Powder-coated aluminum handle is 66" long with aluminum head and wrap around bracing.

14" x 17" Sifting Scoop **SSCOOP**



# DRAG MATS

## ALL STEEL DRAG MATS

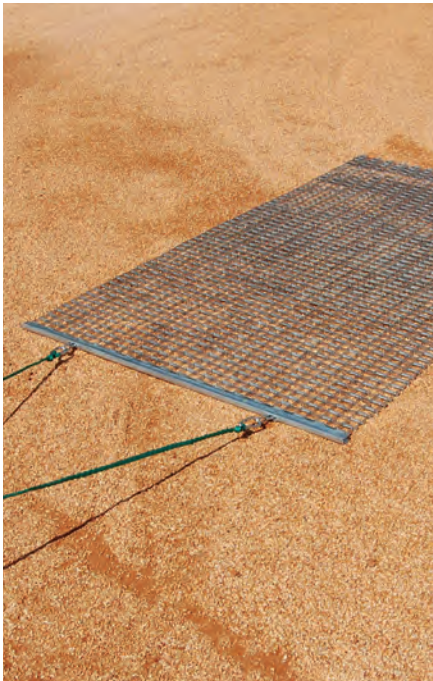

All steel drag mats come complete with drag bar and rope with handle. Perfect for grooming and general field maintenance.

- 3'W x 5'L Drag Mat **BDMAT35**
- 6'W x 3'L Drag Mat **BDMAT63**
- 6'W x 6'L Drag Mat **BDMAT66**

## MONSTER DRAG MATS

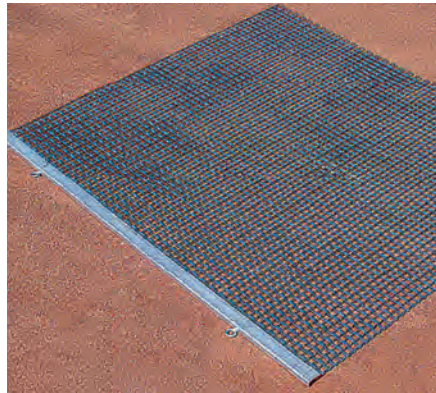

Deluxe mat construction utilizes 1/2" x .062 mesh with 6 gauge connecting rods, each welded on end. Includes angle iron front with welded eye bolts for you to attach your chain. Mat cannot separate & will last for years!

- 6'W x 4'L Drag Mat **BDMATM64**
- 9' Drag Chain **CHAIN**

## RIGID DRAG MATS

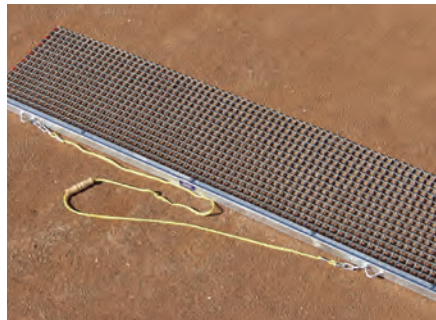

1" x 1" mesh, 13 gauge galvanized connecting rods. Mesh is rotated 90 degrees to make mat rigid. Rigid mats can **NOT** be rolled up for storage.

- 4'W x 18"L Rigid Drag Mat **BDMR418**
- 6'W x 18"L Rigid Drag Mat **BDMR618**

## STEEL BOLT DRAG

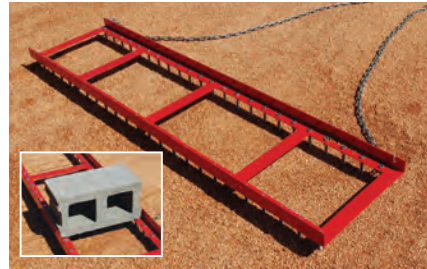

Utilizes 46 staggered heavy grade bolts for heavy dragging. Includes pull chain that can be adjusted by moving to other pre-drilled holes. Additional weight can be added with cement blocks (not included).

- Size:** 6' x 17"
- Steel Bolt Drag **BDRAGDR**
- Replacement Bolts (Set of 46) **BDBOLTS**

## FINISHER MAT

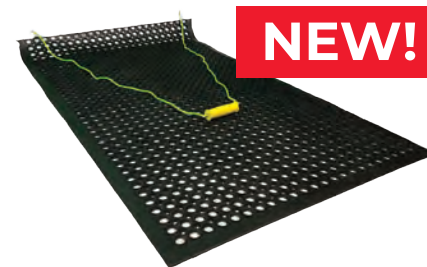

All rubber 'finisher' drag mat provides a great alternative to steel drag mats or to use in conjunction with your steel drag for a smooth surface. Quick drag down your base paths. Mat includes steel front drag bar and tow rope with handle. Easily rolls for transport and storage.

- 3'x5' Finisher Mat **FINMAT35**
- 5'x3' Finisher Mat **FINMAT53**
- 6'x3' Finisher Mat **FINMAT63**
- 6'x6' Finisher Mat **FINMAT66**

## 6' WIDE LEVELING BAR



Cuts out high spots and allows attached drag mat to redistribute and level infield playing surface.

- 6' Wide Leveling Bar **BLVLBAR**

## COCOA DRAG MATS



Features a 1" thick natural fiber surface with a heavy duty rubber backing. Perfect for smoothing out the playing surface after a heavy drag or between innings. Includes drag bar and pull rope with plastic handle. Drag bar can be moved to either side of mat to prolong use. Holes are self-drilled to allow for preferred placement of drag bar.

- 4'W x 2'L Cocoa Drag Mat **BCMAT42**
- 6'W x 2'L Cocoa Drag Mat **BCMAT62**
- 6'W x 4'L Cocoa Drag Mat **BCMAT64**
- 9' Drag Chain **CHAIN**

# DRY LINE MARKERS

## PROCAGE™ 100 LB CAPACITY DRY LINE MARKER



- Galvanized steel with green powder-coated finish.
- Galvanized steel axle and dispensing wheel.
- White guide strip on lid for proper alignment.
- 4 Heavy-duty no-flat turf tires.
- Hand lever is adjustable for 2" or 4" chalk lines.

100 Lb. Capacity Dry Line Marker (Pneumatic Tires) **BDLM100**

## PROCAGE™ 35 LB CAPACITY DRY LINE MARKER



- Galvanized steel with green powder-coated finish.
- Galvanized steel axle and dispensing wheel.
- White guide strip on lid for proper alignment.
- 2 Heavy-duty hard wheels.
- Hand lever is adjustable for 2" or 4" chalk lines.

35 Lb. Capacity Dry Line Marker (Pneumatic Tires) **BDLM35**

## PROCAGE™ 50 LB CAPACITY DRY LINE MARKER



- Galvanized steel with green powder-coated finish.
- Galvanized steel axle and dispensing wheel.
- White guide strip on lid for proper alignment.
- Available with heavy-duty no-flat turf tires or heavy-duty hard wheels.
- Hand lever is adjustable for 2" or 4" chalk lines.

50 Lb. Capacity Dry Line Marker (Pneumatic Tires) **BDLM50P**

50 Lb. Capacity Dry Line Marker (Hard Wheels) **BDLM50**

## FOLDABLE BATTER'S BOX TEMPLATE



This aluminum template has a light-weight design that is foldable for easy transport & storage. Simply align handle with home plate & press down on template to leave 2" pattern for chalking.

- 4'x6' Foldable Template **BFTMP46**
- 3'x6' Foldable Template **BFTMP36**
- 3'x7' Foldable Template **BFTMP37**



## BATTER'S BOX TEMPLATE



Heavy-duty 1" square galvanneal steel construction features a home plate guide for easy alignment. Available in 4'x6' (baseball), 3'x7' (softball) and 3-way adjustable (4'x6', 3'x6', 3'x7').

- 4'x6' Baseball Template **BTMPL46**
- 3'x7' Softball Template **BTMPL37**
- 3-Way Adjustable Template **BTMPLA**



**FOR CHALK, SEE PAGE 28**



# FIELD MARKING

## ATHLETIC FIELD STRIPERS



Fold-up handle. Features four large heavy-duty wheels. Adjustable 2"-4" stripe. Has storage for 12 extra cans of paint. Ideal for grass and dirt fields.

Standard Model (right):

- Four heavy-duty 10" wheels

NEW Deluxe Model (left):

- Four large pneumatic style no-flat wheels

Athletic Field Striper

**BLMSTRIPE**

Deluxe Athletic Field Striper

**BLINERX**

## AEROSOL FIELD PAINT



Fast-drying, water resistant. Universal tip fits most machines. 12 (20oz.) cans per case. Available in white, red, yellow, purple, royal, navy, black, orange, maroon, turf green, brown, silver, pink & gold.

White Aerosol Field Paint

**LINEW**

Color Aerosol Field Paint

**LINEC**

## STRING WINDERS



String line retrieval and storage device complete with 500' of #36 heavy nylon string. Winder makes field lining a breeze & ensures straight lines!

Deluxe Model Features:

- String line retrieval
- Storage device
- 500' of #36 heavy nylon string
- Handle
- Two stakes
- Stand

Standard String Winder

**BSTRING**

Deluxe String Winder

**BDSTRING**

## PROLINE BASEBALL FIELD LAYOUT SYSTEM

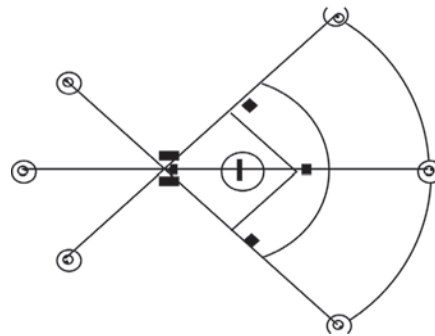

Quickly mark any size baseball field. Measure once and easily restripe year after year. Includes 6 sockets, white plugs and 600' of cord.

Proline Baseball/Softball Field Layout System

**BLS12**

## PROLINE LACROSSE FIELD LAYOUT SYSTEM

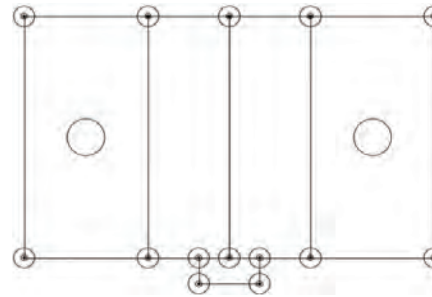

Quickly and easily layout your lacrosse field with this easy to use kit. Measure once and easily re-stripe year after year. Includes 14 sockets, starter tool & 600' of twine.

Proline Lacrosse Field Layout System

**LLS14**

## PROLINE SOCCER FIELD LAYOUT SYSTEM

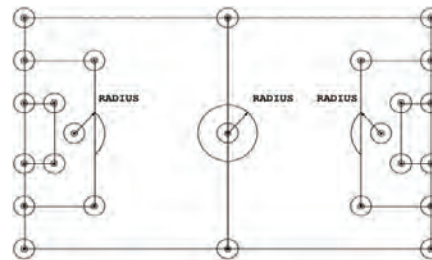

Quickly Mark any size soccer field. Measure once and restripe year after year. Includes 25 locators, starting tool and 600' of cord.

Proline Soccer Field Layout System

**SLS25**

## PROLINE FOOTBALL FIELD LAYOUT SYSTEM

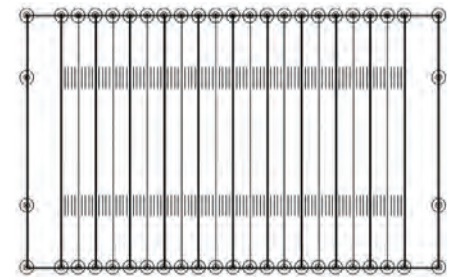

Locate measurements and quickly mark any size football field. If marked lines become too faded to follow for restriping, locators remain in place. Restriping the faded area, and your marked lines are relocated exactly. Additional markers available in 6 and 10-piece sets can be used to locate inbound lines, coaches' boxes and more. All sets include 50 locators, starting tool and 600' roll of cord.

Football Field Layout System

**FLS50**

# IRRIGATION

## 1" FIELD HOSES



Featuring outstanding durability and performance, Trigon's field hose series offers a wide selection of precision engineered and manufactured hoses. Made from reinforced rubber and synthetic yarns, these hoses provide a variety based on your application and budget.

- |                   |                |
|-------------------|----------------|
| 100' Hose - GREEN | <b>BPFH100</b> |
| 50' Hose - GREEN  | <b>BPFH50</b>  |
| 100' Hose - CLEAR | <b>BCFH100</b> |
| 50' Hose - CLEAR  | <b>BCFH50</b>  |
| 50' Hose - RED    | <b>BRFH50</b>  |
| 75' Hose - RED    | <b>BRFH75</b>  |
| 100' Hose - RED   | <b>BRFH100</b> |
| 150' Hose - RED   | <b>BRFH150</b> |



## DIAMOND PUMP

Great for removing water from any playing surface. Unit pumps 20 gallons per minute and prevents debris from being drawn in. Additional hose sections & replacement parts are available.

Diamond Pump **BDPUMP**

## HEAVY DUTY HOSE CARTS



Designed for the Sports Turf Professional. Maximum durability, no flat tires, great leverage to make it easy to bring a hose on and off a field with ease! Shown with optional tool box.

### FEATURES:

- Holds Over 100 Feet of 1" Hose or 125 Feet of 3/4" Hose
- Heavy Duty Hand Truck Frame Easily Maneuvers Hose On and Off the Field
- Solid Rubber Wheels Never Go Flat and Heavy Duty Bearings to Ensure Durability
- Quick Coupler Key Holder Keeps Out of the Way and Accessible
- Includes a 10 Foot Ultramax Blue Leader Hose
- Tool Box Available as Optional Add-On
- Available in 1" or 3/4" Hose Versions

Heavy Duty Hose Cart **HOSECART**  
Hose Cart Tool Box **HOSEBOX**

## PUDDLE PILLOW

Remove small puddles on your field quickly. Place pillows in standing water and when pillows are saturated, squeeze out absorbed water. Can be reused multiple times! 10 pillows per case. Each pillow can absorb up to 3.5 liters of water.



Puddle Pillow **PILLOW**

## PRO SPRAY NOZZLES & COUPLERS



UltraMAX nozzles excel in high demand areas like greens/tees, infield conditioning, and equipment/stadium wash downs. All models offer multi-pattern spray: Fog, Jet Stream, Fan

- |                                    |                  |
|------------------------------------|------------------|
| A. 3/4" Variable Flow Nozzle       | <b>BPNMAG</b>    |
| B. UltraMAX 1" Economy Plus Nozzle | <b>BPNUPE</b>    |
| C. UltraMAX 1" Premium Nozzle      | <b>BPNUP</b>     |
| D. Quick Coupler Valve             | <b>BQUICKV</b>   |
| E. Quick Coupler Key               | <b>BQUICKKEY</b> |
| F. Swivel Elbow                    | <b>BSWIVELB</b>  |

## SUPER SOPPER



Quickly remove standing water from your playing surface. Can be used on grass, tennis courts or artificial turf. Features an outer foam pad that quickly absorbs water and squeezes it into holding tank.

- |                                  |                 |
|----------------------------------|-----------------|
| Mackerel Super Sopper (7 Gallon) | <b>MACKEREL</b> |
| Dolphin Super Sopper (14 Gallon) | <b>DOLPHIN</b>  |



# TURF/GROWTH COVERS



## GROWTH COVERS & WINTER TURF BLANKETS

Maintain thicker, greener and healthier grass all year! Made of 3 oz. 100% woven polypropylene, Growth Covers/Winter Turf Blankets, feature a translucent material that allows 90% light to pass through in order to help with optimal grass growth and protection year-round. The border of the covers has a 6-ply, double stitched hem with brass grommets spaced 5' apart.

**Includes sod staples. 9" safety yellow stakes available and sold separately**

### As a winter turf blanket:

- Provides turf protection from harsh winter conditions.
- Shields your turf from wind, ice, snow, and frost.
- Also prevents unwanted foot and animal traffic.

### As a growth cover:

- Promotes faster growth and green-up in the spring.
- Retains heat and moisture to naturally warm the soil and air temperature.
- Allows sunlight to pass through the cover.



**OPTIONAL SAFETY STAKE**  
SOLD SEPARATELY

- 10'x50' Turf/Growth Cover
- 12'x50' Turf/Growth Cover
- 24'x50' Turf/Growth Cover
- 30'x50' Turf/Growth Cover
- 36'x50' Turf/Growth Cover
- 50'x50' Turf/Growth Cover
- 50'x60' Turf/Growth Cover
- 60'x60' Turf/Growth Cover
- 60'x66' Turf/Growth Cover
- 60'x75' Turf/Growth Cover
- 80'x105' Turf/Growth Cover
- 84'x90' Turf/Growth Cover
- 84'x110' Turf/Growth Cover
- 90'x90' Turf/Growth Cover
- 110'x110' Turf/Growth Cover
- Optional 9" Safety Stake

- GC1050**
- GC1250**
- GC2450**
- GC3050**
- GC3650**
- GC5050**
- GC5060**
- GC6060**
- GC6066**
- GC6075**
- GC80105**
- GC8490**
- GC84110**
- GC9090**
- GC110110**
- GCSTY9**

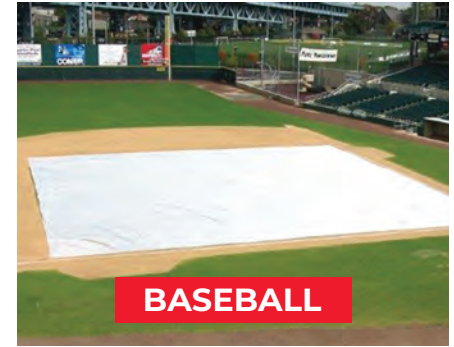

**BASEBALL**



**FOOTBALL**



**SOCCER**



**GOLF**

# SPOT COVERS

## HEAVY-DUTY SPOT COVERS



### CUSTOM SIZES & COLORS AVAILABLE

Heavy-duty covers are constructed of a high grade 18 oz. vinyl. Grommets are spaced 3-4' around perimeter. Ground stakes included.

SIZE	DARK GREEN	CUSTOM COLOR
Complete Set - (3) 10'x10', (1) 20', (1) 26'	<b>BHSPOTS</b>	<b>BHSPOTSC</b>
Set of 3 10'x10' Base Covers	<b>BHSPOT10</b>	<b>BHSPOT10C</b>
12' Circular Base Cover	<b>BHSPOT12</b>	<b>BHSPOT12C</b>
18' Circular Mound Cover	<b>BHSPOT18</b>	<b>BHSPOT18C</b>
20' Circular Mound Cover	<b>BHSPOT20</b>	<b>BHSPOT20C</b>
26' Circular Home Plate Cover	<b>BHSPOT26</b>	<b>BHSPOT26C</b>
30' Circular Home Plate Cover	<b>BHSPOT30</b>	<b>BHSPOT30C</b>

**Custom Colors:** White, Dark Green, Red, Black, Royal Blue, Kelly Green, Grey, Navy Blue, Maroon, Purple, Orange, Yellow & Carolina Blue.



## LIGHT-DUTY SPOT COVERS



Light-duty covers are constructed of a quality 6 oz. poly. Grommets are spaced 3-4' around perimeter. Ground stakes included.

Complete Set - (3) 10'x10', (1) 20', (1) 26' - 59lbs	<b>BSPOTS</b>
Set of 3 10'x10' Base Covers - 13lbs	<b>BSPOT10</b>
18' Circular Mound Cover - 18lbs	<b>BSPOT18</b>
20' Circular Mound Cover - 22lbs	<b>BSPOT20</b>
26' Circular Home Plate Cover - 24lbs	<b>BSPOT26</b>
30' Circular Home Plate Cover - 30lbs	<b>BSPOT30</b>

## WEIGHTED SPOT COVERS



Available in a high-grade 18 oz. vinyl (13 color options) or a 6 oz. poly (Silver/White). Weighted chain sewn-in hems allows for easier rolling and folding. Covers stay in place without stakes or sandbags.

**Custom Colors:** White, Dark Green, Red, Black, Royal Blue, Kelly Green, Grey, Navy Blue, Maroon, Purple, Orange, Yellow & Carolina Blue.



SIZE	HD 18 OZ VINYL	6 OZ POLY (SILVER/WHITE)
10'x10' Square	<b>BHVYCV10</b>	<b>BLTCV10 (3 PIECE SET)</b>
12' Circular	<b>BHVYCV12</b>	<b>BLTCV12</b>
18' Circular	<b>BHVYCV18</b>	<b>BLTCV18</b>
20' Circular	<b>BHVYCV20</b>	<b>BLTCV20</b>
26' Circular	<b>BHVYCV26</b>	<b>BLTCV26</b>
30' Circular	<b>BHVYCV30</b>	<b>BLTCV30</b>



# FIELD COVERS & STORAGE

## FULL FIELD COVERS



3-Year Warranty! Made from 7 oz. high-strength, long-lasting, reinforced PVC and polyethylene fabrics. Double-stitched on all four sides with brass grommets placed evenly around the perimeter every 10'. Cover is fabricated in one piece with welded seams. Reinforced corners and web handles located around perimeter. Our Full Field covers are waterproof and rot resistant.

**INCLUDES 50 SANDBAGS! CALL FOR CUSTOM QUOTE!**

**Color: White/Silver**

SIZE	PURPOSE	WEIGHT	ITEM#
170' x 170'	Baseball Full Field Cover	1,200 lbs	<b>BTARP170</b>
160' x 160'	Baseball Full Field Cover	1,090 lbs	<b>BTARP160</b>
120' x 120'	Softball Full Field Cover	615 lbs	<b>BTARP120</b>
90' x 90'	Little League Full Field Cover	400 lbs	<b>BTARP90</b>

### ACCESSORIES

(12) 9" Heavy-Duty Anchor Stakes	<b>BTARPAS</b>
(20) Poly Sand Bags 14"x25"	<b>BTARPPSB</b>
Vinyl Sand Bag 9"x20"	<b>BTARPVSB</b>
White Roll Repair Tape 3"x60"	<b>BTARPRT</b>

**FIELD COVERS INCLUDE 50 SANDBAGS**



## STORAGE ROLLERS



Heavy-duty 28" double wall corrugated HDPE rollers for storing your full field covers. 34' & 40' rollers come in two pieces for easy assembly on the field with hardware included. **Actual shipping charges apply.**

20' Long (90'x120' covers, 240lbs)	<b>BRLR20</b>
34' Long (160' covers, 400lbs)	<b>BRLR34</b>
40' Long (170' covers, 500lbs)	<b>BRLR40</b>

## ECONOMY STORAGE ROLLER COVERS

Economy covers are constructed of heavy field tarp material. Silver/white color only!

20' Economy Roller Cover	<b>BESRCV20</b>
34' Economy Roller Cover	<b>BESRCV34</b>
40' Economy Roller Cover	<b>BESRCV40</b>

## HEAVY-DUTY STORAGE ROLLER COVERS

Heavy-duty 18 oz. vinyl cover comes in royal, navy, dark green, black, white, gray, burgundy, brown, yellow, red, or tan. Lettering optional. Custom designs available. Please specify color.



20' Heavy-Duty Roller Cover	<b>BSRCV20</b>
34' Heavy-Duty Roller Cover	<b>BSRCV34</b>
40' Heavy-Duty Roller Cover	<b>BSRCV40</b>
Block-Style Lettering One Color, 14"	<b>BSRCVLTR</b>



# FIELD PROTECTORS

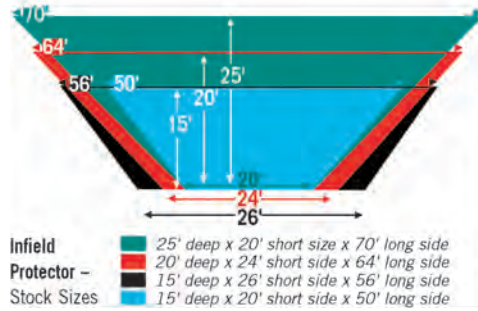
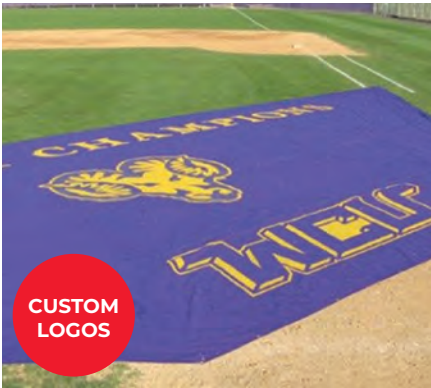

## PROMESH INFIELD PROTECTORS

Heavy-duty mesh infield covers protect your natural turf in front of the batting cage and other high-wear areas. Premium mesh is the most durable mesh available! Strong enough to withstand spike cleats!

### STANDARD 9OZ MESH

**3-YEAR WARRANTY**

DIMENSIONS	ITEM#
15'x20'x50'	<b>BVCM50</b>
15'x26'x56'	<b>BVCM60</b>
20'x24'x64'	<b>BVCM64</b>
25'x20'x70'	<b>BVCM70</b>

Available in: Dark Green, Black and Royal Blue.



### PREMIUM 14OZ MESH

**5-YEAR WARRANTY**

DIMENSIONS	ITEM#
15'x20'x50'	<b>BVCP50</b>
15'x26'x56'	<b>BVCP60</b>
20'x24'x64'	<b>BVCP64</b>
25'x20'x70'	<b>BVCP70</b>

Available in: Dark Green, Red, Black, Royal Blue, Kelly Green, Grey, Navy Blue, Maroon, Purple, Orange, Yellow, Carolina Blue & White.



## PROMESH TWO-PIECE CAGE COLLAR



Heavy-duty cage collar is made from our ProMesh 14 oz. vinyl poly making it the thickest, longest lasting, most durable material on the market! Perfect for protecting field/home plate areas during batting practice. Will stand up to steel spike traffic. Allows more air & water passage than closed fabrics. Collar will not hold water. Sewn borders with grommets on all sides. Can be customizable with letters & logos.

**Size:** 20' x 18' x 8' w/ 12' home plate radius.

Available in: Dark Green, Red, Black, Royal Blue, Kelly Green, Grey, Navy Blue, Maroon, Purple, Orange, Yellow & Carolina Blue.



Promesh Two-Piece Cage Collar

**BIFMP**



# IN-GROUND TEMPORARY FENCING



Fencing features a soft, durable mesh fabric with sewn sleeve sections easy installation of poles. Permanent reinforced vinyl pockets spaced every 10' provides ultimate stability. Slide poles into vinyl pockets and drive directly into ground or slide into optional ground sleeves. Poles feature a locking top cap that securely attaches to the top of fencing. Fence poles are black, high gloss PVC, 5' tall. Poles can be rolled up for easy storage. Fence packages include auger and tape measure. All fencing ships truck freight.

## STANDARD FENCING



FENCING ONLY	HEIGHT	LENGTH	POLES
<b>BMESH50</b>	48"	50'	0
<b>BMESH100</b>	48"	100'	0
<b>BMESH150</b>	48"	150'	0
FENCE PACKAGE			
<b>BDTEMP50</b>	48"	50'	6
<b>BDTEMP100</b>	48"	100'	11
<b>BDTEMP150</b>	48"	150'	16
HOME RUN FENCE PACKAGE			
<b>BDTEMP200</b>	48"	314'	33
<b>BDTEMP300</b>	48"	471'	49

## PREMIUM FENCING



FENCING ONLY	HEIGHT	LENGTH	POLES
<b>BPMESH50</b>	48"	50'	0
<b>BPMESH100</b>	48"	100'	0
<b>BPMESH150</b>	48"	150'	0
PRO FENCE PACKAGE			
<b>BPOF50</b>	48"	50'	6
<b>BPOF100</b>	48"	100'	11
<b>BPOF150</b>	48"	150'	16
HOME RUN FENCE PACKAGE			
<b>BPOF200</b>	48"	314'	33
<b>BPOF300</b>	48"	471'	49

## GROUND SLEEVES

Optional ground sleeves are 12" black, high gloss PVC with pointed tips for easy installation. Ground sleeve caps are included when poles are removed. ***GROUND SLEEVES ARE NOT INCLUDED IN FENCE PACKAGES!***

### OPTIONAL GROUND SLEEVES

1	<b>BTFGS</b>
6	<b>BTFGS6</b>
11	<b>BTFGS11</b>
16	<b>BTFGS16</b>
33	<b>BTFGS33</b>
49	<b>BTFGS49</b>

## INDIVIDUAL COMPONENTS

TempFence Pole	<b>BTPOLE</b>
Reinforced End Pole	<b>BRPOLE</b>
TempFence Ground Sleeve	<b>BTFGS</b>
PVC Driving Tool	<b>BPVCT</b>
12" Auger Bit	<b>BAUG12</b>
Heavy-Duty Rubber Mallet	<b>BMALLET</b>

## EASY SET UP & TAKE DOWN!



1. INSERT POLES INTO FENCING.



2. ATTACH FENCE TO TOP CAP.



3. MARK & DRILL HOLES



4. PLACE POLES & SOCKETS IN HOLES.



5. ROLL UP FENCING WITH POLES IN PLACE.

CALL FOR PRICING 888-313-1303

# ABOVE GROUND TEMPORARY FENCING



Use your portable fencing on synthetic turf, asphalt, concrete, or natural turf. No holes required! Durable, yet soft and easy-to-handle. Quick and easy to set-up and take down. Weighted for each pole to stand up to wind.

## STANDARD ABOVE GROUND FENCING

### WOVEN LOOPS

ITEM#	HEIGHT	LENGTH	POLES
BDTEMP50AG	48"	50'	6
BDTEMP100AG	48"	100'	11
BDTEMP150AG	48"	150'	16
BDTEMP200AG	48"	314'	33
BDTEMP300AG	48"	471'	49

## PREMIUM ABOVE GROUND FENCING

### VINYL SLEEVE POCKETS

ITEM#	HEIGHT	LENGTH	POLES
BPOF50AG	48"	50'	6
BPOF100AG	48"	100'	11
BPOF150AG	48"	150'	16
BPOF200AG	48"	314'	33
BPOF300AG	48"	471'	49

## INDIVIDUAL COMPONENTS

2' Long Weighted Base Pipe	<b>BTFWP2</b>	Hitch Pin	<b>BTFHP</b>
4' Long Weighted Base Pipe with 4-way Fitting	<b>BTFWP4</b>	C-Clamp	<b>BTFCL</b>

# WHICH FENCE KIT DO YOU NEED?

DISTANCE FROM HOME TO CENTER	APPROXIMATE FENCE LENGTH
50'	79'
100'	157'
150'	236'
200'	314'
300'	471'



## SOFTBALL & LITTLE LEAGUE

### KIT INCLUDES:

- 314' of fencing in one piece in blue, green or red.
- 33 fence poles
- 12" auger
- Tape measure

Standard In-Ground	<b>BDTEMP200</b>
Premium In-Ground	<b>BPOF200</b>
Standard Above Ground	<b>BDTEMP200AG</b>
Premium Above Ground	<b>BPOF200AG</b>

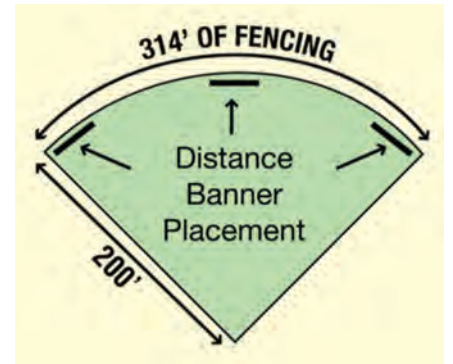

## BASEBALL & MEN'S SOFTBALL

### KIT INCLUDES:

- 471' of fencing in one piece in blue, green or red.
- 49 fence poles
- 12" auger
- Tape measure

Standard In-Ground	<b>BDTEMP300</b>
Premium In-Ground	<b>BPOF300</b>
Standard Above Ground	<b>BDTEMP300AG</b>
Premium Above Ground	<b>BPOF300AG</b>

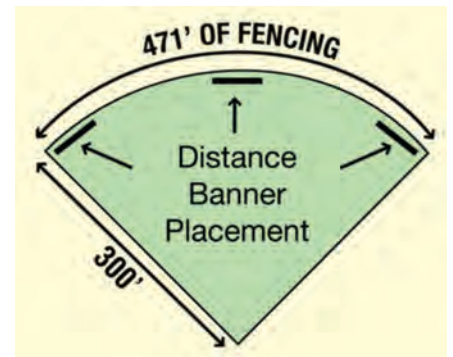



# SAFETY FENCE CAP

## FENCE CROWN/POLY CAP



Protect your players against injury from the top of any chain link fence while you make your ballpark look good. 4<sup>1/2</sup>" diameter corrugated plastic tubing outlines your ballpark and with our polyester windscreen, gives you that "big league" look. Rolls are pre-slit for easy installation. Ships truck freight. Actual freight charges apply.

**Available in:** Yellow, Black & Yellow Gold.

- |                       |                 |
|-----------------------|-----------------|
| Yellow 250' Roll      | <b>BFC250Y</b>  |
| Yellow 100' Roll      | <b>BFC100Y</b>  |
| Gold Yellow 250' Roll | <b>BFC250GY</b> |
| Gold Yellow 100' Roll | <b>BFC100GY</b> |
| Black 250' Roll       | <b>BFC250B</b>  |
| Black 100' Roll       | <b>BFC100B</b>  |

## SAFETY TOP CAP



Protects against chain link injuries, increases visibility and adds beauty to any field. Please specify color when ordering. Comes 80 linear feet per box. 10 pieces, 8 feet long with tie wraps included.

**15-YEAR WARRANTY**

- |                       |               |
|-----------------------|---------------|
| Green Safety Top Cap  | <b>BSTCGR</b> |
| Blue Safety Top Cap   | <b>BSTCBL</b> |
| Red Safety Top Cap    | <b>BSTCRD</b> |
| Yellow Safety Top Cap | <b>BSTCYL</b> |
| White Safety Top Cap  | <b>BSTCWH</b> |
| Black Safety Top Cap  | <b>BSTCBK</b> |

## ATTACHING TOOL



Our Fence Crown Attaching Tool makes installation easy! The installer spreads the fence crown over the fence as you pull.

Attaching Tool

**BFCAT**

## TIE WRAPS



19" Tie Wraps, 100 per pack.

- |                  |                 |
|------------------|-----------------|
| Yellow Tie Wraps | <b>BFCTWRPY</b> |
| Green Tie Wraps  | <b>BFCTWRPG</b> |
| Black Tie Wraps  | <b>BFCTWRPB</b> |

# FIELD SCREEN

## STANDARD MESH FIELD SCREEN



Windscreens attach to any fence to give you an easy and economical solution to just about any outdoor court or field enclosure need. Used to block wind disturbances, unwanted onlookers or other distractions. It provides an excellent visual background for players, and can also be used to wall off special field sections or unsightly areas.

**FEATURES:**

- |   |                         |              |
|---|-------------------------|--------------|
|   | 5' Standard Mesh Screen | <b>BVCM5</b> |
| • Maximum UV sunlight protection                                    | 6' Standard Mesh Screen | <b>BVCM6</b> |
| • Black grommets for a more modern look                             | 9' Standard Mesh Screen | <b>BVCM9</b> |
| • Center lacing lip & wind flaps standard for 9' and taller screens |                         |              |

**Available in:** Dark Green, Red, Black, Royal Blue, Kelly Green, Grey, Navy Blue, Burgundy, Purple, Orange, Yellow, Carolina Blue, Tan, Brown & White.



## FIELD SCREEN LETTERING

Give your fences some style and team spirit with a customized field screen. Even some simple lettering can improve the look of your team's field or stadium. Available in: White, Black, Yellow, Athletic Gold, Royal Blue or Red letters and/or numbers

***CALL FOR PRICING ON CUSTOM PRINTED LOGOS!***

- |                 |               |                 |               |
|-----------------|---------------|-----------------|---------------|
| 14" Block Style | <b>BVCM14</b> | 36" Block Style | <b>BVCM36</b> |
| 24" Block Style | <b>BVCM24</b> | 42" Block Style | <b>BVCM42</b> |
| 30" Block Style | <b>BVCM30</b> |                 |               |

No returns accepted on custom field screen

**WARRANTY:**  
All field screens and windscreens are fully warranted against fabric & manufacturing defects. 3-year pro-rated warranty against breakdown from UV sunlight.

## PROMESH FIELD SCREEN



Made from 16 oz. vinyl coated polyester making it the thickest, longest lasting, most durable windscreen available! Pro Mesh windscreen is so durable we are offering a 5-Year limited warranty! All pieces are custom cut to your specific dimensions and come standard with grommets spaced every 18". All borders are now Heat-Sealed with 21st century heat sealing technology.

**ADVANTAGES OF HEAT-SEALING:**

- |                                   |                   |                |
|-----------------------------------|-------------------|----------------|
| • No possibility of thread breaks | 5' ProMesh Screen | <b>BPMESH5</b> |
| • More professional look          | 6' ProMesh Screen | <b>BPMESH6</b> |
|                                   | 9' ProMesh Screen | <b>BPMESH9</b> |

Standard heights are 6' and 9'. Please call for pricing on pieces larger than 9' high.

**Available in:** Dark Green, Red, Black, Royal Blue, Kelly Green, Grey, Navy Blue, Maroon, Purple, Orange, Yellow, Carolina Blue & White.





# WINDSCREEN

## CLOSED MESH WINDSCREEN

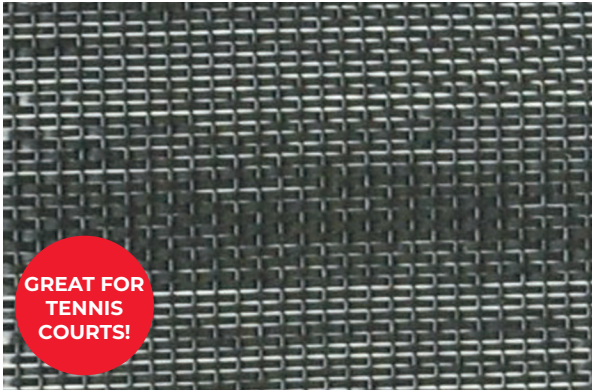

**GREAT FOR TENNIS COURTS!**

Polypropylene windscreen comes in 6' and 9' heights custom-cut to your specified length. All sides finished with sewn vinyl border and grommets. Provides 95% shade. 9' heights come with center lacing lip.

**Colors:** Forest Green & Black Only!

- |                |              |
|----------------|--------------|
| 5' Closed Mesh | <b>PEWC6</b> |
| 9' Closed Mesh | <b>PEWC9</b> |

## OPEN MESH WINDSCREEN

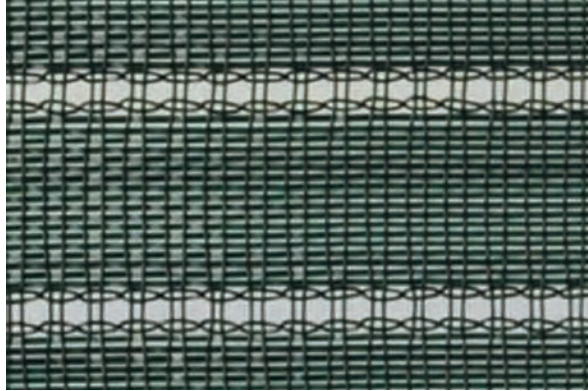

Polypropylene Leno windscreen comes in 6' and 9' heights custom-cut to your specified length. All sides finished with sewn vinyl border and grommets. Provides 84% shade. 9' heights come with center lacing lip.

**Colors:** Forest Green & Black Only!

- |              |             |
|--------------|-------------|
| 5' Open Mesh | <b>PEW6</b> |
| 9' Open Mesh | <b>PEW9</b> |

## ROLLOUT/PRIVACY SCREEN



100% polyethylene engineered to provide site barrier, windbreak, shade, crowd control and privacy. Panels can be attached to chain link fences with plastic wire ties, "S" hooks, or hog rings. Panels can be attached off the roll or can be re-enforced with tape and grommets.

**Colors:** Green (available in all widths with & without eyelets, 1.25" on center), Beige, Brown, Blue, & Black (available in 5' 8" & 7' 8" widths without eyelets).

- |   |              |
|---|--------------|
| 3' 8" x 50 yds. (no eyelets, specify color) | <b>PPV38</b> |
| 5' 8" x 50 yds. (no eyelets, specify color) | <b>PPV58</b> |
| 7' 8" x 50 yds. (no eyelets, specify color) | <b>PPV78</b> |
| 4' x 50 yds. (with eyelets) - GREEN ONLY    | <b>PPV4</b>  |
| 6' x 50 yds. (with eyelets) - GREEN ONLY    | <b>PPV6</b>  |
| 8' x 50 yds. (with eyelets) - GREEN ONLY    | <b>PPV8</b>  |



## FIELD SCREEN ACCESSORIES

- 8" Black Cable Ties (100/bag)
- Black Poly Tie Rope (250')
- 6" x 12" Boxed Cutout
- 18" Diameter Half Moon Vents

- BVCMTIE**
- BKROPE**
- BVCMBC**
- BVCMHMV**



**CALL FOR PRICING 888-313-1303**

# RAIL PADDING

## SAFEFOAM PADDING



Add padding onto any pole or rail 2" or less in diameter, as well as across your chain link fence tops. Padding is 3/4" with an extra-durable toughskin coating. Sold in 8' lengths, pre-split for easy installation. Ships truck freight.

**Specify Color when ordering:** (YE) Yellow, (GR) Green, (RB) Royal Blue, (NB) Navy Blue, (RD) Red, (BL) Black, (PU) Purple, (GY) Grey or (SB) Sky Blue.



Safefoam Padding  
19" Tie Wraps (100 pack)

**BSFPAD**  
**BFC100**

## PREMIUM ROUND RAIL PADDING



- Fits up to 2 1/2" diameter pipe
- Rail & Pole Pads can be customized for any diameter pole
- Priced per liner foot for all.

**Available in:** Forest Green, Red, Black, Royal Blue, Kelly Green, Grey, Navy Blue, Burgundy, Purple, Orange, Yellow, Carolina Blue, Tan & White.



1" Thick Premium Round Rail Padding  
2" Thick Premium Round Rail Padding

**BRLPAD1**

**BRLPAD2**

## 2-SIDED PREMIUM SQUARE RAIL PADDING



- 2 sided pad protects top rail & front side of dugout
- 2" foam, 18oz vinyl, backed with 3/4" wood backed board
- 6 3/4" top pad depth, 8 3/4" front height
- Can be printed with full color lettering & logos
- Hardware not included.
- Priced per linear foot.

**Available in:** Forest Green, Red, Black, Royal Blue, Kelly Green, Grey, Navy Blue, Burgundy, Purple, Orange, Yellow, Carolina Blue, Tan, & White.



1" Thick Premium Square Rail Padding  
2" Thick Premium Square Rail Padding

**BSQRLPAD1**

**BSQRLPAD2**

## PREMIUM SQUARE 3 SIDED RAIL PADDING

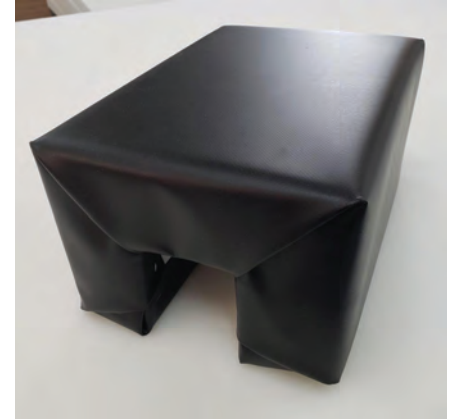

- 3 sided pad protects top rail and both sides of dugout
- 2" foam, 18oz vinyl, backed with 3/4" wood backed.
- 5 1/2" top pad depth, 6 3/4" front height
- Can be printed with full color lettering & logos
- Hardware not included
- Priced per linear foot for all.

**Available in:** Forest Green, Red, Black, Royal Blue, Kelly Green, Grey, Navy Blue, Burgundy, Purple, Orange, Yellow, Carolina Blue, Tan, & White.



Premium Square 3-Sided Rail Padding

**BRLPADSQ3**



## BACKSTOP/WALL PADDING



LAUSANNE COLLEGIATE SCHOOL - MEMPHIS, TENNESSEE

### PREMIUM FOLDING BACKSTOP PADDING

Made of 18oz. vinyl covers with 2" polyfoam filling. Pads are made to fold in 2' wide panels for easy storage and shipping. Grommets are placed along the top, bottom, and sides for anchoring. Please allow 3-4 weeks for delivery. Please specify color when ordering! Ships truck freight.

**Available in:** Forest Green, Red, Black, Royal Blue, Kelly Green, Grey, Navy Blue, Burgundy, Purple, Orange, Yellow, Carolina Blue, Tan, Brown & White.



SIZE	ITEM #	PAD W/ GRAPHICS
2'H X 6'L	<b>BSPAD26</b>	<b>BSPAD26L</b>
2'H X 8'L	<b>BSPAD28</b>	<b>BSPAD28L</b>
2'H X 10'L	<b>BSPAD210</b>	<b>BSPAD210L</b>
2'H X 12'L	<b>BSPAD212</b>	<b>BSPAD212L</b>
3'H X 6'L	<b>BSPAD36</b>	<b>BSPAD36L</b>
3'H X 8'L	<b>BSPAD38</b>	<b>BSPAD38L</b>
3'H X 10'L	<b>BSPAD310</b>	<b>BSPAD310L</b>
3'H X 12'L	<b>BSPAD312</b>	<b>BSPAD312L</b>
4'H X 6'L	<b>BSPAD46</b>	<b>BSPAD46L</b>
4'H X 8'L	<b>BSPAD48</b>	<b>BSPAD48L</b>
4'H X 10'L	<b>BSPAD410</b>	<b>BSPAD410L</b>
4'H X 12'L	<b>BSPAD412</b>	<b>BSPAD412L</b>

## CUSTOM STADIUM PADDING



Our custom wood backed stadium padding features 18oz coated vinyl with high UV rating. All pads manufactured with 3/4" exterior grade water sealed plywood backing and bottom grommet weep holes to allow moisture to drain. Options include 2", 3", or 4" Soft IFD 100 foam. Priced per linear foot.

**Available in:** Forest Green, Red, Black, Royal Blue, Kelly Green, Grey, Navy Blue, Burgundy, Purple, Orange, Yellow, Carolina Blue, Tan, Brown & White.



FOAM	ITEM #	PAD W/ GRAPHICS
2" Soft IFD 100	<b>BWPAD2</b>	<b>BWPAD2L</b>
3" Soft IFD 100	<b>BWPAD3</b>	<b>BWPAD3L</b>
4" Soft IFD 100	<b>BWPAD4</b>	<b>BWPAD4L</b>

## ALUMINUM "Z" MOUNTING CHANNELS

Aluminum Mounting channels with 'Z' clips for easy installation. Priced per linear foot.

Aluminum "Z" Mounting Channels **BWPADZC**



CALL FOR PRICING 888-313-1303

# FACILITY SOLUTIONS



## GYM WALL PADDING

Our indoor wall padding features 18 oz. tough PVC vinyl cover, 2-inch foam cushioning and a 7/16" wood backer board. Call for pricing on custom sizes.

**Available in:** Forest Green, Royal Blue, Red, Navy Blue, Gray, Burgundy, Light Blue, Purple, Yellow, White, Tan, Black, Orange & Kelly Green.



SIZE	2" MEDIUM FIRM FOAM	2" MEDIUM FIRM FOAM W/ GRAPHICS
2'W x 5'H	IWP25F	IWP25FG
2'W x 6'H	IWP26F	IWP26FG
2'W x 7'H	IWP27F	IWP27FG

# INDOOR WALL PADDING



## PREMIUM FOLDING BACKSTOP PADDING

Made of 18oz. vinyl covers with 2" polyfoam filling. Pads are made to fold in 2' wide panels for easy storage and shipping. Grommets are placed along the top, bottom, and sides for anchoring. Please allow 3-4 weeks for delivery. Please specify color when ordering! Ships truck freight.

**Available in:** Forest Green, Red, Black, Royal Blue, Kelly Green, Grey, Navy Blue, Burgundy, Purple, Orange, Yellow, Carolina Blue, Tan, Brown & White.



SIZE	ITEM #	PAD W/ GRAPHICS
2'H X 6'L	BSPAD26	BSPAD26L
2'H X 8'L	BSPAD28	BSPAD28L
2'H X 10'L	BSPAD210	BSPAD210L
2'H X 12'L	BSPAD212	BSPAD212L
3'H X 6'L	BSPAD36	BSPAD36L
3'H X 8'L	BSPAD38	BSPAD38L
3'H X 10'L	BSPAD310	BSPAD310L
3'H X 12'L	BSPAD312	BSPAD312L
4'H X 6'L	BSPAD46	BSPAD46L
4'H X 8'L	BSPAD48	BSPAD48L
4'H X 10'L	BSPAD410	BSPAD410L
4'H X 12'L	BSPAD412	BSPAD412L



## GYM FLOOR COVERS



Ultra protection for your gym floor! Covers are constructed in 10' wide sections for easy handling.

### STANDARD FEATURES:

- Ultra-durable, flame-retardant, 3-ply fabrics with PVC on both sides, so you can use either side.
- Extra-strength seams made to lay smooth & flat.
- Exceeds ADA & OSHA specs for slip-resistant surfaces.
- 15 different colors options in 18, 22, or 27 oz material!
- 8-15 year limited warranty!
- CUSTOMIZABLE WITH SCHOOL NAME, LOGO, SPONSOR & MORE!
- Rack sold separately.

\*We suggest adding 6"-12" when figuring your size to allow for overlapping of each section. (Example: For a 75' x 110' floor, order 8 sections measuring 10' x 110' each.)

18 oz. Gym Floor Cover	<b>FLRCV18</b>
22 oz. Gym Floor Cover	<b>FLRCV22</b>
27 oz. Gym Floor Cover	<b>FLRCV27</b>

## SAFETY MOBILE STORAGE RACK

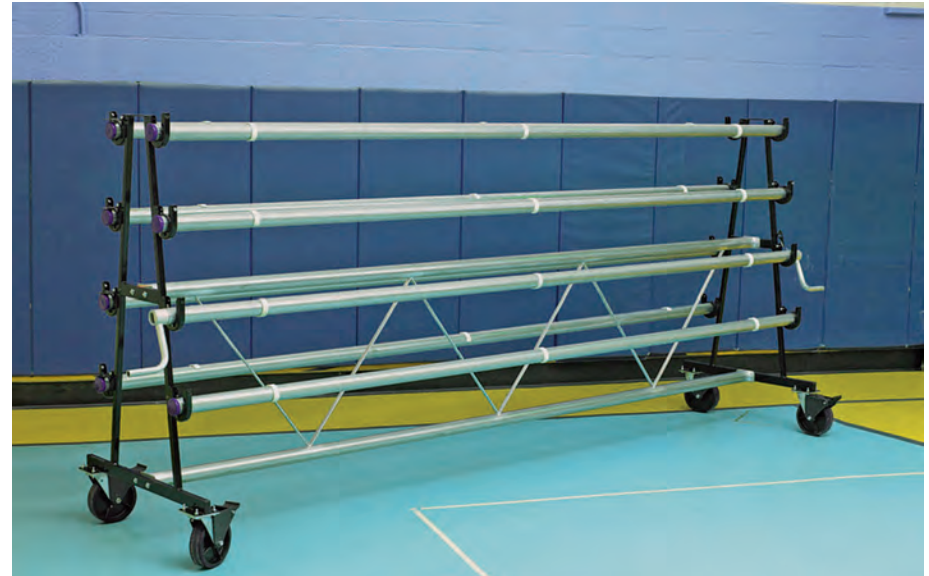

Our Safety Mobile Rack is a great time & back saver.

### FEATURES:

- 8" diameter non-marking urethane swivel-type wheels for easy mobility
- Can support up to 2,800 lbs. of fabric
- Can hold 10'-wide sections of almost any length
- Available in 6', 8' & 10' roller models
- 2 hand cranks (easy winding)
- 3 fabric clips (secure winding) per roller
- Safety Collars
- Safety Brakes



6-Roller Storage Rack  
8-Roller Storage Rack  
10-Roller Storage Rack  
Power Winder



**CVRACK6**  
**CVRACK8**  
**CVRACK10**  
**CVRACKW**



# SCOREBOARDS

## BATTERY-POWERED SCOREBOARD WITH BLUETOOTH



Battery-operated scoreboard with rechargeable battery all the functionalities of the #SCORE2. Features an exterior shot clock with Bluetooth connectivity for remote operation through its own app. **SHOT CLOCK SOLD SEPARATELY!**

- User-Friendly Operation - Plug & Play, easy to use.
- Clock & Alarm - Can be used as a digital clock with alarm functionality.
- Rugged construction, built-in handle, Optional stand available.
- Multi-Sport Functionality

Shot Clock (Set of 2)

**SHCLK3**

Shot Clock Stand

**SHCLKSTND**

Battery-Powered Scoreboard with Bluetooth

**SCORE3**

## MULTI-SPORT INDOOR/OUTDOOR SCORER & TIMER WITH BLUETOOTH



Battery-operated scoreboard with rechargeable battery. Up to 6 hours of battery life when fully charged. Can also be plugged in with included cord. Features all the same timer and game functions as our item #SCORE.

Battery-Powered Portable Scoreboard **SCORE2**  
Replacement Remote **SBRMT**

## SCOREBOARD STAND

Powder-coated frame with heavy-duty casters for easy mobility. Stand raises timer to 4' high.

SCORE2 & 3 Scoreboard Stand Standard

**SBSTND3**

**SBSTAND**



## ELECTRONIC PORTABLE SCOREBOARD



Features three-color display and eight (8) different program options. Basketball feature includes shot clock, period, bonus and foul indicators. Built-in carry handle with 15' power cord. Alarm/buzzer volume is adjustable from low to high.

Electronic Portable Scoreboard **SCORE**  
Replacement Remote **SBRMT**

## POSSESSION ARROW



Bright LED display features indicator lights on the top for fans, coaches and scorekeepers to easily view. Power cord included. Size: 21" x 6" x 3".

Possession Arrow **SBPARR**

## SCOREBOARD CARRYING CASE



Nylon bag with adjustable carrying straps. Rear pocket for power cord and owner's manual. Size: 24"L x 10"D x 16"H.

Scoreboard Carrying Case **SBTBAG**



## HEAVY-DUTY SECURE BALL LOCKER

PRO'S CHOICE

BEST SELLER!



Full-size HD secure locker holds 28-30 balls. Constructed of heavy duty 1" Powder-coated square steel tubing. Lockable hinged lid for security. 4 HD swivel caster wheels for easy mobility.

**Size:** 47"L x 24"W x 38"H.

HD Secure Ball Locker

BLOCKS

## DELUXE BALL LOCKER



Full size locker holds 28-30 balls. Heavy steel wire mesh. Powder-coated for durability. Hinged lid can be locked. 4 HD swivel caster wheels.

**Size:** 42"L x 24"W x 38.5"H

HD Secure Ball Locker

BLOCK

## 3-TIER HEAVY-DUTY BALL CART

PRO'S CHOICE



Holds 15 basketballs. Strong 1" square steel tubing powder coated black for maximum protection. Includes 4 HD swivel, locking caster wheels.

**Size:** 49"L x 16"W x 35"H.

3-Tier HD Ball Cart

CART315

## 2-TIER HEAVY-DUTY BALL CART



Holds 15 basketballs. 2-tier system for better strength and stability. Powder-coated black with 4 HD swivel caster wheels.

**Size:** 51"L x 19"W x 38"H

2-Tier HD Ball Cart

CART215

## DOUBLE-WIDE BALL CART



Holds 30 basketballs. Strong 1" square steel tubing powder coated black for maximum protection. Includes 4 HD swivel, locking caster wheels.

**Size:** 52"L x 25"W x 35" H.

3-Tier Double-Wide Ball Cart

CART330

## BIG BALLER PRO BALL CART



NEW!

Angled design to allow for balls to roll to ends of cart. HD round tubing powder coated black for maximum protection. Holds 15 balls.

**Size:** 49"L x 16"W x 35"H.

Big Baller Pro Ball Cart

BIGBALLER15

CALL FOR PRICING 888-313-1303

## INDOOR RIMS

### BREAKAWAY SINGLE RIM



Front mount 5/8" x 18" single rim with powder coated heavy steel construction. Universal back plate accommodates most fan-shaped and rectangular backboards. For indoor use. Includes net and mounting hardware. 4" x 5" Mounting Pattern.

Breakaway Single Rim **BBRIMBRS**

### BREAKAWAY REAR MOUNT RIM



Rear mount 5/8" x 18" single rim with powder coated heavy steel construction. Compatible with rear mount backboards. Includes net and mounting hardware. 4" x 3 7/8" Mounting Pattern.

Breakaway Rear Mount Rim **BBRMBR**

## OUTDOOR RIMS

### REAR MOUNT RIM



Rear mount 5/8" x 18" single rim with powder coated heavy steel construction. Includes net and mounting hardware. 4" x 3 7/8" Mounting Pattern.

Rear Mount Rim **BBRMS**

### HEAVY-DUTY DOUBLE RIM



Heavy-duty playground rim with welded wing plates & 5/8 x 15 braces. Front mount 18" double rings are 3/4" and 1/2". Back plate accommodates 42" or 48" rectangular & fan-shaped backboards. Includes nylon net & mounting hardware. For outdoor use.

Heavy-Duty Double Rim **BBRIMD**

### BREAKAWAY DOUBLE RIM

Front mount 5/8" x 18" double rim. Full steel wing brace design powder coated for protection. Back plate accommodates 42" or 48" rectangular & fan-shaped backboards. Includes anti-whip net & mounting hardware. For indoor or outdoor use.

Breakaway Double Rim **BBRIMBR**



### HEAVY-DUTY SINGLE RIM

Regulation rim has powder-coated finish & heavy steel bracing for outdoor use. Universal back plate accommodates 42" or 48" rectangular & fan-shaped backboards. Front mount 5/8" x 18" single rim. Includes nylon net & mounting hardware.

Heavy-Duty Single Rim **BBRIMS**





# BACKBOARDS

## ACRYLIC RECTANGULAR BACKBOARD



42" x 60" backboard made of 3/8" UV-resistant acrylic permanently attached to a 3/4" x 11/2" welded steel tubular support frame. Direct mount design allows for permanent attachment of board to post & easy rim replacement. For indoor or outdoor use. **BACKBOARD, PADDING, RIM & NET SOLD SEPARATELY.**

Acrylic Rectangular Backboard

**BBABB**

## PREMIUM BACKBOARD PADDING



High-density urethane foam with a tough exterior skin. Easy bolt-on design fits all 72" wide glass backboards. Kit includes 2 pieces of padding for one backboard and mounting hardware. For indoor use only.

**Available in:** Forest Green, Royal, Red, Navy, Gray, Maroon, Purple, Gold, Black, Orange, Kelly Green, Pink, Columbia Blue, Burgundy, and Brown.



Premium Backboard Padding

**BBPAD**

## STEEL RECTANGULAR BACKBOARD

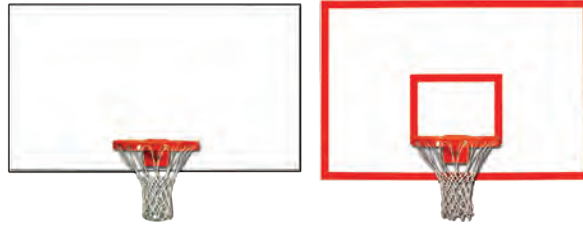

42" x 60" steel backboard with white powder coated finish. Choose from screened target and border or solid white. For indoor or outdoor use. 5" x 5" Mounting Pattern. **RIM & NET SOLD SEPARATELY.**

Steel Backboard with Target & Border  
Steel Backboard Solid White

**BBSRTB**  
**BBSRW**

## OUTDOOR BASKETBALL PLAYGROUND SYSTEM



Systems feature an industry standard 4 1/2" O.D. post. Goose-neck packages include post, 4' extension, Aluminum fan-shape backboard with target & border, & a super double ringed rim.

Complete Playground System  
(includes BBNECK4 Goose-neck)

**BBAL454**

4 1/2" O.D. Goose-neck

**BBNECK4**

Front Mount with Target & Border

**BBFTB**

Heavy-Duty Double-Rim

**BBRIMD**

## FAN SHAPED STEEL BACKBOARD



35" x 54" HD 12-gauge steel backboard with white powder-coat finish. Reinforced mounting points for reduced vibration. Choose from screened target only or screened target & border. For indoor or outdoor use.

**RIM & NET SOLD SEPARATELY.**

Front Mount Backboard

**BBFT**

Front Mount Backboard with Target & Border

**BBFTB**

Rear Mount Backboard

**BBRMW**

Rear Mount Backboard with Target

**BBRIMD**



## SPORTS SPEED & AGILITY KIT



### KIT INCLUDES:

- Dual Harness (Evasion belt)
- 48" Speed Chute
- Shoulder/Speed Harness
- (2) 6" Hurdles
- (2) 9" Hurdles
- (2) 12" Hurdles
- (2) 5m Speed Ladders
- (12) Saucer Cones
- Leg Toning Tube
- Reaction Ball
- Trigon Sports Carry Bag

Sports Speed & Agility Kit **AGKIT**

## SPEED SLED



Improves speed, acceleration & leg strength. Includes powder-coated steel sled & shoulder harness with belt attachment. Add-on weights not included.

Speed Sled **ASLED**

## PLYOMETRIC BOXES



Features heavy-duty, powder-coated steel frame. Top surface constructed of 18" square laminated wood covered with a non-slip synthetic surface.

- |                    |               |
|--------------------|---------------|
| 12" Plyometric Box | <b>PLYO12</b> |
| 18" Plyometric Box | <b>PLYO18</b> |
| 24" Plyometric Box | <b>PLYO24</b> |
| 30" Plyometric Box | <b>PLYO30</b> |
| 36" Plyometric Box | <b>PLYO36</b> |

## AGILITY HURDLES

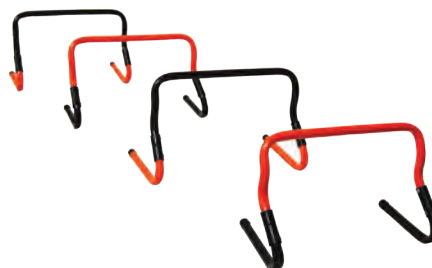

Constructed of heavy-duty PVC. Hurdle can be adjusted from 6" to 12" by twisting the legs in reverse direction. Comes in sets of 4.

Agility Hurdles **AH612**

## PRO AGILITY LADDER

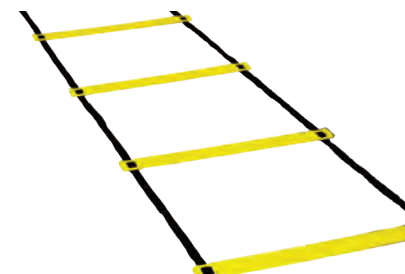

The ultimate speed and agility training ladder. Made from 20" wide flat plastic rungs & 27' long nylon tape border. Distance between rungs is fully adjustable. Use narrow spacing on this workout ladder for short and quick steps or wider spacing for longer strides. Comes with carry bag.

Pro Agility Ladder **ALPRO**

## SPEED CHUTE



This is the ultimate resistance tool for improving speed, stamina, strength & acceleration. Chute opens while running to provide resistance. Comes with carry bag.

- |                 |              |
|-----------------|--------------|
| 40" Speed Chute | <b>ASC40</b> |
| 48" Speed Chute | <b>ASC48</b> |
| 54" Speed Chute | <b>ASC54</b> |



# FOOTBALL TRAINING AIDS

## FOOTBALL PASSING NET WITH SWIVEL TOP



- Powder coated steel frame
- Catch net is adjustable to 7 different swivel positions
- All-terrain turf tires with locking wheels
- Red center target with red outline to easily identify at long distances

**Size:** 51"W x 8'H (At tallest setting)

Football Passing Net  
With Swivel Top

**FBPASS**

## SIDELINE PRO COLLAPSIBLE KICKING CAGE



Strong yet light weight aluminum collapsible kicking cage. Quick and easy assembly in seconds. The high-grade durable net attaches easily using heavy duty Velcro sewn into the 18 oz vinyl.

**Size:** 87" tall x 48" wide

Sideline Pro Collapsible  
Kicking Cage

**FBKSPC**

## PROFESSIONAL KICKING CAGE



Features a sturdy 2" Powder-Coated Steel Base w/ 15/8" uprights. Net made from Heavy-duty knotless netting. Designed for quick & easy set-up and take down. Comes complete with carry bag.

**Size:** 48" x 48" x 86" tall.

Professional Kicking Cage  
Replacement Net

**FBPROK  
FBPROKN**

## RUNNING ROPES

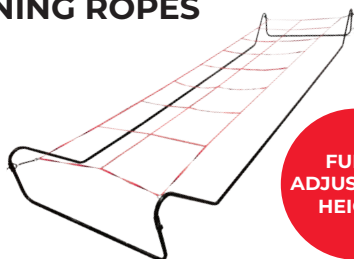

**FULLY  
ADJUSTABLE  
HEIGHT**



Designed for building foot speed and agility. 1" Galvanized steel tube frame, powder-coated black with suspended rope running grid. Adjustable height. Designed for quick assembly and safety with tubing frame outside the running grid.

**Size:** 17' L x 5' W.

Running Ropes  
Replacement Ropes

**FBHSTP  
FBROPE**



## DELUXE HELMET CART



HD steel rack comes with 4" HD swivel-lock wheels. Rack holds 60 football helmets. Size 59"H x 59"L x 24"D allows rack to fit through standard doorway.

Deluxe Helmet Cart

**FBHCART**

## SHOULDER PAD HANGERS

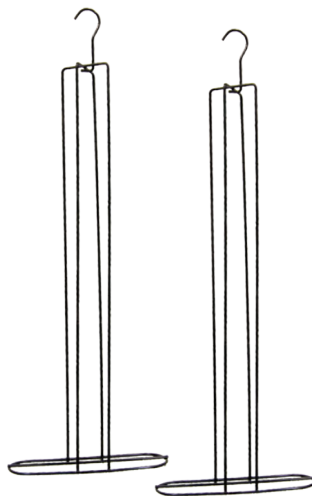

All steel, welded construction powder coated black. Each shoulder pad hangers holds 14 shoulder pads. Sold in sets of 2.

Shoulder Pad Hangers - Set of 2

**SPHGR**

## PRO DELUXE SHOULDER PAD RACK



Holds 60 XXL Pads! Heavy-duty steel bottom frame with retractable pull handle and large locking wheels for easy transport. Steel uprights with bottom position bar allows for neat and orderly stacking.

Pro Deluxe Shoulder Pad Rack

**FSPR60**

## AERIAL ATTACK FOOTBALL MACHINE

The Aerial Attack Football machine is designed for football programs on a tight budget. This unit will deliver right-footed deep spiral punts that turn over as well as end-over-end kickoffs for coverage and return practice. Plus... it throws both long and short passes for receiving and defensive drills. It will pivot in any direction to challenge the defensive coverage or to instantly throw to an exact location.



Aerial Attack Football Machine

**FBAAFM**



## GAMEDAY FIELD LAYOUT

Professional grade 1/16" polyethylene stencils are flexible, allowing them to conform to any smooth or rough surface that needs marking. Get the sharpest, most accurate stencil markings possible. Polyethylene stencils make cleanup quick and easy. When paint dries it simply flakes off. Stencils are backed by a lifetime warranty!

### FOOTBALL FIELD STENCIL KITS



#### STENCIL KITS INCLUDE:

- 1 pc. Characters (# 0-5)  
(PRO Kit includes 2 pc. characters)
- Directional Arrow

- 3' Football Marking Kit (1/16") **FMK3D**
- 3' Football Marking Kit (1/8") **FMK3M**
- 6' Football Marking Kit (1/16") **FMK6D**
- 6' Football Marking Kit (1/8") **FMK6M**
- 6' Pro-Style Football Stencil Kit (1/16") **FMKPRO**

### CUSTOM FIELD STENCILS AVAILABLE

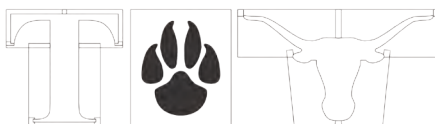

## HASH MARKS STENCIL KITS



#### STENCIL KITS INCLUDE:

- 4 Hash Marks on One Panel

4"x18" Hash Stencil Kit **FBHASH**

## PROLINE FOOTBALL FIELD LAYOUT SYSTEM

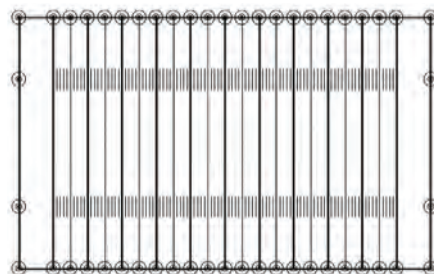

Locate measurements and quickly mark any size football field. If marked lines become too faded to follow for restriping, locators remain in place. Restrung the faded area, and your marked lines are relocated exactly. Additional markers available in 6 and 10-piece sets can be used to locate inbound lines, coaches' boxes and more. All sets include 50 locators, starting tool and 600' roll of cord.

Football Field Layout System **FLS50**

## GAMEDAY FIELD EQUIPMENT

### SOLID FOAM WEIGHTED SIDELINE MARKERS



Triangle weighted sideline markers are a 1 piece foldable design. Each set includes 2 pieces each: "G" (Goal) through "40" and one "50" marker.

Available in: Orange/black

Solid Foam Weighted Sideline Markers (Set of 11) **FBST11**

### WEIGHTED ANCHORLESS PYLONS

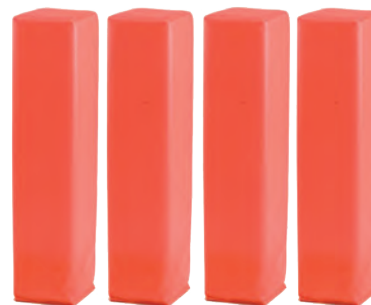

Pylons are one-piece solid foam with weighted bottoms. Sold in sets of 4. Available in Orange.

Football Field Layout System **FBPYLS**

### DELUXE DOWN BOX & CHAIN SET

Unbreakable padded down box with Black foam padding. Chain set is 6'10" with orange foam padding and 12" flip-over numbers. Chain set is 7'6" with 15" padded bull's eye with Orange padded banners and poles. Available in Orange/black.



Deluxe Down Box & Chain Set

**FBDSL3**

Down Box Only  
Chain Set Only

**FBDB03**  
**FBCS03**

### AEROSOL FIELD PAINT



Fast-drying, water resistant. Universal tip fits most machines. 12 (20oz.) cans per case. Available in white, red, yellow, purple, royal, navy, black, orange, maroon, turf green, brown, silver, pink & gold.

White Aerosol Field Paint  
Color Aerosol Field Paint

**LINEW**  
**LINEC**

CALL FOR PRICING 888-313-1303

# SIDELINE & TRACK PROTECTORS



## PROMESH SIDELINE PROTECTOR

Our ProMesh material features heavy-duty 14 oz. mesh that has extreme tear resistance. Tarps are heat-fused for abrasion resistance to spikes and breathable to allow air and water passage. Grommets are spaced at 3' intervals around perimeter. 12 stock colors available. Optional lettering & logo printing available. Ships truck freight.

### AVAILABLE COLOR OPTIONS:



STOCK SIZE	ITEM#
12' x 50'	FPM1250
12' x 75'	FPM1275
12' x 100'	FPM12100
12' x 125'	FPM12125
12' x 150'	FPM12150
15' x 50'	FPM1550
15' x 75'	FPM1575
15' x 100'	FPM15100
15' x 125'	FPM15125
15' x 150'	FPM15150

## BLANKET-STYLE SIDELINE PROTECTOR



Blanket material features non-woven poly fabric that is heather gray in color to deflect heat. Blanket material is breathable to allow air and water passage. Grommets are spaced at 3' intervals around perimeter.



SIZE	ITEM#
14' x 50'	FST1450
14' x 75'	FST1475
14' x 100'	FST14100
14' x 125'	FST14125
14' x 150'	FST14150

## WEIGHTED TRACK PROTECTOR



Premium heavyweight 16 oz. non-woven polypropylene fabric. Heat tempered on both sides for excellent durability to cleat traffic. Light gray color will not absorb heat like dark colors. Features a weighted perimeter with vinyl border that stays in place without the need for stakes or sand bags that could damage track surface. Choose from 14 different border colors!

### BORDER COLOR OPTIONS:



SIZE	ITEM#
7' x 30'	WTP730
7' x 40'	WTP740
7' x 50'	WTP750
14' x 30'	WTP1430
14' x 40'	WTP1440
14' x 50'	WTP1450

## PROMESH WEIGHTED TRACK PROTECTOR



Our ProMesh material features heavy-duty 14 oz. mesh that has extreme tear resistance. Tarps are heat-fused for abrasion resistance to spikes and breathable to allow air and water passage. Features a weighted perimeter with vinyl border that stays in place without the need for stakes or sand bags that could damage track surface. Optional lettering & logo printing available. Ships truck freight.

### AVAILABLE COLOR OPTIONS:



SIZE	ITEM#
6' x 30'	PMWTP630
6' x 40'	PMWTP640
6' x 50'	PMWTP650
12' x 30'	PMWTP1230
12' x 40'	PMWTP1240
12' x 50'	PMWTP1250



# GOAL POSTS

## OFFICIAL FOOTBALL GOAL POSTS



Goose-neck style goalposts are manufactured of heavy Schedule 40 galvanized steel with a 4<sup>1/2</sup>" OD (5' offset). Goal posts feature 3" O.D. crossbars and 2<sup>3/8</sup>" O.D. x 20' H aluminum uprights. Fully adjustable in 2 directions for precise alignment. Goals can be permanently installed in concrete footings or set in optional ground sleeves. Available in powder-coated white or yellow with either 23' 4" High School or 18' 6" Collegiate crossbars. Ships truck freight.

COLOR	CROSSBAR	ITEM #
Yellow	18' 6"	<b>FBGP4YC</b>
White	18' 6"	<b>FBGP4WC</b>
Yellow	23' 4"	<b>FBGP4YHS</b>
White	23' 4"	<b>FBGP4WHS</b>
Optional 4.5" ground sleeves		<b>FBGP4GS</b>

## GOAL POST NETS

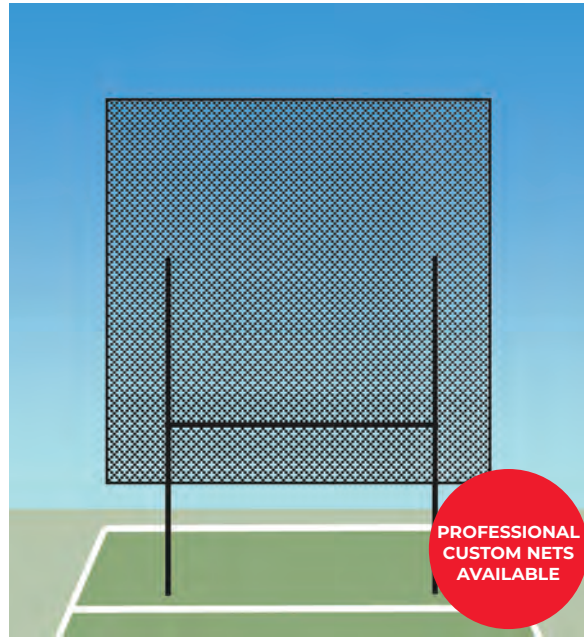

Nets are designed for use behind football goal posts to retrieve kicked balls. Netting is #18 with a 4" square mesh border on all four sides with steel rings in corners for easy hanging. All nets are weather & UV treated to guarantee years of service.

SIZE	ITEM #
30' H x 30' W	<b>FGN3030</b>
30' H x 35' W	<b>FGN3035</b>
35' H x 45' W	<b>FGN3545</b>
40' H x 40' W	<b>FGN4040</b>
40' H x 45' W	<b>FGN4045</b>

## GOAL POST PADS

Made from 18 oz. vinyl with 4" urethane foam. Standard height is 6' with hook & loop Velcro or laced-grommet closures. Custom heights & thicknesses available! Ships truck freight. Shown with optional custom print. Call for custom pricing.

**Available in:** Forest Green, Royal, Red, Navy, Gray, Maroon, Sky Blue, Purple, Yellow, White, Tan, Black, Kelly Green and Orange!

4" Velcro Closure	<b>PPAD4V</b>
4" Laced Closure	<b>PPAD4L</b>
6" Velcro Closure	<b>PPAD6V</b>
6" Laced Closure	<b>PPAD6L</b>



# DUMMIES & PADS



## STAND-UP DUMMIES

Heavyweight durable vinyl design makes the Stand-Up dummy strong, firm and durable. Available with replaceable bottoms. Great for use of all levels of players.

**Color options:**



- 42" x 14" Stand Up Dummy **FPSU42**
- 48" x 14" Stand Up Dummy **FPSU48**

## HALF-ROUND DUMMIES

Dual-purpose for step-over and blocking drills. Handles allow for use as a blocking dummy, while the half-round design gives it versatility for speed & agility drills.

**Color options:**



- 42" x 14" x 7" Half Round Dummy **FPHR147**
- 42" x 16" x 6" Half Round Dummy **FPHR166**



## STEP-OVER DUMMIES



Trapezoidal design keeps dummy in place. 18 oz. vinyl coated nylon, double stitched seams and reinforced handle.

**Color options:**



- 8" x 18" x 48" x 8" Step-Over Dummy **FPSO8**
- 12" x 18" x 48" x 8" Step-Over Dummy (Black not available in 12") **FPSO12**

## FOREARM PADS



Reinforced vinyl cover with 4" thick Poly-Foam filling, contoured forearm design and elbow protectors. Sold in pairs.

**Color options:**



- Forearm Pads **FPFA4**

## CURVED BLOCKING DUMMIES



Reinforced vinyl cover comes with either 3" or 5" Poly-Foam filling. Size: 25" x 18".

**Color options:**



- 3" Thick Shield Dummy **FPBS3**
- 5" Thick Shield Dummy **FPBS5**

## MAN SHIELD



Man-shape provides for more realistic drills. Reinforced vinyl covering, 5" thick molded Poly-Foam core retains shape and lasts longer.

**Size:** 36" T x 31" W.

**Color options:**



- Man Shield **FPMS5**

## SLP BLOCKING PAD



Blocking Pad that has 2 special features. Feature 1 is the "belt" feature that helps safely drill the Gallop technique with no contact to the head. Feature 2 is the "backpack" feature that teaches athletes how to properly distribute their weight against a moving defender.

- SLP Blocking Pad **FSLPBLOCK**



# LACROSSE GOALS

## OFFICIAL LACROSSE GOAL

**BEST SELLER!**



Official size 6'H x 6'W x 7'D features 2" HD orange powder-coated galvanized steel frame. One-piece welded face, mitered corners and lacing rail. 3/8" thick flat steel ground bar for goal stability. Includes 7mm nets and lacing cord. Sold as pairs.

Official Size Lacrosse Goal

**LGOFF**

## DELUXE LACROSSE PRACTICE GOAL



Official size 6'H x 6'W x 7'D features 1.5" powder-coated orange galvanized steel frame. Includes full lacing rail around goal frame and ground supports. Goals include 4mm net and lacing cord. Sold individually.

Deluxe Lacrosse Practice Goal

**LGPRACD**

## LACROSSE PRACTICE GOAL



Official size 6'H x 6'W x 7'D features 1.5" powder-coated orange galvanized steel frame. Net laces around frame face and ground supports. Goals include 4mm nets and lacing cord. Sold individually.

Lacrosse Practice Goal

**LGPRAC**





**SILVERLINE PRACTICE LACROSSE GOAL**



1.5" powder-coated orange galvanized steel frame. Net laces around frame face and ground supports. 4mm net and lacing cord.

**SOLD INDIVIDUALLY.**

Practice Partner® Silverline Lacrosse Goal

**SLVLG**

**LACROSSE GOAL**



Official size lacrosse goal. Formed from 18-gauge, 1.5" powder-coated steel tubing. Includes 3mm, heavy-duty weatherized netting.

**Size:** 72"W x 72"H x 84"D

Practice Partner® Lacrosse Goal

**LGPRAC**

**LACROSSE WALL REBOUNDER**



Constructed of 1.5" 18-gauge steel tubing with 4' x 3' rebounding surface.

**Size:** 84"T x 36"W

Practice Partner® Lacrosse Wall Rebounder

**LPBT**

**LACROSSE NETS**

Official size lacrosse nets with choice of heavy-duty 7mm or standard 5mm net. Sold individually.

Lacrosse Net - 5mm

**LGNET5**

Lacrosse Net - 7mm

**LGNET7**





## LACROSSE GOAL DOLLY



Move any lacrosse goal on and off the field with ease. Slide the front brackets under the front corners of your goal, tilt back on the handle while also holding the top of the goal, then easily move your goal to its desired location. Push-button assembly.

Lacrosse Goal Dolly

**LGODO**

## PROLINE LACROSSE FIELD LAYOUT SYSTEM

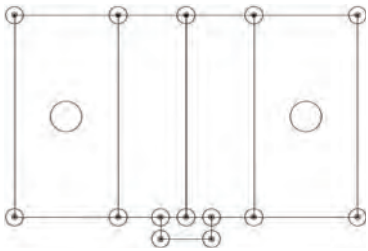

Quickly and easily layout your lacrosse field with this easy to use kit. Measure once and easily re-stripe year after year. Includes 14 sockets, starter tool & 600' of twine.

Proline Lacrosse Field Layout System

**LLS14**

## LACROSSE GOAL TARGET



Great for players of all ages and skill levels, the ProCage™ Lacrosse Goal Target is perfect for improving your shooting precision and accuracy! Black vinyl with seven target zones. Includes fasteners to easily attach to your 6' x 6' goal. Goal and net not included.

Lacrosse Goal Target

**LGT66**

## 30' X 10' MULTI-SPORT BACKSTOP NET

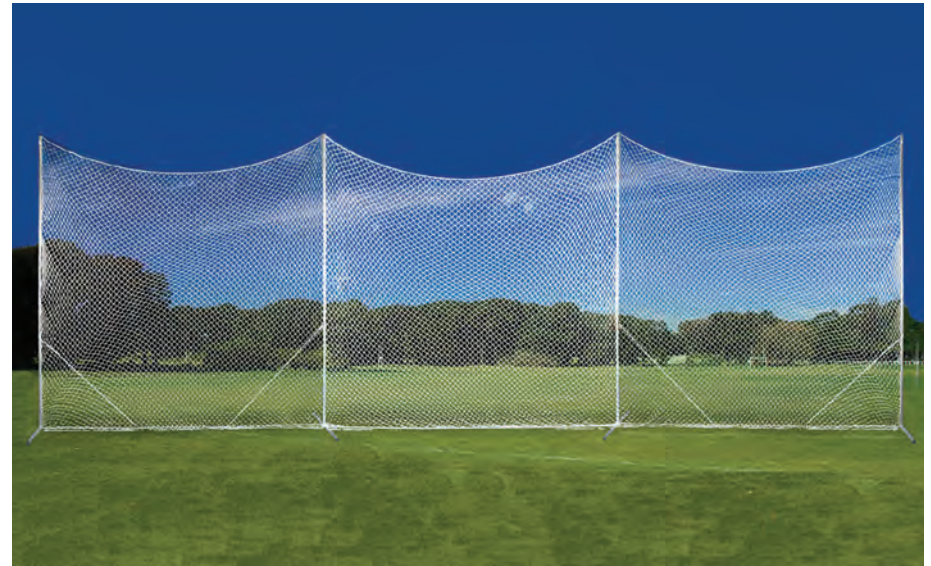

Free-standing backstop is ideal for catching stray balls during you practice sessions or games. Sturdy and durable, the Backstop Net features a 2.5 mm net with 1.25" galvanized steel upright poles. Leg supports provide maximum stability.

30' x 10' Multi-sport Backstop Net

**MSBN**

## AEROSOL FIELD PAINT



Fast-drying, water resistant. Universal tip fits most machines. 12 (20oz.) cans per case. Available in white, red, yellow, purple, royal, navy, black, orange, maroon, turf green, brown, silver, pink & gold.

White Aerosol Field Paint  
Color Aerosol Field Paint

**LINEW**  
**LINEC**

**CALL FOR PRICING 888-313-1303**

# GAMEDAY FIELD EQUIPMENT

## SOCCER REBOUNDER 6' X 12'

**BEST SELLER!**



Large and sturdy 6' x 12' size with powder-coated galvanized steel tube frame. Great for improving shooting strength or accuracy.

**Included Accessories:**

- 3' stabilizing legs for added stability
- UV treated net
- Bungee cords for attachment.

Soccer Rebounder 6' x 12'  
Soccer Rebounder Replacement Net

**SR612**  
**SR612N**

## PROLINE SOCCER FIELD LAYOUT SYSTEM

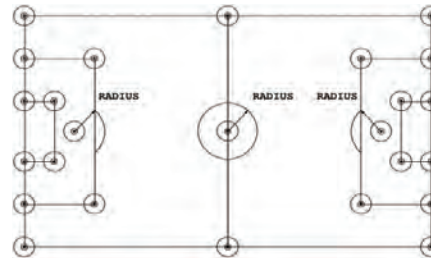

Quickly Mark any size soccer field. Measure once and restripe year after year. Includes 25 locators, starting tool and 600' cord.

Proline Soccer Field Layout System **SLS25**

## SOCCER REFEREE FLAG



Set of 2 soccer linesman flags with a storage bag. Flags include padded handles, fluorescent red and yellow flags with heavy-duty PVC shaft.

Soccer Referee Flag **SREFLAG**

## SOCCER NETS



All nets come in white or orange with 5" square mesh and meet NCAA, NHSAA and FIFA specifications.

THREAD	SIZE	ITEM #
4mm	8' x 24' x 4' x 10"	<b>SN4824</b>
3mm	8' x 24' x 4' x 10"	<b>SN3824</b>
3mm	7' x 21' x 3' x 8'	<b>SN3721</b>
3mm	6.5' x 18' x 3' x 7'	<b>SN3618</b>

## DELUXE CORNER FLAG SET



1" OD x 60"H flexible PVC upright attached to official red flag. Spring-loaded steel base for easy ground insertion. Set of 4.

Deluxe Corner Flag Set **SCFLAGD**

## CORNER FLAG SET CARRY BAG



Features a reinforced vinyl bottom to help prevent spikes from coming through. Holds up to four corner flags.

Corner Flag Set Carry Bag **SCFBAG**



# SOCCER GOALS

## PVC PORTABLE SOCCER GOAL W/NET



Perfect for all levels of play. Ultra-tough and durable molded PVC soccer goal comes in two sizes, 3' high x 4' wide or 4' high x 6' wide. Push-button assembly makes for quick and easy setup and take down. Lightweight and sturdy for easy transport. **ALL GOALS SOLD INDIVIDUALLY.**

### EACH GOAL INCLUDES:

- PVC Crossbar & Uprights
- Red Net
- PVC Backstays
- 25 Net Clips
- U-Type Anchor stakes
- Carry Bag

3 x 4' Portable PVC Soccer Goal	<b>SGP34</b>
4 x 6' Portable PVC Soccer Goal	<b>SGP46</b>

## RECREATIONAL SOCCER GOALS



4" x 2" Recreational Soccer Goals are a popular choice for clubs, camps, practice sessions, and recreational use. Goals meet NCAA, NHSAA, and FIFA specifications. Optional wheel adapter kit available for easy transport.

### ALL GOALS INCLUDE NETS.

### EACH GOAL INCLUDES:

- Crossbar & Uprights
- One-Piece Ground Bar
- Backstays
- Net Clips
- (4) 14" HD Steel Ground Anchors
- Net

8' x 24' Recreational Soccer Goal	<b>SGC824</b>
7' x 21' Recreational Soccer Goal	<b>SGC721</b>
6' x 18' Recreational Soccer Goal	<b>SGC618</b>

## OFFICIAL ALUMINUM SOCCER GOALS

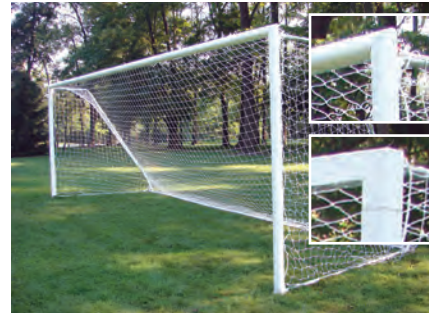

Aluminum soccer goals come in 4" round or square options. Goal is official 8' x 24' size and meets NCAA, NHSAA, and FIFA specifications. Features extruded aluminum frame that is light-weight & easy to transport and rounded corners for safer play. One-piece welded goal frames. Crossbar & uprights include a net channel for easy net attachment with included net clips. Heavy-duty backstays are 1<sup>5/8</sup>" galvanized steel. Optional ground anchors recommended to decrease risk of goal tipping over. **ALL GOALS INCLUDE 4MM NETS.**

### EACH GOAL INCLUDES:

- Backstays
- Crossbar & Uprights
- 8' x 24' Net
- Net Clips
- One-Piece Ground Bar
- (4) 14" HD Steel Ground Anchors

8' x 24' Round Aluminum Soccer Goal	<b>SG824RD</b>
8' x 24' Square Aluminum Soccer Goal	<b>SG824SQ</b>
Ground Anchors	<b>SGANCH</b>
Soccer Goal Wheel Kit	<b>SGWK</b>

## PORTABLE ALUMINUM CLUB SOCCER GOAL



3" Aluminum club soccer goals available in sizes for all levels of play. 3" round aluminum front face with double reinforced corners, available in powder coated white or natural aluminum, also feature a built in net clip track for easy net installation. Galvanized steel 1.66" OD backstays for added stability. All goals include a 3mm white net and "J" Stake anchors for added safety and stability. Underground or Auger style anchors available at an additional cost. **SOLD IN PAIRS.**

### EACH GOAL INCLUDES:

- Crossbar & Uprights
- "J" Stake anchors
- Hardware
- 3mm white net
- Built-in net clip track
- Net clips

U6 4' x 6' Portable Soccer Goal w/ Net	<b>SG3046W</b>
U8 6' x 12' Portable Soccer Goal w/ Net - White Finish	<b>SG3612W</b>
U8 6' x 18' Portable Soccer Goal w/ Net - White Finish	<b>SG3618W</b>
U12 7' x 21' Portable Soccer Goal w/ Net - White Finish	<b>SG3721W</b>
U12 8' x 24' Portable Soccer Goal w/ Net - White Finish	<b>SG3824W</b>

## SILVERLINE SOCCER GOALS



Silverline soccer goal series comes in two sizes: 9'W x 6'H x 4'D and 12'W x 6'H x 4'D. Goals are great for all levels and ages of soccer. Goals are constructed of a 15/8" diameter, 18-gauge steel tubing. Includes a professional quality, heavy-duty weatherized net.

- Practice Partner® Silverline Soccer Goal 6x9 **SLVSG9**
- Practice Partner® Silverline Soccer Goal 6x12 **SLVSG12**
- Practice Partner® 6'x9' Replacement Soccer Net **SOCNET9**
- Practice Partner® 6'x12' Replacement Soccer Net **SOCNET12**

## SOCCER NETS



All nets come in white or orange with 5" square mesh and meet NCAA, NHSAA and FIFA specifications.

THREAD	SIZE	ITEM #
4mm	8' x 24' x 4' x 10"	<b>SN4824</b>
3mm	8' x 24' x 4' x 10"	<b>SN3824</b>
3mm	7' x 21' x 3' x 8'	<b>SN3721</b>
3mm	6.5' x 18' x 3' x 7'	<b>SN3618</b>

## 4' X 8' FOLDING SOCCER GOAL



Foldable goal features push-button assembly and all-weather net. Perfect portable goal for practice.

**Size:** 4'H x 6'W x 3'D

- Practice Partner® Folding Soccer Goal **FOLD95**

## 6X9 SOCCER REBOUNDER

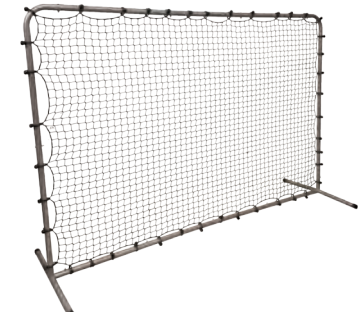

Assembles to 6'H x 9'W. Precision-fit locking pins for easy assembly. Constructed of 1.5", 18-gauge heavy-duty steel tubing.

- Practice Partner® Soccer Rebounder **SOCREB**



## PRO DELUXE HOCKEY GOAL



The Practice Partner 72-in Pro Deluxe Hockey Goal helps the scoring-minded players and goaltenders perfect their skills! The goal's durable frame is made of 2-in galvanized steel tubing with weather treated red powder coating. The double welded net attachment system keeps the net squarely fastened together, perfect for indoor and outdoor use.

Practice Partner® Hockey Goal

**RHX2**

## SILVERLINE HOCKEY GOAL



The Practice Partner 72-in Silverline Pro Style hockey goal matches a strong, power-coated steel tubing frame with heavy-duty weatherized netting. It features a securely welded net attachment system and a Pro-Style rounded back.

Practice Partner® Silverline Hockey Goal

**SLVRHR**

## HOCKEY GOAL TARGET

The Practice Partner hockey goal target is perfect for improving your shooting precision and accuracy. Heavy duty vinyl target with five target zones.

Practice Partner® Hockey Goal Target

**RHTARGET**



**NEW!**

**PRACTICE PARTNER®**  
by TAYLOR SPORTS



## OFFICIAL VOLLEYBALL SYSTEM



Meets USVBA, NCAA, and NFHS competition specifications and is designed for any size budget. Posts adjust to Men's (7' 11<sup>5/8</sup>"), Women's (7' 4<sup>1/8</sup>"), and Junior's (7') net heights. The ratchet winch easily sets net tension and 5-point net attachment makes set-up quick and easy. Locking collar securely holds net in position. Bottom of uprights feature adjustable, non-marking pads. Upright safety pads included with choice of 14 different colors. Ships truck freight.

Complete Volleyball System **VBATS**

### COMPLETE ONE-COURT SYSTEM INCLUDES:

- (1) 3.5" O.D. Upright
- (1) 3.5" O.D. Upright with Winch
- (2) 3.5" O.D. Floor Sleeves
- (2) Hinged Brass or Chrome Cover Plates
- (1) Collegiate Net with Tensioner
- (1) Pair of Antennas and Sideline Markers
- (2) Upright Safety Pads
- (1) Set of 4 Cable Covers

## NET SYSTEMS

### PRO VOLLEYBALL NET



3'1/8" x 32' long with 2.5" white headband & vinyl-coated steel cable at top & bottom. Black, 3.0mm knotless netting. Includes side pockets & dowels.

Pro Volleyball Net **VBNETP**

### COLLEGIATE VOLLEYBALL NET



3' x 32' long with 2.5" white headband top only. Vinyl coated steel cable top & nylon roped bottom. Black, 2.6mm braided poly netting.

College Volleyball Net **VBNETC**

### BASIC VOLLEYBALL NET



3' x 32' long with 2.5" white headband. Polyrope cable with taped sides & bottom. Black, 2.6mm braided poly netting.

Basic Volleyball Net **VBNETB**

## UNIVERSAL REFEREE STAND

Sturdy yet lightweight. Works with any volleyball system. Front legs are removable to allow stand to be securely attached to volleyball post with V-bracket and velcro straps. Platform is 44" high with safety rails extending 34" above the platform. Two non-marring wheels allow for easy transport.

**Optional padding available.** Dense foam covered with reinforced vinyl. Hook and loop attachments.

**Padding Available in:** Red, Black, Maroon, Forest Green, Royal Blue, Navy Blue, and Purple.



Referee Stand **VRSTND**  
Referee Stand Padding **VRPAD**





## WEIGHTED ROLLAWAY STANDARDS

**NEW**  
AND IMPROVED  
DESIGN!



Features heavy-duty steel base powder-coated black with vinyl edge protection and non-marking wheels. Galvanized steel upright is 120" high and includes 2 slide rings for multiple net heights. Sold as pairs. Each base weighs 180 lbs. Ships truck freight.

24" Weighted Standard **VBSTD180**

## FILLABLE ROLLAWAY STANDARDS



Features heavy-duty steel base with vinyl edge protection & non-marking wheels. Uprights are 8'6" plated steel & feature two multi-purpose ring slides that are height adjustable for multi-use. Base comes in 24" or 30" diameters that can be filled with sand or concrete for added weight. Ships truck freight.

24" Fillable Standard **VBSTD24**  
30" Fillable Standard **VBSTD30**

## TARGET CHALLENGER



12' adjustable pole height with 30" target ring. Includes 22 lb. weight for stability and non-marking wheels for easy mobility. Sturdy net collects balls for easy retrieval. Ideal for passing, setting, or shooting. **BALL CART SOLD SEPARATELY.**

Target Challenger **VBTARGET**

## DELUXE BALL LOCKER



**PERFECT FOR  
VOLLEYBALLS**

Full size locker holds 28-30 balls. Heavy steel wire mesh. Powder-coated for durability. Hinged lid can be locked. 4 HD swivel caster wheels.

**Size:** 42"L x 24"W x 38.5"H

HD Secure Ball Locker **BLOCK**

## VERTICAL CHALLENGER



Telescopic pole adjusts from 4-12 feet high. Movable veins spaced 1" apart. Heavy duty base includes weight for stability and non-marking wheels for easy mobility. Includes reset pole.

Vertical Challenger **VBVERT**





## BLEACHER ENCLOSURES

Cover the sides and back of your bleachers to provide a unique branding opportunity. Enclosures are custom made to your specifications.

### INDOOR ENCLOSURES



Produced from 13 oz. soft-knit polyester, which comes white but is fully digitally printed to match your brand.

***CALL FOR CUSTOM PRICING.***

### OUTDOOR ENCLOSURES



Constructed with 16 oz. ProMesh windscreen for durability and weather resistance. Can be printed with the design of your choice.

***CALL FOR CUSTOM PRICING.***

## STADIUM SEAT COVERS



Enhance your stadium's look with color, texture, and even graphics! Block spectators from sitting in certain areas for specific events. Constructed of vinyl polyester mesh that is available in 13 colors.

Seat Covers are custom made to your specifications.

**Color options:**



***CALL FOR CUSTOM PRICING.***



# STANDARD ALUMINUM BLEACHERS

## STANDARD FEATURES:

- 2, 3, 4, 5, 8, & 10 Row Units
- 8' Rise/24' Run per Row
- 10' Seat Planks
- 17' Front Row Seat Height
- Available in 15', 21', and 27' Lengths
- Aluminum Frame
- Single Footboards on Rows 2 & 3
- Double Footboards & Risers on Rows 4 & Above
- Preferred Models Feature Double Foot Planks on ALL Rows

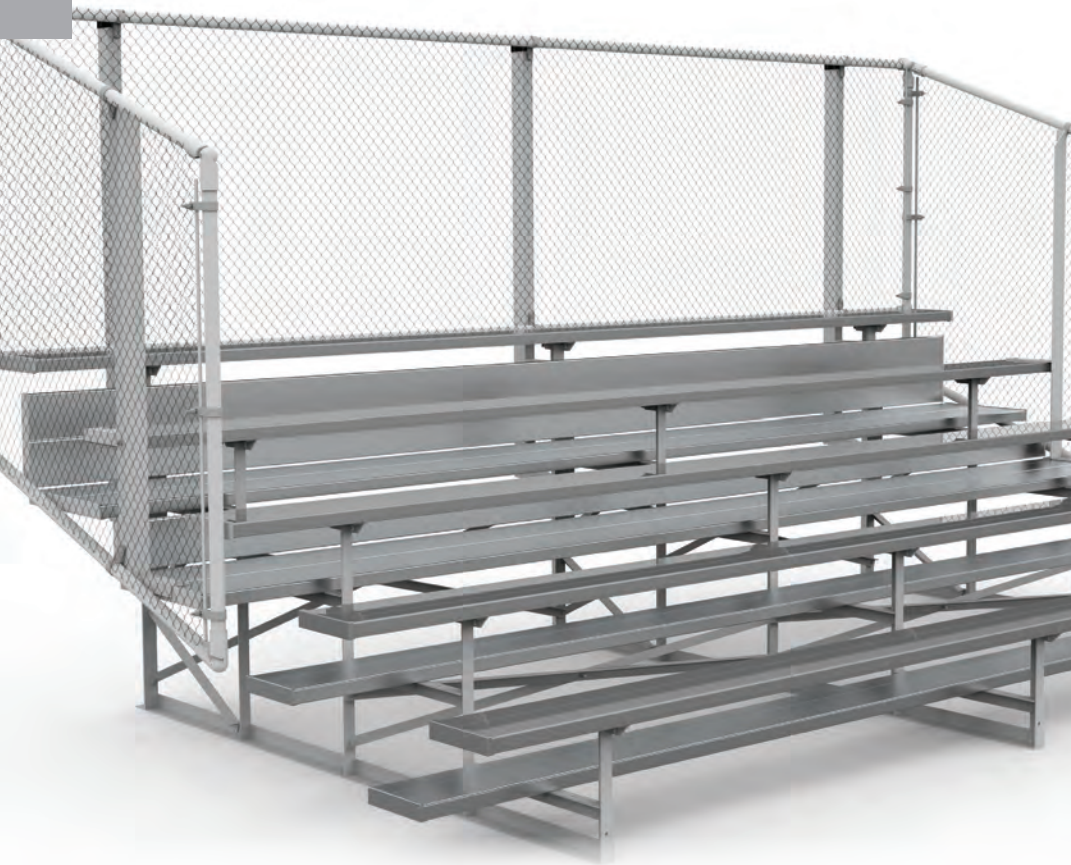

ITEM#	SEATS	ROWS	LENGTH	DEPTH	GUARD RAIL	PREFERRED MODEL
BL315S	30	3	15'	3'	N	BL315SD
BL321S	42	3	21'	3'	N	BL321SD
BL327S	54	3	27'	3'	N	BL327SD
BL415S	40	4	15'	7'	Y	BL415SD
BL421S	56	4	21'	7'	Y	BL421SD
BL427S	72	4	27'	7'	Y	BL427SD
BL515S	50	5	15'	9.5'	Y	BL515SD
BL521S	70	5	21'	9.5'	Y	BL521SD
BL527S	90	5	27'	9.5'	Y	BL527SD
BL815S	80	8	15'	15.2'	Y	BL815SD
BL821S	112	8	21'	15.2'	Y	BL821SD
BL827S	144	8	27'	15.2'	Y	BL827SD
BL1015S	100	10	15'	29.5'	Y	BL1015SD
BL1021S	140	10	21'	29.5'	Y	BL1021SD
BL1027S	180	10	27'	29.5'	Y	BL1027SD

## ELEVATED BLEACHERS

PLEASE CALL WITH YOUR SPECIFICATIONS AND MEASUREMENTS FOR QUOTES ON ELEVATED ALUMINUM BLEACHERS!





## LOW-RISE BLEACHERS



### STANDARD FEATURES:

- 3 & 4 Row Units
- Aluminum Frame
- 6' Rise/24' Tread Depth
- Single Footboards
- 12' Seat Planks
- 12' Front Row Seat Height
- Preferred Models Feature Double Foot Planks on ALL Rows

ITEM#	SEATS	ROWS	LENGTH	DEPTH	HEIGHT	PREFERRED MODEL
<b>BL315LR</b>	30	3	15'	5'	22.5"	<b>BL315LRD</b>
<b>BL321LR</b>	42	3	21'	5'	22.5"	<b>BL321LRD</b>
<b>BL415LR</b>	40	4	15'	7'	28.5"	<b>BL415LRD</b>
<b>BL421LR</b>	56	4	21'	7'	28.5"	<b>BL421LRD</b>
<b>BL427LR</b>	72	4	27'	7'	28.5"	<b>BL427LRD</b>

## TIP & ROLL BLEACHERS

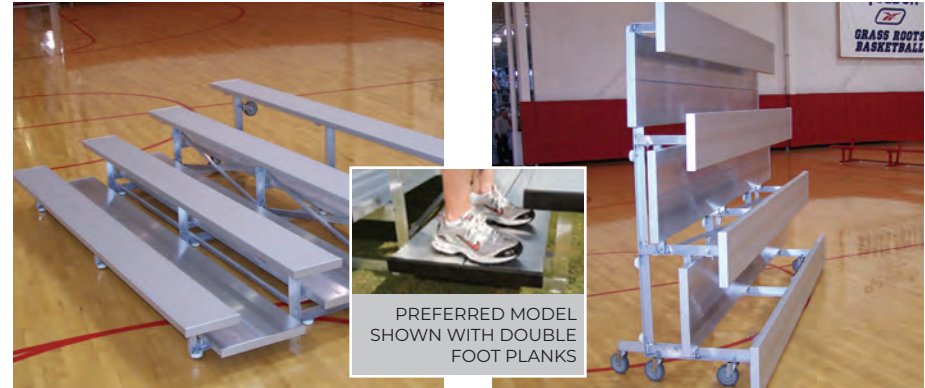

### STANDARD FEATURES:

- Rubber foot pads to protect floors
- Aluminum angle frames for easier tipping
- 6' Rise/24" Tread Depth
- 2' x 10" Anodized Seat Planks (2" x 12" on 4-row model)
- 2' x 10" Mill Finished Foot Planks
- 5" Locking Swivel Caster Wheels for easy rolling
- Preferred Models Feature Double Foot Planks on ALL Rows

ITEM#	SEATS	ROWS	LENGTH	DEPTH	HEIGHT	PREFERRED MODEL
<b>BL27.5TR</b>	10	2	7.5'	36"	36"	<b>BL27.5TRD</b>
<b>BL215TR</b>	20	2	15'	36"	36"	<b>BL215TRD</b>
<b>BL221TR</b>	28	2	21'	36"	36"	<b>BL221TRD</b>
<b>BL37.5TR</b>	15	3	7.5'	36"	36"	<b>BL37.5TRD</b>
<b>BL315TR</b>	30	3	15'	60"	60"	<b>BL315TRD</b>
<b>BL321TR</b>	42	3	21'	60"	60"	<b>BL321TRD</b>
<b>BL47.5TR</b>	20	4	7.5'	84"	84"	<b>BL47.5TRD</b>
<b>BL415TR</b>	40	4	15'	84"	84"	<b>BL415TRD</b>

**ADDITIONAL MATERIAL SURCHARGES MAY APPLY**

## SUPREME SERIES BLEACHERS



### STANDARD FEATURES:

- 4, 5, 8, & 10 Row Units
- Double Footboards & Risers on ALL Rows
- 8' Rise/24' Tread per Row
- Aisle with Anodized Handrails
- 10' Seat Planks
- Aluminum Frame
- 17' Front Row Seat Height
- Chainlink Guardrail

### INSTALLATION AVAILABLE - CALL FOR DETAILS

ITEM#	SEATS	ROWS	LENGTH	DEPTH
BL421SP	50	4	21'	7'-0"
BL427SP	66	4	27'	7'-0"
BL515SP	42	5	15'	9'-5"
BL521SP	58	5	21'	9'-5"
BL527SP	74	5	27'	9'-5"
BL815SP	66	8	15'	15'-2"
BL821SP	91	8	21'	15'-2"
BL827SP	116	8	27'	15'-2"
BL1015SP	82	10	15'	29'-5"
BL1021SP	113	10	21'	29'-5"
BL1027SP	144	10	27'	29'-5"
BL1030SP	164	10	30'	29'-5"

## ADA COMPLIANT BLEACHERS

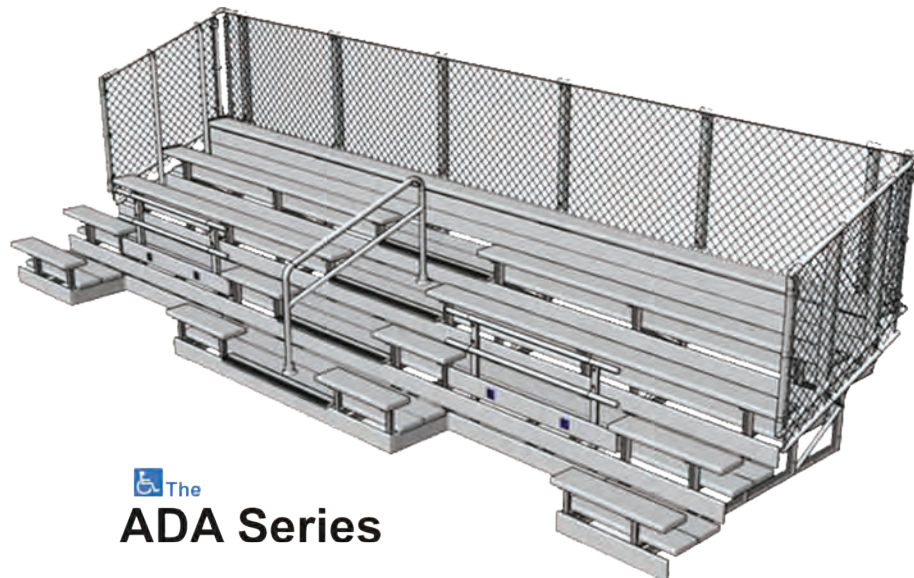

### The ADA Series

### STANDARD FEATURES:

- 5 Row Units
- Double Footboards & Risers on ALL Rows
- 8' Rise/24' Tread per Row
- Aisle with Anodized Handrails
- 10' Seat Planks
- Aluminum Frame
- Chainlink Guardrail
- Open First Row Wheelchair Accessible Area
- Meets Code Including ADA Seating

ITEM#	SEATS	LENGTH	DEPTH
BL515HC	34+2 HC	15'	9' 5"
BL519.5HC	45+2 HC	19' 6"	9' 5"
BL521HC	48+2 HC	21'	9' 5"
BL527HC	58+4 HC	27'	9' 5"



## ALUMINUM TEAM BENCHES



ALL ALUMINUM  
BENCH WITH  
BACK & SHELF



IN-GROUND  
MOUNT



PORTABLE



SURFACE  
MOUNT

Heavy-duty player's benches featuring anodized aluminum seat planks and optional anodized backrests. The galvanized legs are a heavy 23/8" O.D. pipe built for maximum strength. Legs are all aluminum for no rust and extreme durability.

ITEM#	DESCRIPTION	MOUNT TYPE	FRAME TYPE	WEIGHT
<b>PBO8PB</b>	8' Bench with Back	Portable	Galvanized Steel	135 lbs
<b>PB08P</b>	8' Bench without Back	Portable	Galvanized Steel	66 lbs
<b>PBO8SM</b>	8' Bench without Back	Surface Mount	Galvanized Steel	59 lbs
<b>PB08SMB</b>	8' Bench with Back	Surface Mount	Galvanized Steel	95 lbs
<b>PB08IG</b>	8' Bench without Back	In-Ground Mount	Galvanized Steel	62 lbs
<b>PB08IGB</b>	8' Bench with Back	In-Ground Mount	Galvanized Steel	102 lbs
<b>PBS08</b>	8' Bench with Back & Shelf	Surface/Portable	Aluminum	135 lbs
<b>PB15PB</b>	15' Bench with Back	Portable	Galvanized Steel	187 lbs
<b>PB15P</b>	15' Bench without Back	Portable	Galvanized Steel	92 lbs
<b>PB15SM</b>	15' Bench without Back	Surface Mount	Galvanized Steel	81 lbs
<b>PB15SMB</b>	15' Bench with Back	Surface Mount	Galvanized Steel	143 lbs
<b>PB15IG</b>	15' Bench without Back	In-Ground Mount	Galvanized Steel	85 lbs
<b>PB15IGB</b>	15' Bench with Back	In-Ground Mount	Galvanized Steel	150 lbs
<b>PBS15</b>	15' Bench with Back & Shelf	Surface/Portable	Aluminum	198 lbs
<b>PB21PB</b>	21' Bench with Back	Portable	Galvanized Steel	261 lbs
<b>PB21P</b>	21' Bench without Back	Portable	Galvanized Steel	140 lbs
<b>PB21SM</b>	21' Bench without Back	Surface Mount	Galvanized Steel	126 lbs
<b>PB21SMB</b>	21' Bench with Back	Surface Mount	Galvanized Steel	211 lbs
<b>PB21IG</b>	21' Bench without Back	In-Ground Mount	Galvanized Steel	132 lbs
<b>PB21IGB</b>	21' Bench with Back	In-Ground Mount	Galvanized Steel	220 lbs
<b>PBS21</b>	21' Bench with Back & Shelf	Surface/Portable	Aluminum	279 lbs

[trigonsports.com](http://trigonsports.com) • 888-313-1303



**tsi** **TRIGON**  
**SPORTS**®

**MAKE WINNING POSSIBLE**®

Are you interested in becoming a  
**TEAM DEALER?**

**CONTACT US:**

888-313-1303 • [sales@trigonsports.com](mailto:sales@trigonsports.com)

**VISIT TRIGONSPORTS.COM  
FOR CURRENT PRICING**