

For help with the Classic or Classic SL, please see our how-to videos and extended documentation at www.midnitesolar.com/documentIndex.php . Before calling Tech Support, we recommend visiting this website for some of the most common issues.

WARNING: Arc Fault protection is not ON by default.

NOTE: The National Electrical Code Article 690.11 requires Arc Fault protection. The Classic has this built-in as standard equipment and will need to be enabled, if so desired. The Classic SL does not have Arc Fault built-in.

NOTE: The Arc Fault protection has adjustable sensitivity and may require some tuning for your particular system to avoid nuisance tripping. Some house loads like table saws and well pumps and other motor loads can be seen on the PV circuit in the Classic appearing similar to DC arcs. We have started with a general average we have found to work reliably but in some cases this sensitivity level is too high causing false Arc Fault alarms. When the Classic goes into Arc Fault, it goes to Resting and will not charge the batteries. Please consult the Classic Manual for enabling and fine-tuning of the Arc Fault system.

WARNING! IMPORTANT NOTES TO READ!

When the Classic is used with wind or hydro, a Clipper-type device will most likely be needed to protect against over-voltage. A battery-based diversion load **WILL NOT** keep the Classic safe from over-voltage. High input voltage is recorded and over-voltage is not covered under warranty.

Never wire a pump or other load to the input side of the Classic. If a load must be wired to the input side of the Classic, the load and Classic need to have blocking diodes on them.

Never parallel two Classics onto one PV array.

For larger systems with large inverters and or multiple inverters (i.e., Radian or XW+), it is important to use appropriately sized cables and bus bars or damage to the inverters or charge controllers can occur. Take a single XW+ E-Panel, for example, it has a positive bus bar for the charge controller battery side connections. This bus bar is sufficient for two charge controllers; if you need three or more, then you need to look at the best way to handle the amperage. A dual Radian, for example, is actually four separate inverters. Properly sized cables as well as a large enough battery bank is very important. Most manufacturers of battery-based inverters recommend 100Ah of battery per kW of solar modules. Please consult the inverter manufacturer for assistance with cable sizing.

Classic SL

This Owner's Manual covers both the Classic and the Classic SL models.

The Classic SL performs the same functions as the regular Classic, but **WITHOUT** the following features: 1) No Arc Fault circuit; 2) No AUTO EQ function; 3) No Ethernet port; 4) No wind or hydro programming; and 5) The Classic SL does not include the Battery Temp Sensor, sold separately.



Classic 150

Classic 200

Classic 250

Table of Contents

Introduction	5
Safety Instructions	6
Standards and Requirements.....	6
DC and Battery-related Installation Requirements.....	7
How to KILL Your Batteries.....	7
Classic Power Curves	8
Classic Installation	10
Unpacking the Classic.....	10
Removing and Installing Classic Front Cover.....	10
Mounting the Classic.....	11
Alternative Mounting.....	12
Sealed or Vented.....	13
Wiring the Classic	13
Maximum and Minimum Wire Size.....	13
To Connect Wiring to the Classic	14
DC Terminal Connector	16
Current Rating.....	16
Over-current Protection.....	16
Long Distance Wire Runs.....	17
Connecting the Classic to the Clipper	17
Grounding	18
Chassis Grounding.....	18
DC System Grounding	18
DC GFP (Ground Fault Protection)	18
Disabling GFP.....	19
Positive Ground Systems.....	19
Networking	19
Follow-Me – Charge Coordination	19
Ground Fault Sharing	21
Naming the Classic	21
Addressing Classics.....	21
Connecting the Classic to Two MNGPs/Network Cable.....	22
Connecting the Classic to the Internet.....	22
Network Setup through the MNGP	23
DHCP.....	24

Static IP.....	24
IP Address.....	25
Subnet / Gateway / DNS 1	25
Web Access	25
Local Network	26
Battery Temperature	26
Battery Temperature Compensation	26
Battery Temperature Sensor (BTS) Installation	26
Classic Programming.....	27
Commissioning the Classic (Quick Start)	27
MNGP Features and Programming	27
Battery Charge Stages	29
Mode is Off.....	30
Adjusting Absorb, Equalization, and Float Voltages	30
Current Limit	30
LED Modes.....	31
Calibrating Classic and PV Voltage	31
Configuring DC Input Source	32
Programming the Classic for Wind Input Source	33
Equalization.....	35
Setting Date and Time.....	36
Arc Fault	36
Programming for PV Bleed Down	37
Charge/Advanced Settings	38
Auxiliary Ports.....	39
Configuring the Classic's AUX Ports	39
AUX Function Definitions	40
AUX 1 Modes.....	41
AUX 2 Modes.....	43
AUX 1 and 2 Jumpers	45
Logged Data	47
Graphical Logging Display Modes	49
Classic Voice.....	51
Levels of Chattiness.....	51
Programming Classic Voice	51
Updating New Firmware to the Classic	52

Preparing Classic for Update	52
HyperVoc	54
Troubleshooting / FAQs	55
Mechanical Specifications	64
Electrical Specifications	65
Default Battery Charge Set Points	65
Regulatory Approval	66
RS232 Jack Pin Out	66
Classic Breaker Sizing.....	67
Classic Menu Maps	68
Classic Label Set	72
Glossary of Terms	73
Warranty	75
New Turbo Fan Assembly	76

Introduction

The MidNite Classic charge controller is designed to regulate DC input from PV, hydro, or wind turbines. For other DC sources, please contact MidNite Solar Tech Support. The Classic 150, 200, and 250 are designed to work with 12V, 24V, 36V, 48V, 60V, and 72V battery banks. Voice annunciations of operating values are now available in English (French and Spanish coming soon). The Classic can be installed stand-alone or as a multi-unit networked installation. Standard features of the Classic charge controller include:

- ❖ Three input operating voltage ranges: 150, 200, and 250V
- ❖ Multiple DC input options (solar, wind or hydro)
- ❖ Voice annunciations in multiple languages
- ❖ Data logging for 380 days
- ❖ Graphical display
- ❖ Internet-ready

Scope

This manual provides safety guidelines, installation instructions, and usage information for the standard and SL models of the Classic 150, 200, and 250 charge controllers. It does not provide brand specific information about photovoltaic panels, batteries, et cetera. Contact the manufacturer of other components in the system for relevant technical data.

Este manual también está disponible en Español. La versión en Español puede encontrarse en nuestra pagina web en la ficha Documentos y haga clic en Manuales.

Notice of Copyright

MidNite Solar's Classic Charge Controller User's Manual
Copyright © 2019 All rights reserved.

MidNite Solar, Inc. reserves the right to revise this document and to periodically make changes to the content hereof without obligation or organization of such revisions or changes unless required to do so by prior arrangement.

Disclaimer

Unless specifically agreed to in writing, MidNite Solar Inc.: (a) Makes no warranty as to the accuracy, sufficiency or suitability of any technical or other information provided in its manuals or other documentation; (b) Assumes no responsibility or liability for loss or damage whether direct, indirect, consequential or incidental, which might arise out of use of such information. The use of any such information will be entirely at the user's risk.

Contact Information

Telephone: 360.403.7207
Fax: 360.691.6862
Email: customerservice@midnitesolar.com
Web: www.midnitesolar.com

Safety Instructions



WARNING: Identifies conditions or practices that could result in personal injury or loss of life.



CAUTION: Identifies conditions or practices that could result in damage to the unit or other equipment.

This product is intended to be installed as part of a permanently grounded electrical system as shown in the system configuration sections. The following important restrictions apply *unless superseded by local or national codes*:

- ❖ To use the Classic's built-in DC GFP, the system's DC negative conductor must not be bonded to earth ground. The Classic does this with its internal Ground Fault Protection circuitry. The battery negative and ground are not bonded together directly, rather battery negative and ground are connected by the Classic's internal GFP device. All negative conductor connections must be kept separate from the grounding conductor connections. The equipment ground terminal inside the Classic must be connected to earth ground for the internal DC GFP to work.
- ❖ With the exception of certain telecom applications, the Classic should *never* be positively grounded.
- ❖ The Classic equipment ground is marked with this symbol: 
- ❖ If damaged or malfunctioning, the Classic should only be disassembled and repaired by a qualified service center. Please contact your renewable energy dealer/installer for assistance. Incorrect re-assembly risks malfunction, electric shock, or fire.
- ❖ The Classic is designed for indoor installation or installation inside a weatherproof enclosure. It must not be exposed to rain and should be installed out of direct sunlight.
- ❖ Turn off all circuit breakers, including those to the solar modules, batteries, and related electrical connections before performing any maintenance.

Standards and Requirements

All installations must comply with national and local electrical codes; professional installation is recommended. The NEC in the USA requires a DC ground fault interrupter for all residential PV installations. The NEC requires an ARC FAULT detector on all charge controllers and inverters operating above 80VDC. Both devices are built into the Classic.

The MidNite Solar Classic conforms to UL 1741, *Safety for Inverters, Converters, Controllers and Interconnection System Equipment for Use with Distributed Energy Resources*, Second Edition, May 7, 1999 with revisions through January 28, 2010 and CAN/CSA C22.2 No. 107.1: 2001/09/01 Ed: 3 (R2006).

DC and Battery-Related Installation Requirements

- ❖ All DC cables must meet local and national codes (Reference NEC Article 480).
- ❖ Shut off all DC breakers before connecting any wiring.
- ❖ Torque all Classic wire lugs and ground terminals to the specs found on Page 14.
- ❖ Copper wire ONLY with a rating of 75° C or higher.
- ❖ Keep cables close together (e.g., using a tie-wrap) as much as possible to reduce inductance.
- ❖ Ensure both cables pass through the same knockout and conduit to allow the inductive currents to cancel.
- ❖ DC over-current protection must be used on the Classic input and output circuits.
- ❖ Breakers between the battery and the Classic must meet UL489 standards.
- ❖ Breakers between the DC source and the Classic must meet UL1077 or UL489 standards.
- ❖ Design the battery enclosure to prevent accumulation of hydrogen gas at the top of the enclosure. Vent the battery compartment from the highest point to the outside. A sloped lid can also be used to direct the flow of hydrogen to the vent opening. Sealed (AGM, Gel) batteries do not normally require ventilation. Consult your battery manufacturer for details.

WARNING: Personal precautions during installation – Batteries present risk of electrical shock, burn from high, short circuit current, fire, or explosion from vented gases. Follow proper precautions.

- ❖ Someone should be within range of your voice to come to your aid if needed.
- ❖ Keep plenty of fresh water and soap nearby in case battery acid contacts skin, clothing, or eyes.
- ❖ Wear complete eye protection. Avoid touching eyes while working near batteries. Wash your hands with soap and warm water when done.
- ❖ If battery acid contacts skin or clothing, wash immediately with soap and water. If acid enters an eye, immediately flood the eye with running cool water for at least 15 minutes and seek medical attention.
- ❖ Baking soda neutralizes lead acid battery electrolyte. Keep a supply on hand in the area of the batteries.
- ❖ NEVER smoke or allow a spark or flame in vicinity of a battery or generator.
- ❖ Be cautious to reduce the risk of dropping a metal tool onto batteries. Doing so can short the batteries or other electrical parts, resulting in fire or explosion.
- ❖ Never wear metal rings, bracelets, necklaces, and watches when working with a battery or other electrical circuits. A battery can produce a short circuit current high enough to weld a ring or the like to metal, causing severe burns.

How to KILL Your Batteries

Batteries are delicate and require proper attention especially when off-grid. Think of your batteries and solar equipment as a small nuclear power plant, hydro dam, or natural gas-fired power plant. Just like any of those, your system needs DAILY attention to ensure it is performing correctly and safely. For Lithium battery banks we highly recommend using the Logic input on the Classic which allows the BMS to tell the Classic to stop charging if the BMS detects an issue brewing. We also recommend the use of an independent battery monitor/alarm if you have an expensive battery bank. Below is a list of some of the most common ways we have seen people kill their battery bank.

- ❖ Not watching the charge voltages or verifying you are charging to the voltage supplied by the battery manufacturer.
- ❖ Not verifying the temperature compensation neutral point (typically 25° C) and the milli volts per degree C per cell (typically -5mV).
- ❖ Not watching to verify the Absorb or EQ time is set properly and that the equipment actually charges for that period of time. Some equipment will have settings like “End Amps” that can terminate Absorb early and if set up wrong can damage a battery.
- ❖ Not having enough charge current (Solar Panels) to properly charge the size of the battery you have. Consult the battery manufacturer for the minimum charge current.
- ❖ Using tap water or other liquids instead of distilled water in a flooded battery. The minerals in the tap water will destroy a battery.
- ❖ Failing to keep all connections clean.
- ❖ Not using ALL EQUAL LENGTH interconnect cables on each string. It is important that ALL strings be wired EXACTLY the same. Any variance in resistance on one string versus another will cause an imbalance and the batteries will be dead in less than 6 months.
- ❖ Using more than three parallel strings and not using common bus bars. When you use more than three strings it is very hard to properly charge the middle strings. The only safe way to do this is to wire each string with equal length cables to a common bus bar.
- ❖ Not making sure your lead acid batteries get a full charge at least once a week.
- ❖ Routinely using more than 50% of the capacity of the lead acid battery. Using more than half the battery capacity drastically shortens the batteries life; occasionally is fine but on a daily basis will kill them in months.
- ❖ Not leaving ample space between cells for cooling. We recommend at least one inch between the cells for cooling. Ask the battery manufacturer what they recommend.
- ❖ Trusting a State of Charge (SOC) meter, which can lose calibration over time and give you false readings. You need to verify specific gravity and or verify the charge voltage is being met. Never fully rely on the SOC %; it is just a good, quick reference.

Classic Power Curves

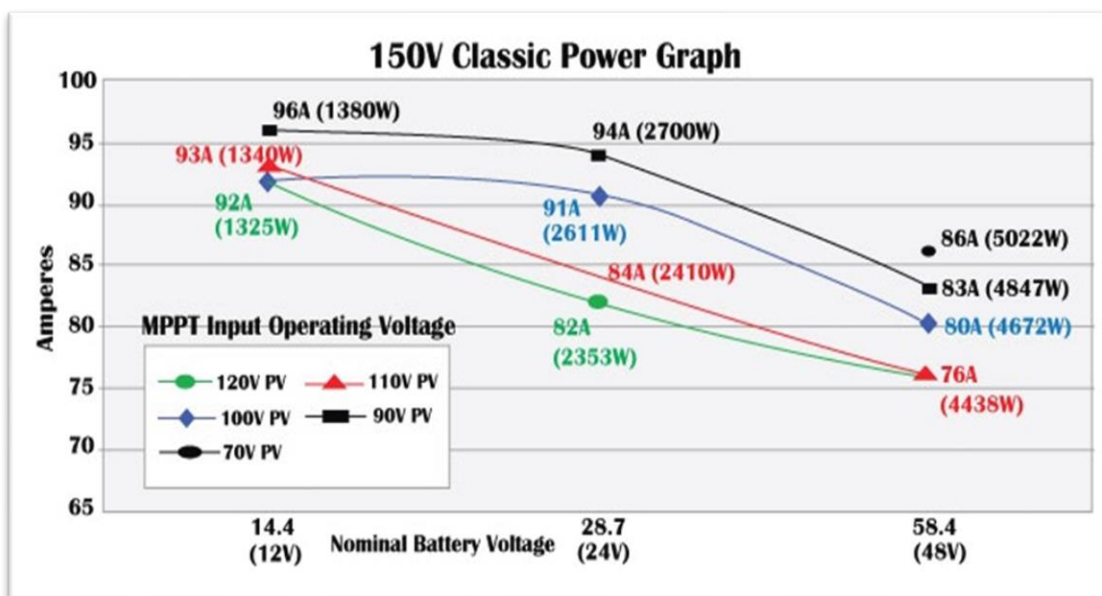

Table 1

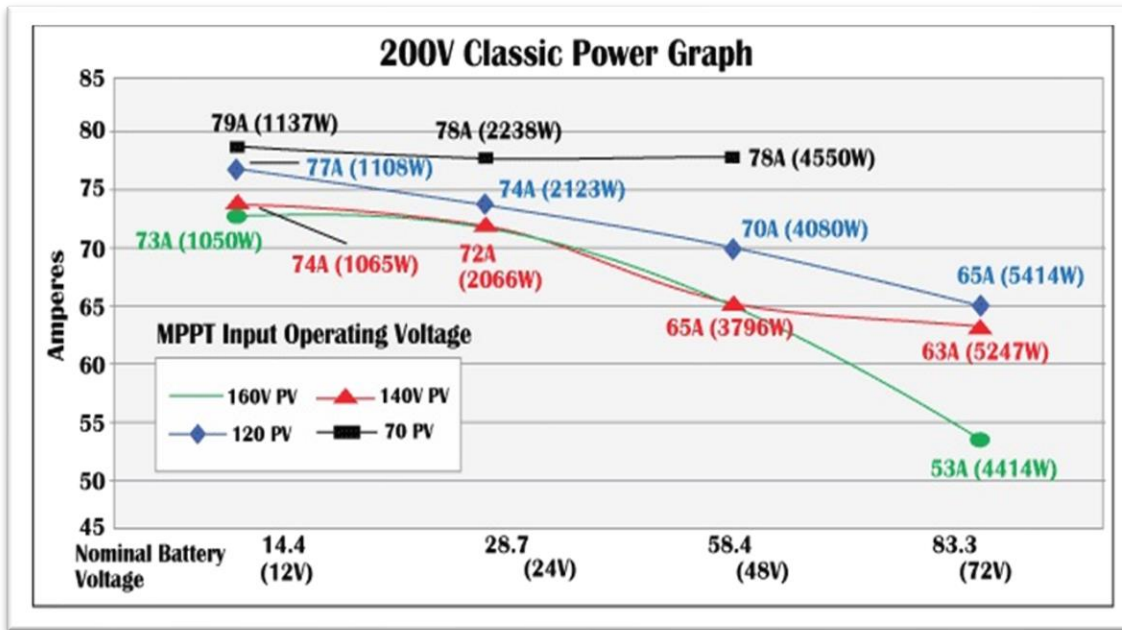

Table 2

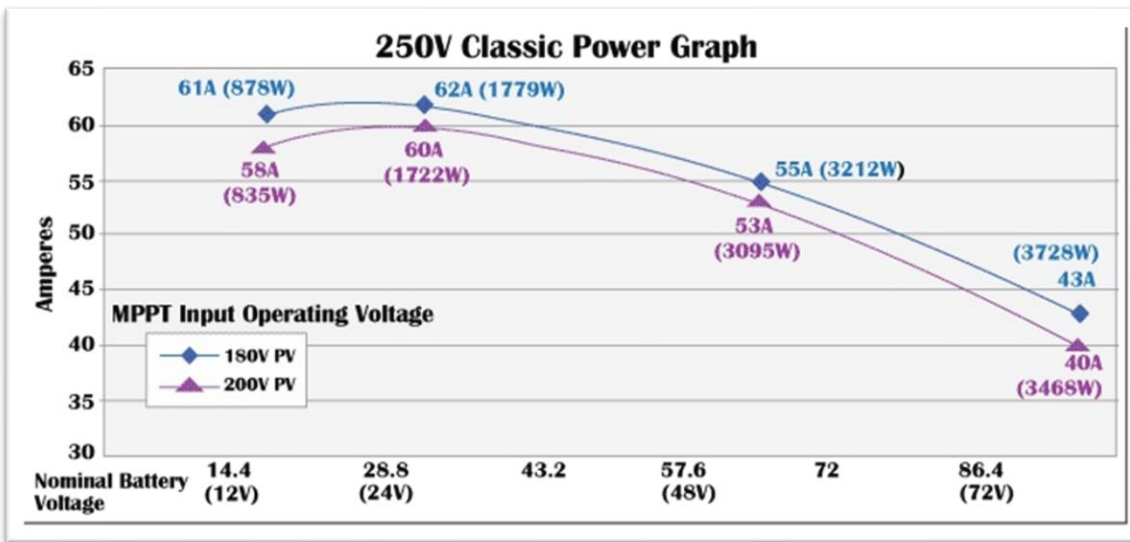

Table 3

Tables 1 through 3 above represent the max power output for a given input for each Classic. Using and understanding these power graphs will help maximize the Classic’s output power and aid in selecting wire and breaker/disconnects. Notice that lower battery voltages and lower PV input voltages result in higher continuous output power. The PV voltages listed are for reference and are not intended to be the only PV voltages supported. The battery voltages listed show common battery bank configurations. Other voltages are also supported. The Classic battery voltage parameters are fully user-adjustable.

Example: If you are using a Classic 250 and 48V battery bank, the maximum continuous output power based on 25° C ambient is 55A when using a PV array that yields a maximum power voltage

of 180V. The same set-up using higher voltage modules that result in a 200V maximum power voltage will result in only 53A. Although 55A to 53A is not a significant change, it does indicate that a lower input voltage is more productive. Design your system to achieve an ideal input voltage, or a “sweet spot,” in terms of sufficient Voc for MPPT operations: not too low, not too high. Keep in mind that an MPPT controller needs to have the open circuit voltage of the array about 33% higher than the highest battery voltage you plan to charge to.

NOTE: You can find the Classic string sizing tool our web page www.midnitesolar.com.

Classic Installation

Unpacking the Classic

When you receive your Classic, you will want to unpack it and make sure everything is there and in good shape. Refer to Figure 1. Included with the Classic:

- ❖ Classic charge controller
- ❖ Battery temperature sensor
- ❖ User’s manual, printed
- ❖ Knock out covers, 3 screened
- ❖ Parts bag with stickers, terminal block cover, and silicone grease

Email customerservice@midnitesolar.com for more information or if anything is missing or damaged.



Figure 1

Removing and Installing Classic Front Cover

Removing the front art deco cover is required to gain access to the wiring compartment.

NOTE: A cable connects the cover to the electronics. Do not pull hard or fast as damage could occur.

To remove the front cover of the Classic in preparation for installation, remove the four Phillip's head screws with a #2 Phillip's screwdriver. Lift the front half of the Classic casting off. You will need to unplug the display cable. It works the same as any phone cable.

When installing the cover for the final time, squeeze a small amount of silicone grease (included in the parts bag) onto the metal pins of the male jacks on the display cable before plugging them in.

To re-install the front cover of the Classic you will need to plug in the display cable and carefully route it around the components on the circuit board as you set the cover in place. See Figure 2. Do not force the cover if it does not seat into place easily; stop and look for any cables or wires that may be interfering. With the cover seated in place, install the four Phillip's screws with a #2 Phillip's screwdriver.

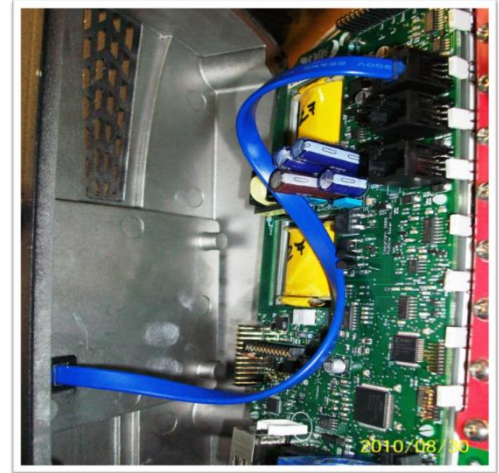

Figure 2

Mounting the Classic

The following section covers typical mounting arrangements. If you require additional details that are not covered here, please contact our tech support team. The Classic is designed to be directly mounted onto the MidNite Solar E-Panel. The Classic can accommodate other installation methods as well. Mount in an upright position out of direct sunlight when possible. For your convenience the Classic has four one-inch knock outs that are pre-cast. The Classic has mounting locations and conduit locations that are similar to other brands of charge controllers to facilitate ease of upgrading older technologies.

Mounting the Classic to the E-Panel:

- ❖ Remove the front cover of the Classic.
- ❖ Install the mounting bracket on the E Panel and start the upper mounting screw into the bracket, leaving it about half-way out so you can hang the Classic on this screw.
- ❖ Install the one-inch close nipple into the E-Panel as shown in the E-Panel directions. The one-inch close nipple, two plastic bushings, and three locknuts are included with each E-Panel. One locknut acts as a spacer.
- ❖ Carefully hang the Classic on the screw in the bracket and slide it over the close nipple (see Figure 5).
- ❖ Install the lock nut and bushing on the close nipple and tighten the screw in the mounting bracket.
- ❖ Do not install the front cover until you complete the wiring of the Classic.

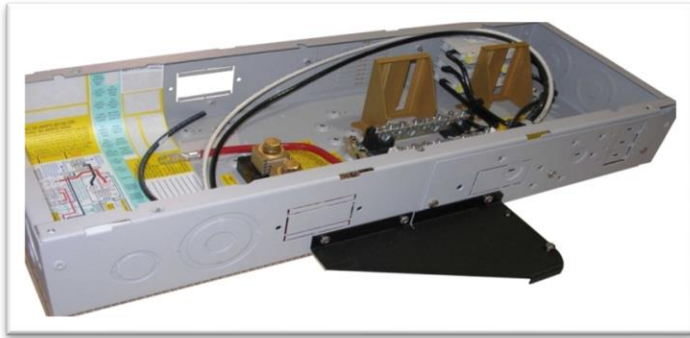

Figure 3 – Classic mounting bracket

IMPORTANT!

Do not mount in a zero-clearance compartment. Overheating may result. The Classic produces heat in normal operation. Airflow around the Classic is required to prevent overheating and shutdown. This is especially true in hot environments.



Figure 4 – Classic mounted to E-Panel



Figure 5 – Nipple, locknuts, and bushings

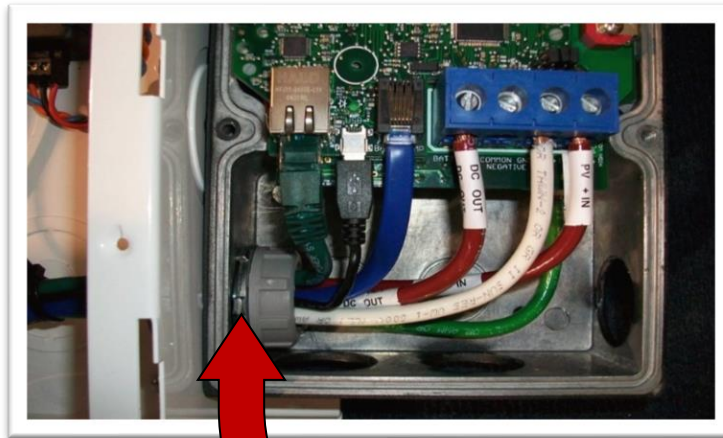

Figure 6

Install locknut here to act as a spacer.

Alternative Mounting

To mount the Classic to a plywood surface, use 1 1/2" wood screws in the top keyhole slot hole and the holes in the wiring compartment, taking care to make sure the Classic is plumb and level.

Sealed or Vented

The Classic can be sealed for protection from salt air or dust. It comes from the factory vented. If you live in a dusty or salt air environment, you may wish to seal the Classic. Sealing the Classic does not make the unit water resistant. To seal the Classic, install the solid plastic knock-out covers into any unused knock-outs and snap the upper vent cover onto the Classic as seen in Figures 7 and 8. Note that the Classic will be slightly de-rated (will put out less power) by sealing it. Refer to the specifications page of this manual for the ratings in the sealed mode (40C+, shown in Table 6). To obtain the parts necessary to seal the Classic, please contact our Tech Support Team and ask for MNCLSEALKIT.



Figure 8



Figure 7

Wiring the Classic

WARNING - SHOCK HAZARD: Disconnect the batteries and input power before opening the Classic front cover. ALWAYS use proper over-current protection and disconnects on the PV+ and battery + wires.

Ensure all source and battery circuits are de-energized and wait five minutes before working on the wiring in the Classic. The Classic has two common neutral (negative) terminals; therefore, only one neutral conductor is required to run from the E-Panel and terminate on either (or both) common neutral terminal. This negative conductor should be sized to match the battery + cable. The positive DC source wire goes to the PV+ setscrew. The positive battery DC wire goes to the battery + terminal. Torque the terminal screws to the specs below.

Connect **ONE** PV array per Classic.

NOTE: The Classic should be wired by a qualified professional and needs to meet all applicable electrical codes.

Maximum and Minimum Wire Size

- ❖ The Classic's blue DC terminal connector will accept wire from #14 to #4 AWG (use THHN; #4 AWG welding cable will not easily fit into the terminal block).
- ❖ The Classic's AUX 1 and AUX 2 terminal connectors will accept wire up to #18 AWG.

To Connect Wiring to the Classic:

- ❖ Ensure the DC source and battery are disconnected.
- ❖ Connect a grounding conductor between the Classic and system ground.
- ❖ Ensure the breaker between the battery and Classic meets UL489 standards.
- ❖ Ensure the breaker between the DC source and Classic meets UL1077 standards.
- ❖ Use copper building wire ONLY.
- ❖ Connect the DC source and battery wires to the Classic.
- ❖ Connect any communications cables or auxiliary input/output wires.
- ❖ Torque terminal connector setscrews to the following specs:
 - Up to #10 AWG: torque at 25- to 35-inch pounds.
 - #8 AWG: torque at 30- to 40-inch pounds.
 - #6 AWG or larger: torque at 40- to 50-inch pounds.

Diagram 1 Explanations:

- 10 - Solar modules (PV).
- 11 - DC combiner (i.e., MidNite MNPV6 or MNPV12).
- 12 - MNSPD300-DC (Surge protection).
- 13 - MNSPD300-AC (Surge protection).
- 14 - MNSPD300-DC (Surge protection).
- 15 - DC breaker for the inverter (Also serves as a disconnect for the Inverter).
- 16 - DC breaker for the PV into the Classic (Also serves as a disconnect for the Classic).
- 17 - DC breaker for the battery into the Classic (Also serves as a disconnect for the Classic).
- 18 - AC L1 input bus bar (This is where the generator L1 input gets wired).
- 19 - AC neutral bus bar (This is where ALL AC Neutrals get wired).
- 20 - AC L1 output bus bar (i.e., L1 output to the load center for the building).
- 21 - Battery positive bus bar (This is where you wire the battery positive side of the Classic, as well as where you wire up DC loads. Do NOT wire the battery cable to this bus bar).
- 22 - Earth ground busbar (This is the common earth ground bus bar where all the grounds get wired back to and it needs to be connected to the building's ground rod system).
- 23 - PV positive bus bar (This is where the solar panels positive lead connects).
- 24 - Battery negative bus bar (This is where the solar panel negative lead goes as well as the Classic's negative lead and any negatives from the loads. Do NOT connect the battery negative cable to this bus bar).
- 25 - DC shunt (The shunt measures the amperage in or out of the battery. You connect the battery to one side and everything else to the other side).
- 26 - Earth ground system of the building.
- 27 - Classic charge controller.
- 28 - AC generator.
- 29 - Batteries (The voltage must match the voltage of the inverter).
- 30 - Classic temperature sensor.
- 31 - DC cables to inverter.

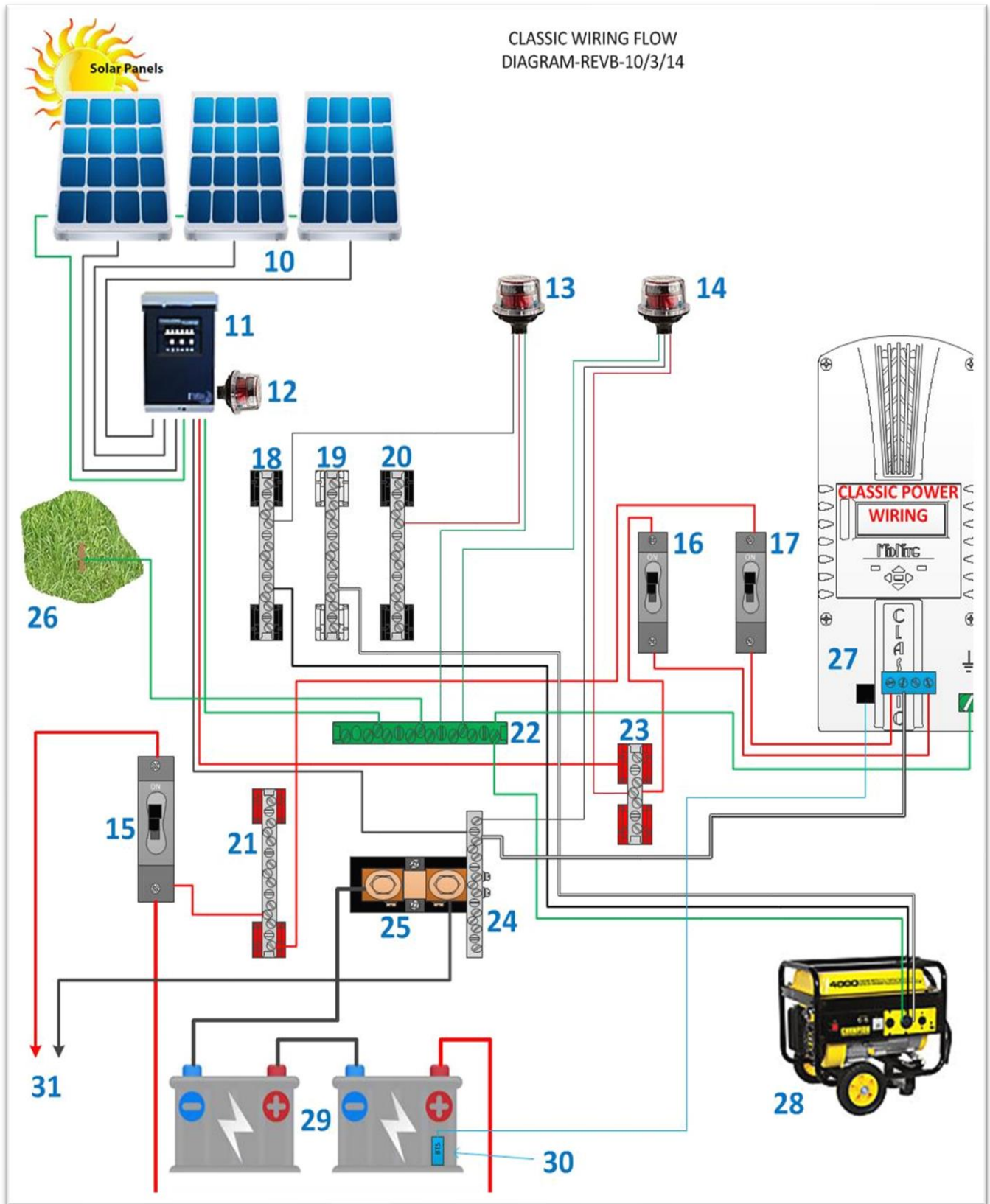

Diagram 1 – Overall System Wiring

DC Terminal Connector

The Classic's DC terminal connector is located on the circuit board as shown in Figure 9. The connector is rated for copper conductors and will take up to a #4 AWG wire (THHN). #4 AWG THHN when installed in the Classic and MidNite E-Panel is rated for over 100A and is therefore suitable for the highest power available from the Classic 150. After installing the wires for the last time, snap in the blue cover that is included in the parts bag.



Figure 9 – Terminal Block

Current Rating

The Classic limits the output current based on model & battery bank voltage:

❖ Classic 150	96A/12V	94A/24V	86A/48V	
❖ Classic 200	79A/12V	78A/24V	78A/48V	65A/72V
❖ Classic 250	61A/12V	62A/24V	55A/48V	43A/72V

Over-current Protection

The Classic must have over-current protection to protect wiring from over-current events. A means of disconnect must be installed on the DC in and DC out of the Classic. Consult your local codes to determine over-current ratings. The breaker between the battery bank and the Classic must conform to UL489. The breaker between the DC source and the Classic must conform to UL1077 or UL489. The NEC requires 1.56 times short circuit current (Isc) for PV over-current protection. This is reduced to 1.25 times when using a breaker rated for continuous duty. All MidNite Solar breakers are rated for continuous duty (100% rating). No de-rating is required for the input or output breakers when using MidNite Solar DC breakers.

Solar panels are capable of producing more current than their name plate rating in extreme situations, so the safe minimum wire size should be selected for the PV array maximum short circuit current. Please consult your PV manufacturer for specifications. The US National Electrical Code requires 1.56 times the PV short circuit current for wire size on the PV input. Output wire size follows the NEC guidelines. Typical wire size for output is #6 AWG for the Classic 250 and #4 AWG for the Classic 200 and 150; check all de-ratings for your wire type and installation method.

The over current devices, wiring, and installation methods used must conform to all electrical codes applicable to the location of installation. Wiring needs to be protected with proper strain relief clamps and or conduit. See Page 66 for a breaker and wire size chart.

The network cables, USB cable, BTS cable, and auxiliary input/output cables should run in a different conduit to preserve their signal. When installing the Classic in a MidNite E-Panel, it is acceptable to run all wiring through the same knockout hole. It is legal to run signal and power wires together if all wiring is listed for the highest voltage to be encountered.

NOTE: Follow all local codes.

Long Distance Wire Runs

The Classic offers some unique opportunities if you are faced with longer than normal wire runs between the DC source and the Classic. The Classic comes in three input voltage ranges letting you design a DC source at a higher voltage if it is beneficial. For example, let's say you have a 300-foot run from a PV array to the Classic. You could wire for an open circuit voltage close to 250V accounting for the coldest temperature you will encounter. This will allow you to run a smaller gauge wire than with a lower voltage charge controller. The efficiency of a high voltage Classic is less than the lower voltage versions, so you need to weigh the benefit. If this sounds too complicated, use this rule of thumb in selecting the proper Classic: PV runs up to 100 feet - use the Classic 150; runs up to 180 feet - use the Classic 200, or above 180 feet - use the Classic 250.

If the wire size between the DC source and the Classic is larger than the Classic's DC terminal connector, you can use a splicer block or similar connector to reduce down to #4 AWG close to the Classic. The MidNite E-Panels are supplied with a PV input bus bar that accepts up to # 2/0 AWG wire.

Connecting the Classic to the Clipper

The connections between the Clipper and Classic are simple. There are the DC - and + conductors from the Clipper to the PV input on the Classic. There is also a smaller set of - and + conductors connecting AUX 2 to the PWM input on the Clipper.

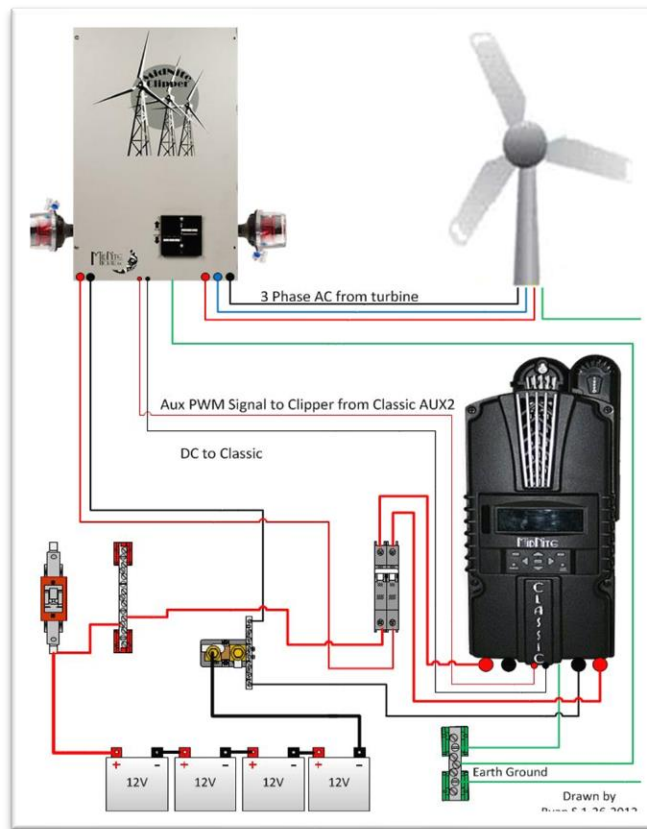

Diagram 2 – Classic and Clipper Wiring

Grounding

Chassis Grounding

In all installations the Classic chassis should be connected to ground. For systems with a battery breaker sized 60A and smaller, #10 AWG (6 mm²) copper is generally sufficient. For systems with a battery breaker sized 100A and smaller, #8 AWG (10 mm²) copper is required. For grounding conductor requirements on your specific installation, please consult your local electrical code. The chassis grounding terminal is in the upper right corner of the electrical connection compartment.

DC System Grounding

The Classic is designed to work with negative ground, positive ground, or ungrounded power systems. In negative ground systems, DC negative may be connected to ground either externally or by using the Classic's internal grounding jumper, shown in Figure 10. The internal grounding jumper should only be installed when the Classic's GFP is enabled. When the chassis ground point is connected to earth ground and the GFP jumper is installed, a DC negative to ground bond exists.

In a positive ground system or for an intentionally ungrounded system, the GFP jumper must be removed.

Also note that with positive ground there will be items still referenced to battery negative that can complete a short circuit of the battery bank. These items include, but are not limited to, the USB Cable and RS232 serial data lines.

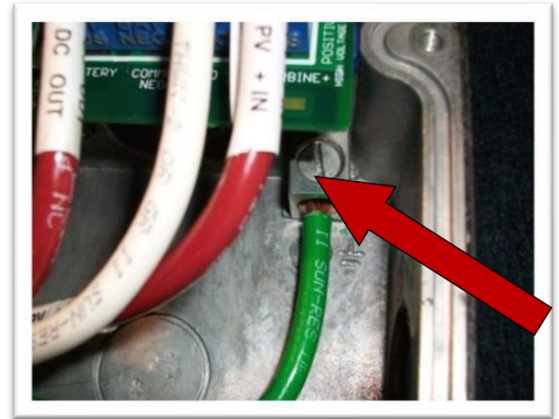

Figure 10 – Chassis Ground Point

DC GFP (Ground Fault Protection)

The Classic has internal ground fault protection (GFP) built-in. Since 2008, the NEC requires a DC-GFP on all PV systems in the USA. The built-in DC-GFP eliminates the need to purchase and install an external DC-GFP. If the internal grounding jumper is installed in a Classic, the battery negative and DC source negative must not be connected to the system grounding conductor anywhere in the system. Grounding of these circuits will defeat the GFP function. In a network with multiple Classics connected in Follow-Me, only one Classic should have its internal grounding jumper installed and all should have GFP enabled. The factory setting will make a DC negative-to-system ground connection in the Classic. Disabled the GFP function for positive ground or an ungrounded DC system.

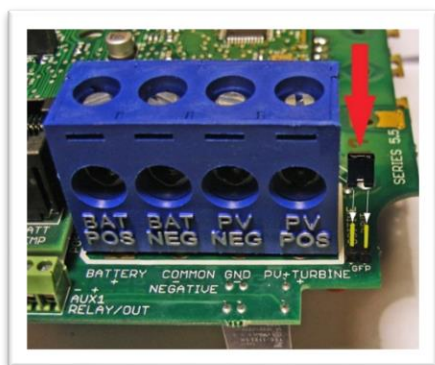

Figure 91 – GFP Jumper

The ground fault device is simple to understand and use. It detects a fault between battery/PV negative and earth ground just like the breaker DC-GFP system. The difference with the Classic is that it turns off the charge ability and sounds a loud warning when a ground fault is detected. The Classic's system consists of a PTC that is between the negative and ground internally in the Classic. A PTC is a self-healing fuse that will open when current exceeds its rating and reclose when current is

dropped below its rating. The Classic will monitor

this PTC and disable the charging when it opens. When the fault is cleared the Classic will restore charging. To disable the internal ground fault protection function, the jumper labeled GFP needs to be removed and the GFP function needs to be disabled in the TWEAKS menu. See “Disabling GFP” for instructions.

Disabling GFP

The GFP feature should only be disabled to operate the Classic in an ungrounded power system or in systems where GFP is not required. See Page 21 for GFP information when in Follow-Me.

- ❖ Depress MAIN MENU key.
- ❖ Scroll to the right or left until TWEAKS is highlighted and depress ENTER.
- ❖ In TWEAKS, depress the RIGHT SOFT key to get to the MORE menu.
- ❖ In MORE, scroll until GFP is highlighted.
- ❖ Use the up and down arrow keys to toggle between on and off.
- ❖ Depress ENTER to save.

To reset the internal GFP function after detection has occurred: fix the actual ground fault, then turn off the Classic and turn it back on (via circuit breaker between Classic and battery bank).

Positive Ground Systems

When installing the Classic in a positive ground system there are a few extra steps that need to be taken. The ground fault jumper needs to be removed, and ground fault needs to be disabled in the TWEAKS menu.

The overcurrent protection needs to be done a little differently as well. The input and output breakers need to be double pole breakers. Battery negative and positive conductor both need to be protected. Refer to Classic Breaker Sizing on Page 67.

CAUTION: Do not connect both positive battery and positive PV input to ground. One or the other positive (normally battery +) but not both, otherwise, the Classic input and output will be shorted.

Networking

Follow-Me – Charge Coordination

Follow-Me allows Classics to share charge stages, battery temperature info, and ground fault coordination. Follow-Me also allows you to program a single Classic for Equalize charging and it will instruct all the others to Equalize as well. You do need to set the Equalize parameters in each Classic. You will only need one BTS and it can be on any of the Classics.

WARNING: MidNite HIGHLY recommends using Follow-Me with two or more Classics. Best for battery bank health. All firmware should match across all Classics.

WARNING: Reversed Follow-Me cables can damage the Classic if left in place for extended periods

of time and will not be considered under warranty. Please verify the proper operation of Follow-Me during the initial set-up.

WARNING: If using Follow-Me on multiple Classics in a positive-grounded system, contact MidNite Tech Support for information on modifying the Follow-Me cables.

The Follow-Me function basically is just what it is called. The Classic will simply ask the Classic to its right, “What do I do now?” and this propagates around the loop continually. Whichever Classic goes to Float first, for example, will simply tell the other Classics it is time to go to Float.

NOTE: Absorb is NOT a Follow-me mode, each Classic MUST reach the Absorb voltage setting on its own. Resting is NOT a Follow-me mode, each Classic goes to Resting on its own.

NOTE: Follow-Me coordinates charge stages but the Classics will still vary in the amount of power processed. Follow-Me was not intended to make them all produce the same amount of current.

To enable Follow-Me, you need to wire the Classic network cables as shown in Diagram 3. You also need to enable Follow-Me as follows:

- ❖ Navigate to the TWEAKS Menu.
- ❖ Depress the MAIN MENU key repeatedly until “Charge” is highlighted.
- ❖ Scroll to the right until TWEAKs is highlighted and depress the ENTER key.
- ❖ Depress the RIGHT SOFT key (upper right button) four times until you see the screen with “Follow-ME” and “BTSNET.”
- ❖ Using the left/right arrow buttons, highlight Follow-Me and turn it on using the up arrow.
- ❖ Highlight BTSNET and turn it on if you want to share battery temperature data.
- ❖ Depress ENTER to save this data.

When installing the Follow-Me cables for the last time, it is recommended you add a bit of the included silicone grease on the metal contacts of the male ends of all the cables.

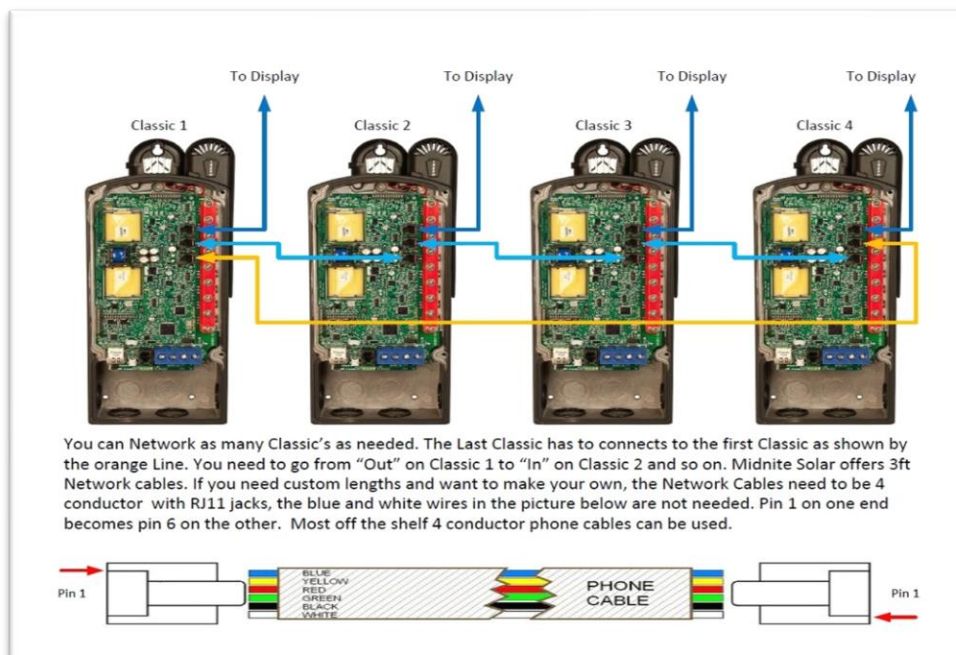

Ground Fault Sharing (in Follow-Me configuration)

To share ground fault, you need to remove the GFP jumpers on all except one Classic. You then need to make sure Ground Fault is enabled in the Tweaks menu for any of the networked Classics you want to shut down on detection of ground fault. For example, say you have three solar Classics and one wind Classic and you do not want the wind Classic to shut down for GFP. Make sure in the Tweaks menu of the wind Classic that GFP is disabled (off).

Naming the Classic

The Local Application software allows you to issue a name to the Classic with upper- and lower-case letters, as well as numbers (available as a free download at <https://mymidnite2.com/?q=node/7>). This name can be up to 8 characters. This name will show up on the display of the Classic instead of the word CLASSIC. It will be shown in all upper-case on the Classic’s display. The naming process can be helpful for networked Classics that use one MNGP (Display) to view multiple Classics.

Addressing Classics

You can assign unique addresses to each networked Classic. This is not necessary for Follow-Me to work but it is necessary if you want to view multiple Classics from a single MNGP. To address a Classic simply use the MNGP that is plugged into that Classic and hold the left arrow button down and tap the up or down button. The normal default address is 10 so going up will take you to 11 and down to 9. When you get to the unused address you want for that Classic hold the left and right arrows for a second until “Data Sent and Saved” shows up. Now this Classic has been re-addressed to the new address. Do this for all the Classics on the network.

To view other Classics on the network, use the same button strokes. Hold the left arrow down and tap the up or down arrow depending on which number you are looking for. We suggest going from 10 up for clarity. So, if you have four Classics, they would be 10, 11, 12, and 13. You would scroll up from the normal position to find the other three.

Diagram 3 – Follow-Me Wiring

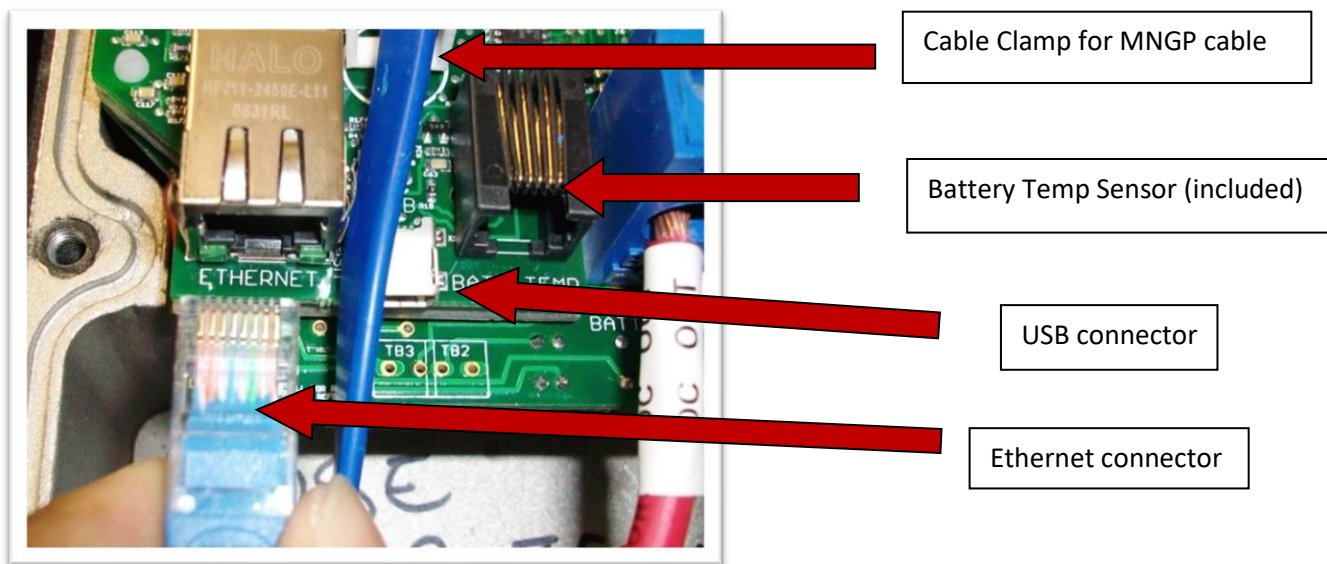

Figure 12

Connecting the Classic to Two MNGPs/Network Cable



Figure 13

The Classic can be controlled with two MNGPs at the same time. This will help when the Classic is in a shop and there is a considerable distance between the Classic and the controlling point (office, inside house, garage etc.). Instead of going to the Classic to check status or to change a setting, the user can run a cable to the controlling point and see the Classic in a second MNGP. The cable is a 6-wire phone cable. Connect one side of the extension cable to the jack in the Classic labeled SLAVE/OUT and the other end to the second MNGP. Since the Classic transmits power and data signals through the phone cable to the MNGP, the length of the cable is limited to 100 feet.

MidNite only offers a 3-ft cable as an optional accessory. If you are making your own cable, insert cable end all the way into the phone terminal to get a good contact. Use phone crimping pliers to crimp both ends of the cable. We recommend using flat phone cable for extension, just because it is easier to work with. Reference Figures 13 and 14. Ensure the color and position of the wires are as shown in Diagram 4. Use terminal connector tab as reference.



Figure 14



Diagram 4

Connecting the Classic to the Internet

The Classic supports standard 10/100-base T Ethernet networks. For Gigabit networks you will need a common network switch that is capable of mixed mode operation. The Classic may also be placed on a, b, g, or n wireless networks by using a wireless network bridge device. Depending on your network you may use one of the topographies detailed in Example 1 through 4 below. Note that the switch may be self-contained or, in many cases, may already be integrated into your cable or DSL modem. Refer to Figure 12 for Ethernet connector location in the Classic.

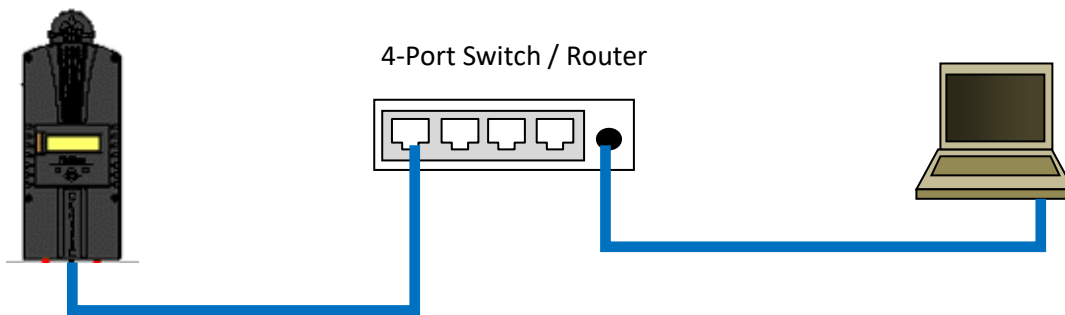

Example 1 - Local network through switch. We do NOT recommend direct-connect between Classic and computer.

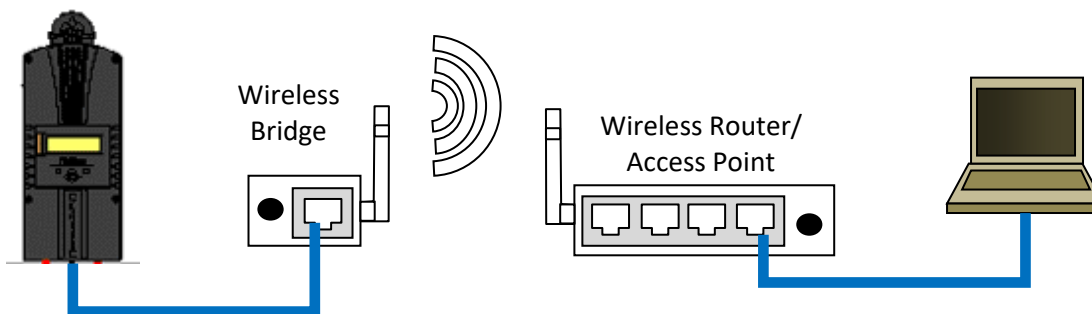

Example 2 - Local network through wireless bridge

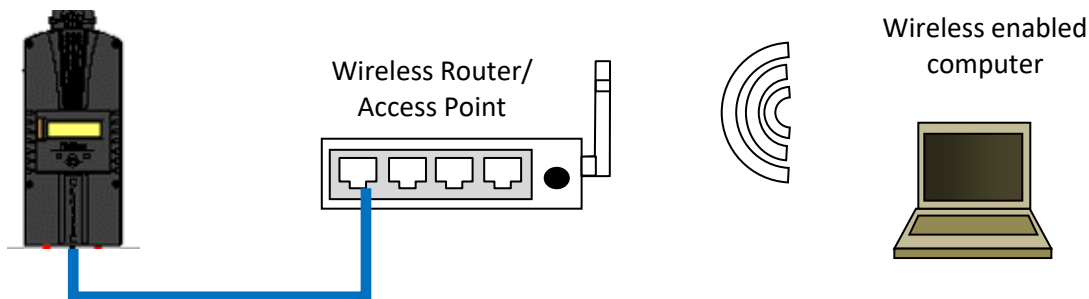

Example 3 - Local wireless network

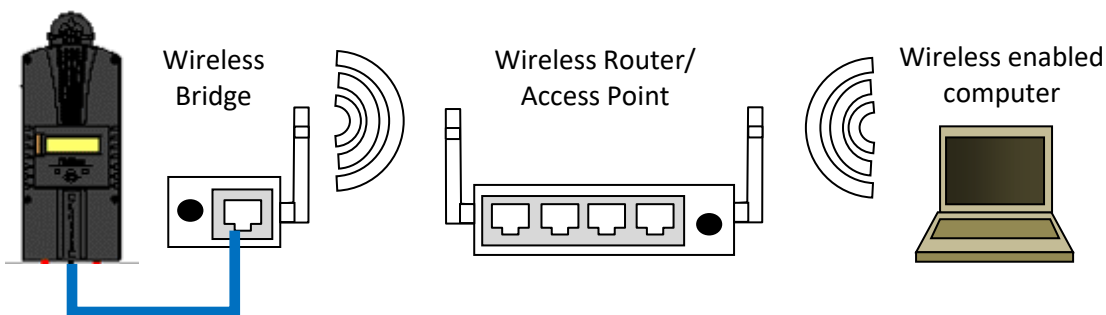

Example 4 - Local wireless network through wireless bridge

Network Setup through the MNGP

The Classic's Ethernet capabilities may be configured using the NET menu on the MNGP. From the main menu, select NET. There are three screens that configure network settings. Table 4 decodes

the descriptions from the MNGP's small screen.

	Long-hand	Description
Mode	IP address configuration mode: DHCP/Static	The Classic supports both static and dynamically (DHCP) allocated IP addresses. If you are unsure which to choose, try DHCP first. If you have trouble, refer to the troubleshooting section.
IP	IP Address	The Network address of the Classic (Assigned by customer's router when using DHCP)
SN	Subnet	The Subnet or address class specifier (Assigned by customer's router when using DHCP)
GW	Gateway Address	The address of the network's gateway device (Assigned by customer's router when using DHCP)
D1	Primary DNS Address	Primary Address lookup device (Assigned by customer's router when using DHCP)
D2	DNS override	This must be 0.0.0.0
Web Access		Enables or disables the Classic's data push to My Midnite
A	MAC Address	The hardware address of the Classic
DI	Device ID	The unique MidNite Solar ID number for the Classic

Table 4

DHCP

The Classic supports Dynamic Host Configuration Protocol (DHCP) in which all networking settings are derived from a DHCP-enabled router. This is the simplest configuration method and recommended unless you explicitly need a statically allocated IP address for your Classic. In this mode all other settings are automatically configured and are read-only (informational), except for the Web Access feature.

- ❖ Depress MAIN MENU key.
- ❖ Scroll to NET menu and depress the ENTER key.
- ❖ Highlight and select DHCP.
- ❖ Depress ENTER key to save changes.

NOTE: The Classic's DHCP protocol implementation usually takes a few seconds up to a minute to update the network settings. If the network settings do not update within a minute, please consult the troubleshooting section.

Static IP

The Classic supports static IP address allocation. In this mode you can assign the Classic a specific IP address. This lets you set up things like port forwarding from your router or for networks with static IP allocations.

- ❖ Depress MAIN MENU key.
- ❖ Scroll to NET menu and depress the ENTER key.
- ❖ Highlight and select STATIC.
- ❖ Using the left and right keys, navigate to the settings to change and use the up and down arrows to adjust the desired fields.
- ❖ Depress the ENTER key at any time to commit the settings to the Classic's flash memory.

NOTE: Static settings span two menu screens. You may use the soft keys to navigate between the two menus. Depressing the ENTER key in either menu saves all settings. For convenience when you manually set the device's IP address, the Gateway and Primary DNS addresses follow the change. See the following sections for details on each of these fields.

IP Address

This is the local network address of your Classic. It usually takes the form "192.169.0/1.x" or "10.0.0.x" depending on your networking equipment. You must be careful when selecting this address. If it does not match your network subnet then the classic will not be able to communicate with the network. If it is the same as another device on the network, then collisions will occur causing both devices to act erratically. Check your router settings or ask your network administrator which local address to use. Also refer to the troubleshooting section for tips.

Subnet

This refers to the class of local network you are using. This depends on your network hardware, but most users should use "255.255.255.0" for this field.

Gateway

This is the address of your router or modem – the device which is connected directly to the Internet. It will usually take the form "192.168.0/1.1" or "10.0.0.1" depending on your network configuration and hardware. Check your router settings or ask your network administrator which local address to use. Also refer to the troubleshooting section for tips.

DNS 1

The DNS is the means by which human-readable internet addresses are resolved to actual IP addresses on the network. These values can usually be set identically to the gateway address depending on your network hardware. If your ISP provides you with specific DNS servers, then use those addresses in these fields instead.

Example 1: Your gateway is a DSL modem with address 192.168.1.1. If your ISP has not given you explicit DNS servers to use, then set the D1 field to 192.168.1.1.

Example 2: Your gateway is a cable modem with address 10.0.0.1. Your ISP has specified primary and secondary DNS server addresses of 11.22.33.44 and 11.22.33.55, respectively. Set the D1 address to 11.22.33.44.

Web Access

MidNite Solar offers a free web service with which you can access your Classic from anywhere in the world simply by pointing your web browser to <https://www.mymidnite2.com>. Instructions on setting up your My MidNite account can be found on the above webpage. Classic firmware 2079 or higher is required to interface with My Midnite 2.

NOTE: Firmware version 2079 or higher (newer) is required for web access.

All communications between the Classic and MidNite Solar's server are encrypted using a strong session-based algorithm. To respect your privacy, however, it is required that you manually enable

this feature if you'd like to use it.

In order to enable the web access feature:

- ❖ Depress MAIN MENU key.
- ❖ Scroll to NET menu and depress ENTER.
- ❖ Using the soft keys, navigate to the ADVANCED menu (**NET**→**NEXT**→**ADVANCED**).
- ❖ The WEB ACCESS option should be highlighted.
- ❖ Use the up/down keys to enable or disable the feature.
- ❖ After saving the change, you will need to reboot the Classic by removing PV power and battery power with the 2 disconnects and waiting for the screen to go dark. Wait 30 seconds and re-apply PV and battery power.

The WEB ACCESS selection indicates the current setting of the feature: i.e., ENABLED means the feature is currently in operation.

You will need the values of MA and DI handy in order to create an account on the My MidNite web site. This unique number pair identifies your particular Classic to our server and helps to prevent malicious users from trying to access your Classic. The DI or (Device ID) is different than your Classic's serial number.

Local Network

Note that your Classic identifies itself by name to DHCP-enabled routers as "Classic." There is facility to change the name of a given Classic via the local and web-based interfaces as well as using third-party MODBUS software packages.

Advanced

The Classic advertises its address every 10 seconds using the UDP protocol. Advanced users and programmers may use this feature to identify Classics on their network.

Battery Temperature

Battery Temperature Compensation

The Classic comes with a battery temperature sensor (BTS). This sensor raises or lowers charge voltages based on temperature. Connect the BTS to the BATT TEMP jack. The Battery Temperature menu appears as **T-Comp** in the BATTERY MENU. In this menu you can change the voltage compensation as needed. If the BTS is disconnected or shorted the Classic will automatically default to 25C on the battery temperature. The Classic also has the ability to change the neutral temperature (typically 25C); this setting can be found in the WBJr set-up menu.

Battery Temperature Sensor (BTS) Installation

CAUTION: To reduce risk of injury, charge only deep-cycle lead acid, lead antimony, lead calcium, gel cell or absorbed glass mat type rechargeable batteries. Other types of batteries may burst, causing personal injury and damage. **NEVER** charge a frozen battery.

WARNING - RISK OF INJURY: To reduce the risk of injury, charge only properly rated (such as 6V, 12V, and 24V) lead-acid (GEL, AGM, Flooded, or Nickel Cadmium) or Lithium (with a

Battery Management System, BMS) rechargeable batteries. Other battery types may burst, causing personal injury and damage.

WARNING - EXPLOSION HAZARD: Flooded, lead-acid batteries generate explosive gases during the Equalization cycle. Follow all battery safety precautions listed in this guide. Ventilate the area around the battery thoroughly using ventilators with brushless motors and ensure that there are no sources of flame or sparks in the vicinity.

The Classic comes with a BTS which plugs into the jack labeled “Batt Temp” (see Figures 15 and 16). Route the cable through the E-Panel into the battery box. Pick a battery in the middle of the bank and about half-way up the side of the battery; thoroughly clean a spot off on the case. Remove the protective tape from the BTS and adhere to the battery. Some manufacturers use a double-wall case on the battery. For mounting a temp sensor to a double-wall battery case, please refer to the battery manufacturer's recommended procedure.

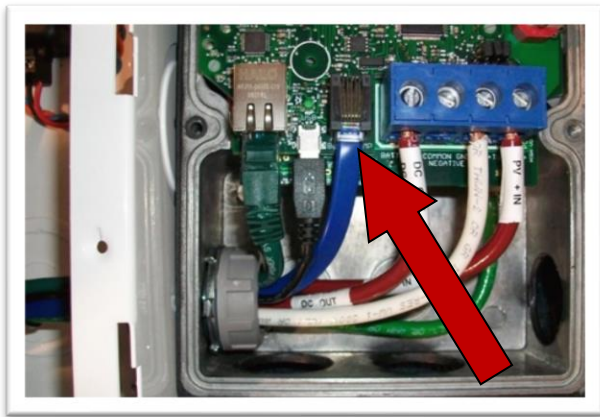

Figure 15 – Battery Temperature Sensor



Figure 16 – Battery Temperature Sensor Mounting

Classic Programming

Commissioning the Classic (Quick Start)

The Classic will enter the Quick Set screens upon initial power up. If the Classic does not enter the Quick Set or you want to restore to Factory Default, follow these steps to initiate a Quick Set:

- ❖ With the power off to the Classic, hold the left and right arrow buttons down.
- ❖ Power-on the Classic, continue holding arrow buttons until the setup screen is displayed.
- ❖ Answer the questions on the next several screens to complete the Quick Set.

MNGP Features and Programming

The Classic comes with an integrated MidNite Graphics Panel (MNGP, shown in Screenshot 1), which is the primary interface to the Classic.

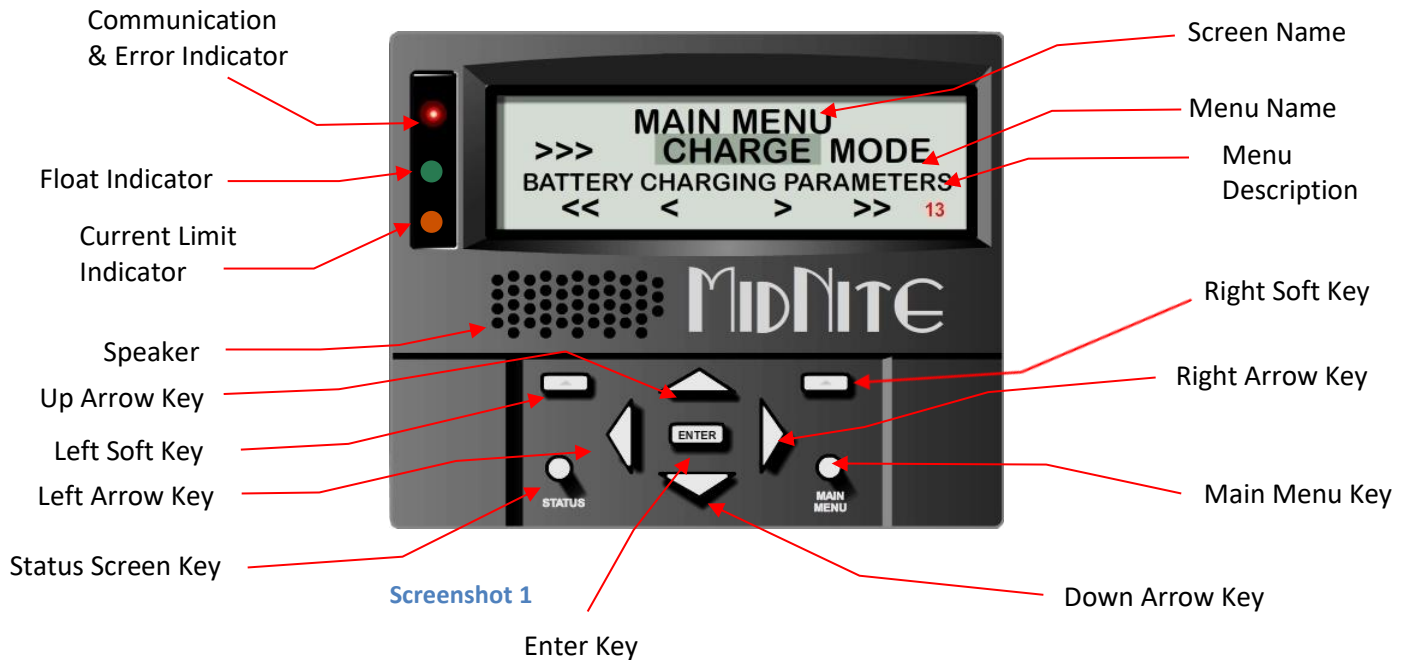

Most settings can be accessed and modified. Navigate using the LEFT & RIGHT arrows. Pressing ENTER takes you into that menu. The MAIN MENU key also backs you out of any submenu. Use the soft-keys for options & views. Be sure to press ENTER to save changes before backing out of any menu/submenu.

The Classic has some helpful safety features including GFP (Ground Fault Protection) and AFD (Arc Fault Detector). When one or more faults are detected, the Classic will stop outputting power and display a fault message in the bottom right corner of the home screen.

Setting up contrast, backlight and volume is simple; just follow the steps below:

- ❖ Depress the MAIN MENU key.
- ❖ Scroll left or right to highlight MISC and depress the ENTER key.
- ❖ Use the left and right arrow keys to select the feature to set, depress the ENTER key.
- ❖ Depress the up and down buttons to adjust; depress ENTER to save.

Navigating the Menu

- ❖ Depress MAIN MENU key.
- ❖ Push right and left buttons to see the different menus.
- ❖ To return to the status screen, depress the STATUS key.

To navigate from one end of the main menus to the other end push the top right or left buttons. Below the name of the menu is a description of the menu. Pushing the left and right buttons will enable you to see all the main menus provided. Inside some of these main menus will be sub-menus to adjust the parameters of the selected feature.

Menu Overview:

<< CHARGE — MODE — AUX — MISC — LOGS — TWEAKS — TEMPS — NET >>

Below each of the menu names is a row with a description of the menu inside. To enter a menu, the name of the menu has to be highlighted. Pushing ENTER will show the submenus. The up and down arrow keys are enabled for easier navigation. Highlighting a sub menu and pushing ENTER will take you inside the submenu where you will be able to change the parameters of the unit. To get out of the submenus push MAIN MENU, this will take you out of the submenus one at a time every time you push it. See Pages 67-70 for Classic Menu Maps.

Battery Charge Stages

Bulk MPPT

The Classic will output as much current as it can to raise the battery voltage to the Absorb voltage set point. This is also known as constant current mode.

Absorb

The Classic will maintain the Absorb set point voltage until the batteries are charged. This stage is terminated at the end of the Absorb time or the End Amps set point, whichever occurs first. In Absorb the Classic is not outputting maximum current, as that would increase the battery voltage over the Absorb set point. Absorb is referred to as constant voltage mode. The battery is considered “full” at the end of the Absorb charge cycle.

NOTE: The Absorb cycle terminates whenever the Absorb timer expires or whenever Ending Amps is reached, whichever occurs first. The amount of time for the Absorb cycle is determined by the battery manufacturer. Without manufacturer guidance, a rule-of-thumb for lead-acid batteries is as follows:

1. Divide the battery bank Ah capacity by the total charging amps from the Classic.
2. Multiple the result by 0.42.
3. The answer is in decimal format, so multiple the tenths by 60 to get the total minutes.
4. **Example:**
 - a. 400Ah bank; 80A max charging current
 - b. $400\text{Ah} / 80\text{A} = 5.00$ hours
 - c. $5.0 \times 0.42 = 2.10$
 - d. $0.10 \times 60 = 6$ minutes
 - e. Absorb time = 2 hours, 6 minutes.

Float

A Float cycle follows the Absorb cycle. Battery voltage is held at the Float voltage set point.

Equalize

The Equalization function can be manually initiated or can be set up to Auto Equalize. The intent of an Equalization charge is to bring all battery cells to an equal voltage by a

controller's deliberate overcharge. The goal is to return each battery cell to its optimum condition through a series of voltage-controlled chemical reactions inside the batteries.

Resting

"Resting" will show on the display when the Classic is not charging the batteries; this is typically due to low light. If the Classic is Resting and should not be, ensure AUX 2 is **NOT** set to a logic input that is forcing it into Resting.

Mode is OFF

The Classic is unique in that it has multiple charging algorithms for just about any DC input. Because we support such a wide variety of DC inputs, we have also added a software "ON" and "OFF" feature. This software "switch" basically turns the relay off, effectively disconnecting the input source so the Classic will not charge the battery. If you see "Mode is Off" in the bottom right corner of the MNGP, then the Mode may have been turned off. To turn the mode back on:

- ❖ Depress the MAIN MENU key several times until CHARGE is highlighted.
- ❖ Scroll to the right until MODE is highlighted.
- ❖ Depress the ENTER key.
- ❖ On this screen, OFF should be highlighted. Use the up or down arrow to change it to ON and depress ENTER.
- ❖ Depress the STATUS key once to return to the main status screen.

NOTE: This is the same menu you would use to change between charging algorithms (i.e., solar, hydro, or wind).

Adjusting Absorb, Equalize, and Float Voltages

Absorb, Equalize, and Float voltages are fully adjustable. You will need to get the actual voltages from the battery manufacturer. To adjust these voltages, follow these steps:

- ❖ Depress MAIN MENU key.
- ❖ Scroll right or left until CHARGE is highlighted, depress the ENTER key.
- ❖ Highlight Volts and depress the ENTER key.
- ❖ Use left and right arrow keys to highlight the set point voltage to adjust.
- ❖ Use up and down arrow keys to lower or raise the voltage.
- ❖ Press the ENTER key to save the new voltages.

Current Limit

The Classic has a current limit component which interacts with the temperature of the charge controller. If the Classic is exposed to extremely hot ambient conditions, the output current will be reduced automatically to keep the Classic safe. If the orange LED comes on the MNGP, it means that the Classic is in current limit mode. If you believe the Classic is not hot and the orange LED is on, most likely the current limit set point is too low. To check this, follow these steps:

- ❖ Depress MAIN MENU key.
- ❖ Highlight the CHARGE menu and depress the ENTER key.
- ❖ Scroll to LIMITS and depress ENTER.
- ❖ Depress the right arrow key to highlight "Output Amps" or "Input Amps" column.

- ❖ Use the up/down arrow keys to change the current limit; depress ENTER to save this data.

LED Modes

- ❖ **OFF** - No LED activity
- ❖ **Rick Mode** - LED activity for errors and warnings only (Over-current, Arc Fault, etc.)
- ❖ **Blinky** - Cycles all the LEDs in a disco fashion (Useful for parties)
- ❖ **LED 1** - LED activity for Float, warnings, and errors
 - A green LED indicates the Classic is in Float
 - A yellow LED indicates a warning (Over-temp, over-current, etc.)
 - A red LED indicates an error (Arc Fault, etc.)

To change the LED Mode:

- Depress the MAIN MENU key repeatedly until CHARGE is highlighted
- Scroll to the right until MISC is highlighted and depress ENTER
- Scroll to LED MODE and depress ENTER
- Use the up and down arrows to select the mode you prefer. After selecting the appropriate LED Mode, depress ENTER to save this data to the Classic.
- Depress STATUS key to return to the main status page

There are three LEDs inside the Classic that can be viewed through the upper vents.

- ❖ **Red LED** - Indicates AUX 1 is active
- ❖ **Yellow LED** - Indicates AUX 2 is active
- ❖ **Blue LED** - Follow-Me:
 - A short (1/10 second) blip means the Classics received a good data packet
 - A long blip (1/2 second) means it got a bad packet or no packet at all.
 - Consistently long blips generally indicate a bad Follow-Me cable.

Calibrating Battery and PV Voltage

To calibrate the Classic battery and PV voltage readings, you will need an accurate and calibrated voltmeter to check the actual battery bank voltage or input PV voltage. Using the voltmeter, measure the voltage on the DC terminal connector of the Classic and compare this reading to the reading on the MNGP in the TWEAKS menu (refer to Screenshot 2). To adjust the reading of the Classic to the reading on the voltmeter, follow these steps:

- ❖ Depress MAIN MENU, scroll to TWEAKS, depress ENTER.
- ❖ Highlight VBatt and use the up and down arrow keys to match both readings.
- ❖ Depress ENTER to save.

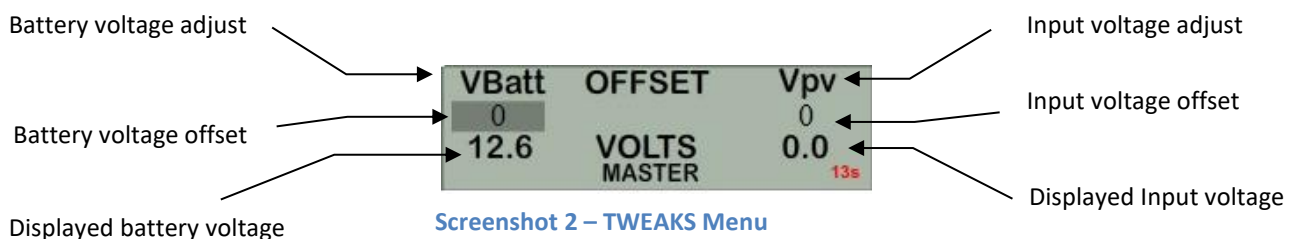

Configuring DC Input Source

To select the Classic's mode of operation, follow the steps below:

- ❖ Depress the MAIN MENU key.
- ❖ Scroll left or right until MODE is highlighted, depress ENTER.
- ❖ Scroll to the right and highlight the current mode, then use the up and down arrows to set the mode you want.
- ❖ Take note of the RIGHT SOFT key - most modes have some set points that can be adjusted.
- ❖ Depress MAIN MENU until you get back to the MODE menu.
- ❖ Set the ON/OFF to ON and depress ENTER.

The following modes will appear in this order in the MODE menu:

Micro Hydro

This mode is intended for use with hydro systems and can be used with other sources as well. When the Classic first turns on after the input voltage goes above battery voltage, it will sweep from that open circuit voltage down to battery voltage, finding the maximum power point voltage (MPP Voltage). Then it will return to that newly found voltage. After the original turn-on sweep, the Classic will do mini sweeps at user adjustable time intervals. If the time interval is set to 0, the Classic will not do any mini sweeps but will stay on this first found MPP V until the user goes to the mode menu and turns it off and back on again.

Micro Hydro mode sweeps slightly slower than Solar mode and has two user adjustable settings. Sweep Interval is the time between mini-sweeps, in minutes, and sweeps around the present (i.e., the last found) MPP Voltage. The range of this sweep is determined by the Sweep Depth user adjustment and is expressed as a percentage of Watts that the sweep started from. For example, if in Micro Hydro mode, the Classic was outputting 1000W and the Sweep Depth percentage was set for 20%, (20% of 1000W = 200W), the sweep will bring the input voltage DOWN until the output power drops down to 800 Watts, then will sweep UP in voltage until the power drops again down to 800 Watts and then go back to the newly found MPP Voltage, waiting for the next sweep.

Solar

This is the default mode for PV systems and has a very fast sweep (typically 1/2 second or less) that will re-sweep at user adjustable sweep intervals, unless the Classic finds that it needs to do a sweep on its own because of changing conditions. The timed sweep interval is user adjustable and is in units of minutes. SOLAR mode is typically best for PV systems, especially if there is partial shading at times during the day. SOLAR mode is best suited for shaded or un-shaded PV arrays that are at least one nominal voltage above the actual battery voltage. For severe partial shading or PV arrays with nominal voltage equal to battery voltage, you may want to try Legacy P&O (Perturb and Observe) MPPT mode.

Legacy P&O

Legacy P&O (Perturb and Observe) mode is a slow tracking mode similar to the Micro Hydro mode but it is slightly faster and will shut off if the power source goes off.

It has two settings that are user adjustable. Sweep Interval is the time between mini-sweeps,

in minutes, and sweeps around the present (i.e., the last found) MPP Voltage. The range of this sweep is determined by the Sweep Depth user adjustment and is expressed as a percentage of watts that the sweep started from. For example, if in Legacy P&O mode, the Classic was outputting 500W and the Sweep Depth percentage was set for 10% (50W), the sweep will bring the input voltage down until the output power drops down to 450W, then will sweep up in voltage until the power drops again down to 450W and then go back to the newly found MPP Voltage, waiting for the next sweep.

Wind Track

This mode uses a wind curve that is either built by the user or one of the pre-installed graphs. The power curve consists of 16 set points that consist of output amperage and input voltage, allowing the user to custom build a curve for their wind turbine. Please refer to the wind section of the manual for full details on programming the curve as well as our video that will help in understanding how to adjust these curves using the wind graph editor.

Dynamic

This is typically used for PV input sources and tries to follow, on a slow dynamic basis, the changing conditions of the input source. This mode has one user adjustment which is a forced sweep perturb trigger interval for times when the input condition changes do not trigger a dynamic sweep. The interval is in units of minutes.

U-Set VOC%

This is a fully manual mode based on a percentage of Voc. The Classic will sweep based on the user set time in minutes and then park at a user set percentage of the Voc the Classic found on that sweep. This mode is useful for testing or constant voltage sources.

NOTE: Mode must be manually turned ON after changing the mode. To turn the mode ON, highlight the OFF under ON/OFF and switch it to ON. Depress ENTER to save this change.

Programming the Classic for Wind Input Source

AUX 2 needs to be programmed for the Classic to work with the Clipper.

- ❖ Enter the MAIN MENU and scroll to AUX, then depress the ENTER key.
- ❖ Scroll to the right to highlight the text under AUX 2 and depress the RIGHT SOFT key.
- ❖ Scroll up or down to find Clipper Control and depress the RIGHT SOFT key again.
- ❖ On this screen, select either AC or DC to match the Clipper being used (AC is default).
- ❖ Depress the RIGHT SOFT key again, set the absolute maximum voltage you want the Clipper to allow before clipping occurs.
- ❖ Depress ENTER to save this data.
- ❖ Depress MAIN MENU until you get back to the AUX 1 and AUX 2 screen.
- ❖ Set the text under AUX 2 to read Clipper Control, depress ENTER.
- ❖ Press STATUS to return to the home screen.

NOTE: See our instructional videos at www.midnitesolar.com.

CAUTION: Connecting a DC Clipper with this set to AC can damage the Clipper.

You will need to select a wind curve from the list of pre-loaded curves or build your own.

Selecting Pre-loaded Wind Curve

To access the list of wind curves, follow these steps:

- ❖ Depress the MAIN MENU key.
- ❖ Scroll left or right until MODE is highlighted and depress ENTER.
- ❖ Set the status to OFF.
- ❖ Depress right arrow, highlight mode under the header FUNCTION. Use up/down arrows till it reads WIND TRACK.
- ❖ Depress the RIGHT SOFT key to select GRAPH.
- ❖ Using the LEFT SOFT key, select MEM.
- ❖ Scroll up/down through the menu and select the curve that was designed for your turbine.
- ❖ Once you find the correct power curve, use the RIGHT SOFT key to select RECALL.
- ❖ Depress ENTER to save this power curve to the Classic's memory.

Building Custom Wind Curve

The Classic uses a 16-step wind curve for holding the turbine output at the Maximum Power Point for increased efficiency and turbine RPM control. The curve is specific to the turbine output characteristics. Each step consists of two variables: 1) the input voltage from the turbine; and 2) the current output to the battery. The output current is the variable the Classic watches; the input voltage is the variable the Classic adjusts. As the current on the output side of the controller changes, the input voltage is adjusted to match the curve you programmed.

Step 1 is always the wake-up voltage of the Classic at 0A. Step 2 is the cut-in voltage of the turbine and the expected current at cut-in. Step 16 is the maximum input voltage (less than 150V for the Classic 150; less than 200V for the Classic 200, and less than 250V for the Classic 250) and maximum current output. The steps in between connect the dots, so to speak. Keep in mind that the minimum voltage of Step 1 must be above the wake-up voltage of the Classic, which is 33% higher than the battery voltage. It is recommended to start with an initial curve and then fine tune it over time. Keep in mind that increasing voltage and/ or decreasing current on the first few steps can help increase turbine RPM to improve low wind speed output. Decreasing voltage on the last step or two can decrease turbine RPM.

To build a custom wind curve, it is easiest to load a pre-built curve, then modify as follows:

- ❖ Follow steps above to load a pre-built wind curve (Do not save yet).
- ❖ Notice in upper right corner of MNGP, it reads X=, Y=, and Step XX. Below Step XX is AMPS or VOLTS.
- ❖ Curve should load at Step 01. If not, use left/right arrows to reach Step 01.
- ❖ Since Step 01 will always be at 0A, depress the RIGHT SOFT key to change to VOLTS.
- ❖ Use up/down arrows to change Step 01 volts.
- ❖ Right arrow to Step 02.
- ❖ If VOLTS is present in lower right corner of MNGP, set volts for Step 02. Depress RIGHT SOFT key for AMPS. Set amps for Step 02.
- ❖ Continue through all 16 steps.

- ❖ When you have the power curve the way you want it, select MEM.
- ❖ There are nine memory spaces for you to save a custom power curve (Do not use MEM location 1, it is corrupt). Use the up and down buttons to select a location 2 through 9 to save it, then select SAVE.
- ❖ Depress ENTER to save it to the Classic's memory.

The MidNite Local Application software can be used to program the wind curve and make real-time adjustments to the curve while your turbine is operating. The Local Application can be downloaded from the MidNite website, www.midnitesolar.com, under Software. Wind programming videos are also available under Documents.

Equalization

Manual EQ

To initiate a manual equalization charge, go into the CHARGE menu and highlight EQ, then depress the ENTER key. "EQ Stopped" will be highlighted. Depress Up Arrow key to select "EQ Started." Depress the STATUS key to return to the home screen. To stop a manual EQ in progress, simply reverse the steps above. A manual EQ, when started, will last for that day unless the Classic is in Hydro or Wind and the controller never goes to Resting that night. In this case, it will stay in EQ until it completes, or the controller goes to Resting.

Set the EQ Timer (Charge/ChgTime) for the amount of time you want to EQ. This EQ Timer pertains to both manual and auto EQ. One hour is common for most applications.

NOTE: Check with your battery manufacturer to determine if EQ is required and/or allowed for your batteries.



Figure 17 – AUTO EQ Menu

Auto EQ

The Classic can be set up to automatically equalize your batteries periodically, programmed as days between Equalization and the number of days the Classic will try to finish the programmed equalization charge cycle. To set up Auto EQ, go into the CHARGE menu and highlight EQ and depress ENTER. Now depress the SOFT RIGHT key labeled "AUTO EQ." Depressing the AUTO EQ soft key enters the AUTO EQ setup menu screen. The left side of the EQ setup menu will show the number of days, or "interval," between auto EQ charge cycles. If set to zero, it will display MANUAL which is the same thing as DISABLED.

On the right side of the AUTO EQ setup menu is the number of DAYS that the AUTO EQ will retry if it does not finish the number of hours and minutes the Classic has been programmed to EQ for during the first day. For instance, you set the AUTO EQ for an interval of every 30 days and the RE-TRY for 3 days. Then the first day it attempts an EQ, the Classic only accumulates 1 hour of a 2-hour EQ cycle, the next day the Classic will re-attempt the EQ cycle. If the Classic does not finish the EQ cycle on the 2nd day of its 3 allotted re-try days, it will have one more day to try to finish the Equalize cycle. After this, if it did not complete the 2 hours of EQ time, it will not continue another day. The Classic will show "EQ DONE" on the status screen until either the start of the next day or until the user presses a button on the MNGP to stop it earlier.

The bottom of the AUTO EQ screen shows the time, in hours and minutes, that the EQ is set for. Depressing the RIGHT SOFT key, labeled VIEW, takes you to a screen where you can view the interval and re-try counters (timers).

Setting Date and Time

To set the date and time manually on the Classic, follow these steps:

- ❖ Depress the MAIN MENU key repeatedly until CHARGE is highlighted.
- ❖ Scroll left or right to highlight MISC and depress ENTER.
- ❖ Scroll to TIME and depress ENTER.
- ❖ Scroll left or right to highlight the data you want to manually change.
- ❖ Use the up and down buttons to change the data.
- ❖ When you have all the data changed, depress ENTER to save the changes.

The Classic includes a battery (CR1216) in the MNGP to keep the time running even when the power is disconnected. To replace the battery, gently pinch the left and right sides of the MNGP and carefully remove the cover. Be careful not to pull the cover too far away from the MNGP base; the cover is connected to the base via speaker wire. Replace battery. Reinstall MNGP cover; ensure all the pushbuttons protrude evenly through the front cover cutouts.

NOTE: If you plan to use the Local App to set the time, TIME SYNCH in the TWEAKS Menu must be disabled to prevent the MNGP from over-writing the time stamp from the Local App.

Arc Fault

Because safety is not an option, the Arc Fault Detector is a unique safety component included in every Classic. The Classic is the first charge controller in the world to successfully stop a series arc. The Classic can detect an arc in less than 100ms. From low power arcing to devastating high power arcing, the Classic will detect then shut down with an audible and visible alert to announce that there is a problem in the PV side of the system. When an arc is detected, the Classic has to be manually cleared.

Resetting the Arc Fault Detector after detection has occurred: The first thing to do is find and fix the actual arcing wire, terminal, splice, etc. The Classic needs to be powered down completely for 15 seconds and then powered back up. Do this by turning the DC source (PV, wind, or hydro) breaker off. Then turn off the external battery breaker. Turn both breakers back on starting with the battery breaker first.

The arc fault module has three adjustable parameters: Mode, Time, and Sensitivity.

MODE: Factory default at 1, and it should stay that way unless instructed by MidNite Solar.

TIME: Sets the length of the arc the Classic has to monitor before tripping the arc fault detector; factory default at 4.

SENSITIVITY: This parameter determines sensitivity of the arc fault detector; 1 being the most sensitive and 15 the least. Factory default at 10.

If you experience nuisance tripping, you can raise the sensitivity one digit at a time. Follow the instructions below to make adjustments or disable arc fault. As a last resort, you may disable arc fault if your system cannot work with the arc fault detector. Be absolutely certain an actual arc fault condition does not exist.

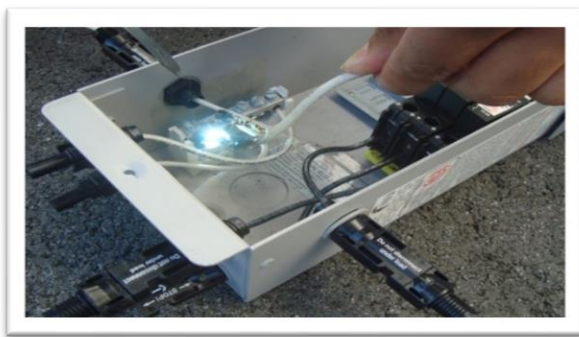

Figure 18 – Actual Arc Fault

To change the parameters of the Arc Fault, follow the steps below:

- ❖ Press Main Menu.
- ❖ Scroll right or left until TWEAKS is highlighted.
- ❖ Depress ENTER.
- ❖ In TWEAKS, depress the RIGHT SOFT key 5 times.
- ❖ Use the left and right keys to select the feature to adjust. Use up and down arrow keys to change settings.

Programming for PV Bleed Down

To enable the Classic to bleed down its PV capacitors in less than 30 seconds, to be used in conjunction with a Rapid Shutdown System (RSS), follow these steps:

- ❖ Depress the Main Menu button several times until Charge is highlighted.
- ❖ Scroll to the right to highlight “Tweaks” and depress Enter.
- ❖ Depress the Right Soft button under the word “More.”
- ❖ Hold the Left Arrow button and depress the Right Soft button 2 times. (See Figure 19)
- ❖ The number under ADDRESS should be highlighted. Scroll up or down to 4289.
- ❖ Use the Right Arrow button to scroll over and highlight the value under VALUE.
- ❖ Change the VALUE to 5.
- ❖ After setting the current limit to the value you desire, hold the Left Soft button and depress Enter. You will see “DATA SENT AND SAVED.”
- ❖ Depress Status to return to the main screen.



Figure 19 – PV Bleed Down

Functional Test - After programming, perform a functional test of the Classic and its ability to bleed-down the PV input voltage. With the sun out and the Classic charging the batteries, you should initiate a rapid shut down. About 10 seconds after initiation, the Classic will cease making any power and then within 5 seconds will go to Resting and the PV voltage will bleed down very rapidly.

Charge/Advanced Settings

Ending Amps – Used in conjunction with the MidNite Whiz Bang Jr current-sensing device. Ending Amps is set by the battery manufacturer and means the point at which the battery bank is full. During the Absorb charge cycle, the charge controller holds the voltage at the preset charge level, say 14.8V. As the batteries fill up, the current into the batteries decreases. When the decreasing current reaches the preset Ending Amps point, the charge controller stops the Absorb cycle and transitions to Float. In the absence of specifications from your battery manufacturer, use 1 – 3% of the bank’s amp-hour capacity (C20 rate) for Ending Amps.

Re-bulk – Forces Classic back into the Bulk charge cycle. Helpful if your inverter runs during the day, bank gets depleted, and enough sunlight hours remain to recharge the battery bank. Good re-bulk setting is your bank’s 50% DOD voltage point (12.1V; 24.2V; or 48.4V). Or you can just let the Classic stay in Float, and the Classic will sense the current outflow and change to Float MPPT. Re-bulk is useful for Lithium batteries as a “stop charge” mechanism.

EXAMPLE:

1. You want the Classic to charge when the battery’s voltage is less than 51.9V and rest when at 52V.
 - a. Set Absorb volts = 52V
 - b. Set Absorb time = 3 minutes.
 - c. Set Float volts = 40V
 - d. Set REBULK = (Voltage you want to start back charging, must be > 40 Volts < 52 Volts.
2. The Classic will report BATTERY OVER VOLTAGE and will stop charging (RESTING) until Re-bulk voltage is reached.

Skip Days – This setting forces the Classic to Float at the start of the charging day instead of to Bulk. Useful if you have an unattended system, say at a remote cabin, one that you do not

frequent often, and you do not need the solar system charging fully every day. Enter the number of days to skip.

Auxiliary Ports

The Classic includes two auxiliary ports which can be configured to become inputs or outputs. These AUX ports can be used as a secondary power supply to be used for accessories such as vent-fan, diversion loads, logic inputs, WBJr, or the Clipper. The AUX output is limited to 200mA or less per channel.

- ❖ An internal, re-settable positive temperature co-efficient (PTC) fuse protects the AUX internal components from over-current or a short circuit.
- ❖ AUX 1 consists of either RELAY or LOGIC operation, depending on user selection. AUX 1 can output either nominal +12V (12-14.5V), 0V, or continuity as a dry contact.

NOTE: When using AUX 1 it is recommended that you have a relay in line to protect the Classic. AUX 1 is only rated for 12V/200mA; if you use a device that will pull more current, doing so can harm the Classic. Using a relay is also good for isolating the Classic from possible stray voltage sources.

- ❖ AUX 2 can be set as an input or output. One at a time this port can read the state of a device connected and takes an action from there. AUX 2 can output nominal +12V, 0V, or a 500Hz PWM +12V signal.

NOTE: When the Classic sends out a PWM signal on AUX 2, it is always +12 to 14.5V, regardless of battery voltage.

Configuring the Classic's AUX ports:

- ❖ Depress the MAIN MENU key.
- ❖ Scroll left or right to highlight AUX and depress ENTER.
- ❖ Scroll left or right to highlight either AUX 1 or AUX 2.
- ❖ Depress the RIGHT SOFT key labeled SETUP.
- ❖ Scroll up or down to change the mode of the AUX terminal.
- ❖ Depress the RIGHT SOFT key to set the parameters of the function.
- ❖ When finished, depress ENTER to save the changes.
- ❖ Depress MAIN MENU key, return to AUX 1 / AUX 2 page
- ❖ Use left/right arrows to highlight AUX 1 or AUX 2
- ❖ Use up/down arrows to turn AUX to OFF, AUTO, or ON.

Off	Places output to Low state (0V)
Auto	Selects the assigned function to the AUX output or input
On	Sets output to High state (12V or Relay Closed)

Table 5

AUX Function Definitions

VOLTS: Refers to the voltage threshold, or set point, or “At what voltage do you want to turn on/off the specified AUX port?”

DELAY: Time in seconds the Classic will wait to turn AUX 1 on/off once the set point is reached.

HOLD: Time in seconds that the Classic will wait to turn AUX 1 on/off once set point is reached.

NOTE: DELAY is at the beginning, HOLD is at the end. For example, if AUX 1 is OFF and the set point voltage is reached, when AUX 1 turns ON, DELAY will be the number of seconds before it actually turns ON, and HOLD will be the number of seconds before it turns fully OFF. The inverse can occur too. If AUX 1 is ON, DELAY is the amount of time before it changes state (to OFF), and HOLD is the amount of time before AUX 1 turns back ON. Another way to explain ... HOLD and DELAY is the amount of time the Classic must wait after the target set point voltage is reached before changing the state of AUX 1.

NOTE: 1) DELAY helps prevent premature reconnects due to voltage spikes. 2) HOLD helps to avoid nuisance disconnecting of the loads due to momentary voltage sags.

DAWN: Point in time when your PV voltage reaches the same as battery voltage. This is not a time factor.

Example: The sun starts coming up and the light hits your panels. The voltage starts to climb and when it hits the same voltage as your batteries the Classic will mark this as DAWN.

DUSK: Point in time when your PV voltage falls below your battery voltage, the Classic will mark this as DUSK. This is not a time factor.

WIDTH: Is the voltage range (usually 1.0V) above or below the target set point, depending on active high or active low, that the PWM goes from full OFF to full ON. The Classic has a voltage resolution of 0.1V. A WIDTH setting of 1.0V therefore is divided into 10 different PWM possibilities. Every 0.1V, the PWM gets a bit wider or narrower depending on if the voltage is going up or down and if it is active high or active low. 0% PWM is OFF all the time ... 100% PWM is ON all the time ... 50% PWM is OFF half the time and ON the other half of the time. The AUX 2 PWM operates at 500Hz, or at 2 milliseconds ($1/500 = 2 \text{ ms}$). So, 50% PWM would be ON for 1 ms and OFF for 1 ms.

Example:

1. 55V is your threshold, or set point, or target voltage ...
2. If battery voltage is below 55V and the WIDTH is 1.0V ...
 - a. The PWM is at 0%
3. When the battery voltage reaches 55.1V ...

- a. The PWM is at 10%
4. When the battery voltage reaches 55.5V ...
 - a. The PWM is at 50%
5. When the battery voltage reaches 56V ...
 - a. The PWM is at 100%

AUX 1 Modes

SOC % Low

When State of Charge (SOC) reaches % LOW AUX 1 will turn OFF. As SOC goes up and reaches % HIGH, AUX 1 will turn ON. DELAY and HOLD can also be used to further control when AUX 1 will turn on/off.

SOC % High

When SOC reaches % LOW, AUX 1 will turn ON. As the SOC goes up and reaches % HIGH, AUX 1 will turn OFF. DELAY and HOLD can also be used to further control when AUX 1 will turn on/off.

NOTE: When the Classic auto-restarts at 23:59 (midnight), the state of AUX 1 will be remembered so it will return to the last state (+12V or OFF) the next charging day.

GFP Trip High

When the Classic sees a Ground Fault, it will pulse AUX 1 OFF and ON at 0.1 second intervals. This was designed to be used for a remote trip notification for an alarm or remote trip breaker.

Vent Fan Low

Once battery voltage rises above set point voltage, AUX 1 will turn OFF with no DELAY. When battery voltage falls below set point voltage, AUX 1 will turn ON after a 30-second HOLD.

Vent Fan High

Once battery voltage raises above set point voltage, AUX 1 will turn ON with no HOLD. When battery voltage falls below set point voltage, AUX 1 will turn OFF after a 30-second DELAY.

Float Low

When the Classic is in Float Mode, AUX 1 will turn OFF. AUX 1 will be ON during all other modes (including Float MPPT). AUX 1 will stay OFF until the Classic falls 0.3V below the Float voltage set point.

Float High

When the Classic is in Float mode, AUX 1 will turn ON. AUX 1 will be OFF during all other modes (including Float MPPT). AUX 1 will stay ON until the Classic falls 0.3V below the Float voltage set point.

Clipper Control

This mode is intended for very basic control of the MidNite Clipper. It will send out a PWM signal whenever the controller is unloading the turbine because the battery is full or close to it. There are no adjustments in this mode. For best results it is strongly recommended to use the AUX 2 Clipper Control.

Day Light

AUX 1 will turn ON at DAWN and will turn OFF at DUSK with a 2-minute DELAY.

Nite Light

AUX 1 will turn ON at DUSK and will turn OFF at DAWN with a 2-minute HOLD.

Toggle Test

AUX 1 cycles for 1-second interval between ON and OFF.

PV V on Low

When PV voltage falls below V LOW Set Point, AUX 1 will turn ON. It will stay on until PV voltage reaches the V HIGH set point. DELAY and HOLD can also be used to further control when AUX 1 will turn on/off. This mode can be useful for controlling a failsafe stopping system for hydro or wind.

PV V on High

When PV voltage reaches V HIGH, AUX 1 will turn ON. AUX 1 will stay ON until PV voltage falls below V LOW set point. DELAY and HOLD can also be used to further control when AUX 1 will turn on/off. This mode can be useful for controlling a failsafe stopping system for Hydro or Wind.

Waste Not Lo

This mode will turn AUX 1 OFF when the Classic gets within a certain range of the voltage set point (V HIGH) for each charging stage (Absorb, Float, EQ) and turn AUX 1 ON when it gets to a low set point (V LOW). This mode will allow maximum diversion while maintaining 3-stage charging. V LOW is the number of volts above or below the charging set points that you want to turn AUX 1 ON; V HIGH is the number of volts above or below the charging set points you want to turn AUX 1 OFF. A negative value means the change of state occurs below the set point and a positive value means the change of state occurs above the set point. DELAY and HOLD are functional and adjustable.

Example:

1. Float programmed in Classic at 54V.
2. Classic is currently in Float.
3. AUX 1 V Low is set at -2.0V
4. AUX 1 V High is set at -0.1V
5. Then when battery voltage drops to 52V, AUX 1 will turn ON. When battery voltage rises to 53.9V, AUX 1 will turn OFF.

Waste Not Hi

This mode will turn AUX 1 ON when the Classic gets within a certain range of the voltage set

point (V HIGH) for each charging stage (Absorb, Float, EQ) and turn AUX 1 OFF when it gets to a low set point (V LOW). This mode will allow maximum diversion while maintaining 3-stage charging. V LOW is the number of volts above or below the charging set points that you want to turn AUX 1 OFF; V HIGH is the number of volts above or below the charging set points you want to turn AUX 1 ON. A negative value means the change of state occurs below the set point and a positive value means the change of state occurs above the set point. DELAY and HOLD are functional and adjustable.

Example:

1. Float programmed in Classic at 54V.
2. Classic is currently in Float.
3. AUX 1 V Low is set at -2.0V
4. AUX 1 V High is set at -0.1V
5. Then when battery voltage drops to 52V, AUX 1 will turn OFF. When battery voltage rises to 53.9V, AUX 1 will turn ON.

Low Bat Disc (Disconnect)

When battery voltage falls below V LOW, AUX 1 will turn ON. AUX 1 will stay ON until battery voltage raises above V HIGH. DELAY and HOLD can also be used to further control when AUX 1 turns on/off.

Diversion

When battery voltage falls below V LOW set point, AUX 1 will turn OFF. AUX 1 will stay OFF until battery voltage rises above V HIGH. DELAY and HOLD can also be used to further control when AUX 1 turns on/off.

AUX 2 Modes

Wizbang Junior (WBjr)

For use with WBjr. There are no settings to configure from this menu.

Force Float In

When AUX 2 detects less than 6V, the Classic will change its charging mode to Float until the voltage goes above 6V.

Logic Input 1

When AUX 2 detects less than 6V in Resting Mode **OR** AUX 2 detects greater than 2V in charging mode (Bulk, Absorb, or Float), a PWM signal will turn ON.

Logic Input 2

When AUX 2 detects greater than 2V in Resting Mode **OR** AUX 2 detects less than 6V in charging mode (Bulk, Absorb, or Float), a PWM signal will turn ON.

Float Low

When the Classic is in Float mode, AUX 2 will be OFF. AUX 2 will be ON in all other modes.

Float High

When the Classic is in Float Mode, AUX 2 will be ON. AUX 2 will be OFF in all other modes.

Day Light

When the Classic notices DAWN, AUX 2 will turn ON; when the Classic notices DUSK, AUX 2 will turn OFF.

Nite Light

When the Classic notices DUSK, AUX 2 will turn ON; when the Classic notices DAWN, it will turn OFF.

Clipper Control

PWM control of the MidNite Clipper. AUX 2 sends a PWM signal to the Clipper whenever the Classic wants to unload the turbine because the battery is full, close to it, or the turbine's output voltage (input to the Classic) approaches the Classic's input limit. AC or DC Clipper is selected here. WIDTH and VOLTS can be adjusted to fine-tune the PWM output. The MAX V setting in the sub-menu should be set just above the voltage in step 16 of the wind curve.

NOTE: If the AC/DC setting within the CLIPPER CONTROL mode is set to DC, then all WIDTH functionality in all AUX 2 modes will be disabled. Set to either AC or DC based on the Clipper model used for your wind turbine. If **NOT** using wind, then set to AC.

PV V on Low

When PV voltage is lower than set point volts, a PWM signal is turned ON. It will automatically turn OFF if PV voltage rises above set point volts.

PV V on High

When PV voltage is higher than set point volts, a PWM signal is turned ON. It will automatically turn OFF if PV voltage falls below set point volts.

Toggle Test

AUX 2 cycles in 1-second intervals between ON and OFF.

Waste Not Lo

This mode will turn AUX 2 ON when the Classic reaches a certain voltage set point (V LOW) for each charging stage (Absorb, Float, EQ) and turn AUX 2 OFF when battery voltage exceeds the set point. This mode will allow maximum diversion while maintaining 3-stage charging. V LOW is the number of volts above or below the charging set points that you want to turn AUX 2 ON: A negative value means the change of state occurs below the set point and a positive value means the change of state occurs above the set point. Set WIDTH to 1.0V unless specifically instructed to do so by our Support Team.

Example:

1. Float programmed in Classic at 54V.
2. Classic is currently in Float.
3. AUX 2 V Low is set at -2.0V
4. Then when battery voltage drops to 52V, AUX 2 will turn ON. When battery voltage

rises to 52.1V, AUX 2 will turn OFF.

Waste Not Hi

This mode will turn AUX 2 OFF when the Classic reaches a certain voltage set point (V Low) for each charging stage (Absorb, Float, EQ) and turn AUX 2 ON when battery voltage exceeds the set point. This mode will allow maximum diversion while maintaining 3-stage charging. V Low is the number of volts above or below the charging set points that you want to turn AUX 2 OFF: A negative value means the change of state occurs below the set point and a positive value means the change of state occurs above the set point. Set Width to 1.0V unless specifically instructed to do so by our Support Team.

Example:

1. Float programmed in Classic at 54V.
2. Classic is currently in Float.
3. AUX 2 V Low is set at -2.0V
4. Then when battery voltage drops to 52V, AUX 2 will turn OFF. When battery voltage rises to 52.1V, AUX 2 will turn ON.

Diversion Lo

When battery voltage rises above set point volts, a PWM signal will turn ON. It will automatically turn OFF if battery voltage falls below the set point volts. Set WIDTH to 1.0V.

Diversion Hi

When battery voltage drops below set point volts, a PWM signal will turn ON. It will automatically turn OFF if battery voltage rises above set point volts. Set WIDTH to 1.0V.

AUX 1 and AUX 2 Jumpers

Figure 20 shows the two AUX port terminals with their respective polarities. These terminals are located at the bottom of the Power Board, below the battery temperature jack. Use a mini flat head screwdriver to tighten the screws. The jumpers are described in the section below.

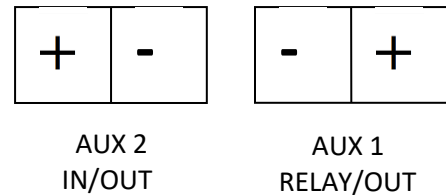

Diagram 5

AUX 1 - 12V Out

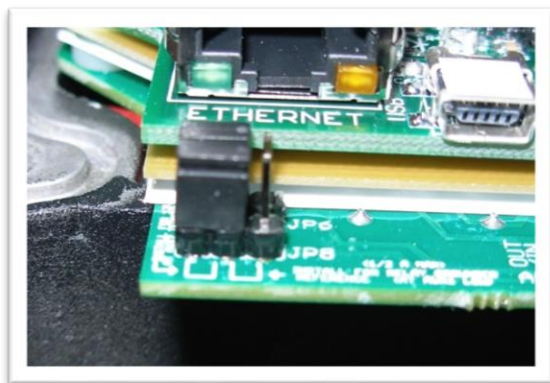

Figure 20

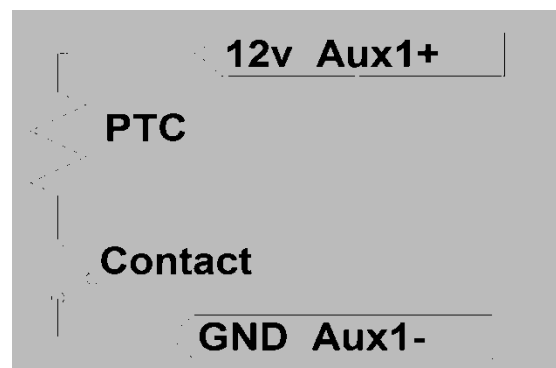

Diagram 6

When AUX 1 is used to supply 12V out, JP6 and JP8 must be in the position shown in Figure 20. The basic schematic of how this works is shown above in Diagram 6. The 12V out is more like 14.5V. The maximum current through AUX 1 should not exceed 200mA.

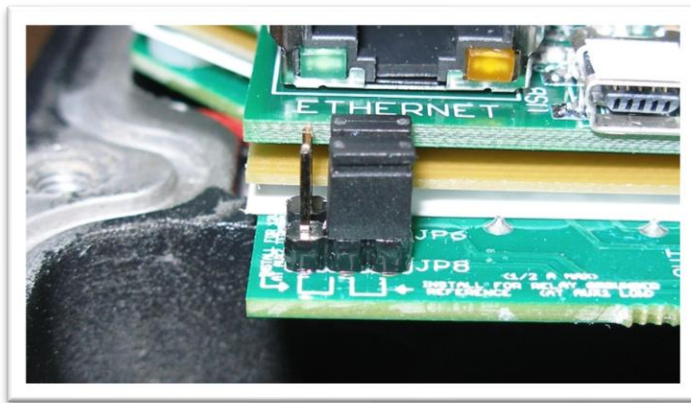

Figure 21

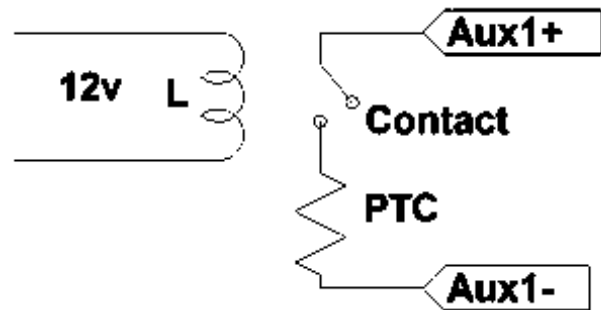

Diagram 7

AUX 1 - Dry Contact

To configure AUX 1 to use the internal relay, JP6 and JP8 must be in the position shown in Figure 21. This configuration is commonly known as “dry contact” because it does not provide 12V at the AUX 1 terminals; it acts more like an isolated switch (to the ratings of the relay).

AUX 1 Volts/Time Graph

Diagram 8 is the AUX 1 Function Graph showing the relationship between voltage and time. The axis labeled VOLTAGE could be battery, PV, wind input voltage, etc., depending on the function selected by the user. V HIGH is the upper voltage limit: when the voltage reaches this limit, the DELAY TIME will start; when the DELAY TIME expires, AUX 1 will change state and stay there until the voltage drops below the V LOW set point, then another timer called HOLD TIME will start and when this expires the output will go back to the original state.

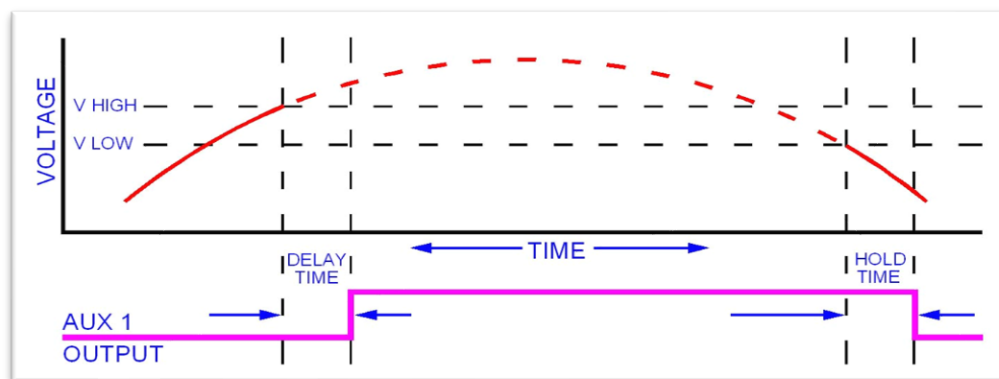

Diagram 8 – AUX 1 Function Graph

AUX 2 Volts/Time Graph

Diagram 9 is the AUX 2 Function Graph showing the relationship between voltage and time. The

difference in AUX 2 is the use of PWM running at a 500Hz rate and is suitable for use with Solid State Relays (SSRs). How it works: user sets a desired threshold and a width voltage; this means that at the desired voltage (VOLTS), AUX 2 will start to PWM and it has to go above or below the width to completely change states (from 0V to 12V, or from 12V to 0V depending on the user selection). This gives a much smoother transition.

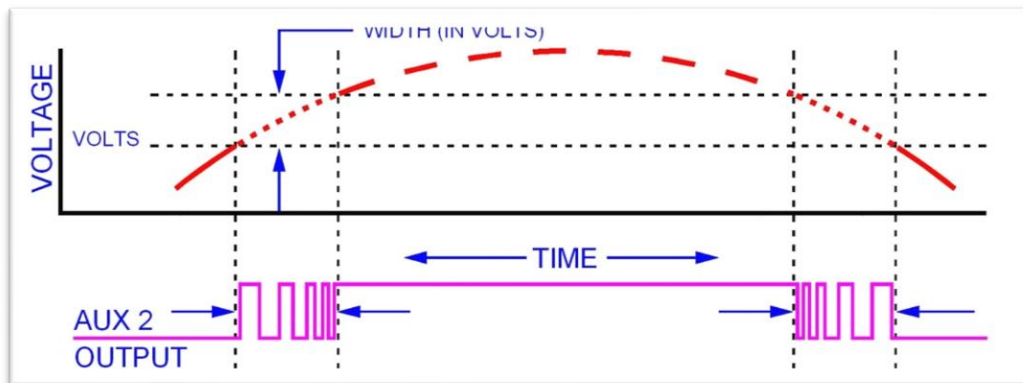

Diagram 9 – AUX 2 Function Graph

Logged Data

The Classic logs 380 days' of data in its memory. The data logging in the Classic has two modes and frequency of data capture: Daily and Hourly.

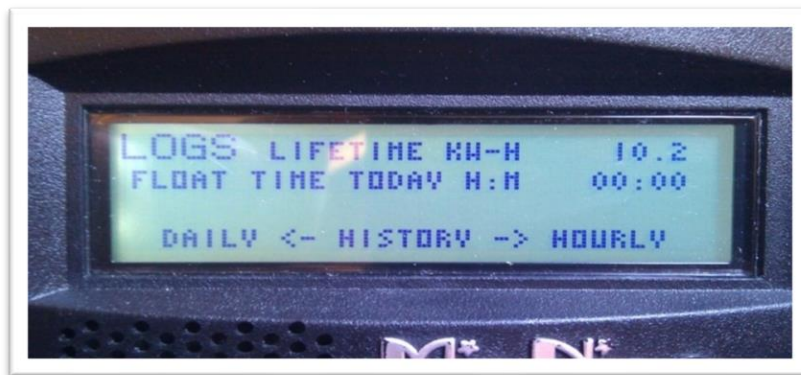

Figure 22

Daily History

Is captured once each day and is saved at night, after 2 hours of no activity when the PV input voltage is below battery voltage for solar, or in modes that do not necessarily rest at night, like wind or hydro, the capture will happen once every 24 hours. Data logged each day is kilowatt-hours, Float time in hours and minutes, the maximum power output for the day,

maximum FET temperature inside the unit, maximum PV or input voltage, and maximum battery voltage for the day.

Hourly History

Also referred to as “Short term History” is captured once every five 5 minutes anytime the Classic is not resting (when it is charging). Data logged every 5 minutes is power, input voltage, battery voltage, charging stage, amps out, and kW/Hours. A time and date stamp is associated with each data entry in both Daily and Hourly history logs. The main time/date stamp for each data logging mode is Date for daily history and Time for recent history, although both time and date are stored and displayed for each logging mode.

When entering the LOGS menu, you will see two items displayed. The top line is lifetime kW/Hours for the Classic and below that is time spent in float today.

NOTE: Absorb, EQ, and Float times are also viewable in the TIMER VU sub-menu of the CHGTIME sub-menu in the main CHARGE menu.

Pressing the LEFT SOFT key enters the DAILY history data viewing menu. Similarly, pressing the RIGHT SOFT key enters the HOURLY recent history data viewing menu.



Figure 23



Figure 24

In the DAILY menu, the left side category of information displayed can be changed by pressing the UP or DOWN arrow keys. Switching over to the right side of the screen by pressing the RIGHT arrow key highlights the DAY change key. Pressing the UP key decrements the date (goes back 1 day) and displays the captured date above the word "DAY." There are 380 days of information stored in the Classic. After 380 days are captured and stored, the oldest data stored will be overwritten as new daily data fills in as the most recent data.

The HOURLY log menu (captured every 5 minutes) works similarly to the DAILY log menu, except that the time stamp above the word TIME is the time--shown in 24-hour format--that the data was captured that day. The category of data captured is of course more suited for minute-by-minute capture rather than the maximum data statistics captured on a day-by-day basis in the DAILY log screen. The left side of the recent history text log screen can be individually viewed by selecting the left side and pressing the UP/DOWN arrow keys to show the power, voltages, charge stage, etc. and various information captured at the time shown on the right-side time selection.

At the bottom of the DAILY text log screen, the time the maximum statistics were stored is shown, whereas at the bottom of the HOURLY text log screen, the date of the capture is shown. Again, if for some reason the year of the time stamp was less than 2011, the time/date will alternate between INVALID and the time/date stamped along with that data and does not necessarily mean the data

itself is not correct. If the data is all zeros and the year is shown as 2000, the data is most likely invalid and not correct or the logging memory has not been filled yet. This is why the Classic powers up with the year 05/04/2003. It means that data was actually logged but the date was not set, whereas if it is showing 00/00/2000, it will normally mean that the data is just zero and therefore invalid data as well as invalid time and date.

The upper right corner of the text log screens displays a number from 1 to 380. This number shows the index or position of the data in the 380 data log time slots. The most recently stored data has an index of 1. Two data points ago shows an index of 2, etc. This index goes for either Daily History or Recent History text log viewing screen.

NOTE: Accurate and complete data logging requires that the date and time be correct. Set date/time in the MISC/TIME menu. For night logging (logs when Classic is Resting), set NITELOG to ON in the TWEAKS menu.

Graphical Logging Display Modes

Both DAILY and HOURLY logging can also be viewed in a graphical manner. While in the text viewing log screen, pressing the RIGHT SOFT key labeled "GRAPH" will bring up this view screen. The HOURLY view is also available in the main status cycle of screens, changed by repeatedly pressing the STATUS key, just after STATUS TWO screen. This is labeled as "SHORT TERM HISTORY" in the STATUS screens.

A summary of the next STATUS screen will be shown while holding the STATUS key before releasing it and entering that next STATUS screen. This also goes for the Recent History graph screen in STATUS. Each data point shown in the graphical view screen is shown as a dot. There are a maximum of 96 dots, appearing horizontally per screen with some information about each dot shown on the left side of the screen. An individual data point can be selected for investigation by moving a small, flashing once per second vertical cursor horizontally across the graphed data by using the left and right arrow keys. The most recent data is shown on the right most side of the first screen. The cursor first appears around 20 dots or data points from the right side of the first screen (About 20 data points ago in history).

To scroll the data viewed one third of a screen to the left, hold the SHIFT key and the LEFT SOFT key down and also tap the LEFT ARROW key. Each press of this combination of buttons will scroll the graphical view horizontally another 1/3 screen. Holding the SHIFT key and RIGHT ARROW key on the most recent data screen will push the cursor up against the right side and onto data point one.

Pressing the UP ARROW key will change the data viewed to the next category. For instance, in the Recent History graph screen, the displayed data will change from power to input voltage, battery voltage and kW-Hours. Pressing the DOWN ARROW key will bring the category of data back down again. A very brief 5- or 6-character annunciator displayed in the upper left corner tells us what category of data the graph is showing us. The number just below this 5- or 6-character descriptions is the actual number in volts or watts or applicable unit of data displayed at that cursor position centered on the dot of the graph. The third line down on the left side of the recent data screen shows the time stamp of that data where the cursor is positioned on the graph. Finally, the bottom left of the graph screen alternates between two indicators. One is the charge stage at the cursor position and the other is the scaling of the vertical axis of the graph. Power, for instance, can show a

very wide range of values and power lends itself better to using a logarithmic vertical scale, shown as LOG. Voltage and other data shows up fine using a LINEAR vertical axis scale and is spelled out on the lower left of the graphic screen.



Figure 25

The date of the particular selected cursor positioned data point is shown on the bottom middle of the graphic screen. Moving the cursor left or right using the LEFT and RIGHT ARROW keys, selects the next data points to the left or to the right of the present cursor position.

The flashing cursor is short and may be hard to detect at first, so you may have to look for it. The cursor aligns and centers itself right on the dot that is selected.

The bottom date or time displayed may tend to obscure the data line graphed behind it. The time/date and the graph data will be mixed together about a second after the date/time is drawn on the bottom of that graph log screen. If, for some reason, the graphic log screen display shows bogus data or dots that look like they should not be shown, simply press the ENTER key and the screen will be quickly erased and re-drawn without the extra lines or dots.

There may or may not be any valid data past a certain point to the left if the unit is fairly new. The data shown in unused spots may be zero, or it may be off the screen and not viewable. As time goes on and new data is acquired, those unused data points will start to appear and be valid. Of course, the Daily History will take many days to fill in, where the Recent Hourly (minutes really) data will fill in after a few hours or maybe a day or two depending on how long the Classic is on and running for that day. Remember, the Classic does not normally log data while it is in Resting mode.

CAUTION: Attempting to download the Logs using the Local app while viewing the Logs on the MNGP will cause the Classic to reboot.

Classic Voice

New Classics in production since November 2017 are available with enhanced voice annunciations. Older Classics can be converted to run the Voice firmware, but only if the audio files are first loaded into the MNGP. To retro an older Classic to Voice Mode, contact MidNite Tech Support. Your MNGP will have to be sent back to the factory for conversion. You will pay return shipping only.

Levels of Chattiness:

- ❖ **Off** - No voice.
- ❖ **Rick Mode** - Arc Fault and Ground Fault warnings only.
- ❖ **Errors**- Any errors such as "no PV voltage," "Over voltage," etc. and the warnings above.
- ❖ **Warnings** - All errors and warnings.
- ❖ **Verbose** - Menu help messages the first time the menus are accessed. Information messages such as status, charge stage and all warnings and errors.
- ❖ **Chatty Cathy** - Menu help messages every time the menus are accessed, all the warnings, errors and status info as described above, plus random hidden messages.

Programming Classic Voice

- ❖ Depress MAIN MENU key until CHARGE is highlighted; this is the beginning of the menu tree.
- ❖ Depress the right arrow key 3 times to highlight MISC, then depress ENTER.
- ❖ Depress the right arrow key once to highlight MNGP and press ENTER.
- ❖ **Adjusting the volume:**
 - Highlight VOLUME and depress ENTER.
 - Adjust the volume as needed using the up and down arrows.
NOTE: Number 65 is about as loud as you can go with clarity.
- ❖ **Audio Mode selection:**
 - From the MAIN MENU press the right arrow 3 times to highlight MISC, then depress ENTER.
 - Press the right arrow twice to highlight AUDIO; depress ENTER.
 - Use up/down arrows to select voice mode.

NOTE: After choosing the level you want to use, you must reboot the Classic for it to work.

- ❖ **Audio Reports** (Only in VERBOSE or CHATTY CATHY mode):
 - While in the Audio menu, press ADVANCED.
 - Select the desired time interval in minutes between the STATUS and ERROR messages.
- ❖ **Quiet Time**
 - While still in the Advanced sub-menu, depress RIGHT SOFT key, then depress NEXT.
 - This is the QUIET TIME function or QT.
 - QT OFF = Talks 24 hours a day.
 - QT ON = Has a WAKEUP time and a SLEEP time. When activated, the Voices will be silenced between the times listed during a 24-hour period.

Updating New Firmware to the Classic

The Classic's firmware can be updated with a standard USB cable and a Windows-based PC (Apple products are not supported). The USB cable is Standard-to-Mini B. Please visit www.midnitesolar.com and click on the Software tab (see Screenshot 3) for the firmware and instructions. Due to the various different Windows configurations, we will not go into detail in the Classic Manual. The firmware upgrade is fail-safe, so if the wrong code is installed the Classic simply

says, "Wrong code," prompting you to load the correct code. Also, if the upload is interrupted for whatever reason, simply start over.

WARNING: The Classic's USB port is NOT isolated from battery negative. This is typically only an issue on positive ground systems or systems with a tripped ground fault protection device. Care must be taken that a computer connected to the Classic's USB port is either isolated from ground and the Classic's negative or that the computer's USB negative is common with the Classic's negative and ground.

WARNING: You cannot turn a Classic 150 into a Classic 200 by using new software; the internal components are different.



Screenshot 3

Preparing Classic for Update

Go to your electrical panel and identify the input and output breakers for the Classic. Turn them off. Wait 3 minutes for the Classic to de-energize (see Figure 26).



Figure 26



Figure 27

Remove the four screws holding the front cover of the Classic charge controller (see Figure 27).

NOTE: Do not let the front cover hang by the cable.

Holding the front cover with one hand, place a screw in the top left hole of the front cover and screw it into the top right hole of the back casting (see Figures 28 & 29).



Figure 28



Figure 29

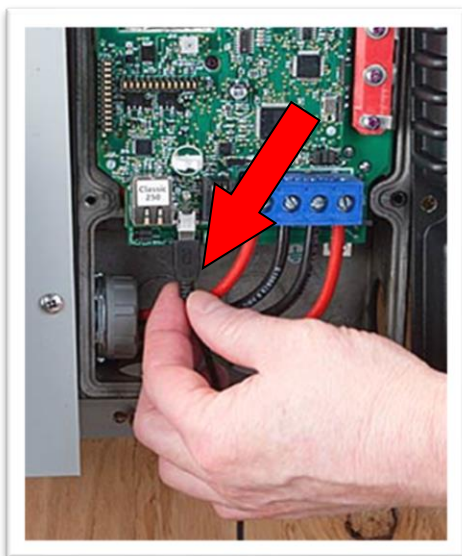

Figure 30

Use any Standard-to-Mini B USB cable to connect the Classic to the PC. The smaller terminal connects to the USB port on the Classic. The USB port is located on the right side of the Ethernet jack in the lower part of the Classic (see Figure 30).

HyperVOC™

HyperVOC is a unique Classic feature. HyperVOC refers to when the DC input voltage rises above the maximum operating voltage (150V, 200V, 250V, depending on the Classic model). HyperVOC gives you the flexibility to go up to the maximum operating voltage PLUS the nominal battery voltage. For example, the Classic 150 has an input voltage rating of 150 operating volts; if the Classic 150 is connected to a 48V battery bank, the HyperVOC voltage limit will be: 150V + 48V for a total of 198V that the Classic can withstand without damage. When the Classic input voltage rises above 150V it will switch off (stop outputting power). As long as the Classic is in HyperVOC mode, the microprocessor and all other functions like AUX will continue running. When the input voltage comes back down below 150V (or the rated operating voltage of the Classic, depending on model) the Classic will wake up and start charging again automatically. This could happen in a really cold morning with a system that has a Voc (open circuit voltage) close to the maximum operating input voltage.

NOTE: A HyperVOC message will be displayed on the bottom right side of the Status screen.

NOTE: The maximum nominal battery voltage to be added is 48V.

HyperVOC can be useful in overcoming an industry shortcoming in charging 48V batteries with standard panels. For example, let's take a sample system with Solar World 165s that have a Voc of 44.1V. The industry has limited us to two of these panels in series making it hard to charge a 48V battery on hot summer days. With the Classic we designed in Hyper VOC to allow you to run three of these in series. Three panels at 44.1V will give you a total Voc of 132.3V. When temperature compensated for cold climates to 125%, Voc rises to 165V. This is above the maximum safe limits for most controllers but falls well into the HyperVOC range of the Classic.

NOTE: Use HyperVOC wisely though; if you abuse it, the Classic will never wake up in cold weather.

Troubleshooting / FAQs

<p>How do I do a software Factory Restore on my Classic or Classic SL?</p>	<p>WARNING: Reset will erase ALL settings.</p> <ul style="list-style-type: none"> • Turn the PV breaker and battery breaker off (What you don't have a breaker? Get one asap) and make sure the display has gone dark. • Hold the left and right arrow keys and turn on JUST the battery breaker; continue to hold the arrow keys until you see the Quick Start menu. • Follow the on-screen prompts to set up your controller. <p>WARNING: You must get the battery charging voltages from the battery manufacturer and it is VERY important you do this and do not just leave it at the default settings, as it is likely this will undercharge and slowly destroy your batteries.</p> <p>WARNING: The Clock is a 24-hr clock. Setting it off by 12 hours will cause it to reset to a new day at noon.</p>
<p>How do I do a HARDWARE factory restore?</p>	<p>WARNING: Reset will erase ALL settings.</p> <ul style="list-style-type: none"> • Turn the PV breaker and battery breaker off (What you don't have a breaker? Get one asap) and make sure the display has gone dark. <p>Do a hardware factory restore. There are 3 jumpers directly above the blue terminal block. For the purpose of this we will call the left most jumper JP1 and the right most JP4 (actually labeled "Boot").</p> <ul style="list-style-type: none"> • Step 1- Turn the PV and battery power off to the Classic and remove the front cover. • Step 2- Locate and remove the 2 jumpers JP1 and JP4; hold the jumpers in your hand. • Step 3- Turn the battery power on to the Classic. • Step 4- Within 1 minute, place jumper JP4 on its two pins and then place jumper JP1 on its two pins. At this point the 3 LEDs on the top of the circuit board should flash back and forth for about 45 seconds. • Step 5- After the flashing stops, power down the Classic and remove JP1 and JP4 and stow them back on a single pin like they were. • Step 6- Put the front cover on and power up the Classic. If you have custom settings you will need to use your MNGP or Local App and reset the battery voltage, set points, and any AUX

	<p>functions that were in use will need to be re-selected and programmed.</p>
<p>What is a “VMM”?</p>	<ul style="list-style-type: none"> • It has become industry slang for our factory restore “Vulcan Mind Meld” from the 2 fingers needed to push the arrows
<p>Classic will not power on. No Fans or life on power up.</p>	<ul style="list-style-type: none"> • Check for reverse polarity on the battery positive and negative terminals on the blue terminal block. • Check for voltage on the battery positive and negative terminals on the blue terminal block; if less than 10V, charge the battery or find the bad connection.
<p>Classic MNGP is blank but the Classic is on</p>	<ul style="list-style-type: none"> • Check that the blue display cable is plugged into the top jack on the main circuit board and the display. • Try the middle jack on the circuit board. • Try a different 6-conductor phone cable (RJ12).
<p>Classic says “Resting” but the sun is out</p>	<ul style="list-style-type: none"> • Resting indicates a lack of power available to the Classic. • Go to the 3rd Status page; reads Voc in lower left corner. • Verify you have Voc on the display that is at least 133% of the actual battery voltage at that time. • Verify the charging mode is correct for the source as well as the “Mode” is on.
<p>Classic switches between Resting and Bulk MPPT repeatedly but produces 0 watts</p>	<ul style="list-style-type: none"> • This is normal under low light conditions. • Watch the input voltage; if it drops down close to battery voltage and then the Classic goes to Resting, this is usually a sign of a bad connection. If it is rock solid call Tech Support. • Try doing a factory restore.
<p>The MNGP shows 0V IN (or really close) but shows battery voltage correctly</p>	<ul style="list-style-type: none"> • If this is a new install, check for reverse polarity on the PV positive and negative on the blue terminal block inside the Classic. • If the system has been running all along and this just happened, call Tech Support.
<p>The MNGP is showing all 0s and/or “Got Comm?”</p>	<ul style="list-style-type: none"> • Ensure you did not put a different display on the Classic. The firmware must match on the Classic and MNGP. • Do a HARDWARE Factory Restore.
<p>The MNGP is showing “Mode is OFF”</p>	<ul style="list-style-type: none"> • Enter the Main Menu and select “Mode.” Turn the Mode “ON” and

	<p>depress Enter to save. Depress Status to return to the main screen.</p> <ul style="list-style-type: none"> • If using the Classic for wind and you cannot turn the mode on, this may indicate the wind curve is not linear and the Classic cannot work with it. Ensure the wind curve continually goes “up hill.”
<p>Stuck in the Quick Start or “VMM”</p>	<ul style="list-style-type: none"> • Check that the blue display cable is plugged in and connections are sound. Try unplugging it and plugging it back in. Check for corrosion also. • Perform a HARDWARE Factory Restore.
<p>The MNGP is fuzzy or has odd characters</p>	<ul style="list-style-type: none"> • Ensure the blue display cable is plugged in well and that it is not running down over the 2 big yellow inductors on the left-hand side of the circuit board.
<p>Multiple charge controllers and one or more is showing 0W and Absorb or Float</p>	<ul style="list-style-type: none"> • This is normal as the battery is almost full and the extra power is not needed so the controller throttles back to prevent over charging of the battery.
<p>Multiple Classics in Follow-Me and they are not all making the same amount of power?</p>	<ul style="list-style-type: none"> • This is normal as Follow-Me simply coordinates the charge stages, each Classic still works independently as far as regulating the PV array.
<p>How do I verify Follow-Me is working properly?</p>	<ul style="list-style-type: none"> • Go to the Main Menu and then into the TEMPS Menu and verify all Classics are seeing the same battery temp from the Classic with the BTS plugged in. • You should see a blue LED flashing inside the top vent. There are two types of blink: a short blink that is about one-tenth of a second means it is getting good information; a long blink that is about half a second indicates it did not get any info. If the blinks are ALL long then you probably have a bad cable and all cables should be checked. • Classic Lites older than serial # CL05435 did not work with Follow-Me. Call Tech Support for a new MNLP.
<p>The fans seem too loud</p>	<ul style="list-style-type: none"> • If it is the internal fans, ensure no wires or anything else has come in contact with the fans. • If it is the external fan (Turbo), remove the front half of the Turbo plastic housing and ensure the fan is still adhered on to the back

	<p>plastic housing. If the fan has come loose, a dab of silicone on each side should solve the noise issue. Do not apply any silicone on the fan blades.</p>
<p>Updating the firmware and the Classic went well but the MNGP will not update</p>	<ul style="list-style-type: none"> • Ensure the MNGP is plugged in using the blue display cable in the top jack of the main circuit board. • Verify you have an MNGP and not an MNLP. The MNLP is an LED panel that comes with the Classic Lite and does not need to be updated. • When the black box pops up telling you to power the Classic up, Count to 4 before turning the breaker on. • If you do not have a breaker or disconnect and you are trying to connect a wire to a terminal block or a battery, the connection will likely be too dirty for the boot loader. Install the proper breakers.
<p>Classic goes to Absorb at too low or too high of a voltage</p>	<ul style="list-style-type: none"> • Verify this is not normal operation due to the battery being warmer than the neutral point. You can verify the battery temperature by going into the Main Menu and selecting the TEMPS Menu. The Classic will adjust the actual charge voltage based on the temperature of the battery. It uses 2 programmable variables: 1) Temperature neutral point (typically 25 degrees C; programmed in the WBJr Status Menu) and 2) millivolts per degree C per cell (typically -5mV). Verify both are set per the battery manufacturers specs. • Too low voltage example: If Absorb were set for 58.8V and the battery is at 35 degrees C and the temp comp is set for -5mV, we have a 10 degree C difference: $10 \times 24 = 240 \times 0.005 = 1200\text{mV}$ (or 1.2V), so the Classic will charge to 57.6V. • Too high voltage example: If Absorb were set for 58.8V and the battery is at 15 degrees C and the temp comp is set for -5mV, we have a 10 degree C difference: $-10 \times 24 = -240 \times 0.005 = -1200\text{mV}$ (or -1.2V), so the Classic will charge to 60V.
<p>Classic goes to Float too early</p>	<ul style="list-style-type: none"> • Ensure End Amps is not set too high causing the Classic to go to Float (End Amps is in the Charge/Advanced Menu and the way it works is if the charge current falls below the End Amps setting AND the Classic is in Absorb, the Classic will go to Float. Setting End Amps to 0 will disable it. End Amps setting is a value the battery manufacturer supplies.

	<ul style="list-style-type: none"> • Make sure you have the Absorb time set properly.
Classic says “OCP is OFF” on the MNGP	<ul style="list-style-type: none"> • This can happen on older Classics that have had the firmware updated. This will have no effect on the operation of the Classic but to make the message go away do a factory restore to fix this.
Classic says “OCP” now and then on the MNGP	<ul style="list-style-type: none"> • This can be normal if the battery bank is small or the inverter cables are too small. If this shows up just once in a great while that would be OK, but if it is happening regularly you may want to look at the size of the battery cables, age of the battery bank, or the size of the battery in amp-hours. Call Tech Support for assistance.
Classic has an orange LED on the display lit up and/or says “Amp Limit”	<ul style="list-style-type: none"> • This indicates the Classic is current limiting. Either because it has reached the current limit you have set in the Charge/Limits Menu or because it is too hot and it is backing its current down to prevent overheating. • Go to the Charge/Limits Menu and verify the amp limits for In and Out are set to what you desire.
Classic says “Hyper VOC” on the MNGP	<ul style="list-style-type: none"> • This indicates that the input voltage has exceeded the operational voltage of the Classic. If this is happening now and then on rare occasions when it is really cold, then it is normal. If this is happening all the time this indicates the PV array was wired for too high a voltage. Contact your solar installer.
Classic says “Battery over V” on the MNGP	<ul style="list-style-type: none"> • This is an indication the Classic thinks the battery voltage is too high and has stopped charging. • This can happen with multiple Classics that are not networked together (Follow-Me). If one of the Classics goes to Float it can show this and will go away as soon as the other Classic goes to Float. • If this is a new install, the wrong nominal voltage may be selected and a factory restore is required. • If this is a running system, then you may have another charging source that has malfunctioned and is over-charging the battery bank.
Classic says “GRND FLT” on the MNGP and is making a loud beeping sound	<ul style="list-style-type: none"> • Generally this would be caused by the PV or battery positive shorting to ground somewhere in the system. • Verify it is a real fault by carefully measuring between battery negative and earth ground. If you measure voltage, then the

	<p>system has a fault. Call your installer for help finding and rectifying the fault.</p> <ul style="list-style-type: none"> • The Classic will automatically stop showing the fault when the issue is fixed.
<p>Classic says “Set date and time” on the MNGP</p>	<ul style="list-style-type: none"> • Verify you are not setting the date and time with the Local App without Time Synch OFF in the TWEAKS Menu. • If not using the Local App to set the time, verify that Time Synch is ON in the TWEAKS Menu. • Verify the “Remove” paper was removed out of the coin battery in the MNGP. • Check coin battery for voltage; replace the battery if less than 2.5V. • Check the coin battery for glue residue from the remove tag. • With coin battery removed, press in on the 2 tabs to bend them in a little tighter and add more spring pressure to the battery.
<p>I have a WBjr and the SOC% is not showing on the main status screen</p>	<ul style="list-style-type: none"> • Verify the WBjr is set properly by looking at the WBjr Status screen and verifying the values are correct. • The SOC% will not show up until the Classic with the WBjr goes to Float once so it can calibrate. • If there are multiple Classics in Follow-Me, ensure the one with the WBjr is the first one to go to Float. • Program the Absorb time in all Classics for 30 minutes longer than the normal Absorb time. This ensures End Amps is achieved before the Absorb timer expires. • If you are using End Amps, ensure you use the Classic with the WBjr to do the sensing of End Amps.
<p>I don’t see a WBjr Status screen or I don’t see all the settings shown in the manual</p>	<ul style="list-style-type: none"> • If the WBjr Status Menu is not present or does not match the manual, then you most likely have older firmware. We recommend updating the firmware and doing a factory restore. The firmware can be found on our website under the “Software” tab.
<p>State of Charge seems inaccurate</p>	<ul style="list-style-type: none"> • Verify the neutral temperature for the temp comp is set per the battery manufacturers specs (typically 25C). • Verify the Amp Hours of the battery bank is set properly NOTE: Batteries in a string do not add in amp-hours. If you have a single string of 8 golf cart batteries, each having 220Ah, then

	<p>you have 220Ah of capacity. If you have 2 such strings, then your bank has 440Ah of capacity.</p> <ul style="list-style-type: none"> • Verify the efficiency of the battery is set properly according to the battery manufacturer’s specs (typically 85% for flooded, 90% for sealed batteries).
<p>Classic says “Arc Fault” on the MNGP and is making a loud beeping noise</p>	<ul style="list-style-type: none"> • This generally indicates you have a bad connection somewhere causing arcs. This can be anywhere in the system so finding it is easier if you can turn things off and see what causes the fault to clear. • This also can be caused by some AC loads powered off the inverter, such as pumps or motors. Adjust the Arc Fault sensitivity settings as required.
<p>Classic keeps going back to address 10 after I readdress it to something else</p>	<ul style="list-style-type: none"> • There was a bug in older firmware that would cause this. We recommend updating the firmware and doing a factory restore. The firmware can be found on our website under the “Software” tab.
<p>I am having issues connecting my Classic directly to my PC without a router</p>	<ul style="list-style-type: none"> • We advise against this as it is more complicated than most people feel comfortable with. We recommend a cheap router for this as it makes it much easier. The way to think about this is the computer and Classic have NO address until the router addresses them, so if you must go direct you have to address both of them. • To do a direct connection we recommend a crossover Ethernet cable. Set the Classic to a static IP, say 192.168.1.5, then you need to go into the IPV4 properties on the PC and set it for a static IP of 192.168.1.2, for example. NOTE: The important part here is that the first 3 sets of numbers match 192.168.1.xxx, for example, and that the LAST sets of numbers do NOT match, as this is the unique identifier of where each item is. You will not need to worry about Gateways or DNS IPs for this connection. For more help with this see our video on direct connection to Classic or consult your network guru.
<p>I cannot find an uninstaller for the MidNite firmware updater</p>	<ul style="list-style-type: none"> • Go to the C directory and find the folder labeled midnitesolar and open it. In here you will find an uninstaller; double left click it to run it. After it is completes, you can delete the midnitesolar folder to completely remove any files left behind.

<p>What is the PASSWORD for the Classic?</p>	<ul style="list-style-type: none"> All Classics use 142 for the password.
<p>I hear a singing sound coming from my Classic, sort of a high pitched whine that varies</p>	<ul style="list-style-type: none"> This is the inductors “Singing” when the input voltage is really low. This is normal and is no cause for concern; however, if it bothers you then you can disable it by going to the Main Menu and disabling LoMax in the TWEAKS Menu. NOTE: If the PV array is really low voltage and its max power point is close to the battery voltage, disabling LoMax will cause a slight loss in power as the Classic will not be able to track all the way to the battery voltage looking for the MPPT voltage.
<p>I have a Classic that came with a grey “Magnum” battery temp sensor. Can I replace it with a MidNite blue one?</p>	<ul style="list-style-type: none"> No, the Magnum sensor has a different resistance value so those Classics were modified to use those sensors. Call MidNite Tech Support if you need help with a new sensor.
<p>How can I verify that all my fans work on my Classic?</p>	<ul style="list-style-type: none"> If you unplug the battery temp sensor and use a flat-blade screw driver to short out all 6 pins inside the jack (carefully so as not to bend the pins), the fans will start spinning. When the Classic is turned-on, all 3 fans are energized momentarily. This is a quick check.
<p>How do I find the “Wizard”?</p>	<ul style="list-style-type: none"> You won’t, we removed the Wizard as it asked a lot of questions that did nothing and was confusing. We replaced it with the Quick Start that comes up when you first power the Classic or do a factory restore.
<p>My fans run all the time no matter what the Classic is doing</p>	<ul style="list-style-type: none"> Ensure the Turbo fan wire is not pinched at the top by the front cover.
<p>I remotely mounted my MNGP and now it won’t power on or it blinks but won’t power up</p>	<ul style="list-style-type: none"> Check that you made the cable exactly the same as the blue one. Note that Pin 1 on one end becomes Pin 6 at the other end (mirror image). Try a heavier cable. We have found that off-the-shelf phone cables are good for about 25 ft max before the voltage drop is too great. Cat3 or Cat5E cable can go about 100 ft, no problem.
<p>How many amps can my Classic handle on the input side? Or, can I put too much PV on my Classic?</p>	<ul style="list-style-type: none"> The Classic regulates very well so within reason there is no limit on the input amps or PV wattage. We recommend you not exceed 150% of the capacity. The Classic, if over-driven on the PV side, will simply produce the max amount it is rated for.

<p>Classic is not making the same amount of wattage as I have for solar panels</p>	<ul style="list-style-type: none"> • First it should be noted a solar panel is rated in a lab so in the real world we typically see about 80% of what it is labeled (i.e., a 100W panel becomes an 80W panel). • Does the Classic say Absorb, Float, or EQ? If so, that means the battery is nearly full and the Classic is throttling back to prevent over charging the battery.
<p>My label is gone or I mixed up my covers. How do I know what model Classic I have?</p>	<ul style="list-style-type: none"> • Remove the front cover and look at the stickers on the big yellow inductors on the left side of the circuit board. • Depress the Status key several times and the Classic will read "Classic XXX. This is your model #.
<p>I can't read my serial # sticker. How can I find my serial #</p>	<ul style="list-style-type: none"> • Depress the Status key several times and a screen will come up showing "Classic XXX." In the bottom right corner is the serial number, it will start with a CL.
<p>How do I know what nominal voltage my Classic is programmed for?</p>	<ul style="list-style-type: none"> • Depress the Status key several times and a screen will come up showing "Classic XXX." To the right of this it will read the battery voltage it is programmed to (i.e., 48V).
<p>I have AUX 1 programmed properly but I cannot get 12V out of it</p>	<ul style="list-style-type: none"> • Most likely the jumpers on the bottom left corner of the circuit board are set for a dry relay, not for a 12V signal. See the AUX portion of the manual for help.
<p>I was in the middle of a firmware update and the update got interrupted, what do I do?</p>	<ul style="list-style-type: none"> • No problem, simply start over with the update. The Classic has a boot loader that will always look for new firmware on boot up so you cannot damage the Classic.
<p>Can I use wind and solar on a single Classic?</p>	<ul style="list-style-type: none"> • No, they both require drastically different tracking algorithms so you will need two Classics.
<p>Can I have more than one Classic on a single battery?</p>	<ul style="list-style-type: none"> • Yes, as long as they have separate PV arrays.
<p>Do I have to shut off my Classic if I have a different charger charging?</p>	<ul style="list-style-type: none"> • No, the Classic will work just fine in conjunction with ANY other charger on the same battery bank.
<p>What is Skip Days?</p>	<ul style="list-style-type: none"> • Skip Days allows the Classic to skip the Bulk charging phase and go directly to Float. Helpful for unattended systems, such as in a weekend cabin. Set for number of days to skip charging. For

example, set to 3 will start Bulk charging on the 4th day.

Mechanical Specifications

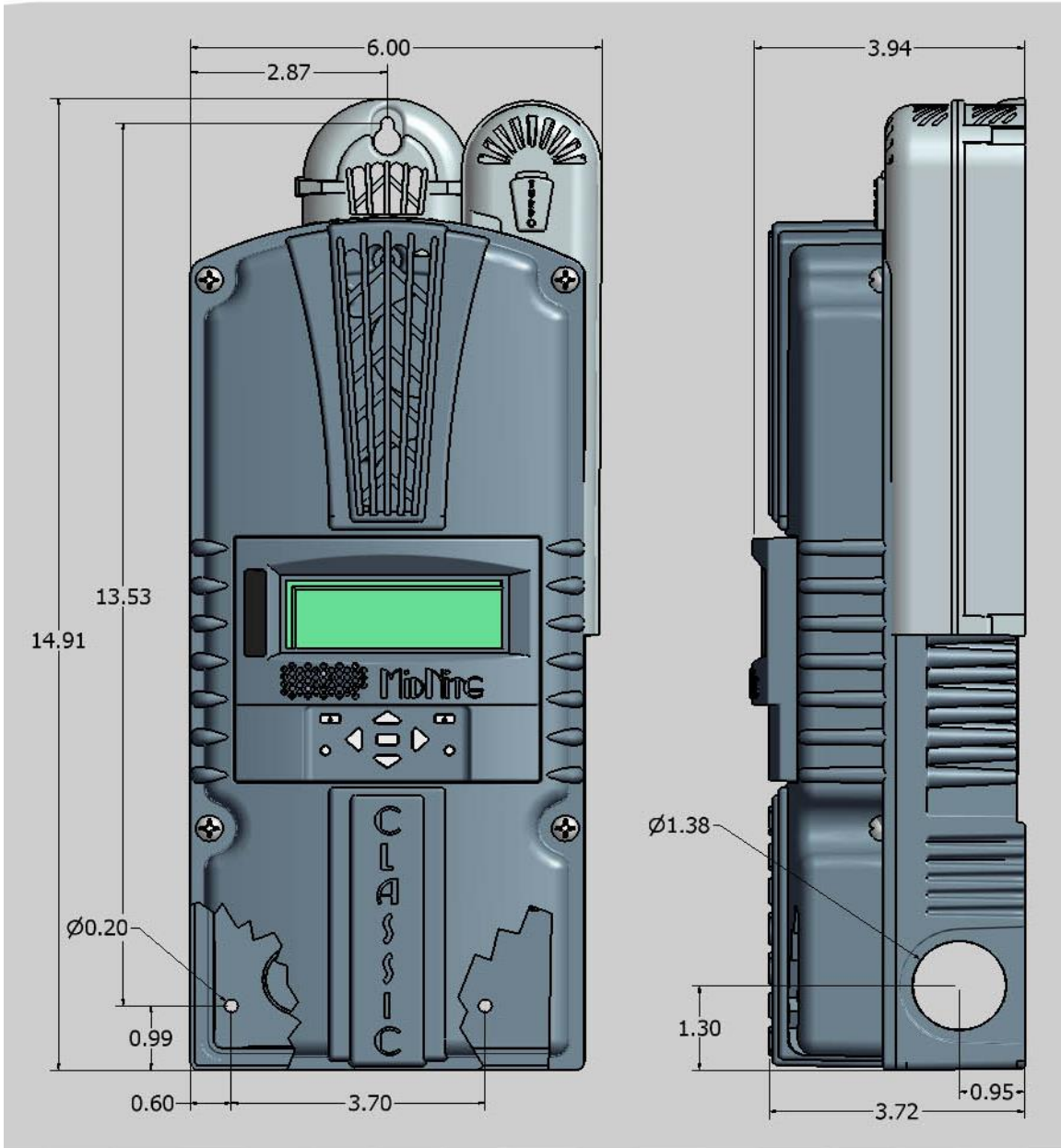

Diagram 10

Electrical Specifications

Model	Classic150	Classic200	Classic250
Operating Volts in	150VDC	200VDC	250VDC
Max Hyper VOC	150 + Batt V*	200 + Batt V*	250 + Batt V*
*Battery Charge Volts	12-93 volts	12-93 volts	12-93 volts
**Absolute Current Output at 25°C	96A at 12V battery 94A at 24V battery 83A at 48V battery	79A at 12V battery 78A at 24V battery 78A at 48V battery	60A at 12V battery 62A at 24V battery 55A at 48V battery
De-rate current at 40°C+	80 amperes	66 amperes	52 amperes
Environment	-40C to 40C		
Dimensions of Classic	14.87"X 5.95"X 4.00" 378mm X 151mm X 102mm		
Dimensions of Box	19.00"X 8.50"X 5.70" 483mm X 216mm xX145mm		
Shipping Weight	11.5 lb 4.9 kg		
<p>NOTE: Current output ratings were measured with 75% of the PV array's Voc (Open Circuit Voltage)</p> <p>*NOTE: Calculated by adding battery nominal voltage to the maximum input operating voltage (48V battery max)</p> <p>**NOTE: Measurement Accuracies: +/- 0.12V, offset calibration adjustment maybe necessary</p>			

Table 4

Default Battery Charge Set Points

The table below describes the default preset voltages for the different nominal battery voltages. This means that if you set the Classic from the QUICK START to a different battery voltage, the Classic will take the default voltage set points. If you manually adjust the Absorb, Float, or Equalization voltage set points, and then nominal battery voltage is changed to a different nominal voltage, (i.e., from 24V to 12V), manual adjustments may be required.

Battery Voltage	12V	24V	36V	48V	60V	72V
Bulk MPPT	14.3V	28.6V	42.9V	57.2V	71.5V	85.8V
Float	13.6V	27.2V	40.8V	54.4V	68.0V	81.6V
Equalize	14.3V	28.6V	42.9V	57.2V	71.5V	85.8V

Table 5

Optional Accessories

Blank MNGP for multiple Classic installations.
MidNite network cable, 3 ft.

Regulatory Approval

The MidNite Solar Classic charge controller conforms to **UL 1741, Safety for Inverters, Converters, Controllers and Interconnection System Equipment for Use with Distributed Energy Resources, Second Edition, May 7, 1999 with revisions through January 28, 2010 and CAN/CSA C22.2 No. 107.1: 2001/09/01 Ed: 3 (R2006)**

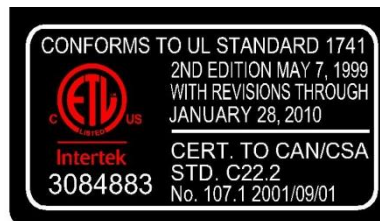

RS232 Jack Pin Out

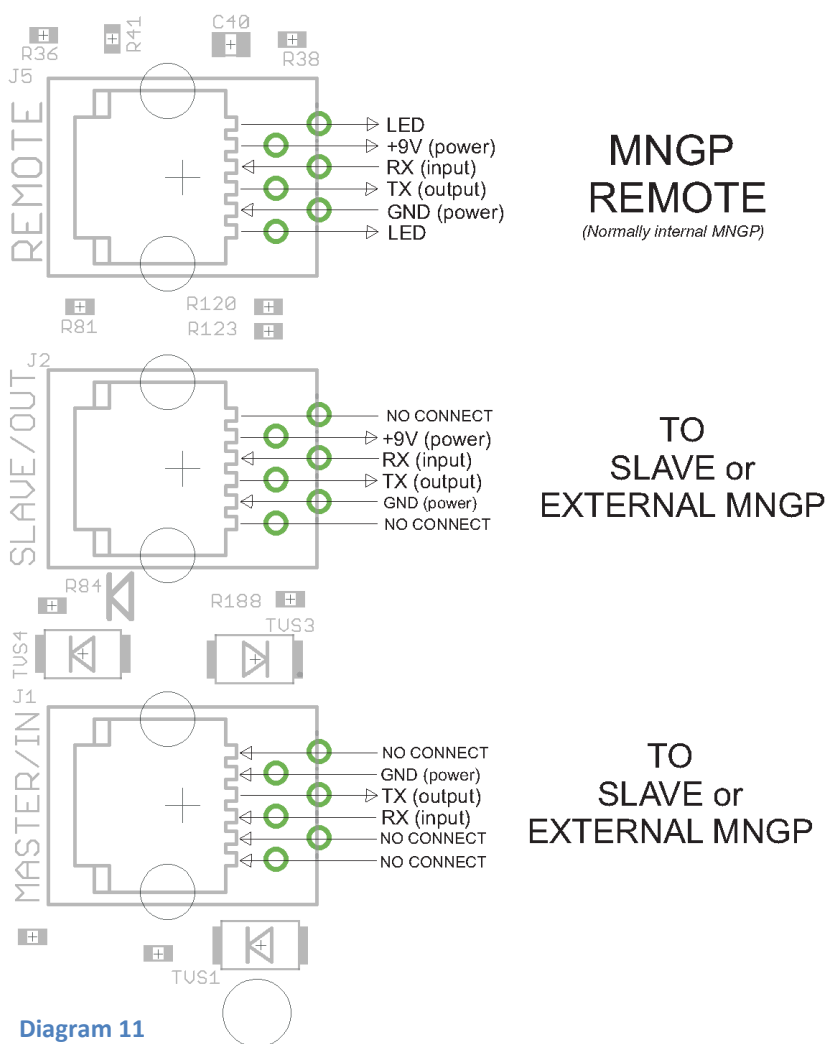

Classic Breaker Sizing

Classic Breaker sizing

Table 8

Model	Bat V	MPPT V (not VOC)	In/Out ratio	Max output A	Output brkr 150VDC	Wire size 310-17*	Max input A	Input breaker/wire with 125% factor**
Classic 150	12	70	5.83	96	100	4AWG	16.46	30A /10AWG - 63A /6AWG 150V
Classic 150	24	70	2.92	94	100	4AWG	32.19	50A/8AWG - 63A/ 6AWG 150V
Classic 150	48	70	1.45	86	90-100	4AWG	59.31	80A/4AWG 150V
Classic 150	12	90	7.5	96	100	4AWG	12.8	30A /10AWG - 63A /6AWG 150V
Classic 150	24	90	3.75	94	100	4AWG	25.06	50A/8AWG - 63A/ 6AWG 150V
Classic 150	48	90	1.87	83	90-100	4AWG	44.38	63A 150V
Classic 150	12	100	8.33	92	100	4AWG	11.04	30A /10AWG - 63A /6AWG 150V
Classic 150	24	100	4.16	91	100	4AWG	21.87	30A /10AWG - 63A /6AWG 150V
Classic 150	48	100	2.08	80	80-90	4AWG	38.46	50A/8AWG - 63A/ 6AWG 150V
Classic 150	12	110	9.16	93	100	4AWG	10.15	30A /10AWG - 63A /6AWG 150V
Classic 150	24	110	4.58	84	90-100	4AWG	18.34	30A /10AWG - 63A /6AWG 150V
Classic 150	48	110	2.29	76	80-90	4AWG	33.18	50A/8AWG - 63A/ 6AWG 150V
Classic 150	12	120	10	92	100	4AWG	9.2	30A /10AWG - 63A /6AWG 150V
Classic 150	24	120	5	82	90-100	4AWG	16.4	30A /10AWG - 63A /6AWG 150V
Classic 150	48	120	2.5	76	80-90	4AWG	30.4	50A/8AWG - 63A/ 6AWG 150V
Classic 200	12	70	5.83	79	80-90	4AWG	13.55	30A/10AWG - 50A/6AWG or 8AWG 300V
Classic 200	24	70	2.91	78	80-90	4AWG	26.8	50A/6AWG or 8AWG 300V
Classic 200	48	70	1.46	76	80-90	4AWG	52.05	80A/4AWG 300V
Classic 200	12	120	10	77	80-90	4AWG	7.7	30A/10AWG - 50A/6AWG or 8AWG 300V
Classic 200	24	120	5	74	80-90	4AWG	14.8	30A/10AWG - 50A/6AWG or 8AWG 300V
Classic 200	48	120	2.5	70	70-80	4AWG	28	50a/6AWG or 8AWG 300V
Classic 200	72	120	1.66	65	70-80	4AWG	39.15	50a/6AWG or 8AWG 300V
Classic 200	12	140	11.66	74	80-90	4AWG	6.34	30A/10AWG - 50A/6AWG or 8AWG 300V
Classic 200	24	140	5.83	72	80-90	4AWG	12.34	30A/10AWG - 50A/6AWG or 8AWG 300V
Classic 200	48	140	2.92	65	70-80	4AWG	22.26	50a/6AWG or 8AWG 300V
Classic 200	72	140	1.94	63	63-70	6AWG	32.47	50A/6AWG or 8AWG 300V
Classic 200	12	160	13.33	73	80-90	4AWG	5.47	30A/10AWG - 50A/6AWG or 8AWG 300V
Classic 200	24	160	6.66	72	80-90	4AWG	10.81	30A/10AWG - 50A/6AWG or 8AWG 300V
Classic 200	48	160	3.33	65	70-80	4AWG	19.52	30A/10AWG - 50A/6AWG or 8AWG 300V
Classic 200	72	160	2.22	53	60-63	6AWG	23.87	50A/6AWG or 8AWG 300V
Classic 250	12	180	15	61	63-70	6AWG	4.06	30A/10AWG - 50A/6AWG or 8AWG 300V
Classic 250	24	180	7.5	62	63-70	6AWG	8.26	30A/10AWG - 50A/6AWG or 8AWG 300V
Classic 250	48	180	3.75	55	60-83	6-4AWG	14.66	30A/10AWG - 50A/6AWG or 8AWG 300V
Classic 250	72	180	2.5	43	50-63	6AWG	17.2	30A/10AWG - 50A/6AWG or 8AWG 300V
Classic 250	12	200	16.6	58	60-70	6AWG	3.49	30A/10AWG - 50A/6AWG or 8AWG 300V
Classic 250	24	200	8.33	60	60-70	6AWG	7.2	30A/10AWG - 50A/6AWG or 8AWG 300V
Classic 250	48	200	4.16	53	60-63	6AWG	12.74	30A/10AWG - 50A/6AWG or 8AWG 300V
Classic 250	72	200	2.77	40	40-63	8-6AWG	14.44	30A/10AWG - 50A/6AWG or 8AWG 300V

*NEC310-17 is the chart for single conductors in free air. This chart is conservatively based on this chart, 75C wire inside a MidNite E-Panel
 ** MidNite Solar breakers are all rated for 100% duty cycle and do not require 156% safety factor. * above also applies to input breaker and wire.

CLASSIC MENU MAP MidNite Solar Inc.

1 of 4

Classic Menu Items Status, Charge, Mode, Aux, Misc, Logs, Tweaks, Temps and Net

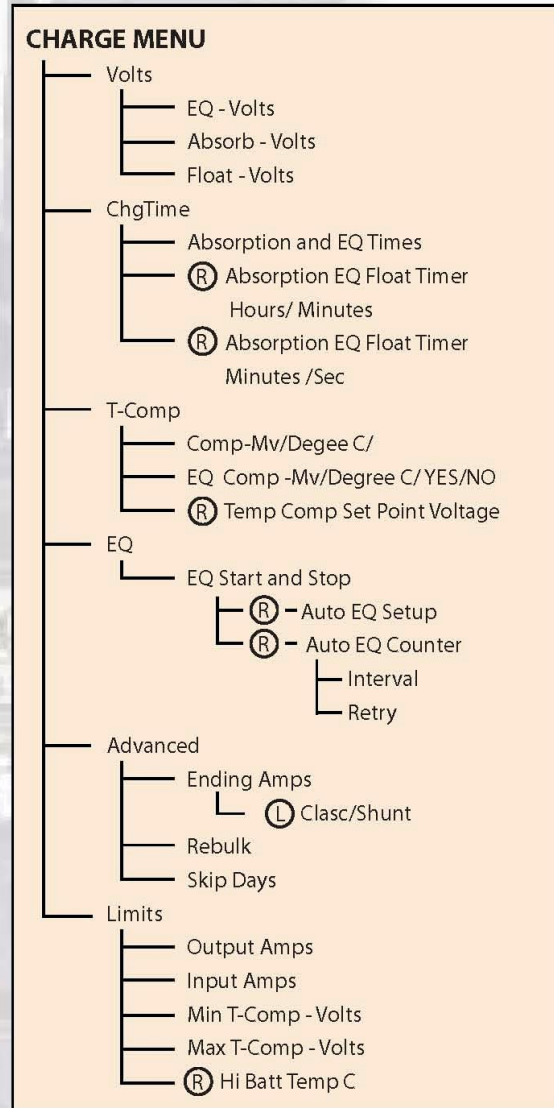
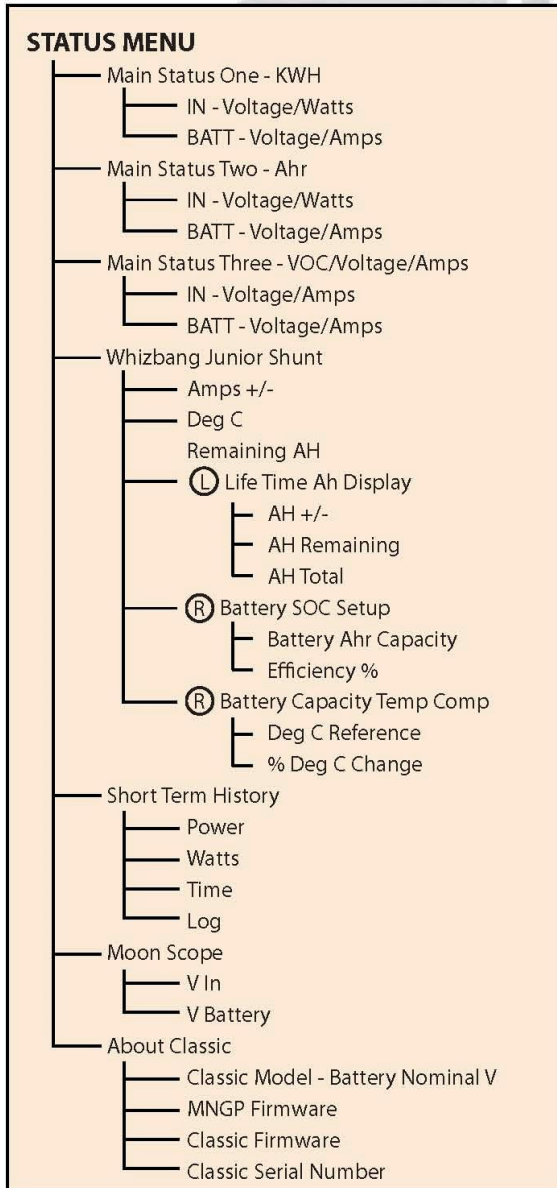

- (R) Symbolizes pushing the Right Soft Key
- (L) Symbolizes pushing the Left Soft Key

WARNING! The Classic's USB port is NOT isolated from battery negative. This is typically only an issue on positive ground systems or systems with a tripped ground fault protection device. Care must be taken that a computer connected to the Classic's USB port is either isolated from ground and the Classic's negative or that the computer's USB negative is common with the Classic's negative and ground.

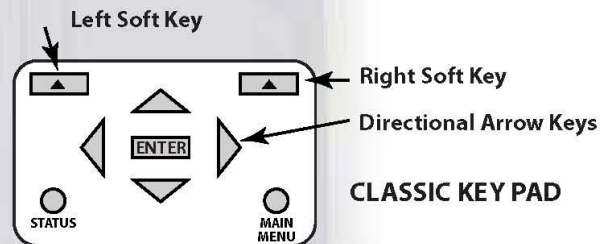

www.midnitesolar.com

17722 - 67th Ave NE Arlington, WA 98223 PH. 360-403-7207 Fax 360-691-6862



CLASSIC MENU MAP
MidNite Solar Inc.

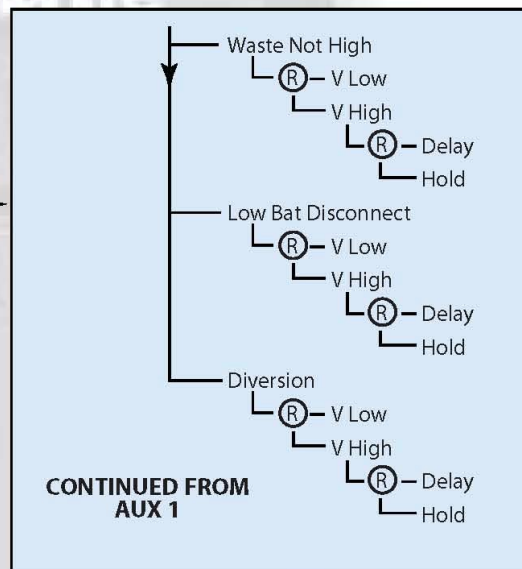
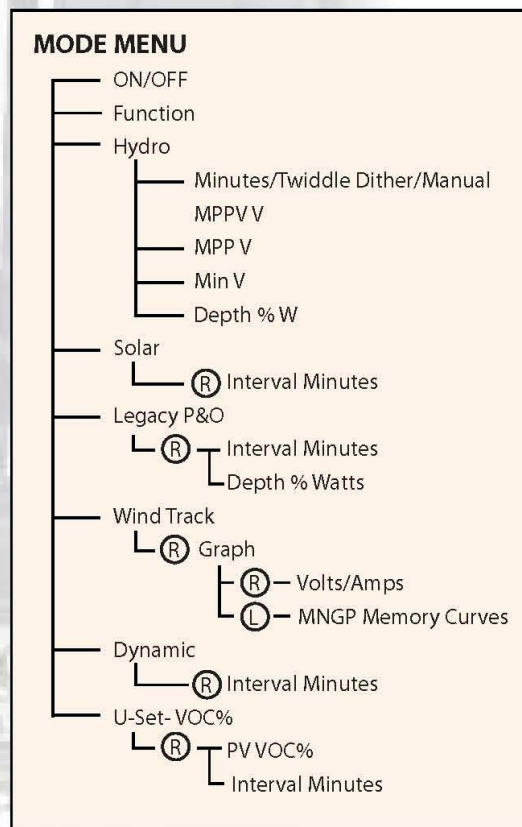
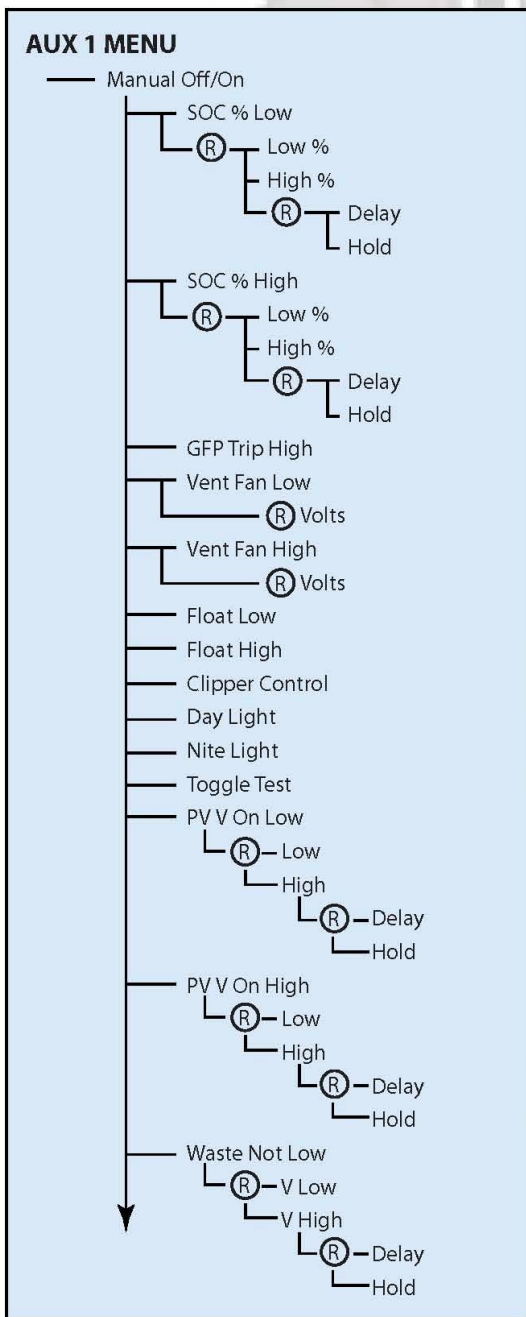

(R) Symbolizes pushing the Right Soft Key
(L) Symbolizes pushing the Left Soft Key



www.midnitesolar.com

17722 - 67th Ave NE Arlington, WA 98223 PH. 360-403-7207 Fax 360-691-6862

CLASSIC MENU MAP
MidNite Solar Inc.

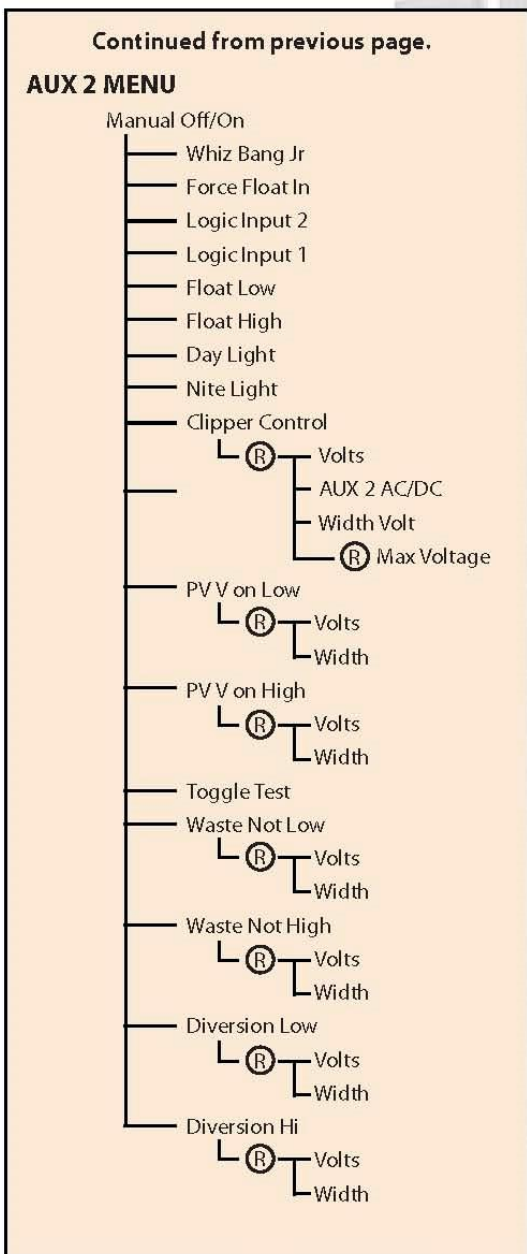

(R) Symbolizes pushing the Right Soft Key
(L) Symbolizes pushing the Left Soft Key

www.midnitesolar.com
17722 - 67th Ave NE Arlington, WA 98223
PH. 360-403-7207 Fax 360-691-6862

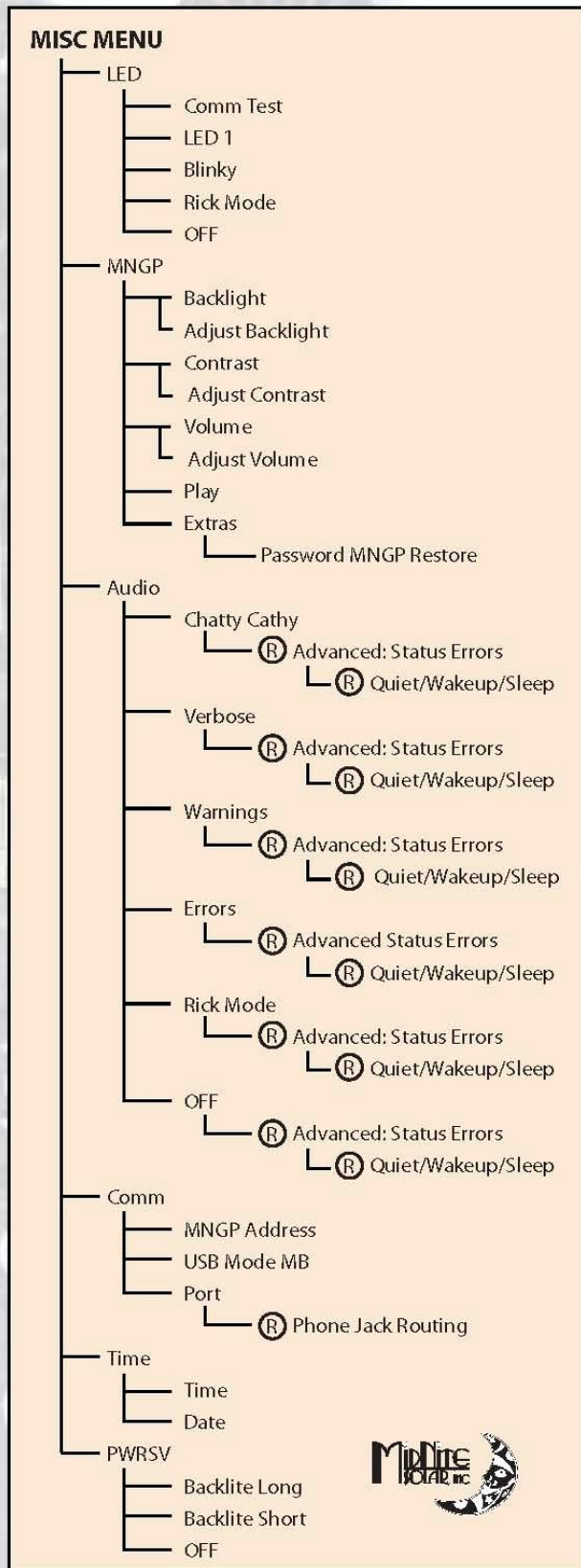

CLASSIC MENU MAP

MidNite Solar Inc.

4 of 4

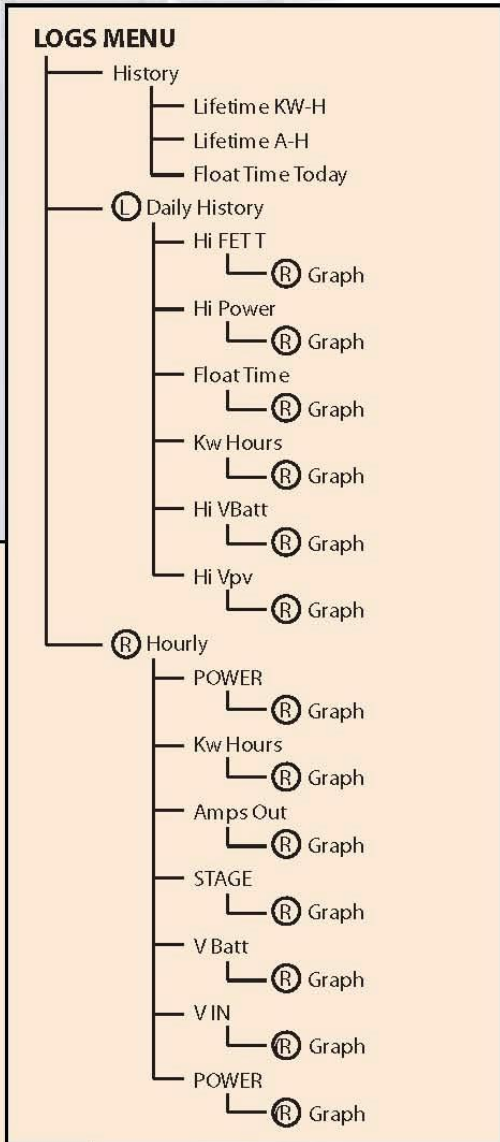
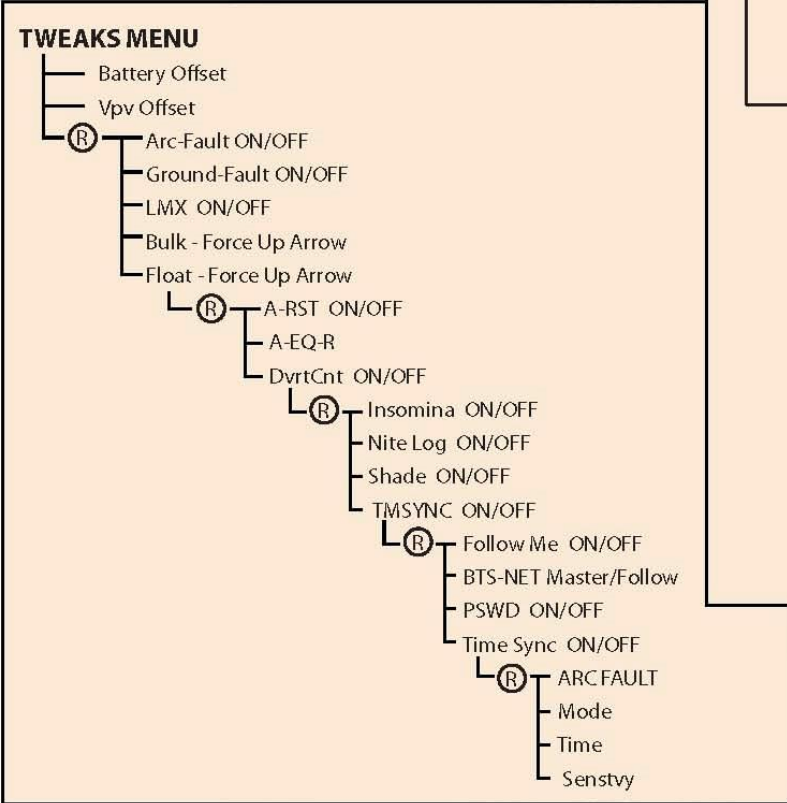
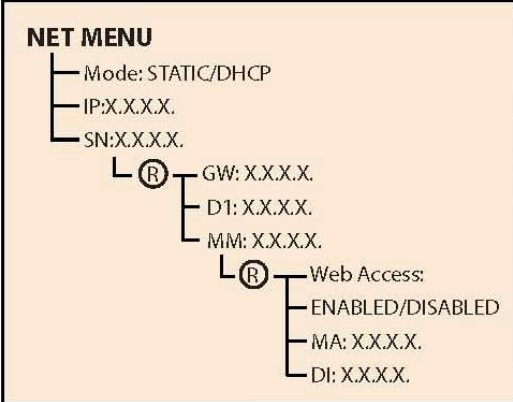

Ⓡ Symbolizes pushing the Right Soft Key
 Ⓛ Symbolizes pushing the Left Soft Key



www.midnitesolar.com

17722 - 67th Ave NE Arlington, WA 98223 PH. 360-403-7207 Fax 360-691-6862

Classic Label Set

MIDNITE SOLAR CLASSIC 150
MPPT SOLAR, WIND, HYDRO, BUCK, BOOST CHARGE CONTROLLER
 NOMINAL OPERATING ENVIRONMENT 25°C (40°C DE-RATED SEE MANUAL)

CONFORMS TO UL STANDARD 1741
 2ND EDITION MAY 7, 1999
 WITH REVISIONS THROUGH
 JANUARY 28, 2010

 CERT. TO CAN/CSA
 STD. C22.2
 3084883 No. 107.1.2001/09/01

MAX PV VOLTAGE (OPERATING) 150V
 MAX PV CURRENT (OPERATING) 96A
 MAX PV VOC 150V + BATTERY VOLTAGE
 MAX PV SHORT CIRCUIT CURRENT 96A
 MAX BATTERY CHARGE CURRENT 96A
 MAX BATTERY CHARGE VOLTAGE 93V
 NOMINAL BAT VOLTAGES 12-72V
 MAX OUTPUT FAULT CURRENT 436A



MIDNITE SOLAR CLASSIC 200
MPPT SOLAR, WIND, HYDRO, BUCK, BOOST CHARGE CONTROLLER
 NOMINAL OPERATING ENVIRONMENT 25°C (40°C DE-RATED SEE MANUAL)

CONFORMS TO UL STANDARD 1741
 2ND EDITION MAY 7, 1999
 WITH REVISIONS THROUGH
 JANUARY 28, 2010

 CERT. TO CAN/CSA
 STD. C22.2
 3084883 No. 107.1.2001/09/01

MAX PV VOLTAGE (OPERATING) 200V
 MAX PV CURRENT (OPERATING) 79A
 MAX PV VOC 200V + BATTERY VOLTAGE
 MAX PV SHORT CIRCUIT CURRENT 79A
 MAX BATTERY CHARGE CURRENT 79A
 MAX BATTERY CHARGE VOLTAGE 93V
 NOMINAL BAT VOLTAGES 12-72V
 MAX OUTPUT FAULT CURRENT 436A



MIDNITE SOLAR CLASSIC 250
MPPT SOLAR, WIND, HYDRO, BUCK, BOOST CHARGE CONTROLLER
 NOMINAL OPERATING ENVIRONMENT 25°C (40°C DE-RATED SEE MANUAL)

CONFORMS TO UL STANDARD 1741
 2ND EDITION MAY 7, 1999
 WITH REVISIONS THROUGH
 JANUARY 28, 2010

 CERT. TO CAN/CSA
 STD. C22.2
 3084883 No. 107.1.2001/09/01

MAX PV VOLTAGE (OPERATING) 250V
 MAX PV CURRENT (OPERATING) 62A
 MAX PV VOC 250V + BATTERY VOLTAGE
 MAX PV SHORT CIRCUIT CURRENT 62A
 MAX BATTERY CHARGE CURRENT 62A
 MAX BATTERY CHARGE VOLTAGE 93V
 NOMINAL BAT VOLTAGES 12-72V
 MAX OUTPUT FAULT CURRENT 436A



ATTENTION SURFACES CHAUDES  **CAUTION** HOT SURFACES **CL00001**

MIDNITE SOLAR, INC.
 17722 67TH AVE NE UNIT C
 ARLINGTON, WA, 98223 USA
 WWW.MIDNITESOLAR.COM









 **DANGER CAUTION**

ELECTRICAL SHOCK AND BURN HAZARD. SOLAR PANELS WILL CONTINUE TO PRODUCE VOLTAGE EVEN WHEN DISCONNECTED. ENSURE THAT PV MODULES ARE COVERED. TURN OFF PV ARRAY AND CHARGE CONTROLLER OUTPUT PRIOR TO SERVICE. RISK OF ELECTRIC SHOCK. DO NOT REMOVE COVER. NO USER SERVICEABLE PARTS INSIDE. REFER SERVICING TO QUALIFIED SERVICE PERSONNEL.

ATTENTION CAUTION 

DANGER DE CHOC ÉLECTRIQUE ET DE RISQUE DE BRÛLURE. LES PANNEAUX SOLAIRES CONTINUERONT DE PRODUIRE L'ÉLECTRICITÉ MÊME S'ils SONT DÉBRANCHÉS. S'ASSURER QUE LES PANNEAUX SOLAIRES SONT COUVERTS PENDANT L'ENTRETIEN. POUR TOUTE ACTION D'ENTRETIEN, LA SORTIE DES PANNEAUX SOLAIRES ET DU CONTRÔLEUR DE CHARGE DOIVENT ÊTRE DÉCONNECTÉES. RIEN À DÉPANNER À L'INTÉRIEUR DU E-PANNEAU NE PAS OUVRIR LE COUVER. POUR TOUTE RÉPARATION OU SERVICE D'ENTRETIEN, CONSULTER UN AGENT SPÉCIALISÉ.

106264

 Q1  Q2  Q3  Q4  12  13  14  15  16

AUX OUTPUT 1: 13VDC 200mA - RECONFIGURABLE AS 3.3VDC AUX **INPUT**
 AUX OUTPUT 2: 500mA RELAY DRY CONTACT- RECONFIGURABLE AS 13VDC 200mA OUTPUT
 MINIMUM INTERRUPT RATING: 4000 AMPS DC FOR OVERCURRENT PROTECTION DEVICE
 TORQUE TERMINAL BLOCK AND GND TERMINAL TO 35 IN-LBS (4Nm). SUITABLE FOR USE WITH 75°C MINIMUM RATED COPPER CONDUCTORS.

Glossary of Terms

Absorb – Constant voltage charge stage to fill the batteries. The Classic is regulating so maximum power will not be seen at this time. The Absorb timer is also counting down to the switch to Float.

A-EQ-R – This will reload the Auto Equalize counters, basically it will start the counters from day 1.

AF – Arc Fault.

Arc Adjust – This menu is where you adjust the Arc Fault sensitivity.

A-RST – Auto reset of the Classic. The Classic will reboot around midnight every night when this is enabled. This is useful for remote sites where a loss of Internet capability would be a hardship.

Aux – Auxiliary relays. The Classic has 2 relays: AUX 1 can be configured as a 12V signal or a dry relay; AUX 2 can be used as a PWM signal output.

BLK – Bulk MPPT Mode. In the TWEAKS Menu, under BLK, use the up arrow to force the Classic into Bulk mode.

Bulk MPPT - Maximum current charge stage, the Classic is trying to bring the batteries to the Absorb voltage set point. The Classic is putting all available power into the batteries.

Comm – This menu allows adjustment of things like Mod Bus port, USB Mode, and MNGP address.

DvrtCnt – When enabled, allows the charge stage timers to continue to run when the diversion modes are holding the battery voltage just below the actual set point.

Equalize - Constant voltage charge stage to equalize the batteries. The Classic is regulating so maximum power will not be seen at this time. The Equalize timer is also counting down to the switch to Float.

EQ MPPT - Maximum current charge stage. The Classic is trying to bring the batteries to the Equalize voltage set point. The Classic is putting all available power into the batteries.

Float – Constant voltage charge stage with a lower voltage than the Absorb charge point. The Classic is regulating so maximum power will not be seen at this time.

Float MPPT – Maximum current charge stage. The Classic is trying to bring the batteries to the Float voltage set point. We are basically putting all available power into the batteries.

FLT – Float mode. In TWEAKS, under FLT, use the up arrow to force the Classic into Float mode.

GF – Ground Fault.

Got Comm? – Indicates a lack of communication between the MNGP and the Classic.

Insomnia – When enabled, will keep the Classic from going to Resting. This is intended for hydro mode only where you may need time to open water valves and do not want to wait for the Classic to wake up.

LED-MODE – This selection lets you pick the function of the six visible LEDs on a standard Classic.

LMX – LoMax. This enables the Classic to track the input voltage all the way down to battery voltage. When disabled the Classic will stop tracking the input around 5V above the battery voltage. When the input voltage is within a couple volts of the battery voltage, the inductors can “sing;” this is usually not very loud and will do no harm.

Local App – Software to monitor Classic over a Local Network or Internet.

MNGP – Midnite Graphical Interface Panel, included with the standard Classic.

Mode – This menu lets you turn the charging ability of the controller On or Off, as well as lets you select the DC input source.

Mod Bus – a standard protocol used for communications. We have published our protocol to allow users to interface with the Classic. See www.midnitesolar.com for our Mod Bus protocol.

My MidNite – Web-based monitoring for the Classic.

NiteLog – When enabled, allows the Classic to log data in the evening when the Classic is Resting.

PV Shading – Indicates the maximum power point voltage is less than half the open circuit voltage.

Pwr Save – Allows you to adjust the time the MNGP backlight stays on.

Resting – The Classic is not charging the battery.

Shade – When enabled the Classic will show PV Shading on the display when the maximum power point voltage is less than half the open circuit voltage.

T-Comp – Temperature compensation using a temperature sensor to measure the ambient temperature of the battery bank and will adjust the voltage set points up or down accordingly to ensure a full battery charge. There are 3 parameters to set: 1) Minimum adjusted voltage; 2) Maximum adjusted voltage; and 3) Volts per degree C per Cell. Typically this is -5 mV, but please consult your battery manufacturer.

VBatt– Battery voltage, measured at the battery terminals of the Classic.

Voc – Open Circuit Voltage, unloaded voltage measurement.

Vpv– Input voltage, measured at the input terminals of the Classic.

Web Access – Allows the Classic to send data over the Internet to My MidNite’s server.

MIDNITE SOLAR INC. LIMITED WARRANTY

MidNite Solar Power electronics, sheet metal enclosures and accessories

MidNite Solar Inc. warrants to the original customer that its products shall be free from defects in materials and workmanship. This warranty will be valid for a period of five (5) years for all products except the MNBRAT Charge Controller along with the MNBIRDHOUSE batteries, these will be two (2) years. MidNite Solar will not warranty third-party inverter components used in MidNites pre-wired systems. Those components are warranted by the original manufacturer.

MidNite Solar offers an extended warranty for all the Classic MPPT charge controllers. Six months prior to the end of the warranty period customers can ship their Classic back to MidNite Solar with a check for \$147 dollars plus shipping and we will replace any wearable parts and do a general tune-up. This will extend the warranty by 2 additional years.

At its option, MidNite Solar will repair or replace at no charge any MidNite product that proves to be defective within such warranty period. This warranty shall not apply if the MidNite Solar product has been damaged by unreasonable use, accident, negligence, service or modification by anyone other than MidNite Solar, or by any other causes unrelated to materials and workmanship. The original consumer purchaser must retain original purchase receipt for proof of purchase as a condition precedent to warranty coverage. To receive in-warranty service, the defective product must be received no later than two (2) weeks after the end of the warranty period. The product must be accompanied by proof of purchase and Return Authorization (RA) number issued by MidNite Solar. For an RMA number contact MidNite Solar Inc., 19115 62nd Avenue NE, Arlington, WA 98223, (360) 403-7207. Purchasers must prepay all delivery costs or shipping charges to return any defective MidNite Solar product under this warranty policy. Except for the warranty that the products are made in accordance with, the specifications therefore supplied or agreed to by customer:

MIDNITE SOLAR MAKES NO WARRANTY EXPRESSED OR IMPLIED, AND ANY IMPLIED WARRANTY OF MERCHANTABILITY OR FITNESS FOR A PARTICULAR PURPOSE WHICH EXCEEDS THE FOREGOING WARRANTY IS HEREBY DISCLAIMED BY MIDNITE SOLAR AND EXCLUDED FROM ANY AGREEMENT MADE BY ACCEPTANCE OF ANY ORDER PURSUANT TO THIS QUOTATION. MIDNITE SOLAR WILL NOT BE LIABLE FOR ANY CONSEQUENTIAL DAMAGES, LOSS OR EXPENSE ARISING IN CONNECTION WITH THE USE OF OR THE INABILITY TO USE ITS GOODS FOR ANY PURPOSE WHATSOEVER. MIDNITE SOLAR'S MAXIMUM LIABILITY SHALL NOT IN ANY CASE EXCEED THE CONTRACT PRICE FOR THE GOODS CLAIMED TO BE DEFECTIVE OR UNSUITABLE.

Products will be considered accepted by customer unless written notice to the contrary is given to MidNite Solar within ten (10) days of such delivery to customer. MIDNITE SOLAR is not responsible for loss or damage to products owned by customer and located on MIDNITE SOLAR'S premises caused by fire or other casualties beyond MIDNITE SOLAR's control. This warranty is in lieu of all other warranties expressed or implied.

MIDNITE SOLAR, INC.
19115 62nd AVENUE NE
ARLINGTON, WA 98223

Email: info@midnitesolar.com
PH: 360.403.7207
FAX: 360.691.6862

New Turbo Fan Assembly

Removal

Step 1: Remove front cover to the Classic.

Step 2: Remove turbo fan wire harness from power board.



Step 3: Turn Classic over, remove two screws on the back of the Classic that secures the fan assembly to the Classic's chassis.

Step 4: Gently separate fan assembly from the Classic. Once the fan assembly is off, it can be discarded.



Assembly

Step 1: Insert one matt on to the fan assembly base. The fan will be “sandwiched” between two matts: one on the bottom of the fan, one on the top.

Step 2: Place the fan into the base with the wires coming out the lower left-hand corner.



Step 3: Insert one matt on top of the fan.

Step 4: Place the fan assembly cover on top of the base and fan.

Step 5: Line up the four screws. Ensure the fan wires are not pinched or crushed, and that they are routed as shown in the picture. Tighten the screws.

Step 6: Pop the top vent into place.



Step 7: Use the screws to mount the base back on the Classic:

