

maXus
Security



PRODUCT CATALOGUE MX.01

CONTENTS

- 1** LOCKS
- 2** PADLOCKS
- 3** UPVC
- 4** HARDWARE
- 5** INDEX

Locks



04 - 11	Cylinders
11	Rim Mortice Locks
12 - 13	Nightlatches
15 - 17	Mortice Locks
18	Door & Window locks
19 - 21	Furniture Locks
22 - 24	Cam Locks
25	Glass Furniture Locks
26	Furniture Lock Kits
26	Hasps & Staples
27	Locking Bolts
27	Mechanical Code Lock
28	Notes

MX-BS MAXUS 3 STAR EURO CYLINDERS



KM 598324

- TS007: 3 Star British Standard
- Sold Secure diamond grade
- Anti-snap molybdenum iron.
- Anti-bump, Anti-drill & Anti-Pick
- Supplied with 3 keys

i Please note that custom size cylinders (Euro Double and Thumb Turn) can be made to order by our dedicated in-house workshop team. Please enquire for more details.

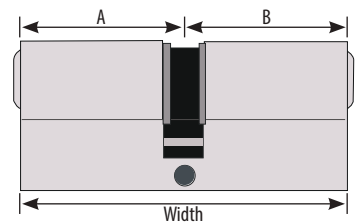

A Ext.	B Int.	TOTAL WIDTH	FINISH	PACK BOX	PACK BLISTER	KEYED ALIKE
EURO - KEY ONE SIDE						
High quality 6 pin euro cylinder with security type key. Anti-Snap, Drill, Bump & Pick protection. Supplied in a 'Dual' finish to reduce stock holding. Available Keyed Alike. Supplied with 3 keys.						
30	10	40mm	Dual	MX-BS/10/30		3 keys
35	10	45mm	Dual	MX-BS/10/35		3 keys
EURO - KEY BOTH SIDES						
High quality 6 pin euro cylinder with security type key. Anti-Snap, Drill, Bump & Pick protection. Supplied in a 'Dual' finish to reduce stock holding. Available Keyed Alike. Supplied with 3 keys.						
30	30	60mm	Dual	MX-BS/30/30		3 keys
30	35	65mm	Dual	MX-BS/30/35		3 keys
35	35	70mm	Dual	MX-BS/35/35	MX-BSB/35/35	3 keys
35	40	75mm	Dual	MX-BS/35/40		3 keys
40	40	80mm	Dual	MX-BS/40/40		3 keys
40	45	85mm	Dual	MX-BS/40/45		3 keys
45	45	90mm	Dual	MX-BS/45/45		3 keys
45	50	95mm	Dual	MX-BS/45/50		3 keys
50	50	100mm	Dual	MX-BS/50/50	MX-BSB/50/50	3 keys
50	55	105mm	Dual	MX-BS/50/55		3 keys
50	60	110mm	Dual	MX-BS/50/60		3 keys

A Ext.	B Int.	TOTAL WIDTH	FINISH	PACK BOX	PACK BLISTER	KEYED ALIKE
EURO - WITH THUMB TURN						
High quality 6 pin Euro cylinder with security type key. Anti-Snap, Drill, Bump & Pick protection. Supplied in a 'Dual' finish to reduce stock holding. Available Keyed Alike. Supplied with 3 keys.						
30	30	60mm	Dual	MX-BS/30/30T		3 keys
35	30	65mm	Dual	MX-BS/35/30T		3 keys
35	35	70mm	Dual	MX-BS/35/35T	MX-BSB/35/35T	3 keys
40	35	75mm	Dual	MX-BS/40/35T		3 keys
40	40	80mm	Dual	MX-BS/40/40T		3 keys
45	40	85mm	Dual	MX-BS/45/40T		3 keys
45	45	90mm	Dual	MX-BS/45/45T		3 keys
50	45	95mm	Dual	MX-BS/50/45T		3 keys
50	50	100mm	Dual	MX-BS/50/50T		3 keys
55	50	105mm	Dual	MX-BS/55/50T		3 keys
60	50	110mm	Dual	MX-BS/60/50T		3 keys



MXKB25



MAXUS PRO EURO CYLINDERS



- Anti Bump, Anti Pick & Anti Drill
- Dual finish to reduce stockholding
- Available KD, KA & MK

i Please note that custom size cylinders (Euro Double and Thumb Turn) can be made to order by our dedicated in-house workshop team. Please enquire for more details.

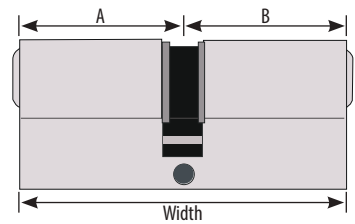

A Ext.	B Int.	TOTAL WIDTH	FINISH	PACK BOX	KEYED ALIKE
EURO - KEY ONE SIDE					
High quality 6 pin Euro cylinder with security type key. Anti-Snap, Drill, Bump & Pick protection. Supplied in a 'Dual' finish to reduce stock holding. Available Keyed Alike & Master Keyed. Supplied with 2 keys.					

A Ext.	B Int.	TOTAL WIDTH	FINISH	PACK BOX	KEYED ALIKE
55	55	110mm	Dual	MX-BS/55/55	
55	60	115mm	Dual	MX-BS/55/60	
60	60	120mm	Dual	MX-BS/60/60	

30	10	40mm	Dual	MX26/10/30	
35	10	45mm	Dual	MX26/10/35	
40	10	50mm	Dual	MX26/10/40	
50	10	60mm	Dual	MX26/10/50	

EURO - KEY BOTH SIDES					
High quality 6 pin Euro cylinder with security type key. Anti-Snap, Drill, Bump & Pick protection. Supplied in a 'Dual' finish to reduce stock holding. Available Keyed Alike & Master Keyed. Supplied with 2 keys.					

30	30	60mm	Dual	MX26/30/30	
30	35	65mm	Dual	MX26/30/35	
30	40	70mm	Dual	MX26/30/40	
30	45	75mm	Dual	MX26/30/45	
30	50	80mm	Dual	MX26/30/50	
30	55	85mm	Dual	MX26/30/55	
30	60	90mm	Dual	MX26/30/60	
35	35	70mm	Dual	MX26/35/35	
35	40	75mm	Dual	MX26/35/40	
35	45	80mm	Dual	MX26/35/45	
35	50	85mm	Dual	MX26/35/50	
35	55	90mm	Dual	MX26/35/55	
35	60	95mm	Dual	MX26/35/60	
40	40	80mm	Dual	MX26/40/40	
40	45	85mm	Dual	MX26/40/45	
40	50	90mm	Dual	MX26/40/50	
40	55	95mm	Dual	MX26/40/55	
40	60	100mm	Dual	MX26/40/60	
45	45	90mm	Dual	MX26/45/45	
45	50	95mm	Dual	MX26/45/50	
45	55	100mm	Dual	MX26/45/55	
45	60	105mm	Dual	MX26/45/60	
50	50	100mm	Dual	MX26/50/50	
50	55	105mm	Dual	MX26/50/55	
50	60	110mm	Dual	MX26/50/60	



T45 (MXKB7)

MAXUS PRO EURO CYLINDERS



- Anti Bump, Anti Pick & Anti Drill
- Dual finish to reduce stockholding
- Available KD, KA & MK

i Please note that custom size cylinders (Euro Double and Thumb Turn) can be made to order by our dedicated in-house workshop team. Please enquire for more details.

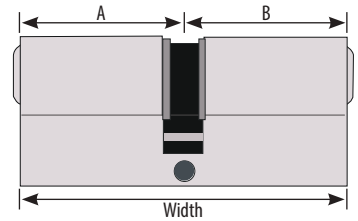

A Ext.	B Int.	TOTAL WIDTH	FINISH	PACK BOX	KEYED ALIKE
EURO - WITH THUMB TURN					
High quality 6 pin euro cylinders with security type key. Anti-Snap, Drill, Bump & Pick protection. Supplied in 'Dual' finish to reduce stock holding. Available Keyed Alike & Master Keyed. Thumb Turn fitted on Size 'B'.					
30	30	60mm	Dual	MX26/30/30T	
30	XX	Custom	Dual	MX26/30/XXT	
35	35	70mm	Dual	MX26/35/35T	
35	XX	Custom	Dual	MX26/35/XXT	
40	40	80mm	Dual	MX26/40/40T	
40	XX	Custom	Dual	MX26/40/XXT	
45	35	80mm	Dual	MX26/45/35T	
45	45	90mm	Dual	MX26/45/45T	
45	XX	Custom	Dual	MX26/45/XXT	
50	40	90mm	Dual	MX26/50/40T	
50	50	100mm	Dual	MX26/50/50T	
50	XX	Custom	Dual	MX26/50/XXT	
55	35	90mm	Dual	MX26/55/35T	
55	40	95mm	Dual	MX26/55/40T	
55	45	100mm	Dual	MX26/55/45T	
55	55	110mm	Dual	MX26/55/55T	
55	XX	Custom	Dual	MX26/55/XXT	
60	XX	Custom	Dual	MX26/60/XXT	



**T45
(MXKB7)**

MAXUS PRO EURO CYLINDERS - MODULAR



Build your own cylinder sizes

Reduce your stock

Complete a job without the need to return back to site

External:

Details

- Pre-pinned
- Supplied with 2 keys
- Includes Molybdenum Anti Snap connector bar
- Requires internal or thumb turn component

Internal:

Details

- Supplied unassembled
- Cam included
- Pinning kit required
- No keys or Pins supplied
- Requires External component

Thumb Turn:

Details

- Cam included
- Requires External component

A/B Size	Width	Finish	EXTERNAL	INTERNAL	THUMB TURN
Euro - Modular					
Modular components to assemble & configure your own Euro cylinders. EXTERNAL pieces come complete with 2 keys. INTERNAL pieces require pinning up to match external. Anti-Snap, Drill, Bump & Pick protection. Supplied in a 'Dual' finish to reduce stock.					
30	30mm	Nickel	MX25/30/EXT	MX25/30/INT	MX25/30/TURN
35	35mm	Nickel	MX25/35/EXT	MX25/35/INT	MX25/35/TURN
40	40mm	Nickel	MX25/40/EXT	MX25/40/INT	MX25/40/TURN
45	45mm	Nickel	MX25/45/EXT	MX25/45/INT	MX25/45/TURN
50	50mm	Nickel	MX25/50/EXT	MX25/50/INT	MX25/50/TURN
55	55mm	Nickel	MX25/55/EXT	MX25/55/INT	MX25/55/TURN
60	60mm	Nickel	MX25/60/EXT	MX25/60/INT	--

Modular Kit

Kit comprises of 2 of each modular component to allow any size Euro cylinder to be assembled. Pinning Kit required.

Pinning Kit

Pinning kit to allow you to re-key, key alike or master key Maxus Pro or Maxus Pro Modular series.



Ref.	Description	Pack
MX25KIT	Euro Modular Kit	Case

Ref.	Description	Pack
MXPK2	Maxus Pro Pinning Kit	Case
MXTK1	Maxus Pro Tool Kit	Bag

MAXUS DUAL FINISH EURO CYLINDERS



- 6 PIN
- Dual Finish to reduce stock
- Anti-snap, Anti-pick, Anti-drill & Anti-pull

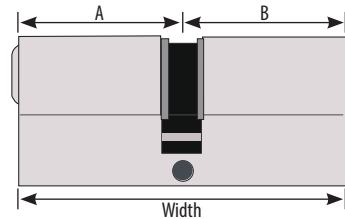

A Ext.	B Int.	TOTAL WIDTH	Finish	BOX PACKED	BLISTER PACKED	KEYED ALIKE
EURO KEY ONE SIDE						
Good quality 6 pin euro cylinder, with adjustable cam. Supplied with 3 keys.						
30	10	40mm	Dual	MX-D/10/30	MX-DB/10/30	MX-D/10/35KA
35	10	45mm	Dual	MX-D/10/35	MX-DB/10/35	MX-D/10/40KA
40	10	50mm	Dual	MX-D/10/40	MX-DB/10/40	
45	10	55mm	Dual	MX-D/10/45	--	
50	10	60mm	Dual	MX-D/10/50	--	
55	10	65mm	Dual	MX-D/10/55	--	
60	10	70mm	Dual	MX-D/10/60	--	



A	B	Total Width	Finish	BOX PACKED	BLISTER PACKED	KEYED ALIKE
EURO KEY BOTH SIDES						
Good quality 6 pin euro cylinder. Supplied with 3 keys.						
30	30	60mm	Dual	MX-D/30/30	MX-DB/30/30	MX-D/30/30KA
30	35	65mm	Dual	MX-D/30/35	--	
30	40	70mm	Dual	MX-D/30/40	MX-DB/30/40	
30	45	75mm	Dual	MX-D/30/45	MX-DB/30/45	
30	50	80mm	Dual	MX-D/30/50	--	
35	35	70mm	Dual	MX-D/35/35	MX-DB/35/35	MX-D/35/35KA
35	40	75mm	Dual	MX-D/35/40	MX-DB/35/40	
35	45	80mm	Dual	MX-D/35/45	MX-DB/35/45	MX-D/35/45KA
35	50	85mm	Dual	MX-D/35/50	MX-DB/35/50	
35	55	90mm	Dual	MX-D/35/55	MX-DB/35/55	
35	60	95mm	Dual	MX-D/35/60	--	
40	40	80mm	Dual	MX-D/40/40	MX-DB/40/40	MX-D/40/40KA
40	45	85mm	Dual	MX-D/40/45	MX-DB/40/45	
40	50	90mm	Dual	MX-D/40/50	MX-DB/40/50	MX-D/40/50KA
40	55	95mm	Dual	MX-D/40/55	MX-DB/40/55	
40	60	100mm	Dual	MX-D/40/60	--	
45	45	90mm	Dual	MX-D/45/45	MX-DB/45/45	MX-D/45/45KA
45	50	95mm	Dual	MX-D/45/50	MX-DB/45/50	MX-D/45/50KA
45	55	100mm	Dual	MX-D/45/55	MX-DB/45/55	MX-D/45/55KA
45	65	110mm	Dual	MX-D/45/65	--	
50	50	100mm	Dual	MX-D/50/50	MX-DB/50/50	MX-D/50/50KA
50	55	105mm	Dual	MX-D/50/55	--	
55	55	110mm	Dual	MX-D/55/55	--	



**T10
(MXKB1)**

MAXUS DUAL FINISH EURO CYLINDERS

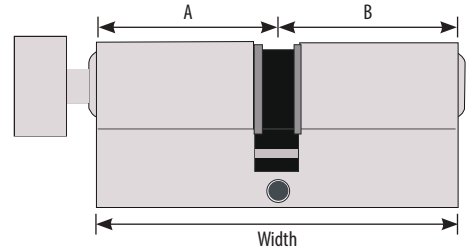

A Ext.	B Int.	Total Width	Finish	BOX PACKED	BLISTER PACKED	KEYED ALIKE
EURO - WITH THUMB TURN						
10	35	45mm	Dual	MX-D/10/35T	MX-DB/10/35T	
30	30	60mm	Dual	MX-D/30/30T	MX-DB/30/30T	MX-D/30/30TKA
35	35	70mm	Dual	MX-D/35/35T	--	MX-D/35/35TKA
35	40	75mm	Dual	MX-D/35/40T	--	
40	35	75mm	Dual	MX-D/40/35T	--	
40	40	80mm	Dual	MX-D/40/40T	MX-DB/40/40T	MX-D/40/40TKA
40	50	90mm	Dual	MX-D/40/50T	--	
45	35	80mm	Dual	MX-D/45/35T	MX-DB/45/35T	
45	45	90mm	Dual	MX-D/45/45T	MX-DB/45/45T	MX-D/45/45TKA
45	50	95mm	Dual	MX-D/45/50T	--	
45	55	100mm	Dual	MX-D/45/55T	--	
50	40	90mm	Dual	MX-D/50/40T	--	
50	45	95mm	Dual	MX-D/50/45T	--	
50	50	100mm	Dual	MX-D/50/50T	MX-DB/50/50T	
55	35	90mm	Dual	MX-D/55/35T	--	



**T10
(MXKB1)**

Maxus Pro Pinning Mat



- Essential tool for re-pinning cylinders
- 6 segmented areas for separating chamber pins
- 2 cylinder plug raise mounts, Non-slip backing

Ref.	Brand	Contents	Pack
MXPPM1	Maxus	Maxus Pro Pinning Mat	Bag

Maxus Pinning Kit



- Pinning Kit for servicing and keying Maxus 6-pin range of Euro Rim and Oval Cylinders
- Includes Top/Bottom Pins, springs and clips
- Replacement pins available to order to top kit up
- Supplied in a sturdy plastic storage box

Ref.	Brand	Contents	Man. Code	Pack
MXPK1	Maxus	Maxus Pinning Kit	--	DP

Maxus Pro Universal Clamp (29mm)



- Essential tool for re-pinning cylinders.

Ref.	Brand	Contents	Pack
MXSP073	Maxus	Maxus Pro Universal Clamp (29mm)	Bag

Maxus Euro Cylinder Carry Bag



- Robust, high quality cylinder storage bag
- Space for 26 cylinders plus 3 spare
- Keeps cylinders protected and in good condition
- Handy sizing guide

Ref.	Brand	Contents	Man. Code	Pack
MXCASE1	Maxus	Maxus Carry Bag	--	L

OVAL CYLINDERS -PRO



Maxus PRO Oval Cylinders

- High quality 6 pin oval cylinders
- Bump, Pick & Drill Resistant
- Available Keyed Alike & Master Keyed (service charges apply)



T45
(MXKB7)

A Ext.	B Int.	Total Width	Finish	SINGLE OVAL	DOUBLE OVAL	THUMB TURN OVAL
30	10	40mm	Nickel	MX24/10/30	--	--
30	30	60mm	Nickel	--	MX24/30/30	MX24/30/30T
35	10	45mm	Nickel	MX24/10/35	--	--
35	35	70mm	Nickel	--	MX24/35/35	MX24/35/35T
40	40	80mm	Nickel	--	MX24/40/40	MX24/40/40T

OVAL CYLINDERS -MX-D

Single Oval:

Double Oval:

Thumb Turn Oval:



Maxus Dual Finish Oval Cylinders

- Good quality 6 pin oval cylinders
- Bump, Pick & Drill Resistant
- Available Keyed Alike (service charges apply)



T10
(MXKB1)

A Ext.	B Int.	Total Width	Finish	SINGLE OVAL	DOUBLE OVAL	THUMB TURN OVAL
30	10	40mm	Dual	MX-DOV/10/30	---	---
30	30	60mm	Dual	---	MX-DOV/30/30	---
35	10	45mm	Dual	MX-DOV/10/35	---	---
35	35	70mm	Dual	---	MX-DOV/35/35	MX-DOV/35/35T
40	10	50mm	Dual	MX-DOV/10/40	---	---
40	40	80mm	Dual	---	MX-DOV/40/40	MX-DOV/40/40T
45	45	90mm	Dual	---	MX-DOV/45/45	MX-DOV/45/45T

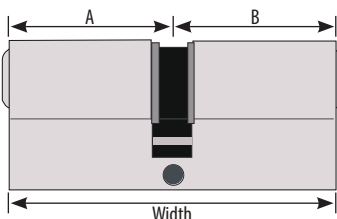

MAXUS SCANDINAVIAN CYLINDERS

Maxus Dual Finish Scandinavian Cylinders



Ext. Int.

- Good quality Scandinavian cylinders
- Supplied as a pair (Internal & External)
- Supplied with 2 keys
- Available keyed alike (Service charges apply)



T10
(MXKB1)

Ref.	Description	Finish	Width	Pack
MX-DSCAN/PAIR	Int. & Ext. Scandinavian Cylinder	Dual	30mm	

Maxus Dual Finish Rim Cylinder



- 6 pin standard rim cylinders
- Boxed packed
- Available keyed to differ or Keyed alike



T10
(MXKB1)

Ref.	Finish	Pin	KD/KA	Keys	Outer	Pack
MX-D/RIM	Dual	6 Pin		3	10	
MX-D/RIMKA	Dual	6 Pin		3	10	

RIM DEADLOCK & SASHLOCK

Maxus Rim Deadlock



- Complete locks with striking plate & fixings
- Ideal for shed doors etc.



WIDTH	FINISH	A	B	C	D	REBATE KIT	Blister Ref.	BLISTER PACK
103mm	Grey	46mm	n/a	76mm	---	n/a	MX630	

Maxus Rim Sashlock



- Complete locks with striking plate & fixings
- Ideal for shed doors etc.



WIDTH	FINISH	A	B	C	D	REBATE KIT	Blister Ref.	BLISTER PACK
140mm	Grey	44mm	65mm	76mm	---	n/a	MX631	

STANDARD NIGHTLATCHES

Maxus Modern Style - Standard

- Complete with 6 pin cylinder, all fixings & 3 keys
- Boxed or display packed
- Also available case only

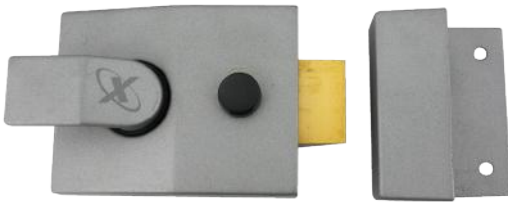

Ref.	Backset	Finish	Cylinder	Pack
MX92/DG	60mm	Grey	PB	
MX92/CH		Chrome	CH	
Boxed and Case Only:				
MX92/DG/B	60mm	Grey	PB	
MX92//CO (Case Only)			--	

Maxus Modern Style - Narrow

- Complete with 6 pin cylinder, all fixings & 3 keys
- Boxed or display packed
- Also available case only



Ref.	Backset	Finish	Cylinder	Pack
MX93/DG	40mm	Grey	PB	
Boxed and Case Only:				
MX93/CO (Case Only)	40mm	Grey	--	
MX93/CO (Case Only)			--	



**T10
(MXKB1)**



**T10
(MXKB1)**

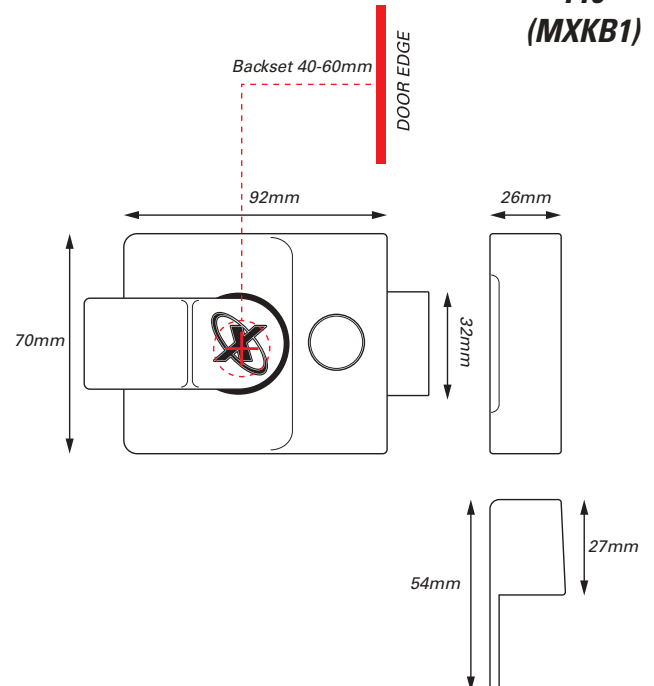
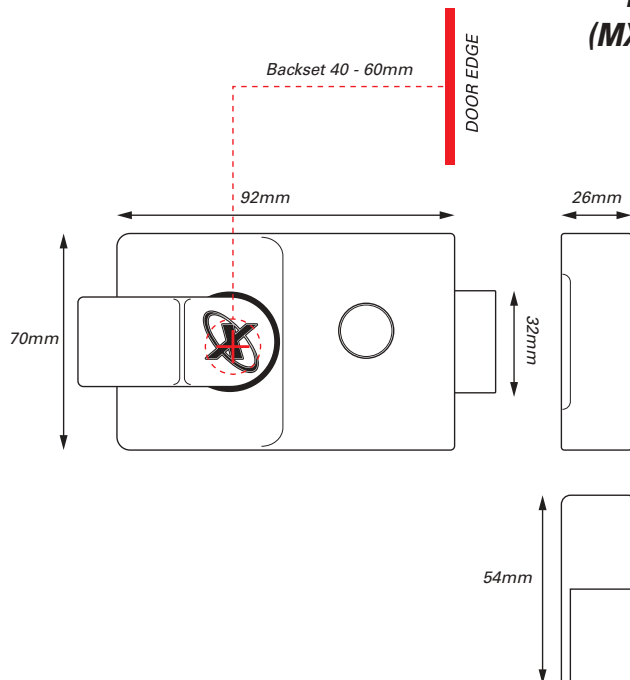

NIGHTLATCHES (OTHER)

Maxus Traditional Style

- Complete with 6 pin cylinder, all fixings & 3 keys
- Boxed or display packed
- Also available case only

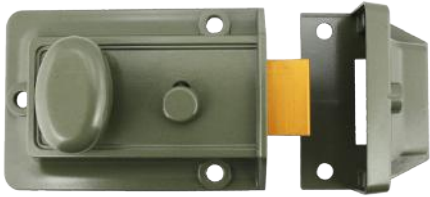

REF	BACKSET	FINISH	CYLINDER	PACK
MX90/GE	60mm	Green	PB	
MX90/GE/B	60mm	Green	PB	
MX90/CO (Case Only)	60mm	Green		
MX91/GE	40mm	Green	PB	
MX91/GE/B	40mm	Green	PB	

Maxus Modern Style (Non-Deadlocking)

- High quality nightlatch with hold back feature which cannot be deadlocked.
- Supplied with 3 keys
- Boxed packed
- Also available case only

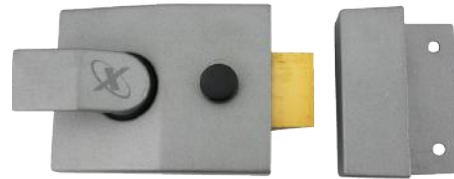

REF	BACKSET	FINISH	CYLINDER	PACK
MX95/DG/B	60mm	Grey	PB	
MX95/CO (Case Only)	60mm	Grey		
MX96/DG/B	40mm	Grey	PB	
MX96/CO (Case Only)	40mm	Grey		



T10
(MXKB1)



T10
(MXKB1)

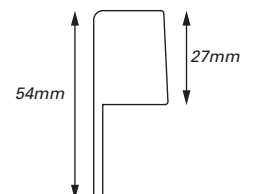
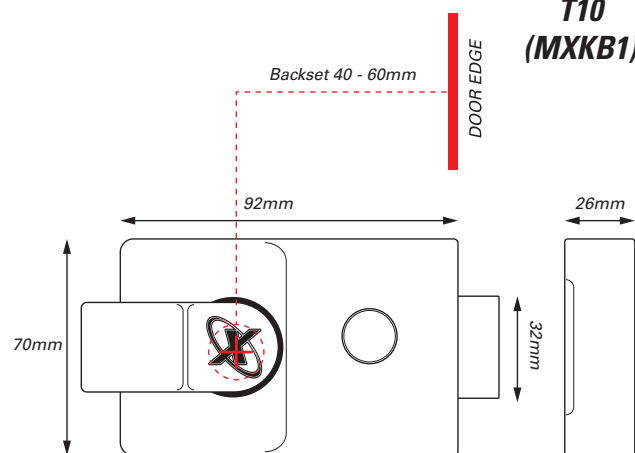
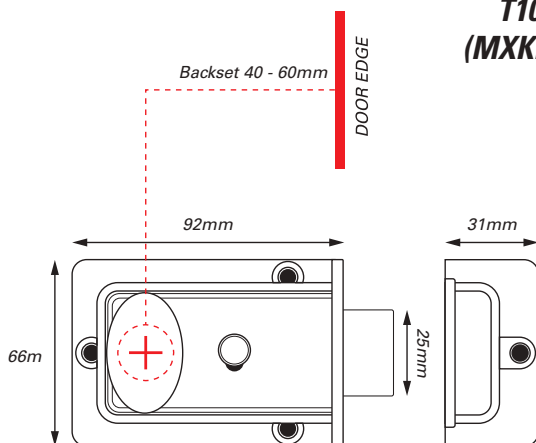

BRITISH STANDARD DEADLOCK & SASHLOCK

Maxus British Standard Deadlock

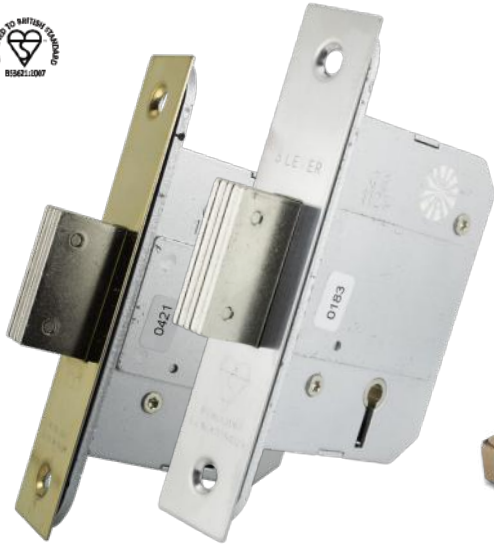

- Supplied with 2 keys
- Backset: 44.5/57mm
- Lock Centres: n/a
- Case Width: 64/76mm
- Case Height: 88.5mm
- Faceplate: 134mm
- Key blank: MXKB20
- Keyed alike available (Service charge applies)

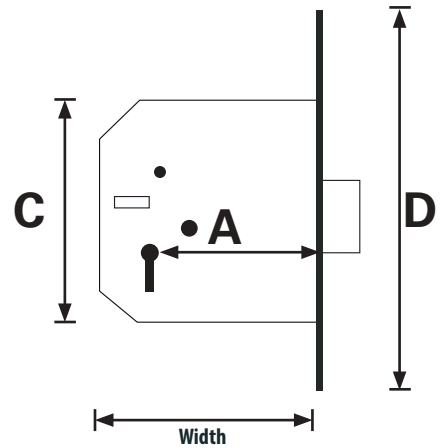

WIDTH	FINISH	A	B	C	D	REBATE KIT	Box Ref.	PACK BOX
64mm	PB						MXBSDL/PB	
64mm	SC	44.5/57mm	n/a	88.5mm	134mm	n/a	MXBSDL/SC	
76mm	PB						MXBSDL/3PB	
76mm	SC						MXBSDL/3SC	

Maxus British Standard 5 Lever Sashlock



- Supplied with 2 keys
- Backset: 44.5/57mm
- Lock Centres: 57mm
- Case Width: 64/76mm
- Case Height: 112mm
- Faceplate: 162mm
- Key blank: MXKB20
- Keyed alike available (Service charge applies)



MXKB20

WIDTH	FINISH	A	B	C	D	REBATE KIT	Box Ref.	PACK BOX
64mm	PB						MXBSSL/PB	
64mm	SC	44.5/57mm	57mm	112mm	162mm	n/a	MXBSSL/SC	
76mm	PB						MXBSSL/3PB	
76mm	SC						MXBSSL/3SC	

5 LEVER DEADLOCK & SASHLOCK

Maxus 5 Lever Deadlock

- Supplied with 2 keys
- Backset: 44/57mm
- Lock Centres: n/a
- Case Width: 67.5/79.5mm
- Case Height: 80mm
- Faceplate: 138mm
- Key blank: MXKB15

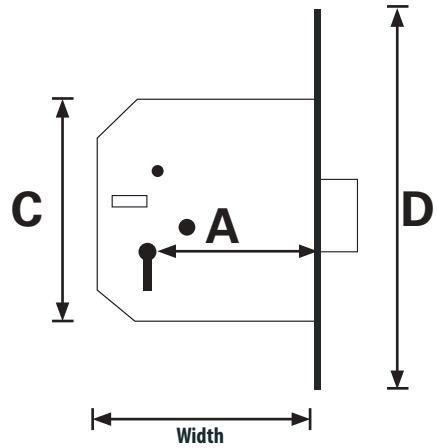

WIDTH	FINISH	A	B	C	D	REBATE KIT	Box Ref.	PACK BOX
67.5mm	PB						MXSOL/PB	
67.5mm	SC	44/57mm	n/a	80mm	138mm	n/a	MXSOL/SC	
79.5mm	PB						MXSOL/3PB	
79.5mm	SC						MXSOL/3SC	



MXKB15

Maxus 5 Lever Sashlock

- Supplied with 2 keys
- Backset: 44.5/57mm
- Lock Centres: 57mm
- Case Width: 67.5/79.5mm
- Case Height: 112mm
- Faceplate: 166mm
- Key blank: MXKB15

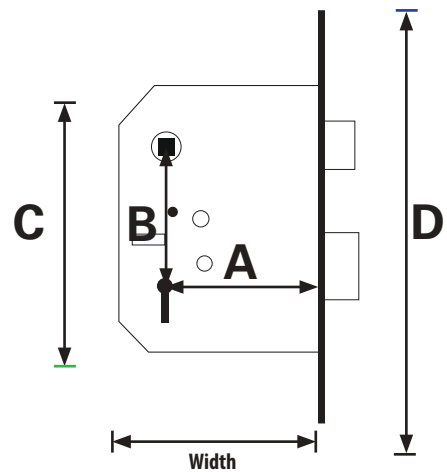

WIDTH	FINISH	A	B	C	D	REBATE KIT	Box Ref.	PACK BOX
67.5mm	SC						MXSSL/PB	
67.5mm	PB	44.5/57mm	57mm	112mm	166mm	n/a	MXSSL/SC	
79.5mm	SC						MXSSL/3PB	
79.5mm	PB						MXSSL/3SC	



MXKB15

3 LEVER DEADLOCK & SASHLOCK

Maxus 3 Lever Deadlock



- 1.BS EN12209:2003 GRADE 2
- Solid brass deadbolt
- Sintered steel follower
- Includes plastic back box
- Supplied with 2 keys
- Keyed alike available (Service charge applies)

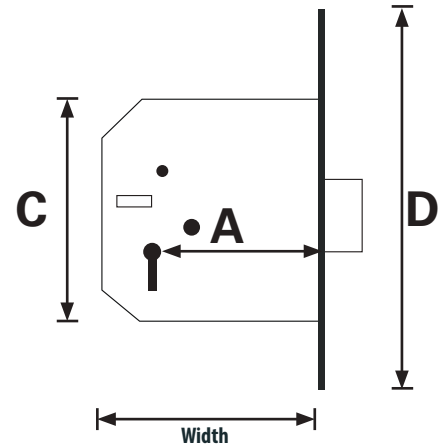

WIDTH	FINISH	A	B	C	D	REBATE KIT	Box Ref.	PACK BOX
65.5mm	PB						MX3DL/3PB	
78mm	SC	44/57mm	n/a	70mm	120mm	n/a	MX3DL/3SC	
67.5mm	PB						MX3DL/PB	
79.5mm	SC						MX3DL/SC	

Maxus 3 Lever Sashlock



- Solid brass deadbolt
- Retro fit UK replacement lock
- Supplied with 2 keys
- Keyed alike available (Service charge applies)



MXKB13

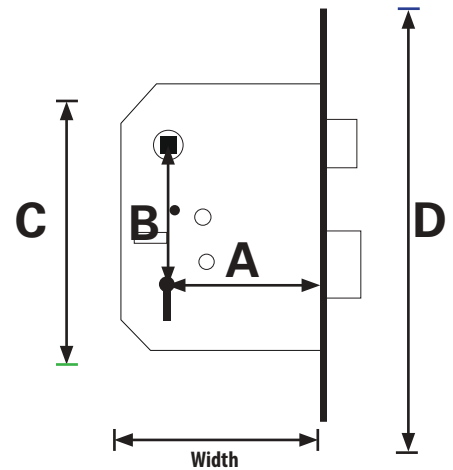

WIDTH	FINISH	A	B	C	D	REBATE KIT	Box Ref.	PACK BOX
65.5mm	PB						MX3SL/3PB	
67.5mm	SC	44/57.5mm	57mm	108mm	152.5mm	n/a	MX3SL/3SC	
78mm	PB						MX3SL/PB	
79.5mm	SC						MX3SL/SC	

EURO PROFILE DEADLOCK & SASHLOCK

Maxus Euro Profile Deadlock



- BS EN 12209 :2003 Grade 2
- Solid brass deadbolt
- Sintered steel follower
- Includes plastic back box

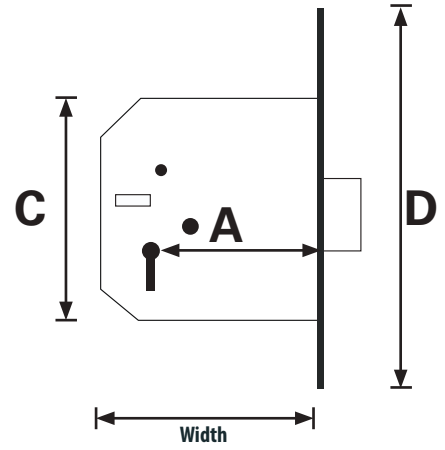

WIDTH	FINISH	A	B	C	D	REBATE KIT	Box Ref.	PACK BOX
79.5mm	PB						MXEDL/3PB	
79.5mm	SC						MXEDL/3SC	
67.5mm	PB	44.5/57mm	n/a	80mm	138mm	n/a	MXEDL/PB	
67.5mm	SC						MXEDL/SC	

Maxus Euro Profile Sashlock

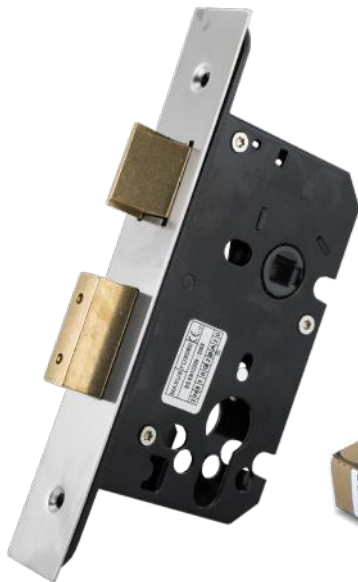

- BS EN 12209 :2003 Grade 2
- Solid brass deadbolt
- Sintered steel follower
- Short travel function
- Includes plastic back box

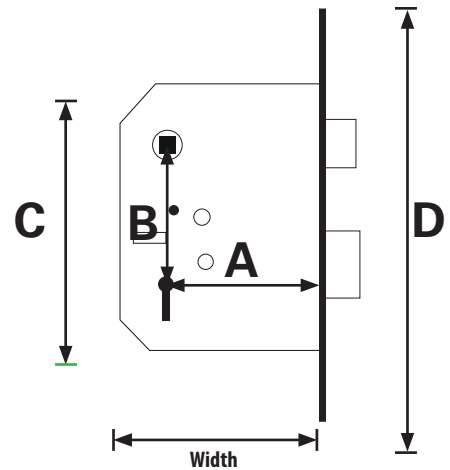

WIDTH	FINISH	A	B	C	D	REBATE KIT	Box Ref.	PACK BOX
79.5mm	PB						MXESL/3PB	
79.5mm	SC						MXESL/3SC	
67.5mm	PB	44.5/57mm	47.5mm	112mm	166mm	n/a	MXESL/PB	
67.5mm	SC						MXESL/SC	

WINDOW LOCKS

Wooden Window Security Bolts

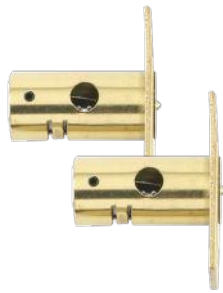

- Morticed in to provide extra security at the top & or bottom of a window (For doors use MX363)
- Supplied as a pack of 2 with 1 key



Key Blank: **KWL2**

Ref.	Contents	Finish	Pack
MX362	2 Locks + 1 Key	Brass	

Multi Purpose Bolt



- Multi-purpose locking bolt
- Can be fitted to aluminium, wooden sliding & hinged doors



Key Blank: **MXKB2**

Ref.	Length	Width	Projection	Contents	Finish	Pack
MX343	82mm	30mm	45mm	1 Lock + 2 Keys	White	

Metal Hinged Window Locks



- Suitable for outward opening hinged metal windows providing the window & frame are not flush
- Increases security against forced attacks
- Supplied as a pack of 2 with 1 key



Key Blank: **KWL9**

Ref.	Contents	Finish	Pack
MX361	2 Locks + 1 Key	White	

Cable Restrictor



- Suitable for all windows, it can be key deadlocked or left in the push to release mode
- Maximum opening of 100mm
- Cable length in 200mm



Key Blank: **KWL82**

Ref.	Contents	Finish	Pack
MX344	1 Lock + 1 Key	White	

Patio Door Locks



- Locking bolts for securing aluminium and UPVC patio sliding doors
- Push to lock



Key Blank: **MXKB2**

Ref.	Contents	Finish	Pack
MX310	1 Lock + 2 Cut Keys	White	
MX310B	1 Lock + 2 Cut Keys	White	
MX310/S	1 Lock + 2 Cut Keys	Silver	
MX310B/S	1 Lock + 2 Cut Keys	Silver	

CUPBOARD LOCKS

Sliding Door Lock

- Locks for securing sliding wooden doors

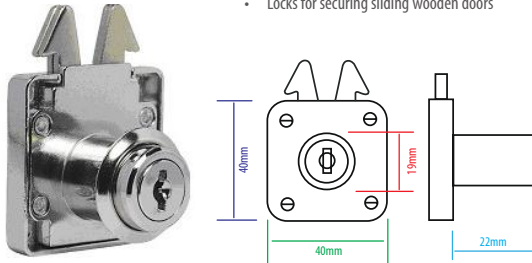

Key Blank: MXKB2

Ref.	Contents	Finish	Pack
MX350	1 Lock	Nickel	
MX350B	1 Lock	Nickel	

Rim Mounted Cupboard Lock

- Replacement locks for wooden cupboard doors and drawers

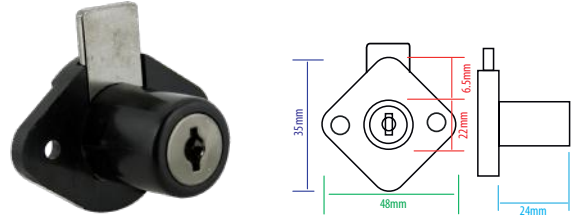

Key Blank: MXKB2

Ref.	Contents	Finish	Pack
MX316	1 Lock	Black	
MX316B	1 Lock	Black	

Rim Mounted Cupboard Lock

- Replacement locks for wooden cupboard doors and drawers

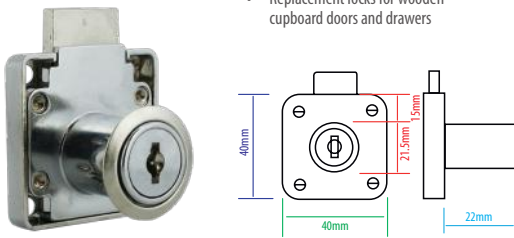

Key Blank: CSB-2D

Ref.	Contents	Finish	Pack
MX317	1 Lock	Chrome	
MX317B	1 Lock	Chrome	

Rim Mounted Slam Lock

- Replacement locks for wooden cupboard doors and drawers

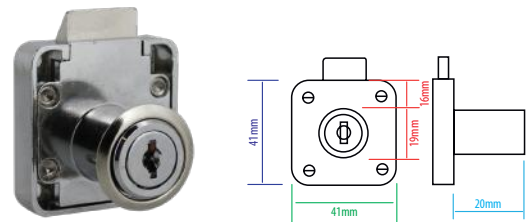

Key Blank: MXKB2

Ref.	Contents	Finish	Pack
MX339	1 Lock	Chrome	
MX339KA	1 Lock (Keyed Alike)	Chrome	

Double Throw Rim Mounted Lock

- Double throw 18mm bolt
- Replacement locks for wooden cupboard doors and drawers

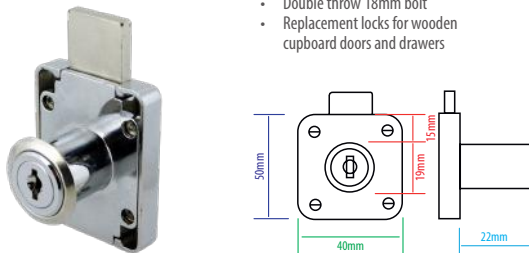

Key Blank: MXKB2

Ref.	Contents	Finish	Pack
MX318	1 Lock	Chrome	
MX318B	1 Lock	Chrome	
MX318KA	1 Lock (Keyed Alike)	Chrome	

Tambour Lock

- Good quality 'Tambour' style lock for cupboards & furniture
- Complete with cam bar



Key Blank: MXKB2

Ref.	Contents	Finish	Pack
MX315	1 Lock	Nickel	
MX315B	1 Lock	Nickel	



CUPBOARD LOCKS

1 Lever Economy Cupboard Lock

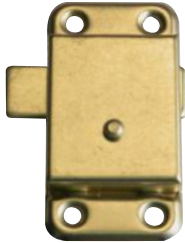

- Flush mounted economy replacement locks for wooden cupboard doors

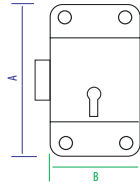

Key Blank: 241/09

Ref.	Contents	A	B	Finish	Pack
SP429	1 Lock	62	32	Brass	

2 Lever Left Hand Cupboard Lock



- Rebate mounted economy replacement locks for wooden cupboard doors

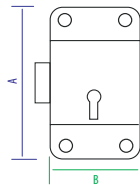

Key Blank: 241/10 - (SP435)138/9

Ref.	Contents	A	B	Finish	Pack
SP433	1 Lock	51	28	Brass	
SP434	1 Lock	64	33	Brass	
SP435	1 Lock	76	39	Brass	

2 Lever Till/Drawer Lock



- Rebate mounted economy replacement locks for wooden tills & drawers

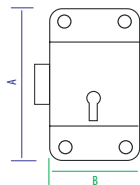

Key Blank: 241/10

Ref.	Contents	A	B	Finish	Pack
SP439	1 Lock	51	38	Brass	
SP440	1 Lock	64	44	Brass	
SP441	1 Lock	76	44	Brass	

2 Lever Straight Cupboard Lock



- Flush mounted economy replacement locks for wooden cupboard doors

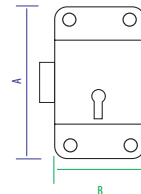

Key Blank: 241/09

Ref.	Contents	A	B	Finish	Pack
SP430	1 Lock	51	29	Brass	
SP431	1 Lock	64	37	Brass	
SP432	1 Lock	76	38	Brass	

2 Lever Right Hand Cupboard Lock



- Rebate mounted economy replacement locks for wooden cupboard doors

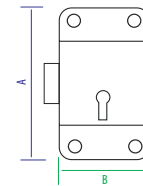

Key Blank: 241/10 - (SP438)138/9

Ref.	Contents	A	B	Finish	Pack
SP436	1 Lock	51	28	Brass	
SP437	1 Lock	64	33	Brass	
SP438	1 Lock	76	39	Brass	



PEDESTAL DESK LOCKS

Pedestal Desk Lock - 2 Flange Horizontal

- Replacement locks for wooden & metal office pedestal locks

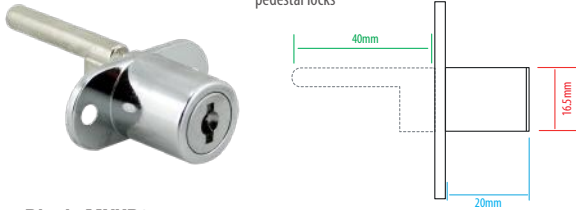

Key Blank: MXKB2

Ref.	Fixing	Finish	Pack
MX320	Horizontal	Chrome	
MX320B	Horizontal	Chrome	

Pedestal Desk Lock - 2 Flange Horizontal

- Replacement locks for wooden & metal office pedestal locks

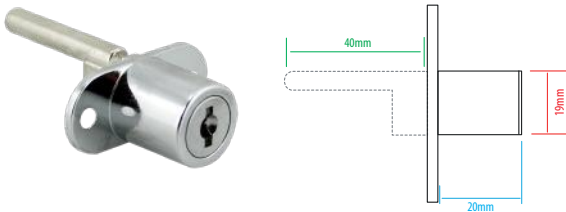

Key Blank: MXKB2

Ref.	Fixing	Finish	Pack
MX321	Horizontal	Chrome	
MX321B	Horizontal	Chrome	

Pedestal Desk Lock - 1 Flange Left

- Replacement locks for wooden & metal office pedestal locks

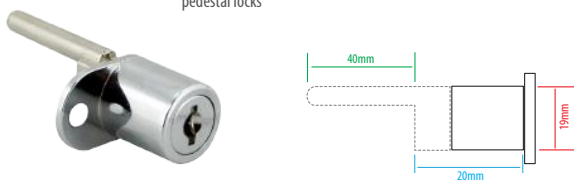

Key Blank: MXKB2

Ref.	Fixing	Finish	Pack
MX323	Left	Chrome	
MX323B	Left	Chrome	

Pedestal Desk Lock - 1 Flange Top

- Replacement locks for wooden & metal office pedestal locks

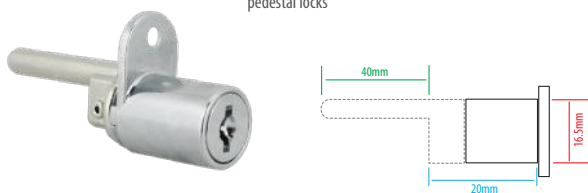

Key Blank: MXKB2

Ref.	Fixing	Finish	Pack
MX336B	Top	Chrome	

Pedestal Desk Lock

- With cam drive
- Replacement locks for wooden & metal office pedestal locks

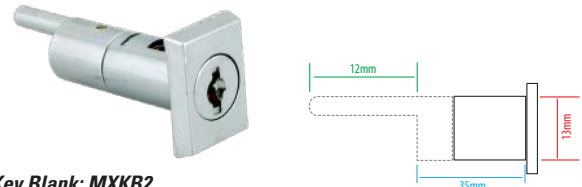

Key Blank: MXKB2

Ref.	Fixing	Finish	Pack
MX319	Universal	Nickel	
MX319B	Universal	Nickel	

Pedestal Desk Lock - 1 Flange Left

- Replacement locks for wooden & metal office pedestal locks

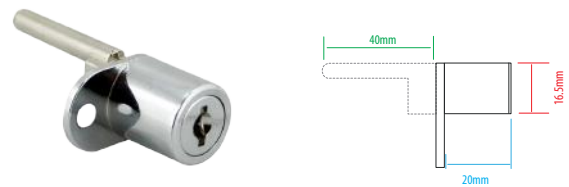

Key Blank: MXKB2

Ref.	Fixing	Finish	Pack
MX322	Left	Chrome	
MX322B	Left	Chrome	

Pedestal Desk Lock - 1 Flange Right

- Replacement locks for wooden & metal office pedestal locks

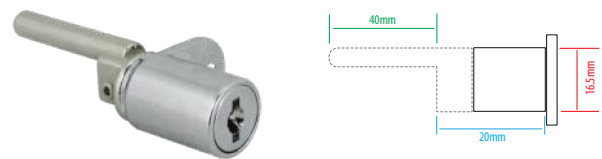

Key Blank: MXKB2

Ref.	Fixing	Finish	Pack
MX335B	Right	Chrome	

Pedestal Desk Lock - 1 Flange Bottom

- Replacement locks for wooden & metal office pedestal locks

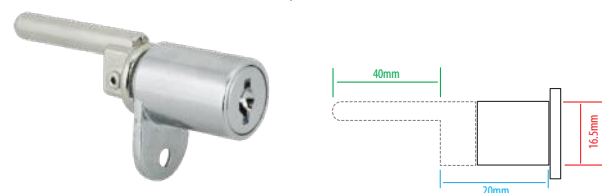

Key Blank: MXKB2

Ref.	Fixing	Finish	Pack
MX337B	Bottom	Chrome	

CAM LOCKS

11mm Round Face

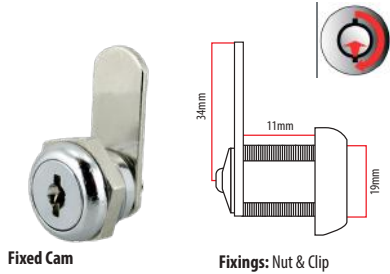

Fixed Cam

Fixings: Nut & Clip

Key Blank: MXKB2

Ref.	Packaging
MX300/11	
MX300/11B	
MX300/11KA	

16mm Round Face

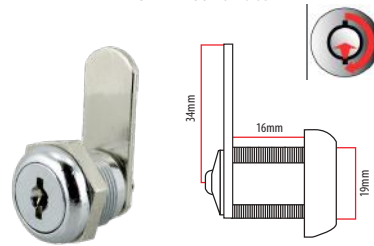

Key Blank: MXKB2

Fixings: Nut & Clip

Ref.	Packaging
MX300/16	
MX300/16B	
MX300/16KA	
MX300/16MK	Master Keyed (Bag)

20mm Round Face

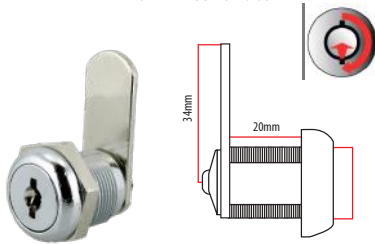

Key Blank: MXKB2

Fixings: Nut & Clip

Ref.	Packaging
MX300/20	
MX300/20B	
MX300/20KA	
MX300/20MK	

25mm Round Face

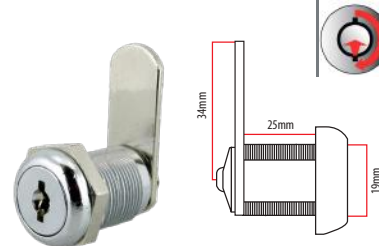

Fixings: Nut & Clip

Key Blank: MXKB2

Ref.	Packaging
MX300/25	
MX300/25B	
MX300/25KA	
MX300/25MK	

30mm Round Face

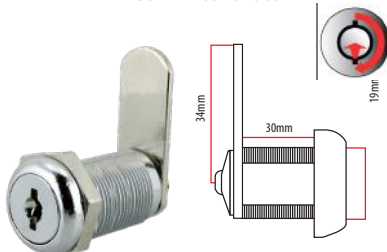

Key Blank: MXKB2

Fixings: Nut & Clip

Ref.	Packaging
MX300/30	
MX300/30B	
MX300/30KA	



CAM LOCKS

17mm Tubular Key

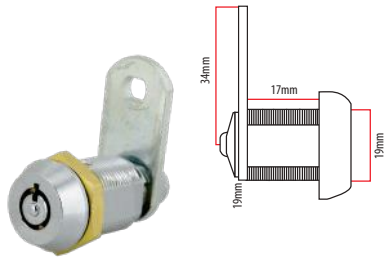

Key Blank: **CHI-1T** Fixings: Nut

Ref.	Packaging
MX303/17	
MX303/17B	
MX303/17KA	

23mm Tubular Key

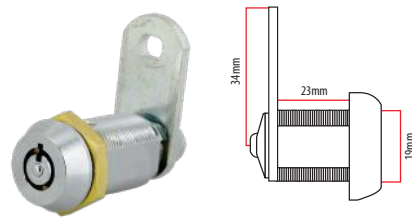

Key Blank: **CHI-1T** Fixings: Nut

Ref.	Packaging
MX303/23	
MX303/23B	
MX303/23KA	

30mm Tubular Key

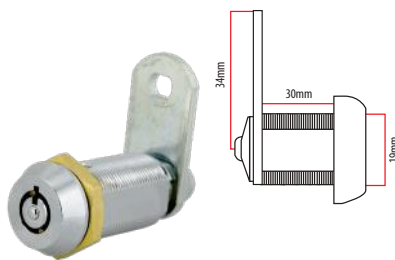

Key Blank: **CHI-1T** Fixings: Nut

Ref.	Packaging
MX303/30	
MX303/30B	

38mm Tubular Key

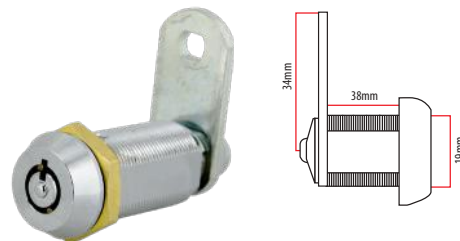

Key Blank: **CHI-1T** Fixings: Nut

Ref.	Packaging
MX303/38	
MX303/38B	

Snap In Cam Lock

- Sprung clip set into the cam lock body allows you to simply push and 'snap' into place
- For metal lockers or drawers only

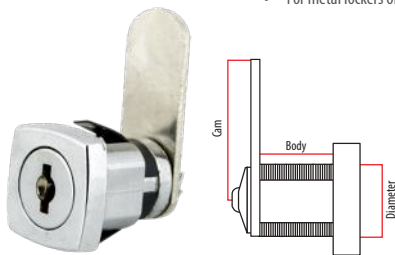

Key Blank: **CHI-1T**

Fixing: Nut/Clip

Ref.	Body	Dia.	Cam	Cam Bar	Pack
MX304	20mm	19mm	20mm	Straight	
MX304B	20mm	19mm	20mm	Straight	

Miniature Cam Locks

- A miniature replacement cam lock used on payphones, alarm boxes & various other items

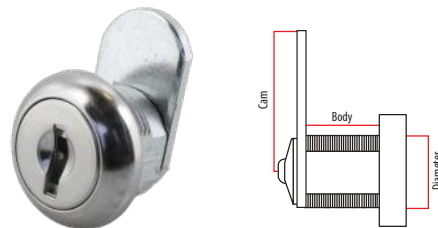

Key Blank: **CHI-1T**

Fixing: Nut/Clip

Ref.	Body	Dia.	Cam	Cam Bar	Pack
MX330	8mm	16mm	20mm	Straight	
MX330B	8mm	16mm	20mm	Straight	
MX330KA	8mm	16mm	20mm	Straight	

CAM LOCKS

Cam Locks to Suit Joma/lfam

- Replacement cam locks to suit lfam & Joma cash/post boxes
- Can also be used to replace other similar size cam locks

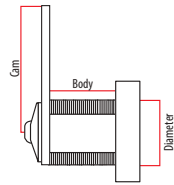

Key Blank: **MXKB2**

Fixing: Nut/Clip

Ref.	Body	Dia.	Cam	Cam Bar	Pack
MX326	17mm	19mm	33mm	Straight	
MX326B	17mm	19mm	33mm	Straight	

Cam Locks to Suit Joma/lfam

- Replacement cam locks to suit lfam & Joma cash/post boxes
- Can also be used to replace other similar size cam locks

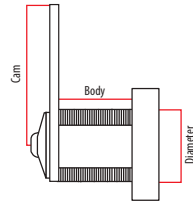

Key Blank: **MXKB2**

Fixing: Nut/Clip

Ref.	Body	Dia.	Cam	Cam Bar	Pack
MX327	17mm	19mm	30mm	Cranked	
MX327B	17mm	19mm	30mm	Cranked	

Cam Locks to Suit Joma/lfam

- Replacement cam locks to suit lfam & Joma cash/post boxes
- Can also be used to replace other similar size cam locks

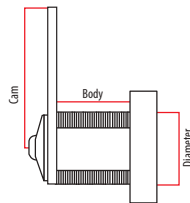

Key Blank: **MXKB2**

Fixing: Nut/Clip

Ref.	Body	Dia.	Cam	Cam Bar	Pack
MX328	17mm	19mm	20mm	Hooked	
MX328B	17mm	19mm	20mm	Hooked	

'D' Shape Cam Lock

- Replacement cam lock with clip fixing for various make post boxes (including "DAD")
- Lock has unique 'D' shape

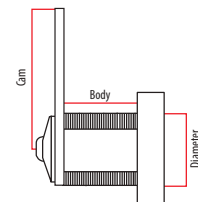

Key Blank: **FR-1D**

Fixing: Nut/Clip

Ref.	Body	Dia.	Cam	Cam Bar	Pack
MX329	15mm	18mm	30mm	Cranked	
MX329B	15mm	18mm	30mm	Cranked	

Gas Meter Budget Cam Lock

- Cam lock which uses standard 8mm triangle "Gas Meter" budget key
- No keys supplied

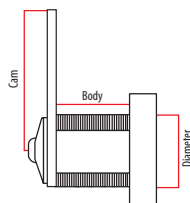

Key Blank: **505-8**

Fixing: Nut

Ref.	Body	Dia.	Cam	Cam Bar	Pack
MX305	18mm	20mm	47mm	Cranked	
MX305B	18mm	20mm	47mm	Cranked	
505-8	Key Blank to Suit Cam Lock				

Lion Locker Lock

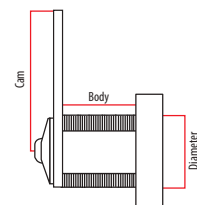

Key Blank: **LF-36**

Fixing: Nut/Clip

Ref.	Body	Dia.	Cam	Cam Bar	Pack
MX341	20mm	19mm	50mm	Cranked	

LATCH LOCKS

Latch Lock

- For school lockers etc. which are locked by a separate padlock
- Saves changing locks when keys are lost! Recommended padlock shackle size 5mm - 7mm

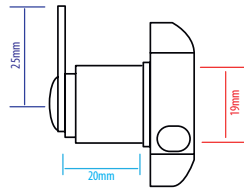

Ref.	Body	Dia.	Cam	Cam Bar	Pack
MX331	20mm	19mm	25mm	Straight	
MX331B	20mm	19mm	25mm	Straight	

Latch Lock

- For school lockers etc. which are locked by a separate padlock
- Saves changing locks when keys are lost! Recommended padlock shackle size 5mm - 7mm

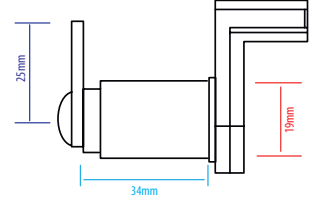

Ref.	Body	Dia.	Cam	Cam Bar	Pack
MX338	34mm	19mm	25mm	Straight	
MX338B	34mm	19mm	25mm	Straight	

COMBINATION CAM LOCKS

Combination Cam Lock

- 3 wheel combination cam lock

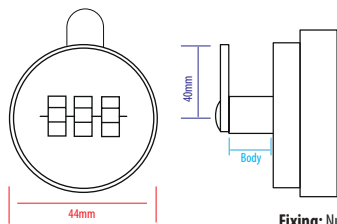

Fixing: Nut

Ref.	Body	Dia.	Cam	Cam Bar	Pack
MX340	20mm	19mm	40mm	Straight	

Combination Cam Lock

- 4 wheel combination cam lock with key override

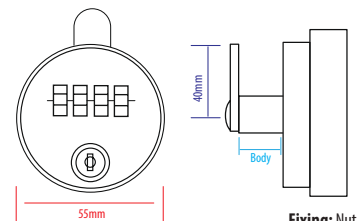

Fixing: Nut

Ref.	Body	Dia.	Cam	Cam Bar	Pack
MX340K/20	20mm	19mm	40mm	Straight	
MX340K/30	30mm	19mm	40mm	Straight	
MX340K/KEY	Code finding key				

GLASS DOOR LOCKS

Glass Door Locks

- Locks to secure overlapping glass doors in display cabinets



Key Blank: MXKB2

Ref.	Finish	Pack
MX324	Chrome	Blister
MX324B	Chrome	
MX324KA	Chrome	

Size: 140mm Long

Hinged Glass Door Locks

- Clamp on (No drilling) Supplied with keeps



Key Blank: MXKB2

Ref.	Finish	Pack
MX325	Chrome	
MX325B	Chrome	
MX325KA	Chrome	

Height x Width x Nozzle: 32 x 36 x 19mm

FURNITURE LOCK KIT

Maxus Cam Lock Kit



82 piece Maxus Cam Lock Kit

The Maxus Cam Lock Kit contains a good selection of quality cam locks and furniture locks. Heavy duty case with 2 locking clips

Contents:

- 5 x 16mm Cam lock
- 5 x 20mm Cam lock
- 5 x 25mm Cam lock
- 5 x 30mm Cam lock
- 5 x Snap in Cam lock
- 3 x Tambour locks
- 2 x Glass door lock
- 5 x Large Lip strike plate
- 5 x Adjustable strike plate
- 5 x 50mm Straight cam bar
- 3 x Diamond Cupboard lock
- 3 x Square Cupboard lock
- 3 x 2 Flange 16.5 Pedestal lock
- 3 x 2 Flange 19mm Pedestal lock
- 3 x 1 Flange 16.5mm Pedestal lock
- 3 x 1 Flange 19mm Pedestal lock
- 3 x Clip fixing Pedestal lock
- 5 x Cam lock washer - Wood
- 5 x Cam lock washer - Metal
- 5 x 32mm x 4mm Cranked cam bar

Ref.	Description	Pack
MX306	82 Piece Cam Lock Kit	Case

HASPS & STAPLES

Integral Locking Hasps

- All in one Hasp & Staple and lock. Simply close hasp and twist lock to secure



Key Blank: MXKB2

Ref.	Size	Finish	Pack
MX332	100mm (4")	Chrome	
MX332B	100mm (4")	Chrome	
MX332KA	100mm (4") - Keyed Alike	Chrome	

Maxus Security Hasp

- Good quality vehicle hasp with a solid steel body & corrosion resistant finish
- Suits shackle-less padlocks
- Resists prying, cutting & sawing attacks
- Great for commercial vans, trucks & trailers
- Fixings not included



Ref.	Size	Finish	Pack
MX415	216mm x 108mm	Gal.	
MX68	Maxus 73mm Circular Padlock	Nickel	
MX68/KA	Maxus 73mm Circular Padlock - KA	Nickel	

Lightweight Hasp

- Suitable for tool boxes, sheds etc.



Ref.	Size	Finish	Pack
SP410	76mm (3")	Zinc	
SP411	100mm (4")	Zinc	
SP411/PACK	100mm (4") - PACK of 12	Zinc	
SP412	125mm (5")	Zinc	
SP413	150mm (6")	Zinc	

Medium Hasp

- Suitable for garage doors, gates etc.



Ref.	Size	Finish	Pack
SP421	140mm (5.5")	Black	

MECHANICAL CODE LOCK

Digital Push Button Lock



- Entry level push button mechanical code lock for light duty use
- Ideal for office doors, storage rooms and cupboards etc.
- Over 8,000 possible combinations
- 60mm backset
- Supplied with black neoprene seals



Ref.	Type	Hold Back?	Key O/ride?	Finish	Pack
MX490/SC	Mortice Latch	✓	X	■ SC	

COMBINATION LOCKING BOLT

Combination Locking Bolt



- Suitable for locking gates, sheds, doors & cupboards
- 10,000 resettable combinations
- Complete with anti tamper security screws

Ref.	Size	Finish	Pack
MX405	89mm x 40mm	■ Black	

Padlocks

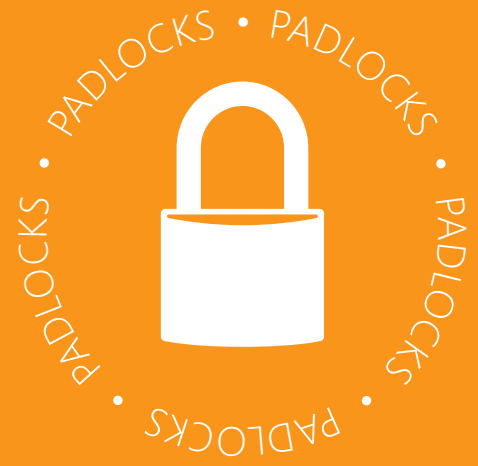

- 30 Brass Padlocks
- 31 Laminated Padlocks
- 31 Marine Padlocks
- 32 - 34 Combination Padlocks
- 35 Anvil Padlocks
- 36 Discus & Concealed Padlocks
- 37 Euro Body Only Padlocks
- 38 Notes

BRASS PADLOCKS

Brass Padlocks



- Quality brass body padlocks with anti pick drivers & hardened steel shackle suitable for medium security requirements
- All 30mm+ sizes are double locking for extra strength
- Available boxed or display packed

Long Shackle Brass Padlocks



- Quality brass body padlocks with anti pick drivers & hardened steel shackle suitable for medium security requirements
- All 30mm+ sizes are double locking for extra strength
- Available boxed or display packed

REF	WIDTH	A	B	C	KA	KR	PACK
MX7/20	20mm	3.5	10.0	12.5	X	X	
MX7/25	25mm	4.0	13.5	13.5	X	X	
MX7/30	30mm	5.0	16.0	18.0	X	X	
MX7/40	40mm	6.0	22.0	24.0	X	X	
MX7/50	50mm	8.0	28.0	29.0	X	X	
MX7/60	60mm	9.5	32.0	36.0	X	X	
MX8/20	20mm	3.5	10.0	12.5	X	X	
MX8/25	25mm	4.0	13.5	13.5	X	X	
MX8/30	30mm	5.0	16.0	18.0	X	X	
MX8/40	40mm	6.0	22.0	24.0	X	X	
MX8/50	50mm	8.0	28.0	29.0	X	X	
MX8/60	60mm	9.5	32.0	36.0	X	X	
MX7/20KA	20mm	3.5	10.0	12.5	✓	X	
MX7/40KA	40mm	6.0	22.0	24.0	✓	X	
MX7/50KA	50mm	8.0	28.0	29.0	✓	X	
MX7/60KA	60mm	9.5	32.0	36.0	✓	X	
MX7/30LS	30mm	5.0	16.0	60.0	X	X	
MX7/40LS	40mm	6.0	22.0	63.0	X	X	
MX7/50LS	50mm	8.0	28.0	80.0	X	X	
MX8/30LS	30mm	5.0	16.0	60.0	X	X	
MX8/40LS	40mm	6.0	22.0	63.0	X	X	
MX8/50LS	50mm	8.0	28.0	80.0	X	X	
MX7/40LSKA	40mm	6.0	22.0	63.0	✓	X	

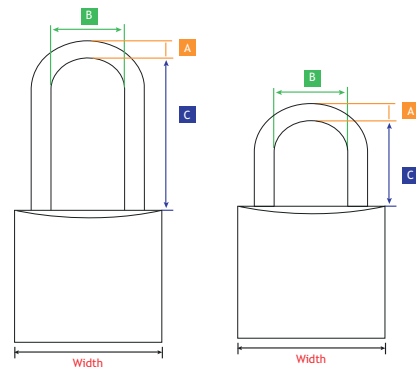

Padlock Counter Stand



High quality metal counter stand complete with a popular range of medium security Maxus brass padlocks.

- Compact size ideal for most counters
- 6 hooks with 5 padlocks per hook
- Can be easily replenished

Ref.	HEIGHT	WIDTH	DEPTH
MXSTAND7	210mm	310mm	150mm
MXSTAND7E	Empty Stand		



LAMINATED & MARINE PADLOCKS

Laminated Padlocks



- Double locking padlocks with a vinyl protective bumper & hardened steel shackle
- Interlocking construction gives exceptional levels of impact resistance
- Double Blister display packed



Ref.	Width	A	B	C	KA	KR	Pack
MX58/40	40mm	6.4	20.3	22.0	X	X	
MX58/50	50mm	8.8	24.1	29.0	X	X	
MX58/60	60mm	9.5	33.5	34.5	X	X	

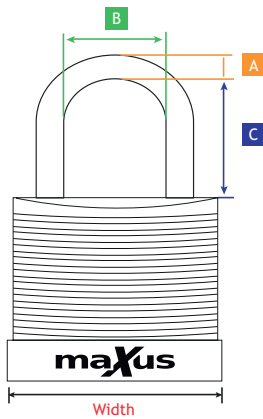

Marine Rustproof Padlocks



- Chrome plated brass body padlocks with stainless steel parts which make these padlocks rust resistant
- Ideal for marine use & coastal locations



Ref.	Width	A	B	C	KA	KR	Pack
MX55/30	30mm	5.0	16.0	18.0	X	X	
MX55/40	40mm	6.0	22.0	24.0	X	X	
MX55/40KA*	40mm	6.0	22.0	24.0	✓	X	
MX55/50	50mm	8.0	28.0	29.0	X	X	
MX55/50KA*	50mm	8.0	28.0	29.0	✓	X	

*Keyed Alike Number Not Guaranteed

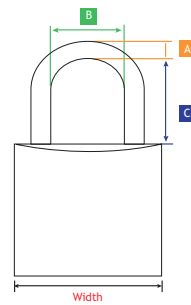

BRASS COMBINATION PADLOCKS

Brass Combination Padlock



- A range of quality, popular, brass resettable combination padlocks
- Ideal for luggage, tool boxes & lockers

Ref.	Width	A	B	C	KA	KR	Pack
MX80/20	20mm	3.2	9.0	22.5	X	X	
MX80/30	30mm	4.8	12.6	27.3	X	X	
MX80/40	40mm	6.3	19.0	30.0	X	X	

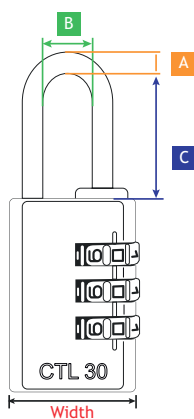

Solid Body Combination Padlock



- A higher security, resettable padlock
- Solid brass body with a hardened shackle
- 4 Wheel Combination

Ref.	Width	A	B	C	KA	KR	Pack
MX85/PB	50mm	8.0	25.0	25.0	X	X	

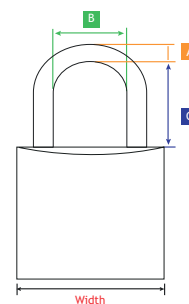

COMBINATION PADLOCKS

High 5' Combination Padlocks



- Sturdy, resettable combination padlocks
- 5 dials for higher security
- Available in blue, red & black



Ref.	Width	A	B	C	KA	KR	Pack
MX75/BLUE	65mm	7.2	40.0	29.0	X	X	
MX75/RED	65mm	7.2	40.0	29.0	X	X	
MX75/BLACK	65mm	7.2	40.0	29.0	X	X	

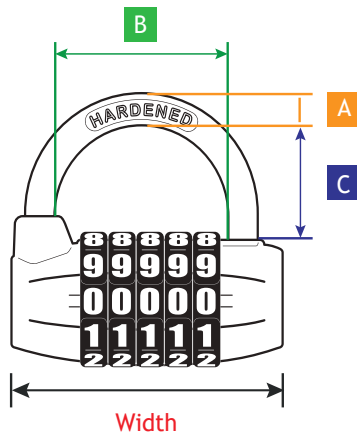

Window Combination Padlocks



- Easy to read window style resettable padlocks
- 30mm - 3 wheels
- 40mm - 4 wheels



Ref.	Width	A	B	C	KA	KR	Pack
MX73/30	30mm	4.5	14.0	20.0	X	X	
MX73/40	40mm	6.0	19.3	24.0	X	X	

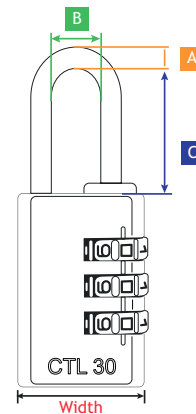

TRAVEL COMBINATION PADLOCKS

Oval Aluminium Coloured Combination Padlocks



- Lightweight, resettable padlocks suitable for luggage
- Available in blue, red & purple
- Modern design



Ref.	Width	A	B	C	KA	KR	Pack
MX72/BLUE	20mm	2.9	10.0	21.5	X	X	
MX72/RED	20mm	2.9	10.0	21.5	X	X	
MX72/PURPLE	20mm	2.9	10.0	21.5	X	X	

Painted Design Combination Padlocks



- Attractive design resettable padlocks
- Suitable for luggage, lockers etc.



Ref.	Width	A	B	C	KA	KR	Pack
MX70/20	20mm	3.2	9.0	18.0	X	X	

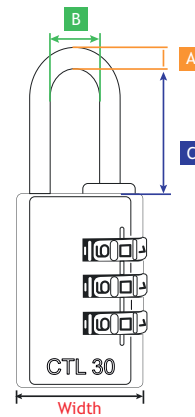
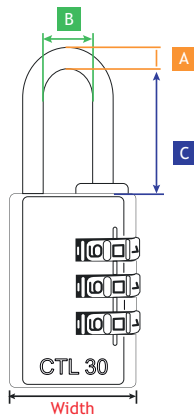

ANVIL PADLOCKS

Double Slot Chain Anvil



- Anvil padlock to secure 2 chain link ends with maximum protection
- A hardened steel 'Armoured' cover provides a high degree of drill and attack resistance
- Suitable for security chains between 10 and 15mm thick
- Supplied with 2 keys

Ref.	Width	A	B	C	KA	KR	Pack
MX65/90	90mm	16.5	16.5	14.7	X	X	

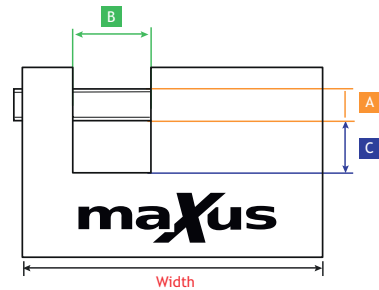

Hardened Steel Padlocks



- High security steel anvil style padlock
- Solid steel body and hardened rolling steel bolt provides excellent protection from cutting and forced attacks
- Key retaining and supplied with 2 keys

Ref.	Width	A	B	C	KA	KR	Pack
MX64/80	80mm	12.7	30.0	18.6	X	✓	

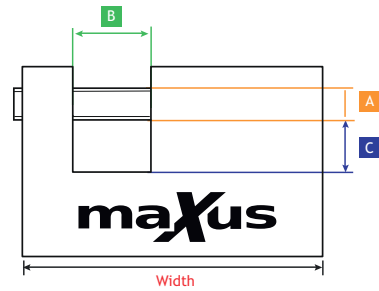

Armoured Anvil Padlocks



- Solid brass padlocks with steel outer body
- Features include a rotating hardened steel shackle for extra attack resistance & a solid brass lock body

Ref.	Width	A	B	C	KA	KR	Pack
MX62/60	60mm	10.0	11.0	23.0	X	✓	
MX62/80	80mm	11.0	15.0	31.0	X	✓	

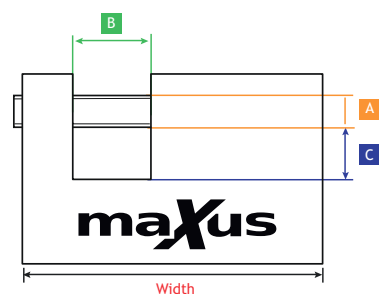

DISCUS PADLOCKS

Discus Padlocks



- High quality hardened steel closed shackle "discus" style padlock housed in a stainless steel body
- Provides excellent weather resistance & security
- Key retaining

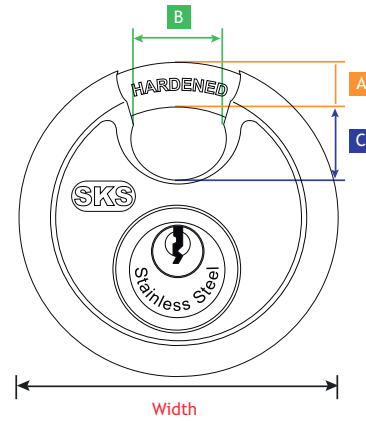

Ref.	Width	A	B	C	KA	KR	Pack
MX60/70	70mm	9.3	21.0	17.0	X	✓	
MX60/70KA	70mm	9.3	21.0	17.0	✓	✓	

HASP PADLOCKS

Circular Hasp Padlocks



- High strength hardened steel padlock with concealed shackle pin
- Suitable for specialised hasps used on factories, warehouses & vans
- Supplied with 2 keys

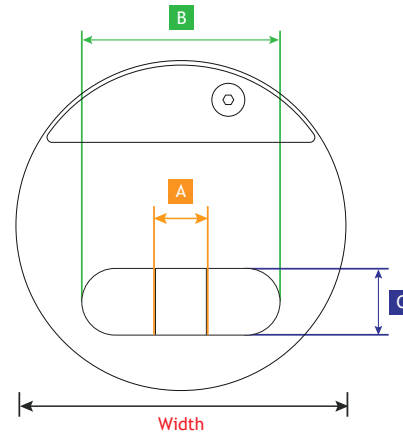



Ref.	Width	A	B	C	KA	KR	Pack
MX68	73mm	10.2	43.8	15.0	X	X	
MX68/KA	73mm	10.2	43.8	15.0	✓	X	

HALF EURO PADLOCKS

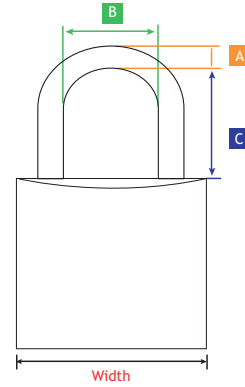
54mm Half Euro Padlock



- High tensile Brass Body with high quality satin Chrome Finish with Stainless Steel shackle
- Protective Bumper
- Add your 'own section' cylinder (45mm) or purchase complete
- Easily assembled with 2 screws

Ref.	Width	A	B	C	KA	KR	Pack
MX66	54mm	9.5	26.5	20.0	X	X	
Body Only:							
MX66NC		Padlock Body Only					

NOTES

Lined area for notes with horizontal lines.

UPVC

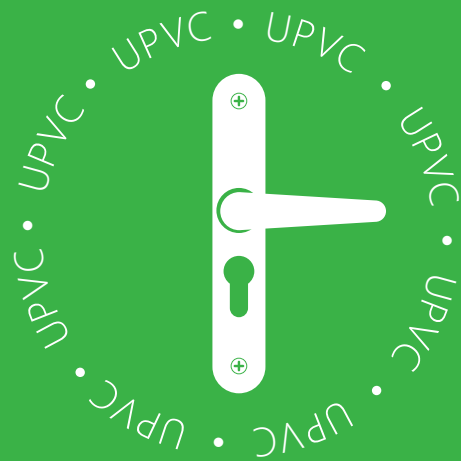

40 - 41 MPL Handles
42 Window Handles

LEVER LEVER

92mm Lever/Lever



Ref.	Finish	A	B	C	D	Sprung	Pack
MPL950/WH	<input type="checkbox"/> White						
MPL950/BK	<input checked="" type="checkbox"/> Black						
MPL950/S	<input type="checkbox"/> Silver	92mm	122mm	212mm	34mm	YES	
MPL950/PC	<input type="checkbox"/> Polished Chrome						
MPL950/PB	<input type="checkbox"/> Polished Brass						

Ref.	Finish	A	B	C	D	E	Pack
MPL960/WH	<input type="checkbox"/> White						
MPL960/BK	<input checked="" type="checkbox"/> Black						
MPL960/S	<input type="checkbox"/> Silver	92mm	210mm	242mm	34mm	YES	
MPL960/PC	<input type="checkbox"/> Polished Chrome						
MPL960/PB	<input type="checkbox"/> Polished Brass						

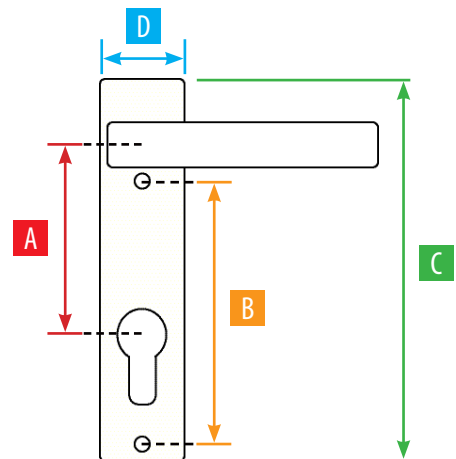

Ref.	Finish	A	B	C	D	Sprung	Pack
MPL970/WH	<input type="checkbox"/> White						
MPL970/BK	<input checked="" type="checkbox"/> Black						
MPL970/S	<input type="checkbox"/> Silver	92mm	215mm	246mm	32mm	YES	
MPL970/PC	<input type="checkbox"/> Polished Chrome						
MPL970/PB	<input type="checkbox"/> Polished Brass						

70mm Lever/Lever



Lever/lever multipoint door handle that is available in a range of finishes including white, black, polished chrome, silver, and polished brass

Ref.	Finish	A	B	C	D	Sprung	Pack
MPL990/WH	<input type="checkbox"/> White						
MPL990/BK	<input checked="" type="checkbox"/> Black						
MPL990/S	<input type="checkbox"/> Silver	70mm	215mm	246mm	32mm	YES	
MPL990/PC	<input type="checkbox"/> Polished Chrome						
MPL990/PB	<input type="checkbox"/> Polished Brass						

68mm Lever/ Lever



Lever/lever multipoint door handle that is available in a range of finishes including white, black, polished chrome, silver, and polished brass

Ref.	Finish	A	B	C	D	E	Pack
MPL980/WH	<input type="checkbox"/> White						
MPL980/BK	<input checked="" type="checkbox"/> Black						
MPL980/S	<input type="checkbox"/> Silver	68mm	215mm	246mm	32mm	YES	
MPL980/PC	<input type="checkbox"/> Polished Chrome						
MPL980/PB	<input type="checkbox"/> Polished Brass						

70mm Lever/Lever



Adjustable PZ

62 - 95

Lever/lever multipoint door handle that is available in a range of finishes including white, black, polished chrome, silver, and polished brass

Ref.	Finish	A	B	C	D	Sprung	Pack
MPL940	<input type="checkbox"/> White						
MPL940/BK	<input checked="" type="checkbox"/> Black						
MPL940/S	<input type="checkbox"/> Silver	62mm - 95mm	260mm	290mm	30mm	YES	
MPL940/PC	<input type="checkbox"/> Polished Chrome						
MPL940/PB	<input type="checkbox"/> Polished Brass						

INLINE MULTI SPINDLE ESPAGNOLETTE HANDLE

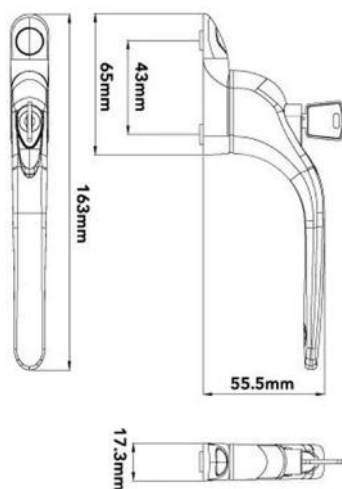

Ref.	Finish	A	B	C	D	Pack
MX100/WH	<input type="checkbox"/> White					
MX100/BK	<input type="checkbox"/> Black					
MX100/SC	<input type="checkbox"/> Satin Chrome	68mm	215mm	163mm	17.3mm	
MX100/CH	<input type="checkbox"/> Chrome					
MX100/PB	<input type="checkbox"/> Polished Brass					

HARDWARE



- 44 - 45 Backplate Handles
- 46 Round Rose Handles
- 47 Interchangeable Backplate Handles
- 48 Cylinder Pulls
- 49 - 50 Door Bolts
- 51 Key Safes
- 52 Notes

BACKPLATE HANDLES

Maxus Lever Lock Handle



- Face-fix backplate
- 100mm spindle supplied
- Supplied with wood screws
- 150mm x 40mm
- Boxed Packaging



Ref.	Type	Pack
MX041/SC	Flat Lever on Lock Backplate - Satin Chrome	
MX041/CP	Flat Lever on Lock Backplate - Pol. Chrome	
MX041/EB	Flat Lever on Lock Backplate - Electro Brass	

Maxus Lever Latch Handle



- Face-fix backplate
- 100mm spindle supplied
- Supplied with wood screws
- 114mm x 40mm
- Boxed Packaging



Ref.	Type	Pack
MX042/SC	Flat Lever on Latch Backplate - Satin Chrome	
MX042/CP	Flat Lever on Latch Backplate - Pol. Chrome	
MX042/EB	Flat Lever on Latch Backplate - Electro Brass	

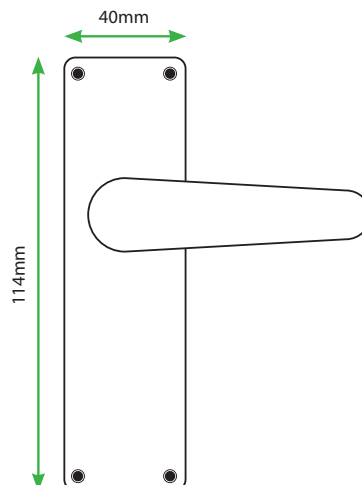
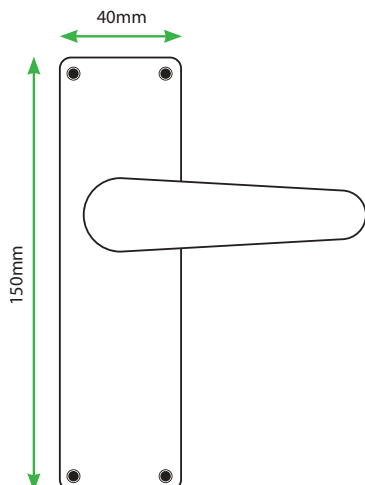

BACKPLATE HANDLES

Maxus Lever Euro Handle



Maxus Lever Bathroom Handle



- Face-fix backplate
- 100mm spindle supplied
- Supplied with wood screws
- 150mm x 40mm
- Boxed Packaging



- Face-fix backplate
- 100mm spindle supplied
- Supplied with wood screws
- 150mm x 40mm
- Boxed Packaging



Ref.	Type	Pack
MX041/EPSC	Flat Lever on Euro Backplate - Satin Chrome	
MX041/EPCP	Flat Lever on Euro Backplate - Pol. Chrome	
MX041/EPEB	Flat Lever on Euro Backplate - Electro Brass	

Ref.	Type	Pack
MX043/SC	Flat Lever on Bathroom Backplate - Satin Chrome	
MX043/CP	Flat Lever on Bathroom Backplate - Pol. Chrome	
MX043/EB	Flat Lever on Bathroom Backplate - Electro Brass	

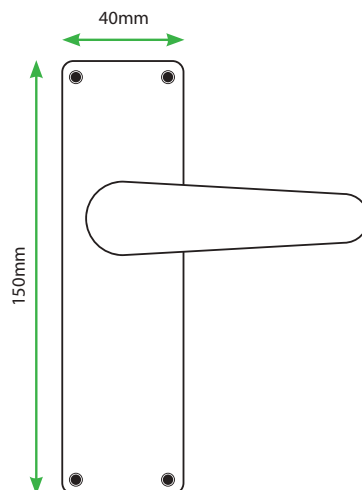
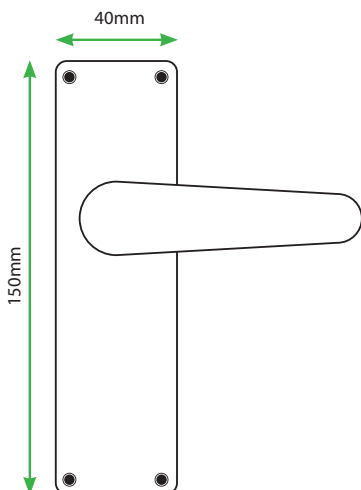

ROUND ROSE

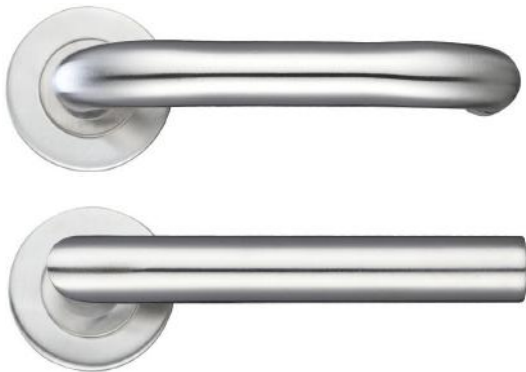

- 52mm x 8mm round sprung rose
- 19mm diameter tubular lever
- ZCS 201 Grade material
- Push on stainless steel outer rose
- M4 male / female fixings supplied
- 100mm Heso steel spindle supplied
- Also supplied with 20mm wood screws



Ref.	Style	Pack
MX045	Maxus 19mm RTD Lever - Push on Rose Grade 201	
MX046	Maxus 19mm Mitred Lever - Push on Rose Grade 201	

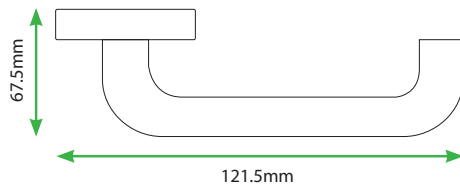

Lever on Round Rose - Accessories



- Turn & release - 5mm spindle
- Rose diameter 52mm

Ref.	Style	Finish	Pack
MX050	Round Rose Blank Escutcheon - Grade 201	S.Steel	
MX051	Round Rose Euro Escutcheon - Grade 201	S.Steel	
MX052	Round Rose Thumbturn Escutcheon - Grade 201	S.Steel	
MX053	Round Rose Disabled Turn Escut. - Grade 201	S.Steel	

BACKPLATE HANDLES (INTERCHANGEABLE FACE PLATES)

Maxus 19mm RTD Lever - Inner Backplate (Pair)

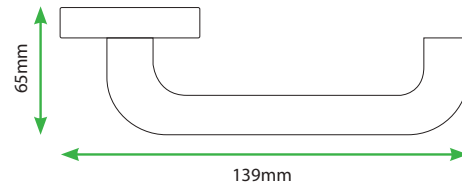

Ref.	Type	Pack
MX060	Maxus 19mm RTD Lever - Inner Backplate (Pair)	

Cover Plates for Maxus 19mm RTD Lever Backplate



MX060-BBP



MX060-BP



MX060-DBP



MX060-LBP



MX060-OBP

Ref.	Type	Pack
MX060/BP	Maxus Lever Latch Cover Plate (Pair)	
MX060/BPR	Maxus Lever Latch Cover Plate - Radius	
MX060/LBP	Maxus Lever Lock UK Cover Plate (Pair)	
MX060/EBP	Maxus Lever Euro Cover Plate (Pair)	
MX060/LBPR	Maxus Lever Lock UK Cover Plate - Radius (Pair)	
MX060/EBPR	Maxus Lever Euro Cover Plate - Radius (Pair)	
MX060/DBP	Maxus Lever Din Euro Cover Plate (Pair)	
MX060/DBPR	Maxus Lever Din Euro Cover Plate - Radius (Pair)	
MX060/BBP	Maxus Lever Bathroom Cover Plate (Pair)	
MX060/BBPR	Maxus Lever Bathroom Cover Plate - Radius	
MX060/DBBP	Maxus Lever Din Bathroom Cover Plate (Pair)	
MX060/DBBPR	Maxus Lever Din Bathroom Cover Plate - Radius (Pr)	
MX060/OBP	Maxus Lever Oval Cover Plate (Pair)	
MX060/OBPR	Maxus Lever Oval Cover Plate - Radius (Pair)	

CYLINDER PULLS

Aluminium Cylinder Pulls



- Rim cylinder door pull
- Fits to a standard size rim cylinder to assist door closing
- Satin anodised aluminium finish



Ref.	Style	Finish	Pack
SP575	Victorian	Aluminium	1

Victorian Cylinder Pulls



- Rim cylinder door pull
- Fits standard size rim cylinder to assist door closing
- Plain Victorian design available in polished brass or chrome



Ref.	Style	Finish	Pack
SP140	Victorian	Brass	1
SP786	Victorian	Chrome	1

Euro Lock Pull



- Mortice lock pull to fit with various types of mortice lock cases
- Finished in satin stainless steel

Ref.	Size	Type	Pack
SP457	44mm x 75mm	Euro Profile	1

Mortice Lock Pull



- Mortice lock pull to fit with various types of mortice lock cases
- Finished in satin stainless steel



Ref.	Size	Type	Pack
SP458	44mm x 75mm	UK Key Hole	1

DOOR BOLTS

Door Guards



- Designed to limit door opening prior to allowing entrance to visitors
- Easily applied & released when the door is closed

Ref.	Description	Finish	Pack
SP015	Door Guard	Brassed	

Standard Door Bolts - Straight

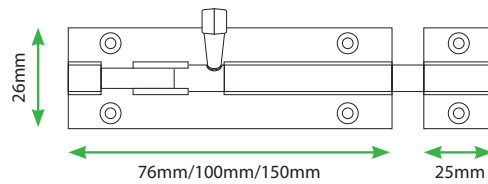

- Straight door bolts for use on wooden cupboards & doors
- Supplied with screws

Ref.	Size	Finish	Pack
SP460	76mm	Brass	
SP462		Chrome	
SP461	100mm	Brass	
SP463		Chrome	
SP473	150mm	Brass	

Standard Door Bolts - Cranked



- Cranked door bolts for use on wooden cupboards & doors
- Supplied with screws

Ref.	Size	Finish	Pack
SP464	76mm	Brass	
SP466	76mm	Chrome	
SP465	100mm	Brass	

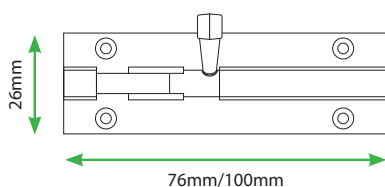

Modern Chrome Door Bolts



- Modern style straight door bolts
- Supplied with screws

Ref.	Size	Finish	Pack
SP398	75mm	Chrome	
SP399	100mm	Chrome	

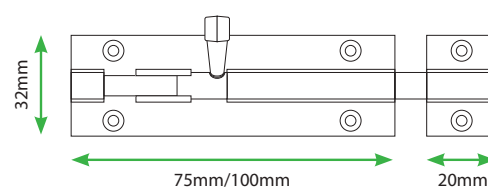

DOOR BOLTS

Heavy Duty Door Bolts



- Heavy duty 38mm section bolts
- Helps provide additional security when fitted to house & french doors
- Supplied with screws

Ref.	Size	Finish	Pack
SP564	150mm Straight	Polished Brass	1
SP477	150mm Straight	Chrome	1
SP567	150mm Cranked	Polished Brass	1

Heavy Duty Tower Bolts

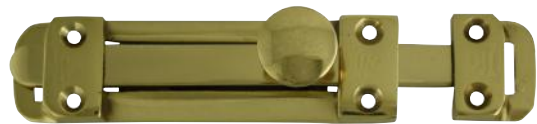

- Heavy duty flat tower bolts
- Helps provide additional security when fitted to house & french doors
- Supplied with screws

Ref.	Size	Finish	Pack
SP468	100mm	Polished Brass	1
SP475	100mm	Chrome	1
SP469	150mm	Polished Brass	1
SP476	150mm	Chrome	1

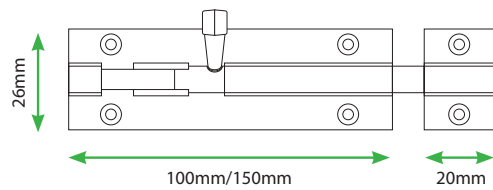

DOOR KNOCKER

Victorian Door Knocker



- Traditional Victorian style polished chrome door knocker
- 165mm length
- Supplied with 2 fixing bolts

Ref.	Contents	Finish	Pack
SP482	165mm Victorian Knocker	Brass	1
SP483	165mm Victorian Knocker	Chrome	1

KEYSAFES

Combination



- Key storage box with 4 resettable dial wheels
- Complete with fixings & fitting instructions
- Blister (MX401A) or box (MX401) packed

Ref.	Size (H x W x D)	Pack
MX401	120 x 85 x 35mm (Ext.)	
MX401A	85 x 60 x 35mm (Int)	

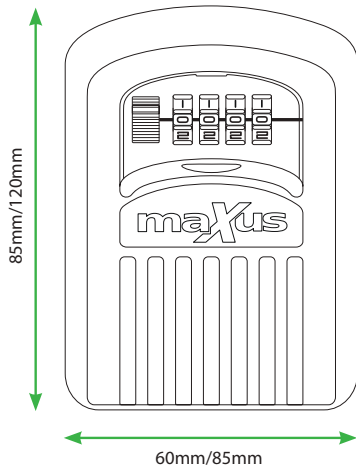

Push Button



- Easy to use & reset 10 digit push button key safe
- With waterproof/disguised cover
- Blister (MX402A) or box (MX402) packed

Ref.	Size (H x W x D)	Pack
MX402	120 x 80 x 60mm (Ext.)	
MX402A	100 x 65 x 50mm (Int)	

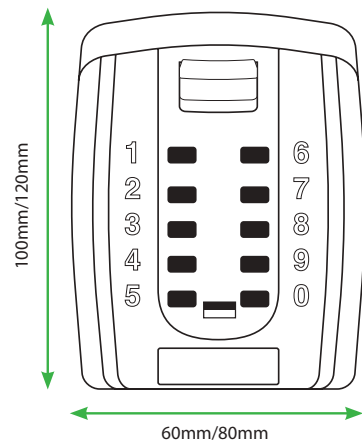

INDEX

54	Icons
55	Index
56	Notes

ICONS USED IN THIS CATALOGUE

PACKAGING

Blister Pack

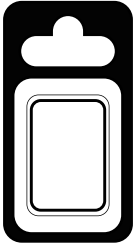

Euro Top Bag



Bagged



Boxed

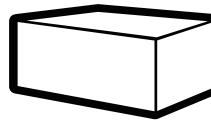

Counter Display



KEYS

Keyed Alike

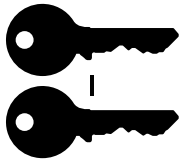

Keyed to Differ



INDEX

Code	Page	Code	Page	Code	Page	Code	Page	Code	Page	Code	Page
MX-BS/...	4	MX317	19	MX341	24	MPL990/...	41	SP476	50		
MX26/...	5,6	MX339	19	MX331	25	MPL980/...	41	SP482	50		
MX25/...	7	MX318	19	MX338	25	MPL940/...	41	SP483	50		
MX25KIT	7	MX315	19	MX340	25	MX100/...	42	MX401	51		
MXPK2	7	MXEDL/...	17	MX324	25	MX041/...	44,45	MX402	51		
MXTK1	7	MXESL/...	17	MX325	25	MX042/...	44				
MX-D/...	8,9	SP429	20	MX306	26	MX043	45				
MXPM1	9	SP430	20	MX322	26	MX045	46				
MXSP073	9	SP431	20	SP410	26	MX046	46				
MXPK1	9	SP432	20	SP411	26	MX050	46				
MXCASE1	9	SP433	20	SP412	26	MX051	46				
MX24/...	10	SP434	20	SP413	26	MX052	46				
MX-DOV/...	10	SP435	20	MX415	26	MX053	46				
MX-DSCAN/PAIR	11	SP436	20	MX68	26	MX060/...	47				
MX-D/RIM	11	SP437	20	SP421	26	SP575	48				
MX630	11	SP438	20	MX490/SC	27	SP140	48				
MX631	11	SP439	20	MX405	27	SP786	48				
MX92/...	12	SP440	20	MX7/...	30	SP457	48				
MX93/...	12	SP441	20	MX8/...	30	SP458	48				
MX90/...	13	MX320	21	MX58/...	31	SP015	49				
MX91/...	13	MX319	21	MX55/...	31	SP460	49				
MX95/...	13	MX321	21	MX80/...	32	SP461	49				
MX96/...	13	MX322	21	MX85/PB	32	SP462	49				
MXBSDL/...	14	MX323	21	MX75/...	33	SP463	49				
MXBSSL/...	14	MX335B	21	MX/73...	33	SP473	49				
MX5DL/...	15	MX336B	21	MX72/...	34	SP464	49				
MX5SL/...	15	MX337B	21	MX70/20	34	SP465	49				
MX3DL/...	16	MX300/...	22	MX65/90	35	SP466	49				
MX3SL/...	16	MX301/...	23	MX64/80	35	SP398	49				
MX362	18	MX304	23	MX62/...	35	SP399	49				
MX344	18	MX330	23	MX60/...	36	SP564	50				
MX343	18	MX326	24	MX68/...	36	SP477	50				
MX310	18	MX327	24	MX66	37	SP567	50				
MX361	18	MX328	24	MPL950/...	40	SP468	50				
MX350	19	MX329	24	MPL960/...	40	SP469	50				
MX316	19	MX305	24	MPL970/...	40	SP475	50				



maxus
Security



Distributed by:
SKS Limited T/A JMA UK
Unit 2 Canalside
Northbridge Road
Berkhamsted
Hertfordshire
HP4 1EG

T: 01442 291400
E: sales@jma-uk.co.uk
www.jma-uk.co.uk