



# PARMOVIL

---

**El almacén del parquet**

---



Descarga el catálogo en PDF

# ÍNDICE

Finfloor .....	8
Purefloor .....	24
Quickstep .....	30
Faus .....	52
Flint .....	56
Zimafloor .....	64
Tilo .....	76
Terhürne .....	83
Castro Wood Floors .....	84
Alphafloor .....	86
Tarima tecnológica (Zimafloor) .....	92
Tarima Bambú (Dasso ) .....	93
IPE grapa vista (Lopez Pigueiras) .....	94
IPE grapa oculta (Parmovil) .....	95
Pino Autoclave (Durapin) .....	96
Douglas Autoclave (Durapin) .....	97
Thermopine (Savia) .....	98
Rastreles y Grapas .....	99
Compact Light Board (Flint) .....	102
Acoustic Wood Panel .....	103
Kobert In .....	104
SlatPanel .....	108
Palillería .....	109
Rodapiés .....	112
Perfilería .....	113
Mamperlanes a medida .....	118
Bases .....	119
<b>120</b>	
Vermeister .....	122
Pentriilo .....	129
Adhesivos y Selladores (varias marcas) .....	131
Reparación.....	136
Virutex .....	140
Unicair .....	144
Stanley .....	146
Läger .....	150
Bessey .....	151
Wolfcraft .....	152
Starcke .....	157
Leman .....	158
CMT Orange Tools .....	163
Fischer .....	165



---

### **BADALONA**

C/Dels Treballadors 2-4  
08911- Badalona  
Tfn. 93 384 29 16  
info@parmovil.com

### **CORNELLÀ**

Psg. Ferrocarrils Catalans 134  
08940 - Cornellà  
Tfn. 93 624 52 97  
cornella@parmovil.com

### **TERRASSA**

Ctra. de Rubí 324. Nave B  
08228 - Terrassa  
Tfn. 93 856 72 82  
terrasa@parmovil.com

---



# PARMOVIL

Parmovil nació hace más de 30 años con la voluntad de ofrecer las mejores soluciones en pavimentos ligeros y convertirse en referente en el **sector de la distribución** para profesionales.

Comprometidos con la calidad, apostamos por las **marcas líderes en el mercado**, para satisfacer las necesidades de nuestros clientes.

Contamos con un **stock permanente** de más de 100.000 m<sup>2</sup> que nos permite dar un servicio inmediato a los profesionales del sector, además de ofrecer **transporte a obra** desde nuestros almacenes de Badalona, Cornellà y Terrassa.

Para nosotros un servicio de calidad es primordial, por eso contamos con **asesoramiento comercial** personalizado y disponemos de varios **showrooms** donde podrás ver nuestros productos o asistir con tus clientes.



**+150.000m<sup>2</sup>  
EN STOCK**



**VENTA 100%  
PROFESIONAL**



**TRANSPORTE  
A OBRA**





# LAMINADO



## Colección ORIGINAL

<b>GARANTÍA</b> <b>20 años</b> uso doméstico	<b>GARANTÍA</b> <b>10 años</b> uso comercial	<b>GARANTÍA</b> <b>3 años</b> cocinas y baños
--	--	---

### La colección más amplia en formato estándar que se adapta a todos los estilos



Resistencia a la abrasión



Clase de uso



Sistema clic Unilin



Reacción al fuego EN14041/EN13501

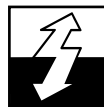

Antiestático EN14041/EN1815

- Núcleo HDF *hydroprotect* de alta estabilidad dimensional.
- Apto para cocinas y baños usando un sellador de juntas y una silicona en todo el perímetro. Solo en productos sin bisel.
- Instalaciones hasta 9x9m (81m<sup>2</sup>) sin juntas de dilatación.
- Sin bisel o microbisel 4 lados, según referencia.

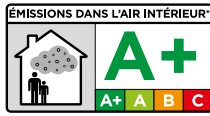

<b>CAJA</b>	8 piezas	2,066 m <sup>2</sup>	14,8 kg
<b>PALET</b>	56 cajas	115,696 m <sup>2</sup>	875,8 kg

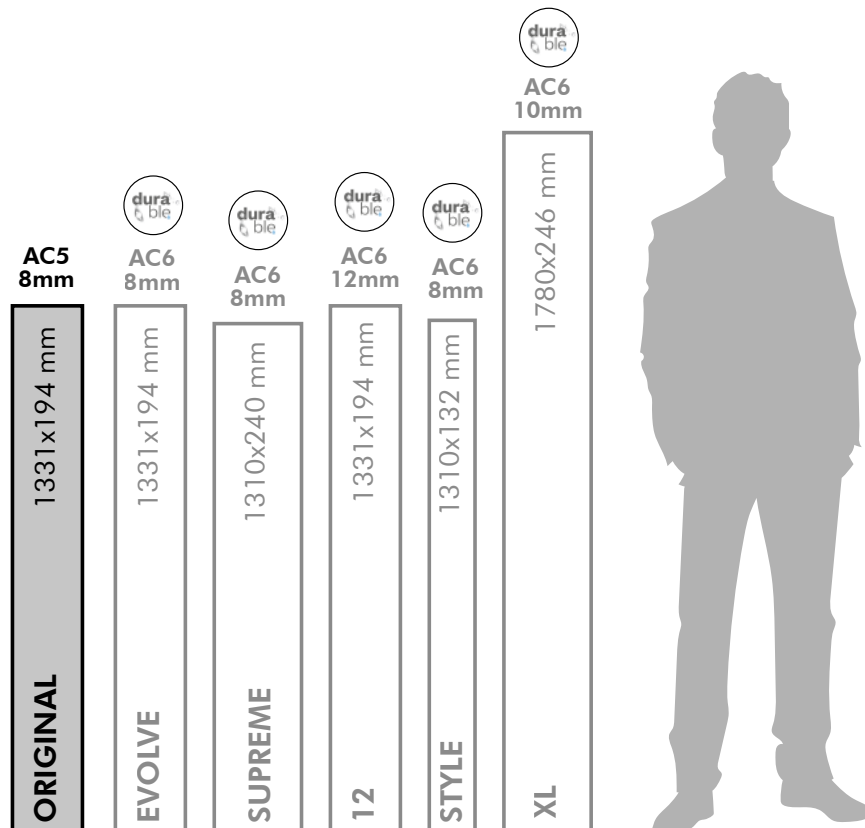





Pino Lofoten



Roble Calcic



Roble Kilimanjaro



Pino Fionia

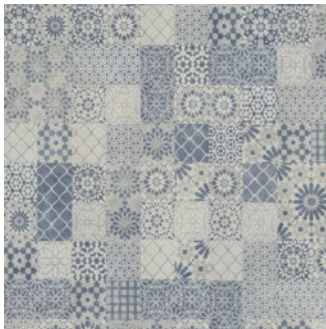

Alfama Tile



Roble Titanio



Roble Bromo



Roble Olimpo



Roble Jasper



Roble Chic



Roble Magari



Roble Taupe



Roble Magari 4MV

MEDIDAS: 1331 x 194 x 8 mm



Roble Glamour

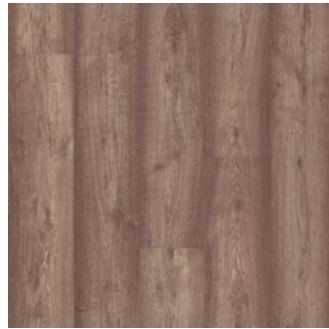

Roble Columbia



Roble Banff



Madera Drift

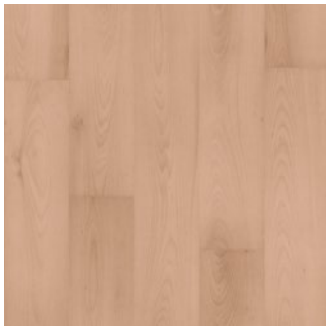

Haya Clara



Roble Sonata



Roble Serrado



Roble Obelisque



Roble Otoño



Roble Egeo



Roble Crescendo



Nogal Minueto



Roble Glamour 4MV

MEDIDAS: 1331 x 194 x 8 mm



Roble Retro

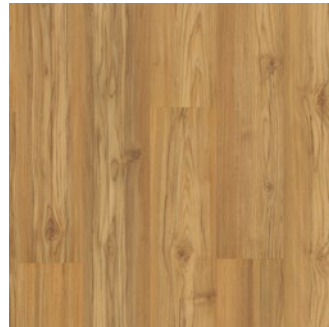

Teka Tasmanian

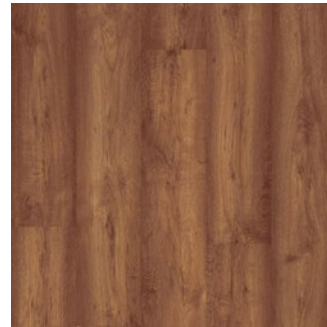

Roble Paramount

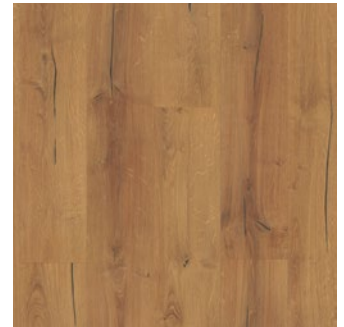

Roble Polka



Roble Vintage

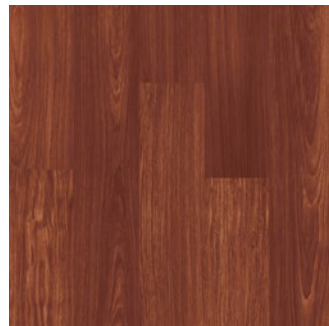

Jatoba Amazonas



Garapa

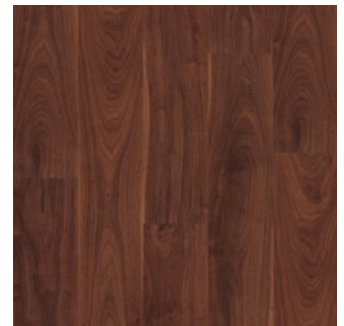

Nogal Siddhartha



Roble Vintage



## Colección EVOLVE

### Colección en formato tradicional con acabados más realistas y tecnología *Durable*



Resistencia a la abrasión



Clase de uso



Sistema clic Unilin



Reacción al fuego EN14041/EN13501

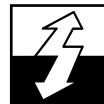

Antiestático EN14041/EN1815

- Núcleo HDF bajo hinchamiento (<8%). Test Nalfa 48h.
- Apto para cocinas y baños.
- Instalaciones hasta 12x12m (144 m<sup>2</sup>) sin juntas de dilatación.
- Sin bisel o microbisel 4 lados, según referencia.

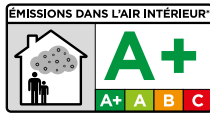

CAJA	8 piezas	2,066 m <sup>2</sup>	15,4 kg
PALET	52 cajas	107,432 m <sup>2</sup>	841,6 kg

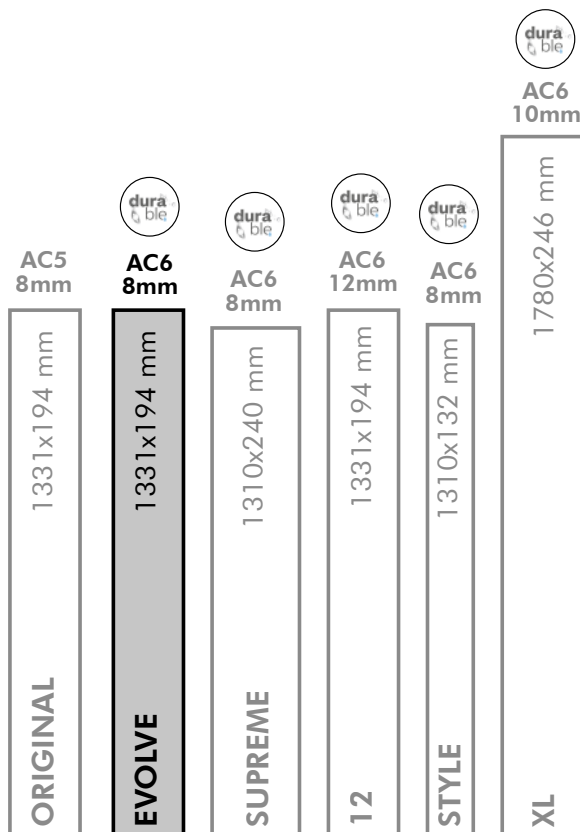



Roble Kalmar Blanco 



Roble Kalas Albar 



Roble Fado Brisa 



Roble Kalmar Esencia 



Roble Kalas Arena 



Roble Fado Gavia 



Roble Wexford Natural 

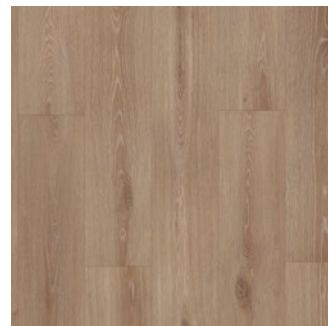

Roble Twilight 



Fado Brisa 4MV

MEDIDAS: 1331 x 194 x8 mm

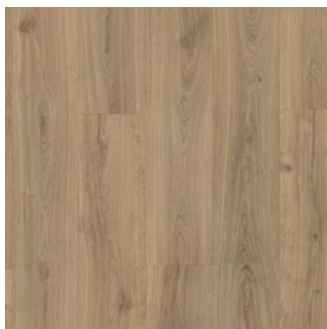

Roble Kalas Pardo

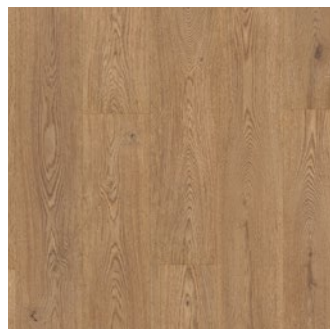

Roble Fado Sotavento



Roble Arles Natural



Roble Fado Tavira





Fado Sotavento 4MV

**MEDIDAS: 1331 x 194 x 8 mm**

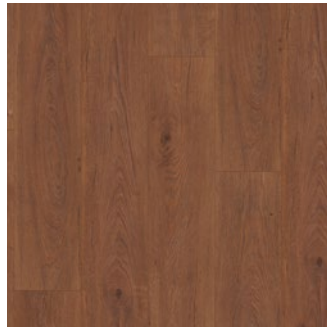

Roble Viena Dorado  



Roble Wexford Tostado  



Roble Kalmar Gris  



Roble Kalas Noz  



Roble Arles Oscuro  



Roble Kalas Bruno  



Belle Epoque Invierno 

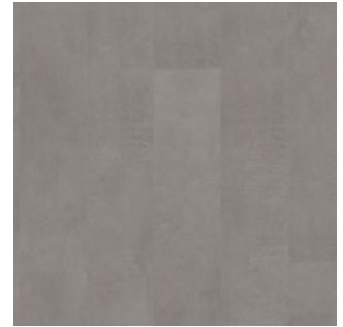

Microcemento 



Fado Microcemento



## Colección SUPREME

<b>GARANTÍA</b> <b>Lifetime</b> uso doméstico	<b>GARANTÍA</b> <b>15 años</b> uso comercial	<b>GARANTÍA</b> <b>10 años</b> cocinas y baños
---	--	--

### Colección en formato más ancho con diseños más realistas y tecnología *Durable*

<b>AC6</b> Resistencia a la abrasión	<b>33</b> Clase de uso	<b>Unilin clic</b> Sistema clic Unilin	<b>Bfl-s1</b> Reacción al fuego EN14041/EN13501	<b>Antiestático</b> EN14041/EN1815
---	---------------------------	---	--	---------------------------------------

- Núcleo HDF bajo hinchamiento (<8%). Test Nalfa 48h.
- Apto para cocinas y baños.
- Instalaciones hasta 12x12m (144 m<sup>2</sup>) sin juntas de dilatación.
- Sin bisel o microbisel 4 lados, según referencia.



<b>CAJA</b>	6 piezas	1,886 m <sup>2</sup>	14 kg
<b>PALET</b>	52 cajas	98,072 m <sup>2</sup>	767,9 kg

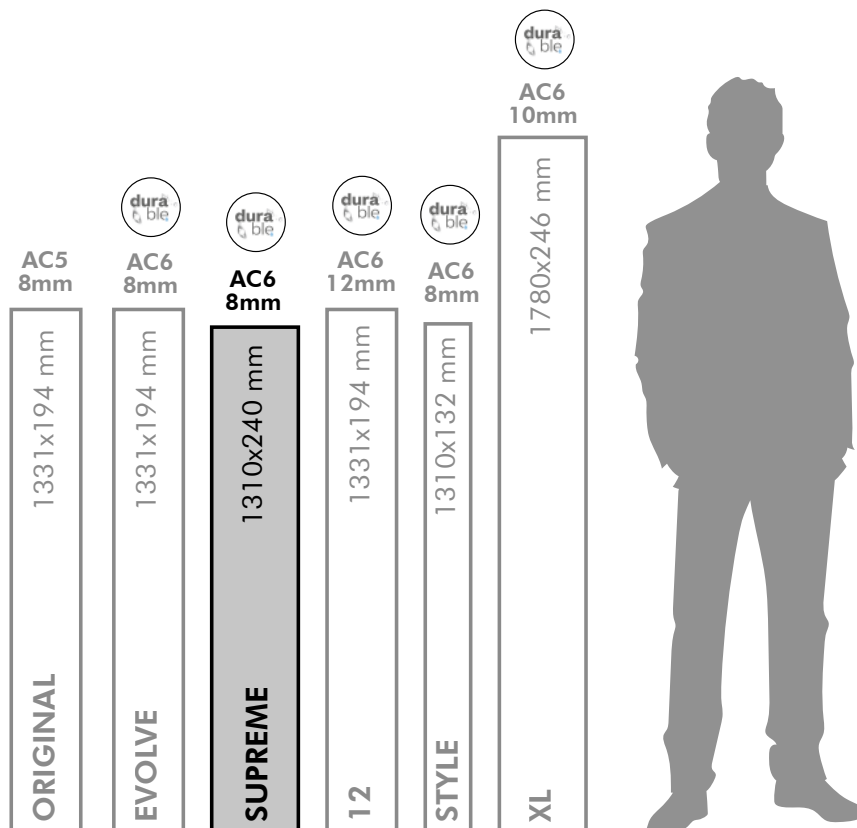





MEDIDAS: 1310 x 240 x 8 mm



Fresno Tango Santorini  



Roble Selena Sable  



Roble Selena Crudo  



Roble Paradise 



Roble Gaia Loreto  



Roble Selena Dorado  



Roble Selena Tostado  



Roble Gaia Dolomites  



Fresno Tango Alsace  



Roble Gaia Victoria  



Roble Gaia Dalmata  



Fresno Tango Etna  



Espiga Dijon 

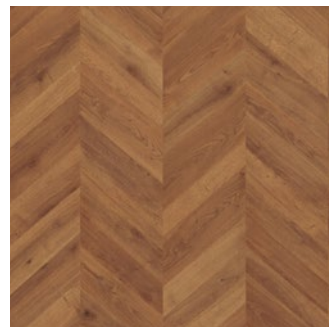

Espiga Nantes 



Espiga Orleans 



Colección  
**12**



## Algunos diseños de la colección Evolve pero con más espesor y más resistencia



Resistencia a la abrasión



Clase de uso



Sistema clic Unilin



Reacción al fuego EN14041/EN13501

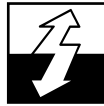

Antiestático EN14041/EN1815

- Núcleo HDF bajo hinchamiento (<8%). Test Nalfa 48h.
- Apto para cocinas y baños.
- Instalaciones hasta 12x12m (144 m<sup>2</sup>) sin juntas de dilatación.
- Sin bisel o microbisel 4 lados.

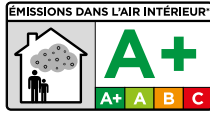

CAJA	6 piezas	1,55 m <sup>2</sup>	16,1 kg
PALET	56 cajas	86,80 m <sup>2</sup>	934,7 kg

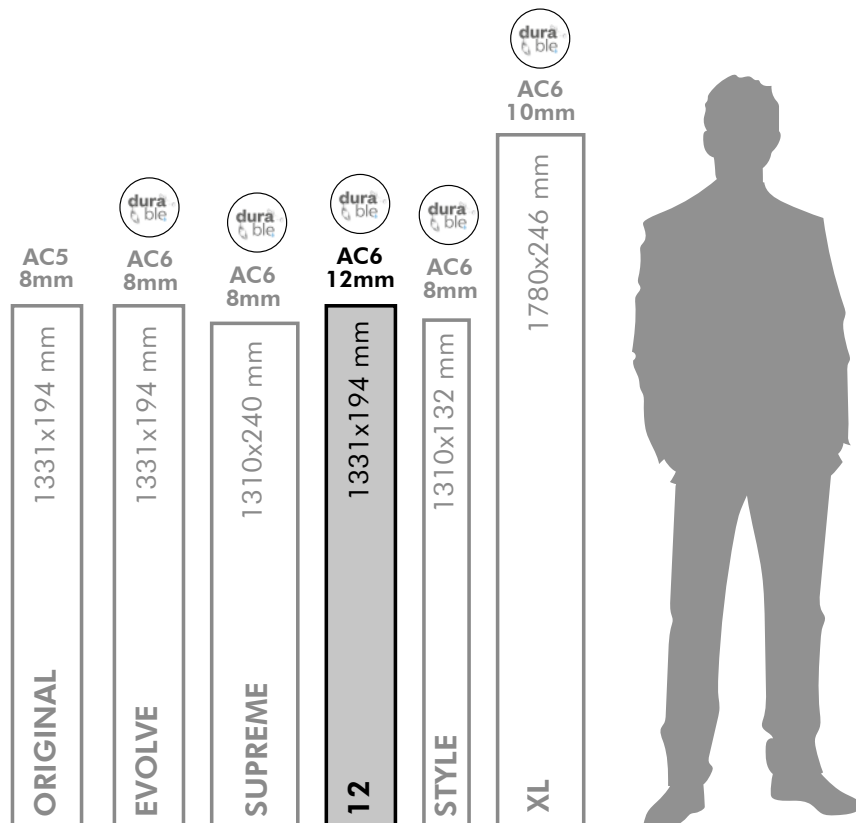

MEDIDAS: 1331 x 194 x 12 mm



Roble Kalas Albar 



Roble Fado Brisa 



Roble Kalmar Esencia 



Roble Fado Gavia 



Roble Fado Sotavento 



Roble Arles Natural 



Roble Viena Dorado 



Roble Wexford Tostado 



Roble Kalas Pardo 



Roble Twilight 



Roble Kalmar Gris 

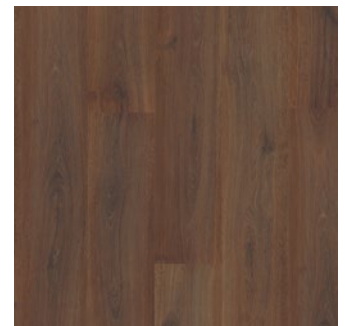

Roble Kalas Noz 



Fado Gavia 4MV



Colección  
**STYLE**

## Una colección con el formato más estrecho y estilizado

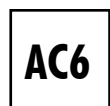

Resistencia a la abrasión



Clase de uso



Sistema clic Unilin



Reacción al fuego EN14041/EN13501



Antiestático EN14041/EN1815

- Núcleo HDF bajo hinchamiento (<8%). Test Nalfa 48h.
- Apto para cocinas y baños.
- Instalaciones hasta 12x12m (144 m<sup>2</sup>) sin juntas de dilatación.
- Sin bisel o microbisel 4 lados.

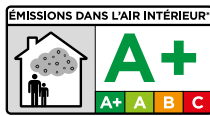

CAJA	10 piezas	1,73 m <sup>2</sup>	12,2 kg
PALET	56 cajas	96,88 m <sup>2</sup>	720,6 kg

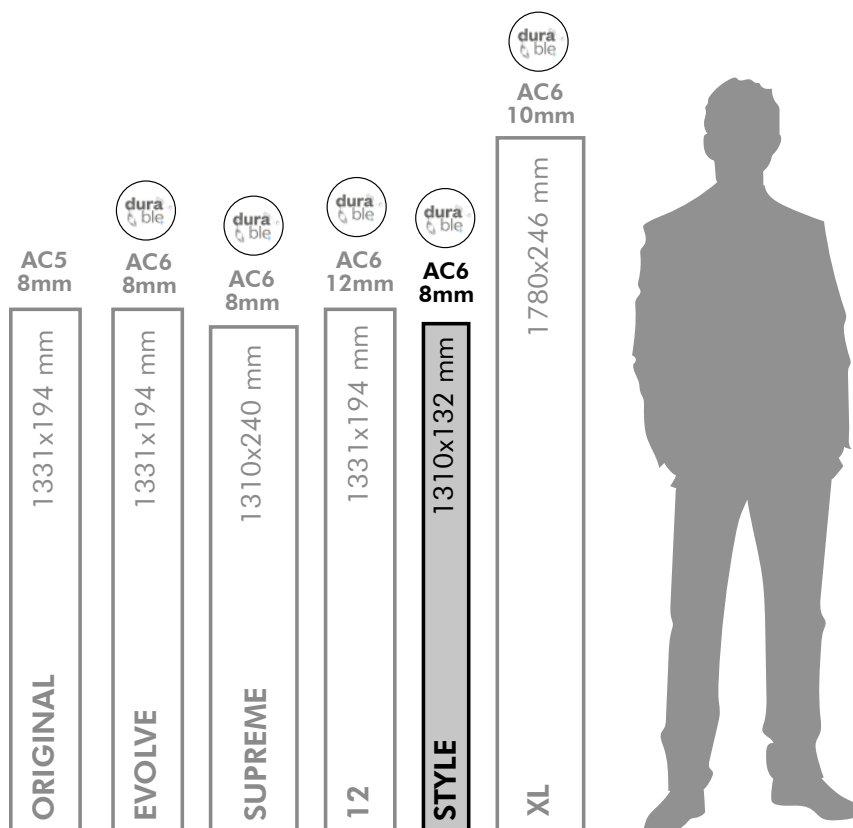



Roble Soberano Ártico 



Roble Selena Crudo 



Roble Selena Sable 



Roble Soberano Plata 



Roble Soberano Natural 



Roble Quercus 

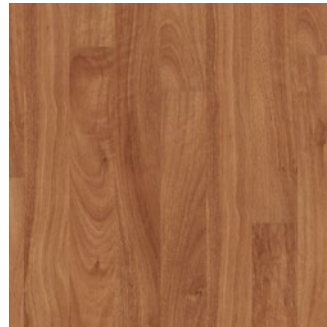

Golden Guadiana 



Afzelia Brasileña 



Roble Breno 

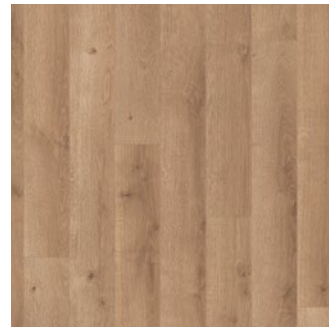

Roble Selena Dorado 



Roble Selena Tostado 



Roble Magno 

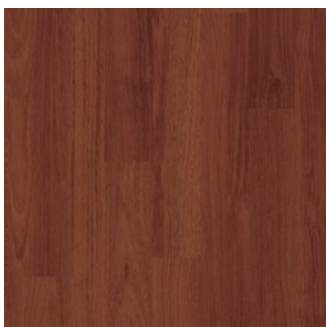

Merbau Clásico 

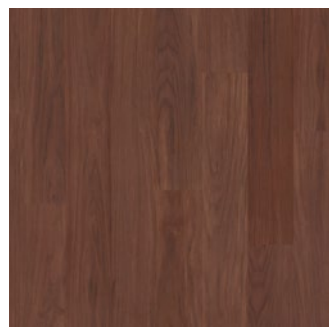

Nogal Majestic 



## Colección XL

GARANTÍA <b>Lifetime</b> uso doméstico	GARANTÍA <b>15 años</b> uso comercial	GARANTÍA <b>10 años</b> cocinas y baños
--	---	---

### Colección de formato extra largo que aporta más profundidad a los espacios

<b>AC6</b> Resistencia a la abrasión	<b>33</b> Clase de uso	Sistema clic Unilin	Reacción al fuego EN14041/EN13501	Antiestático EN14041/EN1815
---	---------------------------	---------------------	-----------------------------------	-----------------------------

- Núcleo HDF bajo hinchamiento (<8%). Test Nalfa 48h.
- Apto para cocinas y baños.
- Instalaciones hasta 12x12m (144 m<sup>2</sup>) sin juntas de dilatación.
- Sin bisel o microbisel 4 lados.

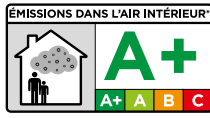

CAJA	4 piezas	1,752 m <sup>2</sup>	16,1 kg
PALET	57 cajas	99,864 m <sup>2</sup>	959,3 kg

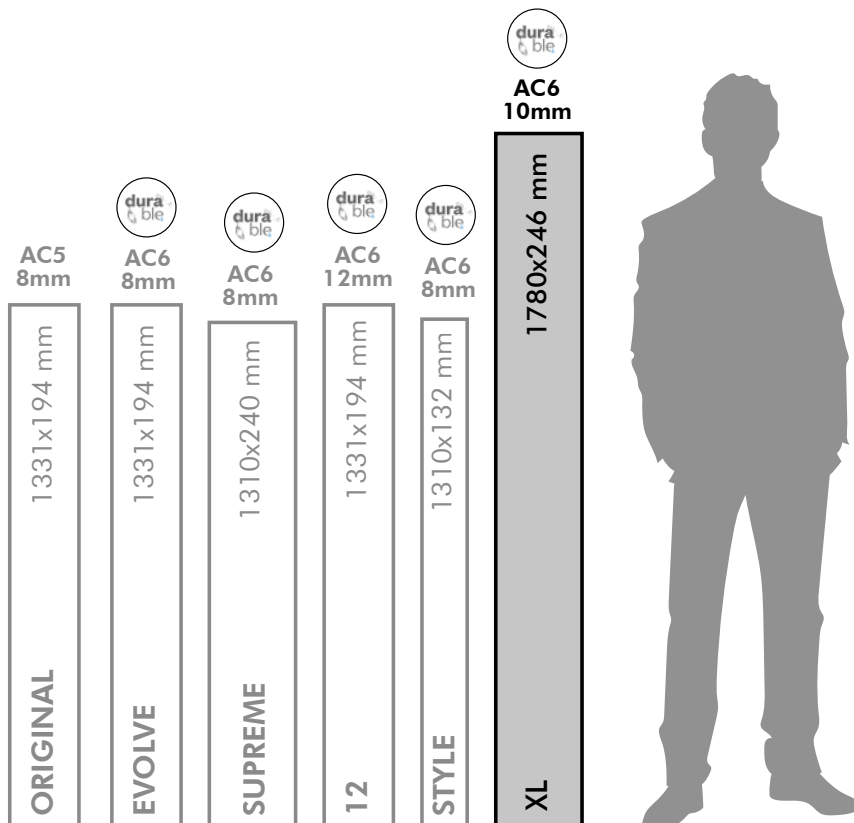



Roble Eyre Gris



Roble Eyre Beige



Roble Eyre Vainilla



Roble Eyre Miel



Roble Eyre Café



Roble Vera Claridad



Roble Vera Siglo



Roble Vera Dulzura



Roble Vera Homenaje

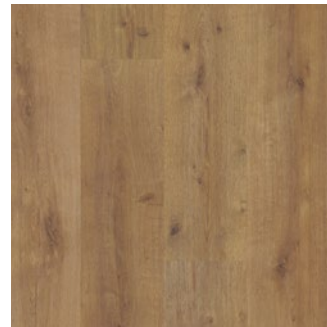

Roble Vera Legado



Roble Vera Siglo 4MV

# Purefloor®

Roble Bolonia



## Colección PUREFLOOR7



### Colección de diseños clásicos y atractivos en formato tradicional

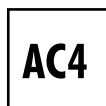

Resistencia a la abrasión



Clase de uso



Sistema clic Unilin



Reacción al fuego EN14041/EN13501

- Núcleo HDF *hydroprotect* de alta estabilidad dimensional.
- Sin bisel. 



CAJA	10 piezas	2,582 m <sup>2</sup>	15,5 kg
PALET	48 cajas	123,936 m <sup>2</sup>	793,7 kg

AC4  
7mm

PUREFLOOR 7 1331x194 mm

AC5  
8mm

PUREFLOOR 8 1331x194 mm

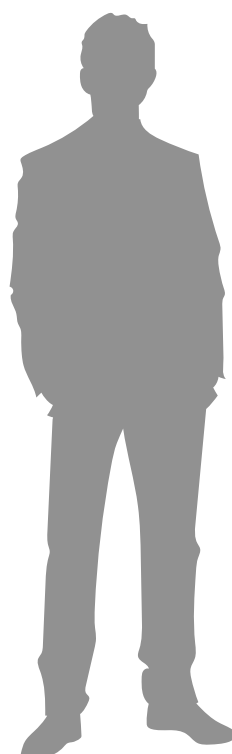





Roble Alpes



Roble Perla



Haya 3.1



Roble 3.3



Roble Bolonia



Roble Siroco



Roble 1.2

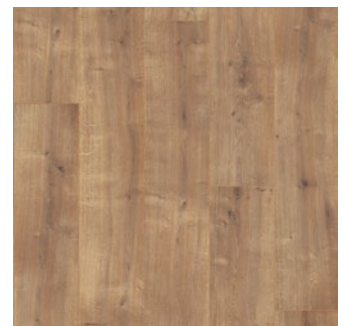

Roble Tobacco



Roble Namibe



Roble Lobios



Roble Tobacco



## Colección PUREFLOOR8

<b>GARANTÍA</b> <b>15 años</b> uso doméstico	<b>GARANTÍA</b> <b>5 años</b> uso comercial	<b>GARANTÍA</b> <b>3 años</b> cocinas
--	---	---

### Colección de diseños clásicos y atractivos en formato tradicional



Resistencia a la abrasión



Clase de uso



Sistema clic Unilin



Reacción al fuego EN14041/EN13501

- Núcleo HDF *hydroprotect* de alta estabilidad dimensional.
- Apto para cocinas. Usando un sellador de juntas y una silicona en todo el perímetro
- Sin bisel o microbisel 4 lados.

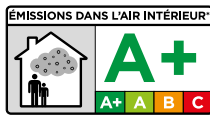

<b>CAJA</b>	9 piezas	2,324 m <sup>2</sup>	16,0 kg
<b>PALET</b>	52 cajas	120,848 m <sup>2</sup>	880,2 kg

AC4  
7mm

AC5  
8mm

PUREFLOOR 7  
1331x194 mm

PUREFLOOR 8  
1331x194 mm

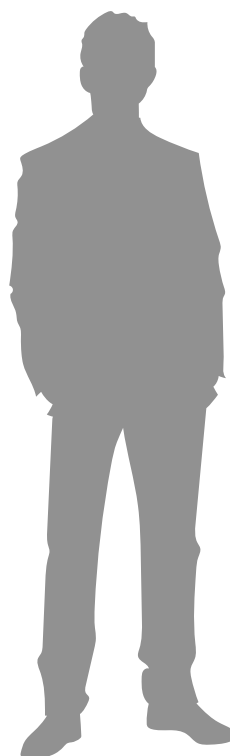



Roble Loira



Roble Troya



Roble Sarela



Roble Ámbar



Roble Pausa

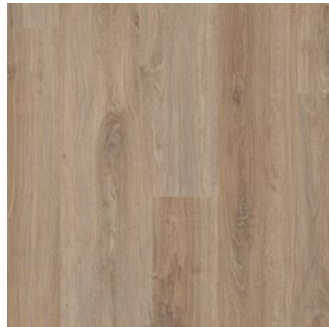

Roble River



Roble Dalia



Roble Cartago



Roble Glaciar

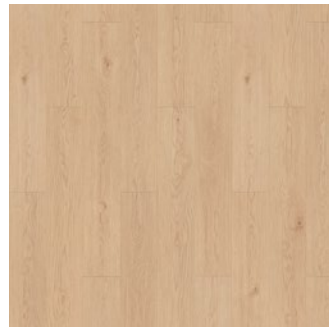

Roble Gala

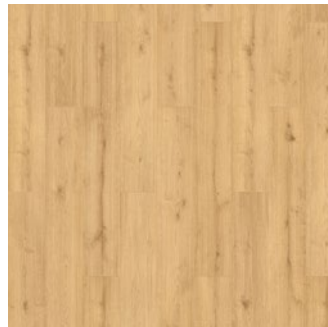

Roble Eneas



Roble Bern



Roble Umbria

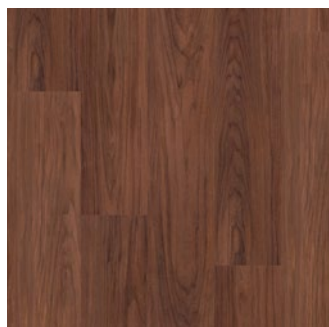

Nogal Majestic



## PERFILES, RODAPIÉS Y MAMPERLÁN

- Largo de 2.400 mm. Mamperlanes: largo según colección.
- Diseño igual al pavimento. Disponible para todas las colecciones de Finfloor y Purefloor.

Roble Eyre Gris

### PERFIL DE EXPANSIÓN

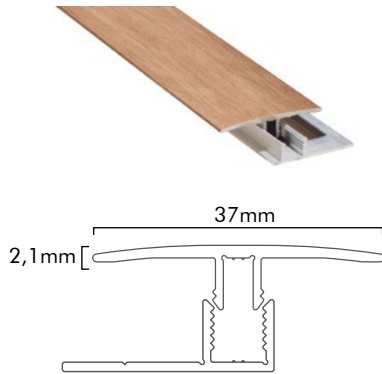

Para pasos de puerta o cuando las dimensiones de la estancia lo requieran.

### PERFIL DE TRANSICIÓN

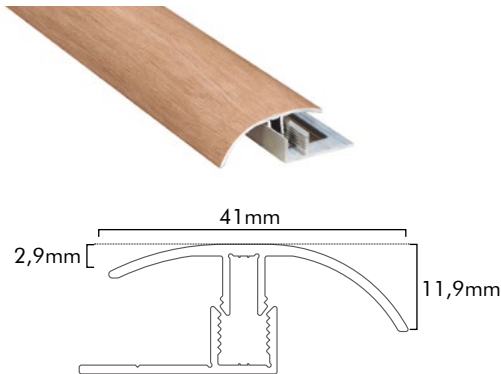

Para utilizar cuando haya un encuentro con un pavimento de otra altura.

### PERFIL TERMINAL

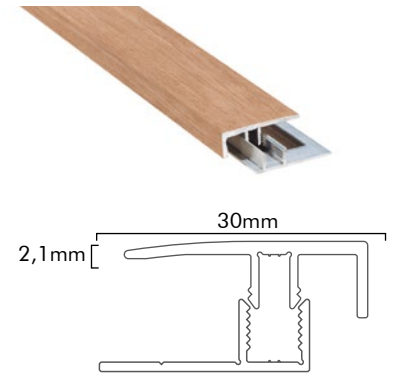

Para rematar las instalaciones sin apenas resalte.

### RODAPIÉ

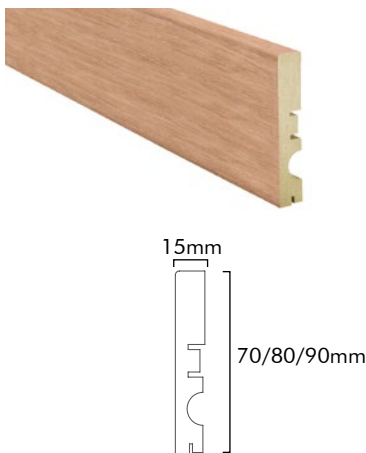

Fabricado en MDF hidrófugo. Incluye pasacables y sistema de enganche a presión para facilitar la colocación.

### JUNQUILLO



Fabricado en MDF hidrófugo. Remate para aplicaciones en las que la altura de los rodapiés resulta excesiva.

### MAMPERLÁN \*

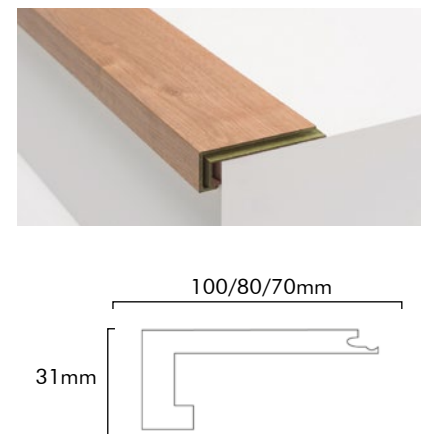

Fabricado en MDF hidrófugo. Se adapta a cualquier altura de peldaño y a la inmensa mayoría de escaleras.

**\*En PARMOVIL fabricamos mamperlanes a medida para cualquier proyecto**



Roble Kalas Arena

### SILENT ELITE UNDERLAY



Espuma de polietileno reticulado de célula cerrada.  
Apto para calefacción radiante.  
Ideal para nivelar el suelo y corregir irregularidades.  
Mejora del ruido de impactos 20dB.  
Protege de la humedad y condensaciones.

Espesor	Densidad	m <sup>2</sup> /Bobina
2mm	130 kg/m <sup>3</sup>	20m <sup>2</sup>

### THERMO UNDERLAY



Espuma de polietileno reticulado de célula cerrada.  
No apto para calefacción radiante.  
Alto aislamiento térmico.  
Mejora del ruido de impactos 18dB.  
Protege de la humedad y condensaciones.

Espesor	Densidad	m <sup>2</sup> /Bobina
2mm	35-40 kg/m <sup>3</sup>	20m <sup>2</sup>

### SILICONA DE APLICACIÓN PERIMETRAL



Evita filtraciones de agua debajo de los suelos flotantes en cocinas o baños.  
Está especialmente indicada para rellenar la junta de dilatación entre el suelo y las paredes, muebles o sanitarios de baños.  
Su aplicación ayuda a prolongar la vida del producto y permite el uso del Finfloor en cocinas y baños con su correspondiente garantía.

	Rendimiento	Cantidad
40716528	10m <sup>2</sup>	280ml

### SELLADOR DE JUNTAS



Bloquea la filtración de agua entre las laminas del suelo laminado evitando posteriores daños en la instalación.  
Su aplicación ayuda a prolongar la vida del producto y permite el uso del Finfloor en cocinas y baños con su correspondiente garantía.

	Rendimiento	Cantidad
40711133	10m <sup>2</sup>	125ml



# Colección MAJESTIC

**GARANTÍA 25 años**  
uso doméstico

**GARANTÍA 10 años**  
antihumedad

## Formato largo y aspecto natural con tecnología hermética antihumedad



- Apto para cocinas y baños. 100% hermético.
- Aspecto y tacto naturales y sincronizados.
- Biselado auténtico: El color, diseño y estructura de la lama son visibles en el bisel.

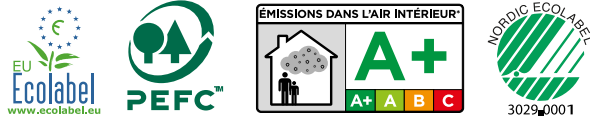

<b>CAJA</b>	6 piezas	2,95 m <sup>2</sup>	24,06 kg
<b>PALET</b>	33 cajas	97,42 m <sup>2</sup>	807,74 kg



9,5mm 9,5mm

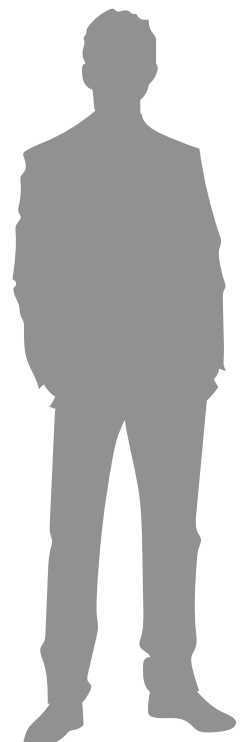
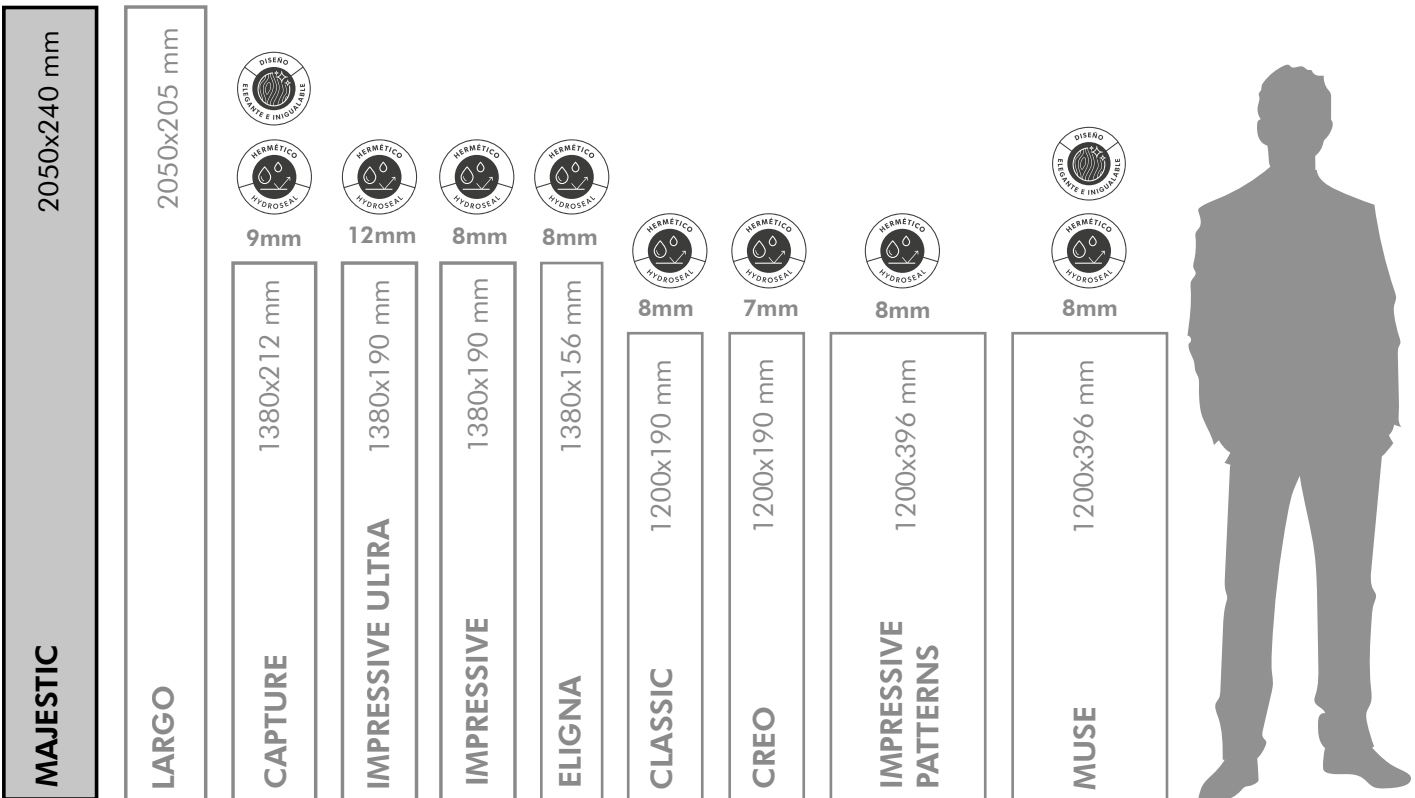



MJ3554  
Roble valle beige claro



MJ3550  
Roble desierto claro natural

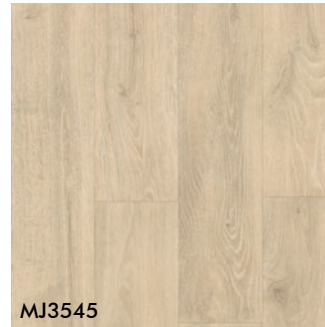

MJ3545  
Roble bosque beige



MJ3546  
Roble bosque natural



MJ3551  
Roble desierto cálido natural



MJ3555  
Roble valle marrón claro



MJ3547  
Roble bosque gris claro



MJ3552  
Roble desierto gris cepillado



MJ3548  
Roble bosque marrón

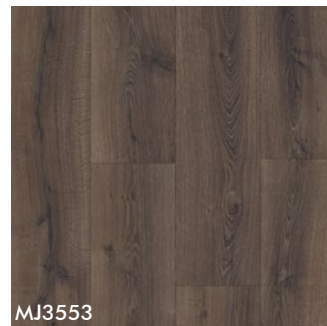

MJ3553  
Roble desierto marrón oscuro cepillado



Roble bosque natural



# Colección LARGO

GARANTÍA  
**25 años**  
uso doméstico

## Colección de diseños clásicos en formato largo con microbiselado



32

Clase de uso



Sistema clic Inilin



Reacción al fuego  
EN13501-1



Antiestático  
EN1815



Antirayadas  
EN 438-2, 25



Antimanchas  
EN 438

- Aspecto y tacto naturales.

- Microbiselado: Finos bordes que delimitan las lamelas con claridad.

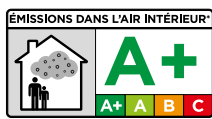

CAJA	6 piezas	2,52 m <sup>2</sup>	20,12 kg
PALET	44 cajas	110,97 m <sup>2</sup>	899,93 kg



9,5mm

9,5mm

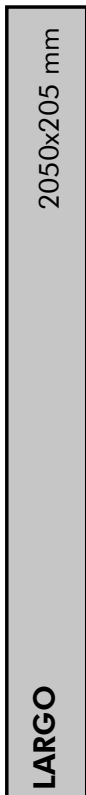

9mm



CAPTURE



12mm



IMPRESSIVE ULTRA



8mm



IMPRESSIVE



8mm



ELIGNA



8mm



CLASSIC



7mm



CREO



8mm



IMPRESSIVE PATTERNS



8mm



MUSE



8mm



MUSE

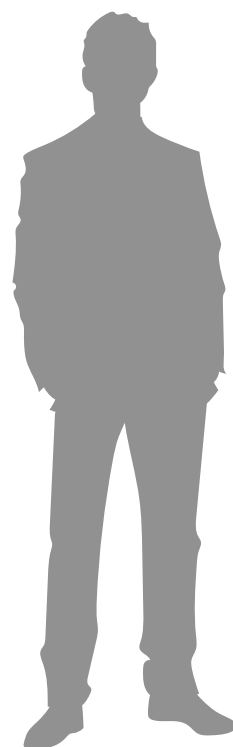



MEDIDAS: 2050 x 205 x 9,5 mm



LPU1507  
Roble Pacífico



LPU1396  
Roble rústico claro



LPU3985  
Roble vintage blanco



LPU1660  
Roble Long Island claro



LPU1663  
Roble dominicano gris



LPU1505  
Roble auténtico



LPU1622  
Roble dominicano natural



LPU1283  
Roble barnizado blanco



LPU1662  
Roble Cambridge natural



LPU1284  
Roble barnizado natural

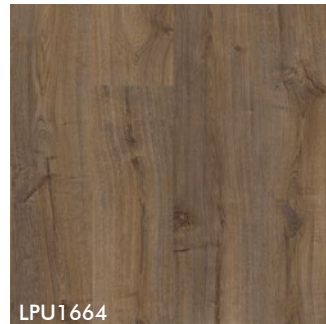

LPU1664  
Roble Cambridge oscuro



LPU3986  
Roble vintage gris



LPU1661  
Roble Long Island natural

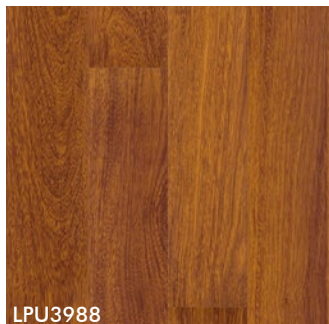

LPU3988  
Merbau barnizado natural





# Colección CAPTURE

**GARANTÍA 25 años**  
uso doméstico

**GARANTÍA 10 años**  
anti-humedad

La colección más sofisticada con sincronizado de color y textura perfectos

- 32**  
Clase de uso
- Sistema clic Unilin
- Reacción al fuego EN13501-1
- Antiestático EN1815
- Antirayadas EN 438-2, 25
- Antimanchas EN 438

- Apto para cocinas y baños. 100% hermético.
- Color, estructura y tacto sincronizados con efecto hiperrealista.
- Biselado auténtico: El color, diseño y estructura de la lama son visibles en el bisel.



<b>CAJA</b>	7 piezas	2,05 m <sup>2</sup>	16,40 kg
<b>PALET</b>	52 cajas	106,50 m <sup>2</sup>	884,00 kg



9,5mm

9,5mm

2050x240 mm

**MAJESTIC**

2050x205 mm

**LARGO**

1380x212 mm

**CAPTURE**

1380x190 mm

**IMPRESSIVE ULTRA**

1380x190 mm

**IMPRESSIVE**

1380x156 mm

**ELIGNA**

1200x190 mm

**CLASSIC**

1200x190 mm

**CREO**

1200x396 mm

**IMPRESSIVE PATTERNS**

1200x396 mm

**MUSE**

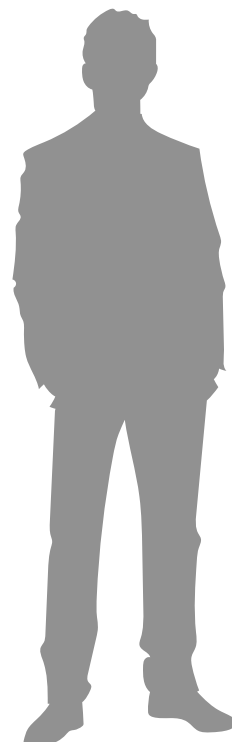



SIG4753

Roble blanco pintado



SIG4757

Roble premium blanco



SIG4748

Roble suave con pátina



SIG4765

Roble gris cepillado



SIG4754

Roble rosa pintado



SIG4750

Roble beige barnizado



SIG4764

Roble beige cepillado



SIG4762

Roble cepillado cálido natural



SIG4749

Roble barnizado natural

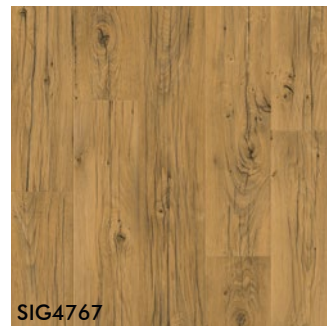

SIG4767

Roble natural agrietado



SIG4751

Roble marrón con pátina



SIG4766

Roble marrón cepillado

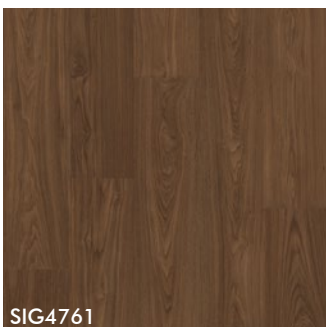

SIG4761

Nogal chic

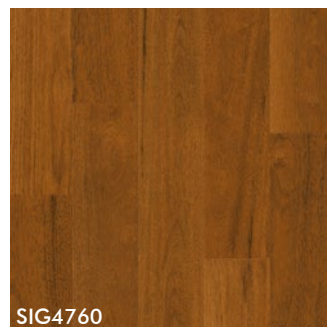

SIG4760

Roble Merbau

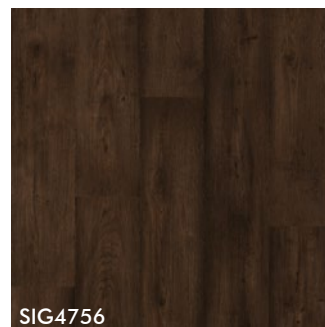

SIG4756

Roble encerado marrón



SIG4755

Roble negro pintado





# Colección IMPRESSIVE

**GARANTÍA 25 años**  
uso doméstico

**GARANTÍA 10 años**  
antihumedad

## Diseños atractivos con sensación natural y acabado hermético en dos grosores

- Clase de uso
- Sistema clic Unilin
- Reacción al fuego EN13501-1
- Antiestático EN1815
- Antirayadas EN 438-2, 25
- Antimanchas EN 438

- Apto para cocinas y baños. 100% hermético.
- Aspecto y tacto naturales y sincronizados.
- Biselado auténtico: El color, diseño y estructura de la lama son visibles en el bisel.

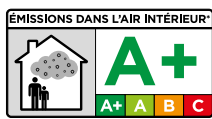

### IMPRESSIVE (clase 32)

<b>CAJA</b>	7 piezas	1,84 m <sup>2</sup>	12,98 kg
<b>PALET</b>	60 cajas	110,1 m <sup>2</sup>	800,94 kg

### IMPRESSIVE ULTRA (clase 33)

<b>CAJA</b>	5 piezas	1,31 m <sup>2</sup>	13,61 kg
<b>PALET</b>	60 cajas	78,66 m <sup>2</sup>	838,92 kg



9,5mm

9,5mm

2050x240 mm

**MAJESTIC**

2050x205 mm

**LARGO**



9mm

1380x212 mm

**CAPTURE**



12mm

1380x190 mm

**IMPRESSIVE ULTRA**



8mm

1380x190 mm

**IMPRESSIVE**



8mm

1380x156 mm

**ELIGNA**



8mm

1200x190 mm

**CLASSIC**



7mm

1200x190 mm

**CREO**



8mm

1200x396 mm

**IMPRESSIVE PATTERNS**



8mm

1200x396 mm

**MUSE**

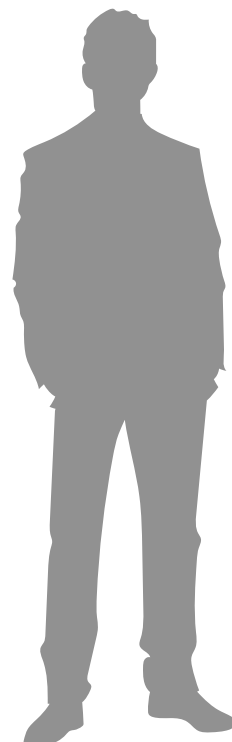

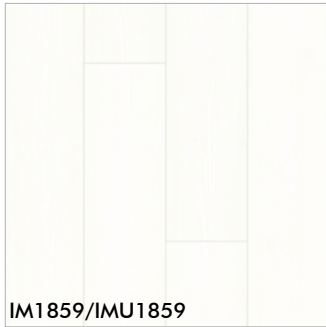

IM1859/IMU1859

Planchas blancas



IM3559/IMU3559

Roble clásico claro con pátina



IM1861/IMU1861

Cemento gris claro



IM3560/IMU3560

Roble clásico gris con pátina



IM1854/IMU1854

Roble suave Claro



IM1858/IMU1858

Roble con cortes de sierra gris



IM3558/IMU3558

Roble suave gris



IM1857/IMU1857

Roble con cortes de sierra beige



IM1860/IMU1860

Pino natural



IM1853/IMU1853

Roble tratado con chorro de arena natural



IM1847/IMU1847

Roble clásico beige



IM3105/IMU3105

Roble barnizado blanco



IM1856/IMU1856

Roble suave medio



IM1855/IMU1855

Roble suave natural



IM3106/IMU3106

Roble barnizado natural



IM1848/IMU1848

Roble clásico natural



IM3557/IMU3557

Roble suave marrón claro

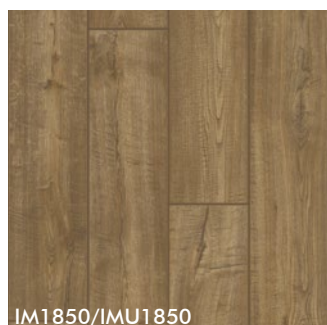

IM1850/IMU1850

Roble raspado gris marrón

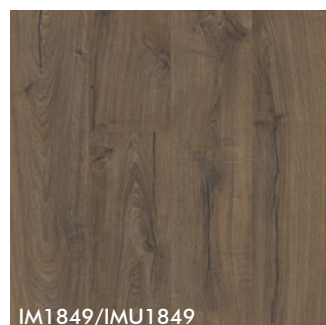

IM1849/IMU1849

Roble clásico marrón

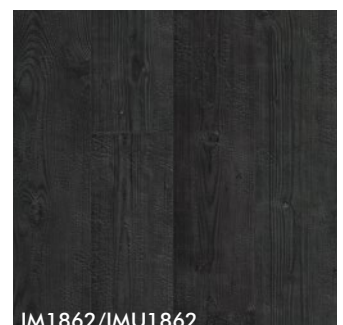

IM1862/IMU1862

Roble quemadas





# Colección ELIGNA



Una colección elegante con formato de lama más estrecho sin biselado



- Apto para cocinas y baños. 100% hermético.
- Aspecto y tacto naturales y sincronizados.
- Sin bisel.

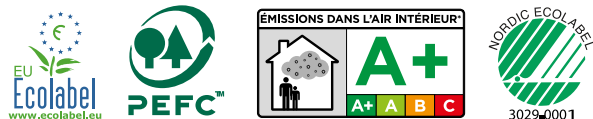

CAJA	8 piezas	1,72 m <sup>2</sup>	11,65 kg
PALET	60 cajas	103,32 m <sup>2</sup>	721,08 kg



9,5mm

9,5mm

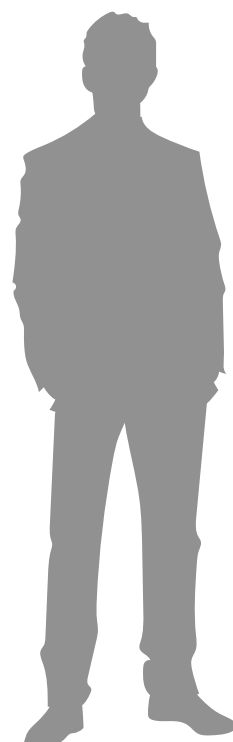
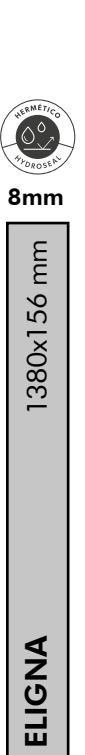



EL1300

Wengé passionata

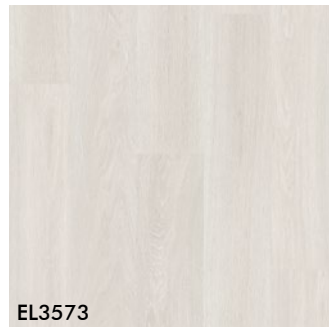

EL3573

Roble estado gris claro



EL3990

Roble Venecia claro



EL3580

Roble Newcastle gris



EL3906

Roble Venecia gris



EL3574

Roble estado beige



EL3907

Roble Venecia beige



EL1304

Roble barnizado gris claro



EL915

Roble barnizado blanco

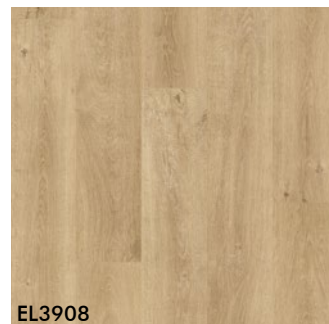

EL3908

Roble Venecia natural

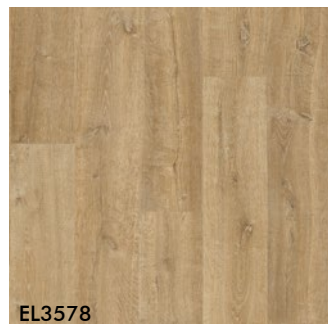

EL3578

Roble riva natural



EL896

Roble barnizado natural



EL1491

Roble blanco claro

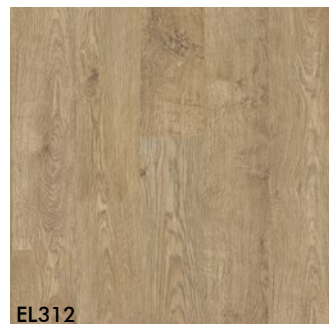

EL312

Roble viejo aceitado mate

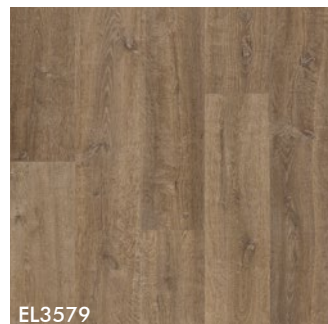

EL3579

Roble riva marrón

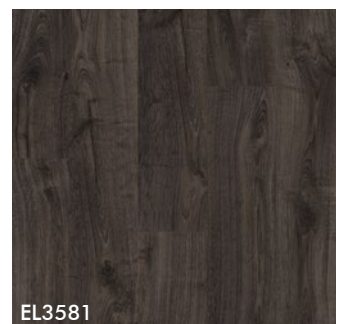

EL3581

Roble Newcastle oscuro

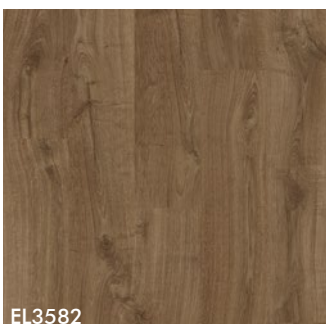

EL3582

Roble Newcastle marrón

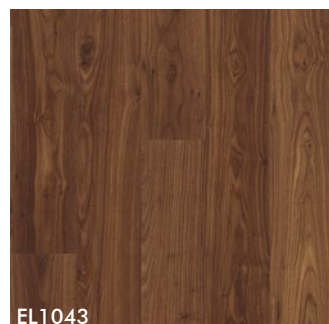

EL1043

Nogal aceitado

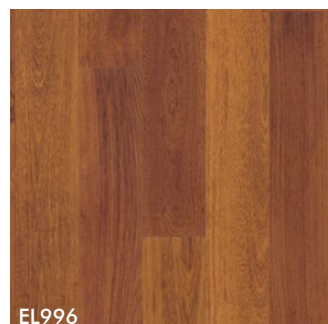

EL996

Roble Merbau





# Colección CLASSIC



## Una selección equilibrada de colores con diseño moderno y natural



- Apto para cocinas y baños. 100% hermético.
- Aspecto y tacto naturales y sincronizados.
- Bisel impreso.



CAJA	7 piezas	1,60 m <sup>2</sup>	10,81 kg
PALET	60 cajas	95,76 m <sup>2</sup>	670,74 kg



9,5mm

9,5mm

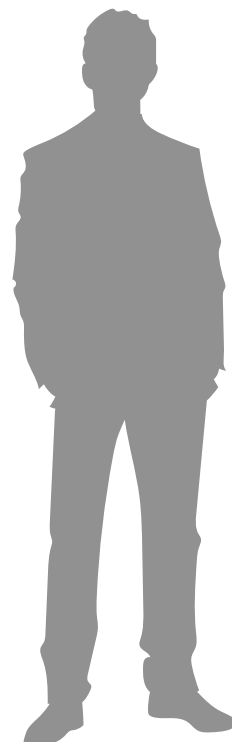
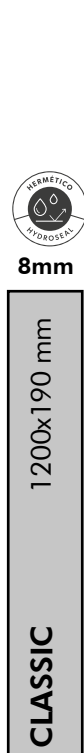



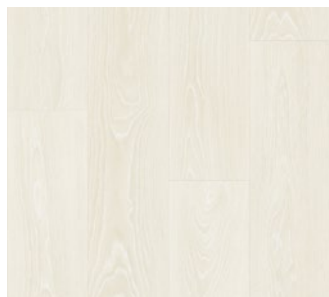

CLM5798  
Roble blanco escarcha

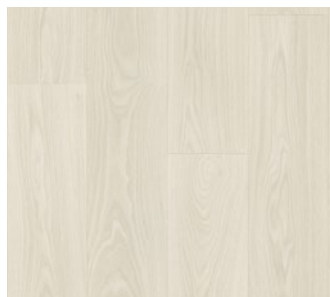

CLM5795  
Roble gris bruma



CLM5790  
Roble gris intenso

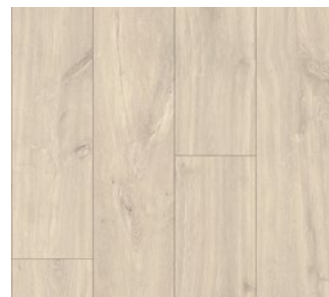

CLM1655  
Roble Havana natural



CLM5799  
Roble beige escarcha



CL1653  
Roble recuperado con pátina blanca



CLM5786  
Roble gris ceniza



CLM5788  
Roble crudo



Roble recuperado con pátina blanca

**MEDIDAS: 1200 x 190 x 8 mm**



CLM5791

Roble crudo arena



CLM5802

Roble crudo desierto



CLM1656

Roble Havana natural  
con cortes de sierra



CLM1487

Roble natural medianoche



CLM5794

Roble marrón galleta



CLM5801

Roble arena

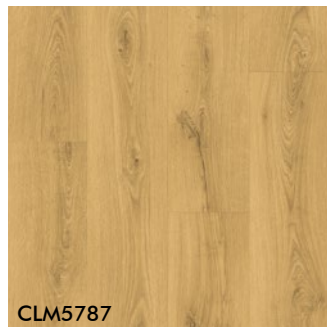

CLM5787

Roble claro clásico



CLM5792

Roble marrón miel



Roble natural medianoche



CLM5796

Roble tostado



CLM1488

Roble oscuro medianoche



CLM1405

Roble viejo gris claro

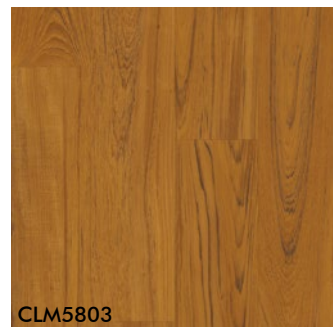

CLM5803

Roble Teca marrón medio

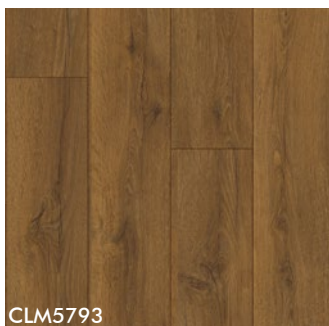

CLM5793

Roble marrón cacao

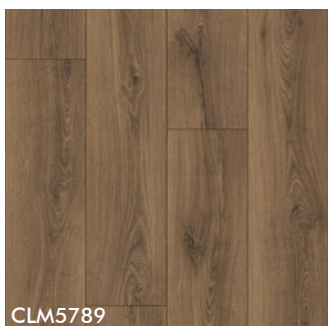

CLM5789

Roble marrón cálido

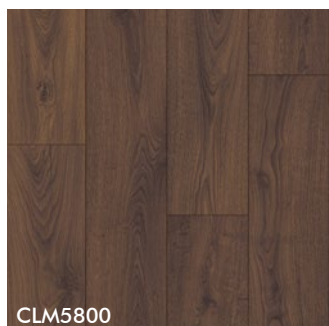

CLM5800

Roble marrón cacahuete

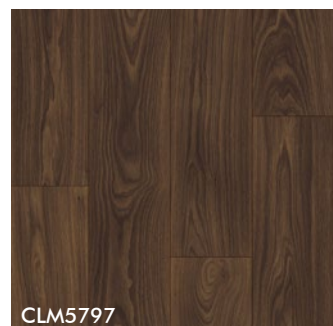

CLM5797

Roble marrón moca



Roble viejo gris claro

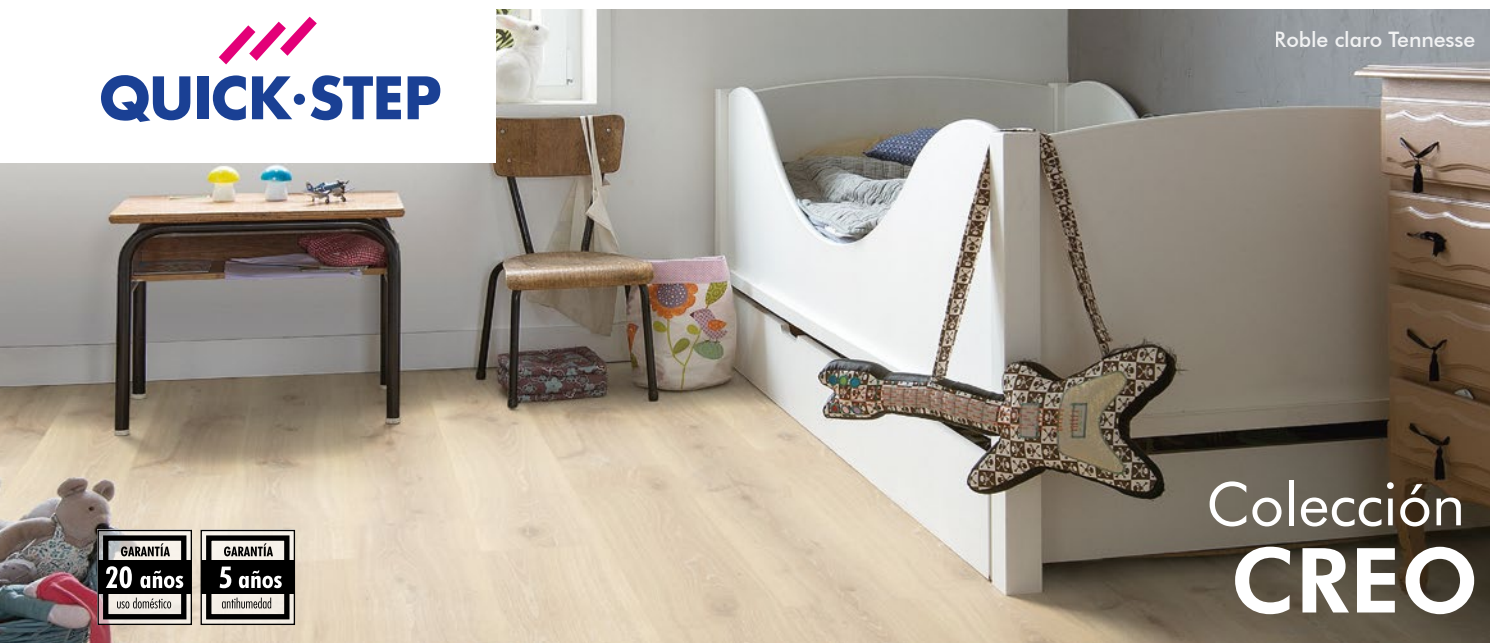

# Colección CREO

**GARANTÍA**  
**20 años**  
uso doméstico

**GARANTÍA**  
**5 años**  
antihumedad

## Lamas sin ranuras con aspecto dinámico y completamente herméticas



**32**

Clase de uso



Sistema clic Unilin



Reacción al fuego EN13501-1

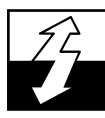

Antiestático EN1815



Antirayadas EN 438-2, 25



Antimanchas EN 438

- Apto para cocinas y baños. 100% hermético.
- Aspecto y tacto naturales y sincronizados.
- Sin bisel.

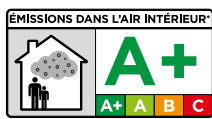

<b>CAJA</b>	8 piezas	1,82 m <sup>2</sup>	11,47 kg
<b>PALET</b>	60 cajas	109,44 m <sup>2</sup>	710,10 kg



9,5mm

9,5mm

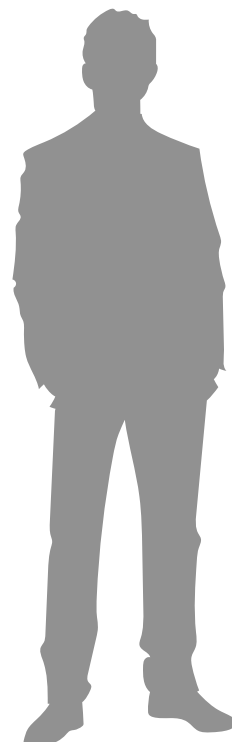
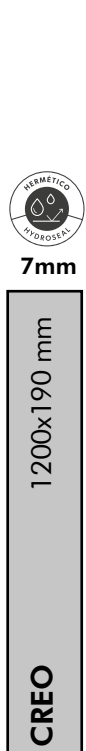



CRH3178  
Roble blanco Charlotte



CRH3177  
Roble marrón Charlotte



CRH3182  
Roble natural Virginia



CRH3181  
Roble gris Tennessee



CRH3175  
Roble beige Louisiana



CRH3179  
Roble claro Tennessee

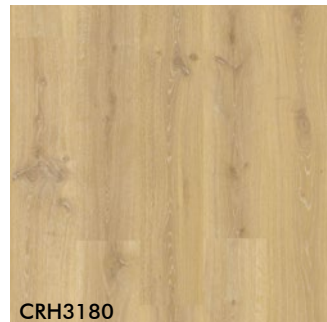

CRH3180  
Roble natural Tennessee



CRH3176  
Roble natural Louisiana



Roble blanco Charlotte



**GARANTÍA**  
**25 años**  
uso doméstico

**GARANTÍA**  
**5 años**  
antihumedad

Colección

# IMPRESSIVE PATTERNS

Diseños con patrones originales y atrevidos: rombos, chevron o diamante



**32**  
Clase de uso



Sistema clic Unilin



Reacción al fuego  
EN13501-1



Antiestático  
EN1815



Antirayadas  
EN 438-2, 25



Antimanchas  
EN 438

- Apto para cocinas y baños. 100% hermético.
- Aspecto y tacto naturales y sincronizados.
- Biselado auténtico: El color, diseño y estructura de la lama son visibles en el bisel.

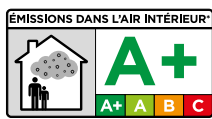

<b>CAJA</b>	4 piezas	1,90 m <sup>2</sup>	14,50 kg
<b>PALET</b>	52 cajas	98,85 m <sup>2</sup>	780 kg



9,5mm

9,5mm

2050x240 mm

**MAJESTIC**

2050x205 mm

**LARGO**

1380x212 mm

**CAPTURE**

1380x190 mm

**IMPRESSIVE ULTRA**

1380x190 mm

**IMPRESSIVE**

1380x156 mm

**ELIGNA**

1200x190 mm

**CLASSIC**

1200x190 mm

**CREO**

1200x396 mm

**IMPRESSIVE PATTERNS**

1200x396 mm

**MUSE**

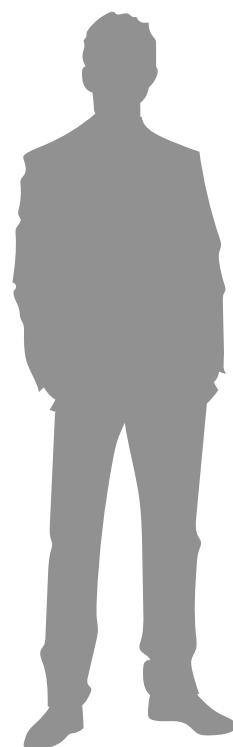



IPA4160  
Roble medio chevrón



IPA4164  
Roble pardo chevrón

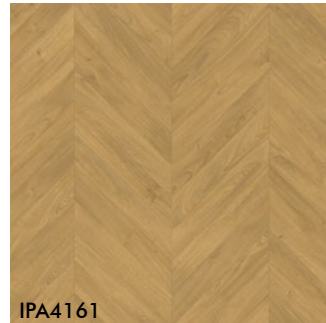

IPA4161  
Roble natural chevrón



IPA4162  
Roble marrón chevrón



IPA4142  
Roble royal natural



IPA4145  
Roble royal marrón oscuro



Roble royal marrón oscuro



# Colección MUSE



## Una colección de diseños de piedra fieles a la naturaleza



- Apto para cocinas y baños. 100% hermético.
- Color, estructura y tacto sincronizados con efecto hiperrealista.
- Biselado auténtico: El color, diseño y estructura de la lama son visibles en el bisel.



CAJA	4 piezas	1,90 m <sup>2</sup>	14,50 kg
PALET	52 cajas	98,85 m <sup>2</sup>	780 kg



9,5mm

9,5mm

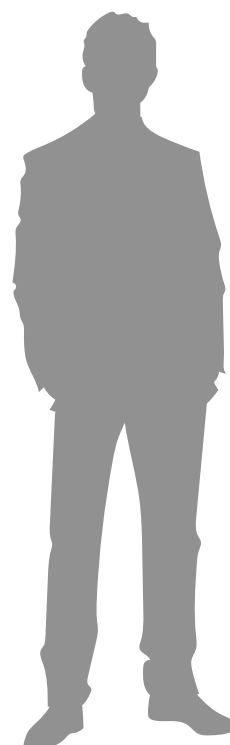



**MEDIDAS: 1200 x 396 x 8 mm**



MUS5487

Tiza



MUS5489

Arenisca



MUS5486

Piedra caliza



MUS5491

Hormigón moteado



MUS5494

Hormigón botánico



MUS5490

Terracota



MUS5488

Hormigón Gris



MUS5485

Arenisca azul oscuro



MUS5493

Pizarra gris



MUS5484

Bluestone ahumado

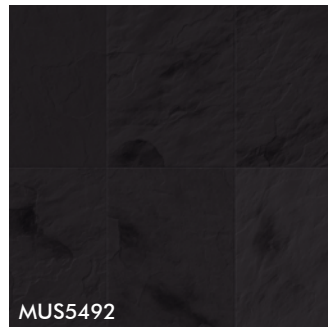

MUS5492

Pizarra negra



Piedra caliza

- Diseño igual al pavimento. Disponibles para todas las colecciones.
- Capa superior resistente a las rayaduras y al desgaste.

**RODAPIÉ - QSPSKR**



Largo de 2400mm. Con espacio para ocultar cables. Fácil de instalar

**PERFIL INCIZO - QSINCP**

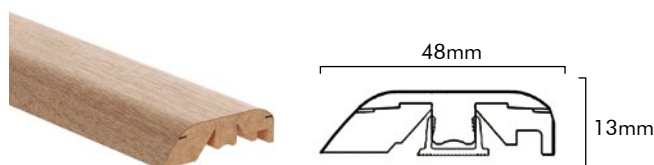

Perfil multifuncional patentado. Largo 2150 mm. Se corta según la forma deseada con el cúter incluido. Para conectar dos suelos con alturas distintas o con la misma altura. Para acabar el suelo junto a la pared o ventana.

## ACCESORIOS

**SET DE INSTALACIÓN**



Incluye un taco de impacto, cuñas regulables (para garantizar que cuenta con las juntas de dilatación correctas) y una palanqueta metálica.

**KIT DE REPARACIÓN**



Para reparar fácilmente daños leves. Contenido: escoplo, cepillo de limpieza, 7 tacos de cera, lija

- Bases para la nivelación del suelo.
- Mejoran el aislamiento acústico y térmico y reducen los crujidos.
- Proporcionan protección contra la humedad ascendente.



**SILENT WALK - QSUDLSW7**



Para espacios con uso muy elevado como la sala de estar o el pasillo. Ofrece reducción de ruido óptima. Compatible con calefacción por suelo radiante.

**UNISOUND - QSUDLRUCO15**



Para espacios con uso muy elevado. Compatible con calefacción por suelo radiante.

**BASIC PLUS - QSUDLBP15/60**



Para espacios con poco uso, como dormitorios y despachos. Compatible con calefacción por suelo radiante.

**TRANSITSOUND - QSUDLTRS15**



La capa de subsuelo ideal para reducir el ruido del suelo de la planta superior. Compatible con calefacción por suelo radiante.

**THERMOLEVEL - QSUDLTL9**



La mejor opción para soleras irregulares. Ofrece un aislamiento adicional. No es compatible con sistemas de calefacción por suelo radiante.



**GARANTÍA Lifetime**  
uso doméstico

**GARANTÍA 5 años**  
uso comercial

**GARANTÍA 5 años**  
cocinas y baños

# Colección MASTERPIECES

Una colección exclusiva y elitista que emula la marquetería clásica

 <b>AC6</b> Resistencia a la abrasión	 <b>33</b> Clase de uso	 Sistema clic Unilin	 <b>Bfl-s1</b> Reacción al fuego EN13501	 Anti estático EN1815	 Anti manchas EN 438
---	--	--	---	---	--

- Apto para cocinas y baños. Resistencia al agua en superficie de 24h. Resistencia de 72h aplicando en el sistema de anclaje una silicona.

- Acabado hiperrealista.

- Microbiselado 

- Tecnología *Jointguard*. Protección de las juntas que evita el deterioro por roces.

- Tecnología *Interplank* en los diseños de Espiga. Continuidad en las lamas. Unión imperceptible.

EMISSIONS DANS L'AIR INTERIEUR  
**A+**  
A+ A B C

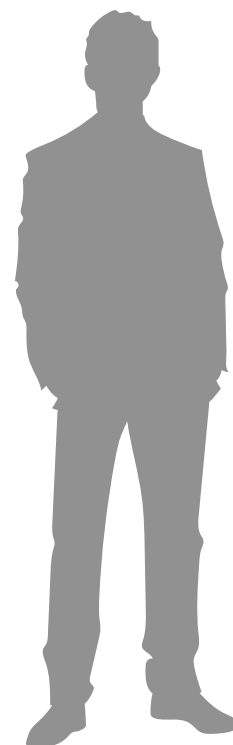
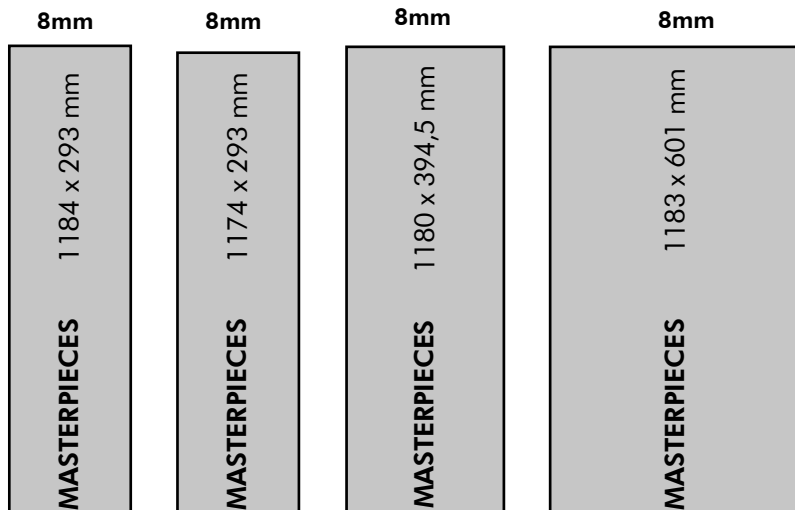

**MEDIDAS: 1184 x 293 x 8 mm**



S176973

Espiga Boho

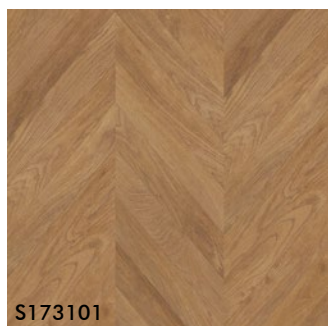

S173101

Espiga Natural



<b>CAJA</b>	6 piezas	2,08 m <sup>2</sup>	16,21 kg
<b>PALET</b>	51 cajas	106,30 m <sup>2</sup>	827 kg

**MEDIDAS: 1174 x 293 x 8 mm**



S180208

Parquet Narbona



<b>CAJA</b>	6 piezas	2,07 m <sup>2</sup>	16,90 kg
<b>PALET</b>	51 cajas	105,51 m <sup>2</sup>	862 kg



Parquet Narbona

**DISPONIBLES TAMBIÉN OTROS DISEÑOS DE LA MARCA**

**MEDIDAS: 1180 x 395 x 8 mm**



S174269

Roble Bretaña



<b>CAJA</b>	5 piezas	2,33 m <sup>2</sup>	18,52 kg
<b>PALET</b>	42 cajas	97,82 m <sup>2</sup>	778 kg

**MEDIDAS: 1180 x 394 x 8 mm**



S176980

Normandie Naturel



<b>CAJA</b>	5 piezas	2,33 m <sup>2</sup>	18,09 kg
<b>PALET</b>	42 cajas	97,68 m <sup>2</sup>	760 kg



Normandie Naturel

**DISPONIBLES TAMBIÉN OTROS DISEÑOS DE LA MARCA**



S177017

Versailles Sahara



<b>CAJA</b>	3 piezas	2,13 m <sup>2</sup>	16,59 kg
<b>PALET</b>	68 cajas	145,04 m <sup>2</sup>	1128 kg



Versailles Sahara

**DISPONIBLES TAMBIÉN OTROS DISEÑOS DE LA MARCA**



## HI-FLOOR: Tablero ultra-compacto de máxima resistencia con tecnología HBP



**MEDIDAS: 1245 x 200 x 5,4 mm**

- 100% resistente al agua.
- Tecnología *HPB (High Pressure Block)* que garantiza máxima estabilidad dimensional.
- Apto para paredes, techos y muebles.
- Sin bisel

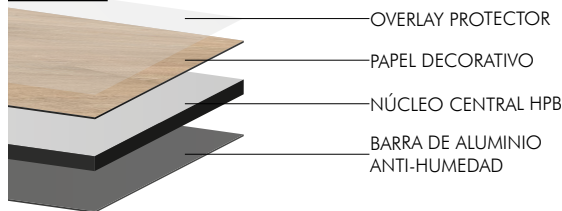

<b>CAJA</b>	8 piezas	1,99 m <sup>2</sup>	16 kg
<b>PALET</b>	40 cajas	79,69 m <sup>2</sup>	640 kg

## CONNECT: Tablero HDF de alta resistencia para zonas no húmedas



**MEDIDAS: 1200 x 196 x 8 mm**

- Tablero HDF de alta densidad.
- Se conecta con Hi-Floor en zonas húmedas con el perfil Connect.
- Sin bisel

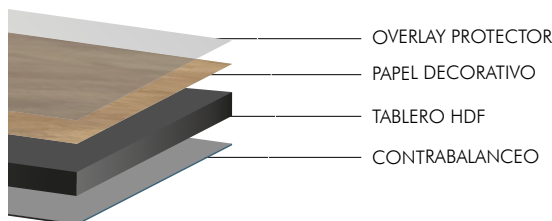

<b>CAJA</b>	9 piezas	2,12 m <sup>2</sup>	16,51 kg
<b>PALET</b>	52 cajas	110,07 m <sup>2</sup>	880 kg







201

Forest Oak



203

Rustic Oak



206

Natural Oak



207

Zen Oak



208

Ancient Oak



209

Fine Oak

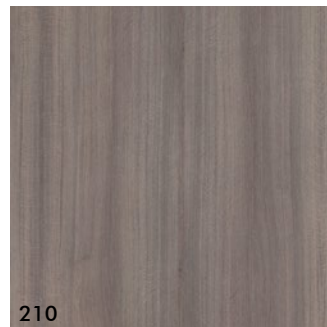

210

Sawed Grey Oak



211

Serene Oak



212

Glimmer Oak



214

Cannelle Oak



215

Amber Oak



216

Ash Oak



217

Ice Wood



219

Artesan Oak

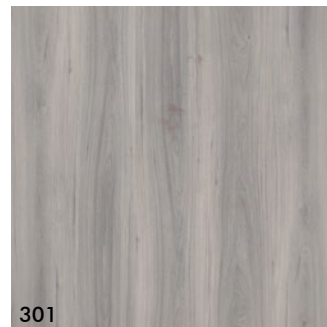

301

Argent Elm

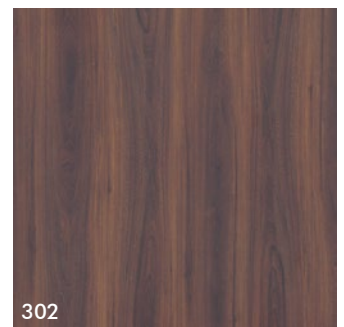

302

Brun Elm



303

Filone Elm



401

Wiry Ash

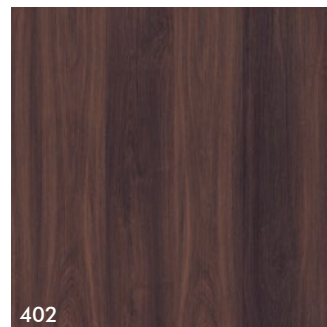

402

Sophis Walnut





218

Classic Oak



220

Century Oak



802

Splinted-Beech



803

Pearl Tsuga

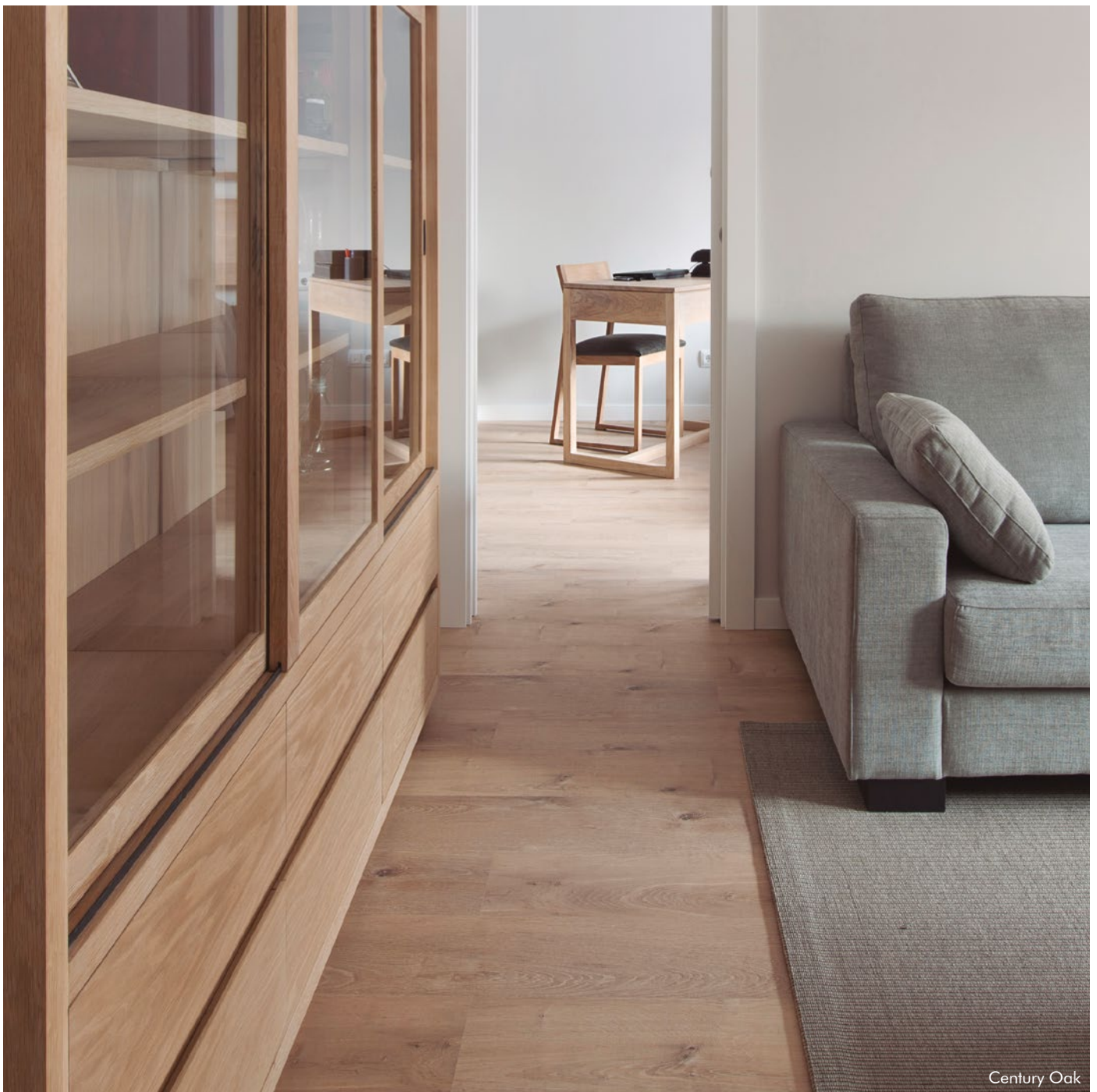

Century Oak

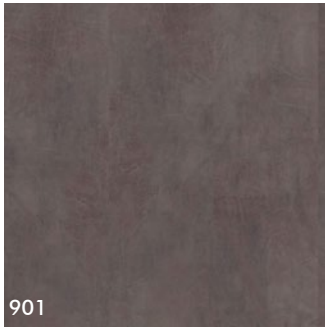

901  
Loft Cement



902  
Cloud



903  
Taj

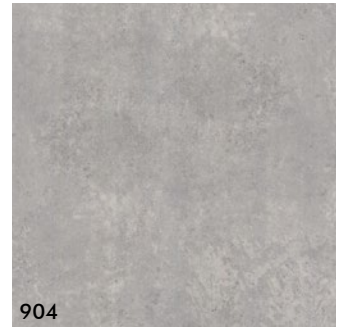

904  
Medley



905  
Mirage

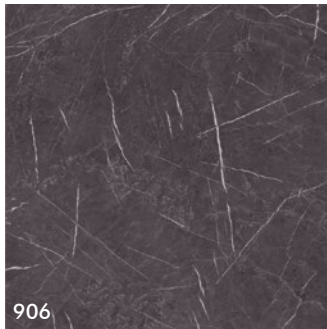

906  
Marble Black

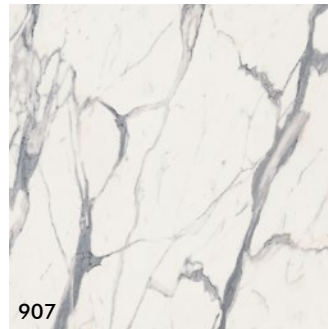

907  
Marble White

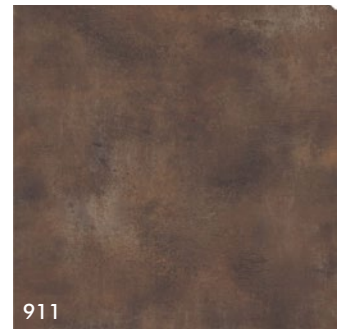

911  
Oxid Stone



912  
Slate Stone



# zenku

Nilo S183506



Colección  
**ARTEC**



## Diseños realistas en punta hungaría con acabado ultra-mate



- Apto para cocinas y baños. Tecnología Aqua Tec. Resistencia al agua en superficie de hasta 48h.

- Continuidad: la unión entre lamas es imperceptible

- Acabado ultra-mate y diseños sincronizados.

- Bisel prensado y microbiselado 

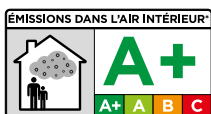

CAJA	5 piezas	2,13 m <sup>2</sup>	17 kg
PALET	54 cajas	114,79 m <sup>2</sup>	918 kg

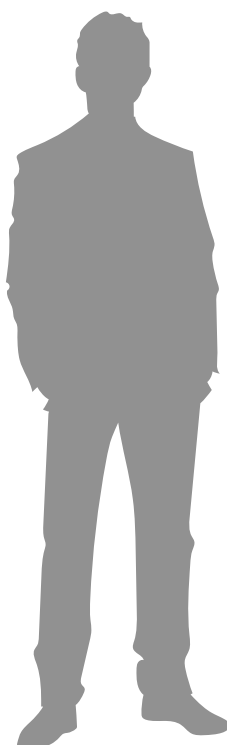

MEDIDAS: 1330 x 320 x 8 mm

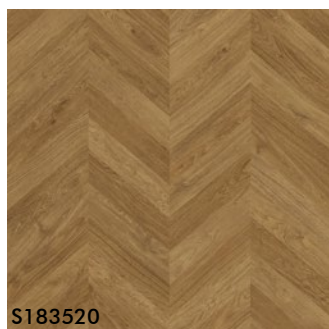

S183520

Amazona

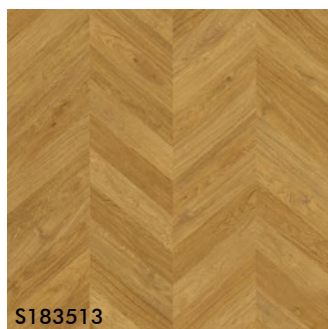

S183513

Congo

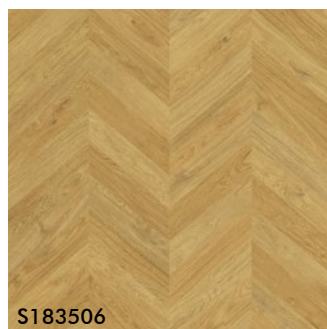

S183506

Nilo

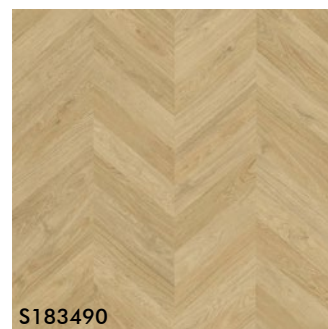

S183490

Obi



Amazona S183520





# VINÍLICO SPC



# Colección CLASSIC

**GARANTÍA**  
**20 años**  
uso doméstico

**GARANTÍA**  
**10 años**  
uso comercial

## Diseños de madera clásicos con formato estándar de alta resistencia

- Apto para uso comercial
- Resistente al agua  
100% waterproof
- Sistema clic Unilin
- Reacción al fuego  
Bfl-s1  
EN ISO 11925
- Antiestático  
EN1815
- Antirayadas  
EN 438-2, 25

- 100% resistente al agua.
- Microbisel en los 4 lados
- Instalaciones hasta 12x12m sin juntas de dilatación.
- Base IXPE de 1,5mm incluida

- Antimanchas  
EN 438
- Resistencia al impacto  
ASTM F1265
- Apto para calefacción radiante



<b>CAJA</b>	8 piezas	1,76 m <sup>2</sup>	18,50 kg
<b>PALET*</b>	55 cajas	96,80 m <sup>2</sup>	1017,5 kg

\*Las cantidades pueden variar

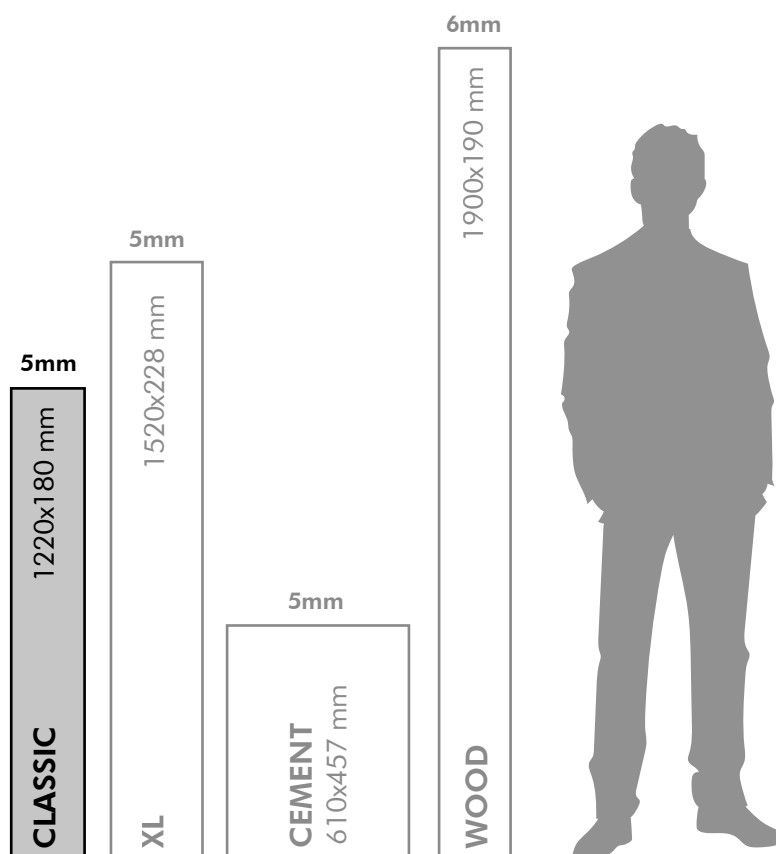



MEDIDAS: 1220 x 180 x 5 (+1.5) mm



Z108

Ártico



Z110

Roble Ceniza



Z111

Tostado Sil

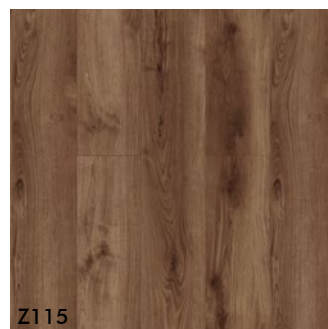

Z115

Ares



Z117

Bohemia



Z118

Perlado



Z119

Clásico



Z120

Bali



Roble Ceniza



**GARANTÍA**  
**20 años**  
uso doméstico

**GARANTÍA**  
**10 años**  
uso comercial

Colección  
**XL**

## Acabados de madera con textura sincronizada en formato largo

- Apto para uso comercial
- Resistente al agua
- Sistema clic Unilin
- Reacción al fuego EN ISO 11925 Bfl-s1
- Antiestático EN1815
- Antirayadas EN 438-2, 25

- 100% resistente al agua.
- Microbisel en los 4 lados.
- Instalaciones hasta 12x12m sin juntas de dilatación.
- Base IXPE de 1,5mm incluida.

- Antimanchas EN 438
- Resistencia al impacto ASTM F1265
- Apto para calefacción radiante



<b>CAJA</b>	5 piezas	1,73 m <sup>2</sup>	18 kg
<b>PALET*</b>	80 cajas	138,40 m <sup>2</sup>	1440 kg

\*Las cantidades pueden variar

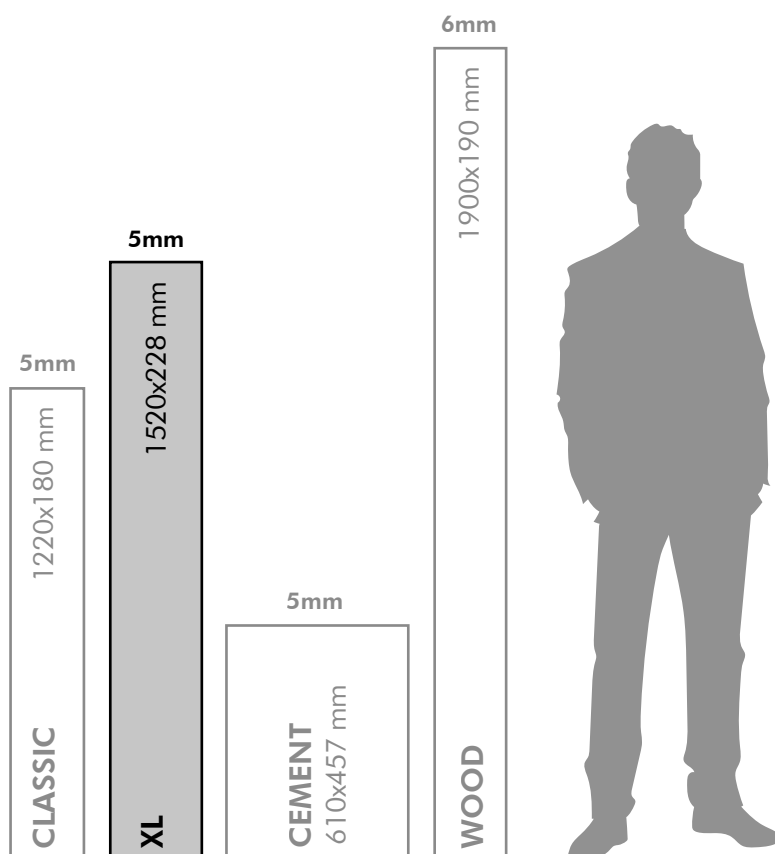



Z209  
Ohio Oak



Z212  
Harlem Oak



Z214  
Montana Oak



Z215  
Brooklyn Oak



Z220  
Soho Oak



Z222  
California Oak



Z223  
Queens Oak



**MÁS REALISMO**  
El relieve coincide con el dibujo  
de las vetas y nudos de la madera

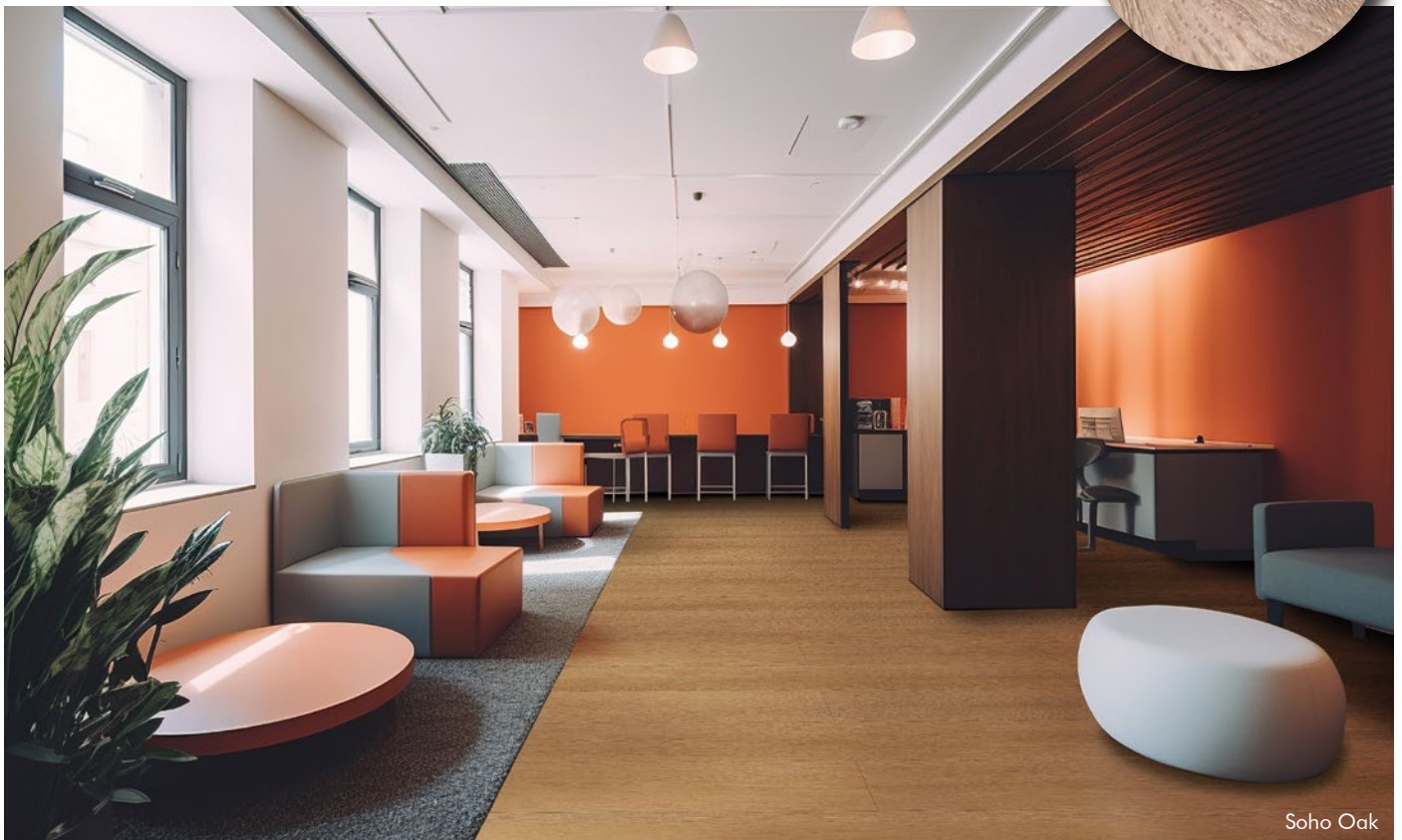

Soho Oak



# Colección CEMENT

**GARANTÍA**  
**20 años**  
uso doméstico

**GARANTÍA**  
**10 años**  
uso comercial

## Diseños de cemento con acabado texturizado en formato loseta

- Apto para uso comercial
- Resistente al agua  
100% waterproof
- Sistema clic Unilin
- Reacción al fuego  
Bfl-s1  
EN ISO 11925
- Antiestático  
EN1815
- Antirayadas  
EN 438-2, 25

- 100% resistente al agua.
- Microbisel en los 4 lados.
- Instalaciones hasta 12x12m sin juntas de dilatación.
- Base IXPE de 1,5mm incluida.

- Antimanchas  
EN 438
- Resistencia al impacto  
ASTM F1265
- Apto para calefacción radiante



<b>CAJA</b>	6 piezas	1,67 m <sup>2</sup>	18 kg
<b>PALET*</b>	68 cajas	113,56 m <sup>2</sup>	1250 kg

\*Las cantidades pueden variar

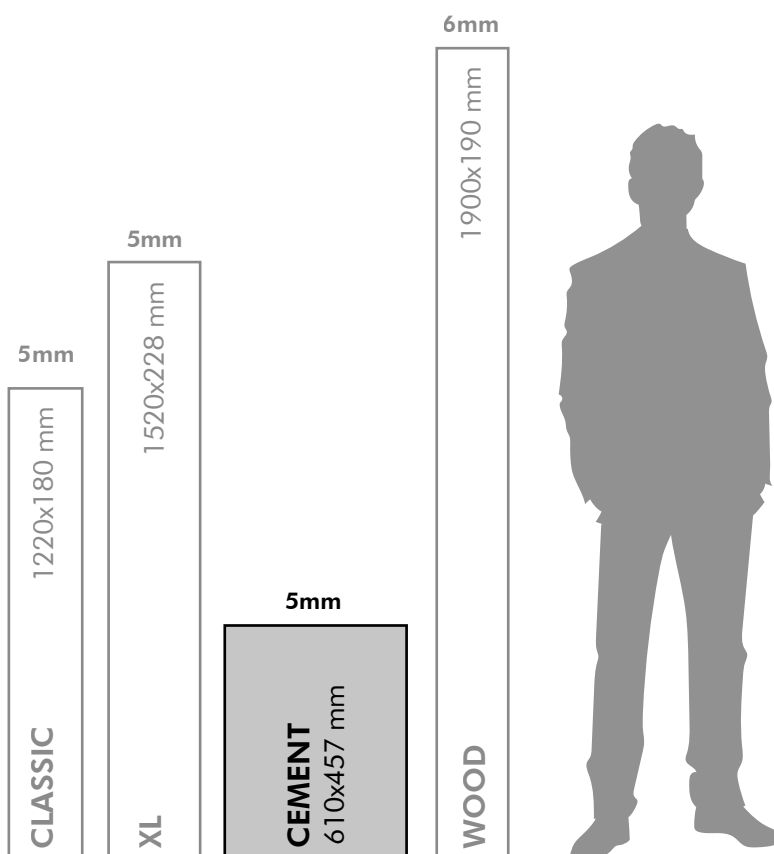

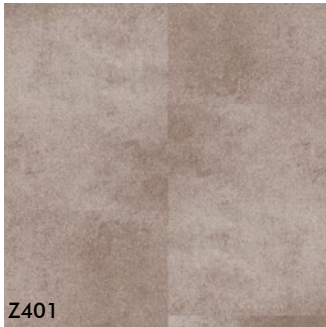

Z401  
Arenal Stone



Z402  
Teide Stone

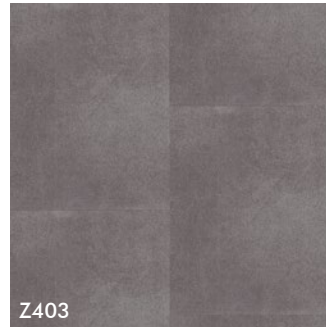

Z403  
Etna Stone



Z404  
Osorno



Osorno



# Colección WOOD

**GARANTÍA 20 años**  
uso doméstico

**GARANTÍA 10 años**  
uso comercial



Apto para uso comercial



Resistente al agua



Sistema clic Uniclic



Reacción al fuego EN ISO 11925

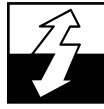

Antiestático EN1815



Antirayadas EN 438-2, 25

- 100% resistente al agua.

- Microbisel en los 4 lados.

- Instalaciones hasta 12x12m sin juntas de dilatación.

- Capa de madera real de 1,2mm.

- Base IXPE de 1,5mm incluida.



Antimanchas EN 438



Resistencia al impacto ASTM F1265



Apto para calefacción radiante



<b>CAJA</b>	6 piezas	2,166 m <sup>2</sup>	17 kg
-------------	----------	----------------------	-------

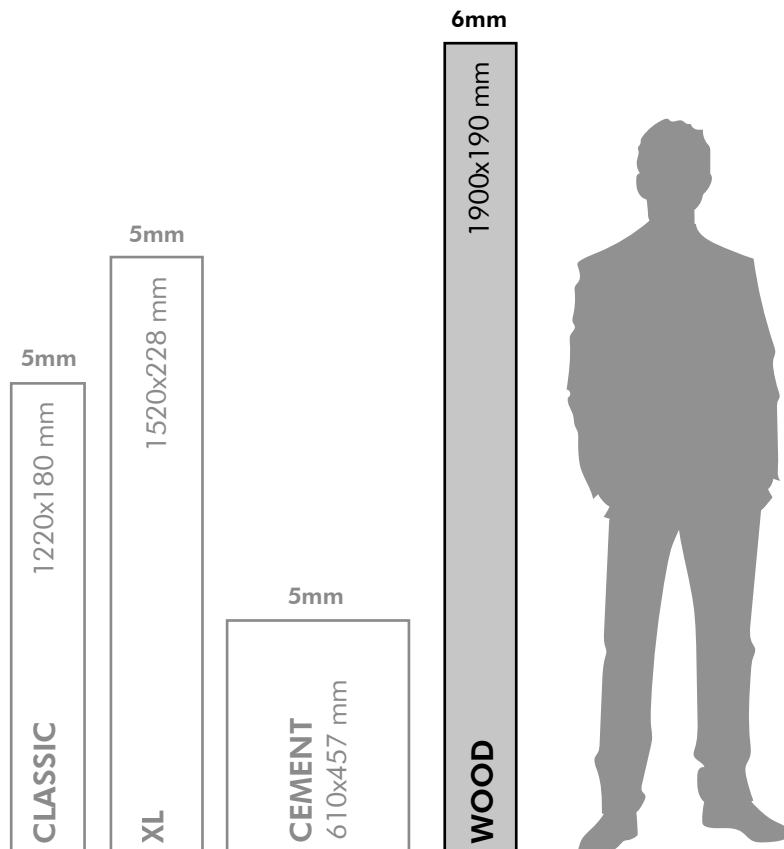

MEDIDAS: 1900 x 190 x 6 (+1,5) mm



ZW410

Oak Natur

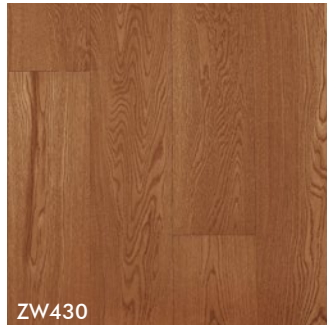

ZW430

Oak Caramel

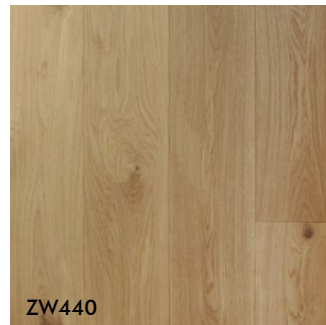

ZW440

Oak Invisible



Oak Caramel

- Resistentes a la humedad.
- Diseño igual al pavimento.
- Disponibles para todas las referencias de las gamas Classic, Cement y XL.

Harlem Oak

**RODAPIÉ**

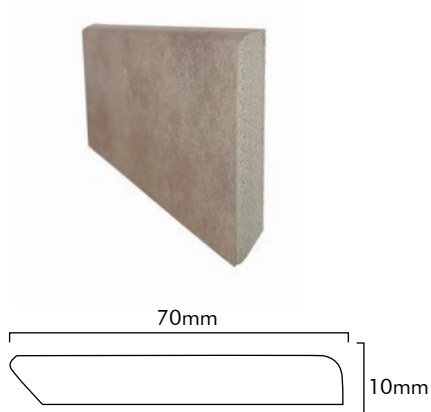

Para rematar la instalación contra las paredes. Fácil de instalar. Largo de 2030 mm.

**PERFIL DE TRANSICIÓN**

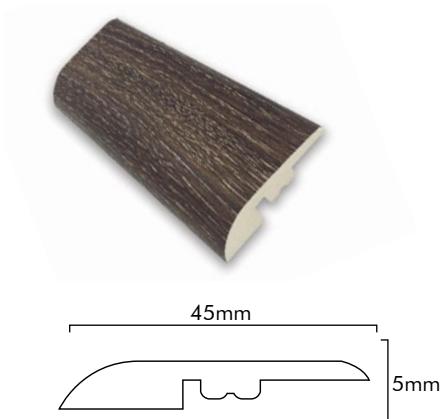

Para utilizar cuando hay un encuentro con pavimento a otro nivel. Largo de 2400mm.

**PERFIL DE DILATACIÓN**

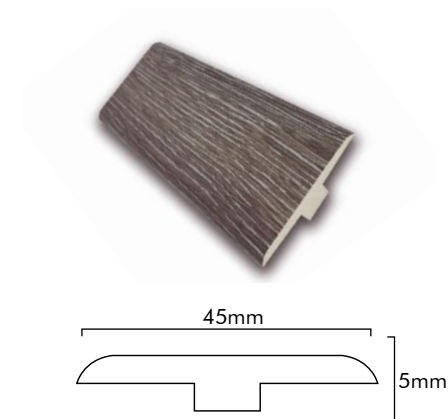

Para encuentros con otros pavimentos al mismo nivel, pasos de puerta o como junta de dilatación en espacios que superen los 12x12m. Largo de 2400mm.



Ártico



- Resistentes a la humedad.
- Diseño igual al pavimento.
- Disponibles para todas las referencias de las gamas Classic, Cement y XL.



Harlem Oak

MAMPERLÁN RECTO



Fabricado a medida según necesidades del proyecto. El largo depende de la colección.

MAMPERLÁN CON RETORNO

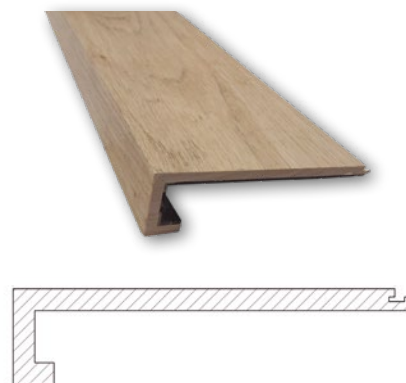

Fabricado a medida según necesidades del proyecto. El largo depende de la colección.

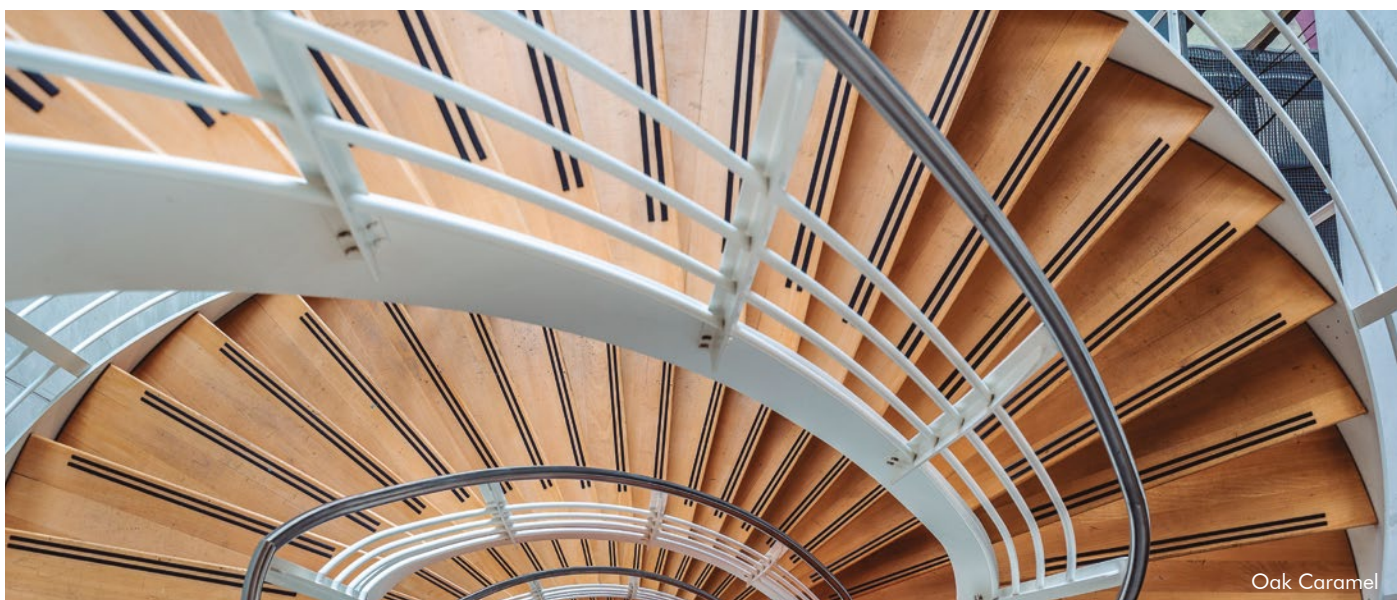

Oak Caramel





# PARQUET



Roble Caramel Purístico



# Colección TREND

## Selección de parquet de roble en colores populares con superficie aceitada mate



Reacción al fuego EN13501



Apto para calefacción radiante

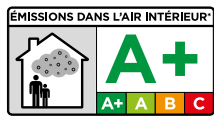

- Superficie cepillada.
- Acabado aceitado *Innovo Natur*.
- Biselado 2 lados.
- Instalación flotante con clic *Powerfix*.
- Apropiado para estancias domésticas con una HRA habitual del 40 % al 60 % y de 16 °C a 24°C.

CAJA	6 piezas	2,328 m <sup>2</sup>	16,98 kg
PALET	48 cajas	111,744 m <sup>2</sup>	815,04 kg



MADERA NOBLE 3.2 mm

NÚCLEO DE ABETO

CONTRACHAPADO MADERA BLANCA

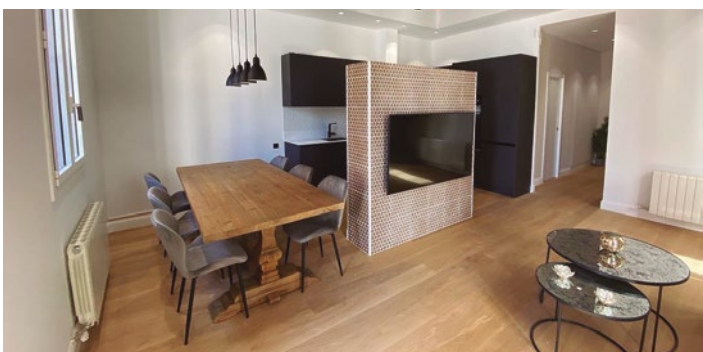

Todas las referencias disponibles en dos selecciones, según el aspecto que se le quiera dar a las estancias.

### SELECCIÓN PURÍSTICA

Maderas escogidas y preseleccionadas con un aspecto tranquilo y uniforme. Los nudos aparecen de forma aislada y apenas hay grietas y surcos.



### SELECCIÓN MARCANTO

Maderas con un toque expresivo y animado. Con algunos nudos y grietas que aportan vitalidad y un aspecto más rústico.



MEDIDAS: 2205 x 176 x 13/3.2 mm



L1411 - Roble Natur Purístico



L1278 - Roble Natur Marcanto



L1414 - Roble Caramel Purístico



L1279 - Roble Caramel Marcanto

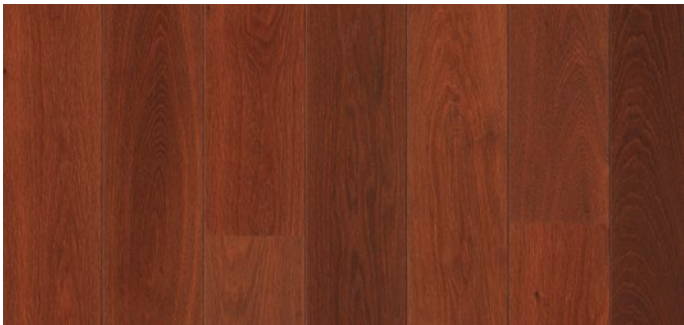

L1416 - Roble Mocca Purístico

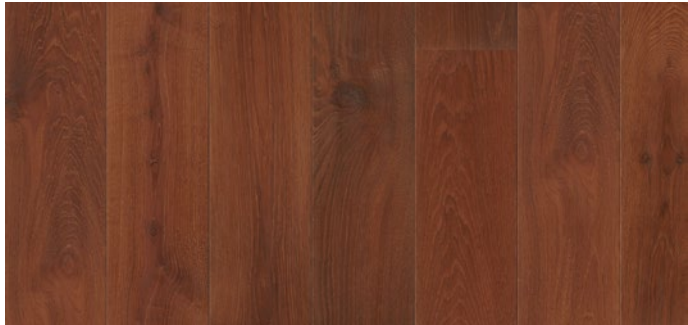

L1280 - Roble Mocca Marcanto



Roble Natur Purístico

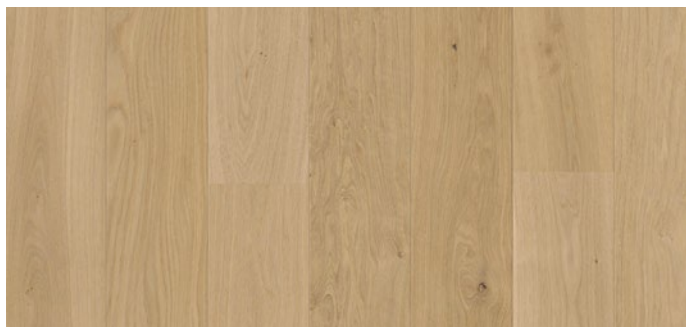

L1746 - Roble Natur Pur Purístico



L1278 - Roble Natur Pur Marcanto

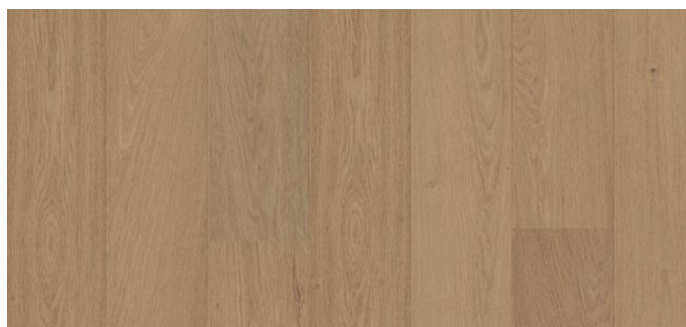

L1821 - Roble Crema Pur Purístico

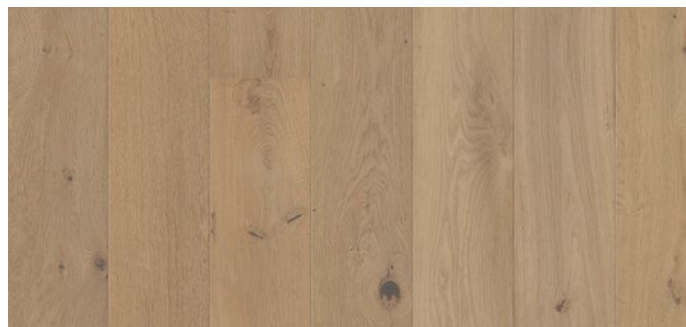

L1797 - Roble Crema Pur Marcanto

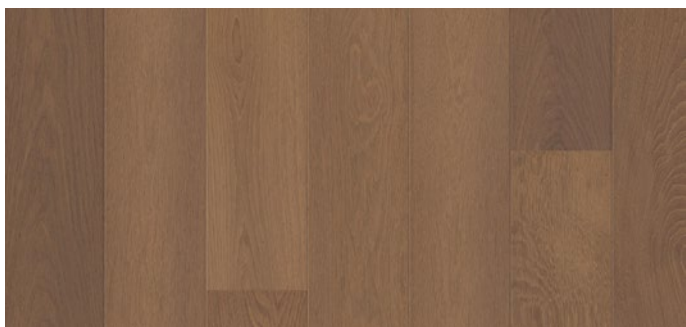

L1822 - Roble Cafe Pur Purístico

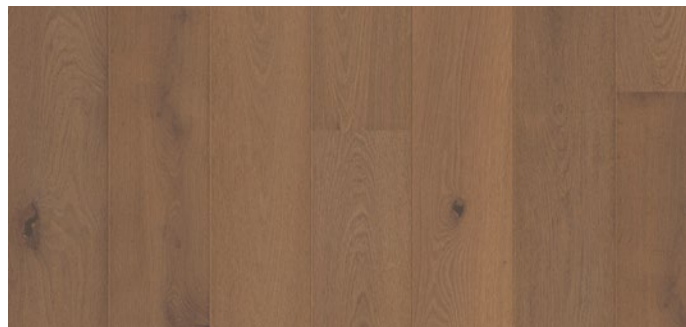

L1798 - Roble Cafe Pur Marcanto



Roble Crema Pur Purístico

MEDIDAS: 2205 x 176 x 13/3.2 mm

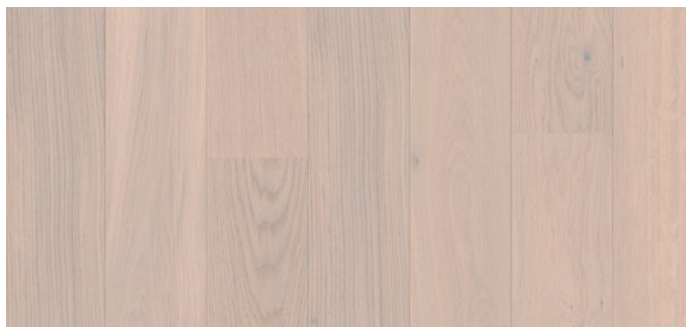

L1407 - Roble Edelweiss Purístico

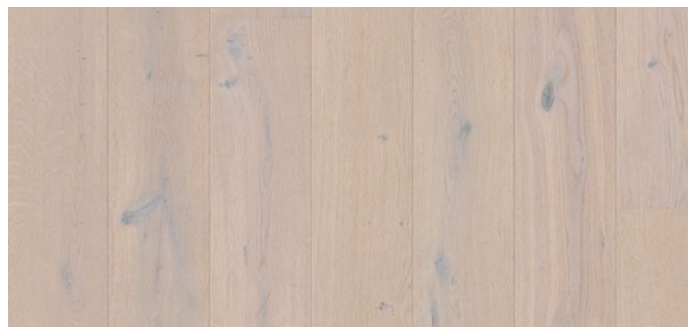

L1419 - Roble Edelweiss Marcanto



L1408 - Roble Weiss Purístico

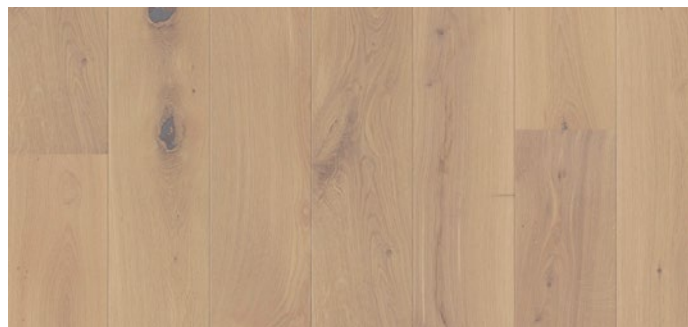

L1277 - Roble Weiss Marcanto

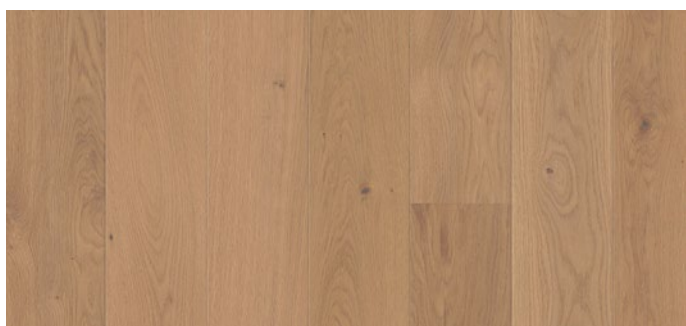

L1409 - Roble Champagne Purístico

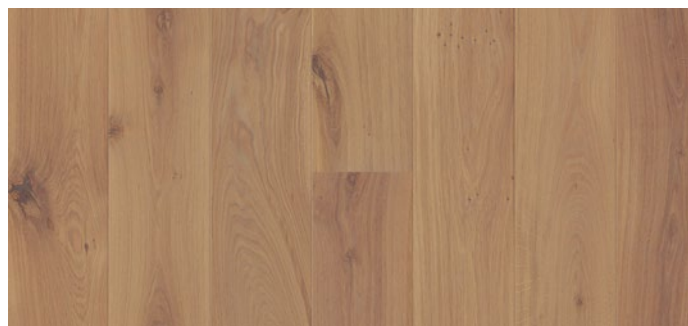

L1623 - Roble Champagne Marcanto



Roble Weiss Marcanto



**MEDIDAS: 2205 x 176 x 13/3.2 mm**



L1410 - Roble Sahara Purístico



L1281 - Roble Sahara Marcanto

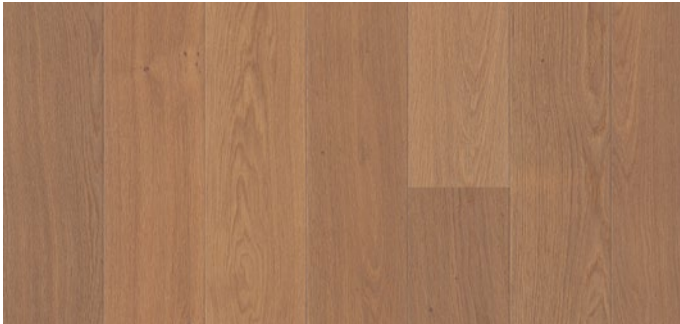

L1413 - Roble Melange Purístico



L1625 - Roble Melange Marcanto

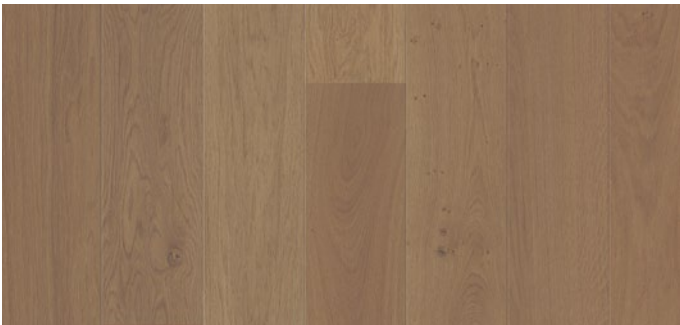

L1417 - Roble Fels Purístico



L1627 - Roble Fels Marcanto



## COMPLEMENTOS Y ACCESORIOS

### RODAPIÉS



Disponibile en todas las referencias.  
Fácil de instalar. Con pasacables.  
Medidas: 50 x 16 x 2500 mm.

### LIMPIEZA Y MANTENIMIENTO



Productos de limpieza y mantenimiento ordinarios o intensivos especialmente elaborados para suelos de madera natural aceitados o barnizados.



Roble Natur

# Colección OCEAN



## Roble natural acabado en 3 lamas

MEDIDAS: 2205 x 206 x 13/3.2 mm



Reacción al fuego EN13501



Apto para calefacción radiante



- Superficie pulida.
- Acabado barnizado.
- Sin bisel
- Instalación flotante con clic *Powerfix*.
- Apropiado para estancias domésticas con una HRA habitual del 40 % al 60 % y de 16 °C a 24°C.

CAJA	6 piezas	2,725 m <sup>2</sup>	19,92 kg
PALET	45 cajas	122,62 m <sup>2</sup>	897 kg



- MADERA NOBLE 3.2 mm
- NÚCLEO DE ABETO
- CONTRACHAPADO MADERA BLANCA

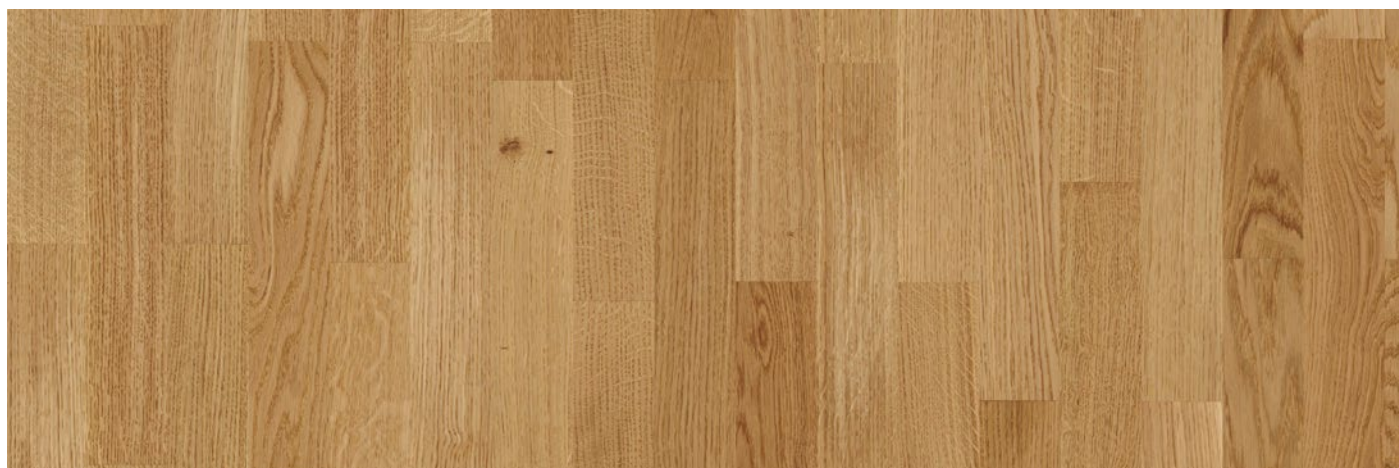

S1102 - Roble Natur





Colección  
**SATIN ELEMENTS**

GARANTÍA  
**30 años**  
uso doméstico

Madera de haya acabado en 3 lamas

MEDIDAS: 2390 x 200 x 13/3.2 mm



Reacción al fuego  
EN13501



Apto para calefacción radiante



- Superficie pulida.
- Acabado barnizado.
- Sin Bisel
- Instalación flotante con clic 5G.

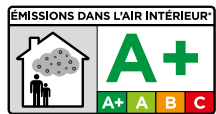

CAJA	7 piezas	3,346 m <sup>2</sup>	22 kg
PALET	35 cajas	117,11 m <sup>2</sup>	785 kg



- MADERA NOBLE 3.2 mm
- NÚCLEO MADERA MACIZA
- CONTRACHAPADO MADERA MACIZA

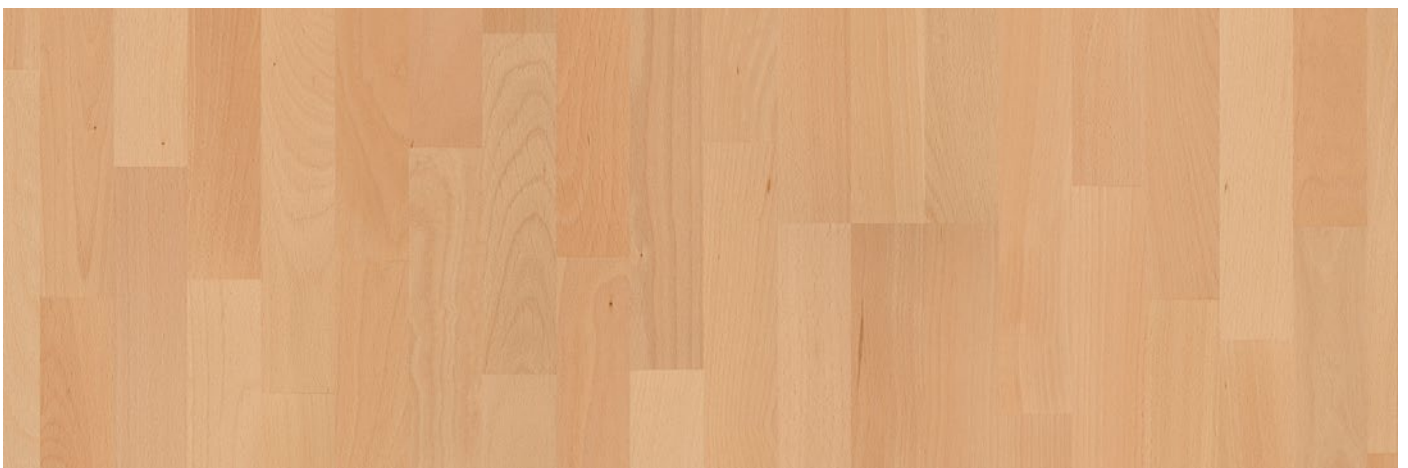

U03- Haya 3 lamas





## Parquet natural bicapa con diferentes acabados y espesores



Reacción al fuego  
EN13501-1



Apto para calefacción radiante



Antideslizante  
EN 12633



- Superficie ligeramente cepillada.
- Acabado barnizado.
- Microbiselado 2 lados.
- Instalación sistema machi-hembrado.
- Largo variable.



MADERA NOBLE

CONTRACHAPADO DE ABEDUL

## PARQUET A LA CARTA BAJO PEDIDO

- Disponible en diferentes maderas: Arce, Nogal, Teka, Sapelly, Iroko, Doussie
- 6 anchos a elegir. 90 - 120 - 140 - 180 - 220 - 250 mm
- Capa de uso en 3 espesores disponibles: 2,5 - 3 - 4 mm
- 3 acabados: Natur, Select o Rústico
- Diferentes formatos

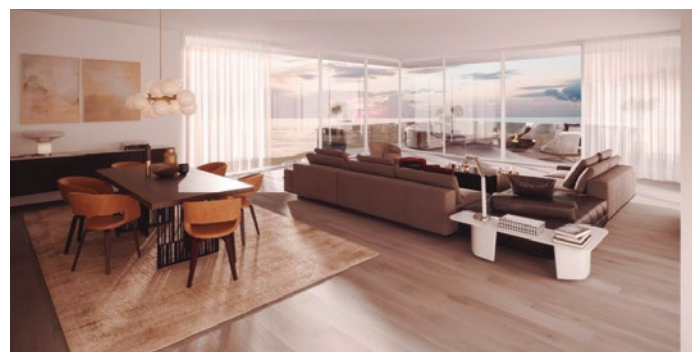

Roble Natur Invisible



Roble Natur 5%





GARANTIA  
25 años  
uso doméstico

## Parquet natural bicapa con microbisel en los 4 lados



Apto para calefacción radiante



- Superficie ligeramente cepillada.

- Acabado barnizado.

- Tinte reactivo.

- Microbiselado 4 lados. 

- Instalación sistema machi-hembrado.



MADERA NOBLE 3 mm

CONTRACHAPADO DE ABEDUL



MEDIDAS: 190 x 14/3 x 1900 mm/ 240 x 14/3 x 2200 mm

Diseños disponibles en dos selecciones:

NATUR (190 x 1900 o 240 x 2200 mm). Madera limpia sin nudos ni marcas pronunciadas.  
SELECT (190 x 1900 mm). Madera con nudos, grietas y marcas con un estilo más rústico.



Roble Nuii

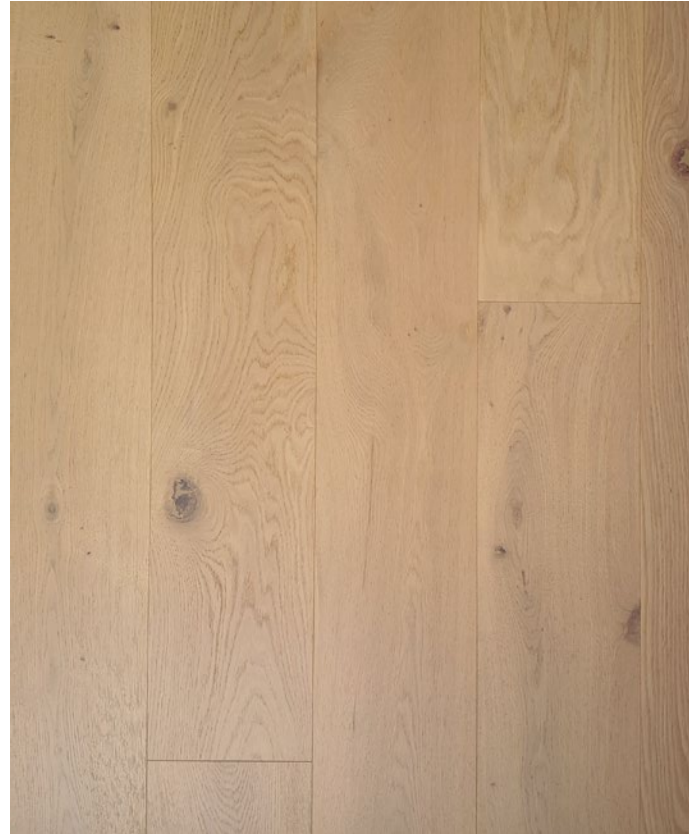

Roble Yuma



Roble Yuma

SELECCIÓN SELECT. Madera con nudos, grietas y marcas con un estilo más rústico.

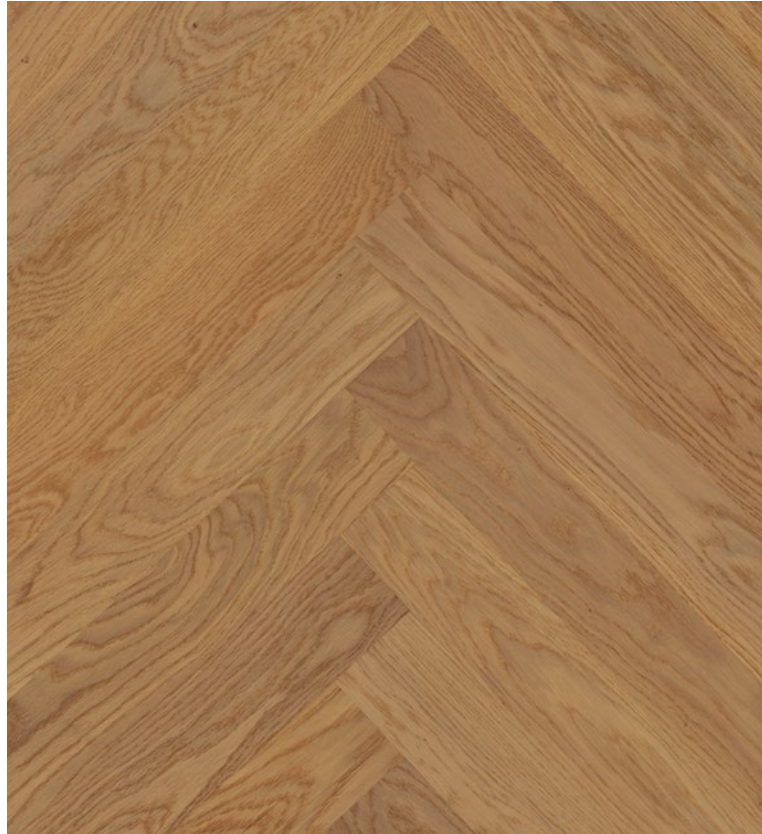

Herringbone





SELECCIÓN SELECT. Madera con nudos, grietas y marcas con un estilo más rústico.

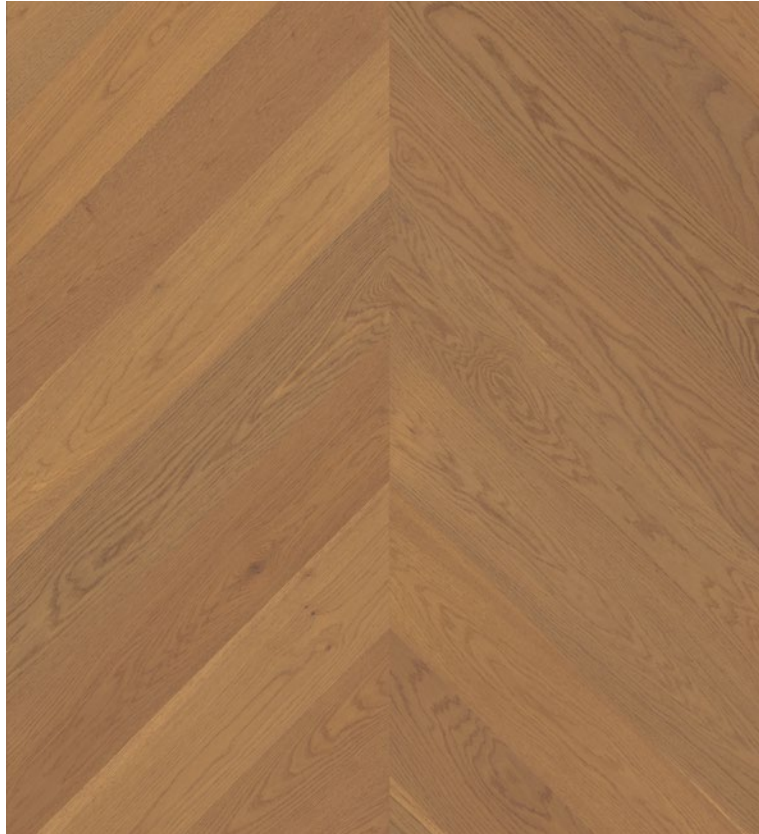

Chevron



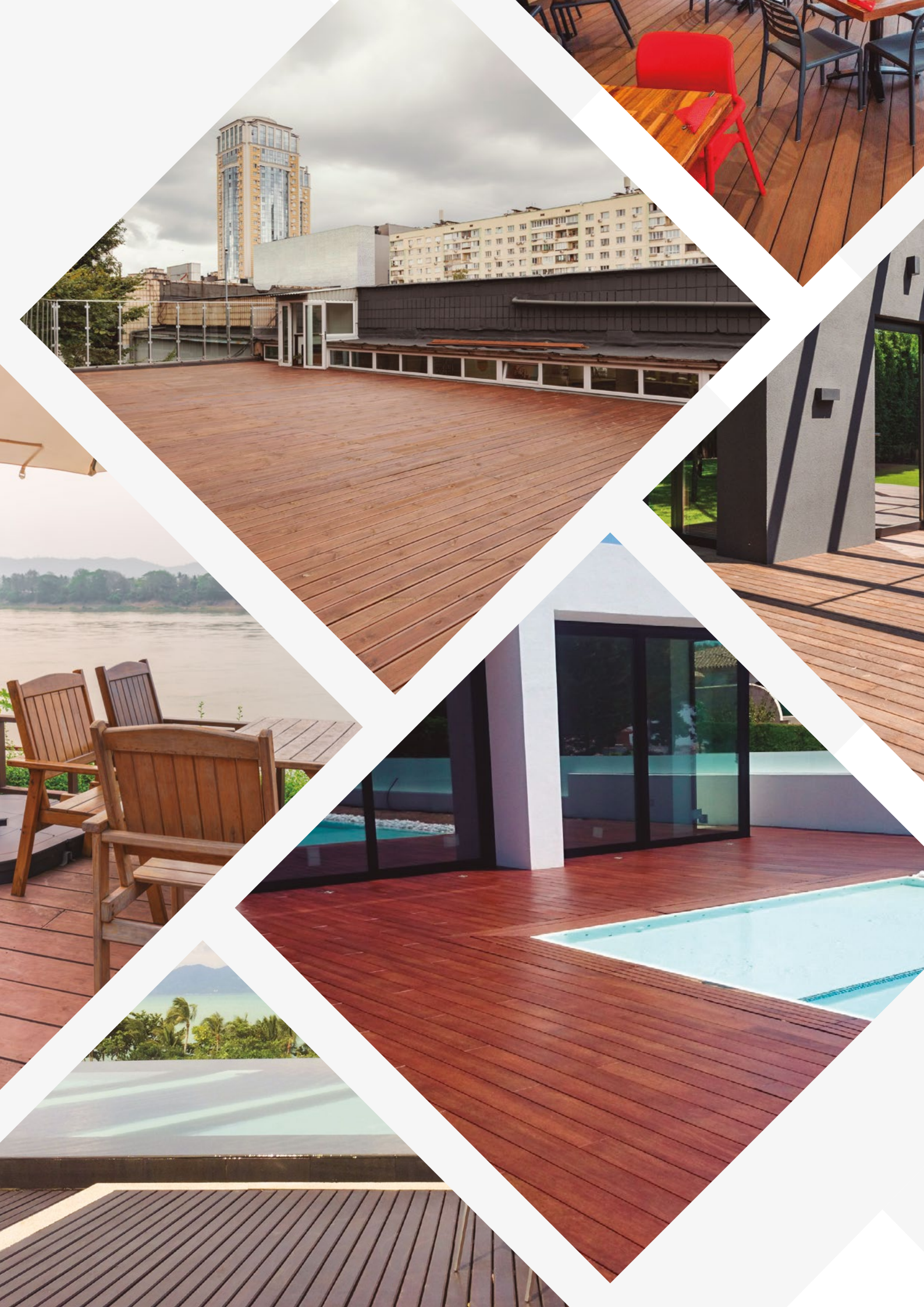



# EXTERIOR



**GARANTÍA**  
**25 años**  
uso doméstico

**GARANTÍA**  
**10 años**  
uso comercial

# Tarima TECNOLÓGICA/WPC

**MEDIDAS: 2200 x 138 x 22 mm**



Antideslizante  
Clase 3



Antimanchas



Resistente a  
los rayos UV

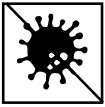

Anti-hongos



Anti-rayadas

- Piezas con color reversible.
- No necesita mantenimiento.
- Estructura alveolar con autoventilación.
- Antideslizante. Apta para colocar en zonas de piscina.
- Resistente a los rayos UV y a las inclemencias meteorológicas.

M <sup>2</sup>	22 Grapas	3,5ml de rastrel
----------------	-----------	------------------

Roble/Gris



IPE/Teka



Tarima tecnológica Roble



Tarima tecnológica IPE



GARANTÍA  
**25 años**

# Tarima natural BAMBÚ

**MEDIDAS: 1850 x 137 x 20 mm**

 Durabilidad Clase 1	 Reacción al fuego Bfl-s1	 FSC www.fsc.org
 Anti-hongos y anti-moho	 Anti-termitas	 Respetuoso con el medio ambiente

- Producto natural.
- Piezas reversibles (Liso o estriado).
- Acabado aceitado.
- No se sobrecalienta con la acción solar.
- Machihembrado de testa.
- Densidad/durabilidad 1100-1200 kg/m<sup>3</sup>

M <sup>2</sup>	22 Grapas	3,5ml de rastrel
----------------	-----------	------------------

**XTR color café**



El proceso de fusión patentado por dassoXTR® extrae los azúcares y almidones de las fibras de bambú y los reemplaza por resinas fenólicas. Luego, las fibras impregnadas se comprimen para crear Fused Bamboo®: muy duro, denso y duradero contra bacterias, hongos y otros microorganismos.

**CTECH color caramelo**



Dasso CTECH® cristaliza las fibras con partículas de CeramiX®, las impregna con resina fenólica y luego se comprime para formar Fused Bamboo. Las partículas de CeramiX® cristalizan los nutrientes para evitar bacterias, hongos, mohos o insectos. Estas fibras no se pudren en ambientes expuestos.





# Tarima natural IPE GRAPA VISTA

**MEDIDAS: 100 x 21 mm**



Antideslizante



Alta Durabilidad



Reacción al fuego Cl s1



Anti-hongos



Anti termitas



- Madera natural IPE.
- Largo variable.
- Densidad aparente al 12% de humedad 1050 kg/m<sup>3</sup>.
- Acabado base agua. 2 capas de Saturador Sikkens Cetol WF 771
- Bajo mantenimiento. *Certificación Sikkens* contra la fotodegradación (12 meses).
- Antideslizante. Apta para colocar en zonas de piscina.
- No se sobrecalienta con la acción solar.

M <sup>2</sup>	22 Grapas	3,5ml de rastrel
----------------	-----------	------------------

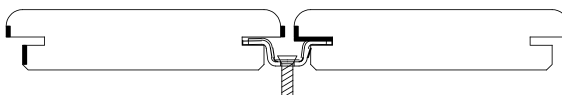

Tarima natural IPE

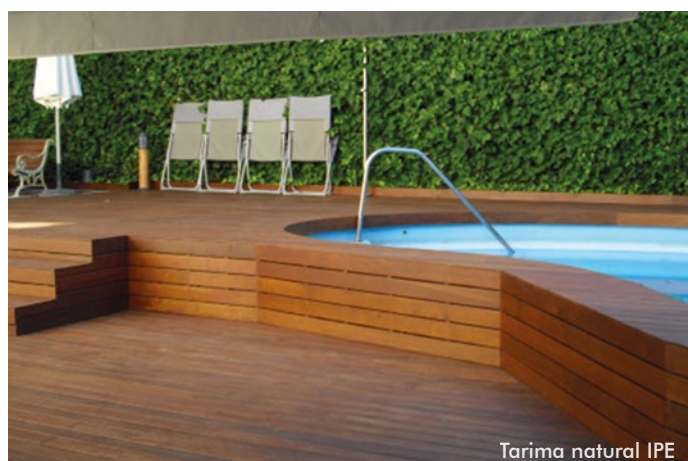

Tarima natural IPE



Tarima natural  
**IPE GRAPA OCULTA**

**MEDIDAS: 100 x 21 mm**



Antimanchas



Alta Durabilidad



Anti-hongos



Anti termitas

- Madera natural IPE.
- Largo variable.
- Densidad aparente al 12% de humedad 1050 kg/m<sup>3</sup>.
- Fijación con grapas.
- No se sobrecalienta con la acción solar.

M <sup>2</sup>	22 Grapas	3,5ml de rastrel
----------------	-----------	------------------

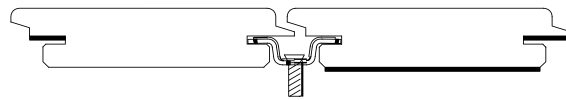
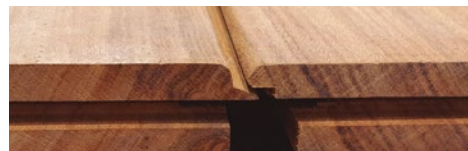

Tarima IPE grapa oculta



Tarima IPE grapa oculta



# Tarima natural PINO AUTOCLAVE



Anti-hongos



Anti-termitas



Clase de uso



PEFC  
10-32-73



FSC  
www.fsc.org

- Madera natural.
- Tratamiento autoclave.
- Fijación con tornillos de acero inoxidable.
- Clase de uso 4. En contacto con el suelo o en vertical con humedad permanente superior al 20%.

Caribe

MEDIDAS: 4000 x 120 x 28 mm

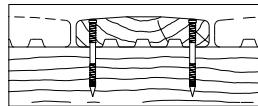

- Color marrón por impregnación.
- Perfil abombado para facilitar el drenaje de agua y reducir la resbaladidad.
- Extremos rectos.
- Distancia recomendada entre rastreles: 60cm

Aruba

MEDIDAS: 2500 x 120 x 22 mm

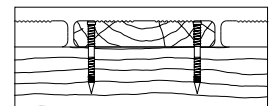

- Color marrón por impregnación.
- Estriada.
- Machihembrado de testa.
- Distancia recomendada entre rastreles: 50cm



Tarima natural Caribe



Tarima natural Aruba



# Tarima natural DOUGLAS AUTOCLAVE



Alta Durabilidad



Clase de uso 3.2



- Madera natural.
- Tratamiento autoclave.
- Fijación con tornillos de acero inoxidable.
- Alta resistencia a cambios de temperatura.
- Mayor densidad. Ideal para espacios muy transitados.

Lavezzi

MEDIDAS: 4000 x 145 x 28 mm

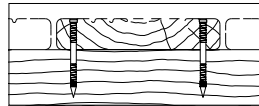

- Color marrón o gris por impregnación.
- Ranurada.
- Machihembrado de testa.
- Distancia recomendada entre rastreles: 60cm
- Garantía 10 años sin contacto con el suelo.

Calypso

MEDIDAS: 4000 x 145 x 28 mm

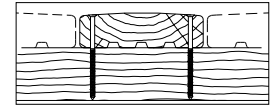

- Color natural.
- Perfil abombado para facilitar el drenaje de agua y reducir la resbaladidad.
- Extremos rectos.



Tarima natural Lavezzi



Tarima natural Calypso



GARANTÍA  
25 años

## Tarima natural THERMOPINE

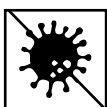

Anti-hongos



Anti-termitas



Clase de uso  
3.2



- Madera natural termotratada.

- Tratamiento térmico a base de agua y calor. Sin químicos.

- Fijación con tornillos de acero inoxidable.

- Alta estabilidad dimensional.



Alta  
Durabilidad



Reacción  
al fuego  
D-s2 d0



Alto aislamiento  
térmico



Pino termotratado liso / antideslizante MEDIDAS: 130 x 26 mm

Fresno termotratado antideslizante MEDIDAS: 100 x 20 mm





**RASTREL PINO CUPERIZADO**



Madera de pino tratada con autoclave para la resistencia a cambios climáticos, hongos e insectos.  
Medidas: 50x40 mm

**RASTREL TROPICAL**



Fabricado con maderas tropicales. Alta densidad, dureza y resistencia.  
Medidas: 50x30 mm

**RASTREL SINTÉTICO**



Fabricado con WPC. No le afecta la humedad.  
Medidas: 50x30mm

**GRAPA POLIPROPILENO**



Venta por unidades sueltas.

**GRAPA ACERO INOXIDABLE**



Venta en caja de 100 uds.

**GRAPA DASSO**



Venta en caja de 80 uds.

**PLOTS DE ELEVACIÓN**



Disponibles en diferentes medidas.



Tarima bambú CTECH





# PAREDES



Amber Oak 215/ Marble white 907

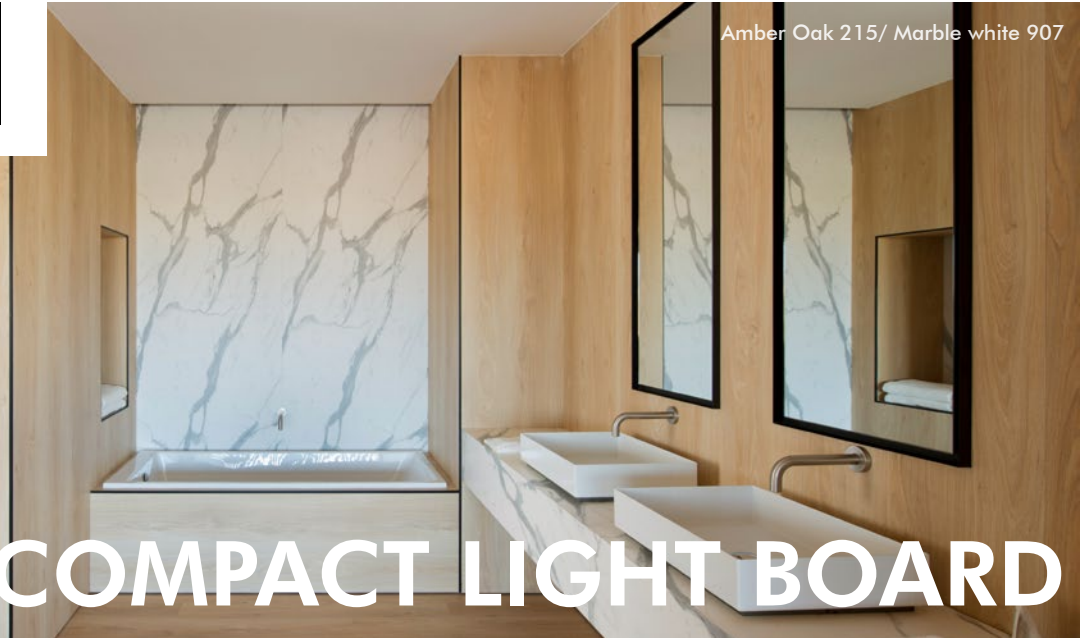

**GARANTÍA**  
**20 años**  
uso doméstico

**GARANTÍA**  
**10 años**  
uso comercial

# COMPACT LIGHT BOARD

## CLB: revestimiento de paredes para zonas húmedas de fácil instalación

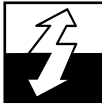

Resistencia a la abrasión

Antiestático EN1815

Reacción al fuego EN13501

Antirayadas EN 438-2, 25

Resistencia al impacto EN 13329

**MEDIDAS: 2500 x 1200 x 5,5 mm**

- 100% resistente al agua.
- Higiénico y antialérgico.
- Apto para zonas de duchas.
- Instalación directa encolado a la pared.
- Unión entre tableros: ranura y falsa lengüeta

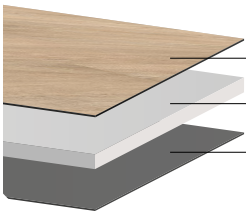

LAMINADO HPL DECORATIVO

NÚCLEO CENTRAL HDP

LAMINADO HPL DECORATIVO



Lado decorativo



901  
Loft Cement



902  
Cloud

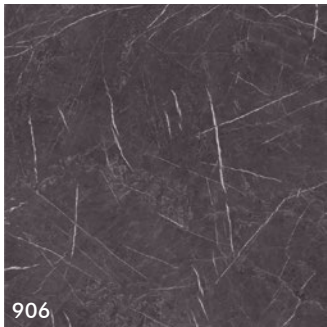

906  
Marble Black

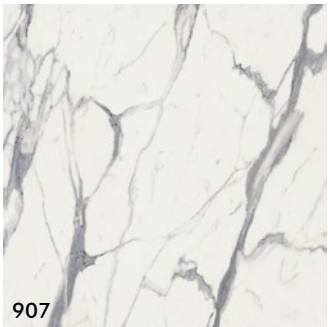

907  
Marble White

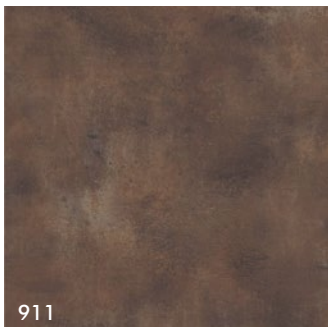

911  
Oxid Stone



206  
Natural Oak

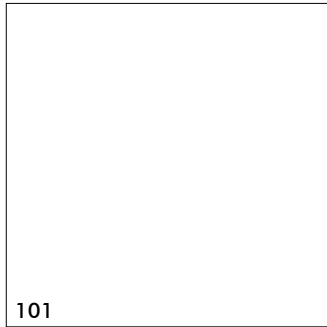

101  
Blanco (Mate o Antihuella)

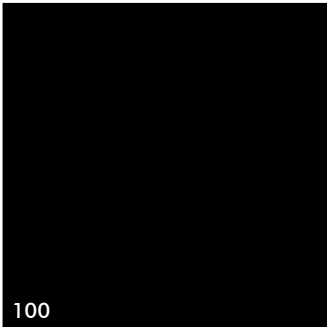

100  
Negro (Mate o Antihuella)



# PANEL ACÚSTICO DECORATIVO

**Paneles decorativos de madera natural con aislamiento acústico**

**MEDIDAS: 2400 x 600 x 21 mm**



Aislamiento acústico



- Núcleo MDF con chapa de madera natural.
- 15 listones por pieza.
- Filtro aislante acústico.
- Excelente reducción de sonido.
- Instalación fácil y rápida. Encolado o atornillado.
- Techos, paredes o mobiliario.

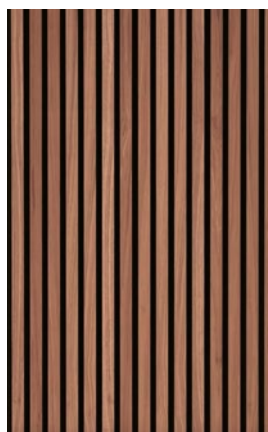
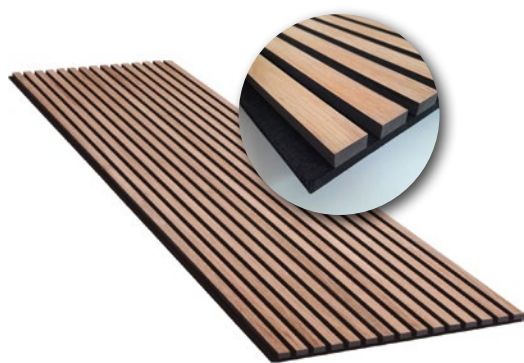

Walnut KSL-WA01



Dark Smoke KSL-SO01

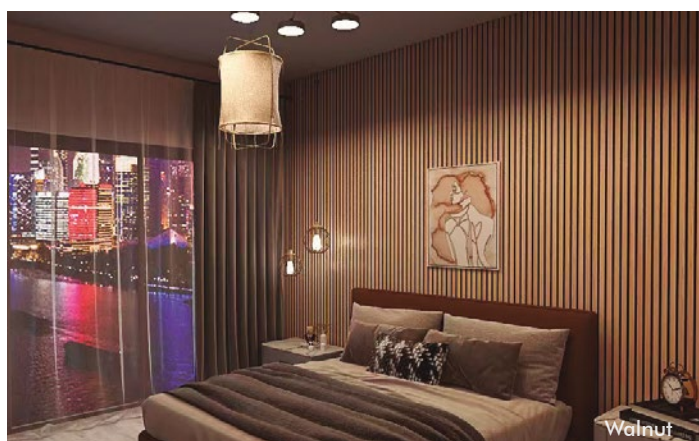

Walnut



Walnut



GARANTÍA  
**10 años**

## PANEL MINERAL

Revestimiento decorativo de gran formato con diferentes acabados



Antimanchas  
EN 14428

Resistencia  
al impacto  
UNE-EN 14323

Reacción  
al fuego  
EN13501

Antirayadas  
UNE-EN 15186

- 100% resistente al agua.
- Ignífugo (sólo versión FR)
- Alta estabilidad dimensional.
- Antibacteriano.
- Apto para zonas de duchas.
- Instalación directa encolado a la pared.
- Diferentes acabados según referencia:

- AB** Alto brillo
- MT** Mate texturizado
- UM** Ultra-mate (Antihuella)

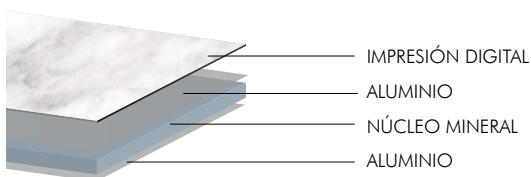

MEDIDAS PE: 2440 x 1220 x 4 mm (Mate Tex)  
MEDIDAS FR: 2600 x 1220 x 4 mm (Mate Tex)

Colección  
**CONCRETE**



KB09  
Chronic

**PE MT FR MT**



KB23  
Concrete B

**PE MT FR MT**



KB34  
Urban Concrete

**FR MT**



**MEDIDAS PE:** 2440 x 1200 x 4 mm (Alto brillo y ultramate)/ 2440 x 1220 x 4 mm (Mate Tex)  
**MEDIDAS FR:** 2600 x 1200 x 4 mm (Alto brillo y ultramate)/ 2600 x 1220 x 4 mm (Mate Tex)

Colección  
**MARBLE**

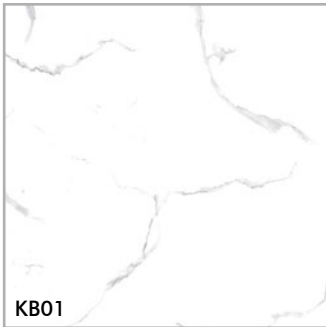

KB01

Mud

PE AB MT FR AB MT

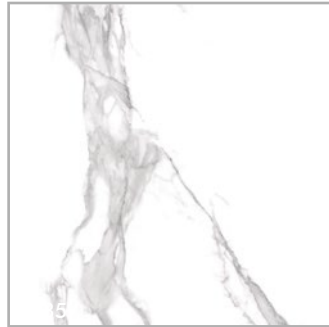

Carrara

PE AB FR AB

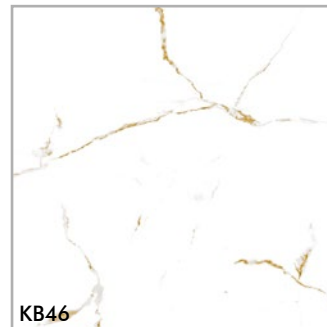

KB46

Calacata Gold

PE AB FR AB

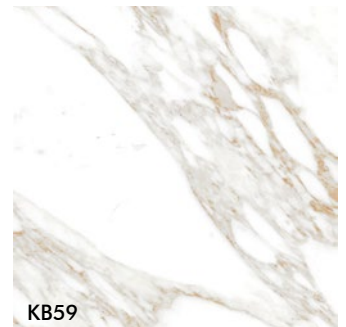

KB59

Sandstorm

FR AB

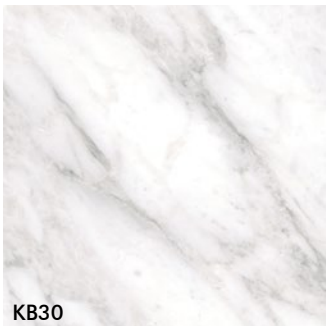

KB30

Versilia

FR AB



KB58

Everest

PE MT FR UM



KB29

Sabana

FR AB



KB29

Sabana Bookmatch

FR AB

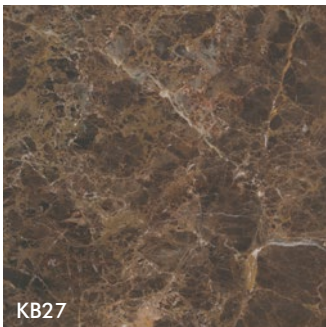

KB27

Emperador

FR AB

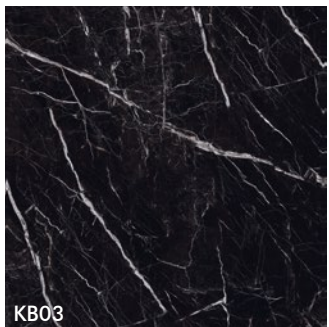

KB03

Infinite

PE AB MT FR AB

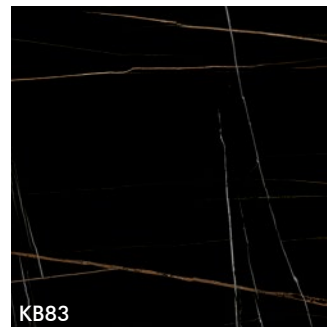

KB83

Tramonto

PE UM FR UM



Infinite KB03

Laminado

Vinílico SPC

Parquet

Exterior

Paredes

Perfilería y complementos

Barnices, adhesivos y reparación

Herramientas

**MEDIDAS PE:** 2440 x 1220 x 4 mm (Mate Tex)

**MEDIDAS FR:** 2600 x 1200 x 4 mm (Alto brillo)/ 2600 x 1220 x 4 mm (Mate Tex)

Colección  
**AUTHENTIC**



KB35

Verona White

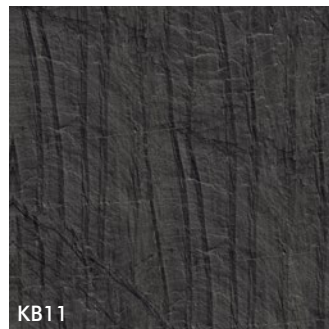

KB11

Manson



KB88

Dune



**MEDIDAS PE:** 2440 x 1200 x 4 mm (Alto brillo)

Colección  
**TILE**

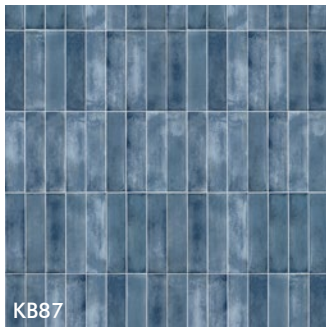

KB87

Marlin

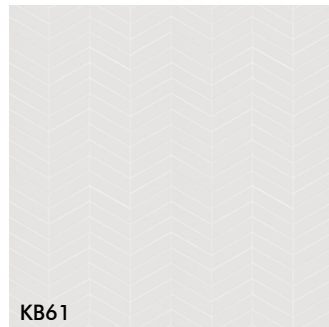

KB61

Chevron Bianco



Manson KB11

**MEDIDAS PE:** 2440 x 1220 x 4 mm (Mate Tex)  
**MEDIDAS FR:** 2600 x 1220 x 4 mm (Mate Tex)

Colección  
**WOOD**



KB21

Natural Oak

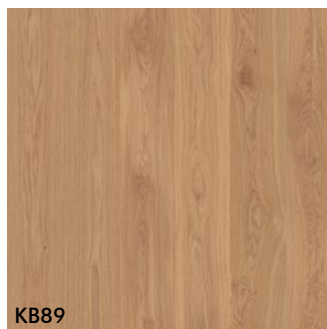

KB89

Coventry Oak



**MEDIDAS PE:** 2440 x 1200 x 4 mm (Alto brillo y ultramate)  
**MEDIDAS FR:** 2600 x 1200 x 4 mm (Alto brillo y ultramate)

Colección  
**UNICOLOR**

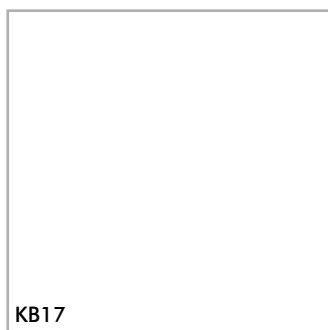

KB17

Blanco



**MEDIDAS PE:** 2420 x 1180 x 4 mm (Ultramate)

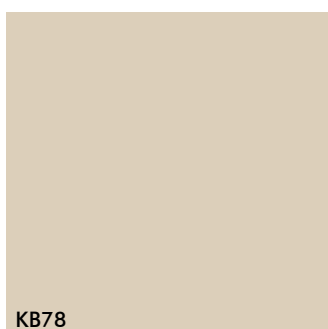

KB78

Nude

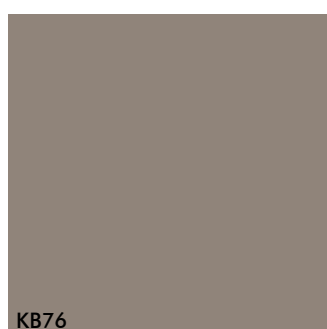

KB76

Basalto



KB80

Antracita

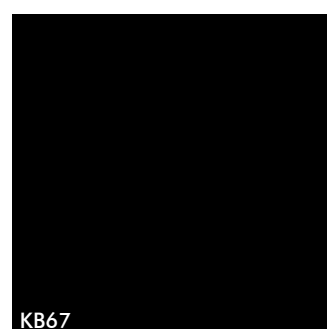

KB67

Black



# SLATPANEL



Tablero de MDF machihembrado imitación a madera de Roble

MEDIDAS: 3050 x 125 x 12 mm



Aislamiento acústico



Reacción al fuego



PEFC™



- Núcleo MDF negro.
- 3 listones por pieza.
- Revestimiento PVC imitación a madera.
- Instalación con sistema machi-hembrado.
- Techos, paredes o mobiliario.

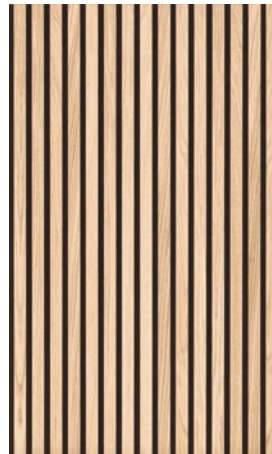
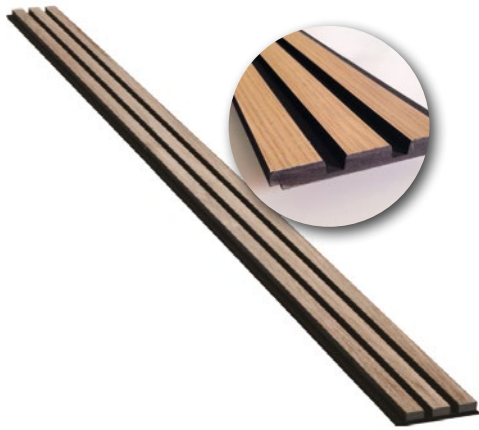

Kopenhagen

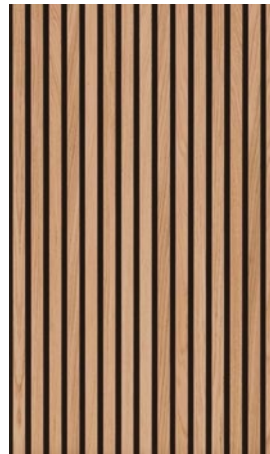

Verade Roble Natural

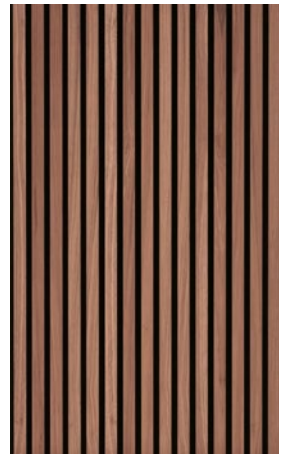

Pamplona Natural





**Listones de madera con base flexible para decorar paredes o muebles**

**MEDIDAS: 2400 x 297 x 12 mm**



Alta Durabilidad



- Listones de MDF con chapa de roble natural.
- 11 listones por pieza.
- Se adaptan facilmente a las curvas.
- Instalación fácil y rápida.



Perfil triangular



Perfil circular pequeño



Perfil circular grande



Perfil romboide



Perfil romboide

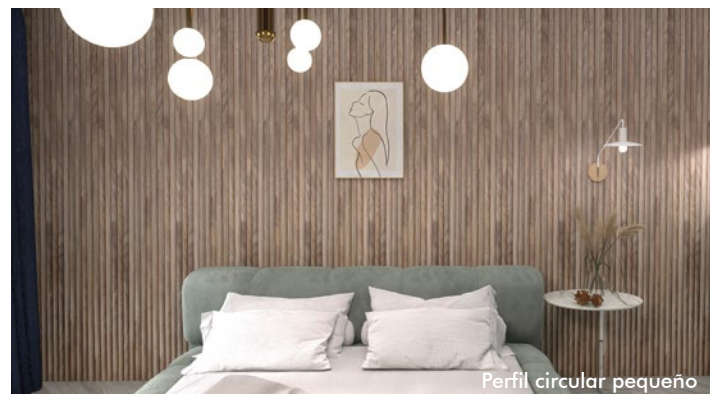

Perfil circular pequeño



# PERFILERÍA Y ACCESORIOS

## RODAPIÉS



**RODAPIÉS DM FORRADO PVC BLANCO**  
Canto recto. Acabado óptimo sin irregularidades.  
Gran resistencia.

	Medidas	Largura
<b>132PM-P945</b>	70x14mm	2,25 metros
<b>133PM-P945</b>	80x14mm	2,25 metros
<b>156PM-P945</b>	100x14mm	2,25 metros

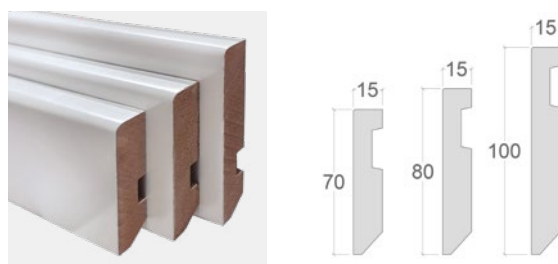

**RODAPIÉS DM LACADO BLANCO**  
Canto recto. Resistente a las rayadas.

	Medidas	Largura
<b>23Z7015L</b>	70x15mm	2,25 metros
<b>23Z8015L</b>	80x15mm	2,25 metros
<b>23Z100L</b>	100x15mm	2,25 metros

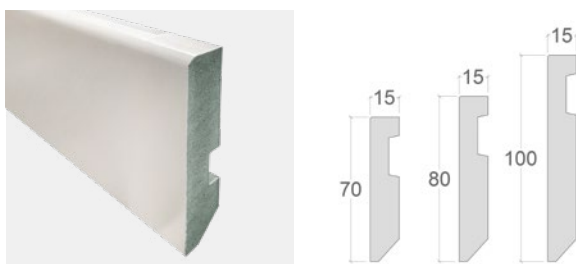

**RODAPIÉ DM LACADO BLANCO HIDRÓFUGO**  
Canto recto. Alta resistencia a la humedad.

	Medidas	Largura
<b>23ZH70L</b>	70x15mm	2,25 metros
<b>23ZH80L</b>	80x15mm	2,25 metros
<b>23ZH10L</b>	100x15mm	2,25 metros

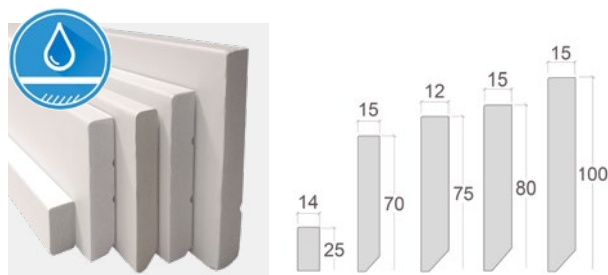

**RODAPIÉS ESPUMADOS**  
100% resistentes al agua. Fabricados con planchas extrusionadas rígidas de PVC expandido.

	Medidas	Largura
<b>ROD220BL20</b>	25x14mm	2,20 metros
<b>ROD220BL70</b>	70x15mm	2,25 metros
<b>53307025</b>	75x12mm	2,40 metros
<b>ROD220BL80</b>	80x15mm	2,25 metros
<b>ROD220B100</b>	100x15mm	2,20 metros
<b>ROD220B150</b>	150x15mm	2,20 metros



**RODAPIÉ DM MOLDURA INGLESA**  
Color Blanco.

	Medidas	Acabado	Largura
<b>8230974</b>	135x15mm	Lacado	2,25 metros
<b>8231330</b>	135x15mm	Forrado PVC	2,25 metros



**RODAPIÉ ESPUMADO MOLDURA INGLESA**  
PVC expandido. 100% resistente al agua. Color Blanco.

	Medidas	Largura
<b>ROD220B150</b>	150x15mm	2,20 metros



## RODAPIÉS

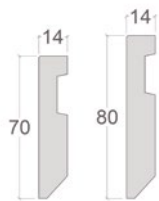

**RODAPIÉS DM CHAPADO MADERA**  
Canto recto. Acabado con chapa de madera natural.

	Madera	Medidas	Largura
<b>23ZX70FV</b>	Haya	70x15mm	2,25 metros
<b>23ZX70RV</b>	Roble	70x15mm	2,25 metros
<b>23ZX80RV</b>	Roble	80x15mm	2,25 metros
<b>23ZX70SV</b>	Sapelly	70x15mm	2,25 metros

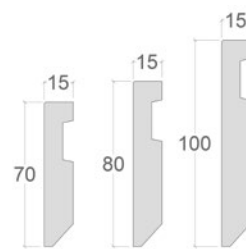

**RODAPIÉS DM CRUDO**  
Canto recto. Para pintar.

	Medidas	Largura
<b>23Z7015M</b>	70x15mm	2,25 metros
<b>23Z8015M</b>	80x15mm	2,25 metros
<b>23Z100M</b>	100x15mm	2,25 metros

## PERFILES EN T

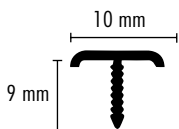

**PERFIL T 10mm**  
De aluminio extrusionado para colocar entre pavimentos al mismo nivel.

	Largura	Acabado
<b>109PS250</b>	2,5 metros	Aluminio plata

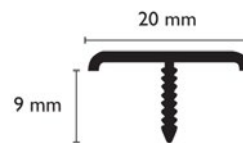
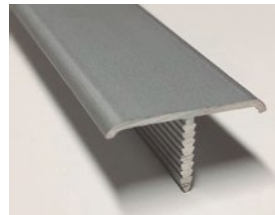

**PERFIL T 20mm**  
De aluminio extrusionado para colocar entre pavimentos al mismo nivel.

	Largura	Acabado
<b>209PS 250</b>	2,5 metros	Aluminio plata

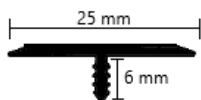
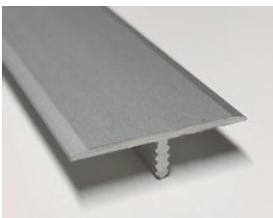

**PERFIL T 25mm**  
De aluminio extrusionado para colocar entre pavimentos al mismo nivel.

	Largura	Acabado
<b>259PS 300</b>	3 metros	Aluminio plata
<b>259NS 300</b>	3 metros	Aluminio negro



**PERFIL T 20mm**  
De aluminio extrusionado acabado imitación madera. Disponible en varias referencias similares al suelo.

	Largura	Acabado
<b>361</b>	2,7 metros	Imitación madera

## CANTONERAS

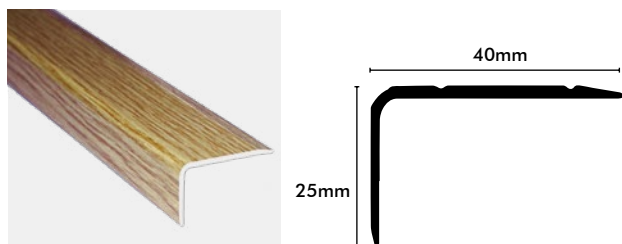

**CANTONERA IMITACIÓN MADERA**  
Autoadhesiva. Perfil de aluminio extrusionado acabado imitación madera similar cualquiera de las referencias. Espesor de 2.1mm.

	Largura	Acabado
<b>405</b>	3 metros	Imitación madera

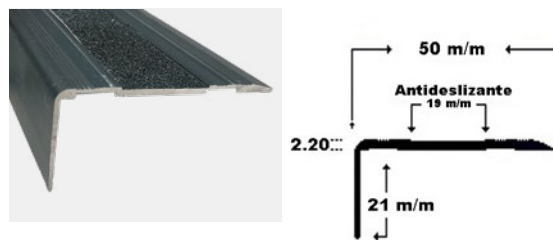

**CANTONERA ANTIDESLIZANTE**  
Para atornillar. Perfil de aluminio extrusionado.

	Largura	Acabado
<b>505PT 300</b>	3 metros	Aluminio plata
<b>505NT 300</b>	3 metros	Negro

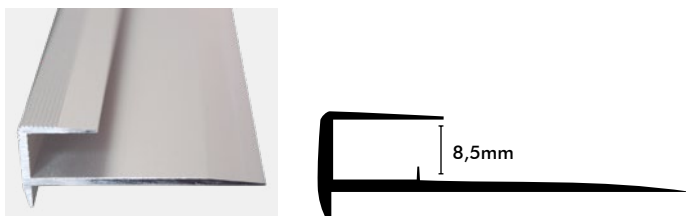

**CANTONERA PARA EMBUTIR LAMINADO**  
Para suelo laminado. Gracias a su cuerpo de aluminio, los ingletes se realizan de manera rápida y fácil. Remate discreto y elegante.

	Largura	Acabado
<b>585IPS 300</b>	3 metros	Aluminio plata
<b>585INS 300</b>	3 metros	Negro

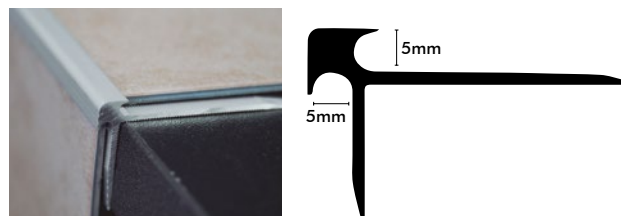

**CANTONERA PARA EMBUTIR VINILO**  
Para pavimento vinílico o pvc. Gracias a su cuerpo de aluminio, los ingletes se realizan de manera rápida y fácil. Remate discreto y elegante.

	Largura	Acabado
<b>555IPS 300</b>	3 metros	Aluminio plata

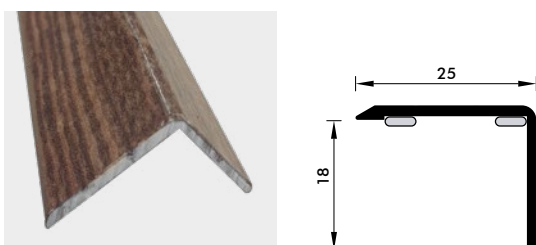

**CANTONERA**  
Adhesiva. Aluminio extrusionado.

	Largura	Acabado
<b>415</b>	90cm	Imitación madera
<b>4152527001C</b>	90cm	Aluminio
<b>4150327001C</b>	90cm	Plata

## ÁNGULOS



### ÁNGULOS METÁLICOS

De aluminio extrusionado y lados iguales. Para rematar esquinas de las paredes o peldaños de escaleras.

	Medidas	Largura	Acabado
306BS 300	15x15mm	3 metros	Blanco
306NS 300	15x15mm	3 metros	Negro
306PS 300	15x15mm	3 metros	Aluminio plata
406BS 300	20x20mm	3 metros	Blanco
406NS 300	20x20mm	3 metros	Negro
406PS 300	20x20mm	3 metros	Aluminio plata
506BS 300	25x25mm	3 metros	Blanco
506NS 300	25x25mm	3 metros	Negro
506PS 300	25x25mm	3 metros	Aluminio plata
305 270	23x23mm	2,70 metros	Imitación madera

## PLETINAS

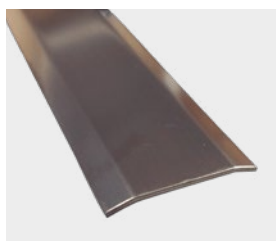

### PERFIL DOS ALAS ACERO SATINADO

Acero inoxidable para rematar pavimentos al mismo nivel.

	Medidas (AxB)	Largura	Instalación
403ASA1250	40x3mm	2,5 metros	Adhesivo
403AST1250	40x3mm	2,5 metros	Taladro
563ASA1250	56x4mm	2,5 metros	Adhesivo
803ASA12250	80x3mm	2,5 metros	Adhesivo

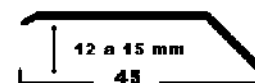

### PLETINA ESCALÓN

Adhesiva. Para rematar pavimentos con un pequeño desnivel de 2-4mm.

	Largura	Acabado
457ASA 250	2,5 metros	Acero satinado

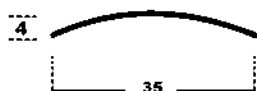

### PERFIL MEDIA CAÑA

Adhesivo. Extrusionados en aluminio anodizado.

	Largura	Acabado
351PA 250	2,5 metros	Aluminio plata

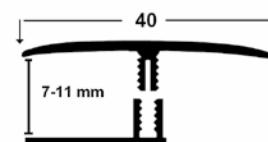

### PERFIL DE CARRIL

Compuesto de dos partes: un carril que se atornilla o pega en el suelo y una tapa que se encaja en este. La parte superior tiene un espesor de 1,6mm.

	Largura	Acabado
7T10P 250	2,5 metros	Aluminio plata

## PLETINAS



**PLETINA PLANA PVC MADERA NATURAL**  
Adhesiva. Cuerpo de PVC revestida con chapa de madera natural y protegida con barniz. Disponible en 7 maderas.

	Largura	Acabado
<b>403P</b>	2,5 metros	Madera natural

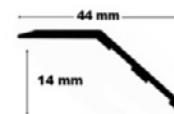

**PLETINA ESCALÓN PVC MADERA NATURAL**  
Adhesiva. Cuerpo de PVC revestida con chapa de madera natural y protegida con barniz. Disponible en 7 maderas.

	Largura	Acabado
<b>457P</b>	2,5 metros	Madera natural

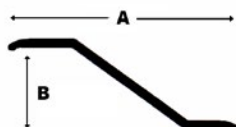

**PERFIL Z ACERO**  
Adhesivo. Cuerpo de acero inoxidable. Para pavimentos a distinto nivel

	Medidas (AxB)	Largura	Acabado
<b>454ASA 250</b>	45x10mm	2,5 metros	Acero satinado
<b>144ASA 250</b>	51x14mm	2,5 metros	Acero satinado

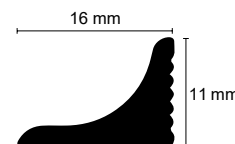

**RINCONERA**  
Aluminio extrusionado.

	Largura	Acabado
<b>275BS 300</b>	3 metros	Blanco
<b>275NS 300</b>	3 metros	Negro
<b>275PS 300</b>	3 metros	Aluminio plata

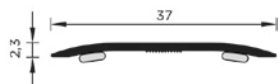

**PLETINA PLANA**  
Junta de expansión. Adhesiva. Aluminio extrusionado.

	Largura	Acabado
<b>370</b>	90cm	Imitación madera
<b>3700409001B</b>	90cm	Dorado
<b>3702509001B</b>	90cm	Aluminio
<b>3700309001B</b>	90cm	Plata
<b>3702009001B</b>	90cm	Negro
<b>3706509001B</b>	90cm	Chapa Roble crudo
<b>3705009001B</b>	90cm	Chapa Roble barnizado

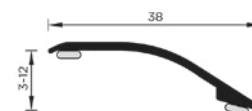

**PLETINA DESNIVEL 38mm**  
Adhesiva. Aluminio extrusionado.

	Largura	Acabado
<b>372</b>	90cm	Imitación madera
<b>3720409001B</b>	90cm	Dorado
<b>3722509001B</b>	90cm	Aluminio
<b>3720309001B</b>	90cm	Plata
<b>3722009001B</b>	90cm	Negro
<b>3726509001B</b>	90cm	Chapa Roble crudo
<b>3725009001B</b>	90cm	Chapa Roble barnizado

## PLETINAS

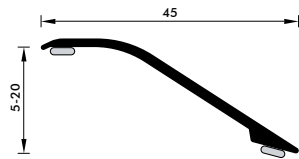

**PLETINA DESNIVEL 45mm**  
Adhesiva. Aluminio extrusionado.

	Largura	Acabado
<b>376</b>	90cm	Imitación madera
<b>3760409001B</b>	90cm	Dorado
<b>3762509001B</b>	90cm	Aluminio
<b>3760309001B</b>	90cm	Plata



**PLETINAS MDF HIDRÓFUGO**  
Núcleo MDF laminado con impresión digital. Disponible en multitud de referencias.

	Medidas	Acabado
<b>Junta de dilatación</b>	2420 x 48mm	Imitación madera
<b>Junta de transición</b>	2420 x 50mm	Imitación madera

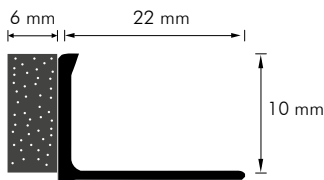

**JUNTA CON ESPUMA 10mm**  
Aluminio extrusionado.

	Largura	Acabado
<b>36A0325054E</b>	2,5 metros	Aluminio plata

## TERMINALES

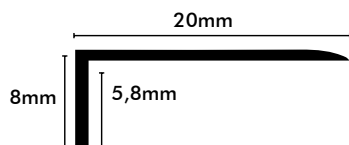

**PERFIL REMATE**  
Perfil de aluminio extrusionado.

	Largura	Acabado
<b>206</b>	3 metros	Imitación madera
<b>206BS 300</b>	3 metros	Blanco
<b>206NS 300</b>	3 metros	Negro
<b>206PS 300</b>	3 metros	Aluminio plata

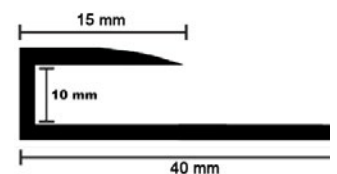

**PERFIL U**  
Perfil de aluminio para embutir el pavimento, quedando a la vista una pequeña parte del perfil de manera discreta.

	Largura	Acabado
<b>356PS250</b>	2,5 metros	Aluminio plata
<b>356NS250</b>	2,5 metros	Negro

**Fabricación  
propia**

# MAMPERLANES A MEDIDA

Todo tipo de pavimentos: laminado, parquet o SPC



**Mamperlán recto**



**Mamperlán con retorno**



## BASES

### ProWALK UNDERLAY



**LÁMINA DE DE POLIETILENO CON FILM PE**  
Con film de barrera de vapor. 40mcs. Apto para suelos flotantes, instalación bajo parquet y forjados, para reducción de ruido de impacto.

	Espesor	m <sup>2</sup> /Bobina
<b>PROFOAM230</b>	2mm	30m <sup>2</sup>
<b>PROFOAM275</b>	2mm	75m <sup>2</sup>
<b>PROFOAM330</b>	3mm	30m <sup>2</sup>



**LÁMINA EVA ALTA DENSIDAD CON FILM PE**  
Caucho reciclado anti bacteriano e impermeable de celda cerrada no poroso. Con lámina PE de 40mcs que le confiere una protección adicional frente a la humedad. Excelente aislamiento térmico y acústico. Con cinta autoadhesiva en el extremo inferior. Apta para calefacción por suelo radiante. Ancho: 1,20m.

	Espesor	m <sup>2</sup> /Bobina
<b>PROEVA2</b>	2mm	30m <sup>2</sup>
<b>PROEVA3</b>	3mm	30m <sup>2</sup>
<b>PROEVA4</b>	4mm	30m <sup>2</sup>
<b>PROEVA5</b>	5mm	30m <sup>2</sup>



**LÁMINA EVA MICROPERFORADA**  
Material de caucho perforado con lámina 100 % impermeable. Con solapa en el extremo superior y una cinta autoadhesiva en el extremo inferior. Apta para sistemas de calefacción radiante. Excelente aislamiento acústico

	Espesor	m <sup>2</sup> /Bobina
<b>PROEVA2B</b>	2mm	30m <sup>2</sup>



**LÁMINA PLÁSTICO LDPE**  
Barrera de vapor. Disponible en bobina o por m<sup>2</sup>.

	Galga	m <sup>2</sup> /Bobina
<b>53.002</b>	400g	150m <sup>2</sup>

### STEICO



**PANEL AISLANTE STEICO**  
Producto a base de fibra de madera estable y sostenible. Aislamiento acústico (contra ruidos de impacto) bajo parquets macizos o flotantes hasta 19 dB/21db (Pro). Compensa las diferencias de nivel de un máximo de 3 mm.

	Espesor	Medidas	Paquete
<b>421319</b>	5mm	790x590mm	7m <sup>2</sup>
<b>421242</b>	7mm	790x590mm	7m <sup>2</sup>
<b>421304 Silent Pro</b>	7mm	790x590mm	7m <sup>2</sup>







# BARNICES, ADHESIVOS Y REPARACIÓN

Zero Concept es una gama de productos probados en los más prestigiosos institutos y entes independientes en materia de rendimiento, de seguridad y del cuidado del medio ambiente.

- Bajo impacto medio ambiental.
- Bajo contenido de compuestos orgánicos volátiles.
- Formulados con materias primas renovables.
- Productos de rendimientos químico/físicos notablemente superiores.



**ZERO%**  
Adhesivo bicomponente epoxi-poliuretánico exento de disolvente y agua para el encolado de suelos de madera de cualquier formato sobre sustratos de cemento, radiantes y no absorbentes. Alto coeficiente de elasticidad después del endurecimiento.

	Cantidad	Transitabilidad	Consumo promedio
<b>502224-6</b>	10kg	24/48h	900/1400 g/m <sup>2</sup>



**ZERO MONO**  
Adhesivo monocomponente higoendurecedor de terminación silánica, exento de agua, disolvente, isocianatos, compuestos epoxídicos y aminados y por esto exento de simbologías de riesgo y peligro.

	Cantidad	Transitabilidad	Consumo promedio
<b>502320</b>	12kg	4h	800/1000 g/m <sup>2</sup>



**ZERO FILLER**  
Resina al agua exenta de disolventes para la preparación de masillas para el sellado de madera obtenida del lijado da origen a una masilla del mismo color del suelo. Idóneo para ciclos de barnizado.

	Cantidad	Secado completo	Consumo promedio
<b>506103</b>	5L	1h	100/120 g/m <sup>2</sup>



**ZERO VOC**  
Terminación de protección al agua exenta de disolvente. Puede ser utilizado como monocomponente o, después del agregado de ZERO VOC BOOST.

	Cantidad	Brillo	Lijado
<b>506379 (X-MATT)</b>	5 (+0,35) L	15	3h
<b>506380</b>	5 (+0,35) L	30	3h
<b>506382</b>	5 (+0,35) L	60	3h



**ZERO OIL**  
Aceite protector natural para suelos de madera compuesto por una "mezcla" de aceites vegetales naturales especiales. Resalta el aspecto natural de la madera y la protege desde su interior.

	Cantidad	Espera para lustrado	Consumo promedio
<b>507120</b>	1L	max 15min	20/30 g/m <sup>2</sup>



**ZERO DECK**  
Agua-aceite para tratamiento de suelos de madera exteriores. Reactiva la tonalidad de la madera.

	Cantidad	Consumo promedio por mano
<b>507118</b>	5L	50/100 g/m <sup>2</sup>

## PREPARACIÓN DEL SUBSUELO



**PRIMER SF**  
Poliuretánico monocomponente exento de agua y de disolvente para el tratamiento de sustratos cementosos antes de la colocación de suelos de madera. Altísima resistencia a la humedad 5% C.M. Especialmente recomendado para sustratos con calefacción incorporada.

	Cantidad	Secado completo	Consumo medio por mano
<b>501106</b>	12kg	24h	150/250 g/m <sup>2</sup>



**PRIMER UR 50**  
Poliuretánico monocomponente exento de MDI. Para uso como enrasado de sustratos de cemento inconsistentes, para tratamiento de sustratos que producen polvo, para acelerar tiempos de colocación en sustratos con alta humedad residual y como aglomerante para preparar morteros sintéticos.

	Cantidad	Secado completo	Consumo medio por mano
<b>501100</b>	10L	24h	150/250 g/m <sup>2</sup>



**PRIMER PU 40**  
Imprimación de poliuretano monocomponente de secado rápido libre de agua y disolvente. Para el tratamiento de soleras polvorientas o con elevada humedad residual, como aglutinante para la preparación de morteros sintéticos para reparaciones rápidas y como consolidante para suelos antiguos.

	Cantidad	Secado completo	Consumo medio por mano
<b>501107</b>	11kg	40min	150/250 g/m <sup>2</sup>



**PRIMER NP**  
Imprimación acrílica nanoestructurada monocomponente en dispersión acuosa. Ideal como antipolvo y consolidante superficial sobre cementos, alisado cementicio, anhídrido y similares. Ideal para fondos con calefacción y/o refrigeración incorporada.

	Cantidad	Secado completo	Consumo medio por mano
<b>501115</b>	10L	3h	100/200 g/m <sup>2</sup>

## ADHESIVOS



**MONOSIL P**  
Adhesivo monocomponente higr endurecedor de terminación silánica específico para pavimentos de madera multicapa y preacabados, con o sin calefacción incorporada. No es agresivo para los barnices y no deja halos.

	Cantidad	Transitabilidad	Consumo promedio
<b>502304</b>	12kg	24h	800/1000 g/m <sup>2</sup>
<b>502313</b>	600ml	24h	800/1000 g/m <sup>2</sup>



**REPOX**  
Adhesivo bicomponente epoxi-poliuretánico para encolar suelos de madera sobre sustratos de cemento, también radiantes, y no absorbentes. Ideal para la colocación de parquet prebarnizado y tablilla. Escasa sensibilidad a las variaciones de temperatura.

	Cantidad	Transitabilidad	Consumo promedio
<b>502200-2</b>	10kg	24/48h	900/1400 g/m <sup>2</sup>



**REVIN B3**  
Adhesivo monocomponente en dispersión acuosa para el encolado de suelos de madera preterminados y laminados flotantes. Cuando se completa el secado el encolado alcanza la clase de resistencia al agua D3.

	Cantidad	Tiempo abierto de trabajo
<b>COLABLANCAD3</b>	0,5kg	8/12min

## RESINAS



### LEGA STUCCO PLUS

Resina monocomponente al disolvente para la preparación de estucos para el sellado de suelos de madera.

	Cantidad	Secado completo
<b>503104</b>	10L	35min



### FILLER

Enduido al agua para el sellado de suelos de madera, de secado rápido y fácil de lijar. Disponible en Roble, Doussie y Nogal.

	Cantidad
<b>506100-1-2</b>	12kg

## FONDOS



### ONE

Fondo monocomponente al agua, fácilmente lijable y de secado rápido. Garantiza una gran cobertura sobre cualquier tipo de madera comparable a la de un fondo bicomponente. Gran penetración en el poro de la madera, buena tonalidad y posibilidad de lijar perfectamente en una hora desde la aplicación.

	Cantidad	Lijado
<b>506212</b>	5L	1h



### AQUA TENAX

Fondo bicomponente al agua caracterizado por su alto poder aislante, óptima cobertura, buen lijado y fácil aplicación. Da tonalidad a la madera sin causar variaciones no deseadas de color en maderas ricas de tanino y de otras sustancias colorantes hidrosolubles (roble, teka...).

	Cantidad	Lijado
<b>506204</b>	5+1L	12h



### FLASH

Fondo monocomponente de secado muy rápido para parquet a base de nitrocelulosa. Nueva aplicación sin necesidad de lijado.

	Cantidad	Secado completo
<b>504104</b>	10L	30min

## BARNICES



### VELVET

Tratamiento de terminación poliuretánico al agua monocomponente, formulado con materias primas renovables. Efecto natural y aterciopelado. Extraordinaria rapidez de secado. Facilidad de retoque en los puntos donde se crean daños sobre la superficie o donde hay defectos localizados.

	Cantidad	Grado brillo	Lijado
<b>8231347</b>	5L	5	1,5h
<b>506367</b>	0,5L	5	1,5h

## BARNICES



**IDRO 2K**  
Terminación poliuretánica bicomponente al agua. Otorga a los suelos una homogeneidad y una limpieza comparable a los ciclos de impregnación con aceite y/o cera. Si se aplica directamente sin fondo revive la coloración de la madera sin dar en el tiempo fenómenos de amarilleamiento. Resistencia a la abrasión y a los rayones que lo hacen indicado para zonas de alto tránsito.

	Cantidad	Grado brillo	Lijado
<b>506334</b>	5+0,5L	10	12h
<b>506330 (Export)</b>	5+0,5L	30	12h
<b>506326 (SAT)</b>	5+0,5L	50	12h



**EZY**  
Barniz de acabado poliuretano bicomponente que ofrece una excelente resistencia al desgaste y mayor facilidad de mezclado y de uso. Mantiene el efecto de la madera natural gracias a su elevada transparencia y posee un excelente poder de recubrimiento y de relleno. Resistencia a la abrasión y a los rayones que lo hacen indicado para zonas de alto tránsito.

	Cantidad	Grado brillo	Lijado
<b>506354 (X-MATT)</b>	5+0,25L	10	12/16h
<b>506358</b>	5+0,25L	30	12/16h
<b>506362</b>	5+0,25L	60	12/16h



**IDRO 2K SPORT**  
Barniz ignífugo bicomponente al agua. Otorga a los suelos de madera un grado de resistencia al desgaste, al deslizamiento y de brillo especular que lo hacen indicado para la aplicación sobre superficies deportivas según cuanto previsto por la norma europea EN 14904:2006.

	Cantidad	Grado brillo	Lijado
<b>506532</b>	5 (+1)L	20	12h



**SOLUZIONE**  
Regulador de secado para agregar a los productos en base agua. Especialmente recomendado para las épocas más calurosas y para facilitar la ejecución de los trabajos más exigentes.

	Cantidad	Disolución máxima
<b>506401</b>	5L	10%



**UP-GRADE**  
Aditivo especial predosificado en base acuosa para tonalizar suelos de madera eliminando antiestéticos virajes de color. Para sistemas mono o bicomponentes al agua, fondos o barnices de acabado. Se podrá regular la intensidad de la tonalidad con la cantidad de manos aplicadas al suelo.

	Cantidad	Colores
<b>506550</b>	0,05L	Blanco, Ámbar

## ACEITES PARA INTERIOR



**OIL PLUS**  
Barniz oleuretánico monocomponente. Gracias al uso de resinas innovadoras, aditivos tecnológicos y secativos especiales permite obtener características únicas de resistencia a la abrasión y al rayado. Su aplicación se distingue por la facilidad de uso y porque puede permanecer largo tiempo abierto.

	Cantidad	Grado brillo	Lijado
<b>505304 (X-MATT)</b>	5L	10	24/48h
<b>505302</b>	5+0,25L	30	24/48h
<b>505300</b>	5+0,25L	60	24/48h



**FIX OIL**  
Tratamiento de acabado a base de aceites y ceras naturales para suelos de madera. Protege la madera contra el agua y las sustancias de uso cotidiano evitando la formación de manchas permanentes. Aumenta la resistencia contra la abrasión de los suelos aceitados.

	Cantidad	Consumo promedio por mano
<b>507401</b>	3L	30/50g/m <sup>2</sup>



**LIFE OIL**  
Aceite de mantenimiento para suelos de madera tratados con aceite. Su fórmula a base de aceites y ceras naturales, protege la madera y se la utiliza para restablecer el aspecto inicial de suelos gastados.

	Cantidad	Consumo promedio por mano
<b>507106</b>	1L	30/50g/m <sup>2</sup>

## ACEITES PARA EXTERIOR



**DECK OIL / DECK OIL STRONG**  
Aceite protector para exteriores de base vegetal que resulta de la composición equilibrada de diferentes aceites (lino, madera, etc.). Exalta las características de suavidad y calor evidenciando notablemente las vetas de la madera.

	Cantidad	Consumo promedio por mano
<b>507102</b>	3L	30/50g/m <sup>2</sup>
<b>507103 (STRONG)</b>	3L	40/100g/m <sup>2</sup>



**DECK RESET**  
Preparador para el tratamiento de suelos de madera y madera en general en exteriores. Solución acuosa para eliminar la pátina gris de la madera colocada en exteriores debida a la degradación y al lavado de la lignina.

	Cantidad	Consumo promedio por mano
<b>507112</b>	1L	50g/m <sup>2</sup> con rociado o tampón
<b>507114</b>	5L	80g/m <sup>2</sup> con rodillo o pincel

## TINTES



**COLOR OIL**  
Aceite pigmentado para la coloración de suelos de madera colocados en interiores. Disponible en múltiples tonalidades que se pueden mezclar entre sí.

	Cantidad	Consumo promedio por mano
<b>Según color</b>	1L	30/50g/m <sup>2</sup>

## LIMPIEZA Y MANTENIMIENTO



**DETERGENTE NEUTRO**  
Para la limpieza frecuente de  
suelos barnizados.

	Cantidad
509104	1L



**IDRONET**  
Cera de mantenimiento para  
suelos barnizados. Limpiador y  
revitalizador.

	Cantidad
509100	1L



**CLEAN OIL**  
Detergente para suelos de  
madera tratados en aceite.

	Cantidad
507108	1L



**SOAP OIL**  
Jabón para suelos de madera  
tratados con aceite.

	Cantidad
507110	1L



**CLEANER**  
Disolvente para la limpieza de  
residuos de cola.

	Cantidad
508303	1L

## ACCESORIOS

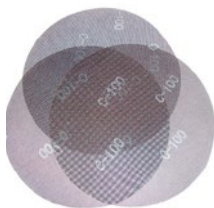

**DISCOS MALLA**  
De Carburo de silicio. 406mm diámetro.

	Grano
700500	60
700502	80
700504	100
700506	120
700508	150
700510	180
700512	220
700514	320



**DISCOS PAD**  
Discos limpiadores de nylon 16"

	Color
800200	Blanco
800202	Verde
800203	Rojo
900406 (HI-PRO)	Negro

ACCESORIOS



MANGO RODILLO  
601305



RECAMBIOS RODILLO TEXTIL  
25cm

	Fibras
601304	6mm
601302	8mm
601316	10mm

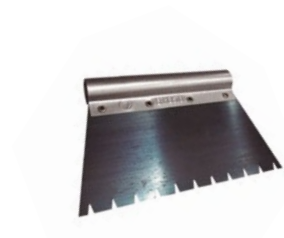

ESPÁTULA DENTADA NR6  
601422



W-CLEANER  
Disolvente para lavado de herramientas  
utilizadas con productos al agua.

	Cantidad
510108	10L



RASCADOR  
Para limpiar el rodillo.  
601310





## BROCHAS



**PALETINA PREMIUM VELOUREX**  
Punta redondeada para mejor adaptación y acabado. Fibra sintética extrafina.

	Ancho
<b>19774000</b>	40mm
<b>19775000</b>	50mm
<b>19777500</b>	75mm



**PALETINA TRIMATERIA RENDIX**  
Mezcla de dos fibras sintéticas con 2 alturas, una con forma cilíndrica hueca y otra de estrella. Mango con enganche y abre-botes incorporado.

	Ancho
<b>19724000</b>	40mm
<b>19726000</b>	60mm
<b>19721000</b>	100mm



**BROCHA PREMIUM PRENSADA VELOUREX N.10**  
Fibra sintética extrafina. Mango con sistema de enganche.

	Ancho
<b>19391000</b>	34mm



**BROCHA TRIMATERIA RENDIX N.8**  
Mezcla de dos fibras sintéticas con 2 alturas, una con forma cilíndrica hueca y otra de estrella. Mango con enganche

	Ancho
<b>19420800</b>	30mm

## VARILLAS, RODILLOS Y RECAMBIOS



**VARILLA ECOBLOCK**  
Casquillos integrados. Para rodillos Ecoblock.

	Diámetro	Ancho
<b>10785200</b>	50mm	22cm



**RECAMBIO ECOBLOCK MICROFIBRA CORTA**  
Microfibra especial de 8 mm con tratamiento biofinish. Ideal para esmaltes y barnices al agua.

	Diámetro	Ancho
<b>11757000</b>	50mm	22cm



**RECAMBIO ECOBLOCK VELOUREX**  
Poliéster fabricado con hilo continuo de 4 mm. Acabado extrafino especial esmaltes base agua y base solvente.

	Diámetro	Ancho
<b>11760500</b>	50mm	22cm



**RECAMBIO ECOBLOCK MICROFIBRA EXCELLENCE**  
Microfibra de 11 mm. Superficies tipo pladur con pinturas plásticas/látex.

	Diámetro	Ancho
<b>11757500</b>	50mm	22cm



**MIDI VELOUREX**  
Para acabados finos en pequeñas superficies con todo tipo de esmaltes. Rodillo de poliéster hilo continuo de 4 mm.

	Diámetro	Ancho
<b>11205300</b>	30mm	11cm



**RECAMBIO MIDI VELOUREX**  
Poliéster hilo continuo de 4 mm. Especial esmaltes base agua y base solvente.

	Diámetro	Ancho
<b>10754700</b>	30mm	11cm

## VARILLAS, RODILLOS Y RECAMBIOS



**VARILLA PREMIUM**  
Para rodillos MINI o MIDI. Mango bimatéria.

	Diámetro	Ancho
<b>17681000</b>	6mm	11cm



**RECAMBIO MIDI MICROFIBRA CORTA**  
Microfibra especial de 8 mm con tratamiento biofinish. Especial para esmaltes y barnices al agua.

	Diámetro	Ancho
<b>10757600</b>	30mm	11cm



**RECAMBIO MIDI MICROFIBRA EXCELLENCE**  
Microfibra superior de 11 mm. Especial para pequeñas superficies muy lisas.

	Diámetro	Ancho
<b>10755900</b>	30mm	11cm

## OTRAS HERRAMIENTAS Y ACCESORIOS



**PAD MADERA HILO LARGO**  
Para tratamientos en madera de exteriores. Fibras acrílicas largas. Evita sobre-espesores y no crea espuma. Rosca cónica para usar con alargador de rosca italo-española.

	Medidas
<b>11329000</b>	22,5 x 8,5cm



**PACK 2 RECAMBIOS PAD MADERA HILO LARGO**  
Para tratamientos en madera de exteriores. Fibras acrílicas largas.

	Medidas
<b>11329100</b>	22,5 x 8,5cm



**RASCADOR CURVO PREMIUM**  
Mango extralargo 100cm. Acero inoxidable europeo de 1,8 mm de espesor.

	Ancho
<b>11303200</b>	10cm



**ALARGADOR DE ALUMINIO CÓNICO**  
Con nueva punta cónica adaptable a todas las tuercas.

	Medidas
<b>10769900</b>	2m (2x1m)



**CUBETA PROFESIONAL CON REJILLA DE PLÁSTICO**  
Para rodillos de 22 Y 25 cm. Doble asa con posibilidad de cambiar a un asa central.

	Medidas
<b>11323100</b>	34 x 28 x 21cm



**CINTA ENMASCAR**  
Papel semicrepado de 125 micras, con adhesivo de caucho natural. Adherencia multisuperficie.

	Medidas
<b>10826400</b>	45mx48mm

Adhesivo elástico de agarre inmediato

# TURBO MAX PREMIUM



- ◆◆ Máxima sujeción inicial: 3 seg
- ◆◆ Secado rápido
- ◆◆ Resistencia a la intemperie
- ◆◆ Resistencia a la temperatura
- ◆◆ Pintable
- ◆◆ Exento de disolventes y de isocianatos



## APLICACIONES

- Ideal para trabajos donde se requiera gran fuerza de pegado y rapidez de sujeción.
- Pegados de planchas galvanizadas, metales férreos o no férreos.
- Sellado elástico en la industria.
- Sellado juntas entre materiales iguales y distintos como juntas entre elementos prefabricados, marco/obra, carpintería metálica, canales de desagües, instalaciones de aire acondicionados o frigoríficas.

## ADHESIVOS Y SELLADORES

# QUIADSA®



**FIJA PLUS TURBO BLANCO**  
Adhesivo de polímero monocomponente. Alto agarre inicial. Sujeta en 3 segundos. Buena adhesión sobre superficies húmedas.

	Cantidad
52503329	290ml
52503414	600ml



**FIJA PLUS S-100**  
Adhesivo de montaje en base solvente de alta viscosidad y de gran agarre inicial. Excelente adhesión sobre la mayoría de los materiales porosos y todo tipo de maderas, No indicado para poliestireno expandido, polietileno, polipropileno o PTFE.

	Cantidad
509104	300ml



**SELLADOR BRIK-CEN CM10**  
Sellador elástico monocomponente elaborado con resinas acrílicas en dispersión. Pintable/Barnizable. Secado rápido. Disponible en: Roble, Pino, Sapelli, Cerezo, Haya, Nogal, Blanco, Wengue, Gris claro y oscuro, Lino Cancún y Blanco Glaciar.

	Cantidad
52502	300ml

# QUIADSA®



**COLA POLIURETANO BRIK-CEN B-1438**  
Adhesivo de poliuretano monocomponente que cumple con los estándares D4 para resistencia al agua. Excelente adhesión sobre: madera, metal y la mayoría de los materiales empleados en la construcción.

	Cantidad
52600016	750g



**MAD MAX ADHESIVO MADERA**  
Adhesivo D4 basado en polímero silano terminado (MST), tixotrópico y monocomponente. Pegado extrafuerte de elementos de madera en interior y exterior.

	Cantidad
52503105	380g

# WÜRTH



**K+D ADHESIVO Y SELLANTE**  
Elástico en base de poliuretano (PU). Se puede pintar una vez seco con la mayoría de pinturas. Disponible en 4 colores: gris, marrón, sapelly, negro y blanco.

	Cantidad
82311/0890	300ml

# Bostik

smart adhesives



**ADHESIVO MSP TURBO**  
Adhesivo elástico de agarre inicial inmediato y elevada resistencia. Grandes propiedades adhesivas tanto en exterior como en interior.

	Cantidad
30613928	290ml

## ADHESIVOS Y SELLADORES

### PENOSIL



**SELLANTE ACRÍLICO D70 BLANCO**  
Masilla monocomponente plasto-elástica, es base de agua, basada en dispersiones acrílicas. Uso interior o exterior.

	Cantidad
H40004	300ml

### fischer



**SOLUCIÓN TOTAL**  
Para pegar y sellar variados tipos de materiales. Alta resistencia al agua. Uso interior o exterior. Disponible en colores: blanco, gris, negro y cristal.

	Cantidad
5709	290ml



**ADHESIVO PL PREMIUM FIX**  
Adhesivo de montaje extrafuerte y de agarre inmediato, formulado a base de polímero Flextec sin disolventes.

	Cantidad
2708154	460g

### König



**KIT CIANOACRILATO**  
Kit con adhesivo de cianoacrilato y activador. Especial para carpintería. Para la unión de materiales derivados de la madera. Ideal para parquet, puertas, cornisas de cocina y tapas de marcos.

	Cantidad adhesivo	Cantidad activador
7003-S00-1100	50gr	200ml

## SILICONAS

### QUIADSA®



**BRK-CEN CS45**  
Sellador de silicona acética. Uso interior y exterior. Elevada resistencia a la radiación UV. Elasticidad permanente. No pintable

	Color	Cantidad
52500003	Blanco	280ml
52500007	Traslúcido	280ml

## MASILLAS

### QUIADSA®



**PLASTE+PLUS**  
Emplaste basado en una dispersión acrílica en base agua. Repara y rellena grietas, agujeros y hendiduras en maderas. Disponible en colores roble, pino, sapelli, haya, cerezo, nogal, blanco, wengue, teka y natural.

	Cantidad
52502	100ml

### teq



**PLASTE PARA MADERA**  
Plaste al agua de secado rápido y alta adherencia para reparaciones en la madera. Disponible en blanco, roble, haya y gris.

	Cantidad
20141210	125ml

## ESPUMAS DE POLIURETANO

# QUIADSA®



**BRK-CEN SP125 TEJAS**  
Espuma de poliuretano monocomponente especial tejas. Excelente adhesión sobre la mayoría de los materiales de construcción que se utilizan en los trabajos de montaje de techos.

	Aplicación	Cantidad
53300025	Pistola	750ml



**BRK-CEN SP131 LIMPIADOR**  
Disolvente especial para la espuma de poliuretano y útiles. En forma de aerosol, elimina restos. También se puede aplicar con pistola.

	Cantidad
53306001	500ml



**BRK-CEN SPSP-FIX TURBO ESPUMA**  
Adhesivo monocomponente de poliuretano de baja expansión formulado para ofrecer un curado rápido y seguro. Se puede aplicar con cánula o pistola.

	Aplicación	Cantidad
53300074	Pistola o canula	750ml

## PENOSIL



**ESPUMA PU-49 TEJAS**  
Espuma de poliuretano para pegar tejas, de aplicación con pistola o manual, con potente poder de adhesión y altas prestaciones.

	Aplicación	Cantidad
A5961	Pistola	750ml
A5959	Manual	750ml



**LIMPIADOR ESPUMA R-47**  
Producto de limpieza de espuma de poliuretano fresca. Para superficies y herramientas.

	Cantidad
A2468	500ml

## PISTOLAS

# QUIADSA®



**PISTOLA BRIK-CEN P130**  
 Aplicador de espuma de poliuretano profesional. Mango ergonómico. Varilla interior y válvula teflonada.

53307001



**PISTOLA BRIK-CEN P-1441**  
 Aplicador de silicona giratorio profesional. Para cartuchos de 310 ml y coaxial de 150 ml.

53307008



**PISTOLA BRIK-CEN P-1443**  
 Aplicador giratorio para masillas/sellantes en bolsa. Apta para cartucho de 310 ml y salchicha (Bolsa) 600 ml y granel.

53307013

## PUENTE DE UNIÓN



**BLUMECRIL SUELOS Y PAREDES C-1346-A**  
 Imprimación para aplicar previa a la pasta niveladora en superficies absorbentes o no, como cerámica, piedra, granito u hormigón. Refuerza bases y paredes antiguas o frágiles, antes de la aplicación del adhesivo.

	Cantidad
8230296	5kg
8231319	10kg

## PASTA AUTONIVELANTE



**SL C340 LEVEL PLUS**  
 Pasta autonivelante uso interior. Absorbe desniveles de 1 a 10 mm.

	Cantidad
8231337	25kg

## ARENA DE MÁRMOL



**GRANOMAR 1.2**  
 Triturado de mármol dolomítico, idóneo para aplicaciones industriales.

	Cantidad
8230189	25kg

# REPARACIÓN



**CERA BLANDA DUO ROYAL**  
Cera muy blanda para reparación, retoque y relleno de rasguños, agujeros y abrasiones en todo tipo de superficies. Recomendado para uso en interiores.

	Punto fusión	Presentación
<b>K131S00772</b>	60°	Caja 10 uds



**CERA BLANDA**  
Cera blanda para rellenar pequeños rasguños y agujeros sobre madera y superficies artificiales de interiores. Disponible en 10 colores.

	Punto fusión	Presentación
<b>B140010</b>	74°	1ud



**CERA DURA MATE**  
Cera dura para reparar rasguños profundos, agujeros y cantos dañados sobre superficies mate en interior. Disponible en 20 colores.

	Punto fusión	Presentación
<b>B147010</b>	81°	1ud
<b>K147S00771</b>	81°	Caja 20 uds



**FUNDIDOR**  
Aparato de fusión a pilas para fundir, moldear y mezclar colores de ceras. Permite ajustar la temperatura dependiendo del material de relleno que se esté usando.

**K438650000**



**ESPÁTULA MULTIUSOS**  
Para aplicar y nivelar la cera blanda fácilmente. Rascador para eliminar el exceso de ceras duras. Los residuos y restos de cera se pueden eliminar con las lanas abrasivas.

**K161149000**



**KANTEN FIX PREMIUM**  
Rotulador para un teñido rápido y fácil de esquinas, cantos, ranuras, dientes de sierra en superficies de madera, plástico y metal. Disponible en colores estándar o especiales, tonos madera, blancos o grises.

**K243**



**BARNIZ DE FIJACIÓN MATE**  
Combinación de barnices para el ajuste del grado de brillo y el sellado de las reparaciones sin dejar cercos.

	Cantidad
<b>K337240000</b>	400ml



**LIMPIADOR UNIVERSAL**  
Para la limpieza de superficies como muebles, cantos, melaminas, puertas lacadas, etc. Elimina restos de adhesivos.

	Cantidad
<b>K580240000</b>	400ml



**MALETIN REPARACIÓN**  
Kit especial para la reparación de superficies. Incluye: Caja de 20 ceras duras, fundidor, espátula multiusos y barniz de fijación mate.

**2061253305**



## REPARACIÓN



**ROTULADORES LACA**  
Para el teñido de pequeños raspones y  
arañazos en superficies de madera.  
Colores: blanco, roble, sapelli y nogal.

8231323-26



**CERA BLANDA**  
Listas para usar, para la rápida reparación  
de toda clase de deterioros en madera o  
laminado. Colores: blanco, gris y roble.

8231327-29



**MALETIN CERAS**  
Incluye 24 ceras blandas,  
2 rotuladores de laca y una  
espátula

56011630







# HERRAMIENTAS

## TRONZADORA



**TRONZADORA TM33W**  
Tronzadora abatible portátil dotada con un disco profesional de 305 mm de diámetro en metal duro y de 48 dientes, ofrece al profesional una capacidad de corte excepcional: hasta 160x95 mm o 200x45 mm con el plato y cabezal a 0°. Equipada con láser de precisión.

	Diámetro disco	Capacidad corte max.	Velocidad en vacío
<b>3300400</b>	300mm	55mm	3.700/min

## RECORTADORA



**RECORTADORA RZ270S**  
Para el recorte de puertas, marcos y zócalos o rodapiés. Potencia 1300W. Profundidad y altura del corte regulables. Incorpora una toma para aspiración externa y un tubo de 3,5 m para su conexión a un aspirador.

	Profundidad de corte	Altura min. de corte	Altura max. de corte
<b>7000300</b>	0-47mm	8mm	35mm

## SIERRAS



**SIERRA CIRCULAR SR165**  
Motor de 1.200 W. Profundidad de corte e inclinación regulables. Dispone de una protección total del disco sierra y cuenta con seguro de puesta en marcha.

	Diámetro	Profundidad corte máx. a 90°	Profundidad corte máx. a 45°
<b>7400600</b>	165mm	55mm	38mm



**SIERRA CIRCULAR SRB165**  
Dotada de motor brushless y control automático para ajustar la velocidad de corte según las condiciones de carga. Gran base de apoyo para corte en diferentes ángulos. No incluye cargador ni baterías.

	Diámetro	Profundidad corte máx. a 90°	Profundidad corte máx. a 45°
<b>7400700</b>	165mm	54mm	41mm



**SIERRA CIRCULAR SR210**  
Motor de 1.900 W. Profundidad de corte e inclinación regulables. Dispone de una protección total del disco sierra y cuenta también con un seguro de puesta en marcha.

	Diámetro	Profundidad corte máx. a 90°	Profundidad corte máx. a 45°
<b>9000700</b>	200mm	75mm	53mm

## SIERRAS



**SIERRA DE CALAR A BATERÍA SCB324**  
Dotada de motor brushless con base anti-ralladuras. Sistema de movimiento pendular ajustable en 4 posiciones. Base inclinable de 0° a 45° para realizar cortes a inglete. Incluye cargador, batería y bolsa.

	Capacidad corte madera	Capacidad corte aluminio	Capacidad corte acero
<b>3400410</b>	85mm	20mm	10mm



**SIERRA DE CALAR CON CABLE SC710**  
Con control electrónico de velocidad y un sistema de movimiento pendular ajustable en 4 posiciones. Base inclinable de 0° a 45°. Permite la realización de cortes circulares al poder usarse como compás. Con toma para aspiración externa.

	Capacidad corte madera	Potencia	Velocidad en vacío
<b>3400500</b>	85mm	710W	700-3.000/min



**SIERRA SABLE SSB65**  
Intercambio de hojas de sierra y posibilidad de cortar con la hoja flexionada. Su cuerpo puede rotar 90° hacia ambos lados, lo que facilita realizar cortes en diferentes posiciones. No incluye cargador ni baterías.

	Carrera
<b>6500100</b>	85mm



**SIERRA DE INCISIÓN SRI74T**  
Motor de 1.150 W. La sierra se desliza directamente sobre el riel sin necesidad de accesorios intermedios. Motor con arranque progresivo. Palanca de bloqueo para un fácil cambio del disco sierra o ajuste de la quilla. Toma para la conexión a un aspirador externo y maletín de transporte incluido.

	Díámetro	Profundidad corte máx. a 90°	Profundidad corte máx. a 45°
<b>7400400</b>	160/20mm	55mm	35mm

## FRESADORAS



**FRESADORA PERNIADORA FP114**  
Para la realización de encajes para la posterior colocación de pernios o bisagras sin usar plantillas. Perfilado de cantos en piezas canteadas y el fresado de ranuras en madera o materiales plásticos. Potencia 430W.

	Díámetro pinza	Profundidad fresado	Profundidad fresado con acc.base
<b>1400100</b>	6mm	30mm	24mm



**FRESADORA PERFILADORA FR192VG**  
Ideal para la realización de encajes de pernios y bisagras. Permite reparar galces en puertas o ventanas y hacer regatas rectas o circulares con gran precisión. Potencia 1000W.

	Díámetro fresa max.	Pinza estándar
<b>9200800</b>	25mm	6mm

## CEPILLO



**CEPILLO CE35E**  
Cuchillas recambiables, desechables de doble uso y de metal duro. Equipado con toma para aspiración externa.

	Ancho de corte	Profundidad corte	Profundidad galce max.	Velocidad portacuchillas
<b>3500100</b>	80mm	0-3mm	11mm	16.500/min

## LIJADORAS



**LIJADORA DE BANDA LB31E**  
Gran superficie de lijado. Dispone de unos topes internos de carburo de tungsteno para evitar el deterioro de la carcasa por desplazamiento de la banda. Equipada con toma de aspiración externa.

	Dimensiones de banda	Superficie lijado	Velocidad de banda
<b>3100100</b>	690x100mm	175x100mm	420mts/min



**LIJADORA ROTORBITAL RTE146L**  
Combina movimiento rotativo y orbital, Dotadas de un nuevo sistema de protección contra el polvo y aspiración integrada que permiten el uso de abrasivos y platos estándar. Regulación electrónica de la velocidad y sistema de frenado del plato.

	Diámetro disco	Diámetro órbita	Velocidad en vacío
<b>4600310</b>	150mm	4mm	4.000-8.000/min



**MULTLIJADORA LRT84H**  
Orbital y rotorbital en una sola máquina. Como Orbital incluye base extra con punta delta y velcro. Como Rotorbital combina los dos movimientos: rotativo y orbital. Sistema de freno del plato y aspiración del polvo integrada.

	Diámetro disco	Diámetro órbita	Dimensiones plato
<b>8400000</b>	125mm	2mm	80x130mm

## TALADROS



**TALADRO ATORNILLADOR ATB40**  
Portabrocas de sujeción rápida. Velocidad de trabajo regulable. 2 posiciones para diferentes necesidades. Incorpora 2 baterías Li-Ion y cargador de carga rápida.

	Portabrocas	Par de giro variable	Velocidad en vacío
<b>4000100</b>	0,8-10mm	25/14 Nm	0-400 / 0-1400/min



**TALADRO ATORNILLADOR PERCUTOR**  
Incorpora un robusto frontal de aluminio. Portabrocas metálico automático de alta resistencia. Velocidad de trabajo regulable con 2 posiciones. Incluye 2 baterías Li-Ion de 20V y 4Ah

	Portabrocas	Par de giro variable	Velocidad en vacío
<b>4000200</b>	1.5-13 mm	45/55 Nm	0-400 / 0-1500/min

## ASPIRADORA



**ASPIRADOR AS182K/AS282K**  
Aspirador profesional para polvos y líquidos, ligero y fácilmente transportable. Cable de conexión de 8m. Dos entradas de aspiración para usar dos máquinas al mismo tiempo.

	Capacidad	Aire aspirado	Depresión
<b>8200100</b>	27l	170 m <sup>3</sup> /h	2.200 mm
<b>8200200</b>	62l	170 m <sup>3</sup> /h	2.200 mm

## MALETA TRANSPORTE



**MALETA TRANSPORTE PLUS M1**  
Para transportar varias máquinas al mismo tiempo. Protege de manera eficaz el contenido cuando las herramientas no se usan. Cuentan con un resistente sistema de fijación dotado de centraje automático. Muy resistente y ligera gracias a la tecnología de fabricación por soplado asimétrico.

	Dimensiones exterior
<b>1094578</b>	550x400x180mm

## ELEVADOR DE PUERTAS



**ELEVADOR DE PUERTAS EP70P**  
Para extraer puertas, ya sean huecas o macizas de gran peso, puertas cortafuegos o puertas blindadas. Permite el giro sobre su eje. Amplio frontal orientable.

	Peso
<b>7000600</b>	1kg

## RECAMBIOS



**CARGADOR CH80 20V**  
Para la carga rápida de las baterías. Con indicador de carga.

**4068658**



**BATERIA BT204 20V 4Ah LI-ION**  
Protección contra sobrecarga, sobrecalentamiento y descarga total. Indicador de cargador con 4 luces LED.

**4860000**



**ESCOBILLAS**  
Juego de dos escobillas de carbón

	Máquina
<b>3317022</b>	Tronzadora TM33W
<b>3517016</b>	Cepillo CE35E



**CORREAS DENTADAS**

	Máquina
<b>3387081</b>	Tronzadora TM33W
<b>3587079</b>	Cepillo CE35E



**FUSIBLE 10A T-26**  
Fusible para ingletadora tronzadora  
Corriente de 230V.

**3317022**



**INTERRUPTOR**  
Interruptor para las ingletadoras tronzadoras con sistema de paro por corte del suministro eléctrico.

**3369109**

## COMPRESORES



MINI COMPRESOR	Potencia	Calderin	Presión	Caudal	Rmp	Nivel sonoro	Peso
<b>0819000</b>	1/4Hp	0,8L	9bar	45L./min	3.500	70db	4,8kg



COMPRESOR HALCON	Potencia	Calderin	Presión	Caudal	Rmp	Nivel sonoro	Peso
<b>0819001</b>	1.5Hp	6L	8bar	180L./min	3.800	97db	9kg



COMPRESOR BATERÍA	Potencia	Calderin	Presión	Caudal	Rmp	Nivel sonoro	Peso
<b>0819005</b>	1/3Hp	4L	8bar	45L./min	3.500	74db	6kg



COMPRESOR SILENCIOSO	Potencia	Calderin	Presión	Caudal	Rmp	Nivel sonoro	Peso
<b>0819013</b>	1Hp	6L	8bar	120L./min	1.400	62db	15kg

## CLAVADORAS



CLAVADORA PINS NOVA 6/30P  
Usa Pins con y sin cabeza de 0,64 mm.  
Medidas 12 – 30 mm.

	Medidas	Presión	Racord flexible	Consumo por impacto	Peso
<b>1801018</b>	230x180 mm	4/5bar	5mm	0,35L	1kg



CLAVADORA PINS NOVA 6/35PB  
Usa Pins con y sin cabeza de 0,64 mm.  
Medidas 12 – 35 mm.

	Medidas	Presión	Racord flexible	Consumo por impacto	Peso
<b>1801017</b>	230x180 mm	4/5bar	5mm	0,35L	1kg



## CLAVADORAS



**CLAVADORA PINS NOVA 8/45**  
Usa Pins con y sin cabeza de 0,82 mm.  
Medidas 15 – 45 mm.

	Medidas	Presión	Racord flexible	Consumo por impacto	Peso
<b>1801051</b>	225x227 mm	4/6bar	5mm	0,45L	1,1kg



**CLAVADORA PINS NOVA 12/60**  
Usa Pins con y sin cabeza de 1,2 mm.  
Medidas 20 – 60 mm.

	Medidas	Presión	Racord flexible	Consumo por impacto	Peso
<b>1801053</b>	230x245 mm	5/7bar	5mm	0,70L	1,4kg



**CLAVADORA C-MINI TN/40 MIX**  
Usa clavos de acero 1,8mm.  
Usa puntas 1,4mm.  
Medidas 20 – 50 mm.

	Medidas	Presión	Racord flexible	Consumo por impacto	Peso
<b>1801010</b>	280x260 mm	5/7bar	8mm	0,60L	1,5kg

## ACCESORIOS Y CONSUMIBLES



### ESPIRAL MANGUERA CON CONEXIONES

	Largo	Presión
<b>0999015</b>	8m	10bar
<b>0999019</b>	12m	10bar



### RECAMBIO PISTÓN + MARTILLO

	Clavadora
<b>UNA514NP</b>	6/30
<b>UNA514K</b>	6/35
<b>UNH12101601A</b>	8/45
<b>UN13901404A</b>	12/60
<b>UN22001601A</b>	C-MINI TN/40MIX



### PINS, PUNTAS Y CLAVOS

	Descripción	Cantidad
<b>0203006</b>	Pins sin cabeza 0.64/25	20.000 uds
<b>0203007</b>	Pins sin cabeza 0.64/30	20.000 uds
<b>0203177</b>	Pins sin cabeza 0.64/35	20.000 uds
<b>0203121</b>	Pins con cabeza 0.64/30	20.000 uds
<b>0203017</b>	Pins con cabeza 0.82/30	10.000 uds
<b>0203027</b>	Puntas con cabeza 1.2/30	5.000 uds
<b>0203028</b>	Puntas con cabeza 1.2/35	5.000 uds
<b>0203135</b>	Clavos con cabeza 1.8/30	3.000 uds
<b>0203164</b>	Clavos con cabeza 1.2/35	3.000 uds
<b>0203136</b>	Clavos con cabeza 1.8/35	1.500 uds
<b>0203137</b>	Clavos con cabeza 1.8/40	1.500 uds

## FORMONES



### FORMÓN FILO BISELADO

Formón con hoja de aleación de acero, rectificada y templeada en todas sus caras. Engrasada para impedir la corrosión. Mango bimatéria más grueso y amortiguador absorbente de los golpes.

	Anchura de la punta	Longitud
<b>0-16870</b>	6mm	125mm
<b>0-16872</b>	10mm	125mm
<b>0-16874</b>	14mm	131mm
<b>0-16876</b>	16mm	131mm
<b>0-16878</b>	20mm	141mm
<b>0-16880</b>	25mm	143mm
<b>0-16890</b>	30mm	150mm
<b>0-16891</b>	35mm	162mm
<b>0-16892</b>	40mm	167mm



JUEGO 3 FORMONES

	Anchura de la punta	Longitud
<b>2-16883</b>	12/18/25mm	125/141/143mm



JUEGO 5 FORMONES

	Anchura de la punta	Longitud
<b>2-16885</b>	6/12/18/25/32mm	125/141/143/159mm



**KIT DE AFILADO FORMONES**  
Guía y piedra de afilado con grano 120 y 240. Incluye frasco de aceite blanco.

**0-16050**

## ESCOFINAS



### ESCOFINAS MEDIA CAÑA

Fabricadas con aceros altos en carbono. Mayor durabilidad de afilado. Diseño ergonómico. Mango bimatéria.

	Descripción	Largo de hoja
<b>0-22469</b>	Basta	200mm
<b>0-22471</b>	Entrefina	200mm



### ESCOFINAS REDONDAS

Fabricadas con aceros altos en carbono. Mayor durabilidad de afilado. Diseño ergonómico. Mango bimatéria.

	Descripción	Largo de hoja
<b>0-22473</b>	Basta	200mm
<b>0-22475</b>	Entrefina	200mm

## INSTRUMENTOS DE MEDICIÓN



**FLEXÓMETRO BIMATERIA TYLON**  
Cinta de acero ultraresistente con revestimiento Tylon™ que aumenta hasta un 50% la durabilidad de la hoja. Revestimiento mate, caja con forma ergonómica contorneada de caucho.

	Longitud	Anchura
<b>0-30657</b>	8m	25mm
<b>0-30687</b>	3m	12,7mm
<b>0-30697</b>	5m	19mm



**FLEXÓMETRO BLADE ARMOR**  
Revestimiento termoplástico Blade Armor™ en los 7,5 primeros centímetros. Mayor durabilidad gracias al revestimiento Mylar™. Clip de sujeción para el cinturón.

	Longitud	Anchura
<b>0-33514</b>	5m	25mm
<b>0-33527</b>	8m	25mm
<b>0-33532</b>	10m	25mm



**METRO PLEGABLE DE MADERA**  
Revestimiento protector a la abrasión y al desgaste. Remaches ocultos.

	Longitud	Anchura
<b>0-35458</b>	2m	17mm

## INSTRUMENTOS DE NIVELACIÓN



**NIVELES PERFILADOS 180°**  
Cuerpo en aluminio y extremos protectores. Burbuja horizontal, vertical y graduable de 0 a 90°. Burbuja central con lectura superior. Precisión 1,5mm.

	Nº Burbujas	Longitud
<b>1-42919</b>	2	40mm
<b>1-42920</b>	3	60mm
<b>1-42921</b>	3	80mm
<b>1-42922</b>	3	100mm
<b>1-42923</b>	3	120mm

## INSTRUMENTOS DE TRAZADO



**CORDEL TRAZADOR**  
Capacidad de polvo 30g. Incluye frasco de polvo de 113g.

**0-47443**



**ESCUADRA CARPINTERO**  
Escuadra angular 45°. Talón de perfil de aluminio. Medidas: 200x300mm

**1-45686**

## BOTADORES



**BOTADOR DOBLE PUNTA FATMAX**  
 Dos puntas en un solo botador. Cuerpo bimateria y sistema de anclaje de la punta magnético que permite adaptar puntas de destornillador convencionales de 1/4".

	Longitud	Diámetro
<b>1-58501</b>	76mm	0,8/1,6mm



**JUEGO 3 BOTADORES DUNAGRIP™**  
 Juego de botadores de acero coloreados según la medida.

	Longitud	Diámetro
<b>0-58930</b>	125mm	0,8/1,6/2,4mm

## OTRAS HERRAMIENTAS DE CARPINTERÍA Y CONSTRUCCIÓN



**MARTILLO DE CARPINTERO**  
 Mango bi-material de fibra de vidrio.

	Peso cabeza	Largura cabeza
<b>1-58501</b>	315g	25mm



**MAZA DE PLÁSTICO**  
 Martillo monobloque con material sintético.

	Peso cabeza	Largura cabeza
<b>1-57053</b>	320g	34mm



**CINCEL FATMAX CON PROTECTOR**  
 Cuerpo de acero cromo vanadio forjado en una sola pieza para incrementar la fuerza y durabilidad.

	Anchura punta	Longitud
<b>4-18331</b>	75mm	279mm



**SERRUCHO PARQUET FATMAX**  
 Aluminio, ABS y caucho. Geometría del dentado de triple bisel. Grosor de lámina 1mm

	Nº dientes	Longitud
<b>2-20533</b>	11	450mm



**INGLETADORA CON SERRUCHO**  
 Ingletadora de plástico con sistema de bloqueo. Para cortes con ángulos de 45°, 90° y 22,5°. Incluye serrucho de 355mm, de acabado fino y dentado.

	Anchura máxima	Longitud
<b>1-20600</b>	130mm	300mm

## OTRAS HERRAMIENTAS DE CARPINTERÍA Y CONSTRUCCIÓN



**BARRA PIE DE CABRA**  
Barra de acero forjado  
acabado pulido y biselado  
en ambos extremos. 32cm

1-55515



**MEDIDOR DE HUMEDAD LED**  
Mide la humedad de la madera  
desde el 6 % al 44 %. Dos  
clavijas de detección. Mide la  
temperatura ambiente

0-77030



**VARILLA MEZCLADORA**  
Compatible con todos los taladros.  
Ideal para mezclar pinturas  
masillas y otros materiales.

STHT2-28043



**PISTOLA DE COLA GR90 40W**  
Uso con o sin cable,  
manteniendo la temperatura  
hasta 12 minutos. Boquillas  
intercambiables, 180° a 210°  
de temperatura y funde hasta  
12grs por minuto.

STHT6-70416



**RODILLERAS**  
Gruesa capa de espuma de alta  
densidad. Anti-deslizante. Cinta  
de posición variable.

FMST82962-1



**TALLER MOVIL 3 EN 1**  
Taller portátil que se separa  
en tres cajas de herramientas.  
Dimensiones: 40x50,6x74cm.  
Capacidad de carga de 45 kg.

STST83319-1



## HERRAMIENTAS ELÉCTRICAS



**MINI-AMOLADORA CON MALETÍN**  
 Motor de hasta 12.000rpm. Protección contra re-arranque. Empuñadura con 3 posiciones. Interruptor deslizable.

	Potencia	Diámetro max.
<b>FMEG210K-QS</b>	850W	115mm
<b>FMEG220K-QS</b>	850W	125mm



**MULTIHERRAMIENTA OSCILANTE**  
 Ajuste de velocidad variable (10.000-22.000 opm)  
 Cortes de inmersión limpios, recorte de materiales sobrantes, lijado de detallar en áreas estrechas, raspado de pintura vieja, etc..

	Potencia	Ángulo oscilación
<b>FME650K-QS</b>	300W	1,4°/2,8°



**MEZCLADOR ELÉCTRICO**  
 Motor de 2 velocidades. Doble empuñadura engomada.  
 Varilla M14 de 140mm de diámetro.

	Potencia	Velocidad en vacío
<b>FME190-QS</b>	1.600W	180-460/300-750rpm



**TACO PERCUTOR DE NYLON**  
 Para ensamblar elementos de parquet o tablas de madera de modo sencillo y cuidadoso.  
 Gracias a su forma especial, queda siempre plano sobre los elementos cuando se coloca contra la ranura o la lengüeta.

7011000100



**DISTANCIADOR PARA PARQUET**

Ajustable para distancias a la pared de 5 a 20 mm. Amplia superficie de apoyo para evitar puntos de presión y marcas en los materiales

	Apertura	Anchura piezas de apriete	Presentación
AV2	20mm	89mm	4uds



**TENSOR SUJECIÓN Y MONTAJE**

SVH con separador y cinta de poliéster de alta resistencia. Resistencia a la rotura 5000N.

	Apertura	Banda bxd
SVH400	4000mm	25x1mm
SVH760	7600mm	25x1mm

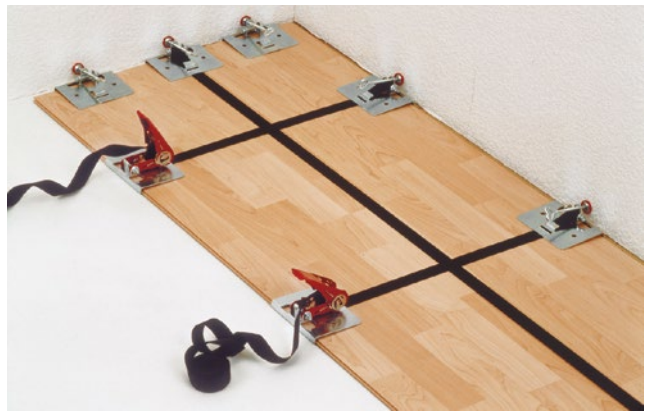

**NAVAJA PROFESIONAL**

Con mango bicomponente. Compartimiento con 5 cuchillas de recambio. Clip para cinturón

	Longitud	Cuchillas
DBKPH-EU	160mm	28mm

## HERRAMIENTAS DE CORTE



**GUILLOTINA VLC800**  
Cortadora profesional para vinilo y laminado.  
Máxima precisión.  
Sin ruidos, sin electricidad, sin polvo.  
Escuadra de comprobación 90°.

	Grosor max. laminado	Grosor max. vinilo
<b>6939000</b>	11mm	6mm



**GUILLOTINA VLC1000**  
Cortadora profesional para vinilo y laminado especialmente grueso.  
Máxima precisión.  
Sin ruidos, sin electricidad, sin polvo.  
Escuadra de comprobación 90°.

	Grosor max. laminado	Grosor max. vinilo
<b>6940000</b>	11mm	6mm



**SIERRA DE MANO**  
Para serrado próximo al suelo.  
Mango acodado y orientable 180°.  
Ideal para cortar marcos de puertas para realizar bordes limpios en suelos recién instalados.

	Longitud de trabajo	Altura de trabajo
<b>6925000</b>	255mm	55mm



**SIERRA JAPONESA**  
Para cortar con facilidad rodapiés, ramas y tubos de plástico.  
Dentado en ambos bordes para realizar cortes bastos y precisos.  
Mango ergonómico largo de dos componentes.

	Longitud de trabajo
<b>6951000</b>	240mm

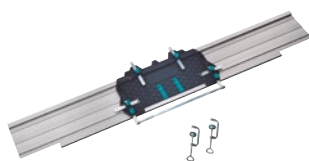

**RIEL DE GUÍA FKS145 PARA SIERRA CIRCULAR**  
Sistema de guía para sierras circulares de mano. Cortes longitudinales, transversales y de inglete rectos hasta una longitud de corte de 110 c.

	Dimensiones
<b>6913000</b>	190 x 1450 x 12mm



**SET PROLONGACIÓN GUÍA FKS 145**  
Prolongación sencilla y rápida a 255 cm con una longitud de corte máxima de 220 cm.

	Dimensiones
<b>6914000</b>	190 x 1100 x 12mm



**CÚTER DE CUCHILLAS SEPARABLES**  
Carcasa de metal con cuchilla negra.

	Segmentos	Altura
<b>4306100</b>	8	18mm



**CUCHILLAS PROFESIONAL CÚTER**  
5 Cuchillas separables profesionales de 18 mm

	Segmentos	Grosor	Altura
<b>4182000</b>	15	0,5mm	18mm



## HERRAMIENTAS DE INSTALACIÓN



### DISPOSITIVO DE TRACCIÓN Y MARTILLADO

Para la unión sin juntas de laminado y entarimado. Reduce la tasa de errores a cero y evita las lesiones y los daños con el martillo.

	Anchura de trabajo	Altura de trabajo
<b>6945000</b>	150mm	7-13mm

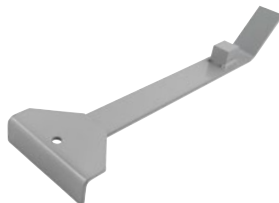

### ESCOPLO PROFESIONAL

Dispositivo de tracción para trabajos exigentes de colocación. Cara inferior con fieltro para proteger las superficies de los materiales.

	Dimensiones
<b>6928000</b>	120 x 440 x 60 mm



### ESCOPLO CÓNICO

Dispositivo de tracción para alinear y ajustar adecuadamente las hileras de laminado. 3 patines de fieltro en la cara inferior protegen la superficie de trabajo.

	Dimensiones
<b>6927000</b>	25 x 310 x 15 mm



### TACO DE MADERA PROFESIONAL

Para posicionar el laminado y el entarimado de 5, 10 y 15 mm de grosor para uniones sin junta. Barras de protección de aluminio con curvatura convexa.

	Dimensiones
<b>6947000</b>	62 x 281 x 24 mm



### CUÑAS UNIVERSALES

Se pueden utilizar como distanciadores para juntas de dilatación o como cuña.

	Dimensiones
<b>6946000</b>	35 x 6 x 60 mm



### PISTOLA PARA CARTUCHOS MG350

Para la aplicación de silicona, acrílicos y adhesivo en cartuchos de 310 ml. Óptima guía gracias a un soporte de cartucho giratorio de 360°.

	Dimensiones
<b>4353000</b>	398 x 64 x 171 mm

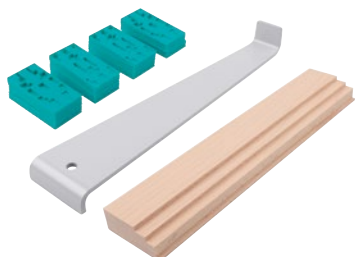

### SET INSTALACIÓN

1 dispositivo de tracción  
1 taco de madera  
20 cuñas distanciadoras

**6931000**



### PERFILADORES DE JUNTAS (2ud)

Para alisar juntas de sellado con perfiles para todas las anchuras, radios y biselés habituales. Perfiles angulares: 45° - 5, 8, 10 mm / circular de 5, 8, 10 mm

**4331000**



### RODILLERAS CONFORT

Tapa protectora transparente ideal para superficies rugosas y delicadas. Protectores elásticos de gel para amortiguación que protegen las articulaciones.

**4860000**

## HERRAMIENTAS DE MEDICIÓN



**CALIBRE PARA CONTORNOS**  
Para palpar y transferir el trazado de cortes. Plantilla de agujas de plástico de calidad para el palpado de perfiles de hasta 130 mm de ancho y 30 mm de profundidad.

	Longitud de trabajo	Anchura de trabajo
<b>6949000</b>	30mm	130mm



**MEDIDOR ÚLTIMA TABLA**  
Para la medición exacta y la transferencia de la última fila de laminado. Ruedas deslizantes y elementos deslizantes guiados por resorte. Transmisión sencilla y precisa de las dimensiones hasta 23,5 cm de

	Ancho de muela	Ancho de tope
<b>6952000</b>	30mm	80mm



**FALSA ESCUADRA**  
Para medir y transferir ángulos, así como para su uso como gramil. Tope extensible y escala en el brazo móvil para trazar más fácilmente ángulos o líneas paralelas.

	Brazo	Tope
<b>6958000</b>	32 x 3,5cm	16,5 x 3,5cm

## HERRAMIENTAS DE SUJECCIÓN



**SARGENTO MONOMANUAL EHZ**  
Sujeción y apertura con una sola mano y hasta 120 kg de fuerza tensora. Gran superficie de sujeción con ranura cruzada y una elevada profundidad de alcance.

	Ancho sujeción	Rango extensión	Profundidad
<b>3030000</b>	150mm	210-410mm	100mm
<b>3031000</b>	300mm	210-560mm	100mm



**PINZA CON RESORTE**  
Adaptación óptima a la pieza mediante las mordazas móviles. Ranura cruzada en forma de V para sujetar material redondo.

	Ancho sujeción	Fuerza de retención
<b>3631000</b>	60mm	1.200g

## TRANSPORTE



**CARRO DE TRANSPORTE TS1500**  
Plegable, pala extragrande y placa de soporte redondeada. Desplazamiento fácil gracias a las grandes ruedas de caucho. Mango de extensión con sistema de enclavamiento central, barra agarradera de forma ergonómica.

	Altura de trabajo	Capacidad de carga
<b>5525000</b>	1000-1240 mm	200kg

## CORONAS



**SIERRA DE CORONA STANDARD**  
Para madera, planchas de placa de yeso y planchas de construcción.  
Incluye 1 broca de centrado diámetro 10mm y 5 hojas de cambio rápido.

	Diámetro hojas de cambio rápido	Profundidad de corte
<b>2162000</b>	60,68,74,80 o 95mm	33mm



**SIERRA DE CORONA STANDARD**  
Para madera, planchas de placa de yeso y planchas de construcción.  
Incluye 1 broca de centrado diámetro 8mm y 7 hojas de cambio rápido.

	Diámetro hojas de cambio rápido	Profundidad de corte
<b>2164000</b>	25,32,38,45,50,56,62 mm	23mm



**SIERRA DE CORONA BIMETAL**  
Para madera, metal, plástico, placas para construcción en seco y de aislante.  
Dentado variado progresivo de acero de alta velocidad (HSS) para agujeros de expulsión grandes, vástago hexagonal de 9,5 mm de diámetro.  
Una broca centradora de 6 mm de diámetro facilita el posicionamiento preciso del taladro. Mediante los agujeros de expulsión grandes puede retirar seguidamente el núcleo de perforación con facilidad.

	Diámetro	Profundidad de corte
<b>5465000</b>	29mm	40mm
<b>5466000</b>	32mm	40mm
<b>5467000</b>	35mm	40mm
<b>5469000</b>	40mm	40mm
<b>5471000</b>	51mm	40mm
<b>5474000</b>	68mm	40mm
<b>5475000</b>	74mm	40mm
<b>5484000</b>	60mm	40mm



## ABRASIVOS

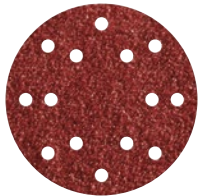

**DISCOS CORINDÓN**  
Aglomerado con resina sintética. Reforzado por tejido.

	Diámetro	Grano	Presentación
<b>1840000</b>	150mm	40	5uds
<b>1842000</b>	150mm	80	5uds
<b>1843000</b>	150mm	120	5uds
<b>2069000</b>	125mm	40	5uds
<b>2250000</b>	125mm	60	5uds
<b>2070000</b>	125mm	80	5uds
<b>2283100</b>	115mm	80	15uds



**HOJAS DE LIJAR CORINDÓN**  
Para delta/multilijadora. Larga duración.

	Medidas	Grano	Presentación
<b>1763000</b>	96x136mm	120	10uds
<b>1764000</b>	96x136mm	240	10uds



**LIJAS DE BANDA CORINDÓN**  
Para lijadora de banda. Larga duración. Flexibles y resistentes.

	Medidas	Grano	Presentación
<b>1916000</b>	75x533mm	40	3uds
<b>1918000</b>	75x533mm	60	3uds
<b>1920000</b>	75x533mm	80	3uds
<b>3122000</b>	100x690mm	40	3uds
<b>3125000</b>	100x690mm	80	3uds
<b>3124000</b>	100x690mm	120	3uds

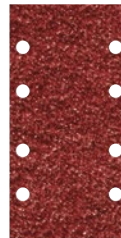

**HOJAS DE LIJAR CORINDÓN**  
Para lijadora orbital. Larga duración.

	Medidas	Grano	Presentación
<b>1766000</b>	93x185mm	40	10uds
<b>1767000</b>	93x185mm	80	10uds
<b>1768000</b>	93x185mm	120	10uds



**HOJAS DE LIJAR CORINDÓN**  
Para delta/multilijadora. Larga duración.

	Medida entre vértices	Grano	Presentación
<b>1851000</b>	95mm	60	5uds
<b>1852000</b>	95mm	80	5uds
<b>1853000</b>	95mm	120	5uds

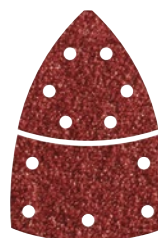

**HOJAS 2 PIEZAS CORINDÓN**  
Aglomerado con resina sintética. Reforzado por tejido.

	Medida entre vértices	Grano	Presentación
<b>1811000</b>	95mm	40	10uds
<b>1813000</b>	95mm	80	10uds



**PLATO ABRASIVO ADHESIVO**  
Para amoladoras angulares.

	Diámetro
<b>2281000</b>	115mm

**ABRASIVOS**



**LIJAS DE BANDA**  
Bandas de corindón con base de papel.

	Medidas	Grano
732X26040	100x690mm	40
732X26060	100x690mm	60
732X26080	100x690mm	80
732X260100	100x690mm	100



**ROLLOS GRIP**  
Corindón con revestimiento especial.

	Medidas	Grano
542B7K180	100x25000mm	180
542B7K220	100x25000mm	220
542BK115GR180	115x25000mm	180
542BK115GR220	115x25000mm	220



**DISCOS VELCRO**  
Grano de carburo de silicio negro de alta calidad sobre papel impermeable.

	Diámetro	Grano
942EK15030	150mm	30
942EK15040	150mm	40
942EK15060	150mm	60
942EK15080	150mm	80
942EK150100	150mm	100
942EK18030	180mm	30
942EK18040	180mm	40
942EK18060	180mm	60
942EK180100	180mm	100



**LIJAS DE BANDA**  
Bandas de carburo de silicio con base de papel.

	Medidas	Grano
942XYP30030	200x750mm	30
942XYP30036	200x750mm	36
942XYP30040	200x750mm	40
942XP30060	200x750mm	60
942XP30080	200x750mm	80
942XP300100	200x750mm	100
942XP300120	200x750mm	120



**DISCOS AGUJERO**  
Grano de carburo de silicio negro de alta calidad sobre papel impermeable.

	Diámetro	Grano
942XYP15030	150mm	30
942XYP15040	150mm	40
942XYP15060	150mm	60
942XP15080	150mm	80
942XYP150100	150mm	100
942EK18030	180mm	30
942EK18040	180mm	40
942XYP18060	180mm	60
942XYP18080	180mm	80
942XYP180100	180mm	100

## HOJAS DE SIERRA CIRCULAR



Hojas para Madera, madera alistonada y contrachapado. Dientes alternos. Hojas suministradas con anillos reductores.

	Diámetro	Dm. Interior	Grosor	Nº Dientes
<b>964.150.2024</b>	150mm	20mm	2,6/1,6mm	24
<b>964.160.3048</b>	160mm	30mm	2,6/1,6mm	48
<b>964.190.3048</b>	190mm	30mm	2,8/1,8mm	48



Utilización universal corte a lo largo y a través para las maderas blandas, duras y exóticas, así como para paneles chapados por una cara o laminados.

	Diámetro	Dm. Interior	Grosor	Nº Dientes
<b>328.250.3040</b>	250mm	30mm	3,2/2,2mm	40
<b>328.300.3048</b>	300mm	30mm	3,2/2,2mm	48



Para mecanizar y dar forma a los paneles 1 o 2 caras, hasta 30 mm de altura de corte. Calidad de corte óptima en los paneles macizos de materia plástica (termoplásticos y duroplásticos), laminados.

	Diámetro	Dm. Interior	Grosor	Nº Dientes
<b>336TF.300.72</b>	300mm	30mm	3,2/2,2mm	72
<b>338TF.300.96</b>	300mm	30mm	3,2/2,2mm	96



Para el corte de perfiles de aluminio delgados, perfiles de plástico, marcos y chapas de aluminio. Avance manual. Sierra con movimiento radial.

	Diámetro	Dm. Interior	Grosor	Nº Dientes
<b>112.300.3096</b>	300mm	30mm	3,2/2,5mm	96

## HOJA DE SIERRA MULTIHERRAMIENTA



Corte de Incisión. Dientes japoneses. Para madera, parquet, MDF/HDF o PVC.

	Anchura	Longitud
<b>4032DJ.01</b>	32 mm	40mm



Corte de Incisión. Dientes japoneses. Para madera, parquet, MDF/HDF o PVC.

	Anchura	Longitud
<b>4045DJ.01</b>	45mm	50mm

## HOJA DE SIERRA CORTE CIRCULAR MULTIHERRAMIENTA



Segmento núcleo abombado bimetallica. Corte de incisión. Ideal para el corte enrasador.

	Diámetro
<b>4009.01</b>	87mm

## HOJAS SIERRA DE CALAR



Madera dura y blanda , contrachapado y PVC

	Longitud	Presentación
7005.05	110mm	Blister 5uds
7002.05	75mm	Blister 5uds



Multimaterial. Madera, aluminio, acero inoxidable

	Longitud	Presentación
7001.05	110mm	Blister 5uds



Corte limpio y sin astillamiento. SPC, melamina, Corian.

	Longitud	Presentación
7017.05	75mm	Blister 5uds



Corte limpio en superficie gracias a sus dientes invertidos. Contrachapado, melamina.

	Longitud	Presentación
7003.05	75mm	Blister 5uds

## CUCHILLAS REVERSIBLES



	Anchura	Longitud	Grosor	Presentación
142.780.02	5,5mm	80mm	1,1mm	2uds
142.782.02	5,5mm	82mm	1,1mm	2uds
7142.780.10	5,5mm	80mm	1,1mm	10uds
7142.782.10	5,5mm	82mm	1,1mm	10uds

## DISCOS DE CORTE



**CORTE FINO INOX**  
Ideal para las chapas y perfiles delgados. Larga vida útil. Corte de gran velocidad (13300 rpm). Fácil y limpio.

	Diámetro	Dm. Interior	Grosor	Presentación
115.10.25	115mm	22,23mm	1,0mm	25uds



**CORTE CARBURO**  
Rápido y polivalente (13300 rpm) Revestimiento de carburo de tungsteno. Uso fácil y seguro. Extrafino, para cortes limpios y precisos.

	Diámetro	Dm. Interior	Grosor	Presentación
1711522	115mm	22,23mm	1,0mm	1ud



**CORTE CARBURO MULTIFUNCIONES**  
Cortes, ranurados en la madera y el yeso. Desbastes manuales de escultura en madera.

	Diámetro	Dm. Interior	Grosor	Presentación
SPEEDWOOD	115mm	22,23mm	3,8mm	1ud

## DISCOS DE CORTE DIAMANTE



**DISCO DIAMANTE HORMIGÓN**  
Disco con segmentos turbo sinterizados. Chapa ventilada perforada para una mejor refrigeración. Gran velocidad de corte. 9 segmentos.

	Diámetro	Dm. Interior	Grosor	Altura segmento
<b>770115</b>	115mm	22,23mm	2mm	12mm



**DISCO DIAMANTE GRES CERÁMICO**  
Disco de banda continua estriada extrafino. Brida reforzada para un corte más preciso y sin vibraciones. Buena duración del corte y acabado.

	Diámetro	Dm. Interior	Grosor	Altura segmento
<b>930115</b>	115mm	22,23mm	1,4mm	8mm

## DISCOS LÁMINAS CORINDÓN



**DISCO LÁMINAS CORINDÓN**  
Abrasivo de corindón, resina. Soporte: fibra de vidrio. 13300 rpm

	Diámetro	Grano	Dm. Interior	Presentación
<b>115.040A</b>	115mm	40	22,23mm	10uds
<b>115.080A</b>	115mm	80	22,23mm	10uds
<b>115.120A</b>	115mm	120	22,23mm	10uds

## BROCAS



**CAJA DE 10 BROCAS PLANAS DE MADERA**  
Punta de centrado, 2 cortes para evacuar las virutas, 2 trazadores.

	Diámetro
<b>304.500.10</b>	6/8/10/14/18/20/22/26/30/35



**CAJA DE 5 BROCAS CILÍNDRICAS HORMIGÓN**  
Broca hormigón con plaquita de carburo. Afilado semipositivo. Hélice fresada en «U». Acabado pulido y ranura negra.

	Diámetro
<b>602.000.05</b>	4/5/6/8/10 mm



**CAJA 15 BROCAS HELICOIDALES MADERA**  
Punta de centrado, 2 trazadores.

	Diámetro
<b>201.500.15</b>	1 X Ø 7/8,5/9 2 X Ø 3/4/5/6/8/10



**CAJA DE 5 BROCAS CILÍNDRICAS PORCELÁNICO**  
Plaquita de carburo afilado positivo. Hélice en «L».

	Diámetro
<b>611.000.05</b>	4/5/6/8/10 mm



## FRESAS



CAJA DE 12 FRESAS DE CARBURO COLA  
Fresas surtidas de metal duro con medidas comunes: Ideal para el corte de maderas blandas.

	Díámetro
416.700.12	6mm
418.700.12	8mm

## CORONAS



LOTE 4 CORONAS BI-METAL  
Gran polyvalencia y precisión.  
1 mandril, 1 broca de centrado,  
1 adaptador

	Díámetro
3004	22/35/44/68 mm

## FORMONES



CAJA DE 3 FORMONES+ PIEDRA AFILADO  
Mango revestido de uretano flexible y refuerzo metálico en el extremo.

	Anchuras
780.500.03	12, 26, 40 mm

## LIMPIADOR DE HERRAMIENTAS



LIMPIADOR DE HERRAMIENTAS DE CORTE  
125ml  
Hojas, fresas, cuchillas, plaquitas...  
Debe diluirse en 5 veces su volumen de agua.  
Sumergir la herramienta y dejar actuar durante unos minutos. Cepillar después con un pincel de fibras sintéticas.  
No debe utilizarse con herramientas de aleación ligera (aluminio).





**PARMOVIL**

# LÁPIZ MARCADOR PROFESIONAL

recargable con minas de grafito o cera de colores



- Fabricado en ABS y acero inoxidable.
- Diseño ergonómico y antideslizante.
- Punta de 45mm de largo ideal para marcar a través de zonas estrechas o agujeros.
- Clip para llevar colgado cómodamente.
- Recambios de grafito, cera roja o amarilla. Para marcar diferentes materiales.

Recambios de **3 colores**

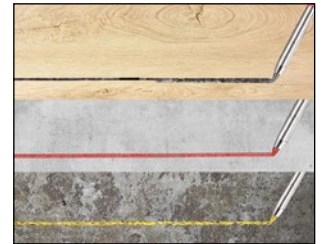

Marca en multitud de superficies



Sacapuntas/afilador integrado

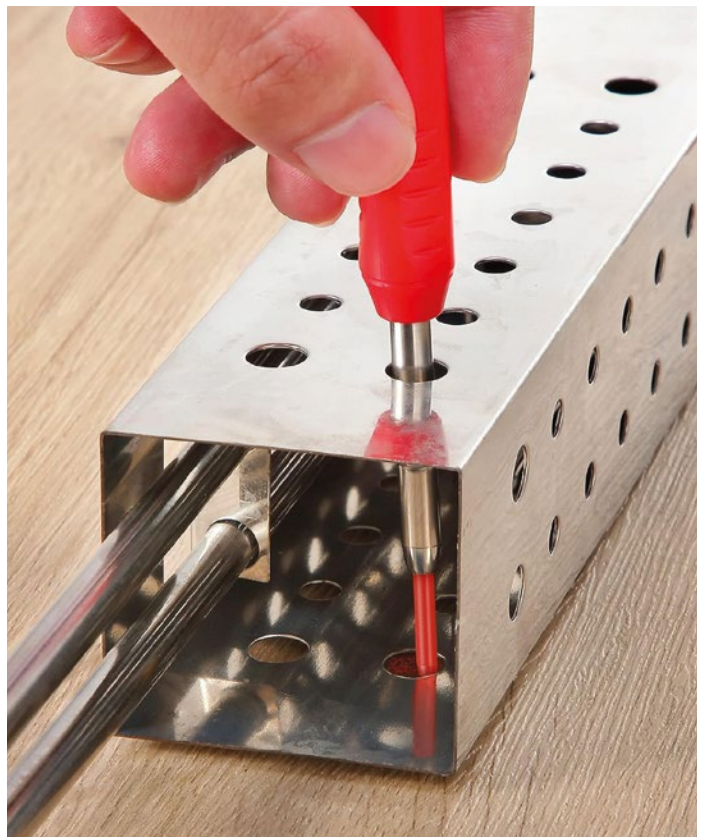

**FRESAS**

**FRESAS PARA PERNIOS**  
Fresas industrial para fresadoras.  
Ideales para fresados laterales.

	Diámetro	Largo corte	Largo total	D. mango
<b>702.140.11</b>	14mm	12mm	38mm	6mm
<b>702.200.11</b>	20mm	11mm	38mm	6mm



**FRESAS PARA REFUNDIR**  
Fresas profesionales con segmentos de carburo de tungsteno para trabajos de precisión en laminados, o para un trabajo rápido de molduras. Ideales para realizar ranuras pasantes en la madera.

	Diámetro	Largo corte	Largo total	D. mango
<b>906.127.11</b>	12,7mm	25,4mm	71mm	8mm
<b>906.096.11</b>	9,5mm	12,7mm	55,5mm	8mm
<b>906.095.11</b>	9,5mm	25,4mm	68,2mm	8mm



**FRESAS RECTAS**  
Fresas rectas de dos cortes fabricadas en acero recubierto con un revestimiento brillante permanente de resina fluorocarbónica. Ideales para diferentes materiales como la madera, contrachapados y compuestos.

	Diámetro	Largo corte	Largo total	D. mango
<b>912.080.11</b>	8mm	31,7mm	60mm	8mm
<b>911.080.11</b>	8mm	20mm	50mm	8mm
<b>912.060.11</b>	6mm	25,4mm	60mm	8mm
<b>911.060.11</b>	6mm	16mm	50mm	8mm
<b>911.050.11</b>	5mm	12mm	50mm	8mm
<b>911.040.11</b>	4mm	10mm	50mm	8mm
<b>911.030.11</b>	3mm	8mm	50mm	8mm
<b>911.200.11</b>	20mm	20mm	50mm	8mm
<b>911.120.11</b>	12mm	20mm	50mm	8mm
<b>911.100.11</b>	10mm	20mm	48mm	8mm
<b>911.180.11</b>	18mm	20mm	50mm	8mm
<b>912.100.11</b>	10mm	31,7mm	60mm	8mm
<b>911.160.11</b>	16mm	20mm	57mm	8mm
<b>911.160.11B</b>	8mm	31,7mm	60mm	8mm



**FRESA PARA TIRADORES**  
Fresa para realizar tiradores de cajones y puertas ligeras. Permite fabricarlos en dos estilos: con perfil realizado en la puerta o con estilo continental en madera maciza.

	Diámetro	Largo corte	Radio	Largo total
<b>955.103.11</b>	38,1mm	20,7mm	6mm	55,5mm



## HOJAS DE SIERRA CIRCULAR



**SIERRA CON DIENTE TRAPEZOIDAL**  
Para seccionar. Acabado perfecto incisor. Para máquinas seccionadoras horizontales o verticales. Excelente para corte en laminados por un lado o ambos lados.

	Diámetro	Dm. Interior	Nº dientes	Ángulo corte
<b>281.160.40H</b>	160mm	20mm	40	10°



**SIERRA CON DIENTE TRAPEZOIDAL**  
Para cortes de acabado. Acabado perfecto incisor. Para máquinas seccionadoras horizontales o verticales. Excelente para corte en laminados por un lado o ambos lados.

	Diámetro	Dm. Interior	Nº dientes	Ángulo corte
<b>281.672.12M</b>	300mm	30mm	72	10°
<b>281.696.12M</b>	300mm	30mm	96	5°



**SIERRA DIENTES ALTERNOS**  
Para cortes transversales a la veta. Para sierras de banco, ingletadoras y máquinas portátiles. Excelente para madera blanda y dura y tableros derivados de madera.

	Diámetro	Dm. Interior	Nº dientes	Ángulo corte
<b>285.648.12M</b>	300mm	30mm	48	15°

## HOJAS DE SIERRA DE CALAR



**HOJA SIERRA**  
Corte pro penetración recto y fino en madera blanda y dura, contrachapada, tableros OBS y plástico de 3 a 30mm.

	Largo corte	Espacio entre dientes	Dientes por pulgada	Presentación
<b>JT101B-5</b>	75mm	2,5mm	10	5uds



**HOJA SIERRA DIENTE INVERTIDO**  
Corte recto con acabado excelente en el lado superior de madera blanda y dura, contrachapada, OSB, laminados y plástico desde 3 a 30mm.

	Largo corte	Espacio entre dientes	Dientes por pulgada	Presentación
<b>JT101BR-5</b>	75mm	2,5m	10	5uds



**HOJA SIERRA PLADUR**  
Para pladur, placas de fibrocemento, GFK, MDF o HDF.

	Largo corte	Espacio entre dientes	Dientes por pulgada	Presentación
<b>JT141HM-3</b>	75mm	4,3mm	6	3uds



**HOJA SIERRA TABLERO**  
Corte de penetración muy rápido y grueso en madera blanda y dura desde 5 a 60mm, madera contrachapada, tableros OBS.

	Largo corte	Espacio entre dientes	Dientes por pulgada	Presentación
<b>JT144D-5</b>	75mm	4mm	6	5uds



**HOJA SIERRA MULTIMATERIAL**  
Corte recto en madera con clavos/metal, aglomerado, laminado, chapas de metal, aluminio (3-18mm)

	Largo corte	Espacio entre dientes	Dientes por pulgada	Presentación
<b>JT318VF-5</b>	100mm	1,7-2,6mm	10-15	5uds

## HOJAS DE SIERRA MULTIHERRAMIENTA



**HOJA SIERRA DENTADO JAPONÉS**  
Bimetal 8% cobalto. Corte de precisión con dentado japonés a doble fila de dientes reforzados. Para cortes de madera hasta 50mm de espesor, cartón, yeso y plástico.

	Anchura corte
OMF205-X50	35mm
OMF232-X50	45mm



### SET MULTIHERRAMIENTA

- 2 hojas con dentado japonés para realizar cortes en madera, aglomerado, cartón yeso, plástico y hormigón poroso.  
- 2 hojas BIM para cortes en madera, Tableros de aglomerado, cartón yeso, fibra de vidrio, resina epoxi, plástico blando, láminas de metal, tubos y perfiles de aluminio.

OMF-X4

## MARCADOR



### LÁPIZ MARCADOR

Para marcar superficies, ásperas o lisas, secas, húmedas o polvorientas, lugares estrechos y de difícil acceso. Cuerpo de metal resistente y práctico clip de bolsillo. Longitud de la punta 45 mm (Ø5,7 mm). Pulsador de alimentación para avance automático de minas con afilador integrado.

PCL-3



**RECAMBIOS PARA LÁPIZ MARCADOR**  
Recargas CMT Ø2.8mm insertables en punta o extremo opuesto.

	Color
PCL-3B	Grafito
PCL-3C	Amarillo, rojo y grafito

## KIT MULTIHERRAMIENTA



### KIT MULTIHERRAMIENTA OSCILANTE + SET DE ACCESORIOS

1) Herramienta para lijar, serrar, abrir articulaciones, cortar plástico, retirar pavimento. Potencia 300 W, 220/230V. Velocidad de oscilaciones 11.000~21.000 RPM.

2) Set de 37 herramientas para máquinas multifuncionales:

- Hoja con 2 diámetros para madera, plástico, planchas, perfiles y tuberías de aluminio y cobre.
- Hoja con dientes para madera y metal.
- Rascadora para eliminar residuos de tapicería, residuos de pintura y silicona.
- Placa en metal duro para azulejos, cartón-yeso, cemento, material de construcción y piedra.
- Hoja con diseño especial para quitar lechadas y residuos de cemento de azulejos, hormigón y piedra, incluso en los rincones más difíciles.
- Soporte y papel abrasivo para lijar ( grano 60,100 y 180)

CMT11X37



### TORNILLOS

Cabeza avellanada, rosca total y engarce PZ. Para tableros de aglomerado. La geometría optimizada de la cabeza permite un acabado de la superficie exacto y sin astillas.

	Medidas	Presentación
657164	3,5x30mm	100 uds
657174	4x40mm	200 uds
657154	3,5x35mm	100 uds



Trabajamos con  
las mejores marcas

**FINfloor**

**QUICK-STEP**

**FAUS**

**purefloor**

**FLINT**





[www.parmovil.com](http://www.parmovil.com)



---

**BADALONA**

C/Dels Treballadors 2-4  
08911 Badalona  
Tfno. 93 384 29 16  
info@parmovil.com

**CORNELLÀ**

Psg. Ferrocarrils Catalans 134  
08940 - Cornellà  
Tfn. 93 624 52 97  
cornella@parmovil.com

**TERRASSA**

Ctra. Rubí 324. Nave B  
08228 - Terrassa  
Tfn. 93 856 72 82  
terrassa@parmovil.com

---