

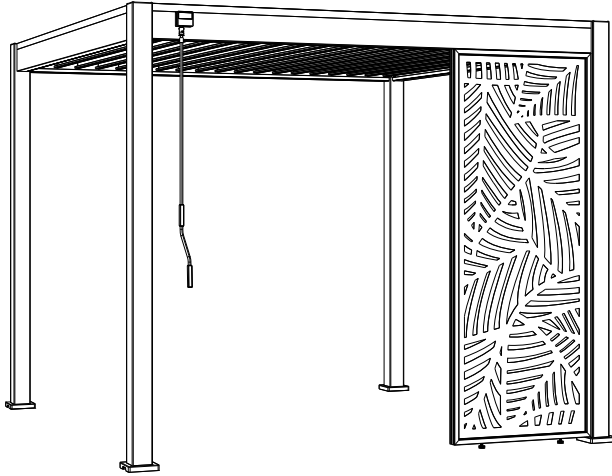





Weide
SONNENSCHUTZ

Aufbauanleitung für dekorative Lamellenwand



REF	BILD	MENGE
G		1

REF	BILD	MENGE
#1	 5×19	4
#2		2
#3		4
#6		1

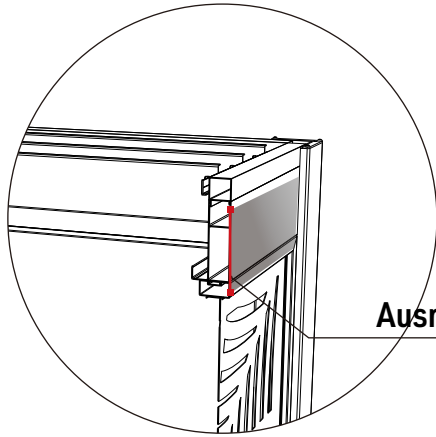
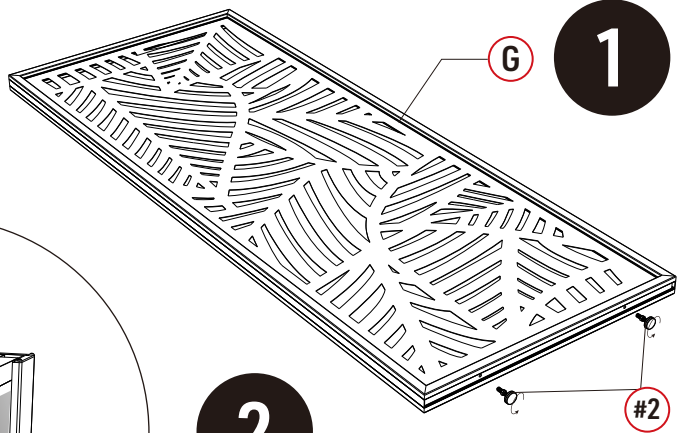

2

Ausrichten !

3

