COSMO

STONE
SOUL

FOUR
SIZES

4
COLORS

PORCELAIN STONEWARE

MADE IN ITALY

CERCOM[®]

Design your life



Cosmo reinventa il look pietra
all'insegna dell'innovazione
e dello stile //
Con quattro colori vibranti e
mosaici ricercati, segna un
nuovo punto di riferimento
nell'incontro tra natura e design //

Cosmo reinvents the
stone look in the name of
innovation and style //
With four vibrant colours
and exquisite mosaics, it
sets a new benchmark for
the meeting of nature and
design //

Cosmo réinvente l'aspect
pierre sous le signe de
l'innovation et du style //
C'est avec quatre couleurs
vibrantes et des mosaïques
raffinées que cette collection
établit de nouveaux repères
dans la rencontre entre la
nature et le design //

Cosmo erfindet eine neue
Steinoptik, im Zeichen der
Innovation und des Stils //
Mit vier lebhaften Farben
und raffinierten Mosaiken
bestimmt sie für die
Verbindung zwischen Natur
und Design einen neuen
Anhaltspunkt //

Под знаком инноваций
и неповторимого стиля
Cosmo придает фактуре
камня новое звучание //
Коллекция, включающая
четыре вибрирующих цвета
и изысканную мозаику,
ставит новую веху на
пути единения дизайна с
природой //

INTO THE SOUL
COSMO



Versatilità e Qualità: la vasta gamma di superfici va dal classico naturale fino all'antiscivolo R11, anche in spessore 20mm //

L'ampio campo di applicazioni spazia dagli ambienti residenziali ai commerciali, coordinando pavimenti interni ed esterni, all'insegna di un'eccellenza senza compromessi //

Versatility and Quality: the large range of surfaces, from classical natural finish to anti-slip R11, also with 20mm thickness //

The broad areas of application include residential and commercial spaces, coordinating indoor and outdoor floors, in the spirit of uncompromising excellence //

Polyvalence et Qualité : la vaste gamme de surfaces part du classique naturel pour arriver à l'antidérapant R11, y compris dans une épaisseur de 20 mm //

Le large éventail d'applications s'étend des environnements résidentiels aux environnements commerciaux, en coordonnant les revêtements de sols intérieurs et extérieurs sous le signe d'une excellence sans compromis //

Vielseitigkeit und Qualität: Die umfangreiche Oberflächenauswahl umfasst die klassische natürliche Oberfläche bis hin zur rutschfesten Oberfläche R11, auch in 20mm Dicke //

Der breite Anwendungsbereich reicht von den Wohnbereichen bis zu den Gewerbebereichen und koordiniert die Böden der Innen- und Außenbereiche im Zeichen einer kompromisslosen Exzellenz //

Универсальность и качество: широкая гамма поверхностей – от классической натуральной до противоскользящей R11, в том числе толщиной 20 мм //

Огромное разнообразие областей применения: от жилых квартир до коммерческих комплексов, обеспечивая непрерывность оформления внутренних и наружных полов для достижения безупречной гармонии и совершенства //

Preziosi effetti di luce:
la finitura di ogni piastrella della
collezione Cosmo racchiude riflessi
sincronizzati che si allineano
armoniosamente con la grafica //
L'alternarsi di effetti lucido-
opaco, evidenziati dal controluce,
arricchiscono le superfici posate
di un'esperienza visiva
dinamica e di pregio //

Precious light effects:
the finish of each tile of
the Cosmo collection
contains synchronised
reflections that fit in
smoothly with the graphics //
The alternation of
glossy-matt effects,
highlighted by the back
light effect, enrich installed
surfaces with a dynamic
and high-quality visual
experience //

Effets de lumière précieux:
la finition de chaque
carreau de la collection
Cosmo renferme des reflets
synchronisés qui s'adaptent
harmonieusement au
graphisme // L'alternance
d'effets brillants/mats,
soulignés par le contre-jour,
enrichit les surfaces posées
d'une expérience visuelle
dynamique et raffinée //

Kostbare Lichteffekte:
Das Finish jeder einzelnen
Fliese der Kollektion Cosmo
beinhaltet synchronisierte
Reflexe, die sich harmonisch
mit der Grafik ausrichten //
Die abwechselnden
blank-matt-Effekte,
die sich im Gegenlicht
abheben, bereichern die
verlegten Flächen mit einer
dynamischen und wertvollen
visuellen Erfahrung //

Роскошная игра света:
отделка поверхности
каждой плитки коллекции
Cosmo создает эффектную
игру бликов, гармонично
переплетающихся
с выразительностью
графики //
Чередование глянцевых и
матовых фактур обретает
особую красоту в лучах
света, привнося в общий
визуальный эффект
уложенной поверхности
нотку динамизма и
изысканности //





RANGE
DETAILS

FOUR
SIZES

120x120
48"x48"

30x60
12"x24"

30x60 R11
12"x24"

60x60
24"x24"

60x60 R11
24"x24"

60x120
24"x48"

60x120 R11
24"x48"

60x120 R11
24"x48"
2cm outdoor

NATURALE

R11



RANGE
DETAILS

1
GRAPHICS

4
COLORS

COMET
CREAM

DARKSIDE

STARLIGHT

METEOR
GREY



COMMERCIAL



RESIDENTIAL



9,5 mm
NAT



120x120

48"x48"



✓ ✓ ✓ ✓

9,5 mm
NAT
R11



60x120

24"x48"

✓ ✓ ✓ ✓



60x60

24"x24"

✓ ✓ ✓ ✓



30x60

12"x24"

✓ ✓ ✓ ✓

20 mm
R11



60x120

24"x48"

✓ ✓ ✓

APPLICATIONS # GALLERIES

A // HOME GALLERY



17 LIVING
STARLIGHT



22 BATHROOM
METEOR GREY



25 BATHROOM
METEOR GREY



32 LIVING
DARKSIDE

B // GARDEN GALLERY



12 IN OUT
COMET CREAM



26 VENTILATED FACADES
METEOR GREY

C // CONTRACT GALLERY



31 RESTAURANT
DARKSIDE



21 GARDEN
STARLIGHT

B // GARDEN IN OUT COMET CREAM

floor in
COMET CREAM 120x120 . 48"x48" RETT

wall
COMET CREAM 60x120 . 24"x48" RETT

floor out
COMET CREAM R11 20MM 60x120 . 24"x48" RETT
COMET CREAM PEZZI SPECIALI R11



#MODERN
LOOK



floor in
COMET CREAM 120x120 . 48"x48" RETT

wall
COMET CREAM 60x120 . 24"x48" RETT

floor out
COMET CREAM R11 20MM 60x120 . 24"x48" RETT



A // HOME LIVING STARLIGHT

wall

STARLIGHT 60x120 . 24"x48" RETT

floor

STARLIGHT 120x120 . 48"x48" RETT

Le tonalità neutre sono
espressione di innovazione e
ricercatezza di stile //
Gli ambienti rivestiti si
avvolgono in atmosfere
naturali dove il design incontra
la funzionalità //

The neutral shades convey
innovation and an
exquisite style //
The tiled spaces envelop
themselves in natural
atmospheres, where design
meets functionality //

Les tonalités neutres
expriment un style innovant
et sophistiqué //
Les espaces habillés
s'entrelacent dans des
atmosphères naturelles
où le design rencontre la
fonctionnalité //

Die neutralen Farbtöne
sprechen von Innovation
und Stilverfeinerung //
Die verkleideten Räume
umhüllen sich mit natürlichen
Atmosphären, in denen das
Design auf Zweckdienlichkeit
trifft //

Нейтральные оттенки
являются воплощением
новаторства и
утонченности стиля //
Облицованные интерьеры
создают атмосферу
естественности, в
которой эстетика и
функциональность
сливаются воедино //



floor
STARLIGHT 120x120 . 48"x48" RETT





B // GARDEN STARLIGHT

wall
STARLIGHT 60x120 . 24"x48" RETT

floor in
STARLIGHT 60x120 . 24"x48" RETT

floor out
STARLIGHT R11 20MM 60x120 . 24"x48" RETT
STARLIGHT PEZZI SPECIALI R11







A // HOME BATHROOM METEOR GREY

wall

METEOR GREY 60x120 . 24"x48" RETT

METEOR GREY MOSAICO TRIANGOLI 26x30 . 10¹/₄"x12" RETT

floor

METEOR GREY 60x60 . 24"x24" RETT

L'elegante mosaico a tessere triangolari permette di aggiungere un accento distintivo e raffinato a ogni ambiente, arricchendolo con un tocco di unicità ed eleganza //

The elegant mosaic with triangular tesserae adds a distinctive and refined tone to every space, enriching it with a unique and elegant touch //

L'élégante mosaïque de tesselles triangulaires permet d'ajouter une note particulière et sophistiquée à chaque espace, en l'enrichissant d'une touche d'originalité et de raffinement //

Das elegante Mosaik mit dreieckigen Steinen fügt jedem Bereich einen kennzeichnenden und raffinierten Touch hinzu und bereichert mit einem Hauch von Einzigartigkeit und Eleganz //

Элегантная мозаика треугольной формы придаст особый изысканный акцент любому помещению, добавив ему нотку роскоши и уникальности //

floor
METEOR GREY 60x120 . 24"x48" RETT

wall
METEOR GREY 60x120 . 24"x48" RETT
METEOR GREY MOSAICO TRIANGOLI 26x30 . 10¹/₄"x12" RETT





B // VENTILATED FACADES METEOR GREY

wall
METEOR GREY 60x120 . 24"x48" RETT

floor out
STARLIGHT R11 60x120 . 24"x48" RETT







wall
METEOR GREY 60x120 . 24"x48" RETT

floor in
STARLIGHT 60x120 . 24"x48" RETT

floor out
STARLIGHT R11 60x120 . 24"x48" RETT



C // CONTRACT RESTAURANT DARKSIDE

wall

DARKSIDE 60x120 . 24"x48" RETT

floor

DARKSIDE 60x120 . 24"x48" RETT

Il concept materico di Cosmo si sviluppa attraverso quattro colorazioni ispiranti e suggestive, capaci di rappresentare con il proprio carattere inconfondibile personalità e stili diversi //

Cosmo's textural concept develops through four inspiring and appealing colours, capable of representing different personalities and styles thanks to its unmistakable character. //

Le concept de la matière de Cosmo se développe à travers quatre couleurs inspirantes et saisissantes, en mesure de représenter, par leur caractère unique, personnalité et styles différents //

Das materische Konzept von Cosmo entwickelt sich durch vier inspirierende und eindrucksvolle Farben, die mit ihrem unverkennbaren Charakter unterschiedliche Persönlichkeiten und Stile darstellen. //

Имитация природного материала представлена в коллекции Cosmo в четырех потрясающе великолепных цветовых вариантах, неповторимое своеобразие которых позволит каждому выразить свою индивидуальность и стиль //





floor
DARKSIDE 120x120 . 48"x48" RETT

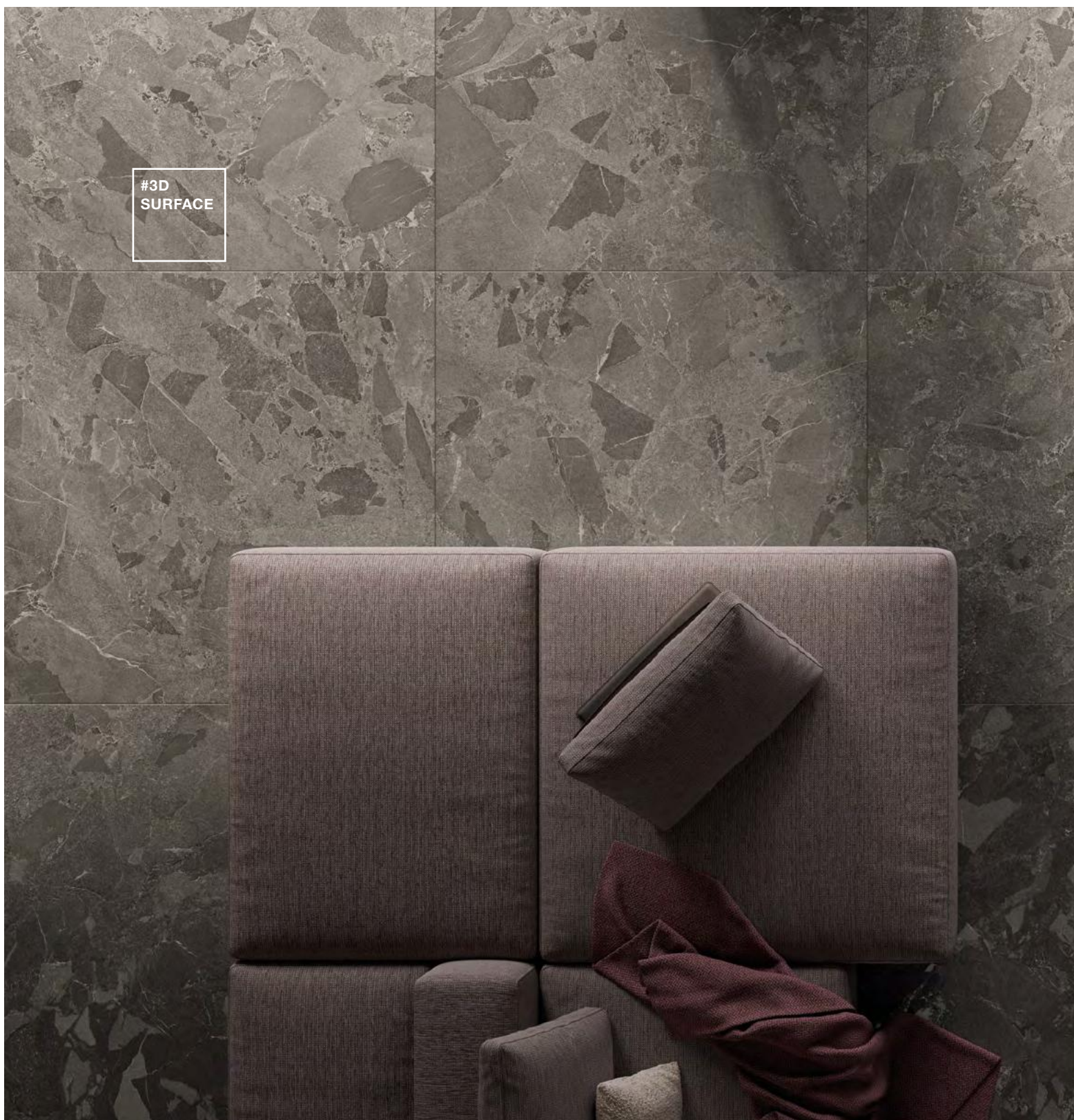

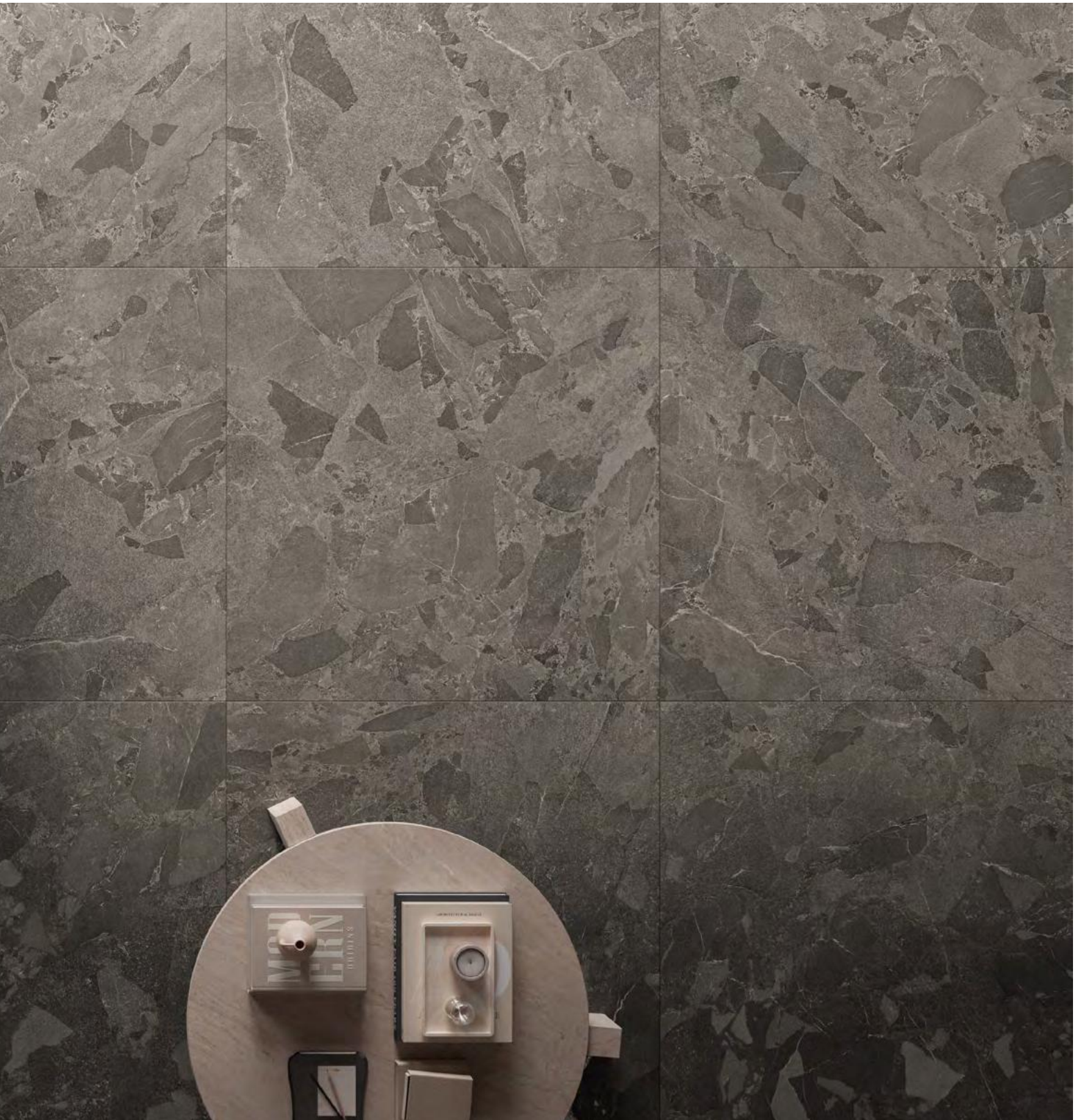

COMET CREAM



GRES PORCELLANATO SMALTATO COLORATO IN MASSA . GLAZED PORCELAIN STONEWARE WITH COLOURED BODY . GRÈS CÉRAME ÉMAILLÉ COLORÉ DANS LA MASSE
 GLASIERTES FEINSTEINZEUG IN DER MASSE GEFÄRBT . ГЛАЗУРОВАННЫЙ КЕРАМОГРАНИТ, ОКРАШЕННЫЙ ПО ВСЕЙ ТООЛЩИНЕ



Sizes

	NAT	R11
9,5 MM 3/8"		
120x120 . 48"x48" RETT	□	
60x120 . 24"x48" RETT	□	□
60x60 . 24"x24" RETT	□	□
30x60 . 12"x24" RETT	□	□
2 CM 13/16"		
60x120 . 24"x48" RETT		□



NAT
RETT



R11
RETT

Mosaics

	NAT
9,5 MM 3/8"	
Mosaico Tessera 5x5 . 2"x2" 30x30 . 12"x12" RETT	□
Mosaico Triangoli 26x30 . 10 1/4"x12" RETT	□

Pezzi speciali . Special pieces . Pièces spéciales
 Formteile . Специальные элементы: Pag. 39

DARKSIDE



GRES PORCELLANATO SMALTATO COLORATO IN MASSA . GLAZED PORCELAIN STONEWARE WITH COLOURED BODY . GRÈS CÉRAME ÉMAILLÉ COLORÉ DANS LA MASSE
 GLASIERTES FEINSTEINZEUG IN DER MASSE GEFÄRBT . ГЛАЗУРОВАННЫЙ КЕРАМОГРАНИТ, ОКРАШЕННЫЙ ПО ВСЕЙ ТООЛЩИНЕ



Sizes

	NAT	R11
9,5 MM 3/8" 		
120x120 . 48"x48" RETT	□	
	□	□
60x120 . 24"x48" RETT	□	□
	□	□
60x60 . 24"x24" RETT	□	□
	□	□
30x60 . 12"x24" RETT	□	□



NAT
RETT



R11
RETT

Mosaics

	NAT
9,5 MM 3/8" 	
Mosaico Tessera 5x5 . 2"x2" 30x30 . 12"x12" RETT	□
Mosaico Triangoli 26x30 . 10 1/4"x12" RETT	□

Pezzi speciali . Special pieces . Pièces spéciales
 Formteile . Специальные элементы: Pag. 39

STARLIGHT



GRES PORCELLANATO SMALTATO COLORATO IN MASSA . GLAZED PORCELAIN STONEWARE WITH COLOURED BODY . GRÈS CÉRAME ÉMAILLÉ COLORÉ DANS LA MASSE
 GLASIERTES FEINSTEINZEUG IN DER MASSE GEFÄRBT . ГЛАЗУРОВАННЫЙ КЕРАМОГРАНИТ, ОКРАШЕННЫЙ ПО ВСЕЙ ТООЛЩИНЕ

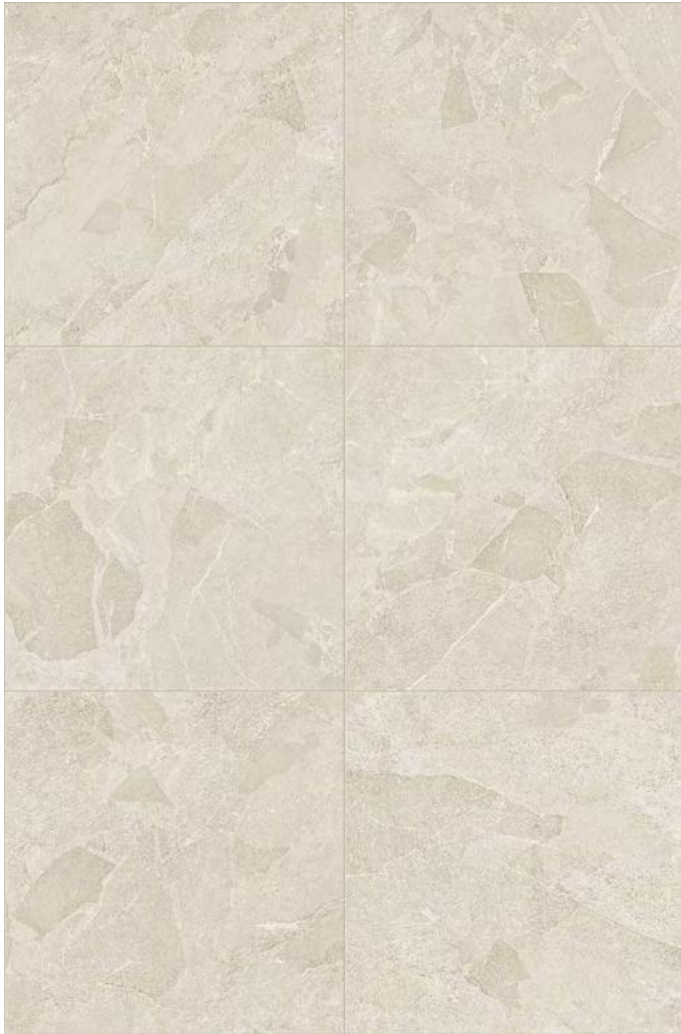

Sizes

	NAT	R11
9,5 MM 3/8"		
 120x120 . 48"x48" RETT	□	
 60x120 . 24"x48" RETT	□	□
 60x60 . 24"x24" RETT	□	□
 30x60 . 12"x24" RETT	□	□
2 CM 13/16"		
 60x120 . 24"x48" RETT		□



NAT
RETT



R11
RETT

Mosaics

	NAT
9,5 MM 3/8"	
 Mosaico Tessera 5x5 . 2"x2" 30x30 . 12"x12" RETT	□
 Mosaico Triangoli 26x30 . 10 1/4"x12" RETT	□

Pezzi speciali . Special pieces . Pièces spéciales
 Formteile . Специальные элементы: Pag. 39

METEOR GREY



GRES PORCELLANATO SMALTATO COLORATO IN MASSA . GLAZED PORCELAIN STONEWARE WITH COLOURED BODY . GRÈS CÉRAME ÉMAILLÉ COLORÉ DANS LA MASSE
 GLASIERTES FEINSTEINZEUG IN DER MASSE GEFÄRBT . ГЛАЗУРОВАННЫЙ КЕРАМОГРАНИТ, ОКРАШЕННЫЙ ПО ВСЕЙ ТООЛЩИНЕ



Sizes

	NAT	R11
9,5 MM 3/8" 120x120 . 48"x48" RETT	□	
 60x120 . 24"x48" RETT	□	□
 60x60 . 24"x24" RETT	□	□
 30x60 . 12"x24" RETT	□	□
2 CM 13/16" 60x120 . 24"x48" RETT		□



NAT
RETT



R11
RETT

Mosaics

	NAT
9,5 MM 3/8" Mosaico Tessera 5x5 . 2"x2" 30x30 . 12"x12" RETT	□
 Mosaico Triangoli 26x30 . 10 1/4"x12" RETT	□

Pezzi speciali . Special pieces . Pièces spéciales
 Formteile . Специальные элементы: Pag. 39

MOSAICI

MOSAICS . MOSAÏQUES . MOSAIKEN . МОЗАИКА



MOSAICO TESSERA



COMET CREAM
30x30 . 12"x12" RETT
tessera 5x5 . 2"x2"

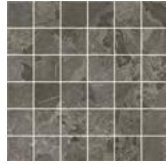

DARKSIDE
30x30 . 12"x12" RETT
tessera 5x5 . 2"x2"



STARLIGHT
30x30 . 12"x12" RETT
tessera 5x5 . 2"x2"

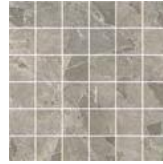

METEOR GREY
30x30 . 12"x12" RETT
tessera 5x5 . 2"x2"

MOSAICO TRIANGOLI



COMET CREAM
26x30 . 10 1/4"x12" RETT



DARKSIDE
26x30 . 10 1/4"x12" RETT



STARLIGHT
26x30 . 10 1/4"x12" RETT



METEOR GREY
26x30 . 10 1/4"x12" RETT

PEZZI SPECIALI

TRIMS . PIÈCES SPÉCIALES . FORMSTÜCKE . СПЕЦИАЛЬНЫЕ ИЗДЕЛИЯ



Battiscopa
6,5x60 . 2 9/16" x 24" RETT

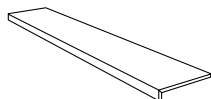

Gradone costa retta
30x120x3,3 . 12"x48"x1 5/16" RETT

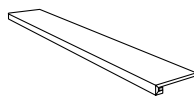

Gradone square assembled
30x120x3,3 . 12"x48"x1 5/16" RETT

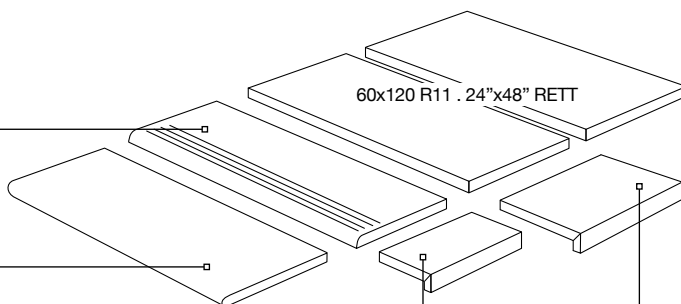

Step Molato R11
30x120 . 12"x48" RETT

60x120 R11 . 24"x48" RETT

Step Torato R11
30x120 . 12"x48" RETT

Gradone Costa Retta R11
30x60x5 . 12"x24"x2" RETT

Elemento ad "L" assembled R11
15x60x5 . 6"x24"x2" RETT

PACKING

	PCS // BOX	SQM // BOX	KGS // BOX	BOXES // PALLET	SQM // PALLET	KGS // PALLET
9,5 MM 3/8"						
120x120 . 48"x48" RETT	1	1,44	31,00	40	57,60	1300
60x120 . 24"x48" RETT / R11 RETT	2	1,44	31,00	36	51,84	1144
60x60 . 24"x24" RETT / R11 RETT	3	1,08	22,80	40	43,20	928
30x60 . 12"x24" RETT / R11 RETT	6	1,08	22,80	40	43,20	928
2 CM 13/16"						
60x120 . 24"x48" R11 RETT	1	0,72	32,30	36	25,92	1190

CARATTERISTICHE TECNICHE

TECHNICAL FEATURES . CARACTÉRISTIQUES TECHNIQUES . TECHNISCHE EIGENSCHAFTEN . ТЕХНИЧЕСКИЕ ХАРАКТЕРИСТИКИ

GRES PORCELLANATO SMALTATO COLORATO IN MASSA - ISO 13006 Bla GL GLAZED PORCELAIN STONWARE WITH COLOURED BODY . GRÈS CÉRAME ÉMAILLÉ COLORÉ DANS LA MASSE GLASIERTES FEINSTEINZEUG IN DER MASSE GEFÄRBT . ГЛАЗУРОВАННЫЙ КЕРАМОГРАНИТ, ОКРАШЕННЫЙ ПО ВСЕЙ ТОЛЩИНЕ			
	Aspetto superficiale Surface appearance Aspect superficiel Oberflächenbeschaffenheit Вид поверхности	≥ 95%	Conforme Compliant Conforme Konform Соответствует
	Lunghezza e larghezza Length and width Longueur et largeur Länge und Breite Длина и ширина	Deviazione valore medio % rispetto a dimensione di fabbricazione. Deviation of the average size for each tile from the work size (%). Ecart dimensionnel moyen en % par rapport aux dimensions de fabrication. Abweichung des Durchschnittswertes in % hinsichtlich der Produktionsgröße. Отклонение средн. значения, % от производственных размеров > 410 cm2 +/- 0,6% - ≤ 410 cm2 +/- 0,75%	± 0,5% ± 1,5 mm
	UNI EN ISO 10545-2	Deviazione valore medio % rispetto a dimensione di fabbricazione. Deviation of the average size for each tile from the average size to the 10 test specimens (%). Ecart de valeur moyenne unitaire % en rapport à la valeur moyenne de 10 échantillons mesurés. Abweichung des Durchschnittswertes der einzelnen Fliesen in % hinsichtlich des Durchschnitts von 10 getesteten Mustern. Отклонение средн. значения, отдельной плитки относительно средн. значения 10 измеренных образцов +/- 0,5%	± 0,5% ± 1,5 mm
	Rettilinearità degli spigoli Straightness of sides Rectitude des arêtes Kantengeradheit Прямолинейность кромок	+/- 0,5%	± 0,3% ± 1,5 mm
	Spessore / Thickness / Epaisseur/Stärke / Толщина	+/- 5%	± 5% ± 0,5 mm
	Ortogonalità Rectangularity Orthogonalité Rechtwinkligkeit Ортогональность	+/- 0,5%	± 0,3% ± 1,5 mm
	Planarità Surface flatness Planéité Ebenflächigkeit Плоскостность	+/- 0,5%	± 0,5% ± 1,5 mm
	UNI EN ISO 10545-3	Assorbimento d'acqua Water absorption Absorption d'eau Wasseraufnahme Водопоглощение	≤ 0,5% GRUPPO Bla GL E ≤ 0,1%
	UNI EN ISO 10545-3	Resistenza della superficie (scala MOHS) Scratch hardness (MOHS scale) Dureté de la surface (échelle MOHS) Oberflächenhärte (MOHS skala) Поверхностная прочность по (шкале Мооса)	EN 101 > 6
	UNI EN ISO 10545-4	Resistenza a flessione e forza di rottura Modulus of rupture and breaking strength résistance à la flexion et force de rupture Biegefestigkeit und Bruchlast Прочность на изгиб Модуль жесткости	S ≥ 1300 N R ≥ 35 N/mm ² S ≥ 1300 N R ≥ 35 N/mm ²
	UNI EN ISO 10545-7	Resistenza alla abrasione della superficie di piastrelle smaltate Resistance to surface abrasion of glazed tiles Résistance à l'abrasion de la surface des carreaux émaillés Widerstand gegen Abrieb der Oberfläche der glasierten Fliesen Стойкость глазурованной плитки к поверхностному истиранию	Come dichiarato dal produttore See manufacturer's declaration Selon déclaration du producteur Entsprechend der Herstellerangaben Как указано изготовителем Classe 3-4 Class 3-4 Classe 3-4 Gruppe 3-4 Класс 3-4
	UNI EN ISO 10545-8	Coefficiente di dilatazione termica lineare Linear thermal expansion coefficient Dilatation thermique linéaire Lineare Wärmeausdehnung Кoeffициент линейного теплового расширения	Come dichiarato dal produttore See manufacturer's declaration Selon déclaration du producteur Entsprechend der Herstellerangaben Как указано изготовителем Metodo disponibile Method available Méthode disponible Verfügbares verfahren Определяется производителем
	UNI EN ISO 10545-9	Resistenza allo shock termico Thermal shock resistance Résistance au choc thermique Temperaturwechselbeständigkeit Стойкость к тепловым перепадам	Nessun campione deve presentare alterazioni No sample must show visible alteration Aucun carreau ne doit présenter d'altération Kein Muster darf sichtbare Veränderungen zeigen Никакой образец не должен показывать изменений Resistente Resistant Résistant Widerstandsfähig Устойчивый
	UNI EN ISO 10545-12	Resistenza al gelo Frost resistance Résistance au gel Frostbeständigkeit Морозостойкость	Non devono presentare difetti visibili No sample must show visible defect Aucun carreau ne doit présenter de défaut Muster dürfen keine sichtbaren Schäden zeigen Не должны обнаруживать видимые дефекты Ingelivo Frost proof Ingelif Frostsicher Морозостойкость
	UNI EN ISO 10545-13	Resistenza all'attacco chimico (tranne acido fluoridrico) Resistance to chemical attack (except hydrofluoric acid) Résistance à l'attaque chimique (sauf acide fluoridrique) Säure- und Laugenbeständigkeit (außer Flußsäure) Стойкость к бытовым химикатам	Nessun campione deve presentare alterazioni No sample must show visible alteration Aucun carreau ne doit présenter d'altération Muster dürfen keine sichtbaren Veränderungen zeigen Никакой образец не должен показывать изменений Classe A-HA-LA Class A-HA-LA Classe A-HA-LA Gruppe A-HA-LA Класс A-HA-LA
	UNI EN ISO 10545-14	Resistenza alle macchie di piastrelle smaltate Resistance to stains of glazed tiles Résistance aux taches des carreaux émaillés Widerstand gegen Fleckenbilder der glasierten Fliesen Стойкость глазурованной плитки к образованию пятен	Nessun campione deve presentare alterazioni No sample must show visible alteration Aucun carreau ne doit présenter d'altération Muster dürfen keine sichtbaren Veränderungen zeigen Никакой образец не должен показывать изменений Classe 5 Class 5 Classe 5 Gruppe 5 Класс 5
	B.C.R.A. REP. CEC. 6/81 DIN 51130 DIN 51097 BOT 3000 Pendulum AS 4586 Pendulum BS 7976	Resistenza alla scivolosità. Coefficiente di attrito medio Skid resistance. Average coefficient of friction Résistance au glissement. Coefficient de frottement moyen Rutschfestigkeit. Mittlerer Reibungswert Сопротивление скольжению. Средний коэффициент трения	B.C.R.A. REP. CEC. 6/81 DIN 51130 ≥ R 9 DIN 51097 DCOF Pendulum Australiano AS 4586 Pendulum Britannico BS 7976
			0,40 ≤ f^A ≤ 0,74 R10 Classe B Class B Classe B Gruppe B Класс B f^A ≥ 0,42 R10: Classe P3 Class P3 Classe P3 Gruppe P3 Класс P3 R11: Classe P4 Class P4 Classe P4 Gruppe P4 Класс P4 PTV > 36 wet

PICS AND STORIES
CERCOM COSMO



POWERED BY UPGRADE
SMART GALLERY



MIX
Paper | Supporting
responsible forestry
FSC® C107168



TILES FOR LIFE



Design your life

Via A. Volta 23/25 - 42013 Casalgrande (Re) Italy
Tel. +39-0522-998911/411



Ceramics of Italy



CE

GRUPPO ROMANI S.p.A. INDUSTRIE CERAMICHE
VIA A. VOLTA 9, 23/25
42013 CASALGRANDE (RE)

05
001CPR2018-07-01

EN 14411:2012

Piastrelle di ceramica pressate a secco,
con assorbimento di acqua E_s ≤ 0,5%
per pavimentazioni interne ed esterne.

Dry pressed ceramic tile,
with water absorption E_s ≤ 0,5%
for internal and external floorings.

© Copyright 2024 Gruppo Romani S.p.A.

Gruppo Romani S.p.A. Industrie Ceramiche
www.grupporomanispa.com



COSMO

#SIZE

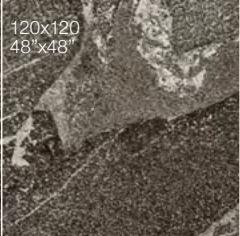

#COLORS



#SURFACES



Cercom is a brand of

