

SS396.COM

A GROUND UP MOTORS COMPANY

VOL 23A

CELEBRATING
30+
YEARS



NOVA

1962-1979
PARTS & ACCESSORIES
CATALOG

2023

We Get It Cause We've Been There Before.

At SS396.com we help with the project, not just the part. Whether you shop online or over the phone you can be confident that our team is devoted to keeping your classic American muscle running and looking its best. With over 30 completed Ground Up restorations under our belt, we don't just sell our parts we use them. That's why we stand behind our products as being the best quality detailing and restoration parts.

GROUND UP | A proud part of the Ground Up Motors
MOTORS family of brands

Why shop with us?

Help with the project, not just the part.

With thousands of parts in stock and ready to ship, we'll help find the right one.

Everyday Super Savings!

We're here to help you save with free shipping or 10% Off available all year and exclusive kits and bundles to save you time & money.

Fast Shipping & Satisfaction Guarantee

Most orders are packed, shipped, and delivered within 3 days from Miami to New York and as far West as Colorado and Texas. If you are not satisfied with your purchase you can return it for an exchange or refund.

66 **Helping Restore
Classic American
Muscle Since 1990.** 99



SS396.COM

A GROUND UP MOTORS COMPANY

Table of Contents

INTERIOR PARTS & TRIM 2-45	HEATING & COOLING 104-111	LIGHTING..... 188-190
STEREO & SPEAKERS46-49	ENGINE PARTS 112-137	LOCKS..... 191
CONVERTIBLE TOP50	ENGINE COMPARTMENT..... 138-141	EMBLEMS..... 192-194
TRUNK.....51	HARDWARE.....142-146	STENCILS & STRIPES 195
WHEELS & TIRES.....52-55	EXTERIOR PARTS & TRIM 147-156	DECALS & PAINT 196-194
BRAKES.....56-67	SHEETMETAL & RELATED 157-174	BOOKS & MANUALS..... 198
STEERING & SUSPENSION68-83	GLASS175-177	INDEX..... 199-201
TRANSMISSION 84-96	WEATHERSTRIP 178-181	ORDER FORMS & POLICIES... 202-208
FUEL & EXHAUST 97-103	ELECTRICAL182-187	

Keep a look out for these logos below throughout the catalog



Take the hassle out of finding the parts you need. Buy & save time with pre-built kits.



These Exclusive products will only be found at ss396.com

Follow us on Social Media



Facebook.com/grounduprestoration
 Instagram.com/groundupss396
 Twitter.com/groundupresto
 Youtube.com/groundupresto

TRUSTED BRANDS WE CARRY



THE ALL NEW SS396.COM

A GROUND UP MOTORS COMPANY

CHECK IT OUT TODAY!
SS396.COM

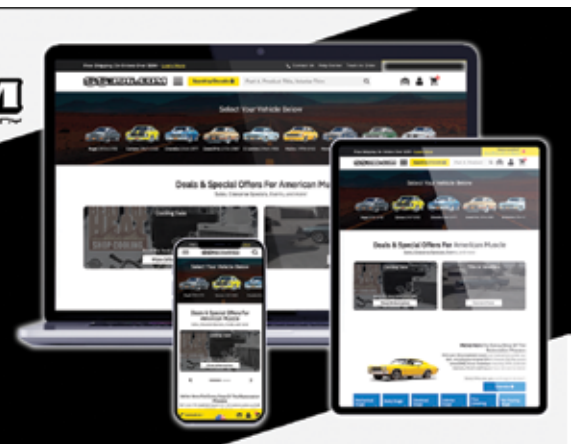

Call Us: U.S. & Canada: (866) 358-2277 • International: (203)-235-1200

Call Center Hours (ET): Monday-Thursday: 9am-6pm • Friday: 9am-3pm • Saturday: 9am-1pm

Shop Online 24/7: www.ss396.com • Chat Online: During Business Hours



PTS-X68F



PTS-X68F-CRB

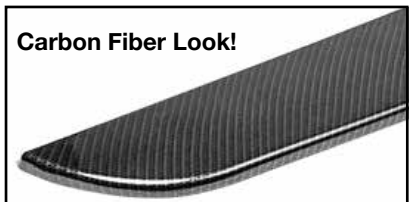

Carbon Fiber Look!

1968-74 Nova Pro Touring Front Spoiler Kit

This front spoiler is just what your pro-touring or resto-mod Nova is missing. Brand new to the market & a Ground Up Motors Exclusive, these spoilers are easy on the wallet, easier to install, and designed with enthusiasts in mind. This front spoiler kit includes the 1968-1974 Nova front spoiler, mounting hardware for a complete upgrade or replacement, and a detailed set of installation instructions.

Fitment:

This 1968-1974 Nova front spoiler features a simple bolt-on application that only requires slight adjustment to the car's original structure.

Durable: Unlike some of the other spoilers on the market, Addictive Flow spoilers are made from a durable polyurethane material (similar to the material used for reproduction spoilers) that is forgiving on both the spoiler and the car. Worry no more about bottoming out and potentially damaging your beloved classic.

Customizable:

Designed with Pro-Touring & Resto-mod enthusiasts in mind! If you want to color key your new spoiler to your car, it's as simple as prepping the surface and spraying on the color of your choice.

Easy Installation: Addictive Flow spoilers have been thoroughly tested and streamlined for bolt-on application. All components and instructions are included to make installation a breeze.

Affordable:

Addictive Flow worked directly with the manufacturer to reduce costs where possible. Because of this, we can pass those savings on to our customers and supply a great looking and affordable front spoiler for your American classic

** 2 holes must be drilled into the Nova's sub-frame to accommodate fitment.*

PTS-X68F	1968-74 Front Spoiler "Flat Black Look"	119.99 kit
PTS-X68F-CRB	1968-74 Front Spoiler "Carbon Fiber Look"	179.99 kit



JXKIT-63S



JXKIT-64S

Interior Kits

Ground Up Motors now offers complete interior kits for your Nova! If your original upholstery has seen better days, replace everything in one shot with one of these convenient kits! Each kit comes with seat covers, door panels, a headliner and a package tray from PUI. Carpet sets are crafted by ACC. Both brands are industry leaders in interior restoration products, so you can be sure you are getting the most authentic pieces on the market!

1968-72 door panels are pre-assembled! Each set includes:

- (1) PUI Front Seat Cover Set • (1) PUI Rear Seat Cover Set • (1) PUI Front Door Panel Set • (1) PUI Rear Door Panel Set
- (1) ACC Carpet Set with Jute Backing • (1) PUI Headliner Set with Side Sails • (1) PUI Package Tray (for Coupe/Sedan)



1962-63 Chevy II / Nova / Nova SS

Seat covers feature Seville grain vinyl with dielectrically sealed impression in the upper backrest with vertically sealed dielectric inserts. Door Panels feature Seville grain vinyl with chrome mylar medallions. Headliner is tier basketweave material. Carpet is correct 80/20 looped.

JXKIT-63B	1962-63 Coupe Bench.....	1211.53 kit
JXKIT-63	1962-63 Coupe Buckets.....	1211.53 kit
JXKIT-63BS	1962-63 Sedan Bench.....	1316.03 kit
JXKIT-63S	1962-63 Sedan Buckets.....	1316.03 kit
JXKIT-63BV	1962-63 Convertible Bench.....	1063.50 kit
JXKIT-63V	1962-63 Convertible Buckets.....	1063.50 kit

These kits will work on 1962 models but will not be original.

These kits feature reproduction SS style seat covers, not original style.

Kits available in black only.

No Volume Discount. Kits ship in multiple Oversize boxes.



1964 Chevy II / Nova / Nova SS

Seat covers are identical to 1963 except for colors. Door panels feature Seville grain vinyl with dielectrically sealed center rectangular criss cross grain vinyl. Headliner is tier basketweave material. Carpet is correct 80/20 looped.

JXKIT-64B	1964 Coupe Bench.....	1211.53 kit
JXKIT-64	1964 Coupe Buckets.....	1211.53 kit
JXKIT-64BS	1964 Sedan Bench.....	1316.03 kit
JXKIT-64S	1964 Sedan Buckets.....	1316.03 kit

Kits available in black only.

No Volume Discount. Kits ship in multiple Oversize boxes.



1965 Chevy II / Nova / Nova SS

Seat covers feature Madrid grain vinyl and dielectric inserts with narrow vertical lines. Door panels feature Madrid grain vinyl and dielectrically sealed ribbed design with milled chrome mylar strip. Headliner is tier basketweave (choose 5 bow or 6 bow for sedan). Carpet is correct 80/20 looped.

JXKIT-65B	1965 Coupe Bench	1211.53 kit
JXKIT-65	1965 Coupe Buckets	1107.03 kit
JXKIT-65BS	1965 Sedan Bench 5 Bow	1249.53 kit
JXKIT-65BS6	1965 Sedan Bench 6 Bow	1264.39 kit
JXKIT-65S	1965 Sedan Buckets 5 Bow	1145.03 kit
JXKIT-65S6	1965 Sedan Buckets 6 Bow	1159.89 kit

Kits available in black only. 5 or 6 bow refers to headliner bows. No Volume Discount. Kits ship in multiple Oversize boxes.



1966 Nova SS

Super Sport seat covers feature Madrid grain vinyl and dielectrically sealed inserts with a ruled border. Door panels feature Madrid grain vinyl and a dielectrically sealed horizontal design with vertical trim strip of chrome and black mylar. Headliner is tier basketweave. Carpet is correct 80/20 looped.

JXKIT-66	1966 Coupe Buckets SS	1078.53 kit
JXKIT-66B	1966 Coupe Bench SS	1183.03 kit
JXKIT-66S	1966 Sedan Buckets SS	1145.03 kit
JXKIT-66BS	1966 Sedan Bench SS	1050.04 kit

Split bench are reproduction SS, not original.

Kits available in black only. No Volume Discount. Kits ship in multiple Oversize boxes.



1966 Chevy II / Nova

Non-SS seat covers feature Madrid grain vinyl with "fish scale" texture inserts and dielectrically sealed inserts with a ruled border. Door panels feature Madrid grain vinyl and a dielectrically sealed horizontal design with vertical trim strip of chrome and black mylar. Headliner is tier basketweave. Carpet is correct 80/20 looped.

JXKIT-66X	1966 Coupe Bench Non-SS	1192.53 kit
JXKIT-66BX	1966 Sedan Bench Non-SS	1192.53 kit

Kits available in black only.

No Volume Discount. Kits ship in multiple Oversize boxes.



1967 Nova SS

Super Sport seat covers feature Madrid grain vinyl and a white vertical stripe down the center of the dielectrically sealed insert. Reproduction SS split bench seat covers have a dielectrically sealed milled center bar without the white stripe. SS door panels feature Madrid grain vinyl and horizontal stitch bar design with a white vertical stripe accented with chrome mylar. Headliner is tier basketweave. Carpet is correct 80/20 looped.

JXKIT-67	1967 Coupe Buckets SS	1078.53 kit
JXKIT-67B	1967 Coupe Bench Repro SS	1183.03 kit
JXKIT-67S	1967 Sedan Buckets SS	1145.03 kit
JXKIT-67BS	1967 Sedan Bench Repro SS	1249.53 kit

Kits available in black only.

No Volume Discount. Kits ship in multiple Oversize boxes.



1967 Chevy II / Nova

Non-SS seat covers feature Madrid grain vinyl with "fish scale" textured vinyl inserts and vertical dielectric grid bar border inserts. Non-SS door panels feature Madrid grain vinyl and dielectrically sealed vertical milled bar design accented with chrome mylar strips. Headliner is tier basketweave. Carpet is correct 80/20 looped.

JXKIT-67X	1967 Coupe Bench Non-SS.....	1192.53 kit
JXKIT-67BX	1967 Sedan Bench Non-SS.....	1192.53 kit

Kits available in black only.

No Volume Discount. Kits ship in multiple Oversize boxes.

1969 Nova SS Custom

Seat covers feature madrid grain vinyl and dielectrically sealed insert with vertical pleats and basketweave design center strip. Door panels feature madrid grain vinyl and parchment colored horizontal strip surrounded by chrome mylar with a wider chrome mylar strip at the top of the panel. Door panels come pre-assembled with a strong metal top rail (ABS rear rail) and windowfelt. Headliner is ribbed. Carpet is correct 80/20 looped.

JXKIT-SS69	1969 Custom Buckets.....	1397.78 kit
JXKIT-SS69B	1969 Custom Bench.....	1397.78 kit

Kits available in black only.

No Volume Discount. Kits ship in multiple Oversize boxes.



1968 Chevy II / Nova / SS Custom

Seat covers feature Madrid grain vinyl and sewn inserts with vertical pleats. Standard door panels feature Madrid grain vinyl and parchment colored vertical strips with chrome "Nova" mylar embossing. Custom door panels feature Madrid grain vinyl and a basketweave pattern across the upper 1/3 of the panel. Both styles come pre-assembled with a strong metal top rail (ABS rear rail) and windowfelt. Headliner is ribbed. Carpet is correct 80/20 looped.

JXKIT-68B	1968 Standard Bench.....	1397.78 kit
JXKIT-68	1968 Custom Buckets.....	1415.83 kit

Kits available in black only.

No Volume Discount. Kits ship in multiple Oversize boxes.

1969-70 Nova Standard

Seat covers feature madrid grain vinyl and dielectrically sealed insert with vertical pleats and basketweave design center strip. Door panels feature Madrid grain vinyl and horizontal dielectric seal lines separated by a vertical parchment mylar strip in front of the door handle in addition to a horizontal chrome mylar piece embossed with "Nova". Door panels come pre-assembled with a strong metal top rail (ABS rear rail) and windowfelt. Headliner is ribbed. Carpet is correct 80/20 looped.

JXKIT-69	1969-70 Standard Buckets.....	1397.78 kit
JXKIT-69B	1969-70 Standard Bench.....	1397.78 kit

Kits available in black only.

No Volume Discount. Kits ship in multiple Oversize boxes.



1970-71 Nova SS Custom

Seat covers feature madrid grain vinyl and dielectrically sealed insert with vertical pleats and basketweave design center strip. Door panels feature Madrid grain vinyl dielectrically sealed and a wood grain horizontal strip surrounded by chrome mylar with a wider chrome mylar strip at the top of the panel. Door panels come pre-assembled with a strong metal top rail (ABS rear rail) and windowfelt. Headliner is perforated. Carpet is correct 80/20 looped.

JXKIT-SS70	1970-71 Custom Buckets.....	1397.78 kit
JXKIT-SS70B	1970-71 Custom Bench.....	1397.78 kit

Kits available in black only.

No Volume Discount. Kits ship in multiple Oversize boxes.



1972 Nova Standard

Seat covers feature Madrid grain with Pigskin inserts and dielectrically sealed center basketweave design. This is the first year for high back buckets. Door panels feature Madrid grain vinyl and horizontal dielectric seal lines separated by a chrome mylar outline in front of the door handle as well as a horizontal medallion. Door panels come pre-assembled with a strong metal top rail (ABS rear rail) and windowfelt. Headliner is perforated. Carpet is correct 80/20 looped.

JXKIT-72	1972 Standard Buckets.....	1492.78 kit
JXKIT-72B	1972 Standard Bench.....	1492.78 kit

Kits available in black only.

No Volume Discount. Kits ship in multiple Oversize boxes.



1971 Nova Standard

Seat covers feature madrid grain vinyl and dielectrically sealed insert with vertical pleats and basketweave design center strip. Door panels feature Madrid grain vinyl and horizontal dielectric seal lines separated by a chrome mylar outline in front of the door handle as well as a horizontal medallion. Door panels come pre-assembled with a strong metal top rail (ABS rear rail) and windowfelt. Headliner is perforated. Carpet is correct 80/20 looped.

JXKIT-71	1971 Standard Buckets.....	1397.78 kit
JXKIT-71B	1971 Standard Bench.....	1397.78 kit

Kits available in black only.

No Volume Discount. Kits ship in multiple Oversize boxes.



1972 Nova SS Custom

Seat covers feature Madrid grain with Pigskin inserts and dielectrically sealed center basketweave design. This is the first year for high back buckets. Door panels feature Madrid grain vinyl dielectrically sealed and a wood grain horizontal strip surrounded by chrome mylar with a wider chrome mylar strip at the top of the panel. Door panels come pre-assembled with a strong metal top rail (ABS rear rail) and windowfelt. Headliner is perforated. Carpet is correct 80/20 looped.

JXKIT-SS72	1972 Custom Buckets.....	1492.78 kit
JXKIT-SS72B	1972 Custom Bench.....	1492.78 kit

Kits available in black only.

No Volume Discount. Kits ship in multiple Oversize boxes.

PUI Standard Seat Covers

These PUI seat covers are constructed of the finest quality materials available. These seat covers are perfect for most cars out there whether they are daily drivers or trailer queens.



1962-64 Chevy II / SS IUP-X63B

Seville grain vinyl with dielectrically sealed impression in the upper backrest with vertically sealed dielectric inserts. (These seat covers are correct for 1963-64 Nova. They are not exactly correct for 1962 Nova but they will fit and look great!)

Black

IUP-X64	Buckets Black	429.99 set
IUP-X63B	2dr Split Bench Black	429.99 set
IUP-X64R	Coupe Rear Black	229.99 set
IUP-X63V	Convrt Rear Black	229.99 set
IUP-X64S	2dr Sedan Rear Black	339.99 set

Colors
Fill in color code below.

IUP-X63XS__U	Buckets Colors	442.99 set
IUP-X62XS__B	2dr Split Bench Colors	442.99 set
IUP-X63XS__C	Coupe Rear Colors	234.99 set
IUP-X63XS__V	Convrt Rear Colors	234.99 set
IUP-X62XS__T	2dr Sedan Rear Colors	374.99 set

1962-64 Aqua (50) • 1962-64 Light Blue (56)
1962-63 Fawn (57) • 1964 Light Fawn (58)
1962 Bright Red (63) • 1963-64 Red (64)
1962-64 Saddle (65) • 1962-64 White (69)



1965 Chevy II / SS IUP-X65

Seat covers feature Madrid grain vinyl and dielectric inserts with narrow vertical lines. (2 door split bench and 2 door sedan rear are reproduction SS style and not original but look great!)

Black

IUP-X65	Buckets Black	319.99 set
IUP-X65B	2dr Split Bench Black	429.99 set
IUP-X65R	Coupe Rear Black	229.99 set
IUP-X65S	2dr Sedan Rear Black	269.99 set

Colors
Fill in color code below.

IUP-X65XS__U	Buckets Colors	327.99 set
IUP-X65XS__B	2dr Split Bench Colors	442.99 set
IUP-X65XS__C	Coupe Rear Colors	234.99 set
IUP-X65XS__T	2dr Sedan Rear Colors	234.99 set

Aqua (02) • Light Blue (12) • Fawn (22)
Red (30) • Light Saddle (35)



1966 Chevy II / Nova / SS IUP-X66

Super Sport seat covers feature Madrid grain vinyl and dielectrically sealed inserts with a ruled border.

Black

IUP-X66	SS Buckets Black	319.99 set
IUP-X66BS	SS Bench Black*	429.99 set
IUP-X66R	SS Coupe Rear Black	199.99 set
IUP-X66S	SS Sedan Rear Black*	269.99 set

Colors
Fill in color code below.

IUP-X66XS__U	SS Buckets Colors	327.99 set
IUP-X66XS__B	SS Bench Colors*	442.99 set
IUP-X66XS__C	SS Coupe Rear Colors	202.99 set
IUP-X66XS__T	SS Sedan Rear Colors*	288.99 set

Aqua (02) • Light Blue (12)** • Bright Blue (14)
Fawn (22) • Red (30)

*2dr split bench & 2dr sedan rear are reproduction SS style, not original style. **Not originally an SS color.



1966 Chevy II / Nova / (Non-SS) IUP-X66B

Non-SS seat covers feature Madrid grain vinyl with "fish scale" texture inserts and dielectrically sealed inserts with a ruled border.

Black

IUP-X66B	Std Bench Black	369.99 set
IUP-X66BR	Std Coupe Rear Black	269.99 set
IUP-X66TS	Std Sedan Rear Black	269.99 set

Colors
Fill in color code below.

IUP-X66XS__BS	Std Bench Colors	397.99 set
IUP-X66XS__CS	Std Coupe Rear Colors	288.99 set
IUP-X66XS__TS	Std Sedan Rear Colors	203.95 set

Aqua (02) • Light Blue (12) • Fawn (22) • Red (30)



1967 Chevy II / Nova / (Non-SS) IUP-X67B

Non-SS seat covers feature Madrid grain vinyl with "fish scale" textured vinyl inserts and vertical dielectric grid bar border inserts.

Black

IUP-X67B	Non-SS Bench Black	369.99 set
IUP-X67BR	Non-SS Coupe Rear Black	269.99 set
IUP-X67TS	Non-SS Sedan Rear Black	269.99 set

Colors
Fill in color code below.

IUP-X67XS__BS	Non-SS Bench Colors	397.99 set
IUP-X67XS__CS	Non-SS Coupe Rear Colors	288.99 set
IUP-X67XS__TS	Non-SS Sedan Rear Colors	288.99 set

Light Blue (12) • Red (30) • Ivy Gold (46)



1967 Chevy II / Nova / SS IUP-X67

Super Sport seat covers feature Madrid grain vinyl and a white vertical stripe down the center of the dielectrically sealed insert. Reproduction SS split bench seat covers have a dielectrically sealed milled center bar without the white stripe.

Black

IUP-X67	SS Buckets Black	319.99 set
IUP-X67R	SS Coupe Rear Black	199.99 set
IUP-X67BS	Repro SS Bench Black	429.99 set
IUP-X67S	Repro SS Sedan Rear Black	269.99 set
IUP-X67CB	Repro SS Coupe Rear Black	199.99 set

Colors
Fill in color code below.

IUP-X67XS__U	SS Buckets Colors	327.99 set
IUP-X67XS__C	SS Coupe Rear Colors	202.99 set
IUP-X67XS__B	Repro SS Bench Colors	311.95 set
IUP-X67XS__T	Repro SS Sedan Colors	202.95 set
IUP-X67XS__CB	Repro SS Coupe Rear Colors	202.99 set

Light Blue (12) • Bright Blue (14) • Red (30)
Gold (43) • Ivy Gold (46)



IUP-X68

1968 Nova / Chevy II / Nova / Custom

Seat covers feature Madrid grain vinyl and sewn inserts with vertical pleats.

Black

IUP-X68	Custom Buckets Black.....	319.99 set
IUP-X68CR	Custom Rear Black	199.99 set

Colors

Fill in color code below.

IUP-X68XS__U-1	Custom Buckets Colors	327.99 set
IUP-X68XS__C-1	Custom Rear Colors.....	202.99 set

68 Blue (17) • Ivy Gold (46)



IUP-X68B

1968 Nova / Chevy II / SS

Seat covers feature Madrid grain vinyl and sewn inserts with vertical pleats.

Black

IUP-X68B	Standard Bench Black.....	319.99 set
IUP-X68R	Standard Rear Black.....	199.99 set

Colors

Fill in color code below.

IUP-X68XS__B	Standard Bench Colors.....	327.99 set
IUP-X68XS__C	Standard Rear Colors	202.99 set

68 Blue (17) • Ivy Gold (46)



IUP-X69

1969-71 Nova / Chevy II / SS

Seat covers feature madrid grain vinyl and dielectrically sealed insert with vertical pleats and basketweave design center strip.

Black

IUP-X69	Buckets Black.....	319.99 set
IUP-X69B	Bench Black.....	319.99 set
IUP-X69R	Rear Black	199.99 set

Colors

Fill in color code below.

IUP-X69XS__U	Buckets Colors.....	251.95 set
IUP-X69XS__B	Bench Colors.....	327.99 set
IUP-X69XS__C	Rear Colors.....	202.99 set

Blue (09) • Light Blue (12) • Bright Blue (14) • Jade Green (19) • Light Green (23) • Dark Metallic Green (24) • Red (30) • Saddle (36) • Sandalwood (41) • Dark Saddle (42) • Gold (43)



IUP-X72

1972 Nova / SS / Custom

Seat covers feature Madrid grain with Pigskin inserts and dielectrically sealed center basketweave design. This is the first year for high back buckets.

Black

IUP-X72	Custom Buckets Black.....	419.99 set
IUP-X72B	Custom Bench Black.....	419.99 set
IUP-X72R	Custom Rear Black	199.99 set

Colors

Fill in color code below.

IUP-X72XS__U	Custom Buckets Colors	443.99 set
IUP-X72XS__B	Custom Bench Colors.....	443.99 set
IUP-X72XS__C	Custom Rear Colors.....	202.99 set

Dark Green (25) • Covert (29) • Sandalwood (41) • Tan (47)



IUP-X73

1973-74 Nova Custom

Seat covers feature Madrid grain with Tetra inserts and sewn vertical pleats on inserts. Buckets are high back style.

Black

IUP-X73	Custom Buckets Black.....	419.99 set
IUP-X73B	Custom Bench Black	449.99 set
IUP-X73R	Custom Rear Black.....	239.99 set
IUP-X73H	Hatchback Rear Black.....	239.99 set

Colors

Fill in color code below.

IUP-X73XS__U	Custom Buckets Colors	443.99 set
IUP-X73XS__B	Custom Bench Colors.....	489.99 set
IUP-X73XS__C	Custom Rear Colors.....	235.99 set
IUP-X73XS__F	Hatchback Rear Colors	235.99 set

White (37) • Sandalwood (41)



IUP-X75

1975-76 Nova Standard

Sierra grain vinyl with vertical Plisse grain vinyl featuring sewn inserts with horizontal lines intercepted by two sets of vertical lines.

Black

IUP-X75	Buckets Black	419.99 set
IUP-X75B	Bench Black.....	419.99 set
IUP-X75R	Coupe Rear Black	229.99 set
IUP-X75H	Hatchback Rear Black.....	229.99 set

Colors

Fill in color code below.

IUP-X75XS__U	Buckets Colors.....	443.99 set
IUP-X75XS__B	Bench Colors	443.99 set
IUP-X75XS__C	Coupe Rear Colors.....	235.99 set
IUP-X75XS__F	Hatchback Rear Colors	235.99 set

Medium Blue (15) • Blue (17) • Saddle (36)
White (37) • Dark Saddle (42)



ISA-669

Bucket Seat Frame

Complete bucket seat frame with springs installed. Highest quality on the market!

ISA-669 1968-71 Bucket 419.99 ea.
No Volume Discount. Ships Oversize.



IST-X68K

1965-71 Seat Track Assemblies

Includes inner and outer tracks with spring.

IST-1632JC 1965 Bucket LH 119.95 ea.
IST-1632JB 1965 Bucket RH 119.95 ea.
IST-X68K 1968-71 Buckets All (Does Both Seats). 269.95 set
IBX-RELO All (4 pc*) 34.99 kit
*Does one seat



BST-12655

Seat Track To Seat Bolt

BST-12655 All (8 pc.) 16.99 kit



IBX-X68KIT

Factory Style Bucket Seat Brackets

These are OE style reproduction bucket seat brackets which are designed for factory seat tracks. These brackets are essential when converting from bench to buckets or when replacing your floor pan.

ICC-1636C 1962-67 129.99 pr.
ICC-50768 1968-71 129.99 set
IBX-X1 1968-72 (Does One Car) 104.99 kit
IBX-X68KIT 1968-71 All* 337.45 kit
IBX-RELO All 4pc* 34.99 kit
*Technically correct for 1969-71 but fits 68-72 with low back seats. *No Volume Discount.



IZ-12815

Seat Frame to Track Springs

These springs go from the seat tracks to the seat frames to provide tension to the adjustment bracket.

IZ-12814 1966-72 Bench (2 pc.) 11.99 kit
IZ-12815 1966-72 Bucket (4 pc.) 21.99 kit



BACK-KITA6800

1966-71 Seat Backs & Side Covers

Exact reproductions with chrome edge piping.

Complete Kits

BACK-KITA606 1966 Black 199.99 kit
BACK-KITA6706 1967 Black 199.99 kit
BACK-KITA6800 1968 Black 199.99 kit
BACK-KITA6804 1968 Medium Blue 249.99 kit
BACK-KITA6910 1969-71 Black 199.99 kit
BACK-KITA6911 1969-71 Red 249.99 kit
BACK-KITA6912 1969-71 Dark Blue 249.99 kit
BACK-KITA6913 1969-71 Bright Blue 249.99 kit
BACK-KITA6914 1969-71 Parchment 249.99 kit
BACK-KITA6915 1969-71 Dark Green 249.99 kit
BACK-KITA6916 1969-71 Light Saddle 249.99 kit
BACK-KITA6917 1969-71 Dark Saddle 249.99 kit
BACK-KITA6918 1969-71 Sandalwood 249.99 kit
BACK-KITA6919 1969-71 White 249.99 kit
BACK-KITA6920 1969-71 Pearl 249.99 kit

1972-74 Seat Backs

Exact reproduction high back seat backs by PUI.

ISB-717 1972-74 Black 133.99 pr.
ISB-71714 1972-74 Bright Blue 157.99 pr.
ISB-71716 1972-74 Dark Blue 157.99 pr.
ISB-71724 1972-74 Dark Green 157.99 pr.
ISB-71730 1972-74 Red 157.99 pr.
ISB-71737 1972-74 White 157.99 pr.
ISB-71742 1972-74 Dark Saddle 157.99 pr.

No Volume Discount. Ships Oversize.



ICC-0259



ICC-0254

Bucket Seat Trim

Correct chrome piping kit for both seat backs and sides and chrome end caps.

ICC-0259 1966-71 Trim* 18.95 kit
ICC-0254 1966-71 Caps 1.99 ea.
ICC-0254K 1966-71 Caps 10pc 20.30 kit
*Only fit reproduction seatbacks and sides.

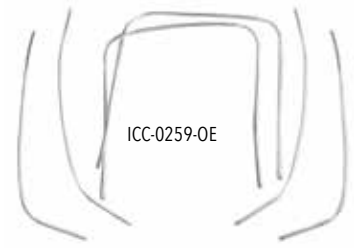

ICC-0259-OE

Molded OE Style Bucket Seat Trim Kit

Correct OE style molded metal bucket seat trim. This kit features the thick clear plastic coating just like the originals. This kit comes with 2 seat back chrome moldings and 4 side moldings, enough for both seats!

ICC-0250-OE 1966-67 Buckets 99.99 kit
ICC-0259-OE 1968-71 Buckets 99.99 kit



BRS-12659

Seat Back Release Hardware

8 correct screws used to hold the folding seat back assembly in the seat back.

BRS-12659 1969-71 10.99 kit



ISF-72-WIRE

Bucket Seat Foams

Correct density injection molded foam. Each set contains one back and one bottom. 1966-71 available with or without built-in listing wire making installation easier.

ISF-65 1962-65 All 127.99 ea.
ISF-65K 1962-65 All 230.38 kit
ISF-65-WIRE 1962-65 All w/ Wire 92.99 ea.
ISF-65-WIRE-KIT 1962-65 All w/ Wire 167.38 kit
ISF-72 1966-71 All (Ex. 67 SS) 127.99 ea.
ISF-72K 1966-71 All (Ex. 67 SS) 243.18 kit
ISF-72-WIRE 1966-71 All (Ex. 67 SS) w/ Wire. 119.99 ea.
ISF-72-WIRE-KIT 1966-71 All (Ex. 67 SS) w/ Wire. 227.98 kit
ISF-X67SS 1967 SS 108.99 ea.
ISF-71FU 1972-79 All Standard Buckets.... 180.99 ea.
Ships Oversize.





ISF-BUNREAR

Bench Front/Rear Seat Foams

This is a universal style bench seat foam which can be used on all front bench seat and rear bench seats. This seat foam is a cost effective alternative to molded seat foam.

ISF-BUNREAR	All.....	69.99 ea.
ISF-A68B	1968-70 Front Bench.....	247.99 ea.
ISF-A71B	1971-72 Front Bench.....	247.99 ea.

Ships Oversize. Includes foam only. Cut to fit.

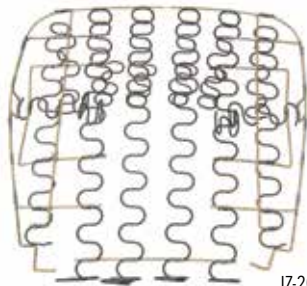

IZ-206

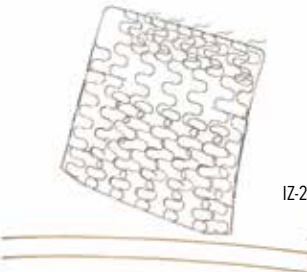

IZ-207

Bucket Seat Springs

Restore the comfort of your buckets with brand new springs!

IZ-203	1962-64 Bottom	109.99 ea.
IZ-205	1966-67 Bottom	89.99 ea.
IZ-206	1968-71 Bottom	89.99 ea.
IZ-207	1962-65 Back.....	89.99 ea.
IZ-208	1966 Back.....	89.99 ea.
IZ-209	1969-71 Back.....	89.99 ea.
IZ-102	1966-67 Side Support Springs*	34.99 pr.
IZ-103	1968-71 Side Support Springs*	26.99 pr.

*One set does one seat. Order 2 per car.



IHG-7

Seat Installation Kit

Complete set of hog rings and pliers for seat cover installation.

IHG-7	All.....	16.95 kit
-------	----------	-----------



ICC-0259K



Bucket Seat Chrome Kit

This is a one step kit to replace all the chrome on your bucket seats! This kit includes the correct chrome piping, 12 end caps, 4 headrest locks and 2 seat back release buttons.

ICC-0259K	1970-71*	134.95 kit
-----------	----------------	------------

**Only fit reproduction seatbacks and sides.*



IT-39200

1972-79 Bucket Seat Side Covers

Correct injection molded side covers for high back seats.

IT-39200	1972-79.....	49.99 pr.
----------	--------------	-----------



IT-3890

Side Hinge Covers

New injection molded seat side covers.

IT-3890	1966-71 Bench.....	55.99 pr.
---------	--------------------	-----------



ISS-5085

Seatback Bumpers

Correct rubber coated steel.

ICQ-387	1962-67 All.....	7.99 pr.
ISS-5085	1968-71 All.....	8.95 pr.



ISE-3049

Bucket Seat Emblems

Exact reproduction seat emblems complete with retainers.

ISE-3049	1966-67.....	76.99 kit
----------	--------------	-----------



ILA-1402B

Seat Back Lock Assembly

Complete seat back lock assembly including seat release button.

ILA-1402B	1969-71.....	119.99 ea.
-----------	--------------	------------



ICC-114



ICC-66



ICI-315



ICE-4636

Seat Adjustment Knobs

ICC-114	1962-65.....	19.99 ea.
ICC-66	1966 All Chrome	18.99 ea.
ICI-315	1967-72 Chrome.....	8.99 ea.
ICE-4636	1967-72 Black	6.95 ea.



IJ-5214



IFC-521

Seat Release Buttons

IJ-5214	1967-68 Buckets.....	39.99 ea.
IFC-521	1969-71 Buckets.....	19.99 ea.
IFC-521K	1969-71 Buckets Pair.....	33.98 kit

BUY'N SAVE
WITH KITS

IJ-5426



ICI-5263K

Headrest Locks

Correct chrome plated headrest locks.

IJ-5426	1969 (Does one seat).....	44.99 pr.
ICI-5263K	1970-71 (4 pc.).....	64.57 kit
ICI-5263	1970-71.....	18.99 ea.



IRG-1042C

Headrest Guides

Correct guides which headrest bars are inserted into on all Strato Bucket seats. Hardware and headrest locks included.

IRG-1042C	1969-71.....	79.14 set
-----------	--------------	-----------



ITC-4321B

Bucket Seat Inner Trim Covers

This is a reproduction of the inner trim panel that mounts onto the bottom of the bucket seat headrest in the correct pebble grain. Mounting clips not included.

ITC-4321B	1966-72 Black.....	32.99 pr.
-----------	--------------------	-----------



IJ-3780

Bucket Seat Headrests

Exact reproduction injection molded headrest covers. Black only.



IJ-3780	1966-67 Buckets.....	209.99 pr.
ITW-3120	1969 Buckets.....	164.99 pr.
ITW-3775	1970-71 Buckets.....	149.99 pr.



Headrest Covers

Pre-sewn and ready to install. Made by PUI.



Enter Color Number in _____.

09 Blue, 10 Black, 12 Light Blue, 14 Bright Blue, 16 Dark Metallic Blue, 17 68' Blue, 19 Jade Green, 23 Light Green, 24 Dark Metallic Green, 25 Dark Green, 27 Parchment, 28 Pearl, 29 Covert, 30 Red, 31 70' Red, 36 70' Saddle, 37 White, 41 Sandalwood, 42 Dark Saddle, 43 Gold, 46 Ivy Gold, 47 Tan

IHC-68AH__U	1968-71 Buckets.....	55.99 pr.
IHC-68AH__B	1968-72 Bench.....	55.99 pr.



ILG-73RBLK



ILG-73TBLK

Seat Belt Loop Guides

Choose from either triangle or rectangle style.

Triangle

ILG-73TBLK	1973-77 Black.....	10.99 ea.
ILG-73TBLU	1973-77 Blue.....	10.99 ea.
ILG-73TRED	1973-77 Red.....	10.99 ea.
ILG-73TTAN	1973-77 Tan.....	10.99 ea.
ILG-73TWTE	1973-77 White.....	10.99 ea.
ILG-73TGRN	1973-77 Green.....	10.99 ea.

Rectangle

ILG-73RBLK	1973-77 Black.....	10.99 ea.
ILG-73RBLU	1973-77 Blue.....	10.99 ea.
ILG-73RRED	1973-77 Red.....	10.99 ea.
ILG-73RTAN	1973-77 Tan.....	10.99 ea.
ILG-73RWTE	1973-77 White.....	10.99 ea.
ILG-73RGRN	1973-77 Green.....	10.99 ea.



GM Push Button Style



Bowtie Lift Latch Style



GM Plastic Push Button Style



Starburst Push Button Style



Chrome Lift Latch Style

Vintage Style Seat Belts

Now you can have the styling of muscle-era GM seat belts without the high price! Choose from plain chrome lift latch style belts, Starburst push button style belts, Bowtie logo lift latch belts, or GM push button style *remanufactured belts. Any of these belts will look right at home in your muscle car. Available individually or as a complete 4 piece kit! Hardware is included with all vintage style seat belts. Fill blank with your color choice. Colors are special order and are non-returnable. See ss396.com for color swatches. Not all colors available for all styles.

SBL-1800-____-74	Chrome Lift Latch Style	
	74" All F/R.....	29.99 ea.
SBL-1800-1000-K	Chrome Lift Latch Style (black only)	
	4 Piece (2) 74" & (2) 60".....	107.96 kit
SBL-1256-____-74	Starburst Push Button Style	
	74" All F/R.....	29.99 ea.
SBL-1256-1000-K	Starburst Push Button Style (black only)	
	4 Piece (2) 74" & (2) 60".....	107.96 kit
SBL-1205-____-74	GM Push Button Style*	
	74" All F/R.....	52.99 ea.
SBL-1205-1000-K	GM Push Button Style* (black only)	
	4 Piece (2) 74" & (2) 60".....	190.96 kit
SBL-305-____-74	GM Plastic Push Button Style*	
	74" All F/R.....	62.99 ea.
SBL-305-1000-K	GM Plastic Push Button* (black only)	
	4 Piece (2) 74" & (2) 60".....	233.96 kit
SBL-1803-____-74	Bowtie Lift Latch Style	
	74" All F/R.....	57.99 ea.
SBL-1803-1000-K	Bowtie Lift Latch Style (black only)	
	4 Piece (2) 74" & (2) 60".....	208.76 kit

Black = 1000	Flame Red = 2006	Red = 2007
Maroon = 2008	Red Wine = 2009	Purple = 2010
Tan = 3000	Brown = 3004	Dark Brown = 3005
Medium Beige = 3008	Desert Tan = 3009	Blue = 4002
Electric Blue = 4000	Dark Blue = 4004	White = 9000
Powder Blue = 400	Cobalt Blue = 4006	Grey = 600
Turquoise = 4009	Military Green = 5002	
Lime Green = 5004	Dark Green = 5006	Silver = 6007
Charcoal = 6009	Orange = 7001	Yellow = 7500
Ivory = 8000		

* Remanufactured. This means the product has been dismantled and reconstructed as necessary. All of its internal and external parts have been cleaned and made rust and corrosion-free. All impaired, defective, or substantially worn parts are restored to sound condition or replaced with new, "rebuilt" or "unimpaired" used parts. All missing parts are replaced with new, rebuilt, or unimpaired used parts.



Shown with GM logo buckles.



1966-73 3 Point Front Seat Belts

Add comfort and safety to your muscle car while still keeping a stock look with Ground Up Motors's 3 point retractable seat belts! These three point belts feature a vintage style lap belt and chest belt so you can have new car safety with old car looks. Each kit includes two seat belts, grade 8 mounting hardware and powder coated mounting brackets all assembled and ready to bolt-in to your Nova. Instructions are also included. These seat belts mount in the factory locations meaning there is no drilling required. Seat belts meet FMVSS standards. Fill blank with your color choice.

SBL-66NO3-_____	1966-67 Buckets w/ Starburst...389.99 kit
SBL-66NO3B-_____	1966-67 Bench w/ Starburst....389.99 kit
SBL-66NO3GM-_____	1966-67 Buckets w/ GM Logo* 542.99 kit
SBL-66NO3BGM-_____	1966-67 Bench w/ GM Logo* .542.99 kit
SBL-68NO3-_____	1968-73 Buckets w/ Starburst...389.99 kit
SBL-68NO3B-_____	1968-73 Bench w/ Starburst....389.99 kit
SBL-68NO3GM-_____	1968-73 Buckets w/ GM Logo* 542.99 kit
SBL-68NO3BGM-_____	1968-73 Bench w/ GM Logo* .542.99 kit

Black = 1000	Silver = 6007
Flame Red = 2006	Ivory = 8000
Red = 2007	Grey = 6005
Red Wine = 2009	Maroon = 2008
Purple = 2010	Dark Blue = 4004
Tan = 3000	Lime Green = 5004
Brown = 3004	Dark Green = 5006
Dark Brown = 3005	Charcoal = 6009
Med. Beige = 3008	Orange = 7001
Desert Tan = 3009	White = 9000
Electric Blue = 4000	Blue = 4002
Powder Blue = 4005	Turquoise = 4009
Cobalt Blue = 4006	Military Green = 5002

Colors are special order and are non-returnable. See ss396.com for color swatches. Not all colors available for all styles. Ask your sales rep for color availability.

** Remanufactured. This means the product has been dismantled and reconstructed as necessary. All of its internal and external parts have been cleaned and made rust and corrosion-free. All impaired, defective, or substantially worn parts are restored to sound condition or replaced with new, "rebuilt" or "unimpaired" used parts. All missing parts are replaced with new, rebuilt, or unimpaired used parts.*

Black	Medium Saddle
Red	Medium Blue
Bright Red	Navy Blue
Maroon	Dark Green
Saddle	Silver



SBL-CHEV6772-1000

OE Style Lap Seat Belt Full Set

This is a *remanufactured front and rear set of lap seat belts featuring the correct OE style retractor, seat belt, buckle assembly, and OE style retractor covers.

Front Sets Lap

SBL-CHEV6772-1000	1968-72 Black.....	332.99 set
SBL-CHEV6772-2007	1968-72 Red.....	322.99 set
SBL-CHEV6772-2006	1968-72 Bright Red.....	322.99 set
SBL-CHEV6772-2008	1968-72 Maroon.....	316.99 set
SBL-CHEV6772-3000	1968-72 Saddle.....	316.99 set
SBL-CHEV6772-3008	1968-72 Medium Saddle.....	322.99 set
SBL-CHEV6772-4003	1968-72 Medium Blue.....	322.99 set
SBL-CHEV6772-4004	1968-72 Navy Blue.....	322.99 set
SBL-CHEV6772-5006	1968-72 Dark Green.....	322.99 set
SBL-CHEV6772-6005	1968-72 Silver.....	316.99 set

Front & Rear Sets Lap

SBL-CHEV6772FR-1000	1968-72 Black.....	470.99 set
SBL-CHEV6772FR-2007	1968-72 Red.....	470.99 set
SBL-CHEV6772FR-2006	1968-72 Bright Red.....	470.99 set
SBL-CHEV6772FR-2008	1968-72 Maroon.....	458.99 set
SBL-CHEV6772FR-3000	1968-72 Saddle.....	458.99 set
SBL-CHEV6772FR-3008	1968-72 Medium Saddle.....	470.99 set
SBL-CHEV6772FR-4003	1968-72 Medium Blue.....	470.99 set
SBL-CHEV6772FR-4004	1968-72 Navy Blue.....	470.99 set
SBL-CHEV6772FR-5006	1968-72 Dark Green.....	458.99 set
SBL-CHEV6772FR-6005	1968-72 Silver.....	458.99 set

Front & Rear Sets Lap & Shoulder

SBL-CHEV6772KIT-1000	1968-72 Black.....	695.99 set
SBL-CHEV6772KIT-2007	1968-72 Red.....	695.99 set
SBL-CHEV6772KIT-2006	1968-72 Bright Red.....	695.99 set
SBL-CHEV6772KIT-2008	1968-72 Maroon.....	672.99 set
SBL-CHEV6772KIT-3000	1968-72 Saddle.....	672.99 set
SBL-CHEV6772KIT-3008	1968-72 Medium Saddle.....	695.99 kit
SBL-CHEV6772KIT-4003	1968-72 Medium Blue.....	695.99 kit
SBL-CHEV6772FR-4004	1968-72 Navy Blue.....	470.99 set
SBL-CHEV6772KIT-5006	1968-72 Dark Green.....	699.99 kit
SBL-CHEV6772KIT-6005	1968-72 Silver.....	672.99 set

Front Shoulder Sets

SBL-CHEV6772SH-1000	1968-72 Black.....	229.99 set
SBL-CHEV6772SH-2007	1968-72 Red.....	229.99 set
SBL-CHEV6772SH-2006	1968-72 Bright Red.....	229.99 set
SBL-CHEV6772SH-2008	1968-72 Maroon.....	224.99 set
SBL-CHEV6772SH-3000	1968-72 Saddle.....	224.99 set
SBL-CHEV6772SH-3008	1968-72 Medium Saddle.....	229.99 set
SBL-CHEV6772SH-4003	1968-72 Medium Blue.....	229.99 set
SBL-CHEV6772SH-4004	1968-72 Navy Blue.....	229.99 set
SBL-CHEV6772SH-5006	1968-72 Dark Green.....	224.99 set
SBL-CHEV6772SH-6005	1968-72 Silver.....	224.99 set

No Volume Discount.



ISB-781RD

1974-79 Seat Belt Set

This is a set of factory style 1974-79 Nova seat belts. This four person seat belt set has been assembled with factory three panel webbing with retractors and factory buckles. Perfect for restoring your interior!

ISB-781BK	Black	399.95 kit
ISB-781TN	Tan	399.95 kit
ISB-781SL	Silver.....	399.95 kit
ISB-781RD	Red.....	399.95 kit
ISB-781BB	Bright Blue.....	399.95 kit
ISB-781MR	Maroon.....	399.95 kit
ISB-781NB	Navy Blue.....	399.95 kit

No Volume Discount.

Recommended Hardware

BSB-5-SBL	1964-77 All Fully Threaded.....	6.99 ea.
-----------	---------------------------------	----------



8700758

Factory Style Seat Belts

Original style lap belts.

8700758	1968-72 Front RH.....	169.99 ea.
8700759	1968-72 Front LH.....	169.99 ea.
IK-320	1968-72 Rear.....	169.99 ea.

No Volume Discount



IBR-732

Shoulder Belt Retainers

Correct roof mounted shoulder belt retainers.

IBR-732	1969-72 All.....	17.99 set
---------	------------------	-----------



BSB-56

BSB-561

BSB-5-SBL

Seat Belt Bolts

Correct shanked style seat belt bolts.

BSB-56	All Front Outer.....	6.99 ea.
BSB-56	1967-72 Front Inner	6.99 ea.
BSB-561	All Rear.....	6.99 ea.
BSB-5-SBL	1962-79 Fully Threaded	6.99 ea.



IGE-74R

Shoulder Belt Guide Escutcheon

Holds the shoulder belt retainer to the upper portion of the bucket seat back.

IGE-74L	1977-79 LH.....	9.99 ea.
IGE-74R	1977-79 RH.....	9.99 ea.



IBR-3200

Seat Belt Retractor Covers

Correct plastic covers available in black.

INL-15063	1967-72 Lap Belt Covers.....	28.99 pr.
IBR-3200	1971-74 w/ Access Door.....	43.99 pr.



IXN-1456

1975-79 Rear Seat Belt Covers

These injection-molded ABS reproductions of the Nova seat belt shoulder retractor covers are manufactured to exact specifications and include correctly placed mounting holes (when required) along with correct grain for each cover.

IXN-1456	2 Door Black.....	53.99 pr.
----------	-------------------	-----------



IBC-672G

IBC-672B

IBC-672BL

IBC-672R

Standard Seat Belt Covers

Factory replacement plastic seat belt cover.

IBC-672B	1967-72 Black	17.99 ea.
IBC-672R	1967-72 Red.....	17.99 ea.
IBC-672G	1967-72 Green	17.99 ea.
IBC-672BL	1967-72 Blue.....	17.99 ea.



SBL-BLADE

Standard Seat Belt Blade

This male blade piece is used on the end of the seat belt lap belt to snap into the female receiver for both front and rear belts.

SBL-BLADE	1965-72.....	14.99 ea.
-----------	--------------	-----------



OER Interior Paint

OER's revolutionary formula provides 40% more coverage than standard dyes and lacquers and actually penetrates and molecularly bonds to the surface to permanently seal in the color. Dries to the touch in 45 seconds, forms a complete bond in just 10 minutes. UV stable and color fast, it will not crack, flake or peel. For use on vinyl, leather, ABS plastic, polycarbonate, polypropylene, polyurethane, acrylic, lexan, fiberglass and recycled plastics. These paints are designed to match our colored PUI interior products. 12oz aerosol can.



HPP-802RED	M30 Red	32.99 ea.
HPP-804BBLU	M14 Bright Blue	32.99 ea.
HPP-808MBLU	M17 Medium Blue	32.99 ea.
HPP-809IGLD	M46 Ivy Gold	32.99 ea.
HPP-810WHITE	M37 White.....	32.99 ea.
HPP-811ORNG	M126 Hugger Orange.....	32.99 ea.
HPP-813DGRN	M24 Dark Green	32.99 ea.
HPP-820CAMEL	Z48 Camel Tan	32.99 ea.
HPP-829FTHR	Z45 Firethorn Red.....	32.99 ea.
HPP-830CARM	Z38 Carmine	32.99 ea.
HPP-1009	Surface Prep.....	19.99 ea.

Paint can not be shipped via air. Ground shipping only.

PUI Standard Door Panels

These PUI door panels are constructed of the finest quality materials available. These door panels are perfect for most cars out there whether they are daily drivers or trailer queens. Most panels come pre-assembled with moldings and PUI Windowfelts already installed unless noted. Take them out of the box, hang them on and you're ready to go!

- **Made in USA**
- **OEM Colors, OEM Materials**
- **"Out of the Box" Installation on most applications**

Please state color at time of order. All door panels ship Oversize.

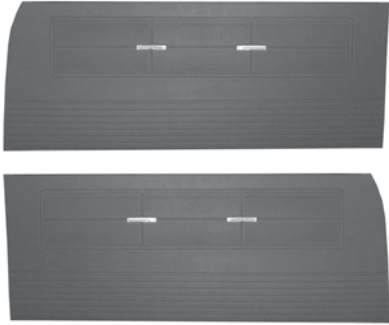

IDP-X63

1962-63 Door Panels

Seville grain vinyl with chrome mylar medallions. (These door panels are correct for 1963 Nova. They are not exactly correct for 1962 Nova but they will fit and look great!) These door panels are not pre-assembled.

Black

IDP-X63	Front Black	188.99 pr.
IDP-X63R	Rear Coupe/Sedan Black.....	99.99 pr.
IDP-X63V	Rear Convertible Black.....	99.99 pr.

Colors
Fill in color code below.
IDP-X63XD__ Front Colors..... 187.99 pr.
IDP-X63XD__C Rear Coupe/Sedan Colors..... 100.99 pr.
IDP-X63XD__V Rear Convertible Colors..... 100.99 pr.
Aqua (50) • Light Blue (56) • Fawn (57)
1962 Bright Red (63) • 1963 Red (64) • Saddle (65)
White (69)



IDP-X64

1964 Door Panels

Seville grain vinyl with dielectrically sealed center rectangle of criss-cross grain vinyl. These door panels are not pre-assembled.

Black

IDP-X64	Front Black	188.99 pr.
IDP-X64R	Rear Coupe/Sedan Black.....	99.99 pr.

Colors
Fill in color code below.
IDP-X64XD__ Front Colors..... 187.99 pr.
IDP-X64XD__C Rear Coupe/Sedan Colors..... 100.99 pr.
Aqua (50) • Light Blue (56) • Light Fawn (58)
Red (64) • Saddle (65) • White (69)

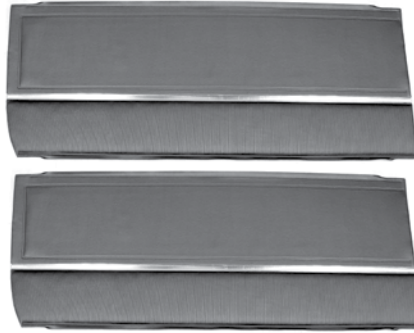

IDP-X65

1965 Door Panels

Madrid grain vinyl with dielectrically sealed ribbed design and milled chrome Mylar strip. These door panels are not pre-assembled.

Black

IDP-X65	Front Black	188.99 pr.
IDP-X65R	Rear Coupe/Sedan Black.....	99.99 pr.

Colors
Fill in color code below.
IDP-X65XD__ Front Colors..... 187.99 pr.
IDP-X65XD__C Rear Coupe/Sedan Colors..... 100.99 pr.
Aqua (02) • Light Blue (12) • Fawn (22) • Red (30)
Light Saddle (35)



IDP-X66

1966 Door Panels

Madrid grain vinyl with dielectrically sealed horizontal design with vertical chrome and black Mylar trim strips. These door panels are not pre-assembled.

Black

IDP-X66	Front Black	188.99 pr.
IDP-X66R	Rear Coupe/Sedan Black.....	99.99 pr.

Colors
Fill in color code below.
IDP-X66D__ Front Colors..... 187.99 pr.
IDP-X66D__C Rear Coupe/Sedan Colors..... 100.99 pr.
Aqua (273) • Light Blue* (275) • Bright Blue (272)
Fawn (274) • Red (271) *Non-SS color



IDP-X67SS

1967 SS Door Panels

Madrid grain vinyl with horizontal stitch bar design with a white vertical stripe accented with chrome Mylar. These door panels are not pre-assembled.

Black

IDP-X67SS	Front Black	188.99 pr.
IDP-X67R	Rear Coupe/Sedan Black.....	99.99 pr.

Colors
Fill in color code below.
IDP-X67D__ Front Colors..... 187.99 pr.
IDP-X67D__C Rear Coupe/Sedan Colors..... 100.99 pr.
Bright Blue (293) • Red (292) • Gold (294)

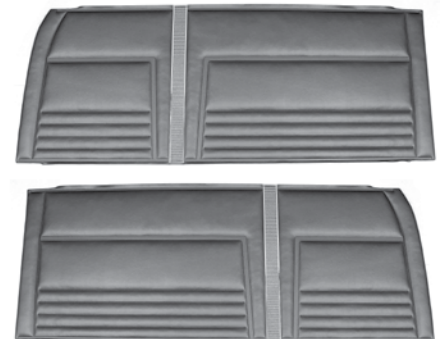

IDP-X67

1967 Non-SS Door Panels

Madrid grain vinyl with dielectrically sealed vertical milled bar design accented with chrome Mylar strips. These door panels are not pre-assembled.

Black

IDP-X67	Front Black	188.99 pr.
IDP-X67R	Rear Coupe/Sedan Black.....	99.99 pr.

Colors
Fill in color code below.
IDP-X67D__ Front Colors..... 187.99 pr.
IDP-X67D__C Rear Coupe/Sedan Colors..... 100.99 pr.
Light Blue (295) • Red (299) • Ivy Gold (299-4)

IPA-X68



1968 Standard Door Panels

Madrid grain vinyl with horizontal dielectric seal lines separated by a vertical parchment Mylar strip in front of the door handle. The horizontal chrome Mylar piece is embossed with the word "Nova". These pre-assembled door panels include top rails (metal front and strong ABS plastic rear) as well as window felts and door lock ferrules.



Black

IPA-X68	Front Black.....	369.99 pr.
IPA-X68R	Rear Coupe/Sedan Black.....	255.99 pr.

Colors
Fill in color code below.

IPA-X68PD__	Front Colors.....	382.99 pr.
IPA-X68PD__C	Rear Coupe/Sedan Colors.....	257.99 pr.

68 Blue (361) • Ivy Gold (362)



1968 Custom Door Panels

Madrid grain vinyl with basketweave pattern across the upper 1/3 of the panel. These pre-assembled door panels include top rails (metal front and strong ABS plastic rear) as well as window felts and door lock ferrules.



Black

IPA-X68C	Front Black.....	369.99 pr.
IPA-X68CR	Rear Coupe/Sedan Black.....	274.99 pr.

Colors
Fill in color code below.

IPA-X68XD__-P	Front Colors.....	382.99 pr.
IPA-X68XD__-PC	Rear Coupe/Sedan Colors.....	209.95 pr.

68 Blue (17) • Ivy Gold (46)

IPA-X69S



1969-70 Standard Door Panels

Madrid grain vinyl with horizontal dielectric seal lines separated by a vertical parchment Mylar strip in front of the door handle. The horizontal chrome Mylar piece is embossed with the word "Nova". These pre-assembled door panels include top rails (metal front and strong ABS plastic rear) as well as window felts and door lock ferrules.



Black

IPA-X69S	Front Black.....	369.99 pr.
IPA-X69R8R	Rear Coupe/Sedan Black.....	255.99 pr.

Colors
Fill in color code below.

IPA-X69PD__	Front Colors.....	382.99 pr.
IPA-X69PD__C	Rear Coupe/Sedan Colors.....	257.99 pr.

Light Blue (341) • Light Green (342) • Gold (343)
Dark Green (344) • Bright Blue (345)



1971-72 Standard Door Panels

Madrid grain vinyl with horizontal dielectric seal lines separated by a chrome Mylar outline in front of the door handle with a horizontal medallion. These pre-assembled door panels include top rails (metal front and strong ABS plastic rear) as well as window felts and door lock ferrules.



Black

IPA-X71	Front Black.....	369.99 pr.
IPA-X68R	Rear Coupe/Sedan Black.....	255.99 pr.

Colors
Fill in color code below.

IPA-X69PD__	Front Colors.....	382.99 pr.
IPA-X69PD__C	Rear Coupe/Sedan Colors.....	257.99 pr.

Blue (355) • Sandalwood (352) • Jade Green (353)
Dark Green (344)

IPA-X69



1969 Custom Door Panels

Madrid grain vinyl dielectrically sealed with Parchment colored horizontal strip surrounded by chrome mylar with a wider chrome mylar strip at the top of the panel. These pre-assembled door panels include top rails (metal front and strong ABS plastic rear) as well as window felts and door lock ferrules.



Black

IPA-X69	Front Black.....	369.99 pr.
IPA-X69R	Rear Coupe/Sedan Black.....	255.99 pr.

Colors
Fill in color code below.

IPA-X69PD__	Front Colors.....	382.99 pr.
IPA-X69PD__C	Rear Coupe/Sedan Colors.....	257.99 pr.

Light Blue (332) • Bright Blue (339-2) • Light Green (333)
Dark Metallic Green (334) • Red (331)



1970-72 Custom Door Panels

Madrid grain vinyl dielectrically sealed with a wood grain horizontal strip surrounded by chrome Mylar with a wider chrome Mylar strip at the top of the panel. These pre-assembled door panels include top rails (metal front and strong ABS plastic rear) as well as window felts and door lock ferrules.



Black

IPA-X70	Front Black.....	369.99 pr.
IPA-X70R	Rear Coupe/Sedan Black.....	255.99 pr.

Colors
Fill in color code below.

IPA-X70PD__	Front Colors.....	382.99 pr.
IPA-X70PD__C	Rear Coupe/Sedan Colors.....	257.99 pr.

1970 Light Blue (322) • 1972 Dark Green (324)
1970 Gold (325) • 1971-72 Sandalwood (326)
1971 Dark Saddle (327) • 1970 Saddle (327-1)
1972 Tan (328) • 1970 Dark Metallic Green (329)
1971 Jade Green (329-3)

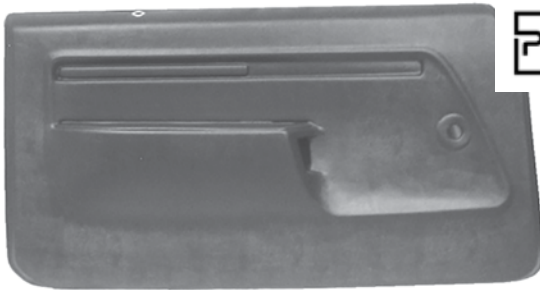

IDP-X73

1973-74 Door Panels

These molded door panels feature all of the correct holes for the door handles and window crank handles.

Black

IDP-X73 Front Black..... 719.99 pr.

Paint to match



IDP-X75

1975-76 Door Panels

Dielectrically sealed Madrid grain door panels feature a stitchbar pattern and rectangular chrome strip accent. Not pre-assembled.

Black

IDP-X75 Front Black 269.99 pr.

Colors

Fill in color code below.

IDP-X75_ Front Colors..... 275.99 pr.

Note: The door panel is the same for standard and deluxe. To make it a deluxe door panel, you must add your existing wood grain assembly.

1975 Blue (17) • 1976 Medium Blue (15) • Red (30) • White (37)
Sandalwood (41) • Dark Saddle (42)

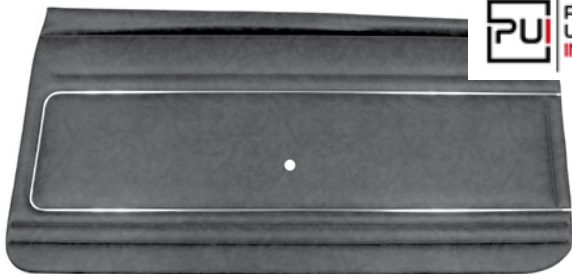

IDP-X77

1977-79 Door Panels

Dielectrically sealed Sierra grain door panels feature a stitchbar pattern and rectangular chrome strip accent. Not pre-assembled.

Black

IDP-X77 Front Black 269.99 pr.

Colors

Fill in color code below.

IDP-X77_ Front Colors..... 275.99 pr.

Note: The door panel is the same for standard and deluxe. To make it a deluxe door panel, you must add your existing wood grain assembly.

1977-78 White (37) • 1979 Carmine (38) • 1977-78 Firethorn (45)
1979 Camel (48) • 1979 Light Blue (90)



IXN-1455

1975-1979 Nova Coupe Lower Rear Side Panels

These injection-molded ABS reproductions of the 1975-1979 Nova lower rear side panels are manufactured to exact specifications and include correctly placed mounting holes (when required) along with correct grain for each panel. Available in black. Each panel may be painted to the desired color using interior paints.

IXN-1455 1975-79 All 2 Door..... 239.99 pr.

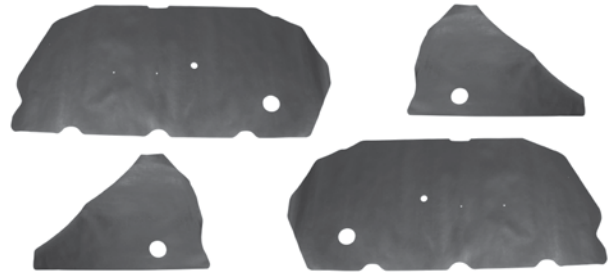

Door Panel Water Shields

Correct pre-cut water resistant paper material

IWS-66X

IWS-66X 1966-67 23.99 kit
IWS-68X 1968-74 22.99 set



IPM-6530

Door Panel Retainers

Exact reproduction door panel retainers / trim moldings for the front door panels and rear quarters.

Complete Set

IPM-6520 1962-65 2 Door..... 259.99 set
IPM-6590 1966-67 2 Door..... 259.99 set

Individual Pieces

IPM-6500 1962-67 Front Door Upper LH=RH..... 39.99 ea.
IPM-6510 1962-67 Front Door Lower LH=RH 39.99 ea.
IPM-6530 1962-65 Rear Quarter Upper LH 33.99 ea.
IPM-6540 1962-65 Rear Quarter Upper RH..... 33.99 ea.
IPM-6550 1966-67 Rear Quarter Upper LH 33.99 ea.
IPM-6560 1966-67 Rear Quarter Upper RH..... 33.99 ea.
IPM-6570 1962-67 Rear Quarter Lower LH..... 33.99 ea.
IPM-6580 1962-67 Rear Quarter Lower RH..... 33.99 ea.



IDE-0751



IDE-3041

Door Panel Emblems

Exact reproduction emblems for your Nova.

IDE-3041 1966-67 "Chevy II" 45.99 pr.
IDE-0751 1969-72 "Nova"..... 39.99 pr.



ISK-64A

Interior Screw Kits

These kits offer the most commonly missing or rusted special style interior screws. All screws are individually bagged and labeled to make replacement painless!

ISK-64A	1962-67	22.95 kit
ISK-68F	1968-72	29.95 kit



IXP-18

Door Panel Plugs

Correct plugs for attaching door panel clips. Buy the kit and save!

IXP-18K	12pc Plug Kit.....	19.10 kit
IXP-18	All Plug	1.99 ea.



IDP-109

Door Panel Screws

Correct size attaching screw for door panels.

IDP-109	All	0.50 ea.
---------	-----------	----------



IXP-33

Door Panel Clips

Correct clips for attaching panels.

IXP-33	All Clips 12pc.....	7.99 kit
--------	---------------------	----------



ICE-6400

IFF-700



Door Lock Knobs & Ferrules

Exact reproduction door lock knobs & ferrules.

ICF-4410	1962-66 Chrome Knob	3.95 ea.
ICF-67X	1967 Only Chrome* Lock Knobs.....	85.99 pr.
ICF-401	1962-67 Clear Ferrule	7.95 pr.
ICE-6400	1968-79 Chrome Knob	2.95 ea.
IFF-700	1968-72 All Ferrule	5.99 ea.

*ICF-67X knobs are made of chrome plated aluminum.



IWT-3010

Windlace End Caps

Correct reproduction of the original end caps, which insert in the doorjamb area and cover where the windlace stops at the quarter window. These give the rear door panels a finished look. Available in black, paint to match.

IWT-3010	1962-67	24.99 pr.
----------	---------------	-----------

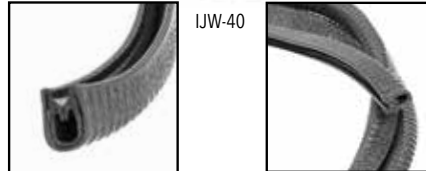

IJW-40



IJW-X68



Door Jamb Windlace

Correct style windlace in black.

IJW-40	1968-72 Replacement*	15.99 pr.
IJW-X68	1968-72 OE Snap in Style	92.99 pr.
IJW-689	1968-72 OER Brand	110.99 pr.
IJW-PERFOOT	Universal	1.89 ea.

*Not technically correct but will fit & function.



TRIM-02



TRIM-01



TRIM-KIT-DLX



TRIM-WR

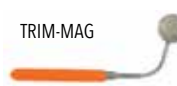

TRIM-MAG

Trim Removal Tools

TRIM-01	Door Panel Removal Tool	9.97 ea.
TRIM-02	Window Crank/Door Handle Removal	6.99 ea.
TRIM-WR	Window Roller Removal Tool	18.99 ea.
TRIM-MAG	Mirror & Magnet Kit 2pc	14.95 set
TRIM-KIT-DLX	Trim Removal Tools 3pc.....	29.99 ea.



IAT-64R



IAT-70C

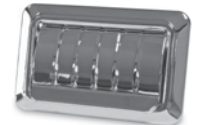

IAT-68C

Arm Rest Ash Trays

Correct chrome ash tray for rear arm rests.

IAT-64R	1962-64	49.99 pr.
IAT-64V	1965-67	49.99 pr.
IAT-70C	1976-79 (Smooth).....	34.99 ea.
IAT-68C	1976-79 (Ribbed).....	32.99 ea.



ICC-0001



ICI-5001



ICI-5101R

Arm Rest Pads

Exact reproduction arm rest pads.

ICC-0001	1962-64 Front Black.....	18.99 ea.
ICI-5001	1965-67 Front Black.....	25.99 ea.
ICC-6264	1962-64 Rear Black.....	71.99 pr.
ICC-0024	1965-67 Rear Black.....	18.99 ea.
ICI-5101L	1968-72 LH All	21.99 ea.
ICI-5101R	1968-72 RH All	21.99 ea.
IXP-03	Attaching Screw	0.50 ea.



ICI-5011



ICI-1960R

Arm Rest Bases

Exact reproduction chrome plated and plastic arm rest bases.

ICC-029	1962-64 Front	34.99 pr.
ICI-5011	1965-67 Front	19.99 ea.
ICC-4900	1962-65 Rear	39.99 pr.
ICI-1960L	1968-72 LH Black	21.99 ea.
ICI-1960R	1968-72 RH Black	21.99 ea.
IAM-6872	1968-72 Molding Inserts	33.99 pr.
IPX-997	Attaching Screw	0.75 ea.

BUY'N SAVE
WITH KITS

ARM-KIT1



1962-67 Front Arm Rest Pad & Base Kits

Complete kits with 2 arm rest bases and 2 front arm rest pads.

ARM-KIT3	1962-64 Black.....	62.02 kit
ARM-KIT1	1965-67 Black.....	82.76 kit



ARM-KIT4

1968-72 Front Arm Rest Pad & Base Kits

Complete kits with 2 arm rest bases and 2 front arm rest pads.

ARM-KIT4	1968-72 Black.....	74.77 kit
ARM-KITA10	1968-72 White.....	129.99 kit
ARM-KITA20	1968-72 Pearl.....	129.99 kit
ARM-KITA30	1968-72 Red.....	129.99 kit
ARM-KITA40	1968-72 Parchment.....	129.99 kit
ARM-KITA50	1968-72 Light Saddle.....	129.99 kit
ARM-KITA60	1968-72 Dark Saddle.....	129.99 kit
ARM-KITA65	1968-72 Light Blue.....	129.99 kit
ARM-KITA70	1968-72 Dark Blue.....	129.99 kit
ARM-KITA75	1968-72 Bright Blue.....	129.99 kit
ARM-KITA80	1968-72 Dark Green.....	129.99 kit
ARM-KITA85	1968-72 Sandalwood.....	129.99 kit



ARMBASE-DBLUE



ARMBASE-RED



ARMBASE-DGREEN



ARMBASE-PARCH



1968-72 Arm Rest Bases - Colors

Replacement arm rest bases now available in colors!

ARMBASE-PARCH	Parchment.....	26.95 pr.
ARMBASE-RED	Red.....	26.95 pr.
ARMBASE-BBLUE	Bright Blue.....	26.95 pr.
ARMBASE-DGREEN	Dark Green.....	26.95 pr.
ARMBASE-WHITE	White.....	26.95 pr.
ARMBASE-DBLUE	Dark Blue.....	26.95 pr.



1962-67 Rear Arm Rest Pad & Base Kit

Complete kit with pads, bases and ash trays.

ARM-KITR6	1962-67 Black.....	115.16 kit
-----------	--------------------	------------



ICI-R4820

1968-74 Nova Arm Rest Base And Pad Set OE Style

Manufactured to exact OE specifications, each arm rest pad is produced using modern urethane material with a sharp Madrid grain around a steel insert.

ICI-R4820	Black.....	89.99 set
-----------	------------	-----------

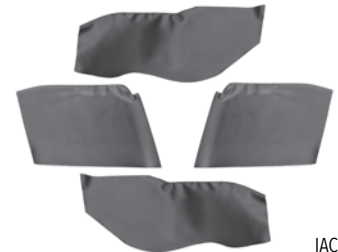

IAC-6263

1962-63 Rear Arm Rest Piston Covers

Correct die-stamped vinyl material for covering convertible rear arm rest and piston covers.

IAC-6263	Black.....	102.99 kit
IAC-626350	Aqua.....	102.99 kit
IAC-626356	Light Blue.....	102.99 kit
IAC-626357	Fawn.....	102.99 kit
IAC-626363	Bright Red.....	102.99 kit
IAC-626364	Red.....	102.99 kit
IAC-626365	Saddle.....	102.99 kit
IAC-626369	White.....	102.99 kit



ICI-X75R

ICI-X75L

1975-1979 Nova Arm Rest Pull Handles

Reproduction of the original arm rest pad and pull. Features correct grain and simulated stitching as original. Available in black only, paint to desired color.

ICI-X75L	All LH 2 Door.....	109.99 ea.
ICI-X75R	All RH 2 Door.....	109.99 ea.

IMB-833



Remote Mirror Bezel

This is an exact reproduction remote side mirror interior bezel for cars with standard interior.

IMB-833	1970-79.....	36.99 ea.
---------	--------------	-----------



IPX-4078C

IPX-4078B



1965-79 Window Cranks & Hardware

Exact reproduction window cranks in kits or individually!
Kit includes 4 cranks, 4 clips and 4 gaskets.

IPX-4078C	1965-79 Clear Knob Kit.....	33.80 kit
IPX-4078B	1965-79 Black Knob Kit.....	33.83 kit
IPO-4080C	1965-79 Clear Knob.....	7.99 ea.
IPO-4080B	1965-79 Black Knob.....	8.00 ea.
IPX-3850	All Gasket.....	1.95 ea.
IPX-3850K	All Gasket 4pc.....	6.79 kit
IPX-39	All Spring.....	1.95 ea.
IPX-38	All Clip.....	0.75 ea.

No Volume Discount.



IWC-X88

IWC-X31

1962-64 Window Cranks & Hardware

IWC-X88	1962-64 (Non SS) Single Arm.....	13.95 ea.
IWC-X31	1962-64 (Deluxe) Double Arm.....	13.95 ea.
IA-64	1965-66 Small Black Knob.....	21.95 ea.
IPX-3850	All Gasket.....	1.95 ea.
IPX-3850K	All Gasket 4pc.....	6.79 kit
IPX-39	All Spring.....	1.95 ea.
IPX-38	All Clip.....	0.75 ea.

IPO-67GMB



1965-72 Factory Correct Window Cranks

Quality die cast. Correct spline depth and clip engagement.
Shorter and with a flatter curvature than later years with correct thin knob. 1968-72 features cast number 9715291.

IPO-67GMB	1965-67 Black Knob.....	13.99 ea.
IPO-67GMC	1965-67 Clear Knob.....	15.99 ea.
IPO-68GMB	1968-72 Black Knob.....	17.99 ea.
IPO-68GMC	1968-72 Clear Knob.....	17.99 ea.

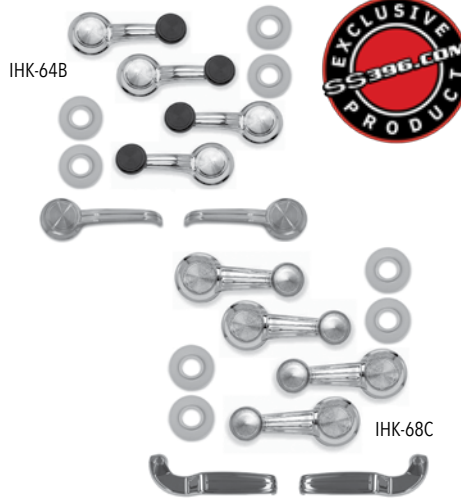

IHK-64B

IHK-68C



Window Crank & Door Handle Kits

Save when you buy the kit! This is a set of exact reproduction window cranks and inside door handles. Including (4) cranks, (4) clips and (4) gaskets, (2) handles with clips.

IHK-64B	1967 Black Knob Kit.....	54.22 kit
IHK-64C	1967 Clear Knob Kit.....	54.19 kit
IHK-68B	1968-74 Black Knob Kit.....	63.82 kit
IHK-68C	1968-74 Clear Knob Kit.....	63.79 kit

No Volume Discount.



IVH-52

Vent Window Handles

Exact reproduction die cast chrome handles.

IVH-52	1962-67.....	36.99 pr.
ITW-1610	1968-72.....	52.99 pr.



PT-203

PT-204

PT-202

Clayton Machine Works Handles

Easily add a nice custom touch to your interior with these custom handles from Clayton Machine Works! These handles are CNC machined and powder coated a satin silver. The perimeters and inside truss edges are then re-machined for subtle yet dynamic highlight. A great match to Clayton pedals!

PT-202	Door Handles.....	175.99 pr.
PT-203	Window Cranks.....	183.99 pr.
PT-204	Vent Window Cranks.....	161.99 pr.

No Volume Discount

Vent Window Rivet

Correct rivet for vent window.



KVF-RVT

KVF-RVT	1962-67.....	1.95 ea.
---------	--------------	----------



IDH-1604

ICE-4814K

ICE-3520X

ICE-36R

Door Handles

Excellent quality reproduction door handles.

Buy the pair and save!

IDH-1604	1962-64.....	13.95 ea.
ICE-4814K	1965-67.....	23.78 pr.
ICE-4814	1965-67.....	13.99 ea.
ICE-3520X	1968-74.....	33.98 pr.
ICE-3520L	1968-74 LH.....	19.99 ea.
ICE-3520R	1968-74 RH.....	19.99 ea.

1975-79 Door Handle Mechanisms

Complete door handle assemblies.

ICE-36L	1975-81 LH.....	9.99 ea.
ICE-36R	1975-81 RH.....	9.99 ea.



GWS-711

4432791

Power Window Switch

Correct OEM style power window switch.

4432790	1962-70 1 Window.....	42.99 ea.
4432791	1962-70 4 Window.....	69.99 ea.
GWS-711	1971-77 1 Window.....	44.99 ea.
GWS-714	1971-72 4 Window.....	69.99 ea.



GWS-634

GWS-635

Power Window Switch Retainer

GWS-634	1964-79 1 Button.....	9.95 ea.
GWS-635	1964-79 4 Button.....	25.00 ea.

GLS-71



Power Lock Switch

Die cast and chrome plated. Reads LOCK and has correct square corners. Replaces GM #1725099.

GLS-71	1971-79 1 Button.....	59.99 ea.
--------	-----------------------	-----------



ITW-X63455



ITW-X6710



ITW-X6810



ITW-X6910

Dash Pads

Our dashes feature solid fiberglass cores surrounded by vinyl wrapped foam to assure you the best look and fit on the market! All of the factory colors are available and will match your new PUI colored interior exactly. Fill in color choice in ____.

1963-65

Black = 55	Aqua = 50	Light Blue = 56	
Fawn = 57	Light Fawn = 58	Bright Red = 63	
Red = 64	Saddle = 65	White = 69	
ITW-X634_	1963-65	259.99 ea.	

1966

Black = 10	Aqua = 02	Bright Blue = 14	
Fawn = 22	Red = 30	Light Blue = 12	
ITW-X66_	1966	259.99 ea.	

1967

Black = 10	Light Blue = 12	Bright Blue = 14	
Red = 30	Gold = 43	Ivy Gold = 46	
ITW-X67_	1967	238.99 ea.	

1968

Black = 10	Med Blue = 17	Ivy Gold = 46	
ITW-X68_	1968	271.99 ea.	

1969-74

Black = 10	Gold = 43	Light Blue = 12	
Bright Blue = 14	Light Green = 23	Dark Metallic Green = 24	
Red = 30			
ITW-X69__AC	1969-74 with A/C	271.99 ea.	
ITW-X69__	1969-74 without A/C	271.99 ea.	

*Ships Oversize. * Black prices shown. Color prices included an up charge.*



ICB-6365

1963-65 Instrument Cluster Bezel

Excellent quality reproduction instrument cluster bezel.

ICB-6365	1963-65 All	99.99 ea.
----------	-------------------	-----------



ICB-26501



ICB-26502

1966-67 Instrument Cluster Bezel

High quality instrument panel bezels featuring correct colors and accenting.

ICB-26501	1966 All	119.99 ea.
ICB-26502	1967 All	119.99 ea.

6406757

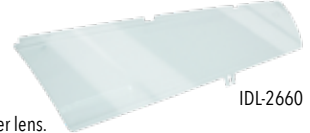

IDL-2660

Dash Cluster Lenses

Exceptional reproduction of the original dash cluster lens.

IDL-6365	1963-65 Dash Lens	52.99 ea.
6406757	1963-65 Dash Lens Plug	9.99 ea.
IDL-2660	1966-67 Dash Lens	59.99 ea.
ITW-2700	1968-76 Lens	74.99 ea.

DT-200016



DT-200008

LED Dash Bulbs

A simple direct replacement for your original 194 style dash light bulbs. Excellent to increase brightness and reduce heat and power.

DT-200008	194 Red LED Bulbs	15.95 pr.
DT-200009	194 Amber LED Bulbs	15.95 pr.
DT-200016	194 White LED Bulbs	16.95 pr.



IK-790



IVB-69F

1969 Right Side Air Vent

Correct injection molded reproduction bezel and vent.

IK-790	1969-74 Vent	25.99 ea.
IVB-69F	1969-72 Bezel RH Only	24.95 ea.
IVC-69F	1969-72 Bezel & Vent Assembly RH	89.99 ea.

IK-269



1970-72 Center AC Vent

This is a center of dash air conditioning vent.

IK-269	1970-72	88.99 ea.
--------	---------------	-----------



ICB-69

1969-74 Dash Gauge Bezel

Nicely detailed reproduction of the hard to find dash gauge carrier featuring correct grain & lettering.

ICB-69	1969-74 w/o Warning Lights w/o AC	319.99 ea.
ICB-69AC	1969-74 w/o Warning Lights w/ AC	319.99 ea.
ICB-69WL	1969-74 w/ Warning Lights w/o AC	319.99 ea.
ICB-69ACWL	1969-74 w/ Warning Lights w/ AC	319.99 ea.

Dashtop

By Palco Industries, Inc.

Dashtop is well-known for premium quality dashboard covers and panels aiming to give additional protection and utility to American muscle. They provide a huge range of components that you can rely on for a long time. When it comes to quality dashboard covers, Dashtop is the brand you can rely on. They provide numerous types of dash covers that ensure excellent protection for a vehicle's dashboard against excessive heat and UV rays, giving a new life to your vehicle's interior. Each dash cover is made with durable materials and designed to fit right the first time, meeting and even outperforming customers' expectations. Installation of their dash covers requires no special skills or tools and takes only a matter of minutes to complete. Complement your vehicle's interior with tested and reliable products from the brand you can trust and ride in style!



DT-224

Dashtop Replacement Dash Covers

This molded plastic dash cover simply fits right over the existing dash to cover unsightly cracks! An easier and more economical alternative to complete dash replacement.

1965

DT-245	1965 Black.....	175.99 ea.
DT-245-1	1965 Blue.....	212.99 ea.
DT-245-15093	1965 Light Buckskin.....	212.99 ea.
DT-245-3	1965 Red.....	212.99 ea.
DT-245-4	1965 Brown.....	212.99 ea.

1966

DT-235	1966 Black.....	175.99 ea.
DT-235-15133	1966 Wedgewood Blue.....	212.99 ea.
DT-235-1	1966 Blue.....	212.99 ea.
DT-235-15093	1966 Light Buckskin.....	212.99 ea.
DT-235-3	1966 Red.....	212.99 ea.

1969-74 w/o AC

DT-205	1969-74 Black.....	179.99 ea.
DT-205-15043	1969-74 Shadow Blue.....	206.99 ea.
DT-205-1	1969-74 Blue.....	206.99 ea.
DT-205-2	1969-74 Green.....	206.99 ea.
DT-205-434	1969-74 Green Metallic.....	206.99 ea.
DT-205-3	1969-74 Red.....	206.99 ea.
DT-205-4	1969-74 Brown.....	206.99 ea.
DT-205-656	1969-74 Tan.....	206.99 ea.
DT-205-15103	1969-74 Super White.....	206.99 ea.

1969-74 with AC

DT-211	1969-74 Black.....	169.99 ea.
DT-211-15043	1969-74 Shadow Blue.....	206.99 ea.
DT-211-1	1969-74 Blue.....	206.99 ea.
DT-211-2	1969-74 Green.....	206.99 ea.
DT-211-434	1969-74 Green Metallic.....	206.99 ea.
DT-211-3	1969-74 Red.....	206.99 ea.
DT-211-4	1969-74 Brown.....	206.99 ea.
DT-211-656	1969-74 Tan.....	206.99 ea.
DT-211-15103	1969-74 Super White.....	206.99 ea.

1975-76 w/o AC

DT-224	1975-76 Black.....	169.99 ea.
DT-224-5	1975-76 Claret.....	206.99 ea.
DT-224-15103	1975-76 Super White.....	206.99 ea.
DT-224-656	1975-76 Tan.....	206.99 ea.
DT-224-4	1975-76 Brown.....	206.99 ea.
DT-224-6	1975-76 Dark Bluemist.....	206.99 ea.

1975-76 with AC

DT-237	1975-76 Black.....	169.99 ea.
DT-237-5	1975-76 Claret.....	206.99 ea.
DT-237-15103	1975-76 Super White.....	206.99 ea.
DT-237-656	1975-76 Tan.....	206.99 ea.
DT-237-4	1975-76 Brown.....	206.99 ea.
DT-237-6	1975-76 Dark Bluemist.....	206.99 ea.

Colors are approximate matches of original and may not match perfectly. Colors other than black are custom ordered and are not returnable. If you are looking to match your colored interior exactly we recommend ordering black and painting to match. Ships Oversize.



Black

Blue



Light Buckskin

Red



Brown

Wedgewood Blue



Shadow Blue

Green



Green Metallic

Tan



Super White

Claret



Dark Bluemist



6406815

1962-64 Speedometer

High quality reproduction speedometer which duplicated the original in every way. Correctly calibrated and ready to install.

6406815 1962-64 All233.99 ea.
No Volume Discount



6455482

1965 Speedometer

High quality reproduction speedometer which duplicated the original in every way. Correctly calibrated and ready to install.

6455482 1965 All.....290.99 ea.
No Volume Discount



5644639

1963-65 Fuel Gauge

High quality reproduction of the original standard dash fuel gauge which also includes the temp, generator and oil warning lights.

5644638 1963-64 All279.99 ea.
5644639 1965 All.....279.99 ea.
No Volume Discount



6459272

1966-67 Speedometer

High quality reproduction speedometer which duplicated the original in every way. Correctly calibrated and ready to install. Includes turn signal indicators and warning light provisions.

6459272 1966-67 All289.99 ea.
No Volume Discount



6430436

1966-67 Fuel Gauge

High quality reproduction of the original in-dash fuel gauge manufactured to exact factory specs.

6430436 1966-67 All134.99 ea.
No Volume Discount



6431585

1969-74 Fuel Gauge

High quality reproduction of the original in-dash fuel gauge for cars without console gauges.

6431585 1969-74139.99 ea.
No Volume Discount



6496615



6496617

1969-74 Speedometer

High quality reproduction speedometer which duplicated the original in every way. Correctly calibrated and ready to install. Includes turn signal indicators and warning light provisions. Available for models with or without console gauges. Does not work with speed warning.

6496615 1969-74 without Console Gauges279.99 ea.
6496617 1969-74 with Console Gauges.....259.99 ea.

No Volume Discount

Note: These speedometers use a threaded speedometer cable.



S138



S156

Column Shift Indicator Lens

New column shift indicator lens for the TH350/400 and overdrive transmissions when used in a car that originally came with a Powerglide transmission.

S138 1962-65 TH350/40022.99 ea.
S139 1962-65 TH700/20022.99 ea.
S153 1966 TH350/40022.99 ea.
S154 1966 TH700/20022.99 ea.
S143 1967 TH350/40022.99 ea.
S144 1967 TH700/20022.99 ea.
S155 1968-74 TH350/40022.99 ea.
S156 1968-74 TH700/20022.99 ea.



GPC-X1

Printed Circuit Board

High quality reproduction circuit board.

- GPC-X1 1968-75 All69.95 ea.
- GPC-788G 1979 w/ Rally Gauges74.99 ea.



6454841

Speed Warning Cable

High quality reproduction of the control cable used with the desirable and highly sought after RPO code U15 (Speed Warning Indicator).

- 6454841 1968-69 Cable29.99 ea.
- 3954257 1968-69 Bracket29.99 pr.



3863796

1963-65 Clock

High quality reproduction of the original dash clock manufactured with quartz movement. Cosmetically correct once installed.

- 3863796 1963-65 All236.99 ea.
- No Volume Discount*



994125

1969-74 Clock

High quality reproduction of the original dash clock manufactured with quartz movement. Cosmetically correct once installed.

- 994125 1969-74 All299.99 ea.
- No Volume Discount*

6496824



1969-74 Clock Opening Cover Plate

This plate was used to cover the opening on the right side of the speedometer on models not originally equipped with a clock.

- 6496824 1969-7469.99 ea.
- No Volume Discount*



5657301

1969-74 Dash Tach

High quality reproduction dash tachometer which was installed by the factory on the left side of the speedometer on console gauge equipped cars. 7000 RPM range with 5000 RPM red line.

- 5657301 1969-74269.99 ea.
- Not correct for 1968-70 327/325 horsepower or 396 models.*
No Volume Discount



2196365

1963-64 SS Instrument Gauge Cluster

High quality reproduction of the original instrument cluster used on SS models. Includes fuel, oil, temp and battery gauges.

- 2196365 1963-64 Super Sport339.99 ea.
- No Volume Discount*



2196565

1965 SS Instrument Gauge Cluster

High quality reproduction of the original instrument cluster used on SS models. Includes fuel, oil, temp and battery gauges.

- 2196565 1965 Super Sport340.99 ea.
- No Volume Discount*



IDT-7579

1975-79 Tachometer

This is an excellent reproduction dash tachometer, which will replace your damaged or missing original GM part number 5658835.

- IDT-7579 1975-79 All219.99 ea.
- No Volume Discount*



Classic Rocket Tach

The retro styled, half sweep tach features a dual layer design, color changing rocket booster, a red pointer and a rich black face with bright white numerals and indices. Finished with a stainless low step bezel and flat glass, the Rocket Tach comes mounted in a chrome cup that allows for a variety of mounting positions.

- RT80SLF 6500 Red Line200.99 ea.



S515

In Dash Tachometer Conversion

Replace your CLOCK with a 7000 RPM TACH. All In-Dash Tachs are engineered to fit into existing dash openings and are designed with a factory look.

- S515 1963-65 All169.99 kit
- No Volume Discount. Tach Conversion Only. Does Not Include Cluster.*



IN-60

Clock Reset Knob

Replacement clock reset knob kit including correct retaining nut. Measures 1/2" long. Includes 2 knobs for early or late cars.

- IN-60 1967-79 All14.99 ea.

Dakota Digital VHX Instruments

Fully lit needles, backlit faces and highly visible LCD message centers are a few of the things that you can see which set the VHX Series apart from yesterday's traditional approach to instrumentation. A few of the features which you don't normally see are the micro-controlled precision stepper motors, solid state sensors for unparalleled accuracy and user-customizable display feedback, all supported by an unrivaled limited lifetime warranty which has become the standard for Dakota Digital instrumentation systems. Completely engineered and manufactured in the USA, the VHX Series has completely revolutionized the instrumentation industry!



VHX-63C-NOV-S-R

1962-65 VHX Instrument System

- VHX-63C-NOV-S-R Silver Alloy Faces, Red Numbers 850.95 kit
- VHX-63C-NOV-S-B Silver Alloy Faces, Blue Numbers 850.95 kit
- VHX-63C-NOV-C-R Carbon Fiber Faces, Red Numbers 850.95 kit
- VHX-63C-NOV-C-B Carbon Fiber Faces, Blue Numbers 850.95 kit
- VHX-63C-NOV-K-R Black Alloy Faces, Red Numbers 850.95 kit
- VHX-63C-NOV-K-B Black Alloy Faces, Blue Numbers 850.95 kit

Fits directly into stock bezel (not included). 1962 must use 1963-65 instrument bezel.



VHX-66C-NOV-S-B

1966-67 VHX Instrument System

- VHX-66C-NOV-S-R Silver Alloy Faces, Red Numbers 850.95 kit
- VHX-66C-NOV-S-B Silver Alloy Faces, Blue Numbers 850.95 kit
- VHX-66C-NOV-C-R Carbon Fiber Faces, Red Numbers 850.95 kit
- VHX-66C-NOV-C-B Carbon Fiber Faces, Blue Numbers 850.95 kit
- VHX-66C-NOV-K-R Black Alloy Faces, Red Numbers 850.95 kit
- VHX-66C-NOV-K-B Black Alloy Faces, Blue Numbers 850.95 kit

Fits directly into stock bezel (not included).



VHX-69C-NOV-S-B

1969-76 VHX Instrument System

- VHX-69C-NOV-S-R Silver Alloy Faces, Red Numbers 850.95 kit
- VHX-69C-NOV-S-B Silver Alloy Faces, Blue Numbers 850.95 kit
- VHX-69C-NOV-C-R Carbon Fiber Faces, Red Numbers 850.95 kit
- VHX-69C-NOV-C-B Carbon Fiber Faces, Blue Numbers 850.95 kit
- VHX-69C-NOV-K-R Black Alloy Faces, Red Numbers 850.95 kit
- VHX-69C-NOV-K-B Black Alloy Faces, Blue Numbers 850.95 kit

Fits directly into stock bezel (not included).

Dakota Digital VFD3 Instrument Clusters

Dakota Digital Series III instrument systems offer the latest technology and features for your custom vehicle. High brightness vacuum fluorescent displays provide a lifetime of trouble free use while offering increased accuracy and features!



VFD3-63C-NOV-B

1962-65 Nova Dakota Digital VFD3 Instrument Cluster

Fits directly into existing bezel. Will only fit 1962 models with the use of 1963-1965 gauge bezel. Choose from blue or teal numbers, MPH or KPH and degrees Fahrenheit or Celsius.

- VFD3-63C-NOV-B Blue, MPH, Fahrenheit 736.95 kit
- MFD3-63C-NOV-B Blue, KPH, Celsius 736.95 kit
- VFD3-63C-NOV-T Teal, MPH, Fahrenheit 736.95 kit
- MFD3-63C-NOV-T Teal, KPH, Celsius 736.95 kit

Does not include bezel. We recommend harness FFW-40. No Volume Discount.



VFD3-66C-NOV-N-B

1966 Nova VFD3 Dakota Digital Instrument Cluster

Includes new reproduction dash carrier bezel. Choose from blue or teal numbers, MPH or KPH and degrees Fahrenheit or Celsius.

- VFD3-66C-NOV-N-B Blue, MPH, Fahrenheit 850.95 kit
- MFD3-66C-NOV-N-B Blue, KPH, Celsius 850.95 kit
- VFD3-66C-NOV-N-T Teal, MPH, Fahrenheit 850.95 kit
- MFD3-66C-NOV-N-T Teal, KPH, Celsius 850.95 kit

We recommend harness FFW-40. No Volume Discount.



VFD3-67C-NOV-N-B

1967 Nova Dakota Digital VFD3 Instrument Cluster

Includes new reproduction dash carrier bezel. Choose from blue or teal numbers, MPH or KPH and degrees Fahrenheit or Celsius.

- VFD3-67C-NOV-N-B Blue, MPH, Fahrenheit 850.95 kit
- MFD3-67C-NOV-N-B Blue, KPH, Celsius 850.95 kit
- VFD3-67C-NOV-N-T Teal, MPH, Fahrenheit 850.95 kit
- MFD3-67C-NOV-N-T Teal, KPH, Celsius 850.95 kit

We recommend harness FFW-40. No Volume Discount.



VFD3-69C-NOV-B

1969-76 Nova Dakota Digital VFD3 Instrument Cluster

Fits directly into existing bezel. Rear housing is included. Choose from blue or teal numbers, MPH or KPH and degrees Fahrenheit or Celsius.

- VFD3-69C-NOV-B Blue, MPH, Fahrenheit 784.95 kit
- MFD3-69C-NOV-B Blue, KPH, Celsius 784.95 kit
- VFD3-69C-NOV-T Teal, MPH, Fahrenheit 784.95 kit
- MFD3-69C-NOV-T Teal, KPH, Celsius 784.95 kit

Does not include bezel. No Volume Discount.



HDX-63C-NOV-S



HDX-69C-NOV-S



HDX-66C-NOV-K

1963-1976 Dakota Digital HDX Instruments

Chevy's first economy car is now a favorite for speed freaks of all kinds. The small instrument housing of the 1963-1965 Chevy II isn't much to work with, but the HDX instrument system packs six analog readings with analog readouts, plus a full color TFT for additional information. Use your stock or reproduction bezel, available separately; and can be used in 1962 models with the addition of a 1963-65 bezel. Available with your choice of black or silver alloy gauge-face styling, each HDX system allows the user to select independent illumination colors for the gauge readings and needles, as well as the message centers. Calibration and personal settings are manipulated with the built-in, capacitive-touch buttons, or the available Bluetooth App for Apple and Android devices. Each needle hub is black nickel plated spun-aluminum to match the buttons. All HDX instrument systems feature dead-faced indicators (turn signals, high beam, check engine, cruise control, parking brake, plus two user-definable) and a red, settable warning light for each gauge. With our central control box, installation is greatly simplified with vehicle harness sourced signals and supplied, solid state sending units connecting cleanly to their respective terminals.

HDX-63C-NOV-S	1963-65 Silver Face	1420.95 ea.
HDX-63C-NOV-K	1963-65 Black Face	1420.95 ea.
HDX-66C-NOV-S	1966-67 Silver Face	1420.95 ea.
HDX-66C-NOV-K	1966-67 Black Face	1420.95 ea.
HDX-69C-NOV-S	1969-76 Silver Face	1420.95 ea.
HDX-69C-NOV-K	1969-76 Black Face	1420.95 ea.

No Volume Discount.



SGN063



SGN063



VSBNO63

Classic Instruments 1963-65 Nova Gauges

Add a totally custom yet vintage look to your interior with these gauges from Classic Instruments. These gauges mount in your stock bezel and utilize your stock diffuser. Includes 140 MPH speedo (Velocity Series 160 MPH), 8,000 RPM tachometer (Velocity Series 10,000 RPM), Quad Cluster (Fuel 0-30 ohms, water temp, oil pressure, volts), integrated turn and high beam indicators and illumination for night time driving. Includes water temp and oil pressure sending units and pulse signal generator for the electronic speedometer. Lens included.

SGN063	G/Stock Series.....	882.99 kit
HRNO63	Hot Rod Series.....	882.99 kit
WHNO63	White Hot Series.....	882.99 kit
VSBNO63	Velocity Black Series.....	882.99 kit
VSWNO63	Velocity White Series.....	882.99 kit
SGN063	SG Series.....	882.99 kit

Does not include bezel or diffuser. No Volume Discount.



NO66W



NO66VSW

1966-67 Classic Instruments Gauge Sets

Direct-fit cluster features a speedometer, tachometer, fuel level, temperature, oil pressure, and volt gauges; along with indicator lights. All the gauges are electronic operation and the molded plastic housing has been designed with factory fitment in mind. The cluster mounts in the original factory bezel and uses the original diffuser plate, both of which will need to be re-used from your original cluster.

- A programmable fuel gauge for any ohm range with a selector switch on the back of the cluster.
- Wiring is handled with a single wire harness connection on the back of the cluster
- Green LED turn signal indicators, red warning light, and a blue high beam indicator
- Speedometer calibration is quick and easy with push-button control

NO66B	Black.....	929.99 ea.
NO66W	White.....	929.99 ea.
NO66GS	G/Stock Series.....	929.99 ea.
NO66VSB	Velocity Series Black.....	929.99 ea.
NO66VSW	Velocity Series White.....	929.99 ea.

Does not include bezel or diffuser. No Volume Discount.



RTX-63C-NOV-X

Dakota Digital RTX Instrument System

The RTX series is the latest from Dakota Digital, focused on retaining that stock look without sacrificing the late-model features you love. Every effort has been put forth to incorporate OEM design elements regarding the layout, face styling and indicators. A casual glance may dismiss these as original equipment, but once you hit the switch and the LED backlighting comes on in your favorite color scheme, all doubts will be removed. Starting from scratch, CNC machined housings are filled with electronics designed and built in-house, helping Dakota Digital once again raise the bar for aftermarket instrumentation. The high-definition TFT message centers can be fully configured to display just about any piece of information needed, or just leave the vintage-looking tumbler odometer on the screen for a totally stock appearance. As you've come to expect from Dakota Digital, the RTX series utilizes a central control box to make installation and setup as easy as possible. Over 30 User-Selectable Display Colors Available: Select backlighting colors for the needles, digital display and printed gauge readings independently, or choose from one of 12 preset lighting themes. Full Color TFT Message Centers: Can be configured to suit each driver, fully adjustable for color and information readout. Bluetooth App: All calibration settings and personal preferences can be selected through the Apple and Android app or through the provided programming switch.

RTX-63C-NOV-X	1962-65 Black Face.....	1515.95 kit
RTX-66C-NOV-X	1966-67 Black Face.....	1515.95 kit
RTX-69C-NOV-X	1969-76 Black Face.....	1515.95 kit

No volume discount.



EHT-335

Dixco Style Hood Tach

These are used on several aftermarket applications for super cars, including Yenko and Motion. White, paint to match.

EHT-335 User Sets Red Line209.99 ea.



IQ-507

Ignition Bezel Nut

OE style reproduction ignition bezel nuts.

IQ-2493-OE 1966 All35.99 ea.
IQ-507 1967 All10.99 ea.



ITW-1640

1966-67 Dash Bezel Set

OE style reproduction dash bezel set (4pc)

ITW-1640 1966-6774.99 set



I GE-3039



I GE-3024

Glove Box Emblems

OE style reproduction glove box door emblems.

I GE-3025 1963-64 "Nova SS"45.99 ea.
I GE-3024 1963-64 "Nova Chevy II"45.99 ea.
I GE-3039 1966 "Nova Chevy II"45.99 ea.



I GE-6601



I GE-3045



I GE-69SS



I GE-68SS

Dash Emblems

OE style reproduction dash emblems.

I GE-6601 1966 "Super Sport"39.99 ea.
I GE-2675 1967 "Super Sport"49.99 ea.
I GE-3045 1967 "Nova Chevy II"45.99 ea.
I GE-68SS 1968 "Nova SS"69.99 ea.
I GE-69SS 1969-74 "Nova SS"52.99 ea.
I GE-NOVA 1969-74 "Nova" Non SS29.99 ea.

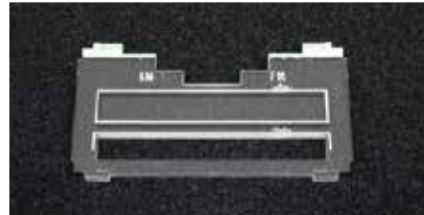

I RL-2120

Radio Lenses

Authentic reproduction radio lenses with correct lettering and colors.

I RL-2120 1969-70 Mono, 1970 AM/FM33.99 ea.
I RL-2121 1969 AM/FM33.99 ea.
I RL-4615 1971-76 AM/FM Mono34.99 ea.
I RL-4616 1971-76 AM/FM Stereo34.99 ea.



IDT-6500SS



Detailed View

1965 Dash Trim Piece Set

Correct dash trim pieces for 1965 Nova SS. 5 pieces.

IDT-6500SS 1965 Nova SS302.99 kit



I CM-3023

1962-64 Ignition Bezel

OE style reproduction of the original ignition bezel for 1962-64 Chevy II's (not correct for Nova)

I CM-3023 1962-64 Bezel11.99 ea.



I DSE121505

Billet Headlamp Switch

Attaches to the stock switch stalk with a set screw - a great complement to your DSE Selecta-Speed Wiper Kit which includes a billet aluminum wiper knob.

DSE121502 1962-6440.99 ea.
DSE121503 196540.99 ea.
DSE121504 196640.99 ea.
DSE121505 196740.99 ea.



IDK-69C

1969-70 Dash Knob Kit

This complete dash knob set will replace the old or worn out original knobs and help bring your dash back to a factory fresh appearance. Includes the lighter knob with element, light switch knob, radio knobs, and windshield washer knob.

IDK-69C	1969-70 Mono	29.99 set
IDK-69SC	1969-70 Stereo	29.99 set



IRB-1617

1966-67 Radio Face Plate

Reproduction of the original radio bezel for 1966-67 Chevy II's

IRB-1617	1966-67 All	29.99 ea.
----------	-------------------	-----------



IRD-69F

1969-72 Radio Delete Plate

Originally used on specially optioned cars that did not come with a factory radio. Injection molded like original with hot stamped chrome on the edge. This is a show quality piece.

IRD-69F	1969-72 All	74.99 ea.
---------	-------------------	-----------

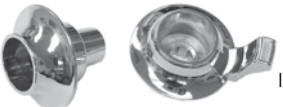

IK-231S



IK-245



IRT-7S



IRK-712

Radio Knobs

Correct inner and outer radio knobs.

IK-520S	1967 Inner Stereo	8.99 pr.
IK-231	1969-70 Inner Mono	13.99 pr.
IK-231S	1969-70 Inner Stereo	15.99 pr.
IK-245	1969-70 Outer	20.99 pr.
IRT-712	1971-75 Inner Mono	27.99 pr.
IRT-7S	1971-75 Inner Stereo	27.99 pr.
IRK-712	1971-79 Outer w/ Logo	27.99 pr.
IK-1049	1975-79 AM	39.99 set



GHR-88

Headlamp Switch Nut

Correct special nut used for retaining switch to the dash.

GHR-88	1969-79 All	12.99 ea.
--------	-------------------	-----------



IK-268



IK-353



IHL-722



IHL-837

Headlight Knobs

Correct knobs with rods.

IK-268	1967 All	16.99 ea.
IK-353	1969-70 All	19.99 ea.
IHL-712	1972-75 w/ Logo	18.99 ea.
IHL-722	1972-75 w/o Logo	18.99 ea.
IHL-837	1977-79 All	24.99 ea.



IK-214



IQ-05

Wiper Knobs

OE style chrome reproduction wiper knobs with correct textures and designs.

IK-214	1967 All	10.99 ea.
IQ-05	1969-71 All	6.99 ea.



IGB-202

Glove Box Door Hinge Screw Set

OE style reproduction of original black Chevrolet glove box door hinge screws.

IGB-202	1966-67 3pc	5.99 set
---------	-------------------	----------



IGD-1647

1966-67 Glove Box Door

OE style reproduction glove box door great for replacing your dented or rusty original. Includes hinge.

IGD-1647	1966-67 All	119.95 ea.
----------	-------------------	------------



IGD-659

1969-79 Nova Glove Box Door Black

Features correct hold for lock cylinder and pre-assembled hinge with proper mounting holes for installation. Glove box door features a black EDP coating for rust and corrosion resistance. Ready to prep and paint to the desired interior color. Will fit and install as original.

IGD-659	1969-79 All	79.99 ea.
---------	-------------------	-----------



IGD-X62

Glove Box

Correct, die stamped cardboard reproductions.

IGD-X62	1962-65	26.99 ea.
IGD-X66	1966-67	26.99 ea.
IGD-X68	1968 w/o AC	26.99 ea.
IGD-X75	1969-75 w/o AC	26.99 ea.
IGD-X69	1969-75 w/ AC	26.99 ea.



IGB-023

Glove Box Door Arm Bumper

Installs on the glove box door arm to prevent rattling.

IGB-023	1962-65	6.99 ea.
---------	---------------	----------



LGC-6881

Glove Box Lock Casing

This is the assembly that holds your lock cylinder in place and is commonly broken or damaged.

LGC-6881	1968-79	11.99 kit
----------	---------------	-----------



ILS-69

Glove Box Lock Striker

Mounts to the dash in the glove box opening to secure the door when it is closed.

ITW-1310	1962-65 All.....	9.99 ea.
ITW-1312	1966-67 All.....	9.99 ea.
ILS-69	1969-79 All.....	9.99 ea.



ILA-656



IQ-421



IK-298



ICG-71

Cigarette Lighter Assemblies

Brand new cigarette lighter assemblies with heating elements.

ILA-656	1965-66 All.....	25.99 ea.
IK-298	1967 All.....	24.99 ea.
ICG-68	1968 All.....	23.95 ea.
IQ-421	1969 All.....	30.99 ea.
ICG-71	1970-78 All.....	23.95 ea.



ICH-64K

Cigarette Lighter Housings

Correct 2 piece dash housings for lighter assemblies.

ICH-64K	1967-69 All.....	30.00 ea.
ICH-72K	1970-79 All.....	26.95 ea.



IAT-143A



IC-486

Dash Ash Tray

OE style reproduction insert which fits in the center dash ash tray on your 1969-79 Nova.

IAT-143A	1969-79 Door & Receiver Black.....	74.99 ea.
IC-486	1969-79 Insert Only.....	25.99 ea.



Glove Box Lamp

Socket, bulb and wire.

18000

18000	1962-74 All.....	20.99 kit
-------	------------------	-----------



ICB-9

Courtesy Lamp Bracket

Correct under dash bracket for lamp.

ICB-9	1962-72 All.....	10.99 ea.
-------	------------------	-----------

2 required per car



TRIM-IGN



TRIM-IGNX66



TRIM-HL



TRIM-GB



TRIM-HLX66

Interior Dash Tools

Handy tools for easily removing and installing dash nuts.

TRIM-IGN	1962-65, 1968 Ignition Nut 3 Pin..	11.95 ea.
TRIM-IGNX66	1966-67 Ignition Nut 4 Pin.....	14.99 ea.
TRIM-HLX66	1964-68 Headlamp Nut.....	12.95 ea.
TRIM-HL	1964-72 Headlamp Nut.....	12.95 ea.
TRIM-GB	1969-77 Glove Box Nut.....	13.99 ea.



IK-536

Deluxe Steering Wheels

OE style reproduction deluxe steering wheel featuring correct "spider style" chrome insert.

IK-436	1967 Chrome Finish.....	309.99 ea.
IK-536	1968 Brushed Finish.....	299.99 ea.
IHC-KIT	Mounting Kit.....	29.99 ea.



IK-574

1967 Deluxe SS Wheel

Excellent reproduction injection molded steering wheel equipped on Nova SS models.

IK-574	Deluxe Wheel.....	329.99 ea.
--------	-------------------	------------



IHC-67SS

1967 SS Wheel Cap

OE style reproduction of the original SS horn cap found on 1967 Nova Super Sports.

IHC-67SS	1967 SS.....	77.99 ea.
----------	--------------	-----------



IHB-67SS



IK-67SS

IBC-67SS

1967 Deluxe SS Horn Buttons & Mounting

OE style reproduction horn buttons, contacts and mounting components for Deluxe SS wheels.

IHB-67SS	1967 Buttons.....	35.99 pr.
IBC-67SS	1967 Contacts.....	29.99 pr.
IK-67SS	1967 Mounting.....	36.99 kit



GT14-4331-2K



GT36-5459-1K



Optional Yenko or SS Cap

IWN-SSKIT

IWN-KIT

Wood Steering Wheel Kits

Add one of these beautiful wood grain steering wheels to your car with one of our kits. Each kit includes steering wheel, hub, contacts, horn cap, cam and hardware.

BUY'N SAVE WITH KITS

IWN-KIT	1967-68 Walnut w/o Tilt.....	388.83 kit	IRW-9T	1969 Rosewood w/ Tilt.....	383.36 kit
IWN-7T	1967-68 Walnut w/ Tilt.....	374.33 kit	IRW-SSKIT	1969 Rosewood w/o Tilt w/ SS Cap.....	413.87 kit
IWN-KIT-YENKO	1968 Walnut w/o Tilt Yenko Cap	433.83 kit	IRW-SS9T	1969 Rosewood w/ Tilt w/ SS Cap	418.37 kit
IWN-7T-YENKO	1968 Walnut w/ Tilt Yenko Cap	433.83 kit	IRW-KIT-YENKO	1969 Rosewood w/o Tilt Yenko Cap	423.86 kit
IWN-SSKIT	1967-68 Walnut w/o Tilt w/ SS Cap... ..	423.83 kit	IRW-9T-YENKO	1969 Rosewood w/ Tilt Yenko Cap	428.36 kit
IWN-SS7T	1967-68 Walnut w/ Tilt w/ SS Cap	423.83 kit			
IRW-KIT	1969 Rosewood w/o Tilt	378.86 kit			

*Correct for 1967-69 but can be used on all 1967-79.
No Volume Discount.*



IXS-69T-H



IXS-SS6970-S

Comfortgrip Steering Wheel Kits

Add some muscle to your interior with our Comfortgrip steering wheel kits.

Each kit includes steering wheel, hub, contacts, horn cap, cam and hardware. These wheels can be used on all models up to 1979.

IXS-678-S	1967-68 Black w/ Silver Spokes w/ Slots.....	247.25 kit
IXS-678-H	1967-68 Black w/ Silver Spokes w/ Holes.....	251.53 kit
IXS-6970-S	1969-70 Black w/ Silver Spokes w/ Slots w/o Tilt.....	251.53 kit
IXS-6970-H	1969-70 Black w/ Silver Spokes w/ Holes w/o Tilt.....	255.82 kit
IXS-69T-S	1969-70 Black w/ Silver Spokes w/ Slots w/ Tilt.....	255.78 kit
IXS-69T-H	1969-70 Black w/ Silver Spokes w/ Holes w/ Tilt.....	260.07 kit
IXS-678	1967-68 Black w/ Silver Spokes.....	243.00 kit
IXS-678-BLK	1967-68 Black w/ Black Spokes.....	251.53 kit
IXS-6970-BLK	1969-70 Black w/ Black Spokes w/o Tilt.....	255.82 kit
IXS-69T-BLK	1969-70 Black w/ Black Spokes w/ Tilt.....	260.07 kit
IXS-6970	1969-72 Black w/o Tilt.....	247.28 kit
IXS-69T	1969-72 Black w/ Tilt.....	251.53 kit
IXS-SS678-S	1967-68 Black w/ Silver Spokes w/ Slots & SS Cap.....	284.75 kit
IXS-SS678-H	1967-68 Black w/ Silver Spokes w/ Holes & SS Cap.....	289.03 kit
IXS-SS6970-S	1969-70 Black w/ Silver Spokes w/ Slots w/o Tilt & SS Cap.....	289.03 kit
IXS-SS6970-H	1969-70 Black w/ Silver Spokes w/ Holes w/o Tilt & SS Cap.....	293.32 kit
IXS-SS69T-S	1969-70 Black w/ Silver Spokes w/ Slots w/ Tilt & SS Cap.....	293.28 kit
IXS-SS69T-H	1969-70 Black w/ Silver Spokes w/ Holes w/ Tilt & SS Cap.....	297.57 kit
IXS-SS6970	1969-70 Black w/o Tilt w/ SS Cap.....	284.78 kit
IXS-SS69T	1969-70 Black w/ Tilt w/ SS Cap.....	289.03 kit
IXS-SS678-BLK	1967-68 Black w/ Silver Spokes w/ SS Cap.....	289.03 kit
IXS-SS6970-BLK	1969-70 Black w/ Black Spokes w/o Tilt w/ SS Cap.....	293.32 kit
IXS-SS69T-BLK	1969-70 Black w/ Black Spokes w/ Tilt w/ SS Cap.....	297.57 kit
IXS-69T-YENKO	1969-70 Black w/ Tilt Yenko Cap.....	299.03 kit
IXS-6970-YENKO	1969-70 Black w/o Tilt Yenko Cap.....	294.78 kit
IXS-6970-BLUE	1969-70 Bright Blue w/o Tilt.....	264.28 kit
IXS-69T-BLUE	1969-70 Bright Blue w/ Tilt.....	268.53 kit
IXS-6970-RED	1969-70 Red w/o Tilt.....	264.28 kit
IXS-69T-RED	1969-70 Red w/ Tilt.....	268.53 kit
IXS-SS6970-BLUE	1969-70 B. Blue w/o Tilt w/ SS Cap.....	301.78 kit
IXS-SS69T-BLUE	1969-70 B. Blue w/ Tilt w/ SS Cap.....	319.33 kit
IXS-SS6970-RED	1969-70 Red w/o Tilt w/ SS Cap.....	301.78 kit
IXS-SS69T-RED	1969-70 Red w/ Tilt w/ SS Cap.....	319.33 kit

Correct for 1969-70 but can be used on all 1967-79. No Volume Discount.

BUY'N SAVE WITH KITS

GT Performance Steering Wheel Kits

Our exclusive GT Performance steering wheel kits take away all guess work! Upgrade your worn out, original steering wheel with this exclusive GT Performance steering wheel kits! They include everything you'll need to make the swap: steering wheel, hub and horn button.

GT14-4331-1K	1967-68 GT3 Classic Foam Wheel.....	196.99 kit
GT14-4331-2K	1969-79 GT3 Classic Foam Wheel.....	196.99 kit
GT14-5437-1K	1967-68 GT3 Classic Wood Wheel.....	306.99 kit
GT14-5437-2K	1969-79 GT3 Classic Wood Wheel.....	306.99 kit
GT36-5431-1K	1967-68 GT3 Retro Foam Wheel Chrome.....	202.99 kit
GT36-5431-2K	1969-79 GT3 Retro Foam Wheel Chrome.....	202.99 kit
GT36-5451-1K	1967-68 GT3 Retro Foam Wheel Stainless.....	302.99 kit
GT36-5451-2K	1969-79 GT3 Retro Foam Wheel Stainless.....	302.99 kit
GT36-5457-1K	1967-68 GT3 Retro Light Wood Wheel.....	390.99 kit
GT36-5457-2K	1969-79 GT3 Retro Light Wood Wheel.....	390.99 kit
GT36-5459-1K	1967-68 GT3 Retro Dark Wood Wheel.....	390.99 kit
GT36-5459-2K	1969-79 GT3 Retro Dark Wood Wheel.....	390.99 kit

No Volume Discount. Not eligible for free shipping.



IK-622



IK-623



IM-370



IM-370-BLKSPK

Sport Steering Wheels

OE style reproduction sport steering wheels to replace your original or upgrade from standard.

IK-622	1967-68 Walnut.....	289.99 ea.
IK-623	1969 Rosewood.....	289.99 ea.
IM-370	1969-70 Black.....	159.95 ea.
IM-370-BLUE	1969-79 Bright Blue.....	179.95 ea.
IM-370-RED	1969-79 Red.....	179.95 ea.
IM-370-SADDLE	1969-79 Saddle Tan.....	179.95 ea.
IM-370-BLKSPK	1969-70 Black w/ Black Spokes...	169.99 ea.
IM-379	1969-70 Black w/ Silver Spokes w/ Slots.....	164.95 ea.
IM-377	1969-70 Black w/ Silver Spokes w/ Holes.....	169.99 ea.

All will fit 1968-74.



IK-062



IJ-3520

Steering Wheel Hubs

Correct cast steering wheel mounting hub for all cars with sport wheels.

IK-062	1967-68 All.....	42.95 ea.
IJ-3520	1969-70 All.....	44.99 ea.



IJ-44

Standard Steering Wheel

GM licensed reproduction standard wheels.

IJ-44	1969-70 All.....	249.99 ea.
-------	------------------	------------



NK-126



NJ-127



NK-213



IC-588



NK-292

Standard Shroud

Excellent high quality reproduction.

NK-126	1969-70 Shroud Black.....	64.99 ea.
NJ-127	1969-70 Shroud Wood.....	69.99 ea.
NK-213	1969-70 Horn Buttons.....	19.99 pr.
NK-292	1969-70 Horn Contacts.....	19.99 pr.
IC-588	1969-70 SS Emblem.....	19.99 ea.
IC-589	1969-70 Bowtie.....	11.95 ea.



NR-492

BUY 'N SAVE
WITH KITS

Standard Wheel Kits

Everything you need to replace your original wheel! High quality reproduction steering wheel, center shroud, horn buttons & contacts.

NR-492	1969-70 Black.....	289.99 kit
NR-493	1969-70 Wood.....	323.96 kit
NR-70	1970 Black OE Grain.....	289.99 ea.

*No Volume Discount



IK-712SS

Nova Super Sport Steering Wheel Black

OE style reproduction of this hard to find wheel.

IK-712SS	1971-72 SS Wheel.....	324.99 ea.
----------	-----------------------	------------



IK-7Z

1969+ 4 Spoke Steering Wheel-Simulated Rope Wrap

IK-7Z	1969+ 4 Spoke Wheel.....	239.99 ea.
-------	--------------------------	------------

ICC-9



ICC-93



Turn Signal Cancel Cam

Correct cam which turns off signal light.

ICC-7	1968 All.....	17.99 ea.
ICC-9	1969-74 w/o Tilt.....	17.99 ea.
ICC-93	1969-74 w/ Tilt.....	17.99 ea.



IHC-SS

SS Horn Button

Awesome brushed aluminum cap with SS logo for all sport wheels.

IHC-SS w/ Sport 99.99 ea.
Will fit 1968-74 with 68-70 style Sport Wheel.



IHC-YENKO

Yenko Horn Button

Custom brushed aluminum cap with Yenko Logo. For all sport wheels.

IHC-YENKO w/ Sport 99.99 ea.
Will fit 1968-74 with 68-70 style Sport Wheel.



ICE-3021

1963-64 SS Horn Button Emblem Insert

OE style reproduction featuring correct colors.

ICE-3021 1963-64 SS 34.99 ea.



IC-3380

1968-70 Sport Horn Cap

Excellent reproduction of the original horn cap used on sport wheels and woodgrain wheels.

IC-3380 All Sport 49.99 ea.
Will fit 1968-74 with 68-70 style Sport Wheel.



IK-8



IHC-KIT

Horn Contact Kits

Complete kit for repairing horn contacts.

IHC-646	1962-66 Standard Wheel	24.99 kit
IHC-KIT	1967-68 Deluxe	29.99 ea.
IK-579	1969-70 Sport w/o Tilt	35.99 ea.
IK-7	1968 Sport Wheel All	32.99 ea.
IK-8	1969-70 Sport w/ Tilt	40.99 ea.
ICS-3	1968-70 Sport Spring/Pin	7.99 ea.
ICS-48	1966-70 Cap Mount Sport Wheel	19.99 ea.

1969-70 fits with 1969-74 with 1969-70 style Sport Wheel.



IWE-6775



IWE-4475

1968 N30 Emblems

OE style reproduction emblems for the 1968 optional N30 deluxe steering wheel.

IWE-6775	1968 SS	21.99 ea.
IWE-4475	1968 SS396	34.99 ea.



IHC-71

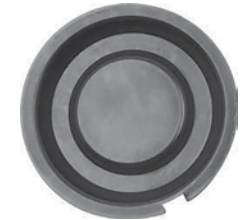

ICR-71



ICE-742



ICE-886

1971-79 NK4 Horn Caps

OE style reproduction caps and accessories for your optional NK4 sport wheel.

IHC-71	1971-79 Horn Cap	18.99 ea.
ICR-71	1971-79 Cap Retainer	9.99 ea.
ICE-742	1971-79 Bowtie Emblem	31.99 ea.
ICE-886	1975-76 Nova SS	32.99 ea.



IFK-3



IFK-1

Hazard Lamp Knob

This is a chrome replacement Nova emergency flasher knob which mounts on the steering column.

IFK-3	1967-74 All	11.95 ea.
IFK-1	1967-70 Long Style	13.99 ea.
IFK-7888	1978-79 4pc Set	22.99 set



Original Tilt Steering Columns
These steering columns are the real deal! Each original GM unit is professionally rebuilt using OEM parts. We even include the turn signal switch! Limited supply!

TILT-67N	1967.....	703.99 ea.
TILT-68N	1968.....	509.95 ea.
TILT-69FA	1969-74 All on Floor.....	744.99 ea.
TILT-69FAOC	1969-74 Automatic on Column.....	676.99 ea.
INT-69FA	1969-74 Non-Tilt Auto.....	598.99 ea.
TILT-75N	1975-79.....	676.99 ea.

No Volume Discount. Ships Oversize.



Steering Column Shim
Steering column shim (wedge). 2 usually required.

RCS-1	1967 All.....	23.99 ea.
-------	---------------	-----------



Steering Column Upper Bearing
Brand new upper steering column bearings. This part commonly fails and is an easy way to make your worn out column like new again.

FBK-TILT	1969-75 w/ Tilt.....	74.99 ea.
FBK-6977-U	1969-77 w/o Tilt.....	49.99 ea.



Tilt Steering Column Lower Bearing Upgrade Kit
You would want to replace this bearing if you are changing the lower steering shaft or replacing the steering coupler that attaches to the gear box, as the lower steering shaft has to be removed to slip the old bearing assembly out and install the new one. You do not need to remove the main steering shaft that this bearing kit goes onto.

FBK-678	1967-68 All w/o Tilt.....	79.99 ea.
FBK-7572	1976-79 All w/ Tilt.....	49.99 kit



Tilt Steering Column Housing Sleeve Floor Shift
Reproduction tilt steering column housing sleeve. This can be used to replace a column shift sleeve to convert your column to floor shift manual or automatic.

ISC-6981	1969-79 w/ Tilt Floor Shift.....	99.99 ea.
----------	----------------------------------	-----------

No Volume Discount.



Steering Column Covers
Correct injection molded lower covers.

ISC-4100	1969-74 All.....	39.99 ea.
----------	------------------	-----------



Steering Column Cap
Correct cap used to hold the end of the column together.

ICC-12005	1969-77.....	22.99 ea.
-----------	--------------	-----------



Steering Column Dress Up Kit
A great way to personalize your interior! Includes turn signal lever, tilt wheel lever and emergency flasher knob.

GCS-S6062	1967-72.....	19.99 kit
-----------	--------------	-----------



Billet Column Shifter Lever
A great upgrade to any column shifted car!

GCS-S6063	1967-72.....	39.99 ea.
-----------	--------------	-----------



Tilt Wheel Levers
OE style reproduction tilt wheel release levers.

IT-2299	1963-66.....	17.99 ea.
IT-4470	1967.....	17.99 ea.
IT-5168	1968-70.....	15.99 ea.
IT-2951	1971-74.....	16.99 ea.



Turn Signal Levers
OE style reproduction turn signal levers.

IT-3208	1963-66 w/o Tilt.....	23.99 ea.
IT-5162	1962-66 w/ Tilt.....	23.99 ea.
IT-5165	1967 All.....	19.99 ea.
IT-5174	1968-70 All.....	17.99 ea.
IT-5176	1971-74 All.....	17.99 ea.



1969-76 Heater Control Assembly
Complete heater control unit pre-assembled and ready to install. Includes face plate with correct lettering and cables.

IHC-69	1969-76 w/o AC.....	309.99 ea.
IHC-69AC	1969-74 w/ AC.....	329.99 ea.



Heater Control Lenses

Correct letters and backgrounds.

ICR-495	1969-74 w/o AC White	19.99 ea.
ICR-496	1969-74 w/ AC White	19.99 ea.
ICR-498	1969-74 w/ AC Black	19.99 ea.
ICR-497	1969-74 w/o AC Black	19.99 ea.
IC-410	1969-79 Lens Clips 3pc.....	8.99 kit



Heater Control Knob

Chrome heater control knobs.

IJ-660	1969-79 All	4.99 ea.
IJ-426	1969-79 All 4 pc	12.99 kit



Heater Control Cables

Set of three correct heater control cables with inner poly line for smooth operation.

IHC-497CC	1969-74 w/o AC	46.99 set
IHC-497ACC	1969-74 w/ AC	46.99 set



Heater Cable Retainer Set

Correct inner cable retaining clips.

BCR-12658	1967-69 6 pc.....	3.99 kit
-----------	-------------------	----------



1969 Heater Lever Repair Kit

Includes 3 levers, 3 sleeves and 3 knobs to repair your original heater control.

I-69FX	1969 All.....	64.99 kit
--------	---------------	-----------



Dash Defroster Vent

Each defroster vent assembly is manufactured to OE specifications.

IK-11DF	1968 All.....	144.99 ea.
IVA-69	1969-79 All	149.99 ea.



1966-67 Heater Control Lever Set

Complete set of levers and hardware.

I-667X	1966-67 w/o A/C	64.99 kit
--------	-----------------------	-----------



IVC-6190



Vent Cable Assembly

OE style reproduction of the original vent cable assemblies including knob, bracket, cable and casing like the original.

IVC-6185	1962-64 Assembly	37.99 ea.
IVC-6190	1965-66 Assembly	37.99 ea.
IVC-6192	1967-72 Assembly	37.99 ea.
ICC-546	1968-79 Clip Only.....	3.99 ea.
IVK-5190B	1965-66 Black Knob Only	11.99 pr.
IVK-5198B	1967-72 Black Knob Only	11.99 pr.

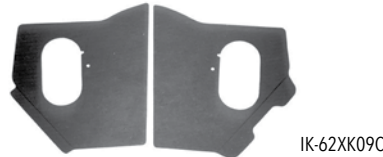

1962-64 Kick Panels

Colored panelboard pieces that surround the front air grilles on both sides just in front of the doors.

1962-64 Coupe

IK-62XK09C	Black.....	18.99 pr.
IK-62XK16C	Fawn.....	18.99 pr.
IK-62XK38C	Dark Blue.....	18.99 pr.
IK-62XK67C	Red.....	18.99 pr.
IK-62XK69C	Light Blue.....	18.99 pr.
IK-62XK74C	Aqua.....	18.99 pr.
IK-62XK77C	Light Green.....	18.99 pr.
IK-62XK78C	Dark Green	18.99 pr.
IK-62XK80C	Saddle.....	18.99 pr.

1962-63 Convertible

IK-62XK09V	Black.....	18.99 pr.
IK-62XK16V	Fawn.....	18.99 pr.
IK-62XK38V	Dark Blue.....	18.99 pr.
IK-62XK67V	Red.....	18.99 pr.
IK-62XK69V	Light Blue	18.99 pr.
IK-62XK74V	Aqua.....	18.99 pr.
IK-62XK77V	Light Green.....	18.99 pr.
IK-62XK78V	Dark Green	18.99 pr.
IK-62XK80V	Saddle.....	18.99 pr.



1965-79 Kick Panels

Each kick panel is manufactured to exact factory specifications in ABS plastic and features the correct vent flap, outlet and vent pull cable with knob. Designed to replace the original exactly, each kick panel features correct material grain and fully functional vent flap.

IK-6567L	1965-67 LH	112.99 ea.
IK-6567R	1965-67 RH.....	112.99 ea.
IK-69XL	1969-79 LH	115.99 ea.
IK-69XR	1969-79 RH.....	115.99 ea.
IK-70XACL	1970-79 w/ AC LH	119.99 ea.
IK-70XACR	1970-79 w/ AC RH.....	119.99 ea.



Kick Panels with Speakers

Enhance your sound quality with these custom molded ABS panels fitted with 6.5", 80 watt speakers or 6.5", 120 watt speakers. They fit directly in place of your stock kicks with no modification necessary.

With 80 Watt Speakers

KNOV-62-3	1962-63 Convnt.....	139.99 pr.
KNOV-62-5	1962-65 Coupe.....	145.99 pr.
KNOV-66-7	1966-67 All	145.99 pr.
KNOV-68-2	1968-72 All	145.99 pr.



Brake Light Switches

OE style brake light switches located above the brake pedal.

GBL-852	1962-79 All w/o Cruise Control ..	7.95 ea.
GBL-852-CC	1962-79 All w/ Cruise Control ..	24.99 ea.
GSR-12999	Retainer.....	7.99 ea.



Brake Pedal Assembly

OE style reproduction brake pedal assembly for automatic transmission.

FCI-99A	1968-72	45.99 ea.
FCI-69	1968-74 Pedal Support.....	100.99 ea.



Accelerator Pads

OE style reproduction pads with correct ribbing.

ICE-0328	1962-67 Pad	15.99 ea.
ICE-0296	1968-79 Pad	6.95 ea.

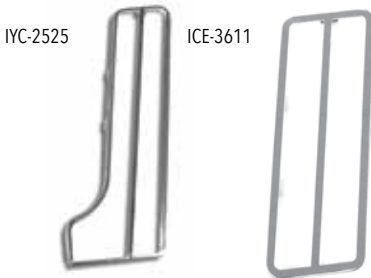

Accelerator Pad Trim

This stainless trim adds a beautiful finishing touch to your interior.

IYC-2525	1962-67 All Trim	14.95 ea.
ICE-3611	1968-79 All Trim	7.99 ea.



Accelerator Hardware

Correct hardware for pad and cable.

IST-3	1962-67 Pedal Stud	3.99 ea.
ICE-8078	1968-79 Pedal Spring/Pin	9.95 ea.
AZC-88	Cable Clip	6.95 ea.
AY-12	1968-74 Pedal Rod Support Plastic	25.99 ea.



Accelerator Pedal Linkage Kit

New assemblies complete from the pedal to the arm and includes the pedal trim.

APA-68	1968-74	64.99 kit
--------	---------------	-----------



Brake Pads & Trim

OE style reproduction pads with correct ribs and medallions where applicable.

IBP-2063	1962-67 Auto w/ PB	9.99 ea.
IBP-2066	1962-67 Auto w/o PB	9.99 ea.
IBP-4047	1962-67 4 Speed w/ Horizontal Ribs	7.99 ea.
IBP-40471	1962-67 All Power Brake w/ Manual Shift	7.99 ea.
IBP-2065	1962-67 4 Speed w/ Vertical Ribs	5.99 ea.
IHQ-236	1968-79 Auto Drum 6.5"	5.99 ea.
IHQ-0163	1968-79 Auto Disc 6.5"	12.99 ea.
IBB-8683	1968-79 Auto Trim	7.99 ea.
IHQ-0191	1968-79 4 Speed Drum	5.99 ea.
IHQ-0120	1968-79 4 Speed Disc	12.99 ea.
IHQ-0192	1968-79 4 Speed Trim	6.99 ea.



Clutch Pads & Trim

This stainless trim adds a beautiful finishing touch to your interior. Exact reproduction pads with correct ribbing.

IBP-4047	1962-67 Pad w/ Horizontal Ribs	7.99 ea.
IBP-2065	1962-67 Pad w/ Vertical Ribs	5.99 ea.
IHQ-0191	1968-79 Pad	5.99 ea.
IHQ-0192	1968-79 Trim	6.99 ea.



Brake Pedal Pivot Pin

Accurate reproduction automatic brake pedal pin. Quality heat treated material. 5/8 inch diameter.

IBP-628	1962-76	17.99 ea.
---------	---------------	-----------



E Brake Knobs

OE style reproduction pull knobs.

IEB-3005	1962-67 Knob Only	23.95 ea.
IEB-110	1968-79 Knob Only	5.95 ea.
IEB-110-CH	1968-79 Knob Only Chrome	6.99 ea.



E Brake Pedal

OE style reproduction emergency brake pedal and stainless trim.

IHQ-0229	1968 Pad	4.99 ea.
IHQ-0203	1969-77 Pad	4.99 ea.
IHQ-0108	1968 Trim	5.99 ea.
IHQ-0122	1969-77 Trim	5.99 ea.



Muscle Car Pedal Assembly

This awesome Nova pedal assembly by Clayton Machine Works is machined from forged aluminum and comes complete with pedal arms, pedals with dimpled rubber pads and all necessary hardware for installation. This means that you'll have that one-off custom look without the one-off price all in a complete easy to install bolt-in package.
DBW = Drive by Wire

IPA-68XA	1968-74 Auto	770.99 kit
IPA-68XAD	1968-74 Auto DBW	700.99 kit
IPA-68XM	1968-74 Manual	1021.99 kit
IPA-68XMD	1968-74 Manual DBW	928.99 kit

No Volume Discount



Billet Throttle Assembly

This billet throttle assembly by Clayton Machine Works is a killer interior upgrade for your muscle car! This set includes a complete billet throttle assembly with a custom pedal pad featuring unique rubber inserts. Also included are matching pedal covers for your brake pedal (automatic) or brake and clutch pedals (manual). These pads require no drilling and simply clamp over your existing pedals.

Black Anodized

TA-206-BKM1	1968-74 Manual	514.99 kit
TA-206-BKA1	1968-74 Automatic	435.99 kit



Muscle Car E-Brake Cover

This Muscle Car e-brake cover is meant to match your new Chevrolet Muscle Car series forged aluminum pedal assembly by Clayton Machine Works. Installation hardware is included.

IPA-EB	1962-74	75.99 ea.
--------	---------------	-----------



1968-79 OEM Style Rubber Floor Mats

Correct factory style rubber floor mats with ribbing and GM logo.

IBT-GM-BLK	1968-79 Black	99.99 set
IBT-GM-CAR	1968-79 Carmine	109.99 set
IBT-GM-TAN	1968-79 Tan	109.99 set
IBT-GM-GRY	1968-79 Gray	109.99 set
IBT-GM-BLU	1968-79 Dark Blue	109.99 set
IBT-GM-RED	1968-79 Red	109.99 set
IBT-GM-LTBLU	1968-79 Light Blue	109.99 set

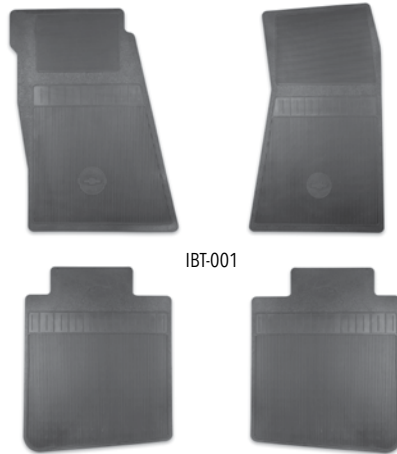

Vinyl Floor Mats

GM Restoration vinyl floor mats complete with raised "bowtie" and correct grain. Black only.

IBT-001	1968-74 4pc	189.99 set
---------	-------------------	------------



Sill Plate Extensions

Installed on the rear ends of the door sill plates below the rear inner side panel. Manufactured to original specifications featuring pre-punched mounting holes and the correct stainless finish.

ICM-1622-XTN	1968-72	39.99 pr.
--------------	---------------	-----------

Carpeted Floor Mats

This is a set of four Nova custom carpeted floor mats featuring correct 80/20 looped carpet and modern style ribbed backing. These universal floor mats fit all years of Nova and the ribbed backing ensures that these mats will not slide around under your feet.



USE YOUR PHONES CAMERA OR ANY QR APP & SCAN NOW TO SHOP FOR THE MATS YOU NEED!



Carpet Sill Plates

Authentic "Body by Fisher" sill plates available as beautiful reproductions or original GM.

ICM-3001	1962-63 Convertible	151.99 pr.
ICM-62RL	1962-67 Coupe w/ Rivets & Logo LH	49.99 ea.
ICM-62RR	1962-67 Coupe w/ Rivets & Logo RH	49.99 ea.
ICM-62X	1962-67 Coupe w/ Rivets & Logo Set*	89.98 pr.
ICM-68RL	1968-79 w/ Rivets LH	46.99 ea.
ICM-68RR	1968-79 w/ Rivets RH	46.99 ea.
ICM-68RK	1968-79 w/ Rivets Set*	84.58 pr.
ISP-KIT	8 pc Screw Kit (2 kits required)	3.95 kit

* No Volume Discount.

Looking to replace your Nova carpet with something that meets your quality and originality standards? Look no further than our ACC brand OEM carpet sets. We are proud to offer these carpets in several styles, from factory original 80/20 rayon and nylon looped blend (cutpile for 1974-77 models) to our new ESSEX Style for those who are looking for a "modern" auto style carpet seen in high end Mercedes or Porsche cars, to our "Mass Backing" carpet sets which offer factory installed sound deadening material built-in for an overall quieter, cooler and more comfortable interior.

ALL of our ACC brand carpets are factory molded with correct heel pad & dimmer switch grommet for a model specific fit.

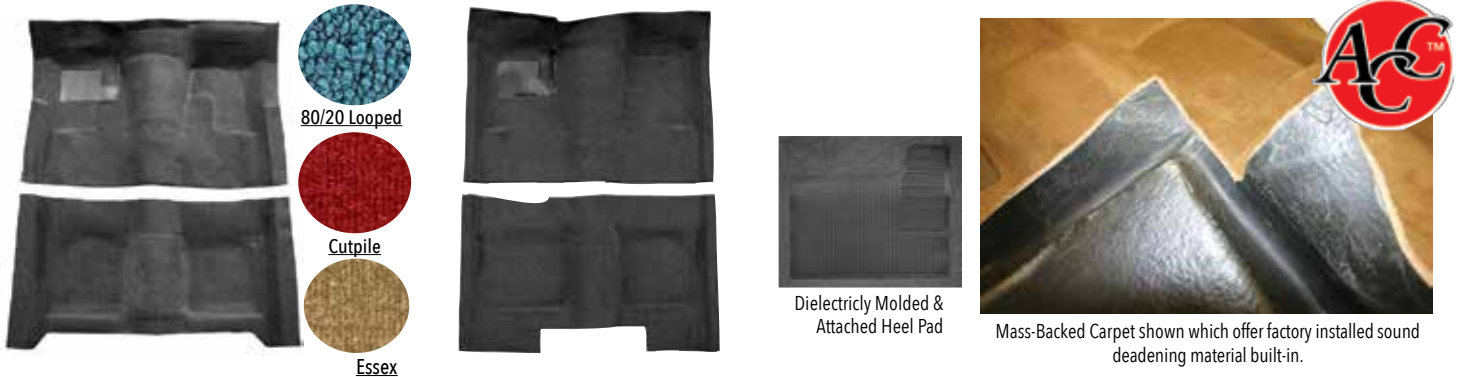

80/20 Looped Carpet Colors



Cutpile Carpet Colors



USE YOUR PHONES CAMERA OR ANY QR APP & SCAN NOW TO SHOP FOR THE CARPET YOU NEED!

Use the all new ACC Carpet Configurator on SS396.com



Molded Carpet Kits

Looking to replace your worn original carpet with something that meets your quality and originality standards? Look no further than our ACC brand OEM carpet sets. These are not those cheap carpets that fade out in a year or two! Unlike other brands, all ACC carpets feature a true 80/20 rayon and nylon "looped" blend for 1962-74 Novas and Cutpile for 1975-79 Novas. All are molded for a perfect fit. We include original style die stamped sound deadener constructed of heavy insulation as factory. Carpets and sound deadener kits are also available individually.

Complete Kits

IXC-62X	1962-67 Carpet & Sound Deadener Kit.....	224.98 kit
IXC-68X	1968-74 Carpet & Sound Deadener Kit.....	224.98 kit
IXC-75X	1975-79 Carpet & Sound Deadener Kit.....	225.88 kit

Carpets Only

ICC-X62	1962-67 Carpet Only.....	179.99 ea.
ICC-X62MB	1962-67 Carpet Only w/ Mass Backing	329.99 ea.
ICC-X68	1968-74 Carpet Only.....	179.99 ea.
ICC-X68MB	1968-74 Carpet Only w/ Mass Backing	319.99 ea.
ICC-X75	1975-79 Carpet Only.....	180.99 ea.
ICC-X75MB	1975-79 Carpet Only w/ Mass Backing	334.99 ea.

Sound Deadener Only

JN-112	1962-67 Sound Deadener Only.....	69.99 ea.
JN-113	1968-74 Sound Deadener Only.....	69.99 ea.
JN-114	1975-79 Sound Deadener Only.....	69.99 ea.

Please state color at time of order. No Volume Discount. All carpets & sound deadeners ship Oversize.

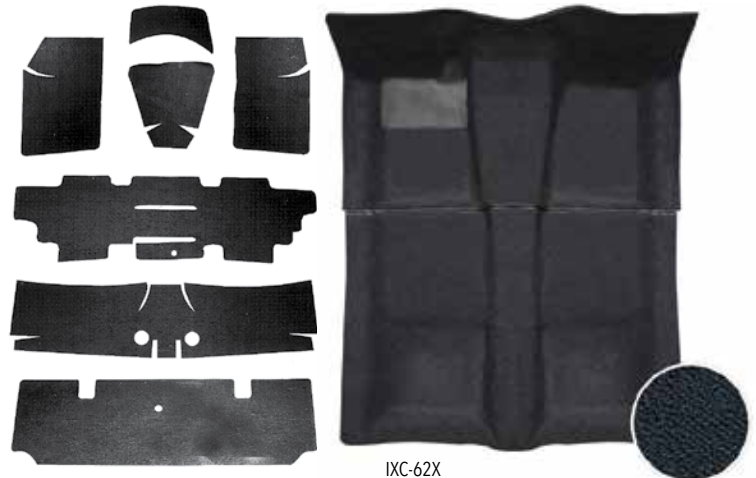

Note: Due to variations in printing, it is impossible to perfectly represent carpet colors in this catalog. Use our color swatch chart as a guide only. We will gladly mail you a color sample before you place your order upon request. Please note that colors other than black are non-returnable.

QuietRide AcoustiShield

The AcoustiShield kit is a multi-stage automotive sound dampening system to give your muscle car the quiet riding comfort found in today's new cars. AcoustiSHIELD kits are designed on state of the art auto acoustic technology to insulate and control the noise, vibration and heat in the passenger cabin. Kits are pre-cut and come with easy to follow installation instructions: The first stage consists of pre-trimmed, self-adhesive sound damper pads which are bonded to strategically located trouble spots to control body panel vibration and noise. These spots are mapped and labeled in the detailed instructions. Complete Kits include Body, Cowl, Floor, Roof (except convertible) and Trunk Floor Kits.

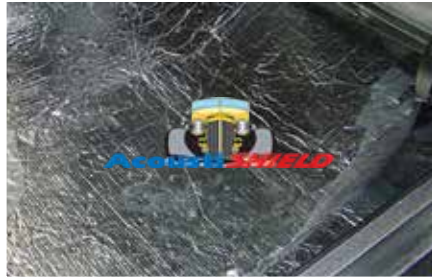

1962-63 Nova Convertible

NOVA-6267-CVAK	Complete Kit	690.99 kit
NOVA-6267-CVBPK	Body Kit	149.99 kit
NOVA-6267-CVCK	Cowl/Dash Kit	103.99 kit
NOVA-6267-CVFK	Floor Kit	263.99 kit
NOVA-6267-CVTK	Trunk Floor Kit	147.99 kit

1962-67 2 Door Coupe/Sedan

NOVA-6267-CAK	Complete Kit	833.99 kit
NOVA-6267-CBPK2	Body Kit	147.99 kit
NOVA-6267-CCK	Cowl/Dash Kit	103.99 kit
NOVA-6267-CFK	Floor Kit	263.99 kit
NOVA-6267-CRK	Roof Kit	147.99 kit
NOVA-6267-CTK	Trunk Floor Kit	147.99 kit

1962-67 4 Door Sedan

NOVA-6267-CAK	Complete Kit	862.99 kit
NOVA-6267-SBPK4	Body Kit	117.99 kit
NOVA-6267-SCK	Cowl/Dash Kit	103.99 kit
NOVA-6267-SFK	Floor Kit	263.99 kit
NOVA-6267-SRK	Roof Kit	147.99 kit
NOVA-6267-STK	Trunk Floor Kit	147.99 kit

1962-67 4 Door Wagon

NOVA-6267-SWAK	Complete Kit	904.99 kit
NOVA-6267-SWBPK	Body Kit	147.99 kit
NOVA-6267-SWCK	Cowl/Dash Kit	103.99 kit
NOVA-6267-SWFK	Floor Kit	263.99 kit
NOVA-6267-SWRFK	Rear Floor Kit	132.99 kit
NOVA-6267-SWRK	Roof Kit	175.99 kit

1968-72 2 Door Coupe/Sedan

NOVA-6872-CAK	Complete Kit	832.99 kit
NOVA-6872-CBPK2	Body Kit	147.99 kit
NOVA-6872-CCK	Cowl/Dash Kit	103.99 kit
NOVA-6872-CFK	Floor Kit	263.99 kit
NOVA-6872-CRK	Roof Kit	147.99 kit
NOVA-6872-CTK	Trunk Floor Kit	138.99 kit

1968-72 4 Door Sedan

NOVA-6872-CAK	Complete Kit	865.99 kit
NOVA-6872-SBPK4	Body Kit	117.99 kit
NOVA-6872-SCK	Cowl/Dash Kit	103.99 kit
NOVA-6872-SFK	Floor Kit	263.99 kit
NOVA-6872-SRK	Roof Kit	147.99 kit
NOVA-6872-STK	Trunk Floor Kit	147.99 kit

1973-77 2 Door Coupe/Sedan

NOVA-7377-CAK	Complete Kit	790.99 kit
NOVA-7377-CBPK2	Body Kit	119.99 kit
NOVA-7377-CCK	Cowl/Dash Kit	103.99 kit
NOVA-7377-CFK	Floor Kit	214.99 kit
NOVA-7377-CRK	Roof Kit	147.99 kit
NOVA-7377-CTK	Trunk Floor Kit	119.99 kit

1973-77 4 Door Sedan

NOVA-7377-CAK	Complete Kit	484.99 kit
NOVA-7377-SBPK4	Body Kit	119.99 kit
NOVA-7377-SCK	Cowl/Dash Kit	103.99 kit
NOVA-7377-SFK	Floor Kit	236.99 kit
NOVA-7377-SRK	Roof Kit	150.99 kit
NOVA-7377-STK	Trunk Floor Kit	150.99 kit



NOVA-6872-AC

Firewall Insulators

A Firewall Insulator panel by QuietRide Solutions is your first line of defense to stop engine noise and heat from entering the passenger cabin. This firewall panel is an exact OEM replacement and is year, make and model specific. It is molded to fit the engine setback and firewall contours and fits like a glove.

NOVA-6267-C	1962-67 All	299.99 kit
NOVA-6872-HC	1968-72 Heat Only	207.99 kit
NOVA-6872-AC	1968-72 AC	218.99 kit



IRE-1281

Firewall Insulation Pad

Correct die-stamped original material complete with clips.

IRE-X62	1962-67 All	74.99 ea.
IRE-1281	1968-74 w/o AC	59.99 ea.
IRE-1281A	1968-74 w/ AC	59.99 ea.
IRE-PLUG	Plug Only	3.99 ea.



IK-252

Carpet Firewall Guard

Correct plastic injection molded piece which installs below steering column.

IK-252	1968-72 All	29.99 ea.
IN-197	1968-72 All Screws	6.99 pr.



IFL-TABX3011



IFL-TABX3009



Flatline Barriers

Flatline Barriers is the new leader in automotive thermal acoustic insulation products. Utilizing cutting edge technology and materials, Flatline is able to offer a solution that significantly reduces unwanted sound and heat. Did we mention that the product is ultra-lightweight as well? Extremely lighter than other insulation products, packing the same punch in sound and heat control properties. The material is also offered in pre-cut kits and universal options. Our designs were created by in house automotive enthusiasts and DIYers. Making our kits easy to install, logical in layout and highly effective. All of this provided to you at an extreme value. Remember the name is Flatline, it's that quiet

1962-67 Nova

IFL-TABX3002	Complete Kit Coupe	289.99 kit
IFL-TABX3003	Complete Kit Convertible	239.99 kit
IFL-TABX3004	Doors/Quarter Panel	132.99 kit
IFL-TABX3001	Roof	55.99 kit
IFL-TABX3005	Floor	182.99 kit
IFL-TABX3007	Trunk	114.99 kit
IXC-62X-FL	Floor Kit w/ Black Carpet	326.68 kit

1968-74 Nova

IFL-TABX3011	Complete Kit Coupe	299.99 kit
IFL-TABX3009	Doors/Quarter Panel	119.99 kit
IFL-TABX3001	Roof	55.99 kit
IFL-TABX3010	Floor	169.99 kit
IXC-68X-FL	Floor Kit w/ Black Carpet	314.98 kit

No Volume Discount.



IK-037

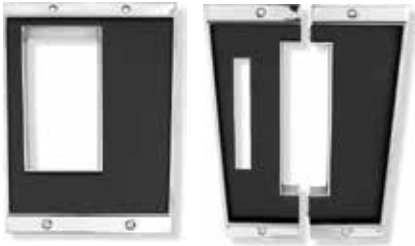

IE-895

IK-037

1968-79 Shift Plates

OE style reproduction shift plates with correct semigloss satin black paint with triple chrome plated outer trim.

IK-037	1968-74 Automatic 2pc.....	62.99 ea.
IE-895	1968-74 Manual 1pc.....	53.99 ea.
IK-759	1975-79 Automatic 1pc.....	74.99 ea.
ISP-490	1968-74 Plate Screws.....	4.99 kit



IQ-108

IQ-109

IQ-127

Shift Indicator Lenses

Injection molded clear shift indicator lenses.

IQ-108	1966-67 All.....	23.99 ea.
IQ-109	1968-74 Powerglide.....	12.99 ea.
IQ-127	1968-74 TH350/TH400.....	8.99 ea.
S121	1968-74 700-R4/200-4R.....	22.99 ea.



IK-210



IK-209

Shift Bulb Mounting & Backing Plates

Correct shift plate bulb retainers.

IK-210	1968-74 Mounting Plate.....	16.99 ea.
IK-208	1968 Backing Plate.....	13.99 ea.
IK-209	1969-74 Backing Plate.....	9.99 ea.



IC-123



IC-45



IW-340

Shifter Sliders

Correct die stamped plastic shifter sliders.

IC-123	1968-74 Manual.....	13.99 ea.
IC-45	1968-74 Automatic.....	7.99 ea.
ICE-3522	1968-72 Boot Seal.....	14.99 ea.
IW-340	1968-74 Slider Retainer.....	7.99 ea.



ITW-1058



ITW-1050

ITW-1100

Shift Boot Retainers

Correct die stamped steel boot retainers.

ITW-1050	1962-67 All Black.....	24.99 ea.
ITW-1050-C	1962-67 All Chrome.....	21.99 ea.
ITW-1058	1968-74 w/o Console.....	49.99 ea.
ITW-1100	1968-74 w/ Console.....	26.99 ea.



ITW-1022



ICE-4526



ITW-1057



ITW-1054

Shifter Boots

Brand new injection molded boots.

ITW-1022	1966-67 4 Speed.....	26.99 ea.
ICE-4526	1968-74 4 Speed Console.....	22.95 ea.
ITW-1057	1968-74 4 Speed w/o Console.....	34.99 ea.
ITW-1054	1968-74 Auto w/ Console.....	26.99 ea.



IC-3553



IC-3561



IC-6874

1966-79 Console Shells

This brand new console shell will replace your cracked or damaged original exactly!

IC-3553	1966-67 4 Speed.....	239.99 ea.
IC-3561	1966-67 Automatic.....	239.99 ea.
IC-6874	1968-72 All.....	160.99 ea.
IC-7374	1973-74 4 Speed.....	139.99 ea.
IC-7579	1975-79 Auto.....	379.99 ea.
ICB-3555	1966-67 Brackets 4 Speed 3pc.....	46.99 kit
ICB-3565	1966-67 Brackets Automatic 3pc.....	36.99 kit
IC-68XB	1968-74 Mounting Bracket.....	19.99 ea.



For 60 years... Hurst has been attached to some of America's most legendary vehicles, such as the Hurst OLDS/442, the Hemi Under Glass Barracuda, and even the only non-OEM official pace car of NASCAR. Over the years, Hurst has been the OEM shifter supplier for the Pontiac GTO, Plymouth Barracuda, Plymouth Super Bird, Ford Mustang Boss 302, Ford Mustang Shelby GT500 KR, Oldsmobile, AMC, and the Dodge SRT-10 pick-up, just to name a few.



Hurst Replacement Shifter Handles

These handles all feature a universal installation kit with SAE 1/2"-20, 7/16"-20, 3/8"-16 and also Metric M10x1.25, M10x1.50, M12x1.25, M12x1.75 and M16x1.50 thread size.

- HURST-1531000 Pistol Grip Silver73.99 ea.
 - HURST-1536010 Pistol Grip Black.....87.99 ea.
 - HURST-1536200 Pistol Grip Silver w/ 12v Switch93.99 ea.
 - HURST-1536210 Pistol Grip Black w/ 12v Switch.....93.99 ea.
 - HURST-1539000 Pistol Grip Silver73.99 ea.
 - HURST-1630050 Round Black* w/ 12v Switch.....99.99 ea.
 - FW-38HURST Hurst White 3/8" 4 Speed.....47.99 ea.
- 7/16" - 20 threads only. No Volume Discount.



ISP-734X



1973-1974 Nova 4 Speed Console Shift Tunnel

This OER reproduction of the one piece standard shift plate originally installed on all 1973-1974 Nova models with a standard transmission and a console. Manufactured in zinc die-cast metal as original. Each item is chrome plated, polished to a brilliant shine and painted with semi-gloss black in the accent areas for authenticity.

- ISP-734X 1973-1974 / 4 Speed.....99.99 ea.



1965-67 Slider Seal

Correct shifter slider seal for console.

- IC-1014 1965-67 Manual.....17.99 ea.

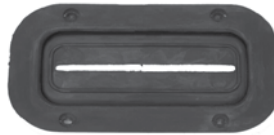

ITW-1020

1963-64 Shifter Seal

OE style reproduction of the original automatic floor shifter rubber seal for console cars.

- ITW-1020 1963-6429.99 ea.



ISK-616



ISN-617

Console Shift Knob

Reproduction gearshift control knob installed on models with console shift automatic transmissions.

- ISK-616 1975-79 Auto Knob.....29.99 ea.
- ISN-617 1975-79 Auto Button15.99 ea.



ISB-67

Console Seat Belt Holder

Each clip is manufactured in quality stamped steel replicating the original in appearance and fitment.

- ISB-67 1967-69 All w/ Console.....21.99 pr.



As for performance enthusiasts today, most people are accustomed to having access to whatever performance parts they need for their vehicle readily available at their local dealer. It usually never crosses anyone's mind who invented these products?

Racers themselves invented these products, B&M's founders identified the needs of local racers and street performance enthusiasts, and developed products to fill those needs. Of course, as the industry grew so did B&M. And as racers went faster, B&M developed products to help them break the records they just set. In the 50s it was them who came up with the idea of using a performance reinforced Hydramatic for racing. Similarly in the 60s, it was B&M who developed shifters to go along with it, and later in the decade came race converters. Again in the 70s, B&M introduced shift and transmission improving kits - always the constantly refining and expanding existing product lines.

If you've ever raced a vehicle, or driven a hot rod with an automatic transmission, high stall torque converter, an aftermarket automatic shifter, or performance enhancing shifting kit.

Thank B&M. From Trick Shift performance ATF to reverse pattern valve bodies, 1.80 gear sets to cool canisters, the list of firsts goes on and on...



- BM-46112
 - BM-80534 Quicksilver Billet Aluminum Silver81.99 ea.
 - BM-46112 Round White w/ 12v Switch*97.99 ea.
- *Works with 12 volt and 16 volt systems and may be used to activate transbrake, launch control, nitrous or two step.
No Volume Discount.



BM-80658

B&M Universal Shift Handle w/ Button

This B&M Universal Button T-handle fits most B&M and aftermarket shifters.

Includes: Thread inserts to fit 1/2"-20, 3/8"-24, 3/8"-16 & 5/16"-18 SAE. A 12v momentary switch to activate Line-Lock, transbrake or nitrous.

- BM-80658 Aluminum Polished69.99 ea.
 - BM-80659 Aluminum Chrome77.99 ea.
- No Volume Discount.



IC-KIT6M



IC-KIT6A

1966-67 Complete Consoles

This is a brand new 4 speed console assembly complete with shell, top plate, shift plate and shift slider assembly. This console has been hard to find until now. All new parts featuring the correct materials, grain and factory mounting points.

- IC-KIT6M 1966-67 4 Speed599.99 ea.
 - IC-KIT6A 1966-67 Automatic599.99 ea.
- Note: These kits are meant to replace your exiting console. If your car did not come with a console additional parts may be needed. Such as: mounting brackets, harness, shifter assembly, etc. No Volume Discount.



SW280-RCT-03



SW280-RCT-06

Shiftworks Console Shifter Kits

These reproduction shifters are offered complete with the neutral safety/back-up light switch, console indicator, slider, shifter cable and all required installation hardware. Multiple linkage styles are available to best suit your chosen transmission.

8" Straight Handle

SW280-NT7	1965-67 TH350,400,700R4,4L60E.....	441.99 kit
SW280-NT7-05	1965-67 4L80E,85E	441.99 kit
SW280-NT7-06	1965-67 6L80E,90E	441.99 kit
SW280-RCT-03	1968-72 TH350-400.....	374.99 kit
SW280-RCT-04	1968-72 TH200-700R4, 4L60	365.99 kit
SW280-RCT-04E	1968-72 4L60-65-70E.....	374.99 kit
SW280-RCT-05	1968-72 4L80E.....	374.99 kit
SW280-RCT-06	1968-72 6L80-90E	365.99 kit



ICB-3555

ICB-68XB

1968-1974 Nova Console Mounting Bracket

Correct Nova console mounting bracket.

ICB-3565	1966-67 Auto	36.99 kit
ICB-3555	1966-67 4 Speed	46.99 kit
IC-68XB	1968-74	19.99 ea.



IK-121

1968-1974 Nova Console Gauge Hardware Kit

Complete hardware kit to assemble console gauges. Kit contains ground wire and 44 pieces of hardware.

IK-121	1968-74	17.99 kit
--------	---------------	-----------



ISB-3570

ISB-3554

1966-67 Shifter Bezels

Excellent reproduction shifter bezel assemblies.

ISB-3570	1966-67 Auto	109.99 ea.
ISB-3554	1966-67 Manual	119.99 ea.



ICD-68F

Heater Duct For Cars With Center Console

Installed on all factory console cars. Attaches to heater box to distribute heat evenly in driver and passenger areas. Made of durable fiberglass, which looks original.

ICD-68F	1968-74 w/ Console.....	109.95 ea.
---------	-------------------------	------------



FLK-1774

Transmission Shifter Linkage Rod And Bracket

This rod helps to put the transmission into the correctly selected gear. Includes the rod and forward bracket.

FLK-1774	1968-72 TH350,400	79.99 ea.
----------	-------------------------	-----------

No volume discount.



IFP-620B

Console Forward Plate

Die stamped matte black featuring attached mounting studs with mounting hardware. No emblem holes.

IFP-620B	1968-74	30.99 ea.
----------	---------------	-----------



510122

1968-74 Console Voltmeter Gauge

These new Voltmeter gauges are engineered as a direct replacement to install in place of the factory Ammeter gauge that was used in the original saw tooth console gauge packages installed in many 1968-1974 Novas. This gauge is a must when using American Autowire Classic Update or any other updated wiring harness, because those kits will not support the use of an Ammeter.

510122	1968-74.....	142.99 ea.
--------	--------------	------------



IX-689K

1968-74 Console Gauge Kit

This unique gauge package contains everything you need to replace or add original type console gauges. This complete assembly includes cover, bezels, base, lenses, fuel gauge, temperature gauge, battery gauge and oil gauge pre-assembled and ready to install.

IX-689K	1968-74 All	386.99 kit
NP-1234Z	1968-74 Oil Line	29.99 ea.

Wiring harness sold separately. No Volume Discount

Classic Consoles

Do you enjoy cruising in your classic muscle car but get frustrated by the lack of drink holders and storage space? These consoles are easy to install with no tools or drilling (easy removal for car shows) and look like they could have been factory.



BC Cruiser Bench Seat Console

- 2 large drink holders • Storage compartment
- Comfortable arm rest

CC-BCCRUISER-(COLOR) All Bench 204.99 ea.

Low-Rider Cruiser Console

- Sits on floor in front of bench seat • 2 large drink holders
- Storage compartment

CC-LRCRUISER-(COLOR) All Bench 225.99 ea.



CC-CAMPC69



CC-NOVAHH6871CP

CC-BCSHORTY



Plug & Chug Drink Holder

- Designed to fit the factory ash tray slot
- Simply slide out ash tray and insert drink holder

CC-CAMPC69-(COLOR) 1969-72 All 82.99 ea.

Humphugger Console for Buckets

- 1 large & 1 can-sized drink holder • Storage compartment
- Comfortable arm rest

CC-NOVAHH6871CP-(COLOR) 1968-71 Buckets 225.99 ea.
CC-CVLHH6487CP-(COLOR) 1972-79 Buckets 225.99 ea.

BC Shorty Bench Seat Console

- Same as BC Cruiser but shorter for 4 speed cars
- Prevents shifter from hitting in 2nd & 4th gear

CC-BCSHORTY-(COLOR) All Bench 190.99 ea.

Classic Console Colors

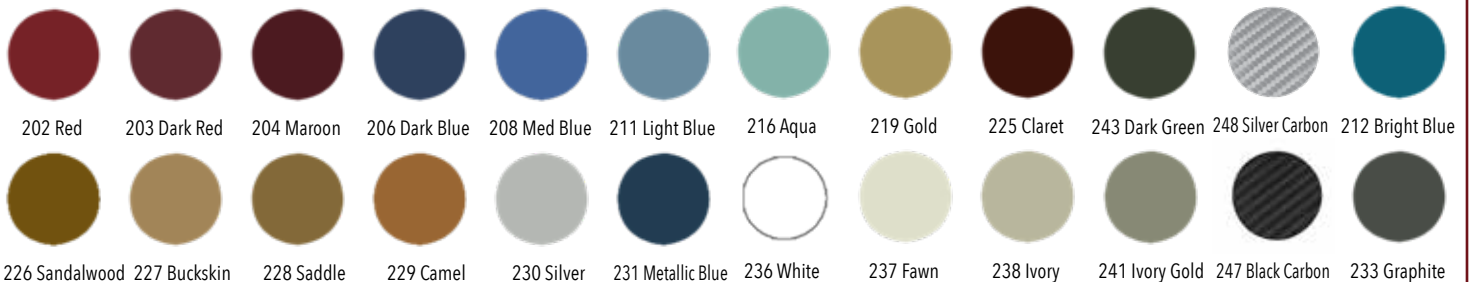



Headliners

We offer the highest quality headliners on the market. Period. They duplicate the original colors and grains exactly and come ready to install with correct cardboard covered side sails (except 1962-65 Nova). Please include color choice in _.

1962-65 Chevy II Nova Coupe/ 2 Door Sedan

Crafted in correct tier basketweave material.
101 = White 102 = Bright Red
103 = Dark Red 104 = Light Blue
107 = Aqua

IHX-62H Coupe Black.....134.99 ea.
IHX-62XH_A Coupe Color.....134.99 ea.
IHX-62S Sedan Black*.....134.99 ea.
IHX-62XH_AS Sedan Color*.....134.99 ea.

*For 1965 Sedan with 5 bows.

1965 Chevy II Nova 2 Door Sedan w/ 6 Bow

Crafted in correct tier basketweave material.
101 = White 102 = Bright Red
103 = Dark Red 104 = Light Blue
107 = Aqua

IHX-65S6 Sedan Black 158.99 ea.
IHX-65S6_ Sedan Color 134.99 ea.

1966-67 Chevy II Nova Coupe/ 2 Door Sedan

Crafted in correct tier basketweave material.
101 = White 103 = Dark Red
104 = Light Blue 106 = Bright Blue
107 = Aqua

IHX-66H Coupe Black.....134.99 ea.
IHX-66XH_A Coupe Color.....134.99 ea.
IHX-66S Sedan Black.....134.99 ea.
IHX-66XH_AS Sedan Color 134.99 ea.

1968-69 Chevy II Nova 2 Door Sedan

Crafted in correct tier basketweave material.
101 = White 103 = Dark Red
104 = Light Blue 105 = Dark Blue
106 = Bright Blue 107 = Aqua

IHX-68 Sedan Black..... 134.99 ea.
IHX-68XH_A Sedan Color..... 134.99 ea.

1970-72 Chevy II Nova 2 Door Sedan

Crafted in correct perforated material.
101 = White 103 = Dark Red
105 = Dark Blue 106 = Bright Blue
108 = Dark Saddle 109 = Dark Green
111 = Sandalwood 112 = Buckskin

IHX-70 Sedan Black..... 134.99 ea.
IHX-68XH_B Sedan Color..... 134.99 ea.

Tier Basketweave



Perforated

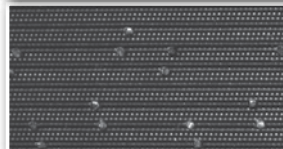

IHI-68

Headliner Insulation

Correct factory style insulation to help keep noise and heat from entering car. Cut to fit.

IHI-68 All 22.99 ea.



IBC-10

Headliner Bow Clips

Correct style plastic bow retaining clips.

IBC-20 1968-72 Small Clip 6.99 ea.
IBC-12 1968-72 Small Clip 4pc 14.99 set
IBC-73 1968-72 Large Clip 6.95 ea.
IBC-10 1968-72 Large Clip 6pc 26.99 kit

Headliner Bows IHB-352X

New replacement bows specifically manufactured to eliminate problems associated with missing or bent originals. Each bow is color coded for a hassle free installation.

IHB-352X 1962-64 Sedan - 2 Dr 79.99 set
IHB-353X 1962-65 Hardtop - 2 Dr 79.99 set
IHB-355X 1966-67 Hardtop - 2 Dr 79.99 set
IHB-354X 1966-67 Sedan - 2 Dr 74.99 set
IHB-356X 1968-72 Hardtop - 2 Dr 79.99 set

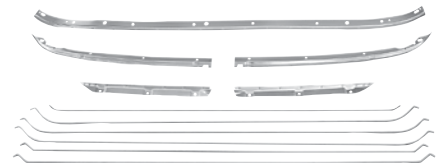

IHR-X66

1966-67 Headliner Retaining Kit

This is an 11 piece set of correct retainers which keep the headliner tightly secured to the roof.

IHR-X66 1966-67 All 139.99 kit



ISS-12545

Sunvisor Support Screw Kit

Correct set of support to roof screws.

ISS-12545 1965-74 6pc 3.99 kit



1973-79 Bow Type Headliner Conversion Kit

This kit allows you to convert from your original perforated style headliner (which often sags over the years) to the 1970-72 bow style headliner. Includes all pieces for a complete replacement.*

Insert color choice in _.

32 = Off White 33 = Saddle
34 = Sandalwood 35 = Buckskin
36 = Med Blue 38 = Light Blue
39 = Dark Blue 45 = Carmine Red

IHX-73 1973-79 Black 199.99 kit
IHX-73_ 1973-79 Color 199.99 kit

* Does not come with sail panels.



Coat Hooks

ICH-556 1962-66 Chrome 1st Design 10.99 pr.
ICH-511 1967-79 Black 6.69 ea.
ICH-511K 1967-77 Black Pair* 14.99 kit
ICH-753 1967-79 Chrome 6.95 ea.
ICH-753K 1967-77 Chrome Pair* 12.95 kit



ISX-62

1962-65 Coupe/Sedan Sunvisors

Superior quality sunvisors complete with metal shaft and double stitched piping in correct Basketweave material.

Include color choice in _.

- 101 = White
- 102 = Bright Red
- 103 = Dark Red
- 104 = Light Blue
- 107 = Aqua

ISX-62	Black.....	125.99 pr.
ISX-62SV12_AC	Color.....	125.99 pr.



ISX-68

1968-69 2 Door Sedan Sunvisors

Superior quality sunvisors complete with metal shaft and double stitched piping in correct Basketweave material.

Include color choice in _.

- 101 = White
- 103 = Dark Red
- 104 = Light Blue
- 105 = Dark Blue
- 106 = Bright Blue
- 107 = Aqua

ISX-68	Black.....	125.99 pr.
ISX-68SV6_AC	Color.....	125.99 pr.



ISX-77

1977-79 2 Door Sedan Sunvisors

Superior quality sunvisors in correct Sierra grain material.

Include color choice in _.

- 45 = Firethorn
- 48 = Camel
- 90 = Light Blue

ISX-77	Black.....	99.95 pr.
ISX-77_	Color.....	125.99 pr.



ISX-62V

1962-63 Convertible Sunvisors

Superior quality sunvisors complete with metal shaft and double stitched piping in correct Seville grain material.

Include color choice in _.

- 50 = Aqua
- 56 = Light Blue
- 57 = Light Fawn
- 63 = Bright Red
- 64 = Red
- 65 = Saddle
- 69 = White

ISX-62V	Black.....	125.99 pr.
ISX-62V_	Color.....	125.99 pr.



IRS-451

1970-74 2 Door Sedan Sunvisors

Superior quality sunvisors complete with metal shaft and double stitched piping in correct Perforated material.

Include color choice in _.

- 101 = White
- 103 = Dark Red
- 105 = Dark Blue
- 106 = Bright Blue
- 108 = Dark Saddle
- 109 = Dark Green
- 111 = Sandalwood
- 112 = Buckskin

IRS-451	Black.....	124.99 pr.
IRS-451SV6_BC	Color.....	125.99 pr.

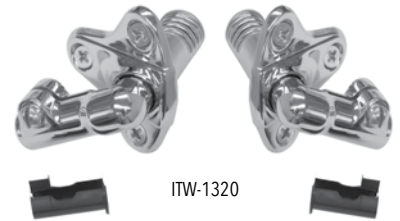

ITW-1320

1962-64 Sunvisor Supports

New chrome sunvisor supports which allow the sunvisor to swivel.

ITW-1320	1962-64	69.99 pr.
ISS-12545	1965-74 Sunvisor Support Screws.....	3.99 kit



ISX-66

1966-67 Coupe/Sedan Sunvisors

Superior quality sunvisors complete with metal shaft and double stitched piping in correct Basketweave material.

Include color choice in _.

- 101 = White
- 103 = Dark Red
- 104 = Light Blue
- 106 = Bright Blue
- 107 = Aqua

ISX-66	Black.....	125.99 pr.
ISX-66SV10_AC	Color.....	125.99 pr.

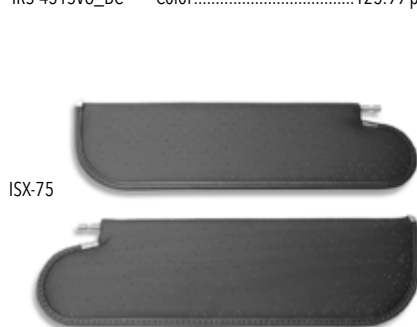

ISX-75

1975-76 2 Door Sedan Sunvisors

Superior quality sunvisors in correct Madrid grain material.

Include color choice in _.

- 15 = Blue
- 17 = Medium Blue
- 36 = Saddle
- 42 = Dark Saddle

ISX-75	Black.....	126.99 pr.
ISX-75_	Color.....	125.99 pr.



IBB-0753

1965-74 Sunvisor Supports

Exact reproduction chrome plated supports complete with screws and nylon bushing.

IBB-0753	1965-74	24.99 ea.
ISS-12545	1965-74 Sunvisor Support Screws..	3.99 kit



IVS-366

1975-78 Sunvisor Supports

Exact reproduction sunvisor support designed to replace your original exactly. Fits left or right. Two required per car.

IVS-366	1975-78	36.99 ea.
---------	---------------	-----------



IC-21

Sunvisor Bushing Tip Kit

Correct bushing and tip kit for two visors.

IC-21	1962-74	8.99 pr.
-------	---------------	----------



IK-483

Rear View Mirrors

OE style reproduction polished stainless steel mirrors with day/night levers.

IM-621	1962-67 8" 1st Design.....	39.95 ea.
IK-483	1962-67 8".....	49.95 ea.
IM-6810	1968-72 10".....	53.99 ea.
IE-842	1968-72 Adjustor Screw.....	2.99 ea.
IM-7081	1973-79 10" Stainless.....	62.99 ea.
IM-419B	1973-79 10" Black.....	54.99 ea.
IMP-1Z	1973-79 Mount To Glass.....	6.99 ea.

Note: 1st design does not have a day/night lever.



IM-6808-ML

Rear View Mirror w/ Map Light

Custom factory style mirror featuring a built-in map light day/night lever. Mounts easily in place of your factory mirror and features correct terminal to plug into your factory fuse block.

IM-6808-ML	1962-67 8" All.....	105.95 ea.
IM-6810-ML	1968-72 10" All.....	105.95 ea.
IM-6812-ML	1968-72 12" All.....	109.95 ea.

Years listed correctly by size but all of these will fit years 1962-72

IK-18



Rear View Mirror Bracket

Correct bracket for supporting rear view mirror.

IT-1730N	1962-65 Coupe.....	36.99 ea.
IT-1732	1966-67 All.....	44.99 ea.
IK-18	1968-72 All.....	46.99 ea.

IBC-712C



Rear View Mirror Bracket Boot

Correct cover which installs directly over the rear view mirror bracket.

IBC-712C	1968-72.....	32.99 ea.
----------	--------------	-----------



GCS-S6065

Chrome Rear View Mirror

Show quality chrome plated rear view mirror.

GCS-S6065	Polished Billet Aluminum.....	52.99 ea.
-----------	-------------------------------	-----------

Note: Glues to the windshield glass.

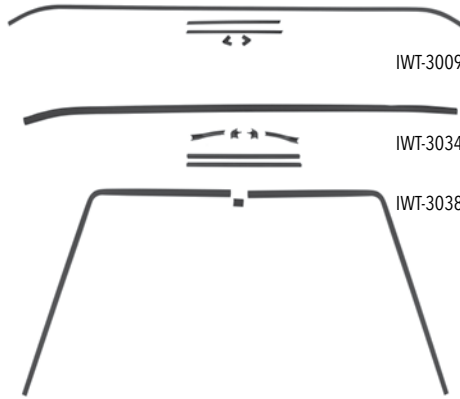

Interior Rear Window Trim Molding

Our interior window trim molding and windlace kits are of the highest quality on the market today! Many items are officially licensed by GM Restoration parts. These are made in the USA, no cheap imports here! Don't be fooled by the price, all of our trim sets are pre-formed and ready to install!

IWT-3009	1962-65 2-Door Hardtop (5pc kit).....	74.99 kit
IWT-3007	1962-64 Sedan (3pc. kit).....	107.99 kit
IWT-3011	1965 Sedan (3pc. kit).....	106.99 kit
IWT-3034	1966-67 2-Door Hardtop (7pc. kit).....	96.99 kit
IWT-3037	1966-67 2-Door Hardtop Sides /Upper Only (3pc. kit).....	49.99 kit
IWT-3038	1966-67 Sedan (2/4 Dr.) (3pc. kit).....	99.99 kit
IJ-3212	1968-72 (1pc).....	59.99 ea.



IHT-KIT-NOVA

IHT-KIT-NOVADLX

1968-72 Inner Window & Headliner Trim Kits

This is a set of correctly molded plastic Nova inner window and headliner trim which is a must have finishing item for your interior restoration. For 2 door cars.

IHT-KIT-NOVA	Window & Headliner.....	143.98 kit
IHT-KIT-NOVADLX	Window Headliner & B-Pillar.....	215.97 kit

No Volume discount.



IWT-3033

Headliner Trim Moldings

IWT-3033	1962-67 Front Upper (2pc.).....	45.99 kit
IWT-68F	1968-72 Front.....	49.99 ea.
IWT-68S	1968-72 Sides.....	69.99 pr.
IJ-3212	1968-72 Rear.....	59.99 ea.

IXN-1451

IXN-1454

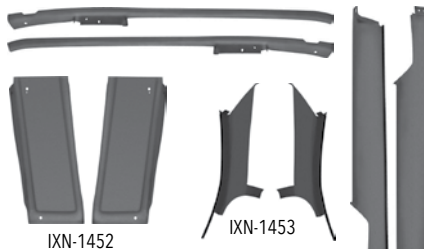

IXN-1452

IXN-1453

1975-79 Headliner and Pillar Trim

These injection-molded ABS reproductions of these moldings are manufactured to exact specifications and include correctly placed mounting holes (when required) along with correct grain for each molding. Available in black. Each molding may be painted to the desired color using interior paints.

IXN-1451	Upper Side Headliner Moldings.....	150.99 pr.
IXN-1452	Quarter Window Post Moldings.....	139.99 pr.
IXN-1453	Quarter Window Rear Moldings.....	156.99 pr.
IXN-1454	Quarter Window Lower Moldings.....	150.99 pr.
IXN-1455	Lower Rear Side Panels w/ Armrests.....	239.99 pr.



INQ-0203



ICE-2777

Dome Light Lenses

Correct white plastic lenses.

INQ-0203	1962-70.....	4.99 ea.
ICE-2777	1971-79.....	5.95 ea.



IHQ-0117



ICE-0351

Dome Light Lens Bezel

New plastic molded chrome plated as original.

IHQ-0117	1962-70.....	10.99 ea.
ICE-0351	1971-79.....	11.95 ea.
30205-PIGTAIL	All Repair Harness.....	13.99 pr.



DT-200007

LED Dome Light Bulb

A simple direct replacement for your dome light bulb. This LED bulb features 9 dual super bright LEDs in a 211 bulb package. Excellent to increase brightness and reduce heat and power.

DT-200007 211 LED Bulb..... 13.95 ea.



IHQ-0117K

Dome Lamp Kit

Complete kit with new plastic molded and chrome plated dome light, bezel, lens, bulb terminals and harness extension.

IHQ-0117K 1962-70 All..... 39.95 kit
ICE-0351K 1971-79 All..... 39.95 kit



IDL-CLIP

Dome Lamp Harness Clips

Correct clips for flat ribbon dual wire.

IDL-CLIP Most GM cars..... 11.99 ea.



BULB-67XI

Interior Bulb Kits

Vehicle specific kits include all interior bulbs for a complete replacement.

BULB-62XI 1962-65 19.99 kit
BULB-66XI 1966 26.99 kit
BULB-67XI 1967 24.99 kit
BULB-68XI 1968-69 24.99 kit
BULB-70XI 1970 25.99 kit



IRE-X66



IRP-X68

Package Tray

Replace your cracked and dry rotted original Nova package tray with this exact reproduction from PUI. This standard package tray is die stamped and vinyl covered as original and will really help to freshen up your interior. Available in OEM style standard or deluxe mesh with speaker cutouts on the underside.

Standard Tray

IRP-X62 1962-65 21.99 ea.
Black • Fawn (16) • Bright Red (63) • Red (67)
Light Blue (69) • Aqua (74) • Saddle (80)
IRE-X66 1966-67 21.99 ea.
Black • Bright Blue (14) • Fawn (16) • Gold (43)
Red (67) • Light Blue (69) • Aqua (74) • Saddle (80)
IRP-X68 1968-73 20.99 ea.
Black • Medium Blue (17) • Jade Green (19)
Dark Blue (38) • Sandalwood (41) • Dark Saddle (42)
Ivy Gold (46) • Tan (47) • Red (67) • Light Blue (69)
Light Green (77) • Dark Green (78)
IRE-X73 1974 34.99 ea.
Black only

Deluxe Mesh Tray

Available in black only.
IRD-X62 1962-65 2 Door Hardtop..... 64.99 ea.
IRD-X66 1966-67 2 Door Hardtop..... 64.99 ea.
IRD-X68 1968-73 12" Wide..... 64.99 ea.
IRD-X73 1974 10" Wide..... 64.99 ea.
All package trays ship double Oversize.



ITD-X62

Trunk Divider Boards

Correct die-stamped cardboard piece which installs between the rear seat and trunk area.

ITD-X62 1962-67 21.99 ea.
ITD-X68 1968-74 21.99 ea.
ITD-X73 1975-79 17.95 ea.

All trunk divider boards ship double Oversize. Some trimming will be required for convertible.



GWC-SPK

Speaker Wire Clip

Correct clips to hold speaker wire to package tray.

GWC-SPK 1962-79 19.99 pr.



IER-70F

Rear Speaker Enclosure Retainer

IER-70F 1973-77 7.99 ea.



INL-15429

1962-1972 Package Tray Hold Down Blow Out Clip

This clip is correct for all Nova coupes and sedans to hold the package tray to the metal underbody. When the trunk was slammed, the package tray would blow up and this clip prevented that from happening.

INL-15429 1962-72 Coupe/Sedan 19.99 ea.



IJU-X62

Package Tray Insulation

Correct die-stamped jute insulation.

IJU-X62 1962-65 12.99 ea.
IJU-X66 1966-67 12.99 ea.
IJU-X68 1968-73 14.99 ea.



ITJ-X2

Trunk Divider Insulation

Correct die-stamped jute insulation.

ITJ-X1 1962-65 19.99 ea.
ITJ-X2 1966-67 19.99 ea.
ITJ-X3 1968-74 19.99 ea.



ITC-1212

Package Tray Corners

Finally available! Correct molded plastic package tray corners for your 1968-72 Nova.

ITC-1212 1968-72 36.99 pr.



IXM-68-B

B-Pillar Moldings

Correct plastic B-pillar moldings. Paint to match.

IXM-68-B 1968-72 All..... 89.99 pr.
IXN-1450 1975-79 All..... 139.99 pr.



USA-74NOV66



USA-74NOV62



USA 740 AM/FM 300 Watts

The USA-740 offers the same classic look that Custom AutoSound has always been known for with today's latest features. Now, with built-in Bluetooth (microphone included), answer calls and get Bluetooth streaming music from your Bluetooth capable phone or Bluetooth compatible device. A solid 300-watt peak power should be all the juice you need, yet the USA-740 has Hi 4 volt, 4 channel RCA pre-outs and a subwoofer RCA pre-out for additional amplifiers. The USB input allows you to plug in a USB flash drive for playback of MP3/WMA/FLAC/WAV song files. A front 3.5mm mini jack auxiliary audio input and a rear RCA auxiliary audio input provide versatility for options like satellite radio, iPod or any portable player you wish to use. Match the dominant color of your instrument cluster with user selectable multiple LCD color choices with LCD dimmer control. The AM/FM RDS tuner shows station, song and artist on the LCD display. For those of us committed to music collections on compact disc, the USA-740 fully controls the optional Custom AutoSound CD-1 CD player. Classic style with today's sound and performance taking every road and curve with you in your Nova.

USA-74NOV62	1962-65 All	350.99 ea.
USA-74NOV66	1966-67 All	350.99 ea.
USA-74NOV68	1968-76 All	350.99 ea.
USA-74NOV77	1977-79 All	350.99 ea.

Note: These radios do not come with a factory radio bezel.



Custom Autosound USA-630 AM/FM 240 Watts

The USA-630 is the pinnacle of 30 years of evolution in Custom Autosound's quest for the perfect classic car radio. This radio has large OEM style push-buttons that give a perfect look in a classic dash. Although it looks classic, it has the latest modern features. USB input on the back of the radio. This jack is on an 18" extension which allows you to place it in the glove box or ash tray for easy access (no unsightly wires or plugs hanging out of the front of the radio). The new alpha numeric display (30% larger than previous models) shows the song/artist/album (id3) titles during playback of MP3/WMA files. With the built-in CD controller you have complete control (no FM modulation) of CAS's 10 disc CD changer.

With 240 watts, the radio should have all the power you may need. If you want more, there are four pre-outs jacks on the back of the radio for optional amplifiers. The back of the radio also has auxiliary audio input for satellite radio or any portable player you may wish to use.

- AM-FM Stereo • USA/Euro Tuner • Power Antenna Lead • Alpha Numeric id3 Display for MP3/WMA files • Electronic Tuning and Volume Control • 4 Way Fader • Left Right Balance • Digital Clock • 16 Pre-sets (12FM-4AM) • 4 Channel RCA Pre-outs • Separate Bass and Treble • 2 Channel RCA Auxiliary Input for Satellite / iPod etc.

USA-63NOV62	1962-65 All	265.99 ea.
USA-63NOV66	1966-67 All	265.99 ea.
USA-63NOV68	1968-76 All	265.99 ea.
USA-63NOV77	1977-79 All	265.99 ea.

Note: These radios do not come with a factory radio bezel.



SSK-625X



SSK-625X-P



Custom AutoSound Sound System Kits

Crank up the tunes with Ground Up Motors's exclusive Sound System Kits! Each kit comes with an in-dash radio, rear speakers, and dash speakers, making it easy to bundle and save while still looking and sounding great!



Basic Kits

These kits feature a USA-230 radio, front dash speakers, and rear 6x9 speakers.

SSK-625X	1962-65 All	313.17 kit
SSK-667X	1966-67 Without AC	313.17 kit
SSK-667X-A	1966-67 With AC	313.17 kit
SSK-6876X	1968-76 Without AC	313.17 kit
SSK-6876X-A	1968-76 With AC	313.17 kit

Upgraded Kits

These kits feature a USA-630 radio, front dash speakers, and rear 6x9 speakers.

SSK-625X-U	1962-65 All	397.77 kit
SSK-667X-U	1966-67 Without AC	397.77 kit
SSK-667X-A-U	1966-67 With AC	397.77 kit
SSK-6876X-U	1968-76 All	397.77 kit

Premium Kits

These kits feature a USA-740 radio, front dash speakers, and rear 6x9 speakers.

SSK-625X-P	1962-65 All	474.27 kit
SSK-667X-P	1966-67 Without AC	474.27 kit
SSK-667X-A-P	1966-67 With AC	474.27 kit
SSK-6876X-P	1968-76 All	474.27 kit

No Volume Discount. Note: These radios do not come with a factory radio bezel.



USA-230NOV62



USA-230 AM/FM 200 Watts

A great look and sound at an awesome price. This USA-230 radio has no cassette but comes with Auxiliary Input for iPod, MP3, Satellite radio, etc. Classic features with a classic look. These exciting features include:

- AM/FM Stereo • 200 Watts (4 x 50) • Auxiliary Input
- Digital Clock • Electronic Tuner • 30 Pre-sets (12AM-18FM)
- 4 Channel RCA Pre-Outs • 4 Way Fader • Power Antenna Lead

USA-230NOV62	1962-65 Chrome Nose	200.99 ea.
USA-230NOV66	1966-67 Chrome Nose	200.99 ea.
USA-230NOV68	1968-76 Chrome Nose	200.99 ea.
USA-230NOV77	1977-79 Chrome Nose	200.99 ea.

Note: These radios do not come with a factory radio bezel.



AAR-634NOV



AAR-69-GM



All Antique Automobile Radios now feature built-in Bluetooth 3.0 EDR compliance; Place and answer calls or stream your favorite programs while maintaining the original appearance! Includes a built-in microphone for HFP (hands free profile calling). HSP, A2DP, AVRCP profiles are also supported.



Antique Auto Radios

If you are looking for a radio that sounds great and looks just like your original, this Antique Auto Radio is perfect for you! Max power 180 watts RMS 45W x 4 MOSFET onboard power amplifier. Analog controls look and feel just like your original. AM dial scale in foreground looks original with a FM dial scale in background. All controls are easily accessible. Volume, bass, treble, balance, fader and tuning from original looking controls. Digitally tuned AM/FM/Stereo front end provides stable, high quality reception. Shafts are the original size for quick and accurate mounting, just like your original. Also included are additional line outs and output options: 3 RCA jacks for left channel, right channel and sub-woofer, a 6 foot 3.5mm male-to-male auxiliary cable, 3.5 mm phone jack for input from iPod, satellite radio or MP3 player, switch selectable for 1,2,3 or 4 speakers, switch selectable for North America or Europe mode. Doesn't include a remote or a USB for a flashdrive or SD card port.

AAR-62NOV	1962 All	850.99 ea.
AAR-634NOV	1963-64 All	850.99 ea.
AAR-65NOV	1965 All	850.99 ea.
AAR-69-GM	1969 All	850.99 ea.
AAR-70-GM	1970 All	850.99 ea.
AAR-716NOV	1971-76 All	850.99 ea.



SECRET-SST



Secret Audio SST

Secretaudio SST is a hidden audio system that offers great flexibility for mounting in any type of vehicle. The main receiver/amplifier unit is usually hidden under the seat or behind the dash. A 10ft cord from the Tuner/Amp plugs into a LCD display. The system can be operated from up to 40 feet away with the included RF (radio frequency) remote.

Included with the system is a flush mount bezel for console or dash mounting. The small dimensions of the flush mount system allow you to install the LCD display almost anywhere. The LCD also comes with a bracket mount for easy installation in the glove box, under the dash, in the ashtray, sunvisor, console, or wherever you choose. Since its only 1" deep its especially handy for custom or streetrod applications where there may be wiring or ducting routed behind the panels you wish to utilize for mounting. When your installation is finished you'll be rewarded with a quality and professionally installed look.

Features:

- AM/FM Stereo 200 watts 4x50 • Auxiliary Audio Input • USB MP3/WMA Flash Drive Player • iPod® Direct Control Interface (built-in tuner/amp unit) iPod Docking Cable Included • Alpha Numeric LCD Display Shows Artist / Song Titles for USB, iPod® and Satellite Radio • Satellite Radio Input (for optional Sirius® satellite radio tuner) • Direct CD Changer Control (CD changer optional)
- 4 Channel 3 Volt RCA Pre-Outs (for optional Amplifiers) • Subwoofer Pre-Out (for optional Subwoofer Amplifier)
- Electronic Volume, Bass, Treble, Balance, Fader • 5 Selectable iEQ Curves – pop/jazz/classic/beat/rock
- Zero Memory Current Draw (will not drain car battery when unit not in use) • 24 Station pre-sets (18FM / 6AM) • Power Antenna 12V Trigger Lead

SECRET-SST	1964-72	350.99 ea.
------------	---------------	------------



CAM-NOV25-SBR2

Custom AutoSound Sidebar Radio

The Sidebar Radio provides the best of both worlds, a true working sidebar display and a full-featured digital display in the same stereo. Simply slide the bar in the center of the radio to the right and hide the analog sidebar revealing a full-featured digital display underneath. The sidebar is designed with large OEM style push-buttons to compliment the look of your classic car. Its digital display provides seven backlit color options designed to match the color of your dash instrumentation.

CAM-NOV25-SBR2	1962-65 All	349.99 kit
----------------	-------------------	------------



BLUKIT

Bluetooth Interface for USA-630, Secretaudio

This adaptor plugs into the CD changer port of your radio and gives you the ability to do hands free calling from your Bluetooth capable phone. You can listen to music stored on your A2DP enabled Bluetooth device. You can still use your CD changer with the adaptor plugged in.

BLUKIT	Bluetooth Interface.....	105.99 ea.
--------	--------------------------	------------

Note: Works with Custom Autosound USA-630 and Secretaudio systems.



Dash Speakers

2002

Since at least 2 speakers are required for true stereo sound, these speakers are a perfect upgrade to OEM and do not require any modification to your dash. The 1000 series are held in place by the original screws and the 2000 series are held in place by the original bracket.

1001	1962-65 All.....	45.99 ea.
2008	1966-67 Non-AC	45.99 ea.
2009	1966-67 With AC	45.99 ea.
2001	1968-76 Non-AC	45.99 ea.
2002	1968-76 With AC.....	45.99 ea.



KNW-2001



KNW-2002



Kenwood Upgraded Dash Speakers

These Custom Autosound speakers feature Kenwood quality upgrade replacement speakers for your original front in-dash speakers. These great quality speakers can handle up to 60 watts and are built and designed to fit directly under the dash including all correct mounting brackets and wiring. Each assembly includes two speakers.

KNW-2001	1962-65	74.99 ea.
KNW-2002	1968-76	74.99 ea.



KPS-62X



KPS-66X



Ground Up Motors's Premium Quality Kick Panel Speakers

These Ground Up Motors kick panel speakers offer great sound quality for your Nova. These kick panels are as true to the originals as possible while offering a modern speaker in a convenient location. No cutting of the body required! Made of ABS textured plastic, they can be painted to match any interior for a clean look. All speakers are 6.5" 300 watt two way speaker driver.

KPS-62X	1962-65 Coupe 300 Watt 2 Way	199.99 pr.
KPS-66X	1966-67 Coupe 300 Watt 2 Way	199.99 pr.



KNOV-68-2

Kick Panel Speakers

Enhance your sound quality with these custom molded kick panel speakers from Custom Autosound. They are a direct bolt in!

With 80 Watt Speakers

KNOV-62-3	1962-63 Convertible (4x6)	139.99 pr.
KNOV-62-5	1962-65 (4x6)	145.99 pr.
KNOV-66-7	1966-67 (4x6)	145.99 pr.
KNOV-68-2	1968-72 100 Watt	145.99 pr.

With 120 Watt Pioneer Speakers

PKNOV-62-3	1962-63 Convertible (4x6)	199.99 pr.
PKNOV-62-5	1962-65 (4x6)	199.99 pr.
PKNOV-66-7	1966-67 (4x6)	199.99 pr.
PKNOV-68-2	1968-72 200 Watt	199.99 pr.

These work on non-AC cars only.



3001

4008



4001



Dual Voice Coil Speakers

These DVC speakers will give you the best possible sound and power handling from your stock speaker locations. They give up to 70% more cone area than a conventional dual speaker setup with 140 Watt power capacity, left and right channel hook up and tweeters.

3001	1962-65 All	55.99 ea.
4008	1966-67 w/o AC	60.99 ea.
4009	1966-67 w/AC	60.99 ea.
4001	1968-76 w/o AC	60.99 ea.



SPUV-693C



Rear Speakers

These rear speakers are a high performance replacement for your originals and includes grilles, wires and hardware.

SPUV-693C	6x9 3 Way 200W	100.99 pr.
-----------	----------------	------------



SPG-6480



SPG-7081



SPG-70AN

Package Tray Speaker Grilles

Often dealer installed and often broken or missing, these OE correct speaker grilles are the perfect finishing touch to your restoration. The grille is designed to fit 6x9 speakers.

SPG-6480	1962-79 Square Sides	44.99 ea.
SPG-70AN	1970 Fully Square	92.99 ea.
SPG-7081	1971-79 Round Sides	39.99 ea.

No volume discount.



BKT-6774



IER-70F

Dash Speaker Bracket

Heavy gauged stamped steel dash speaker mounting bracket with correct plating.

BKT-6774	1968-74 Dash All	32.99 ea.
IER-70F	1973-77 Rear All	7.99 ea.



Since 1977, Custom Autosound Mfg. remains the originator and innovator of audio products for classic cars, trucks and streetrods. Many competitors and imitators have followed in our footsteps with similar products. But only Custom Autosound offers over 400 different radio applications for the year, make and model of your vintage vehicle, ready to install. Everything you need in one box and nothing to assemble. In addition to the custom radios, we offer a multitude of upgrade/custom fit speakers and kick panel speakers. Custom Autosound Mfg. is a regular exhibitor at SEMA and is licensed by Ford and GM to use their trademarks and logos.



UNDERCOVER1



Undercover Speakers

These compact speakers are specifically made for under seat installation and they pack a 120 Watt punch! Each unit features a 5 1/2" woofer and piezo tweeter. 3" H X 8-1/4" W X 11-1/4" L.

UNDERCOVER1 1964-72 All..... 135.99 pr.



UNDERCOVER2



Undercover II Speakers

Want a little more from your hidden speaker system? This is it! Each unit features an 8" woofer and 2 Piezo tweeters. With the 8" woofer in UNDERCOVERII you get a much fuller deeper sound with a 200 Watt capability! 11"W x 12.5"D x 3"H

UNDERCOVER2 1964-72 All..... 175.99 pr.



ANT-7088

Antenna Lead Wire

Correct antenna lead wire which goes from the windshield mounted antenna to the radio. Mounts on the firewall with pigtail.

ANT-7088 1970-79 All..... 34.99 ea.



ANT-HIDE



Hidden Antenna

For the best AM/FM reception, nothing works better than this hidden amplified antenna! You can mount this anywhere and plug it into your new Custom Autosound stereo for the best reception quality!

ANT-HIDE 1964-72 All..... 30.99 ea.



GRC-12835

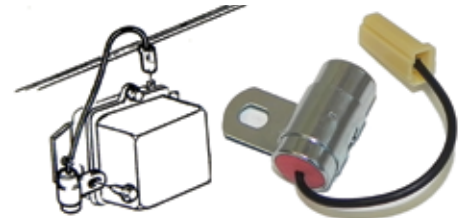

GRC-12834

Radio Capacitor

Came from the factory on all cars with radio. Correct length lead wire & brass connector.

GRC-12834 1964-71 Voltage Regulator..... 39.99 ea.

Stamped 1964086 "DR" & ".5MF"

GRC-12835 1970-1974 Radio..... 39.99 ea.

1964452 "DR" & ".3MF"



MTB-X62

Convertible Top Boot

This superior quality boot features the correct HEAVY weight vinyl and original style stitching construction. Seville grain as original.



MTB-X62	1962-63 Black.....	233.99 ea.
MTB-X6250	1962-63 Aqua.....	233.99 ea.
MTB-X6256	1962-63 Light Blue.....	233.99 ea.
MTB-X6257	1962-63 Fawn.....	233.99 ea.
MTB-X6263	1962-63 Bright Red.....	233.99 ea.
MTB-X6264	1962-63 Red.....	233.99 ea.
MTB-X6265	1962-63 Saddle.....	233.99 ea.
MTB-X6269	1962-63 White.....	233.99 ea.



Convertible Tops

OE style reproduction convertible tops with correct grain and weight as well as seam treatment just like factory. Plastic rear window is included.

MP-62XB	1962-63 Black.....	417.99 ea.
MP-62XW	1962-63 White.....	417.99 ea.

No Volume Discount. Ships Oversize.



ITC-2147

Convertible Top Latches

OE style reproduction of original convertible top latch assembly featuring a bright chrome finish.

ITC-2147	1962-63 RH.....	186.99 ea.
ITC-2148	1962-63 LH.....	187.99 ea.



MTP-62X

Convertible Top Pads

High quality reinforcement pads which fit between the frame rails and top.

MTP-62X	1962-63 Convertible.....	60.99 pr.
---------	--------------------------	-----------

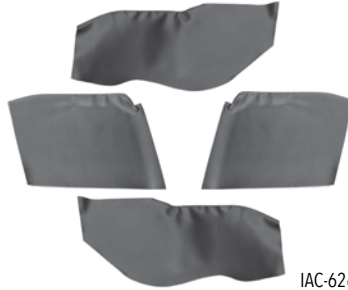

IAC-6263

1962-63 Rear Arm Rest Piston Covers

Correct die-stamped vinyl material for covering convertible rear arm rest and piston covers.

IAC-6263	Black.....	102.99 kit
IAC-626350	Aqua.....	102.99 kit
IAC-626356	Light Blue.....	102.99 kit
IAC-626357	Fawn.....	102.99 kit
IAC-626363	Bright Red.....	102.99 kit
IAC-626364	Red.....	102.99 kit
IAC-626365	Saddle.....	102.99 kit
IAC-626369	White.....	102.99 kit



MHL-701K

Convertible Latch Knuckle Hook

Screws directly into latch knuckle assembly.

MHL-701K	1962-63.....	39.99 kit
----------	--------------	-----------



MCT-1

Header Bow End Clip

Correct header bow for outside of convertible top.

MCT-1	1962-63.....	5.99 pr.
-------	--------------	----------



RTP-5195

Convertible Door Wedge Kits

These wedges fit into the upper door jamb and contact each other when the door is closed.

RTP-5195	1963.....	45.99 set
----------	-----------	-----------



LMC-6263K

Convertible Well Molding Clips

Complete set of well molding clips.

LMC-6263K	1962-63.....	23.99 kit
-----------	--------------	-----------



MWL-62X

Convertible Well Liner

Correct vinyl material for "top down" well area.

MWL-62X	1962-63.....	89.99 ea.
---------	--------------	-----------



JSS-4029

Convertible Top Weatherstrip Kit

Complete 7 piece convertible top weatherstrip kit.

JSS-4029	1962-63.....	449.99 kit
----------	--------------	------------



MMB-3

MTM-101

Convertible Top Motors

New OEM motors.

MTM-101	1962-63.....	325.99 ea.
MMB-3	Bushing.....	5.95 ea.

No Volume Discount.



MTC-62X

Convertible Top Cylinder

This is a correct replacement convertible top cylinder made in the USA featuring all metal construction with hard chrome finished rods. This top cylinder comes with a 5 year warranty when used with automatic transmission fluid or a 3 year warranty when used with standard DOT 3 brake fluid.

MTC-62X	1962-63.....	159.99 ea.
---------	--------------	------------

No Volume Discount.



MADE IN THE USA

MTH-33K

Convertible Top Hose Set

Correct white hose with original brass fittings.

MTH-33K	1962-63.....	95.95 pr.
---------	--------------	-----------

No Volume Discount.



Trunk Mats

These new die stamped heavy duty vinyl trunk mats are the perfect finishing touch to your trunk! Constructed of heavy duty vinyl, this mat will last for years to come!

PMX-62	1962-66 Crows Foot Black & Gray.....	50.99 ea.
PMX-67	1967 Houndstooth.....	50.99 ea.
PMX-68	1968-72 Herringbone.....	52.99 ea.

Spare Tire Cover

These spare tire covers are constructed of the same durable material as our trunk mats, so they make an excellent finishing touch!

PEM-164A	1964-66 Gray Crowsfoot 14".....	69.99 ea.
PEM-161A	1967 Aqua Houndstooth 14".....	64.99 ea.
PEM-162	1967 Aqua Houndstooth 15".....	69.99 ea.
PEM-163A	1968-72 Herringbone 14".....	69.99 ea.
PEM-163B	1968-72 Herringbone 15".....	69.99 ea.



PEM-161A



P-2000

Spare Tire Anchor Plate

Correct spare tire hold down and jack floor brackets.

P-2000	Anchor Plate.....	11.99 ea.
--------	-------------------	-----------

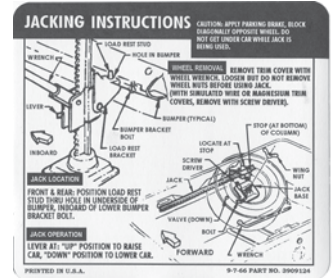

HJC-756

Jacking Instructions

HJC-840	1962-66 All.....	8.99 ea.
HJC-843	1967 All.....	8.99 ea.
HJC-756	1968-70.....	8.99 ea.
HJC-845	1971 All.....	8.99 ea.



Trunk Spatter Paint

Correct OEM aerosol spray to detail your trunk floor.

DUP-DM109	Aqua/Black.....	11.99 ea.
DUP-DM100	Gray/White.....	11.99 ea.
DUP-DAL1695	Clear Coat.....	9.99 ea.
DUP-DM102	Black/Grey.....	11.99 ea.



RDP-100

Trunk Floor Drain Plug

Correct stamped plug for trunk floor.

RDP-100	1962-74.....	3.95 ea.
---------	--------------	----------



BHE-1970

Spare Tire Hold Down

Correct hold down for retaining spare tire.

BHE-1970	All.....	14.99 set
----------	----------	-----------



PLW-KIT

Lug Nut Wrench & Sleeve

Correct GM lug wrench and rubber sleeve for retaining it to the jack.

PLW-3	Wrench.....	19.99 ea.
PLS	Sleeve.....	11.99 ea.
PLW-KIT	Sleeve, Wrench, Hold Down.....	42.27 kit

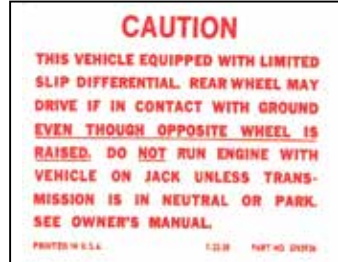

HBH-797

Positraction Decal

HBH-797	Most.....	8.99 ea.
---------	-----------	----------



Custom Trunk Panels

This pre-cut custom trunk panel set makes it easy to clean up your trunk. Each kit includes pre-cut hardboard panels to cover the floor, trunk divider area and the sides of the trunk saving you or your upholstery shop hours over hand trimming your own custom panels. Add your choice of finishing material such as carpet (not included) and you will have a clean and modern looking trunk to set your muscle car apart from the crowd!

CTPM-817-4	1968-72.....	213.99 kit
------------	--------------	------------



NRK-146

Complete Rally Wheel Kits

Why sift through the junkyard for a used set of wheels or try to repair your originals? Ground Up Motors offers complete wheels kits including a complete set of rims, caps, trim rings and a set of lug nuts! These kits include everything you need to get your muscle car rolling in style.

with Chevrolet Motor Division Flat Caps

NRK-146	14 x 6	584.62 kit
NRK-146DB	14 x 6 w/ Factory Disc	584.62 kit
NRK-147	14 x 7	602.59 kit
NRK-157	15 x 7	606.37 kit
NRK-158	15 x 8	674.77 kit
NRK-157-8K	15 x 7 Front 15x8 Rear	631.58 kit

with Chevrolet Disc Brakes Flat Caps

NRK-246	14 x 6	584.62 kit
NRK-246DB	14 x 6 w/ Factory Disc	584.62 kit
NRK-247	14 x 7	602.59 kit
NRK-257	15 x 7	606.37 kit
NRK-258	15 x 8	674.77 kit
NRK-257-8K	15 x 7 Front 15x8 Rear	631.58 kit

with Turbine Style Raised Caps (1968+ Style)

NRK-346	14 x 6	885.20 kit
NRK-346DB	14 x 6 w/ Factory Disc	885.20 kit
NRK-347	14 x 7	903.16 kit
NRK-357	15 x 7	906.94 kit
NRK-358	15 x 8	975.34 kit
NRK-357-8K	15 x 7 Front 15x8 Rear	959.15 kit



NVW-70K

Complete Super Sport Wheels Kits

This kit includes a complete set of SS rims, center caps with retainers, trim rings and a set of lug nuts to get your Super Sport rolling!

NVW-70K	14 x 7	1297.17 kit
NVW-71K15	15 x 7	925.17 kit

No Volume Discount. All wheel kits ship in multiple Oversize Boxes.



NVW-4837-MAG

Retro Magnum Alloy SS Wheels

Constructed of aluminum, these brand new retro 15 x 7 Super Sport wheels will give your muscle car a more modern look while keeping the old school styling! These awesome new wheels are black powder coated on the inside and feature machined lips.

NVW-4837-MAG-KIT4	15 x 7 Kit	715.84 kit
NVW-4837-MAG	15 x 7 Spare	169.99 ea.

Ships Oversize. Not eligible for free shipping. No Volume Discount. 17 Inch rims come with a blank center cap.

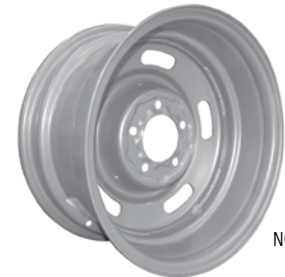

NCE-8984

Rally Wheels

Our rally wheels come correctly powder coated in Argent Silver assuring you not only a great appearance but quality as well.

NCE-8984	14 x 6, 4" Backspace	99.95 ea.
NCE-8985	14 x 6 Disc, 4" Backspace*	99.95 ea.
NCE-0530	14 x 7, 4-1/4" Backspace	99.95 ea.
NCE-0535	15 x 7, 4-1/4" Backspace	105.99 ea.
NCE-0540	15 x 8, 4-1/4" Backspace	109.99 ea.

* Fits factory OEM disc brakes only. Ships Oversize.



USW-615-88344

US Wheel Series 615 Gunmetal Machined

Constructed on aluminum, these brand new retro wheels will give your classic that retro look you love with modern tire choices. Not only will these wheels fit larger 17 inch tires but larger big brake kits!

USW-615-88344	17x8, 4.25" Backspace	257.99 ea.
USW-615-88345	17x8, 5" Backspace	257.99 ea.
USW-615-8934G	17x9, 5.125" Backspace	257.99 ea.

Ships Oversize. Not eligible for free shipping. No volume discount. Wheel accepts original OE cap. Lug nuts and center cap not included. Please check proper fitment before mounting



NCE-0530C

Chrome Rally Wheels

This reproduction Nova Rally Wheel is made in the USA and comes in high quality chrome plated steel for a custom look. This Nova wheel is ready to install right out of the box.

- NCE-8984C 14 x 6, 4" b/s.....149.95 ea.
 - NCE-0530C 14 x 7, 4-1/8" b/s.....149.95 ea.
 - NCE-0535C 15 x 7, 4-1/4" b/s.....139.95 ea.
 - NCE-0540C 15 x 8, 4-1/2" b/s.....129.95 ea.
- Fits cars with 5 lug axles. These wheels do not include center caps or lug nuts. Ships Oversize.



NSW-146

Steel COPO Wheels

This is a brand new factory style steel wheel which was usually standard equipment on six cylinder cars, Special High Performance Cars and COPO cars. These steel wheels were usually discarded over the years in favor of rally wheels or super sport wheels and are tough to find. This rim is perfect for your bone stock restoration, COPO recreation, or sleeper.

- NSW-146 14 x 6, 4-1/2" b/s.....124.99 ea.
- NSW-147 14 x 7, 4-3/4" b/s.....124.99 ea.
- NSW-157 15 x 7, 4-3/4" b/s.....124.99 ea.

MIX & MATCH SPECIAL!
BUY ANY 4 RIMS SAVE 15%

NVW-4832



Super Sport Wheels

OE style reproduction SS wheel which comes correctly painted and ready to install.

- NVW-4832 14 x 7 4.25" Backspace..... 257.99 ea.
 - NVW-4837 15 x 7 4-25" Backspace.....159.99 ea.
 - NVW-4838 15 x 8 4.5" Backspace.....169.99 ea.
- Ships Oversize.*



NVW-4831C

Chrome Super Sport Wheels

This reproduction Nova Super Sport Wheel is made in the USA and comes in high quality chrome plated steel for a custom look. This Nova wheel is ready to install right out of the box.

- NVW-4831C 14 x 6, 4" b/s..... 184.95 ea.
 - NVW-4832C 14 x 7, 4.12" b/s..... 149.99 ea.
 - NVW-4837C 15 x 7, 4.5" b/s.....179.99 ea.
 - NVW-4838C 15 x 8, 4.5" b/s..... 189.99 ea.
- These wheels do not include center caps, or lug nuts. Ships Oversize.*



NW1785SLV



17 Inch N90 Wheels

Add a modern stance to your muscle car while keeping with its classic styling! This is a 17 inch version of the N90 wheel that original came on 1980-1981 Z/28 and 1986-1988 Monte Carlo models. Accepts original style center caps and lug nuts.

- NW1784SLV 17 x 8, 4.25" B/S 257.99 ea.
- NW1785SLV 17 x 8, 5" B/S.....254.99 ea.



CMW178BLK



17 Inch SS Mag Wheels

Add a modern stance to your muscle car while keeping with its classic styling! This is a 17 inch version of the Super Sport Wheel that originally came on various GM models. Accepts original style center caps and lug nuts.

- CMW178BLK 17 x 8, 4.5" B/S257.99 ea.
- CMW179BLK 17 x 9, 5.125" B/S.....257.99 ea.
- MWR2 Center Cap Retainers.....29.99 set
- C5782 Screws (10pc.).....4.99 kit

Note: If using your existing center caps you will need to use MWR2 center cap retainers and C5782 screws to fit these retainers.



ZW1784GUN



17 Inch 5 Spoke Rally Wheels

Add a modern stance to your muscle car while keeping with its classic styling! This is a 17 inch version of the 5 spoke Z/28 wheel that originally came on 1970-1981 Camaro. Accepts original style center caps and lug nuts.

- ZW1784GUN 17 x 8, Gunmetal, 4.25" B/S257.99 ea.
- ZW179GUN 17 x 9, Gunmetal, 5" B/S.....257.99 ea.



NWB-781

1979 Rally Wheel Bezel

This is the correct chrome bezel that inserts into the slots on your ZJ7 6 slot rally wheels.

- NWB-781 1979 w/ Rally Wheel..... 12.99 ea.
- 6 required per wheel.*



NJT-665



NJT-716

Lug Nuts

Correct style lug nuts for your wheels.

- NJT-716 Acorn 7/16 0.99 ea.
- NJT-665 Stainless SS..... 2.49 ea.
- NJT-665KIT SS 20pc.....44.82 kit



NJ-1530

Rally Wheel Center Cap

Correct turbine style raised style center cap with "Chevrolet Motor Division".

- NJ-1530 Motor Division Cap 1968+ 115.99 ea.

BUY 'N SAVE
WITH KITS



NJ-150K



NJ-151K



NJ-152K

Rally Wheel Cap Kits

Ground Up Motors offers complete rally wheel center cap kits which include the center caps, bases, and hardware for all 4 wheels. Chrome plated metal center cap with a polished stainless steel base.

NJ-150K	Chevrolet Motor Division.....	129.99 kit
NJ-151K	Chevrolet Disc Brakes.....	129.99 kit
NJ-152K	Motor Division Raised.....	417.56 kit



HTP-172

Tire Pressure Decals

HTP-198	1966 All.....	8.99 ea.
HTP-182	1967 All.....	8.99 ea.
HTP-172	1968 All.....	8.99 ea.
HTP-189	1969 All.....	8.99 ea.
HTP-190	1969 SS Code DW.....	8.99 ea.
HTP-170	1969-70 SS Code AO.....	8.99 ea.
HTP-173	1970-72 All.....	8.99 ea.

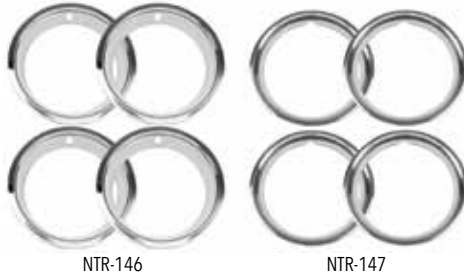

NTR-146

NTR-147

Trim Ring Sets

OE style reproduction trim ring kits at an affordable price.

NTR-146	14 x 6 Rally.....	99.99 kit
NTR-147	14 x 7 Rally.....	119.95 kit
NTR-157	15 x 7 Rally.....	99.99 kit
NTR-158	15 x 8 Rally.....	99.99 kit



NTW-1090

SS Trim Ring Sets

OE style reproduction trim rings packaged in convenient sets for your Super Sport.

NTW-1090	1969-70 14 x 7.....	99.99 kit
NTW-1095	1969-70 15 x 7.....	119.99 kit
NTR-70Z	1971-72 15 x 7*.....	159.99 kit

*Gray 5 Spoke Style



HMK-6970

SS Wheel Restoration Supplies

Ground Up Motors offers everything you need to restore your original Super Sport Wheels. Order our 4 piece paint mask kit along with Argent Silver and SS Insert grey paint for a complete job.

HMK-6970	Paint Mask Set.....	27.95 kit
DUP-HWP101	Argent Silver Paint Can.....	10.99 ea.
HDP-1214	Insert Grey Paint Can.....	13.99 ea.



NJT-YENKO

Yenko SS Wheel Center Cap Kit

This is a set of 4 SS style center caps with the iconic Yenko logo.

NJT-YENKO	1969-70 Complete.....	139.95 kit
-----------	-----------------------	------------



NJT-671K



NJT-63K

Center Cap Kit

This complete set includes (4) nice reproduction center caps with retainers (where applicable) for your SS wheels.

NJT-671K	1969-70 8pc.....	103.88 kit
NJT-63K	1971-72 4pc.....	82.76 kit



NSS-70K

SS Center Cap Kit

These center caps are reserved for the true purist because they feature a deep indented SS center cap like factory OEM. These metal caps are made of high quality cast aluminum just like they came from the factory! These caps are a little pricier, but are clearly the obvious choice when going for a totally stock restoration.

NSS-70K	1969-70 Complete.....	99.95 kit
---------	-----------------------	-----------

Super Sport Center Caps

OE style reproduction retainers and caps to freshen up your Super Sport Wheels.



NCE-6770

NCE-6770	SS Cap.....	19.99 ea.
----------	-------------	-----------



NCX-396



NCX-454

NCX-396	SS396 Cap.....	19.99 ea.
NCX-454	SS454.....	19.99 ea.

TRSD Performance Series Disc Brake Conversions

These all new disc brake conversions from The Right Stuff feature Wilwood 2 piston calipers, street performance brake pads, stainless braided flex hoses, spindles, caliper brackets, dust shields, proportioning valve, brake booster with master cylinder and factory size drilled and slotted rotors making for a super easy installation. These kits fit with most 15" or larger wheels.



Street Performance Series Upgrade Featuring Wilwood Calipers

The Right Stuff Detailing's new Street Performance Series front disc brake upgrade kit is an easy way to add a nice finishing touch to your car. This kit features Wilwood dual piston black powder coated calipers, fully loaded with pads and hardware, drilled & slotted rotors and spindles. No booster, master cylinder, or pro-valve included. Installation hardware and instructions are included.



AFXDC32S



AFXDC32SX



RCP69Z

AFXRDM25S



F69RDM25S

AFXWK32DZ

AFXWK32DS

4 Wheel Kits

Non Staggered Shocks

AFXSD23CS	1962-67 Black Calipers Manual	1462.99 kit
AFXSD23CZ	1962-67 Red Calipers Manual.....	1462.99 kit
AFXDC23CS	1962-67 Black Calipers 9" Gold Booster.....	2020.99 kit
AFXDC23CZ	1962-67 Red Calipers 9" Gold Booster	2020.99 kit

Non Staggered Shocks 2" Drop Spindle

AFXSD23DS	1962-67 Black Calipers Manual.....	1498.99 kit
AFXSD23DZ	1962-67 Red Calipers Manual	1498.99 kit
AFXDC23DS	1962-67 Black Calipers 9" Gold Booster.....	1796.99 kit
AFXDC23DZ	1962-67 Red Calipers	1796.99 kit

Staggered Shocks

AFXSD25CS	1968-74 Black Calipers Manual.....	1934.99 kit
AFXSD25CZ	1968-74 Red Calipers Manual	1462.99 kit
AFXDC25CS	1968-74 Black Calipers 11" Gold Booster.....	2020.99 kit
AFXDC25CZ	1968-74 Red Calipers 11" Gold Booster.....	2020.99 kit
AFXSD25CSX	1968-74 Black Calipers Manual Chrome Master.....	1997.99 kit
AFXSD25CZX	1968-74 Red Calipers Manual Chrome Master.....	1507.99 kit
AFXDC25CSX	1968-74 Black Calipers 8" Chrome Booster.....	2077.99 kit
AFXDC25CZX	1968-74 Red Calipers 8" Chrome Booster.....	2077.99 kit

Staggered Shocks 2" Drop Spindle

AFXSD21DS45DS	1968-74 Black Calipers Manual.....	1985.99 kit
AFXSD21DZ45DZ	1968-74 Red Calipers Manual	1985.99 kit
AFXDC21DS45DS	1968-74 Black Calipers 11" Gold Booster.....	2065.99 kit
AFXDC21DZ45DZ	1968-74 Red Calipers 11" Gold Booster.....	2065.99 kit
AFXSD25DSX	1968-74 Black Calipers Manual Chrome Master.....	2043.99 kit
AFXSD25DZX	1968-74 Red Calipers Manual Chrome Master.....	2043.99 kit
AFXDC21DSX45DSX	1968-74 Black Calipers 8" Chrome Booster.....	2129.99 kit
AFXDC21DZX45DZX	1968-74 Red Calipers 8" Chrome Booster.....	2129.99 kit

Front End Kits Stock Height

AFXDC32S	1968-74 Black Calipers 11" Gold Booster.....	1187.99 kit
AFXDC32Z	1968-74 Red Calipers 11" Gold Booster.....	1187.99 kit
AFXDC32SX	1968-74 Black Calipers 8" Chrome Booster.....	1312.99 kit
AFXDC32ZX	1968-74 Red Calipers 8" Chrome Booster.....	1312.99 kit

Front End Kits 2" Drop Spindle

AFXDC32DS	1968-74 Black Calipers 11" Gold Booster.....	1273.99 kit
AFXDC32DZ	1968-74 Red Calipers 11" Gold Booster.....	1273.99 kit
AFXDC32DSX	1968-74 Black Calipers 8" Chrome Booster.....	1358.99 kit
AFXDC32DZX	1968-74 Red Calipers 8" Chrome Booster.....	1358.99 kit

Front End Upgrade Kits

These kits come with drilled and slotted rotors, calipers, spindles and hardware.

AFXWK32S	1968-74 Black Calipers Stock Height.....	1021.99 kit
AFXWK32Z	1968-74 Red Calipers Stock Height.....	1021.99 kit
AFXWK32DS	1968-74 Black Calipers 2" Drop Spindle.....	1072.99 kit
AFXWK32DZ	1968-74 Red Calipers 2" Drop Spindle.....	1072.99 kit

These kits come with drilled and slotted rotors, loaded calipers and hardware.

RCP69S	1968-74 Black Calipers	816.99 kit
RCP69Z	1968-74 Red Calipers	816.99 kit
RCP70S	1975-78 Black Calipers	614.99 kit
RCP70Z	1975-78 Red Calipers	614.99 kit
RCP79S	1979 Black Calipers	614.99 kit
RCP79Z	1979 Red Calipers.....	614.99 kit

Rear End Kits Non Staggered Shocks

AFXRDM21S	1962-79 Black Calipers.....	889.99 kit
AFXRDM21Z	1962-79 Red Calipers	889.99 kit

Rear End Kits Staggered Shocks

AFXRDM25S	1962-79 Black Calipers	889.99 kit
AFXRDM25Z	1962-79 Red Calipers	889.99 kit

Rear Kits With Front Upgrade Kits

These kits come with a complete rear kit, a front kit with drilled and slotted rotors, loaded calipers and hardware.

F69RDM25S	1969-74 Black Calipers	1609.99 kit
F69RDM25Z	1969-74 Red Calipers	1609.99 kit
F70RDM25S	1975-77 Black Calipers	1609.99 kit
F70RDM25Z	1975-77 Red Calipers	1609.99 kit
F78RDM25S	1978 Black Calipers	1609.99 kit
F78RDM25Z	1978 Red Calipers.....	1609.99 kit

These kits ship oversize. No Volume Discount.



AFXDC42CZ



AFXR01

Rear Disc Brake Conversion Kit

Complete rear disc brake conversion kit for the ultimate stopping power. This kit includes rotors, loaded calipers, caliper brackets, bracket hardware, flex hoses and rear brake cables.

To add drilled and slotted rotors and painted calipers, add the following letters.

S for black calipers, Z for red calipers.

Ex. AFXRD01S is 1967-69 with black calipers. Add \$120.00 to the cost for this option.

AFXR07_	1975-79 All	668.99 kit
AFXR01N	1962-67 All	521.99 kit
AFXR01NS	1962-67 All Black Calipers	668.99 kit
AFXR01NZ	1962-67 All Red Calipers	668.99 kit
AFXR01_	1968-74 w/o Staggered	668.99 kit
AFXR05_S	1968-74 w/ Staggered	668.99 kit

5 lug only. No Volume Discount. Ships in multiple Oversize boxes.

Four Wheel Power Disc Brake Conversion Kits

Upgrade your classic to the ultimate in stopping power. Upgrade packages available -see ledger below. Our 4 wheel kits are the most complete kits in the industry at rock bottom prices. Add our No Brainer- Disc Brake line kit for a care-free installation.

Stock Height	Non-Staggered Rear Shocks	
AFXDC42C	1968-74 Nova 11" PB	1187.99 kit
AFXDC42CZ	1968-74 Nova 11" PB, DS, RPC	1460.99 kit
AFXDC42CX	1968-74 Nova 8" Chrome PB	1312.99 kit
AFXDC42CSX	1968-74 Nova 8" Chrome PB, DS, BPC	1551.99 kit
AFXDC42CZX	1968-74 Nova 8" Chrome PB, DS, RPC	1551.99 kit

Stock Height	Staggered Rear Shocks	
AFXDC45C	1968-74 Nova 11" PB	1187.99 kit
AFXDC45CS	1968-74 Nova 11" PB, DS, BPC	1460.99 kit
AFXDC45CX	1968-74 Nova 8" Chrome PB	1312.99 kit
AFXDC45CSX	1968-74 Nova 8" Chrome PB, DS, BPC	1551.99 kit
AFXDC45CZX	1968-74 Nova 8" Chrome PB, DS, RPC	1551.99 kit

2" Dropped	Spindle Height Non-Staggered Rear Shocks	
AFXDC42D	1968-74 Nova 11" PB	1250.99 kit
AFXDC42DS	1968-74 Nova 11" PB, DS, BPC	1523.99 kit
AFXDC42DZ	1968-74 Nova 11" PB, DS, RPC	1523.99 kit
AFXDC42DX	1968-74 Nova 8" Chrome PB	1375.99 kit
AFXDC42DSX	1968-74 Nova 8" Chrome PB, DS, BPC	1614.99 kit
AFXDC42DZX	1968-74 Nova 8" Chrome PB, DS, RPC	1614.99 kit

Staggered Rear Shocks		
AFXDC45D	1968-74 Nova 11" PB	1250.99 kit
AFXDC45DS	1968-74 Nova 11" PB, DS, BPC	1523.99 kit
AFXDC45DZ	1968-74 Nova 11" PB, DS, RPC	1523.99 kit
AFXDC45DX	1968-74 Nova 8" Chrome PB	1375.99 kit
AFXDC45DSX	1968-74 Nova 8" Chrome PB, DS, BPC	1614.99 kit
AFXDC45DZX	1968-74 Nova 8" Chrome PB, DS, RPC	1614.99 kit

*PB- Gold Power Booster, DS- Drilled & Slotted Rotors, BPC-black powder coated calipers, RPC-red powder coated calipers CH-Chrome power assembly (booster, master, pro-valve)

1962-67 w/ 5 Lug & Non Staggered Shocks		
AFXDC43C	9" PB	999.99 kit
AFXDC43CS	9" PB DS Rotors Black Calipers	1460.99 kit
AFXDC43CZ	9" PB DS Rotors Red Calipers	1460.99 kit

Fits 5 lug wheels only.



FSK-69KIT

Deluxe Disc Brake Mini Kit

This deluxe disc brake mini kit contains essential parts to convert to your own disc brake setup or refurbish your factory set up. Includes spindles, caliper brackets, caliper backing plates, flex hoses, pro valve kit, bearing and seal kit and hardware.

FSK-69KIT	1969-74 With Single Piston Calipers	378.99 kit
-----------	-------------------------------------	------------

Can be used on 1968 when using 69-72 single piston calipers. No Volume Discount.



FSK-69

Basic Disc Brake Mini Kit

Basic kit for converting to disc brakes or restoring factory disc brake setup. Complete with 2 spindles, 2 caliper brackets, 2 caliper backing plates and 2 bolts.

FSK-X62	1962-67	222.99 kit
FSK-69	1969-74	263.12 kit

Can be used on 1968 when using 69-72 single piston calipers. No Volume Discount.

BEST SELLER! \$AVE BIG!

Front Power Disc Brake Conversion Kits

Upgrade your Nova today with the most complete front disc brake kit on the market. Includes all OEM parts and is available with multiple upgrades. Increase stopping power and give your car that factory stock disc brake appearance. Works with 15" wheels or larger. Includes:

- 11" rotors
- Forged spindles
- Bearings & Seals
- Loaded calipers
- Caliper brackets
- Backing plates
- Flex Hoses & Clips
- All hardware
- Master cylinder
- Power Booster (9" or 11" Gold)
- Combination valve & bracket

FM-1790X62	1962-67 Nova w/ 9" 3 Bolt Booster*	747.99 kit
FM-1790FS	1968-74 Nova w/ 11" Booster*	713.89 kit
FM-1790FS9	1968-74 Nova w/ 9" Booster Kit*	713.89 kit
* Free Upgrade- Add Drilled & Slotted Rotors- ADD - UP to Part #		
FM-1790DSF	1968-74 Nova 2" Drop Spindle-11" Booster.....	799.99 kit
FM-1790DSF9	1968-74 Nova 2" Drop Spindle-9" Booster.....	799.99 kit



SHOW N'GO UPGRADE

This package adds drilled and slotted rotors and red or black powder coated calipers.

FM-1790FS-UP-S	D/B Kit w/ Show N Go Black.....	716.96 kit
FM-1790FS-UP-Z	D/B Kit w/ Show N Go Red.....	724.95 kit
FM-1790DSFS	2" Drop Kit-11" w/ Show N Go Black.....	941.99 kit
FM-1790DSFZ	2" Drop Kit-11" w/ Show N Go Red.....	941.99 kit



BEST OF SHOW UPGRADE

Adds drilled & slotted rotors, 8" chrome master, booster, pro-valve assembly and powder coated calipers.

FM-1790FS-UP-SX	D/B Kit w/ Best of Show Black.....	847.21 kit
FM-1790FS-UP-ZX	D/B Kit w/ Best of Show Red.....	855.21 kit
FM-1790DSFX	2" Drop Kit- w/ Best of Show Black.....	1039.99 kit
FM-1790DZFX	2" Drop Kit- w/ Best of Show Red.....	1039.99 kit

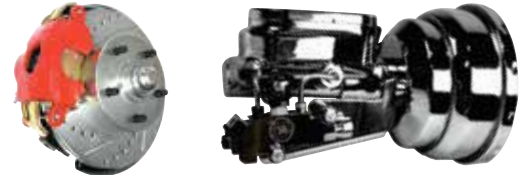

SHOW STOPPER UPGRADE

Adds drilled & slotted rotors and a chrome master, booster, pro-valve assembly

FM-1790FS-UP-X	D/B Kit w/ Show Stopper Chrome.....	817.15 kit
----------------	-------------------------------------	------------



1962-67 Four Wheel Disc Brake Conversions

Ground Up Motors's all new four wheel disc brake conversion kits feature plain as cast, black, or red powder coated calipers, with the option for drilled & slotted rotors! This disc brake conversion kit allows you to convert to a four wheel disc setup for dramatically increased stopping power and safety. Installation hardware and instructions are included.

Stock Height Spindles. Gold Booster.

DBK6267K	1962-67 9" PB.....	879.99 kit
DBK6267K-DS	1962-67 9" PB DS.....	899.99 kit
DBK6267K-DSB	1962-67 9" PB DS BPC.....	859.99 kit
DBK6267K-DSR	1962-67 9" PB DS BPC.....	899.99 kit
CNB67D6	1962-67 Lines OM.....	146.99 kit
SCNB67D6	1962-67 Lines SS.....	175.99 kit

DS = Drilled & Slotted Rotors
BPC = Black Powder Coated Calipers
RPC = Red Powder Coated Calipers

Requires the use of 5 lug 15 inch or larger wheels. Ships oversize. No Volume Discount.

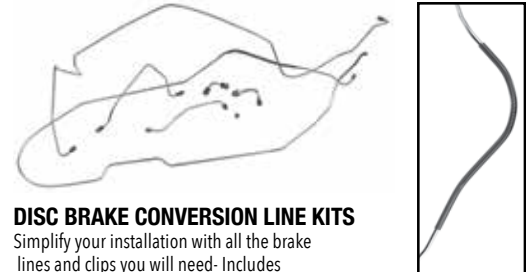

DISC BRAKE CONVERSION LINE KITS

Simplify your installation with all the brake lines and clips you will need- Includes

- Front line kit • Front to Rear line
- Rear axle line set • Rear flex hose • Clip set

X62DCKIT_ _ _ _	1962-67 Nova.....	Original 117.99 kit
		Stainless 157.99 kit
X68DCKIT_ _ _ _	1968-74 Nova.....	Original 117.99 kit
		Stainless 157.99 kit

M Manual brakes-No Power booster used

*4 4 wheel disc brakes *SS for stainless steel lines

FCS68DC	1968-74 All Line Clip Kit.....	18.99 kit
---------	--------------------------------	-----------

Signature
by TRSD

THE
RIGHT
Stuff



AFXDC55CSX

SIGNATURE* BY TRSD 4-WHEEL DISC BRAKE CONVERSION KITS

*FOR 17" OR LARGER WHEELS. LIFETIME WARRANTY!!!

Bold looks define the Signature line of Brake Kits. Large diameter (13") zinc plated rotors, powder coated calipers and USA made Timken bearings: Only premium quality components make the grade. These are amazing brakes at a great price. Add the No Brainer Brake Line Kit for true bolt-in installation. Requires minimum 17" wheel. Bolts to stock drum or disc spindles.

Complete kit includes:

- 13" front drilled/slotted zinc plate rotors
- 12" rear drilled/slotted zinc plate rotors
- 2024-T6 forged aluminum hubs w/ 7/16" and 1/2" studs for multiple applications.
- Twin piston aluminum powder coated calipers- red or black
- Fully machined caliper brackets
- Ceramic brake pad
- Braided stainless steel hoses
- Integrated parking brake
- Premium quality hardware
- OEM style Master cylinder w/ Combination Valve
- Chrome Master/Booster/Valve upgrade available*

*PB- Gold Power Booster, DS- Drilled & Slotted Rotors, BPC-black powder coated calipers, RPC-red powder coated calipers CH-Chrome power assembly (booster, master, pro-valve)

STOCK HEIGHT SIGNATURE KITS

AFXDC53CS	1962-67 Nova w/ PB, DS, BPC.....	2083.99 kit
AFXDC53CZ	1962-67 Nova w/ PB, DS, RPC.....	2083.99 kit
AFXDC55CS	1968-74 Nova w/ PB, DS, BPC.....	1934.99 kit
AFXDC55CZ	1968-74 Nova w/ PB, DS, RPC.....	1934.99 kit
AFXDC55CSX	1968-74 Nova w/ PB, DS, BPC, CH.....	2060.99 kit

2" DROPPED SPINDLE SIGNATURE KITS

AFXDC55DS	1968-74 Nova w/ PB, DS, BPC.....	2145.99 kit
AFXDC55DZ	1968-74 Nova w/ PB, DS, RPC.....	2145.99 kit
AFXDC55DSX	1968-74 Nova w/ PB, DS, BPC, CH.....	2271.99 kit
AFXDC55DZX	1968-74 Nova w/ PB, DS, RPC, CH.....	2271.99 kit

4 WHEEL DISC BRAKE CONVERSION LINE KITS - "NO BRAINER"

Simplify your installation when doing a 4- wheel disc brake conversion with all the brake lines and clips you will need-

Includes Front line kit, Front to Rear line, Rear axle line set, Rear flex hoses and Clip set.

	Original	Stainless
X62DCKIT4__	1962-67 Nova 4W D/B lines 117.99 kit	157.99 kit
X68DCKIT4__	1968-74 Nova 4W D/B lines 117.99 kit	157.99 kit



FRC-69FB

FRC-69FR

Powder Coated Calipers

Add a nice finishing touch with these loaded calipers, complete with pads and hardware.

FRC-69FR	1969-74 Red	159.98 kit
FRC-69FB	1969-74 Black.....	159.98 kit
FRC-70FR	1975-77 Red.....	159.98 kit
FRC-70FB	1975-77 Black.....	159.98 kit
FRC-78FR	1978-79 Red.....	159.98 kit
FRC-78FB	1978-79 Black.....	159.98 kit



FRC-4059

FRC4044



Single Piston Brake Calipers

New single piston loaded calipers, complete with pads and all new hardware. Ready to install!

FRC4044	1969-74 LH	59.95 ea.
FRC4043	1969-74 RH.....	59.95 ea.
FRC-4060	1975-77 LH	61.95 ea.
FRC-4059	1975-77 RH.....	61.95 ea.
FRC-4124	1978-79 LH	84.95 ea.
FRC-4123	1978-79 RH.....	84.95 ea.

No Volume Discount.



FBC-4PSTL



XFC6701

4 Piston Brake Calipers

All new 4 piston calipers with Delco Moraine logo and casting numbers 5455530 and 5455533. Completely assembled.

FBC-4PSTL	1967-68 LH	270.99 ea.
FBC-4PSTR	1967-68 RH.....	270.99 ea.

No Volume Discount.

Caliper Inlet Lines

XFC6701	1967-68 OM	19.99 pr.
XFC6701SS	1967-68 SS	25.99 pr.



FMP-0200

Disc Brake Pads
New brake pad set.

FMP-0400	1967-68 4 Piston	49.99 set
FMP-0200	1969-74 1 Piston	36.95 set



FNW-103

Bearing Nut - Washer Kit
Correct castle nut, thrust washer and cotter pin. 2 kits are required per car.

FNW-103	1968-74 All	8.99 kit
---------	-------------	----------



FBK-67D

Bearing & Seal Kit
New GM bearing & seal kit (2) inners, (2) outers and (2) grease seals.

FBK-67D	1968-74 All w/ Disc	46.53 kit
---------	---------------------	-----------



FBC-605

FBC-99

Bearing Cap
Original GM bearing & dust shield cap.

FBC-605	1968-75 All (Correct Dimple)	11.99 ea.
FBC-99	1976-79 All	19.99 ea.



FKW-4160

Caliper Backing Plates
OE style reproduction zinc backing plates.

FKW-4160	1967-68 4 Piston	87.99 pr.
FPP-11J	1969-72 Single Piston	39.95 pr.

No Volume Discount.

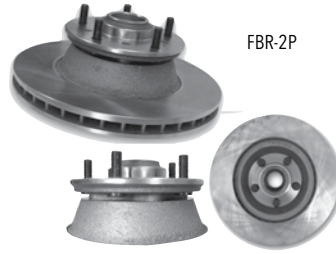

FBR-2P

2 Piece Rotors
Available for the first time! All cars from 1967-72 originally came with 2 piece rotors from the factory. These 2 piece rotors duplicate the originals and are a must for a concours restoration.

FBR-2PK	1968-74 All Pair	324.99 kit
---------	------------------	------------



FBR-880

Rotors
New replacement style rotors.

FBR-780	1967-68 4 Piston	74.99 ea.
FBR-880	1969-74 All	99.99 ea.
FBR-880KIT	1969-74 Pair	199.99 pr.
FBR-990	1975-79 All	69.95 ea.



FCDR-66



FCDR-7981

Drilled & Slotted Rotors
Drilled and slotted for maximum cooling and reduced fade; the ultimate in high performance braking and looks.

FCDR-66	1969-74*	163.99 pr.
FCDR-7078	1975-78	188.99 pr.
FCDR-7981	1979	188.99 pr.

*Works on 1968 with single piston calipers.



FRH-6474HK-OE

Drum Brake Front Hub Kit
OE quality drum brake hub kit. Replace your worn out drum brake hubs with this complete kit.

FRH-6474HK-OE	1968-74 All	99.99 set
---------------	-------------	-----------

No volume discount.



EVP01

Electric Vacuum Kit
If you have a big cam and low vacuum is making it tough for your power disc brakes to work properly, then this electric vacuum pump kit will solve your problems! A minimum of 16 inches of vacuum is critical to ensure that your power disc brakes are functioning and this kit ensures that your vacuum stays above that level so you will never have to worry about losing your brakes when you need them the most. The system automatically activates when the vacuum falls below that critical level and turns off when the engine is producing enough vacuum.

This kit includes an efficient electric pump, relay switch, distributor with vacuum switch, wiring, hoses and brackets. This system requires a 12V negative ground system for operation.

EVP01	Vacuum Pump Kit	309.99 kit
-------	-----------------	------------



FBP-035

Disc Brake Retaining Pin
Correct pin for retaining 4 piston caliper brake pads to caliper. 2 required.

FBP-035	1967-68 4 Piston	6.99 ea.
---------	------------------	----------



BCP-373

Backing Plate Bolt
Correct bolt for attaching plate to spindle.

BCP-373	1969-74 Single Piston	20.99 ea.
---------	-----------------------	-----------



BMP-1000

Brake Caliper Bolts
Correct bolts/pins for mounting caliper to bracket. Two per caliper.

BMP-1000	1969-77 Single Piston	2.99 ea.
----------	-----------------------	----------



FM-155X

FM-2501

Caliper Mounting Brackets
OE style reproduction caliper mounting brackets.

FM-155X	1967-68 4 Piston	150.99 pr.
FM-2501	1969-74 Single Piston*	86.99 pr.

*15" or larger wheels.



FSA-02

Steering Arms

OE style reproduction steering arms for your worn or missing originals.

FSA-02 1968-74 79.99 pr.
Can be used on 1962-66 when converting to disc brakes.



FM-373B

FM-3712

Spindles

New OEM spindles

FM-X62 1962-67 Disc..... 119.00 pr.
FM-3712 1969-72 Disc..... 79.99 ea.
FM-1712 1969-72 Drum 99.99 ea.
FM-373B Attaching Bolts 6.95 pr.



RSBK67

Front Hose to Caliper Brackets

Correct bracket to attach the front brake hose to the 4 piston calipers on your 1967-68 Nova.

RSBK67 1967-68 4 Piston 34.99 pr.



HURST-1745000

Hurst Roll Control Line Lock

Used primarily in drag racing to provide positive locking action to the front wheels of race cars, reducing the chance of "Rolling the Lights" and producing more effective "Burn Outs" for heating up the tires. Rigorous testing has proved a 1/100,000 of a second release time and vibration tests have seen up to 30 G's applied without mechanical failure. Adaptable to most domestic and import hydraulic brake systems.

HURST-1745000 All Universal Roll Control..... 164.99 kit
HURST-5671510 Installation Kit 62.99 kit
No Volume Discount.



FMP-1362

FMP-1966



FMP-1967

FMP-069



FMP-1970

FMP-070

OEM Style Master Cylinders

Choose from a wide variety of master cylinders to suit your needs. OEM style master cylinders feature cast bodies with caps. Choose a master with bleeders for the ultimate in authenticity.

FMP-1362 1962-66 Single Drum 69.99 ea.
FMP-1966 1967-74 Dual Drum 99.99 ea.
FMP-1967 1968-69 Power Disc 63.99 ea.
FMP-069 1968-69 Power Disc with Bleeders..... 113.99 ea.
FMP-1970 1970-79 Power Disc 69.95 ea.
FMP-070 1970-79 Power Disc with Bleeders..... 107.99 ea.



FMP-1967C

FMP-51C

Chrome Master Cylinders

A chrome master cylinder will add a beautiful finishing detail to your engine compartment so you will be proud to pop your hood at any car show!

FMP-1967C 1967-79 Round Disc/Drum 1-1/8" Bore..... 107.99 ea.
FMP-04C 1967-79 Round Disc/Disc 1" Bore 107.99 ea.
FMP-51C 1967-79 Slimline Disc/Drum 1-1/8" Bore.. 126.99 ea.
FMP-56C 1967-79 Slimline Disc/Disc 1" Bore 126.99 ea.



NMKT813

Dual Master Conversion Kits

Give your pre-1967 Nova a dual master cylinder system. This kit separates the front brakes from the rear brakes for a much safer system. Each kit includes a distribution block, mounting bracket with hardware and a full set of pre-bent brake lines to finish the installation.

NMKT811 Standard Drum w/ MasterOM 252.87 kit
.....SS 291.57 kit
NMKT813 Power Drum w/ Master.....OM 252.87 kit
.....SS 291.57 kit
RSBB07 Brass Dist Block Only95.99 kit



FMC-6700



FG-67B

Master Cylinder Caps & Gaskets

New correct gold cadmium plated caps.

Caps

FMC-6450 1962-66 Single..... 24.99 ea.
FMC-67D 1967-74 Drum..... 18.95 ea.
FMC-6700 1967-69 Disc 16.95 ea.
FMC-6800 1970-79 Disc 16.95 ea.

Gaskets

FG-67D 1967-74 Drum..... 7.99 ea.
FG-67B 1967-69 Disc 9.99 ea.
FG-695 1970-79 Disc 7.99 ea.



FMR-12441

Master Cylinder Rod Assembly

Correct master cylinder push rod assembly used when converting to manual disc or if the car is manual drum.

FMR-12441 1968-74 56.99 ea.



FLN-12968

Master Cylinder Clevis Lock Nut

Equipped on all factory manual or power disc cars to prevent the rod from spinning so that the clevis does not fall off.

FLN-12968 1964-72 2.99 ea.



FMP-12046

Master Cylinder Firewall Reinforcement Plate

Used only on manual brakes to provide support at the firewall for the master cylinder.

FMP-12046 1968-74 9.99 ea.



BMK-9SB

BUY'N SAVE
WITH KITS



Booster/Master Kits

Replace your old booster and master in one shot and save! These kits are available in many configurations to suit your restoration needs. If you are restoring a car to original specs, the factory style bleeder screws featured in this master cylinder are a must. The booster is available in 9" or 11" configurations and with or without the Delco Moraine stamp. 1968-69 includes round master and 1970-72 includes square master.

BMK-69GM	1967-69 11" Booster w/ Stamp OEM Style w/ Pro-valve.....	249.99 kit
BMK-9R	1968-69 with 9" Booster.....	227.68 kit
BMK-11R	1968-69 with 11" Booster.....	227.68 kit
BMK-9RD	1968-69 with 9" Booster Delco Stamp.....	227.68 kit
BMK-11RD	1968-69 with 11" Booster Delco Stamp.....	227.68 kit
BMK-9RB	1968-69 with Bleeder Screws with 9" Booster.....	272.68 kit
BMK-11RB	1968-69 with Bleeder Screws with 11" Booster.....	272.68 kit
BMK-9RBD	1968-69 with Bleeder Screws with 9" Booster Delco Stamp.....	272.68 kit
BMK-11RBD	1968-69 with Bleeder Screws with 11" Booster Delco Stamp.....	272.68 kit
BMK-9S	1970-74 with 9" Booster.....	237.58 kit
BMK-11S	1970-74 with 11" Booster.....	237.58 kit
BMK-9SD	1970-74 with 9" Booster Delco Stamp.....	237.58 kit
BMK-11SD	1970-74 with 11" Booster Delco Stamp.....	237.58 kit
BMK-9SB	1970-74 with Bleeder Screws with 9" Booster.....	267.28 kit
BMK-11SB	1970-74 with Bleeder Screws with 11" Booster.....	267.28 kit
BMK-9SBD	1970-74 with Bleeder Screws with 9" Booster Delco Stamp.....	267.28 kit
BMK-11SBD	1970-74 with Bleeder Screws with 11" Booster Delco Stamp.....	267.28 kit

No Volume Discount.



AXP-0656

Power Brake Hose Kit

OEM hose with correct double circle Delco check valve, gasket and black phosphate clamps.

AXP-0656	1967-74.....	21.95 kit
----------	--------------	-----------



FBB-3715

Power Booster Boot

Exact reproduction of this often missing boot.

FBB-3715	1968-74 All.....	14.99 ea.
----------	------------------	-----------



APJ-1217

APN-0270

Power Brake Tube

Correct "pre-bent" tube with bracket for cars with power brakes (high quality zinc plated as original).

APN-7938	1968-69 All BB.....	28.99 ea.
APN-0270	1970 All BB.....	21.99 ea.
APN-71	1971-72 All BB.....	21.99 ea.

Power Brake Hose Bracket

APJ-1217	Most SB w/ PB.....	15.95 ea.
----------	--------------------	-----------

BMK-SHOW11R



Chrome Booster/Master/Pro Valve Kit

This show quality chrome plated power brake master cylinder and brake booster kit also includes a polished and chromed proportioning valve with stainless steel valve to master cylinder lines. This kit will be a great finishing touch for your classic Chevy.

BMK-SHOW9R	1968-74 Disc/Drum, 9" Booster.....	439.99 kit
BMK-SHOW11R	1968-74 Disc/Drum, 11" Booster.....	439.99 kit
BMK-SHOW9R4W	1968-74 Disc/Disc, 9" Booster.....	439.99 kit
BMK-SHOW11R4W	1968-74 Disc/Disc, 11" Booster.....	439.99 kit

No Volume Discount.

SLIM-8C-2



Slimline Booster / Master / Pro-Valve Kits

These Slimline kits allow you to replace your booster, master cylinder, and proportioning valve in one simple step! All kits feature an 8" booster.

SLIM-8G-2	1968-74 Disc/Drum 8" Booster Gold.....	279.99 kit
SLIM-8G-4	1968-74 Disc/Disc 8" Booster Gold.....	203.99 kit
SLIM-8C-2	1968-74 Disc/Drum 8" Booster Chrome.....	399.99 kit
SLIM-8C-4	1968-74 Disc/Disc 8" Booster Chrome.....	349.99 kit
SLIM-8B-2	1968-74 Disc/Drum 8" Booster Black.....	279.95 kit
SLIM-8B-4	1968-74 Disc/Disc 8" Booster Black.....	279.95 kit



FPB-62X

1962-67 Nova 3 Stud Booster

This is a special 1962-1967 Chevy 2 Nova power brake booster which is specifically made to fit the 3 stud pattern on the firewall. The booster is gold cadmium plated, meaning you get better stopping power with an original look.

FPB-62X	1962-67	188.99 ea.
---------	---------	------------



FPB-1003C

Chrome Booster

This is a brand new Nova power brake booster crafted with chrome plating to set your car apart from the others.

FPB-9021C	1968-74 9"	248.99 ea.
FPB-1003C	1968-74 11"	188.99 ea.



FPB-7537C

7" Dual Slimline Booster

A good booster when room is tight. Great for big block cars with tall valve covers. Roughly the same assist as a 9" single booster.

FPB-7537	1968-74 Gold	109.95 ea.
FPB-7537C	1968-74 Chrome	119.95 ea.
FPB-7537S	1968-74 Stainless	175.99 ea.



FBB-6

11" Delco Moraine Booster

Crafted with the same gold cadmium plating as original, as well as the infamous Delco Moraine logo stamping for the ultimate in authenticity.

FBB-6	1968-74	188.99 ea.
-------	---------	------------



FPB-1102

11" Delco Style Booster

This is a brand new Nova power brake booster crafted with the same gold cadmium plating as the original.

FPB-1102	1968-74	136.99 ea.
----------	---------	------------



FPB-8531

8" Dual Slimline Booster

Our most powerful Slimline booster. 10-15% more assist than a 9" single. Compact enough to fit most applications.

FPB-8531	1968-74 Gold	115.99 ea.
FPB-8531C	1968-74 Chrome	119.95 ea.
FPB-8531S	1968-74 Stainless	194.99 ea.



FBB-3

9" Delco Moraine Booster

Crafted with the same gold cadmium plating and Delco Moraine logo as our 11" booster, this 9" booster allows more clearance when running tall valve covers.

FBB-3	1968-74	188.99 ea.
-------	---------	------------



FPB-9022

9" Delco Style Booster

This is a brand new Nova power brake booster crafted with the same gold cadmium plating as the original. This 9" booster allows more clearance when running tall valve covers.

FPB-9022	1968-74	136.99 ea.
----------	---------	------------



FPB-9102

9" Single Slimline Booster

Nice clean look and performance that won't disappoint. A good choice if you're undecided on which booster to get.

FPB-9102	1968-74 Gold	136.99 ea.
----------	--------------	------------



FBB-6-UP

11" Delco Booster w/ Upside Down Logo

Features authentic gold cadmium plating with correct upside down Delco Moraine logo for the purist.

FBB-6-UP 1968-74 188.99 ea.



FPV-05

1967-69 Distribution Block

Correct brake distribution block for factory drum or disc brakes. This valve is located under the master cylinder.

FPV-05 1967-69 All 85.99 ea.



FPR-110

1970-74 Distribution Block

Correct brake distribution block for factory drum or disc brakes. This valve is located under the master cylinder.

FPR-110 1970-74 All 89.99 ea.



FPR-104E

1967-69 Hold Off Valve

Originally used to hold pressure to the rear brakes so the front brakes could engage a split second earlier to prevent fishtailing.

FPR-104E 1967-69 Disc 69.99 ea.



FPR-104C

1970 Hold Off Valve

Originally used to hold pressure to the rear brakes so the front brakes could engage a split second earlier to prevent fishtailing.

FPR-104C 1970 Disc 79.99 ea.



FPR-114

1967-68 Pro Valve

Correct brake proportioning valve for factory original disc brakes. This valve is located under the master cylinder and includes the bracket.

FPR-114 1967-68 w/ PDB 99.99 ea.



FPV-89

1969 Pro Valve

Correct brake proportioning valve for factory original disc brakes. This valve is located under the master cylinder. Bracket not included.

FPV-89 1969 w/ PDB 96.99 ea.



FPV-7

1970 Pro Valve

Correct brake proportioning valve for factory original disc brakes. This valve is located under the master cylinder. Includes brackets and dust boots.

FPV-7 1970 w/ PDB 89.99 ea.



FPVB-3



FPV-BOOT

Proportioning Valve Bracket & Boot

Correct gold plated pro-valve bracket.

FPVB-3 1967-70 Bracket 39.99 ea.
FPV-BOOT All Boot 6.95 ea.



FPR-102

1971-77 Pro Valve

OEM style proportioning valve with correct wire lead for direct replacement.

FPR-102 1971-77 w/ PDB 79.99 ea.



FBRK-71F

1971-77 Valve Bracket

Correct reproduction of this proportioning valve bracket unique to 1971-77 Nova.

FBRK-71F 1971-77 23.99 ea.



PVK-71COMBOKIT

Proportioning Valve Kit

This is a universal proportioning valve that can be used on all cars when converting to disc brakes. Includes valve, bracket, harness and hardware. Choose from gold or chrome.

PVK-71COMBOKIT 2 Wheel Disc Gold 96.99 kit
PVK-72COMBO-KIT 4 Wheel Disc Gold 96.99 kit
PVK-71CK 2 Wheel Disc Chrome 138.99 kit
PVK-72CK 4 Wheel Disc Chrome 138.99 kit
MMC002 Brake Lines OM 18.99 kit
MMC002SS Brake Lines SS 24.99 kit

No Volume Discount.

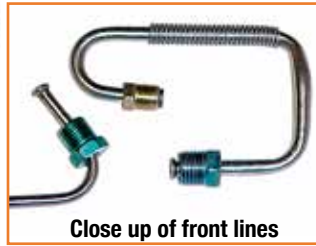
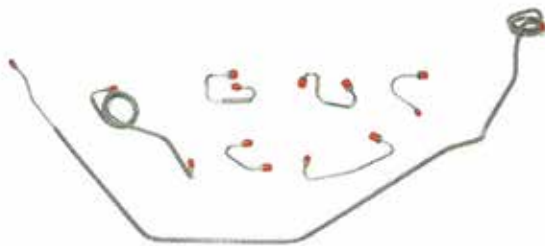

Close up of front lines

Brake Lines Pre-Bent

Our OE style reproduction brake lines are crafted from original GM blueprints as well as from low mileage original cars. All lines feature correct double flared fittings, correct color coded nuts and correct coiled armor shields. Available in original material (OM) or stainless steel (SS).
These lines are for original setups only and will not fit aftermarket conversions!

Front Line Kits

	OM	SS
XKT6201	1962-64 Manual Drum 4pc	56.99 kit 77.99 kit
XKT6202	1962-64 Power Drum 4pc	56.99 kit 77.99 kit
XKT6501	1965-66 Manual Drum 4pc	56.99 kit 77.99 kit
XKT6502	1965-66 Power Drum 4pc	56.99 kit 77.99 kit
XKT6701	1967 Manual Drum 6pc	66.99 kit 92.99 kit
XKT6703	1967 Manual Disc 7pc	66.99 kit 92.99 kit
XKT6704	1967 Power Disc 7pc	66.99 kit 109.99 kit
FKT6701	1968 Manual Drum 4pc	71.99 kit 106.99 kit
FKT6703	1968 Power Drum 4pc	71.99 kit 106.99 kit
FKT6705	1968 Manual Disc 5pc	71.99 kit 106.99 kit
FKT6707	1968 Power Disc 5pc	71.99 kit 106.99 kit
XKT6905	1969 Power Disc 5pc	70.99 kit 87.99 kit
FKT6903	1969-74 Power Drum 4pc	71.99 kit 106.99 kit
XKT6907	1969-73 Manual Drum 4pc	60.99 kit 92.99 kit
XKT7001	1970 Power Disc 7pc	71.99 kit 99.99 kit
XKT7201	1971-74 Power Disc 4pc	69.99 kit 87.99 kit
XKT7401	1974 Manual Drum 4pc	69.99 kit 87.99 kit
XKT7501	1975 Power Disc 5pc	60.99 kit 87.99 kit
XKT7601	1976-77 Power Disc 4pc	69.99 kit 87.99 kit
XKT7801	1978 Power Disc 4pc	60.99 kit 91.99 kit

Ships Oversize



Front to Rear Line Kits

	OM	SS
XIN6201	1962-65 All	59.99 kit 72.99 kit
XIN6601	1966 L-79 Only	51.99 kit 72.99 kit
XIN6602	1966 All	51.99 kit 72.99 kit
XIN6701	1967 All	51.99 kit 79.99 kit
XIN6801	1968 All	51.99 kit 72.99 kit
XIN6901	1969 P/Disc, P/Drum	69.99 kit 81.99 kit
XIN6902	1969-70 P/D 2pc	65.99 kit 89.99 kit
XIN6903	1969-73 Man Drum	72.99 kit 89.99 kit
XIN7001	1970 All Power	70.99 kit 95.99 kit
XIN7105	1971 Power Disc	60.99 kit 95.99 kit
XIN7103	1971-73 Power Drum	69.99 kit 69.99 kit
XIN7201	1972-73 Power Disc	64.99 kit 81.99 kit
XIN7402	1974 Power Disc	72.99 kit 89.99 kit
XIN7501	1975 All Power	60.99 kit 81.99 kit
XIN7601	1976-77 Power Disc	71.99 kit 95.99 kit
XIN7801	1978 Power Disc	60.99 kit 81.99 kit

Ships Oversize 2

Rear Axle Kits

XRA6202	1962-65 All	26.99 kit 36.99 kit
XRA6602	1966-67 All	26.99 kit 39.99 kit
FRA6802	1968 Mono Leaf	29.99 kit 42.99 kit
FRA6805	1968 Multi Leaf	29.99 kit 42.99 kit
XRA6902	1969-73 All	26.99 kit 36.99 kit
XRA7402	1974 All	29.99 kit 39.99 kit
XRA7502	1975 All	26.99 kit 36.99 kit
XRA7601	1976-77 All	28.99 kit 36.99 kit
XRA7801	1978 All	26.99 kit 36.99 kit



ELC-316 ELC-1316 ELC-516



ELC-038T ELC-10P BLC-056

Individual Brake Line Clips

Correct clips for attaching hard brake lines to frame. (Tabbed clips push into frame holes.)

ELC-316	3/16" Front	1.99 ea.
ELC-1316	3/16" w/ Tab	4.99 ea.
ELC-1516	5/16" Main	1.99 ea.
ELC-516	5/16" w/ Tab	4.99 ea.
ELC-038T	3/8" w/ Tab	3.99 ea.
ELC-10P	Double Push-In	3.95 ea.
BLC-056	Clip Bolt	0.50 ea.
INL-14999	1975-79 Master Cylinder Line Clip	12.99 ea.

**Use on main line with armor shielding.*

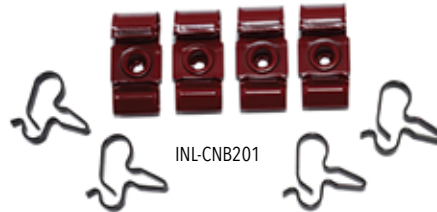

INL-CNB201

Brake Line Clip Kits

Complete brake line clip kits including all of the factory correct clips in the original colors.

INL-CNB201	1964-65 8pc	24.99 kit
INL-CNB202	1966 8pc	24.99 kit
INL-CNB203	1967 11pc	29.99 kit
INL-CNB204	1968 17pc	29.99 kit
INL-CNB205	1969 25pc	39.99 kit
INL-CNB206	1970 25pc	39.99 kit
INL-CNB207	1971-74 25pc	42.99 kit
INL-CNB208	1975-79 24pc	39.99 kit



INL-CNB206

BUY'N SAVE WITH KITS

Buy a complete set of front lines, front to rear lines and rear axle lines and take 10% off. Just mention this offer to your sales rep at the time of order!

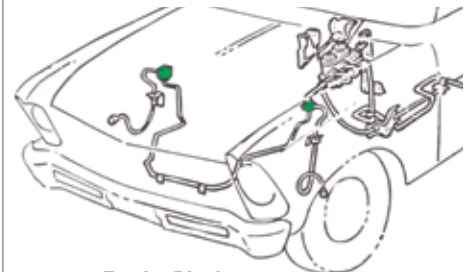

1962-67 Fender Blocks

Correct front flex hose fender blocks.

RSBB262	1962-1964 LH	18.99 ea.
RSBB265	1965-1966 LH	18.99 ea.
RSBB267	1967 LH	18.99 ea.
RSBB362	1962-1965 RH	22.99 ea.
RSBB366	1966 RH	18.99 ea.
RSBB367	1967 RH	18.99 ea.



EBH-05

Front Flex Hoses

New OEM front flex hoses exact to original.

EBH-35	1962-66 Drum	18.99 ea.
EBH-37	1967 Drum	31.99 ea.
EBH-42	1967 Factory Disc	37.99 ea.
EBH-012	1968-73 Drum	13.99 ea.
EBH-003	1969-72 Disc	13.99 ea.
EBH-163	1976 All	25.99 ea.
EBH-08	1977-78 All	16.99 ea.
EBH-09	1979 All	13.99 ea.

Rear Flex Hoses

New OEM rear flex hoses exact to original.

EBH-32	1962-65 All	17.99 ea.
EBH-04	1966-67 All	13.99 ea.
EBH-05	1968 All	13.99 ea.
EBH-06	1969-72 All	21.99 ea.
EBH-12	1974-75 All	19.99 ea.
EBH-76	1976 All	30.99 ea.
EBH-13	1977-79 All	25.99 ea.



RSBK67

Front Hose to Caliper Brackets

Correct bracket to attach the front brake hose to the 4 piston calipers on your 1967-68 Nova.

RSBK67	1967-68 4 Piston	34.99 pr.
--------	------------------------	-----------



EBB-691

Flex Hose Bolts

Correct OEM brake fluid bolt with hollow center and (2) special washers for attaching flex hose to caliper.

EBB-691	All w/ Disc Brakes	3.99 ea.
---------	--------------------------	----------



EBC-22

Flex Hose Clip

Correct clip for retaining flex hose.

EBC-22	All	3.99 ea.
--------	-----------	----------



FXB-105

Rear Flex Hose Brackets

Correct rear axle line flex hose brackets for the rear end.

FXB-103	1967-68 All	14.99 ea.
FXB-105	1969-74 12-Bolt	17.99 ea.
FXB-18	1969-74 10-Bolt	21.99 ea.



FBLK-1

Flex Hose Block

Correct brass block for rear axle hose.

FBLK-1	1966-68 All	13.99 ea.
--------	-------------------	-----------

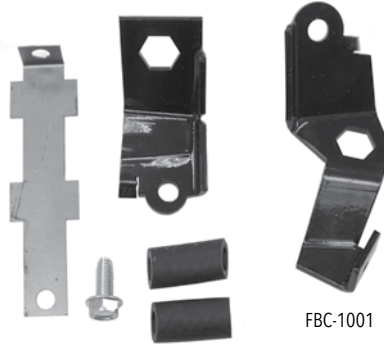

FBC-1001

Disc Brake Flex Hose Bracket Set

Set of three correct brackets to hold flex hoses.

FBC-1001	1969 w/ PDB	42.99 kit
----------	-------------------	-----------



FCR-176

Wheel Cylinder Rods

Correct brake shoe thrust rods for engaging shoes. (2) required per wheel cylinder.

FCR-176	1962-79 All	5.99 ea.
---------	-------------------	----------



FWC-01

Wheel Cylinders

New OEM wheel cylinders exact to original.

FWC-24	1962-63 Front LH	33.99 ea.
FWC-25	1962-63 Front RH	33.99 ea.
FWC-26	1962-63 Rear LH	33.99 ea.
FWC-27	1962-63 Rear RH	33.99 ea.
FWC-28	1965-67 Front LH	37.99 ea.
FWC-29	1965-67 Front RH	37.99 ea.
FWC-01	1968-74 Front LH	21.99 ea.
FWC-02	1968-74 Front RH	21.99 ea.
FWC-08R	1965-79 Rear LH or RH	19.95 ea.
FWC-04	1976-79 Rear LH or RH	34.99 ea.
BWC-100	Attaching Bolts (2)	1.95 pr.

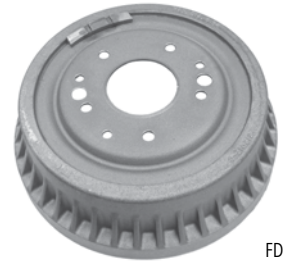

FD-95F

Brake Drums

Brand new finned brake drums.

FBD-95R	1962-74 Rear*	64.99 ea.
FD-95F	1962-74 Front*	69.99 ea.

*For original 5 lug hubs or conversions only.



FBP-41L

Backing Plates

New replacement rear drum backing plates.

FBP-41L	All LH	64.99 ea.
FBP-41R	All RH	64.99 ea.
FBP-41K	All RH/LH	116.98 kit
FPB-BOLT	Retaining Bolt/Nut	0.95 ea.



FPK-1671



FPK-REAR-KIT

Brake Hardware Kit

Correct springs, rods, retainer, adjustor and clamp for mounting shoes to car. Does 2 wheels.

FPK-1671	All 1966-79 Front	45.84 kit
FPK-2642	All 1966-79 Rear	43.32 kit
FPK-REAR-KIT	All 1966-79 9.5" Drums	154.99 kit



F5-64R

FB5-64F

Brake Shoes

Complete shoes for 2 drums.

F5-64R	All Rear.....	29.95 pr.
FB5-64F	All Front.....	32.95 pr.



FAP-2R

FBG-17

Drum Brake Guide/Pin

FBG-17	Upper Guide Plate.....	5.95 ea.
FAP-2R	Attaching Pin Rear.....	19.99 ea.

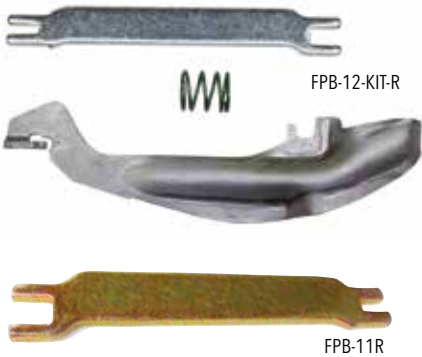

FPB-12-KIT-R

FPB-11R

Parking Brake Shoe Bar

Correct horizontal bar for activating parking brakes.

FPB-11R	1968-74 All Rear.....	14.99 ea.
FPB-12-KIT-R	Lever/Spring Kit RH.....	43.99 kit
FPB-12-KIT-L	Lever/Spring Kit LH.....	43.99 kit

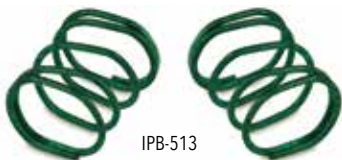

IPB-513

Parking Brake Guide Bar Springs

Correct green springs for 9.5 inch rear drum brakes.

IPB-513	1964-79.....	9.99 pr.
---------	--------------	----------



NQ-397

Parking Brake Guide

Correct hooks for supporting cables to crossmember.

NQ-397	1968-74 All.....	9.99 ea.
NQ-X75	1975-79 All.....	12.99 ea.



Parking Brake Cable Super Kits

These kits include everything you need to totally replace your old parking brake cables! These kits come with (1) front cable, (1) intermediate cable (where applicable), (2) rear cables, (1) cable equalizer, (2) cable connectors, (2) frame hooks, (1) crossmember hook and (3) cable retainer clips. Available in original material (OM) or stainless steel (SS).

	OM	SS
FBSN-6401	1964-67 Kit..... 150.99 kit.....	238.99 kit
FBSN-6801	1968-74 Kit..... 116.99 kit.....	199.99 kit
FBSN-7501	1975-79 Kit..... 143.99 kit.....	195.99 kit

No Volume Discount



NQ-93

Brake Cable Support

Correct rear cable support brackets which mount to the lower plates for multi leaf springs.

NQ-93	1968-74 Multi Leaf.....	23.95 ea.
-------	-------------------------	-----------



NJ-4675

Brake Cable Connector

Correct U shaped zinc connector for connecting intermediate cable to rear cables.

NJ-4675	1968-79 All.....	6.99 ea.
---------	------------------	----------



NJ-525

Brake Cable Equalizer

Correct support for connecting front cable to intermediate cable and provides equalizing tension for rear cables.

NJ-525	1968-79 All.....	4.99 ea.
--------	------------------	----------



NX-281

Brake Cable Retainer

Correct clip for all cars (3 required).

NX-281	1964-79 All.....	3.99 ea.
--------	------------------	----------



GBL-99PC



GBL-9EB

Parking Brake Light Switch

Mounts on the parking brake pedal and activates the lights on your dash.

GBL-9EB	1968-74.....	19.99 ea.
GBL-99PC	1968-74 Bracket.....	19.99 ea.



GBL-852

GBL-852-CC

Brake Light Switches

OE style brake light switches located above the brake pedal.

GBL-852	1962-79 All w/o Cruise Control.....	7.95 ea.
GBL-852-CC	1962-79 All w/ Cruise Control.....	24.99 ea.
GSR-12999	Retainer.....	7.99 ea.



ECRE-ADJ-KIT

Universal Emergency Brake Cable Kit

This universal kit is the perfect fit for your modified ride. With a 108" total length, you can cut to fit any application with ease. This hassle-free kit is designed for use with either pull handle or foot brake and includes all necessary hardware for a simple installation.

ECRE-ADJ-KIT	All.....	99.99 kit
--------------	----------	-----------

VELOCITY SERIES SUSPENSION

Why own a muscle car you hate to drive? A great suspension is the key to a great driving car. That is why Ground Up Motors created our Velocity Series Suspension Kits. Our Velocity line of suspensions offer you the chance to update and upgrade your suspension while maintaining your budget. Whether you are looking for an upgraded system, a stock replacement system or just a basic budget friendly system, Ground Up Motors has you covered.



E-DIX69

Value Front Suspension Kit

This kit is perfect for your daily driver or restoration on a budget. It includes all high quality imported suspension parts.

- 2 Upper Ball Joints
- 2 Lower Ball Joints
- 4 Lower Control Arm Bushings
- 4 Upper Control Arm Bushings
- 2 Outer Tie Rods
- 2 Inner Tie Rods
- 2 Stabilizer End Links
- 2 Adjustor Sleeves
- 2 Sway Bar Bushings

E-DIX69 1968-74 All256.16 kit
No Volume Discount.



3-18119G

Energy Suspension Hyperflex Kit

These complete Hyperflex kits include all the bushings for the suspension, subframe and include a transmission mount.

Add G to the part number for black. Add R to part number for red. Example: 3-18119G is for 68-74 in black.

3-18119_ 1968-74 Mono.....312.99 kit
3-18118_ 1968-74 Multi.....313.99 kit



DIX-69

Deluxe OEM Front Suspension Kit

This is the ultimate OEM suspension kit! Each kit includes the finest quality OEM components.

- 2 Upper Ball Joints
- 4 Lower Control Arm Bushings
- 2 Lower Ball Joints
- 4 Upper Control Arm Bushings
- 2 Outer Tie Rods
- 2 Stabilizer End Links
- 2 Inner Tie Rods
- 2 Adjustor Sleeves
- 1 Idler Arm

DIX-69 1968-74 All326.21 kit
Ships Oversized. No Volume Discount.



DJR-69

Junior OEM Front Suspension Kit

This kit is perfect for freshening up your front suspension! Each kit includes the finest quality OEM components.

- 2 Upper Ball Joints
- 4 Lower Control Arm Bushings
- 3 Lower Ball Joints
- 4 Upper Control Arm Bushings
- 2 Outer Tie Rods
- 2 Stabilizer Ends Links

DJR-69 1968-74 All177.44 kit
Ships Oversized. No Volume Discount.



68745FK-P

Polygraphite Complete Front End Kit

For the ultimate in performance, install a polygraphite front end kit! This kit offers increased longevity and better performance than the stock rubber front end components. Kit includes upper and lower ball joints, inner and outer tie rods, tie rod adjusting sleeves, idler arm and control arm bushing kit and bump stops.

68745FK-P 1968-74 All350.06 kit
End link kit sold separately. No Volume Discount. Ships Oversized.



6874FK-P

Polygraphite Basic Front End Kit

Polygraphite bushings used in this kit are the ultimate combination of polyurethane and graphite. You get performance and durability with superior lubricating qualities which provides smooth operation. Kit include upper and lower ball joints, outer tie rods, control arm bushing kit and lower bump stops.

6874FK-P 1968-74 All249.36 kit
Ships Oversized. No Volume Discount.



Individual OEM Suspension Components

Unlike most other suspension components on the market, our line consists of quality OEM parts where available. You can see the difference when you start taking a look! US made rubber and sleeved bushings for a smooth installation, OEM "cast" steel tie rods and center links that feature grease fittings in the correct locations, adjustment sleeves and stabilizer links with correct "true" threads.



Ball Joints

FA-487	1968-74 All Upper.....	29.99 ea.
FA-688	1975-79 All Upper.....	26.95 ea.
FA-993	1968-74 All Lower.....	22.95 ea.
FA-291	1975-79 All Lower.....	26.95 ea.



Outer Tie Rods

Correct OEM cast steel outer tie rods. The highest quality original style suspension products on the market! Fits LH or RH.

ES-381	1968-74	26.99 ea.
ES-441RL	1975-79	29.95 ea.



Inner Tie Rods

Correct OEM cast steel inner tie rods. The highest quality original style suspension products on the market!

ES-681	1968-74 LH/RH	29.95 ea.
ES-442L	1975-79 LH	34.95 ea.
ES-443L	1975-79 RH	34.95 ea.



Adjustment Sleeves

OEM style adjustment sleeve for proper adjustment of tie rods.

ES-350	1968-74 LH/RH	12.99 ea.
ES-2004	1975-79 LH/RH	14.95 ea.



Center Drag Links

DK-0142	1968-74	99.99 ea.
DS-829	1975-79	54.99 ea.

No Volume Discount.

No Volume Discount.



Tie Rod Dust Boots

Correct tie rod end dust boots. Approx. 1-3/16" on bottom and 1-1/4" on top with a 1/2" hole.

ES-48DB	1962-79 4pc OE Style.....	29.99 kit
9-13101G	1962-79 2pc Poly Black.....	5.99 pr.
9-13101R	1962-79 2pc Poly Red.....	5.99 pr.



DSE Tubular Adjustment Sleeves

Tubular tie rod adjustors improve the strength and integrity of your steering system over stock. The tubular design is stiffer than the OEM split clamp adjustor and weighs less.

DSE090101B	1968-74 Black	89.99 kit
DSE090101G	1968-74 Grey	65.99 kit

No Volume Discount.



Idler Arms

D-18718	1968-74 All	39.99 ea.
K-6186	1975-79 w/o Rally.....	32.95 ea.
BPX-9873	Bolts	3.95 pr.

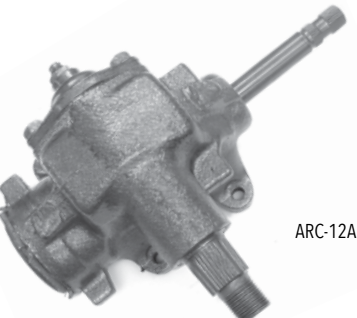

Manual Gear Boxes

Complete remanufactured original Saginaw assemblies. No core charge.

ARC-12A	1968-69 24:1 Standard	299.99 ea.
ARC-12B	1970-76 24:1 Standard	299.99 ea.
ARC-12SF	1968-74 16:1 Quick.....	329.99 ea.

Use ATE-8869B coupler with ARC-12SF.
No Volume Discount. Ships UPS Oversized.



Power Steering Gearbox Kits

Our kit comes with steering box, GM steering coupler (rag joint) and correct attaching bolts. Will fit 1968-74 Nova. No core charge!

1968-74 Nova

GBK-1F	Fast Ratio 3-3.5.....	391.86 kit
GBK-1SFF	Super Fast Ratio 2.5.....	361.96 kit

No Volume Discount. Ships UPS Oversized.



Manual Steering Box Kits

Our kit comes complete with the steering box, rag joint and correct bolts to mount the box to the frame. No core charge!

ARC-12AK	1968-69 24:1 Standard	333.82 kit
ARC-12BK	1970-76 24:1 Standard	333.82 kit
ARC-12SF	1968-74 16:1 Quick.....	329.99 ea.

No Volume Discount.

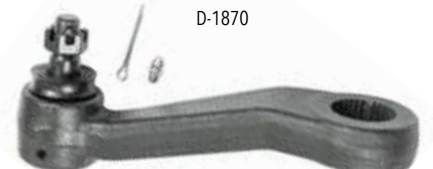

Pitman Arms

OEM pitman arm.

DA-985	1968-74 Manual	75.95 ea.
D-1870	1968-72 Power.....	69.95 ea.
DPA-73	1973-74 Power.....	74.99 ea.
BX-64K	Nut w/ Washer for P/S.....	6.95 ea.



KAR-KIT



**BUY'N SAVE
WITH KITS**

1968-74 Control Arms

OE style reproduction upper control arms with ball joint shaft and bushings. All control arms are powder coated in correct semi gloss black and are ready to install. Control arms are available individually or as a specially priced complete kit!

KAR-KIT	1968-74 Complete Control Arm Kit ...	464.36 kit
KAU-6L	1968-74 Upper LH only	119.99 ea.
KAU-6R	1968-74 Upper RH only	119.99 ea.
KAL-9L	1968-74 Lower LH only	137.99 ea.
KAL-9R	1968-74 Lower RH only	137.99 ea.

Ships Oversized. No Volume Discount.



UCA6769-KIT

Tubular Control Arms

These tubular control arms include everything you need to bolt them on and go. They are black powder coated for a nice looking and long lasting finish.

UCA6769-KIT	1968-74 Uppers & Lower.....	299.98 kit
-------------	-----------------------------	------------



KAU-66L

KAU-66R

1966-67 Control Arms

OE style reproduction control arms for your 1966-67 Nova. The upper control arms include upper ball joints and shafts with bushings already installed. Lower control arms include the lower ball joints and bushings already installed.

KAU-66L	1966-67 Upper LH	160.99 ea.
KAU-66R	1966-67 Upper RH	160.99 ea.
KAL-66L	1964-67 Lower LH	119.99 ea.
KAL-66R	1964-67 Lower RH	119.99 ea.



FA-1019

Control Arm Shaft Kit

New OEM shaft, bushings, washers & nuts.

FA-1019	1968-74 All	52.99 kit
FA-7479	1975-79 All	62.95 kit



DS-594

Control Arm Shims

DS-594	1/16"	2.99 ea.
DS-595	1/8"	2.99 ea.



FB-149

Upper Arm Bushings

FB-149	1968-74	6.95 ea.
K-6144	1975-79	10.95 ea.



FB-6076

Lower Arm Bushings

FB-6076	1968-74 Round	16.99 pr.
---------	---------------------	-----------



BPB-1430

Lower Control Arm Bolt

Original GM bolt with correct reduced body shaft and pointed end. Includes correct locking nut.

BPB-1430	1968-74 All	7.99 ea.
----------	-------------------	----------



BPX-8542

Upper Control Arm Bolt & Washer Kit

Correct heavy cup washers and correct OEM bolts for retaining upper bushings into arms.

BPX-8542	1968-74 All	19.95 kit
----------	-------------------	-----------



DCE-4220K

Control Arm Bumpers

Correct upper and lower control arm bumpers.

DCE-2410	1968-74 Lower	7.95 ea.
DCE-9222	1975-79 Lower	13.99 ea.
DCE-4220	1968-74 Upper	7.95 ea.
DCE-2014	1975-79 Upper	7.99 ea.
DCE-4220K	1968-74 Kit (4)	27.03 kit



9-9151G

9-9154G

Energy Suspension Control Arm Bumpers

These polyurethane control arm bumpers offer increased performance and longevity over stock.

Add G to the part number for black. Add R to part number for red. Example. 3-2134G is for 67-81 in black.

9-9151_	1968-74 All Upper	12.99 pr.
9-9154_	1968-74 All Lower	22.99 pr.
ENGGIT-1_	1968-74 Upper & Lower Kit	32.38 kit



BPX-0918

Control Arm Bolt Kit

Correct OEM serrated bolts with special locking nuts.

BPX-0918	1968-74 All	18.99 kit
----------	-------------------	-----------



DSE031713

DSE Camber/Caster Kit

This kit allows you to adjust camber easily with our one-piece slotted camber shims. Each shim is machined from 6061 aluminum and is then anodized black for durability. Includes four 1/16" shims, four 1/8" shims and two 1/4" shims.

With DSE Subframe

DSE031713	1962-74	129.99 kit
-----------	---------------	------------

With OEM Subframe

DSE03171421	1962-74	98.99 kit
DSE031715	1975-79	129.99 kit



FSA-02

Steering Arms

OE style reproduction steering arms for your worn or missing originals.

FSA-02	1966-74	79.99 pr.
--------	---------------	-----------

Note: With 5 Lug Hubs.

DSE030101



DSE Tubular Upper Control Arm Kit

These DSE tubular upper control arms are a direct replacement for your stock control arms and offer better suspension geometry and more strength which equals better handling and performance. Everything needed to install these new control arms is included in this COMPLETE kit.

DSE030101 1968-74 All 799.99 kit
Installation should be followed by a professional alignment.
Ships Oversized. No Volume Discount.



DSE031201



DSE031202



DSE Tubular Lower Control Arm Kit

These DSE tubular lower control arms are a direct replacement for your stock control arms and offer better suspension geometry and more strength which equals better handling and performance. Everything needed to install these new control arms is included in this COMPLETE kit.

DSE031201 1968-74 with Stock Springs 899.99 kit
DSE031202 1968-74 with DSE Coilover Springs 709.99 kit
Installation should be followed by a professional alignment.
Ships Oversized. No Volume Discount.

ENERGY SUSPENSION
Performance POLYURETHANE Components



3-3101G

Polygraphite Control Arm Bushings

These Poly Graphite bushings from Energy Suspension offer better handling than stock and are impervious to the elements. Add G to the part number for black. Add R to part number for red. Example: 3-3160G is for 62-67 in black.

3-3160_ 1962-67 All 83.99 kit
3-3101_ 1968-74 All 98.99 kit
3-3105_ 1975-79 All 98.99 kit



DSE030201

Delrin Lower Bushings

These Delrin bushings eliminate deflection and greatly improve response. The steel outer housings can be welded to the control arm.

DSE030201 1968-74 All 172.99 kit
Works great for street cars as well as race cars.



DSE030401

Urethane Upper Bushings

These urethane bushings are designed as an upgrade over stock for improved handling.

DSE030401 1968-74 All 68.99 kit



DSE030501

DSE Jounce Rebound Bumpers

These urethane bumpers can be used for bounce and rebound control for your stock control arms. The bumper dimensions are 1-9/16" tall and 1-5/8" base diameter. They are sold in pairs.

DSE030501 1968-74 19.99 pr.



DBB-67K



BUY 'N SAVE
WITH KITS

Body Mounting Kits

Complete with everything you need to mount your body to the frame including correct rubber bushings with steel inserts and factory style OEM flanged head frame bolts with washers!

DBB-67K 1968-74 All60.25 kit

BPB-2230



Body Bolt Kit

Correct OEM body mounting kit complete with (4) correct body bolts, (4) correct large washers, (2) correct radiator support bolts, (2) bushing washers, (2) correct spacer washers and (2) nuts & lock washers.

BPB-2230 1968-7426.99 kit



DCI-3025

Body Mounting Bushing Kit

Correct OEM style rubber bushings with steel inserts for mounting body to frame; complete with radiator support bushings.

DCI-3025 1968-7439.95 kit
DCI-892 1975-7669.99 kit
DCI-893 1977-7969.99 kit



DRS-67H

Radiator Support Bushings

Complete kit with all bushings and hardware for mounting radiator support to car.

DRS-67H 1968-74 All24.21 kit

Front Rad. Support



Middle



Rear



DSE010201

DSE010801



DSE Solid Body Mounts

DSE solid body mounts provide a simple approach to eliminating the flex that occurs between the body and subframe connection. This will improve vehicle handling response by increasing chassis stiffness. CNC machined from billet aluminum and then hard coated. Stainless bolts sold separately.

DSE010201 1968-74 1/2 Height219.99 kit
DSE010301 1968-74 Stock Height219.99 kit
DSE010801 Stainless Bolts126.99 kit
No Volume Discount

RFR-646



Subframe Repair Plates

Stamped steel plates for repairing your rusted or damaged subframe mounting points. Complete set of (6) includes radiator support.

RFR-646 1968-7460.99 kit

3-4142G



Poly Graphite Body Mounting Kit

These polyurethane body mounts offer increased performance and longevity over stock bushings.

3-4142G 1968-74 All Black 100.99 kit
3-4142R 1968-74 All Red 100.99 kit



DAA-136

Front Sway Bar Kit

Eliminate poor handling by installing one of these sway bars! It includes sway bar, brackets, bushings and end links to replace your old, small bar.

DZ2-1000	1962-67 All.....	193.99 kit
DAA-136	1968-74 1".....	199.99 kit
DAA-599	1968-74 All 1-1/8".....	235.99 kit

No Volume Discount. Ships Oversize 2.



DSE031401

Detroit Speed Front Sway Bar Kit

This larger than stock bar is powder coated black and comes with everything you need to bolt it on including greasable polyurethane bushings and end links.

DSE031401	1968-74 All 1-1/8" Hollow.....	286.99 kit
-----------	--------------------------------	------------

No Volume Discount. Ships Oversize 2.



DBB-6769K

1968-74 Sway Bar Bushing Kits OE Style

These kits come complete with front sway bar bushings, brackets and bolts.

DBB-6769K	1968-74 11/16" Bar.....	49.95 kit
DBB-671K	1968-74 1" Bar.....	49.95 kit

No Volume Discount.

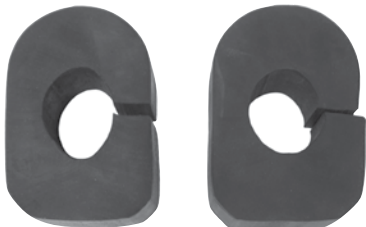

DHB-69

Sway Bar Bushings

DHB-69	1968-74 Repro.....	15.99 pr.
DCI-679	1968-74 1-1/16" Bar.....	9.95 pr.



3-5202G



Energy Suspension Sway Bar Bushings

These polyurethane body bushings offer increased performance and longevity over stock.

Add G to the part number for black. Add R to part number for red. Example. 3-5202G is for 68-74 in black.

3-5202_	1968-74 11/16" bar.....	25.99 pr.
3-5203_	1968-74 13/16" bar.....	26.99 pr.



9-8125G

Energy Suspension Sway Bar End Links

These Polyplus sway bar end links will improve handling and steering response.

9-8125G	1968-79 Black.....	23.99 pr.
9-8125R	1968-79 Red.....	23.99 pr.



DSL-90

Stabilizer End Links

Complete kit for one car.

DSL-90	1968-79 All.....	14.95 kit
--------	------------------	-----------

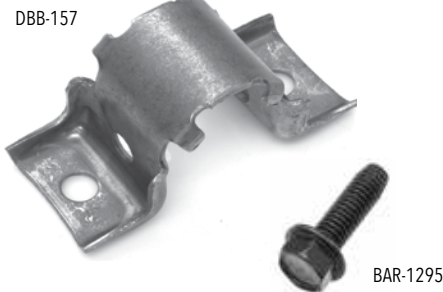

BAR-1295

Sway Bar Brackets

Correct mounting bracket for front sway bar.

DBB-157	1968-74 Front 1-1/16.....	7.99 ea.
DBB-81R	1968-74 Rear OEM Bar.....	12.99 ea.
BAR-1295	Correct Front Bar To Frame Bolt.....	0.75 ea.
BAR-1295K	Correct Front Bar To Frame Bolts.....	2.55 kit



DCS-6246



Coil Springs

Brand new OEM replacement coil springs sold in matched pairs. These are not cheap aftermarket springs. These springs will restore your car to the original ride height.

DCS-6246	1962-67 All with V8.....	109.99 pr.
DCS-6246	1962-67 All Cars w/ AC.....	109.99 pr.
DCS-6320	1968-74 SB w/o A/C.....	119.99 pr.
DCS-0009	1968-74 SB w/ A/C.....	109.99 pr.
DCS-0009	1968-74 All BB.....	109.99 pr.

No Volume Discount



DSI-170

Coil Spring Insulators

Rubber insulators for the top of the front coils.

DSI-170	1968-79 All.....	9.99 pr.
---------	------------------	----------



DSE 2" Dropped Front Coil Springs

These DSE 2" drop coil springs will lower the front of your car easily to give it a pro-touring stance. These springs will also provide great ride and handling.

DSE031115	1968-74 SB, LSX.....	235.99 pr.
DSE031118	1968-74 BB.....	285.99 pr.

Ride height may vary depending on weight differences of cars.



RSS-1625W



DSP-62

Front Coil Spring Seat & Perch

Reproductions of these commonly rotted out coil spring mounts.

RSS-1625W	1966-67 All Upper Seat.....	24.95 ea.
DSP-62	1962-67 Lower Perch.....	89.99 pr.



DPX-440

GM Shock Kit

Complete kit featuring 4 gas charged shocks, correct front & rear hardware, grey paint & 4 shock ID decals.

DPX-440	1968-74 All Kit.....	145.58 kit
NT-2005	1968-74 Front Only	29.99 ea.
NT-2201	1968-74 Rear Only	29.99 ea.

No Volume Discount.



KYB-68X-KIT

KYB Excel-G Shock Kit

Are you looking for more performance from your shocks and a smooth ride? This KYB shock kit is the answer! They feature velocity sensing valving, hard chrome piston rods, twin tube design, low pressure nitrogen gas to prevent foaming of the oil, iron pistons & guide tubes. These shocks are great for normal to moderate driving! Our kit includes: (2) front shocks, (2) rear shocks and hardware.

KYB-68X-KIT	1968-74 All Front & Rear	125.99 kit
KYB-68F	1968-74 Front Only	42.99 ea.
KYB-64R	1968-74 Rear Only	29.95 ea.

No Volume Discount



RSF-69F

Factory Subframe

This is an OEM style Nova subframe which is an exact replacement for your rusty, dented, or bent original. There is no longer any need to waste money trying to repair your damaged original subframe. This subframe features factory style welds for an OEM appearance, extra bracing in the lower cross member to add strength while jacking the car (but completely invisible on the outside) and holes and brackets as original. This subframe is very hard to tell from OEM due to all of these correct details.

RSF-68F	1968 All.....	1499.99 ea.
RSF-69F	1969-72 All.....	1499.99 ea.

Ships Truck Freight to a commercial address. No Volume Discount.



DSS-F72

DSS-R72

Spiral Shocks

New GM licensed reproductions of the original spiral twist shocks in correct gray color.

DSS-F72	1968-74 All Front.....	124.99 ea.
DSS-R72	1968-74 All Rear.....	124.99 ea.

No Volume Discount



DSR-384

Shock Mounting Hardware

Correct GM rubber bushings, cup washer and nut for one shock.

DSR-384	1962-74 All Front.....	7.95 kit
---------	------------------------	----------



DR-041

Shock Mounting Stud

Correct rear shock mounting stud.

DR-041	1968-74 Rear.....	11.99 ea.
--------	-------------------	-----------



BPX-9715

Shock Mounting Kit

Correct GM front shock mounting kit with (4) clips and (4) OEM bolts/washers.

BPX-9715	1968-79 All Front.....	8.99 kit
----------	------------------------	----------



9-8101G

9-8101R

Energy Suspension Upper Shock Bushings

These are sets of 4 correct front upper Polyurethane shock bushings. Bushings only. No hardware included.

9-8101G	1962-79 2pc Poly Black	5.99 kit
9-8101R	1962-79 2pc Poly Red	5.99 kit

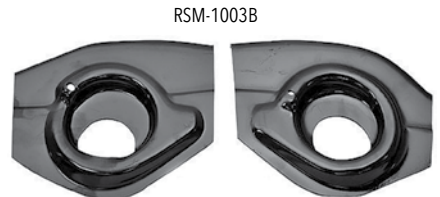

RSM-1003B

Coil Spring Upper Mounts

Replacement coil spring upper mounts which are located in the subframe. Weld-in.

RSM-1003B	1968-74.....	34.95 pr.
-----------	--------------	-----------



DSE060415

DSE LS Engine Mounting Bracket Kit

This DSE LS engine mount bracket kit enables easy, no hassle installation of any LS engine into your new DSE hydroformed subframe. This kit mounts the engine in the proper location, provides the correct method of adapting the 3 bolt engine mounts to the 4 bolt LS engine and requires no fabrication. Complete with frame side engine mount stands, CNC aluminum adapter plates and polyurethane engine mounts.

DSE060415	1962-67 SB	315.99 kit
DSE060416	1962-67 LS.....	349.99 kit
DSE060401	1968-74 All	369.99 kit



DTR-7412

OEM Style Replacement Leaf Springs

These are excellent OEM replacement leaf springs which will restore the proper rear ride height.

DTR-7910	1968-79 Mono Leaf	299.99 pr.
DTR-7412	1968-79 4 Leaf	229.99 pr.
DTR-7815	1968-79 5 Leaf	299.99 pr.

No Volume Discount. Ships Oversize 2.



DLK-69M

Leaf Spring Mounting Kit

This kit comes complete with (4) correct pads, (2) U-bolts and (4) T bolts with (8) nuts. Does one car.

DLK-67	1968-79 Mono.....	60.75 kit
DLK-69M	1968-79 Multi.....	57.15 kit



DSE041101

Mono-to-Multi Leaf Conversion Kit

Use this kit to convert your original mono-leaf spring to multi-leaf spring configuration. Kit includes: U-bolts, a hardcoated steel locating pad, aluminum spacers, washers & nuts.

DSE041101	1968-79.....	116.99 kit
-----------	--------------	------------



DTR-4RBK

Leaf Spring Rebuild Kits

Leaf spring rebuild kit includes the correct hardware to disassemble the leaves and put them back together like new.

DTR-4RBK	1968-79 4 Leaf	39.99 kit
DTR-5RBK	1968-79 5 Leaf	41.95 kit



DSB-5814

Rear Sway Bar Kit

This complete direct OEM replacement rear sway bar kit comes complete and ready to install with all brackets, bushings, hardware and sway bar. While not technically correct, this sway bar will fit and function as original and is excellent for street, strip, road racing and everything in between!

DSB-5814	1968-74 All 7/8" Bar.....	184.99 kit
----------	---------------------------	------------

Ships Oversized. No Volume Discount.

DSE041501



DSE Heavy Duty Leaf Spring Shackle Kit

Upgrade your rear leaf spring and shackle bushings with this heavy duty shackle kit from Detroit Speed. Your choice of polyurethane or Delrin bushings.

DSE041501	1968-74 Polyurethane.....	187.99 kit
DSE041502	1968-74 Delrin	359.99 kit

No Volume Discount



DSE041633

DSE Rear Leaf Spring Suspension Kit

This DSE rear leaf spring suspension kit works great with any DSE front suspension kit. These leaf springs improve handling due to the increased spring rate and are available in either a 2" or 3" dropped ride height. Includes DSE rear leaf springs, heavy duty shackle kit and Koni classic rear shocks.

DSE041633	1968-74 2" Drop.....	1020.99 kit
DSE041636	1968-74 3" Drop.....	1020.99 kit

No Volume Discount. Ships Oversize 2. Ride height may vary depending on weight differences of cars.



DSE031301



DSE Speed Kit 1

This exclusive DSE Speed Kit is a complete bolt-on suspension upgrade system designed for ease of installation with no modification to subframe.

This kit includes:

- Tubular Upper & Lower Control Arms
- Koni Classic Front Shocks
- Front 2" Drop Spring • Front Sway Bar

DSE031301	1968-74 SB,LSX.....	2453.99 kit
DSE031304	1968-74 BB.....	2453.99 kit

Ships Oversized. No Volume Discount.



DSE031350



DSE Speed Kit 2

Speed Kit 2 improves the handling and performance to the next level and offers ride height adjustment.

This kit includes:

- Tubular Upper & Lower Control Arms • Coil Conversion Kit
- Koni Aluminum Body Coilover Shocks • Coilover Springs • Front Sway Bar

DSE031350	1968-74 SB, LS Base Shocks.....	2811.99 kit
DSE031351	1968-74 BB, Base Shocks	2811.99 kit
DSE031350S	1968-74 SB, LS Single Adj Shocks	3307.99 kit
DSE031351S	1968-74 BB, Single Adj Shocks.....	3307.99 kit
DSE031350D	1968-74 SB, LS Double Adj Shocks...	3968.99 kit
DSE031351D	1968-74 BB, Double Adj Shocks	3968.99 kit

Ships Oversized. No Volume Discount.



DSE031352



DSE Speed Kit 3

Speed Kit 3 is the most advanced handling system that you can buy for your stock subframe and gives you the steering performance of today's modern cars.

This kit includes:

- Tubular Upper & Lower Control Arms • Coil Conversion Kit
- Idle Arm • Pitman Arm • Koni Aluminum Body Coilover Shocks
- Coilover Springs • Front Sway Bar • DSE 600 Gear w/ Rag Joint
- DSE Tie Rod Adjusters • Inner & Outer Tie Rod Ends

DSE031352	1968-74 SB, LS Base Shocks	3361.99 kit
DSE031353	1968-74 BB, Base Shocks	3361.99 kit
DSE031352S	1968-74 SB, LS Single Adj Shocks	3704.99 kit
DSE031353S	1968-74 BB, Single Adj Shocks.....	3704.99 kit
DSE031352D	1968-74 SB, LS Double Adj Shocks...	4305.99 kit
DSE031353D	1968-74 BB, Double Adj Shocks	4140.99 kit

Ships Oversized. No Volume Discount.



3-2134G

Energy Suspension Rear Shackle Kits

Be in control of your suspension while you're maneuvering through turns, doing drag-style launches and braking. Add G to the part number for black. Add R to part number for red.
Example: 3-2136G is for 68-74 in black.

3-2134_	1968-74 Multi.....	142.99 kit
3-2136_	1968-74 Mono.....	144.99 kit

Bushings Only

3-2103_	1968-74 Multi.....	80.99 kit
3-2101_	1968-74 Mono.....	81.99 kit



NRD-0045

Leaf Spring Rear Shackle Kit

Exact reproduction shackle kit complete with plates, bushings, bolts and nuts. Does 1 car.

NRD-0045	1962-79 All	72.99 kit
NRD-0050	1962-79 All OE Style	59.95 kit



DSB-8R

Rear Shackle Bushings

Exact reproduction rear shackle bushings.

DSB-8R	1968-74 All	39.99 kit
--------	-------------------	-----------

DSE Mini Tub Kit

This is a complete Detroit Speed & Engineering mini tub kit which includes all of the necessary parts for a complete project package. The original rear seat back and bottom frames must be slightly modified, but the rear seat can be used!

- DSE Deep Tubes
- Rear Shock Crossmember
- Rear Upper Shock Mounts
- Offset Shackles
- Adjustable Leaf Spring Pads
- Lower Shock Plates
- U-Bolts
- Mini-tub Installation CD
- Rear Leaf Springs
- Instructions

DSE041207	1968-74 with 2" Drop.....	2006.99 kit
DSE041208	1968-74 with 3" Drop.....	2006.99 kit
DSE041301	1968-74 Mini Tub Rear Shocks	329.99 pr.

Delrin Upgrade

Upgrade front and rear bushings to Delrin material.

DSE041503	1968-74 Mini-Tub Kit.....	325.99 kit
-----------	---------------------------	------------

A narrowed fuel tank is required. Ask your sales rep for details! These kits require a 3" axle tube. DSE041301 shocks required. Ships Oversized. No Volume Discount.



Energy Suspension Leaf Spring Pads

These new Hyper-Flex polyurethane spring pads can take the abuse from performance suspensions and are impervious to any contaminants. **GUARANTEED!** Add G to the part number for black. Add R to part number for red.
Example: 3-6112G is for 68-74 in black.

3-6112_	1962-79 Multi.....	31.99 kit
3-6113_	1962-79 Mono.....	28.99 kit

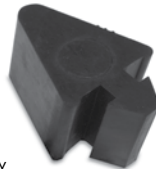

DAB-6X



DAB-088

Rear End Bumpers

DAB-6X	1968-69 Pinion.....	14.95 ea.
DAB-088	1973-79 Axle.....	23.99 ea.

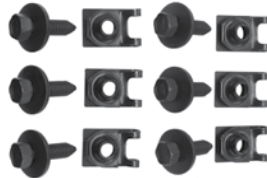

BLS-1130

Front Leaf Spring Bracket Hardware Kit

Correct bolts and special clips for mounting front leaf spring brackets to car. This kit includes (6) OEM bolts and (6) J nuts.

BLS-1130	1968-79 All	16.95 kit
----------	-------------------	-----------



DSP-500

Leaf Spring Perch

Correct leaf spring perches for rear axle.

DSP-500	1968-74 Multi.....	79.99 pr.
DSP-501	1968-74 Mono.....	69.95 pr.

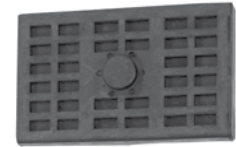

DTE-67

Leaf Spring Pads

Correct rubber pads for mounting springs.

DTE-7818	1968-79 Mono.....	6.95 ea.
DTE-67	1968-79 Multi.....	5.95 ea.



BBB-2743

Front Leaf Spring Eye Bolt

Correct OEM bolt with washers and special nut for mounting front leaf spring to car. 2 required.

BBB-2743	1968-74 All	3.95 ea.
----------	-------------------	----------



BPB-2949

T-Bolt

Correct T bolt & nut for mono leaf springs.

BPB-2949	T Bolt.....	6.95 ea.
----------	-------------	----------

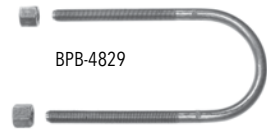

BPB-4829

U-Bolt

Correct U-bolt & nuts for multi leaf springs.

BPB-4829	U Bolt.....	5.95 ea.
----------	-------------	----------



DSB-99

Leaf Spring Eye Bushing

Correct front eye bushing.

DSB-99	1968-74 All	26.99 ea.
--------	-------------------	-----------

NJX-283



Leaf Spring Plates

Correct lower leaf spring mounting plates.

NJX-283	1968-74 Multi.....	42.95 ea.
NJX-7R	1968-72 Mono All LH/RH.....	44.95 ea.

QA1



QA1-52717



QA1-52520



QA1-TN505

QA1 Upper & Lower Tubular Control Arms

QA1's GM 2.0 Control Arms provide increased positive caster compared to OE arms, are among the lightest arms available featuring lower unsprung weight and improved performance without sacrificing durability. They include QA1's integrated ball joint design: stronger than OEM and rebuildable for tunability, providing long-term reliable service. These arms feature billet cross shafts for reduced weight and durability for the long haul. Double-shear lower mounts are coil-over ready for a clean installation. QA1 GM 2.0 Control Arms look incredible and use no unsightly additional adaptors! Form meets function - these newly designed arms look and perform great and don't require painstaking restoring like factory stamped steel control arms. High strength, low alloy steel enables optimized thinner wall construction and results in overall lighter weight. QA1's integrated low-maintenance ball joints feature integrated ball joint dust boots, are stronger than competing ball joints, give long-term service and are rebuildable. QA1 GM 2.0 Control Arms will work with either OE or drop spindles. Increased positive caster design improves straight line stability. Mounts in OE location with no cutting, fabricating, or welding required. Accommodates either factory or aftermarket disc brakes. All of these arms are designed to add 3-4 degrees of caster and 0.5 to 1 degree of negative camber when used together (i.e. upper & lower). When used independently they will add approximately half of the preceding numbers. All parts sold in pairs and includes mounting hardware. Made in the USA.

Street Arms

QA1-52717	1968-74 All Upper	569.99 pr.
QA1-52719	1968-74 All Lower	786.99 pr.
QA1-52718	1975-79 All Upper	569.99 pr.
QA1-52720	1975-79 All Lower	786.99 pr.

Race Arms

QA1-52517	1968-74 All Upper	665.99 pr.
QA1-52519	1968-74 All Lower	848.99 pr.
QA1-52518	1975-79 All Upper	665.99 pr.
QA1-52520	1975-79 All Lower	848.99 pr.

No volume discount.

QA1 Stocker Star Shocks

These stock mount adjustable front & rear shocks are available for your Nova. Available in double, single, Drag R Series and non-adjustable options, these shocks provide exactly the ride you want, high performance handling and great looks. These QA1 aluminum shocks are 100% dyno tested and serialized before leaving our factory. Made in the USA. Easy, bolt-in installation. NA = non-adjustable SA = single adjustable DA = double adjustable DR = drag series adjustable

QA1-TN703	1962-67 Rear NA	142.99 ea.
QA1-TS703	1962-67 Rear SA	190.99 ea.
QA1-TD703	1962-67 Rear DA	284.99 ea.
QA1-TN505	1968-79 Front NA	142.99 ea.
QA1-TS505	1968-79 Front SA	190.99 ea.
QA1-TD505	1968-79 Front DA	284.99 ea.
QA1-TN801	1968-79 Rear NA	142.99 ea.
QA1-TS801	1968-79 Rear SA	190.99 ea.
QA1-TD801	1968-79 Rear DA	284.99 ea.

No Volume Discount.



QA1-52816

QA1 Sway Bars

Give your chassis the stability it needs to keep your tires planted on the road. These sway bars are an easy bolt-on upgrade to help reduce body roll and handle corners better. For maximum strength and durability, QA1 sway bars are manufactured from either lightweight hollow-core (4130) chromoly steel or heavy duty solid-core (1045) cold formed steel. The bars are formed using precision CNC equipment for a true bolt-on installation, then gloss black powder coated for durability and corrosion resistance. Sway bars include new mounting components to replace old and worn out sway bar bushings and end links. Made in the USA.

QA1-52816	1968-74 All Front 1 1/4"	311.99 ea.
QA1-52893	1975-79 All Front 1 3/8"	324.99 ea.

No Volume Discount.



QA1-5251

QA1 Tie Rod Sleeves

These QA1 Heavy Duty Tie Rod Sleeves are manufactured from solid steel hex stock then zinc plated for durable good looks and corrosion resistance. These are stronger than stock OE split sleeves and easier to adjust. Made in the USA.

QA1-5251	1968-79 All	80.99 pr.
----------	-------------------	-----------

No Volume Discount.

QA1 Front Coilover Shock Kits

The QA1 Pro Coil System is a great option for anyone looking for fully adjustable ride height and valving control. Choose a spring rate and adjustability that fits your driving style, adjust the valving to match and you are on your way. These shocks also utilize a fully threaded body that allows you to adjust your ride height for the perfect stance or to finely tune the weight balance for superior handling. Specially designed for QA1's Pro Coil Systems, the American-made lightweight high travel springs have fewer coils and a smaller wire diameter, resulting in increased travel due to the larger distance between the coils. They reduce unsprung weight and react faster, optimizing suspension performance. Adjustable Pro Coil System Features: Available in MOD Series, independent compression and rebound double adjustable, simultaneous compression and rebound adjustable, or drag R Series adjustable. Lightweight Billet Aluminum Coilover Shocks High Travel Springs Easy, Bolt-In Installation Ride Height Adjustable, Made in the USA.

SA = single adjustable DA = double adjustable DR = drag series adjustable MO = mod series



QA1-GD401-10500C QA1-GS401-10400A

Small Block Included spring rate: 400 Lbs, ideal for front axle weight between 1801-1900 Lbs.

QA1-GS401-10400A	1968-74 SA	665.99 kit
QA1-GD401-10400A	1968-74 DA	866.99 kit
QA1-GR401-10400A	1968-74 DR	605.99 kit
QA1-MG401-10400A	1968-74 MO	1800.99 kit
QA1-GS401-10400C	1975-79 SA	665.99 kit
QA1-GD401-10400C	1975-79 DA	866.99 kit
QA1-MG401-10400C	1975-79 MO	1800.99 kit

Big Block Included spring rate: 500 Lbs, ideal for front axle weight between 2001-2100 Lbs.

QA1-GS401-10500A	1968-74 SA	665.99 kit
QA1-GD401-10500A	1968-74 DA	866.99 kit
QA1-GR401-10500A	1968-74 DR	605.99 kit
QA1-MG401-10500A	1968-74 MO	1800.99 kit
QA1-GS401-10500C	1975-79 SA	665.99 kit
QA1-GD401-10500C	1975-79 DA	866.99 kit
QA1-MG401-10500C	1975-79 MO	1800.99 kit

No Volume Discount.

QA1

QA1 Performance Handling Kits

Want better handling for your classic? Turn to QA1's handling suspension kits for the best ride that fits your needs. Available in three different levels of performance, these handling kits offer easy, bolt-in installation and seamlessly works with whatever OE component each piece attaches to. You can build your car in stages using our parts list as a road map to get to the level of performance you want and have the peace of mind knowing you won't have compatibility issues.

Level 1 Includes: Front single adjustable Pro coil shock system, front & rear sway bars, tie rod adjuster sleeves, and rear lower boxed control arms.

Level 2 Includes: Front & rear single adjustable Pro coil shock system, front & rear sway bars, thrust bearing/spanner wrench kit, upper street control arms, lower street control arms, rear upper & lower tubular control arms, tubular rear control arm braces, tie rod adjuster sleeves.

Level 3 Includes: Front & rear double adjustable Pro coil shock system, front & rear sway bars, thrust bearing/spanner wrench kit, upper race control arms, lower race control arms, rear upper & lower boxed control arms, tubular rear control arm braces, tie rod adjuster sleeves. Level 2 & 3 kits available with and without shocks.



QA1-HK21-GMX2

Level 1 Kits	
QA1-HK21-GMX2	1968-74 w/ shocks1500.99 kit
QA1-HK21-GMX3	1975-79 w/ shocks1513.99 kit
Level 2 Kits	
QA1-HK22-GMX2	1968-74 w/ shocks3247.99 kit
QA1-HK33-GMX2	1968-74 w/o shocks1890.99 kit
QA1-HK22-GMX3	1975-79 w/ shocks3260.99 kit
QA1-HK32-GMX3	1975-79 w/o shocks1823.99 kit
Level 3 Kits	
QA1-HK23-GMX2	1968-74 w/ shocks4419.99 kit
QA1-HK33-GMX2	1968-74 w/o shocks1890.99 kit
QA1-HK23-GMX3	1975-79 w/ shocks4432.99 kit
QA1-HK33-GMX3	1975-79 w/o shocks2060.99 kit

No Volume Discount.

QA1

From bolt-on products that get you behind the wheel faster, to experienced technicians available to help decrease your 60' times or handle curves with confidence, everything QA1 does is designed to get you out on the road. Whether your goal is a Saturday night sprint across the checkered flag or a slow, easy cruise down the main street, QA1 has the suspension and driveline products you need for the experience you want.



QA1-DK21-GMX2



QA1-DK22-GMX2

QA1 Drag Race Suspension Kits

Looking for a better launch, straight line stability and consistent performance? Turn to QA1's drag racing suspension kits for a full-vehicle upgrade that fits your needs. Available in two different levels of performance, these drag racing kits offer easy, bolt-in installation and seamlessly works with whatever OE component each piece attaches to.

Level 1 Includes: Front R series Stocker Star shocks, upper street control arms, lower street control arms, stock spring seat adapter, tie rod adjuster sleeves.

Level 2 Includes: Front Double Adjustable Pro Coil shock system, thrust bearing/spanner wrench kit, Upper race/pro-touring control arms, Lower race control arms, tie rod adjuster sleeves, ball joint tool kit. Available with and without shocks.

Level 1 Kits	
QA1-DK21-GMX2	1968-74 w/ shocks1221.99 kit
QA1-DK21-GMX3	1975-79 w/ shocks1221.99 kit
Level 2 Kits	
QA1-DK22-GMX2	1968-74 w/ shocks3124.99 kit
QA1-DK32-GMX2	1968-74 w/o shocks1686.99 kit
QA1-DK22-GMX3	1975-79 w/ shocks3124.99 kit
QA1-DK32-GMX3	1975-79 w/o shocks1686.99 kit

No Volume Discount.



AAS-300112



AAS-300178

AAS-AFBFHS

Aldan American Coil Over Kits

Aldan Road Comp kits are designed to convert your suspension to coil-overs. Aldan Phantom Series, single adjustable coil-overs deliver superior handling and ride quality for a drastic improvement over stock suspension. Aldan High tensile, high travel coil-springs provide greater consistency over stock springs. Aldan's rear bolt-on shock absorber kit includes 2 TrueLine Series shocks, 2 brackets, 2 T-Bars and hardware. Uses OEM shock mounting locations. TrueLine adjustable shock absorbers are designed to work with factory and aftermarket springs to add a more consistent, smoother ride.

Complete Front & Rear Kits

AAS-300176	1962-67 SB.....	1643.99 kit
AAS-300177	1962-67 BB	1643.99 kit
AAS-300112	1968-74 SB.....	1149.99 kit
AAS-300113	1968-74 BB	1149.99 kit

Front Coil Over Kits

AAS-300174	1962-67 450lb Springs	1162.99 kit
AAS-300175	1962-67 550lb Springs	1162.99 kit
AAS-AFBFMS	1968-74 450lb Springs	640.99 kit
AAS-AFBFHS	1968-74 550lb Springs	640.99 kit
AAS-AGFMS	1975-79 450lb Springs	640.99 kit
AAS-AGFHS	1975-79 550lb Springs	640.99 kit

Rear Shock Kits

AAS-300178	1962-67 All	480.99 kit
AAS-100110	1968-74 All.....	495.99 kit
AAS-100113	1975-79 All.....	495.99 kit

Parts & Tools

Thrust bearings aka Torrington bearings make it easier to adjust spring tension and ride height when installed at the base of a coil spring and coilover spring seat. Includes 2 thrust bearings and 4 steel washers. 2.5 in. inner diameter, 3.225 in. outer diameter.

AAS-ALD-27	Bearings & Spanner Wrench.....	89.99 kit
AAS-ALD-26	Bearings Only	50.99 kit
AAS-ALD-1	Spanner Only.....	39.99 ea.



APS-6153



APS-6086



APS-6165

Concourse Series "Banjo" Style Power Steering Pumps

These are brand new banjo style power steering pumps with correct reservoir, inlet and outlet fittings.

NO CORE CHARGE!

APS-6086	1967-68 All V8	175.95 ea.
APS-6153	1969 SB	199.99 ea.
APS-6151	1969 BB	219.99 ea.
APS-6165	1970-72 All V8	199.99 ea.

No Volume Discount.



TUF-6183A



TUF-6183B



TUF-6193A

Tuff Stuff Power Steering Pumps

GM Saginaw style pumps feature all new components reservoir, pump assembly, cap & dipstick and hardware when it applies. Rated at 1200 PSI rated to work with most gearbox systems.

TUF-6197A	1968 All Chrome Banjo Style.....	253.99 ea.
TUF-6197B	1968 All Black Banjo Style	201.99 ea.
TUF-6198A	1969 Non V8 Chrome Banjo Style..	253.99 ea.
TUF-6198B	1969 Non V8 Black Banjo Style	201.99 ea.
TUF-6191A	1969 SB Chrome Banjo Style.....	253.99 ea.
TUF-6191B	1969 SB Black Banjo Style	201.99 ea.
TUF-6195A	1969 BB Chrome Banjo Style	253.99 ea.
TUF-6191B	1969 SB Black Banjo Style.....	201.99 ea.
TUF-6193B	1970 All V8 Black Banjo Style	201.99 ea.
TUF-6183A	1970-74 All V8 Chrome	238.99 ea.
TUF-6183B	1970-74 All V8 Black.....	188.99 ea.
TUF-5559	Universal Inline Filter.....	35.99 ea.

No Volume Discount.



No Core Charge

APS-6000R

Power Steering Pumps Replacement Style

Completely rebuilt second design power steering pumps. These pumps will differ in appearance from our originals, but will fit and function the same. **NO CORE CHARGE!**

APS-6000R 1969-74 All 115.99 ea.
No Volume Discount.



ADR-077

Power Steering Pump Cap

Your choice of black plastic or metal power steering pump cap.

ADR-077 All Plastic..... 8.95 ea.



APC-42

OE Power Steering Pump Cap

OE style reproduction metal cap.

APC-42 1962-68 19.95 ea.



AFP-513

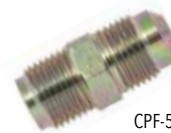

CPF-580

Power Steering Pump Fitting

OE style reproduction of the very difficult to find power steering pump fitting which is usually missing on remanufactured pumps.

CPF-580 1962-79 All 11.99 ea.
AFP-513 1967-69 All 34.95 ea.



ASP-509



ADP-61

Power Steering Pump Pulleys

ADP-61	1968 BB Driver	49.99 ea.
ASP-509	1962-74 1 Groove	38.99 ea.
ASP-3847	1968 1 Groove, SHP 396/375, 427	189.99 ea.
ASP-107	1969-74 2 Groove w/ AC.....	36.99 ea.
ASP-1395	1969-74 1 Groove SHP	59.99 ea.
23-28	Pulley Nut	3.95 ea.



BUY 'N SAVE
WITH KITS



PSKIT-69FBB



PSKIT-702XBAC

Power Steering Conversion Kits

Are you tired of getting a workout every time you want to turn a corner? Ground Up Motors makes it easy to convert to power steering with these power steering conversion kits! We have taken all the guesswork out of selecting the parts required to convert with this all in one solution. Includes: Banjo style pump, Pump cap, Brackets, Hardware, Pulley nut, Pressure hose and the return hose kit.

PSKIT-69FSB	1969 SB w/o AC.....	391.34 kit
PSKIT-69FSBAC	1969 SB w/ AC.....	389.54 kit
PSKIT-69FBB	1969 BB w/o AC.....	403.01 kit
PSKIT-69FBBAC	1969 BB w/ AC.....	401.21 kit
PSKIT-702XSB	1970-72 SB w/o AC.....	386.76 kit
PSKIT-702XSBAC	1970-72 SB w/ AC.....	381.45 kit
PSKIT-702XBB	1970-72 BB w/o AC.....	376.92 kit
PSKIT-702XBBAC	1970-72 BB w/ AC.....	375.12 kit

These kits fit engines with a long water pump. No Volume Discount.

Power Steering OEM High Pressure Hose

New correctly bent OEM high pressure hoses with correct fittings.



ARK-62X

ARK-62X 1962-67 All V896.99 pr.



CPX-6616

CPX-6616 1968 All V8.....26.95 ea.



CPX-6602

CPX-6602 1969 All V8.....26.95 ea.



CPX-586

CPX-584 1970-79 6 Cyl27.95 ea.
CPX-586 1970-72 All V829.95 ea.



CPX-577

CPX-577 1973-74 All V827.95 ea.



BUY'N SAVE
WITH KITS



ARK-678F

Power Steering Hose Kits

This kit comes with OEM high pressure hose, low pressure return tube, hose and correct clamps.

ARK-678F	1968 All V8	44.05 kit
ARK-69F	1969 All V8	44.05 kit
ARK-586	1970-72 All V8	44.15 kit
ARK-577	1973-74 All V8	42.45 kit

No Volume Discount.



NPX-16

Power Steering Return Hose

Complete with correct pre-bent flared tube, OEM hose and correct clamps.

NPX-16	1964-72 All V8	21.99 kit
CPS-038	OEM Return Hose	2.95 pr ft
CPN-512	OEM Clamps Screw Type	1.95 ea.



BSB-1970

Power Steering Hardware Kits

Our kits feature all correct hardware to attach power steering brackets to engine. A MUST!

G-4804	1967 SB (13 pc.)	15.99 kit
G-4805	1967 BB (13 pc.)	15.99 kit
G-4917	1968 SB 327 (14 pc.)	15.99 kit
G-4918	1968 BB 396 (13 pc.)	15.99 kit
BSB-69SB	1969-72 All SB	22.99 kit
BSB-1969	1969 BB	22.99 kit
BSB-1970	1970-72 All BB	12.95 kit

ASC-128



Power Steering Hose Retaining Clip

Correct clip for retaining hose to steering box.

ASC-128	All V8	12.95 ea.
---------	--------------	-----------

Power Steering Brackets

Original style reproduction and original GM brackets.



ASB-366

ASB-366 1965-68 SB Cradle49.95 ea.
For use with short water pump.

AAP-5910

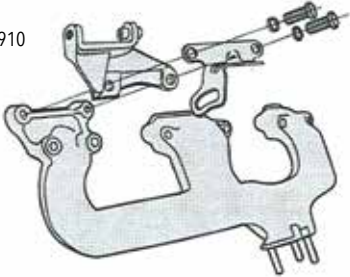

AAP-5910 1964-68 SB Upper Adjustor (to manifold)..... 29.95 ea.
For use with short water pump. Not for use with Ramshorn exhaust manifolds.



ASB-383

ASB-383 1966-67 L-79.....44.99 kit
For use with short water pump.



ASB-184

ASB-184 1968 SS396 Cradle65.99 ea.
For use with short water pump.



ASB-186

ASB-186 1968 396 Adjustor40.99 ea.
For use with short water pump.



AQW-1418

AQW-1418 1969 All BB (3 piece) 65.99 kit
Works with original long water pump & P/S pump.

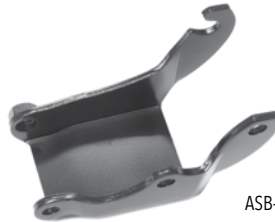

ASB-3941

ASB-3941 1969-74 All SB Cradle 29.99 ea.
For use with long water pump.



ASB-874

ASB-874 1969-74 SB Rear Support36.99 ea.
For use with long water pump.



AAB-2610

AAB-2610 1969-76 SB Adjustor39.99 ea.
For use with long water pump.



ASB-422

ASB-422 1969-74 All BB Cradle77.99 ea.
For use with long water pump.



ASB-931

ASB-931 1969-74 All BB (adjuster).....27.99 ea.

BUY 'N SAVE WITH KITS



ASB-7KIT

1970-74 Big Block Power Steering Bracket Kit

Complete kit with cradle, adjustment brackets and hardware.

ASB-7KIT 1970-74 All BB* 107.04 kit
Will work on most BB engines with long pump. May need some modification.



ASB-9KIT

1969-72 Small Block Power Steering Bracket Kit

Complete kit with all three brackets.

ASB-9KIT 1969-74 SB 92.67 kit

**BUY'N SAVE
WITH KITS**



GBK-1F

Power Steering Gearbox Kits

Now you can add on one of these awesome "close ratio" gear boxes to get better handling out of a stock style box. Our kit comes with steering box, steering coupler (rag joint) and correct attaching bolts. Will fit 68-74 Nova.

NO CORE CHARGE!

GBK-1F	3 - 3.5 Fast.....	391.86 kit
GBK-1XX	1968-76 All 3.25 Fast*.....	399.99 ea.
GBK-1SFA	2.5 Super Fast.....	370.96 kit

*No Volume Discount. Ships UPS Oversized Note: Saginaw 600 Gear Box. *Brand new not reman. Box only, no bolts or rag joint.*

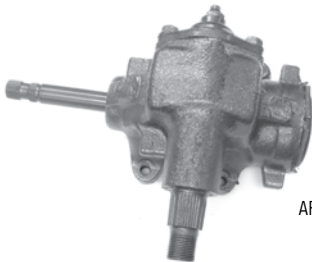

ARC-12SF

Manual Steering Boxes

Complete remanufactured original Saginaw assemblies. Choose from standard or quick ratio. **NO CORE CHARGE.**

ARC-12A	1968-69 24:1 Std.....	299.99 ea.
ARC-12B	1970-74 24:1 Std.....	299.99 ea.
ARC-12SF	1968-74 16:1 Quick.....	329.99 ea.

*Note: Use ATE-8869B coupler with ARC-12SF.
No Volume Discount. Ships UPS Oversized.*



D-1870

Pitman Arm

OEM pitman arm.

Manual Steering

DA-985	1968-74.....	75.95 ea.
--------	--------------	-----------

Power Steering

D-1870	1968-72.....	69.95 ea.
D-1870-USA	1968-74 Made In USA.....	89.99 ea.
DPA-73	1973-74.....	74.99 ea.



BX-64K

Pitman Arm Nut

Correct nut with washer.

BX-64K	1968-74 All.....	6.95 ea.
--------	------------------	----------



ATE-8869A



ATE-8869B

Steering Coupler

Complete joint for connecting column to box. 1968-69 with manual steering features fine spline and 1970-74 with manual steering features coarse spline.

ATE-8869A	1968-69 Manual.....	49.95 ea.
ATE-8869B	1970-74 Manual.....	49.95 ea.
ATE-8871	1968-74 Power.....	49.99 ea.



ATJ-411

Steering Coupler Bolt

Correct OEM bolt for coupler.

ATJ-411	1968-74 All.....	5.99 ea.
---------	------------------	----------



BSB-757

Steering Box Bolt

Complete with correct thick washer and bolt.

BSB-757	1968-74 All.....	3.99 ea.
---------	------------------	----------



DSE090204

600 Steering Gear

DSE's 600 steering gearbox provides you with rack and pinion performance with a bolt-in steering gear. Choose from paintable finish or ceramic coated.

- All new, not rebuilt!
- Increased steering feel due to low friction gear design!
- Precision rack and pinion valve technology!
- Late model performance car feel!
- Quick ratio 12.7:1!
- Original power pitman arm may be used!
- 6 pounds lighter than stock!

DSE090204	1968-74 Bare.....	876.99 ea.
-----------	-------------------	------------

DSE090204C	1968-74 Coated.....	1093.95 ea.
------------	---------------------	-------------

Note: Part number DSE 090205 rag joint and DSE 091202 hose kit are required with this box. Ships Oversize. No Volume Discount.



DSE090205

DSE Steering Coupler

Correct steering coupler for use with 600 box.

DSE090205	1968-74.....	49.99 ea.
-----------	--------------	-----------

No Volume Discount



DSE091202

DSE Power Steering Hose Kit

Includes fittings to convert your steering gear to -6 AN fittings. High quality stainless steel hoses are Teflon lined to handle the high pressure demands of the steering system. The hoses come with pre-crimped stainless steel fittings to attach to the -6 AN fittings at the steering gear. Each kit includes 30 inches of hose length that can be routed and cut to length at the pump end.

DSE091202	1968-74.....	215.99 kit
-----------	--------------	------------

No Volume Discount.



Overdrive Conversion Kits

This kit allows the use of your factory shifter with a TH700-R4 or TH200 4R transmission. Includes new laser cut and hardened detent, indicator plate, all hardware and all brackets to allow the use of your factory cable. You can barely tell it isn't factory!

S1041 1965-67 All* 65.99 kit

Complete Kits

S105-DA 1968-72 2 to 3 Speed Conversion 187.99 kit

S105-DB 1968-72 3 to 4 Speed Conversion 187.99 kit

*It is recommended to use a longer rod when installing an overdrive transmission (# SW431)..... 49.99 kit



Turbo Hydramatic Shifter Conversion Kit

Perfect for installing a TH350 or TH400 in your early Nova! Now you can use your factory automatic floor shifter with a newer 3 or 4 speed automatic transmission! This kit retains the rod linkage and includes a new laser cut and hardened detent for proper stops and gear selection, a new matching transmission shift lever, all necessary hardware and instructions.

S1031 1965-67 All 3 Speed 65.99 kit

S1041 1965-67 All 4 Speed 65.99 kit



Column Shift Transmission Bracket

Correct column shift transmission bracket which mounts on all column shift GM cars from 1969-1979.

FTB-13433 1969-79 16.99 ea.



TH Rod Linkage

Brand new rod linkage for your turbo hydramatic transmission.

SW435 All TH 94.99 kit

Shifter Handle Spring

Correct spring which mounts under the shifter handle for proper operation.

S501 All 7.99 ea.



EBC-22

Shifter Cable Clip

Correct clip for mounting cable.

EBC-22 Mounting Clip 3.99 ea.



FTH-049

Shifter Cable Clip

Correct push-on clip which mounts to shifter.

FTH-049 Push-on Clip (to shifter)..... 7.99 ea.



FSC-3914801

FSC-3895290

Steering Column Lockout / Bellcrank

Correct 1969-1972 Nova steering column lockout. Also fits 1968 Nova as a column shift bellcrank.

FSC-3895290 Powerglide..... 54.99 ea.

FSC-3914801 TH350/TH400 54.99 ea.



FKR-62

Lower Transmission Kickdown Rod

Used on all 1967-72 Novas with V8 engine and Powerglide. This mounts between the trans case kickdown arm and bellhousing mounted kickdown actuator arm.

FKR-62 All V8 w/ Powerglide..... 39.95 ea.



SW427

Rod Linkage Swivel Kit

When changing from a stock transmission to an overdrive unit, it is recommended that you use this longer rod.

SW427 1965-67 w/ PG or TH 81.99 kit

SW418 Universal 18" 51.99 set



FLK-1774

Transmission Shifter Linkage Rod And Bracket

This rod helps to put the transmission into the correctly selected gear. Includes the rod and forward bracket.

FLK-1774 1968-72 TH350,400 79.99 ea.

No volume discount.



S636

Flexi-Rod Shift Actuator

This is a new Flexi-Rod shift actuator that will replace the original GM stamped spring-steel actuator found in 1968-72 Novas with automatic transmission and factory console shifters. Unlike the original which usually breaks over the years, this one is flexible. The bottom tangs are both hardened for years of use!

S636 1968-72 60.99 ea.



FKR-666

Upper Transmission Kickdown Linkage Rod

Satin plated, exact reproduction comes complete with rod and swivel, from carburetor lever to bellhousing bellcrank.

FKR-666 1967-72 All with 2bbl 33.99 ea.

FKR-667 1967-70 All with 4bbl 33.99 ea.



FTH-973R

Shifter Cables

Original GM or high quality reproduction shifter cables for floor mounted TH shifter.

FTH-973R 1968-72 Repro..... 32.99 ea..



GCS-S6053

Stainless Steel Kickdown Cables

Show quality look with more adjustability than your factory cable.

GCS-S6053 TH350..... 40.99 ea.

GCS-S6051 TH700-R4 46.99 ea.

Note: For carburetor applications only.



S530

Kickdown Cable

Correct kickdown cable for all Novas with TH350.

S530 All TH350..... 20.95 ea.



S531

Kickdown Bracket

Correct kickdown bracket for all small blocks.

S530KIT All Cable and Bracket Kit 36.85 kit

S530 All Cable 20.95 ea.

S531 All Bracket 20.99 ea.

FSA-ZRLOS

Column Shift Linkage and Lockout Swivel Assembly

Correct swivel assembly for automatic column shift linkage and lockout.

FSA-ZRLOS 1968-7226.99 ea.

FCB-1210

FCB-220

Cable Mounting Bracket

Correct bracket for mounting cable to tranny.

FCB-1210 1968-72 TH350 16.99 ea.

FCB-220 1968-72 TH400 21.99 ea.

FCB-222

FTH-050

FCB-322

Shifter Cable Lever Brackets

Correct cable lever brackets which mount to transmission.

FCB-322 1968-72 1st Design19.99 ea.

FCB-222 1972-79 2nd Design24.99 ea.

FTH-050 Mounting Stud (to bracket)11.99 ea.

FTB-13433

Column Shift Transmission Bracket

This is the correct column shift transmission bracket which mounts on all column shift GM cars and is used to shift the transmission.

FTB-13433 1962-79 Auto 16.99 ea.

FCR-3920215

FCR-3914805

Steering Column Rods

FCR-3920215 1968-72 Upper PG 21.99 ea.

FCR-3972257 1968-72 Upper TH350/TH400 21.99 ea.

FCR-3945511 1968-72 Lower TH350 21.99 ea.

FCR-3914805 1968-72 Lower TH400 21.99 ea.

FCR-3895294 1968 Lower PG 21.99 ea.

FCR-3939743 1969-72 Lower PG 21.99 ea.

RBS-6781 1967-79 All Column Arm Grommet .. 9.99 ea.



Transmission Cooler Lines

OE style reproduction transmission cooling lines with flared ends and correct nuts.

		OM	SS
XTC67NN	1962-67 700-R4 w/ Large Radiator	49.99 ea.	129.99 ea.
XTC6601	1966-67 Powerglide w/o Spacer at Radiator	49.99 ea.	77.99 ea.
XTC6603	1966-67 Powerglide, 3" Spacer at Radiator.....	46.99 ea.	77.99 ea.
XTC6803	1968-72 All Automatic w/ 12" Span	49.99 ea.	89.99 ea.
XTC7001	1968-72 All Automatic w/ 8" Span	53.99 ea.	89.99 ea.
XTC7401	1974 V8, TH350.....	53.99 ea.	79.99 ea.
XTC7501	1975 V8, TH350.....	46.99 ea.	77.99 ea.
XTC7603	1976-78 V8, TH350.....	60.99 ea.	89.99 ea.

Ships Oversize

Transmission Vacuum Lines

OE style reproduction transmission vacuum lines with flared ends and correct nuts.

		OM	SS
FTV6701	1967-69 Powerglide.....	35.99 ea.	47.99 ea.
FTV6703	1967-68 TH350 LH Modulator	35.99 ea.	47.99 ea.
FTV6705	1967 TH400.....	35.99 ea.	47.99 ea.
FTV6903	1969-70 TH350 RH Modulator.....	35.99 ea.	47.99 ea.
XTV6805	1968-72 TH400	34.99 ea.	46.99 ea.
XTV7401	1974 TH350.....	34.99 ea.	40.99 ea.
XTV7501	1975 TH350.....	30.99 ea.	30.99 ea.

Ships Oversize

GCS-S5047

Transmission Cooler Hose Kit

These flexible braided stainless steel transmission cooler hoses fit either single or dual pass cooler set ups. Includes fittings.

GCS-S5047 All Universal 123.99 kit
48" hose length.



FCM-RCNV-350

GForce Transmission Crossmembers

Whether you need extra exhaust clearance, or just want to make your car handle better, these crossmembers are for you!

FCM-RCNV-350	1962-67 Coupe TH350, Muncie, PowerGlide, T10, Saginaw	285.99 ea.
FCM-RCNV-400	1962-67 Coupe 200R4, TH400 Short Tail.....	285.99 ea.
FCM-RCNV-700	1962-67 Coupe 700R4, 4L60, Early 4L60E.....	285.99 ea.
FCM-RCF1-350	1968-74 TH350, TH200, Muncie, PowerGlide, T10, Saginaw	285.99 ea.
FCM-RCF1-400	1968-74 200R4, TH400 Short Tail	285.99 ea.
FCM-RCF1-700	1968-74 700R4, 4L60, Early 4L60E	285.99 ea.
FCM-RCF1-4L80	1968-74 4L800E, 4L85E	339.99 ea.
FCM-RCF1-T56	1968-74 GM T-56 (from a 93-97 F-body).....	285.99 ea.
FCM-RCF2L-350	1975-79 TH350, TH200, Muncie, PowerGlide, T10, Saginaw	285.99 ea.
FCM-RCF2L-400	1975-79 200R4, TH400 Short Tail	285.99 ea.
FCM-RCF2L-700	1975-79 700R4, 4L60, Early 4L60E	285.99 ea.
FCM-RCF2L-4L80	1975-79 4L800E, 4L85E.....	339.99 ea.
FCM-RCF2L-T56	1975-79 GM T-56 (from a 93-97 F-body).....	285.99 ea.

Note: Energy Suspension mounts are required with all GForce crossmembers. No Volume Discount.



FCM-85

Transmission Crossmember

OE style reproduction crossmembers for mounting your transmission.

FCM-85	1968-74 BB* TH400	74.99 ea.
FCM-85B4	1968-74 BB/4 Speed	139.99 ea.
FCM-85M	1968-74 TH350/4 Speed	99.99 ea.
BPC-7000	1968+ Bolt Kit (16 pc)	6.95 kit

*Must be used with 69-72 big block motor mounts and frame stands.

FMCK-69S

Manual Transmission Conversion Kit
Planning on swapping from automatic to a 4 speed manual? This kit will take the headache out of the switch by providing you with all of the parts needed to make your conversion simple! This complete kit includes the brake/clutch pedals, Z bar, rods, boots, cross shaft kit, springs, bracket and all hardware!

FMCK-69S	1968-74 All SB	241.27 kit
FMCK-69S-HD	1968-74 SB w/ Headers.....	234.48 kit
FMCK-67B	1968 All BB.....	227.67 kit
FMCK-67B-HD	1968 BB w/ Headers.....	209.84 kit
FMCK-69B	1969-74 All BB	237.02 kit

No Volume Discount

FCA-5051

Clutch Linkage Kit
If you're looking to freshen up your original linkage but don't need the pedals, this is perfect!

FCA-5051	1968-74 SB	178.07 kit
FCA-5051-HD	1968-74 SB w/ Headers	170.87 kit
FCA-5053	1968-74 BB	173.57 kit
FCA-5053-HD	1968-74 BB w/ Headers.....	165.47 kit

FCI-69

FCI-1966

Clutch & Brake Pedal Assemblies
Complete reproduction brake/clutch pedals.

FCI-1962	1962-65 All	119.99 ea.
FCI-1966	1966-67 All	119.99 ea.
FCI-1869	1968-74 All	100.99 ea.
FCI-69	1969-74 Pedal Support.....	100.99 ea.

IBP-2065

IBP-4047

IHQ-0191

IBP-40471

Pedal Pads

OE style reproduction pedal pads.

IBP-2065	1962-67 Brake/Clutch Pad	5.99 ea.
IBP-4047	1962-67 Brake/Clutch.....	7.99 ea.
IHQ-0191	1968-74 Brake/Clutch Pad	5.99 ea.
IBP-40471	1962-67 All Power Brake w/ Manual Shift... 7.99 ea.	

FPB-97

FPB-103

Clutch Pedal Bushing & Bumper
Correct nylon bushing used for ease of pedal.

FPB-97	All Bushing.....	2.99 ea.
FPB-103	All Bumper.....	3.99 ea.

FBC-799

FBF-606

Clutch Pedal Booster Rod & Clip
For use with power disc brakes.

FBC-799	Booster Rod Clip.....	9.99 ea.
FBF-606	Booster Rod Fork	14.95 ea.

NTR-235

Transmission Mounts

NPG-100	All Powerglide	11.95 ea.
NTR-235	All TH350/Manual	13.95 ea.
NTR-225	All TH400.....	13.95 ea.
BTE-7939	Mounting Bolt.....	0.95 ea.

3-1108G

Poly Transmission Mounts
Poly mounts outlast OEM mounts and are able to absorb most driveline vibrations.

ENERGY SUSPENSION
Performance POLYURETHANE Components

3-1108G	1968-79 All Black.....	39.99 ea.
3-1108R	1968-79 All Red	39.99 ea.



BUY'N SAVE
WITH KITS

FBH-621SUPERKIT



621 Bellhousing Kit

Complete kit with reproduction "621" bellhousing, clutch fork, fork boot, throw-out bearing, bolts and inspection cover. Fits cars with 11" clutch.

FBH-621SUPERKIT	Complete Kit.....	340.88 kit
FBH-621K	Bellhousing & Cover.....	212.26 kit
FBH-621	Bellhousing Only.....	179.99 ea.



FTE-3943

Flywheel Inspection Covers

OE style reproduction flywheel covers.

FTE-3943	Manual 11".....	24.95 ea.
NK-4497	Manual 10.5".....	26.99 ea.
NJ-088	All Powerglide.....	31.99 ea.
NE-810	All TH350.....	34.95 ea.
NJ-089	All TH400.....	137.99 ea.
BFW-506K	Bolts 4 pc.....	1.95 kit



BPP-9021

Bellhousing Hardware

BPP-9021	Bellhousing to Block 6pc.....	8.95 kit
BTE-307	Bellhousing to Trans 4pc 4 Speed.....	8.95 kit



FFW-105

Flywheels

Original GM flywheels.

FFW-105	10.5" w/o 454.....	279.99 ea.
HAYS-10-020	168t 70-90 SBC BBC**.....	114.99 ea.
BPP-5116	1962-79 Flywheel to Crank Bolts 12pc.....	19.99 kit
BPP-5118	1962-79 Flex Plate to Crank Bolts 12pc.....	18.99 kit
BPP-8386	1962-79 Flywheel to Pressure Plate Bolts 12pc.....	9.99 kit

No Volume Discount. *Internally balanced. **Externally balanced.



FCK-258

Heavy Duty Clutch Kits

HD clutch kits include clutch disc, pressure plate, throw out bearing, pilot bushing, alignment tool and grease pack.

FCK-258	11" 10 Spline BB.....	189.99 kit
FCK-260	11" 26 Spline BB.....	189.99 kit
FCK-105	10.5" 10 Spline SB.....	199.95 kit
FCK-108	10.5" 26 Spline SB.....	199.95 kit

No Volume Discount

FPB-66ROLLER



Pilot Bushing

Correct GM needle bearings for input shaft.

FPB-ROLLER	All Roller.....	26.99 ea.
FPB-667	All Brass OE Style.....	14.99 ea.



FTO-641

Throw Out Bearing

Original OEM throw out bearing.

FTO-641	All.....	44.95 ea.
---------	----------	-----------



FTE-9000-ADJ



FTE-9000

Clutch Fork Ball

Clutch fork mounting ball for inside of bellhousing.

FTE-9000	All.....	16.99 ea.
FTE-9000-ADJ	Adjustable.....	29.99 ea.



FKW-4999

Clutch Fork Boot

Original clutch fork dust boot.

FKW-4999	1968-79 All.....	9.99 ea.
FKW-11LW	For Lakewood Scatter Shield Bellhousing.....	38.99 ea.



HAYS-92-1003

Hays Manual Clutches

Hays Street 450 single disc kits are an excellent upgrade offering up to 30% more holding power over your stock clutch. Designed to handle stock to mildly modified engines up to 450 horsepower. This is a great clutch where drivability is the most important factor along with a stock pedal feel.

HAYS-91-1003	10.5" 26 Spline	363.99 kit
HAYS-91-1002	10.5" 10 Spline	358.99 kit
HAYS-91-1004	11" 10 Spline	371.99 kit
HAYS-91-1005	11" 26 Spline	371.99 kit

Hays Street 650 single disc kits are designed to handle highly modified naturally aspirated engines up to 650 horsepower. Designed as a true street/strip clutch for spirited high performance driving or frequent track use.

HAYS-92-1003	10.5" 26 Spline	717.99 kit
HAYS-92-1002	10.5" 10 Spline	690.99 kit
HAYS-92-1004	11" 10 Spline	735.99 kit
HAYS-92-1005	11" 26 Spline	728.99 kit

No Volume Discount.



LW-15000LKW



FKW-11LW



FEH-397



FKW-4999

Lakewood Bellhousing

The Lakewood 15000LKW bellhousing connects Chevy small and big block engines to transmissions utilizing the standard GM pattern such as the Muncie, Saginaw, Borg Warner T10 and Tremec TKO transmissions. This bellhousing is hydro formed to fit '58-'87 GM full and midsize cars, 67-81 F-body vehicles and 68-79 Novas. This bellhousing is S.F.I. 6.1 certified which is required by many sanctioning bodies for cars running 11.49 or faster in the quarter mile. The Lakewood 15000 comes complete with engine block plate and Grade 8 mounting hardware.

LW-15000LKW	1962-1979 SBC, BBC	656.99 ea.
FEH-397	1968-1979 All Resto Clutch Fork	70.99 ea.
FKW-4999	1962-1979 All Clutch Fork Boot OE	9.99 ea.
FKW-11LW	1968-1979 All Clutch Fork Boot	38.99 ea.
FTE-9000-ADJ	1962-1979 All Adjustable Clutch Fork Ball	29.99 ea.

No Volume Discount.



HOL-319-575

LS Clutch And Flywheel Kit

This Kit includes all the hardware and components needed for a complete clutch install on a 6-bolt crank LS engine using a T-56 transmission. A 12-inch organic disc with 6 spring helix sprung hub provides superior grip needed for the strip, while the matched diaphragm style pressure plate provides a pedal feel comfortable enough for the street. This provides 30 percent more clamping pressure and transmits that through a billet steel flywheel.

HOL-319-575	All w/ 6 Bolt Crank LS & T56	1000.99 set
-------------	------------------------------------	-------------

No volume discount.



HAYS-10-010

Hays Automatic Flexplate

Hays heavy duty flexplate for high performance competition Chevy engines are constructed of a thicker than stock steel plate. This enables them to withstand the stress of high-stall torque converters and high-RPM engines. These flexplates are supplied with a ring gear that is securely welded in place and feature a dual bolt pattern for use with a Powerglide or Turbo style torque converter.

HAYS-10-010	168t 57-85 SBC 65-70 BBC*	121.99 ea.
HAYS-10-020	168t 70-90 SBC BBC**	114.99 ea.

*Internally balanced. **Externally balanced.
No Volume Discount.



BM-20230

B&M Automatic Flexplate

Heavy duty flexplate for extreme racing or street applications. SFI certified for NHRA & IHRA.

BM-20230	55-85 168t SBC up to 1991 BBC	140.99 ea.
BM-20232	55-85 168t SBC 400	150.99 ea.
BM-20233	55-85 168t BBC 454	137.99 ea.
BM-20232	55-85 153t SBC	150.99 ea.

*Except SBC 400 and BBC 454. No Volume Discount.

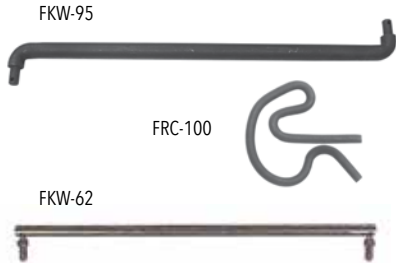

Clutch Firewall Rods

FKW-62	1962-67 All	33.95 ea.
FKW-95	1968-74 All	27.99 ea.
FRC-100	Attaching Clip	1.99 ea.



Firewall Rod Boots

OE style reproduction rubber boots for firewall.

FRB-1	1962-67	33.95 ea.
FHQ-0239	1968-74	7.99 ea.
FHQ-0891	1975-79	17.95 ea.



Clutch Fork

New GM clutch fork.

FCF-3583	1962-67	56.99 ea.
FEH-397	1968-74	70.99 ea.



Clutch Cross Shaft Kit

Original GM stud balls, nylon seats, protective felts, retaining clips, nuts and washers.

FPX-828	Complete All V8	29.95 kit
FPX-6568	Block Ball Only	13.95 ea.
FPX-5289	Frame Ball Only	23.99 ea.
FPX-3349	Plastic Seat Only	3.99 ea.
FPX-3360	Ball Felt	14.99 ea.
FPX-0696	Retaining Clip	2.99 ea.
FPX-33K	Cross Shaft Seat & Seal Kit	38.20 kit

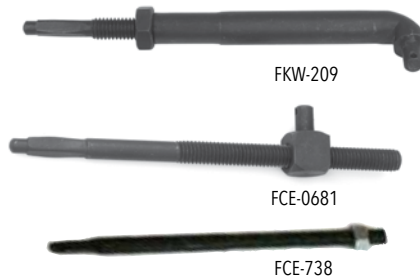

Clutch Adjustment Rod Kits

FKW-3	1962-67 SB	33.95 ea.
FKW-209	1968-74 SB	25.99 kit
FCE-0681	1968-74 BB	20.99 kit
FCE-738	Universal Extra Long*	19.99 ea.
FRC-100	Clip	1.99 ea.

*Cut to fit



Clutch Return Springs

Original return springs for clutch fork, etc.

FKW-1461	1968-74 SB	6.99 ea.
FPC-520	1968-74 BB	7.99 ea.



Clutch Spring Extension Rod

Correct clutch spring extension rod for small blocks.

FKW-1460	1968-74 SB	7.99 ea.
----------	------------------	----------



Block Conversion Pivot Bracket

Allows the stock clutch linkage to be used with non-Chevy II specific blocks.

FCB-30	1962-67	32.99 ea.
--------	---------------	-----------



Clutch Fork Return Spring Extension

Correct clutch spring extension plate for big blocks.

FXB-533	1968-74 BB	7.99 ea.
---------	------------------	----------



Clutch Z Bar

OE style reproduction "zerk" bar.

FCI-3523	1962-67 SB	69.99 ea.
FCI-501	1968-75 SB	50.99 ea.
FCI-108	1968-75 BB	49.99 ea.



Clutch Frame Brackets

Correct bracket for mounting Z bar to frame.

FB-62	1962-67 All	23.95 ea.
FK-130	1968-74 All	22.99 ea.
BFB-605	Attaching Bolt	0.75 ea.



Reverse Lockout Kit

Complete with 2 rods and swivel mechanism.

NA-578	1969 All 4 Speed	104.99 kit
--------	------------------------	------------



BM-80675



BM-80706



BM-80690



BM-80840

B&M Automatic Floor Shifters

From the originator of high performance manual shifters, our line of performance, street and racing shifters for automatic transmissions won't let you down. With classic good looks and proven mechanical designs, giving choices of either positive ratcheting actions or gated racing shifters provide positive shifts guaranteeing you won't miss a shift when it counts.

Starshifter

Features include NHRA/ IHRA reverse lockout, backup light switch, neutral safety switch, polished T-handle. Cable operated for quick installation and accurate shifting.

BM-80675 All 2&3 Speed 284.99 ea.

Megashifter

The B&M Megashifter has it all, form, function and classic style. This all adds up to bring you a quality shifter that's been one of the most popular automatic shifters of all time. First off let's talk function. The Megashifter's positive ratcheting function won't allow you to over shift and miss a gear at that critical moment, along with the reverse lockout feature meets NHRA/IHRA safety rules for those weekend grudge races at the track. The look and feel of the T-handle and accordion style shift boot really shows off the racing heritage of the Megashifter.

BM-80690 All 2,3,4 Speed..... 456.99 ea.

BM-80694 1973-79 2,3,4 Speed..... 461.99 ea.

Quicksilver

The B&M Quicksilver features a ratcheting action for positive shifts, chrome knob, neutral safety switch, NHRA/IHRA approved reverse lockout.

BM-80683 All 2,3,4 Speed..... 413.99 ea.

BM-80688 1973-79 2,3,4 Speed..... 404.99 ea.

Hammer

The Hammer shifter may just be the most comfortable and versatile shifter available. The unique design of the shift handle easily fits all sizes of hands providing the best wrist angle and feel when shifting.

BM-80885 All 2,3,4 Speed..... 314.99 ea.

Pro Stick

The Original Pro Stick shifter delivers rock-solid performance, mixed with clean design cues and compact size. This is why you see so many Pro Stick shifters at the race track.

BM-80706 All 2,3,4 Speed..... 403.99 ea.

Stealth Magnum Pro Stick

The Stealth Magnum Grip Pro Stick shifter delivers rock-solid performance, mixed with clean design cues and compact size.

BM-81052 All 2,3,4 Speed..... 384.99 ea.

Pro Ratchet

The Pro Ratchet shifter is one of our most popular and easiest to operate race shifters. Features include a positive ratcheting design that self-centers the handle after each shift giving you maximum clearance behind the shifter and won't allow you to miss a shift by over-shifting a gear. This versatile shifter will operate both forward and reverse shift patterns.

BM-80840 All Silver 2 Speed Powerglide 406.99 ea.

BM-80842 All Silver 3,4 Speed* 406.99 ea.

BM-80843 All Carbon 3,4 Speed* 409.99 ea.

BM-81120 All Stealth 3,4 Speed* 507.99 ea.

*May require PRNDL switch for some applications. No Volume Discount.



HURST-3838530



HURST-3160001

Hurst Automatic Shifters

Pro-Matic 2

Ratchet-action shifter with its chrome-plated stick and black knob is quality engineered for years of precise, trouble-free operation. Once the shifter is installed, the textured console and brilliant top cover that can be trimmed to fit any floor contour integrates the shifter with the interior.

HURST-3838500 All 3 Speed 389.99 ea.

V-Matic 3 Shifter

Designed with a park and reverse lock trigger actuating system that allows smooth and flawless ratcheting through the forward gears.

HURST-3838530 All 3 & 4 Speed 453.99 ea.

Quarter Stick

The Quarter Stick shifter provides positive gear change control for both street and race applications. Its compact size fits easily in racecars with limited space and is very lightweight at only 2.5 pounds. Features include black oxide coated steel construction, 1018 hardened steel gate plate, forged aluminum shift stick with 7/16"-20 tpi and a classic white Hurst shift knob.

HURST-3160001 All 2 Speed* 391.99 ea.

HURST-3160006 All 3 Speed** 391.99 ea.

HURST-3160020 All 3 Speed* 394.99 ea.

*Reverse valve body. **Forward valve body.



HURST-5389020



HURST-5389023

Hurst Billet Shifter Handles

This is a great way to add a contemporary performance look to your muscle car. Billet Aluminum construction is precision CNC machined for a modern look and feel. Fits classic Hurst shifters with a 2 bolt pattern.

HURST-5389020	6" Straight	101.99 ea.
HURST-5389021	8" Straight	116.99 ea.
HURST-5389022	10" Straight	132.99 ea.
HURST-5389023	6" Lay Back	116.99 ea.
HURST-5389024	8" Lay Back	132.99 ea.
HURST-5389025	10" Lay Back	159.99 ea.

No Volume Discount.



HURST-5010002

Hurst Indy Manual Shifters

For the past 60 years Hurst has been the most recognized name in performance shifters.

HURST-5010002	Indy 3 Speed	340.99 ea.
HURST-5030030	Indy 4 Speed	498.99 ea.



HURST-3162001



HURST-3162023

Pistol Grip Quarter Stick

The Pistol-Grip Quarter Stick shifter provides positive gear change control for both street and race applications. Its compact size fits easily in racecars with limited space and is very lightweight at only 2.5 pounds. Features include black oxide coated steel construction, 1018 hardened steel gate plate, ergonomic billet aluminum pistol-grip shift handle that incorporates a momentary switch which can be used to activate a Hurst Roll control, a trans-brake or a nitrous system.

HURST-3162001	All Silver Handle 2 Speed*	514.99 ea.
HURST-3162002	All Black Handle 2 Speed*	514.99 ea.
HURST-3162006	All Silver Handle 3 Speed**	514.99 ea.
HURST-3162007	All Black Handle 3 Speed**	514.99 ea.
HURST-3162023	All Black Handle 4 Speed**	504.99 ea.

*Reverse valve body. **Forward valve body. No Volume Discount.



HURST-5008555



HURST-5000029

Hurst Shifter Cables

These premium quality cables feature a solid 303 stainless steel inner wire core encased within a nylon liner wrapped with helical lay wires and swaged ends for superior strength. The core is lubricated with Teflon prior to assembly and then sealed in a heavy plastic outer casing for a lifetime of durability and smooth operation.

Single eyelet on one end and threaded on the other end.

HURST-5000023	3 Feet	88.99 ea.
HURST-5000025	5 Feet	83.99 ea.
HURST-5000028	8 Feet	109.99 ea.

Single eyelet on one end and threaded on the other end. For Pro-Matic & V-Matic shifters

HURST-5008555	5 Feet	80.99 ea.
---------------	--------------	-----------

Eyelets on both ends for quarter stick.

HURST-5000029	5 Feet	94.99 ea.
---------------	--------------	-----------

No Volume Discount.



BM-20248



B&M Governor Recalibration Kit

This kit allows you to adjust the shift points of your transmission after it is installed in your vehicle. The Governor Recalibrating Kit is very useful if you have a vehicle that is very light; has a low rear-end gear ratio.

BM-20248	55-85 TH350, TH400, TH700R4	101.99 kit
----------	-----------------------------------	------------

No Volume Discount.



BM-30228



BM-30229



BM-21042

B&M Transpak, Transkit & Master Overhaul Kits

The B&M Transpak has all the features in the Shift Improver Kit, plus it provides additional driver manual control. Retain full automatic features and standard shift points with selector in drive.

BM-30228	1968-79 TH350	121.99 ea.
----------	---------------------	------------

B&M Transkits give you the same high-quality components that are used in all B&M Street and Strip transmissions. They also include special directions on how to modify your case, pump and components.

BM-30229	1968-79 TH350	349.99 ea.
----------	---------------------	------------

B&M Master Racing overhaul kits are supplied with all of the gaskets, seals, bushings and friction material required for a complete high performance or racing trans overhaul.

BM-21042	1968-79 TH350	297.99 kit
BM-21041	1968-79 TH400	322.99 kit

No Volume Discount

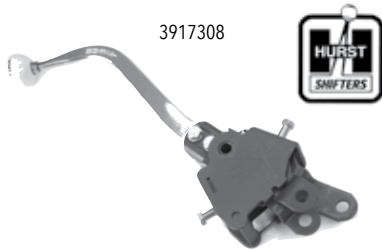

Hurst Shifters

New Hurst Competition Plus shifter complete with Hurst handle and shifter ball.

3917308	1964-67 All	493.99 ea.
3914339	1968 with Console.....	499.99 ea.
3916848	1968-73 w/o Console	493.99 ea.

No Volume Discount



Hurst Installation Kits

Complete kit with rods, levers, swivels and hardware.

3733163	1964 All	261.99 kit
3734529	1968 All	274.99 kit
3737131	1969-70 w/o Console	280.99 ea.
3737834	1971-73 w/o Console	261.99 kit

No Volume Discount



Shifter Balls

OE style reproduction shifter balls.

FZ-1300	1965-67 White Bench.....	42.99 ea.
FZ-1400	1965-67 Chrome	22.99 ea.
FZ-1420	1968-72 White 5/16"	23.99 ea.
FZ-1424	1968-72 White 3/8".....	23.99 ea.
FW-115	Chrome 5/16"	27.99 ea.
FW-117	Chrome 3/8"	23.99 ea.
FW-157	Black/Chrome 5/16".....	22.99 ea.
FW-159	Black/Chrome 3/8".....	23.99 ea.
FW-38HURST	Hurst White 3/8" 4 Speed.....	47.99 ea.



FW-HURST

Hurst-T Handle Shifter Knob

This brushed aluminum t-handle provides a positive feel for accurate gear selection. A favorite in the performance world for years! Includes adaptors for most popular shift handles.

FW-HURST	T-Handle.....	45.99 ea.
----------	---------------	-----------



Shifter Handles

OE style reproduction chrome shifter handles.

FRZ-5134	1965-67 Bench.....	99.95 ea.
FZ-513B	1965-66 Bucket.....	99.95 ea.
FRZ-5131	1967 Bucket.....	109.99 ea.

Muncie - Hurst Adaptor

This handy bracket allows you to bolt up your original Muncie shifter handle to a Hurst shifter. The original Muncie handle featured a top mount design while the Hurst handle features a side mount design. The Hurst design is much stronger

FHB-64	1964-67.....	69.99 ea.
--------	--------------	-----------



1968-72 Auto Shifter

This shifter is complete with neutral safety/back up switch, all rod linkage components and factory-like reverse lock out and detents for each gear. Also includes a universal floor mounting bracket kit. It mounts to the floor and with much of the body below the floor to clear factory consoles.

SW280-RCT	1968-72 Universal Replacement.....	341.99 kit
-----------	------------------------------------	------------

SH-203-8

SH-202-8

SH-204-10

Billet Shifter Handles

These billet aluminum shifter handles from Clayton Machine work with any Hurst or Tremec, TK500/TK0600 2 bolt shifter mount and are a great finishing touch for your custom ride! Available in three styles. Basic black anodized, truss style with grey powder coat, truss style adjustable grey powder coat. Shift knob not included. Requires knob with 3/8"-16" thread. Same as most Hurst knobs.

SH-203-8	8" Black Anno 30 Degree Kick Back	234.99 ea.
SH-203-10	10" Black Anno 30 Degree Kick Back	241.99 ea.
SH-202-8	8" Grey PC Truss Style 30 Degree Kick Back	184.99 ea.
SH-202-10	10" Grey PC Truss Style 30 Degree Kick Back.....	191.99 ea.
SH-204-10	10" Grey PC Truss Style Adjustable Kick Back.....	316.99 ea.

No Volume Discount.

FMCASE-660

FMSYNCHRO-6674

FMBEARING-6374

Muncie 4-Speed Transmission Parts

Rebuild your Nova's damaged or broken M-20, M-21 transmission with these awesome rebuild kits, cases and synchros!

Cases

FMCASE-660	1968-70 M-20, 21, 22 Casting Number 3925660	309.99 ea.
FMCASE-661	1970-74 M-20, 21, 22 Casting Number 3925661	309.99 ea.

Parts

FMSYNCHRO-6674	1966-74 M-20, 21, 22 Synchro Assembly	69.99 kit
FMBEARING-6374	1964-74 M-20, 21, 22 Front Bearing.....	64.99 kit

No Volume Discount.



ITW-1022 ICE-4526

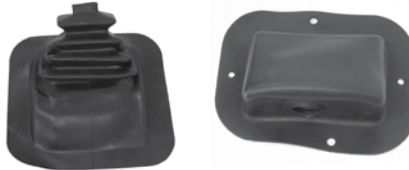

ITW-1057 ITW-1054

Shifter Boots

Brand new injection molded boots.

ITW-1022	1964-67 4 Speed	26.99 ea.
ICE-4526	1968-74 4 Speed Console	22.95 ea.
ITW-1057	1968-74 4 Speed w/o Console.....	34.99 ea.
ITW-1054	1968-74 Auto w/ Console	26.99 ea.
ICE-HURST	Universal.....	74.99 ea.
ICE-INDY	Universal Indy Shift Boot.....	34.99 ea.



ITW-1050 ITW-1100



ITW-1058

Shift Boot Retainers

Correct die stamped steel boot retainers.

ITW-1050	1962-67 All	24.99 ea.
ITW-1058	1968-74 w/o Console.....	49.99 ea.
ITW-1100	1968-74 w/ Console.....	26.99 ea.

S500



Neutral Safety Switch

This neutral safety switch is necessary when converting your early Nova to a TH or OD transmission.

S500	1962-65 w/ Console.....	57.99 ea.
------	-------------------------	-----------

GNS-13



Neutral Safety Switch

Correct steering column switch for proper engine and reverse light activation.

GNS-13	1962-66 Powerglide Column	22.99 ea.
GDR-411	1969-72 Automatic Console.....	34.99 ea.

GNS-1969



Neutral Start Switch

Correct safety switch located at the pedal to prevent the car from starting in gear.

GNS-1969	1969 Manual	79.99 ea.
FSR-372	1969 Rod & Clip.....	22.99 ea.
GNS-X99	1970-75 Manual.....	59.99 ea.

GNS-503



Neutral Safety Switch

For console shift automatic transmission equipped cars.

GNS-696	1965-67 Auto.....	69.99 ea.
GNS-503	1968-72 Powerglide.....	42.99 ea.
GNQ-375	1968-72 TH350/TH400.....	43.99 ea.
GNS-35	1969-72 Auto Column	21.99 ea.

39504



Reverse Switch Mounting Kit

Complete with bracket, shield, rod, clips and hardware for mounting the reverse switch.

39504	1964-68 Complete.....	52.99 kit
GRB-342	1964-68 Bracket Only	14.95 ea.
GWT-17	1964-68 Shield Only.....	9.95 ea.
GRR-58	1964-68 Rod/Clips Only	17.95 ea.

1993413



Reverse Lamp Switch

Correct switch assembly for activating reverse lamps.

1998728	1962 4 Speed	62.99 ea.
1997929	1963 4 Speed	62.99 ea.
1993661	1964 4 Speed	69.99 ea.
1993307	1965-67 4 Speed.....	69.99 ea.
1993413	1968 4 Speed	74.99 ea.

10665



Reverse Switch Extension Harness

Correct harness which plugs into firewall.

27315	1962-63 Auto	20.99 ea.
28160	1962 4 Speed	41.99 ea.
28335	1963 All Connector	26.99 ea.
10665	1967-68 All	31.99 ea.

REVSKIT-UNI



Universal Reverse Lamp Switch Manual

This kit allows you to add a reverse light switch to non-stock applications. If you have a Hurst shifter this kit is a must.

REVSKIT-UNI	All Manual.....	48.99 ea.
-------------	-----------------	-----------

BUY'N SAVE WITH KITS



REVSKIT-67X

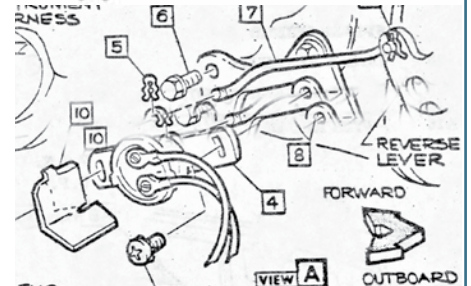

Reverse Switch Kit

This kit includes all components needed for a complete installation: Switch, extension harness, bracket, shield and rod.

REVSKIT-67X	1967	139.47 kit
REVSKIT-67F	1968	143.97 kit

No Volume Discount.

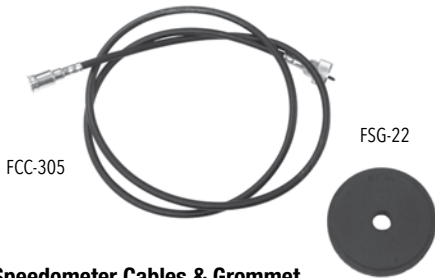

Speedometer Cables & Grommet

New complete cables with casings and correct ends ready to install.

FCC-201	1962-68 64"	19.99 ea.
FCC-203	1962-68 83"	19.99 ea.
FCC-305	1969-72 61"	19.99 ea.
FCC-205	1969-72 80"	19.99 ea.
FSG-22	1962-74 All Grommet	7.95 ea.

*Longer cables are for cars with passenger side screw ins on transmission.



Modulator Valve

Replacement modulator valve for automatic transmission.

FTM-12903	PG, TH350, TH400	39.95 ea.
-----------	------------------	-----------

Note: Smaller than original but functions the same.



Speedometer Cable Clip

Bolts to bottom of manual transmission tail shaft bolt to keep cable from hanging down.

FHB-13653	1970-79 Manual Trans	14.99 ea.
-----------	----------------------	-----------



Universal Driveshaft Loop

GCS-S7120	Universal	35.99 ea.
-----------	-----------	-----------



U-Joint Attaching Kits

Correct straps and bolts for attaching drive shaft to rear yoke.

BPU-337	All Straps with Bolts	15.99 kit
BPU-334	All U-bolts with Nuts	16.99 kit



Yokes

New front drive shaft & rear differential yokes.

FY-123	Front Yoke TH400	99.95 ea.
FY-935	Front Yoke TH350/4 Speed	99.95 ea.
FY-2122	1965-79 12 Bolt Strap Type	119.99 ea.



TCS Transmission Switches

Correct TCS switch located on transmission.

ATS-21MP	1970-75 Pin Style	36.99 ea.
ATS-21MS	1970-75 Spade Style	36.99 ea.



TCS Wire Retainer

Correct reproduction for Muncie.

ATS-653	1970-74 w/ Muncie	21.99 ea.
---------	-------------------	-----------



Tail Seals

Correct tail shaft yoke seals.

FTS-PG	Powerglide	5.99 ea.
FTS-350	TH350	5.95 ea.
FTS-400	TH400	10.95 ea.



Tail Shaft Bolts

Correct TR head markings & black phosphate plating.

BSB-12925	PG, TH350, TH400 6pc	9.99 kit
-----------	----------------------	----------

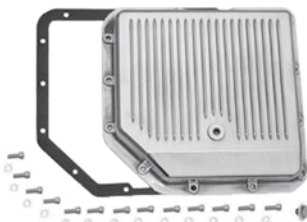

Polished Finned Transmission Pans

Show quality polished stock depth pan crafted from cast aluminum and polished to a bright finish. Includes gasket, drain plug and bolts.

GCS-S8491	TH350	62.99 ea.
GCS-S8492	TH400	74.99 ea.
GCS-S8493	TH700-R4	74.99 ea.



Chrome Transmission Pans

Stock depth. Chrome plated steel for a show quality finish.

GCS-S9074	TH350	23.99 ea.
GCS-S7599	TH700-R4	32.99 ea.



Chrome Finned Transmission Pans

Stock depth. Chrome plated steel with fins.

GCS-S9124	Powerglide	23.99 ea.
GCS-S9122	TH350	20.99 ea.
GCS-S9121	TH400	20.99 ea.
GCS-S9712	TH700-R4	31.99 ea.



Extra Capacity Finned Transmission Pans

Same quality show finish as our stock pans but with extra fluid capacity for better cooling.

GCS-S9197	TH400 1.5 Extra Qts.	23.99 ea.
GCS-S9196	TH400 2.5 Extra Qts.	32.99 ea.
GCS-S9197BK	TH400 1.5 Extra Qts. Black	23.99 ea.
GCS-S9198BK	TH350 1.5 Extra Qts. Black	24.99 ea.
GCS-S9712BK	700-R4 1.5 Extra Qts. Black	32.99 ea.



B&M Deep Transmission Pan Cast

These B&M automatic transmission deep pans provide additional fluid capacity and cooling ability. No modifications to the dipstick are needed. They include a drain plug for clean and easy fluid changes. Adds 2-3 quarts to the transmission.

BM-30280	All TH350, TH250 3 Qts.	234.99 ea.
BM-20280	All TH400 2 Qts.	215.99 ea.
BM-70280	All Powerglide 2 Qts.	227.99 ea.
BM-70260	All TH700RH, 4L60/65E 3 Qts.	325.99 ea.

No Volume Discount.



FR-158RB



FR-158RK



FR-158RS



FR-158RV



FR-158SH

Transmission Speedometer Gears

These are the correct speedometer driven gears which go inside the transmission case. Please compare the gear you have to what you are ordering as the color or tooth count may vary from original. We do not have an application chart for these, so if changing axle ratios or tire size, please consult various online resources.

Muncie M20, M21, M22,

Saginaw 3 & 4 Speed and Powerglide

FR-158RB	17 Tooth Purple.....	16.95 ea.
FR-158RD	18 Tooth Brown.....	16.95 ea.
FR-158RF	19 Tooth Natural	16.95 ea.
FR-158RH	20 Tooth Blue.....	16.95 ea.
FR-158RK	21 Tooth Red.....	16.95 ea.
FR-158RM	22 Tooth Gray.....	16.95 ea.
FR-158RS	23 Tooth Black.....	16.95 ea.
FR-158RV	24 Tooth Orange	16.95 ea.

TH350, TH375, TH400, TH475

FR-158SB	35 Tooth Pink.....	16.95 ea.
FR-158SD	36 Tooth White.....	16.95 ea.
FR-158SF	37 Tooth Red.....	19.95 ea.
FR-158SH	38 Tooth Blue.....	16.95 ea.
FR-158SM	40 Tooth Black.....	16.95 ea.
FR-158SP	41 Tooth Yellow.....	16.95 ea.
FR-158SS	42 Tooth Green.....	16.95 ea.
FR-158SV	43 Tooth Purple.....	16.95 ea.
FR-158SX	44 Tooth Dark Gray.....	16.95 ea.
FR-158SZ	45 Tooth Light Green.....	16.95 ea.
FR-RETAINER	1964-88 All w/ Large Gear	6.99 ea.



BM-70264

B&M Transmission Coolers & Kits

B&M Super Coolers are 100% aluminum stacked plate style core which is ideal for additional transmission cooling. With oven brazed construction, this sturdy cooler design is practically impervious to flying rocks or other debris.

Small

BM-70265	All 7,500 BTU Polished.....	124.99 ea.
BM-70273	All 15,000 BTU Black.....	112.99 ea.

Medium

BM-70268	All 13,000 BTU Black	114.99 kit
BM-70266	All 20,500 BTU Black.....	154.99 ea.
BM-70272	All 20,500 BTU Polished.....	210.99 ea.

Large

BM-70264	All 14,400 BTU Black	136.99 kit
BM-70274	All 29,200 BTU Black	186.99 ea.

No Volume Discount.



BM-70298

B&M HiTek Cooling Systems

Hi-Tek Super Coolers are fitted with a high quality 12 Volt electric fans and built in mounting brackets which makes it ideal for maximum cooling. Suitable for many fluids including ATF, Engine Oil, Differential Oil and power steering fluid.

BM-70298	All 350 CFM Black.....	413.99 ea.
BM-70297	All 590 CFM Black.....	456.99 ea.

No Volume Discount.



FDT-350



FDS-3

Dipstick & Tubes

GM replacement dipstick and tubes.

FDT-350	TH350 Tube	24.99 ea.
FDT-350K	TH350 Tube & Stick Set.....	22.99 kit
FDT-400	TH400 Tube	33.99 ea.
FDS-3	TH350 Stick	9.95 ea.
FDS-4	TH400 Stick	9.95 ea.
FDT-400K	TH400 Tube & Stick Set.....	22.99 kit



GCS-S9422



GCS-S4995

Chrome Dipsticks and Tubes

Show quality dipsticks are an excellent upgrade to any engine compartment. Includes dipstick & tube.

GCS-S9422	Powerglide.....	15.99 ea.
GCS-S9421	TH350.....	15.99 ea.
GCS-S9421BA	TH350 Billet Handle.....	24.99 ea.
GCS-S4994	TH350 34".....	16.99 ea.
GCS-S4994BA	TH350 34" Billet Handle.....	19.99 ea.
GCS-S4995	TH400 24".....	13.99 ea.
GCS-S4995BA	TH400 24" Billet Handle.....	17.99 ea.



MRG-41G01MRG



MRG-41G03MRG

Mr. Gasket Differential Cover Gaskets

Mr. Gasket Differential Cover Gaskets offer simple, no silicone installation. They use an aluminum carrier, silicone elastomer beading and a rubber coated binder to create a strong, long lasting seal perfect for the demands of factory or high performance front and rear ends. Whether it's your daily driver, race car, or off-road rig, these premium differential cover gaskets from Mr. Gasket have you covered.

MRG-41G01MRG	Chevy 8.875 inch 12 bolt.....	26.99 ea.
MRG-41G03MRG	GM 8.5 inch 10 bolt.....	26.99 ea.

No volume discount.



BM-70500



B&M Differential Covers

B&M Cast Aluminum Differential Covers are designed to strengthen the differential by preventing case distortion, ring gear & bearing cap deflection. Constructed of A356.0-T6 aluminum, these rugged covers significantly increase the fluid capacity and dissipate heat much faster than the stock factory unit to prolong the life of your ring and pinion gears.

BM-70500	12 Bolt 8.875" Ring Gear Silver	244.99 ea.
BM-70502	10 Bolt 8.2,5, or 6" Ring Gear Silver	250.99 ea.
BM-71502	10 Bolt 8.2,5, or 6" Ring Gear Black	272.99 ea.
BM-70503	10 Bolt 8.2" BOP Ring Gear Silver	224.99 ea.

No Volume Discount.



HBB-5847



FDP-5R



FPT-3



N-7081

Rear End Plugs & Posi Tag

OE style reproduction plugs and posi tag.

HBB-5847	All Metal Tag.....	6.95 ea.
FDP-5R	Plug 1"	16.99 ea.
FPT-3	Posi Tag 1"	13.99 ea.
FDP-3R	Plug 3/4"	16.99 ea.
FPT-1	Posi Tag 3/4"	13.99 ea.
N-7081	1967-72 Vent Plug.....	9.95 ea.



GCS-S4787



GCS-S5082

Custom Rear End Covers

Choose from high quality chrome or bright polished aluminum. A great finishing touch!

GCS-S4786	10 Bolt* Chrome	18.99 ea.
GCS-S4787	12 Bolt Chrome	19.99 ea.
GCS-S5082	12 Bolt Polished	110.99 ea.
GCS-R0002X	Bolt Kit	13.99 kit

*8.5" Corporate 10 Bolt



NP-109

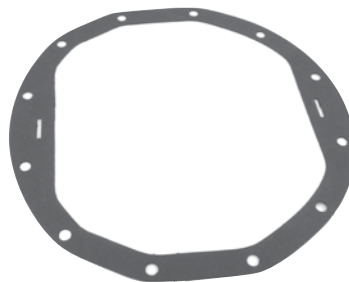

FP-12B

Rear End Cover

OE style reproduction 12 bolt cover.

NP-109	All 12 Bolt Cover	52.99 ea.
FP-10B	10 Bolt Gasket	7.99 ea.
FP-12B	12 Bolt Gasket	7.99 ea.
BRE-2008	Cover Bolt	0.95 ea.



TTP-68



TTP-70



TTP-71



TTP-6972

Turbo HydraMatic Transmission ID Tags

Turbo HydraMatic transmission ID tag with rivet, measuring 1-1/8 inch x 1-15/16 inch. This installs on the side of the transmission case with the rivet. You must punch your own info onto the tag.

TTP-68	1968 Dark Olive	29.99 ea.
TTP-6972	1969 & 1972 Yellow	29.99 ea.
TTP-70	1970 Black	29.99 ea.
TTP-71	1971 Light Blue	29.99 ea.



PF-49



PF-668

Rear End Fluid

Original GM special fluid and posi additive.

PF-668	Rear End Fluid.....	26.99 ea.
PF-49	Posi Additive	14.99 ea.



Fuel Tank Doors

Correct spring loaded fuel tank door.

XTD-1630	1969-72 Door.....	26.99 ea.
XTD-1630	1975-79 Door.....	26.99 ea.
XTD-10B	Door Bumper.....	1.95 ea.
BTB-56K	Door Bolt.....	2.59 pr.
XTD-132	1962-65 Bumpers 4pc.....	3.99 kit
XTD-10B	1968-74 Bumper.....	1.95 ea.



Fuel Tank Filler Neck

OE style reproduction fuel filler neck and gasket for your early Nova.

XTW-2662	1962-64 All.....	99.99 ea.
XTW-2665	1965-67 All.....	99.99 ea.



Fuel Tank Filler Neck Gasket

OE style reproduction fuel filler neck gasket which prevents fuel from leaking behind the quarter panel.

XFG-605	1962-67 All.....	3.95 ea.
---------	------------------	----------



Fuel Tank Sending Units

Original GM or exact reproduction sending units and locking ring.

XSU-300	1962-65 5/16" Repr.....	74.99 ea.
XSU-066	1962-65 3/8" Repr.....	63.99 ea.
XSU-014	1966-67 5/16" Repr.....	63.99 ea.
XSU-022	1966-67 3/8" Repr.....	63.99 ea.
XSU-19	1968-72 3/8" Repr.....	42.99 ea.
XSU-016	1968-72 3/8" GM.....	194.99 ea.
XSU-041	1973-75 3/8" Repr.....	54.99 ea.
XSU-042	1973-75 3/8" w/ 1/4" Return Repr.....	59.99 ea.
XLR-937	1962-72 Lock Ring w/ Gasket.....	5.95 ea.

*For cars with fuel return line. No Volume Discount on GM.

XFF-092	All 3/8".....	17.95 ea.
---------	---------------	-----------

Sender Filter

Correct mesh filter to keep debris out.

XFF-092	All 3/8".....	17.95 ea.
---------	---------------	-----------

Fuel Lines Front to Rear

Exact reproduction pre-bent fuel lines featuring correct armor shielding and cloth insulation as original. Available in original material (OM) and stainless steel (SS).



Front to Rear Lines

		OM	SS
XGL6204	1962-64 V8 (through tenderwell by battery box) 5/16".....	77.99 ea.	101.99 ea.
XGL6201	1962-67 6 cyl (runs through tunnel) 5/16".....	69.99 ea.	101.99 ea.
XGL6205	1962-67 5/16" station wagon.....	66.99 ea.	103.99 ea.
XGL6202	1965-67 V8 (through fenderwell by battery box) 5/16".....	66.99 ea.	103.99 ea.
XGL6203	1965-67 V8 (through fenderwell by battery box) 3/8".....	66.99 ea.	101.99 ea.
XGL6601	1966-67 L-79, 3/8" line 1pc.....	66.99 ea.	101.99 ea.
XGL6602	1966-67 L-79, 3/8" line 2pc.....	66.99 ea.	119.99 ea.
XGL6603	1966-67 6 cylinder, wagon.....	66.99 ea.	103.99 ea.
XGL6801	1968 3/8" Main Line.....	66.99 ea.	101.99 ea.
XGL6802	1968 Front To Rear Line.....	66.99 ea.	111.99 ea.
XGL6901	1969-73 3/8" Main Line.....	69.99 ea.	109.99 ea.
XGL6902	1969-73 1/4" Return Line.....	69.99 ea.	119.99 ea.
XGL6906	1969-73 6 cyl, 5/16".....	66.99 ea.	101.99 ea.
XGL7401	1974 3/8" Main Line.....	78.99 ea.	101.99 ea.
XGL7403	1974 1/4" Return Line.....	78.99 ea.	101.99 ea.
XGL7501	1975 3/8" Main Line.....	78.99 ea.	101.99 ea.
XGL7502	1975 1/4" Return Line.....	78.99 ea.	101.99 ea.
XGL7601	1976-77 3/8" Main Line.....	66.99 ea.	103.99 ea.
XGL7801	1978 3/8" Main Line.....	66.99 ea.	103.99 ea.

Ships Oversize 2.

Vapor Return Lines Sets

XEM7105	1971-72 5/16" Vapor Set 5pc.....	113.99 ea.	154.99 ea.
XEM7401	1974 5/16" Vapor Line 1pc.....	78.99 ea.	103.99 ea.
XEM7501	1975 5/16" Vapor Set 5pc.....	113.99 ea.	154.99 ea.
XEM7601	1976-78 5/16" Vapor Set 2pc.....	66.99 ea.	113.99 ea.



Fuel Line Clips

Correct clips for attaching fuel lines to frame.

ELC-1516	5/16" Line.....	1.99 ea.
ELC-516	5/16" w/ Tab.....	4.99 ea.
ELC-038	3/8" Line.....	1.99 ea.
ELC-038T	3/8" w/ Tab.....	3.99 ea.
ELC-1438	1/4" - 3/8" Line.....	3.99 ea.
ELC-1438T	1/4" - 3/8" w/ Tab.....	4.99 ea.
BLC-056	Correct Bolt.....	0.50 ea.



Fuel Tank Hose Kits

Correct GM hose and pinch clamps.

AXP-3800	All 3/8".....	4.95 kit
AXP-1438	All 3/8" - 1/4".....	7.99 kit



Sending Unit Harness

New exact reproduction with correct boot.

39704	1968-72 All.....	19.99 ea.
33835	1973-75.....	21.99 ea.



Fuel Line Clips

These convenient kits include all of the correct clips needed to install a set of factory fuel lines.

INL-CNF301	1964-65 5pc.....	21.99 kit
INL-CNF306	1966 6pc.....	24.99 kit
INL-CNF302	1967 6pc.....	22.99 kit
INL-CNF303	1968 9pc.....	24.99 kit
INL-CNF304	1969-74 3/8" No Return 14pc.....	22.99 kit
INL-CNF305	1969-74 3/8" w/ Return 15pc.....	29.99 kit
INL-CNF308	1975-79 3/8" No Return 16pc.....	24.99 kit
INL-CNF307	1975-79 3/8" w/ Return 17pc.....	34.99 kit

AXD-69

GM 3942527 LH
6

GM Restoration Parts

AXD-396

GMRH2
3916178

Exhaust Manifolds SB
New GM restoration manifolds. These brand new manifolds are sold in matched pairs and come with GM cast numbers. AXD-67 features alternator bracket provision as original for some cars.

AXD-67	SB non-SMOG 3840912 / 3892679*	429.99 pr.
AXD-69	SB non-SMOG 3932376 / 3942529	399.99 pr.
AXD-69S	SB with SMOG 3946826 / 3942527	419.99 pr.

*Features alternator mount provision. No Volume Discount. Ships Oversize.

Exhaust Manifolds BB
New GM restoration manifolds. Sold in matched pairs with GM cast numbers (3909879-3916178). Correct for most cars.

AXD-396	BB non-SMOG 3916178 / 3909879	429.99 pr.
AXD-396S	BB with SMOG 3916178 / 3909879	419.99 pr.

No Volume Discount. Ships Oversize.

XG-20

XE-153

XD-500

Exhaust Gaskets & Donuts

XG-20	Riser Gasket 2" SB	1.95 ea.
XG-225	Riser Gasket 2.5" BB	2.99 ea.
XD-400	Donut 2" SB	3.99 ea.
XD-500	Donut 2.5" BB	4.95 ea.
XE-152	Extension 2" SB	12.99 ea.
XE-153	Extension 2.5" BB	15.99 ea.

AHR-1180

AHR-1190

Heat Riser Valves
Correct valve for pre-heating engine on cold start.

AHR-1190	Valve SB 2"	69.99 ea.
AHR-1180	Valve BB 2.5"	84.99 ea.

N-660

Heat Riser Spacers
Takes the place of the heat riser for increased flow.

N-660	2" Spacer SB	54.99 ea.
N-733	2.5" Spacer BB	54.99 ea.

APB-1382

OEM Exhaust Manifold Bolts
Correct head marked and colored bolts for mounting exhaust manifolds to block.

APB-1382	SB w/ Washers 24pc	39.99 kit
APB-1821	BB Flanged Head 16pc	23.99 kit
APB-3506	BB Loose Washer 32pc	26.99 kit

ALI-2228

Exhaust Stud Kit
Studs for attaching pipe to manifolds.

ALI-2228	All V8	22.99 kit
----------	--------	-----------

EHS-473

EHS-471

Heat Stove
Works in conjunction with the air heat tube to preheat the air cleaner thermo-sensor. This item mounts on the right hand (passenger side) exhaust manifold. Manufactured to original specifications featuring the correct zinc plating.

EHS-471	1969-76 Upper Small Block	9.99 ea.
EHS-473	1969-76 Lower	19.99 ea.
EHS-128	1968-79 Heat Stove Tube	21.99 ea.

EXL-10

Exhaust "French Locks"
Our kit comes with (4) correct stainless steel stamped locks for corners of exhaust manifold as installed by factory.*

EXL-100	SB w/o Ram's Horn	14.95 kit
EXL-10	SB Ram's Horn	14.95 kit
EXL-200	All BB	14.95 kit

*Not to be used with "Flanged" head bolts.



Pypes Performance Exhaust Systems

Pypes Exhaust Systems are designed to deliver enhanced performance, provide extra punch in the passing lane and improve gas mileage. Fabricated using the highest quality materials, the smooth, 16 gauge, mandrel-bent, stainless steel pipe ensures maximum exhaust gas flow, which can significantly boost horsepower.

Pypes 2.5" Crossmember Back w/ X-Pipe

SGF11R	1968-77 w/ Race Pros, Rear Exit, 409 Stainless	570.99 kit
SGF11S	1968-77 w/ Street Pros, Rear Exit, 409 Stainless	571.99 kit
SGF11V	1968-77 w/ Violators, Rear Exit, 409 Stainless	571.99 kit

Pypes 3" Crossmember Back w/ X-Pipe

SGF13R	1968-77 w/ Race Pros, Rear Exit, 409 Stainless	668.99 kit
SGF13S	1968-77 w/ Street Pros, Rear Exit, 409 Stainless	659.99 kit
SGF13V	1968-77 w/ Violators, Rear Exit, 409 Stainless	659.99 kit

Pypes 2.5" Crossmember Back w/o X-Pipe

SGF31R	1968-77 w/ Race Pros, Rear Exit, 409 Stainless	563.99 kit
SGF31S	1968-77 w/ Street Pros, Rear Exit, 409 Stainless	563.99 kit
SGF31V	1968-77 w/ Violators, Rear Exit, 409 Stainless	563.99 kit

Pypes 2.5" Crossmember back H Bomb H-pipe

SGN40R	1962-67 Race Pros 409 SS.....	603.99 kit
SGN40S	1962-67 Street Pros 409 SS.....	601.99 kit
SGN40V	1962-67 Violator 409 SS.....	599.99 kit
SGN40T	1962-67 Turbo Pros 409 SS.....	606.99 kit

Ships Oversize 2.



SGN30V

Pypes Hybrid 3/2.5" Systems

Need a 3 inch exhaust system for your Nova, but are concerned about the fit around your shocks and/or gas tank? With plenty of flow to handle the horsepower and a fit that rivals OEM, the new Pypes 3 inch Hybrid systems combine the best of both worlds. These 3 inch Pypes Hybrid Systems use our 3 inch X-Pipe technology and a set of custom (3 inches in to 2.5 inches out) mufflers connected to a set of 2.5 inch mandrel bent tailpipes.

409 Stainless

SGN30R	1962-67 w/ Race Pros. Rear Exit.....	643.99 kit
SGN30S	1962-67 w/ Street Pros. Rear Exit.....	649.99 kit
SGN30V	1962-67 w/ Violators. Rear Exit.....	639.99 kit

Ships Oversize.

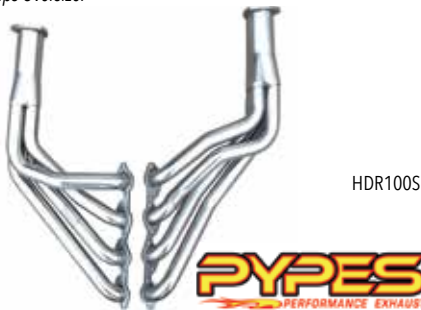

HDR100S

Pypes Big Block Header

Pypes big block headers for Nova big blocks feature large 2" primary tubes and 3.5" in collectors with power spikes. Constructed of 304 mandrel bent stainless steel and fully TIG welded, they include stainless collector reducers, premium hardware and gaskets.

HDR100S	1968-74 Big Block.....	732.99 ea.
---------	------------------------	------------

No Volume Discount.

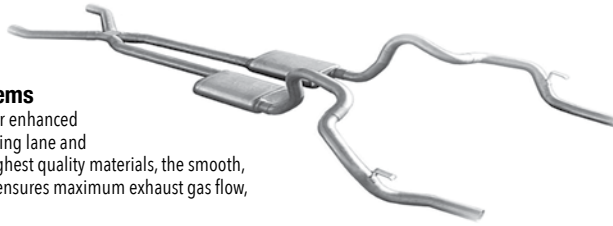

SGN975SE

Pypes EPA Compliant Exhaust System

Pypes Nova Exhaust Systems are designed to deliver enhanced performance, provide extra punch in the passing lane and improve gas mileage. Fabricated using the highest quality materials, our 16 gauge, mandrel-bent, stainless steel pipe ensures maximum exhaust gas flow, which can significantly boost horsepower. These systems feature EPA compliant catalytic converters are the best in the market in terms of performance, design, and longevity. Expect more power, improved MPG, superior emissions, and sound control. These converters are made from a high quality 304 grade stainless steel.

Pypes 2.5" Crossmember back w/ H-pipe

SGN945E	1975-79 No Mufflers	1001.99 kit
SGN945RE	1975-79 Race Pro Mufflers	1130.99 kit
SGN945SE	1975-79 Street Pro Mufflers	1128.99 kit
SGN945VE	1975-79 Violator Mufflers	1126.99 kit
SGN945TE	1975-79 Turbo Pro Mufflers.....	1134.99 kit

Pypes 2.5" Crossmember back w/ X-pipe

SGN975E	1975-79 No Mufflers	996.99 kit
SGN975RE	1975-79 Race Pro Mufflers.....	1130.99 kit
SGN975SE	1975-79 Street Pro Mufflers	1128.99 kit
SGN975VE	1975-79 Violator Mufflers	1125.99 kit
SGN975TE	1975-79 Turbo Pro Mufflers.....	1132.99 kit

Ships oversize 2.



SGF70S

Pypes Crossflow Exhaust System

This crossflow system was designed for incredible clearance but with an ultra high flow crossflow muffler. Designed to specifically run in the drive shaft tunnel for extra ground clearance and you've got an awesome exhaust system!

SGF70	1968-77 2.5" 409 Stainless.....	694.99 kit
SGF70S	1968-77 2.5" 304 Polished Stainless.....	914.99 kit

Ships Oversize 2.

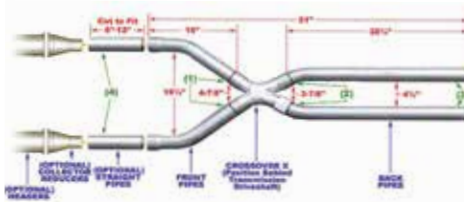

XVF10

Pypes Crossovers

X-Crossovers add 15-30 HP while improving torque. The X-Change is the same but gives you the option to uncork the exhaust.

	409	Polished
XVF10	2.5"	220.99 kit
XVF13	3".....	265.99 kit



EVT49

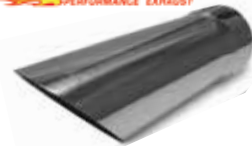

EVT59



Pypes Exhaust Tips

Add the finishing touch to your exhaust system with a set of triple chrome plated tips from Pypes! All tips are slip fit.

EVT49	2.5" Angle Cut.....	42.99 pr.
EVT50	3" Angle Cut.....	49.99 pr.
EVT59	2.5" Hockey Stick Style.....	108.99 pr.
EVT61	3" Hockey Stick Style.....	114.99 pr.



PVD13

Downturns

These universal downturns are perfect for off road applications when tail pipes are not desired.

PVD10	2.5" 409 Stainless	51.99 pr.
PVD13	3" Aluminized.....	83.99 pr.

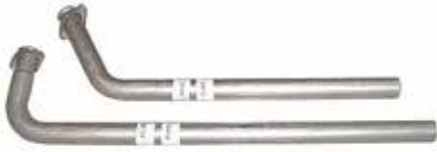

DGU14S

Downpipes

If you are using stock manifolds, you will need a pair of these downpipes to connect to the system. 409 Stainless steel.

DGU14S	1967-79 SB.....	178.99 pr.
DGU20S	1967-79 BB.....	162.99 pr.



Collector Reducers

These act as connectors from your header collectors to intermediate pipes for a clean look.

PVR10S	3" Header to 3" Pipe	88.99 pr.
PVR13S	3.5" Header to 3" Pipe	90.99 pr.
PVR16S	3" Header to 2.5" Pipe	88.99 pr.
PVR19S	3.5" Header to 2.5" Pipe	90.99 pr.



HKR-11051HKR

Hooker Dual Exhaust Cut-Out Kits

The choice is yours - Tease the Street or Please the Track with Hooker's new "Street-Tease" exhaust cut-outs! Good and "old" ideas improved with new materials, that's what we have here! These cut-outs will provide years of worry free use with a mixture of stainless steel and aluminum. The materials will keep the elements out and the sound, well that's up to you, with a flip of the toggle or a push of the remote button.

- Tig-welded T-304 stainless steel tubing for a clean and weather resistant finish
- 6061 aircraft aluminum motor and valve bracket
- Instant performance gains when opened
- Stainless tip can be positioned for any direction of exhaust
- Simple 12v cigarette lighter plug in for main power supply
- Welding Required

HKR-11051HKR	Dual 2.5" Kit.....	530.99 kit
HKR-11052HKR	Dual 3" Kit.....	530.99 kit

No Volume Discount.



HKR-8501-1HKR

HKR-8501-4HKR

HKR-8501HKR

Hooker Cast Iron LS Exhaust Manifolds

Hooker cast iron exhaust manifolds have been designed to hug close to the engine block so they fit into a wide variety of replacement and engine-swap applications. Their contoured design aims the exhaust directly at the exit port for improved flow. Being cast iron means they will provide years of leak-free performance with less under hood noise than traditional headers. Plus, their shorty design means you can route exhaust tubing close to your frame/floor pan for maximum ground clearance. "Hook" up your GM LS engine with Hooker cast iron manifolds today!

- Intended for all GM LS (except LS7 and LS9) engine swap applications where durability, quiet operation, emissions compliance and leak-free sealing is desired
- Cast from Hi-Silicon-Moly Ductile Iron to provide durability and corrosion resistance
- 2.25-inch outlet diameter
- Free-flowing for good performance and catalytic converter efficiency
- Recommended for strong performance on engines making up to 500 horsepower



HKR-8501-1HKR	Silver Ceramic Coated	540.99 kit
HKR-8501-3HKR	Black Ceramic Coated.....	540.99 kit
HKR-8501-4HKR	Titanium Ceramic Coated.....	540.99 kit
HKR-8501HKR	Natural Cast Finish	405.99 kit
HKR-8510HKR	Natural Cast Finish Turbo*.....	596.99 kit

*For use with a turbo charger. No Volume Discount.



HKR-2451HKR



HKR-2455-2HKR

Hooker Competition Headers

Hooker Competition headers offer the best value in the high performance header market. Designed for the value-conscious buyer who is running either a "stock" or "mildly-modified" engine, these headers offer premium features at a very competitive price. Made of durable 16 gauge mild steel tubing, header design utilizes a long transition collector to reduce back pressure and increase exhaust flow. A perfect sealing surface is assured with the 5/16" machined flanges, with welded O-ring seals. Experience has proven that this flange size is ideal to maintain header integrity and be pliable enough to seal each exhaust port. Tubing is mandrel-bent to maintain metal strength and provide consistent tube diameter at radii to maximize performance.

- All necessary hardware included for a complete installation
- Designed for easy, trouble-free fit
- Industry's best welds for durability
- Long transition collector for decreased back pressure
- Tuned-length primary tubes for street performance

Hooker Long Tubes

Small Block

HKR-2451HKR	1968-79 Black Paint 1-5/8" Tubes 3" Collector	265.99 pr.
HKR-2451-1HKR	1968-79 Silver Ceramic 1-5/8" Tubes 3" Collector	579.99 pr.
HKR-2451-3HKR	1968-79 Black Ceramic 1-5/8" Tubes 3" Collector	689.99 pr.
HKR-2451-2HKR	1968-79 Stainless 1-5/8" Tubes 3" Collector.....	837.99 pr.
HKR-2466HKR	1968-79 Black Paint 1-5/8" Tubes 3" Collector	252.99 pr.
HKR-2466-1HKR	1968-79 Silver Ceramic 1-5/8" Tubes 3" Collector.....	624.99 kit
HKR-2466-3HKR	1968-79 Black Ceramic 1-5/8" Tubes 3" Collector	650.99 kit

No Volume Discount.



FT-11100FLT

Flowtech Long Tube Headers

Flowtech headers are the perfect combination of performance and value. Flowtech long tube headers are precision engineered using mandrel bent tubing, formed collectors and 5/16" flanges with sealing rings for a leak-free seal. All mounting hardware and gaskets are included for a simple installation. This header is coated in a high heat resistant black paint for a stealthy appearance. Instant performance gains when opened.

- Tuned-length primary tubes for street performance
- Mandrel-bent tubing for smooth exhaust flow
- Light weight & sturdy 16 gauge tubing
- Mandrel-formed Power Plenum collector for low back pressure
- Sturdy, leak-tested O-Ring port seals
- Engineered for an easy, trouble-free precision fit
- Includes all mounting hardware and premium gaskets



Small Block

FT-11100FLT	1968-79 Black Paint 1-5/8" Tubes 3" Collector.....	213.99 pr.
FT-31100FLT	1968-79 Silver Ceramic 1-5/8" Tubes 3" Collector.....	446.99 pr.
FT-11104FLT	1968-79 Black Paint 1-5/8" Tubes 3" Collector.....	189.99 pr.

Big Block

FT-11130FLT	1968-74 Black Paint 1-3/4" Tubes 3" Collector.....	240.99 pr.
FT-11132FLT	1968-74 Black Paint 1-7/8" Tubes 3.5" Collector.....	280.99 pr.

No Volume Discount.



FT-11108FLT

Flowtech Mid-Length Headers

Flowtech headers are the perfect combination of performance and value. Flowtech Mid-Length headers are precision engineered using mandrel bent tubing, formed collectors and 5/16" flanges with sealing rings for a leak-free seal.

- Tuned-length primary tubes for street performance
- Mandrel-bent tubing for smooth exhaust flow
- Light weight & sturdy 16 gauge tubing
- Mandrel-formed Power Plenum collector for low back pressure
- Sturdy, leak-tested O-Ring port seals
- Engineered for an easy, trouble-free precision fit
- Includes all mounting hardware and premium gaskets

Small Block

FT-11108FLT	1968-79 Black Paint 1-1/2" Tubes 2.5" Collector.....	209.99 pr.
-------------	--	------------

No Volume Discount.



FT-11000FLT

Flowtech Block Hugger Headers

Flowtech Block Hugger headers are ideal for street rods where fit and finish is really important. Block Huggers make performance and style easy for engine swaps and with our new Hugger Toobs you can hook up to an existing system with ease.

- Computer-controlled mandrel-bent tubing for smooth exhaust flow
- Sturdy 16 gauge tubing
- Easy installation - can be used with stock motor mounts
- Precision die-cut exhaust port flanges
- Engineered and tested for a leak-proof seal
- All necessary hardware included for a complete installation



Small Block

FT-11000FLT	1962-79 Black Paint 1-5/8" Tubes 2.5" Collector.....	236.99 pr.
FT-31000FLT	1962-79 Silver Ceramic 1-5/8" Tubes 2.5" Collector.....	457.99 pr.

Big Block

FT-11030FLT	1968-79 Black Paint 1-3/4" Tubes 2.5" Collector.....	244.99 pr.
FT-31030FLT	1968-79 Silver Ceramic 1-3/4" Tubes 2.5" Collector.....	529.95 pr.

Big Block Tight Fit

FT-11701FLT	1968-79 Black Paint 1-3/4" Tubes 2.5" Collector.....	286.99 pr.
FT-11701-1FLT	1968-79 Silver Ceramic 1-3/4" Tubes 2.5" Collector.....	124.99 pr.
FT-11701-7FLT	1968-79 Stainless 1-3/4" Tubes 2.5" Collector.....	366.95 pr.
FT-11701-2FLT	1968-79 Chrome 1-3/4" Tubes 2.5" Collector.....	140.99 pr.

No Volume Discount.



FT-49100FLT

Flowtech Afterburner Headers

Flowtech's Afterburner Turbo Chamber Headers represent the first new major design change in exhaust technology in decades. This design combines the race-proven 4 into 1 design with the torque managing capabilities of a Tri-Y header. The turbo chamber helps smooth out exhaust turbulence for increased performance and a broad power curve.

- Horsepower and torque increased over conventional header design
- Big 3" secondary collector for reduced back pressure
- Tuned-length primary tubes combine with velocity tube to smooth out exhaust pulses
- All hardware and premium gaskets included for a complete installation
- Patented velocity tube increases cylinder scavenging

FT-49100FLT	1968-79 Black Paint 1-5/8" 3" Collector.....	328.99 pr.
FT-49100-1FLT	1968-79 Silver Ceramic 1-5/8" 3" Collector.....	510.99 pr.

No Volume Discount.



Flowmaster Pre-bent Tail Pipes

These 16 gauge mandrel bent pipe kits are designed to fit perfectly onto your vehicle with all the quality and performance that you would expect from Flowmaster.

- Premium Flowmaster Quality
- Mandrel bent 16 Gauge Tubing
- Rear Exit

Aluminized Steel

FLOW-15801 1968-74 2.5" Rear Exit 197.99 pr.

409 Stainless Steel

FLOW-815801 1968-74 2.5" Rear Exit 252.99 pr.

No Volume Discount.

Flowmaster American Thunder Exhaust Systems

American Thunder systems deliver a moderate to aggressive interior and exterior tone and are suited to the enthusiast who wants their performance to be heard. Like all Flowmaster systems, the benefits include improved throttle response, power and mileage. Designed for an easy fit, these systems include all necessary parts and hardware for easy installation.

- Dyno tuned for maximum performance
- Includes hangers and hardware for easy installation
- Moderate to Aggressive Sound Exterior Exhaust Tone
- Mandrel bent 16 Gauge Tubing



409 Stainless Dual Muffler Systems

FLOW-817673 1962-67 2.5" 44 Series Mufflers** Rear Exit 827.99 kit

FLOW-817158 1968-74 2.5" 44 Series Mufflers** Rear Exit 740.99 kit

409 Stainless Single Muffler Systems

FLOW-817673 1968-74 2.5" 80 Series Muffler* Dual Rear Exit 827.99 kit

FLOW-817104 1968-74, 2.5", Stainless, Transverse 880.99 kit

Aluminized Single Muffler System

FLOW-17104 1968-74 2.5" 80 Series Muffler* Dual Rear Exit 667.99 kit

*Moderate sound. **Aggressive sound. *No Volume Discount.*



FLOW-81068



Flowmaster Downpipes

Flowmaster's manifold downpipe kits are designed for the person who wants to use a Header-back exhaust system while using the factory exhaust manifolds. Utilizing mandrel bent 409S stainless steel tubing and high quality flange gaskets, Flowmaster's manifold downpipe kits are designed for the perfect leak free fit.

- Pipes designed to be used without heat riser
- 2.50 in manifold downpipe
- Mandrel bent 16 gauge 409 stainless steel tubing

FLOW-81068 1968-79 Small Block 195.99 kit

No Volume Discount.



FLOW-814111

Scavenger Series Elite Shorty Headers

Flowmaster's Scavenger Series Elite shorty headers are designed to replace the restrictive factory manifolds. These high quality headers are manufactured from stainless steel and are ceramic coated for maximum durability. They feature 1-3/4 in. primary tubes, 3/8 in. thick laser cut flanges and factory collector connections, ensuring a direct-fit, leak free installation. Like all Flowmaster products, the benefits include improved throttle response, power and engine efficiency.

- 3/8" laser cut flanges
- Dyno tuned for maximum performance
- High temperature ceramic coating
- 409 stainless steel construction

FLOW-814111 168-74 Big Block 1-3/4" Primary.. 894.99 kit

No Volume Discount.



FLOW-814110

Scavenger Series Elite Long Tube Headers

Scavenger Series Elite long tube headers deliver maximum performance and are suited to the enthusiast who wants the best. Like all Flowmaster products the benefits include improved throttle response, power and engine efficiency. Designed for an easy fit, these headers include gaskets and necessary hardware for easy installation.

- Ball & socket collector
- Ceramic coated
- 0.375 inch thick laser cut flanges
- 3 inch collector outlet

FLOW-814110 1968-79 SB 1-5/8" 894.99 kit

FLOW-814112 1968-74 BB 2" 894.99 kit

No Volume Discount.



FLOW-15938



Flowmaster Header Collector Ball Flange

This header collector kit takes the place of three bolt flange type connections and allows for a leak free and gasket free ball flange type connection.

FLOW-15938 1962-79 All 2.5" to 2.5" 141.99 kit

FLOW-15925 1962-79 All 2.5" to 3" 141.99 kit

FLOW-15925 1962-79 All 3" to 3" 141.99 kit

No Volume Discount.



Fan Shroud Attaching Kits

Correct OEM clips and screws for attaching fan to shroud.

AX-3970 1968-74 All 6.95 kit

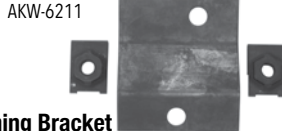

Fan Shroud Attaching Bracket

Correct bracket kit with clip and bolt for mounting fan shroud.

AKW-6211 1968-70 BB 13.99 kit



Lower Fan Shroud Clips

Correct "S" style clips for mounting lower fan shroud.

APC-0100 1968-72 All 2.95 pr.



Fan Attaching Kits

Correct style bolts/studs for attaching fan to water pump.

BPX-2792 Studs 12 Piece 6.95 kit
BPX-2791 Bolts 8 Piece 5.95 kit



Fan Clutches

Heavy duty fan clutch with Gold cadmium coloring in limited supply!

AWT-7719 1962-68 Short Pump Replacement 74.99 ea.
ABR-2710 1969-74 Long Pump 74.99 ea.
BKP-516 Correct Attaching Nuts (4) 1.50 kit



Universal Coolant Recovery Tank

This compact tank can be mounted anywhere and is used to recover coolant overflow. 6" wide x 4" deep x 5" tall.

ACR-001 Universal 15.99 ea.



Fan Clutch Kits

Complete kit to convert your car to this heavy duty GM fan clutch option. This kit includes fan, fan clutch and all necessary hardware.

FANKIT-5BR 1962-68 All (w/ Replacement Clutch)* 172.74 kit
FANKIT-6BS 1962-68 6 Blade (Short Water Pump)* 145.70 kit
FANKIT-7BS 1962-68 7 Blade (Short Water Pump)* 172.74 kit
FANKIT-7BL 1969-72 All (w/ Long Water Pump)* 154.74 kit
* Small Block Only.



ABR-3996



Fan Blades

Reproduction fan blades to be used with fan clutches only.

APR-705 1962-68 5 Blade 17.5" 109.99 ea.
ABR-6BLD 1962-68 6 Blade 17.5" 79.95 ea.
ABR-3996 1969-72 7 Blade 18" 89.99 ea.
ABR-7BLD 1962-68 7 Blade 17.5" Curved Tips 109.99 ea.

ABR-518A69



1969-70 Dated Coded Fan Blades

Correct reproduction with GM cast number 3947772 and date code.

ABR-518A69 1969-70 Dated A69 129.99 ea.
ABR-518C69 1969-70 Dated C69 129.99 ea.
ABR-518E69 1969-70 Dated E69 129.99 ea.
ABR-518G69 1969-70 Dated G69 129.99 ea.
ABR-518J69 1969-70 Dated J69 129.99 ea.
ABR-518M69 1969-70 Dated M69 129.99 ea.

ABR-5NOV



OE Style Big Block Fan

Correct 5 blade fan blade and spacer for big block long water pump cars. Comes complete with OE style "W" stamped into the blade.

ABR-5NOV 1969-70 Blade 17.5" 269.99 ea.
INL-15092 1969-70 Spacer 1" 24.99 ea.
No Volume Discount.

Notes: Will not work with a fan clutch. Factory big block Novas did not use a fan clutch due to radiator clearance issues. Can be used on all 69-72 cars with a big block engine.

FANKIT-7BL

AEF-14



Electric Cooling Fans

This electric radiator cooling fan is perfect for older muscle cars where an electric water pump is being used, or as supplemental cooling.

AEF-12 12" Universal 53.99 ea.
AEF-14 14" Universal 57.99 ea.
AEF-16 16" Universal 64.99 ea.



CCS-CCFK10



Electric Cooling Fans

Features a reversible swept blade design meaning it can be configured as a puller or pusher. The blades are computer balanced.

CCS-CCFK10 10", 7.5 Amp Draw, 650 CFM 80.99 ea.
CCS-CCFK12 12", 10 Amp Draw, 870 CFM 82.99 ea.
CCS-CCFK14 14", 12 Amp Draw, 1200 CFM 94.99 ea.
CCS-CCFK16 16", 14 Amp Draw, 1600 CFM 105.99 ea.



ARX-404M



ARX-106A

Heavy Duty 4 Core Radiators

These direct factory replacement Super Cooler radiators come complete with new high density cores, correct screw in fittings for automatics, correct mounting brackets where applicable and are ready to install.

ARX-106M	1962-65 SB 4 Row HD for Manual Transmission.....	652.99 ea.
ARX-106A	1962-65 SB 4 Row HD for Automatic Transmission.....	688.99 ea.
ARX-206M	1966-67 SB 4 Row HD for Manual Transmission.....	677.99 ea.
ARX-206A	1966-67 SB 4 Row HD for Automatic Transmission.....	713.99 ea.
ARX-304M	1968-71 SB 4 Row HD for Manual Transmission.....	626.99 ea.
ARX-304A	1968-71 SB 4 Row HD for Automatic Transmission.....	662.99 ea.
ARX-504M	1968-71 BB 3 Row HD for Manual Transmission.....	577.99 ea.
ARX-504A	1968-71 BB 3 Row HD for Automatic Transmission.....	613.99 ea.
ARX-606M	1972-79 SB 4 Row HD for Manual Transmission.....	626.99 ea.
ARX-606A	1972-79 SB 4 Row HD for Automatic Transmission.....	577.99 ea.
ARX-404M	1972-75 SB 4 Row 23" Manual.....	664.99 ea.
ARX-404A	1972-75 SB 4 Row 23" Automatic.....	700.99 ea.
VHT-SP139	Paint.....	10.99 ea.

Big block uses a 3 core radiator to clear fan. All radiators are shipped Oversized. No Volume Discount.

Fan Shrouds

These reproduction fan shrouds all feature the same rough grain as original and are the perfect finishing item for your engine detailing.



AFS-892 1962-65 V8..... 119.99 ea.



3938613 1969-72 SB.....99.99 ea.



AFS-1700 1966-67 V8..... 119.99 ea.

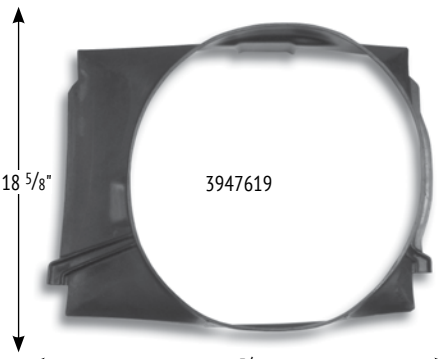

3947619 1969-72 BB..... 109.99 ea.



AHB-330



AHB-329

AC Inner Evaporator Case Covers

Commonly broken inner half of air conditioning case core box. This is a fiberglass reproduction of the inner portion of the air conditioning condenser cover. This item is usually found broken or cracked due to replacement of an engine or the addition of headers. Commonly known as the air conditioning suitcase assembly.

AHB-330	1969-73 Small Block.....	126.99 ea.
AHB-329	1969-72 Big Block.....	126.99 ea.

No volume discount.



AX-68X

Radiator & Fan Shroud Hardware Kit

Correct hardware to mount fan shroud to radiator to core support and radiator top seal.

AX-68X	1968-72 BB.....	24.99 kit
--------	-----------------	-----------



HFA-930

Caution Fan Decal

HFA-930	Universal.....	9.99 ea.
---------	----------------	----------



ATE-4100

ATE-6041

Radiator Mounting Pads

Correct upper and lower rubber pads for mounting your radiator into the support. Lower pads feature steel cores.

ATE-6041	1968-72 Upper.....	9.95 pr.
ATE-4100	1968-72 Lower.....	9.95 pr.
ATE-65B	1968-72 3 Core/Most Small Block.....	6.99 ea.



CPN-0638

Radiator Overflow Hose OEM

Correct thin walled ribbed hose as original.

CPN-0638	1962-79.....	2.95 pr ft
----------	--------------	------------



AXP-1106

Radiator Petcock

Correct gold colored fluted end drain valve for radiator.

AXP-1106 All 6.99 ea.



AB-31X

Radiator Attaching Hardware

Correct OEM hardware for attaching the radiator to the support.

AB-31X 1968-72 All 6.99 kit



AAC-6072



AAC-6415

Radiator Caps

Your choice of exact reproduction GM RC15 cap with correct large ears and correct wording or new GM replacement.

AAC-6072 1964-72 Reproduction.....29.99 ea.
AAC-6415 1964-72 Replacement20.99 ea.



GCS-S5010

GCS-S5012

Custom Radiator Caps

Show quality radiator caps with 16 lb. of opening pressure.

GCS-S5010 Polished Aluminum.....20.99 ea.
GCS-S5011 Chrome.....24.99 ea.
GCS-S5009 Chrome w/ Flames.....26.99 ea.
GCS-S5012 Polished Aluminum.....18.99 ea.



CPX-8739

Radiator Overflow Hose Clip

Correct clip for retaining overflow hose.

CPX-8739 1968-79 All 13.99 ea.



AOF-172

Stainless Overflow Tank

Polished stainless steel universal fluid reservoir is great for older cars that didn't come from the factory w/ a coolant recovery tank.

AOF-103 10" x 3"52.99 ea.
AOF-132 13" x 2"52.99 pr.
AOF-152 15" x 2"52.99 ea.
AOF-172 17" x 2"52.99 ea.

Note: 1/4 in. Hose Barb Inlet/Outlet



CPX-6368

CPX-4796

Tower Clamp Kits

Original Witek Tower style clamps. These factory installed clamps were used on most GM cars. 1962-68 used tower clamps on the radiator hoses and spring clamps on the heater hoses. Cars built 1969 or later used all tower clamps.

CPX-6368 1962-68 (8).....22.95 kit
CPX-4796 1969-79 (8).....26.95 kit

AQJ-387



Radiator Overflow Jar

Reproduction featuring correct FULL HOT/FULL COLD markings, GM number and mounting tabs. Includes lower mounting clip.

AQJ-387 1973-74 All 46.99 ea.
AQJ-448 1975-79 All 36.99 ea.



AJC-194



AJC-978

Radiator Overflow Jar Cap

Correct cap with "ENGINE COOLANT ONLY".

AJC-194 1974-75 All 7.95 ea.
AJC-978 1976-79 All 9.99 ea.

Upper Radiator Hoses GM Licensed

OE style reproduction upper radiator hoses featuring the correct GM part numbers and ID codes!



CPH-0687

3790407 1964-65 SB 19.95 ea.
CPH-0687 1964-65 SB w/ AC 16.95 ea.



CPH-8956

CPH-8956 1966-67 SB 16.95 ea.
CPH-2883 1966-67 SB w/ AC 16.95 ea.
3892682 1966-67 L79 21.55 ea.
3882885 1966-67 L79 w/ AC 19.95 ea.



CPH-2229

CPH-2229 1968 SB 16.95 ea.



CPH-1650

CPH-1650 1969-74 SB 16.95 ea.



CPN-9866

CPN-9866 1968-72 BB 16.95 ea.

Lower Radiator Hoses

OE style reproduction lower radiator hoses featuring the correct GM part numbers and ID codes!



3790408

3790408 1964-67 SB 19.95 ea.
3881856 1966-67 L79 19.95 ea.



3923231

3923231 1968 SB 21.99 ea.



3959490

3959490 1969-74 SB 16.95 ea.



CPH-9698

CPH-9698 1968 BB 16.95 ea.



CPH-6044

CPH-6044 1969-74 BB 16.95 ea.





GCS-S6676

Braided Hose Sleeve Kit

An economical way to get the look of braided hoses without the high cost! Kit includes 3' of vacuum line sleeve, 4' of fuel line sleeve, 4' of radiator hose sleeve, 12' of heater hose sleeve and matching aluminum clamp covers.

- GCS-S6676 Kit w/ Red Fittings.....54.99 kit
 - GCS-S6677 Kit w/ Blue Fittings.....54.99 kit
 - GCS-S6678 Kit w/ Chrome Fittings.....54.99 kit
- Note: Sleeves can be cut with scissors. Vacuum line uses shrink tubing instead of aluminum fittings. Hose clamps are not included.



PAC-2800BT

Dakota Digital Electronic Fan Controller

This controller was designed for the ultimate in flexibility and to be a simple add-on in any application using an electric fan. Included is a 70amp relay, enough for even the most power hungry of cooling fans. Fully programmable, the PAC-2800BT will work with your existing water temp gauge, operating from the temperature sending unit already installed.

- PAC-2800BT All w/ Electric Cooling Fans..... 148.95 kit
- No Volume Discount.



CCS-CCFKRL

Electric Fan Relay

Recommended for all electric fan application. Only one relay is needed for single or dual fans.

- CCS-CCFKRL Fan Relay.....96.99 ea.

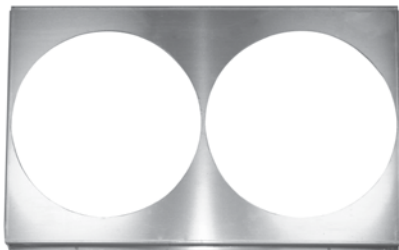

CCS-FS162

Aluminum Fan Shrouds

Designed to fit Champion aluminum radiators and hold electric fans.

- CCS-FS162 Fits 162 Radiators, Holds (2) 14" Fans..... 174.99 ea.
- CCS-FS571 Fits 571 Radiators, Holds (2) 10" Fans..... 167.99 ea.



CCS-EC162



CCS-CC6267

Aluminum Radiators by Champion Cooling Systems

These aluminum radiators are made to the highest of standards paired with unequalled quality precision and workmanship. The highest of aluminum grades available are used in all manufacturing processes. All Champion aluminum radiators are constructed using 100% welded seams brazed core technology and absolutely no epoxy. All Champion radiators come with a limited lifetime warranty and are made to install with little or no modifications using your original mounts giving you the confidence you deserve. Choose from the following series:

- EC Economy Core Series - 2Row - Two Rows of 3/4 inch Tubes = Approx. 400-600+ Horsepower Cooling Capacity.**
- CC Champion Core Series - 3Row - Three Rows of 5/8 inch Tubes = Approx. 600-800+ Horsepower Cooling Capacity.**
- MC Monster Core Series - 4Row - Four Rows of 5/8 inch Tubes = Approx. 800-1200+ Horsepower Cooling Capacity.**

CCS-CC6265	1966-65 Champion Core Series 21-1/2" x 26-1/8"	292.99 ea.
CCS-EC6267	1966-67 Economy Core Series 21-1/4" x 25-1/2"	239.99 ea.
CCS-CC6267	1966-67 Champion Core Series 21-1/4" x 25-1/2"	299.99 ea.
CCS-EC571	1968-79 Economy Core Series 27" x 19"	242.99 ea.
CCS-CC571	1968-79 Champion Core Series 27" x 19"	292.99 ea.
CCS-MC571	1968-79 Monster Core Series 27" x 19"	389.99 ea.
CCS-EC162	1975-79 Economy Core Series 31-5/8" x 18-1/4"	229.99 ea.
CCS-CC162	1975-79 Champion Core Series 31-5/8" x 18-1/4"	299.99 ea.
CCS-MC162	1975-79 Monster Core Series 31-5/8" x 18-1/4"	377.99 ea.



COLD-11AL



COLD-548MFK

1962-79 Cold Case Radiators

These COLD-CASE radiators are TIG welded 100% aluminum. These radiators have dual oversize 1" cooling rows making them more efficient than 4 1/2" rows seen on 4 row models. Cold Case aluminum radiators cool 20% better than OEM copper radiators and are more than 50% lighter. They are original in appearance with OEM style stamped tanks for strength and that OEM original look. Once painted, they look like originals to all but the concourse fanatic. Each radiator is pressure tested, direct fit and carries a Lifetime Warranty!

COLD-540M	1962-67 Manual 20.69" x 22.36"	387.99 ea.
COLD-540A	1962-67 Auto 20.69" x 22.36"	397.99 ea.
COLD-548M	1968-79 BB Manual 18.5" x 27.5"	386.99 ea.
COLD-548A	1968-79 BB Auto 18.5" x 27.5"	395.99 ea.
COLD-11ML	1968-79 BB Manual 18.5" x 27.5" w/ Brackets	388.99 ea.
COLD-11AL	1968-79 BB Auto 18.5" x 27.5" w/ Brackets	398.99 ea.
COLD-543M	1968-79 SB Manual 20.69" x 22.36"	388.99 ea.
COLD-543A	1968-79 SB Auto 20.69" x 22.36"	397.99 ea.

Kits With Electric Fans And Shroud

Cold Case made it easy with kits that include the radiator, fan and shroud. All kits come with transmission cooler fittings in the radiator.

COLD-540MFK	1962-67 Manual Single 16" Fan	587.99 kit
COLD-540AFK	1962-67 Auto Single 16" Fan	598.99 kit
COLD-548MFK	1968-79 Manual Single 16" Fan	584.99 kit
COLD-548AFK	1968-79 Auto Single 16" Fan	596.99 kit
COLD-RC100	Radiator Cap All	23.99 ea.
COLD-FAN12	12 Inch Cooling Fan 1400 CFM	65.99 ea.
COLD-FAN16	16 Inch Cooling Fan 2500 CFM	89.99 ea.
COLD-EF1	Fan Wiring Kit All	96.99 kit

All radiators are shipped Oversize. Not eligible for free shipping.



GCS-S9427

Chrome Radiator Top Panel

This chrome plated steel radiator top panel will add a nice custom touch to your show car! Complete with hardware.

GCS-S9427 1968-73 3 Bolt 24" 26.99 ea.



ARP-68A3C

Custom Radiator Covers

This custom radiator top panel offers a totally unique look and will keep your engine compartment neat & clean looking!

ARP-68A3B 1968-75 3 Bolt Black Anodized 94.99 kit
 ARP-68A3C 1968-75 3 Bolt Clear Anodized 94.99 kit
 ARP-68A3P 1968-75 3 Bolt Polished 109.99 kit

No Volume Discount.



CPR-5834

Heater Hose

1969-72 features correct black ribbed design.

CPH-5834 1962-68 With GM Logo 18.95 kit
 CPR-5834 1969-79 w/o Logo 22.99 kit



ABM-CAGE

Blower Motor Cage

Replacement OEM quality metal blower motor fan cage.

ABM-CAGE All 39.99 ea.

Note: 5-1/8" dia. and 2-3/8" deep



ATE-2059



ATE-5416

Heater Hose Retainers

Correct heater hose retainers for most Novas.

ATE-2059 All Passenger Side Inner Fender 6.99 ea.
 ATE-5416 Top of Alternator Bracket 6.99 ea.



AHC-627X



AHC-9086



AHC-CLAMP

Heater Cores

New OEM heater cores which are factory tested for long life & durability.

AHC-627X 1962-67 All w/o A/C 119.99 ea.
 AHC-8008 1968 BB 129.99 ea.
 AHC-9056 1968-79 SB w/ A/C 99.99 ea.
 AHC-9086 1968 SB w/o AC 2" Wide Core* 99.99 ea.
 AHC-9065 1968-79 SB w/o AC 2" Wide Core 99.99 ea.
 AHC-759X 1975-79 w/ A/C 99.99 ea.
 AHC-CLAMP 1962-79 All 19.99 pr.

*Early 1968 models were equipped with 2-1/2 inch core.



AHC-KIT1



Heater Cores & Box Seal Kits

This kit includes a heater core and the box seals at a reduced cost!

AHC-KIT1 1968-74 SB w/o A/C 115.18 kit
 AHC-KIT3 1968-74 BB w/o A/C 142.18 kit



AHC-SUPERKIT3-S

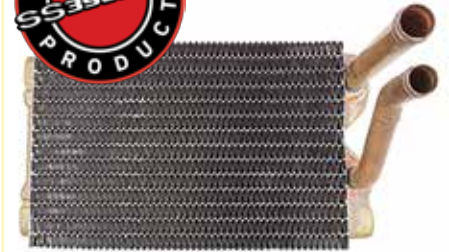

Heater Core & Box Cover Super Kits

These kits contain the heater core, under hood heater box cover and seals. It's a great way to freshen up your cooling system and under your hood! Available with a black OE style cover or chrome.

AHC-SUPERKIT1-S 1968 SB w/o A/C
 Black 182.66 kit
 AHC-SUPERKIT1-SC 1968 SB w/o A/C
 Chrome 214.16 kit
 AHC-SUPERKIT2-S 1969-79 SB w/o A/C
 Black 182.66 kit
 AHC-SUPERKIT2-SC 1969-79 SB w/o A/C
 Chrome 214.16 kit
 AHC-SUPERKIT3-S 1968-70 BB w/o A/C
 Black 209.66 kit
 AHC-SUPERKIT3-SC 1968-70 BB w/o A/C
 Chrome 241.16 kit

No Volume Discount.



AHC-69I

Heater Boxes

New complete inner heater box assemblies for under the dash.

AHC-69I 1968-74 Non - AC 299.95 ea.

No Volume Discount.



AL-963



JHC-3064

Heater Box Seal Kits

Correct die stamped neoprene seals for installing your heater core and cover. A must!

JHC-3064 1968-79 w/o A/C 27.99 kit
AL-963 1968-70 BB 9.99 kit



ABM-1041W

Heater Blower Motor

New OEM replacement heater blower motor for cars with or without A/C.

ABM-870 1962-79 Motor Only 41.99 ea.
ABM-1041W 1962-79 Motor with Cage 73.78 ea.



AHC-458

Big Block Heater Core Clips

OE style reproduction heater core clips manufactured from spring steel as original.

AHC-458 1968-74 BB 36.99 pr.



ABO-417

Heater Box Block Off

Factory block off for heater box. Molded rubber as original.

ABO-417 1968-70 BB non A/C 21.99 ea.



ICD-68F

Heater Duct For Cars With Center Console

Installed on all factory console cars. Attaches to heater box to distribute heat evenly in driver and passenger areas. Made of durable fiberglass which looks original.

ICD-68F 1968-74 w/ Console 109.95 ea.



AL-303-CHROME



AL-304-CHROME



JCS-10459



AL-305

Heater Box Cover

Brand new firewall heater box cover for all cars without air conditioning.

AL-304 1968-74 SB w/o A/C 64.99 ea.
AL-303 1968-74 BB w/o A/C 64.99 ea.
AL-304-CHROME 1968-74 SB w/o A/C Chrome 99.99 ea.
AL-303-CHROME 1968-74 BB w/o A/C Chrome 99.99 ea.
ALS-27 Retaining Nut 0.95 ea.
GWC-SPK Wire Clips 19.99 pr.
AL-305 1968-70 BB non A/C Cover Plate 19.99 ea.
AHB-1X Heater Box Wire Clip 5.99 ea.
JN-137 1962-67 Firewall Seal 14.99 kit
JCS-10459 Sealant 9.99 ea.

AHD-899



AHD-808



Heater Delete Plate

New factory style firewall heater delete plate set. This highly sought after option comes with block off plates for firewall heater and blower motor assembly.

AHD-808 1968-79 w/o Factory A/C 98.99 ea.
AHD-899 1968-74 w/ Factory A/C 109.99 set



ABR-71



ABR-77



ABR-69AC

Heater Blower Motor Resistors

Correct blower motor resistors.

ABR-71 1964-70 w/ AC 29.99 ea.
ABR-77 1964-72 w/o AC 24.99 ea.
ABR-69AC 1970-72 w/o AC 29.99 ea.
ARS-304 Mounting Screws 0.95 pr.



AV-560



ACV-1901

Heater Control Valve

New GM heater control valve for all Novas with air conditioning. Correct gold plating.

ACV-1901 1969-70 w/ A/C 48.99 ea.
AV-560 Mounting Screws (2) 0.95 ea.



AFC-68X

Firewall Cover

A quick and easy way to cover up your rough firewall! Constructed of 16 gauge anodized aluminum.

AFC-68X 1968-72 Blank 149.99 ea.
AFC-68XW 1968-72 Wiper Holes 149.99 ea.
AFC-68XWH 1968-72 Wiper & Heater Holes 149.99 ea.
It is recommended to install with silicone so the panel stays smooth and allows the body to flex behind it. This item ships Oversize 3



DSE010901

Detroit Speed Firewall Fill Plate

This panel smoothes the passenger side firewall, while retaining the stock cowl to firewall seam. The weld-in panel is made of 18-gauge steel and has a rolled edge. It comes complete with installation instructions and is stamped with pride in the USA.

DSE010901 1968-74 All 97.99 ea.



AHG-737

A/C Hose Grommet

This hose grommet insulates the AC hoses from the condenser to the engine compartment. Manufactured in rubber material including a steel spine just like original.

AHG-737 1968 All w/ AC.....29.99 ea.



APG-184

Heater Core Pipe Grommet with A/C

Rubber grommet for use on air-conditioned vehicles to seal and support the heater core outlet tubes to the evaporator core case.

APG-184 1968-79 All w/ AC.....14.99 ea.



ACB-119

A/C Condenser Brackets

Reproduction bracket used to mount the air conditioning condenser to the radiator support. For use on small block or big blocks with AC.

ACB-119 1968-69 All w/ AC.....23.95 pr.



AEC-73D

AC Evaporator Case Drain Hose

This is the correct hose that goes into the bottom of the under hood AC evaporator case.

AEC-73D All.....13.99 ea.



AXB-7A

A/C Delete Cover

This covers the large hole where your A/C used to be and allows you to use your factory heater core when removing your A/C.

AXB-7A 1968-79 All.....139.99 ea.
Uses seam sealer to seal to firewall.

AXB-15241



AXB-67-AC-DELETE

A/C Block Off

These are bolt-in panels to block off the AC openings on the firewall.

AXB-67-AC-DELETE 1968-79 Aluminum.....69.99 ea.
AXB-15241 1968-74 Steel.....52.99 pr.



IVA-69

Dash Defroster Vent

Each defroster vent assembly is manufactured to OE specifications.

IK-11DF 1968 All144.99 ea.
IVA-69 1969-79 All149.99 ea.



TUF-4515NADP7

Tuff Stuff AC Compressors

Tuff Stuff's black chrome plated A/C compressor is quality built-in Cleveland, Ohio with 100% new components. The understated black chrome look complements any engine compartment. Black chrome finish will not discolor, rust or fade over time. Provides a consistent, eye-appealing finish for under hood accessories. These compressors are designed to fit late model or custom applications. These will not work with original factory brackets on your Nova.

TUF-4517NA6G7 "Peanut Style"6 Groove Pulley467.99 ea.
TUF-4517NADP7 "Peanut Style"2 Groove Pulley467.99 ea.
TUF-4515NA6G7 "Sanden 508 Style"6 Groove Pulley457.99 ea.
TUF-4515NADP7 "Sanden 508 Style"2 Groove Pulley457.99 ea.

No Volume Discount.



Vintage Air SureFit kits

Vintage Air SureFit kits are the most complete, bolt-in climate control systems available. SureFit kits install easily and utilize most of the factory sheet metal and body features and are engineered as "vehicle specific" complete systems. Our SureFit kits are designed to place the evaporator case and air duct hoses behind the dash for a factory-clean look. In most cases, the SureFit system will be controlled by your stock dash controls using our exclusive patented "Cable Converters." In some applications, a new "factory" look control panel is included with the kit. All SureFit systems provide full OEM-style operations including air conditioning, floor or vent exit heating and a powerful dehumidified defroster. To retain a true factory look, the A/C air exits through the factory dash louvers, if originally equipped in your car's dash. SureFit kits also offer the most complete and straightforward installations available anywhere. The Gen IV is Vintage Air's most powerful and intelligent climate control system available. The Gen IV uses an exclusive fully electronic microprocessor control system that eliminates cables or vacuum connections. Separate high-capacity copper parallel-flow heat coil and aluminum plate-and fin-cooling coils provide outstanding performance and instant temperature adjustments. Complete kits include the evaporator unit and mounting brackets, louvers (where required), duct hose, wiring harness, patented Electronic Cable Converters, compressor, engine brackets, condenser with brackets, preformed refrigerant lines, drier, fittings, hardware and installation instructions.

Features Include:

- Fly-By-Wire fully electronic servo motor controls with no cables or capillary tube to route
- Infinite just-right-temperature air blending • Infinite blower fan speed adjustment (3-speed on factory air models)
- High-volume dehumidified defrost mode • Separate high-capacity aluminum plate & fin cooling coil
- Copper/brass CuproBraz™ parallel-flow heater coil • Mounts behind the dash • Uses your factory system controls with our patented Electronic Cable Converters • Flat steel firewall cover panel • Replacement molded glove box (reduced capacity)

VA-961164 1962-65 All*1824.99 kit
VA-961166 1966-67 All*1824.99 kit
VA-965069 1968 All w/ Factory Air1824.99 kit
VA-961069 1968 All w/o Factory Air1824.99 kit
VA-965072 1969-72 All w/o Factory Air1824.99 kit
VA-961072 1969-72 All w/ Factory Air1824.99 kit

No Volume Discount. Ships oversize. Not eligible for free shipping.
*Works with or without factory air. Must specify factory subframe or not.

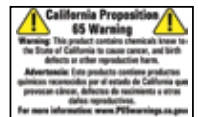

Cannot Ship to California Addresses



ATE-3907



ACQ-1224



AAC-8864



ACQ-1220N

Open Element Air Cleaner

Excellent reproduction of the original GM open element air cleaner assembly. Complete base with elbow assembly, chrome plated lid and AC Delco filter. Will fit most V8s with 4 bbl. carburetor.

ATE-3907	Complete Kit	99.99 kit
ACQ-1224	Chrome Lid Only	44.99 ea.
ACQ-1220N	Chrome Lid Only w/ Service Instructions.....	59.95 ea.
AAC-8864	Base Only w/ Elbow Assembly.....	85.99 ea.



FG2001



FG2031



FG2003



FG2042



FG2005



FG2044



FG2007



FG2046

Fender Gripper

If you spend a lot of time working under the hood but don't want to scratch your paint a Fender Gripper is the answer! Made of non-slip material the Fender Gripper will not slide off slick surfaces.

- Soft and cushioned for protection
- Tools will not slip off fender cover
- Completely washable 22" X 34" standard size
- Strong PVC product reinforced with nylon mesh
- Impervious to motor oil, coolant, lacquer thinner, brake fluid, etc.
- Many favorite brand logos are available
- Will not harm your paint

FG2001	Bowtie	29.99 ea.
FG2003	Genuine Chevrolet	29.99 ea.
FG2005	Heartbeat of America	29.99 ea.
FG2007	Chevrolet Racing	29.99 ea.
FG2048	El Camino	29.99 ea.
FG2031	Chevelle	29.99 ea.
FG2042	General Motors	29.99 ea.
FG2044	SS	29.99 ea.
FG2046	Super Sport	29.99 ea.



ATW-3361



ATW-3359

1964-67 Closed Air Cleaner System

New complete closed air cleaner assemblies for your Nova, complete with base, lid and filter!

ATW-3359 1964-65 Complete Assembly.....189.99 kit
ATW-3361 1966-67 Complete Assembly.....189.99 kit
No Volume Discount.



GCS-S2194



GCS-S2194C

Retro Style Air Cleaner

This retro style hot rod air cleaner assembly is constructed of steel and is a great inexpensive custom touch to any street machine or sleeper. This filter kit includes a 3" paper air filter and the mounting stud with chrome wing nut.

GCS-S2194 All Black.....159.99 kit
GCS-S2194C All Chrome.....215.99 kit



ACQ-1460

Dual Snorkel Air Cleaner Kit

OE style of the original factory closed element style dual snorkel air cleaner. Complete with original style base with correct elbow, lid and filter. Originally installed on 1970 Yenko Deuce but fits most 1968-74.

ACQ-1460 Complete Kit.....266.99 ea.
ACQ-1461 Chrome Lid Only 17".....59.95 ea.
ACQ-1462 Satin Black Lid Only.....58.99 ea.
No Volume Discount



ACC-3375

L-79 Dual Snorkel Air Cleaner

OE style reproduction of this hard to find chrome dual snorkel air cleaner which was installed on all L-79 (327 cubic inch 350 horsepower) Novas. Complete with base, filter and lid.

ACC-3375 1966-67 L79 Complete.....389.99 kit
AL79-LIDN 1966-67 L79 Chrome Lid Only.....269.99 ea.
ACC-3379 1966-67 L79 Base Only.....199.99 ea.
No Volume Discount



GCS-S8005X

Stainless Steel Air Cleaner

Highly polished stainless steel 14" air cleaner. Includes washable 3" filter.

GCS-S8005X Drop Base.....70.99 kit
Note: 5-1/8" carb opening. Includes mounting stud and chrome wing nut. Does not include gasket.



GCS-S6915

Ball Milled Flames Air Cleaner

Highly polished ball milled flames aluminum 14" air cleaner. Includes washable 3" filter.

GCS-S6915 Flat Base.....108.99 kit
GCS-S6905X Drop Base.....115.99 kit
Note: 5-1/8" carb opening. Does not include stud, wing nut, or gasket.



GCS-S6815C

Ball Milled Air Cleaner

Highly polished ball milled aluminum 14" air cleaner. Includes washable 3" filter.

GCS-S6815C Drop Base.....104.99 kit
Note: 5-1/8" carb opening. Does not include stud, wing nut, or gasket.



GCS-S6320



GCS-S6723

Finned Aluminum Air Cleaner

Highly polished finned aluminum air cleaners. Includes washable 3" filter.

GCS-S6320 Flat Base 12" Oval.....77.99 kit
GCS-S6723 Flat Base 14" Round.....111.99 kit
GCS-S6725 Drop Base 14" Round.....111.99 kit
Note: 5-1/8" carb opening. Includes mounting stud. Does not include wing nut or gasket.



GCS-10095

Black Steel Air Cleaner Assembly

This black air cleaner assembly is constructed of steel and is a great inexpensive custom touch to any street machine or sleeper. Includes lid, filter, base and wing nut.

GCS-10095 Holley.....36.99 kit
GCS-10099 Edelbrock.....42.99 kit

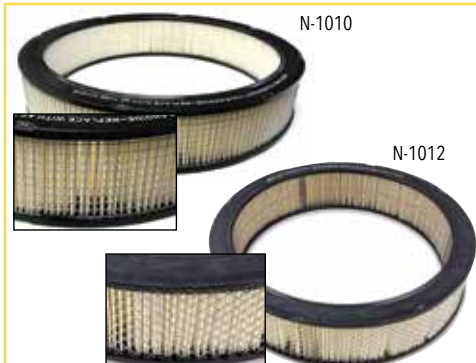

N-1010

N-1012

Air Filter Exact Reproduction

Exact reproduction of the original style with "square mesh" design and original GM wording (silk screened) or AC Delco replacement style air filters.

N-1012 1967-69 Diagonal Mesh.....32.95 ea.
N-1010 1970-72 Horizontal Mesh.....32.95 ea.
ACW-212 All 14" AC Delco.....11.99 ea.



ACQ-454-425

"Turbo Jet" Air Cleaner Lids

Our chrome 14" air cleaner lid (ACQ-1224) featuring high quality die cast "Turbo Jet" medallions.

- ACQ-396 396.....105.99 ea.
- ACQ-454 454.....105.99 ea.
- ACQ-396-375 396, 375 Hp.....159.99 ea.
- ACQ-454-425 454, 425 Hp.....159.99 ea.
- ACQ-454-450 454, 450 Hp.....159.99 ea.

Can be used with open element air cleaners or cowl induction.

APX-1400



ATE-5695



APJ-2153

ATE-5256



AP-315



APX-7700

Wing Nuts, Flame Arrestor & Studs

- APX-1400 Chrome Wing Nut.....5.99 ea.
- APX-7700 Black Wing Nut.....5.99 ea.
- ATE-5695 Flame Arrestor.....9.99 ea.

Carburetor Studs

- APJ-2153 All w/ Holley Open Element.....12.95 ea.
- AP-315 All w/ Q-Jet.....13.99 ea.
- ATE-5256 Universal w/ Point End.....8.99 ea.



AP-2B

Air Cleaner Gasket

Correct paper gasket for sealing air cleaner base to carburetor.

- AP-2B All 2 bbl.....3.95 ea.
- AP-4B All 4 bbl.....4.95 ea.



GAC-660

TCS Temp Sending Unit

Correct 2 prong sending unit mounts on right side cylinder head. This unit sends both low and high temperature signals to the TCS vacuum switch for correct operation.

- GAC-660 1970 All.....18.95 ea.



ATCS-33R

TCS Littlefuse Relay

This is an exact reproduction of the correct Nova littlefuse TCS relay which was discontinued by GM in 1999. This authentic reproduction of the original transmission spark control relay vacuum advance delay features 4 prongs as original and replaces Delco number 3961573 exactly.

- ATCS-33R 1970-72.....54.99 ea.



1114434

TCS Solenoid

Correct TCS solenoids which mount to the carburetor stud. Includes correct brackets.

- 1114432 1970-71 350/400.....111.99 ea.
- 1114434 1970 BB.....111.99 ea.



ATS-653

TCS Wire Retainer

Correct reproduction for Muncie.

- ATS-653 1970-74 w/ Muncie.....21.99 ea.



APR-4060



AX-301

Vacuum Advance Clips

Correct clip for retaining tube to intake manifold.

- APR-4060 All V8.....8.95 ea.
- AX-301 1970 w/ TCS.....13.95 ea.
- CPN-100 Hose.....1.95 pr ft



AHT-2328

Cowl Wiring Gutter

Correct plastic gutter used to hold engine harness against firewall.

- AHT-2328 All.....8.95 ea.
- ABH-102 Correct Attaching Screws.....0.95 pr.



APX-4946K

1970 TCS Vacuum Advance Kits

This one year only design utilized two steel tubes and a double clip.

- APX-3944K 1970 BB Q-Jet TCS.....29.99 kit
- APX-4946K 1970 BB Holley TCS.....29.99 kit



APX-3002

Vacuum Advance Kits

Our kits come complete with correct pre-bent tapered tube(s), correct white stripe vacuum hose and correct clip.

- APX-3002 1964-69 SB 2bbl.....15.99 kit
- APX-3042 1964-69 SB 4bbl.....15.99 kit
- APX-2628 1964-71 SB Holley.....15.99 kit
- APX-3940 1968-69 BB Q-Jet.....15.99 kit
- APX-3946 1968-69 BB Holley.....15.99 kit



GCS-S5973



GCS-S4973

Vacuum Advance Cover

This vacuum advance pod cover will give your distributor that show car look. Fits most GM distributors.

- GCS-S4973 Chrome.....5.99 ea.
- GCS-S5973 Polished.....16.95 ea.



ACK-1679

Choke Kits

Our kits come complete with thermal coil, cover, rod, retaining clip and screw.

- ACK-1679 1967-69 SB Q-Jet.....37.99 kit
- ACK-8889 1966-69 BB Q-Jet.....39.99 kit
- ACK-1669 1968-69 BB Holley.....36.95 kit
- ACK-7072 1970-72 BB Q-Jet.....46.99 kit
- ACK-7071 1970-72 BB Holley.....46.99 kit



QF-Q-750

Q-Series Race carburetors are purpose-built for the dragstrip. To combat the g's experienced during hard launches, Q-Series carbs are equipped with notched floats and secondary jet extensions. The high-flow aluminum main body isn't just lightweight, but it also features recessed air bleed cavities for improved air flow. Die-cast venturi are machined to exacting tolerances for outstanding throttle response. Billet metering blocks ensure a uniform fuel curve, while throttle-bodies enhance durability. For those days when track conditions vary from one pass to the next, QFT's QuickLink system makes adjusting the secondaries easy on models equipped with mechanical secondaries. The Q-Series is our most comprehensive line of carburetors, with applications available for use with gasoline, methanol and E85 fuels, forced induction, drag race, circle track and comes in both vacuum and mechanical secondary models.

- Lightweight aluminum main body
- Mechanical secondary
- Aluminum fuel bowls with dual sight glass windows
- Billet metering blocks with 4-corner idle system
- Changeable idle feed and power valve channel restrictions
- PTFE coated and sealed shafts that have been slabbed for added air flow
- Red anodized billet metering blocks and throttle plate

4150 Carburetors Square Bore

QF-Q-750	750CFM Mechanical Silver/Red.....	954.99 ea.
QF-Q-750-B2	750CFM Mechanical Silver/Red*....	1021.99 ea.
QF-Q-850	850CFM Mechanical Silver/Red.....	1021.99 ea.
QF-Q-950	950CFM Mechanical Silver/Red.....	1087.99 ea.
QF-BDQ-750	750CFM Mechanical Black/Black....	1021.99 ea.

*Draw thru supercharger applications with 2 carbs.

No Volume Discount.



QFX-FX-4710

QFX-Series stands as the flagship model in QFT's lineup.

Raised air horns improve entry angle into the venturi while ensuring undisrupted flow over the air bleeds. Annular boosters with CNC-machined billet aluminum inserts provide increased air flow, a stronger signal and less turbulence. QFX carbs offer unparalleled fuel atomization with annular boosters specific for either gas, methanol, or E85 fuels. Five-emulsion billet metering blocks and four-corner idle circuits offer flexible tunability that today's high-horsepower engines demand. Ready to run out of the box, the QFX-Series carburetor will help you get to the winner's circle.

- QFX aluminum main body w/raised venturi
- Billet aluminum metering blocks with screw in restrictions
- Aluminum fuel bowls with dual sight windows and fuel inlets
- Viton .130" Needles and Seats
- Billet Aluminum annular booster inserts
- QuickLink™ adjustable secondary opening adjustment
- Hand assembled and engine tested

4500 Spread Bore Dominator Style

QF-FX-4710	1150CFM Mechanical Black/Black....	1379.99 ea.
------------	------------------------------------	-------------

No Volume Discount.



BTE-1475

BMG-0095

Carb Attaching Kits

Correct OEM bolt kit for attaching carburetor to intake manifold.

BMG-0095	All w/ Holley.....	7.99 ea.
BTE-1475	All w/ Q-Jet.....	8.95 ea.



AHL-38

Carburetor Inlet Nuts

Correct Holley carb fuel inlet nuts & washers.

AHL-516	5/16" (Stock GM).....	15.99 ea.
AHL-38	3/8".....	15.99 ea.



AS-761



AS-166



ACS-0069



ATE-0068



ACS-7454

Carb Return Springs

New correct color coded springs.

AS-761	Most 4bbl Black.....	9.95 ea.
AS-166	1967-68 Holley Green.....	8.95 ea.
ACS-0069	1969 Holley Green.....	8.95 ea.
ATE-0068	1968-72 Q Jet Black.....	8.95 ea.
ACS-7454	1970-72 Holley Blue.....	9.95 ea.



MS142-08B



MS142-08R

Eddie Motorsports Billet Throttle Cable Brackets

These Eddie Motorsports billet GM throttle cable brackets mount to the base of Holley carburetors. The kit includes the cable mount bracket, return springs and bracket and installation hardware.

With 4150/4160 Series Carburetor

MS142-08B	1967-87 Blue.....	102.99 kit
MS142-08R	1967-87 Red.....	102.99 kit
MS142-08BA	1967-87 Black Anodized.....	102.99 kit
MS142-08CA	1967-87 Clear Anodized.....	102.99 kit

With 4500 Series Carburetor

MS142-09B	1967-87 Blue.....	135.99 kit
MS142-09R	1967-87 Red.....	135.99 kit
MS142-09BA	1967-87 Black Anodized.....	135.99 kit
MS142-09CA	1967-87 Clear Anodized.....	135.99 kit

No Volume Discount.



GCS-S2291

Chrome Universal Carburetor Throttle Return Kit

Designed to make mounting the spring a snap! Works on most carburetors.

GCS-S2291	Universal.....	7.99 kit
-----------	----------------	----------

Note: Due to the universal nature of this part, fitting and/or modifications may be required.

GCS-S2083



Chrome Holley Carburetor Throttle Return Kit

Designed to make mounting the spring a snap! Works on most Holley carburetor applications.

GCS-S2083	Holley.....	16.99 kit
-----------	-------------	-----------

Note: Due to the universal nature of this part fitting and/or modifications may be required.



Intake Manifold 3963569
OE style SHP big block manifolds.

- 3885069 1968 396 L78, L79, 427 L88.....399.95 ea.
 - 3933198 1968-69 396, 427 SHP L88 ZL-1399.95 ea.
 - 3933163 1968-69 396/375 L78 L89.....399.95 ea.
 - 3963569 1970 Low Rise 396/375 L78 L89 ... 399.95 ea.
 - ABB-3569C 1970 LS6, L78, L89 Splash Shield49.99 ea.
- Ships Oversize 2 in a special box.*



WND-8120WND

Weiland Street Warrior Intake Manifolds

The Weiland Street Warrior is designed for use on stock or stroker combinations that feature efficient cylinder heads. The latest advances in cam design necessitated the design of a new intake manifold and the Weiland Street Warrior manifolds fill that void.

Square Bore Carburetors

- WND-8120WND Small Block w/ 55-86 Heads 210.99 ea.
- WND-8121 Small Block w/ Vortec Heads 262.99 ea.

Spread Bore Carburetors

- WND-8126 Small Block w/ 87-95 Heads 262.99 ea.
- No Volume Discount.*



WND-8150

Weiland Speed Warrior Intake Manifolds

The Weiland Speed Warrior features long, separated runners for bottom-end and mid-range power, plus a special runner design and larger plenum to flow the air needed for high-RPM horsepower. All of this usable power makes this intake perfect for your street and strip hot rod!

- WND-8150 Small Block w/ 55-86 Heads 240.99 ea.
 - WND-8170WND Small Block w/ 87-95 Heads 245.99 ea.
- No Volume Discount.*



BPI-2271

BPI-9140

Intake Manifold Bolts OEM

Our OEM intake bolts feature correct size, coloring and head markings.

- BPI-4400 All SB "M" Flanged (12p)..... 16.95 kit
- BPI-9140 All BB "M" Cast Intake (16p)..... 21.95 kit
- BPI-2271 All BB "A" Aluminum Intake (16p)..... 28.99 kit



APN-0138

APN-0238

APN-0038

APN-638

APN-738

APN-838

Intake Manifold Vacuum Fittings

These high quality fittings for rear of intake manifold have correct "slip-on" and threaded ends. These fittings have a variety of uses: power brake hose, auto transmission, air conditioning, cruise control, etc. Guaranteed to look, fit and function exactly as original.

- APN-0138 (1) Slip-On Fitting 25.99 ea.
- APN-0238 (2) Slip-On Fittings..... 25.99 ea.
- APN-0038 (1) Threaded Port 25.99 ea.
- APN-638 (1) Threaded (1) Slip-On 25.99 ea.
- APN-738 (1) Threaded (2) Slip-On 25.99 ea.
- APN-838 (1) Threaded (3) Slip-On 29.95 ea.



BPS-3679

BPS-7432

Intake Studs

Correct intake manifold studs for various uses: alternator, solenoid and power brake tube. Includes correct nut.

- BPS-3679 All 3/8" x 3/8" (Zinc)..... 5.99 ea. (p.s. bracket, alternator mount, etc.)
- BPS-7432 All 5/16" x 3/8" (Black) 5.99 ea. (TCS, P.B. tube, etc.)



N-1252

Oil Filler Tube

Chrome intake oil filler tube used with screw-in PCV filter.

- N-2258 1966-67 283 / 327 Black..... 36.95 ea.
- N-1252 1966-67 L79..... 59.99 ea.



AOC-1254

AOC-1689

Oil Filler Tube Cap

Correct chrome twist-on cap with "S" rivet.

- AOC-1689 1966-67 283 / 327 Black..... 11.95 ea.
- AOC-1254 1966-67 L89..... 17.95 ea.



APX-1115



APX-1015

Engine Block Lifting Ring

These correct steel stamped lifting rings were installed at the engine plant for ease of installation.

- APX-1015 Most SB..... 36.99 set
- APX-1115 All BB 25.99 set
- BPX-230 Lifting Ring Bolt..... 0.95 ea.



GCS-S9619

GCS-S9620

Chrome Throttle Cable Brackets

Designed to work with your GM throttle cable on most carburetor applications. Available with or without kickdown provision.

- GCS-S9619 Without Kickdown 11.99 kit
- GCS-S9620 With Kickdown..... 11.99 kit

Note: Due to the universal nature of this part fitting and/or modifications may be required.



APA-6CBH

Throttle Linkage To Cable Conversion Kit

Remove the old sticky linkage and upgrade to a smooth operating throttle cable set up. This kit includes the accelerator pedal assembly, accelerator cable, cable bracket and cable retaining clip.

APA-6CBH	1968-74 Holley	135.88 kit
APA-6CBOJ	1968-74 Q-Jet	142.22 kit

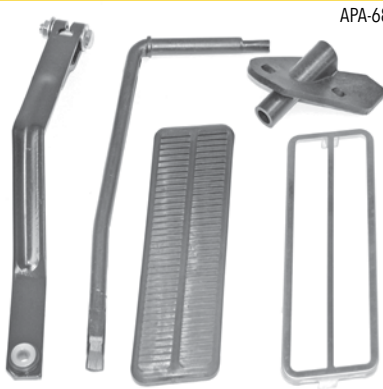

APA-68

Accelerator Pedal Linkage Kit

New assemblies complete from the pedal to the arm and includes the pedal trim.

APA-68	1968-72 All V8	64.99 kit
--------	----------------------	-----------



APJ-1302

Accelerator Rod Kits

For those using rods, our kits come complete with pre-bent rod, swivel, grommet, sleeve and hardware.

AR-4320	1963-67 All*	19.99 kit
NA-103	1968-72 SB 4bbl	31.99 kit
APJ-1302	1968 Holley SB	35.99 kit
APJ-1369	1968-74 BB Holley	35.99 kit

* May require slight modification.



APJ-1314

Accelerator Rod Grommet Kit

APJ-1314	1962-72 Most	7.95 kit
----------	--------------------	----------

BUY N SAVE
WITH KITS



CPX-9038

PCV Hose & Filter Kit

Our kits come complete with correct hose, AC Delco filter and correct black pinch clamp. Pieces also available separately.

CPX-9038	All Complete	17.95 kit
CPH-9038	Hose Only	12.99 ea.
CTC-1132	Pinch Clamp Only	0.50 ea.
CAC-3800	PCV Filter Only	5.95 ea.



ATH-99

Accelerator Cables

New GM service replacement cables with casings and bushings as original.

ATH-99	1968-74 V8 4bbl	34.95 ea.
AZC-88	Cable Clip	6.95 ea.
AXJ-CE	Cable Decal	4.95 ea.
ATH-99-BOLT	Cable to Firewall Bolt	0.25 ea.

Accelerator Arm & Rod

APJ-1314	1962-72 Most	7.95 kit
----------	--------------------	----------



A-9801

ADR-476

Accelerator Arm & Rod

Correct throttle arm and rod for attaching it to the accelerator pedal.

AMD-1600	1962-67 Arm	59.95 ea.
A-9801	1968-72 Thru-Rod	33.99 ea.
ADR-476	1968-72 Arm	24.99 ea.

AX-2963



CPN-3819

PCV Retaining Hose Clip

Exact reproduction of original PCV hose retaining clip, with correct bends and black phosphate coating.

CPN-3819	1967-72 SB Holley	16.99 ea.
CPN-3819	1966-67 L-79	16.99 ea.
AX-2963	1968-69 BB Q-Jet	24.99 ea.



CRC-7074

Cruise Control Servo Actuator Cable

This cable goes from the vacuum servo on the inner fender to the carburetor.

CRC-7074	1970-74 All w/ Cruise	89.99 ea.
----------	-----------------------------	-----------

No volume discount.



ATH-3369KIT-H

Accelerator Cable & Bracket Kit - All BB/SB with SHP Holley

This new accelerator cable and bracket kit is the perfect solution for smooth operation when your originals are either worn or missing. This kit includes a reproduction accelerator cable, bracket and retaining clip.

ATH-3369KIT-H	1968-74 All	69.20 kit
---------------	-------------------	-----------

No Volume Discount.

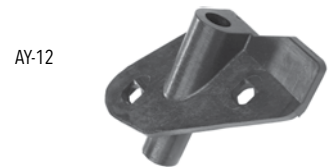

AY-12

Accelerator Rod Support

Correct support bracket used to hold rod in place. Complete with screws.

AY-12	1968-72 (plastic)	25.99 ea.
-------	-------------------------	-----------

3992376















Accelerator Brackets

Your choice of brackets with GM numbers or without GM numbers. Both fit as original.

3992376	w/ Q-Jet GM #'s	32.95 ea.
3972619	w/ Holley GM #'s	33.99 ea.
AXK-68	w/ Q-Jet No #'s	26.99 ea.
ADT-0014	w/ Holley No #'s	19.95 ea.

Air Conditioning Brackets Big Block

OE style reproduction brackets for installing original Delco air conditioning compressors in all 1969-72 Novas with big blocks using long water pumps.

	ZAC-A658-2			ZAC-A5		ZAC-A6		ZAC-B5
ZAC-A658-2	1968 Front Compressor Support.....	69.99 ea.	ZAC-A5	1969-71 Lower Bracket (to head).....			ZAC-B5	1972+ Lower Bracket (to head).....
			ZAC-A6	1969-70 Rear Compressor Spacer.....				
						ZAC-B2		
			ZAC-B2	1970+ Front Bracket (on head).....				ZAC-B3
	ZAC-A1		ZAC-A3			ZAC-A3		
ZAC-A1	1969-70 Rear Compressor Bracket.....	49.99 ea.	ZAC-A3	1969-70 Front Compressor Bracket.....			ZAC-B3	1970+ Front Compressor Bracket.....
						ZAC-B1		
	ZAC-A4		ZAC-B1	1970+ Compressor to Intake Bracket ...				ZAC-B4
ZAC-A4	1969-70 Rear Compressor Plate.....	24.99 ea.	ZAC-B1	26.99 ea.			ZAC-B4	1970+ Rear Compressor Plate.....
	ZAC-A2							
ZAC-A2	1969-70 Front Bracket (on head).....	74.99 ea.						

1969-70 1st Design AC Brackets

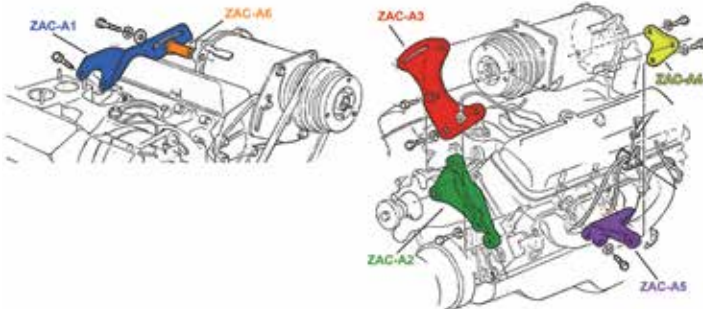

1970-75 2nd Design AC Brackets

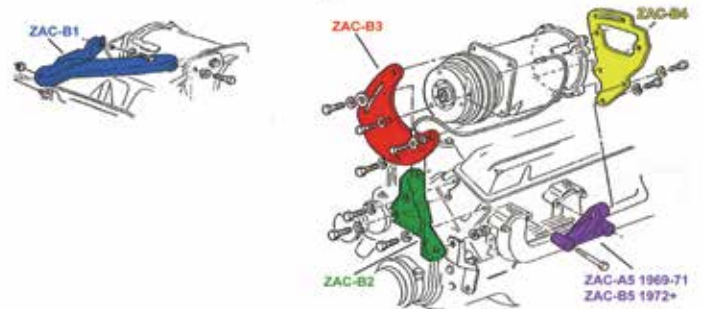

Buy a complete set of big block air conditioning brackets and save! The design changed midway through 1970, so be sure to check your original brackets for early style (ZAC-AKIT) or late style (ZAC-BKIT).

ZAC-AKIT	1969-70 BB	249.25 kit
ZAC-BKIT	1970-71 BB	217.76 kit
ZAC-BKIT2	1972 BB.....	217.76 kit

AMK inc
PRODUCTS



AC On Engine Hardware Kits

68AA-SB	1968 SB.....	29.99 kit
68AA-SSB	1968 SB w/ Smog.....	31.99 kit
69AA-SB	1969 SB.....	42.99 kit
70AA-SB	1970 SB.....	39.99 kit
70AA-BB	1970 BB.....	36.99 kit
71AA-SB	1971 SB.....	36.99 kit
72AA-SB	1972 SB.....	36.99 kit

AC Box Under Hood On Firewall Hardware Kits

68NA-F	1968 SB.....	49.99 kit
69NA-F	1969 SB.....	59.99 kit
70NA-F	1970 SB.....	55.99 kit
71NA-F	1971 SB.....	49.99 kit
72NA-F	1971 SB.....	48.99 kit



ABR-0898

AC Delco Water Pumps

Brand new AC Delco water pumps.



ABR-0898	1962-68 SB (Short Style).....	63.95 ea.
ABR-0918	1968 BB (Short Style).....	119.99 ea.
ABR-1109	1969-74 SB (Long Style).....	65.95 ea.
ABR-1002	1969-74 BB (Long Style).....	89.99 ea.



ATR-4334

ATR-3232

Water Pump OEM Attaching Bolt Kits

Correct style attaching bolts with "TR" head markings.

ATR-3232	1964-68 3 Bolts 1 Stud.....	16.99 kit
ATR-4334	1969-72 All 4 Bolts M Mark.....	11.99 kit
AWS-301S	Stud Only (Short).....	4.99 ea.
AWS-302L	Stud Only (Long).....	3.95 ea.



AWP-1394



AWP-949

Water Pump Pulley

OE style or original water pump pulleys.

AWP-796	1969+ All V8 (1 Groove).....	31.99 ea.
AWP-9950	1968 All BB (1 Groove).....	44.99 ea.
AWP-656	1968 BB (2 Groove Deep).....	89.99 ea.
AWP-1394	1969+ BB (1 Groove Deep).....	54.99 ea.
AWP-949	1969+ All (2 Groove w/ AC).....	79.99 ea.



TUF-1354NA



Tuff Stuff Water Pumps

Tuff Stuff water pumps are available in multiple different finishes. Available in standard flow or high flow (Super Cool) version for high power applications. Also available in "Smoothie" version, which features flat top casting with no top water port or plug.

Small Block

TUF-1354NA	1962-68 Short, Chrome.....	118.99 ea.
TUF-1354N	1962-68 Short, SC, Cast Finish.....	82.99 ea.
TUF-1354NC	1962-68 Short, SC, Black.....	95.99 ea.
TUF-1354NB	1962-68 Short, SC, Chrome.....	126.99 ea.
TUF-1354NAS	1962-68 Short, Smoothie, Chrome.....	124.99 ea.
TUF-1449NA	1969-79 Long, Chrome.....	150.99 ea.
TUF-1511NC	1969-79 Long, S, Plat, Cast Finish.....	170.99 ea.
TUF-1449N	1969-79 Long, SC, Cast Finish.....	82.99 ea.
TUF-1449NC	1969-79 Long, SC, Black.....	95.99 ea.
TUF-1449NB	1969-79 Long, SC, Chrome.....	168.99 ea.
TUF-1448NC	1969-79 Long, SC, Smooth, Cast.....	131.99 ea.
TUF-1448NB	1969-79 Long, SC, Smooth, Pol Alum.....	168.99 ea.
TUF-1353NA7	1964-68 Short, Smooth Blk Chrome.....	199.99 ea.
TUF-1448NA7	1969-77 Long, Smooth Blk Chrome.....	209.99 ea.

Big Block

TUF-1494N	1962-68 Short, Cast Finish.....	89.99 ea.
TUF-1494NC	1962-68 Short, SC, Black.....	113.99 ea.
TUF-1494NA	1962-68 Short, SC, Chrome.....	150.99 ea.
TUF-1461NA	1969-79 Long, S, Chrome.....	177.99 ea.
TUF-1461N	1969-79 Long, SC, Cast Finish.....	101.99 ea.
TUF-1461NC	1969-79 Long, SC, Black.....	121.99 ea.
TUF-1496NA7	1964-68 Short, Smooth Blk Chrome.....	270.99 ea.
TUF-1495NA7	1964-68 Short, SC, Smooth Blk Chrome.....	350.99 ea.
TUF-1459NA7	1969-77 Long, Smooth Blk Chrome.....	247.99 ea.
TUF-1448NA7	1969-77 Long, SC, Smooth Blk Chrome.....	209.99 ea.

No Volume Discount.

Tuff Stuff Water Pump Bolt Kits

Chrome plated hex head bolts. Includes 4 bolts, 4 flat washers and 4 lock washers.

TUF-7675A	All SB, Short Style.....	20.99 ea.
TUF-7676A	All BB, Short Style.....	20.99 ea.
TUF-7678A	All BB, Long Style.....	20.99 ea.



AWW-65

Short Water Pump Washer

This washer is for any Chevrolet engine with a short water pump. Since this part can't be seen when the pulley is installed, most people are unaware it exists, but it provides important support for the pulley.

AWW-65 1962-68 All.....8.99 ea.



GCS-S9478



GCS-S8840

Billet Water Pump Pulleys

These show quality billet aluminum water pump pulleys will set your show car apart from the crowd. Made of high quality aircraft aluminum.

- GCS-S9478 SB, SWP, 1 Groove, Satin 42.99 ea.
- GCS-S9478POL SB, SWP, 1 Groove, Polished 45.99 ea.
- GCS-S9600 SB, SWP, 1 Groove, Chrome 26.99 ea.
- GCS-S9479 SB, SWP, 2 Groove, Satin 58.99 ea.
- GCS-S9479POL SB, SWP, 2 Groove, Polished 60.99 ea.
- GCS-S9601 SB, SWP, 2 Groove, Chrome 34.99 ea.
- GCS-S9482 SB, LWP, 1 Groove, Satin..... 43.99 ea.
- GCS-S9482POL SB, LWP, 1 Groove, Polished..... 49.99 ea.
- GCS-S9604 SB, LWP, 1 Groove, Chrome..... 26.99 ea.
- GCS-S9483 SB, LWP, 2 Groove, Satin..... 61.99 ea.
- GCS-S9483POL SB, LWP, 2 Groove, Polished 65.99 ea.
- GCS-S9605 SB, LWP, 2 Groove, Chrome..... 33.99 ea.
- GCS-S8840 BB, SWP, 1 Groove, Satin..... 45.99 ea.
- GCS-S8840POL BB, SWP, 1 Groove, Polished 49.99 ea.
- GCS-S8842 BB, SWP, 2 Groove, Satin..... 56.99 ea.
- GCS-S8842POL BB, SWP, 2 Groove, Polished 63.99 ea.
- GCS-S9815 BB, SWP, 2 Groove, Chrome 36.99 ea.
- GCS-S8844 BB, LWP, 2 Groove, Satin 58.99 ea.
- GCS-S8844POL BB, LWP, 2 Groove, Polished..... 68.99 ea.
- GCS-S9723 BB, LWP, 2 Groove, Chrome..... 36.99 ea.

Note: SWP = Short Water Pump. LWP = Long Water Pump.



AWN-058 APN-1060 AWN-1059

Heater Hose / Bypass Nipples

OE style reproduction zinc plated fitting.

- AWN-058 5/8" Short..... 7.95 ea.
- AWN-034 3/4" Short..... 7.95 ea.
- AWN-134 3/4" Long w/ A-C..... 8.95 ea.
- APN-1060 3/4" Bypass Slotted 10.99 ea.
- AWN-1059 1966-67 L-79 SHP 90°..... 22.95 ea.



TUF-4450A

Tuff Stuff Chrome Heater Hose/Bypass Nipples

Chrome plated heater hose/bypass hose fittings.

- TUF-4450A 3/4" Long 11.99 ea.
- TUF-4450B 3/4" Short..... 11.99 ea.
- TUF-4450C 5/8" Short..... 11.99 ea.

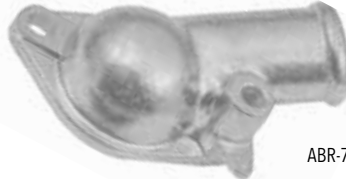

ABR-7660

Cast Iron Thermostat Housing

Correct thermostat housing for cast iron manifolds. This was the most common housing and was found on most V8s.

ABR-7660 Most V8..... 17.99 ea.



ACI-7660

Aluminum Thermostat Housing

Correct thermostat housing for high performance engines with aluminum intake manifolds. GM #3877660.

ACI-7660 Aluminum 56.99 ea.



ATE-7396

L-79 Thermostat Housing

This is the correct gooseneck style thermostat housing for your L-79 engine.

ATE-7396 1966-67 L-79..... 59.95 ea.



GCS-S9229

Chrome Thermostat Housing

Chrome steel thermostat housing with o-ring and bolts. Water neck points toward the driver side of the radiator.

GCS-S9229 Most V8..... 14.99 kit



ACT-180

Thermostat

Original AC-Delco thermostat.

- ACT-180 180-85 Degrees..... 6.95 ea.
- ACT-190 190-95 Degrees..... 6.95 ea.



TUF-900160

Tuff Stuff Performance Thermostats

These stainless steel thermostats flow up to 56 gallons per minute, ordinary thermostats flow 37 gallons per minute. The 50 percent increased coolant flow reduces the delay in engine warm-up times, allowing trapped air in the cooling system to escape and stabilize the pressure of the cooling system. Ideal for high performance muscle cars, street rods and customs.

- TUF-900160 160 Degree 18.99 ea.
- TUF-900180 180 Degree 18.99 ea.
- TUF-900195 195 Degree 19.99 ea.

No Volume Discount.



Tuff Stuff Performance Accessories provide you with the "Ultimate" in Looks and Performance!

Specializing in Chrome Plated, Polished, Factory Cast PLUS+ and Powder Coat Finished accessories that give your ride the style and performance it deserves.

Billet Engine Pulley Kit

All of the common dress up items in one easy kit! Includes water pump pulley, crank pulley, alternator pulley, power steering pulley and billet aluminum bracket kit.

GCS-S8702	SB, SWP, 1 Groove.....	315.99 kit
GCS-S8703	SB, LWP, 1 Groove.....	294.99 kit
GCS-S8704	SB, SWP, 2 Groove.....	331.99 kit
GCS-S8705	SB, LWP, 2 Groove.....	315.99 kit
GCS-S8706	BB, SWP, 1 Groove.....	315.99 kit
GCS-S8707	BB, SWP, 2 Groove.....	347.99 kit

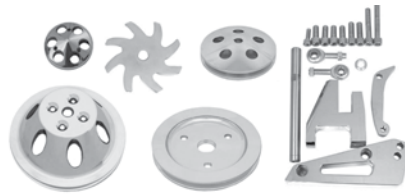

GCS-S8702



GCS-S8707



GCS-S9481POL

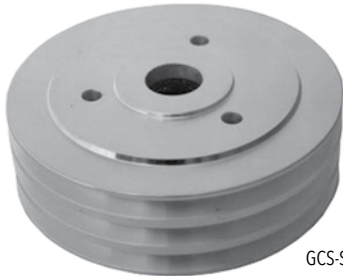

GCS-S8849

Billet Crank Pulleys

These show quality billet aluminum crank pulleys will set your show car apart from the crowd. Made of high quality aircraft aluminum.

GCS-S9480	SB, SWP, 1 Groove, Satin.....	34.99 ea.
GCS-S9480POL	SB, SWP, 1 Groove, Polished.....	45.99 ea.
GCS-S9602	SB, SWP, 1 Groove, Chrome.....	27.99 ea.
GCS-S9481	SB, SWP, 2 Groove, Satin.....	49.99 ea.
GCS-S9481POL	SB, SWP, 2 Groove, Polished.....	54.99 ea.
GCS-S9603	SB, SWP, 2 Groove, Chrome.....	33.99 ea.
GCS-S8858	SB, SWP, 3 Groove, Satin.....	66.99 ea.
GCS-S8858POL	SB, SWP, 3 Groove, Polished.....	68.99 ea.
GCS-S8963	SB, SWP, 3 Groove, Chrome.....	45.99 ea.
GCS-S9484	SB, LWP, 1 Groove, Satin.....	60.99 ea.
GCS-S9484POL	SB, LWP, 1 Groove, Polished.....	57.99 ea.
GCS-S9606	SB, LWP, 1 Groove, Chrome.....	48.99 ea.
GCS-S9485	SB, LWP, 2 Groove, Satin.....	64.99 ea.
GCS-S9485POL	SB, LWP, 2 Groove, Polished.....	62.99 ea.
GCS-S9607	SB, LWP, 2 Groove, Chrome.....	52.99 ea.
GCS-S9486	SB, LWP, 3 Groove, Satin.....	64.99 ea.
GCS-S9486POL	SB, LWP, 3 Groove, Polished.....	63.99 ea.
GCS-S9608	SB, LWP, 3 Groove, Chrome.....	51.99 ea.
GCS-S8841	BB, SWP, 1 Groove, Satin.....	36.99 ea.
GCS-S8841POL	BB, SWP, 1 Groove, Polished.....	44.99 ea.
GCS-S9817	BB, SWP, 1 Groove, Chrome.....	32.99 ea.
GCS-S8843	BB, SWP, 2 Groove, Satin.....	46.99 ea.
GCS-S8843POL	BB, SWP, 2 Groove, Polished.....	58.99 ea.
GCS-S9816	BB, SWP, 2 Groove, Chrome.....	34.99 ea.
GCS-S8849	BB, SWP, 3 Groove, Satin.....	63.99 ea.
GCS-S8849POL	BB, SWP, 3 Groove, Polished.....	65.99 ea.
GCS-S8845	BB, LWP, 3 Groove, Satin.....	92.99 ea.
GCS-S8845POL	BB, LWP, 3 Groove, Polished.....	103.99 ea.
GCS-S9724	BB, LWP, 3 Groove, Chrome.....	48.99 ea.

Note: SWP = Short Water Pump. LWP = Long Water Pump.



ACP-904



ACP-833



ACP-414



NQ-457



ACP-203



ACP-108



ACP-333

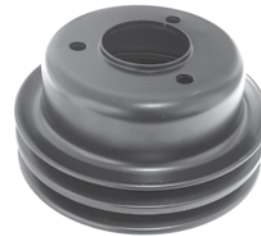

AHQ-1396



ACP-404

Crank Pulleys

All pulleys are original GM or the highest quality reproductions on the market. Each pulley is finished in factory matte black like the originals.

ACP-904	1964-67 327/350 1 Groove.....	39.99 ea.
ACP-904-2	1962-68 327/350 2 Groove SWP.....	42.99 ea.
ACP-904-3	1962-68 327/350 3 Groove SWP.....	68.99 ea.
ACP-833	1966-67 2 Groove Deep.....	59.99 ea.
ACP-414	1969-72 SB 3 Groove.....	65.99 ea.
NQ-457	1969-72 350 2 Groove Deep.....	81.99 ea.
ACP-313	1969-77 SB 1 groove LWP.....	56.99 ea.
ACP-203	1964-68 396 1 Groove.....	49.99 ea.
ACP-108	1965-68 396/375 2 Groove Deep**.....	54.99 ea.
ACP-333	1965-68 396/375 3 Groove Deep Cast.....	318.99 ea.
AHQ-1396	1969-72 396 2 Groove Deep.....	69.99 ea.
ACP-330	1969-72 396/454 3 Groove w/ A/C.....	64.99 ea.
ACP-404	1969-72 SB 2 Groove.....	52.99 ea.

**for all with power steering use with ADP-61



BPB-5934

Harmonic Balancer Attaching Bolt-Washer

BPB-5933	1964-72 Most SB	8.99 kit
BPB-5934	1965-72 All BB	12.99 kit



ABB-5799



ABB-5790

Alternator Pulleys

ABB-5799	Standard (2-3/4" OD)	20.99 ea.
ABB-5790	All w/ SHP (3-1/4" OD) Deep	44.99 ea.
ABN-105	Correct Retaining Nut	4.99 ea.



TUF-7629



Tuff Stuff Hot Start Remote Solenoid Kit

Give your starter an extra 12V boost with these hot start kits from Tuff Stuff! This kit is designed to eliminate hot start problems that are common with starter-mounted solenoids. Ideal for GM full-size OEM starters.

TUF-7629	1964-77 All	25.99 kit
----------	-------------------	-----------

No Volume Discount.

NO CORE CHARGE



AIT-6961



AIT-3342

Alternators

Rebuilt alternator made in the USA. Each alternator is 100% tested and rebuilt to exceed OEM specs.

AIT-6961	41 Amp External Reg	79.95 ea.
AIT-6963	55 Amp External Reg	82.99 ea.
AIT-3342	63 Amp Internal Reg	84.99 ea.

No Volume Discount.



TUF-7102



TUF-7102NA

Tuff Stuff Externally Regulated Alternators

All Tuff Stuff alternators are hand built in Cleveland, Ohio and are tested to meet or exceed OEM specifications. All Tuff Stuff alternators are made from 100% new components and carry a one year limited warranty. All alternators are for 12 volt, negative ground systems, except where noted.

TUF-7102	80 Amp Cast Aluminum V-Belt	99.99 ea.
TUF-7102NA	80 Amp Chrome V-Belt	137.99 ea.
TUF-7102NAP	80 Amp Pol Aluminum V-Belt	137.99 ea.
TUF-7102NF	80 Amp Black V-Belt	132.99 ea.
TUF-7102NC	100 Amp Chrome V-Belt	140.99 ea.
TUF-7102NCP	100 Amp Pol Aluminum V-Belt	140.99 ea.
TUF-7102NE	100 Amp Black V-Belt	132.99 ea.
TUF-7102NFBW	100 Amp Black Wrinkle V-Belt	136.99 ea.
TUF-7102NKBW	140 Amp Black Wrinkle V-Belt	164.99 ea.

No Volume Discount.



TUF-7520B

Tuff Stuff Alternator Pigtails

Replace worn or broken alternator connectors with Tuff Stuff's replacement pigtails to eliminate any electrical issues. These will fit factory alternators.

TUF-7520B	Externally Regulated 10DN	11.99 ea.
TUF-7520A	Internally Regulated 10SI	8.99 ea.
TUF-7520C	Internally Regulated CS130, CS144	11.99 ea.



27555



37787



500295



500802



500541

Alternator Conversion Kits

These alternator conversion kits will make it easier than ever to install a modern alternator on your classic.

27555	External to Internal SI Style	28.99 ea.
37787	External to Internal CS Style	35.99 ea.
500295	SI to CS130D Style	36.99 ea.
500802	SI to Ford 3G Style	36.99 ea.

Diode Kit

This kit is designed to prevent alternator feed-back to the ignition circuit. A common problem associated with internal regulated alternators.

500541	SI Series Diode Kit	19.99 ea.
--------	---------------------------	-----------



APX-1724



APX-2559



AVC-1144

Alternator Accessories

APX-1724	All Fan/Nut	15.99 kit
AVC-1144	1962-74 All Pigtail External	4.95 ea.
APX-2559	Rear Alternator Boot	4.95 ea.



TUF-7127ND



TUF-7140ABULL7



TUF-7127NF

Tuff Stuff Internally Regulated Alternators

Designed to handle the demand for power needed for today's electronics, Tuff Stuff's high powered internally regulated alternators are perfect if you have added a set of high powered headlights, or a high powered stereo system, or any other electronic systems to your Nova. Although meant for 1971 and newer internally regulated set ups, they can be used on older models that have been converted from external to internally regulated.

TUF-7127NB	80 Amp, 1 Wire, Chrome	136.99 ea.
TUF-7127D	100 Amp, 1 Wire, Cast Finish.....	99.99 ea.
TUF-7127NF	100 Amp, 1 Wire, Black	136.99 ea.
TUF-7127ND	100 Amp, 1 Wire, Chrome.....	136.99 ea.
TUF-7127NDP	100 Amp, 1 Wire, Polished Aluminum	136.99 ea.
TUF-7127K	140 Amp, 1 Wire, Cast Finish.....	141.99 ea.
TUF-7127NK	140 Amp, 1 Wire, Chrome.....	156.99 ea.
TUF-7139ABULL	100 Amp, Silver Bullet, 1 Wire, Chrome.....	176.99 ea.
TUF-7140FBULL	140 Amp, Silver Bullet, 1 Wire, Black	194.99 ea.
TUF-7140ABULL	140 Amp, Silver Bullet, 1 Wire, Chrome.....	236.99 ea.
TUF-7127ND7	100 Amp, 1 Wire Black Chrome V-Belt	160.99 ea.
TUF-7127ND6G7	100 Amp, 1 Wire Black Chrome Serp Belt	160.99 ea.
TUF-7139ABULL7	100 Amp, Silver Bullet 1 Wire Black Chrome V-Belt.....	206.99 ea.
TUF-7139ABULL6G7	100 Amp, Silver Bullet 1 Wire Black Chrome Serp Belt.....	208.99 ea.
TUF-7127NK7	140 Amp, 1 Wire Black Chrome V-Belt	183.99 ea.
TUF-7127NK6G7	140 Amp, 1 Wire Black Chrome Serp Belt	184.99 ea.
TUF-7140ABULL7	140 Amp, Silver Bullet 1 Wire Black Chrome V-Belt.....	277.99 ea.
TUF-7140ABULL6G7	140 Amp, Silver Bullet 1 Wire Black Chrome Serp Belt.....	280.99 ea.

Tuff Stuff Alternator Accessories

TUF-7500A	Chrome Alternator Case Kit	70.99 kit
TUF-7600A	Chrome Fan and Pulley Kit, Single Groove.....	25.99 kit
TUF-7600B	Chrome Fan and Pulley Kit, Double Groove	29.99 kit
TUF-7610E	Chrome Alternator Pulley, Single Groove.....	19.99 ea.



APX-ALT-CAP

Alternator Positive Terminal Cap Red

This is a new reproduction red plastic GM style alternator positive terminal cap and retainer kit. Check alternator to cylinder head clearance before ordering. Some applications are tight.

APX-ALT-CAP	1964-77	13.99 set
-------------	---------------	-----------



BN-339

Alternator Hardware

All of the correct hardware needed to mount your alternator!

BN-339	1969-72 BB Lower Stud/Nut.....	10.99 ea.
BZ-117	1965-68 BB Hardware Kit.....	18.99 kit
BRB-938	1969-72 SB Lower Bolt	4.95 ea.



APX-1138

APX-1138	1969-72 SB Spacer Brace.....	18.99 ea.
----------	------------------------------	-----------



APX-1038

APX-1038	1969-72 BB Spacer Brace	15.95 ea.
----------	-------------------------------	-----------



AWB-1114

AWB-1114	1964-72 Upper Adj Kit w/ W Bolt.....	5.99 kit
----------	--------------------------------------	----------



ABC-23

ABC-23	1969-72 Bat Cable Clip SB.....	13.95 ea.
--------	--------------------------------	-----------

For top of alternator



ATE-5416

ATE-5416	1969-72 Heater Hose Retainer.....	6.99 ea.
----------	-----------------------------------	----------

For top of alternator



AW-506

AW-506	1964-72 Neg Cable Ground Bolt/Washer	0.95 ea.
--------	--	----------



G-4962

Alternator Mounting Kits

These complete kits make installing your alternator and bracket easy.

G-4805	1967 396, 427 16pc.....	15.99 kit
G-4645	1967-68 327, 350 16pc.....	14.99 kit
G-4918	1968 396, 427 16pc.....	15.99 kit
G-4962	1969-74 SB All.....	15.99 kit

No Volume Discount.



GCS-S6679

BUY'N SAVE
WITH KITS

Alternator Dress Up Kit

This kit is designed to take your stock internally regulated alternator and make it show ready. This kit includes a chrome alternator case, pulley, fan and hardware.

GCS-S6679 1973-85 GM59.99 kit

Note: For 1973-85 internal regulated alternators only.



AR-0180

1965-68 SHP Alternator Bracket Kit

Correct upper and lower bracket stamped "GT" for all 1965-68 SB.

AR-0180 1965-68 SHP79.95 kit

GCS-S9487



Billet Alternator Pulleys

Show quality billet alternator pulleys.

GCS-S9487 1 Groove, Satin.....30.99 ea.

GCS-S9487POL 1 Groove, Polished.....34.99 ea.

GCS-S9447 2 Groove, Chrome.....20.99 ea.



GCS-S8867

Billet Alternator Fan

Polished billet aluminum.

GCS-S8867 Polished14.99 ea.



GCS-S9446

Chrome Alternator Fan w/ Pulley

Chrome plated steel OEM style alternator fan with chrome single groove pulley. Includes nut.

GCS-S9446 Chrome16.99 kit

Small Block Alternator Brackets

OE style reproduction alternator brackets for your small block Chevy.



AAB-65L

AAB-65L 1962-68 SB Lower.....17.95 ea.

Use with AAB-64L if you have headers.



ACE-5333

ACE-5333 1969-72 SB Lower.....17.99 ea.

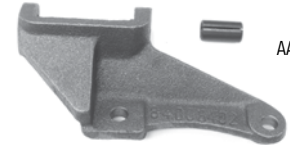

AAB-64L

AAB-64L 1962-68 SB Lower.....39.95 ea.

For exhaust manifolds.

ACE-2956

AAB-227



ACE-2956 1969-75 SB Upper.....34.99 ea.

AAB-227 1976-79 SB Upper.....24.99 ea..



ALB-22

ALB-22 1962-67 SB Lower Early Style41.95 ea.



AAB-3400

AAB-3400 1962-68 SB Upper.....37.99 ea.

Big Block Alternator Brackets

OE style reproduction alternator brackets for your big block Chevy.



AAB-4500

AAB-4500 1965-68 BB Upper.....21.99 ea.



AK-173

AK-173 1969-72 BB Upper.....24.99 ea.



AK-175

AK-175 1969-72 BB Lower20.99 ea.



ARZ-0027

ARZ-0027 1965-68 BB Lower46.95 ea.



AA-45KIT

Big Block Alternator Bracket Kit

This is a complete set of alternator brackets and hardware for your 1965-68 Nova big block with short water pump. This kit works on all cars with short water pumps.

AA-45KIT 1965-68 BB Short Pump.....87.26 kit

BUY'N SAVE
WITH KITS



AKK-301









1969-72 Big Block Alternator Mounting Kit

OE style reproduction of upper-lower brackets, lower mounting stud, lower spacer-brace and upper adjustment bolt w/ special washer.

AKK-301 1969-72 All BB.....70.99 kit

OE Style Chrome Alternator Brackets







These high quality brackets will give your show car that finishing touch!

	GCS-S9315		GCS-S9637		GCS-S9318
GCS-S9315	SB Upper SWP..... 17.99 ea.	GCS-S9637	SB Lower LWP (69-75)..... 8.99 ea.	GCS-S9318	BB Upper LWP (69-92)..... 17.99 ea.
	GCS-S9316		GCS-S9502		GCS-S9638
GCS-S9316	SB Upper LWP (69-75)..... 17.99 ea.	GCS-S9502	BB Lower SWP 39.99 ea.	GCS-S9638	BB Lower LWP (69-92)..... 9.99 ea.
	GCS-S9317		GCS-S9581		GCS-S9254
GCS-S9317	SB Upper LWP (76-86)..... 18.99 ea.	GCS-S9581	BB Upper SWP 16.99 ea.	GCS-S9254	Bracket for Headers..... 13.99 ea.

Note: SWP = Short Water Pump. LWP = Long Water Pump.

Custom Style Alternator Brackets

These chrome plated steel alternator brackets will give your engine a unique custom look that will stand out from the crowd.

	GCS-S9319		GCS-S9320		GCS-S1637
GCS-S9319	SB Upper SWP..... 16.99 ea.	GCS-S9320	V8 Upper LWP (69-75)..... 14.99 ea.	GCS-S1637	SB Upper LWP (76-86)..... 23.99 ea.
	GCS-S9321		GCS-S1647		GCS-S1647
GCS-S9321	SB Upper LWP (76-86)..... 15.99 ea.	GCS-S1647	BB Upper LWP (69-92)..... 23.99 ea.	GCS-S1647	BB Upper LWP (69-92)..... 23.99 ea.



AJ-408

Timing Covers

New covers complete with crankshaft seal.

AJ-408	1968-76 All Small Block.....	48.95 ea.
AJ-SB-8	1969-70 SB w/ 8" Balancer*.....	96.99 set
AJ-850	1965-72 All Big Block.....	53.99 ea.
AJ-BB-7	1968-77 BB w/ 7" Balancer*.....	95.99 set
AJ-BB-8	1968-77 BB w/ 8" Balancer*.....	95.99 set
BTC-650	Correct Attaching Bolts.....	8.95 kit

*Factory OEM style.



GCS-S4935

Chrome Timing Covers

Brilliantly polished timing cover with a rigid sealing surface.

GCS-S4932	SB SWP Chrome.....	23.99 ea.
GCS-S4934	SB LWP Chrome.....	23.99 ea.
GCS-S4935	BB All Chrome.....	23.99 ea.
GCS-S4935R	BB All Unfinished Steel.....	20.99 ea.

Note: These covers may not work with some double roller timing chains. Check clearance before starting engine. Doubling of the gaskets or shims may be required to use cover with a short water pump. SWP = Short water pump. LWP = Long water pump.



GCS-S6040C

2 Piece Aluminum Timing Covers

An excellent upgrade for your engine. Rigid sealing surface for positive seal and it looks great, too!

GCS-S6040	SB Polished Billet.....	30.99 ea.
GCS-S6040C	SB Chrome Billet.....	55.99 ea.
GCS-S8422	BB Polished Billet.....	54.99 ea.
GCS-S8422C	BB Chrome Billet.....	62.99 ea.

Note: These covers may not work with some double roller timing chains. Check clearance before starting engine. Doubling of the gaskets or shims may be required to use cover with a short water pump.



Timing Cover Pointers

Correct pointer for adjustment of engine timing.

ATP-07	1965-68 SB.....	8.99 ea.
ATP-36	1969-72 SB.....	7.99 ea.
ATP-47	1965-72 SB w/ 7" Bal.....	13.99 ea.
ATP-07	1965-72 BB SHP w/ 8" Bal.....	8.99 ea.



Chrome Adjustable Timing Pointers

Provides a convenient way to adjust and verify your engine's ignition timing. Finished brilliant chrome plated steel.

GCS-S9178	SB 7".....	9.99 ea.
GCS-S9179	SB 8".....	9.99 ea.
GCS-S4961	BB 8".....	5.99 ea.
GCS-S9180	BB 9" Adjustable.....	6.99 ea.



SB Billet Timing Cover Pointer

Provides a convenient way to adjust and verify your engine's ignition timing. Adjustable and can be used with 6" or 7" balancers.

GCS-S6041C	Chrome Plated Billet.....	26.99 ea.
GCS-S6042	Ball Milled.....	28.99 ea.
GCS-S6042C	Ball Milled Chrome.....	28.99 ea.
GCS-S4960	Chrome Plated Steel.....	6.99 ea.
GCS-S6041	Billet.....	27.99 ea.



Chrome Holley Carburetor Throttle Return Kit

Designed to make mounting the spring a snap! Works on most Holley carburetor applications.

GCS-S2083	Holley.....	16.99 kit
-----------	-------------	-----------

Note: Due to the universal nature of this part fitting and/or modifications may be required.



Distributor Hold Down

Correct retaining hardware for distributors.

ACE-1400	All V8.....	13.99 kit
----------	-------------	-----------



Custom Distributor Hold Down Kit

Designed to secure your distributor settings and look good doing it. Choose from chrome or billet.

GCS-S4116	Chrome.....	6.99 ea.
GCS-S5116	Billet.....	19.99 ea.



Radio Capacitor

Came from the factory on all cars with radio. Correct length lead wire & brass connector. Stamped 1964452 "DR" & ".3MF" as original.

GRC-12834	1964-71 3MF.....	39.99 ea.
GRC-12835	1970-74 5MF.....	39.99 ea.



Tune Up Kit

AC Delco tune up kit with new points, condenser and rotor.

N-2441	1964-72 All.....	49.99 ea.
--------	------------------	-----------



Coil Bracket

OE style reproduction of original comes with retaining screw.

ALI-65	1965 L79.....	99.95 ea.
ALI-3119	All V8.....	20.99 ea.
BAN-516	SEMS Bolts.....	1.95 pr.



Starter Solenoid Wire Clip

Correct clip for retaining wire harness to solenoid.

ALI-1504	1964-67 All V8.....	17.99 ea.
A-193	1968-72 All V8.....	24.95 ea.



Chrome Ignition Coil Bracket

This brightly chrome plated ignition coil bracket will look great in your engine compartment. Fits most round cylinder style ignition coils.

GCS-S9366	Coil Bracket.....	8.99 ea.
-----------	-------------------	----------



HEI Distributor Pigtail

GCS-S3112	All.....	13.99 ea.
-----------	----------	-----------



Distributor Cap

Choose from AC Delco replacement distributor cap or OE style reproduction distributor cap with GM numbers. Red cap features heavy duty brass terminals for high performance engines.

1971244	Black Cap.....	79.99 ea.
AAD-308	Replacement.....	22.95 ea.

ADS-2100-SC-CLEAR



ADS-2100-SC-RED

HEI Distributor

Chrome aluminum HEI electronic distributor with built-in 50K coil.

- ADS-2100 All V8 94.99 ea.
 - ADS-2100-SC-RED All V8, Red Super Cap 99.99 ea.
 - ADS-2100-SC-CLEAR All V8, Clear Super Cap 97.99 ea.
 - GCS-S3938-BLUE 16 Blue Super Cap* 90.99 ea.
- * For 292 Inline 6 cyl. Only.



Accel Replacement HEI Distributor

Using all new components, these distributors feature: High performance ACCEL Electronics. All new components-housing castings, ce. Direct plug-in replacement with factory type connector. Fits standard deck height small and big block engines. Coil Not Included!

- ACCEL-59107 All w/ HEI 176.99 ea.
- No Volume Discount.



MSD-8362



MSD HEI Distributor

For value conscious enthusiasts, the Street Fire HEI is a great choice! We know the importance of a centrifugal advance in a distributor so our engineers made sure that the Street Fire received an advance assembly with coated weights and welded weight pins (not just pressed in like other models). Another area that you cannot afford to scrimp on is with a distributor gear. The Street Fire is fit with the same gear that is used on our Pro-Billet models. The metallurgy of this gear has been refined for years to perform through the harshest conditions.

- MSD-8362 All, Red Cap 4 Pin* 213.99 ea.
- MSD-8365 All Billet, Red Cap 4 Pin* 560.99 ea.

Note: Standard deck height blocks only. Will not fit gen 5 and 6 big blocks. *Refers to the amount of terminals on the ignition module. No Volume Discount.

MSD-8360



MSD Pro Billet Distributor

The Pro-Billet Ready-to-Run distributor is the perfect upgrade for outdated points distributors or bulky HEIs. Simply install the distributor in the engine, connect three wires, the coil and fire it up!

- MSD-8360 Chevy V8* 453.99 ea.
- MSD-85551 Chevy V8** 352.99 ea.

*Does not have nor can accept a vacuum advance canister.

**Must be used with a MSD 6,7, or 8 ignition box.

Note: Standard deck height blocks only. Will not fit gen 5 and 6 big blocks. No Volume Discount.



Mallory Unilite Distributor

A legend returns - the tried and true Mallory Unilite Distributor line is back! The easy three wire hookup of the Unilite makes running a stock coil, a Mallory performance coil and even a Mallory HyFire CD ignition a snap. Supplied with a quality cap and rotor, the Mallory Unilite also provides a fully adjustable mechanical advance to dial in the perfect timing curve for a multitude of engine combinations. The Unilite features a compact housing that lends itself well to applications where space is a premium due to tight firewall clearance or blower applications.

- MAL-3748201 All SBC, BBC* 398.99 ea.

*Standard deck height blocks only. Will not fit gen 5 and 6 big blocks. No Volume Discount.



MSD-6201

MSD Ignition

An MSD Ignition will improve the overall performance of your engine thanks to its high output capacitive discharge sparks.

Below 3,000 RPM the ignition delivers multiple sparks that will clean up the idle, improve starting and throttle response. If you're looking to improve the performance of your modified mill, we have the answer. Whether you've done a cam swap, or bolted on a carb, intake and headers the 6A is a surefire way to harness all the ponies under your hood. Step up to the 6AL to have an engine saving rev limiter.

- MSD-6201 Red All 6A 292.99 ea.
- MSD-6425 Red All 6AL 339.99 ea.

- MSD-64253 Black All 6AL 339.99 ea.
- MSD-6421 Red All 6AL-2 403.99 ea.

No Volume Discount.



Coil

Brand new GM replacement ignition coil.

- GAC-505 1964-72 All Replace 39.95 ea.
- No Volume Discount.



GCS-S2039BLU



GCS-S2039BK

External Ignition Coils

Choose from our upgraded external ignition coils. 45,000-volt output. Anodized finish, includes pigtails and hardware for installation.

- GCS-S2039BK All, Black 55.99 ea.
- GCS-S2039BLU All, Blue 57.99 ea.
- GCS-S2039C All, Chrome 55.99 ea.
- GCS-S2039RED All, Red 60.99 ea.



APJ-5240

Ground Strap Kit

Correct braided copper wire and ends complete with OEM screws.

- APJ-5240 1964+ (3 pc.) 19.99 kit

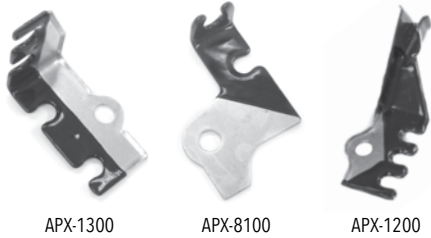

Wire Separators

Correct spark plug wire separators.

APX-1300	1969-72 SB/BB Left Rear.....	17.99 ea.
APX-1200	1969-72 SB Left Front.....	17.99 ea.
APX-8100	All BB Right Side.....	17.99 ea.



Spark Plug Wire Stands

New exact reproduction of originals

AX-423	All SB (right side).....	14.95 ea.
AX-486A	1968 All SB (left side).....	27.95 ea.
AX-486	1969-72 All SB (left side).....	27.95 ea.

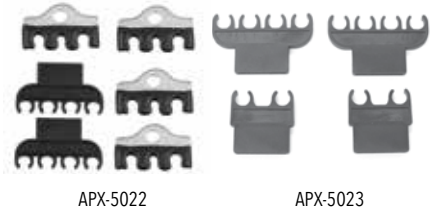

Valve Cover Spark Plug Wire Loom Kits

Correct spark plug wire separators for valve covers

APX-5022	SB 6pc.....	21.99 kit
APX-5023	BB 4pc.....	12.99 kit



"Dated" Spark Plug Wire Set

New exact reproduction wire set correctly dated for your specific car, pre-cut and ready to install! Each set features correct colored wires and correct angle "cut" boots. Please give your sales rep your desired date. Non-HEI cars only. Here's how to order:

ALL-70BB1Q..... 99.99 set
**For example, if the build date of your car was on or before January 15th of the model year, order 3rd quarter of the previous year. If the build date was after January 15th of the model year, order 1st quarter of that year. i.e. A 1970 Nova built on or before Jan 15th of 1970 would receive 70BB1Q.*



AHC-1508



AHC-2508

Spark Plug Wire Sets

New pre-cut OEM replacements.

AHC-1508	All SB.....	39.95 set
AHC-2508	All BB.....	39.95 set
AHC-3508	All w/ HEI.....	54.99 set



MAL-937C

Mallory Pro Spark Plug Wires

Burning spark plug boots in high heat applications is a thing of the past with Mallory's high temp ceramic boot spark plug wires. The ceramic boot is capable of withstanding temps up to 2,000 degrees F, making them ideal for applications with close tolerance headers and any other application where boot failure is an issue. These universal sets come with HEI type and socket type distributor ends. Cut and crimp to fit. 90 Degree boots typically fit small block and the 135 degree boots typically fit big block.

MAL-937C	90 Degree Red.....	148.99 set
MAL-947C	135 Degree Red.....	148.99 set
MSD-35051	Universal Crimper Tool.....	116.99 ea.

No Volume Discount.



MSD-35593



MSD Ignition Spark Plug Wires

Engineered from the inside out, the 8.5 offers everything you have ever wanted in a wire; incredibly low resistance without electronic interference! In a single 12 inch length of Super Conductor Wire there is only 40 - 50 ohms of resistance!

Without Headers

MSD-31359	Red, SBC 350 HEI w/o Headers....	118.99 kit
-----------	----------------------------------	------------

With Headers

MSD-35593	Black, SBC 350 HEI* Cap.....	124.99 kit
MSD-35599	Red, SBC 350 HEI* Cap.....	124.99 kit
MSD-35603	Black, BBC 350 HEI* Tower Cap...	130.99 kit
MSD-35609	Red, BBC 350 HEI* Tower Cap....	130.99 kit
MSD-35653	Black, SBC 350 HEI* Tower Cap...	127.99 kit
MSD-35659	Black, SBC 350 HEI* Cap.....	127.99 kit

*Works on any HEI or MSD style cap with male terminals.

No Volume Discount.

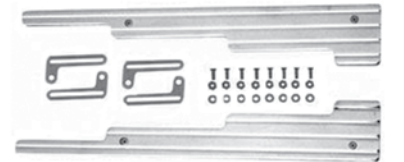

GCS-S6038



GCS-S6038X

Billet Spark Plug Wire Looms

These wire looms will keep your spark plug wires neat and organized, minimizing wear on the wires. Also prevents cross firing and grounding of the wires. Choose from plain, ball milled, or milled flames in either polished billet or chrome billet. Includes mounting hardware.

GCS-S6039	Plain, Polished.....	55.99 kit
GCS-S6039C	Plain, Chrome.....	83.99 kit
GCS-S6038	Ball Mill, Polished.....	54.99 kit
GCS-S6038C	Ball Mill, Chrome.....	80.99 kit
GCS-S6038X	Flames, Polished.....	61.99 kit
GCS-S6038XC	Flames, Chrome.....	90.99 kit

Note: Fits up to 9.5 mm wires.



Universal Chrome Wire Looms GCS-S7251

These wire looms will keep your spark plug wires neat and organized minimizing wear on the wires. Also prevents cross firing and grounding of the wires.

GCS-S7251 Universal23.99 kit
Note: Fits up to 9 mm wires.

AC43



AC Delco Spark Plugs

This is a brand new set of 8 spark plugs for your Chevrolet. These high quality reproduction AC Delco spark plugs feature the correct green AC and markings as original.

AC43 1964-70 #4362.99 set
AC44 1964-70 #4462.99 set
AC45 1964-70 #4562.99 set

Note: The number on the plug refers to its operating temperature. The lower number is a cooler running plug which is typically found on the SHP high performance engines. A hotter, higher numbered plug would be used in engines where plug fouling may be, or is a problem.



APX-650

Spark Plug Heat Shield Kit SB

Correct die stamped shields and arms for most small blocks without Rams Horn style manifolds. Complete with mounting hardware.

APX-650 1964-72 SB.....44.99 kit
BXX-650 Bolts (4)1.00 kit



AT-3030

OEM Style Spark Plug Heat Shield Kit BB

This is a set of correctly stamped spark plug heat shields which are Silver Cadmium plated.

AT-3030 1965-72 BB62.99 kit



Spark Plug Heat Shield Kit BB APX-6584

Correct stamped shields for various Chevrolet cars with BB engines (8pcs).

APX-6584 1965-72 BB39.99 kit



AD-052

Smog Tube & Extension

Correct pre-bent powder coated AIR smog tubes and extensions.

AD-252 1969-72 SB Tubes 119.99 pr.
AD-052 1969-72 BB Tubes 109.99 pr.
AZ-840 1967-72 Extension 8.95 ea.



AZ-840



ASH-695

Smog Hose Kit

Original OEM ribbed hose complete with white stripe vacuum hose, T fittings and clamps.

ASH-695 All SB Complete41.95 kit
ASH-698 All BB Complete41.95 kit
CPN-100 OEM Vacuum Hose Only 1.95 pr ft



AVC-542

1968 SHP Valve Covers

Accurate reproductions of the original 1968 Special High Performance (SHP) valve covers in chrome or ready to paint EDP coating.

AVC-542 Chrome170.99 pr.
AVC-543 Paintable..... 129.99 pr.



GCS-S6142

GCS-S6142G

Fabricated LS1 Valve Covers

2.5" height to clear aftermarket valve train. Includes oil cap, O-ring type gasket and bolts. Available with or without mounts for coil brackets.

GCS-S6141 LS1, No Coil Bracket Mounts, Anodized 203.99 pr.
GCS-S6141C LS1, No Coil Bracket Mounts, Chrome 233.99 pr.
GCS-S6141POL LS1, No Coil Bracket Mounts, Polished 221.99 pr.
GCS-S6142 LS1, w/ Coil Bracket Mounts, Anodized 182.99 pr.
GCS-S6142C LS1, w/ Coil Bracket Mounts, Chrome 220.99 pr.
GCS-S6142POL LS1, w/ Coil Bracket Mounts, Polished 203.99 pr.
GCS-S6142G LS1 O-Ring Type Gasket 10.99 pr.
GCS-S6142BOLT LS1 Valve Cover Bolt Kit 8.99 kit
GCS-S6143 LS1 Coil Mounting Brackets 27.99 pr.



MOTION-VC

"Motion" Valve Covers

Original style Cal Custom finned valve covers featuring the notorious Baldwin Motion die cast logos.

AVC-100 Most BB (Blank)..... 199.00 pr.
MOTION-VC Most BB "Motion" 289.95 pr.
Note: 2-5/8" - 3" inside clearance.



ATE-4207

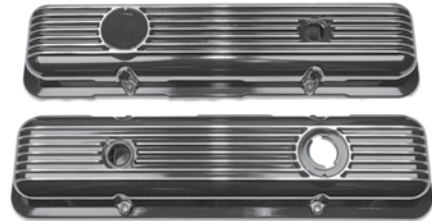

ATE-4207-BLK

Finned Aluminum Valve Covers

Exact reproduction of original GM high performance valve covers.

ATE-4207 SB..... 229.99 pr.
ATE-4207-BLK SB Black 229.95 pr.
HVC-28 Flag Decal..... 10.99 ea.



GCS-S6047BK

Small Block Center Bolt Ball Milled Valve Covers

These aluminum valve covers are a great custom touch to any street machine or sleeper.

GCS-S6047BK Center Bolt Small Block..... 150.99 pr.
Fits 1987 and newer small block with center bolt heads except LS.



GCS-S6145BK



GCS-S6145POL

Fabricated Tall Height Valve Covers

High quality fabricated aluminum valve covers. Mounting hardware included. Available with or without breather holes.

GCS-S6144C	SB, No Hole, Chrome	179.99 pr.
GCS-S6144POL	SB, No Hole, Polished	157.99 pr.
3-3/4" height		
GCS-S6145	SB, Flat Top, w/ Hole, Anodized	144.99 pr.
GCS-S6145C	SB, Flat Top, w/ Hole, Chrome	167.99 pr.
GCS-S6145POL	SB, Flat Top, w/ Hole, Polished	152.99 pr.
GCS-S6145BK	SB, Flat Top, w/ Hole, Black	164.99 pr.
GCS-S6147	SB, Flat Top, No Hole Anodized.....	129.99 pr.
GCS-S6147C	SB, Flat Top, No Hole Chromw.....	148.99 pr.
GCS-S6147POL	SB, Flat Top, No Hole Polished	129.99 pr.
3-7/8" height		
GCS-S6244	BB, Long Screw, No Hole, Anodized	181.99 pr.
GCS-S6244C	BB, Long Screw, No Hole, Chrome	203.99 pr.
3-1/2" height		
GCS-S6248	BB, Short Screw, w/ Hole, Anodized	175.99 pr.
GCS-S6248POL	BB, Short Screw, w/ Hole, Polished	161.99 pr.



GCS-S7617



GCS-S7619

Small Block Tall Valve Covers

These high quality small block Chevy valve covers are a great way to dress up your engine, as well as gain some extra clearance for roller rockers.

GCS-S6336	Chevrolet Logo, Black	277.99 pr.
GCS-S7618	Chevrolet Logo, Orange	274.99 pr.
GCS-S6341POL	Chevrolet Logo, Polished.....	314.99 pr.
GCS-S7617	383 Stroker Logo, Black.....	236.99 pr.
GCS-S7619	383 Stroker Logo, Orange	258.99 pr.



AVC-540



AVC-541

1967 Chevrolet Script Valve Covers

Excellent reproductions of the original stamped "Chevrolet" valve covers in chrome or ready to paint EDP coating. These valve covers feature the correct wire retainers and "0" stamp.

AVC-540	Chrome.....	199.99 pr.
AVC-541	Paintable.....	154.99 pr.



ALS-1065



Original Style Chrome Valve Covers

These OE style reproduction covers offer the highest quality chrome plating, correct wire stands and factory oil deflectors "drippers". Valve covers are available with a left side slant to increase booster clearance in tight engine compartments. Also available in tall style to fit roller rockers.

ALS-1065	All BB w/o Left Slant	69.99 pr.
ALS-1165	All BB w/ Left Side Slant	69.99 pr.
ACC-3362	All BB w/o Drippers	51.99 pr.
ACC-3365	All BB w/ Slant w/o Drippers	51.99 pr.
ALS-1065XT	All BB Tall w/o Left Slant w/o Drippers	89.95 pr.
ALS-1165XT	All BB Tall w/ Left Slant w/o Drippers	89.95 pr.



BUY'N SAVE
WITH KITS

XA-101

Big Block Valve Cover Kit

Save money on our complete kit! All kits come complete with the following items:

(2) valve covers, (2) gaskets, valve cover retainers and TR bolts, (2) V.C. grommets, V.C. oil cap, V.C. elbow and Hose and V.C. wire separators.

XA-101	w/o Left Slant w/ Drippers	169.04 kit
XA-101S	w/ Left Side Slant w/ Drippers*	169.04 kit

**Use slanted valve covers when brake booster clearance may be an issue. OE kits with silver gaskets, correct oil cap and Tonawanda decal.*

XA-101-OE	w/o Left Slant w/ Drippers	186.03 kit
XA-101S-OE	w/ Left Slant w/ Drippers	186.07 kit

**Use slanted valve covers when brake booster clearance may be an issue.*



396TJVC-1

"Turbo Jet" Valve Covers

Cal Custom finned valve covers featuring the famous "Turbo Jet" medallions.

396TJVC-1	All BB	299.99 pr.
427TJVC-1	All BB	229.95 pr.
454TJVC-1	All BB	229.95 pr.
502TJVC-1	All BB	229.95 pr.
572TJVC-1	All BB	229.95 pr.

2-5/8" - 3" inside clearance. Will work with most roller rockers.



454VC-R

"454" Valve Covers

Original Cal Custom style valve covers featuring red "454" medallions.

454VC-R	Most BB "454"	229.95 pr.
---------	---------------------	------------

2-5/8" - 3" inside clearance. Will work with most roller rockers.



SS427VC-R

"SS 427" Valve Covers

Original Cal Custom style valve covers featuring red "SS 427" medallions.

SS427VC-R	Most BB "SS 427"	279.95 pr.
-----------	------------------------	------------

2-5/8" - 3" inside clearance. Will work with most roller rockers.



427VC-1

"427" Valve Covers

Like our "YENKO" covers with cast "427" medallions.

427VC-1	Most BB "427"	229.95 pr.
427VC-R	Most BB "427" Red	229.95 pr.

2-5/8" - 3" inside clearance. Will work with most roller rockers.



HARREL-VC

Dick Harrel Aluminum Valve Covers

"Cal Custom" finned aluminum covers feature the notorious Dick Harrel die cast medallions.

HARREL-VC	Most BB	229.95 pr.
-----------	---------------	------------

2-5/8" - 3" inside clearance. Will work with most roller rockers.



YSCVC-1

"Yenko" Valve Covers

These limited edition "Cal Custom" style finned aluminum covers feature the notorious "YENKO" Red, White and Blue die cast logos.

YSCVC-1	Most BB "YENKO"	229.95 pr.
---------	-----------------------	------------

2-5/8" - 3" inside clearance.



AT-3662



Small Block Valve Covers

AT-3666

New original style early small block Chevrolet covers. These covers come ready to install in correct Chevrolet Orange or chrome plated.

- AT-3662 SB Chrome Covers.....144.99 pr.
- AT-3666 SB Orange Covers119.99 pr.



GCS-9215B

Black Painted Valve Covers

This is a pair of high quality tall black painted valve covers. A great inexpensive custom touch to any street machine or sleeper!

- GCS-9215B 1964-77 SB.....31.99 pr.



ALS-1165-OJ

Big Block Valve Covers – Chevrolet Orange

This is a pair of brand new big block valve covers painted in Chevy orange. These valve covers are correct for most big blocks and will fit cars with power brakes.

- ALS-1165-OJ All Big Block.....109.99 pr.



Valve Cover Gaskets

AFP-059

- AFP-057 All SB.....11.99 pr.
- AFP-059 All BB.....22.99 pr.



APB-1027

APB-1023

Valve Cover Retainers OEM Bolt Kits

Correct steel stamped zinc plated retainers & OEM bolts.

- APB-1023 SB TR Bolts (16 pc.).....14.95 kit
- APB-2023 BB TR Bolts (28 pc.).....23.99 kit
- APB-1027 SB M Aluminum (8 pc.).....16.99 kit



APO-2043



APR-2136

Valve Cover Oil Caps

Choose from either chrome GM replacement, chrome reproduction with correct "S", or black rubber push-in cap.

- APX-5763 Replacement.....6.95 ea.
- APR-2136 Reproduction "S".....16.95 ea.
- APO-2043 Rubber "OIL".....5.95 ea.

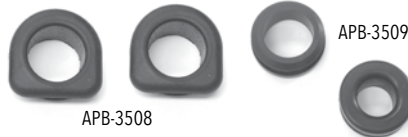

APB-3508

APB-3509

Valve Cover Grommet Original GM

- APB-3508 All SB.....9.99 pr.
- APB-3509 All BB.....12.99 pr.



APT-3509

APT-3960

Valve Cover Elbows

Correct GM steel valve cover elbows.

- APT-3960 All SB.....12.95 ea.
- APT-3509 All BB.....12.99 ea.



APH-3843

APH-2109

Valve Cover Hose

Correct marked OEM hose which extends from valve cover to air cleaner base. Choose from open or closed element.

- APH-3961 All SB Open.....12.99 ea.
- APH-3843 All BB Open.....5.99 ea.
- APH-2109 1970-72 BB Closed.....15.99 ea.



AM2-3628

1962-67 V8 Oil Pan Conversion

This kit is essential when converting from a 6 cylinder to a small block V8 engine. Includes standard volume oil pump, oil pan, dip stick, dip stick tube, oil pump pick up tube and oil pump shaft.

- AM2-3628399.99 kit

No Volume Discount.



GCS-S8442BK

Small Block Finned Aluminum Oil Pans

These finned aluminum oil pans will help keep your oil cooler and add some custom style to your street machine or sleeper.

- GCS-S8442BK 1968-79 SB105.99 ea.
- 2-piece rear main seal, drivers side dipstick.
- GCS-S8443BK 1980-85 SB105.99 ea.
- 2-piece rear main seal, passenger side dipstick.
- GCS-S8444BK 1986 + SB115.99 ea.
- 1-piece rear main seal, passenger side dipstick.



AEH-999

Oil Pans

OEM supplier.

- AJ-221 1968-72 SB w/out SHP119.99 ea.
- AEH-999 1968-72 All BB.....169.99 ea.



APC-744

Oil Pan Clip

Correct clip for retaining positive battery cable routing to solenoid.

APC-744 All SB-BB..... 5.95 ea.



BPO-1988

Oil Drain Bolt/Washer

Original GM.

BPO-1988 All SB/BB..... 6.95 ea.



ACP-1SB

Oil Pan Gasket Set

Correct OEM gaskets.

ACP-1SB All SB..... 19.95 ea.

ACP-2BB All BB..... 16.95 ea.



BOP-2002

Oil Pan Attaching OEM Bolt Kit

Correct "L" head marked bolts for attaching pan to block.

BOP-2001 All SB (18 pc.)..... 9.95 ea.

BOP-2002 All BB (24 pc.)..... 26.99 ea.



AJ-4

Oil Pan Baffle / Windage Tray

Often installed on most High Performance cars, this "windage tray" was used to keep oil from splashing the crankshaft. A MUST!

AJ-4 Small Block..... 44.99 ea.

AJ-6 Big Block..... 29.99 ea.



NFX-25

Oil Canister - Filter

OE style reproduction of early canister style filter.

NFX-25 PF-25 AC Filter "White"..... 26.99 ea.



N-137

N-133

N-142

Oil Pressure Fittings

N-137 1968+ All SB..... 7.99 ea.

N-133 All BB w/o SHP..... 18.99 ea.

N-142 All BB w/ SHP..... 24.99 ea.

N-A6474 Back of Gauge Fitting..... 6.95 ea.



GAC-310

GAC-110

Oil Pressure Switches

Correct GM switches.

GAC-310 1969 w/ Gauges..... 39.99 ea.

GAC-110 1970-72 w/ Gauges..... 11.95 ea.

GAC-110 1964-72 w/o Gauges..... 11.95 ea.



HOC-28

Oil Canister Decal

HOC-28 1962-67..... 9.99 ea.



N-1131

CHQ-3200

Oil Pressure Lines

Correct material lines with correct fittings for all cars with gauges.

N-1131 1964-67 (Steel Coiled)..... 33.95 ea.

CHQ-3200 1968+ (Black Plastic)..... 10.99 ea.



GCS-S4994BA

Chrome Dipsticks and Tubes

Show quality dipsticks are an excellent upgrade to any engine compartment. Includes dipstick & tube.

GCS-S9422 Powerglide..... 15.99 ea.

GCS-S9421 TH350..... 15.99 ea.

GCS-S9421BA TH350 Billet Handle..... 24.99 ea.

GCS-S4994 TH350 34"..... 16.99 ea.

GCS-S4994BA TH350 34" Billet Handle..... 19.99 ea.

GCS-S4995 TH400 24"..... 13.99 ea.

GCS-S4995BA TH400 24" Billet Handle..... 17.99 ea.



ATE-1576 Detail

ATE-1567 Detail

ATE-1576

Oil Dipstick Kits

Complete with tube and gauge (stick)

ATE-1567 1968-79 SB (Green Dot)..... 33.99 ea.

ATE-1576 1965-72 BB (Yellow Dot)..... 49.99 ea.



GCS-S5005

Chrome Dipsticks w/ Braided Tubes

Stainless steel braided tube with chrome handle.

Bellhousing Mount

GCS-S5004 TH350..... 45.99 ea.

GCS-S5005 TH400..... 45.99 ea.

GCS-S5006 TH700-R4..... 45.99 ea.

Firewall Mount

GCS-S5104 TH350/TH400 29"..... 52.99 ea.

GCS-S5106 TH700-R4..... 52.99 ea.



GCS-S5002

Billet Engine Dipstick with Braided Tube

Show quality billet aluminum dipstick with braided tube.

GCS-S5002 1968-79 SB..... 38.99 ea.

GCS-S5001 1980-95 SB..... 38.99 ea.

GCS-S5003 1968-90 BB..... 44.99 ea.

Note: Oil level varies depending on the oil pan used. You may need to mark the dipstick with your own new full level mark.



GCS-S6060

Billet Aluminum Engine Dipstick

Show quality dipstick with billet handle. 11.5" length.

GCS-S6060 Billet Handle..... 0.99 ea.

Note: Oil level varies depending on the oil pan used. You may need to mark the dipstick with your own new full level mark.



GCS-S4957



GCS-S4957BA

Chrome/Billet Dipsticks & Tubes

Show quality dipsticks with matching tubes. A great upgrade to any engine compartment!

GCS-S4957 1968-79 SB, Chrome, 19"..... 7.99 ea.

GCS-S4957BA 1968-79 SB, Billet, 19"..... 13.99 ea.

GCS-S9420 1980-82 SB, Chrome, 23"..... 9.99 ea.

GCS-S9420BA 1980-82 SB, Billet, 23"..... 15.99 ea.

GCS-S9231 1983-85 SB, Chrome, 24.5"..... 11.99 ea.

GCS-S9231BA 1983-85 SB, Billet, 24.5"..... 13.99 ea.

GCS-S4958 1968-90 BB, Chrome, 21"..... 10.99 ea.

GCS-S4958BA 1968-90 BB, Billet, 21"..... 12.99 ea.

Note: Oil level varies depending on the oil pan used. You may need to mark the dipstick with your own new full level mark.

Holley



HOL-302-2

Holley LS Swap Oil Pan

GM's popular LS engines are finding their way into a large variety of vehicles. They make great power, plus they're very durable and reliable. Unfortunately, the factory LS pans don't always fit or they hang too low for today's hot rods. Holley's new LS Retro-fit Engine Oil Pan is designed to help! It provides maximum clearance to the chassis and ground, plus provides an OEM fitment for durability and proper sealing.

- Provides OEM fitment- OEM oil filter mounting, OEM oil cooler port provision, OEM engine NVH suppression, OEM flange gasket and sealing, proper structural rigidity and OEM bellhousing attachments.
- Traditional high-quality cast aluminum appearance with clean exterior styling.
- Provides maximum clearance to chassis.
- Cast and machined aluminum.
- Complete kit including sump baffle, pick-up tube, sump plug, oil filter stud & oil passage cover.
- Fits GM rear wheel drive applications that were originally equipped with a Small Block or Big Block Chevy engine and traditional rear sump oil pan*.

HOL-302-2 1968-74 All436.99 ea.
Maximum crankshaft stroke = 4.25"

*Engine location may need to be adjusted (up / down or fore / aft) for cross member or steering linkage clearance depending on the vehicle, steering configuration and chassis type.

No Volume Discount.



AMX-96



Motor Mounts OE

These new motor mounts are from GM's original supplier! MADE IN USA!!!

ART-2289 1968-74 SB Except 1969-74 35039.99 pr.
AMX-96 1969-74 350, BB69.95 pr.



3-1117G

3-1116G

Poly Motor Mounts

Energy Suspension motor mounts can take the abuse of today's high performance engines. Poly bushings can last longer than stock rubber mounts while handling more power. Add G to the part number for black. Add R to the part number for red.

Example: 3-4114G is for 68-72 black.
3-1114_ 1968-72 SB 2-5/8" x 3/4" H.....50.99 ea.
3-1117_ 1969-72 BB 2-3/8" x 1-3/16" H.....55.99 ea.
3-1116_ 1973-79*34.99 ea.
Two mounts required per car. *You must reuse your original clamshells on the 1973-79 applications by drilling out the rivets and replacing the rubber insert with the new poly mount.



AEM-67FS

Engine Mounting Kits

These convenient engine mounting kits make it easy to convert from a 6 cylinder engine to a small block or from a small block to a big block. Each kit includes motor mounts, frame brackets, attaching bolts, thru-bolts and frame bracket bolts.

AEM-67FS 1968-74 SB exc 1969-74 35095.28 kit
AEM-67FB 1968 All BB119.58 kit
AEM-69FZO 1969-74 350 OEM.....137.48 kit
AEM-69FBO 1969-74 All BB OEM.....146.51 kit

1973-74 may require some frame drilling.



ENG-67FS-G

Poly Engine Mount Kits

Same as our OE style engine mount kits with upgraded Energy Suspension Poly motor mounts. The poly mounts can take the abuse of today's high performance engines, yet still absorb drive-line vibrations. They are available in Poly Graphite black or red.

ENG-67FS-G 1968-74 SB 307-327 Black151.07 kit
ENG-67FS-R 1969-74 SB 307-327 Red.....151.07 kit
ENG-69FZO-G 1968-74 SB 350 Black175.30 kit
ENG-69FZO-R 1968-74 SB 350 Red175.30 kit
ENG-67FB-G 1968 BB 396-454 Black.....175.37 kit
ENG-67FB-R 1968 BB 396-454 Red.....175.37 kit
ENG-69FBO-G 1969-74 BB 396-454 Black184.34 kit
ENG-69FBO-R 1969-74 BB 396-454 Red.....184.34 kit
No Volume Discount.

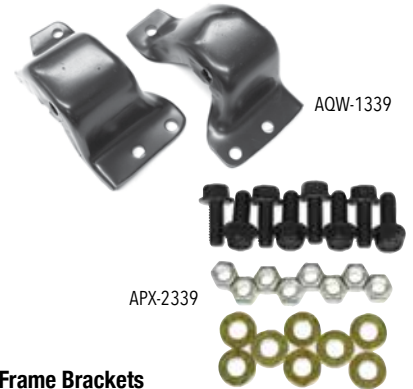

AQW-1339

APX-2339

Frame Brackets

OE style reproduction of the long discontinued GM brackets for mounting the engine to frame of car. Sold in matched pairs.

AFM-23 1962-67 SB.....79.99 kit
AQW-1339 1968-74 SB exc 1969-74 35039.99 pr.
ATE-5978 1968 BB.....66.99 pr.
AR-397 1969-74 35059.95 pr.
ACE-9412 1969-74 BB69.99 pr.

Frame Bracket Attaching Bolt Kit

Correct OEM bolts, washers and locking nuts as original.

APX-2339 1964-72 All V86.95 kit



BJ-998

Motor Mount Attaching Bolt Kit

Correct style bolts for attaching mount to block.

BJ-998 All (12 pc).....8.95 kit



ATW-2853

Motor Mount Clip

Correct clip for attaching positive cable to right side motor mount.

ATW-2853 Most V819.95 ea.

APB-7057

Motor Mount "Thru" Bolt Kit

Correct OEM bolts for retaining mount to frame bracket. Comes complete with special high strength washers and cadmium plated locking nuts as original.

APB-9057 4.5"9.99 kit
APB-7057 3.5"6.95 kit

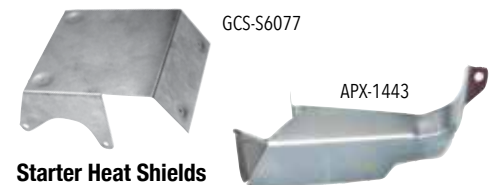

GCS-S6077

APX-1443

Starter Heat Shields

APX-1443 All BB Correct OE Style26.99 ea.
GCS-S6077 Satin Aluminum Universal20.99 ea.

Note: May require some custom fitting. May not clear larger starters.

TUF-6550B



Tuff Stuff Gear Reduction Starters

These gear reduction starters have less draw than traditional replacement starters and crank over engines with higher compression. These starters will work on both Small Block/Big Block Engines using 153 or 168 tooth flywheels. Check your flywheel tooth count before ordering.

TUF-6550B	1.6 H.P., 11:1 Comp, White Zinc.....	154.99 ea.
TUF-6550A	1.6 H.P., 11:1 Comp, Chrome.....	197.99 ea.
TUF-6584B	1.9 H.P., 12:1 Comp, Black.....	150.99 ea.
TUF-6772B	2.6 H.P., 18:1 Comp, Black.....	191.99 ea.
TUF-3193NB	3 H.P., 18:1 Comp, White Zinc.....	189.99 ea.
TUF-3510A	1.9 H.P., 18:1 Comp, Chrome*.....	180.99 ea.
TUF-3510B	1.9 H.P., 18:1 Comp, Black*.....	134.99 ea.

*Offset mounting bolts, 168 tooth flywheel only.



ASM-10A



Starter Motor

We carry original AC Delco USA remanufactured starter motors complete with warranty. No core charge.

ASM-10A	1964-72 SB Auto.....	113.99 ea.
ASM-10M	1964-72 SB Manual.....	113.95 ea.
ASM-20A	1965-72 BB Auto.....	99.99 ea.
ASM-20M	1965-72 BB Manual.....	102.99 ea.

No Volume Discount.

BV-2070



BV-2072



BV-2074



Starter Motor Bolts OEM

Correct "Knurled" bolts for attaching starter motor to block.

BV-2070	SB 3/8-16 x 1-7/8" (short).....	5.99 ea.
BV-2072	BB 3/8-16 x 3-5/8" (long).....	4.99 ea.
BV-2074	3/8-16 x 4-11/16" (x-long).....	6.99 ea.

ATE-4353



Starter Motor Brace

Correct brace for attaching starter to block.

ATE-4353	1964-72 SB w/o 350.....	11.95 ea.
ATW-2516	1964-72 SB 350.....	8.95 ea.
ABB-9655	1964-72 All BB.....	12.99 ea.
APO-516	Attaching Screw.....	0.50 ea.



FPC6975

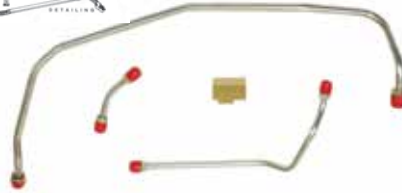

Holley Pump To Carb Lines - Original

Correct reproductions of the original Holley fuel pump to carb lines complete with lines and fuel blocks. These lines are for factory Holleys with 5/16" inlet nuts. These lines will only work on stock engines.

	OM	SS
FPC6775	1968 396/375 HP.....	57.99 ea. 69.99 ea.
FPC6975	1969 396/375 HP.....	57.99 ea. 69.99 ea.
PCY03	5/16" Inlets, 9-3/8" Center to Center.....	36.99 ea. 42.99 ea.

Add "SS" to end of part number when ordering stainless.



PCY02

BPS-7432

PCY01

PCY04

Fuel Pump to Carburetor Parts

Correct Y blocks and T blocks for your dual feed Holley carburetor.

PCY01	Y Block w/o Bracket, Brass.....	21.99 ea.
PCY02	Y Block w/ Bracket, Brass.....	33.99 ea.
BPS-7432	Stud for PCY02.....	5.99 ea.
RSBB06	Y Block w/ 3/8" Ports, Used for PCY05.....	28.99 ea.



8 5/8"

PCY05

Holley Pump To Carb Lines - Replacement

Now you can add a new Holley dual feed carburetor without having to change the 3/8" inlet nuts! This new kit comes complete with pre-bent lines and a new 3/8" brass Y block.

	OM	SS
PCY05	3/8" inlets, 8-5/8" Center to Center.....	36.99 ea. 42.99 ea.
PCY07	3/8" inlets, 9-3/8" Center to Center.....	36.99 ea. 42.99 ea.



AHL-516



AHL-38

Carburetor Inlet Fittings

Correct inlet nuts with washers.

AHL-516	5/16" (Stock GM).....	15.99 ea.
AHL-38	3/8".....	15.99 ea.

AAC-455



AAC-427



Fuel Filters

Original GM AC Delco

AAC-427	Q-Jet Short Style.....	4.95 ea.
AAC-455	All Holley Brass.....	5.99 ea.

BUY'N SAVE WITH KITS



GF-432K

GF-432 Fuel Filter & Bracket

This is an OE style reproduction of the original GF-432 fuel filter and bracket for use with 3 piece fuel line. Buy the kit and save!

GF-432K	1969 GF-432 Complete.....	63.88 kit
AAC-432	1969 GF-432 Filter.....	52.99 ea.
AFB-234	1969 GF-432 Bracket.....	17.99 ea.

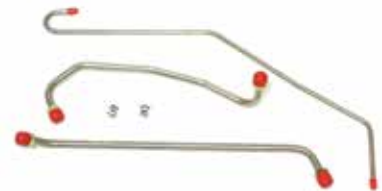

1969 Nova 350 & 396

3 Piece Line Sets

These unique lines are for use with cars equipped with the GF-432 canister filter and bracket.

	OM	SS
FPC6905	1969 350.....	35.99 ea. 47.99 ea.
FPC6903	1969 396/325.....	35.99 ea. 47.99 ea.
FPC6903	1969 396/350.....	35.99 ea. 47.99 ea.



ACDelco

AFP-1021

Fuel Pump

Original replacement fuel pumps. Brand new AC-Delco units "gold anodized" as original.

AFP-1116	1964-68 327, 350 5/16"	69.95 ea.
AFP-1021	1968-72 All SB 3/8"	49.99 ea.
AFP-1121	1967-72 All BB 3/8"	49.99 ea.
AFP-1124	1968-72 All BB w/ Return	59.99 ea.

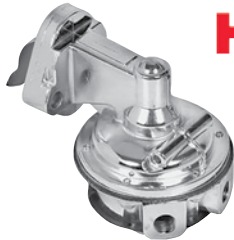

Holley

HOL-12834

Holley Chrome Fuel Pumps

Mechanical pumps designed to work with stock or mildly modified engines. Free-flow output of 80 GPH (SB) or 80-130 GPH (BB). Body castings can be rotated 360-degrees to ease mounting in difficult places. Heavy duty construction can withstand long periods at high RPM. 1/4" (SB) 3/8" (BB) pipe thread inlet and outlet ports.

HOL-12834	Small Block.....	116.99 ea.
HOL-12835	Big Block.....	116.99 ea.

Note: Not compatible with methanol or alcohol. Cannot be used with fuel injection systems.



QUICK FUEL TECHNOLOGY

QF-30-350QFT

Quick Fuel Technology Fuel Pumps

For the street cruiser, it's tough to beat the simplicity and reliability of a mechanical fuel pump. Quick Fuel Technology's mechanical pumps flow 110 gallons per hour and utilize lightweight aluminum housings. They feature integrated shutoff valves that are preset at 6.5- to 8 psi, eliminating the need for a separate pressure regulator. For added installation flexibility, the pump casting can be rotated to accommodate various plumbing configurations. 3/8" NPT threads. Gasoline only.

QF-30-350QFT	Small Block	127.99 ea.
QF-30-450QFT	Big Block	138.99 ea.

No Volume Discount.



QF-30-125-1QFT



Quick Fuel Technology Electric Fuel Pumps

QFT's electric fuel pumps are perfect for combinations that are neither stock nor all out race cars. These pumps flow more than enough fuel to support between 400-750 hp. Mounting hardware and brackets are included.

- 125 GPH Flow Rate
- 14 PSI Maximum Pressure
- Features 3/8" NPT Inlets and Outlets
- Draws 4 Amps or Less at Full Load
- For Carbureted Gasoline Applications Only

QF-30-125-1QFT	Pump Only	146.99 ea.
QF-30-125-1RQFT	Pump/Regulator.....	166.99 ea.

No Volume Discount.

Holley



HOL-12-426

Holley Electric Fuel Pumps

Holley is proud to introduce the all new Holley Mighty Mite™ electric fuel pumps! They're big on performance, but small in size! They're quiet, easy to install and work with gas, diesel, blended alcohol and E85!

12 volt operation, .25 gal/hr flow, Good for up to 300HP naturally aspirated, Simple 2 wire hookup, Self-priming and regulating, Quiet operation - 65db, Hose barbs Fit 5/16" Fuel Hose, Made in the USA

HOL-12-426	All 25 GPH 1.5-4 PSI.....	62.99 ea.
HOL-12-427	All 32 GPH 4-7 PSI	62.99 ea.

No Volume Discount.

Holley



HOL-12-803BP

Holley Fuel Pressure Regulator

Holley fuel pressure regulators are designed to precisely control the fuel pressure from the fuel pump to the carburetor. Too much fuel pressure for a given needle and seat assembly will overload and may cause flooding or drivability problems. Each Holley fuel pressure regulator is fully adjustable so regulating the fuel pressure to your engine's needs is simple.

12 volt operation, Preset to 7psi, 3/8" NPT ports (1 in, 1 out, 1 bypass or return), Used in systems with a return line back to the fuel tank

HOL-12-803BP	All Carbureted.....	109.99 ea.
--------------	---------------------	------------

No Volume Discount.



GCS-S4297 GCS-S9245 GCS-S9407 GCS-S9177

Chrome Inline Fuel Filters

Choose from a variety of show quality chrome fuel filters to dress up your engine.

Carburetor

GCS-S9407	Bronze Element, 3/8", Chrome	14.99 ea.
GCS-S9177	Paper Element, 3/8", Chrome.....	9.99 ea.
GCS-S9177BK	Paper Element, 3/8", Black	10.99 kit
GCS-S9245	Glass Element, 3/8", Chrome.....	13.99 ea.

Red Top High Capacity Chrome Fuel Filters

Show quality chrome plated fuel filter with paper element and pipe fittings.

GCS-S4297	Small.....	39.99 ea.
GCS-S4295	Large	42.99 ea.



AJE-395

ACE-4867

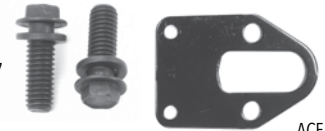

ACE-9599

Fuel Pump Hardware

AJE-395	All Activating Rod	15.99 ea.
ACE-9599	All SB Plate	10.99 ea.
ACE-4867	Fuel Pump Bolts.....	6.99 kit



AXP-3800

AXP-6400

Fuel Pump Hose Kit

Correct GM hose for connecting fuel pump to main fuel line. Complete with correct "colored" pinch clamps.

AXP-3800	All 3/8" 3pc	4.95 kit
AXP-1438	All 3/8"-1/4" 6pc	7.99 kit
AXP-6400	All 3/8" 90 Degree Bend.....	11.95 kit



AFT-238

Fuel Line Brace

Correct factory installed brace for carb line.

AFT-238	1970 L-78, LS-6	15.95 ea.
---------	-----------------------	-----------

THE RIGHT Stuff



Fuel Pump to Carburetor Lines

Correct reproductions of the original fuel lines that run from the fuel pump to the carburetor. Each is CNC bent using original factory blueprints. All lines are available in original steel material (OM) or state of the art, show quality stainless steel (SS). All lines are made right here in the USA. These lines will only work on stock engines.

	OM	SS
XPC6301	1963-65 6 Cylinder.....	19.99 ea..... 25.99 ea.
BPC6202	1965 327/300 L74 (2pc).....	24.99 ea..... 36.99 ea.
BPC6602	1966 283 2 BBL.....	21.99 ea..... 29.99 ea.
BPC6604	327/275 Carter (enters rear).....	21.99 ea..... 29.99 ea.
FPC6702	1967 327/210, 2 BBL. Pre-4/1/67.....	21.99 ea..... 29.99 ea.
FPC6701	1967-68 6 Cylinder.....	21.99 ea..... 29.99 ea.
FPC6703	1967-68 327/210, 2 BBL, After 4/1/67.....	21.99 ea..... 29.99 ea.
FPC6705	1967-68 327/275 & 350/295 4 BBL, 5/16.....	21.99 ea..... 29.99 ea.
FPC6707	1967-68 327/275 & 350/295 3/8.....	21.99 ea..... 29.99 ea.
FPC6709	1967-68 396/325 or 396/350.....	21.99 ea..... 29.99 ea.
FPC6775	1968 396/375, Holley, 3 Lines & Block.....	57.99 ea..... 69.99 ea.
XPC6801	1968-70 6 Cylinder, 1 BBL.....	19.99 ea..... 25.99 ea.
XPC6904	1968-70 4 Cylinder.....	19.99 ea..... 25.99 ea.
FPC6901	1969 350 2 BBL, 3/8.....	21.99 ea..... 29.99 ea.
FPC6902	1969 307 & 327 2 BBL, 5/16.....	21.99 ea..... 29.99 ea.
FPC6903	1969 396 Q-Jet (3pc).....	35.99 ea..... 47.99 ea.
FPC6905	1969 350 4 BBL Q-Jet.....	35.99 ea..... 47.99 ea.
FPC6975	1969 396/375 Holley w/Y Block.....	57.99 ea..... 69.99 ea.
CPC7007	1970 396/375.....	71.99 ea..... 83.99 ea.
FPC7001	1970-72 350/300.....	21.99 ea..... 29.99 ea.
CPC7101	1971-72 402 4 BBL.....	21.99 ea..... 29.99 ea.
CPC7102	1971-72 350/270 4 BBL.....	21.99 ea..... 29.99 ea.
XPC7206	1972 250 6 Cylinder.....	19.99 ea..... 25.99 ea.
XPC7208	1972 350 4 BBL Q-Jet.....	19.99 ea..... 25.99 ea.
FPC7502	1975 350 4 BBL.....	21.99 ea..... 29.99 ea.

Add "SS" to end of part number when ordering stainless.



AWS-6

Wiper Motor Seals

Correct foam rubber seal for firewall.

AWS-6	1963-67 1 Speed.....	4.95 ea.
AWS-7	1963-67.....	6.99 ea.
AWS-792	1968-72.....	6.99 ea.



AWA-086

Wiper Motor Arms with Ball Studs

These are the correct arms with studs that attach to the motor itself.

AWA-086	1968-74 All.....	15.99 ea.
---------	------------------	-----------



APW-2401

Wiper Motor Mounting Kit

Correct steel rubber grommets & screws for mounting motor to firewall.

APW-2401	1963-79 All.....	11.99 kit
AWS-2002	1963-79 All Screws Only.....	6.99 set



AWM-83T



AWM-84T



AWM-8242

Windshield Wiper Motors

Original AC Delco remanufactured units built with original cores.

AWM-83T	1967 2 Speed 3 Terminal.....	149.95 ea.
AWM-84T	1967 2 Speed 4 Terminal.....	159.99 ea.
AWM-8242	1968-79 All.....	149.99 ea.

No Volume Discount.



LWA-1702T



LWT-6872X

Wiper Transmission Arm

Exact reproduction arm which connects wiper motor to wipers.

LWA-1702T	1963	119.95 ea.
LWA-1702U	1964	119.95 ea.
LWT-6872X	1968-72*	114.99 ea.
AWS-1001	1963-79 Mounting Screws Only	7.99 set
FMP-CLIP	1964-79 Clip	4.99 ea.

*The wiper motor arm AWA-086 is not included and must be purchased separately.



AWP-6488



AWP-6971

Washer Pumps

AC Delco replacement washer pumps will fit and function as original.

AWP-6971	1968-72 w/o Hidden	79.99 ea.
AWP-6971WN	1968-72 w/o Hidden White Nozzle	74.99 ea.
AWP-6488	1967-74 Single Speed Cover Only	14.99 ea.

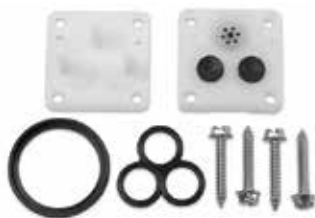

AHL-5400

Washer Pump Repair Kit

Correct white plastic nozzle, rubber seals and screws to repair your original washer pump.

AHL-5400	1968-74	11.99 ea.
----------	---------	-------	-----------



AWN-2223

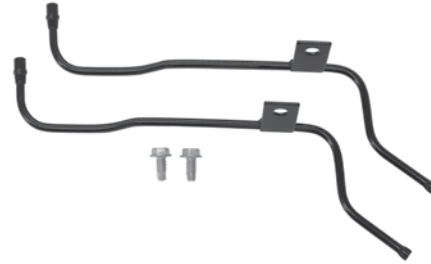

AWN-2224

Washer Nozzles

OE style reproduction washer nozzles complete with correct mounting screws.

AWN-2223	1962-67 All	36.99 pr.
AWN-2224	1968-74 All	31.99 pr.
AWJ-10M	Screws	0.95 pr.

AWJ-0083



AWJ-0892



AWJ-7038



Washer Jars

Correct white plastic washer jars.

AWJ-0083	1962-70 All	6.99 ea.
AWJ-0083-CAP	1962-70 1st Design w/ Cap	12.70 kit
AWJ-0892	1971-74 All	16.95 ea.
AWJ-0892K	1971-74 w/ Cap	22.41 kit
AWJ-7038	1975-79 All	22.95 ea.
AWJ-10M	1971-74 Screws	0.95 pr.
1962-70 uses bracket. 1971-74 screws to fender.			



APX-9738

Washer Cap Kit

Correct GM cap, ribbed hose and pick up screen.

APX-9738	All Cap Kit	7.95 kit
AWJ-8372	Cap Only	4.95 ea.
AWJ-100	Screen Only	2.95 ea.



AWB-6267



AVB-591



AWB-8939

Washer Jar Bracket

Correct bracket for mounting jar to fender.

AWB-6267	1962-67 All	19.99 ea.
AWB-8939	1968-70 All	11.99 ea.
AVB-591	Screws	0.95 pr.



APH-1132

Washer Hose Kit

Correct GM ribbed thin walled style washer hose in pre cut lengths (7/32" - 11/32") diameter. This kit does one car, including hose for the washer jar.

APH-1132	1962-79 All	11.95 kit
----------	-------------	-------	-----------





R89-TOP



R59-TOP

Battery Toppers

This new plastic injection molded cover will give your modern battery the look and feel of an original! This topper works with Group 24-60 sized batteries only. Inside size = 6-7/8" x 10-3/8".

R59-TOP	1967-74 R-59	54.99 ea.
R89-TOP	1969-74 R-89 Side	54.99 ea.



ASR-62XSB

Spring Ring Cables

OE style reproduction of the original factory installed spring type cables sold as a matched pair with GM numbers.

ASR-62XSB	1962-67 SB.....	89.95 pr.
ASR-68XSB	1968-74 SB.....	89.95 pr.
ASR-68XBB	1968-74 BB	89.95 pr.



AST-1001

Side Terminal Battery Cables

Correct cables for cars with the heavy duty R-89 batteries with correct GM part numbers.

AST-1001	1970-74 HD.....	124.99 kit
----------	-----------------	------------



500723

Trunk Mounted Battery Cable Kit Top Post

This is a true 1 gauge battery cable kit. Overall cable length of 18 feet, and the negative cable includes a 36 inch 10 gauge secondary lead. Complete with terminal lugs, crimp tool and shrink tubing.

500723	All w/ Top Post	189.99 ea.
--------	-----------------------	------------

No volume discount.



GCS-S6323



GCS-S6325

Billet Aluminum Battery Trays

Secure your battery in style! Fits Optima batteries.

GCS-S6323	Optima Group 34/78 Top/Side Post ...	91.99 kit
GCS-S6324	Optima Group 35 Top Post.....	73.99 kit
GCS-S6325	Optima Group 75/25 Top/Side Post....	83.99 kit

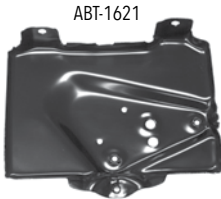

ABT-1621



ABT-1620



ABT-7579

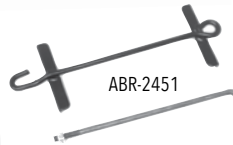

ABR-2451



ABR-9533

Battery Trays

OE style reproduction EDP coated battery trays.

ABT-1620	1962-67	22.99 ea.
ABT-1621	1968-74	18.99 ea.
ABT-1621K	1968-74.....	19.53 kit
ABT-7579	1975-79	22.99 ea.

Battery Retainer Kits

Complete battery retainer kits with all correct hardware.

ABR-2451	1962-67	16.99 kit
ABR-9533	1968-72	3.99 kit



GCS-S9323

Universal Stainless Battery Tray

This polished stainless steel tray will secure your battery in style! Fits batteries measuring 7.5" L x 13.25" W x 9.25" tall.

GCS-S9323	Battery Tray	43.99 kit
-----------	--------------------	-----------



GRC-12834



GRC-12835

Radio Capacitor

Came from the factory on all cars with radio. Correct length lead wire & brass connector. Stamped 1964452 "DR" & "3MF" as original.

GRC-12834	1964-71 3MF.....	39.99 ea.
GRC-12835	1970-74 5MF.....	39.99 ea.



GAC-515



GAC-515GM

Voltage Regulator

New correct GM replacement.

GAC-515	1968-74 All D635.....	84.99 ea.
GAC-515GM	1968-74 OE Style Reproduction.....	94.99 ea.
AVX-515	1968-74 Screws (2)	0.95 kit
AWX-818	1968-74 Mounting Kit	6.95 kit



GQH-118

Electric Junction Block

Original GM junction block for attaching positive lead from battery to main harness. Mounts to radiator support. Includes correct nut.

GQH-118	All	9.95 ea.
---------	-----------	----------



Temp Sending Units

Correct screw-in sending units.

- GAC-250 1964-72 without Gauges..... 19.99 ea.
- GAC-560 1964-72 with Gauges*..... 16.95 ea.
- GAC-760 1969-70 with Gauges..... 34.99 ea.
- GAC-660 1970-72 TCS Sender..... 18.95 ea.

*can be used with CPX-999 harness.



Temperature Sending Unit Harness

Pre-cut wire section with correct clip and cloth insulator.

- CPX-999 1964-72 w/ Gauges* 12.95 ea.

*for use with GAC-560 sender.



Engine Compartment Retaining Hooks

Pre-bent hooks for various wires, cables and hoses.

- BCE-9738 Large Rubber Coated 4.99 ea.
- APC-744 Small Hook (oil pan, etc.)..... 5.95 ea.
- AHB-1X Heater Box Wire Clip..... 5.99 ea.

Harness Retaining Clips

Correct retaining clips for harness.

- AHC-1 Clip Style #1 4.95 ea.
- AHC-2 Clip Style #2 4.95 ea.



Electrical Harness Tape

Correct non-stick factory style tape. Over 100 feet.

- GDT-0330 All..... 11.95 ea.



Harness Retaining Straps

Correct push-in style plastic retainers.

- BPX-2350 All..... 3.95 pr.



Marking Crayons

Original crayons used to mark the frame and firewall. Includes (1) yellow crayon and (1) white crayon.

- ACY-100 All..... 5.99 kit



Marking Crayons

These paint sticks are used for final detailing to replicate the marks left on the frame, body and other parts of the car. Just like when it came down the assembly line!

- ACY-KIT All 12pc..... 34.99 kit



Horn Relay

New reproduction of the original GM Delco style relay.

- GAC-723 1966-71..... 52.95 ea.
- GAC-775 1972-73..... 56.99 ea.
- AVN-506 Mounting Screw..... 0.95 ea.



Horns

Reproduction Delco Remy horns correct for most Novas. These horns feature the correct high and low notes. Brackets included.

- ADR-3-GM 1962-79 Universal Horn Set..... 139.99 kit
- ADR-3H 1964-72 Replacement*..... 159.99 kit
- ADR-3-CHROME 1964-72 Repro Chrome..... 159.99 pr.

*Brackets may require some modification.



Harness Wire Ties

Original GM wire ties used on various hoses, cables and harnesses.

- BJN-300 Short..... 3.99 ea.

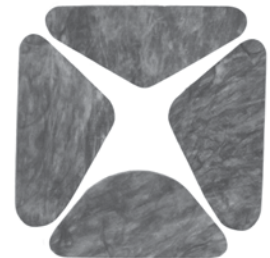

Hood Insulation

Correct die stamped OEM material for insulating the underside of the hood. A MUST for final detailing!

- NV-601 1962-65..... 26.99 ea.
- NV-602 1966-67..... 26.99 ea.
- NV-603 1968-74..... 26.99 ea.
- NV-604 1975-79..... 24.99 ea.



Underhood Lamp

Complete with bracket, hardware, harness and built-in switch.

- AMH-15 1968-74 All..... 52.99 kit

AMK inc PRODUCTS



Master Body Kit

Master body kits contain just about every piece of hardware to assemble the body of your Nova. Each kit contains hardware for your battery tray, bumpers, filler panel, filler panel moldings, bumper brackets, cowl vent panel, door latches, emblems, fender braces, fenders, front tie bar, grille, grille brackets, grille moldings, headlamps, headlamps bezels, hood, hood hinges, hood latch, hood latch support, license plate, mirrors, parking lamps, tail lamps, trunk latch, trunk lid hinges, wheel opening moldings, wheel houses, radiator support and more! This kit truly has it all!

64NB	1964 Nova All 376 pc	189.99 kit
65NB	1965 Nova All 383 pc	179.99 kit
66NB	1966 Nova All 383 pc	169.99 kit
67NB	1967 Nova All 384 pc	174.99 kit
68NB	1968 Nova All 322 pc	199.99 kit
69NB	1969 Nova All 327 pc	219.99 kit
70NB	1970 Nova All 317pc	199.99 kit
71NB	1971-72 Nova All 314 pc.....	199.99 kit

Master Chassis Kit

Typical kit includes fasteners to attach:

accelerator lever & support, axle housing springs, axle retainer plates, brake booster & hose, brake cables, brake plates, brake hose retainers & brackets, brake valve & pressure switch, calipers & brackets & shields, upper & lower control arms, control arm bushings, differential cover, driveshaft, engine mounts, fuel filler neck cover, fuel hoses, gas tank, grease fittings, idler arm, leaf spring hangers & front eye, master cylinder & push rod, parking brake control, pitman arm, radius rod & bracket & bumper, shackles (nuts), shocks & brackets, stabilizer bar brackets and end links (includes rubber), steering gear & rag joint, steering linkage & ball joints, speedometer cable trans, suspension bumper, transmission crossmember & insulator, wheel cylinders.

64NS-SB	1964-65 SB Drum Brakes Mono Leaf (448 pc.)	299.99 kit
66NS-SB	1966 SB Drum Brakes Mono Leaf (443 pc.)	299.99 kit
67NS-DRSB	1967 SB Drum Brakes Mono Leaf (449 pc.)	319.99 kit
67NS-DCSB	1967 SB Disc Brakes Mono Leaf (454 pc.)	319.99 kit
68NS-DRSB1	1968 SB Drum Brakes Mono Leaf (338 pc.)	299.99 kit
68NS-DRSB4	1968 SB Drum Brakes Multi Leaf (338 pc.)	319.99 kit
68NS-DCSB1	1968 SB Disc Brakes Mono Leaf (345 pc.)	319.99 kit
68NS-DCSB4	1968 SB Disc Brakes Multi Leaf (343 pc.)	329.99 kit
68NS-BB	1968 BB Disc Brakes Multi Leaf (344 pc.)	319.99 kit
69NS-DRSB1	1969 SB Drum Brakes Mono Leaf (348 pc.)	299.99 kit
69NS-DRSB4	1969 SB Drum Brakes Multi Leaf (352 pc.)	329.99 kit
69NS-DCSB1	1969 SB Disc Brakes Mono Leaf (345 pc.)	319.99 kit
69NS-DCSB4	1969 SB Disc Brakes Multi Leaf (351 pc.)	349.99 kit
69NS-BB	1969 BB Disc Brakes Multi Leaf (352 pc.)	389.99 kit
70NS-DRSB1	1970 SB Drum Brakes Mono Leaf (346 pc.)	299.99 kit
70NS-DRSB4	1970 SB Drum Brakes Multi Leaf (350 pc.)	329.99 kit
70NS-DCSB1	1970 SB Disc Brakes Mono Leaf (344 pc.)	319.99 kit
70NS-DCSB4	1970 SB Disc Brakes Multi Leaf (374 pc.)	369.99 kit
70NS-BB	1970 BB Disc Brakes Multi Leaf (375 pc.)	359.99 kit
71NS-DRSB1	1971-72 SB Drum Brakes Mono Leaf (353 pc.)	299.99 kit
71NS-DRSB4	1971-72 SB Drum Brakes Multi Leaf (349 pc.)	319.99 kit
71NS-DCSB1	1971-72 SB Disc Brakes Mono Leaf (356 pc.)	319.99 kit
71NS-DCSB4	1971-72 SB Disc Brakes Multi Leaf (378 pc.)	344.99 kit

No Volume Discount.



AMK inc
PRODUCTS

AC On Engine Hardware Kits

66AA-SB	1967 SB.....	33.99 kit
68AA-SB	1968 SB.....	29.99 kit
68AA-SSB	1968 SB w/ Smog.....	31.99 kit
69AA-SB	1969 SB.....	42.99 kit
70AA-SB	1970 SB.....	39.99 kit
70AA-BB	1970 BB.....	36.99 kit
71AA-SB	1971 SB.....	36.99 kit
72AA-SB	1972 SB.....	36.99 kit

AC Box Under Dash Hardware Kits

68NA-R	1968 SB.....	32.99 kit
69NA-R	1969 SB.....	39.99 kit
70NA-R	1970 SB.....	39.99 kit
71NA-R	1971 SB.....	39.99 kit
72NA-R	1971 SB.....	36.99 kit

AC Box Under Hood On Firewall Hardware Kits

68NA-F	1968 SB.....	49.99 kit
69NA-F	1969 SB.....	59.99 kit
70NA-F	1970 SB.....	55.99 kit
71NA-F	1971 SB.....	49.99 kit
72NA-F	1971 SB.....	48.99 kit

Master Engine Hardware Kits

64N-SBS	1964-65 SB w/o AC (150 pc.).....	139.99 kit
64N-SBA	1964-65 SB w/ AC (170 pc.).....	139.99 kit
66N-SBS	1966-67 SB w/o AC (153 pc.).....	139.99 kit
66N-SBA	1966-67 SB w/ AC (165 pc.).....	139.99 kit
66N-SBH	1966-67 L-79 (175 pc.).....	139.99 kit
66-SBS	1968 SB w/o AC (152 pc.).....	129.99 kit
66-SBA	1968 SB w/ AC (164 pc.).....	139.99 kit
68-BBS	1968 BB Iron Intake (159 pc.).....	144.99 kit
68-BBH	1968 BB Alum Intake (149 pc.).....	144.99 kit
69-SB	1969 SB (170 pc.).....	134.99 kit
69-BBS	1969 BB Iron Intake (143 pc.).....	139.99 kit
69-BBH	1969 BB Alum Intake (155 pc.).....	149.99 kit
72-SB	1972-73 SB (139 pc.).....	129.99 kit
70-BBH	1970-72 BB Alum Intake (152 pc.).....	139.99 kit

No Volume Discount.



Alternator Fan Nut

ABN-105 All.....4.99 ea.

BRB-938

BN-339

Alternator Lower Attaching Hardware

BRB-938 1969-79 SB Bolt.....4.95 ea.
BN-339 1969-70 BB Stud.....10.99 ea.



Alternator Neg Cable Bolt

AW-506 All.....0.95 ea.



Alternator Spacer Brace

APX-1038 1969-70 BB.....15.95 ea.

AWB-1114



Alternator Upper Adjustment Kit

Correct WB head marked bolt with washers.
AWB-1114 1962-79 All.....5.99 kit



Battery Retainer Kits

ABR-2451 1962-67 All.....16.99 kit
ABR-9533 1968-74 All.....3.99 kit

ABR-9533

BPB-9021

Bellhouse Attaching Kit

BPB-9021 All (6 pc.).....8.95 kit



BPB-2230

Body Bolt Kit

Correct black flanged head bolts and washers.
BPB-2230 1968-74 All.....26.99 kit



Brake Caliper Bolt

BMP-1000 All 1969-77.....2.99 ea.
2 required per caliper.



Bumper Bracket Hardware

BBF-13 Bolt, Nut, Teeth Washers.....6.99 ea.



Bumper Bolts

Complete bumper bolt kits with nuts.
BPB-716 1962-74 All.....1.95 ea.
BPB-716K 1962-74 Most (8 pc.).....17.99 kit
Many Novas take more than 8 bolts.
Please check your application before ordering.

BCP-373

Caliper Backing Plate Bolt

BCP-373 Plate to Spindle.....20.99 ea.



Carburetor Attaching Kits

BTE-1475 All Q-Jet.....8.95 ea.
BMG-0095 All Holley.....7.99 ea.

DS-594

Control Arm Shims

DS-594 1/16".....2.99 ea.
DS-595 1/8".....2.99 ea.

BPX-8542

Control Arm Upper Washers

Complete kit to do one car.
BPX-8542 1968-74 All.....19.95 kit

BPB-1430

Control Arm Bolt Front Lower

BPB-1430 All.....7.99 ea.



Control Arm to Frame Bolts

4 serrated bolts and 4 locking nuts for one car.
BPX-0918 1968-74 All.....18.99 kit



Crossmember Bolts

BPC-7000 To Frame.....6.95 kit
BTE-7939 To Transmission.....0.95 ea.

BTE-7939



Coil Bracket Screws

BAN-516 Correct SEMS Bolts.....1.95 pr.



Cylinder Head Bolts

NRM-1888 All BB (32 pc.).....79.99 kit



Deluxe Grille Mounting Kits

Complete kits with all of the correct factory hardware to properly mount your grille.

BAG-64X 1964 18pc..... 16.99 kit
 BAG-65X 1965 34pc..... 16.99 kit
 BAG-66X 1966 25pc..... 16.99 kit
 BAG-67X 1967 28pc..... 16.99 kit
 BAG-689X 1968-69 26pc..... 16.99 kit
 BAG-70X 1970-72 24pc..... 16.99 kit



Door Hinge Pin Kits

BPX-1225 1968-79 All..... 16.99 ea.



Door Hinge Bolts

BAV-2622 Phillips..... 1.99 ea.
 BAV-2623 Hex 1.99 ea.
 BAV-2622K Phillips (16 pc.) Hex (18 pc.) 32.95 kit
 BAV-2623K Hex (24 pc.) 29.61 kit



Door Strikers w/ Washer

BPX-1275 GM Replacement..... 12.99 ea.
 BPX-1299 Exact Reproduction*..... 13.99 ea.
 BPX-1275-GSKT Plastic Gaskets 4.99 pr.
 *Correct Allen Head Zinc Plated.



Distributor Hold Down

ACE-1400 Correct retaining hardware for distributor.
 ACE-1400 All..... 13.99 kit



EMS Stainless Hood Adjusters

Eddie Motorsports Nova stainless steel hood adjusters are machined completely from stainless steel. They will not rust or corrode. Sold individually.

MS275-38 Machined..... 38.99 ea.
 MS275-38P Polished..... 39.99 ea.



EMS Stainless Strikers

Replace your plain steel strikers with these attractive Eddie Motorsports Nova stainless steel door striker bolts. These billet striker bolts are cut with a Torx head and fit most Chevy muscle cars.

MS277-20M 1968-79 Machined..... 55.99 pr.
 MS277-20P 1968-79 Polished..... 62.99 pr.



Engine Bracket to Frame Bolt Kit

APX-2339 Brackets to Frame 6.95 kit



Exhaust Manifold Bolts

With correct double circle logos.

APB-1382 All SB w/ Washers (24 pc.) 39.99 kit
 APB-3506 All BB w/ Washers (32 pc.) 26.99 kit
 APB-1821 All BB Flanged (16 pc.) 23.99 kit



Exhaust Stud Kits

ALI-2228 OEM Steel (12 pc.)..... 22.99 kit



Fan Attaching Kits

BPX-2792 All w/ Clutch Studs 6.95 kit
 BPX-2791 All w/ Clutch Bolts 5.95 kit

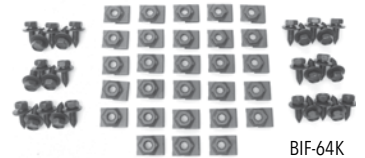

Fender Inner Bolt Kit

BIF-64K All 56 pc..... 29.99 ea.



Fender Front End Bolts

BPA-5160 5/16" Bolt w/o Washer..... 0.69 ea.
 BPA-5161 5/16" Bolt w/ Washer..... 0.59 ea.
 BPA-381 3/8" x 1" Bolt 0.65 ea.
 BPA-385 3/8" x 1-1/2" Bolt..... 0.75 ea.
 BFJ-516 Fender J Clip 5/16"..... 1.99 ea.
 BJF-038 Fender J Clip 3/8"..... 1.50 ea.



Fender Cup Washers

BCW-51 All Zinc 3.99 ea.



BFE-7001

BUY'N SAVE
WITH KITS



Front End Fastener Kit

Over 175 pieces individually bagged!
 Includes everything you need to assemble your front end!

BFE-7001 1962-67 All..... 69.99 kit
 BFE-7002 1968-74 All..... 69.99 kit



BPB-5116

Flywheel Attaching Kit

BPB-5116	All 4 Speed.....	19.99 kit
BPB-5118	All Auto	18.99 kit



BCI-4753

Fuel Tank Attaching Kit

Complete with correct bolts, screws and washers and nuts.

BCI-4753	1968-74 All.....	8.95 kit
----------	------------------	----------



ACE-4867

Fuel Pump Bolts

ACE-4867	All.....	6.99 kit
----------	----------	----------



BAG-D3

Grille Attaching Kits

BAG-D3	1968-74 Basic Kit.....	7.99 kit
BAG-64X	1964 Deluxe 18pc.....	16.99 kit
BAG-65X	1965 Deluxe 34pc.....	16.99 kit
BAG-66X	1966 Deluxe 25pc.....	16.99 kit
BAG-67X	1967 Deluxe 28pc.....	16.99 kit
BAG-68X	1968-72 Deluxe 24pc.....	16.99 kit



BPB-5934

Harmonic Balancer Bolt

BPB-5933	All SB w/ Washer.....	8.99 kit
BPB-5934	All BB w/ Washer.....	12.99 kit



BPO-4011

Hood Adjustment Bolts

BPO-4011	All.....	9.95 kit
----------	----------	----------



BPA-381

Hood Hinge Bolt

BPA-381	3/8" x 1".....	0.65 ea.
---------	----------------	----------



BPX-9873

Idle Arm Bolts

BPX-9873	To Frame	3.95 pr.
----------	----------------	----------



BPI-4400



BPI-9140

BPI-2271

Intake Manifold Kits

Featuring correct flanged head bolts.

BPI-4400	SB "M" (12 pc.).....	16.95 kit
BPI-9140	BB Cast "M" (16 pc.).....	21.95 kit
BPI-2271	BB Alum. "A" (16 pc.).....	28.99 kit

BPS-3679

BPS-7432

Intake Studs

BPS-3679	3/8" x 3/8".....	5.99 ea.
BPS-7432	5/16" x 3/8".....	5.99 ea.



ISK-64A

Interior Screw Kits

These kits offer the most commonly missing or rusted special style interior screws. All screws are individually bagged and labeled to make replacement painless!

ISK-64A	1962-67.....	22.95 kit
ISK-68F	1968-74.....	29.95 kit



BHE-1970

Jack/Tire Retainer Kit

BHE-1970	All.....	14.99 set
----------	----------	-----------

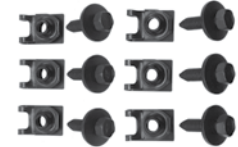

BLS-1130

Leaf Bracket Mounting Kit (to Body)

BLS-1130	1968-79 (12 pc.).....	16.95 kit
----------	-----------------------	-----------

BBB-2743



Leaf Spring Front Eye Bolt

BBB-2743	All.....	3.95 ea.
----------	----------	----------



BPA-53K

License Plate Attaching Kit

BPA-53K	All (4 pc.).....	3.95 kit
---------	------------------	----------



APB-9057

Motor Mount ThrU-bolts

APB-9057	4-1/2".....	9.99 kit
APB-7057	3-1/2".....	6.95 kit

BSL-516



Self Locking Nut

BSL-516	5/16" Zinc.....	0.40 ea.
BSL-38	3/8" Zinc.....	0.50 ea.
BSL-716	7/16" Zinc.....	0.75 ea.
BSL-12	1/2" Zinc.....	0.95 ea.

BPO-1988



Oil Drain Bolt w/ Washer

BPO-1988	All.....	6.95 ea.
----------	----------	----------



BOP-2001

BOP-2002

Oil Pan Attaching Bolts

With correct head marked SEMS bolts.

BOP-2001	All SB.....	9.95 ea.
BOP-2002	All BB.....	26.99 ea.



BPP-8386

Pressure Plate Bolt Kit

BPP-8386 All Manual (12pc.).....9.99 kit



BFC-333

Pulley Attaching Bolts

BFC-333 All Fine (6 pc.).....6.95 kit
BRB-100 All Coarse (6 pc.).....6.95 kit

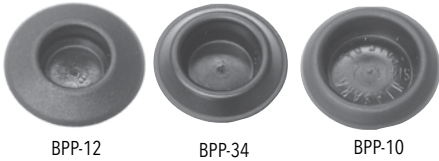

BPP-12

BPP-34

BPP-10

Push-In Plugs

BPP-12 1/2" Cowl Top, etc.....0.75 ea.
BPP-34 3/4" Wheelhouse.....1.00 ea.
BPP-10 1" Trunk Extension.....1.25 ea.
BPP-138 1-3/8" Rubber Plug.....1.50 ea.

Rear End Cover Bolt

BRE-2008 All Flanged.....0.95 ea.



BPP-084

Rubber Body Plugs

Exact reproduction body plugs. GM licensed.

BPP-084 1964-79 1".....7.99 pr.
BPP-091 1964-79 3/4".....3.99 ea.

BSB-56

Seat Belt Bolts

BSB-56 All Front Outer.....6.99 ea.
BSB-56 1967-68 Front Inner.....6.99 ea.
BSB-561 1969-72 Front Inner.....6.99 ea.
BSB-561 All Rear.....6.99 ea.
BSB-5-SBL 1962-79 Fully Threaded.....6.99 ea.
1969-72 used (2) front seat belts.

Seat Mounting Bolts

BSM-516 All Front.....1.35 ea.
BSM-5NT All Rear.....1.35 ea.



BSM-516

BPX-1950

Sheet Metal Screw Kit

Over 20 pieces for small under hood items.

BPX-1950 All.....5.95 kit

BPX-9715

Shock Mounting Kit

Complete set of screws for lower front shocks.

BPX-9715 All.....8.99 kit

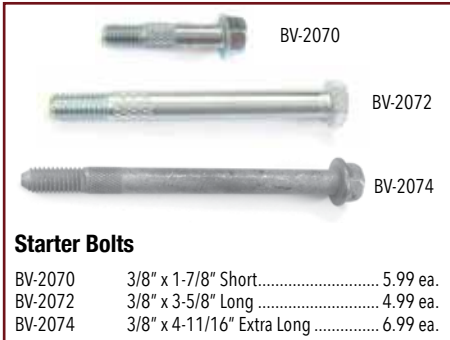

BV-2070

BV-2072

BV-2074

Starter Bolts

BV-2070 3/8" x 1-7/8" Short.....5.99 ea.
BV-2072 3/8" x 3-5/8" Long.....4.99 ea.
BV-2074 3/8" x 4-11/16" Extra Long.....6.99 ea.

Steering Box Bolt

BSB-757 1968-74.....3.99 ea.



BSB-757

Thermostat Housing

ATR-1039 Most SB Bolt/Stud.....8.99 ea.
ATR-2039 All SB-BB Bolt.....7.99 ea.
ATR-3039 1966-67 Gooseneck.....8.99 kit



BTC-650

Timing Cover Bolt Kit

BTC-650 Correct SEMS Bolts.....8.95 kit



BTE-307

BTE-7939

Transmission Mounting Hardware

BTE-307 To Bellhousing (4 pc.).....8.95 kit
BTE-7939 To Rear Mount.....0.95 ea.



APB-1023 shown

Valve Cover Bolts

APB-1023 SB "TR" (16 pc.).....14.95 kit
APB-2023 BB "TR" (28 pc.).....23.99 kit
APB-1027 SB "M" (8 pc.).....16.99 kit
M bolts were used on finned aluminum valve covers.



AWX-818

Voltage Regulator Well Nuts and Screws

AWX-818 All.....6.95 kit



ATR-4334

ATR-3232

Water Pump Attaching Kit

ATR-3232 1967-68.....16.99 kit
ATR-4334 1969-79 M Mark.....11.99 kit



AWS-302L

AWS-301S

Water Pump Studs

AWS-301S Short Pump.....4.99 ea.
AWS-302L Long Pump.....3.95 ea.



APX-1400

APX-7700

Wing Nuts

APX-1400 Chrome.....5.99 ea.
APX-7700 Black.....5.99 ea.

BUY'N SAVE
WITH KITS

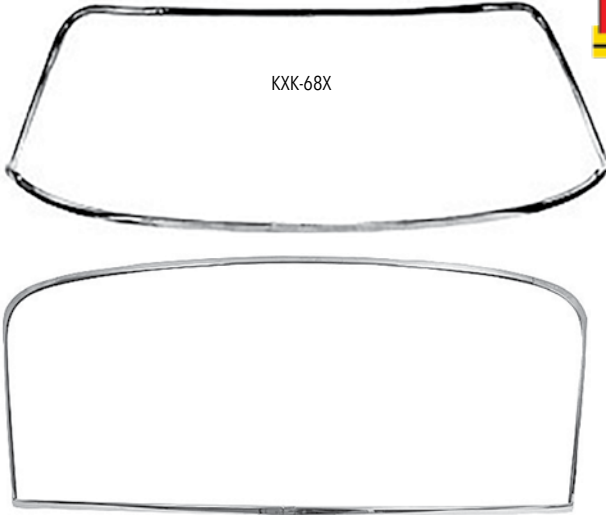

KXX-68X

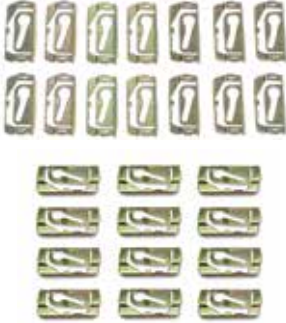

1968-79 Window Molding Kits
Save when you buy a pair of our high quality window moldings! Kit includes front windshield molding, rear window molding and a full set of mounting clips.

KXX-68X	1968-72 All.....	309.46 kit
KX-7579	1975-79*.....	342.88 kit

All windshield moldings ship Oversize and well protected.
* Does not include mounting clips.



KXF-1650

Windshield Molding Kits
New high quality, exact reproduction stainless windshield molding kits offer a very nice fit and finish and will really freshen up your car's exterior.

KXF-1650A	1962-67 Coupe.....	159.95 kit
KXF-1650B	1962-67 Sedan.....	169.99 kit
KXF-1650	1968-74 All.....	159.95 kit
KXF-1448	1975-79 All.....	189.99 kit

All windshield moldings ship Oversize and well protected.



KWC-939

KWC-938

1968-79 Windshield Lower End Molding Clips
Correct clips for retaining lower windshield molding.

KWC-6872	1968-74 LH/RH.....	10.99 pr.
KWC-939	1975-79 LH.....	4.99 ea.
KWC-938	1975-79 RH.....	4.99 ea.



KXR-1652

Rear Window Molding Kits
Excellent quality stainless steel rear window moldings to give your car the finishing touch.

KXR-1650C	1962-65 Coupe.....	179.95 kit
KXR-1652	1966-67 Coupe.....	189.95 kit
KXR-1651	1968-74 Coupe.....	159.99 kit
KXR-1449	1975-79 Coupe.....	190.99 kit

All rear window moldings ship Oversize and well protected.
KXR-1651 does NOT fit 1973-74 hatchback models.



KTW-2222

KW-648

Windshield Glass Stop Clip
Correct galvanized clip with rubber coated end.

KTW-2222	1962-65.....	18.99 ea.
KW-648	1968-75.....	8.99 ea.

BUY'N SAVE
WITH KITS



WIPERKIT-15V

Wiper Arm/Blade Kit
Complete kit with (2) arms and (2) blades.

WIPERKIT-15V	1962-67*.....	62.73 kit
WIPERKIT-15	1968-75.....	69.60 kit

**Note: Will not fit sedan and convertible with 13" blades.*

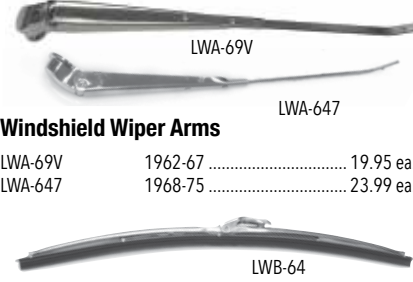

LWA-69V

LWA-647

Windshield Wiper Arms

LWA-69V	1962-67.....	19.95 ea.
LWA-647	1968-75.....	23.99 ea.



LWB-64

Wiper Blades 15"
New polished stainless steel blades.

LWB-64	1962-75 Stainless.....	16.95 ea.
--------	------------------------	-----------



KMC-270065

Window Molding Clips
Complete set of clips for one car.

Front

KMC-270067	1968-72.....	11.95 kit
------------	--------------	-----------

Rear

KMC-62XR	1962-65.....	54.99 kit
KMC-270519	1966-67.....	11.95 kit
KMC-270065	1968-74.....	11.95 kit
KRC-031	1975-79 Lower Center Molding Clip....	3.99 ea.



KMC-15KWS

Trim Stud Repair Kit OE GM
OEM GM replacement trim studs for mounting front and rear window moldings and some rocker moldings. These studs come with a sealant to prevent corrosion.

KMC-15KWS	1967-79 All (8 pc.).....	34.99 kit
-----------	--------------------------	-----------



KMC-15

Window Molding Stud/Pin Kit
Self tapping screws replace the original body studs used to retain factory window or vinyl top molding clips.

KMC-15	All (12 pc.).....	3.50 kit
--------	-------------------	----------

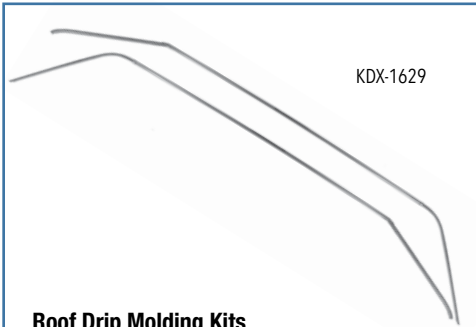

KDX-1629

Roof Drip Molding Kits

Correct reproduction of the original roof drip molding, ready to install. Joins rear quarter window chrome moldings.

KDX-1626	1962-65 (4 pc.).....	99.95 kit
KDX-1628	1966-67 (2 pc.).....	99.95 kit
KDX-1629	1968-72 (6 pc.).....	169.99 kit
KDX-1629A	1973-74 (6 pc.).....	169.99 kit



KM-1680



KT-6872N

Vinyl Top Molding Set

Complete (4) piece set.

KM-1680	1968-72	139.95 kit
KT-6872N	1968-72 Corner Moldings.....	59.99 pr.



ANT-03

Antenna Kits

Our kits come complete with correct cable, antenna base, gasket and fixed mast for front fender.

ANT-03	1962-65 Front Fender AM/FM	49.99 kit
ANT-05R	1962-64 Rear RH "Live" AM	69.99 kit
ANT-05L	1962-64 Rear LH "Dummy"	79.99 ea.
ANT-X68F	1968-74 Front Fender AM/FM Fixed.....	49.95 kit
ANT-X68T	1968-74 Front Fender AM Telescoping	199.99 kit



MCC-5255

Door Handle Push Buttons

This is a complete Nova door handle push button kit. This kit includes (2) buttons, (2) rubber rings, (2) springs and (2) retainers for a complete replacement.

MCC-5255	1968-79	18.95 kit
----------	---------------	-----------



MEM-1037

Door Handle Kits

Complete kit with (2) door handles, (1) gasket set and (1) push button set.

MEM-1030	1962-65	59.95 kit
MEM-1037	1966-67	59.95 kit
MEM-1601	1968-79	54.99 kit



MPX-3013



TrimParts Door Handle Kits

High quality door handles made exclusively by TrimParts in the USA. Fit and function is exact to original. Highest quality on the market!

MPX-3013	1962-65 GM 9702866	75.99 pr.
MPX-3062	1966-67 GM 5719143	65.99 pr.
MPX-3081	1968-75 GM 5716871A.....	64.99 pr.

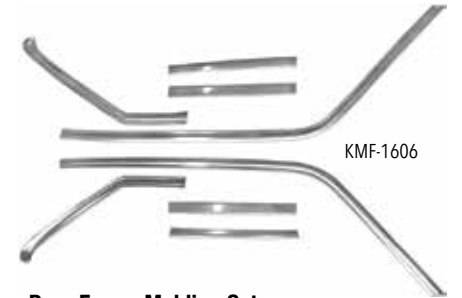

KMF-1606

Door Frame Molding Set

Finally available! This exact reproduction kit replaces your original door frame moldings.

KMF-1606	1968-72 8pc	259.99 kit
----------	-------------------	------------

Ships Oversized.



Vinyl Tops

Original double seamed top in correct "Levant" grain as original.

VT-N624	1962-64 Coupe Black	209.99 ea.
VT-N624W	1962-64 Coupe White	179.99 ea.
VT-N624G	1962-64 Coupe Green	169.99 ea.
VT-N624BU	1962-64 Coupe Buckskin	238.99 ea.
VT-N624DB	1962-64 Coupe Dark Blue	238.99 ea.
VT-N657	1965-67 Coupe Black	179.99 ea.
VT-N657W	1965-67 Coupe White	179.99 ea.
VT-N657G	1965-67 Coupe Green	238.99 ea.
VT-N657BU	1965-67 Coupe Buckskin	179.99 ea.
VT-N657DB	1965-67 Coupe Dark Blue	238.99 ea.
VT-N657S	1965-67 Sedan Black	199.99 ea.
VT-N657SW	1965-67 Sedan White	169.99 ea.
VT-N657SG	1965-67 Sedan Green	238.99 ea.
VT-N657SBU	1965-67 Sedan Buckskin	238.99 ea.
VT-N657SDB	1965-67 Sedan Dark Blue	238.99 ea.
VTX-100B	1968-74 2dr or 4dr Black	181.99 ea.
VTX-100W	1968-74 2dr or 4dr White	164.99 ea.
VTX-100G	1968-74 2dr or 4dr Green	238.99 ea.
VTX-100BU	1968-74 2dr or 4dr Buckskin	181.99 ea.
VTX-100DB	1968-74 2dr or 4dr Dark Blue	238.99 ea.



Side View Mirrors

OE style reproduction, triple chrome plated rear view mirror. There are many different mirrors on the market, but these are tried and true. We use them on our own cars! Now Includes Mounting Kit!

MIR-1035	1963-65 Round w/ Bowtie.....	33.95 ea.
MHQ-3171	1966-74 Round w/ Bowtie.....	36.99 ea.
MRR-68	1966-74 Round w/o Bowtie.....	29.99 ea.
MHQ-1316L	1968-74 Square LH.....	36.99 ea.
MHQ-1316R	1968-74 Square RH.....	36.99 ea.



Mirror Kits
Complete kit (2) rear view mirrors and (2) mirror mounting kits.

MIR-64K	1963-65 Round Bowtie.....	59.75 kit
MIR-88K	1966-74 w/o Bowtie.....	50.98 kit
MIR-71K	1966-74 Round Bowtie.....	62.88 kit
MIR-69K	1966-74 Rectangle.....	62.88 kit



Premium Quality Outside Mirrors

These premium mirrors are manufactured the right way out of die-cast zinc with all of the correct authentic details. Triple chrome plating and professional assembly rounds out these finely crafted reproductions.

MIR-1035-PQ	1963-65 w/ Bowtie.....	69.99 ea.
MHQ-3171-PQ	1966-68 w/ Bowtie.....	53.95 ea.
MHQ-1316L-PQ	1969-74 Rectangle LH.....	52.99 ea.
MHQ-1316R-PQ	1969-74 Rectangle RH.....	52.99 ea.



Mirror Mounting Kits

Complete with bracket, gasket and screws.

MT-1820	1963-65.....	4.95 kit
MHQ-1234	1966-72.....	4.95 kit
9832129	1973-74 Bullet Gasket Only.....	7.99 ea.



Bullet Mirror Glass

Reproduction bullet mirror glass.

EMG-231	1970-79 LH.....	26.99 ea.
EMG-156	1970-79 RH.....	26.99 ea.



Remote Mirror Bezel

This is an OE style reproduction remote side mirror interior bezel for cars with standard interior.

IMB-833	1970-79.....	36.99 ea.
---------	--------------	-----------



1964-66 Remote Side View Mirror

OE style reproduction of the ultra rare remote rear view mirror featuring the correct length cable, interior chrome bezel, mounting kit and highly polished triple chrome finish.

MK-907	1966-67 All.....	169.99 ea.
--------	------------------	------------

No Volume Discount.

1968 Remote Side View Mirror

OE style reproduction of the ultra rare remote rear view mirror featuring the correct length cable, mounting kit and highly polished triple chrome finish.

3921816	1968 All.....	169.99 ea.
---------	---------------	------------

No Volume Discount.

1973-74 Remote Side View Bullet Mirror

Manufactured with a die-cast zinc outer body featuring correct remote style swivel mirror. Includes correct remote cable pre-installed on the mirror. Each mirror comes primed and ready to prep and paint to the desired exterior color. LH drivers side.

MK-801	1973-74 LH.....	169.99 ea.
--------	-----------------	------------

Does not include gasket or door panel bezel.

BUY'N SAVE
WITH KITS



KVF-1330 KVF-1332

Vent Window Frames

Excellent reproduction chrome vent window frames. Buy the pair and save!

KVF-62X	1962-67 Pair.....	134.98 kit
KVF-68X	1968-72 Pair.....	134.98 kit
KVF-1330	1962-67 LH.....	74.99 ea.
KVF-1332	1962-67 RH.....	74.99 ea.
KVF-1335	1968-72 LH.....	74.99 ea.
KVF-1336	1968-72 RH.....	74.99 ea.



KDT-1825

Door Glass Upper Frames Coupe/Convrt

Excellent reproduction of the original door glass upper frames for 1962-65 Nova coupe or convertible with seal and attaching screws.

KDT-1825	1962-65	124.99 pr.
----------	---------------	------------



KDT-1964

Quarter Window

Glass Upper Frames
Comes with seal and attaching screws.

KDT-1964	1962-65 Coupe	89.99 pr.
KDT-1975	1962-65 Convertible.....	99.99 pr.

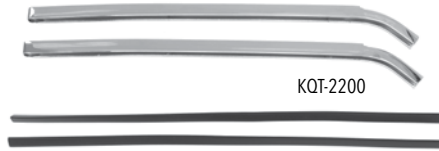

KQT-2200

Quarter Glass Chrome Sash Molding

Attaches quarter glass seals to window.

KQT-2200	1966-67	89.99 pr.
----------	---------------	-----------



KQT-3043

Quarter Window Chrome Molding

Excellent reproductions of the original quarter window "C" trim moldings made in polished aluminum.

KQT-3043	1966-67	89.99 pr.
----------	---------------	-----------



JTW-X2301

Rear Quarter Glass Seals

Stop the rattles and leaks in your quarter window glass by replacing the worn felt channel on your Chevy II / Nova 2 door with this 4 piece quarter window upper channel replacement kit. These channels have a chrome bead on the outer edge. Non-functional kits are used to seal the windows and restore the appearance of your Nova if the channel guide tab on your glass is missing. The windows will not roll up or down. If you have the original plastic channel guide tab please select the functional kits. Rebuild kits are the glass channels only. You must reuse your original brackets. Most cars came from the factory without the chrome bead. Please check before ordering.

Non-Function Kits

JTW-X6250	1962-65 Sedan w/ Chrome Bead.....	134.99 kit
JTW-X6251	1962-65 Sedan w/o Chrome Bead.....	134.99 kit
JTW-X6670	1966-67 Sedan w/ Chrome Bead.....	134.99 kit
JTW-X6671	1962-67 Sedan w/o Chrome Bead.....	134.99 kit
JTW-2300	1968-72 Sedan w/ Chrome Bead.....	139.99 pr.
JTW-X2301	1968-72 Sedan w/o Chrome Bead.....	135.99 kit
JTW-X7340	1973-74 Sedan w/ Chrome Bead.....	136.99 kit
JTW-X7341	1973-74 Sedan w/o Chrome Bead.....	136.99 kit

Functional Kits

JTW-X2300-K	1968-72 Sedan w/ Chrome Bead.....	201.99 kit
JTW-X2301-K	1968-72 Sedan w/o Chrome Bead.....	201.99 kit
JTW-X7340-K	1973-74 Sedan w/ Chrome Bead.....	204.99 kit
JTW-X7341-K	1973-74 Sedan w/o Chrome Bead.....	199.99 kit

Rebuild Kits

JTW-X6250-R	1962-67 Sedan w/ Chrome Bead.....	94.99 kit
JTW-X6251-R	1962-67 Sedan w/o Chrome Bead.....	94.99 kit
JTW-X2300-R	1968-72 Sedan w/ Chrome Bead.....	84.99 kit
JTW-X2301-R	1968-72 Sedan w/o Chrome Bead.....	84.99 kit
JTW-X7340-R	1973-74 Sedan w/ Chrome Bead.....	84.99 kit
JTW-X7341-R	1973-74 Sedan w/o Chrome Bead.....	84.99 kit



KTW-1705

Reveal Molding Clips

Correct reproduction of original upper body side reveal molding clips.

KTW-1705	1962-65 (8 pc.).....	19.99 kit
KTW-1715	1966-67 (10 pc.).....	28.99 kit



KWO-667N

Wheel Opening Moldings

Correct reproduction wheel opening moldings with screws included. Superb fit and look.

KWO-625N	1962-65	179.95 set
KWO-667N	1966-67	179.95 set
KWO-682N	1968-72	189.99 set

Ships UPS Oversized.

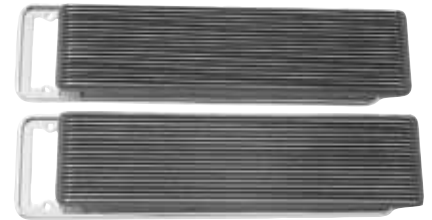

KHB-KIT

1968-72 SS Hood Ornament Kit

This complete 1968-72 Nova SS hood ornament kit comes with (2) louvers and (2) bezels to give your SS hood that finishing touch.

KHB-KIT	1968-72	239.99 kit
NR-46	Louvers Only.....	168.99 pr.
KHB-S	Gaskets.....	15.99 pr.



KHB-1601A

Hood Louver Brackets

KHB-1601A	1968-72	19.95 pr.
-----------	---------------	-----------

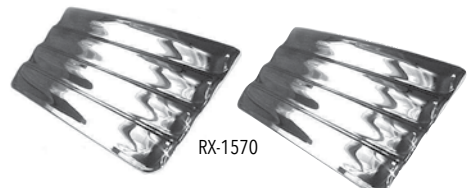

RX-1570

Front Fender Louvers

These reproduction front fender louvers are correct for 1969-70 Novas but will fit most 1968-72 models.

RX-1570	1968-72	79.99 pr.
---------	---------------	-----------



PTS-X68F



Carbon Fiber Look!



Addictive Flow Spoilers

This front spoiler is just what your pro-touring or resto-mod Nova is missing. Brand new to the market & a Ground Up Motors Exclusive, these spoilers are easy on the wallet, easier to install, and designed with enthusiasts in mind. This front spoiler kit includes the 1968-1974 Nova front spoiler, mounting hardware for a complete upgrade or replacement, and a detailed set of installation instructions.

PTS-X68F	1968-74 Front Spoiler "Flat Black Look"	119.99 kit
PTS-X68F-CRB	1968-74 Front Spoiler "Carbon Fiber Look"	179.99 kit

*Carbon spoilers utilize a process called "hydro-dipping" to apply a realistic Carbon Fiber look at a fraction of the cost of real Carbon Fiber.



Hood Edge Molding

Brand new correct reproduction hood edge molding

KH-1040	1966	59.99 ea.
KH-1050	1967	59.99 ea.
KH-1630	1968-72	69.95 ea.
KH-1630-US	1968-72	99.99 ea.
KH-1630KIT-US	1968-72 Hood & Eyebrow Molding Kit	188.98 kit
KH-1630B	1973-74	99.99 ea.

Hood Spear Molding

Brand new correct hood spear for your early Nova/Chevy II!

KH-1631	1962-65	139.95 ea.
---------	---------------	------------



1963-64 SS Body Side Peak Moldings

OE style reproduction side of body moldings for Super Sport models.

LBM-1060	1963-64 (8 pc.)	369.99 kit
----------	-----------------------	------------

Ships UPS Oversized

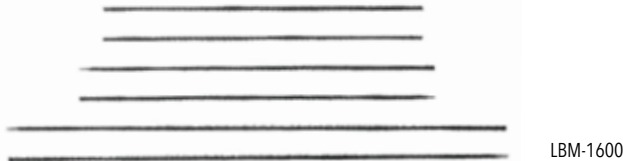

1969-72 Body Side Molding Kit

These often missing or damaged side moldings can now be replaced with these exact reproductions of original aluminum body side moldings.

LBM-1600	1969-72 (6 pc.)	239.99 kit
----------	-----------------------	------------

Ships UPS Oversized



1968-72 SS Body Side Molding Kit

OE style reproduction thin body side moldings which are installed above the rocker panel moldings on Super Sport models.

KRP-X68	1968-72 Deluxe Molding (8 pc.)	179.99 set
---------	--------------------------------------	------------

Ships UPS Oversized



Rocker Panel Molding Kits

OE style reproduction of original rocker panel molding with clips which installs on the area below the doors and runs from the front well opening to the rear opening.

KRP-X62	1962-63	199.99 pr.
KRP-1672	1966-67	134.99 pr.
KRP-1250	1968-74 Molding	159.99 pr.
KRP-1260	1968-74 Extension	84.99 pr.

Ships UPS Oversized



1966 SS Rocker/Door/Fender Moldings

This is a set of show quality 1966 Nova Super Sport rocker moldings. This four piece set includes two lower rocker moldings and two lower door moldings. These are factory style high polished aluminum. The front fender extension moldings are constructed of high quality aluminum.

KRP-X66S	1966 SS Rockers/Doors	677.99 kit
KFM-X66SS	1966 SS Front Fenders	84.99 pr.

Ships UPS Oversized. No Volume Discount.



1967 SS Lower Body Molding Set











New factory style lower body molding set with hardware. These show quality moldings are made of aluminum and include 40 studs to install.

KRP-X67S	1967 SS	699.95 kit
----------	---------------	------------

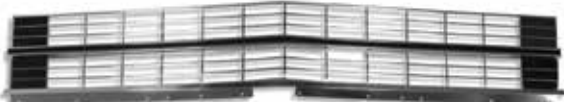
Ships UPS Oversized. No Volume Discount.

Grilles

OE style reproductions manufactured with the correct end contours for a superb fit and appearance!

-  KGN-2544 1962 All Silver w/ Brackets469.99 set
-  KGN-6030 1963.....269.99 ea.
-  KGN-6040 1964.....269.99 ea.
-  KGN-1965 1965.....489.99 ea.
-  KGN-1610 1966.....139.99 ea.
-  KGN-1611 1967.....139.99 ea.
-  KGN-1612 1968-69 Non-SS.....109.99 ea.
-  KGN-1613 1968-69 SS.....109.99 ea.
-  KGN-1614 1970-72 Non-SS.....119.99 ea.
-  KGN-1615 1970-72 SS.....119.99 ea.
-  KGN-7374 1973-74149.99 ea.
-  KGN-7678 1976-78299.99 ea.

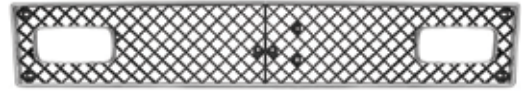

KGN-7678SS 1976-78 Super Sport.....219.99 ea.



KGN-7678R 1976-78 Rally Sport229.99 ea.

Grille Kits



1968-69 Nova Grille Kit Non-SS

GRILLEKIT-68N 1968-69.....368.93 kit
GRILLEKIT-68N-GMBZL 1968-69 w/ GM Resto Bezels.....386.93 kit



1968-69 Nova Grille Kit SS

GRILLEKIT-68NSS 1968-69.....368.93 kit
GRILLEKIT-68NSS-GMBZ 1968-69 w/ GM Resto Bezels.....386.93 kit



1970-72 Nova Grille Kit Non-SS

GRILLEKIT-70N 1970-72.....377.93 kit
GRILLEKIT-70N-GMBZL 1970-72 w/ GM Resto Bezels.....395.93 kit



1970-72 Nova Grille Kit SS

GRILLEKIT-70NSS 1970-72.....377.93 kit
GRILLEKIT-70NSS-GMBZ 1970-72 w/ GM Resto Bezels.....395.93 kit



1968-72 Upper Grille Reinforcement

Reproduction upper grille reinforcement panel for your Nova. Manufactured to factory specs this panel features original style contours, pre-punched mounting holes and comes black EDP coated.

KGB-6872 All69.99 ea.
Ships UPS Oversized.



1966 Lower Grille Molding

New reproduction of the lower grille molding found on 1966 Novas.

KGM-1220 1966 All69.99 ea.



1962-65 Grille Guard

Optional grille guard could be found on 1962-65 Nova and Chevy II models. This is a sharp dress up item that is easily installed using existing bumper bolt holes. This is an OER reproduction.

985435 1962-65 Grille Guard309.99 ea.



BAG-64X

Deluxe Grille Mounting Kits

Complete kits with all of the correct factory hardware to properly mount your grille.

BAG-64X	1964 18 pc.....	16.99 kit
BAG-65X	1965 34 pc.....	16.99 kit
BAG-66X	1966 25 pc.....	16.99 kit
BAG-67X	1967 28 pc.....	16.99 kit
BAG-70X	1968-72 24 pc.....	16.99 kit

KGB-1244

KGB-6061



KGH-1235

1962-66 Grille Mounting Brackets & Hardware

Reproduction grille mounting brackets sets.

KGB-8732	1962 5 pc Brackets	119.99 ea.
KGB-8697	1963 3 pc Brackets	109.99 kit
KGB-1244	1964 5 pc Brackets	129.99 kit
KGB-8733	1965 5 pc Brackets	119.99 ea.
KGB-6061	1966 6 pc Brackets	36.99 kit
KGH-1235	1963-1964 Silver Bracket Hardware*	39.99 kit
KGH-1236	1963-1964 Black Bracket Hardware*	33.99 kit

Each hardware set includes 25 nuts and bolts (use as required).



KGS-68XR

1968-72 Grille Mounting Supports

This reproduction of this hard to find part is stamped out of heavy gauge steel and is an exact replacement for your rusty or missing original.

KGS-68XL	1968-72 LH	59.99 ea.
KGS-68XR	1968-72 RH	59.99 ea.



KHB-2210

1962-64 Headlamp Bezels

Reproduction aluminum headlamp bezels as original.

KHB-2210	1962-64	159.99 pr.
KHB-22GML	1962-64 LH GM Restoration.....	84.99 ea.
KHB-23GMR	1962-64 RH GM Restoration.....	84.99 ea.
KHB-22GMK	1962-64 LH/RH GM Restoration.....	152.98 kit



KHB-1965

1965 Headlamp Bezel

OE style reproduction headlamp bezel sold individually.

KHB-1965	1965	79.99 ea.
KHB-1965-K	1965 All LH/RH.....	139.18 kit



KHB-157



KHB-281L

KHB-282R

1966-1967 Headlamp Bezel

OE style reproduction polished aluminum headlamp bezel with correct paint.

KHB-157	1966 RH = LH	79.99 ea.
KHB-281L	1967 LH	139.99 ea.
KHB-282R	1967 RH	139.99 ea.
KHB-41562	1967 Seal	10.99 pr.



KHB-790KIT

1968-72 Headlamp Bezels

OE style reproduction or original GM headlamp bezels with correct accenting for 1969-72 Nova. Also fits 1968 Nova but slightly different in appearance.

KHB-790KIT	Repro	129.99 pr.
KHB-790GMK	1969-72 GM Restoration.....	149.99 kit



KHB-111

KHB-607

1975-78 Headlamp Bezels

This headlamp bezel is manufactured to factory specs and features the correct finish and accents.

KHB-607	1975-78 Black LH	94.99 ea.
KHB-608	1975-78 Black RH	94.99 ea.
KHB-627	1975-78 Silver LH	107.99 ea.
KHB-628	1975-78 Silver RH	107.99 ea.
KHB-111	1975-78 Chrome LH.....	94.99 ea.
KHB-112	1975-78 Chrome RH.....	94.99 ea.

LHR-10K

LHR-663



Headlamp Retainer

Correct stainless steel rings and attaching screws.

LHR-663	1962-74 All.....	11.99 ea.
LHR-K2	1962-74 All, Set of 2 w/ Screws	22.00 kit
LHR-39	1975-78 All.....	24.99 ea.
LHR-10K	Screws (3 pc.).....	0.95 kit



LHA-73K

Headlamp Adjustment Kit

Plastic nuts and screws for headlamp adjustment. Each kit does one car.

LHA-73K	1968-78 4 pc.....	5.95 kit
LHA-789K	1979 w/ Square Headlights.....	11.95 kit



KMC-X62L



KMC-X62R

Headlamp Mud Caps Steel

These OE style steel mud caps are for the purist! Installed on the radiator support these OE style steel mud caps protect the headlights from road debris.

KMC-X62L	1962-65 Steel LH	69.99 ea.
KMC-X62R	1962-65 Steel RH	69.99 ea.
KMC-X62K	1962-65 Steel LH/RH	125.98 kit

No Volume Discount.



KMC-3720

Headlamp Mud Caps ABS Plastic

These install on the radiator support to protect the headlights from road debris and are made out of ABS plastic, unlike the original metal pieces which usually rust out.

KMC-3720	1962-65	69.99 pr.
KMC-3750	1966-67	69.99 pr.



LHS-67

Headlamp Spring

Correct spring used for proper adjustment.

LHS-67	1962-74 All.....	4.99 ea.
--------	------------------	----------



KMC-1600 & KMC-1601



KMC-1602 & KMC-1603

Headlamp Housings

These housings attach to the radiator support to hold the headlamp buckets in place.

KMC-1604	1962-64 RH.....	79.99 ea.
KMC-1605	1962-64 LH.....	79.99 ea.
KMC-1600	1966 RH.....	92.99 ea.
KMC-1601	1966 LH.....	92.99 ea.
KMC-1601K	1966 LH/RH Set.....	167.38 pr.
KMC-1602	1967 RH.....	92.99 ea.
KMC-1603	1967 LH.....	92.99 ea.
KMC-1603K	1967 LH/RH Set.....	167.38 pr.



LHB-67L

LHB-67R

Headlamp Mounting Buckets

OE style reproduction headlamp buckets which attach to the headlamp housings and keep the headlights in place.

LHB-X62	1962-65 All LH/RH.....	44.99 ea.
LHB-67L	1966-67 LH.....	33.99 ea.
LHB-67R	1966-67 RH.....	33.99 ea.
LHB-67L	1968-73 RH.....	33.99 ea.
LHB-67R	1968-73 LH.....	33.99 ea.
LHB-67K	1968-73 LH/RH Pair.....	57.78 kit



KEB-1410

1965 Eyebrows

Brand new correct eyebrow moldings.

KEB-1410	1965 All.....	219.99 pr.
----------	---------------	------------



KEB-1636

1968-72 Eyebrows

Correct polished aluminum reproduction moldings that attach to the front fender surrounding the headlamp area.

KEB-1636	1968-72.....	99.99 pr.
KEB-1636-US	1968-72 Premium Quality.....	109.99 pr.



1968-1972 Nova Front End Molding Kit

Freshen up your 1968-72 Nova's front end with this convenient Ground Up Motors kit, featuring TrimParts' GM Restoration licensed hood edge molding and fender moldings. Made in the USA!

KH-1630KIT-US	1968-72.....	188.98 kit
---------------	--------------	------------

No Volume Discount.

BUY 'N SAVE
WITH KITS



LSM-68X307

1968-69 Side Marker Kit

This kit includes (4) side marker lens bezels, and (4) lenses. Choose from any engine size!

LSM-68X307	1968 307.....	141.23 kit
LSM-68X327	1968 327.....	141.23 kit
LSM-68X350	1968 350.....	139.43 kit
LSM-68X396	1968 396.....	113.33 kit
LSM-68X427	1968 427.....	133.13 kit
LSM-69X307	1969 307.....	143.03 kit
LSM-69X327	1969 327.....	143.03 kit
LSM-69X350	1969 350.....	141.23 kit
LSM-69X396	1969 396.....	115.13 kit
LSM-69X427	1969 427.....	134.93 kit
LSG-X68	1968-69 All Bezel Gaskets.....	6.99 kit



LSM-70K

1970-72 Side Marker Kit

This kit includes (4) chrome side marker lens bezels, (4) side marker light lenses, & (4) gaskets.

LSM-70K	1970-72 All.....	167.34 kit
---------	------------------	------------



LSB-4523

Side Marker Bezel

Excellent reproduction of the original side marker bezel for use on front fenders and rear quarters and are available with or without engine size designation. The front bezels are installed over the side marker lens assemblies and act as a chrome trim molding piece, displaying your vehicle's engine designation.

LSB-4520	1968-69 Front 307.....	95.99 pr.
LSB-4521	1968-69 Front 327.....	95.99 pr.
LSB-4522	1968-69 Front 350.....	93.99 pr.
LSB-4523	1968-69 Front 396.....	64.99 pr.
LSB-4524	1968-69 Front 427.....	86.99 pr.
LSB-459	1968-69 Rear no ID.....	8.99 ea.
LSB-2420	1970-74 Front.....	21.99 ea.
LSB-2430	1975-79 Front.....	21.99 ea.
LSB-2430	1970-79 Rear.....	21.99 ea.
LSG-X68	1968-69 Marker Gaskets.....	6.99 kit
LSG-X70	1970-79 Marker Gaskets.....	7.99 set

LPG-3045



Parking Lamp Gaskets

Correct sponge material replacement gaskets for use with original parking lamp housings.

LPG-3043	1962-64.....	4.99 pr.
LPG-3045	1965-67.....	4.99 pr.
LPG-3055	1968-69.....	4.99 pr.
LPG-3060	1970-72.....	4.99 pr.

GSS-883



Side Marker Sockets

Correct side marker sockets.

GSS-883	1968-79 All.....	5.95 ea.
GSS-893	1962-79 All Right Angle.....	5.95 ea.



MEH-1576

License Plate Lamps

Complete with bracket, lamp, lens and wiring harness.

LPL-2500	1962-65.....	52.99 ea.
MEH-1576	1966-72.....	19.95 ea.
LPH-192	1975-79.....	26.99 ea.



LPL-338



LPL-1G

License Plate Lens & Gasket

Correct license plate lens and gasket.

LPL-338	1966-72 Lens.....	8.99 ea.
LPL-1G	1966-72 Gasket.....	4.99 ea.



1968-72 Grille Filler Panel

Original plastic filler panel that installs between the grille and front bumper, directly above the steel reinforcement panel (RX-1615C).

RGF-1615D 1968-7249.99 ea.
Ships UPS Oversize 2.



MX-KIT68



BUY'N SAVE
WITH KITS

1962-72 Chrome Bumper Kits

Nothing will freshen up your Nova more than a new set of front and rear bumpers! These bumpers are triple chrome plated for a beautiful shine. Each kit includes (1) front bumper and (1) rear bumper.

MX-KIT62	1962-64 All	417.98 kit
MX-KIT65	1965 All	417.98 kit
MX-KIT66	1966-67 All	417.98 kit
MX-KIT68	1968-69 All	417.94 kit
MX-KIT70	1970-72 All	463.96 kit
MX-KIT73	1973 All	757.13 kit

Bumper Bolts

Correct crowned, round head, stainless steel bolt complete with lock washer and nut.

BPB-716	1962+ All	1.95 ea.
BPB-716K	1962+ All (8pc)	17.99 kit

Many Novas take more than 8 bolts.

Please check your application before ordering.



Bumper Bracket Attaching Bolts

Correct bumper bracket bolt with correct teeth washers and nut.

BBF-13	1962-72 Front Bracket To Subframe	6.99 ea.
--------	---	----------



MBB-X62K

Bumper Bracket Kits

Save when you buy one of these convenient bumper bracket kits! Each kit includes all of the front and rear brackets needed to replace your damaged or missing original brackets. Perfect with our bumper kit!

MBB-X62K	1962-65 Front & Rear (6 pc.)	310.47 kit
MBB-X66K	1966-67 Front & Rear (4 pc.)	188.90 ea.
MBB-X68K	1968-72 Front & Rear (6 pc.)	152.97 kit

See next page for individual bumper brackets.

BBF-6201

Bumper Bracket Mounting Hardware

Complete hardware kits for mounting the bumper brackets.

BBF-6082	1964-65 Front (10 pc.)	10.99 kit
BBF-6083	1964-65 Rear (18 pc.)	10.99 kit
BBF-6201	1966-67 Front (12 pc.)	10.99 kit
BBF-6083	1966-67 Rear (18 pc.)	10.99 kit
BBF-6024	1968-72 Front (16 pc.)	20.99 kit
BBF-4274	1968-72 Rear (8 pc.)	13.99 kit

Bracket to bumper bolts not included.

Bumpers

These are the highest quality reproduction bumpers on the market. Each bumper starts out with a nickel core and is then triple chrome plated for a beautiful shine. You will not find a nicer reproduction bumper.



MX-62F 1962-64 Front 219.99 ea.



MX-65F 1965 Front 219.99 ea.



MX-66F 1966-67 Front 219.99 ea.



MX-68F 1968-69 Front 219.97 ea.



MX-70F 1970-72 Front 219.97 ea.



MX-62R 1962-65 Rear 219.99 ea.



MX-66R 1966-67 Rear 219.99 ea.



MX-68R 1968-72 Rear 219.99 ea.



MX-70F 1970-72 Front Premium Quality 219.97 ea.



MX-73F

MX-73F 1973-74 Front 359.99 ea.

MX-74F 1973-74 Front w/ Impact Strip Holes 339.00 ea.

MX-73R 1973 Rear 436.99 ea.

All bumpers ship Oversize 2.



MBB-X62 1962-65 Front Inner.....109.99 pr.
MBB-2240 1962-65 Front Outer.....109.99 pr.



MBB-2268 1962-65 Rear 124.99 pr.



MBB-X66 1966-67 Front.....109.99 pr.



MBB-1611A 1966-67 Rear RH.....49.95 ea.
MBB-1611B 1966-67 Rear LH.....49.95 ea.



MBB-1614A 1968-72 Front RH 54.99 ea.
MBB-1614B 1968-72 Front LH 54.99 ea.
MBB-68XFK 1968-72 Front LH/RH98.98 kit



MBB-68XRL 1968-72 Rear LH 34.99 ea.
MBB-68XRR 1968-72 Rear RH..... 34.99 ea.
MBB-68XRK 1968-72 Rear LH/RH 62.98 kit



1966-67 Bumper Guard Kits

These sets of chrome bumper guards are a great replacement for your missing or pitted originals.

MBG-X66F Front..... 109.95 pr.
MBG-X66R Rear 109.95 pr.



1962-65 Cove Moldings

Complete three piece cove molding set.

KRC-1027 1962-65 3pc..... 199.99 kit



KRT-X68



KRT-SS68



KRT-X70



KRT-SS70

Rear Panel Trim Moldings

OE style reproduction rear panel moldings used on all 1968-72 Novas. These moldings are crafted using the same plastic and chrome plating process used on new vehicles, giving you modern quality with a factory look. The correct paint finish and contours are applied to give you a factory look.

KRT-X68 1968-69 Non-SS..... 119.99 ea.
KRT-SS68 1968-69 SS 136.99 ea.
KRT-X70 1970-72 Non-SS..... 119.99 ea.
KRT-SS70 1970-72 SS 136.99 ea.

Ships Oversize. Not eligible for free shipping.



KRT-SS70-USA

Rear Panel Trim Molding – Die Cast - MADE IN USA

Die cast on the original GM tooling, not a cheap aluminum extrusion. The engineering quality guarantees a precise fit and lasting quality. Original GM part # 8702427.

KRT-SS70-USA 1970-72338.99 ea.
KRT-70USA 1970-72396.99 ea.

Ships Oversize. Not eligible for free shipping.

Fenders

Our reproduction fenders are manufactured to duplicate the originals in both fit and appearance. All fenders come EDP coated. Just as with original GM fenders, we recommend test fitting before painting.

No Volume Discount. All fenders ship Truck Freight to a commercial address.



RFX-1619

RFX-1619	1962-65 LH	239.99 ea.
RFX-1618	1962-65 RH	219.99 ea.



RFX-1619B

RFX-1619B	1966 LH.....	389.99 ea.
RFX-1619A	1966 RH	389.99 ea.



RFX-1619D

RFX-1619D	1967 LH.....	389.99 ea.
RFX-1619C	1967 RH	389.99 ea.



RFX-1617



RFX-1617	1968-69 LH.....	329.99 ea.
RFX-1616	1968-69 RH.....	329.99 ea.



RFX-1617B



RFX-1617B	1970-74 LH.....	369.99 ea.
RFX-1617A	1970-74 RH.....	369.99 ea.

BUY'N SAVE
WITH KITS

RFW-68K



Front Inner Fenders

Brand new die-stamped inner fender wells. Buy the pair and save 10%!

RFW-1627	1968-74 LH	111.99 ea.
RFW-1626	1968-74 RH	111.99 ea.
RFW-68K	1968-74 Pair.....	201.58 kit

Ships Oversize 2.

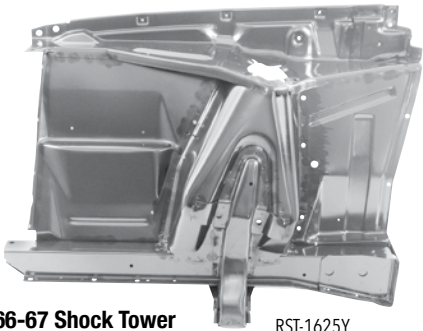

1966-67 Shock Tower & Apron Assembly

RST-1625Y

This is a complete shock tower and apron assembly which is the perfect replacement for this commonly rotted out area.

- RST-1625Z 1966-67 LH 659.95 ea.
 - RST-1625Y 1966-67 RH 659.95 ea.
- No Volume Discount. Ships Oversize.



1962-67



RSS-1625W

RSS-1627F

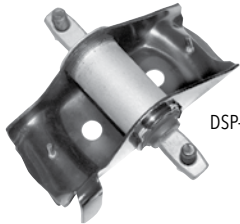

DSP-62

1966-67 Shock Tower Components

- RST-1625X Cap Black 32.95 ea.
- 1962-67 Cap Chrome 89.99 pr.
- RST-1627F Outer Panel LH 55.95 ea.
- RST-1627E Outer Panel RH 55.95 ea.
- RSS-1625W Top Spring Seat 24.95 ea.
- DSP-62 Spring Saddle 89.99 pr.

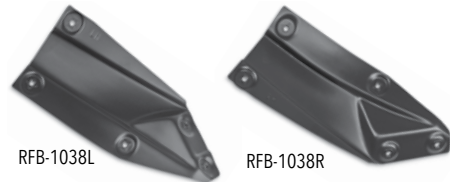

RFB-1038L

RFB-1038R

Inner Fender To Firewall Braces

Correct steel braces that connect the inner fenders to the firewall.

- RFB-1038R 1968-74 RH 24.99 ea.
- RFB-1038L 1968-74 LH 24.99 ea.
- RFB-1038K 1968-74 Pair 44.98 kit



RFW-621R

1962-65 Front Inner Fender Apron Patch

This is the frequently damaged apron on the RH side under the battery tray on early Novas.

- RFW-621R 1962-65 99.99 ea.



RSP-68L

1968-74 Shock Tower Support Bolt Plate

This is an OE style reproduction of the shock tower support bolt plate which is commonly rotted out.

- RSP-68L 1968-74 LH 49.95 ea.
- RSP-68R 1968-74 RH 49.95 ea.



RFB-1616C

Front Fender Braces

These lower fender extension braces connect the extension to the fender. These are special stamped braces and are exact reproductions for originals. Sold in pairs only.

- RFB-1616A 1962-65 13.99 pr.
- RFB-1616B 1966-67 13.99 pr.
- RFB-1616C 1968-74 13.99 pr.



BFE-7001

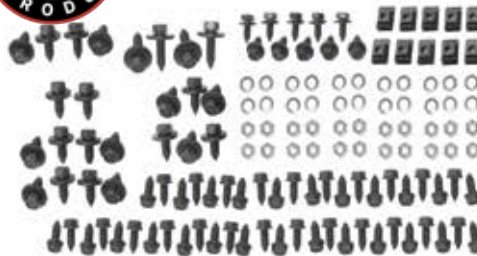

Front End Fastener Kit

Over 125 pieces all individually bagged to attach all of your front end sheet metal including fenders, grille, inner fenders, hood, etc.

- BFE-7001 1962-67 All 69.99 kit
- BFE-7002 1968-74 All 69.99 kit



RFP-X68L

Fender Patches

High quality fender patch which is perfect for repairing the commonly rusted area behind the front wheel.

- RFP-X68L 1968-74 LH 84.99 ea.
- RFP-X68R 1968-74 RH 84.99 ea.

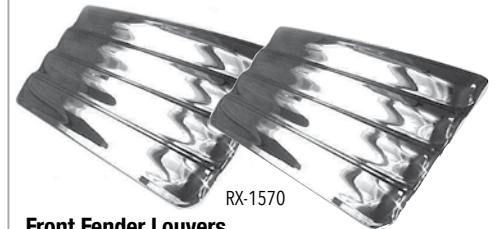

RX-1570

Front Fender Louvers

These reproduction front fender louvers are correct for 1969-70 Novas but will fit most 1968-72 models.

- RX-1570 1968-72 79.99 pr.

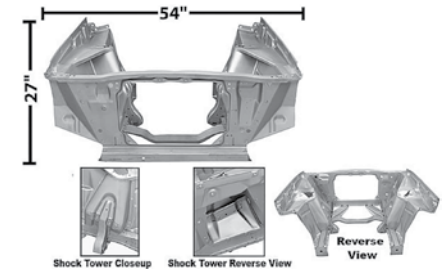

1966-67 "Doghouse" Complete Front End Assembly

Complete "doghouse" assembly including shock towers, radiator support and braces. Completely replaces your rusted out front end.

- RDA-1625SWT 1966-67 2399.95 ea.
- No Volume Discount. This item ships truck freight.

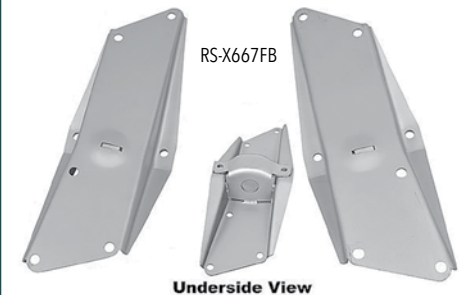

RS-X667FB

Underside View

1966-67 Radiator To Frame Braces

Correct braces to connect the radiator support to the frame rails.

- RS-X667FB 1966-67 119.95 pr.

RHG-68KWS



Hood Hinge Kit 1968-79 Repro Style

These are high quality reproduction hood hinges complete with springs and featuring a black EDP coating.

RHG-68KWS	1968-79 All LH & RH	119.99 kit
BPA-381	3/8" x 1" Bolt	0.65 ea.

Note: Bolts are not included.



MS149-40B



MS149-40P



Eddie Motorsports Billet Hood Hinges

These billet hood hinges are machined from 6061-T6 aluminum and will add an awesome custom touch to your engine compartment. They bolt-in and require no cutting of your sheet metal. Complete with stainless steel nitrogen gas shocks and all stainless steel fasteners.

M = Machined	P = Polished	R = Red Fusioncoat
B = Blue Fusioncoat	W = White Fusioncoat	PR = Purple Fusioncoat
BK = Gloss Black Fusioncoat	BKA = Gloss Black Anodized	MB = Matte Black Fusioncoat
MBA = Matte Black Anodized	CL = Clear Coat	CA = Clear Anodized

		M	P	Colors
MS149-40	1963-65 All	695.99 pr.	745.99 pr.	690.99 pr.
MS149-53	1966-67 Factory Clip.....	695.99 pr.	745.99 pr.	690.99 pr.
MS149-38	1966-67 Aftermarket Clip*.....	695.99 pr.	725.99 pr.	690.99 pr.
MS149-54	1968-79 All	650.99 pr.	675.99 pr.	720.99 pr.

*For use with aftermarket front clip (subframe).



RHG-996L



OE Style Pre-Assembled Hood Hinges

These hood hinges are for the purist who won't settle for anything less than the best! Sold each or as a set of left and right hinges with the correct springs pre-installed. They feature an OE correct black phosphate coating just like the OEM.

RHG-142WSK	1966-67 All LH & RH	116.98 ea.
RHG-996K	1968-79 All LH & RH	199.99 kit
RHG-996L	1968-79 All LH	100.99 ea.
RHG-996R	1968-79 All RH.....	100.99 ea.
BPA-381	3/8" x 1" Bolt.....	0.65 ea.

Note: Bolts are not included.

RHG-667L



Hood Hinges

Your choice of high quality, exact reproduction hood hinges or GM hinges.

RHG-64R	1963-65 Repro RH	64.99 ea.
RHG-64L	1963-65 Repro LH.....	64.99 ea.
RHG-142R	1966-67 Repro RH	44.99 ea.
RHG-142L	1966-67 Repro LH.....	44.99 ea.
RHG-667R	1966-67 GM RH	120.99 ea.
RHG-667L	1966-67 GM LH.....	120.99 ea.
RHG-68R	1968-79 Repro RH	49.99 ea.
RHG-68L	1968-79 Repro LH.....	49.99 ea.
BPA-381	3/8" x 1" Bolt.....	0.65 ea.

RHG-955

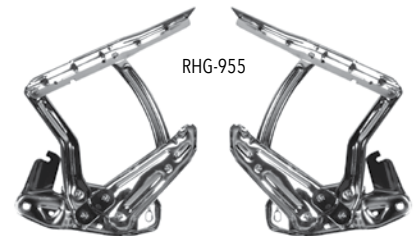

Chrome Hood Hinges

OE quality chrome plated hood hinges stamped from high strength steel.

RHG-955	1966-67 All	369.99 pr.
---------	-------------------	------------



RHX-1600A

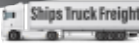

Cowl Induction Hoods

These are the hoods that GM should have made! Let people know your Nova means business with one of these awesome cowl hoods!

RHX-6265	1962-65 2".....	369.99 ea.
RHX-1600A	1966-67 2".....	369.99 ea.
RHX-1603	1968-72 2".....	439.99 ea.
RHX-684	1968-72 4".....	429.99 ea.
RHX-7374	1973-74 2".....	419.99 ea.

All hoods ship truck freight to a commercial address.
No Volume Discount.



RHX-1602

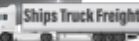

Standard Flat Hoods

If factory stock is your style, these OE style reproduction standard hoods are a perfect replacement for rusty or dinged up originals.

RHX-1602	1962-65.....	399.99 ea.
RHX-1600	1966-67.....	319.99 ea.
RHX-68SS	1968-72*.....	399.99 ea.

*Comes with brackets for SS hood louvers on underside of hood.
Can be used on SS models. All hoods ship truck freight to a commercial address. No Volume Discount.

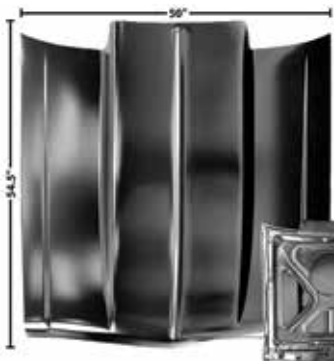

RHX-1603B

1973-74 Cowl Hood w/ Bug Screen

This hood is perfect when air cleaner clearance is an issue or when you simply want that serious muscle car look. This hood also features a unique rear bug screen to keep debris from entering your engine compartment.

RHX-1603B	1973-74 2".....	459.95 ea.
-----------	-----------------	------------

All hoods ship truck freight to a commercial address.

Eddie Motorsports Billet Hood Latch Assembly

CNC machined from a solid chunk of 6061-T6 aluminum and stainless steel. This is a direct replacement for your cheap stock stamped steel hood latch. The EMS billet hood latch kit comes complete with a billet aluminum base plate and billet stainless steel pilot bolt and retaining cup. Stainless steel fasteners and billet aluminum finishing washers are also included.



M = Machined Fusioncoat P = Polished R = Red B = Blue Fusioncoat W = White Fusioncoat PR = Purple Fusioncoat BK = Gloss Black Fusioncoat BKA = Gloss Black Anodized MB = Matte Black Fusioncoat MBA = Matte Black Anodized CL = Clear Coat CA = Clear Anodized

		M	P	Colors
MS276-16	1963-65 All	183.99 ea.....	213.99 ea.....	172.99 ea.
MS276-17	1966-67 All	169.99 ea.....	189.99 ea.....	172.99 ea.
MS276-18	1968-74 All	183.99 ea.....	213.99 ea.....	172.99 ea.



RHR-X68

Hood Catch

OE style reproduction. Mounts on underside of hood.

RHR-X625	1962-65.....	57.99 ea.
RHR-X667	1966-67.....	49.95 ea.
RHR-X68	1968-72.....	49.99 ea.

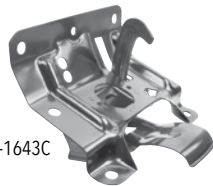

RHL-1643C



RHL-1643B

Hood Release

OE style reproduction hood release to replace your rusty or missing original.

RHL-1643B	1966 All.....	89.95 ea.
RHL-1643C	1968-72 All.....	89.95 ea.



GCS-S4051

Hood Pin Kit - Hair Pin Style

Universal chrome hood pin kit for use on any vehicle.

GCS-S4051	All.....	12.99 kit
-----------	----------	-----------



HPK-BC

HPK-BB

Universal Hood Pin Kits Peel N Stick

These hood pin kits are a great way to add that pro-touring/ racing look without drilling or cutting your hood. The pin mounts are either chrome plated or black aluminum with chrome pins and feature rubber coated cables. They attach with high quality double sided 3M adhesive tape.

HPK-BC	Chrome All.....	29.99 kit
HPK-BB	Black All.....	29.99 kit



RVL-1643



RHB-6972

Hood Latch Support Brace

New reproduction of original hood latch support brace which attaches to the radiator support

RVL-1602C	1963-64 All.....	44.99 ea.
RVL-1643	1966 All.....	39.99 ea.
RVL-1643D	1967 All.....	44.99 ea.
RHB-6972	1968-72 All.....	34.99 ea.



RHS-642



RHS-25

Hood Hinge Spring

Brand new high quality reproduction hood springs.

RHS-642	1963-65.....	15.99 ea.
RHS-25	1968-79.....	16.99 ea.

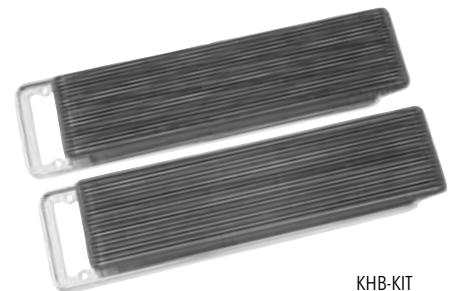

KHB-KIT

1968-72 SS Hood Ornament Kit

This complete 1968-72 Nova SS hood ornament kit comes with (2) louvers and (2) bezels to give your SS hood that finishing touch.

KHB-KIT	1968-72.....	239.99 kit
---------	--------------	------------

1962-65 Front Valance Panel
Excellent reproduction of the original lower valance panel on early cars with excellent fit and function.

RVP-1615A 1962-65 69.99 ea.
Ships UPS Oversize 2.

1966-67 Front Valance Panel
Correct filler panel which fits between the front bumper and the grille. Manufactured to original factory specifications.

RX-1615B 1966-67 Filler..... 69.99 ea.
Ships UPS Oversize 2.

1968-72 Front Valance Panel
Steel filler panel which installs below the plastic filler panel (RGF-1615D).

RX-1615C 1968-72 Reinforcement..... 69.99 ea.
Ships UPS Oversize 2.

1968-72 Grille Filler Panel
Original plastic filler panel that installs between the grille and front bumper, directly above the steel reinforcement panel (RX-1615C).

RGF-1615D 1968-72 49.99 ea.
Ships UPS Oversize 2.

1968-72 Grille Filler Panel Kit
This Ground Up Motors exclusive Nova parts kit includes a correct fiberglass grille filler panel and a correct steel grille filler reinforcement panel at a specially discounted kit price.

RGF-68KIT 1968-72 107.98 kit
Ships UPS Oversize 2.



Dash Top Panel

Correct reproduction of the inner metal dash panel assembly. Extends from the windshield area to the instrument panel assembly where the dash pad mounts. Welding is required when installing this panel.

RDP-439 1968-74 All 74.99 ea.
Some years may require modification. Ships Oversize.

Outer Cowl Panels & Shoulders

Excellent quality repair panels for these commonly rusted out areas.

RCP-1642A 1962-67 Outer LH 66.99 ea.
RCP-1642 1962-67 Outer RH 69.99 ea.
RCS-1642C 1966-67 Shoulder LH 119.99 ea.
RCS-1642B 1966-67 Shoulder RH 119.99 ea.
RCP-679L 1968-72 Outer LH 52.99 ea.
RCP-679R 1968-72 Outer RH 52.99 ea.
RCP-679K 1968-72 Outer LH & RH 95.38 kit

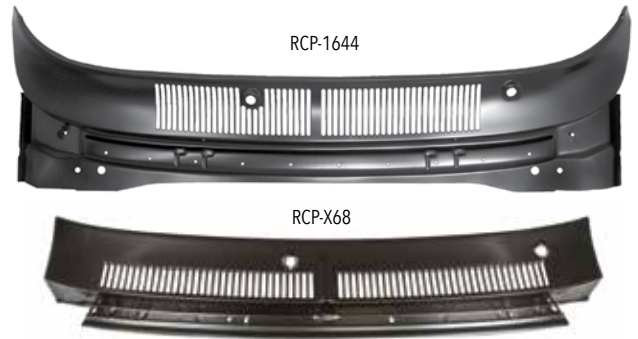

Cowl Vent Panel

Louvered sheet metal piece which installs directly below the windshield and behind the hood.

RCP-1644 1966-67 All 239.95 ea.
RCP-X68 1968-74 All 199.99 ea.
Ships Oversize.

RCP-68X



Upper Cowl Panel

Complete upper cowl panel assembly replaces this commonly rusted out area.

RCP-68X 1968-74 174.95 ea.
This item ships Oversize 2.

RCP-1642D



Lower Cowl Panel

This is a complete lower cowl panel assembly which replaces this entire area which is commonly rotted out.

RCP-1642D 1966-67 All 239.95 ea.
Ships Oversize.

RS-1641



Radiator Support

Excellent quality reproduction radiator support. Black EDP coated.

RS-32062 1962-64 All 209.99 ea.
RS-32065 1965 All 209.99 ea.
RS-32066 1966-67 All 209.99 ea.
RS-1641 1968-74 V8* 149.99 ea.
**Must be modified for big block. Ships Oversize 2.*

RDP-X69



Steel Dash Panel

Excellent reproduction steel dash panels for your 1966-1967 or 1969-72 Nova. This will replace your damaged or rotted original perfectly.

RDP-X66 1966-67 All 359.95 ea.
RDP-X69 1969-72 All w/o AC 319.99 ea.
RDP-X69AC 1969-72 All w/ AC 319.99 ea.
This item ships Oversize 2.

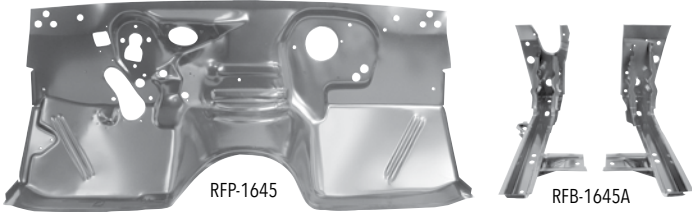

Firewall & Brackets

This is an OE style reproduction complete Nova firewall which will replace your rotted original exactly. The days of patching and welding in new firewall pieces are over. EDP coated to prevent rust and ready to prep, paint and install.

RFP-1645	1966-67 All Firewall	389.99 ea.
RFB-1645A	1966-67 All Brackets	249.99 pr.
RFW-X68	1968 w/o AC Firewall.....	369.99 ea.
RFW-X68AC	1968 w/ AC Firewall.....	399.99 ea.
RFW-X69	1969 w/o AC Firewall.....	369.99 ea.
RFB-67FL	1968-74 LH Firewall Bracket	79.99 ea.
RFW-X69AC	1969 w/ AC Firewall.....	369.99 ea.
RFB-67FR	1968-74 RH Firewall Bracket.....	79.99 ea.

Firewall Ships Truck Freight to a Commercial Address.



Top Inner Cowl Panel

Features a complete panel with wiper valley all in a sealed unit. This is a great item to repair your original rusted out top inner cowl panel area.

RCP-1072B	1968-74	299.95 ea.
-----------	---------------	------------

This item ships Oversize 2.



Window Tracks

Correct lower track in front door that holds the window in place. This track moves up and down to move the window up and down. These tracks replace your old rusty and damaged window tracks.

RWT-1608	1962-65 Lower RH	64.99 ea.
RWT-1608A	1962-65 Lower LH.....	64.99 ea.

REG-X62FL



Window Regulators

Complete regulators with rollers.

Front Manual Coupe

REG-X62FL	1962-65 LH	89.99 ea.
REG-X62FR	1962-65 RH.....	89.99 ea.
REG-X66FL	1966-67 LH.....	89.99 ea.
REG-X66FR	1966-67 RH.....	89.99 ea.
REG-X69FL	1969-72 LH.....	99.99 ea.
REG-X69FR	1969-72 RH.....	99.99 ea.
REG-X69FL-4	1969-72 LH 4 Door.....	89.99 ea.
REG-X69FR-4	1969-72 RH 4 Door.....	89.99 ea.

Rear Manual Coupe

REG-X62RL	1962-65 LH	89.99 ea.
REG-X62RR	1962-65 RH.....	89.99 ea.
REG-X66RL	1966-67 LH.....	89.99 ea.
REG-X66RR	1966-67 RH.....	89.99 ea.
REG-X69RL	1969-72 LH	89.99 ea.
REG-X69RR	1969-72 RH	89.99 ea.
REG-X69RL-4	1969-74 LH 4 Door	89.99 ea.
REG-X69RR-4	1969-74 RH 4 Door.....	89.99 ea.



RDX-1623D

Door Skins

Door skins are perfect for repairing doors that have not rusted through the inner shell. These stamped steel panels replace your old rusty skin.

RDX-1621N	1962-65 RH.....	169.99 ea.
RDX-1621M	1962-65 LH	179.99 ea.
RDX-1621J	1966-67 RH.....	169.99 ea.
RDX-1621K	1966-67 LH	169.99 ea.
RDX-1623C	1968-74 RH.....	159.99 ea.
RDX-1623D	1968-74 LH	159.99 ea.

RDX-1623 will work on 1973-74 only if the original inner top rail is reused on the new skin. Ships Oversize 2.



RSH-X68L

Door Shells

Finally available! These exact reproduction door shells will save you hours over trying to repair original doors or line up skins!

RSH-X62SL	1962-65 Sedan LH	389.99 ea.
RSH-X62SR	1962-65 Sedan RH.....	389.99 ea.
RSH-X62CL	1962-65 Coupe/Convertible LH	369.99 ea.
RSH-X62CR	1962-65 Coupe/Convertible RH.....	369.99 ea.
RSH-X66L	1966 LH.....	389.99 ea.
RSH-X66R	1966 RH	389.99 ea.
RSH-X66CL	1966 2 Door Sedan LH	389.99 ea.
RSH-X66CR	1966 2 Door Sedan RH	389.99 ea.
RSH-X67L	1967 LH.....	389.99 ea.
RSH-X67R	1967 RH	389.99 ea.
RSH-X67CL	1967 2 Door Sedan LH	389.99 ea.
RSH-X67CR	1967 2 Door Sedan RH	389.99 ea.
RSH-X68L	1968-72 LH	439.99 ea.
RSH-X68R	1968-72 RH.....	439.99 ea.

1962-67 sedan shells include door frame.

1971-72 models will require rewelding of the door hinges as factory.

Door shells must ship truck freight to a commercial address.

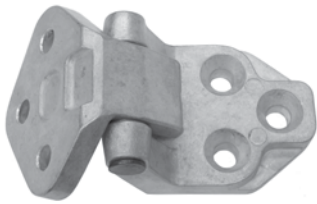

RDH-2236



RDH-2232

1962-67 Door Hinges

OE style reproduction replacement door hinges.

RDH-2236	1962-67 LH/RH Upper.....	54.99 ea.
RDH-2232	1962-67 RH Lower.....	79.99 ea.
RDH-2230	1962-67 LH Lower.....	79.99 ea.

Upper can be modified to fit 1967.



RDH-406UL



RDH-211LL

1968-79 Door Hinges

OE style reproduction replacement door hinges.

RDH-406UL	1968-79 Upper LH.....	52.99 ea.
RDH-406UR	1968-79 Upper RH.....	52.99 ea.
RDH-211LL	1968-79 Lower LH.....	54.99 ea.
RDH-211LR	1968-79 Lower RH.....	54.99 ea.
RDH-69FX-K	1968-79 Set of 4*.....	194.36 kit

No Volume Discount.



BAV-2622

RHS-9

BAV-2623

Door Hinge Hardware

Correct OEM bolts and heavy spring.

BAV-2622	Phillips.....	1.99 ea.
BAV-2623	Hex.....	1.99 ea.
BAV-2623K	1968-79 24pc Set*.....	29.61 kit
RHS-9	1968-79 Hinge Spring All.....	8.99 ea.

No Volume Discount.



RDR-689K

Hinge Detent Rollers

Correct machined detent rollers for lower hinges.

RDR-689K	1968-74 All.....	25.99 pr.
----------	------------------	-----------



BPX-1225

Door Hinge Pin Kits

Correct hinge pins and brass bushings for repairing all 4 of your door hinges.

BPX-1225	1968-74 (12 pc.).....	16.99 ea.
----------	-----------------------	-----------

May require slight modification to hinges.



BPX-1275

BPX-1299

Door Strikers w/ Washer

BPX-1275	GM Replacement.....	12.99 ea.
BPX-1299	Exact Reproduction*.....	13.99 ea.

**Correct Allen Head Zinc Plated.*



MS277-20M

Eddie Motorsports Billet Door Strikers

Replace your plain steel strikers with these attractive Eddie Motorsports stainless steel door striker bolts. These billet striker bolts are cut with a Torx head.

MS277-20M	1968-79 Machined.....	55.99 pr.
MS277-20P	1968-79 Polished.....	62.99 pr.

No Volume Discount.

REC-070B



Door Opening Rod End Clips

Spring steel retaining clips which attach the door opening rod to the door opening mechanism and the inner door lock rod end to the latch mechanism.

REC-070B	Various.....	5.99 pr.
----------	--------------	----------

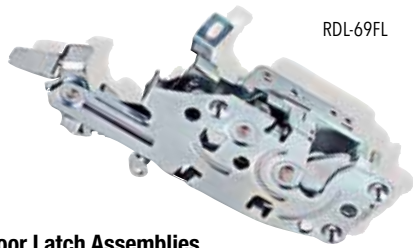

RDL-69FL

Door Latch Assemblies

OE style reproduction door latch assemblies.

RDL-1621R	1966-67 RH.....	79.99 ea.
RDL-1621S	1966-67 LH.....	79.99 ea.
RDL-69FR	1969-74 RH.....	79.99 ea.
RDL-69FL	1969-74 LH.....	79.99 ea.
RDL-69FK	1969-74 Kit.....	143.98 kit

WR-76



WR-78



Window Rollers

Correct replacement window rollers.

WR-068	1963-65 Door.....	8.99 ea.
WR-78	1962-64 Door All.....	13.99 ea.
WR-76	1962-64 Lower Quarter All.....	8.95 ea.



TRIM-WR

Window Roller Tool

Allows you to easily install window rollers.

TRIM-WR	All.....	18.99 ea.
---------	----------	-----------

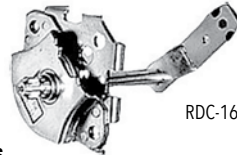

RDC-1621Q

Door Relays

OE style reproduction of the original door controllers which will save you hours of frustrating repair work to your original.

RDC-1621P	1966 RH.....	39.95 ea.
RDC-1621Q	1966 LH.....	39.95 ea.
RDR-1621Y	1967 RH.....	44.99 ea.
RDR-1621Z	1967 LH.....	44.99 ea.

1966 can be used on 1962-65 with slight modification.

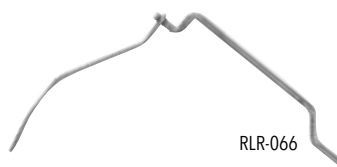

RLR-066

1968-74 Inner Door Lock Rod & Bellcrank

Plated and threaded inner door lock rod with attached bellcrank.

RLR-066	1968-74 All LH=RH.....	13.99 ea.
---------	------------------------	-----------



RBR-067

Bellcrank Retainer

Two required to mount one bellcrank to door frame.

RBR-067	1967-75 All.....	6.99 ea.
---------	------------------	----------

Quarter Panels

If your original quarter panels are dented or rotted right through to the ground, these exact reproduction quarter panels are the perfect replacement! There is no need to spend a fortune on an NOS quarter because this reproduction features a complete door jamb area, complete trunk jamb area and full roof sail panel. These are extremely high quality pieces, so you can be sure to get the best fit possible. *No Volume Discount. All quarter panels ship Truck Freight to a commercial address.*

RFQ-1621X



RFQ-1621W	1966-67 RH.....	399.99 ea.
RFQ-1621X	1966-67 LH.....	399.99 ea.

RFQ-68XL



RFQ-68XR	1968-69 RH.....	369.95 ea.
RFQ-68XL	1968-69 LH.....	369.95 ea.

RFQ-70XL



RFQ-70XR	1970-72 RH.....	399.99 ea.
RFQ-70XL	1970-72 LH.....	399.99 ea.

RQS-X75R



RQS-X75L	1975-79 LH 20"H x 76"L.....	169.99 ea.
RQS-X75R	1975-79 RH 20"H x 76"L.....	169.99 ea.

RFQ-1621R

95% Quarter Panels
Complete and correct reproduction quarter panels are manufactured to exact factory tolerances. These 95% quarters are of the finest quality available today and come complete with trunk weatherstrip lip, correct doorjamb area, reinforced bumper bracket area and correct side marker cutouts. These OE style panels are made from brand new tooling.

RFQ-1621R	1962-65 RH.....	299.99 ea.
RFQ-1621L	1962-65 LH.....	299.99 ea.

*These will work for coupes or convertibles.
No Volume Discount. Ships truck freight to a commercial address.*

RQD-1619Q

Weight: 59lbs.

RQD-1619P

1966-67 Quarter Panel & Door Frame Assembly

This is a complete Nova quarter panel and door frame assembly. This massive piece of sheet metal includes the entire inner quarter panel and door structure as well as the windshield pillars, rocker panels and wheel houses just as pictured. This assembly will save you hours and dollars over having to custom fabricate your own pieces of metal to repair your old rusty structure.

RQD-1619Q	1966-67 LH.....	1199.95 ea.
RQD-1619P	1966-67 RH.....	1199.95 ea.
RQF-667L	1966-67 LH Un-Assembled.....	2148.95 kit
RQF-667R	1966-67 RH Un-Assembled.....	2148.95 kit

No Volume Discount. Ships truck freight to a commercial address.



RQR-X68L

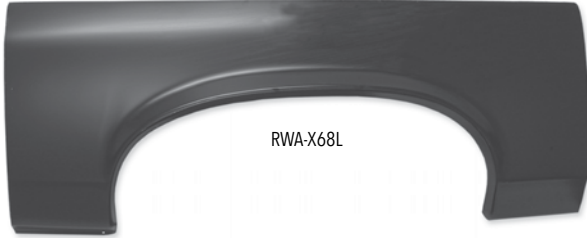

RWA-X68L

Quarter Panel Patches

High quality, die stamped quarter panel patches which are perfect when only portions of your quarter panel are rotted out.

RQR-X66FL	1966-67 LH Front Lower.....	94.99 ea.
RQR-X66FR	1966-67 RH Front Lower.....	94.99 ea.
RQR-X66RL	1966-67 LH Rear Lower.....	112.99 ea.
RQR-X66RR	1966-67 RH Rear Lower.....	112.99 ea.
RQR-X68L	1968-72 Rear Lower LH.....	54.99 ea.
RQR-X68R	1968-72 Rear Lower RH.....	54.99 ea.
RWA-X68L	1968-72 Wheel Arch LH.....	54.99 ea.
RWA-X68R	1968-72 Wheel Arch RH.....	54.99 ea.
RWA-X68K	1968-72 Wheel Arch Pair.....	98.98 kit
RQR-X73L	1973-74 Rear w/ Arch LH.....	69.99 ea.
RQR-X73R	1973-74 Rear w/ Arch RH.....	69.99 ea.



RWH-1628C



RWH-1628D

Outer Wheelhouse Assembly

Brand new! Complete outer wheelhouse assemblies.

RWH-1628C	1966-67 RH.....	209.99 ea.
RWH-1628D	1966-67 LH.....	209.99 ea.

Ships UPS Oversize 2.



RQS-62R



RQS-X66R



RQS-X68R



RQS-X70L



RQS-73L

Quarter Panel Skins

These quarter panel repair skins offer a quick and inexpensive way to repair your original factory quarter panels without fully cutting them out. They extend from the upper belt line down. Fits all coupes and convertibles.

RQS-62L	1962-65 LH 26"H x 75"L.....	199.99 ea.
RQS-62R	1962-65 RH 26"H x 75"L.....	199.99 ea.
RQS-X66R	1966-67 LH 26"H x 75"L.....	239.99 ea.
RQS-X66L	1966-67 RH 26"H x 75"L.....	239.99 ea.
RQS-X68R	1968-69 RH 26"H x 75"L.....	239.99 ea.
RQS-X68L	1968-69 LH 26"H x 75"L.....	239.99 ea.
RQS-X70L	1970-72 LH 26"H x 75"L.....	239.99 ea.
RQS-X70R	1970-72 RH 26"H x 75"L.....	239.99 ea.
RQS-73L	1973-74 RH 20"H x 76"L.....	199.99 ea.
RQS-73R	1973-74 LH 20"H x 76"L.....	199.99 ea.
RQS-X75L	1975-79 LH 20"H x 76"L.....	169.99 ea.
RQS-X75R	1975-79 RH 20"H x 76"L.....	169.99 ea.

No Volume Discount. Ships Truck Freight to a commercial address.



RWH-68XL

Rear Inner Wheelhouse

OE style reproductions of the original inner wheelhouse panels.

RWH-68XL	1968-74 LH	116.99 ea.
RWH-68XR	1968-74 RH	116.99 ea.
RWH-68XK	1968-74 Inner LH-RH Pair	210.58 pr.

Ships Oversize 2.



RWH-1629R

Rear Outer Wheelhouse

OE style reproductions of the original outer wheelhouse panels.

RWH-1627R	1962-65 RH	94.99 ea.
RWH-1627L	1962-65 LH	94.99 ea.
RWH-1628R	1966-67 RH	89.99 ea.
RWH-1628L	1966-67 LH	89.99 ea.
RWH-1629R	1968-74 RH	109.99 ea.
RWH-1629L	1968-74 LH	109.99 ea.

Ships Oversize 2.



RTB-X62-1P

1962-1974 Toe Boards

Toe boards are the extension piece that connects the front floor pan to the firewall. This is an exact replacement for your rotted out original.

RTB-X62-1P	1962-67 Complete 1 Piece	219.99 ea.
RTB-X62L	1962-67 Left Side Only	99.99 ea.
RTB-X62R	1962-67 Right Side Only	99.99 ea.
RTB-X68-1P	1968-74 Complete 1 Piece	149.99 ea.
RTB-X68L	1968-74 Left Side Only	104.99 ea.
RTB-X68R	1968-74 Right Side Only	104.99 ea.

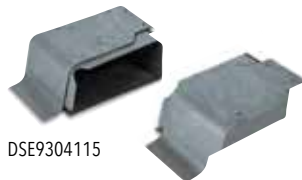

DSE9304115

1962-67 DSE Torque Boxes

This set of DSE torque boxes is required when using DSE's subframe connectors if you are not installing a DSE Quadralink rear suspension.

DSE9304115	1962-67	199.99 pr.
------------	---------------	------------

No Volume Discount.



DSE040402



DSE Deep Tubs

Detroit Speed & Engineering deep tubs are inner wheel housings designed to accommodate wider tire and wheel packages. They are engineered for a perfect fit, retain a stock appearance and are stamped from 18 gauge steel. They allow for 335mm tires and 13" wide tires. Made in USA.

DSE040404	1962-67 All	545.99 pr.
DSE040402	1968-74 All	485.99 kit

Ships Oversized. No Volume Discount.

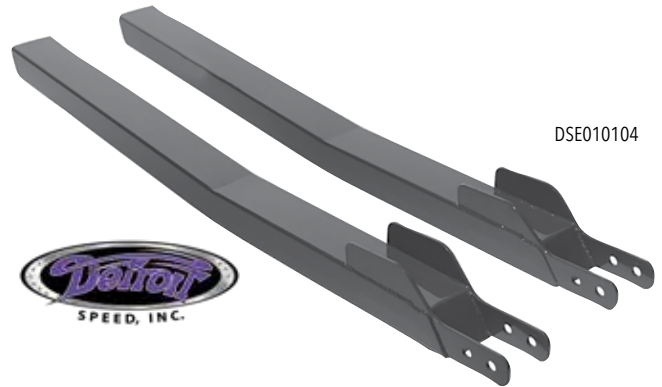

DSE010104



DSE Subframe Connectors

These uniquely designed DSE weld-in subframe connectors increase your car's stiffness by connecting the front subframe to the rear frame rails. DSE subframe connectors are fabricated from 2 inch x 3 inch x 0.120 inch wall rectangular steel tubing. Laser cut brackets are included that attach the rear of the subframe to the connector for an easy, strong and simple welded joint. Unlike others, the DSE subframe connectors are barely visible from underneath the car. The rear of the connector is tapered to attach to the rear frame rails and also has a laser cut slot that conforms to the rear seat floor pan. The connectors are bent and TIG welded in a fixture for accuracy and repeatability. DSE subframe connectors do not interfere with seat attachment hardware or the installation and removal of the rear leaf spring pocket. These can be installed on coupes and convertibles and the molded factory carpet will still fit over them. DSE weld-in connectors include templates, pictures and detailed instructions.

DSE010104	1962-67 All*	237.99 pr.
DSE010102	1968-74 All	299.99 pr.

** If not installing the Chevy 2 Quadralink you will need to purchase the DSE torque boxes.*



1962-67 Full Floor w/ A/T Cutout

This COMPLETE floor pan features transmission hump with cutout for automatic. It also features correct floor pan braces. This truly takes the hassle out of having to weld together your own replacement floor pan!

RFP-1636 1962-67 Automatic on Floor 499.99 ea.
This item ships truck freight to a commercial address. No Volume Discount.

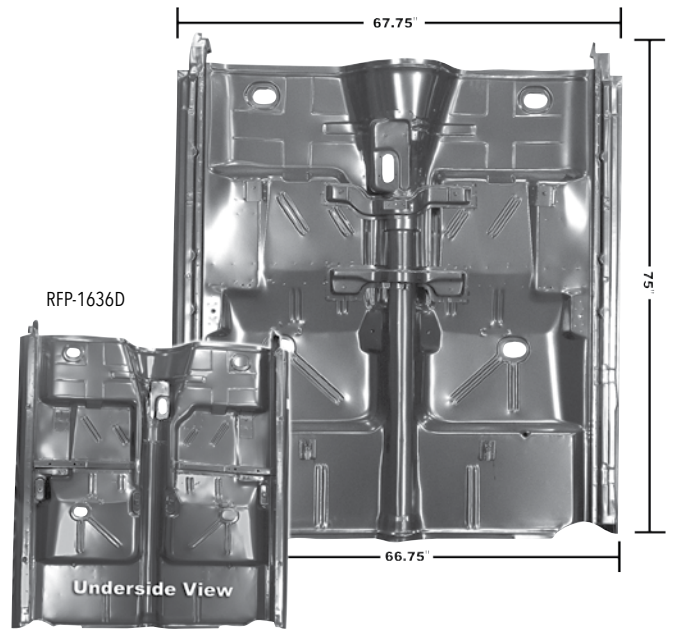

1962-67 Full Floor with Rockers

This is the ultimate replacement floor pan. This truly takes the hassle out of having to weld together your own replacement floor pan and rockers!

RFP-1636D 1962-67 Automatic 979.95 ea.
This floor includes seat mounts and hole for automatic floor shift.
This item ships truck freight to a commercial address. No Volume Discount.

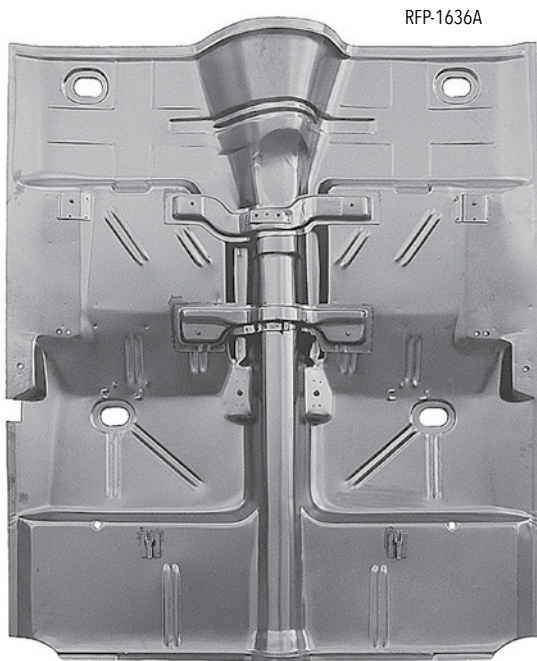

1962-67 Full Floor

This COMPLETE floor pan features transmission hump without any cutout for column shifted cars. It also features correct floor pan braces. This truly takes the hassle out of having to weld together your own replacement floor pan!

RFP-1636A 1962-67 No Hole..... 499.99 ea.
Cut for manual transmission and use ITW-4004 hump.
This item ships truck freight to a commercial address. No Volume Discount.



1962-67 Full Floor with Rockers

This is the ultimate replacement floor pan. This truly takes the hassle out of having to weld together your own replacement floor pan and rockers!

RFP-1636E 1962-67 No Hole..... 969.95 ea.
This floor does NOT include transmission hole or seat mounts.
Cut for manual transmission and use ITW-4004 hump.
This item ships truck freight to a commercial address. No Volume Discount.



RFP-1636A-DLX



RFP-1636-DLX

1962-1967 Nova Floor Assembly with Toe Board & Bucket Seat Brackets

This convenient 1962-1967 Nova floor pan truly takes the hassle out of having to weld together your own replacement floor pan! It also features a complete toe board and correct seat mounting brackets.

- RFP-1636A-DLX 1962-67 w/o Auto Shifter Hole 799.99 ea.
 - RFP-1636-DLX 1962-67 with Auto Shifter Hole 899.99 ea.
- This item ships truck freight to a commercial address. No Volume Discount.*

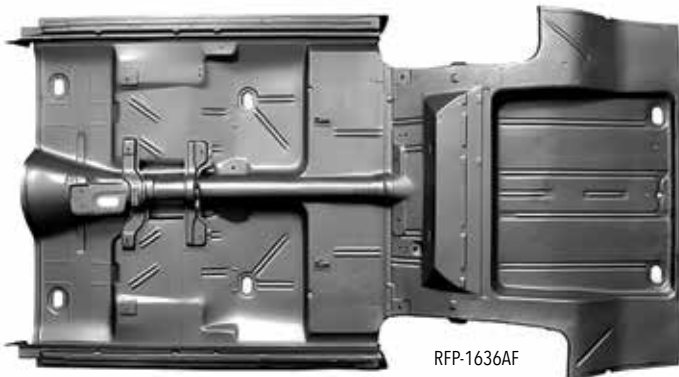

RFP-1636AF

1966-67 Complete Floor/Trunk Pan

This monstrous piece of sheet metal consists of our complete floor pan with rockers already attached to our complete trunk floor pan so you can replace the entire floor of your Nova in one shot! Measures approximately 129.5" long x 66.75" wide (front) x 64.75" wide (rear).

- RFP-1636AF 1966-67 All 2199.99 ea.
- Due to the size and special handling requirements of this item, this item ships truck freight to a commercial address directly from the manufacturer. A minimum shipping & handling cost of \$499 applies. Please ask your sales rep for a shipping quote. No Volume Discount.*

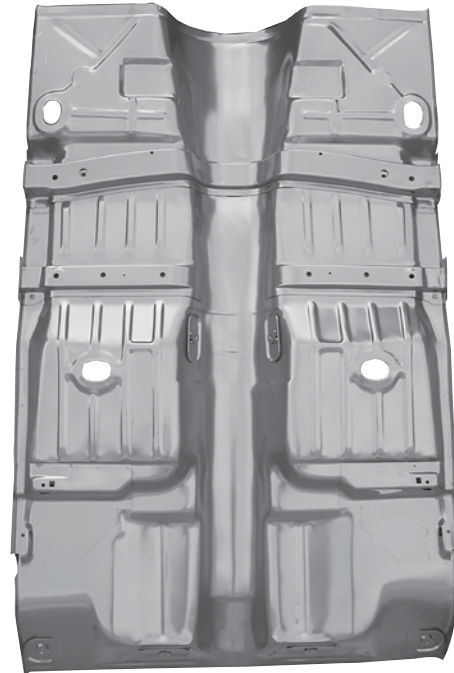

RFP-X1968

1968-74 Full Floor Pan w/ Braces

This is a complete, brand new one piece floor pan assembly which includes all of the braces. This floor will eliminate the hassle of piecing together individual parts. Braces are included.

- RFP-X1968 1968-74 All 469.99 ea.
- This floor includes seat mount.
This item ships truck freight to a commercial address. No Volume Discount.*



RFB-68X

Floor Pan Braces

These often rusted body braces attach under the front seat and rear of the car and extend across the car to reinforce the floor pan.

- RFB-62L 1962-67 LH All 69.99 ea.
- RFB-62R 1962-67 RH All 69.99 ea.
- RFB-68X 1968-74 Front 109.99 ea.
- RFB-68R 1968-74 Rear RH 79.99 ea.
- RFB-68L 1968-74 Rear LH 79.99 ea.

Ships UPS Oversize 1.



ITW-4004



ITW-4008

Transmission Floor Hump

This was the stamped steel hump that was factory installed on all 3 or 4 speed models.

- ITW-4004 1962-67 Manual 84.99 ea.
- RST-1636G 1962-67 Automatic 44.95 ea.
- ITW-4008 1968-72 All w/ Console 69.99 ea.



RFP-1630



RFP-1631

Half Floor Pans

These exceptional quality reproduction floor pans will replace the original floor pans exactly and are all manufactured in the correct gauge metal with the same configurations and die-stamped patterns as the originals.

RFP-1630	1962-67 RH 27"W x 60"L	99.99 ea.
RFP-1631	1962-67 LH 27"W x 60"L	99.99 ea.
RFP-1634	1968-74 LH 20"W x 60"L	109.99 ea.
RFP-1635	1968-74 RH 20"W x 60"L	109.99 ea.

Ships Oversize 2. No Volume Discount.



RFP-681L

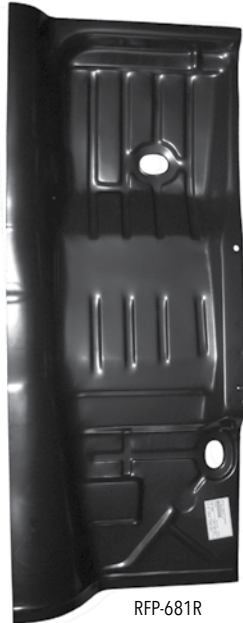

RFP-681R

1962-74 Half Floor Pans with Tunnel

This is a correct Nova half floor pan complete with transmission tunnel hump. Unlike other half floor pans that lack the transmission tunnel, this floor pan will literally seam together with the other half, offering a complete replacement.

RFP-X621L	1962-67 LH	89.99 ea.
RFP-X621R	1962-67 RH	89.99 ea.
RFP-681L	1968-74 LH	119.99 ea.
RFP-681R	1968-74 RH	119.99 ea.

Ships Oversize 2. No Volume Discount.



1962-67 Quarter Floor Pans

These are correct Nova floor pan quarters complete with the transmission tunnel hump. These are more complete than the other floor pan patches out there and will make repairing your floor a snap.

RFP-X62FL	1962-67 LH Front	119.99 ea.
RFP-X62FR	1962-67 RH Front	119.99 ea.
RFP-X62RL	1962-67 LH Rear	69.99 ea.
RFP-X62RR	1962-67 RH Rear	69.99 ea.



Factory Style Bucket Seat Brackets

These are OE style reproduction bucket seat brackets which are designed for factory seat tracks. These brackets are essential when converting from bench to buckets or when replacing your floor pan.

ICC-1636C	1962-67	129.95 pr.
ICC-50768	1968-71	129.99 set
IBX-X1	1968-72*	104.99 kit
IBX-RELO	All 4pc**	34.99 kit

**Does one car. **Technically correct for 1969-71 but fits 68-72 with low back seats.*

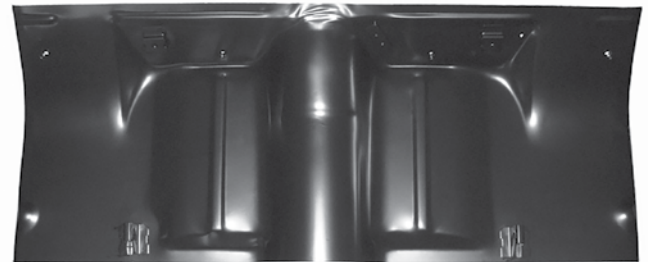

RFP-68U

1962-74 Rear Seat Floor Pan

Complete under rear seat floor pan w/ braces.

RFP-1632B	1962-67 All w/ Braces	299.99 ea.
RSP-X62	1962-67 Full w/o Braces	89.99 ea.
RSP-X62L	1962-67 Left Side	49.99 ea.
RSP-X62R	1962-67 Right Side	49.99 ea.
RFP-68U	1968-74 All Complete	139.99 ea.
RFP-68UL	1968-74 Left Side	84.99 ea.
RFP-68UR	1968-74 Right Side	84.99 ea.

Ships Oversize.



1968-74 Rear Seat Mounting Brackets

This rear seat mounting bracket will replace your rusted out original perfectly.

RSB-X68L	1968-74 LH	69.99 ea.
RSB-X68R	1968-74 RH	69.99 ea.

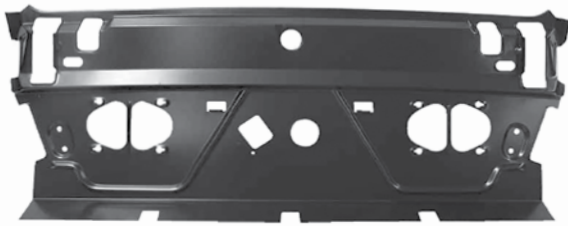

RPT-X68

1968-72 Rear Deck Package Tray Panel

This Nova rear seat shelf panel replaces the commonly rusted area under the rear deck package tray.

RPT-X68 All Coupe239.99 ea.
Ships Oversize.



KPS-682L

Kick Panel Supports

This piece attaches on the front of the rocker panel and retains the kick panel. This is an OE style replacement for this often rotted out area.

KPS-682L 1968-74 LH59.99 ea.
KPS-682R 1968-74 RH59.99 ea.



RRP-4010L



RIP-X68R



RRP-X68L

Rocker Panels

Correct factory style outer rocker panels which are die-stamped and EDP coated and match the original factory mounting points.

RRP-4010L 1962-67 LH Full Outer.....129.99 ea.
RRP-4010R 1962-67 RH Full Outer.....129.99 ea.
RRP-66L 1966-67 Complete LH.....269.99 ea.
RRP-66R 1966-67 Complete RH.....269.99 ea.
RIP-X68L 1968-72 Full Inner LH.....129.99 ea.
RIP-X68R 1968-72 Full Inner RH.....129.99 ea.
RRP-X68L 1968-79 Full Outer LH.....149.99 ea.
RRP-X68R 1968-79 Full Outer RH.....149.99 ea.
RIP-1665L 1968-79 Full Inner w/ Kick Panel Support LH.....174.99 ea.
RIP-1664R 1968-79 Full Inner w/ Kick Panel Support RH.....174.99 ea.

Ships Oversized.



RFB-1632D

RFB-1632F

Frame Rail Braces

Correct front and rear frame rail braces which are highly recommended when replacing your frame rails.

RFB-1632F 1966-67 Front LH 54.95 ea.
RFB-1632E 1966-67 Front RH..... 54.95 ea.
RFB-1632D 1966-67 Rear LH 32.99 ea.
RFB-1632C 1966-67 Rear RH..... 32.99 ea.



RFR-646

Subframe Repair

Choose our 6 piece repair kit to repair your rusted out body mount points on the frame.

RFR-646 1968-74 6pc.....60.99 kit



RFR-1632Z



RFR-1632Y

Frame Rails

Stop looking for a donor car and get one of these rear frame rails to repair this often rusted out piece! Each frame rail is made of high quality steel and is exact to original.

RFR-1632Z 1966-67 LH 319.99 ea.
RFR-1632Y 1966-67 RH..... 319.99 ea.
RFR-X8L 1968-74 LH289.99 ea.
RFR-X8R 1968-74 RH.....289.99 ea.

Ships Oversize.



FCM-1625P

1966-67 Engine Crossmember

This is an exact reproduction of the original engine cradle which will replace your rotted or damaged original exactly.

FCM-1625P 1966-67 All.....74.99 ea.

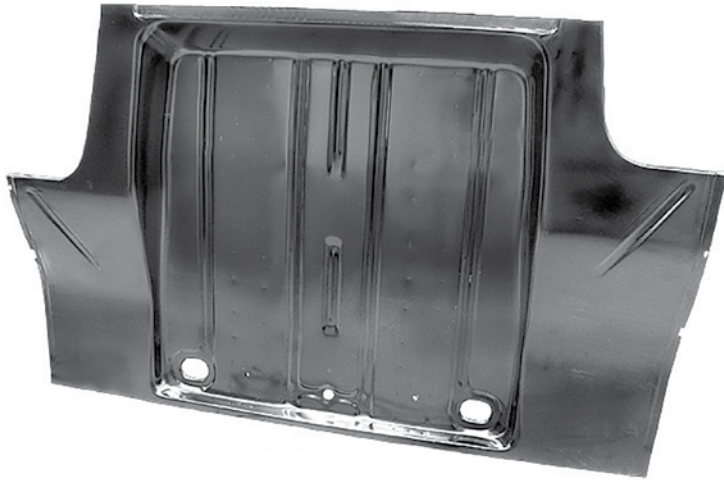

RTF-1632A



Complete Trunk Floor Pan

Brand new! Manufactured to OE style original factory specifications, these stamped floor pans include all necessary straps for a hassle free installation!

RTF-1632A 1962-67 399.95 ea.

This item ships truck freight to a commercial address. No Volume Discount.

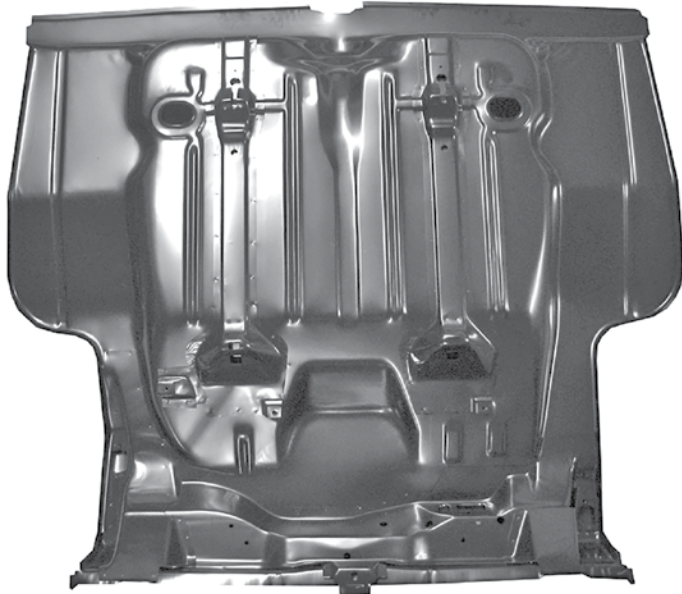

RTF-X71



Complete Trunk Floor Pan

This is a complete Nova trunk floor with braces for a hassle free installation. This full trunk floor will save you a lot of time and money over piecing together or attempting to patch your original rotted trunk floor pan.

RTF-X68F 1968-70 All..... 369.99 ea.

RTF-X71 1971-72 All..... 369.99 ea.

No Volume Discount. Ships Truck Freight to a commercial address.



RTF-62-3P

1962-1967 Nova Trunk Floor Kit 3 Piece

This is a complete 3 piece trunk floor pan to patch and repair your original trunk.

RTF-62-3P 1962-67 227.99 kit

No Volume Discount.



RTF-1632



RTF-X68



RTF-1633

Center Trunk Floor Pans

Correct die stamped center trunk floor pans, perfect when only the center is rusted out.

RTF-1632 1962-67 39" x 39" 99.99 ea.

RTF-X68 1968-72 47" x 37" 129.99 ea.

RTF-1633 1968-72 39.5" x 30.5" (Small) 99.99 ea.

Ships Truck Freight to a commercial address.



RTE-66R



RTE-68L

Trunk Floor Drop Offs

Die stamped panels that extend between the quarter panel and trunk floor (commonly known as drop offs).

RTE-62L	1962-65 LH	69.99 ea.
RTE-62R	1962-65 RH	69.99 ea.
RTE-66L	1966-67 LH	54.99 ea.
RTE-66R	1966-67 RH	54.99 ea.
RTE-68L	1968-74 LH	49.99 ea.
RTE-68R	1968-74 RH	49.99 ea.



REC-3068L

Trunk Floor Drop Off End Cap

Correct end cap for the trunk floor drop off (floor to quarter panel extension).

REC-3068L	1968-72 LH	39.99 ea.
REC-3068R	1968-72 RH	39.99 ea.



RTE-68EL

Trunk Floor Extensions

OE style reproduction trunk floor extension.

RTE-62EL	1962-67 LH	59.99 ea.
RTE-62ER	1962-67 RH	59.99 ea.
RTE-68EL	1968-72 LH	69.99 ea.
RTE-68ER	1968-72 RH	69.99 ea.

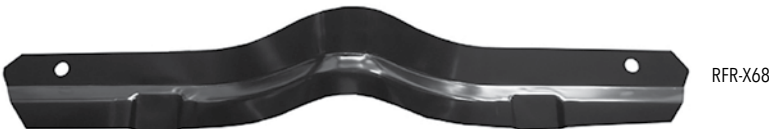

RFR-X68



RFR-X68R

Rear Trunk Cross Rails

OE style reproduction front and rear cross rails which weld to the trunk floor for support.

RFR-X62	1962-65 Rear Cross Rail	129.99 ea.
RFR-X68	1968-74 Front Cross Rail Only	89.99 ea.
RFR-X68R	1968-72 Complete Rear Assembly	259.99 ea.



RDP-100

Trunk/Floor Pan Drain Plug

Correct die stamped floor drain plug.

RDP-100	1962-74	3.95 ea.
---------	---------	----------



RSM-681B

Rear Shock Mount

Correct Weld-in rear shock mounting point.

RSM-681B	1968-74	22.99 ea.
----------	---------	-----------

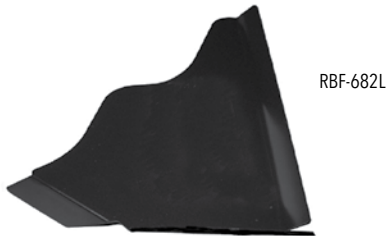

RBF-682L



RBF-682R

Cross Bar Filler Panels

Correct rear cross bar filler behind rear seat panel.

RBF-682L	1968-74 LH	19.99 ea.
RBF-682R	1968-74 RH	19.99 ea.



RRB-684L

Rear Side Rail Brace

OE style reproduction rear side rail reinforcement piece.

RRB-684L	1968-74 LH	44.99 ea.
RRB-684R	1968-74 RH	44.99 ea.



RTB-100



RTB-X68

Trunk Floor Fuel Tank Brace

Die stamped steel trunk floor braces that the gas tank straps attach to and are welded to the bottom side of the trunk floor.

RTB-100	1962-67	39.99 ea.
RTB-X68	1968-74	84.99 ea.
RTB-X68K	1968-74 LH/RH	152.98 kit



RGB-68XL



RGB-70XL

Trunk Gutter Side Braces

Correct stamped steel side braces which support the trunk gutter.

RGB-625XL	1962-65 LH	39.99 ea.
RGB-625XR	1962-65 RH	39.99 ea.
RGB-68XL	1968-69 LH	54.99 ea.
RGB-68XR	1968-69 RH	54.99 ea.
RGB-70XL	1970 LH	54.99 ea.
RGB-70XR	1970 RH	54.99 ea.
RGB-71XL	1971-72 LH	54.99 ea.
RGB-71XR	1971-72 LH	54.99 ea.



Trunk Lid

Reproduction trunk lids are now available featuring die-stamped steel and top quality craftsmanship!

RT-1603X	1962-64.....	389.99 ea.
RT-1603Y	1965.....	349.99 ea.
RT-1604	1966-67.....	329.99 ea.
RT-1605	1968-74.....	229.99 ea.

All trunk lids ship truck freight only. No Volume Discount.

RT-1605



RTL-6470

Trunk Catch

Used to latch the trunk lid and make the adjustment in the catch.

RTL-6470	1964-70.....	26.99 ea.
----------	--------------	-----------

Trunk Catch Anchor

Welds to the center of the rear body panel to provide the mounting location for the catch. Stamped steel.

RSA-550	1968-72.....	46.99 ea.
---------	--------------	-----------



RSA-550

Trunk Lid Latch

OE style reproduction of the often damaged or missing trunk latching device.

RTL-1019	1962-72 All.....	29.95 ea.
TLB-716	1962-79 Latch Bolts.....	9.99 set



RTL-1019



RTP-1615

Rear Window to Trunk Panel

Correct reproduction of the original panel that installs between the rear window and trunk lid.

RTP-1615	1966-67.....	72.99 ea.
RTP-1968	1968-74.....	79.99 ea.

Ships Oversize.

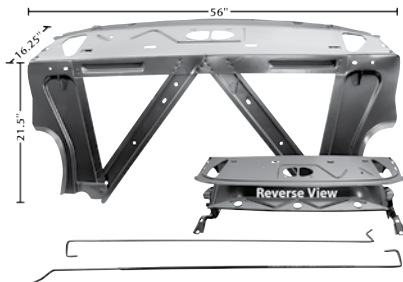

RTD-1632H

Trunk Divider / Package Shelf & Supports

Complete assembly to replace this commonly rusted out area. Includes trunk torsion rods. Supports are sold separately.

RTD-1632H	1966-67 Assembly	499.95 ea.
RPT-1632K	1966-67 Supports	74.99 pr.
RLS-1606	1966-67 Torsion Rods Only	44.95 ea.
RPT-X68	1968-72 Package Tray Panel.....	239.99 ea.

Ships Oversize 2.

Rear Body Panels – Tail Light Panels

Correct die-stamped reproductions of the rear tail light panels including correct cut outs for tail light assemblies.



RP-6265



RP-62-X

RP-6265	1962-65 Upper With Gutter	179.99 ea.
RP-62-X	1962-64 Complete.....	319.99 ea.



RP-1621C	1962-64 RH.....	59.95 ea.
RP-1621D	1962-64 LH	59.95 ea.

Panels can be used on 1965 with modifications.



RP-1621V	1966-67 RH.....	59.95 ea.
RP-1621U	1966-67 LH	59.95 ea.



RP-1623Z	1966-67.....	104.95 kit
----------	--------------	------------



RP-1623Y	1966-67 Complete	329.99 ea.
----------	------------------------	------------



RP-1624	1968-69.....	119.99 ea.
---------	--------------	------------



RP-1625	1970-72.....	119.99 ea.
---------	--------------	------------



RP-1626	1973-74.....	139.99 ea.
---------	--------------	------------

All tail panels above ship oversized 2.



RTG-3000

1962-65 Trunk Lid Guides

Correct plastic trunk lid guides which screw onto the quarter panels to keep the trunk lid centered.

RTG-3000	1962-65.....	11.99 pr.
----------	--------------	-----------



RTH-1604B

1966-67 Trunk Hinges

This is a pair of OE style reproduction Nova trunk lid hinges which will replace your damaged or worn out originals.

RTH-1604B	1966-67 All.....	128.95 pr.
-----------	------------------	------------



1966-67 Windshield Pillar

This is an OE style reproduction Nova windshield pillar which extends from the roof to the windshield base. This is the perfect replacement for your rotted original.

RWP-1642G	1966-67 LH	39.95 ea.
RWP-1642F	1966-67 RH	39.95 ea.

KPR-1672



1966-67 Drip Rails

Correct metal drip rails which run along the sides of the roof panel.

KPR-1672	1966-67 All.....	139.99 pr.
----------	------------------	------------



GWC-SPK

Trunk Wire Clip

Correct clips used to hold the power trunk or trunk light wires to the hinge.

GWC-SPK	1962-79 All.....	19.99 pr.
---------	------------------	-----------



MS149-11P

Eddie Motorsports Billet Trunk Hinges

These billet trunk hinges are CNC machined from high quality 6061-T6 aluminum. They utilize Nitrogen filled gas struts that replace the stock torsion springs and high quality Delrin bushings for smooth reliable operation. The hinges are designed as direct fit, "bolt on" parts with some minor drilling required for fastening of the strut mount. The hinges come complete with mounting hardware, brackets (where required) and gas struts.

M = Machined
B = Blue Fusioncoat
BK = Gloss Black Fusioncoat
MBA = Matte Black Anodized

P = Polished
W = White Fusioncoat
BKA = Gloss Black Anodized
CL = Clear Coat

R = Red Fusioncoat
PR = Purple Fusioncoat
MB = Matte Black Fusioncoat
CA = Clear Anodized

		M	P	R, B, W, PR, BK, BKA, MB, MBA, CL, CA
MS149-11	1962-65 All	425.99 pr.	465.99 pr.	435.99 pr.
MS149-04	1966-67 All	425.99 pr.	465.99 pr.	405.99 pr.

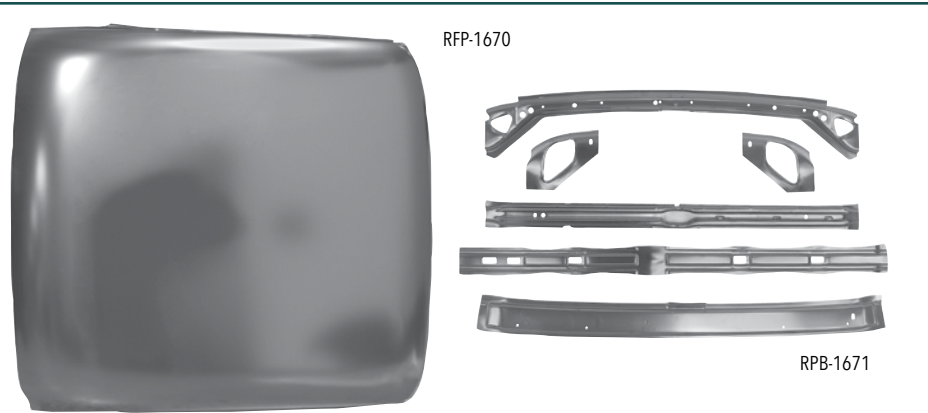

RFP-1670

RPB-1671

1962-72 Roof Panel

Excellent reproduction roof panel skin which will replace your rotted out original perfectly. Roof panel brace kit includes all necessary reinforcement pieces and is a must when replacing the roof.

RFP-1669	1962-65 Coupe Roof Panel	499.99 ea.
RFP-1670	1966-67 Roof Panel	449.99 ea.
RPB-1671	1966-67 Roof Panel Braces	209.95 ea.
RP-X68	1968-72 Roof Panel	399.99 ea.

Roof panel ships Truck Freight to a commercial address.

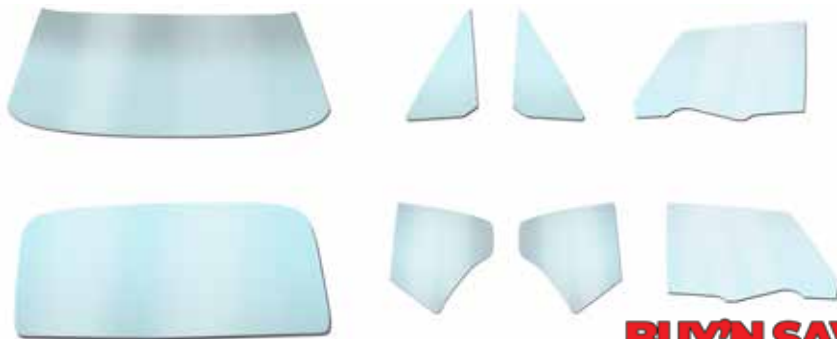

BUY 'N SAVE
WITH KITS

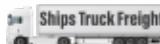

Complete Glass Kits

Save when you buy a complete set of replacement window glass! Green tinted as original.

GL-62XX	1962 2 Door Coupe.....	699.99 kit
GL-62XKS	1962 2 Door Sedan.....	699.99 kit
GL-62XKV	1962 Convertible.....	699.99 kit
GL-63XX	1963-65 2 Door Coupe.....	799.99 kit
GL-63XKV	1963 Convertible.....	699.99 kit
GL-63XKS	1963-64 2 Door Sedan.....	799.99 kit
GL-65XKS	1965 2 Door Sedan.....	649.99 kit
GL-66XX	1966-67 2 Door Coupe.....	799.99 kit
GL-66XKS	1966-67 2 Door Sedan.....	649.99 kit
GL-68XX	1968-69 2 Door w/o Antenna.....	921.99 kit
GL-68XKA	1970-72 2 Door w/ Antenna.....	949.99 kit
GL-73XKN	1973-74 2 Door Notchback.....	999.99 kit

No Volume Discount. Ships Truck Freight to a Commercial Address.

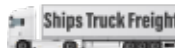

Windshield Glass

Concourse quality tinted windshield glass for an OE style factory replacement.

GL-62XF	1962-67 Hardtop / 1962-63 Convertible.....	155.99 ea.
GL-62XSF	1962-67 Sedan.....	149.99 ea.
GL-68XF	1968-69 2 Door.....	163.99 ea.
GL-68XFA	1970-72 2 Door.....	197.99 ea.
GL-73XF	1973-74 2 Door.....	165.99 ea.

1970-72 includes built-in antenna. No Volume Discount. Ships Truck Freight to a Commercial Address.

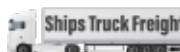

Rear Window Glass

Concourse quality tinted rear window glass for an OE style factory replacement.

GL-62XB	1962-65 Coupe.....	231.99 ea.
GL-62XSB	1962-64 Sedan.....	242.99 ea.
GL-65XSB	1965 Sedan.....	242.99 ea.
GL-66XB	1966-67 Coupe.....	239.99 ea.
GL-66XSB	1966-67 Sedan.....	242.99 ea.
GL-68XB	1968-72 2 Door.....	292.99 ea.
GL-73XBN	1973-74 2 Door Notchback.....	319.99 ea.

Ships Truck Freight to a Commercial Address.

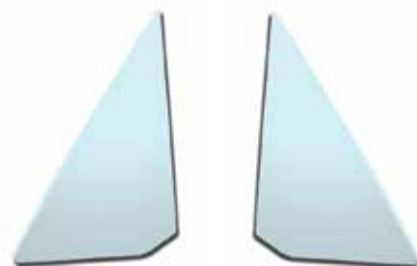

Vent Window Glass

GL-62XV	1962 LH or RH.....	60.99 ea.
GL-63XV	1963-67 LH or RH.....	30.99 ea.
GL-68XVL	1968-72 LH.....	87.99 ea.
GL-68XVR	1968-72 RH.....	87.99 ea.



Quarter Window Glass

Concourse quality tinted quarter window glass for an OE style factory replacement.

GL-62XQ	1962-65 Coupe LH or RH.....	57.99 ea.
GL-66XQ	1966-67 Coupe LH or RH.....	59.99 ea.
GL-62XSQ	1966-67 Sedan LH or RH.....	64.99 ea.
GL-66XSQ	1966-67 Sedan LH or RH.....	57.99 ea.
GL-62XVQ	1962 Convertible LH or RH.....	70.99 ea.
GL-63XVQ	1963 Convertible LH or RH.....	70.99 ea.
GL-68XQL	1968-72 All LH.....	141.99 ea.
GL-68XQR	1968-72 All RH.....	141.99 ea.
GL-73XQL	1973-74 All LH.....	109.99 ea.
GL-73XQR	1973-74 All RH.....	109.99 ea.



Door Window Glass

Concourse quality tinted door window glass for an OE style factory replacement.

GL-62XD	1962-65 Coupe/Convertible LH=RH....	61.99 ea.
GL-66XD	1966-67 Coupe LH=RH.....	65.99 ea.
GL-62XSD	1962-67 Sedan LH=RH.....	57.99 ea.
GL-68XDL	1968-72 2 Door LH.....	159.99 ea.
GL-68XDR	1968-72 2 Door RH.....	159.99 ea.
GL-73XDL	1973-74 2 Door LH.....	220.99 ea.
GL-73XDR	1973-74 2 Door RH.....	220.99 ea.

Ships Oversize 2.



RWT-1608



RWT-1608A

Window Tracks

Correct lower track in front door that holds the window in place. This track moves up and down to move the window up and down. These tracks replace your old rusty and damaged window tracks.

RWT-1608	1962-65 RH.....	64.99 ea.
RWT-1608A	1962-65 LH.....	64.99 ea.



TRIM-WR

Window Roller Tool

Allows you to easily install window rollers.

TRIM-WR	All.....	18.99 ea.
---------	----------	-----------



KTW-2222



KW-648

Windshield Glass Stop

OE style reproduction windshield glass stop clip rubber coated as original. Two required.

KTW-2222	1962-65 All	18.99 ea.
KW-648	1968-79 All	8.99 ea.

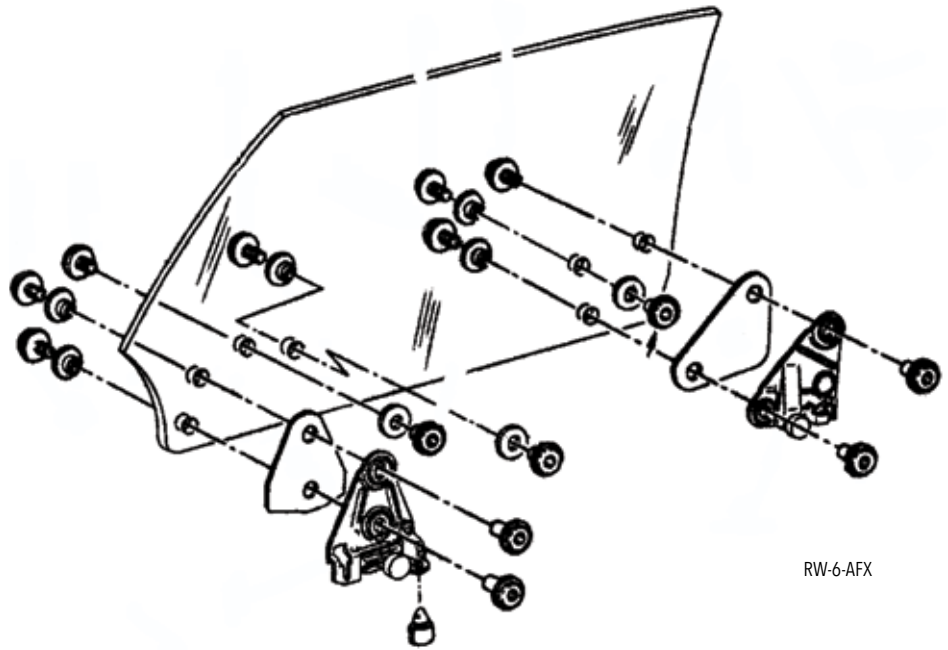

RW-6-AFX

Door Window Hardware Kit

This convenient door window hardware kit includes all of the necessary pieces to rebuild the rollers, guides and bushings on the door window regulators. Made in USA.

RW-6-AFX	1962-72 Front Door	39.99 kit
----------	--------------------------	-----------



RSC-748D



RSC-748C

Window Sash

Replacement for the commonly bent or missing track the window regulator rollers ride in to raise and lower the front door glass.

RSC-748D	1966-67 Inner.....	22.99 ea.
RSC-748C	1966-67 Upper	27.99 ea.



RW-62XR

Quarter Window Hardware Kit

This convenient quarter window hardware kit includes all of the necessary pieces to rebuild the rollers, guides and bushings on the quarter window regulators. Made in USA.

RW-62XR	1962-65	65.95 kit
RW-66XR	1966-67	41.95 kit
RW-68XR	1968-72	14.99 kit
RW-68XR-OE	1968-72 LH/RH	47.99 kit

**BUY'N SAVE
WITH KITS**

PWK-62NOV-NOST



PWK-68NOV-2-BLACK



PWK-73NOV-CRANK



Power Window Retrofit Kits

Ground Up Motors's exclusive power window kits are the best available on the market today! They bolt into the original mounting holes making for a hassle free installation. Using 1018 cold-roll steel, bronze oilite thrust bearing at all the pivot points and heat treated metal for all gears results in a quality smooth operating regulator that will last for many years. The motors are all brand new and have been thoroughly tested for quality and feature a strong dependable motor. Kits include: new regulators, new ACI window motors, a new completed wiring harness, your choice of switches and the conduit from the a-pillar to the door. Our kits feature detailed instructions with helpful diagrams and photos. F/R= Front and Rear Kit, Cpe/Sed = 2 Door Coupe or Sedan, Cvt = Convertible

1962-67 2 Door

PWK-62NOV-NOST	1962-67 Cpe/Sed F/R Nostalgic Switches	1124.99 kit
PWK-62NOV-CRANK	1962-67 Cpe/Sed F/R Crank Switches	1288.99 kit
PWK-62NOV-CHROME	1962-67 Cpe/Sed F/R Chrome Switches	972.99 kit
PWK-62NOVV-NOST	1962-63 Cvt F/R Nostalgic Switches	1124.99 kit
PWK-62NOVV-CRANK	1962-63 Cvt F/R Crank Switches	1288.99 kit
PWK-62NOVV-CHROME	1962-63 Cvt F/R Chrome Switches	972.99 kit
PWK-62NOV-2-CHROME	1962-67 All Front Only Chrome Switches	497.99 kit
PWK-62NOV-2-BLACK	1962-67 All Front Only Black Switches	498.99 kit
PWK-62NOV-2-NOST	1962-67 All Front Only Nostalgic Switches	588.99 kit
PWK-62NOV-2-CRANK	1962-67 All Front Only Crank Switches	650.99 kit

1968-72 2 Door

PWK-68NOV-NOST	1968-72 All F/R Nostalgic Switches	1124.99 kit
PWK-68NOV-CRANK	1968-72 All F/R Crank Switches	1288.99 kit
PWK-68NOV-CHROME	1968-72 All F/R Chrome Switches	972.99 kit
PWK-68CAM-2-CHROME	1968-72 All Front Only Chrome Switches	497.99 kit
PWK-68NOV-2-BLACK	1968-72 All Front Only Black Switches	498.99 kit
PWK-68NOV-2-NOST	1968-72 All Front Only Nostalgic Switches	588.99 kit
PWK-68NOV-2-CRANK	1968-72 All Front Only Crank Switches	650.99 kit

1973-79 2 Door

PWK-73NOV-BLACK	1973-79 All Front Only Black Switches	513.99 kit
PWK-73NOV-NOST	1973-79 All Front Only Nostalgic Switches	603.99 kit
PWK-73NOV-CRANK	1973-79 All Front Only Crank Switches	664.99 kit

No Volume Discount. Not eligible for free shipping.



4432791

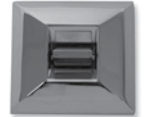

GWS-711

Power Window Switch

Correct OEM style power window switch.

4432790	1962-70 1 Window	42.99 ea.
4432791	1962-70 4 Window	69.99 ea.
GWS-711	1971-77 1 Window	44.99 ea.
GWS-712	1971-77 2 Window	52.99 ea.
GWS-714	1971-72 4 Window	69.99 ea.
GWS-635	Retainer All 4 Button	25.00 ea.
GWS-634	Retainer All 1 Button	9.95 ea.



GHB-6481

Power Window Grommets

This is the correct grommet that runs from the A-pillar to the door on cars with power windows and/or locks.

GHB-6481	1962-79	9.99 ea.
GHB-4412	1968-74 Tube & Boot Set	54.99 pr.



TRIM-01



TRIM-02



TRIM-WR



TRIM-KIT-DLX



TRIM-MAG

Trim Removal Tools

TRIM-01	Door Panel Removal Tool	9.97 ea.
TRIM-02	Window Crank/Door Handle Removal ..	6.99 ea.
TRIM-WR	Window Roller Removal Tool	18.99 ea.
TRIM-MAG	Mirror & Magnet Kit 2pc	14.95 set
TRIM-KIT-DLX	Trim Removal Tools 3pc	29.99 ea.



BUY'N SAVE
WITH KITS



Junior Weatherstrip Kits

Our most popular weatherstrip kit includes all of the basic soft trim components that commonly crack and wear out on your Nova. Included are (2) door opening weatherstrips, (2) roofrail weatherstrips (coupe only) and (1) trunk weatherstrip.

JR-62X	1962-64 Hardtop	152.97 kit
JR-62XS	1962-64 Sedan	89.23 kit
JR-65X	1965 Hardtop	152.97 kit
JR-65XS	1965 Sedan	89.23 kit
JR-66X	1966-67 Hardtop	152.97 kit
JR-66XS	1966-67 Sedan	89.23 kit
JR-68X	1968-74 All	76.48 kit

Deluxe Weatherstrip Kits

This kit is great when you want to replace all of the major weatherstripping on your car. Included are (2) door weatherstrips, (2) roof rail weatherstrips (coupe only), (1) trunk weatherstrip, (1) OEM style windowfelt set or (1) replacement style windowfelt kit, (1) hood to cowl seal, (1) rubber stopper kit and (2) quarter glass seals (62-67 hard top only).

JDX-X62C	1962-64 Hardtop Standard Felts	299.99 kit
JDX-X62COE	1962-64 Hardtop OEM Felts	333.99 kit
JDX-X62S	1962-64 Sedan Standard Felts	220.11 kit
JDX-X65C	1965 Hardtop Standard Felts	299.99 kit
JDX-X65COE	1965 Hardtop OEM Felts	333.99 kit
JDX-X65S	1965 Sedan Standard Felts	220.11 kit
JDX-X66C	1966-67 Hardtop Standard Felts	302.54 kit
JDX-X66COE	1966-67 Hardtop OEM Felts	353.54 kit
JDX-X66S	1966-67 Sedan Standard Felts	220.11 kit
JDX-X68S	1968-72 All Standard Felts	186.97 kit
JDX-X68OE	1968-72 All OEM Felts	254.97 kit
JDX-X73S	1973-74 All Standard Felts	186.97 kit

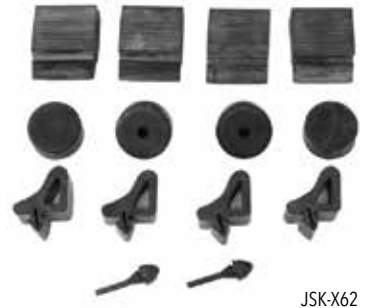

Rubber Stopper Kits

Complete set of rubber stoppers including doors, hood, console, glove box and trunk lid.

JSK-X62	1962-65	20.99 kit
JSK-X66	1966-67	20.99 kit
JSK-X68	1968-74	18.99 kit



JDG-E3

Door Glass Channeling

Original style weatherstripping channel that fits inside the upper and rear door frame and seals the window when it is rolled up to prevent rattling and wind noise. These are the "U" shaped window post weatherstrips used on front and rear side glass. Trimming may be necessary.

JDG-E3	1962-74 All	39.99 ea.
--------	-------------------	-----------



JLM-20K

Door Opening Weatherstrip

This brand new state of the art door weatherstrip features correct extruded rubber with correct molded ends and push-in clips just like original.

JLM-20K	1962-67 2dr Sedan.....	84.99 pr.
JLM-20N	1962-67 2dr Coupe/Conv.....	89.99 pr.
JLM-20L	1962-67 4dr Sedan Front.....	69.99 pr.
JLM-20LR	1962-67 4dr Sedan Rear.....	69.99 pr.
JLM-20LW	1962-67 Wagon Rear.....	74.99 pr.
JLM-12K	1968-74 2dr All.....	74.99 pr.
JLM-20M	1968-74 4dr Front.....	89.99 pr.
JLM-20MR	1968-74 4dr Rear.....	69.99 pr.
JLM-20-O	1975-79 2dr All.....	69.99 pr.



JSS-4031

Roof Rail Weatherstrip

Correct extruded rubber that seals the roof line of the car in from the elements.

JSS-4031	1962-65.....	69.99 pr.
JRR-5011	1966-67.....	74.99 pr.



JSS-309

Trunk / Hatchback Weatherstrip

Correct molded trunk weatherstrip.

JSS-309	1962-74 Trunk.....	19.99 ea.
JSS-73H	1973-79 Hatch.....	59.99 ea.
JSS-4014	1962-67 Tail Gate.....	116.99 ea.
JSS-101	1975-79 Trunk.....	45.99 ea.



JTW-X2301

JTW-X6250-R

Rear Quarter Glass Seals

Stop the rattles and leaks in your quarter window glass by replacing the worn felt channel on your Chevy II / Nova 2 door with this 4 piece quarter window upper channel replacement kit. These channels have a chrome bead on the outer edge. Non-functional kits are used to seal the windows and restore the appearance of your Nova if the channel guide tab on your glass is missing. The windows will not roll up or down. If you have the original plastic channel guide tab please select the functional kits. Rebuild kits are the glass channels only. You must reuse your original brackets. Most cars came from the factory without the chrome bead. Please check before ordering.

Non-Function Kits

JTW-X6250	1962-65 Sedan w/ Chrome Bead.....	134.99 kit
JTW-X6251	1962-65 Sedan w/o Chrome Bead.....	134.99 kit
JTW-X6670	1966-67 Sedan w/ Chrome Bead.....	134.99 kit
JTW-X6671	1962-67 Sedan w/o Chrome Bead.....	134.99 kit
JTW-2300	1968-72 Sedan w/ Chrome Bead.....	139.99 pr.
JTW-X2301	1968-72 Sedan w/o Chrome Bead.....	135.99 kit
JTW-X7340	1973-74 Sedan w/ Chrome Bead.....	136.99 kit
JTW-X7341	1973-74 Sedan w/o Chrome Bead.....	136.99 kit

Functional Kits

JTW-X2300-K	1968-72 Sedan w/ Chrome Bead.....	201.99 kit
JTW-X2301-K	1968-72 Sedan w/o Chrome Bead.....	201.99 kit
JTW-X7340-K	1973-74 Sedan w/ Chrome Bead.....	204.99 kit
JTW-X7341-K	1973-74 Sedan w/o Chrome Bead.....	199.99 kit

Rebuild Kits

JTW-X6250-R	1962-67 Sedan w/ Chrome Bead.....	94.99 kit
JTW-X6251-R	1962-67 Sedan w/o Chrome Bead.....	94.99 kit
JTW-X2300-R	1968-72 Sedan w/ Chrome Bead.....	84.99 kit
JTW-X2301-R	1968-72 Sedan w/o Chrome Bead.....	84.99 kit
JTW-X7340-R	1973-74 Sedan w/ Chrome Bead.....	84.99 kit
JTW-X7341-R	1973-74 Sedan w/o Chrome Bead.....	84.99 kit



JWR-2020

Vent Window Weatherstrip

Seals the front door vent windows.

JWR-2020	1962-63 Conv.....	89.99 pr.
JWR-2020	1962-67 Hardtop.....	89.99 pr.
JWR-2021	1962-67 Sedan.....	92.99 pr.
JPP-X68	1968-72 All.....	94.99 pr.

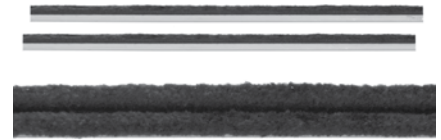

JSS-2245

Vent Window Division Bar Channel

JSS-2245	1962-67.....	49.99 pr.
JSS-40403	1968-72.....	29.99 pr.



JN-137

Blower Motor to Firewall Seal

Set of correct gaskets which are used to seal the heater motor to the firewall.

JN-137	1962-67.....	14.99 kit
--------	--------------	-----------



DSB-83

Steering Shaft Boot

New steering shaft dust boot.

DSB-83	1968-69.....	34.99 ea.
--------	--------------	-----------



DBR-647

Steering Shaft Boot Retainer

Correct ring which holds the seal between the steering shaft and the swivel.

DBR-647	1968-79.....	8.99 ea.
---------	--------------	----------

JSS-2627

Glass Channel Weatherstrip
OE style reproduction window glass channeling which should be replaced when installing a new windshield or rear window.

JSS-1627	1962-67 Coupe/Conv Windshield.....	64.99 ea.
JSS-3627	1962-67 Sedan / 4 Dr Windshield.....	65.95 ea.
JSS-2627	1962-65 Hardtop Rear Window.....	64.95 ea.
JSS-4627	1962-64 Sedan / 4 Dr Rear Window.....	84.95 ea.
JSS-40381	1965 Sedan / 4 Dr Rear Window.....	139.95 ea.



KHB-41562

1967 Headlamp Bezel Seal

Correct seal used to seal the headlamp bezel from the front fenders.

KHB-41562 1967 10.99 pr.

JSS-69



Steering Column Seal

Correct neoprene seal for firewall.

JN-132 1962-66 7.99 ea.
JN-133 1967 6.95 ea.
JSS-69 1968-74 5.99 ea.



JN-135

Radiator Support to Fan Shroud Seal

Correct reproduction of the original seal installed between the fan shroud and radiator on big block Novas.

JN-135 1968-70 BB 15.99 ea.
Does not include clips.



JALP-5009

Door Jamb U Rubbers

Correct steel core rubber.

JALP-5009 1962-67 21.95 pr.

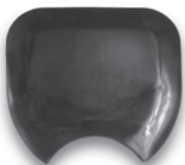

FTW-3000

Master Cylinder Firewall Plug

This plug goes below the master cylinder on manual brake cars.

FTW-3000 1962-67 11.99 ea.

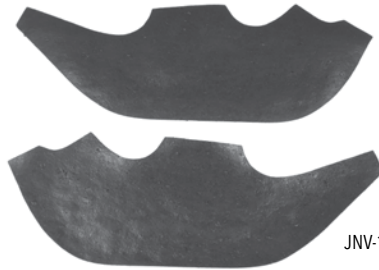

JNV-111

A-Arm Dust Shields

Correct die stamped material that seals the engine compartment. Mounts to inner fender wells, complete with staples.

JNV-111 1968 "A" Arm Dust Shields 15.99 pr.
JNV-112 1969 "A" Arm Dust Shields 15.99 pr.
JNV-113 1970-74 "A" Arm 15.99 pr.
JNV-186 1975-79 "A" Arm 15.99 pr.



JVS-4X

Quarter Glass Seals

Correct rubber seal which attaches to the quarter window and seals the front and rear windows. Features steel core with rubber coating as factory.

JVS-4X 1962-65 All Rubber 18.99 pr.
JSS-4033 1966-67 All Rubber 21.99 pr.
JVS-3X 1966-67 w/ Steel Core 27.99 pr.

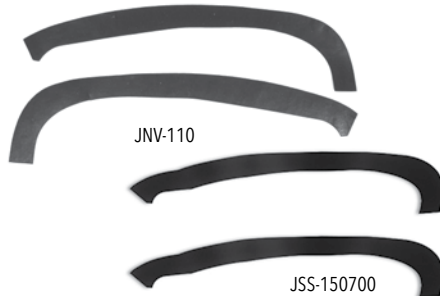

JNV-110

JSS-150700

Inner Fender To Firewall/Cowl Seal

Comes as a 2 piece set.

JSS-150700 1962-65 19.95 pr.
JNV-110 1966-67 17.99 pr.

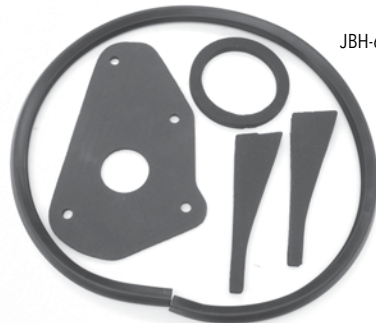

JBH-69

Cowl-Firewall Seal Kit

Correct die-stamped gasket kit containing steering column seal, hood to cowl seal, cowl vent side seals and wiper motor seal. 5 pieces.

JBH-69 1969-74 All 39.99 kit



JN-134

Wiring Harness to Firewall Seal

Seals the hole where the engine harness and light harness pass through the firewall.

JN-134 1962-65 5.99 ea.



JCS-1585

Hood to Cowl Seal

Correct rubber seal that mounts to the top edge of the cowl to seal the engine compartment. Each seal is cut to the correct length and is ready to install.

JCS-1585 1962-67 12.99 ea.
JCS-1595 1968-74 9.99 ea.



JN-126

Paint Seal Kit

This kit is a must for all of those partial or full restorations.

JN-124 1962-64 21.99 kit
JN-126 1965 17.99 kit
JN-127 1966-67 19.99 kit
JN-128 1968-69 18.99 kit
JN-129 1970 18.99 kit
JN-130 1971-72 19.99 kit



JSS-3M

Weatherstrip Glue

JSS-3M 5oz Yellow 14.99 ea.
JSS-3M-BLK 5oz Black 21.99 ea.

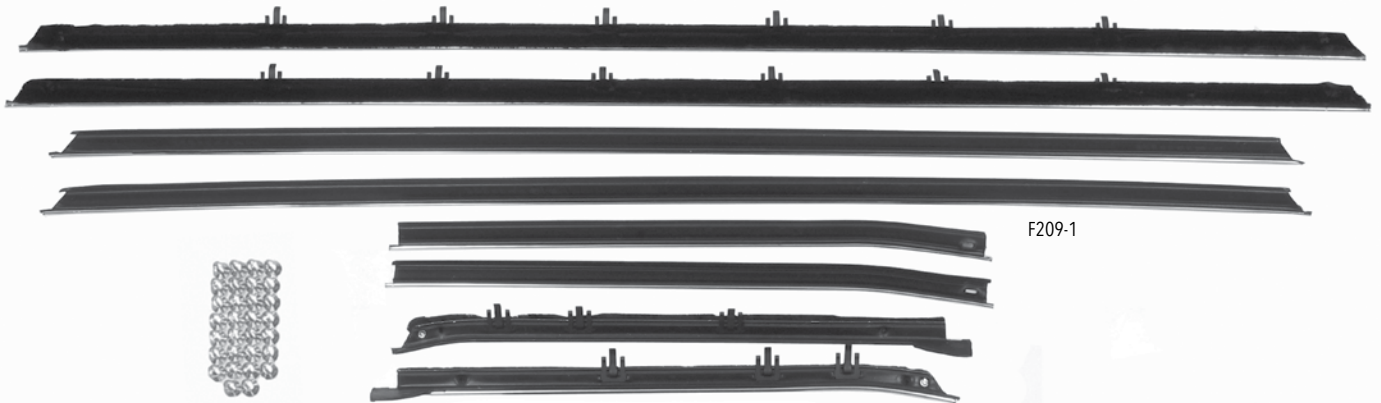

F209-1

Outer Window Felt Kits

These OE style reproduction window felts feature correct stainless round beads with flocked rubber sealing strips. All include the correct anti-rattle bumpers attached.

4 Piece OEM Style (Outers)

O210-10	1966-67 2dr Hardtop.....	89.99 kit
O210-20	1966-67 2dr Sedan.....	109.99 kit
O211-10	1968-72 2dr Sedan.....	149.99 kit
N182A	1975-79 2dr Sedan.....	199.99 ea.

4 Piece Replacement Style

76WXWC	1975-79 2dr Sedan.....	99.99 kit
--------	------------------------	-----------



Replacement Style Flat Bead



OEM Style Round

Complete Window Felt Kits

OE style reproduction OEM style window felts feature correct stainless round beads with flocked rubber sealing strips. Replacement style feature flat stainless. All include the correct anti-rattle bumpers attached.

8 Piece Replacement Style

F209-1	1962-65 Hardtop.....	119.99 kit
F208-1	1962-63 Convertible	119.99 kit
F210-1	1966-67 Hardtop.....	119.99 kit
F209-2	1962-65 Sedan.....	119.99 kit
F210-2	1966-67 Sedan.....	119.99 kit
F211-1	1968-72 2dr All	119.99 kit
F277-1	1973-74 2dr All	119.99 kit
F209-3	1962-65 4dr Sedan	119.99 kit
F210-3	1966-67 4dr Sedan	119.99 kit
F211-2	1968-72 4dr Sedan	119.99 kit
F277-2	1973-74 4dr Sedan	119.99 kit
76XWC-4	1975-79 4dr Sedan	126.99 kit
F209-4	1962-65 Wagon	105.99 kit
F209-5	1962-65 Tail Gate	69.99 kit
F210-4	1966-67 Tail Gate	119.99 kit

8 Piece OEM Style

O209-1	1962-65 2dr Hardtop	159.99 kit
O210-1	1966-67 2dr Hardtop	179.99 kit
O210-2	1966-67 2dr Sedan	149.99 kit
O211-1	1968-72 2dr Sedan	199.99 kit
N143A	1973-74 2dr Sedan	199.99 set



MBS-68X



MBS-62X

Rear Bumper to Body Seal

Reproduction body seal fills the area between the rear bumper and the body panels and is manufactured to exact specifications, allowing a perfect 5 foot piece.

MBS-62X	1962-67	29.99 ea.
MBS-68X	1968-72	29.95 ea.



JHC-3064

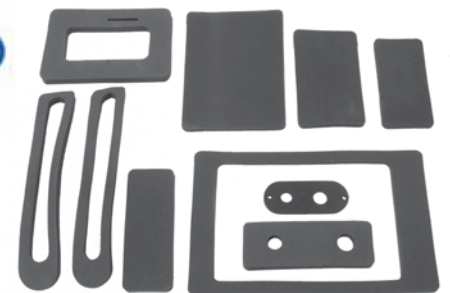

Heater Box Seal Kits

Correct die stamped neoprene seals for installing your heater core and cover. A must!

JHC-3064	1968-79 All V8 without A/C.....	27.99 kit
JCS-10459	Sealant.....	9.99 ea.

PACKARD RADIO TVRS LR 3-Q-64



Dated Spark Plug Wires

New OE style reproduction wire set correctly dated for your specific car, pre-cut and ready to install! Each set features correct colored wires and correct angle "cut" boots. The date coding identified the quarter and year in which the wires were produced. As an example, a wire date coded as 1-Q-67 would have been produced in the first quarter of 1967.

Research has shown that most cars had spark plug wires installed that were dated from 1 to 4 quarters prior to the build date of the car.

ALL-64SB3Q	1964 SB "3-Q-63"	99.99 set
ALL-64SB1Q	1964 SB "1-Q-64"	99.99 set
ALL-65SB3Q	1965 SB "3-Q-64"	99.99 set
ALL-65SB1Q	1965 SB "1-Q-65"	99.99 set
ALL-66SB3Q	1966 SB "3-Q-65"	99.99 set
ALL-66SB1Q	1966 SB "1-Q-66"	99.99 set
ALL-67SB3Q	1967 SB "3-Q-66"	99.99 set
ALL-67SB1Q	1967 SB "1-Q-67"	99.99 set
ALL-68SB3Q	1968 SB "3-Q-67"	99.99 set
ALL-68SB1Q	1968 SB "1-Q-68"	99.99 set
ALL-68BB3Q	1968 BB "3-Q-67"	99.99 set
ALL-68BB1Q	1968 BB "1-Q-68"	99.99 set
ALL-69SB3Q	1969 SB "3-Q-68"	99.99 set
ALL-69SB1Q	1969 SB "1-Q-69"	99.99 set
ALL-69BB3Q	1969 BB "3-Q-68"	99.99 set
ALL-69BB1Q	1969 BB "1-Q-69"	99.99 set
ALL-70SB3Q	1970 SB "3-Q-69"	99.99 set
ALL-70SB1Q	1970 SB "1-Q-70"	99.99 set
ALL-70BB3Q	1970 BB "3-Q-69"	99.99 set
ALL-70BB1Q	1970 BB "1-Q-70"	99.99 set
ALL-71SB3Q	1971 SB "3-Q-70"	99.99 set
ALL-71SB1Q	1971 SB "1-Q-71"	99.99 set
ALL-72SB3Q	1972 SB "3-Q-71"	99.99 set
ALL-72SB1Q	1972 SB "1-Q-72"	99.99 set
ALL-73SB3Q	1973 SB "3-Q-72"	99.99 set
ALL-73SB1Q	1973 SB "1-Q-73"	99.99 set

AHC-1508



Spark Plug Wire Sets

New pre-cut OEM replacements.

AHC-1508	All SB w/o HEI	39.95 set
AHC-2508	All BB w/o HEI	39.95 set
AHC-3508	1973-79 HEI	54.99 set



Retaining Straps

Correct push-in style plastic retainers.

BPX-2350	All	3.95 pr.
----------	-----	----------

BPX-2350



Harness Retaining Clips

Correct retaining clips for harness.

AHC-1	Clip Style #1	4.95 ea.
AHC-2	Clip Style #2	4.95 ea.



BJN-300

Harness Wire Ties

Original GM wire ties used on various hoses, cables and harnesses.

BJN-300	Short	3.99 ea.
---------	-------	----------



38131

Breakerless SE Ignition Conversion

The Breakerless SE ignition kit is designed to convert GM V8 engines originally equipped with breaker points, windowed style distributor cap and stock coil to solid-state electronic ignition. No distributor modification, disassembly, or removal is required. Easier starting.

38131	Breakerless SE Conversion	154.99 kit
-------	---------------------------	------------

ADS-2100-SC-RED



HEI Distributor

Chrome Aluminum HEI Electronic Distributor with 50K Coil.

ADS-2100	All	94.99 ea.
ADS-2100-SC-RED	Red Super Cap	99.99 ea.
ADS-2100-SC-CLEAR	Clear Super Cap	97.99 ea.

ADS-2100-SC-CLEAR



ASR-62XSB

Spring Ring Cables

OE style reproduction of the original factory installed spring type cables sold as a matched pair with GM numbers.

ASR-62XSB	1962-67	89.95 pr.
ASR-68XSB	1968-74 SB	89.95 pr.
ASR-68XBB	1968-74 BB	89.95 pr.



AST-1001

Side Terminal Battery Cables

Correct cables for cars with the heavy duty R-89 batteries with correct GM part numbers.

AST-1001	1969-72 HD	124.99 kit
----------	------------	------------



AC43

AC Delco Spark Plugs

This is a brand new set of 8 spark plugs for your Nova. These high quality reproduction AC Delco spark plugs feature the correct green AC and markings as original.

AC43	1964-70 #43	62.99 set
AC44	1964-70 #44	62.99 set
AC45	1964-70 #45	62.99 set

Note: The number on the plug refers to its operating temperature. The lower number is a cooler running plug which is typically found on the SHP high performance engines. A hotter, higher numbered plug would be used in engines where plug fouling may be or is a problem.



MAL-937C



Mallory Pro Spark Plug Wires

Burning spark plug boots in high heat applications is a thing of the past with Mallory's high temp ceramic boot spark plug wires. The ceramic boot is capable of withstanding temps up to 2,000 degrees F making them ideal for applications with close tolerance headers and any other application where boot failure is an issue. These universal sets come with HEI type and socket type distributor ends. Cut and crimp to fit. 90 Degree boots typically fit small block and the 135 degree boots typically fit big block.

MAL-937C	90 Degree Red	148.99 set
MAL-947C	135 Degree Red	148.99 set
MSD-35051	Universal Crimper Tool	116.99 ea.

No Volume Discount.



GAC-505

Coil

Choose from our new OE style reproduction Delco coils with GM numbers or GM replacement coil.

GAC-505 1964-72 All Replace..... 39.95 ea.



ALI-3119



BAN-516

Coil Bracket

OE style reproduction of original, comes with retaining screw.

ALI-3119 All V8..... 20.99 ea.
BAN-516 SEMS Bolts..... 1.95 pr.



N-2441

Tune Up Kit

Tune up kit with new points, condenser and rotor.

N-2441 1962-73 All..... 49.99 ea.



1971244

Distributor Cap

Choose from AC Delco replacement distributor cap or OE style reproduction distributor cap with GM numbers. Red cap features heavy duty brass terminals for high performance engines.

1971244 Black Cap 79.99 ea.
AAD-308 Replacement..... 22.95 ea.

ACE-1400



Distributor Hold Down

Correct retaining hardware for distributors.

ACE-1400 All V8..... 13.99 kit

GRA-8172



Air Conditioner Relay

Correct GM blower motor relay.

GRA-8172 1962-68 w/ A/C..... 22.95 ea.
GRA-885 1969-79 w/ A/C..... 54.99 ea.

GAC-385



Blower Motor Switches

GAC-385 1969-74 w/ AC 46.99 ea.
GBS-939 1969-79 w/o AC 34.99 ea.



GBL-852

GSR-12999



Brake Light Switch

Correct switch located at pedal for engagement of rear brake lights.

GBL-852 1962-79 All 7.95 ea.
GBL-852-CC 1967-79 All w/ Cruise Control..... 24.99 ea.
GSR-12999 Retainer 7.99 ea.

GRW-016



Circuit Breaker

Correct 30 amp breaker used for power windows, power doors, & power tailgate window.

GRW-016 1967 P/ Tailgate Window..... 18.99 ea.
GRW-016 1975-79 PDL, PW..... 18.99 ea.



GWC-SPK

Speaker/Trunk/Blower Motor Wire Clips

Used to hold the wiring under the dash, power trunk or trunk light wires to hinge, speaker wires to package tray, or blower motor wire to vent.

GWC-SPK 1962-77 All 19.99 pr.

ACDelco

GAC-515



Voltage Regulator

New correct GM replacement.

GAC-515 1964-71 All D635 84.99 ea.
GAC-515GM 1964-71 All 94.99 ea.
AVX-515 1968-71 Screws (2)..... 0.95 kit
AWX-818 1964-67 Mounting Kit..... 6.95 kit

GQH-118



Electric Junction Block

Original GM junction block for attaching positive lead from battery to main harness. Mounts to radiator support. Includes correct nut.

GQH-118 1962-79 All 9.95 ea.

GDT-0330



Electrical Harness Tape

Correct non-stick factory style tape. Over 100 feet.

GDT-0330 All..... 11.95 ea.

GRC-12835



GRC-12834



Voltage Regulator & Radio Capacitor

Came from the factory on all cars with radio. Correct length lead wire & white connector. Stamped 1964086 "DR" & ".5MF" as original.

GRC-12834 1967-71 3MF..... 39.99 ea.
GRC-12835 1970-74 5MF..... 39.99 ea.

GDJ-11



GDJ-3F



GDJ-10

Door Jamb Switches

GDJ-11 Dual Pin (Male)..... 7.99 ea.
GDJ-10 Single Pin (Male)..... 9.99 ea.
GDJ-3F Single Pin (Female)..... 8.99 ea.

18000



Glove Box Lamp

Complete assembly with socket, switch, bulb and correct harness, wires, or terminals.

18000 1962-74 All..... 20.99 kit



GIS-821

Ignition Switch

GIS-87	1962-64	26.99 ea.
GIS-172	1965	16.95 ea.
GIS-821	1966-67	37.99 ea.
GIS-152	1968	24.99 ea.
GIS-042	1969-72 w/o Tilt	29.99 ea.



GIS-042

IQ-507



Ignition Switch Nut

Correct heavy chrome nut for retaining switch to dash.

IQ-507	1967 All	10.99 ea.
--------	----------	-----------



GFS-502

Hazard Light Switch

Correct flasher switch that plugs into fuse box.

GFS-502	All	11.95 ea.
---------	-----	-----------



GAC-808

Headlight Dimmer Switch

Correct floor mounted high beam switch.

GAC-808	1962-79 All	8.95 ea.
GAC-808-HARNS	1962-79 Repair Harness	6.95 ea.



GHS-588

Headlight Switch

GHS-726	1962-63	34.99 ea.
GHS-588	1964-73	19.99 ea.
GHS-217	1974-79	21.99 ea.



GHD-6472

Body Wiring Hold Down

Interior body floor panel wiring hold down clip used to hold body harness to floor pan.

GHD-6472	1964-72 All	4.99 ea.
----------	-------------	----------

Note: Typically 3 required.

GNS-13



Neutral Safety Switch

Correct steering column switch for proper engine and reverse light activation.

GDR-411	1969-72 Automatic	34.99 ea.
GNS-13	1962-66 Powerglide	22.99 ea.
GDR-411	1969-72 Auto Console	34.99 ea.
GNS-35	1969-72 Auto Column	21.99 ea.

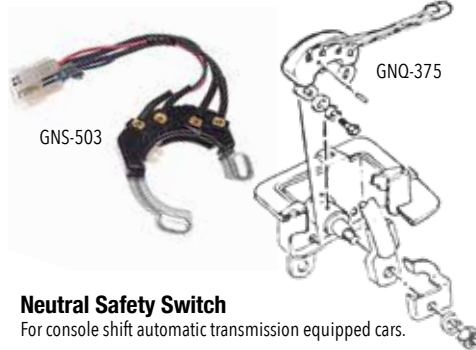

GNS-503

GNO-375

Neutral Safety Switch

For console shift automatic transmission equipped cars.

GNS-696	1965-67 Auto	69.99 ea.
GNS-503	1968-72 Powerglide	42.99 ea.
GNO-375	1968 TH350/TH400	43.99 ea.



GNS-1969

Neutral Start Switch

Correct safety switch located at pedal which prevents your car from being started in gear.

GNS-1969	1969 Manual	79.99 ea.
FSR-372	1969 Switch Rod & Clip	22.99 ea.
GNS-X99	1970-75 Manual	59.99 ea.



4432790

GWS-711

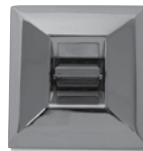

Power Window Switch

Correct OEM style power window switch.

4432790	1962-70 1 Window	42.99 ea.
4432791	1962-70 4 Window	69.99 ea.
GWS-711	1971-77 1 Window	44.99 ea.
GWS-712	1971-77 2 Window	52.99 ea.
GWS-714	1971-72 4 Window	69.99 ea.
GWS-635	Retainer All 4 Button	25.00 ea.
GWS-634	Retainer All 1 Button	9.95 ea.

1993413



Reverse Lamp Switch

1998728	1962 4 Speed	62.99 ea.
1997929	1963 4 Speed	62.99 ea.
1993661	1964 4 Speed	69.99 ea.
1993307	1965-67 4 Speed	69.99 ea.
1993413	1968 4 Speed	74.99 ea.
GNS-33	1969-72 4 Speed	52.99 ea.



10665

Reverse Switch Extension Harness

Correct harness which plugs into firewall.

27315	1962-63 Auto	20.99 ea.
28160	1962 4 Speed	41.99 ea.
28335	1963 Switch to 27315	26.99 ea.
10665	1967-68 All	31.99 ea.



GTS-62

GTS-623



GTS-304



GTS-6208

Turn Signal Switches

Complete switch assemblies with correct plug-in harnesses.

898197	1963-64 1st Design	69.99 ea.
910821	1964-65 2nd Design	49.99 ea.
GTS-62	1966 No Tilt BPC	99.99 ea.
GTS-623	1966 No Tilt GUIDE	69.99 ea.
GTS-304	1967-68 All	54.99 ea.
GTS-6208	1969-79 All	54.99 ea.
GTS-6208GM	1969-79 All OE Style	59.99 ea.



LHT-7PB-HI Detail LHT-7T-HI Detail

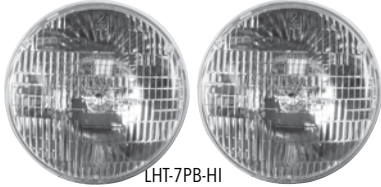

LHT-7PB-HI



FACTORY T3

HI-INTENSITY T3

T-3 Headlamps

Upgrade your weak old original T3 and Power Beam headlamps with a pair of high performance headlamps from Ground Up Motors! These headlamps utilize modern bulb filaments with a much brighter high/low beam, which are considerably brighter than the original factory and Power Beam units. These fit and function exactly as original which makes installing these a breeze. They feature a T3 or Power Beam logo and look just like the originals! We tested these on our own 1969 Camaro in our warehouse and you can really see the difference!

LHT-7PB-HI	1962-78 All Power Beam.....	139.99 pr.
LHT-7T-HI	1962-78 All T3	149.99 pr.



Ground Up Motors Pro-Touring Restomod Led Headlight Conversion

Upgrade the look of your headlights with Ground Up Motors's brand new Exclusive Plug n' Play DOT approved headlight kit by Aroara. This easy to install headlight kit comes with everything you need for a simple install. With our included modified headlamp buckets no welding, cutting, or intense fabrication is required. This Exclusive kit is one of the only true Plug n' Play kits on the market for your Nova. Ground Up Motors's Exclusive Aroara LED headlights are equipped with a high and low beam with a color temperature of 6000k which produces a crisp white light which greatly assists in lighting things up for you like never before. This light is also equipped with a half circle driving light (DRL) that easily integrates into your factory parking light system. You will not find a set of headlights for your Nova like this anywhere else! This kit comes complete with everything you need to convert your standard headlights to a set of new Ground Up Motors Exclusive Aroara LED headlights.

This kit includes:

- A pair of Aroara LED headlights
- 2 modified headlamp buckets designed to house the new LED lights
- 2 retaining springs that work with the modified bucket
- An extra wire for the day time running light halo rings

Features:

- High and Low beam color temperature of 6000k
- True plug & play installation
- Easily integratable Half Circle Daytime Running Lights (DRL)
- DOT & Transport Canada compliant for on-road use

ARA-6265K	1962-65 All Black	299.95 kit
ARA-6674K	1966-74 All Black	299.95 kit

No Volume Discount.

Tail Lamp Assemblies

Complete with tail and back up lenses, bezel, gasket, cross bracket and mounting screws.



LTA-X62K



LTA-X66K



LTA-X68K

LTA-X62K	1962-64 Pair.....	161.98 pr.
LTA-X62	1962-64.....	89.99 ea.

LTA-X66K	1966-67 Pair.....	210.58 pr.
LTA-1415	1966-67.....	116.99 ea.

LTA-X68K	1968-69 Pair.....	199.98 pr.
LTA-2770L	1968-69 LH.....	99.99 ea.
LTA-2775R	1968-69 RH.....	99.99 ea.



LTA-X70K



LTA-X72K



LTA-X75R



LTA-X75L

LTA-X70K	1970-71 Pair.....	233.98 pr.
LTA-2780L	1970-71 LH.....	129.99 ea.
LTA-2780R	1970-71RH.....	129.99 ea.

LTA-X72K	1972 Pair.....	233.98 pr.
LTA-2790L	1972 LH.....	129.99 ea.
LTA-2790R	1972 RH.....	129.99 ea.

LTA-X75L	1975-79 LH.....	199.99 ea.
LTA-X75R	1975-79 RH.....	199.99 ea.

Parking Lamp Assembly, Continued...



1962-64 Chrome Bezels

OE style reproduction parking lamp bezels.

LPB-1130 1962-64.....59.99 kit



1962-64 Extensions

Correct parking lamp extension moldings.

LPB-1150 1962-64.....66.99 kit



LAMP-KIT65X 1965 Pair125.98 kit
LPH-2150L 1965 LH69.99 ea.
LPH-2154R 1965 RH69.99 ea.



LAMP-KIT66X 1966-67 Pair125.98 kit
LPH-2160L 1966-67 LH69.99 ea.
LPH-2164R 1966-67 RH69.99 ea.



LAMP-KIT69X 1968-69 Pair98.98 kit
LPH-2170 1968-69 LH/RH54.99 ea.



LAMP-KIT70X 1970 Pair98.98 kit
LPH-2190 1970 LH/RH54.99 ea.



LAMP-KIT71X 1971-72 Pair98.98 pr.
LPH-2195 1971-72 LH/RH54.99 ea.



LPH-087 1973-74 Assembly49.99 ea.
LPH-7374 1973-74 Lens Only39.99 ea.
LAMP-KITX73 1973-74 Lenses Only Pair71.98 kit
Assembly includes lens, housing, bulb, socket and wiring.

1973-74 Chrome Bezels

Correct parking lamp bezels, which mount in the grille on your 1973-74 Nova.



LPB-7374K 1973-7439.58 kit
LPB-7374 1973-7421.99 ea.



LPH-X75 1975 LH/RH Amber29.99 ea.
LPH-X75SS 1975 SS LH/RH Clear29.99 ea.
LPH-401 1977-78 LH26.99 ea.
LPH-402 1977-78 RH26.99 ea.
LPH-324 1976-78 SS and Rally74.99 ea.



LPH-333 1976-77 1st Design LH49.99 ea.
LPH-332 1976-77 1st Design RH49.99 ea.
LPH-331 1977-78 2nd Design LH49.99 ea.
LPH-330 1977-78 2nd Design RH49.99 ea.
1st design features white bowtie. 2nd design bowtie is not white.

Parking Lamp Lenses

Correct coloring and grain of originals.



LPL-3043 1962 Clear36.99 pr.
LPL-3044 1963-64 Amber30.99 pr.
LPL-3045 1965 Amber43.99 pr.
LPL-3046 1966-67 Amber36.99 pr.
LPL-3055 1968-69 Amber27.99 pr.
LPL-3060 1970 Clear26.99 pr.
LPL-3031 1971-72 Amber36.99 pr.

Side Marker Lenses

OE style reproduction side marker lenses featuring correct colors and SAE markings.



LSM-9885 1968 Front8.99 ea.



LSM-9884 1969 Front9.99 ea.



LSM-7013 1970-74 Front44.99 pr.



LSM-2100 1975-79 Front29.99 ea.



LSM-9916 1968-69 Rear8.99 ea.

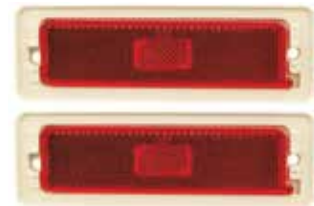

LSM-7047 1970-74 Rear44.99 pr.



LSM-2099 1975-79 Rear24.99 ea.

LID-69F



Ignition & Door Locks

Brand new lock cylinders and "keyed" alike keys, complete with correct attaching clips and gaskets.

LID-64A	1962-65.....	54.99 kit
LID-67F	1966-67.....	38.99 kit
LID-68F	1968.....	38.99 kit
LID-69F	1969-74.....	38.99 kit



LGT-67F

Glove Box & Trunk Locks

Brand new lock cylinders and "keyed" alike keys, complete with correct attaching clips and gaskets.

LGT-62X	1962-65.....	41.99 kit
LGT-67F	1966-67.....	35.99 kit
LGT-68A	1968.....	39.99 kit
LGT-69A	1969-79.....	36.99 kit

LDL-X62A



Door Lock Sets

Brand new door lock cylinders complete with the correct attaching clips and gaskets.

LDL-X62A	1967-68 Early Style Key Correct Groove..	21.99 kit
LDL-X62B	1962-66 Early Style Key	33.99 kit
LDL-X62SK	1962-79 Early Style Square Key	18.99 kit

LDT-X69



Door & Trunk Lock Sets

Brand new door and trunk lock cylinders keyed alike.

LDT-X62	1962-66 Pear Head Knock Out	29.99 kit
LDT-X69	1962-66, 1969-79 Late Style Round.....	26.99 kit

LCK-X65IDT



Ignition Door & Trunk Lock Sets One Key Opens All

Brand new ignition, door and trunk lock cylinders keyed alike. Although not factory correct we all can agree that one key makes it easier!

LCK-X62IDT	1962-64 Early Style Key	47.99 kit
LCK-X65IDT	1965 Early Style Key	47.99 kit
LCK-X667IDT	1966-67 Early Style Key	47.99 kit
LCK-X68IDT	1968 Early Style Key	69.99 kit
LCK-X69IDT	1969-78 Late Style Key	64.99 kit

BUY 'N SAVE WITH KITS

LCK-67F



Complete Lock Sets

Our lock kits come complete with ignition and doors keyed alike and glove box and trunk keyed alike just as original. We also include all necessary hardware for a complete job.

LCK-62X	1962-65.....	82.43 kit
LCK-67F	1966-67.....	63.73 kit
LCK-68A	1968.....	71.08 kit
LCK-69A	1969-79.....	64.58 kit

LID-69-OE



Concourse Lock Sets

This is a complete ignition and door lock set which includes OEM lock cylinders, keys, clips and gaskets. These concourse correct lock sets are accepted by most judges as original. The keys have the correct knockouts and the code stamped into the key.

LID-69-OE	1969.....	66.99 kit
LID-70-OE	1970.....	66.99 kit
LID-71-OE	1971.....	66.99 kit
LID-72-OE	1972.....	66.99 kit



LCK-X68IDGT

Complete Lock Sets One Key Opens All

Brand new ignition, door, glove box and trunk lock cylinders keyed alike. Although not factory correct, we all can agree that one key makes it easier!

LCK-X62IDGT	1962-64 Early Style Key	62.99 kit
LCK-X62IDGT	1962-64 Early Style Key	62.99 kit
LCK-X65IDGT	1965 Early Style Key	62.99 kit
LCK-X667IDGT	1966-67 Early Style Key	62.99 kit
LCK-X68IDGT	1968 Early Style Key	64.99 kit
LCK-X69IDGT	1969-78 Late Style Key	69.99 kit



ITW-1310

Glove Box Latch Striker

Original style latch striker for your glove box.

ITW-1310	1962-65 All	9.99 ea.
ITW-1312	1966-67 All	9.99 ea.



LPC-7

LP-1112

Door Lock Pawls & Clips

Correct bracket that attaches to the end tip of the door lock cylinder. The pawl trips the inner door latch assembly to open the door.

LP-1128	1962-67 RH	6.99 ea.
LP-1127	1962-67 LH.....	6.99 ea.
LP-1112	1968-79 RH	6.99 ea.
LP-1113	1968-79 LH.....	6.99 ea.
LPC-7	1962-79 All Door Lock Pawl Clip.....	1.69 pr.



TLR-458

Trunk Lock Rods

Correct rod/shaft that connects the cylinder to the lock assembly.

TLR-458	1962-79 4 5/8" L Straight	3.99 ea.
---------	---------------------------------	----------



LTB-90

Door/Trunk Lock Bracket

Correct bracket for retaining lock cylinder in place.

LTB-90	1962-79 All	2.99 ea.
--------	-------------------	----------



LTR-3110

Trunk Lock Retainer

OE style reproduction of this hard to find bracket.

LTR-3110	1962-65 All.....	16.99 ea.
LTR-3120	1966-67 All.....	17.99 ea.
LTR-3130	1968-72 All.....	17.99 ea.



RTL-6470



RSA-550

Trunk Catch / Catch Anchor

RTL-6470	1964-70 Trunk Catch	26.99 ea.
RSA-550	1968-70 Trunk Catch Anchor	46.99 ea.

RTL-1019



Trunk Lid Latch

OE style reproduction of the often damaged or missing trunk latching device.

RTL-1019	1962-72 All	29.95 ea.
----------	-------------------	-----------



T-3042



T-3050



TK-8003

SS Grille Emblems

These are OE style reproduction Nova super sport grille emblems.

T-3042	1966 SS.....	54.99 ea.
T-3050	1967 Nova SS.....	84.99 ea.
TK-8003	1968-69 SS.....	24.95 ea.
TK-8871	1970-72 SS.....	49.99 ea.
TK-7374	1973-74 SS.....	59.99 ea.
T-7555	1975-76 SS.....	69.99 ea.



T-3051

1966-67 Chevy II Grille Emblem

This is an OE style reproduction 1966-67 Nova Chevy II grille emblem which features a chrome finish piece, which includes the Chevy II logo on a black background.

TGE-66X	1966.....	49.99 ea.
T-3051	1967.....	61.99 ea.



T-5779

1968 Chevy II Hood Emblem

Mounts to the front of the hood over the chrome hood edge molding.

T-5779	1968 Chevy II.....	99.99 ea.
--------	--------------------	-----------



T-3085

1969-72 Bowtie Hood Emblem

This emblem mounts onto the front of the hood over the chrome hood edge molding.

T-3085	1969-72 Bowtie Hood.....	58.99 ea.
--------	--------------------------	-----------



T-838

1973-74 Nova Bowtie Grille Emblem

This is an OE style reproduction 1973-74 Nova bowtie grille emblem which is manufactured to factory specifications and features a bright chrome finish with original gold coloring.

T-838	1973-74 Bowtie.....	69.99 ea.
-------	---------------------	-----------



T-744

1975 Nova Custom Grille Emblem

This is an OE style reproduction 1975 Nova Custom grille emblem, die cast and correct in every detail. This emblem is correct for all 1975 Nova Custom models except LN and SS.

T-744	1975 Nova Custom.....	84.99 ea.
-------	-----------------------	-----------



T-743

1975 Nova Standard Grille Emblem

Reproduction die-cast 'Nova' nameplate grille emblem for standard models (except SS and Rally). Features the correct font and mounting studs as original.

T-743	1975.....	69.99 ea.
-------	-----------	-----------



T-170

1976-1977 Nova Standard Grille Emblem

Reproduction die-cast 'Nova' nameplate grille emblem for 1976-1977 Nova standard models (except SS and Rally). Features the correct font and mounting studs as original.

T-170	1976-77.....	44.99 ea.
-------	--------------	-----------



TK-MOTION

Motion Emblem

This universal Baldwin Motion die-cast emblem is perfect for custom projects.

TK-MOTION	All.....	59.99 ea.
-----------	----------	-----------



TG-502

Universal Cross Flag Emblems

These universal cross flag emblems can be mounted anywhere on your car for a nice custom touch while still looking vintage. Universal. Measures 2-7/8" x 4-1/2" with 3 pins on back.

TG-454	454.....	49.99 ea.
TG-502	502.....	49.99 ea.
TG-572	572.....	49.99 ea.



TK-SS427

Baldwin Motion SS427 Emblem

This emblem (GM number 7752254) was originally used on the deck lid of 1968 427 Impalas but it was also used by super car dealers on a lot of their conversions on fenders, hoods and trunk lids. Baldwin Motion often used these emblems on the valve covers of their super cars. Perfect for any super car, tribute car, or custom!

TK-SS427	All.....	39.99 ea.
----------	----------	-----------



TK-427

427 Super Car Emblem

This emblem (GM number 3901932) was originally used on 1967 427 Impalas but it was also used by super car dealers on a lot of their conversions on fenders, hoods and trunk lids. Baldwin Motion used these emblems on the fenders of their super cars in 1969.

TK-427	All.....	19.99 ea.
--------	----------	-----------



T-742

1975 Nova Bowtie Grille Emblem

This is an OE style reproduction 1975 Nova bowtie grille emblem which is correct for all models except LN and SS.

T-742	1975 Bowtie.....	79.99 ea.
-------	------------------	-----------



T-940

1977-79 Rally Grille Emblem

This is an OE style reproduction 1977-79 Rally Nova grille emblem which is die cast with correct coloring.

T-940	1977-79 Rally.....	96.99 ea.
-------	--------------------	-----------



TG-833

1965 283 Fender Emblem

This is an OE style reproduction 1965 Nova fender emblem for models equipped with a 283 engine.

TG-833	1965-67 283.....	18.99 ea.
--------	------------------	-----------



TG-834

1965-67 327 Fender Emblem

This is an OE style reproduction 1965-67 Nova fender emblem for models equipped with a 327 engine.

TG-834	1965-67 327.....	14.99 ea.
--------	------------------	-----------



5th Gen Camaro Emblems

These peel & stick factory GM emblems can be applied to any vintage muscle car for a powerful modern look. Perfect for pro touring cars!

T-12SSW	SS White.....	33.99 ea.
T-12SSR	SS Red.....	34.99 ea.
T-ZL1	ZL1.....	49.95 ea.



T-3022

1964 Chevy II Fender Emblem

This is a pair of correct Chevy II fender emblems.

T-3022 1964 Chevy II.....81.99 pr.



T-3016

T-3018

1962-64 Chevy II 6 Cylinder Fender Emblem

This is a pair of 6 cylinder front fender shield emblems.

T-3016 1962-64 Black..... 65.99 pr.
T-3018 1962-64 Red..... 65.99 pr.



TG-318

1965-67 V Flags Fender Emblem

This is an OE style reproduction Nova fender V emblem.

TG-318 1965-67 V Flags..... 15.99 ea.



TG-1980

1968 Super Sport Fender Emblem

OE style reproduction of this one year only fender emblem.

TG-1980 1968 Super Sport..... 99.99 ea.



TGF-676

1969-72 Nova Fender Emblem

Excellent quality reproduction of the fender emblem.

TGF-676 1969-72 Nova.....51.99 ea.



TQ-356

1969-74 350 Fender Emblem

This is an OE style reproduction Nova fender emblem for models equipped with a 350 engine.

TQ-356 1969-74 350..... 32.99 pr.
NT-1242 1970 Fender Template..... 15.99 kit



TQ-409

1969-74 396 Fender Emblem

This is an OE style reproduction Nova fender emblem for models equipped with a 396 engine.

TQ-409 1969-74 396.....29.99 pr.



TQ-427

1969-74 427 Fender Emblem

This is an OE style reproduction Nova fender emblem for models equipped with a 427 engine.

TQ-427 1969-74 42721.99 ea.



TGF-867



TGF-1989

1973-74 Nova Fender Emblem

Excellent quality reproduction of the emblem found on the fender of your 1973-1974 Nova.

TGF-867 All Chrome.....32.99 ea.
TGF-1989 Black/Chrome.....29.99 ea.



T-3100

1973-74 SS Fender Emblem

This is an OE style reproduction Nova fender emblem for SS models.

T-3100 1973-74 SS.....32.99 ea.



TQ-773-PS

Peel & Stick Super Sport SS Emblems

This is a pair of universal SS fender emblems in custom peel & stick, so no drilling of mounting holes into the fender is required. Each emblem is plastic and chrome plated for a show quality shine. Included are colored sticker inserts for white, black, or red to give this emblem set that custom finish. Since this does not have any mounting pins, it can be placed anywhere and on any vehicle you choose.

TQ-773-PS All..... 18.99 pr.
This is a set of 2 emblems. Does one fender.



T-939

1977-79 Rally Fender Emblem

This is an OE style reproduction 1977-79 Rally Nova fender emblem which is die cast with correct coloring.

T-939 1977-79 Rally96.99 ea.



TG-7579

1975-79 Fender Emblem

Correct die-cast emblem with chrome letters on black background.

TG-7579 1975-79.....32.99 ea.



TG-75C

1975 Nova Custom Fender/Trunk Emblem

Authentic emblem features the correct chrome and red lettering with black background.

TG-75C 197539.99 ea.



TT-502

Universal 502 Emblem

Universal 502 emblem can be used for multiple applications including fenders, trunk lids, header panels, or hoods. Must drill holes for installation of mounting pins.

TT-502 Universal.....31.99 pr.



TK-8013



TK-678

Yenko Emblems

Correct Yenko and 427 emblems which are perfect for an original or recreation.

TK-8013 Yenko32.95 ea.
TK-678 42729.99 ea.



TK-8013-C

Chrome Yenko Emblem

This is a chrome Yenko fender and tail panel emblem. While the original was white, this chrome version is perfect for custom projects.

TK-8013-C Yenko49.99 ea.



T-3015

1962 Chevy II Nova 400 Quarter Panel Emblem

This is a pair of rear quarter panel emblem with fasteners.

T-3015 1962 Nova 400..... T-3015



T-1075

1963 SS Quarter Panel Emblem

This is a pair of correct 1963 Nova SS quarter panel emblems with white SS and red bar.

T-1075 1963 Nova SS59.99 pr.



T-3022

1963 Chevy II Quarter Panel Emblem

This is a pair of correct Chevy II quarter panel emblems.

T-3022 1963 Chevy II.....81.99 pr.



T-1077

1964 SS Quarter Panel Emblem

This is a pair of correct 1964 Nova SS quarter panel emblems with red SS and black bar.

T-1077 1964 Nova SS.....89.99 pr.



T-3030

1965 Nova Chevy II Quarter Panel Emblem

This is a pair of correct 1965 Chevy II quarter panel emblems.

T-3030 1965 Nova Chevy II.....93.99 pr.



TG-75C

1975 Nova Custom Fender/Trunk Emblem

Authentic emblem features the correct chrome and red lettering with black background.

TG-75C 197539.99 ea.



T-3031

1965 Nova SS Quarter Panel Emblem

This is a pair of correct 1965 Chevy Nova SS quarter panel emblems.

T-3031 1965 Nova SS.....96.99 pr.



T-3040

1966-67 Nova Chevy II Quarter Panel Emblem

This is a pair of correct 1966-67 Chevy II quarter panel emblems.

T-3040 1966-67 Nova Chevy II88.99 pr.



TGQ-7012

1966-67 Super Sport Quarter Panel Emblem

This is a pair of correct 1966-67 SS quarter panel emblems.

TGQ-7012 1966-67 Super Sport65.99 pr.



1968 Nova Quarter Panel Emblem
Excellent quality reproduction of the emblem found on the quarter panel of your 1968 Nova.
TGF-676 1968 Nova51.99 ea.



1965 SS Rear Panel Emblem
This is an OE style reproduction 1965 Nova SS rear panel emblem.
T-3032 1965 Nova SS54.99 ea.



1965 Bowtie Panel Emblem
This is an OE style reproduction 1965 Nova bowtie rear panel emblem.
T-3029 1965 Bowtie.....64.99 ea.



T-3075



T-3090

1968-72 SS Rear Panel Emblem
This is an OE style reproduction SS rear panel emblem for Super Sport models.
T-3075 1968-69 SS 53.99 ea.
T-3090 1970-72 SS 53.99



1963-64 Nova SS Trunk Emblem
This is a correct 1963-64 Nova SS trunk lid emblem.
T-3020 1963-64 Nova SS 52.99 ea.



T-3070

1968 Chevy II Trunk Emblem
This is a correct 1968 Nova Chevy II trunk emblem. This emblem is mounted on the trunk lid on all models.
T-3070 1968 Chevy II..... 48.99 ea.



TGQ-1089

1969-72 Trunk Lid Emblem
This is a correct "Nova by Chevrolet" trunk lid emblem.
TGQ-1089 1968-72 Nova.....33.99 ea.



T-3100

1973-74 SS Trunk Emblem
This is an OE style reproduction Nova trunk emblem for SS models.
T-3100 1973-74 SS 32.99 ea.



T-4406

1977 Chevrolet Concours Trunk Emblem
Reproduction trunk emblem for 1977 Nova Concours models. Features correct chrome finish and proper script font for an authentic appearance. Attaches to the passenger side of the trunk lid with an adhesive back installation as original.
T-4406 1977 32.99 ea.



DH1018

Dick Harrell Emblem
This universal diecast emblem is perfect for custom projects.
DH1018 All59.99 ea.



LSB-4523



LSB-2420

Side Marker Bezel
Excellent reproduction of the original side marker bezel for use on front fenders and rear quarters and are available with or without engine size designation. The front bezels are installed over the side marker lens assemblies and act as a chrome trim molding piece displaying your vehicle's engine designation.

LSB-4520	1968-69 Front 307.....	95.99 pr.
LSB-4521	1968-69 Front 327.....	95.99 pr.
LSB-4522	1968-69 Front 350.....	93.99 pr.
LSB-4523	1968-69 Front 396.....	64.99 pr.
LSB-4524	1968-69 Front 427.....	86.99 pr.
LSB-459	1968-69 Rear No ID.....	8.99 ea.
LSB-502	1968-69 Front 502.....	99.99 pr.
LSB-2420	1970-79 Front.....	21.99 ea.
LSB-2430	1970-79 Rear.....	21.99 ea.
LSG-X68	1968-69 Marker Gaskets.....	6.99 kit
LSG-X70	1970-79 Marker Gaskets.....	7.99 set



LSM-68X307

1968-69 Side Marker Kit
This kit includes (4) side marker lens bezels and (4) lenses. Choose from any engine size!

LSM-68X307	1968 307.....	141.23 kit
LSM-68X327	1968 327.....	141.23 kit
LSM-68X350	1968 350.....	139.43 kit
LSM-68X396	1968 396.....	113.33 kit
LSM-68X427	1968 427.....	133.13 kit
LSM-69X307	1969 307.....	143.03 kit
LSM-69X327	1969 327.....	143.03 kit
LSM-69X350	1969 350.....	141.23 kit
LSM-69X396	1969 396.....	115.13 kit
LSM-69X427	1969 427.....	134.93 kit



Since 1985, Phoenix Graphix's goal has been to provide factory correct restoration, user-complete decal, and striping kits at an affordable price and in a timely fashion. With this philosophy, Phoenix Graphix leads the industry. They sell of- ficially licensed restoration decals and stripe kits for General Motors (GM), Mopar, American Motors (AMC), Jeep and Ford Motor Company vehicles. Their complete product line is proudly manufactured in the USA.



1969 Yenko Stripe Kit

This stripe kit is exclusively for this one year only Yenko Super Car! Includes hood, fender, door and quarter panel stripes and is available in black or white. This kit does (1) car.

69-YNKO	Black.....	209.95 kit
69-YNKOW	White.....	209.99 kit

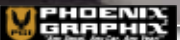

1970 Yenko Deuce Stripe Kit

This stripe kit is for the one year only Yenko Deuce with the LT-1 engine. Includes hood, door, fender, quarter panel and wide trunk lid stripes and is available in black or white. This kit does (1) car.

70-YNDB	Black.....	319.95 kit
70-YNDW	White.....	319.95 kit



1971-72 Rally Nova Stripe Kit

This stripe kit is for the rare Rally Nova option and is complete with fender, door, quarter panel and rear end panel stripes as well as a "Rally Nova" hood decal. This kit does (1) car.

712-RLYB	Black.....	219.95 kit
712-RLYW	White.....	219.95 kit



1973 Nova SS Stripe Kit

This stripe kit for the 1973 Nova SS includes fender, door and quarter panel stripes. This kit does (1) car.

73-NSSB	Black.....	219.95 kit
73-NSSW	White.....	219.95 kit



1974 Nova SS Stripe Kit

This stripe kit for the 1974 Nova SS includes header/hood stripes, trunk/hatchback stripes, Nova SS fender decals and Nova SS trunk decal.

74-NSSB	Black/Gold.....	209.95 kit
74-NSSG	Gold/Red.....	209.95 kit

1975-76 Nova SS Stripe Kit

This is a complete 1975-76 Nova SS Super Sport decal kit. Includes (3) SS fender and trunk decals, squeegee and instructions. These factory optioned decals will add a tough muscle car look to your Nova.



7576-NSSB	Black.....	29.95 kit
7576-NSSW	White.....	32.99 kit
7576-NSSG	Gold.....	29.95 kit
7576-NSSS	Silver.....	29.95 kit
7576-NSSR	Red.....	29.95 kit
7576-NSSMR	Metallic Red*.....	29.95 kit

*Correct for 1976 only.



1977-79 Nova SS Stripe Kit

This is a complete 1977-79 Nova SS Super Sport decal kit. Includes (2) front wheel well stripes, (2) door stripes, (2) rear wheel well stripes, (2) rear tail lamp stripes, squeegee and instructions. These factory optioned decals will add a tough muscle car look to your Nova.

7779-NRB	Black.....	199.95 kit
7779-NRW	White.....	199.95 kit
7779-NRG	Gold.....	199.95 kit
7779-NRR	Red.....	199.95 kit
7779-NRO	Orange.....	199.95 kit



Universal Rally Stripe Stencil Kit

This universal rally stripe kit makes it easy to add stripes to any year Nova. Based off of the 1969 Camaro Z/28 stripes this complete kit includes (2) sets of front hood stencils, (2) trunk stencils and (1) 9/32 x 38-1/2 foot roll of stripe masking which can be cut to desired length depending on car.

MSS-0688	All.....	64.95 kit
----------	----------	-----------

Note: This is a universal stencil kit. Simply cut the roll of stripe masking to your desired length to add stripes to any car.

Pre-Application Surface Cleaner

Nothing is more important than proper preparation of a vehicle's painted surface prior to applying decals and stripes. Remove contaminants like silicones, wax, tree sap and bug guts for a clean and adherent surface. Nothing beats smooth decals and stripes that resist lifting because of a proper PRE-APPLICATION!



PREAPP	4 oz. Pre-App Cleaner.....	13.95 ea.
--------	----------------------------	-----------

SLIDE-ON Application Gel

Slide-On Application Gel will provide you the greatest advantage of a perfect application; time. Slide-On contains a special formula that resists drying until you are ready to squeegee the graphic into place. Only then does the decal "set up". With Slide-On time is on your side. The more Slide-On you use the more time you have.



SOAG	16 oz. Application Gel.....	19.95 ea.
------	-----------------------------	-----------

SLIDE-OVER UV Protectant

Help protect your decal from harsh elements and natural aging by applying our revolutionary Slide-Over UV Protectant & Conditioner. Slide-Over is not oily or greasy and does not attract dust. More importantly, unlike petroleum distillates, it does not draw moisture from the vinyl.



SOPC	8 oz. UV Protectant.....	19.95 ea.
------	--------------------------	-----------



Air Cleaner Decals SB

HOJ-(Engine Horsepower).....8.99 ea.
Ex. HOJ-350250 for decal above.



Cross Flag Decals BB

HOJ-(Engine).....11.99 ea.
Ex. HOJ-396 for decal above.



Diecast Air Cleaner Decals

HOJ-(engine)-DC Diecast.....69.99 ea.
Ex. HOJ-396-DC for the decal above.



Turbo Jet Decals BB

HOJ-(Horsepower)11.99 ea.
Ex. HOJ-375 for decal above.



Diecast Turbo Jet Decals

HOJ-(Horsepower)-DC Diecast.....69.99 ea.
Ex. HOJ-375-DC for the decal above



HY-164



HV-225



HY-069

Yenko Decals

HY-164 Yenko S/C Fan Shroud Decal.....10.99 ea.
HV-225 Yenko S/C Valve Cover Decal.....11.99 ea.
HY-069 Yenko S/C Window Decal.....10.99 ea.



HFA-930

Caution Fan Decal

HFA-930 Universal.....9.99 ea.

HAC-67



A/C Window Decals

HAC-64 1964-65.....5.99 ea.
HAC-67 1966-67.....8.99 ea.

AIR CONDITIONED



A/C Box Decals

HOJ-550 All Harrison.....8.99 ea.



Cooling System Decal

HOJ-242 1970-74 All.....8.99 ea.



Emission Decals

HE-68H

HE-68H All.....8.99 ea.
HE-CH 1969 396/375 CH.....8.99 ea.
HE-U 1964-68 V8 w/o SHP.....8.99 ea.
HE-CG 1969 396/325-350 CG.....8.99 ea.
HE-DR 1970 396/350 4spd DR.....8.99 ea.
HE-AX 1970 SB AX.....8.99 ea.
HE-AT 1970 396/350 Auto AT.....8.99 ea.
HE-CF 1969 SB CF.....8.99 ea.



Air Cleaner Decal

HOJ-476 All.....8.99 ea.



Valve Cover Decal Cross Flags

HVC-28 Finned Alum Valve Covers.....10.99 ea.



Valve Cover Decals

HJI-69

HJL-69 1969 396/375 Auto.....5.95 ea.
HJI-69 1969 396/350 Auto.....5.95 ea.
HJJ-69 1969 396/375 Manual.....5.95 ea.
HJJ-69 1969 L89 396/375.....5.95 ea.
HMO-69 1969 427/425 Auto.....5.95 ea.
HMN-69 1969 427/427 Manual.....5.95 ea.

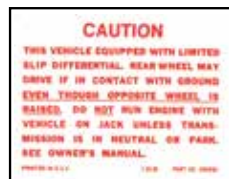

Positraction Decal

HBH-797 Most.....8.99 ea.

HJC-756

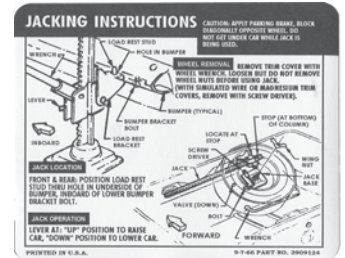

Jacking Instructions

HJC-840 1962-66 All.....8.99 ea.
HJC-843 1967 All.....8.99 ea.
HJC-756 1968-70 All.....8.99 ea.
HJC-845 1971-72 All.....8.99 ea.



HSF-PS

Shock Decals

HSF-PS Most Front.....7.95 pr.
HSF-PW Most BB Front.....7.95 pr.
HSR-TN Most BB Rear.....7.95 pr.



Door Jamb Decals

HDJ-678 Green.....8.99 ea.
HDJ-69 Blue.....7.99 ea.
HDJ-706CA 1970-76 GM Of Canada.....13.99 ea..



HOJ-599

A/C Compressor Decals

HOJ-590 1963-65 All.....5.99 ea.
HOJ-599 1967-68 Red.....5.99 ea.
HOJ-741 1967-68 Green.....5.99 ea.
HOJ-607 1969-72 Red.....8.99 ea.
HOJ-738 1969-72 Green.....5.99 ea.

HDL-70



Steering Box Decals

HBA-70 1970 Power Steering BA.....4.95 ea.
HDL-70 1970 Manual Steering DL.....4.95 ea.



Valve Cover Decals

ATO-3000 All BB Tonawanda.....8.99 ea.
HFT-50 1967 Flint SB.....4.99 ea.

Wiring Diagrams

Original GM wiring schematic from bumper to bumper.

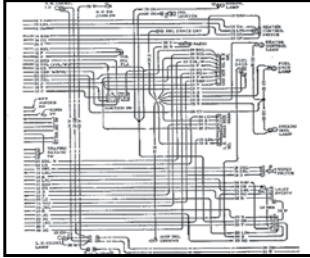

HWD-62X	1962 All	13.99 ea.
HWD-63X	1963 All	13.99 ea.
HWD-64X	1964 All	13.99 ea.
HWD-65X	1965 All	13.99 ea.
HWD-66X	1966 All	13.99 ea.
HWD-67X	1967 All	13.99 ea.
HWD-68X	1968 All	13.99 ea.
HWD-69X	1969 All	13.99 ea.
HWD-70X	1970 All	13.99 ea.
HWD-71X	1971 All	13.99 ea.
HWD-72X	1972 All	13.99 ea.

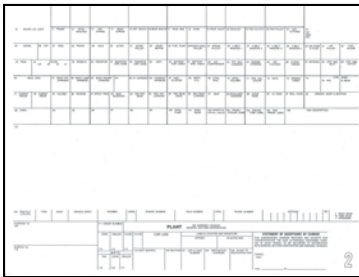

Blank Build Sheet

OE style reproduction of the factory build sheet which allows you to make your own custom paper perfect for a recreation car!

HBS-66	1968-74 All	10.99 ea.
--------	-------------	-----------

Blank Window Sticker

OE style reproduction of the factory window sticker which allows you to make your own custom paper perfect for a recreation car.



HOB-661

HOB-661	1962-65 All	14.99 ea.
HOB-386	1966-67 All	14.99 ea.
HOB-879	1968-69 All	14.99 ea.
HOB-350	1970-72 All	14.99 ea.



Objects in Mirror Are Losing Decal

This outside mirror decal gives the appearance of the words being etched into the mirror. It is sure to bring a chuckle to anyone close enough to see it. It's a real hit at race tracks and cruise nights. Two sizes available!

HOJ-LOSE-3	3" x 1/2"	6.25 ea.
HOJ-LOSE-4	4" x 5/8"	5.95 ea.



Engine Paint

VHT® High Temperature Engine Enamel; Nu-Cast Aluminum; 11 oz. Aerosol		
VHT-SP995	Nu-Cast Aluminum	10.99 ea.
VHT® High Temperature Engine Enamel; Cast Iron; 11 oz. Aerosol		
VHT-SP997	Cast Iron	10.99 ea.
VHT® High Temperature Engine Enamel; Chevy Orange; 11 oz. Aerosol		
VHT-SP123	Chevy Orange	10.99 ea.
VHT® High Temperature Engine Enamel; Gloss Black; 11 oz. Aerosol		
VHT-SP124	Gloss Black	10.99 ea.
VHT® High Temperature Engine Enamel; Flat Black; 11 oz. Aerosol		
VHT-SP130	Flat Black	10.99 ea.
VHT® High Temperature Engine Enamel; GM Blue; 11 oz. Aerosol		
VHT-SP135	GM Blue	10.99 ea.
VHT® High Temperature Engine Enamel; Motor-Brite Clear; 11 oz. Aerosol		
VHT-SP29	Motor-Brite Clear	10.99 ea.
VHT® Wrinkle Plus; High Temp Wrinkle Finish; Black; 11 oz. Aerosol		
VHT-SP201	Black Wrinkle	13.99 ea.

Trunk Paint

Dupli-Color® Spatter Paint; Black/Gray; 11 oz. Aerosol		
DUP-DM102	Black/Gray Spatter	11.99 ea.
Dupli-Color® Spatter Paint; Gray/White; 11 oz. Aerosol		
DUP-DM100	Gray/White Spatter	11.99 ea.
Dupli-Color® Spatter Paint; Black/Aqua; 11 oz. Aerosol		
DUP-DM109	Black/Aqua Spatter	11.99 ea.
Dupli-Color® Premium Lacquer; Clear; 12 oz. Aerosol		
DUP-DAL1695	Clear Coat	9.99 ea.
AC Delco Splatter Paint Grey/White 13oz Aerosol		
HDP-64-GW	Gray/White Splatter	19.99 ea.
AC Delco Splatter Paint Black/Aqua 13oz Aerosol		
HDP-68-BA	Black/Aqua Splatter	19.99 ea.

Vinyl Paint

VHT Vinyl Dye Gloss Jet Black; 11 oz. Aerosol		
VHT-SP941	Gloss Jet Black	12.99 ea.
VHT Vinyl Dye White Satin; 11 oz. Aerosol		
VHT-SP943	White Satin	12.99 ea.

Primer

Dupli-Color® Self-Etching Primer; Green; 12 oz. Aerosol		
DUP-DAP1690	Self-Etching Primer	12.99 ea.
VHT® Prime Coat; Red Oxide; 12 oz. Aerosol		
VHT-SP303	Red Oxide Primer	8.99 ea.

Detailing Paint

Dupli-Color® Premium Enamel; Machinery Gray; 12 oz. Aerosol		
DUP-DA1612	Machinery Gray	9.99 ea.
Dupli-Color® Premium Lacquer; Flat Black; 12 oz. Aerosol		
DUP-DAL1607	Flat Black	9.99 ea.
Dupli-Color® Premium Lacquer; Semi-Gloss Black; 12 oz. Aerosol		
DUP-DAL1608	Semi-Gloss Black	9.99 ea.
Dupli-Color® Premium Lacquer; Gloss Black; 12 oz. Aerosol		
DUP-DAL1677	Gloss Black	9.99 ea.
Dupli-Color® Premium Lacquer; Clear; 12 oz. Aerosol		
DUP-DAL1695	Clear	9.99 ea.
Dupli-Color® Automotive Metallic Coating; Stainless Steel; 11 oz. Aerosol		
DUP-SS100	Stainless Steel	9.99 ea.
Dupli-Color® Trim Paint; Black; 11 oz. Aerosol		
Formulated to restore an OEM Flat Black finish to metal trim and molding around windows, body sides and other vehicle areas.		
DUP-TP70	Black	9.99 ea.
VHT® Plate Finish; Chrome; 11 oz. Aerosol		
VHT-SP5251	Chrome	10.99 ea.

Radiator Paint

VHT-SP139	Radiator Black	10.99 ea.
-----------	----------------	-----------

Dupli-Color Rust Barrier

DUP-RBQ100	Quart Flat Black	39.95 ea.
DUP-RBQ101	Quart Gloss Black	50.99 ea.
DUP-RBQ102	Quart Silver	50.99 ea.
DUP-RBG100	Gallon Flat Black	159.99 ea.
DUP-RBG101	Gallon Gloss Black	159.99 ea.
DUP-RBG102	Gallon Silver	159.99 ea.

Dupli-Color Clear Truck Bed/Trunk Coating

DUP-CTBA100	Aerosol	15.99 ea.
DUP-CTBQ100	Quart	29.99 ea.
DUP-CTBG100	Gallon	69.95 ea.

DUP-RBG100



DUP-CTBG100



DECALS & PAINT CONTINUED



DUP-SAR102

DUP-SAR100

Dupli-Color Spray Adhesive

Ideal for use on vehicle carpets, headliners, accessories & more!

DUP-SAR102 Adhesive 15.99 ea.

DUP-SAR100 Adhesive Remover 12.99 ea.

No volume discount.



DUP-HWP102 Shown

Wheel & Tire Paint

Dupli-Color® Hot Tires Tire Paint; White; 0.5 oz. Paint Pen

Whether your tires are old or new, Dupli-Color® Hot Tires™ gives you a way to add color or personalize your muscle car, truck, or sport compact tires. This fast-drying, durable coating allows you to touch-up faded white walls or tattoo your high performance tires. Hot Tires goes on smooth, resists fading and is available in an easy-to-use pen.

DUP-HT100 White Tire Paint 13.99 ea.

Dupli-Color® Wheel Coating; Silver; 11 oz. Aerosol

Argent silver for Chevrolet Rally Wheels.

DUP-HWP101 Argent Silver 10.99 ea.

Details® 1969-70 SS Wheel Insert Gray Paint

Correct gray for 1969-70 SS wheel inserts.

HDP-1214 1969-70 SS Insert Gray 13.99 ea.

Dupli-Color® Wheel Coating; Graphite; 11 oz. Aerosol

Dark gray for SS 5 spoke wheels.

DUP-HWP102 1971-81 SS Gray 10.99 ea.

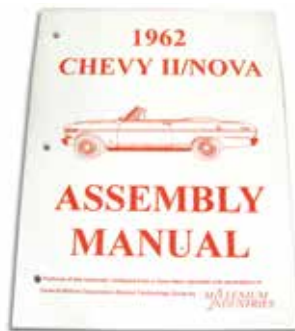

HA-X62

Assembly Manual

A must for all restorations! These books were used at the factory plants as a reference guide for linemen. This book features all engineering drawings, GM numbers and torque specs.

HA-X62	1962 All	24.99 ea.
HA-X63	1963 All	24.99 ea.
HA-X64	1964 All	24.99 ea.
HA-X65	1965 All	24.99 ea.
HA-X66	1966 All	24.99 ea.
HA-X67	1967 All	24.99 ea.
HA-X68	1968 All	24.99 ea.
HA-X69	1969 All	24.99 ea.
HA-X70	1970 All	24.99 ea.
HA-X71	1971 All	24.99 ea.
HA-X72	1972 All	24.99 ea.



HDG-69

Factory Owner's Manual

Authentic reproductions of the original factory owner's manuals which came with all cars.

HDG-62X	1962 All	19.99 ea.
HDG-63X	1963 All	19.99 ea.
HDG-64X	1964 All	19.99 ea.
HDG-65X	1965 All	19.99 ea.
HDG-66X	1966 All	19.99 ea.
HDG-67X	1967 All	19.99 ea.
HDG-68X	1968 All	19.99 ea.
HDG-69	1969 All	19.99 ea.
HDG-70X	1970 All	19.99 ea.
HDG-71X	1971 All	19.99 ea.
HDG-72X	1972 All	19.99 ea.



HMB-2

Owner's Manual Bags

Correct factory plastic bag for your owner's manual and dealer information.

HMB-1	1963-66 All	14.99 ea.
HMB-2	1967-68 All	14.99 ea.
HMB-3	1969-72 All	14.99 ea.



HSM-67

Factory Service Manual

This manual was used by GM dealers to service your car when new. From simple maintenance to major component repair, this manual has all of the info needed to service your car.

HSM-65	1965 All	29.99 ea.
HSM-66	1966 All	29.99 ea.
HSM-67	1967 All	29.99 ea.
HSM-68	1968 All	29.99 ea.
HSM-69	1969 All	29.99 ea.
HSM-70	1970 All	29.99 ea.
HSM-71	1971 All	29.99 ea.
HSM-72	1972 All	29.99 ea.



HFB-69

Fisher Body Manual

Complete information on the actual body of the car including interior, trim, door panels, glass, trunk and more!

HFB-65	1965	26.95 ea.
HFB-66	1966	26.95 ea.
HFB-67	1967	26.95 ea.
HFB-68	1968	26.95 ea.
HFB-69	1969	26.95 ea.
HFB-70	1970	26.95 ea.
HFB-71	1971	26.95 ea.
HFB-72	1972	26.95 ea.
HFB-73	1973	29.99 ea.



Chevy Start Sleeve

OE style reproduction starting instruction sleeve which was installed on the sunvisor.

HSS-69 1969-72 11.99 ea.

A

Accel.....128

Accelerator

Bracket.....116-118

Cable.....118

Hardware.....34

Linkage.....34, 118

Pedal/Pad.....34

Rod.....118

Air Cleaner

Assembly.....112-113

Decal.....196

Flame Arrestor.....114

Wing Nut.....114, 146

Air Conditioning.....111

Brackets.....119

Delete.....110

Hardware.....143

Alternator.....123

Bracket.....124-126

Fan.....125

Hardware.....124, 143

American Auto Wire.....183

American Racing.....55

AMK

A/C Hardware Kits.....143

Chassis/Body Kits.....142

Engine Hw Kits.....143

Antenna.....49, 148

Hidden.....49

Lead Wire.....49

Arm Rest.....17-18

Ash Tray

Dash/Rear.....17-18

B

Battery

Battery Topper.....140

Cable.....140, 184

Tray/Retainer.....140

Bell Crank

Door Lock Rod.....163

Bezel

Dash.....20

Headlamp.....153

Parking Lamp.....190

Side Marker.....154

Tail Lamp.....189

Billet Accessories

Dipstick/Tube.....134

Headlight Knob.....27

Hood Hinge.....159

Pedals.....35

Pulleys.....121-125

Rear View Mirror.....44

Trunk Hinge.....174

Blower Motor

Blower Motor.....110

Resistor.....111

Switch.....185

Body Bolt Kit.....72, 142-143

Bracket

A/C.....119

Alternator.....124-126

Bumper.....155-156

Flex Hose.....61

Grille.....152-153

License Plate.....98

Mirror (Door).....149

Power Steering.....82

Seat.....169

Washer Jar.....139

Brake Lines

Clips.....65

Conversion.....58-59

Factory.....65

Brake Parts

Booster/Booster Master Kits.....62-63

Calipers.....59

Distribution Block.....64-66

Drum.....66-67

Flex Hoses.....66

Hardware.....60-61, 65-67

Master Cylinder.....61

Pads.....60

Parking Brake.....67

Pedal Assembly.....33, 86

Proportioning Valve.....64

Rotors.....60

Shoes.....67

Wheel Cylinder.....66

Bumper

Bolt.....143, 155

Bolt (to Bracket).....143, 155

Bracket.....155-156

Filler Panel.....155, 161

Front/Rear.....155

Kit.....155

Seal.....181

Bushing

Body.....77

Control Arm.....70-71

Leaf Spring.....76

Pilot.....87

Radiator Support.....72

Sway Bar.....73

B&M

Deep Pans.....94

Differential Covers.....96

Flexplate.....88

Trans Coolers.....95

Shifters.....90

Overhaul Kits.....91

C

Cable

Accelerator.....118

Battery.....140, 184

Heater Control.....33

Parking Brake.....67

Shifter.....91

Speedometer.....27, 94-95

Cap

Bearing.....60

Fuel Tank.....97

Master Cylinder.....61

Power Steering.....80

Radiator.....105

Washer Jar.....139

Carburetor.....115-116

Base Shield.....115

Block.....136

Choke Kit.....114

Fittings/Lines.....136

Stud.....114

Carpet

Firewall Guard.....37

Sill Plates.....35

Center Link.....69

Cigarette Lighter.....28

Classic Console.....41

Clock.....23

Dash.....23

Reset Knob.....23

Clutch

Clutch Kit.....87-88

Clutch Parts.....87-88

Fan.....104

Linkage.....86, 89

Pedal Assembly.....86

Throwout Bearing.....87

Z-Bar.....86, 89

Coil Spring

Insulator.....73

Lowering.....73

OE Replacement.....73

Console.....38-41

Console Gauges.....40

Harness.....182

Shell.....38-39

Control Arm

Bushings.....70-71

Front.....70-71

Hardware.....70, 143

Tubular Kit.....70-71

Conversion Kit

Disc Brake.....56-59

Manual Trans.....86

Convertible

Boot.....50

Cylinder.....50

Hose.....50

Motor.....50

Top.....50

Top Hook.....50

Top Latch.....50

Weatherstrip.....50, 178

Well Liner.....50

Cooling System

Champion Cooling.....107

Radiator.....105, 107, 108

Rad. Hoses.....106

Thermostat.....121

Cowl

Panel.....161-162

Seal.....188

Shoulder.....161

Side Panel.....161

Vent Panel.....161

Crank

Crank Pulley.....122

Window.....19

Crossmember.....85, 170

Cross Rail.....172

Custom Auto Sound.....46-49

D

Dash

Ash Tray.....28

Bezel.....20

Conversion Kit.....23

Dashtop.....21

Dash Pad.....20

Emblem.....26

Gauges.....22-26

Harness.....182

Instrument Cluster.....23

Knobs.....23, 26-28

Lens.....20, 22

Panel.....161

Speaker.....47-48

Top Panel.....161

Trim.....26-27

Vents.....20

Dakota Digital.....24-25

Decals.....195-196

Demon Carburation.....115

Detroit Speed

Coilover Kit.....71

Deeptubs.....76, 166

Lowering Springs.....73

Speed Kit.....75

Steering Box.....83

Suspension Kits.....75

Sway Bar.....73

Tubular Control Arms.....71

Digi-Tails

LED Parking Lamp.....187

LED Tail Light.....187

Disc Brakes

Conversion.....56-59

Conversion Lines.....58-59, 61

Dip Stick

Engine Oil.....134

Transmission.....95

Distributor

Cap.....127, 185

HEI.....128, 184

Hold Down.....127, 185

Dome Light.....44-45, 187

Door

Door Jamb Switch.....185

Glass.....175

Handle (Exterior).....148

Handle (Interior).....19

Handle Mechanism.....19

Hardware.....144, 163

Hinge.....163

Hinge Bolts.....144, 163

Latch.....163

Shell.....162

Skin.....162

Striker.....144, 163

Weatherstrip.....179

Door Panels.....14-16

Clips & Plugs.....17

Emblems.....16

Knobs & Ferrules.....17

Retainer.....16

Trim Tools.....17

Water Shield.....16

E

Eddie Motorsports

Door Strikers.....144, 163

Hood Adj. Bolts.....144

Hood Hinges.....159

Hood Latches.....160

Trunk Hinges.....174

Electrical.....182-187

Emblems.....10, 16, 26, 30-31, 191-194

Engine

Hardware Kits.....142

Harness.....182-183

Lifting Rings.....117

Mount.....74, 135

Paint.....197

Exhaust

Downpipe.....100, 103

Flowmaster.....103

French Locks.....99

Headers.....100-103

Heat Riser Valve.....99

Heat Stove.....99

Manifolds.....99

Manifold Bolts.....99, 144

PYPES Exhaust.....100

F

Fan

Blade.....104

Clutch.....104

Electric Fan.....104

Hardware.....104, 144

Shroud.....105

Fender.....157-158

Bolts.....144, 158

Braces.....158

Fender Grippers.....113

Inner Fender Wells.....157

Patch Panel.....158

Washer.....144

Filter

Air Cleaner.....112-113

Fuel.....98, 136-137

Oil.....134

Fire Extinguisher.....37

Firewall.....162

A/C Delete.....110

Bracket.....162

Insulation.....37

Rods.....89

Flaming River.....79

Floor Mats.....35

Floor Pan

Brace.....168

Drain Plug.....172

Full Floor.....167-168

Half.....169

Shifter Tunnel.....168

Trunk Floor.....171

Flowmaster

Exhaust.....103

Flowtech.....102

Flywheel.....87-88
Bolts.....87, 145
Inspection Cover.....87
Forward Lamp Harness.....183
Frame Marking Crayons.....141
Frame Rails.....170
Frostbite Cooling.....108
Fuel
Cap.....97
Clips.....98
Door.....98
Filter.....98, 136-137
Fuel Lines.....98, 136-137
Fuel Pump.....137
Fuel Tanks.....97
Gauge.....27
Hose.....98, 136
Hardware.....98, 136
Kit.....97
Pump to Carb Line.....136
Sender Harness.....98
Sending Unit.....98
Straps.....97

G

Gaskets
Air Cleaner.....114
Exhaust (Donut).....99
Exhaust (Heat Riser).....99
Heater Box.....180-181
Oil Pan.....133
Paint Seal Kit.....180
Parking Lamp.....154
Rear End Cover.....96
Side Marker.....154
Tail Lamp.....188
GForce Crossmembers.....85
Glass.....175
Glass Hardware.....176-177

Glove Box
Box.....27
Door.....27
Emblems.....26
Lamp.....28, 185
Lock.....191

Grille
Brackets.....153
Filler Panel.....155, 161
Grille Kits.....152
Hardware.....145, 153
Moldings.....152
Mounting Kit.....145, 153

H

Handle
Door Handle (Inside).....19
Door Handle (Exterior).....148
Vent Window.....19
Hardware.....142-146
Harness Retainer.....141, 184
Harness Tape.....141, 184
Hays Clutches.....88
Headlamp.....188
Adjustment Kit.....153
Bezel.....153
Bucket.....153
Dimmer Switch.....186
Hardware.....153
Retainer.....153
Switch.....186
Headliner.....42
Bows.....42
Insulation.....42
Trim.....44
Headrests.....11
Brackets & Guides.....11
Covers.....11
Locks.....11

Heater
Blower Motor.....110
Box.....109-110

Box Cover.....110
Control Assembly.....33
Control Cables.....33
Control Lens.....33
Control Valve.....111
Delete Plate.....110
Heater Core.....109
Hoses.....109
Hose Fittings.....121

Hinge
Door.....163
Hood.....159
Trunk.....174
Holley Hood.....97, 115, 135, 137
Holley Hood
Adjustment.....144-145
Catch.....160
Cowl Induction.....160
Emblem.....192
Hinge.....159
Hinge Bolt.....145
Insulation.....141
Latch.....160
Latch Support.....160
Louvers.....150, 160
Pin Kit.....160
Tach.....26

Hooker.....101
Horn.....141
Button.....28-31
Cap.....28-31
Contact Kit.....28-31
Relay.....141, 187

Hose
Bypass.....120
Clamps.....106, 120
Convertible Top.....50
Fuel.....98, 137
Heater.....109
Overflow.....105
PCV.....118
Power Brakes.....62
Power Steering.....81, 83
Radiator.....106
Retainers.....81, 105, 109, 114, 118
Washer.....139

Hurst
Auto Shifters.....90-91
Installation Kit.....91-92
Line Lock.....61
Shifter.....90-92
Shifter Cables.....91

I

Idle Arm.....69
Bolts.....69, 145
Ignition
Coil.....128, 184
Lock Cylinder.....191
Switch.....186

Insulation
Fuel Tank.....97
Headliner.....42
Hood.....141
Package Tray.....45
Intake Manifold.....117
Bolt Kits.....117, 145
Stud.....117, 145
Vacuum Fittings.....117

Interior
Bulb Kits.....45, 187
Fastener Kits.....17, 145
Interior Kits.....3-6

J

Jack
Decal (Instructions).....51, 196
Retainer.....51, 145
Junction Block.....140, 185

K

Kickdown
Cable.....84
Bracket.....84
Kick Panels.....33, 48
Cables.....33
Speakers.....48
Support.....170

Knob
Bucket Seat Release.....10
Clock.....23
Dash.....26-28
Door Lock.....17
Emergency Brake.....34
Emergency Flasher.....31
Headlamp.....27
Heater Control.....33
Radio.....27
Seat Adjustment.....10
Wiper.....27

L

Lakewood Bellhousing.....88
Latch
Door.....163
Hood.....160
Trunk.....173, 191
Light Bulbs
Bulbs Interior.....20, 45, 187
Bulbs Exterior.....187-188
LED.....20, 187
Kits.....45, 187-189

Lens
Dash (Instrument).....20
Dash (Indicators).....22
Dome Light.....44, 187
Heater Control.....33
License Plate Lamp.....154
Parking Lamp.....190
Reverse Light.....189
Side Marker.....190
Shift Indicator.....22, 38
Tail Lamp.....189-190

Lever
Heater Control.....33
Tilt Wheel.....32
Turn Signal.....32

License Plate
Bracket.....98
Hardware.....98, 145
Lamp.....154
Locks.....191

M

Mallory Ignition.....128-129
Manifold
Exhaust.....99
Intake.....117
Manuals.....198
Manual Transmission
Conversion Kits.....86

Mirror
Bracket.....44, 149
Inside.....44
Outside.....149
Molding
C Molding.....150
Clips.....147, 150
Drip Rail.....148
Eyebrow.....154
Front Windshield.....147
Grille.....152
Hood.....151
Quarter Window.....150
Rear Window.....147
Rocker Panel.....151
Studs.....147
Vinyl Top.....148
Wheel Opening.....150

Motor Mount.....74, 135

Bolts.....135, 145
Frame Brackets.....135
MSD.....128-129

O

Oil
Cap.....117, 133
Dipstick.....134
Filler Tube.....117
Filter.....134
Line Kit.....134
Oil Pan
Bolts.....133, 145
Drain Plug.....133, 145
Gasket.....133
Oil Pressure Fitting & Switch.....134
Windage Tray.....134

P

Package Tray.....45, 170, 173
Insulation.....45
Repair Panel.....170, 173
Paint.....197
Parking Brake.....67
Parking Lamps
Bezel.....190
Housing.....189-190
Lens.....189-190
PCV.....118
Pedal
Brake/Clutch.....34-35, 86
Pads & Trim.....34-35, 86
Pilot Bushing.....87
Pitman Arm.....69, 83
Plugs
Plastic/Rubber.....146
Positraction
Decal/Tag.....96, 197
Power Seat Relay.....187
Power Steering
Brackets.....82
Gear Box.....69, 83
Hardware.....81, 83
Hose.....81, 83
Pulley.....80
Pump.....79
Rag Joint.....83

Power Top
Cylinder.....50
Hoses.....50
Pressure Plate
Bolts.....146
Printed Circuit Board.....187
Pulley
Alternator.....123-125
Bolts.....143
Crank.....122
Power Steering.....80
Water Pump.....120-121

Pump
Fuel.....137
Power Steering.....79
Washer.....139
Water.....120

Q

Quarter Panel
Full.....164
Patch.....165
Skin.....164-165
Quarter Window
Glass.....175
Seal.....150, 179-180
Quick Fuel.....115-116, 137
Quietride Acoustishield.....37

R

Radiator
Cap.....105
Champion Cooling.....104, 107
Clamps.....106
Cold Case.....107

Fan Shroud.....105, 107
 Frame Bracket.....158
 Hoses.....106
 Mounting.....105
 OEM.....105
 Overflow Jar.....106
 Support.....161
 Show Panel.....108
 Top Panel.....109
Radio.....46-47
 Bezel.....27
 Capacitor.....127, 140, 185
 Lens.....26
Rear End.....95-96
Rear Lamp Harness.....183
Regulator
 Window (Front/Rear).....162
 Voltage.....140, 185
Repair Panel
 Cowl.....161-162
 Dash.....161
 Fender.....158
 Package Tray.....170, 173
 Quarter Panel.....165
Reverse Lamp.....188-189
 Lockout Kit.....89
 Switch.....92, 186
Rocker Panel.....170
 Molding.....151
Roof Panel.....174
 Brace Kit.....174
 Drip Molding.....148
 Drip Rail.....174
 W. Strip Channel.....179
Rubber Stopper Kit.....178

S

Seats.....7-11
 Adjustment Knob.....10
 Back Components.....9-10
 Back & Sides.....9
 Belts.....11-13
 Belt Anchor Bolt.....13, 146
 Belt Components.....11-13
 Covers.....7-8
 Emblems.....10
 Foam.....9-10
 Frame.....9
 Mounting Bolt.....9, 146
 Side Hinge Covers.....10
 Spring.....10
 Tracks & Extenders.....9
 Trim.....9-10
Sending Unit
 Fuel.....98
 Temperature.....114, 141
Shifter
 Automatic.....90-91
 Ball.....92
 Boot/Retainer.....38, 93
 Cable.....91
 Handle.....91-92
 Lens.....22, 38
 Lever.....32
 Seal.....39
 Slider.....38-39
 Tunnel.....168
Sheet Metal.....157-174
Shocks/Hardware.....74, 146
Side Marker
 Lens.....154, 190
 Socket.....154, 187
Sound Deadener.....36-37
Spare Tire Anchor/Cover/Retainer.....51
Spark Plug.....130, 184
 Heat Shields.....130
 Loom.....129-130
 Wire.....129
Speakers
 Dash.....46-48
 Rear.....48-49

Speedometer
 Cables.....94
 Gear.....95
Spring
 Carb Return.....116
 Coil Springs/Leaf Springs.....73, 75
 Clutch Return.....89
 Headlamp.....153
 Hinge (Hood).....160
Starter
 Bolt.....136, 146
 Motor.....136
Steering
 Arm.....61, 70
 Box.....69, 83
 Column.....32, 78
 Column Parts.....32
 Column Seal.....179-180
 Coupler.....83
Steering Wheel.....28-30
 Cap.....28-31
 Cancel Cam.....30-31
 Hub.....30
 Kit.....29-30
 Shroud.....30
Stripe Kits.....195
Sunvisors/Bushings/Supports.....43
Suspension
 Ball Joint.....69
 End Links (Sway Bar).....73
 Kits.....68-78
 Leaf Springs.....75-76
 Spindle.....57, 61
 Tie Rod.....69
Sway Bar
 Brackets/Bolts.....73
 Bushings.....73
 Kit.....73
Switch
 Blower Motor.....185
 Brake Light.....67, 185
 Door Jamb.....185
 Headlamp.....185
 Headlamp Dimmer.....85
 Ignition.....185
 Neutral Safety.....93, 186
 Neutral Start.....93, 186
 Power Window.....19, 186
 Reverse.....93, 186
 TCS.....84
 Turn Signal.....186-187
 Wiper/Washer.....187

T

Tachometer.....23, 26,
Taillights
 Bezel/Gasket/Housing.....189
 Lens.....189
 Kit.....188-189
 Rear Lamp Harness.....183
 Socket.....187
TCS
 Relay.....114
 Solenoid.....114
 Switch.....114
Thermostat.....121
 Bolts.....146
 Housing.....121
Throw Out Bearing.....87
Tilt
 Column.....32, 78
 Lever.....32
Timing Cover.....126
 Bolts.....126, 146
 Pointer.....127
Tires.....55
Tools
 Door Handle/Window.....17, 177
 Door Panel.....17, 177
 Glove Box Nut.....28
 Headlamp Washer Nut.....28
 Hog Ring Pliers.....10

Ignition Nut.....28
 Window Roller.....17, 163, 177
Transmission
 Bellhousing.....87-88
 Coolers.....95
 Cooler Lines.....85
 Crossmember.....85, 170
 Dipstick.....95
 Linkage.....84-86, 89
 Manual Conversion.....86
 Mount.....86
 Pan.....94
 Speedo Gear.....95
 Rebuild Kits.....91-92
 Tail Seal.....94
 Vacuum Lines.....85
 Yoke.....94
Trunk
 Brace.....172
 Catch.....173, 191
 Divider Board.....45
 Drop Off.....172
 Floor.....171
 Floor Drain Plug.....51, 172
 Hinge.....174
 Lamp Harness.....183
 Latch.....173, 191
 Lock.....191
 Lid.....173
 Mat.....51
 Paint.....197
 Spare Tire Cover.....51
 Weatherstrip.....179
Tuff Stuff
 Alternator.....123-124
 Gear Reduc. Start.....136
 Power Steering Pump.....79
 Water Pump.....120

U

Undercover Innovations.....108
Under Hood Lamp.....141

V

Vacuum Advance.....114
 Cover.....114
Valve Cover.....130-133
 Decal.....196
 Elbow.....133
 Gasket.....133
 Grommets.....133
 Hardware.....133, 146
 Hose.....133
 Oil Cap.....133
 Wire Loom.....129-130
Vent Channel Run.....178-179
Vent Window.....174
 Frame.....150
 Glass.....175
 Handle.....19
 Hardware.....19
Vintage Air.....111
Vinyl Top.....148
 Moldings.....148
Voltage Regulator.....140, 185
 Screws.....140, 185

W

Washer
 Cap.....139
 Hose Kit.....139
 Jar.....139
 Nozzles.....139
 Pump.....139
Water Pump.....120-121
 Attaching Kit.....120-121, 146
 Bypass Hose.....120-121
 Pulley.....120-121
 Stud.....120, 146
 Tuff Stuff.....120
Weatherstrip

Convertible.....50, 178
 Deluxe Kits.....178
 Door.....178-179
 Dust Shield (A-Arm).....180
 Firewall Seals.....180-181
 Junior Kits.....178
 Paint Seal Kits.....180
 Quarter Glass.....179-180
 Roof Rail.....179
 Trunk.....179
 Vent Window.....179
 Window Felts.....181
Wheels.....52-55
 Cap.....52-55
 Kits.....52-55
 Lug Nuts.....53
 Paint.....197
 Trim Rings.....54
Wheel Opening Moldings.....150
Wheelhouse
 Inner (Front).....157
 Inner (Rear).....165-166
 Outer (Rear).....165-166
Weiland Intake.....117
Windlace
 Door Jamb.....17
Window
 Crank.....19
 Frame.....150
 Glass (Door).....175
 Glass (Quarter).....175
 Glass (Windshield).....175
 Glass Stop.....175
 Molding.....147
 Molding Pin/Stud.....147
 Regulator.....162
 Rollers.....163, 176
 Stickers.....196-197
 Switch.....19, 186
 Tracks.....162, 176
 Trim.....44
Window Felts.....181
Windshield Wipers
 Arm.....147
 Blades.....147
 Knob.....27
 Motor.....138
 Switch.....187
 Transmission.....139
Wiring Diagram.....183, 197

Company Policies

Hassle Free Returns

Products may be returned for a full refund, credit, or exchange within 30 days of receipt. Products returned after 30 days can only be returned for store credit. All returns are subject to a 25% restocking fee after 30 days. Should you need to return a part for a full refund, credit, or exchange, please contact our customer service department for a return authorization number and instructions or click the link below for our online return form. Ground Up Motors - SS396.com will not accept returned goods without prior authorization. The customer will pay freight on all return orders unless otherwise specified by Ground Up Motors - SS396.com.

Ground Up Motors - SS396.com always recommends professional installation on all the products we sell. Any item which has been altered, painted, installed, or deemed non-resalable by Ground Up Motors - SS396.com will be returned to the customer at the customer's expense. Ground Up Motors - SS396.com is not responsible or liable for labor fees associated with the installation, removal, modification, or repair of any product purchased regardless of the circumstances. Ground Up Motors - SS396.com is not responsible for any damage or discoloration incurred in relation to chemical products including cleaners, waxes, polishes, paints, etc.

Product Availability & Pricing

Availability of all items on SS396.com and in the catalogs are subject to change without notice. Ground Up Motors - SS396.com reserves the right to discontinue products, services or accessories, and/or substitute products of a similar nature (i.e. different manufactures) without notice. Ground Up Motors - SS396.com makes every effort to honor the prices contained herein. However, due to increased costs of manufacturing, materials, etc., prices can change. We reserve the right to change prices without notice. For current pricing please visit our web site, or contact a Ground Up Motors - SS396.com sales representative during normal business hours.

Backorders

The invoice located in the packing slip of your order will notate any items that were out of stock at the time of shipping. The unavailable items will be back ordered unless otherwise specified on your order form or verbally to a sales representative when placing your order by phone. Back orders are usually shipped when the products arrive at our warehouse without prior notification. Ground Up Motors - SS396.com will make an effort to contact the customer if the backorder is more than 90 days old. If you wish to cancel a back order, please notify our customer service department immediately. The customer will be responsible for a 25% restocking fee and freight charges if the back order is cancelled or returned after the items are shipped.

Kit Products

All Ground Up Motors - SS396.com Parts and Accessories catalogs include kits which contain a variety of products. On occasion we may run out of an item supplied with a kit. If this happens we will generally ship what is in stock and back order the item(s) which are not in stock. You may contact our sales department by phone to verify which items are not in stock at the time the order is placed. The customer may decide whether to accept the partial kit or have the entire kit back ordered until the kit is completed and all the items can be shipped at the same time. If the customer decides to accept partial delivery of the kit, then the full price of the kit will be charged to the customer and the back ordered items will be shipped no charge when they arrive at our warehouse. Customers will be charged the appropriate freight fees when applicable. Cancellation of products from a kit will be accepted at 25% below the actual current retail price of the item.

Color Matches

Due to multiple manufacturers of products Ground Up Motors - SS396.com provides, color variations may occur. Slight color variations are common especially amongst interior products and does not constitute a defect. These products are not eligible for return for this reason. Due to variances among computer monitors the colors that appear on your screen may differ slightly from the actual color of the product. If exact color matching on interior items is a concern, please request fee samples prior to ordering. Returns on colored interior items will be subject to a restocking fee.

Discounting

Ground Up Motor - SS396.Com is proud to offer you several ways to save money. These offers do not apply to kit items, sale items, specially priced items, or any items marked "Part eligible for free shipping: NO or Part eligible for discounting: NO. This offer only applies to items that are in stock at the time of ordering. Ground Up Motors - SS396.com reserves the right to exclude items for discounting even though they may not be noted as "No Volume Discount" in this online catalog. Discounts (including team discounts) cannot be combined. Discounting will be reflected on your final invoice after your order has shipped.

Sales Tax Information

Orders shipped outside of Connecticut & Florida may be exempt from sales tax. Connecticut and Florida residents are required to add the appropriate current sales tax. Due to regular variations in Connecticut and Florida sales tax, rates are subject to change without notice. Connecticut and Florida orders are subject to tax, this tax will be applied to the invoice or noted at checkout online.

Ordering Lefts and Rights

Some items in this catalog are presented as right hand (RH) or left hand (LH). RH and LH sides are determined by sitting in the vehicle. RH = passenger and LH = driver.

Trademark and Copyright

The content of Ground Up Motors - SS396.com, including the Ground Up Motors - SS396.com Parts and Accessories catalog is copyright 2023, all rights are reserved. No part of this publication including text, photos or illustrations may be reproduced without the prior written permission of Ground Up Motors - SS396.com.

International Orders

Ground Up Motors - SS396.com is happy to ship parts to international customers via International Economy shipping. Shipping can also be arranged per the customer and the packages will be boxed at our dock. Please call our sales department or send an email to logistics@ss396.com to get a shipping quote for the parts that you wish to order.

Shipping Information

Oversize Items

All items which are considered to be Oversize are items that can be shipped via UPS Ground at an Oversize rate indicating a minimum dimensional weight fee of 30 lbs for Oversize or 70 lbs for Oversize 2. Ground Up Motors - SS396.com® reserves the right to charge an Oversize fee on any item that is Oversize even though it may not be indicated as an Oversize item.

Truck Freight

Some products in this catalog are too large or heavy to be shipped via Ground freight and must be shipped via truck freight. Ground Up Motors - SS396.com charges a minimum of \$199.00 for all orders which must be shipped via Truck Freight to a commercial address. Actual rates can be higher depending on your location and items ordered. Residential addresses require an additional \$150.00, so please provide a commercial address whenever possible. If a commercial address is not available, you can arrange pickup at the closest terminal. (Your sales rep can provide you with the location.) If an address is not deemed to be a commercial address by the carrier, additional charges may apply. These charges are the sole responsibility of the customer.

Expedited Shipping

Ground Up Motors - SS396.com offers several expedited shipping methods for your convenience: UPS 3 Day Saver • UPS 2 Day Air • UPS Overnight Orders must be placed by 2:00 pm Mon-Thur & 12:00 pm Fri. Weekends and holidays do not count as shipping days. Ground Up Motors - SS396.com is not responsible for lost or damaged goods due to carrier mishandling. You must contact our sales department for actual shipping rates.

Insurance

Each order is charged an insurance fee of \$1.00 per \$100.00 to insure the entire order and protect you completely from damages or loss in shipping.

APO/FPO

Parcel post is the only means of shipping to an APO or FPO address. Due to size restrictions, the maximum shipping box cannot exceed 72" width and girth combined. All military personal must write, call or email us prior to ordering to ensure that the desired parts do not exceed the size limit.

Damage Claims

Ground Packages - Always check the contents of your delivery in the presence of the person delivering the merchandise. Should any damage be present, immediately notify our customer service department so that Ground Up Motors - SS396.com can take all necessary steps to file a claim with the carrier and ensure a prompt replacement of the damaged goods. Replacement parts will normally be sent out within 2 business days after receipt of a claim number from the carrier. Ground Up Motors - SS396.com is not responsible for any damaged good that have not been reported within 3 business days of receipt of delivery. If the customer files a claim with the carrier, Ground Up Motors - SS396.com will not be responsible to pay for any replacements until the carrier pays the claim.

Truck Freight - You MUST check the contents of your delivery in the presence of the carrier! DO NOT ALLOW THE DELIVERY PERSON TO LEAVE PRIOR TO CHECKING YOUR SHIPMENT! Should there be any damage, you MUST note the damage on the Bill of Lading. If the damage is beyond repair, REFUSE THE SHIPMENT! The Bill of Lading is a legal document. Should you accept the shipment and sign the Bill of Lading stating the items you received are in good condition without checking them, there is NO RECOURSE with the carrier if the goods are later found to be damaged. If items are discovered to be damaged at the time of delivery and noted as damaged on the Bill of Lading or refused, immediately notify our customer service department so that Ground Up Motors - SS396.com can take all steps necessary to ensure a prompt replacement or adjustment on the damaged goods.

Shortages

Always check the contents of your delivery to ensure that all parts ordered were received. If you are missing any items, first check your invoice to check for back-orders or drop shipments before calling our customer service department. If a shortage has occurred, please contact our customer service department immediately for a prompt replacement. Ground Up Motors - SS396.com is not responsible for any delivery shortages after 3 business days.

Refusals

All refused deliveries will be subject to a 25% restocking fee plus return shipping charges (unless it was refused because of damage in shipping. See our damage claim policy above).

Billing Address

Name _____
 Address _____
 Address 2 _____
 City _____ State _____ Zip _____
 Home Phone _____
 Business Phone _____
 E-Mail _____

Vehicle Information Year _____ Model _____

Body Style _____ Engine Trans _____
 Interior Color _____ Exterior Color _____
 (Circle any applicable) A/C • Buckets or Bench • PBrakes
 Other information to help us better understand your vehicle _____

Shipping Address

Name _____
 Address _____
 Address 2 _____
 City _____ State _____ Zip _____

Special Comments

Page #	Part #	Quantity	Description	Price (each)	Total Price

Payment Type: Check Money Order Credit Card
 Card # _____
 Expires _____ / _____ CVV code _____
 Authorized Signature _____



Subtotal	
Sales Tax	
Shipping & Handling see chart	
Insurance 1st \$100 free -\$1 per 100	
Total	

*All checks are held for 21 business days. All money orders are held for 7 business days. Ground Up Motors does not accept COD orders.

Shipping & Handling Guide
 Shipping charges are based on actual shipping charges and are listed below as approximate estimates for UPS Ground. Your actual shipping & handling charge may be more or less than the amounts listed below. Use this chart as a guide.

Orders up to \$25.....Add \$8.95 \$25.01 to \$40.00.....Add \$10.95 \$40.01 to \$60.00.....Add \$14.95 \$60.01 to \$75.00.....Add \$17.95 \$75.01 to \$100.00.....Add \$20.95 \$100.01 to \$150.00.....Add \$24.95 \$150.01 to \$200.00.....Add \$27.95 \$200.01 to \$300.00.....Add \$32.95 \$300.01 to \$400.00.....Add \$36.95 \$400.01 to \$500.00.....Add \$42.95 \$500.01 to \$600.00.....Add \$49.95 \$600.01 to \$1000.00.....Add \$54.95	UPS Oversize 1.....each item.....Add \$19.95 UPS Oversize 2.....each item.....Add \$39.95 Insurance.....per \$100.00.....Add \$1.00 Truck Freight Commercial.....Call Truck Freight Residential.....Call International.....Call
--	--

This chart does not apply to truck freight and international orders. All truck freight and international orders must be quoted by a Ground Up Motors customer service representative. Please call 1-866-358-2277 to receive your shipping quote today!

*Charges below still apply

Company Policies

Hassle Free Returns

Products may be returned for a full refund, credit, or exchange within 30 days of receipt. Products returned after 30 days can only be returned for store credit. All returns are subject to a 25% restocking fee after 30 days. Should you need to return a part for a full refund, credit, or exchange, please contact our customer service department for a return authorization number and instructions or click the link below for our online return form. Ground Up Motors - SS396.com will not accept returned goods without prior authorization. The customer will pay freight on all return orders unless otherwise specified by Ground Up Motors - SS396.com.

Ground Up Motors - SS396.com always recommends professional installation on all the products we sell. Any item which has been altered, painted, installed, or deemed non-resalable by Ground Up Motors - SS396.com will be returned to the customer at the customer's expense. Ground Up Motors - SS396.com is not responsible or liable for labor fees associated with the installation, removal, modification, or repair of any product purchased regardless of the circumstances. Ground Up Motors - SS396.com is not responsible for any damage or discoloration incurred in relation to chemical products including cleaners, waxes, polishes, paints, etc.

Product Availability & Pricing

Availability of all items on SS396.com and in the catalogs are subject to change without notice. Ground Up Motors - SS396.com reserves the right to discontinue products, services or accessories, and/or substitute products of a similar nature (i.e. different manufactures) without notice. Ground Up Motors - SS396.com makes every effort to honor the prices contained herein. However, due to increased costs of manufacturing, materials, etc., prices can change. We reserve the right to change prices without notice. For current pricing please visit our web site, or contact a Ground Up Motors - SS396.com sales representative during normal business hours.

Backorders

The invoice located in the packing slip of your order will notate any items that were out of stock at the time of shipping. The unavailable items will be back ordered unless otherwise specified on your order form or verbally to a sales representative when placing your order by phone. Back orders are usually shipped when the products arrive at our warehouse without prior notification. Ground Up Motors - SS396.com will make an effort to contact the customer if the backorder is more than 90 days old. If you wish to cancel a back order, please notify our customer service department immediately. The customer will be responsible for a 25% restocking fee and freight charges if the back order is cancelled or returned after the items are shipped.

Kit Products

All Ground Up Motors - SS396.com Parts and Accessories catalogs include kits which contain a variety of products. On occasion we may run out of an item supplied with a kit. If this happens we will generally ship what is in stock and back order the item(s) which are not in stock. You may contact our sales department by phone to verify which items are not in stock at the time the order is placed. The customer may decide whether to accept the partial kit or have the entire kit back ordered until the kit is completed and all the items can be shipped at the same time. If the customer decides to accept partial delivery of the kit, then the full price of the kit will be charged to the customer and the back ordered items will be shipped no charge when they arrive at our warehouse. Customers will be charged the appropriate freight fees when applicable. Cancellation of products from a kit will be accepted at 25% below the actual current retail price of the item.

Color Matches

Due to multiple manufacturers of products Ground Up Motors - SS396.com provides, color variations may occur. Slight color variations are common especially amongst interior products and does not constitute a defect. These products are not eligible for return for this reason. Due to variances among computer monitors the colors that appear on your screen may differ slightly from the actual color of the product. If exact color matching on interior items is a concern, please request fee samples prior to ordering. Returns on colored interior items will be subject to a restocking fee.

Discounting

Ground Up Motors - SS396.com is proud to offer you several ways to save money. These offers do not apply to kit items, sale items, specially priced items, or any items marked "Part eligible for free shipping: NO or Part eligible for discounting: NO. This offer only applies to items that are in stock at the time of ordering. Ground Up Motors - SS396.com reserves the right to exclude items for discounting even though they may not be noted as "No Volume Discount" in this online catalog. Discounts (including team discounts) cannot be combined. Discounting will be reflected on your final invoice after your order has shipped.

Sales Tax Information

Orders shipped outside of Connecticut & Florida may be exempt from sales tax. Connecticut and Florida residents are required to add the appropriate current sales tax. Due to regular variations in Connecticut and Florida sales tax, rates are subject to change without notice. Connecticut and Florida orders are subject to tax, this tax will be applied to the invoice or noted at checkout online.

Ordering Lefts and Rights

Some items in this catalog are presented as right hand (RH) or left hand (LH). RH and LH sides are determined by sitting in the vehicle. RH = passenger and LH = driver.

Trademark and Copyright

The content of Ground Up Motors - SS396.com, including the Ground Up Motors - SS396.com Parts and Accessories catalog is copyright 2023, all rights are reserved. No part of this publication including text, photos or illustrations may be reproduced without the prior written permission of Ground Up Motors - SS396.com.

International Orders

Ground Up Motors - SS396.com is happy to ship parts to international customers via International Economy shipping. Shipping can also be arranged per the customer and the packages will be boxed at our dock. Please call our sales department or send an email to logistics@ss396.com to get a shipping quote for the parts that you wish to order.

Shipping Information

Oversize Items

All items which are considered to be Oversize are items that can be shipped via UPS Ground at an Oversize rate indicating a minimum dimensional weight fee of 30 lbs for Oversize or 70 lbs for Oversize 2. Ground Up Motors - SS396.com® reserves the right to charge an Oversize fee on any item that is Oversize even though it may not be indicated as an Oversize item.

Truck Freight

Some products in this catalog are too large or heavy to be shipped via Ground freight and must be shipped via truck freight. Ground Up Motors - SS396.com charges a minimum of \$199.00 for all orders which must be shipped via Truck Freight to a commercial address. Actual rates can be higher depending on your location and items ordered. Residential addresses require an additional \$150.00, so please provide a commercial address whenever possible. If a commercial address is not available, you can arrange pickup at the closest terminal. (Your sales rep can provide you with the location.) If an address is not deemed to be a commercial address by the carrier, additional charges may apply. These charges are the sole responsibility of the customer.

Expedited Shipping

Ground Up Motors - SS396.com offers several expedited shipping methods for your convenience: UPS 3 Day Saver • UPS 2 Day Air • UPS Overnight Orders must be placed by 2:00 pm Mon-Thur & 12:00 pm Fri. Weekends and holidays do not count as shipping days. Ground Up Motors - SS396.com is not responsible for lost or damaged goods due to carrier mishandling. You must contact our sales department for actual shipping rates.

Insurance

Each order is charged an insurance fee of \$1.00 per \$100.00 to insure the entire order and protect you completely from damages or loss in shipping.

APO/FPO

Parcel post is the only means of shipping to an APO or FPO address. Due to size restrictions, the maximum shipping box cannot exceed 72" width and girth combined. All military personal must write, call or email us prior to ordering to ensure that the desired parts do not exceed the size limit.

Damage Claims

Ground Packages - Always check the contents of your delivery in the presence of the person delivering the merchandise. Should any damage be present, immediately notify our customer service department so that Ground Up Motors - SS396.com can take all necessary steps to file a claim with the carrier and ensure a prompt replacement of the damaged goods. Replacement parts will normally be sent out within 2 business days after receipt of a claim number from the carrier. Ground Up Motors - SS396.com is not responsible for any damaged good that have not been reported within 3 business days of receipt of delivery. If the customer files a claim with the carrier, Ground Up Motors - SS396.com will not be responsible to pay for any replacements until the carrier pays the claim.

Truck Freight - You MUST check the contents of your delivery in the presence of the carrier! DO NOT ALLOW THE DELIVERY PERSON TO LEAVE PRIOR TO CHECKING YOUR SHIPMENT! Should there be any damage, you MUST note the damage on the Bill of Lading. If the damage is beyond repair, REFUSE THE SHIPMENT! The Bill of Lading is a legal document. Should you accept the shipment and sign the Bill of Lading stating the items you received are in good condition without checking them, there is NO RECOURSE with the carrier if the goods are later found to be damaged. If items are discovered to be damaged at the time of delivery and noted as damaged on the Bill of Lading or refused, immediately notify our customer service department so that Ground Up Motors - SS396.com can take all steps necessary to ensure a prompt replacement or adjustment on the damaged goods.

Shortages

Always check the contents of your delivery to ensure that all parts ordered were received. If you are missing any items, first check your invoice to check for back-orders or drop shipments before calling our customer service department. If a shortage has occurred, please contact our customer service department immediately for a prompt replacement. Ground Up Motors - SS396.com is not responsible for any delivery shortages after 3 business days.

Refusals

All refused deliveries will be subject to a 25% restocking fee plus return shipping charges (unless it was refused because of damage in shipping. See our damage claim policy above).

Billing Address

Name _____
 Address _____
 Address 2 _____
 City _____ State _____ Zip _____
 Home Phone _____
 Business Phone _____
 E-Mail _____

Vehicle Information Year _____ Model _____

Body Style _____ Engine Trans _____
 Interior Color _____ Exterior Color _____

(Circle any applicable) A/C • Buckets or Bench • PBrakes
 Other information to help us better understand your vehicle _____

Shipping Address

Name _____
 Address _____
 Address 2 _____
 City _____ State _____ Zip _____

Special Comments

Page #	Part #	Quantity	Description	Price (each)	Total Price

Payment Type: Check Money Order Credit Card

Card # _____

Expires ____ / ____ CVV code _____

Authorized Signature _____



Subtotal	
Sales Tax	
Shipping & Handling see chart	
Insurance 1st \$100 free -\$1 per 100	
Total	

*All checks are held for 21 business days. All money orders are held for 7 business days. Ground Up Motors does not accept COD orders.

Shipping & Handling Guide	
Shipping charges are based on actual shipping charges and are listed below as approximate estimates for UPS Ground. Your actual shipping & handling charge may be more or less than the amounts listed below. Use this chart as a guide.	
Orders up to \$25.....Add \$8.95 \$25.01 to \$40.00.....Add \$10.95 \$40.01 to \$60.00.....Add \$14.95 \$60.01 to \$75.00.....Add \$17.95 \$75.01 to \$100.00.....Add \$20.95 \$100.01 to \$150.00.....Add \$24.95 \$150.01 to \$200.00.....Add \$27.95 \$200.01 to \$300.00.....Add \$32.95 \$300.01 to \$400.00.....Add \$36.95 \$400.01 to \$500.00.....Add \$42.95 \$500.01 to \$600.00.....Add \$49.95 \$600.01 to \$1000.00.....Add \$54.95	UPS Oversize 1.....each item.....Add \$19.95 UPS Oversize 2.....each item.....Add \$39.95 Insurance.....per \$100.00.....Add \$1.00 Truck Freight Commercial.....Call Truck Freight Residential.....Call International.....Call
<i>This chart does not apply to truck freight and international orders. All truck freight and international orders must be quoted by a Ground Up Motors customer service representative. Please call 1-866-358-2277 to receive your shipping quote today!</i>	
*Charges below still apply	

Company Policies

Hassle Free Returns

Products may be returned for a full refund, credit, or exchange within 30 days of receipt. Products returned after 30 days can only be returned for store credit. All returns are subject to a 25% restocking fee after 30 days. Should you need to return a part for a full refund, credit, or exchange, please contact our customer service department for a return authorization number and instructions or click the link below for our online return form. Ground Up Motors - SS396.com will not accept returned goods without prior authorization. The customer will pay freight on all return orders unless otherwise specified by Ground Up Motors - SS396.com.

Ground Up Motors - SS396.com always recommends professional installation on all the products we sell. Any item which has been altered, painted, installed, or deemed non-resalable by Ground Up Motors - SS396.com will be returned to the customer at the customer's expense. Ground Up Motors - SS396.com is not responsible or liable for labor fees associated with the installation, removal, modification, or repair of any product purchased regardless of the circumstances. Ground Up Motors - SS396.com is not responsible for any damage or discoloration incurred in relation to chemical products including cleaners, waxes, polishes, paints, etc.

Product Availability & Pricing

Availability of all items on SS396.com and in the catalogs are subject to change without notice. Ground Up Motors - SS396.com reserves the right to discontinue products, services or accessories, and/or substitute products of a similar nature (i.e. different manufactures) without notice. Ground Up Motors - SS396.com makes every effort to honor the prices contained herein. However, due to increased costs of manufacturing, materials, etc., prices can change. We reserve the right to change prices without notice. For current pricing please visit our web site, or contact a Ground Up Motors - SS396.com sales representative during normal business hours.

Backorders

The invoice located in the packing slip of your order will notate any items that were out of stock at the time of shipping. The unavailable items will be back ordered unless otherwise specified on your order form or verbally to a sales representative when placing your order by phone. Back orders are usually shipped when the products arrive at our warehouse without prior notification. Ground Up Motors - SS396.com will make an effort to contact the customer if the backorder is more than 90 days old. If you wish to cancel a back order, please notify our customer service department immediately. The customer will be responsible for a 25% restocking fee and freight charges if the back order is cancelled or returned after the items are shipped.

Kit Products

All Ground Up Motors - SS396.com Parts and Accessories catalogs include kits which contain a variety of products. On occasion we may run out of an item supplied with a kit. If this happens we will generally ship what is in stock and back order the item(s) which are not in stock. You may contact our sales department by phone to verify which items are not in stock at the time the order is placed. The customer may decide whether to accept the partial kit or have the entire kit back ordered until the kit is completed and all the items can be shipped at the same time. If the customer decides to accept partial delivery of the kit, then the full price of the kit will be charged to the customer and the back ordered items will be shipped no charge when they arrive at our warehouse. Customers will be charged the appropriate freight fees when applicable. Cancellation of products from a kit will be accepted at 25% below the actual current retail price of the item.

Color Matches

Due to multiple manufacturers of products Ground Up Motors - SS396.com provides, color variations may occur. Slight color variations are common especially amongst interior products and does not constitute a defect. These products are not eligible for return for this reason. Due to variances among computer monitors the colors that appear on your screen may differ slightly from the actual color of the product. If exact color matching on interior items is a concern, please request fee samples prior to ordering. Returns on colored interior items will be subject to a restocking fee.

Discounting

Ground Up Motor - SS396.Com is proud to offer you several ways to save money. These offers do not apply to kit items, sale items, specially priced items, or any items marked "Part eligible for free shipping: NO or Part eligible for discounting: NO. This offer only applies to items that are in stock at the time of ordering. Ground Up Motors - SS396.com reserves the right to exclude items for discounting even though they may not be noted as "No Volume Discount" in this online catalog. Discounts (including team discounts) cannot be combined. Discounting will be reflected on your final invoice after your order has shipped.

Sales Tax Information

Orders shipped outside of Connecticut & Florida may be exempt from sales tax. Connecticut and Florida residents are required to add the appropriate current sales tax. Due to regular variations in Connecticut and Florida sales tax, rates are subject to change without notice. Connecticut and Florida orders are subject to tax, this tax will be applied to the invoice or noted at checkout online.

Ordering Lefts and Rights

Some items in this catalog are presented as right hand (RH) or left hand (LH). RH and LH sides are determined by sitting in the vehicle. RH = passenger and LH = driver.

Trademark and Copyright

The content of Ground Up Motors - SS396.com, including the Ground Up Motors - SS396.com Parts and Accessories catalog is copyright 2023, all rights are reserved. No part of this publication including text, photos or illustrations may be reproduced without the prior written permission of Ground Up Motors - SS396.com.

International Orders

Ground Up Motors - SS396.com is happy to ship parts to international customers via International Economy shipping. Shipping can also be arranged per the customer and the packages will be boxed at our dock. Please call our sales department or send an email to logistics@ss396.com to get a shipping quote for the parts that you wish to order.

Shipping Information

Oversize Items

All items which are considered to be Oversize are items that can be shipped via UPS Ground at an Oversize rate indicating a minimum dimensional weight fee of 30 lbs for Oversize or 70 lbs for Oversize 2. Ground Up Motors - SS396.com® reserves the right to charge an Oversize fee on any item that is Oversize even though it may not be indicated as an Oversize item.

Truck Freight

Some products in this catalog are too large or heavy to be shipped via Ground freight and must be shipped via truck freight. Ground Up Motors - SS396.com charges a minimum of \$199.00 for all orders which must be shipped via Truck Freight to a commercial address. Actual rates can be higher depending on your location and items ordered. Residential addresses require an additional \$150.00, so please provide a commercial address whenever possible. If a commercial address is not available, you can arrange pickup at the closest terminal. (Your sales rep can provide you with the location.) If an address is not deemed to be a commercial address by the carrier, additional charges may apply. These charges are the sole responsibility of the customer.

Expedited Shipping

Ground Up Motors - SS396.com offers several expedited shipping methods for your convenience: UPS 3 Day Saver • UPS 2 Day Air • UPS Overnight Orders must be placed by 2:00 pm Mon-Thur & 12:00 pm Fri. Weekends and holidays do not count as shipping days. Ground Up Motors - SS396.com is not responsible for lost or damaged goods due to carrier mishandling. You must contact our sales department for actual shipping rates.

Insurance

Each order is charged an insurance fee of \$1.00 per \$100.00 to insure the entire order and protect you completely from damages or loss in shipping.

APO/FPO

Parcel post is the only means of shipping to an APO or FPO address. Due to size restrictions, the maximum shipping box cannot exceed 72" width and girth combined. All military personal must write, call or email us prior to ordering to ensure that the desired parts do not exceed the size limit.

Damage Claims

Ground Packages - Always check the contents of your delivery in the presence of the person delivering the merchandise. Should any damage be present, immediately notify our customer service department so that Ground Up Motors - SS396.com can take all necessary steps to file a claim with the carrier and ensure a prompt replacement of the damaged goods. Replacement parts will normally be sent out within 2 business days after receipt of a claim number from the carrier. Ground Up Motors - SS396.com is not responsible for any damaged good that have not been reported within 3 business days of receipt of delivery. If the customer files a claim with the carrier, Ground Up Motors - SS396.com will not be responsible to pay for any replacements until the carrier pays the claim.

Truck Freight - You MUST check the contents of your delivery in the presence of the carrier! DO NOT ALLOW THE DELIVERY PERSON TO LEAVE PRIOR TO CHECKING YOUR SHIPMENT! Should there be any damage, you MUST note the damage on the Bill of Lading. If the damage is beyond repair, REFUSE THE SHIPMENT! The Bill of Lading is a legal document. Should you accept the shipment and sign the Bill of Lading stating the items you received are in good condition without checking them, there is NO RECOURSE with the carrier if the goods are later found to be damaged. If items are discovered to be damaged at the time of delivery and noted as damaged on the Bill of Lading or refused, immediately notify our customer service department so that Ground Up Motors - SS396.com can take all steps necessary to ensure a prompt replacement or adjustment on the damaged goods.

Shortages

Always check the contents of your delivery to ensure that all parts ordered were received. If you are missing any items, first check your invoice to check for back-orders or drop shipments before calling our customer service department. If a shortage has occurred, please contact our customer service department immediately for a prompt replacement. Ground Up Motors - SS396.com is not responsible for any delivery shortages after 3 business days.

Refusals

All refused deliveries will be subject to a 25% restocking fee plus return shipping charges (unless it was refused because of damage in shipping. See our damage claim policy above).

Billing Address

Name _____
 Address _____
 Address 2 _____
 City _____ State _____ Zip _____
 Home Phone _____
 Business Phone _____
 E-Mail _____

Vehicle Information Year _____ Model _____

Body Style _____ Engine Trans _____
 Interior Color _____ Exterior Color _____
 (Circle any applicable) A/C • Buckets or Bench • PBrakes
 Other information to help us better understand your vehicle _____

Shipping Address

Name _____
 Address _____
 Address 2 _____
 City _____ State _____ Zip _____

Special Comments

Page #	Part #	Quantity	Description	Price (each)	Total Price

Payment Type: Check Money Order Credit Card

Card # _____
 Expires _____ / _____ CVV code _____
 Authorized Signature _____



Subtotal	
Sales Tax	
Shipping & Handling see chart	
Insurance 1st \$100 free -\$1 per 100	
Total	

*All checks are held for 21 business days. All money orders are held for 7 business days. Ground Up Motors does not accept COD orders.

Shipping & Handling Guide
 Shipping charges are based on actual shipping charges and are listed below as approximate estimates for UPS Ground. Your actual shipping & handling charge may be more or less than the amounts listed below. Use this chart as a guide.

Orders up to \$25.....	Add \$8.95	UPS Oversize 1.....	each item.....	Add \$19.95
\$25.01 to \$40.00.....	Add \$10.95	UPS Oversize 2.....	each item.....	Add \$39.95
\$40.01 to \$60.00.....	Add \$14.95	Insurance.....	per \$100.00.....	Add \$1.00
\$60.01 to \$75.00.....	Add \$17.95	Truck Freight Commercial.....		Call
\$75.01 to \$100.00.....	Add \$20.95	Truck Freight Residential.....		Call
\$100.01 to \$150.00.....	Add \$24.95	International.....		Call
\$150.01 to \$200.00.....	Add \$27.95	<i>This chart does not apply to truck freight and international orders. All truck freight and international orders must be quoted by a Ground Up Motors customer service representative. Please call 1-866-358-2277 to receive your shipping quote today!</i>		
\$200.01 to \$300.00.....	Add \$32.95			
\$300.01 to \$400.00.....	Add \$36.95			
\$400.01 to \$500.00.....	Add \$42.95			
\$500.01 to \$600.00.....	Add \$49.95			
\$600.01 to \$1000.00.....	Add \$54.95			

*Charges below still apply



FREE CATALOGS

Have another car? You can request additional high-quality print catalogs packed with thousands of restoration parts at ss396.com!



We've moved to a new location!

2 Commerce Blvd, Palm Coast, FL 32164

Part not in our catalog?

Visit ss396.com or give us a call to shop for thousands of parts & accessories just for your Chevelle or El Camino!

We love showing off our customer's cars just as much as we love showing off our cars!



#builtfromthegroundup



"So far everything has been speedy, quality and fits like it should all with the factory style fitment I'm after."

**-Gregg C
(1969 Nova)**

We Love to see customer cars and hear their stories. Submit your story today and have a chance to be the feature in our quarterly customer car email featuring your rides! Go online to submit your story at ss396.com.

GROUND MOTORS - SS396.COM
2 COMMERCE BLVD
PALM COAST, FL 32164

PRSRT STD
U.S. POSTAGE PAID
PALM COAST FL 32164
PERMIT NO. 114

CURRENT RESIDENT OR:



1968-1974 Pro-Touring Front Spoilers

Starting At \$119.99



Black/Paintable



Carbon-Dipped



Addictive Flow is a proud part of the Ground Up Motors family of brands.