

THE WORLD'S LARGEST CATALOGUE

promotional products

2021

PROTECT
&
PROMOTE

mkt

ZERO PROBLEMS

THE LARGEST STOCK



amfori
Trade with purpose



SMETA



EN71
European Safety Approval



OEKO-TEX®
CONFIDENCE IN TEXTILES
STANDARD 100



UV400



21.1

Catalogue

WELCOME TO THE FUTURE OF THE PROMOTIONAL PRODUCT

People & Planet Protection

we adapt to new times

A COLLECTION OF INNOVATIVE PRODUCTS ADAPTED TO THE NEW REALITY
EINE KOLLEKTION INNOVATIVER PRODUKTE, DIE AN DIE NEUE REALITÄT ANGEPASST SIND
EEN COLLECTIE VAN INNOVATIEVE PRODUCTEN DIE ZIJN AANGEPAST AAN DE NIEUWE REALITEIT

SUSTAINABILITY AND ECOLOGICAL AWARENESS, APPLIED TO A NEW CONCEPT OF THE PROMOTIONAL GIFT
Yes, we **join the change**, sustainable consumption and environmentally friendly lifestyle.
We are committed to the **3R concept: Recycle, Reuse and Reduce.**

NACHHALTIGKEIT UND ÖKOLOGISCHES BEWUSSTSEIN, ANGEWENDET IN EINER NEUEN PROMO-GESCHENKSAKTION
Ja, wir **tragen zu Veränderung**, nachhaltigem Konsum und einem umweltfreundlichem
Lebensstil bei. Wir setzen auf das **3R-Konzept: Recycling, Re-use und Reduktion.**

DUURZAAM EN ECOLOGISCHE BEWUSTZIJD, TOEGEPAST OP EEN NIEUW CONCEPT VAN PROMOTIE ARTIKELEN.
Ja, we sluiten ons ook aan bij de verandering van duurzame consumptie en een milieuvriendelijke
leefstijl. We hebben onszelf toegewijd aan het **3R-concept; Recycle, Reuse en Reduce.**





PLA



+300 NOVELTIES

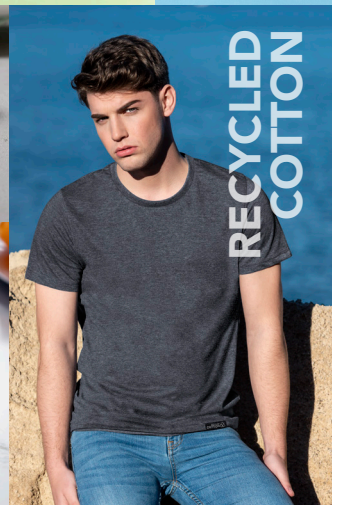

NEW TIMES, NEW MATERIALS

ANTI-BACTERIAL



Antibacterial material specially processed to inhibit and prevent bacterial growth, due to the incorporation of permanent static microbial agents, which are highly effective in the control against bacterial contamination.

LIMESTONE CEMENT



Limestone cement is a binder formed by the mixture of natural materials, mainly ground limestone and water, resulting in a material of great consistency and durability.

RPET / RECYCLED PET



RPET or recycled PET is a material made from the reuse of PET, a kind of plastic present, mainly in the manufacture of bottles and other packaging for drinks. Through industrial processes, PET waste is 100% recycled, resulting in rPET, whose carbon footprint (CO2 emissions into the atmosphere) is drastically reduced. In this way, a simple plastic bottle becomes a resistant material with a multitude of applications and functionalities. This is, at the same time, a recycled and recyclable compound.

PLA (POLYLACTIC ACID)



PLA (Polylactic Acid) is manufactured from 100% natural resources such as corn starch, yucca or sugar cane, being degradable and in our products, it becomes 100% compostable at the end of its lifespan, avoiding the generation of toxic waste. In addition, its versatility and different textures makes it a suitable compound for the elaboration of diverse articles, from bags to bottles, reducing considerably the use of energy during its manufacturing process.

WHEAT STRAW



Wheat straw is obtained from organic waste of the remains of the wheat harvest. Through its reuse, it contributes to the reduction of the use of plastics in a remarkable way, resulting in durable, versatile and resistant compounds, which can be applied in the elaboration of infinite products.

BAMBOO FIBRE



Bamboo fibre is obtained from the organic filaments of this plant, characterized by its rapid growth and its wide ecological connotations. The inclusion of bamboo fiber (FIBRE) in various compounds creates new and resistant materials, becoming a sustainable alternative to the traditional highly polluting plastics.

ORGANIC COTTON



Organic cotton, the cotton of our ancestors, grown using sustainable methods with low impact on the environment. The non-use of insecticides, fertilizers or other chemicals in the yarn and production processes results in a comfortable fabric, 100% plant-derived and hypoallergenic, in a natural weave that claims traditional agriculture.

RECYCLED COTTON



Cotton waste from manufacturing processes, together with that from products that have reached the end of their lifespan, takes on a new life. A question arises: Does cotton recovery result in a quality fabric? The answer is YES, preserving natural resources and reducing the amount of waste generated. In addition, regenerated cotton keeps the properties of soft touch.

CORK



Cork is considered an excellent insulator, flexible, which regenerates naturally around the trunk of the trees from which it is extracted, mainly from the oak tree. The processes of cork extraction have a minimum impact on the environment, also standing out for being one of the most durable and resistant organic materials.

YUTE NATURAL

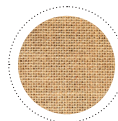

Natural jute stands out among sustainable materials because the manufacturing processes have a low impact on the environment, together with its rapid regeneration. The natural aspect, together with its resistance and durability, makes of it a sustainable material of reference.

BAMBOO



The natural bamboo plant is characterised by its great resistance, flexibility and above all, by its rapid growth and regeneration, a characteristic that makes it a sustainable material and an excellent alternative to the use of traditional wood, with a multitude of applications. It is naturally resistant to plagues, so it does not require the use of pesticides.

RECYCLED PAPER



The remains of paper from the manufacturing processes, together with the paper that has reached the end of its lifespan, become an ecological and sustainable material. During the paper recycling process, the amount of virgin fibres used is drastically reduced, contributing to the conservation of forests. In addition, the amount of energy used in the process of recycled paper is considerably reduced, compared to the energy required for the production of traditional white paper.

INDEX

WELCOME TO THE FUTURE OF PROMOTIONAL GIFTS

06-139 **TECH GIFTS**

Technologie und Accessoires

/ Technology and Accessories / **Technologie en toebehoren**

140-251 **DESKTOP WONDERS**

Büro und Arbeit / Office and Business /

Kantoor en bedrijf

252-333 **LET'S WRITE**

Schreiben / Writing / **Schrijven**

334-385 **URBAN LIFESTYLE & LEISURE**

Rucksäcke, Taschen und Freizeit / Backpacks & Leisure /

Rugzakken, tassen en vrije tijd

386-453 **DRINKWARE**

Tassen, Flaschen und Thermoskannen / Mugs, Bottles and

Thermos / **Mokken, flessen en thermosfles**

454-473 **TO GO**

Take Away / Take Away / **Om mee te nemen**

474-529 **FITNESS & OUTDOOR**

Sport und Abenteuer / Sport and Adventure /

Sport en avontuur

530-553 **URBAN TRAVEL**

Reise / Travel / **Reizen**

554-595 **SHOPPING BAGS**

Taschen / Bags / **Tassen**

596-677 **GIFTS FOR ALL**

Geschenke und Preise / Gifts and Premiums /

Geschenken en premies

678-723 **MARKAS**

Die Eleganz der Marken / The elegance of brands /

De elegantie van merken

724-731 **HANDLING & PACKAGING**

Spezielle Verpackungen / Special Packaging /

Speciale verpakking

732-749 **SUBLIMATION**

Sublimationslinie / Sublimation line / **Sublimatielijn**

750-801 **MY HOME**

Zuhause und Dekoration / Home and Decoration /

Huishouden en decoratie

802-837 **BARWARE**

Wein-, Bar- und Hotelaccessoires / Wine, Bar and Hotel

Accessories / **Wijn, bar en hoteltoebehoren**

838- 853 **ANTIBACTERIAL LINE**

Antibakteriell / Antibacteriano /

Antibacterieel

854-875 **TAKE CARE**

persönliche Pflege und Pharma / Personal

care and pharma / **Persoonlijke verzorging en farmacie**

876-893 **SAFETY**

Hygieneschutz / Hygienic Protection /

Bescherming van de hygiëne

894-923 **SHE**

Frauen / Woman / **Vrouw**

924-983 **LET'S PLAY**

Kinder / Kids / **Kinderen**

984-1047 **SUMMER TIME**

Sommer und Strand / Summer and beach /

Zomer en strand

1048-1071 **HEADWEAR**

Kappen und Hüte / Caps and Hats /

Petten en mutsen

1072-1121 **TEXTILE**

Textilien / Textile / **Textiel**

1122-1151 **IT'S RAINING AGAIN!**

Regen und Kälte / Rain and Cold / **Regen en kou**

1152-1189 **DIY**

Werkzeug und KFZ-Zubehör / Tools, Brico and

Car / **Gereedschappen, baksteen en Auto**

1190-1195 **BEST FRIENDS**

Haustierprodukte / Pets Products /

Mascottes

1196-1221 **FIESTA & EVENTS**

Events und Partys / Events and party /

Evenementen en feesten

1222-1235 **CHRISTMAS &**

SEASONAL

Weihnachten / Christmas / **Kerstmis**

1236-1287 **UNIQUE OFFERS**

Outlet

TECH- NOLO- GY

NEW

Tresan
PG.17

BAMBOO





WHEAT STRAW & CORK



Nerel
PG.11



ANTIBACTERIAL

Supot
PG. 31



Simont
PG.37

LIMESTONE
CEMENT

BAMBOO



Piler
6700

Speaker. Limestone Cement/ Bamboo. Bluetooth Connection. Power 3W. USB Rechargeable. Cable Included.
Lautsprecher. Kalksteinzement/ Bambus. Bluetooth Anschluss. Power 3W. USB Wiederaufladbar. Kabel Inklusiv.
Haut-Parleurs. Ciment Calcaire/ Bambou. Connexion Bluetooth. Puissance 3W. Rechargeable USB. Câble Inclus.
Luidspreker. Kalksteen Cement/ Bamboe. Bluetooth Verbinding. Vermogen 3W. USB Oplaadbaar. Kabel Inclusief.

Ø 7.2 × 6.8 cm

30 / 15

Print Code: F(4), L2

NEW



PIECES FROM NATURAL CUTS OF BAMBOO.
THE TEXTURE AND COLOUR MAY VARY.

PIEZAS PROCEDENTES
DE CORTE DE BAMBÚ NATURAL.
SU TEXTURA Y COLOR PUEDEN VARIAR

08



NEW



Wireless
Charger



NEW



WIRELESS CHARGER

Feskon
6701

Charger. Limestone Cement/ Bamboo. Wireless. Cable Included.
Ladegerät. Kalksteinzement/ Bambus. Drahtlos. Kabel Inklusiv.
Chargeur. Ciment Calcaire/ Bambou. Sans Fil. Câble Inclus.
Oplader. Kalksteen Cement/ Bamboe. Draadloos. Kabel Inclusief.

Ø 9 × 1.3 cm

50 / 25

Print Code: E(4), L2

Wiket
6702

Charger. Limestone Cement/ Bamboo. Wireless. Cable Included.
Ladegerät. Kalksteinzement/ Bambus. Drahtlos. Kabel Inklusiv.
Chargeur. Ciment Calcaire/ Bambou. Sans Fil. Câble Inclus.
Oplader. Kalksteen Cement/ Bamboe. Draadloos. Kabel Inclusief.

Ø 10 × 12.5 cm

30

Print Code: E(4), L2



Wireless
Charger

LIMESTONE
CEMENT
CORK



NEW

NEW

09



Seynol
6745



Speaker. Limestone Cement/ Natural Cork. Bluetooth Connection. Power 3W. USB Rechargeable. Cable Included.
Lautsprecher. Kalksteinzement/ Naturkork. Bluetooth Anschluss. Power 3W. USB Wiederaufladbar. Kabel Inklusive.
Haut-Parleurs. Ciment Calcaire/ Bouchon Naturel. Connexion Bluetooth. Puissance 3W. Rechargeable USB. Cable Inclus.
Luidspreker. Kalksteen Cement/ Natuurlijk Kurk. Bluetooth Verbinding. Vermogen 3W. USB Oplaadbaar. Kabel Inclusief.

7.1 × 7.1 × 5.8 cm

20

Print Code: E(4), L2



WIRELESS CHARGER

Normux
6744

Charger. Limestone Cement/ Natural Cork. Wireless. Cable Included.
Ladegerät. Kalksteinzement/ Naturkork. Drahtlos. Kabel Inklusive.
Chargeur. Ciment Calcaire/ Bouchon Naturel. Sans Fil. Cable Inclus.
Oplader. Kalksteen Cement/ Natuurlijk Kurk. Draadloos. Kabel Inclusief.

Ø 9 × 1.3 cm

50 / 25

Print Code: E(4), L2

WHEAT STRAW & CORK

10

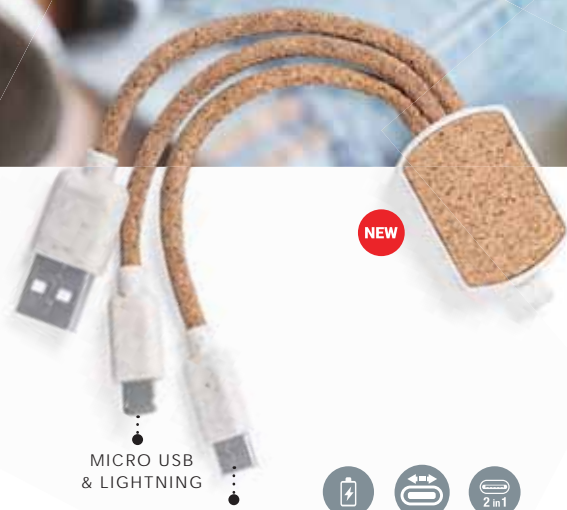

MICRO USB
& LIGHTNING
TYPE C



Guiss

6742

Keyring Charger. Wheat Straw/ ABS/ Natural Cork. Micro USB, Type C and Lightning Connection.
Schlüsselanhänger Ladegerät. Weizenstroh/ ABS/ Naturkork. Anschluss Micro USB, Typ C und Lightning.
Chargeur Porte-Clés. Paille de Blé/ ABS/ Bouchon Naturel. Connexion Micro USB, Type C et Lightning.
Steutelhanger Oplader. Tarwestro/ ABS/ Natuurlijk Kurk. Micro USB, Type C en Lightning Connectie.

2.6 × 16.5 × 1 cm

500 / 100

Print Code: D(4), L1



WIRELESS CHARGER

Livor

6740

Charger. Wheat Straw/ ABS/ Natural Cork. Wireless. Cable Included.
Ladegerät. Weizenstroh/ ABS/ Naturkork. Drahtlos. Kabel Inklusiv.
Chargeur. Paille de Blé/ ABS/ Bouchon Naturel. Sans Fil. Câble Inclus.
Oplader. Tarwestro/ ABS/ Natuurlijk Kurk. Draadloos. Kabel Inclusief.

Ø 10 × 0.7 cm

100 / 50

Print Code: E(4), W



WHEAT STRAW & CORK



Nerel

6743

Speaker. Wheat Straw/ ABS/ Natural Cork. Bluetooth Connection. Power 3W. USB Rechargeable. Cable Included.
Lautsprecher. Weizenstroh/ ABS/ Naturkork. Bluetooth Anschluss. Power 3W. USB Wiederaufladbar. Kabel Inklusiv.
Haut-Parleurs. Paille de Blé/ ABS/ Bouchon Naturel. Connexion Bluetooth. Puissance 3W. Rechargeable USB. Câble Inclus.
Luidspreker. Tarwestro/ ABS/ Natuurlijk Kurk. Bluetooth Verbinding. Vermogen 3W. USB Oplaadbaar. Kabel Inclusief.

▬▬▬▬▬▬ Ø 6 × 5 cm

📦 50 / 25

🌈 Print Code: F(4), L2



11



WIRELESS CHARGER



Merak

6741

Power Bank. Wheat Straw/ ABS/ Natural Cork. Wireless. 5000 mAh. 2 USB Outputs. Type C Input. Cable Included.
Power Bank. Weizenstroh/ ABS/ Naturkork. Drahtlos. 5000 mAh. 2 USB Ausgänge. Typ C Eingang. Kabel Inklusiv.
Power Bank. Paille de Blé/ ABS/ Bouchon Naturel. Sans Fil. 5000 mAh. 2 Sorties USB. Entrée Type C. Câble Inclus.
Power Bank. Tarwestro/ ABS/ Natuurlijk Kurk. Draadloos. 5000 mAh. 2 USB Outputs. Typ C Input. Kabel Inclusief.

▬▬▬▬▬▬ 6.3 × 9.1 × 1.5 cm

📦 50 / 25

🌈 Print Code: E(4), L2, W



WHEAT
STRAW &
BAMBOO



Claudix
6536

Charger. Wheat Straw/ ABS/ Bamboo. Wireless. Cable Included.
Ladegerät. Weizenstroh/ ABS/ Bambus. Drahtlos. Kabel Inklusive.
Chargeur. Paille de Blé/ ABS/ Bambou. Sans Fil. Câble Inclus.
Oplader. Tarwestro/ ABS/ Bamboe. Draadloos. Kabel Inclusief.

11.2 × 1.4 × 6.9 cm
Print Code: E(4)

50 / 25



PIECES FROM NATURAL CUTS OF BAMBOO.
THE TEXTURE AND COLOR MAY VARY.

PIEZAS PROCEDENTES
DE CORTE DE BAMBÚ NATURAL.
SU TEXTURA Y COLOR PUEDEN VARIAR

12



NEW

5000
mAh



Gorix
6736

Power Bank. Wheat Straw/ ABS/ Bamboo. Wireless. 5000
mAh. 2 USB Outputs. Type C Input. Cable Included.

Power Bank. Weizenstroh/ ABS/ Bambus. Drahtlos. 5000
mAh. 2 USB Ausgänge. Typ C Eingang. Kabel Inklusive.

Power Bank. Paille de Blé/ ABS/ Bambou. Sans Fil. 5000
mAh. 2 Sorties USB. Entrée Type C. Câble Inclus.

Power Bank. Tarwestro/ ABS/ Bamboe. Draadloos. 5000
mAh. 2 USB Outputs. Typ C Input. Kabel Inclusief.

6.3 × 9.1 × 1.5 cm

50 / 25

Print Code: E(4), L2, W



NEW



Fiore
6668

Charger. Wheat Straw/ ABS/ Bamboo. Wireless. Cable Included.
Ladegerät. Weizenstroh/ ABS/ Bambus. Drahtlos. Kabel Inklusive.
Chargeur. Paille de Blé/ ABS/ Bambou. Sans Fil. Câble Inclus.
Oplader. Tarwestro/ ABS/ Bamboe. Draadloos. Kabel Inclusief.

Ø 6 × 1.1 cm

100 / 50

Print Code: E(4), L1, W



NEW



TYPE C
MICRO USB
& LIGHTNING

Korux
6669

Keyring Charger. Wheat Straw/ ABS/ Bamboo. Micro USB, Type C and Lightning Connection.
Schlüsselanhänger Ladegerät. Weizenstroh/ ABS/ Bambus. Anschluss Micro USB, Typ C und Lightning.
Chargeur Porte-Clés. Paille de Blé/ ABS/ Bambou. Connexion Micro USB, Type C et Lightning.
Sleutelhanger Oplader. Tarwestro/ ABS/ Bamboe. Micro USB, Type C en Lightning Connectie.

2.2 × 16 × 2.1 cm

500 / 100

Print Code: D(4), L1



PIECES FROM NATURAL CUTS OF BAMBOO.
THE TEXTURE AND COLOR MAY VARY.

PIEZAS PROCEDENTES
DE CORTE DE BAMBÚ NATURAL,
SU TEXTURA Y COLOR PUEDEN VARIAR

WHEAT
STRAW &
BAMBOO
Bluetooth

SPEAKER

Kepir

6666

Speaker. Wheat Straw/ ABS/ Bamboo. Bluetooth Connection. Power 3W. USB Rechargeable. Cable Included.
Lautsprecher. Weizenstroh/ ABS/ Bambus. Bluetooth Anschluss. Power 3W. USB Wiederaufladbar. Kabel Inklusive.
Haut-Parleurs. Paille de Blé/ ABS/ Bambou. Connexion Bluetooth. Puissance 3W. Rechargeable USB. Câble Inclus.
Luidspreker. Tarwestro/ ABS/ Bamboe. Bluetooth Verbinding. Vermogen 3W. USB Oplaadbaar. Kabel Inclusief.

7.4 × 7 × 4.5 cm

50 / 25

Print Code: F(4), L2



NEW

MOYA

WIRELESS CHARGER



Trecam

6546

Charger Speaker. Wheat Straw/ ABS/ Bamboo. Wireless. Fast Charger 10W.
Bluetooth Connection. Power 5W. USB Rechargeable. Cable Included.

Ladegerät Lautsprecher. Weizenstroh/ ABS/ Bambus. Drahtlos. Schnelle
Aufladung 10W. Bluetooth Anschluss. Power 5W. USB Wiederaufladbar. Kabel
Inklusive.

Haut-Parleurs Chargeur. Paille de Blé/ ABS/ Bambou. Sans Fil. Charge Rapide
10W. Connexion Bluetooth. Puissance 5W. Rechargeable USB. Câble Inclus.
Oplader Luidspreker. Tarwestro/ ABS/ Bamboe. Draadloos. Snellader 10W.
Bluetooth Verbinding. Vermogen 5W. USB Oplaadbaar. Kabel Inclusief.

16 × 5.9 × 6 cm

30 / 15

Print Code: F(4), L2

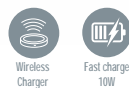

Kion

6775

Charger Pencil Holder. Bamboo/ Wheat Straw/ ABS. Wireless. Fast Charger 10W. Cable Included.
Ladegerät Stifthalter. Bambus/ Weizenstroh/ ABS. Drahtlos. Schnelle Aufladung 10W. Kabel Inklusive.
Porte-Crayons Chargeur. Bambou/ Paille de Blé/ ABS. Sans Fil. Charge Rapide 10W. Câble Inclus.
Oplader Pennenbakje. Bamboe/ Tarwestro/ ABS. Draadloos. Snellader 10W. Kabel Inclusief.

15 × 11 × 7.5 cm

40 / 20

Print Code: F(4), L2



NEW



Dilfox

6525

Organizer Charger. Natural Cork. Wireless. Cable Included.
 Ordner Ladegerät. Naturkork. Drahtlos. Kabel Inklusive.
 Chargeur Organiseur. Bouchon Naturel. Sans Fil. Câble Inclus.
 Organizer Oplader. Natuurlijk Kurk. Draadloos. Kabel Inclusief.

26.9 x 1.8 x 15 cm

50 / 25

Print Code: F(2), L2, W



Wireless
Charger



14



Toskan

6616

Charger Notepad. Natural Cork. Wireless. 64 Sheets. Cable Included.
 Ladegerät Notizblock. Naturkork. Drahtlos. 64 Seiten. Kabel Inklusive.
 Bloc Notes Chargeur. Bouchon Naturel. Sans Fil. 64 Feuilles. Câble Inclus.
 Oplader Notitieblokje. Natuurlijk Kurk. Draadloos. 64 Blaadjes. Kabel Inclusief.

17.5 x 22.5 x 3 cm

20

Print Code: G(1), L2



64 Sheets
Lined



Wireless
Charger



Wireless
Charger



Anti Slip



Holder

Relium

6615

Charger Mousepad. Natural Cork/ Velvet. Wireless. Cable Included.
 Ladegerät Mauspad. Naturkork/ Wildleder. Drahtlos. Kabel Inklusive.
 Tapis Souris Chargeur. Bouchon Naturel/ Suéline. Sans Fil. Câble Inclus.
 Oplader Muispad. Natuurlijk Kurk/ Fluweel. Draadloos. Kabel Inclusief.

26.5 x 20.5 cm

50

Print Code: F(1), L2



Video

CORK



Yuxter

6738

Speaker. Natural Cork. Bluetooth Connection. Power 3W. USB Rechargeable. Cable Included.

Lautsprecher. Naturkork. Bluetooth Anschluss. Power 3W. USB Wiederaufladbar. Kabel Inklusive.

Haut-Parleurs. Bouchon Naturel. Connexion Bluetooth. Puissance 3W. Rechargeable USB. Cable Inclus.

Luidspreker. Natuurlijk Kurk. Bluetooth Verbinding. Vermogen 3W. USB Oplaadbaar. Kabel Inclusief.

Ø 6.2 × 7.5 cm

50 / 25

Print Code: F(4), L2

NEW

vertrio

WIRELESS CHARGER



NEW

Kronex

6739

Charger. Natural Cork. Wireless. 2 USB Outputs. 2100 mA. Cable Included.

Ladegerät. Naturkork. Drahtlos. 2 USB Ausgänge. 2100 mA. Kabel Inklusive.

Chargeur. Bouchon Naturel. Sans Fil. 2 Sorties USB. 2100 mA. Câble Inclus.

Oplader. Natuurlijk Kurk. Draadloos. 2 USB Outputs. 2100 mA. Kabel Inclusief.

9.4 × 1 × 9.4 cm

50 / 25

Print Code: E(4), L2, W



NEW

Kibox

6699

Charger. Natural Cork. Wireless. Cable Included.

Ladegerät. Naturkork. Drahtlos. Kabel Inklusive.

Chargeur. Bouchon Naturel. Sans Fil. Câble Inclus.

Oplader. Natuurlijk Kurk. Draadloos. Kabel Inclusief.

Ø 9.8 × 0.6 cm

100 / 50

Print Code: E(1), L2



BAMBOO

PIECES FROM NATURAL CUTS OF BAMBOO.
THE TEXTURE AND COLOR MAY VARY.

PIEZAS PROCEDENTES
DE CORTE DE BAMBÚ NATURAL.
SU TEXTURA Y COLOR PUEDEN VARIAR

 **Bluetooth®**



THE BEST PRICE



Kaltun

6143

Speaker. Bamboo. Bluetooth Connection. Power 3W. USB Rechargeable. Cable Included.
Lautsprecher. Bambus. Bluetooth Anschluss. Power 3W. USB Wiederaufladbar. Kabel Inklusiv.
Haut-Parleurs. Bambou. Connexion Bluetooth. Puissance 3W. Rechargeable USB. Câble Inclus.
Luidspreker. Bamboe. Bluetooth Verbinding. Vermogen 3W. USB Oplaadbaar. Kabel Inclusief.

 Ø 6 × 5.1 cm

 50 / 25

 Print Code: F(4), L1

16



Denzel

6181

Speaker. Bamboo. Bluetooth Connection. Power 3W. USB Rechargeable. Cable Included.
Lautsprecher. Bambus. Bluetooth Anschluss. Power 3W. USB Wiederaufladbar. Kabel Inklusiv.
Haut-Parleurs. Bambou. Connexion Bluetooth. Puissance 3W. Rechargeable USB. Câble Inclus.
Luidspreker. Bamboe. Bluetooth Verbinding. Vermogen 3W. USB Oplaadbaar. Kabel Inclusief.

 Ø 7.3 × 4.3 cm

 100 / 50

 Print Code: F(4), L1



Kevil

6528

Speaker. Bamboo. Smart Leds. 2 Light Modes. Bluetooth Connection. Power 3W. USB Rechargeable. Cable Included.
Lautsprecher. Bambus. Intelligente Leds. 2 Leuchtfunktionen. Bluetooth Anschluss. Power 3W. USB Wiederaufladbar. Kabel Inklusiv.
Haut-Parleurs. Bambou. Leds Intelligentes. 2 Modes de Lumière. Connexion Bluetooth. Puissance 3W. Rechargeable USB. Câble Inclus.
Luidspreker. Bamboe. Smart Leds. 2 Licht Posities. Bluetooth Verbinding. Vermogen 3W. USB Oplaadbaar. Kabel Inclusief.

 Ø 6.4 × 10.6 cm

 50 / 25

 Print Code: F(4), L1





BAMBOO



PIECES FROM NATURAL CUTS OF BAMBOO.
THE TEXTURE AND COLOR MAY VARY.

PIEZAS PROCEDENTES
DE CORTE DE BAMBU NATURAL.
SU TEXTURA Y COLOR PUEDEN VARIAR



Treiko

6627

Headphones. Bamboo. Bluetooth Connection. 3.5 mm Jack Socket. USB Rechargeable. Cable Included.
Kopfhörer. Bambus. Bluetooth Anschluss. 3,5 mm Klinckenstecker. USB Wiederaufladbar. Kabel Inklusiv.
Écouteurs. Bambou. Connexion Bluetooth. Connexion Jack 3,5 mm. USB Rechargeable. Câble Inclus.
Koptelefoon. Bamboe. Bluetooth Verbinding. 3,5 mm Jack Aansluiting. USB Oplaadbaar. Kabel Inclusief.

17.5 × 20.5 × 9 cm

20

Print Code: F(1), L2



NEW

CHARGING
STATION



TOUCH SENSITIVE BUTTON/
BOTÓN TÁCTIL

Tresan

6808

Earphones. Bamboo/ ABS. Bluetooth Connection. USB Rechargeable. Cable Included.
Kopfhörer. Bambus/ ABS. Bluetooth Anschluss. USB Wiederaufladbar. Kabel Inklusiv.
Écouteurs. Bambou/ ABS. Connexion Bluetooth. Rechargeable USB. Câble Inclus.
Oordopjes. Bamboe/ ABS. Bluetooth Verbinding. USB Oplaadbaar. Kabel Inclusief.

4.7 × 9 × 3.3 cm

100 / 50

Print Code: E(4), L1, W



Bluetooth 5.0

Hands-free

17



NEW



Wireless
Charger

Bluetooth 5.0

WIRELESS CHARGER

Zakrox

6776

Charger Speaker. Bamboo/ ABS. Wireless. Bluetooth Connection. Power 3W. USB Rechargeable. Cable Included.
Ladegerät Lautsprecher. Bambus/ ABS. Drahtlos. Bluetooth Anschluss. Power 3W. USB Wiederaufladbar. Kabel Inklusiv.
Haut-Parleurs Chargeur. Bambou/ ABS. Sans Fil. Connexion Bluetooth. Puissance 3W. Rechargeable USB. Câble Inclus.
Oplader Luidspreker. Bamboe/ ABS. Draadloos. Bluetooth Verbinding. Vermogen 3W. USB Oplaadbaar. Kabel Inclusief.

7.4 × 6.8 cm

50

Print Code: F(4), L1

BAMBOO

PIECES FROM NATURAL CUTS OF BAMBOO.
THE TEXTURE AND COLOR MAY VARY.

PIEZAS PROCEDENTES
DE CORTE DE BAMBÚ NATURAL.
SU TEXTURA Y COLOR PUEDEN VARIAR

EXTENDABLE/
EXTENSIBLE

TYPE C

MICRO USB
& LIGHTNING



Charger



Type-C
Connection



2 in 1
Micro USB
& Lightning

Grets 6576

Charger. Bamboo. Micro USB, Type C and Lightning Connection. Retractable Cable.
Ladegerät. Bambus. Anschluss Micro USB, Typ C und Lightning. Ausziehbar Kabel.
Chargeur. Bambou. Connexion Micro USB, Type C et Lightning. Câble Extensible.
Oplader. Bamboe. Micro USB, Type C en Lightning Connectie. Verlengbare Kabel.

100 × 4.1 × 1.6 cm

400 / 100

Print Code: E(4), L1

18



MICRO USB
& LIGHTNING

TYPE C

USB HUB

Tolem 6798



Charger



IN/OUT Type C



2 in 1
Micro USB
& Lightning

Multifunction Charger. Bamboo. Micro USB, Type C and Lightning Connection.
Multifunktion Ladegerät. Bambus. Anschluss Micro USB, Typ C und Lightning.
Chargeur Multifonction. Bambou. Connexion Micro USB, Type C et Lightning.
Multifunctioneel Oplader. Bamboe. Micro USB, Type C en Lightning Connectie.

2.7 × 15.5 × 1.5 cm

300 / 50

Print Code: D(4), L1, W

Laiks 6529



Charger



IN/OUT Type C



2 in 1
Micro USB
& Lightning

Keyring Charger. Bamboo. Led Lights. Micro USB, Type C and Lightning Connection.
Schlüsselanhänger Ladegerät. Bambus. Led Lichter. Anschluss Micro USB, Typ C und Lightning.
Chargeur Porte-Clés. Bambou. Lumières Led. Connexion Micro USB, Type C et Lightning.
Sleutelhanger Oplader. Bamboe. Led Lichten. Micro USB, Type C en Lightning Connectie.

4 × 18 × 1.5 cm

400 / 100

Print Code: D(4), L1

Revolt 6518

USB Hub. Bamboo. 3 Hubs. USB 2.0.
USB Hub. Bambus. 3 Hubs. USB 2.0.
Port USB. Bambou. 3 Ports. USB 2.0.
USB Hub. Bamboe. 3 Poorten. USB 2.0.

8 × 1.5 × 4 cm

200 / 50

Print Code: D(4), L1, W



4000
mAh



Harleim

6150

Power Bank. Bamboe. 4000 mAh. USB Output. Micro USB Input. Kabel Inclusief.
 Power Bank. Bambus. 4000 mAh. USB Ausgang. Micro USB Eingang. Kabel Inklusive.
 Power Bank. Bamboou. 4000 mAh. Sortie USB. Entrée Micro USB. Câble Inclus.
 Power Bank. Bamboe. 4000 mAh. USB Output. Micro USB Input. Kabel Inclusief.

6.3 x 10.5 x 1.7 cm

50 / 25

Print Code: E(4), L2, W



PIECES FROM NATURAL CUTS OF BAMBOO.
THE TEXTURE AND COLOR MAY VARY.

PIEZAS PROCEDENTES
DE CORTE DE BAMBÚ NATURAL.
SU TEXTURA Y COLOR PUEDEN VARIAR



8000
mAh



Wireless
Charger



Wireless
Charger

Dickens

6273

Power Bank. Bamboe. Wireless. 8000 mAh. 2 USB Outputs. Micro USB and Type C Input. Kabel Inclusief.
 Power Bank. Bambus. Drahtlos. 8000 mAh. 2 USB Ausgänge. Micro USB und Typ C Eingang. Kabel Inklusive.
 Power Bank. Bamboou. Sans Fil. 8000 mAh. 2 Sorties USB. Entrée Micro USB et Type C. Câble Inclus.
 Power Bank. Bamboe. Draadloos. 8000 mAh. 2 USB Outputs. Micro USB en Type C Input. Kabel Inclusief.

7.1 x 13.5 x 1.5 cm

50 / 25

Print Code: E(4), L2, W



Nembar

6182

Charger. Bamboe. Wireless. Kabel Inclusief.
 Ladegerät. Bambus. Drahtlos. Kabel Inklusive.
 Chargeur. Bamboou. Sans Fil. Câble Inclus.
 Oplader. Bamboe. Draadloos. Kabel Inclusief.

10 x 0.7 cm

100 / 50

Print Code: E(4), L2, W



BAMBOO



PIECES FROM NATURAL CUTS OF BAMBOO.
THE TEXTURE AND COLOR MAY VARY.

PIEZAS PROCEDENTES
DE CORTE DE BAMBÚ NATURAL,
SU TEXTURA Y COLOR PUEDEN VARIAR



Tulax 6517

- Alarm
- Time & Date
- Temperature
- Radio

Radio Alarm Clock. Bamboo. 2 Batteries AAA Not Included.
Radio Tischuhr. Bambus. 2 AAA Batterien Nicht im Lieferumfang.
Horloge Radio. Bambou. 2 Piles AAA Non Inclus.
Radio Klok. Bamboe. 2 Batterijen AAA Niet Inclusief.

12.5 x 8.5 x 4.7 cm 50 / 25
 Print Code: F(4), L1, W



NEW

- Temperature
- Alarm
- Time & Date
- Humidity

Behox 6806

Weather Station. Bamboo. 2 Batteries AAA Not Included.
Wetterstation. Bambus. 2 AAA Batterien Nicht im Lieferumfang.
Station Météo. Bambou. 2 Piles AAA Non Inclus.
Weerstation. Bamboe. 2 Batterijen AAA Niet Inclusief.

13 x 13 x 2.4 cm 50 / 25
 Print Code: F(4), L2, W



- Temperature
- Time
- Humidity

Helein 6516

Weather Station. Bamboo. 2 Batteries AAA Not Included.
Wetterstation. Bambus. 2 AAA Batterien Nicht im Lieferumfang.
Station Météo. Bambou. 2 Piles AAA Non Inclus.
Weerstation. Bamboe. 2 Batterijen AAA Niet Inclusief.

8.5 x 12 x 6 cm 50 / 25
 Print Code: F(4), L1, W



BAMBOO

PIECES FROM NATURAL CUTS OF BAMBOO.
THE TEXTURE AND COLOR MAY VARY.

PIEZAS PROCEDENTES
DE CORTE DE BAMBÚ NATURAL,
SU TEXTURA Y COLOR PUEDEN VARIAR



NEW



Petrox 6807

Multifunction Pencil Holder. Bamboo/ABS. Button Battery Included.
Multifunktion Stifthalter. Bambus/ABS. Knopfzelle Inklusive.
Porte-Crayons Multifonction. Bambou/ABS. Pile Bouton Inclus.
Multifunctioneel Pennebakje. Bamboe/ABS. Knopcel Batterij Inclusief.

10.2 x 11.9 x 5.4 cm

50

Print Code: F(4), L2



Temperature



Alarm



Time & Date

WIRELESS CHARGER ORGANIZER



Wireless
Charger



Wireless
Charger

Trons 6527

Organizer Charger. Bamboo. Wireless. USB Output. 1000 mA. Cable Included.
Ordner Ladegerät. Bambus. Drahtlos. USB Ausgang. 1000 mA. Kabel Inklusive.
Chargeur Organiseur. Bambou. Sans Fil. Sortie USB. 1000 mA. Câble Inclus.
Organizer Oplader. Bamboe. Draadloos. USB Output. 1000 mA. Kabel Inclusief.

18.5 x 1.4 x 11.5 cm

50 / 25

Print Code: E(4), L2, W



Tankul 6526

Organizer Charger. Bamboo. Wireless. USB Output. 1000 mA. Cable Included.
Ordner Ladegerät. Bambus. Drahtlos. USB Ausgang. 1000 mA. Kabel Inklusive.
Chargeur Organiseur. Bambou. Sans Fil. Sortie USB. 1000 mA. Câble Inclus.
Organizer Oplader. Bamboe. Draadloos. USB Output. 1000 mA. Kabel Inclusief.

25.5 x 1.4 x 13.5 cm

50 / 25

Print Code: E(4), L2, W



WIRELESS CHARGER

BAMBOO

Kalery



PIECES FROM NATURAL CUTS OF BAMBOO. THE TEXTURE AND COLOR MAY VARY.

PIEZAS PROCEDENTES DE CORTE DE BAMBÚ NATURAL, SU TEXTURA Y COLOR PUEDEN VARIAR

22



Kalery

6524

Power Bank. Bamboo. Wireless. 6000 mAh. 2 USB Outputs. Micro USB and Type C Input. Cable Included.
Power Bank. Bambus. Drahtlos. 6000 mAh. 2 USB Ausgänge. Micro USB und Typ C Eingang. Kabel Inklusive.
Power Bank. Bambou. Sans Fil. 6000 mAh. 2 Sorties USB. Entrée Micro USB et Type C. Câble Inclus.
Power Bank. Bamboe. Draadloos. 6000 mAh. 2 USB Outputs. Micro USB en Type C Input. Kabel Inclusief.

7.4 x 14.8 x 1.7 cm

50 / 25

Print Code: E(4), L2, W



Wireless Charger



ALOIA



Dimper

6521

Charger. Bamboo. Wireless. Cable Included.
Ladegerät. Bambus. Drahtlos. Kabel Inklusive.
Chargeur. Bambou. Sans Fil. Câble Inclus.
Oplader. Bamboe. Draadloos. Kabel Inclusief.

7 x 11.5 x 8 cm

50 / 25

Print Code: E(4), L2

5000 mAh



Nipax

6523

Power Bank. Bamboo. 5000 mAh. USB Output. Micro USB Input. Cable Included.
Power Bank. Bambus. 5000 mAh. USB Ausgang. Micro USB Eingang. Kabel Inklusive.
Power Bank. Bambou. 5000 mAh. Sortie USB. Entrée Micro USB. Câble Inclus.
Power Bank. Bamboe. 5000 mAh. USB Output. Micro USB Input. Kabel Inclusief.

7 x 11.6 x 1.5 cm

50 / 25

Print Code: E(4), L2, W



BAMBOO



PIEZAS PROCEDENTES
DE CORTE DE BAMBÚ NATURAL,
SU TEXTURA Y COLOR PUEDEN VARIAR

PIECES FROM NATURAL CUTS OF BAMBOO
THE TEXTURE AND COLOR MAY VARY.



MAGNETIC



Wireless
Charger



Fast charge
10W

Hataway

6895

Charger. Bamboo. Wireless. Magnetic. Fast Charger 10W. Cable Included.
Ladegerät. Bambus. Drahtlos. Magnetisch. Schnelle Aufladung 10W. Kabel Inklusive.
Chargeur. Bambou. Sans Fil. Magnétique. Charge Rapide 10W. Câble Inclus.
Oplader. Bamboe. Draadloos. Magnetisch. Snellader 10W. Kabel Inclusief.

Ø 6.8 × 0.8 cm

200 / 100

Print Code: E(4), L1

23



Hebant

6522

Charger. Bamboo. Wireless. Cable Included.
Ladegerät. Bambus. Drahtlos. Kabel Inklusive.
Chargeur. Bambou. Sans Fil. Câble Inclus.
Oplader. Bamboe. Draadloos. Kabel Inclusief.

Ø 9.2 × 0.9 cm

100 / 50

Print Code: E(4), L2, W

Dumiax

6542

Charger. Bamboo. Wireless. 2 USB Outputs. 2100 mA. Cable Included.
Ladegerät. Bambus. Drahtlos. 2 USB Ausgänge. 2100 mA. Kabel Inklusive.
Chargeur. Bambou. Sans Fil. 2 Sorties USB. 2100 mA. Câble Inclus.
Oplader. Bamboe. Draadloos. 2 USB Outputs. 2100 mA. Kabel Inclusief.

9 × 0.9 × 9 cm

50 / 25

Print Code: E(4), L2, W

Vartol

6735

Charger. Bamboo. Wireless. Cable Included.
Ladegerät. Bambus. Drahtlos. Kabel Inklusive.
Chargeur. Bambou. Sans Fil. Câble Inclus.
Oplader. Bamboe. Draadloos. Kabel Inclusief.

12.5 × 1.6 × 8 cm

100 / 50

Print Code: E(4), L2

SUITABLE FOR TABLETS
AND MOBILE PHONES
/ VÁLIDO TABLETS Y
TELÉFONOS MÓVILES

WHEAT STRAW

24



Bluetooth 5.0



Bluetooth 5.0



Micro SD



USB Player

Cayren 6540

Speaker. Wheat Straw/ ABS. Bluetooth Connection. Power 3W. USB Rechargeable. Cable Included.
Lautsprecher. Weizenstroh/ ABS. Bluetooth Anschluss. Power 3W. USB Wiederaufladbar. Kabel Inklusiv.
Haut-Parleurs. Paille de Blé/ ABS. Connexion Bluetooth. Puissance 3W. Rechargeable USB. Câble Inclus.
Luidspreker. Tarwestro/ ABS. Bluetooth Verbinding. Vermogen 3W. USB Oplaadbaar. Kabel Inclusief.

Ø 7.4 × 4.5 cm

Print Code: F(4)

50 / 25



Dadil 6541

Speaker. Wheat Straw/ ABS. Bluetooth Connection. Power 3W. USB Rechargeable. Cable Included.
Lautsprecher. Weizenstroh/ ABS. Bluetooth Anschluss. Power 3W. USB Wiederaufladbar. Kabel Inklusiv.
Haut-Parleurs. Paille de Blé/ ABS. Connexion Bluetooth. Puissance 3W. Rechargeable USB. Câble Inclus.
Luidspreker. Tarwestro/ ABS. Bluetooth Verbinding. Vermogen 3W. USB Oplaadbaar. Kabel Inclusief.

8.6 × 7.2 × 3.9 cm

Print Code: F(4)

50 / 25

WHEAT STRAW



Datrex 6510

Headphones. Wheat Straw/ ABS. Bluetooth Connection. 3,5 mm Jack Socket. USB Rechargeable. Cable Included. Kopfhörer. Weizenstroh/ ABS. Bluetooth Anschluss. 3,5 mm Klinikenstecker. USB Wiederaufladbar. Kabel Inklusive. Écouteurs. Paille de Blé/ ABS. Connexion Bluetooth. Connexion Jack 3,5 mm. USB Rechargeable. Câble Inclus. Koptelefoon. Tarwestro/ ABS. Bluetooth Verbinding. 3,5 mm Jack Aansluiting. USB Oplaadbaar. Kabel Inclusief.

17 × 18.5 × 7.5 cm

20 / 10

Print Code: F(1)



CHARGING
STATION



OK
PATENT-FREE

TOUCH SENSITIVE BUTTON/
BOTÓN TÁCTIL

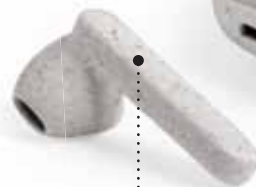

Vounel 6628

Earphones. Wheat Straw/ ABS. Bluetooth Connection. USB Rechargeable. Cable Included. Kopfhörer. Weizenstroh/ ABS. Bluetooth Anschluss. USB Wiederaufladbar. Kabel Inklusive. Écouteurs. Paille de Blé/ ABS. Connexion Bluetooth. Rechargeable USB. Câble Inclus. Oordopjes. Tarwestro/ ABS. Bluetooth Verbinding. USB Oplaadbaar. Kabel Inclusief.

4.5 × 6.8 × 2.2 cm

100 / 50

Print Code: E(4), W



WHEAT STRAW



Chelun
6592

Holder. Wheat Straw/ ABS. Adhesive.
Halter. Weizenstroh/ ABS. Haftend.
Support. Paille de Blé/ ABS. Adhésif.
Houder. Tarwestro/ ABS. Klevend.

📏 Ø 4.4 × 2.9 cm 📦 1000 / 100
🌈 Print Code: B(4), W

26



Lastrow
6786

Holder. Wheat Straw/ PP.
Halter. Weizenstroh/ PP.
Support. Paille de Blé/ PP.
Houder. Tarwestro/ PP.

📏 8.5 × 3 × 8.5 cm 📦 500 / 100
🌈 Print Code: C(4), W



Fildon
6575

Webcam Cover. Wheat Straw/ ABS. Adhesive.
Webcam-Blocker. Weizenstroh/ ABS. Haftend.
Bloqueur Webcam. Paille de Blé/ ABS. Adhésif.
Webcam Blocker. Tarwestro/ ABS. Klevend.

📏 4.1 × 1.6 × 0.2 cm 📦 10000 / 5000
🌈 Print Code: B(4), W



WHEAT STRAW



Brunox

6574

USB Hub. Wheat Straw/ ABS. 4 Hubs. USB 2.0.
 USB Hub. Weizenstroh/ ABS. 4 Hubs. USB 2.0.
 Port USB. Paille de Blé/ ABS. 4 Ports. USB 2.0.
 USB Hub. Tarwestro/ ABS. 4 Poorten. USB 2.0.

Ø 5.2 × 1.8 cm

200 / 50

Print Code: D(4), W

27



Shaun

6573

Keyring Charger. Wheat Straw/ ABS. Micro USB, Type C and Lightning Connection.
 Schlüsselanhänger Ladegerät. Weizenstroh/ ABS. Anschluss Micro USB, Typ C und Lightning.
 Chargeur Porte-Clés. Paille de Blé/ ABS. Connexion Micro USB, Type C et Lightning.
 Sleutelhanger Oplader. Tarwestro/ ABS. Micro USB, Type C en Lightning Connectie.

3.1 × 14 × 1.5 cm

400 / 100

Print Code: D(4)

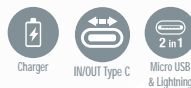

Niara

6538

Charger Synchronizer. Wheat Straw/ ABS. Micro USB, Type C and Lightning Connection.
 Ladegerät Sincro. Weizenstroh/ ABS. Anschluss Micro USB, Typ C und Lightning.
 Chargeur Synchroniseur. Paille de Blé/ ABS. Connexion Micro USB, Type C et Lightning.
 Oplader Synchronizer. Tarwestro/ ABS. Micro USB, Type C en Lightning Connectie.

3.5 × 12 × 1 cm

500 / 100

Print Code: D(4)





WHEAT STRAW

5000 mAh



Shiden

6539

Power Bank. Wheat Straw/ ABS. 5000 mAh. 2 USB Outputs. Micro USB Input. Cable Included.
Power Bank. Weizenstroh/ ABS. 5000 mAh. 2 USB Ausgänge. Micro USB Eingang. Kabel Inklusiv.
Power Bank. Paille de Blé/ ABS. 5000 mAh. 2 Sorties USB. Entrée Micro USB. Câble Inclus.
Power Bank. Tarwestro/ ABS. 5000 mAh. 2 USB Outputs. Micro USB Input. Kabel Inklusief.



6.3 x 9.4 x 1.4 cm

50 / 25

Print Code: E(4), W

28

PENCIL HOLDER



WIRELESS CHARGER



HOLDER / SOPORTE



USB HUB

Dowex

6709

Multifunction Pencil Holder. Wheat Straw/ ABS. Wireless. 3 Hubs. USB 2.0. Cable Included.
Multifunktion Stifthalter. Weizenstroh/ ABS. Drahtlos. 3 Hubs. USB 2.0. Kabel Inklusiv.
Porte-Crayons Multifonction. Paille de Blé/ ABS. Sans Fil. 3 Ports. USB 2.0. Câble Inclus.
Multifunctioneel Pennebakje. Tarwestro/ ABS. Draadloos. 3 Poorten. USB 2.0. Kabel Inklusief.

8.5 x 10 x 9 cm

50 / 25

Print Code: F(4), W



4 IN 1



Birniax

6537

Charger. Wheat Straw/ ABS. Wireless. Fast Charger 10W. Cable Included.
Ladegerät. Weizenstroh/ ABS. Drahtlos. Schnelle Aufladung 10W. Kabel Inklusiv.
Chargeur. Paille de Blé/ ABS. Sans Fil. Charge Rapide 10W. Câble Inclus.
Oplader. Tarwestro/ ABS. Draadloos. Snelladder 10W. Kabel Inklusief.

7 x 11.2 x 8.6 cm

50 / 25

Print Code: E(4)



WHEAT STRAW

WIRELESS CHARGER

Aleix

6667

Charger. Wheat Straw/ ABS. Wireless. Fast Charger 10W. Cable Included.
Ladegerät. Weizenstroh/ ABS. Drahtlos. Schnelle Aufladung 10W. Kabel Inklusive.
Chargeur. Paille de Blé/ ABS. Sans Fil. Charge Rapide 10W. Câble Inclus.
Oplader. Tarwestro/ ABS. Draadloos. Snellader 10W. Kabel Inclusief.

Ø 10 × 0.8 cm

50 / 25

Print Code: E(4), W



NEW



29



Wireless
Charger



Riems

6534

Charger. Wheat Straw/ ABS. Wireless. 2 USB Outputs. 2100 mA. Cable Included.
Ladegerät. Weizenstroh/ ABS. Drahtlos. 2 USB Ausgänge. 2100 mA. Kabel Inklusive.
Chargeur. Paille de Blé/ ABS. Sans Fil. 2 Sorties USB. 2100 mA. Câble Inclus.
Oplader. Tarwestro/ ABS. Draadloos. 2 USB Outputs. 2100 mA. Kabel Inclusief.

9 × 0.9 × 9 cm

50 / 25

Print Code: E(4), W



Wireless
Charger



Cirkal

6535

Charger. Wheat Straw/ ABS. Wireless. Cable Included.
Ladegerät. Weizenstroh/ ABS. Drahtlos. Kabel Inklusive.
Chargeur. Paille de Blé/ ABS. Sans Fil. Câble Inclus.
Oplader. Tarwestro/ ABS. Draadloos. Kabel Inclusief.

Ø 7 × 1 cm

50 / 25

Print Code: E(4), W



ANTIBACTERIAL



Kumol 6686

Antibacterial Holder. Adhesive.
Antibakteriell Halter. Haftend.
Support Antibactérien. Adhésif.
Antibacterieel Houder. Klevend.

Ø 4.4 × 2.9 cm

1000 / 100

Print Code: B(4), W

30



Hislot 6687

Antibacterial Webcam Cover. Adhesive.
Antibakteriell Webcam-Blocker. Haftend.
Bloqueur Webcam Antibactérien. Adhésif.
Antibacterieel Webcam Blocker. Klevend.

3.2 × 1.3 × 0.1 cm

10000 / 5000

Print Code: B(1), W



Antibacterial



ULTRA SLIM /
ULTRA DELGADO



Adhesive



Sustre 6685

Antibacterial Holder. Adhesive. 4 Functions.
Antibakteriell Halter. Haftend. 4 Funktionen.
Support Antibactérien. Adhésif. 4 Fonctions.
Antibacterieel Houder. Klevend. 4 Functies.

Ø 3.3 × 0.6 cm

2000 / 1000

Print Code: B(4), W



Antibacterial



Adhesive



360°



45°



NEW



Wireless Mouse



Antibacterial

Supot
6689

Antibacterial Mouse. Wireless. Optical. 2 Batteries AAA Not Included.
Antibakteriell Maus. Drahtlos. Optisch. 2 AAA Batterien Nicht im Lieferumfang.
Souris Antibactérienne. Sans Fil. Optique. 2 Piles AAA Non Inclus.
Antibacterieel Muis. Draadloos. Optical. 2 Batterijen AAA Niet Inclusief.

11.2 × 2.4 × 5.7 cm

200 / 100

Print Code: E(4), W

DPI BUTTON
BOTÓN DPI



NEW

TOUCH SENSITIVE
BUTTON
BOTÓN TACTIL



Antibacterial

OK
PATENT-FREE



Bluetooth 5.0



Hands-free



CHARGING STATION

Kikey
6688

Antibacterial Earphones. Bluetooth Connection. USB Rechargeable. Cable Included.
Antibakteriell Kopfhörer. Bluetooth Anschluss. USB Wiederaufladbar. Kabel Inklusiv.
Écouteurs Antibactérien. Connexion Bluetooth. Rechargeable USB. Câble Inclus.
Antibacterieel Oordopjes. Bluetooth Verbinding. USB Oplaadbaar. Kabel Inclusief.

4.5 × 6.8 × 2.2 cm

100 / 50

Print Code: E(4), W





Nerby

6253

Speaker. Bluetooth Connection. Power 3W. USB Rechargeable. Cable Included.
Lautsprecher. Bluetooth Anschluss. Power 3W. USB Wiederaufladbar. Kabel Inklusiv.
Haut-Parleurs. Connexion Bluetooth. Puissance 3W. Rechargeable USB. Câble Inclus.
Luidspreker. Bluetooth Verbinding. Vermogen 3W. USB Opladbaar. Kabel Inclusief.

📏 7 × 7 × 3.8 cm

📦 50

🌈 Print Code: F(4), N(8)

32



Tirko

6252

Speaker. Bluetooth Connection. Power 3W. USB Rechargeable. Cable Included.
Lautsprecher. Bluetooth Anschluss. Power 3W. USB Wiederaufladbar. Kabel Inklusiv.
Haut-Parleurs. Connexion Bluetooth. Puissance 3W. Rechargeable USB. Câble Inclus.
Luidspreker. Bluetooth Verbinding. Vermogen 3W. USB Opladbaar. Kabel Inclusief.

📏 11.1 × 8.3 × 4.1 cm

📦 50

🌈 Print Code: F(4), N(8)



Devel

6256

Charger. Wireless. Cable Included.
Ladegerät. Drahtlos. Kabel Inklusiv.
Chargeur. Sans Fil. Câble Inclus.
Oplader. Draadloos. Kabel Inclusief.

📏 Ø 10 × 0.7 cm

📦 100 / 50

🌈 Print Code: F(1), N(8)



Vendrel

6267

Power Bank. Wireless. 3000 mAh. 2 USB Outputs. Micro USB Input. Cable Included.
Power Bank. Drahtlos. 3000 mAh. 2 USB Ausgänge. Micro USB Eingang. Kabel Inklusiv.
Power Bank. Sans Fil. 3000 mAh. 2 Sorties USB. Entrée Micro USB. Câble Inclus.
Power Bank. Draadloos. 3000 mAh. 2 USB Outputs. Micro USB Input. Kabel Inclusief.

📏 6.7 × 12.6 × 1.2 cm

📦 50 / 25

🌈 Print Code: F(1), N(8)





Simultaneous connection
Conexión simultánea



Delgor 5844

Earphone. Bluetooth Connection. USB Rechargeable. Cable Included.
Kopfhörer. Bluetooth Anschluss. USB Wiederaufladbar. Kabel Inklusiv.
Écouteur. Connexion Bluetooth. Rechargeable USB. Câble Inclus.
Oordopjes. Bluetooth Verbinding. USB Oplaadbaar. Kabel Inclusief.

6.2 × 6.2 × 2 cm
Print Code: E(4), W

200 / 50



Boizen 6148

Earphone. Bluetooth Connection. USB Rechargeable. Cable Included.
Kopfhörer. Bluetooth Anschluss. USB Wiederaufladbar. Kabel Inklusiv.
Écouteur. Connexion Bluetooth. Rechargeable USB. Câble Inclus.
Oordopjes. Bluetooth Verbinding. USB Oplaadbaar. Kabel Inclusief.

8.1 × 8.1 × 3.6 cm
Print Code: E(4)



200 / 50



Bluetooth



SIMULTANEOUS CONNECTION
CONEXIÓN SIMULTÁNEA

Lacoust 5527

**EARPHONES & CAR CHARGER
MULTIFUNCTION**

Earphone Car Charger. Aluminium. Bluetooth Connection. 2 USB Outputs. 2100 mA.
Kopfhörer Ladegerät. Aluminium. Bluetooth Anschluss. 2 USB Ausgänge. 2100 mA.
Chargeur Écouteur. Aluminium. Connexion Bluetooth. 2 Sorties USB. 2100 mA.
Oordopje Oplader. Aluminium. Bluetooth Verbinding. 2 USB Outputs. 2100 mA.

Ø 2.1 × 9.7 cm

50

Print Code: E(4), L1



CHARGING
STATION



Double Wall

**EARPHONES & BOTTLE
MULTIFUNCTION**

Husod 6004



Earphones Bottle. Stainless Steel. 580 ml. Bluetooth Connection.
USB Rechargeable. Individual Presentation. Cable Included.

Kopfhörer Trinkflasche. Rostfreier Stahl. 580 ml. Bluetooth
Anschluss. USB Wiederaufladbar. Individuelle Präsentation. Kabel
Inklusiv.

Bidon Écouteurs. Acier Inox. 580 ml. Connexion Bluetooth.
Rechargeable USB. Présentation Individuelle. Câble Inclus.

Oordop Fles. Roesstvrjij Staal. 580 ml. Bluetooth Verbinding. USB
Oplaadbaar. Individuele Presentatie. Kabel Inclusief.

Ø 7.2 × 25 cm

30

Print Code: K(1), L2



580 ml

33



Video



TOUCH SENSITIVE BUTTON/
BOTÓN TÁCTIL



CHARGING STATION



OK
PATENT-FREE

Protex 6511

Earphones. Bluetooth Connection. USB Rechargeable. Cable Included.
Kopfhörer. Bluetooth Anschluss. USB Wiederaufladbar. Kabel Inklusiv.
Écouteurs. Connexion Bluetooth. Rechargeable USB. Câble Inclus.
Oordopjes. Bluetooth Verbinding. USB Oplaadbaar. Kabel Inclusief.

4.5 × 6.8 × 2.2 cm

100 / 50

Print Code: E(4), W



CHARGING STATION

5200
mAh



Molik 6302

Power Bank Earphones. Wireless. 5200 mAh. USB Output. Type C Input. Bluetooth Connection. USB Rechargeable. Cable Included.
Power Bank Kopfhörer. Drahtlos. 5200 mAh. USB Ausgang. Typ C Eingang. Bluetooth Anschluss. USB Wiederaufladbar. Kabel Inklusiv.
Écouteurs Power Bank. Sans Fil. 5200 mAh. Sortie USB. Entrée Type C. Connexion Bluetooth. Rechargeable USB. Câble Inclus.
Power Bank Oordopjes. Draadloos. 5200 mAh. USB Output. Typ C Input. Micro USB Input. Bluetooth Verbinding. USB Oplaadbaar. Kabel Inclusief.

8.4 × 9.8 × 2.6 cm

50 / 25

Print Code: F(4), W



CHARGING STATION



Merkus 6257

Earphones. Bluetooth Connection. USB Rechargeable. Cable Included.
Kopfhörer. Bluetooth Anschluss. USB Wiederaufladbar. Kabel Inklusiv.
Écouteurs. Connexion Bluetooth. Rechargeable USB. Câble Inclus.
Oordopjes. Bluetooth Verbinding. USB Oplaadbaar. Kabel Inclusief.

7.2 × 3 × 3.8 cm

100 / 50

Print Code: E(4), W

**EARPHONES & WIRELESS CHARGER
MULTIFUNCTION**



NEW

CHARGING STATION



Aniken
6777

Earphones. Bluetooth Connection. USB Rechargeable. Cable Included.
Kopfhörer. Bluetooth Anschluss. USB Wiederaufladbar. Kabel Inklusive.
Écouteurs. Connexion Bluetooth. Rechargeable USB. Cable Inclus.
Oordopjes. Bluetooth Verbinding. USB Oplaadbaar. Kabel Inclusief.

6 x 6.2 x 3.4 cm
Print Code: E(4), W

100 / 50

CHARGING STATION
WITH WIRELESS
CHARGING / ESTACIÓN
CON CARGA
INALÁMBRICA



Benyer
6891



Charger Earphones. Bluetooth Connection. Wireless Rechargeable. Cable Included.
Ladegerät Kopfhörer. Bluetooth Anschluss. Drahtlos Wiederaufladbar. Kabel Inklusive.
Écouteurs Chargeur. Connexion Bluetooth. Rechargeable Sans Fil. Cable Inclus.
Oplader Oordopjes. Bluetooth Verbinding. Draadloos Oplaadbaar. Kabel Inclusief.

7.6 x 7.6 x 3.8 cm
Print Code: F(4), W

50 / 25



AUTOMATIC TEMPERATURE MEASUREMENT
TOMA DE TEMPERATURA AUTOMÁTICA

COLOUR SCREEN /
PANTALLA COLOR



NEW



COMPATIBLE WITH
ANDROID & iOS



Droy 6651

Smart Bracelet. TPU Strap. Bluetooth Connection. 0,96" TFT Screen. USB Rechargeable. Cable Included.
Intelligente Armband. TPU Armband. Bluetooth Anschluss. 0,96" TFT Screen. USB Wiederaufladbar. Kabel Inklusive.
Bracelet Intelligent. Bracelet TPU. Connexion Bluetooth. Écran TFT 0,96". Rechargeable USB. Câble Inclus.
Smart Armband. TPU Band. Bluetooth Verbinding. 0,96" TFT Scherm. USB Oplaadbaar. Kabel Inclusief.

25.5 x 2.2 x 1.1 cm 100 / 50
Print Code: I(1), L2

36



03



Beytel 5599

Smart Bracelet. TPU Strap. Bluetooth Connection. 0,42" LCD Screen. USB Rechargeable. Cable Included.
Intelligente Uhr. TPU Armband. Bluetooth Anschluss. 0,42" LCD Screen. USB Wiederaufladbar. Kabel Inklusive.
Bracelet Intelligent. Bracelet TPU. Connexion Bluetooth. Écran LCD 0,42". Rechargeable USB. Câble Inclus.
Smart Armband. TPU Band. Bluetooth Verbinding. 0,42" LCD Scherm. USB Oplaadbaar. Kabel Inclusief.

24.5 x 2 x 0.9 cm 100 / 50
Print Code: I(1), L2



COMPATIBLE WITH
ANDROID & iOS

COLOUR SCREEN/
PANTALLA COLOR



02



COMPATIBLE WITH
ANDROID & iOS

Ragol 6351

Smart Bracelet. TPU Strap. Bluetooth Connection. 0,96" TFT Screen. USB Rechargeable.

Intelligente Armband. TPU Armband. Bluetooth Anschluss. 0,96" TFT Screen. USB Wiederaufladbar.

Bracelet Intelligent. Bracelet TPU. Connexion Bluetooth. Écran TFT 0,96". Rechargeable USB.

Smart Armband. TPU Band. Bluetooth Verbinding. 0,96" TFT Scherm. USB Oplaadbaar.

24 x 2.1 x 1.4 cm 100 / 50
Print Code: I(1), L2

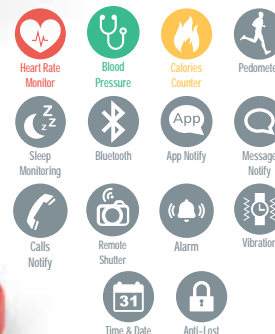



COLOUR SCREEN/
PANTALLA COLOR

COMPATIBLE WITH
ANDROID & iOS

NEW



01

02



Simont
6747

Smart Watch. TPU Strap. Bluetooth Connection. 1,3" LCD Screen. USB Rechargeable.
Intelligente Uhr. TPU Armband. Bluetooth Anschluss. 1,3" LCD Screen. USB Wiederaufladbar.
Montre Intelligente. Bracelet TPU. Connexion Bluetooth. Ecran LCD 1,3". Rechargeable USB.
Smartwatch. TPU Band. Bluetooth Verbinding. 1,3" LCD Scherm. USB Oplaadbaar.

25 × 3,6 × 1,3 cm

50

Print Code: I(1), L2

37

BLUETOOTH CALLS

MAKE AND RECEIVE CALLS
WITHOUT A SIM CARD /
REALICE Y RECIBA LLAMADAS SIN
NECESIDAD DE TARJETA SIM



COMPATIBLE WITH
ANDROID & iOS

NEW



COLOUR SCREEN /
PANTALLA COLOR
METAL CASING /
CARCASA METAL
TACTILE SCREEN/
PANTALLA TÁCTIL

Proxor
6746



Smart Watch. TPU Strap. Bluetooth Connection. 1,54" IPS Screen. USB Rechargeable. Cable Included.
Intelligente Uhr. TPU Armband. Bluetooth Anschluss. 1,54" IPS Screen. USB Wiederaufladbar. Kabel Inklusive.
Montre Intelligente. Bracelet TPU. Connexion Bluetooth. Ecran IPS 1,54". Rechargeable USB. Cable Inclut.
Smartwatch. TPU Band. Bluetooth Verbinding. 1,54" IPS Scherm. USB Oplaadbaar. Kabel Inclusief.

27 × 4 × 1,3 cm

50

Print Code: I(1), L2



NEW



HIGH TEMPERATURE ALERT/
ALERTA TEMPERATURA ALTA



Leroux

6652

Thermometer Watch. TPU Strap. 0.96" LED Screen. USB Rechargeable. Cable Included.
Thermometer Uhr. TPU Armband. 0.96" LED Screen. USB Wiederaufladbar. Kabel Inklusiv.
Montre Thermomètre. Bracelet TPU. Écran LED 0.96". Rechargeable USB. Câble Inclus.
Thermometer Horloge. TPU Band. 0.96" LED Scherm. USB Oplaadbaar. Kabel Inclusief.

25 x 2.1 x 1 cm

200 / 50

Print Code: I(1), L2



16



COMPATIBLE WITH
ANDROID & IOS



Wesly

5314

Smart Bracelet. Silicone Strap. Bluetooth Connection. 0.49" LCD Screen. USB Rechargeable. Cable Included.
Intelligente Uhr. Silikonarmband. Bluetooth Anschluss. 0.49" LCD Screen. USB Wiederaufladbar. Kabel Inklusiv.
Bracelet Intelligent. Bracelet Silicone. Connexion Bluetooth. Écran LCD 0.49". Rechargeable USB. Câble Inclus.
Smart Armband. Siliconen Band. Bluetooth Verbinding. 0.49" LCD Scherm. USB Oplaadbaar. Kabel Inclusief.

25 x 2 x 1.1 cm

100 / 50

Print Code: G(1), L2



03

Drogon

5313

Watch. Silicone Strap.
Uhr. Silikonarmband.
Montre. Bracelet Silicone.
Horloge. Siliconen Band.



25 x 2.8 x 1.5 cm

100 / 50

Print Code: F(1)





WITH EARPHON

PRESS TO REMOVE PRESIONAR PARA EXTRAER

- Heart Rate Monitor
- Calories Counter
- Pedometer
- Sleep Monitoring
- Bluetooth
- Hands-free
- Alarm
- Vibration
- Time & Date

Rusk 6226 Smart Bracelet. TPU Strap. Bluetooth Connection. 0,96" LCD Screen. USB Rechargeable. Cable Included. Intelligente Uhr. TPU Armband. Bluetooth Anschluss. 0,96" LCD Screen. USB Wiederaufladbar. Kabel Inklusiv. Bracelet Intelligent. Bracelet TPU. Connexion Bluetooth. Ecran LCD 0,96". Rechargeable USB. Cable Inclus. Smart Armband. TPU Band. Bluetooth Verbindung. 0,96" LCD Scherm. USB Oplaadbaar. Kabel Inclusief.

24.5 x 2.4 x 1.9 cm 100 / 50
Print Code: I(1), L2



MONITOR YOUR TRAINING ROUTE
MONITORIZA TU RUTA DE ENTRENAMIENTO

Radilan 6147 COMPATIBLE WITH ANDROID & iOS

Smart Watch. TPU Strap. Bluetooth Connection. 1,44" LCD Screen. USB Rechargeable. Cable Included. Intelligente Uhr. TPU Armband. Bluetooth Anschluss. 1,44" LCD Screen. USB Wiederaufladbar. Kabel Inklusiv. Montre Intelligente. Bracelet TPU. Connexion Bluetooth. Ecran LCD 1,44". Rechargeable USB. Cable Inclus. Smartwatch. TPU Band. Bluetooth Verbindung. 1,44" LCD Scherm. USB Oplaadbaar. Kabel Inclusief.

25.5 x 3.6 x 1.1 cm 100 / 50
Print Code: I(1), L2

- Calories Counter
- Pedometer
- Sleep Monitoring
- Bluetooth
- App Notify
- Message Notify
- Call
- Remote
- Alarm
- Vibration
- Time & Date
- Anti-Lost



MONITORIZA TU RUTA DE ENTRENAMIENTO

APP
COMPATIBLE WITH ANDROID & iOS



- Heart Rate Monitor
- Blood Pressure
- Blood Oxygen Monitor
- Calories Counter

- Pedometer
- Sleep Monitoring
- Stopwatch
- Bluetooth

- App Notify
- Message Notify
- Calls Notify
- Alarm
- Remote Camera
- Vibration
- Time & Date
- Anti-Lost

Shaul 5536

Smart Bracelet. TPU Strap. Bluetooth Connection. 0,66" OLED Screen. USB Rechargeable. Cable Included. Intelligente Uhr. TPU Armband. Bluetooth Anschluss. 0,66" OLED Screen. USB Wiederaufladbar. Kabel Inklusiv. Bracelet Intelligent. Bracelet TPU. Connexion Bluetooth. Ecran OLED 0,66". Rechargeable USB. Cable Inclus. Smart Armband. TPU Band. Bluetooth Verbindung. 0,66" OLED Scherm. USB Oplaadbaar. Kabel Inclusief.

26 x 2.4 x 1.2 cm 100 / 50
Print Code: L2



- APP
- Nano SIM
- Micro SD
- Calls
- Hands-free
- Music Player
- Sound Recorder
- Remote Shutter
- Image Viewer
- Phone Book
- Bluetooth
- App Notify
- Message Notify
- Calculator
- Alarm
- Vibration
- Time & Date
- Anti-Lost
- Calories Counter
- Pedometer
- Sleep Monitoring

Bogard 5788

Smart Watch. TPU Strap. Bluetooth Connection. 1,22" LCD Screen. Multilingual. USB Rechargeable. Cable Included. Intelligente Uhr. TPU Armband. Bluetooth Anschluss. 1,22" LCD Screen. In Mehreren Sprachen. USB Wiederaufladbar. Kabel Inklusiv. Montre Intelligente. Bracelet TPU. Connexion Bluetooth. Ecran LCD 1,22". Multilingue. Rechargeable USB. Cable Inclus. Smartwatch. TPU Band. Bluetooth Verbindung. 1,22" LCD Scherm. Meertalig. USB Oplaadbaar. Kabel Inclusief.

26 x 4.6 x 1.4 cm 50
Print Code: L2





2048 x 1024

40



01

02

Type-C

Micro USB



Ribben 5771

360° Camera. Micro USB and Type C Connection.
Kamera 360°. Anschluss Micro USB und Typ C.
Camera 360°. Connexion Micro USB et Type C.
Camara 360°. Micro USB en Type C Connecite.

4.4 x 4.6 x 4 cm

Print Code: J(1)

50



COMPATIBLE WITH
ANDROID & iOS

HDMI
Micro SD



08

01

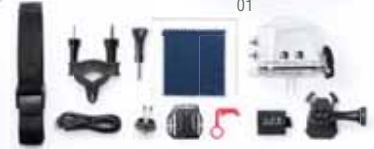

Camera 360°



Wi-Fi Support



2448P
Resolution



Waterproof



Micro SD

HALF - HALF

VR

INNER RIM

HALFROUND

SQUARE

ROUND

ANNULAR

360° PANORAMIC

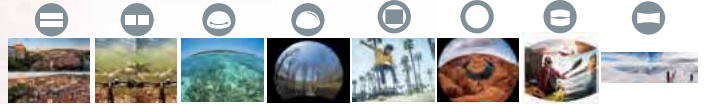

Logans 5529

Action Camera 360°. 2448P. Wifi. 0,96" LCD Screen. 10 Accessories. Multilingual. USB Rechargeable. Cable Included.
Sportkamera 360°. 2448P. Wifi. 0,96" LCD Screen. 10 Teile. In Mehreren Sprachen. USB Wiederaufladbar. Kabel Inklusiv.
Caméra Sportive 360°. 2448P. Wifi. Écran LCD 0,96". 10 Accessoires. Multilingue. Rechargeable USB. Câble Inclus.
Sport Camara 360°. 2448P. Wifi. 0,96" LCD Scherm. 10 Accessoires. Meertalig. USB Oplaadbaar. Kabel Inclusief.

13 x 13 x 11 cm

18

Print Code: K(1)



Video



Kyan 3694

Universal Tripod.
Universal Stativ.
Trépied Universel.
Universeel Statief.

Ø 2 x 12.2 cm

Print Code: F(1)

400 / 100



07

19

02

03





2" SCREEN

MICRO SD

HDMI



COMPATIBLE WITH
ANDROID & iOS



01

02

08



Garrix

5528

Action Camera. 4K. Wifi. 2" LCD Screen. 16 Accessories. Multilingual. USB Rechargeable. Cable Included.
Sportkamera. 4K. Wifi. 2" LCD Screen. 16 Teile. In Mehreren Sprachen. USB Wiederaufladbar. Kabel Inklusiv.
Camera Sportive. 4K. Wifi. Ecran LCD 2". 16 Accessoires. Multilingue. Rechargeable USB. Cable Inclus.
Sport Camara. 4K. Wifi. 2" LCD Scherm. 16 Accessoires. Meertalig. USB Oplaadbaar. Kabel Inclusief.

16 x 23 x 6 cm

20

Print Code: K(4)



HD
High Definition

Waterproof

Micro SD



19

04

05

03

02

09

01

MICRO SD



2" SCREEN



Komir

5246

Action Camera. 720P. 2" LCD Screen. 14 Accessories. Multilingual. USB Rechargeable. Cable Included.
Sportkamera. 720P. 2" LCD Screen. 14 Teile. In Mehreren Sprachen. USB Wiederaufladbar. Kabel Inklusiv.
Camera Sportive. 720P. Ecran LCD 2". 14 Accessoires. Multilingue. Rechargeable USB. Cable Inclus.
Sport Camara. 720P. 2" LCD Scherm. 14 Accessoires. Meertalig. USB Oplaadbaar. Kabel Inclusief.

12 x 23 x 5.8 cm

20

Print Code: K(4)



COMPATIBLE WITH
ANDROID & IOS

Roxman 6136



Drone. Wifi. USB Rechargeable. Cable Include. Remote Control 3 AAA Batteries AAA Not Included.
Drohne. Wifi. USB Wiederaufladbar. Kabel Inklusive. Fernbedienung 3 AAA Batterien Nicht im Lieferumfang.
Drone. Wifi. Rechargeable USB. Câble Inclus. Contrôle à Distance 3 Piles AAA Non Inclus.
Drohne. Wifi. USB Oplaadbaar. Kabel Inclusief. Afstandsbediening 3 Batterijen AAA Niet Inclusief.

7.5 × 2.5 × 7 cm
Print Code: J(1)

50

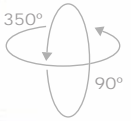

REMOTE CONTROL MOVEMENT
MOVIMIENTO POR CONTROL REMOTO

Baldrick 5533

COMPATIBLE WITH
ANDROID & IOS

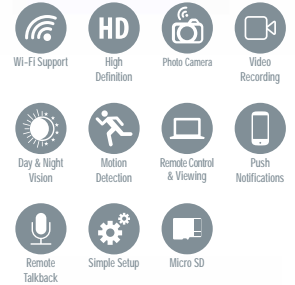

Smart Camera. AC 220-240V. Cable Included.
Smart Kamera. AC 220-240V. Kabel Inklusive.
Vidéosurveillance Intelligente. AC 220-240V. Câble Inclus.
Smart Camara. AC 220-240V. Kabel Inclusief.

9.5 × 11.5 cm
Print Code: J(1)

20



CAMERA



Remlux 6137

Camera. 1080P. 2.4" LCD Screen. Multilingual. USB Rechargeable. Cable Included.
Kamera. 1080P. 2.4" LCD Screen. In Mehreren Sprachen. USB Wiederaufladbar. Kabel Inklusive.
Camera. 1080P. Ecran LCD 2,4". Multilingue. Rechargeable USB. Câble Inclus.
Camara. 1080P. 2.4" LCD Scherm. Meertalig. USB Oplaadbaar. Kabel Inclusief.

13 × 9 × 9.6 cm
Print Code: J(1)

40



CERAMIC

350 ml

Wireless Charger

Fast charge 10W

Home / Office

Kalan **CUP WARMER & WIRELESS CHARGER**
MULTIFUNCTION

6533

Charger Cup Warmer. Ceramic/ABS. 350 ml. Wireless. Fast Charger 10W. USB Connection. Cable Included.
Tasse Warmer Ladegerät. Keramik/ABS. 350 ml. Drahtlos. Schnelle Aufladung 10W. Anschluss USB. Kabel Inklusiv.
Chauffe Tasses Chargeur. Céramique/ABS. 350 ml. Sans Fil. Charge Rapide 10W. Connexion USB. Câble Inclus.
Warmhoudplaatje Oplader. Keramiek/ABS. 350 ml. Draadloos. Snellader 10W. USB Connectie. Kabel Inclusief.

11 × 12.5 × 11 cm

20

Video

Print Code: G(4), L2

CHARGER CUP WARMER

43



NEW

FAST HEATING

Calpy Electric Lunch Box. 1 L. Cable Included.
Elektrische Lunch Box. 1 L. Kabel Inklusiv.
Électrique Gamelle. 1 L. Câble Inclus.
Elektrische Lunch Box. 1 L. Kabel Inclusief.

6724

Home / Office

BPA FREE

1 L

23.5 × 16.5 × 11 cm

20

Print Code: G(1)

Video

vertrio

Bluetooth®

MULTIFUNCTION

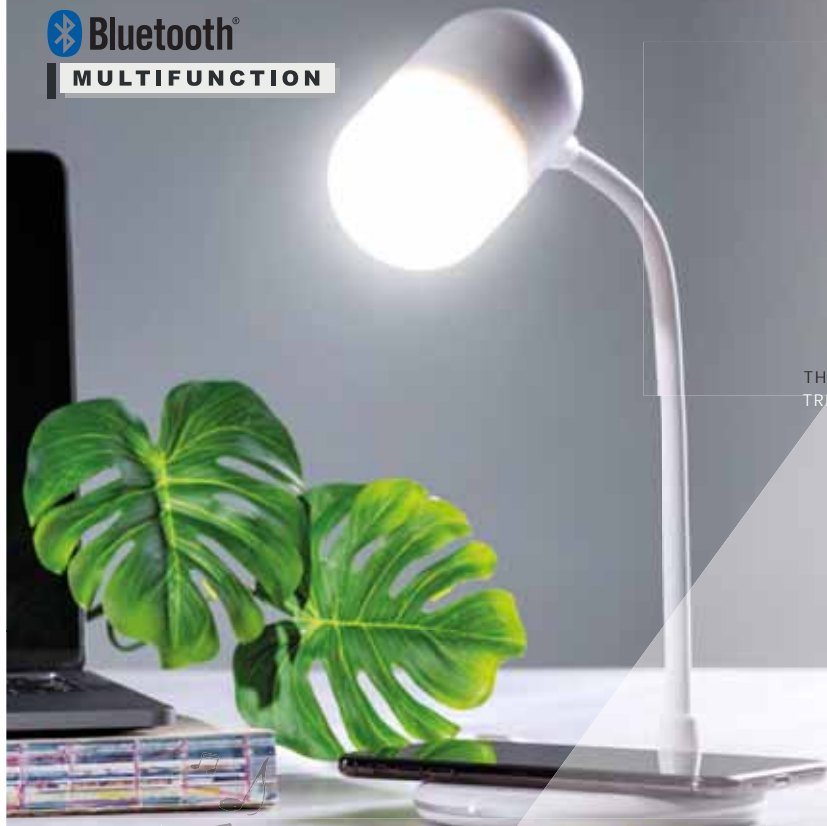

THREE LIGHT MODES
TRES MODOS DE LUZ



Lerex

6268

Multifunction Lamp, 14 Leds, Flexible, 3 Light Modes, Adjustable Brightness, Wireless, Bluetooth Connection, Power 3W, USB Connection, Cable Included.

Ladegerät Lautsprecher, 14 Leds, Flexibel, 3 Leuchtfunktionen, Einstellbare Lichtintensität, Drahtlos, Bluetooth Anschluss, Power 3W, USB Anschluss, Kabel Inklusiv.

Haut-Parleurs Chargeur, 14 Leds, Flexible, 3 Modes de Lumière, Lumière à Intensité Réglable, Sans Fil, Connexion Bluetooth, Puissance 3W, Connexion USB, Câble Inclus.

Oplader Luidspreker, 14 Leds, Flexibel, 3 Licht Posities, Lamp met Instelbare Lichtintensiteit, Draadloos, Bluetooth Verbinding, Vermogen 3W, USB Verbinding, Kabel Inclusief.

12 x 32 x 12 cm

30

Print Code: F(1)

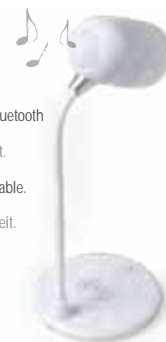

44



SPEAKER

4000
mAh



Power Bank

Wireless Charger

Speaker

Bluetooth



Hands-free

Line IN

Mousepad

Francy

6126

Multifunction Mousepad, Wireless, 4000 mAh, USB Output, Micro USB Input, Bluetooth Connection, Power 2Wx2, USB Rechargeable, Cable Included.

Multifunction Mauspad, Drahtlos, 4000 mAh, USB Ausgang, Micro USB Eingang, Bluetooth Anschluss, Power 2Wx2, USB Wiederaufladbar, Kabel Inklusiv.

Tapis Souris Multifonction, Sans Fil, 4000 mAh, Sortie USB, Entrée Micro USB, Connexion Bluetooth, Puissance 2Wx2, Rechargeable USB, Câble Inclus.

Multifunctioneel Muispad, Draadloos, 4000 mAh, USB Output, Micro USB Input, Bluetooth Verbinding, Vermogen 2Wx2, USB Opladbaar, Kabel Inclusief.

29.2 x 21.1 cm

20

Print Code: G(1), W



INPUT / OUTPUT

6700
mAh



Power Bank

Wireless Charger

IN/OUT Type C

Travel

Home / Office

Roktum

6129



Wireless Charger

Charger Keyboard, Wireless, Bluetooth Connection, USB Rechargeable, Cable Included.

Ladegerät Tastatur, Drahtlos, Bluetooth Anschluss, USB Wiederaufladbar, Kabel Inklusiv.

Clavier Chargeur, Sans Fil, Connexion Bluetooth, Rechargeable USB, Câble Inclus.

Oplader Toetsenbord, Draadloos, Bluetooth Verbinding, USB Opladbaar, Kabel Inclusief.

24 x 0.6 x 17 cm

20

Print Code: G(1), W



Teimpor

6141



Multifunction Travel Adapter, Wireless, 6700 mAh, 2 USB Outputs 2400 mA and 1 Type C Output 2400 mA, Type C Input, USA, Europe, Asia, UK, Australia.

Multifunktion Reise Adapter, Drahtlos, 6700 mAh, 2 USB Ausgänge 2400 mA und 1 Typ C Ausgang 2400 mA, Typ C Eingang, USA, Europa, Asien, UK, Australien.

Adaptateur Voyage Multifonction, Sans Fil, 6700 mAh, 2 Sorties USB 2400 mA et 1 Sortie Type C 2400 mA, Entrée Type C, USA, Europe, Asie, Royaume-Uni, Australie.

Multifunctioneel Reis Adapter, Draadloos, 6700 mAh, 2 USB Outputs 2400 mA en 1 Typ C Output 2400 mA, Typ C Input, USA, Europa, Azië, Australië.

2.9 x 8 x 8 cm

40

Print Code: F(4), W



HOLDER INCLUDED



Mandux 5955

Charger. Wireless. 3 USB Outputs. 3100 mA. Cable Included.
Ladegerät. Drahtlos. 3 USB Ausgänge. 3100 mA. Kabel Inklusiv.
Chargeur. Sans Fil. 3 Sorties USB. 3100 mA. Câble Inclus.
Oplader. Draadloos. 3 USB Uitgangen. 3100 mA. Kabel Inclusief.

16.2 x 9.4 x 3.9 cm

40 / 20

Print Code: F(4), W



NEW

Pekon 6737

Multifunction Pencil Holder. Wireless. 2 USB Outputs 2000 mA. 1 Hub USB 2.0. Cable Included.
Multifunktion Stifthalter. Drahtlos. 2 USB Ausgänge 2000 mA. 1 Hub USB 2.0. Kabel Inklusiv.
Porte-Crayons Multifonction. Sans Fil. 2 Sorties USB 2000 mA. 1 Port USB 2.0. Câble Inclus.
Multifunctioneel Pennebakje. Draadloos. 2 USB Outputs 2000 mA. 1 Poorten USB 2.0. Kabel Inclusief.

8.8 x 9.8 x 8.9 cm

50

Print Code: F(4)



45



CLOCK & WIRELESS CHARGER MULTIFUNCTION



Dolbix 6264

Alarm Clock Charger. MDF. Wireless. 3 Light Modes. Cable and Button Batteries Included.
Tischuhr Ladegerät. MDF. Drahtlos. 3 Leuchtfunktionen. Kabel und Knopfzellen Inklusiv.
Horloge Chargeur. MDF. Sans Fil. 3 Modes de Lumière. Câble et Piles Bouton Inclus.
Klok Oplader. MDF. Draadloos. 3 Licht Posities. Kabel en Knopcel Batterijen Inclusief.

16.2 x 3.1 x 7.8 cm

50

Print Code: F(4), L2, W



Minfly 6512

Alarm Clock Charger. Wireless. 3 Light Modes. USB Connection. Cable and Button Batteries Included.
Tischuhr Ladegerät. Drahtlos. 3 Leuchtfunktionen. Anschluss USB. Kabel und Knopfzellen Inklusiv.
Horloge Chargeur. Sans Fil. 3 Modes de Lumière. Connexion USB. Câble et Piles Bouton Inclus.
Klok Oplader. Draadloos. 3 Licht Posities. USB Connectie. Kabel en Knopcel Batterijen Inclusief.

14 x 7.5 x 10 cm

40

Print Code: F(1)





Tuzer

6519

Charger. Wireless. Cable Included.
Ladegerät. Drahtlos. Kabel Inklusiv.
Chargeur. Sans Fil. Câble Inclus.
Oplader. Draadloos. Kabel Inclusief.

Ø 9.5 × 0.7 cm

100 / 50

Print Code: E(4), L1, W



02



01



Wireless
Charger



03

Neblin

5763

Charger. Wireless. Cable Included.
Ladegerät. Drahtlos. Kabel Inklusiv.
Chargeur. Sans Fil. Câble Inclus.
Oplader. Draadloos. Kabel Inclusief.

Ø 9.8 × 1.1 cm

50 / 25

Print Code: E(4), W

19

08

02



Donson

5764

Charger. Wireless. 2 USB Outputs. 2100 mA. Cable Included.
Ladegerät. Drahtlos. 2 USB Ausgänge. 2100 mA. Kabel Inklusiv.
Chargeur. Sans Fil. 2 Sorties USB. 2100 mA. Câble Inclus.
Oplader. Draadloos. 2 USB Outputs. 2100 mA. Kabel Inclusief.

9 × 0.9 × 9 cm

50

Print Code: E(4), W



Wireless
Charger



Radik

5324

Charger. Wireless. Cable Included.
Ladegerät. Drahtlos. Kabel Inklusiv.
Chargeur. Sans Fil. Câble Inclus.
Oplader. Draadloos. Kabel Inclusief.

Ø 7 × 0.9 cm

200 / 50

Print Code: E(4), W



Wireless
Charger



19

08

03



Video

WIRELESS
FAST CHARGE

TECHNOLOGY

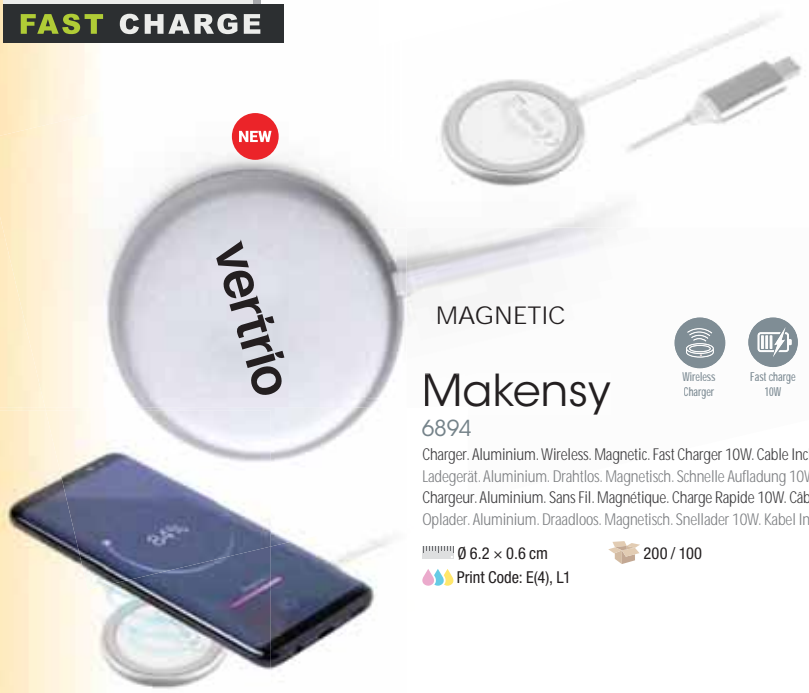

NEW

MAGNETIC

Makensy

6894

Charger. Aluminium. Wireless. Magnetic. Fast Charger 10W. Cable Included.
Ladegerät. Aluminium. Drahtlos. Magnetisch. Schnelle Aufladung 10W. Kabel Inklusive.
Chargeur. Aluminium. Sans Fil. Magnétique. Charge Rapide 10W. Câble Inclus.
Oplader. Aluminium. Draadloos. Magnetisch. Snellader 10W. Kabel Inclusief.

Ø 6.2 x 0.6 cm
Print Code: E(4), L1

200 / 100



Lumbert

6520

Charger. Wireless. Fast Charger 10W. Cable Included.
Ladegerät. Drahtlos. Schnelle Aufladung 10W. Kabel Inklusive.
Chargeur. Sans Fil. Charge Rapide 10W. Câble Inclus.
Oplader. Draadloos. Snellader 10W. Kabel Inclusief.

10 x 0.9 cm
Print Code: E(4), W

100 / 50



Tarmix

6544

Charger. Wireless. Fast Charger 10W. Cable Included.
Ladegerät. Drahtlos. Schnelle Aufladung 10W. Kabel Inklusive.
Chargeur. Sans Fil. Charge Rapide 10W. Câble Inclus.
Oplader. Draadloos. Snellader 10W. Kabel Inclusief.

7 x 10.9 x 8.5 cm
Print Code: E(4)

50 / 25





MICRO USB
& LIGHTNING



TYPE C

Pikat

6259

Charger. Wireless. Micro USB, Type C and Lightning Connection.
Ladegerät. Drahtlos. Anschluss Micro USB, Typ C und Lightning.
Chargeur. Sans Fil. Connexion Micro USB, Type C et Lightning.
Oplader. Draadloos. Micro USB, Type C en Lightning Connectie.

110 cm

300 / 100

Print Code: E(4)



2 POSITIONS

Sakrol

6262

Charger. Wireless. Cable Included.
Ladegerät. Drahtlos. Kabel Inklusiv.
Chargeur. Sans Fil. Câble Inclus.
Oplader. Draadloos. Kabel Inclusief.

6.3 x 6.3 x 1.2 cm

200 / 50

Print Code: E(4), W

Zafren

6260

Charger. Wireless. Cable Included.
Ladegerät. Drahtlos. Kabel Inklusiv.
Chargeur. Sans Fil. Câble Inclus.
Oplader. Draadloos. Kabel Inclusief.

9.5 x 1.2 x 7.6 cm

200 / 50

Print Code: E(4), W



UV
STERILIZER



Halby
6670

Charger UV Sterilizer Box. Wireless. Ultraviolet Light. USB Connection. Cable Included.
Ladegerät UV Sterilisator Kasten. Drahtlos. Ultravioletes Licht. USB Anschluss. Kabel Inklusiv.
Boîte Stérilisateur UV Chargeur. Sans Fil. Ultraviolets. Connexion USB. Câble Inclus.
Oplader UV Sterilisator Kist. Draadloos. Ultraviolet Licht. USB Verbinding. Kabel Inclusief.

20.5 x 4.5 x 12.5 cm 30
Print Code: F(2), W



Blay
6671

Charger UV Sterilizer Lamp. Wireless. USB Output. 1000 mA. Fast Charger 10W. Ultraviolet Light. USB Connection. Cable Included.
Ladegerät UV Sterilisator Lampe. Drahtlos. USB Ausgang. 1000 mA. Schnelle Aufladung 10W. Ultravioletes Licht. USB Anschluss. Kabel Inklusiv.
Lampe Stérilisateur UV Chargeur. Sans Fil. Sortie USB. 1000 mA. Charge Rapide 10W. Ultraviolets. Connexion USB. Câble Inclus.
Oplader UV Sterilisator Lamp. Draadloos. USB Output. 1000 mA. Snellader 10W. Ultraviolet Licht. USB Verbinding. Kabel Inclusief.

11 x 12 x 11 cm 30
Print Code: F(2)

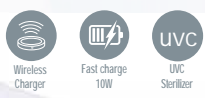

Strey
6889

Charger UV Sterilizer Box. Bamboo/ABS. Wireless. Ultraviolet Light. USB Connection. Cable Included.
Ladegerät UV Sterilisator Kasten. Bambus/ABS. Drahtlos. Ultravioletes Licht. USB Anschluss. Kabel Inklusiv.
Boîte Stérilisateur UV Chargeur. Bambou/ABS. Sans Fil. Ultraviolets. Connexion USB. Câble Inclus.
Oplader UV Sterilisator Kist. Bamboe/ABS. Draadloos. Ultraviolet Licht. USB Verbinding. Kabel Inclusief.

20.5 x 4.5 x 12.5 cm 30
Print Code: F(2), L2, W



 **Bluetooth**





STEREO SOUND



Clarens 6054

Speakers. Aluminium. Bluetooth Connection. Power 3Wx2. USB Rechargeable. Cable Included.
Lautsprecher. Aluminium. Bluetooth Anschluss. Power 3Wx2. USB Wiederaufladbar. Kabel Inklusiv.
Haut-Parleurs. Aluminium. Connexion Bluetooth. Puissance 3Wx2. Rechargeable USB. Cable Inclus.
Luidsprekers. Aluminium. Bluetooth Verbinding. Vermogen 3Wx2. USB Oplaadbaar. Kabel Inclusief.

 12 x 5.8 x 5.8 cm
 Print Code: F(4), L1

 20





2 FUNCTIONS/ HEADPHONES AND SPEAKER

Milcof 6131



Speakers Headphones. Bluetooth Connection. 3.5 mm Jack Socket. Power 3Wx2. USB Rechargeable. Cable Included.
Lautsprecher Kopfhörer. Bluetooth Anschluss. 3,5 mm Klinkestecker. Power 3Wx2. USB Wiederaufladbar. Kabel Inklusiv.
Ecouteurs Haut-Parleurs. Connexion Bluetooth. Connexion Jack 3,5 mm. Puissance 3Wx2. Rechargeable USB. Cable Inclus.
Luidsprekers Koptelefoon. Bluetooth Verbinding. 3,5 mm Jack Aanstluiting. Vermogen 3Wx2. USB Oplaadbaar. Kabel Inclusief.

 18 x 18 x 8.5 cm
 Print Code: F(1)

 10

SPEAKER FUNCTION
FUNCIÓN ALTAVOZ





Varox 5958



SPEAKER FUNCTION
FUNCIÓN ALTAVOZ

Speaker Sunglasses. UV400 Protection. Bluetooth Connection. Power 1W. USB Rechargeable. Cable Included.
Lautsprecher Brillen. UV400 Schutz. Bluetooth Anschluss. Power 1W. USB Wiederaufladbar. Kabel Inklusiv.
Lunettes Haut-Parleurs. Protection UV400. Connexion Bluetooth. Puissance 1W. Rechargeable USB. Cable Inclus.
Luidspreker Bril. UV400 Bescherming. Bluetooth Verbinding. Vermogen 1W. USB Oplaadbaar. Kabel Inclusief.

 17 x 5.2 x 7 cm
 Print Code: F(4), G(4), W

 50 / 25

SPEAKER





NEW



SPEAKER WITH WIRELESS CHARGING / ALTAVOZ CON CARGA INALÁMBRICA



Bionix 6890

Charger Speaker. Bluetooth Connection. Power 3W. Wireless Rechargeable. Cable Included.
Ladegerät Lautsprecher. Bluetooth Anschluss. Power 3W. Drahtlos Wiederaufladbar. Kabel Inklusive.
Haut-Parleurs Chargeur. Connexion Bluetooth. Puissance 3W. Rechargeable Sans Fil. Câble Inclus.
Oplader Luidspreker. Bluetooth Verbinding. Vermogen 3W. Draadloos Oplaadbaar. Kabel Inclusief.

Ø 5.8 x 7 cm 50 / 25
Print Code: F(4)



Bulpex 6146

SPEAKER & WIRELESS CHARGER
MULTIFUNCTION

Charger Speaker. Aluminium. Wireless. Bluetooth Connection. Power 3W. USB Rechargeable. Cable Included.
Ladegerät Lautsprecher. Aluminium. Drahtlos. Bluetooth Anschluss. Power 3W. USB Wiederaufladbar. Kabel Inklusive.
Haut-Parleurs Chargeur. Aluminium. Sans Fil. Connexion Bluetooth. Puissance 3W. Rechargeable USB. Câble Inclus.
Oplader Luidspreker. Aluminium. Draadloos. Bluetooth Verbinding. Vermogen 3W. USB Oplaadbaar. Kabel Inclusief.

6.2 x 6.6 x 6.2 cm 50
Print Code: F(4), W



SPEAKER & POWER BANK
MULTIFUNCTION

2200 mAh



Viseron 5530

Power Bank Speaker. 1 Led. 2200 mAh. USB Output. Micro USB Input. Bluetooth Connection. Power 3W. USB Rechargeable. Cable Included.
Power Bank Lautsprecher. 1 Led. 2200 mAh. USB Ausgang. Micro USB Eingang. Bluetooth Anschluss. Power 3W. USB Wiederaufladbar. Kabel Inklusive.
Haut-Parleurs Power Bank. 1 Led. 2200 mAh. Sortie USB. Entrée Micro USB. Connexion Bluetooth. Puissance 3W. Rechargeable US. Câble Inclus.
Power Bank Luidspreker. 1 Led. 2200 mAh. USB Output. Micro USB Input. Bluetooth Verbinding. Vermogen 3W. USB Oplaadbaar. Kabel Inclusief.

Ø 3.5 x 15.2 cm 50
Print Code: J(1), L2





Bluetooth



Bluetooth Hands-free Waterproof

WATERPROOF



Rariax 4929

Speaker. Bluetooth Connection. Power 3W. USB Rechargeable. Cable Included.
Lautsprecher. Bluetooth Anschluss. Power 3W. USB Wiederaufladbar. Kabel Inklusive.
Haut-Parleurs. Connexion Bluetooth. Puissance 3W. Rechargeable USB. Câble Inclus.
Luidspreker. Bluetooth Verbinding. Vermogen 3W. USB Oplaadbaar. Kabel Inclusief.

Ø 8.5 × 5.5 cm

50

Print Code: F(1)

52



19



03



01



Bluetooth Hands-free Micro SD Radio USB Player Line IN

Morals 5154

Speaker. Bluetooth Connection. Power 3W. USB Rechargeable. Cable Included.
Lautsprecher. Bluetooth Anschluss. Power 3W. USB Wiederaufladbar. Kabel Inklusive.
Haut-Parleurs. Connexion Bluetooth. Puissance 3W. Rechargeable USB. Câble Inclus.
Luidspreker. Bluetooth Verbinding. Vermogen 3W. USB Oplaadbaar. Kabel Inclusief.

15 × 5.6 × 5.8 cm

50

Print Code: F(1)



11



01

02

04

05

07

19

03



Bluetooth Hands-free Micro SD Line IN

Braiss 4628

Speaker. Bluetooth Connection. Power 3W. USB Rechargeable. Cable Included.
Lautsprecher. Bluetooth Anschluss. Power 3W. USB Wiederaufladbar. Kabel Inklusive.
Haut-Parleurs. Connexion Bluetooth. Puissance 3W. Rechargeable USB. Câble Inclus.
Luidspreker. Bluetooth Verbinding. Vermogen 3W. USB Oplaadbaar. Kabel Inclusief.

Ø 6 × 7.5 cm

50

Print Code: F(1)



Martins

4936

Speaker. Metal. Bluetooth Connection. Power 3W. USB Rechargeable. Cable Included.
 Lautsprecher. Metall. Bluetooth Anschluss. Power 3W. USB Wiederaufladbar. Kabel Inklusive.
 Haut-Parleurs. Métal. Connexion Bluetooth. Puissance 3W. Rechargeable USB. Câble Inclus.
 Luidspreker. Metaal. Bluetooth Verbinding. Vermogen 3W. USB Oplaadbaar. Inclusief Kabel.

Ø 5.9 x 5 cm

50 / 25

Print Code: F(4)



SPECIAL LASER ENGRAVING WHITE LIGHT LOGO



This bluetooth speaker with illuminated interior has an external coating specially designed for laser engraving, with which you will see your advertising or brand illuminated with white light.

Este altavoz bluetooth con interior iluminado tiene un recubrimiento exterior especialmente diseñado para grabado láser, con el que conseguirá que su publicidad o marca quede iluminada con luz blanca.



Viancos

5775

Speaker. Led Lights. Bluetooth Connection. Power 3W. USB Rechargeable. Cable Included.
 Lautsprecher. Led Lichter. Bluetooth Anschluss. Power 3W. USB Wiederaufladbar. Kabel Inklusive.
 Haut-Parleurs. Lumières Led. Connexion Bluetooth. Puissance 3W. Rechargeable USB. Câble Inclus.
 Luidspreker. Led Lichten. Bluetooth Verbinding. Vermogen 3W. USB Oplaadbaar. Kabel Inclusief.

Ø 6.2 x 5.1 cm

50

Print Code: F(4), L1



53



Stockel

6086

Speaker. Smart Leds. 3 Light Modes. Bluetooth Connection. Power 3W. USB Rechargeable. Cable Included.
 Lautsprecher. Intelligente Leds. 3 Leuchtfunktionen. Bluetooth Anschluss. Power 3W. USB Wiederaufladbar. Kabel Inklusive.
 Haut-Parleurs. Leds Intelligentes. 3 Modes de Lumière. Connexion Bluetooth. Puissance 3W. Rechargeable USB. Câble Inclus.
 Luidspreker. Smart Leds. 3 Licht Posities. Bluetooth Verbinding. Vermogen 3W. USB Oplaadbaar. Kabel Inclusief.

Ø 6 x 6 cm

50

Print Code: F(4)





Helber 5152

Speaker. Bluetooth Connection. Power 3W. USB Rechargeable. Cable Included.
Lautsprecher. Bluetooth Anschluss. Power 3W. USB Wiederaufladbar. Kabel Inklusiv.
Haut-Parleurs. Connexion Bluetooth. Puissance 3W. Rechargeable USB. Câble Inclus.
Luidspreker. Bluetooth Verbinding. Vermogen 3W. USB Oplaadbaar. Kabel Inclusief.

11.9 x 5.5 x 3.8 cm

50

Print Code: F(1)



Syrene 5566



Speaker. Bluetooth Connection. Power 3W. USB Rechargeable. Cable Included.
Lautsprecher. Bluetooth Anschluss. Power 3W. USB Wiederaufladbar. Kabel Inklusiv.
Haut-Parleurs. Connexion Bluetooth. Puissance 3W. Rechargeable USB. Câble Inclus.
Luidspreker. Bluetooth Verbinding. Vermogen 3W. USB Oplaadbaar. Kabel Inclusief.

6 x 6.9 x 5.8 cm

50

Print Code: F(4)



Hecno 5059



Speaker. Bluetooth Connection. Power 3W. USB Rechargeable. Cable Included.
Lautsprecher. Bluetooth Anschluss. Power 3W. USB Wiederaufladbar. Kabel Inklusiv.
Haut-Parleurs. Connexion Bluetooth. Puissance 3W. Rechargeable USB. Câble Inclus.
Luidspreker. Bluetooth Verbinding. Vermogen 3W. USB Oplaadbaar. Kabel Inclusief.

5 x 5.4 x 5 cm

50

Print Code: F(4), W



Audric 4934



Speaker. Bluetooth Connection. Power 3W. USB Rechargeable. Cable Included.
Lautsprecher. Bluetooth Anschluss. Power 3W. USB Wiederaufladbar. Kabel Inklusiv.
Haut-Parleurs. Connexion Bluetooth. Puissance 3W. Rechargeable USB. Câble Inclus.
Luidspreker. Bluetooth Verbinding. Vermogen 3W. USB Oplaadbaar. Kabel Inclusief.

Ø 8.1 x 4.6 cm

50

Print Code: F(1)



Klide

6254

Speaker. Bluetooth Connection. Power 3W. USB Rechargeable. Cable Included.

Lautsprecher. Bluetooth Anschluss. Power 3W. USB Wiederaufladbar. Kabel Inklusiv.

Haut-Parleurs. Connexion Bluetooth. Puissance 3W. Rechargeable USB. Cable Inclus.

Luidspreker. Bluetooth Verbinding. Vermogen 3W. USB Oplaadbaar. Kabel Inclusief.

9.8 x 7.1 x 5.7 cm

50 / 25

Print Code: F(4)



Bluetooth®



MULTICOLOR LIGHT

TOUCH TO CHANGE COLOR AND INTENSITY
PULSAR PARA CAMBIAR COLOR E INTENSIDAD

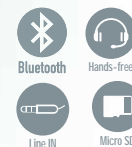

Bluetooth 5.0

Yois

6507

TWO LIGHT MODES
DOS MODOS DE LUZ
ADJUSTABLE INTENSITY
INTENSIDAD AJUSTABLE

Speaker. Led Lights. 2 Light Modes. Adjustable Brightness. Bluetooth Connection. Power 3W. USB Rechargeable. Cable Included.

Lautsprecher. Led Lichter. 2 Leuchtfunktionen. Einstellbare Lichtintensität. Bluetooth Anschluss. Power 3W. USB Wiederaufladbar. Kabel Inklusiv.

Haut-Parleurs. Lumières Led. 2 Modes de Lumière. Lumière à Intensité Réglable. Connexion Bluetooth. Puissance 3W. Rechargeable USB. Cable Inclus.

Luidspreker. Led Lichten. 2 Licht Posities. Lamp met Instelbare Lichtintensiteit. Bluetooth Verbinding. Vermogen 3W. USB Oplaadbaar. Kabel Inclusief.

12 x 15 x 12 cm

20

Print Code: F(1), L2

Alaric

5153

Speaker. Smart Leds. 3 Light Modes. Adjustable Brightness. Bluetooth Connection. Power 3W. USB Rechargeable. Cable Included.

Lautsprecher. Intelligent Leds. 3 Leuchtfunktionen. Einstellbare Lichtintensität. Bluetooth Anschluss. Power 3W. USB Wiederaufladbar. Kabel Inklusiv.

Haut-Parleurs. Leds Intelligentes. 3 Modes de Lumière. Lumière à Intensité Réglable. Connexion Bluetooth. Puissance 3W. Rechargeable USB. Cable Inclus.

Luidspreker. Smart Leds. 3 Licht Posities. Lamp met Instelbare Lichtintensiteit. Bluetooth Verbinding. Vermogen 3W. USB Oplaadbaar. Kabel Inclusief.

9.8 x 12.6 cm

20

Print Code: J(1)



Video





Baran

6269

Speaker. Bluetooth Connection. Power 3W. USB Rechargeable. Cable Included.
Lautsprecher. Bluetooth Anschluss. Power 3W. USB Wiederaufladbar. Kabel Inklusive.
Haut-Parleurs. Connexion Bluetooth. Puissance 3W. Rechargeable USB. Cable Inclus.
Luidspreker. Bluetooth Verbinding. Vermogen 3W. USB Oplaadbaar. Kabel Inclusief.

7 × 7 × 3.8 cm

50

Print Code: F(4)

56



Video



Lakon

6587

Speaker. ABS/ Silicone. Bluetooth Connection. Power 3W. USB Rechargeable. 3 Accessories. Cable Included.
Lautsprecher. ABS/ Silikon. Bluetooth Anschluss. Power 3W. USB Wiederaufladbar. 3 Teile. Kabel Inklusive.
Haut-Parleurs. ABS/ Silicone. Connexion Bluetooth. Puissance 3W. Rechargeable USB. 3 Accessoires. Cable Inclus.
Luidspreker. ABS/ Siliconen. Bluetooth Verbinding. Vermogen 3W. USB Oplaadbaar. 3 Accessoires. Kabel Inclusief.

22.5 × 2.8 × 15.8 cm

20

Print Code: F(1)



Garbo

6301

Speaker. Bluetooth Connection. Power 3W. USB Rechargeable. Cable Included.
Lautsprecher. Bluetooth Anschluss. Power 3W. USB Wiederaufladbar. Kabel Inklusive.
Haut-Parleurs. Connexion Bluetooth. Puissance 3W. Rechargeable USB. Cable Inclus.
Luidspreker. Bluetooth Verbinding. Vermogen 3W. USB Oplaadbaar. Kabel Inclusief.

6.2 × 9.2 cm

50 / 25

Print Code: F(4)

22.5 × 2.8 × 15.8 cm

20

Print Code: F(1)



4 PIECES



vertrio



Kafir

6413

Speaker. Bluetooth Connection. Power 3W. USB Rechargeable. Cable Included.
Lautsprecher. Bluetooth Anschluss. Power 3W. USB Wiederaufladbar. Kabel Inklusiv.
Haut-Parleurs. Connexion Bluetooth. Puissance 3W. Rechargeable USB. Câble Inclus.
Luidspreker. Bluetooth Verbinding. Vermogen 3W. USB Oplaadbaar. Kabel Inclusief.

11.1 × 8.3 × 4.1 cm
Print Code: F(4), N(8)



Netpak

6300

Speaker. Bluetooth Connection. Power 3W. USB Rechargeable. Cable Included.
Lautsprecher. Bluetooth Anschluss. Power 3W. USB Wiederaufladbar. Kabel Inklusiv.
Haut-Parleurs. Connexion Bluetooth. Puissance 3W. Rechargeable USB. Câble Inclus.
Luidspreker. Bluetooth Verbinding. Vermogen 3W. USB Oplaadbaar. Kabel Inclusief.

0.6.2 × 9.2 cm
Print Code: F(4)





Clarmunt 5767

Speaker. Bluetooth Connection. Power 3W. USB Rechargeable. Cable Included.
Lautsprecher. Bluetooth Anschluss. Power 3W. USB Wiederaufladbar. Kabel Inklusiv.
Haut-Parleurs. Connexion Bluetooth. Puissance 3W. Rechargeable USB. Cable Inclus.
Luidspreker. Bluetooth Verbinding. Vermogen 3W. USB Oplaadbaar. Kabel Inclusief.

13 × 11.7 × 6.7 cm

30

Print Code: F(1)



Bolfing 5766

Speaker. Bluetooth Connection. Power 3W. USB Rechargeable. Cable Included.
Lautsprecher. Bluetooth Anschluss. Power 3W. USB Wiederaufladbar. Kabel Inklusiv.
Haut-Parleurs. Connexion Bluetooth. Puissance 3W. Rechargeable USB. Cable Inclus.
Luidspreker. Bluetooth Verbinding. Vermogen 3W. USB Oplaadbaar. Kabel Inclusief.

11.1 × 8.3 × 4.1 cm

50

Print Code: F(1), N(8)





Wanap 6506



Speaker. Bluetooth Connection. Power 3W. USB Rechargeable. Cable Included.
Lautsprecher. Bluetooth Anschluss. Power 3W. USB Wiederaufladbar. Kabel Inklusive.
Haut-Parleurs. Connexion Bluetooth. Puissance 3W. Rechargeable USB. Câble Inclus.
Luidspreker. Bluetooth Verbinding. Vermogen 3W. USB Oplaadbaar. Kabel Inclusief.

Ø 5.2 × 5.9 cm

100 / 50

Print Code: F(1), L1



WOW!
DANCER SPEAKER
ALTAVOZ BAILARIN



Karlion 6189

Speaker. Bluetooth Connection. Power 3W. USB Rechargeable. Cable Included.
Lautsprecher. Bluetooth Anschluss. Power 3W. USB Wiederaufladbar. Kabel Inklusive.
Haut-Parleurs. Connexion Bluetooth. Puissance 3W. Rechargeable USB. Câble Inclus.
Luidspreker. Bluetooth Verbinding. Vermogen 3W. USB Oplaadbaar. Kabel Inclusief.

8.9 × 10.7 × 3.8 cm

50

Print Code: F(4), W



WOW!
DANCER SPEAKER
ALTAVOZ BAILARIN



Laryn 6508

Speaker. Bluetooth Connection. Power 3W. USB Rechargeable. Cable Included.
Lautsprecher. Bluetooth Anschluss. Power 3W. USB Wiederaufladbar. Kabel Inklusive.
Haut-Parleurs. Connexion Bluetooth. Puissance 3W. Rechargeable USB. Câble Inclus.
Luidspreker. Bluetooth Verbinding. Vermogen 3W. USB Oplaadbaar. Kabel Inclusief.

Ø 5.1 × 9.5 cm

100 / 50

Print Code: F(1)



tritan™
Tritan® material

500 ml



Padow

5819

Speaker Bottle. Tritan. 500 ml. Bluetooth Connection. Power 3W. USB Rechargeable. Individual Presentation. Cable Included.

Lautsprecher Trinkflasche. Tritan. 500 ml. Bluetooth Anschluss. Power 3W. USB Wiederaufladbar. Individuelle Präsentation. Kabel Inklusiv.

Bidon Haut-Parleurs. Tritan. 500 ml. Connexion Bluetooth. Puissance 3W. Rechargeable USB. Présentation Individuelle. Câble Inclus.

Luidspreker Fles. Tritan. 500 ml. Bluetooth Verbinding. Vermogen 3W. USB Oplaadbaar. Individuele Presentatie. Kabel Inclusief.

Ø 6.9 × 25.5 cm

50

Print Code: G(1)



FLOATABLE
FLOTANTE

Haclix
6444



Speaker. PVC/ ABS. Bluetooth Connection. Power 3W. USB Rechargeable. Cable Included.
Lautsprecher. PVC/ ABS. Bluetooth Anschluss. Power 3W. USB Wiederaufladbar. Kabel Inklusiv.
Haut-Parleurs. PVC/ ABS. Connexion Bluetooth. Puissance 3W. Rechargeable USB. Câble Inclus.
Luidspreker. PVC/ ABS. Bluetooth Verbinding. Vermogen 3W. USB Oplaadbaar. Kabel Inclusief.

Ø 17 × 6 cm

50

Print Code: F(1)



TACTILE
WATERPROOF



Livion
5774



Speaker Multipurpose Bag. PVC. Bluetooth Connection. Power 1.1W. USB Rechargeable. Waterproof. Touch Screen. Cable Included.

Lautsprecher Mehrzwecktasche. PVC. Bluetooth Anschluss. Power 1.1W. USB Wiederaufladbar. Wasserdicht. Touch Screen. Kabel Inklusiv.

Fourre-Tout Haut-Parleurs. PVC. Connexion Bluetooth. Puissance 1.1W. Rechargeable USB. Imperméable. Ecran Tactile. Câble Inclus.

Luidspreker Multifunctioneel Tasje. PVC. Bluetooth Verbinding. Vermogen 1.1W. USB Oplaadbaar. Waterdicht. Touch Screen. Kabel Inclusief.

12.8 × 22 cm

200 / 50

Print Code: G(1)



MULTICOLOR LIGHT

Trobel

6255

Ice Bucket Speaker. Smart Leds. Bluetooth Connection. Power 5W. USB Rechargeable. Cable Included.
Lautsprecher Eiskübel. Intelligente Leds. Bluetooth Anschluss. Power 5W. USB Wiederaufladbar. Kabel Inklusive.
Sac Glaçons Haut-Parleurs. Leds Intelligentes. Connexion Bluetooth. Puissance 5W. Rechargeable USB. Câble Inclusif.
Luidspreker Ijs Emmer. Smart Leds. Bluetooth Verbinding. Vermogen 5W. USB Oplaadbaar. Kabel Inclusief.

24.5 × 29 × 23.5 cm

4

Print Code: I(1)



Zhilang

6347

Lamp Speaker. 18 Leds. Flexible. Adjustable Brightness. Bluetooth Connection. Power 5W. USB Rechargeable. Cable Included.

Lampe Lautsprecher. 18 Leds. Flexibel. Einstellbare Lichtintensität. Bluetooth Anschluss. Power 5W. USB Wiederaufladbar. Kabel Inklusive.

Lampe Haut-Parleurs. 18 Leds. Flexible. Lumière à Intensité Réglable. Connexion Bluetooth. Puissance 5W. Rechargeable USB. Câble Inclusif.

Lamp Luidspreker. 18 Leds. Flexibel. Lamp met Instelbare Lichtintensiteit. Bluetooth Verbinding. Vermogen 5W. USB Oplaadbaar. Kabel Inclusief.

10 × 53 cm

30

Print Code: F(1)



61

ADJUSTABLE INTENSITY
INTENSIDAD AJUSTABLE





Vildrey 5945

Headphones. Bluetooth Connection. 3.5 mm Jack Socket. USB Rechargeable. Cable Included.
Kopfhörer. Bluetooth Anschluss. 3.5 mm Klinkestecker. USB Wiederaufladbar. Kabel Inklusiv.
Écouteurs. Connexion Bluetooth. Connexion Jack 3.5 mm. USB Rechargeable. Câble Inclus.
Koptelefoon. Bluetooth Verbinding. 3.5 mm Jack Aansluiting. USB Oplaadbaar. Kabel Inclusief.

17.5 x 20.5 x 9 cm
Print Code: F(1), L2

20



09 ALUMINIUM



19



03



04

05

11



Tresor 5562

Headphones. Bluetooth Connection. 3.5 mm Jack Socket. USB Rechargeable. Cable Included.
Kopfhörer. Bluetooth Anschluss. 3.5 mm Klinkestecker. USB Wiederaufladbar. Kabel Inklusiv.
Écouteurs. Connexion Bluetooth. Connexion Jack 3.5 mm. USB Rechargeable. Câble Inclus.
Koptelefoon. Bluetooth Verbinding. 3.5 mm Jack Aansluiting. USB Oplaadbaar. Kabel Inclusief.

19 x 17.5 x 7 cm
Print Code: F(1)

20 / 10



02



01

Darsy 4938

Headphones. Bluetooth Connection. 3.5 mm Jack Socket. USB Rechargeable. Cable Included.
Kopfhörer. Bluetooth Anschluss. 3.5 mm Klinkestecker. USB Wiederaufladbar. Kabel Inklusiv.
Écouteurs. Connexion Bluetooth. Connexion Jack 3.5 mm. USB Rechargeable. Câble Inclus.
Koptelefoon. Bluetooth Verbinding. 3.5 mm Jack Aansluiting. USB Oplaadbaar. Kabel Inclusief.

19 x 17.5 x 8 cm
Print Code: F(1)

20 / 10





01



01



03



19



02



Legolax

5531



Bluetooth



Hands-free



Micro SD



Radio



Line IN

Headphones. Bluetooth Connection. 3,5 mm Jack Socket. USB Rechargeable. Cable Included.
Kopfhörer. Bluetooth Anschluss. 3,5 mm Klinkestecker. USB Wiederaufladbar. Kabel Inklusive.
Écouteurs. Connexion Bluetooth. Connexion Jack 3,5 mm. USB Rechargeable. Câble Inclus.
Koptelefoon. Bluetooth Verbinding. 3,5 mm Jack Aansluiting. USB Oplaadbaar. Kabel Inclusief.

18 × 18,5 × 7,8 cm

20 / 10

Print Code: F(1)



02

Magnel

6266



Bluetooth 5.0



Hands-free



Line IN

Headphones. Bluetooth Connection. 3,5 mm Jack Socket. USB Rechargeable. Cable Included.
Kopfhörer. Bluetooth Anschluss. 3,5 mm Klinkestecker. USB Wiederaufladbar. Kabel Inklusive.
Écouteurs. Connexion Bluetooth. Connexion Jack 3,5 mm. USB Rechargeable. Câble Inclus.
Koptelefoon. Bluetooth Verbinding. 3,5 mm Jack Aansluiting. USB Oplaadbaar. Kabel Inclusief.

17,5 × 18,5 × 7,7 cm

20

Print Code: F(1)



5000
mAh



Kendrix

6261

Power Bank. Wireless. 5000 mAh. USB Output. Micro USB Input. Cable Included.
Power Bank. Drahtlos. 5000 mAh. USB Ausgang. Micro USB Eingang. Kabel Inklusive.
Power Bank. Sans Fil. 5000 mAh. Sortie USB. Entrée Micro USB. Câble Inclus.
Power Bank. Draadloos. 5000 mAh. USB Output. Micro USB Input. Kabel Inclusief.

7.5 × 8.4 × 1.6 cm

50 / 25

Print Code: E(4), W



64



4000
mAh

Woding

6272

Power Bank. Wireless. 4000 mAh. USB Output. Micro USB Input. Cable Included.
Power Bank. Drahtlos. 4000 mAh. USB Ausgang. Micro USB Eingang. Kabel Inklusive.
Power Bank. Sans Fil. 4000 mAh. Sortie USB. Entrée Micro USB. Câble Inclus.
Power Bank. Draadloos. 4000 mAh. USB Output. Micro USB Input. Kabel Inclusief.

6.7 × 11.4 × 1 cm

100 / 70

Print Code: E(4), W



8000
mAh

POWER BANK

Zenon

5959

Power Bank Charger. Wireless. 2200 mAh. USB Output. Micro USB Input. Cable Included.
Power Bank Ladegerät. Drahtlos. 2200 mAh. USB Ausgang. Micro USB Eingang. Kabel Inklusive.
Chargeur Power Bank. Sans Fil. 2200 mAh. Sortie USB. Entrée Micro USB. Câble Inclus.
Power Bank Oplader. Draadloos. 2200 mAh. USB Output. Micro USB Input. Kabel Inclusief.

12 × 10.7 × 6.2 cm

80 / 40

Print Code: F(4)



2200
mAh

Crooft

5782

Power Bank. Wireless. 8000 mAh. USB and Type C Output. Micro USB and Type C Input. Cable Not Included.
Power Bank. Drahtlos. 8000 mAh. USB und Typ C Ausgang. Micro USB und Typ C Eingang. Kabel Nicht im Lieferumfang.
Power Bank. Sans Fil. 8000 mAh. Sortie USB et Type C. Entrée Micro USB et Type C. Câble Non Inclus.
Power Bank. Draadloos. 8000 mAh. USB en Type C Output. Micro USB en Type C Input. Kabel Niet Inclusief.

2.6 × 7.4 × 9.7 cm

40 / 10

Print Code: E(4)

TYPE C
INPUT / OUTPUT



WIRELESS CHARGE





4000 mAh



02

03

19

09

Tikur

6263

Power Bank. Aluminium. Wireless. 4000 mAh. USB Output. Micro USB Input. Cable Included.
 Power Bank. Aluminium. Drahtlos. 4000 mAh. USB Ausgang. Micro USB Eingang. Kabel Inklusiv.
 Power Bank. Aluminium. Sans Fil. 4000 mAh. Sortie USB. Entrée Micro USB. Câble Inclus.
 Power Bank. Aluminium. Draadloos. 4000 mAh. USB Output. Micro USB Input. Kabel Inclusief.

7 × 12.2 × 1 cm
 Print Code: E(4), W

50 / 25



6000 mAh

MICRO USB INPUT

TYPE C INPUT / OUTPUT

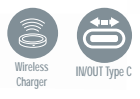

5000 mAh

65

Boxlem

6139

Power Bank. Aluminium. Wireless. Ultra Slim. 5000 mAh. USB Output. Micro USB Input. Cable Included.
 Power Bank. Aluminium. Drahtlos. Ultradünn. 5000 mAh. USB Ausgang. Micro USB Eingang. Kabel Inklusiv.
 Power Bank. Aluminium. Sans Fil. Ultra Fin. 5000 mAh. Sortie USB. Entrée Micro USB. Câble Inclus.
 Power Bank. Aluminium. Draadloos. Ultra Dun. 5000 mAh. USB Output. Micro USB Input. Kabel Inclusief.

6.8 × 13 × 1 cm
 Print Code: E(4), W, L2

50 / 25



ULTRA SLIM
 ULTRA DELGADO

Quizet

5783

Power Bank. Wireless. 6000 mAh. USB and Type C Output. Micro USB and Type C Input. Cable Not Included.
 Power Bank. Drahtlos. 6000 mAh. USB und Typ C Ausgang. Micro USB und Typ C Eingang. Kabel Nicht im Lieferumfang.
 Power Bank. Sans Fil. 6000 mAh. Sortie USB et Type C. Entrée Micro USB et Type C. Câble Non Inclus.
 Power Bank. Draadloos. 6000 mAh. USB en Type C Output. Micro USB en Type C Input. Kabel Niet Inclusief.

7.4 × 14.5 × 1.9 cm
 Print Code: F(4), W

40 / 10

SOLAR CHARGER



4000 mAh



4000 mAh



Lenard 4939

Power Bank. 1 Led. 4000 mAh. 2 USB Outputs. Micro USB Input. Cable Included.
 Power Bank. 1 Led. 4000 mAh. 2 USB Ausgänge. Micro USB Eingang. Kabel Inklusive.
 Power Bank. 1 Led. 4000 mAh. 2 Sorties USB. Entrée Micro USB. Cable Inclus.
 Power Bank. 1 Led. 4000 mAh. 2 USB Outputs. Micro USB Input. Kabel Inclusief.

7.5 x 14.5 x 1.5 cm
 Print Code: E(4)

50 / 25



Rudder 6307

Power Bank. Aluminium. 4000 mAh. USB Output. Micro USB Input. Cable Included.
 Power Bank. Aluminium. 4000 mAh. USB Ausgang. Micro USB Eingang. Kabel Inklusive.
 Power Bank. Aluminium. 4000 mAh. Sortie USB. Entrée Micro USB. Cable Inclus.
 Power Bank. Aluminium. 4000 mAh. USB Output. Micro USB Input. Kabel Inclusief.

7.8 x 12.5 x 1.4 cm
 Print Code: E(4), L2, W

50 / 25



10.000 mAh



10000 mAh

Marlet 4964

Power Bank. 10000 mAh. 2 USB Outputs. Micro USB Input. Cable Included.
 Power Bank. 10000 mAh. 2 USB Ausgänge. Micro USB Eingang. Kabel Inklusive.
 Power Bank. 10000 mAh. 2 Sorties USB. Entrée Micro USB. Cable Inclus.
 Power Bank. 10000 mAh. 2 USB Outputs. Micro USB Input. Kabel Inclusief.

7.4 x 15.4 x 1.6 cm
 Print Code: E(4), W

50 / 25





10000 mAh



Backers 5537

Power Bank. Aluminium. 10000 mAh. 2 USB Outputs. Micro USB, Type C and Lightning Inputs. Cable Not Included.
Power Bank. Aluminium. 10000 mAh. 2 USB Ausgänge. Micro USB Eingang, Micro USB, Typ C und Lightning Eingänge. Kabel Nicht im Lieferumfang.
Power Bank. Aluminium. 10000 mAh. 2 Sorties USB. Entrées Micro USB, Type C et Lightning. Câble Non Inclus.
Power Bank. Aluminium. 10000 mAh. 2 USB Outputs. Micro USB, Type C en Lightning Inputs. Kabel Niet Inclusief.

7.5 x 14.1 x 1.3 cm 50 / 25
Print Code: E(4), W, L2



NEW

20000 mAh



Kiubert 6892

Power Bank. 20000 mAh. 2 USB and 1 Type C Outputs. Type C Input.
Power Bank. 20000 mAh. 2 USB und 1 Typ C Ausgänge. Typ C Eingang.
Power Bank. 20000 mAh. 2 Sorties USB et 1 Type C. Entrée Type C.
Power Bank. 20000 mAh. 2 USB en 1 Typ C Outputs. Typ C Input.

6.8 x 13.8 x 2.5 cm 30 / 10
Print Code: E(4), W



10000 mAh

Kaprin 5779



Power Bank. 1 Led. 10000 mAh. 3 USB Outputs. Micro USB Input. Cable Not Included.
Power Bank. 1 Led. 10000 mAh. 3 USB Ausgänge. Micro USB Eingang. Kabel Nicht im Lieferumfang.
Power Bank. 1 Led. 10000 mAh. 3 Sorties USB. Entrée Micro USB. Câble Non Inclus.
Power Bank. 1 Led. 10000 mAh. 3 USB Outputs. Micro USB Input. Kabel Niet Inclusief.

6.5 x 14.3 x 2.2 cm 40 / 10
Print Code: E(4), W



67





2200 mAh

19



02
03
09

Telstan

5538

Power Bank. Aluminium. 2200 mAh. USB Output. Micro USB Input. Cable Included.
 Power Bank. Aluminium. 2200 mAh. USB Ausgang. Micro USB Eingang. Kabel Inklusiv.
 Power Bank. Aluminium. 2200 mAh. Sortie USB. Entrée Micro USB. Câble Inclus.
 Power Bank. Aluminium. 2200 mAh. USB Output. Micro USB Input. Kabel Inclusief.

6.5 x 9.5 x 0.8 cm 100 / 25
 Print Code: E(4), W, L2



02



SELFIES



2000 mAh



2000 mAh



03

19

01

Privek

5960

Power Bank. 2000 mAh. USB Output. Micro USB Input. Cable Not Included.
 Power Bank. 2000 mAh. USB Ausgang. Micro USB Eingang. Kabel Nicht im Lieferumfang.
 Power Bank. 2000 mAh. Sortie USB. Entrée Micro USB. Câble Non Inclus.
 Power Bank. 2000 mAh. USB Output. Micro USB Input. Kabel Niet Inclusief.

5.9 x 9 x 3.8 cm 100 / 25
 Print Code: E(4)



HOLDER/
 SOPORTE

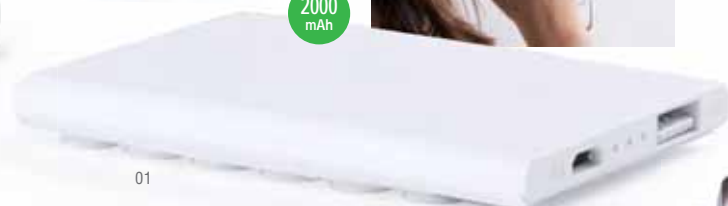

01



02

Ventox

5325

Power Bank. 2000 mAh. USB Output. Micro USB Input. Cable Included.
 Power Bank. 2000 mAh. USB Ausgang. Micro USB Eingang. Kabel Inklusiv.
 Power Bank. 2000 mAh. Sortie USB. Entrée Micro USB. Câble Inclus.
 Power Bank. 2000 mAh. USB Output. Micro USB Input. Kabel Inclusief.

5.9 x 9 x 1 cm 100 / 25
 Print Code: E(4), W

Video





Thazer

4743

- Power Bank. Aluminium. 2200 mAh. USB Output. Micro USB Input. Cable Included.
- Power Bank. Aluminium. 2200 mAh. USB Ausgang. Micro USB Eingang. Kabel Inklusive.
- Power Bank. Aluminium. 2200 mAh. Sortie USB. Entrée Micro USB. Cable Inclus.
- Power Bank. Aluminium. 2200 mAh. USB Output. Micro USB Input. Kabel Inclusief.

2.2 x 9.4 x 2.2 cm 100 / 25
 Print Code: D(4), L2



Youter

4941

- Power Bank. 1200 mAh. USB Output. Micro USB Input. Cable Included.
- Power Bank. 1200 mAh. USB Ausgang. Micro USB Eingang. Kabel Inklusive.
- Power Bank. 1200 mAh. Sortie USB. Entrée Micro USB. Cable Inclus.
- Power Bank. 1200 mAh. USB Output. Micro USB Input. Kabel Inclusief.

2.6 x 9.7 x 2.3 cm 100 / 25
 Print Code: D(4), W



09

09

6000
mAh

02



5000
mAh



23

Wilkes

4960

Power Bank. Aluminium. 5000 mAh. USB Output. Micro USB Input. Cable Included.
 Power Bank. Aluminium. 5000 mAh. USB Ausgang. Micro USB Eingang. Kabel Inklusive.
 Power Bank. Aluminium. 5000 mAh. Sortie USB. Entrée Micro USB. Câble Inclus.
 Power Bank. Aluminium. 5000 mAh. USB Output. Micro USB Input. Kabel Inclusief.

6.5 × 12 × 1.1 cm
 Print Code: E(4), L2

50 / 25

Quench

4963

Power Bank. Aluminium. 6000 mAh. 2 USB Outputs. Micro USB Input. Cable Included.
 Power Bank. Aluminium. 6000 mAh. 2 USB Ausgänge. Micro USB Eingang. Kabel Inklusive.
 Power Bank. Aluminium. 6000 mAh. 2 Sorties USB. Entrée Micro USB. Câble Inclus.
 Power Bank. Aluminium. 6000 mAh. 2 USB Outputs. Micro USB Input. Kabel Inclusief.

7 × 13 × 1.3 cm

50 / 25

Print Code: E(4), L2

70

VALID FOR DIGITAL PRINTING

2200
mAh



19

Vilek

4744

Power Bank. 2200 mAh. USB Output. Micro USB Input. Cable Included.
 Power Bank. 2200 mAh. USB Ausgang. Micro USB Eingang. Kabel Inklusive.
 Power Bank. 2200 mAh. Sortie USB. Entrée Micro USB. Câble Inclus.
 Power Bank. 2200 mAh. USB Output. Micro USB Input. Kabel Inclusief.

5.6 × 9.2 × 1 cm
 Print Code: E(4), W

100 / 25



02

03

01

19



4000
mAh



09

03

Cufon

4959

Power Bank. Aluminium. 1 Led. 4000 mAh. USB Output. Micro USB Input. Cable Included.
 Power Bank. Aluminium. 1 Led. 4000 mAh. USB Ausgang. Micro USB Eingang. Kabel Inklusive.
 Power Bank. Aluminium. 1 Led. 4000 mAh. Sortie USB. Entrée Micro USB. Câble Inclus.
 Power Bank. Aluminium. 1 Led. 4000 mAh. USB Output. Micro USB Input. Kabel Inclusief.

4.1 × 9.5 × 2.3 cm

50 / 25

Print Code: E(4), L2



02



2000 mAh



Hebernal 5326

Power Bank. 2000 mAh. USB Output. Micro USB Input. Cable Included.
 Power Bank. 2000 mAh. USB Ausgang. Micro USB Eingang. Kabel Inklusiv.
 Power Bank. 2000 mAh. Sortie USB. Entrée Micro USB. Câble Inclusif.
 Power Bank. 2000 mAh. USB Output. Micro USB Input. Kabel Inklusief.

6.2 x 9.6 x 0.8 cm 100 / 25
 Print Code: E(4), W

IDEAL FOR DIGITAL PRINTING



Osnel 4745

Power Bank. Stainless Steel/ ABS. 4000 mAh. USB Output. Micro USB Input. Cable Included.
 Power Bank. Rostfreier Stahl/ ABS. 4000 mAh. USB Ausgang. Micro USB Eingang. Kabel Inklusiv.
 Power Bank. Acier Inox/ ABS. 4000 mAh. Sortie USB. Entrée Micro USB. Câble Inclusif.
 Power Bank. Roestvrij Staal/ ABS. 4000 mAh. USB Output. Micro USB Input. Kabel Inklusief.

6.5 x 11.6 x 1 cm 50 / 25
 Print Code: E(4), W

4000 mAh

ULTRA SLIM



TYPE-C CONNECTION



2200 mAh

MICRO USB

TYPE C

19



4000 mAh

TYPE C

MICRO USB

09



Type-C Connection

02

Villex 5776

Power Bank. Aluminium. 2200 mAh. USB Output. Micro USB and Type C Input. Cable Not Included.
 Power Bank. Aluminium. 2200 mAh. USB Ausgang. Micro USB und Typ C Eingang. Kabel Nicht im Lieferumfang.
 Power Bank. Aluminium. 2200 mAh. Sortie USB. Entrée Micro USB et Type C. Câble Non Inclusif.
 Power Bank. Aluminium. 2200 mAh. USB Output. Micro USB en Type C Input. Kabel Niet Inklusief.

6.5 x 9.5 x 0.8 cm 100 / 25
 Print Code: E(4), W, L2

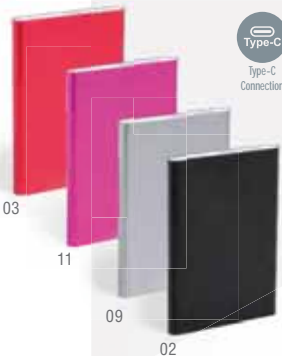

03

11

09

02

Dicker 5777

Power Bank. Aluminium. 4000 mAh. USB Output. Micro USB and Type C Input. Cable Not Included.
 Power Bank. Aluminium. 4000 mAh. USB Ausgang. Micro USB und Typ C Eingang. Kabel Nicht im Lieferumfang.
 Power Bank. Aluminium. 4000 mAh. Sortie USB. Entrée Micro USB et Type C. Câble Non Inclusif.
 Power Bank. Aluminium. 4000 mAh. USB Output. Micro USB en Type C Input. Kabel Niet Inklusief.

6.9 x 11 x 1 cm 100 / 25
 Print Code: E(4), W, L2





Tradak

4966

Power Bank. 2200 mAh. USB Output. Micro USB Input. Cable Included.
 Power Bank. 2200 mAh. USB Ausgang. Micro USB Eingang. Kabel Inklusive.
 Power Bank. 2200 mAh. Sortie USB. Entrée Micro USB. Câble Inclus.
 Power Bank. 2200 mAh. USB Output. Micro USB Input. Kabel Inclusief.

10.5 × 4 × 5 cm

100 / 25

Print Code: E(1)

2200 mAh



03

72

2000 mAh



19

4000 mAh

Sirouk

4956

Power Bank. 2000 mAh. USB Output. Micro USB Input. Cable Included.
 Power Bank. 2000 mAh. USB Ausgang. Micro USB Eingang. Kabel Inklusive.
 Power Bank. 2000 mAh. Sortie USB. Entrée Micro USB. Câble Inclus.
 Power Bank. 2000 mAh. USB Output. Micro USB Input. Kabel Inclusief.

2.5 × 9.2 × 2.5 cm

100 / 25

Print Code: D(4)



Nibbler

4958

Power Bank. 4000 mAh. USB Output. Micro USB Input. Cable Included.
 Power Bank. 4000 mAh. USB Ausgang. Micro USB Eingang. Kabel Inklusive.
 Power Bank. 4000 mAh. Sortie USB. Entrée Micro USB. Câble Inclus.
 Power Bank. 4000 mAh. USB Output. Micro USB Input. Kabel Inclusief.

4.5 × 9.7 × 2.3 cm

50 / 25

Print Code: D(4), W





Boltok

5328

Power Bank. 1200 mAh. USB Output. Micro USB Input. Cable Not Included.
 Power Bank. 1200 mAh. USB Ausgang. Micro USB Eingang. Kabel Nicht im Lieferumfang.
 Power Bank. 1200 mAh. Sortie USB. Entrée Micro USB. Câble Non Inclus.
 Power Bank. 1200 mAh. USB Output. Micro USB Input. Kabel Niet Inclusief.

3 × 9,6 × 2,1 cm 100 / 25
 Print Code: D(4), W



Kanlep

4740

Power Bank. 2000 mAh. USB Output. Micro USB Input. Cable Not Included.
 Power Bank. 2000 mAh. USB Ausgang. Micro USB Eingang. Kabel Nicht im Lieferumfang.
 Power Bank. 2000 mAh. Sortie USB. Entrée Micro USB. Câble Non Inclus.
 Power Bank. 2000 mAh. USB Output. Micro USB Input. Kabel Niet Inclusief.

2,6 × 9,7 × 2,3 cm 100 / 25
 Print Code: D(4), W



Keox

4955

Power Bank. 2000 mAh. USB Output. Micro USB Input. Cable Included.
 Power Bank. 2000 mAh. USB Ausgang. Micro USB Eingang. Kabel Inklusive.
 Power Bank. 2000 mAh. Sortie USB. Entrée Micro USB. Câble Inclus.
 Power Bank. 2000 mAh. USB Output. Micro USB Input. Kabel Inclusief.

2,6 × 9,7 × 2,3 cm 100 / 25
 Print Code: D(4), W



Colians 4987

Power Bank. 4000 mAh. USB Output. Micro USB Input. Cable Included.
 Power Bank. 4000 mAh. USB Ausgang. Micro USB Eingang. Kabel Inklusive.
 Power Bank. 4000 mAh. Sortie USB. Entrée Micro USB. Câble Inclus.
 Power Bank. 4000 mAh. USB Output. Micro USB Input. Kabel Inclusief.

📏 5.9 × 13.2 × 6.5 cm 📦 50 / 25

🌈 Print Code: E(4), W



Spencer 5242

USB Power Bank. 2500 mAh. USB Output. Micro USB Input. 8GB. Cable Included.
 USB Power Bank. 2500 mAh. USB Ausgang. Micro USB Eingang. 8GB. Kabel Inklusive.
 Power Bank USB. 2500 mAh. Sortie USB. Entrée Micro USB. 8GB. Câble Inclus.
 USB Power Bank. 2500 mAh. USB Output. Micro USB Input. 8GB. Kabel Inclusief.

📏 6.2 × 11.4 × 0.8 cm 📦 100 / 50

🌈 Print Code: E(4), W



Kenfac 4962



Light

Power Bank. 1 Led. 6000 mAh. 2 USB Outputs. Micro USB Input. Cable Included.
 Power Bank. 1 Led. 6000 mAh. 2 USB Ausgänge. Micro USB Eingang. Kabel Inklusive.
 Power Bank. 1 Led. 6000 mAh. 2 Sorties USB. Entrée Micro USB. Câble Inclus.
 Power Bank. 1 Led. 6000 mAh. 2 USB Outputs. Micro USB Input. Kabel Inclusief.

📏 6.3 × 9.7 × 2.5 cm 📦 50 / 25

🌈 Print Code: E(4), W



Harubax 4999



Light

Power Bank. 1 Led. 4000 mAh. USB Output. Micro USB Input. Cable Included.
 Power Bank. 1 Led. 4000 mAh. USB Ausgang. Micro USB Eingang. Kabel Inklusive.
 Power Bank. 1 Led. 4000 mAh. Sortie USB. Entrée Micro USB. Câble Inclus.
 Power Bank. 1 Led. 4000 mAh. USB Output. Micro USB Input. Kabel Inclusief.

📏 4.4 × 9.7 × 2.3 cm 📦 50 / 25

🌈 Print Code: E(4), W



2200 mAh

07



02 01 19 16 05 03 11

Khatim 4742

Power Bank. 2200 mAh. USB Output. Micro USB Input. Cable Included.
 Power Bank. 2200 mAh. USB Ausgang. Micro USB Eingang. Kabel Inklusive.
 Power Bank. 2200 mAh. Sortie USB. Entrée Micro USB. Câble Inclus.
 Power Bank. 2200 mAh. USB Output. Micro USB Input. Kabel Inclusief.

2.5 x 9.6 x 3.2 cm 100 / 25
 Print Code: D(4)

75



2200 mAh

Sanders 5240

Power Bank. 2200 mAh. USB Output. Micro USB Input. Cable Included.
 Power Bank. 2200 mAh. USB Ausgang. Micro USB Eingang. Kabel Inklusive.
 Power Bank. 2200 mAh. Sortie USB. Entrée Micro USB. Câble Inclus.
 Power Bank. 2200 mAh. USB Output. Micro USB Input. Kabel Inclusief.

2.5 x 7.3 x 3.4 cm 100 / 25
 Print Code: D(4), W



2200 mAh

Ventur 4942

Power Bank. 2200 mAh. USB Output. Micro USB Input. Cable Included.
 Power Bank. 2200 mAh. USB Ausgang. Micro USB Eingang. Kabel Inklusive.
 Power Bank. 2200 mAh. Sortie USB. Entrée Micro USB. Câble Inclus.
 Power Bank. 2200 mAh. USB Output. Micro USB Input. Kabel Inclusief.

2.5 x 10 x 3.4 cm 100 / 25
 Print Code: D(4)



**POWER BANK
MULTIFUNCTION**



Tandem

5171

Power Bank Display Stand. 10000 mAh. 4 USB Outputs. Micro USB Input. Cables Included.

Power Bank Graphic Rahmen. 10000 mAh. 4 USB Ausgänge. Micro USB Eingang. Kabel Inklusiv.

Support Graphique Power Bank. 10000 mAh. 4 Sorties USB. Entrée Micro USB. Câbles Inclus.

Power Bank Display Standraad. 10000 mAh. 4 USB Outputs. Micro USB Input. Inclusief Kabels.

16 × 27.5 × 7.8 cm

Print Code: J(4), W



20



Power Bank

10000
mAh



76



Solius

5144

Power Bank Stylus Touch Ball Pen. Metall. 650 mAh. USB Output. Micro USB Input. Black Ink. Cable Included.

Power Bank Kugelschreiber Pointer. Metall. 650 mAh. USB Ausgang. Micro USB Eingang. Schwarze Tinte. Kabel Inklusiv.

Stylét Bille Power Bank. Métal. 650 mAh. Sortie USB. Entrée Micro USB. Entrée Noire. Câble Inclus.

Power Bank Touch-Screen Balpen. Metaal. 650 mAh. USB Output. Micro USB Input. Zwarte Inkt. Kabel Inclusief.

1.5 × 15.2 cm

Print Code: D(4), L1



Power Bank

650
mAh

02



Slatham

5200

Power Bank Selfie Stick. Aluminium/ Stainless Steel. 2200 mAh. USB Output. Micro USB Input. 3.5 mm Jack Socket. 7 Positions. Cable Included.

Power Bank Monopod. Aluminium/ Rostfreier Stahl. 2200 mAh. USB Ausgang. Micro USB Eingang. 3,5 mm Klinckenstecker. 7 Positionen. Kabel Inklusiv.

Trepied Power Bank. Aluminium/ Acier Inox. 2200 mAh. Sortie USB. Entrée Micro USB. Connexion Jack 3,5 mm. 7 Positions. Câble Inclus.

Power Bank Selfie Stick. Aluminium/ Roestvrij Staal. 2200 mAh. USB Output. Micro USB Input. 3,5 mm Jack Aansluiting. 7 Posities. Kabel Inclusief.

2.2 × 69 cm

Print Code: E(1), L1



50 / 25

2200
mAh

03



Power Bank



02



19



SUITABLE FOR ALL DEVICES

TECHNOLOGY



8000
mAh

Atazzi

4967

Power Bank Set. Power Bank 8000 mAh, 2 USB Outputs, Micro USB Input. Car Charger 2 USB Outputs 2100 mA. USB Charger 1000 mA. Cable Included.

Power Bank Set. Power Bank 8000 mAh, 2 USB Ausgänge, Micro USB Eingang. Autoladegerät 2 USB Ausgänge 2100 mA. USB Ladegerät 1000 mA. Kabel Inklusiv.

Set Power Bank. Power Bank 8000 mAh, 2 Sorties USB, Entrée Micro USB. Chargeur Voiture 2 Sorties USB 2100 mA. Chargeur USB 1000 mA. Cable Inclus.

Power Bank Set. Power Bank 8000 mAh, 2 USB Outputs, Micro USB Input. Auto Oplader 2 USB Outputs 2100 mA. USB Oplader 1000 mA. Kabel Inclusief.

17 × 5 × 8.5 cm

40 / 20

Print Code: E(4), W



77



2200
mAh

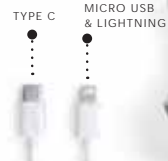

Tilmix

5967



Power Bank Set. Aluminium. Power Bank 2200 mAh. USB Output, Micro USB Input, USB Car Charger 2 USB Outputs 2100 mA 2 Functions. USB Charger 1000 mA. Cable Included Micro USB, Type C and Lightning Connection.

Power Bank Set. Aluminium. Power Bank 2200 mAh. USB Ausgang, Micro USB Input. USB Autoladegerät 2 USB Ausgänge 2100 mA 2 Funktionen. USB Ladegerät 1000 mA. Kabel inklusive Anschluss Micro USB, Typ C und Lightning.

Set Power Bank. Aluminium. Power Bank 2200 mAh. Sortie USB, Entrée Micro USB. Chargeur Voiture USB 2 Sorties USB 2100 mA 2 Fonctions. Chargeur USB 1000 mA. Cable Inclus Connexion Micro USB, Type C et Lightning.

Power Bank Set. Aluminium. Power Bank 2200 mAh. USB Output, Micro USB Input. USB Auto Oplader 2 USB Uitgangen 2100 mA 2 Functies. USB Oplader 1000 mA. Inclusief Kabel Micro USB, Type C en Lightning Connectie.

14 × 4 × 7.5 cm

100 / 50

Print Code: E(1), F(4), L2



GLASS BREAKER/
ROMPECRISTALES

TYPE C MICRO USB



Charger



Type-C Connection



Home / Office



Car



Dutian

5966

Power Bank Set. Power Bank 2000 mAh, USB Output, Micro USB Input. USB Chargers 1000 mA. Cable Included Micro USB, Type C and Lightning Connection.

Power Bank Set. Power Bank 2000 mAh, USB Ausgang, Micro USB Eingang, USB Ladegerät 1000 mA. Kabel Inklusive Anschluss Micro USB, Typ C und Lightning.

Set Power Bank. Power Bank 2000 mAh, Sortie USB, Entrée Micro USB. Chargeurs USB 1000 mA. Câble Inclus Connexion Micro USB, Type C et Lightning.

Power Bank Set. Power Bank 2000 mAh, USB Output, Micro USB Input. USB Chargers 1000 mA. Inclusief Kabel Micro USB, Type C en Lightning Connectie.

11.5 x 4 x 7.5 cm

100 / 50

Print Code: E(1), F(4)



2000 mAh



2600 mAh



Car



Micro USB Connection

Nacorap

5046

Power Bank Set. Power Bank 2600 mAh, USB Output, Micro USB Input. Car Charger 2 USB Outputs 2100 mA. Cable Included.

Power Bank Set. Power Bank 2600 mAh, USB Ausgang, Micro USB Eingang. Autoladegerät 2 USB Ausgänge 2100 mA. Kabel Inklusive.

Set Power Bank. Power Bank 2600 mAh, Sortie USB, Entrée Micro USB. Chargeur Voiture 2 Sorties USB 2100 mA. Câble Inclus.

Power Bank Set. Power Bank 2600 mAh, USB Output, Micro USB Input. Auto Oplader 2 USB Outputs 2100 mA. Kabel Inclusief.

11.5 x 4 x 7.5 cm

100 / 25

Print Code: E(1), F(4)



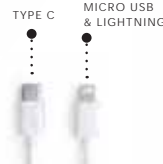

90CM



Sinkord 6090



USB Chargers Set. USB Charger 1000 mA. Cable Included Micro USB, Type C and Lightning Connection.
 USB Ladegerät Set. USB Ladegerät 1000 mA. Kabel Inklusive Anschluss Micro USB, Typ C und Lightning.
 Set Chargeurs USB. Chargeur USB 1000 mA. Cable Inclus Connexion Micro USB, Type C et Lightning.
 USB Opladers Set. USB Oplader 1000 mA. Inclusief Kabel Micro USB, Type C en Lightning Connectie.

11.5 x 3.5 x 8.5 cm 100 / 50
 Print Code: E(1), F(4)



Canox 4331

USB Chargers Set. 1000 mA.
 USB Ladegerät Set. 1000 mA.
 Set Chargeurs USB. 1000 mA.
 USB Opladers Set. 1000 mA.

8 x 4.2 x 6.3 cm
 Print Code: E(1), F(4)



200 / 50

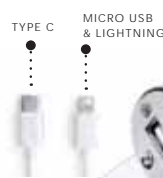

Luzzer 6091



USB Chargers Set. USB Chargers 1000 mA. Cable Included Micro USB, Type C and Lightning Connection.
 USB Ladegerät Set. USB Ladegerät 1000 mA. Kabel Inklusive Anschluss Micro USB, Typ C und Lightning.
 Set Chargeurs USB. Chargeurs USB 1000 mA. Cable Inclus Connexion Micro USB, Type C et Lightning.
 USB Opladers Set. USB Opladers 1000 mA. Inclusief Kabel Micro USB, Type C en Lightning Connectie.

9.3 x 4.2 x 9.3 cm 100 / 50
 Print Code: E(1), F(4)



Drimon
6177

Charger. Aluminium. Micro USB, Type C and Lightning Connection.
Ladegerät. Aluminium. Anschluss Micro USB, Typ C und Lightning.
Chargeur. Aluminium. Connexion Micro USB, Type C et Lightning.
Oplader. Aluminium. Micro USB, Type C en Lightning Connectie.

Ø 4.7 × 10.3 cm
Print Code: E(1), L1, F(1)

TYPE C

MICRO USB & LIGHTNING

100CM



03

02

09

19



Ketul
5957

Charger. Micro USB, Type C and Lightning Connection.
Ladegerät. Anschluss Micro USB, Typ C und Lightning.
Chargeur. Connexion Micro USB, Type C et Lightning.
Oplader. Micro USB, Type C en Lightning Connectie.

6.5 × 5.9 × 2.8 cm
Print Code: E(1), W



MICRO USB & LIGHTNING

03

01

02

19



19

09

02

Scolt
6089



Keyring Charger. Aluminium. Micro USB, Type C and Lightning Connection.
Schlüsselanhänger Ladegerät. Aluminium. Anschluss Micro USB, Typ C und Lightning.
Chargeur Porte-Clés. Aluminium. Connexion Micro USB, Type C et Lightning.
Sleutelhanger Oplader. Aluminium. Micro USB, Type C en Lightning Connectie.

2.2 × 17 × 0.8 cm
Print Code: D(1), L1



03

MICRO USB & LIGHTNING



19

SUITABLE FOR PAD PRINTING /
VÁLIDO PARA TAMPOGRAFÍA



TYPE C
MICRO USB & LIGHTNING

09

03

02

04

Zaref
5956

Keyring Charger. Led Lights. Micro USB, Type C and Lightning Connection.
Schlüsselanhänger Ladegerät. Led Lichter. Anschluss Micro USB, Typ C und Lightning.
Chargeur Porte-Clés. Lumières Led. Connexion Micro USB, Type C et Lightning.
Sleutelhanger Oplader. Led Lichten. Micro USB, Type C en Lightning Connectie.

1.4 × 13 × 1.4 cm
Print Code: D(4), L1

**SPECIAL
LASER ENGRAVING
WHITE LIGHT LOGO**



This keychain charger with illuminated interior has an external coating especially designed for laser engraving, with which you will see your advertising or brand illuminated with white light. Ideal for pad printing too.

Este cargador llavero con interior iluminado tiene un recubrimiento exterior especialmente diseñado para grabado láser, con el que conseguirá que su publicidad o marca quede originalmente iluminada con luz blanca. Ideal para tamponografía también.



SUITABLE FOR ALL DEVICES

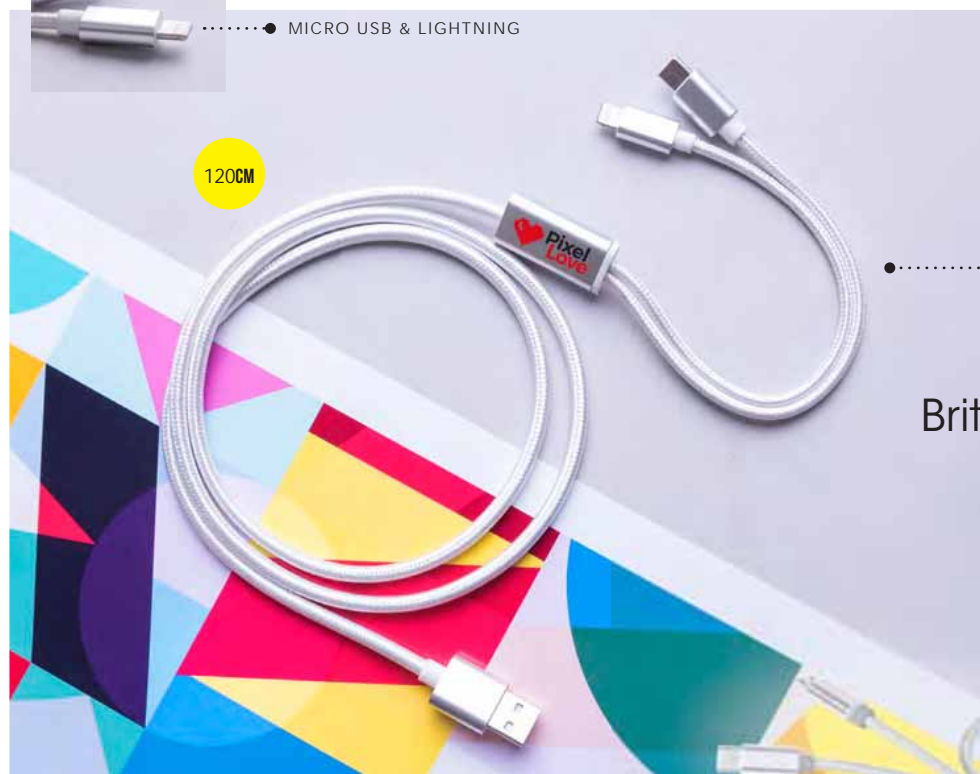

120CM



Britian
5786

Charger. Aluminium. Micro USB, Type C and Lightning Connection.
Ladegerät. Aluminium. Anschluss Micro USB, Typ C und Lightning.
Chargeur. Aluminium. Connexion Micro USB, Type C et Lightning.
Oplader. Aluminium. Micro USB, Type C en Lightning Connectie.

120 x 1.8 x 0.8 cm 200 / 50
Print Code: D(1), L1

81



TYPE C ● MICRO USB & LIGHTNING



TYPE C ●

MICRO USB & LIGHTNING ● MICRO USB

EXTENDABLE / EXTENSIBLE

Vital
5843



Charger. Micro USB, Type C and Lightning Connection.
Ladegerät. Anschluss Micro USB, Typ C und Lightning.
Chargeur. Connexion Micro USB, Type C et Lightning.
Oplader. Micro USB, Type C en Lightning Connectie.

21 x 1.5 x 0.8 cm 400 / 200
Print Code: D(1)

Mirlox
5803



Keyring Charger. Micro USB, Type C and Lightning Connection.
Schlüsselanhänger Ladegerät. Anschluss Micro USB, Typ C und Lightning.
Chargeur Porte-Clefs. Connexion Micro USB, Type C et Lightning.
Sleutelhanger Oplader. Micro USB, Type C en Lightning Connectie.

3.1 x 14 x 1.5 cm 500 / 50
Print Code: D(4)

Sanseg
6888

EXTENDABLE / EXTENSIBLE

Charger. Aluminium/ ABS. Micro USB, Type C and Lightning Connection. Extendable Cable.
Ladegerät. Aluminium/ ABS. Anschluss Micro USB, Typ C und Lightning. Ausziehbar Kabel.
Chargeur. Aluminium/ ABS. Connexion Micro USB, Type C et Lightning. Câble Extensible.
Oplader. Aluminium/ ABS. Micro USB, Type C en Lightning Connectie. Verlengbare Kabel.

100 x 4.1 x 2.1 cm 300 / 100
Print Code: D(4), L1, V



LANYARD



LANYARD

Glusol

6145

Lanyard Charger. Polyester. Micro USB, Type C and Lightning Connection.
 Schlüsselband Ladegerät. Polyester. Anschluss Micro USB, Typ C und Lightning.
 Chargeur Lanyard. Polyester. Connexion Micro USB, Type C et Lightning.
 Lanyard Oplader. Polyester. Micro USB, Type C en Lightning Connectie.

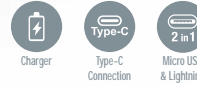

3.2 × 52 cm
 Print Code: D(4), F(1)

500 / 50

TYPE C
 MICRO USB & LIGHTNING

Doffer

5785

Charger Synchronizer. Type C Connection.
 Ladegerät Sincro. Anschluss Typ C.
 Chargeur Synchroniseur. Connexion Type C.
 Oplader Synchronizer. Type C Connectie.

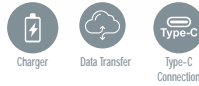

1.5 × 43.5 × 1.1 cm
 500 / 50
 Print Code: C(1)



01



MICRO USB INPUT

02



Litor

5765

Adapter. Type C Connection.
 Adapter. Anschluss Typ C.
 Adaptateur. Connexion Type C.
 Adapter. Type C Connectie.

1 × 2.4 × 0.5 cm
 5000 / 1000
 Print Code: C(4)

Dorip

5961

Charger. Micro USB, Type C and Lightning Connection.
 Ladegerät. Anschluss Micro USB, Typ C und Lightning.
 Chargeur. Connexion Micro USB, Type C et Lightning.
 Oplader. Micro USB, Type C en Lightning Connectie.



8.5 × 8.5 × 1.3 cm
 200 / 50
 Print Code: D(4)





MICRO USB & LIGHTNING

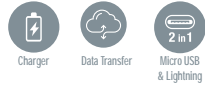

01 02 19



MAGNET



MICRO USB & LIGHTNING

Holnier

5741

Charger Synchronizer. Micro USB and Lightning Connection.
Ladegerät Sincro. Anschluss Micro USB und Lightning.
Chargeur Synchroniseur. Connexion Micro USB et Lightning.
Oplader Synchronizer. Micro USB Connectie en Lightning.

1.3 x 5.3 x 1.1 cm 500 / 250
Print Code: C(4)

Hedul

5969

Charger Synchronizer. Micro USB, Type C and Lightning Connection.
Ladegerät Sincro. Anschluss Micro USB, Typ C und Lightning.
Chargeur Synchroniseur. Connexion Micro USB, Type C et Lightning.
Oplader Synchronizer. Micro USB, Type C en Lightning Connectie.

1.2 x 6.7 x 1 cm 500 / 250
Print Code: C(4)



01 03 05 04 19



TYPE C



02

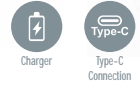

02

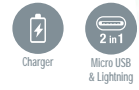

01

MICRO USB & LIGHTNING



Ceyban

6088

Bracelet Charger. Aluminium/ TPE. Type C Connection.
Armband Ladegerät. Aluminium/ TPE. Anschluss Typ C.
Chargeur Bracelet. Aluminium/ TPE. Connexion Type C.
Armband Oplader. Aluminium/ TPE. Type C Connectie.

22 x 1.2 x 0.8 cm 300 / 50
Print Code: L1

Leriam

6087

Bracelet Charger. Aluminium/ TPE. Micro USB and Lightning Connection.
Armband Ladegerät. Aluminium/ TPE. Anschluss Micro USB und Lightning.
Chargeur Bracelet. Aluminium/ TPE. Connexion Micro USB et Lightning.
Armband Oplader. Aluminium/ TPE. Micro USB Connectie en Lightning.

22 x 1.2 x 0.8 cm 300 / 50
Print Code: L1

SPECIAL LASER ENGRAVING WHITE LIGHT LOGO



These items with illuminated interior have an external coating specially designed for laser engraving, with which you will see your advertising or brand illuminated with white light. Ideal for pad printing too.

Estos artículos con interior iluminado tienen un recubrimiento exterior especialmente diseñado para grabado láser, con el que conseguirá que su publicidad o marca quede originalmente iluminada con luz blanca. Ideal para tampografía también.

84

4000
mAh



Kustol

6271

Power Bank. Led Lights. 4000 mAh. USB Output. Micro USB Input. Cable Included.
Power Bank. Led Lichter. 4000 mAh. USB Ausgang. Micro USB Eingang. Kabel Inklusive.
Power Bank. Lumières Led. 4000 mAh. Sortie USB. Entrée Micro USB. Câble Inclus.
Power Bank. Led Lichten. 4000 mAh. USB Output. Micro USB Input. Kabel Inclusief.

6.7 × 11.4 × 1 cm

100 / 50

Print Code: E(4), L2, W



2500
mAh



Simmon

6149

Power Bank. Led Lights. 2500 mAh. USB Output. Micro USB Input. Cable Included.
Power Bank. Led Lichter. 2500 mAh. USB Ausgang. Micro USB Eingang. Kabel Inklusive.
Power Bank. Lumières Led. 2500 mAh. Sortie USB. Entrée Micro USB. Câble Inclus.
Power Bank. Led Lichten. 2500 mAh. USB Output. Micro USB Input. Kabel Inclusief.

6.2 × 12.3 × 0.9 cm

100 / 50

Print Code: E(4), L2, W



Wireless
Charger



Wireless
Charger

Brizem

6130

Charger. Led Lights. Wireless. Cable Included.
Ladegerät. Led Lichter. Drahtlos. Kabel Inklusive.
Chargeur. Lumières Led. Sans Fil. Câble Inclus.
Oplader. Led Lichten. Draadloos. Kabel Inclusief.

10 × 0.7 cm

100 / 50

Print Code: E(4), L2, W

Keilmit

6142

Charger. Led Lights. Wireless. Cable Included.
Ladegerät. Led Lichter. Drahtlos. Kabel Inklusive.
Chargeur. Lumières Led. Sans Fil. Câble Inclus.
Oplader. Led Lichten. Draadloos. Kabel Inclusief.

15.5 × 1 × 6.1 cm

100 / 25

Print Code: E(4), L2, W



SPECIAL LASER ENGRAVING WHITE LIGHT LOGO



These items with illuminated interior have an external coating specially designed for laser engraving, with which you will see your advertising or brand illuminated with white light. Ideal for pad printing too.

Estos artículos con interior iluminado tienen un recubrimiento exterior especialmente diseñado para grabado láser, con el que conseguirá que su publicidad o marca quede originalmente iluminada con luz blanca. Ideal para tampografía también.

Bluetooth®



02



03

19

02



Viancos

5775

Speaker, Led Lights, Bluetooth Connection, Power 3W, USB Rechargeable, Cable Included.

Lautsprecher, Led Lichter, Bluetooth Anschluss, Power 3W, USB Wiederaufladbar, Kabel Inklusiv.

Haut-Parleurs, Lumières Led, Connexion Bluetooth, Puissance 3W, Rechargeable USB, Cable Inclus.

Luidspreker, Led Lichtten, Bluetooth Verbinding, Vermogen 3W, USB Oplaadbaar, Kabel Inclusief.

Ø 6.2 × 5.1 cm

50

Print Code: F(4), L1



Lunem

6132

Speaker, Led Lights, Bluetooth Connection, Power 3W, USB Rechargeable, Cable Included.

Lautsprecher, Led Lichter, Bluetooth Anschluss, Power 3W, USB Wiederaufladbar, Kabel Inklusiv.

Haut-Parleurs, Lumières Led, Connexion Bluetooth, Puissance 3W, Rechargeable USB, Cable Inclus.

Luidspreker, Led Lichtten, Bluetooth Verbinding, Vermogen 3W, USB Oplaadbaar, Kabel Inclusief.

5.9 × 7.2 × 5.9 cm

50

Print Code: F(4), L1, W



Zucker

6176

Speaker Keyring, Led Lights, Bluetooth Connection, Power 1W, USB Rechargeable, Cable Included.

Lautsprecher Schlüsselanhänger, Led Lichter, Bluetooth Anschluss, Power 1W, USB Wiederaufladbar, Kabel Inklusiv.

Haut-Parleurs Porte-Clefs, Lumières Led, Connexion Bluetooth, Puissance 1W, Rechargeable USB, Cable Inclus.

Luidspreker Sleutelhanger, Led Lichtten, Bluetooth Verbinding, Vermogen 1W, USB Oplaadbaar, Kabel Inclusief.

4 × 4.6 × 2.1 cm

400 / 50

Print Code: D(4), L1

SPECIAL LASER ENGRAVING WHITE LIGHT LOGO



These items with illuminated interior have an external coating specially designed for laser engraving, with which you will see your advertising or brand illuminated with white light. Ideal for pad printing too.

Estos artículos con interior iluminado tienen un recubrimiento exterior especialmente diseñado para grabado láser, con el que conseguirá que su publicidad o marca quede originalmente iluminada con luz blanca. Ideal para tampografía también.



Delawer

5993

USB Hub. Led Lights. 3 Hubs. USB 2.0.

USB Hub. Led Lichter. 3 Hubs. USB 2.0.

Port USB. Lumières Led. 3 Ports. USB 2.0.

USB Hub. Led Lichten. 3 Poorten. USB 2.0.

7.6 × 3.4 × 6 cm

200 / 50

Print Code: D(1), L1

86



Novuk 16GB

6234 16GB

USB Memory. Led Lights. Individual Presentation.
USB Speicher. Led Lichter. Individuelle Präsentation.
Clé USB. Lumières Led. Présentation Individuelle.
USB Memory. Led Lichten. Individuelle Presentatie.

3.7 × 5.9 × 0.9 cm

500 / 50

Print Code: D(4), L1



Ronal 16GB

6235 16GB

USB Memory. Led Lights. Individual Presentation.
USB Speicher. Led Lichter. Individuelle Präsentation.
Clé USB. Lumières Led. Présentation Individuelle.
USB Memory. Led Lichten. Individuelle Presentatie.

3 × 5.2 × 0.8 cm

300 / 50

Print Code: D(4), L1



Daclon 16GB

6243 16GB

USB Memory. Led Lights. Individual Presentation.
USB Speicher. Led Lichter. Individuelle Präsentation.
Clé USB. Lumières Led. Présentation Individuelle.
USB Memory. Led Lichten. Individuelle Presentatie.

2.2 × 6.2 × 1.3 cm

300 / 50

Print Code: D(4), L1



SPECIAL LASER ENGRAVING WHITE LIGHT LOGO



These items with illuminated interior have an external coating specially designed for laser engraving, with which you will get your advertising or brand originally illuminated with white light. Ideal for pad printing too.

Estos artículos con interior iluminado tienen un recubrimiento exterior especialmente diseñado para grabado láser, con el que conseguirá que su publicidad o marca quede originalmente iluminada con luz blanca. Ideal para tampografía también.

Weston

WIRELESS

4000
mAh64 Sheets
Lined

Power Bank

Wireless
Charger

Weston

6184

Power Bank Notepad. Polyester 300D. Led Lights. Wireless. 4000 mAh. 64 Sheets Notepad. USB Output. Micro USB Input. Cable Included.
Power Bank Notizblock. Polyester 300D. Led Lichter. Drahtlos. 4000 mAh. 64 Seiten Notizblock. USB Ausgang. Micro USB Eingang. Kabel Inklusiv.
Bloc Notes Power Bank. Polyester 300D. Lumières Led. Sans Fil. 4000 mAh. Bloc 64 Feuilles. Sortie USB. Entrée Micro USB. Câble Inclus.
Power Bank Notizblockje. Polyester 300D. Led Lichten. Draadloos. 4000 mAh. 64 Blaadjes Notepad. USB Output. Micro USB Input. Kabel Inclusief.

18 × 22.5 × 2.5 cm

20

Print Code: G(1), N(8), L2



WIRELESS

4000
mAh20 Sheets
Lined

Power Bank

Wireless
Charger

Drayton

6183

Power Bank Folder. Polyester 300D. Led Lights. Wireless. 4000 mAh. 20 Sheets Notepad. USB Output. Micro USB Input. Cable Included.
Power Bank Mappe. Polyester 300D. Led Lichter. Drahtlos. 4000 mAh. 20 Seiten Notizblock. USB Ausgang. Micro USB Eingang. Kabel Inklusiv.
Porte-Documents Power Bank. Polyester 300D. Lumières Led. Sans Fil. 4000 mAh. Bloc 20 Feuilles. Sortie USB. Entrée Micro USB. Câble Inclus.
Power Bank Map. Polyester 300D. Led Lichten. Draadloos. 4000 mAh. 20 Blaadjes Notepad. USB Output. Micro USB Input. Kabel Inclusief.

23.5 × 31 × 2.5 cm

10

Print Code: G(1), N(8), L2



Corden

5973

Stylus Touch Ball Pen. Led Lights. Button Batteries Included.
Kugelschreiber Pointer. Led Lichten. Knopfzellen Inklusiv.
Stylét Bille. Lumières Led. Piles Bouton Inclus.
Touch-Screen Balpen. Led Lichten. Knoopecel Batterijen Inclusief.

Ø 1.3 x 14.2 cm

1000 / 50

Print Code: B(4), L1



ABSOLUTE LASER ENGRAVING COLOUR LIGHT LOGO



This pen with illuminated interior with colored LEDs has a coating especially designed for laser engraving, with which you will see your advertising or brand lit with colour light to match the touch ball of the pen.

Este bolígrafo con interior iluminado con ledes de colores tiene un recubrimiento especialmente diseñado para grabado láser, con el que conseguirá que su publicidad o marca quede originalmente iluminada con luz de color a juego con el puntero de su



88



Petrok

5994

Holder. Led Lights. Button Batteries Included.
Halter. Led Lichten. Knopfzellen Inklusiv.
Support. Lumières Led. Piles Bouton Inclus.
Holder. Led Lichten. Knoopecel Batterijen Inclusief.

8 x 3.7 x 7.9 cm

200 / 50

Print Code: D(1), L1

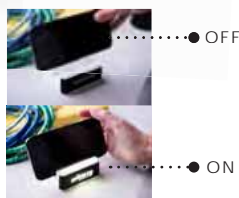

SPECIAL LASER ENGRAVING WHITE LIGHT LOGO



These items with illuminated interior have an external coating specially designed for laser engraving, with which you will see your advertising or brand illuminated with white light. Ideal for pad printing too.

Estos artículos con interior iluminado tienen un recubrimiento exterior especialmente diseñado para grabado láser, con el que conseguirá que su publicidad o marca quede iluminada con luz blanca. Ideal para tampografía también.



Heban

5807

Stylus Touch Ball Pen. Led Lights. Button Batteries Included.
Kugelschreiber Pointer. Led Lichten. Knopfzellen Inklusiv.
Stylét Bille. Lumières Led. Piles Bouton Inclus.
Touch-Screen Balpen. Led Lichten. Knoopecel Batterijen Inclusief.

Ø 1.3 x 13.8 cm

1000 / 50

Print Code: B(4), L1



SUITABLE FOR PAD PRINTING /
VÁLIDO PARA TAMPOGRAFÍA



Derstak

6190

Torch. 1 Led. Button Batteries Included.
Lampe. 1 Led. Knopfzellen Inklusiv.
Lampe. 1 Led. Piles Bouton Inclus.
Zaklamp. 1 Led. Knoopcel Batterijen Inclusief.

Ø 1.8 x 6.6 cm 300 / 50
Print Code: D(4), L1

LASER ENGRAVING WHITE LIGHT LOGO



These items with illuminated interior have an external coating specially designed for laser engraving, with which you will see your advertising or brand illuminated with white light. Ideal for pad printing too.

Estos artículos con interior iluminado tienen un recubrimiento exterior especialmente diseñado para grabado láser, con el que conseguirá que su publicidad o marca quede originalmente iluminada con luz blanca. Ideal para tampografía también.



SUITABLE FOR PAD PRINTING /
VÁLIDO PARA TAMPOGRAFÍA

TYPE C MICRO USB & LIGHTNING

09 03 02 04

03 04 09 19

02

Zaref

5956

Keyring Charger. Led Lights. Micro USB, Type C and Lightning Connection.
Schlüsselanhänger Ladegerät. Led Lichter. Anschluss Micro USB, Typ C und Lightning.
Chargeur Porte-Clés. Lumières Led. Connexion Micro USB, Type C et Lightning.
Sleutelhanger Oplader. Led Lichten. Micro USB, Type C en Lightning Connectie.

1.4 x 13 x 1.4 cm 500 / 100
Print Code: D(4), L1



Bimox

5834

Torch. 1 Led. Button Batteries Included.
Lampe. 1 Led. Knopfzellen Inklusiv.
Lampe. 1 Led. Piles Bouton Inclus.
Zaklamp. 1 Led. Knoopcel Batterijen Inclusief.

Ø 1.4 x 8.5 cm 500 / 50
Print Code: C(4), L1



MICRO USB & LIGHTNING

TYPE C



Gatil

6303

Charger. Led Lights. Micro USB, Type C and Lightning Connection.
Ladegerät. Led Lichter. Anschluss Micro USB, Typ C und Lightning.
Chargeur. Lumières Led. Connexion Micro USB, Type C et Lightning.
Oplader. Led Lichten. Micro USB, Type C en Lightning Connectie.

2.5 x 7.2 x 1.1 cm 500 / 100
Print Code: D(4), L1

WHEAT STRAW



Kontix 16GB

6470 16GB
 USB Memory. Wheat Straw/ ABS. Individual Presentation.
 USB Speicher. Weizenstroh/ ABS. Individuelle Präsentation.
 Clé USB. Paille de Blé/ ABS. Présentation Individuelle.
 USB Memory. Tarwestro/ ABS. Individuelle Präsentation.

1.7 × 5.9 × 0.9 cm 500 / 50
 Print Code: D(4), W

Glyner 16GB

6559 16GB
 USB Memory. Wheat Straw/ ABS. Individual Presentation.
 USB Speicher. Weizenstroh/ ABS. Individuelle Präsentation.
 Clé USB. Paille de Blé/ ABS. Présentation Individuelle.
 USB Memory. Tarwestro/ ABS. Individuelle Präsentation.

5.2 × 8.3 × 0.3 cm 500 / 50
 Print Code: D(4), W



Mozil 16GB

6633 16GB
 USB Memory. Wheat Straw/ ABS. Individual Presentation.
 USB Speicher. Weizenstroh/ ABS. Individuelle Präsentation.
 Clé USB. Paille de Blé/ ABS. Présentation Individuelle.
 USB Memory. Tarwestro/ ABS. Individuelle Präsentation.

1.9 × 5.7 × 0.9 cm 500 / 50
 Print Code: D(4), L1

90

BAMBOO



Zilda 16GB

6445 16GB
 USB Memory. Bamboo. Individual Presentation.
 USB Speicher. Bambus. Individuelle Präsentation.
 Clé USB. Bamboo. Présentation Individuelle.
 USB Memory. Bamboe. Individuelle Präsentation.

5.4 × 9 × 0.5 cm 500 / 50
 Print Code: D(4), W



Haidam 16GB

6125 16GB
 USB Memory. Bamboo. Individual Presentation.
 USB Speicher. Bambus. Individuelle Präsentation.
 Clé USB. Bamboo. Présentation Individuelle.
 USB Memory. Bamboe. Individuelle Präsentation.



Cetrex 16GB

6229 16GB
 USB Memory. Bamboo. Individual Presentation.
 USB Speicher. Bambus. Individuelle Präsentation.
 Clé USB. Bamboo. Présentation Individuelle.
 USB Memory. Bamboe. Individuelle Präsentation.

2 × 5.8 × 1 cm 300 / 50
 Print Code: D(4), L1

CORK & RECYCLED CARDBOARD

PERMANENT STOCK



Domar 16GB

6560 16GB

USB Memory. Natural Cork/ Glass. Individual Presentation.
USB Speicher. Naturkork/ Glas. Individuelle Präsentation.
Clé USB. Bouchon Naturel/ Verre. Présentation Individuelle.
USB Memory. Natuurlijk Kurk/ Glas. Individuele Presentatie.

Ø 2.9 × 5.7 cm

300 / 50

Print Code: F(1), L1



Nosux 16GB

6561 16GB

USB Memory. Recycled Cardboard/ Natural Cork. Individual Presentation.
USB Speicher. Recycling Pappe/ Naturkork. Individuelle Präsentation.
Clé USB. Carton Recyclé/ Bouchon Naturel. Présentation Individuelle.
USB Memory. Gerecycled Karton/ Natuurlijk Kurk. Individuele Presentatie.

2.9 × 7 × 0.5 cm

500 / 50

Print Code: D(4), L1, W

Trugel 16GB

6228 16GB

USB Memory. Recycled Cardboard. Individual Presentation.
USB Speicher. Recycling Pappe. Individuelle Präsentation.
Clé USB. Carton Recyclé. Présentation Individuelle.
USB Memory. Gerecycled Karton. Individuele Presentatie.

2 × 5.8 × 1 cm

300 / 50

Print Code: D(4), L1

Eku 16GB

6124 16GB

USB Memory. Recycled Cardboard. Individual Presentation.
USB Speicher. Recycling Pappe. Individuelle Präsentation.
Clé USB. Carton Recyclé. Présentation Individuelle.
USB Memory. Gerecycled Karton. Individuele Presentatie.

Ø 1.8 × 6.7 cm

200 / 50

Print Code: D(4), W

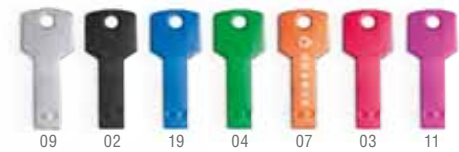

Fixing 16GB

5846 16GB

USB Memory. Aluminium. Individual Presentation.
 USB Speicher. Aluminium. Individuelle Präsentation.
 Clé USB. Aluminium. Présentation Individuelle.
 USB Memory. Aluminium. Individuelle Presentatie.

2.4 × 5.7 × 0.3 cm 200

Print Code: D(4), L1



8GB Sokian

5756 8GB
 16GB
 5850 16GB

USB Memory. Individual Presentation.
 USB Speicher. Individuelle Präsentation.
 Clé USB. Présentation Individuelle.
 USB Memory. Individuelle Presentatie.

1.5 × 4.2 × 0.6 cm 1000 / 100

Print Code: L1



Laval 16GB

6242 16GB

USB Memory. Individual Presentation.
 USB Speicher. Individuelle Präsentation.
 Clé USB. Présentation Individuelle.
 USB Memory. Individuelle Presentatie.

2 × 5.8 × 1 cm 500 / 50

Print Code: L1, V



Sondy 16GB

5848 16GB

USB Memory. Individual Presentation.
 USB Speicher. Individuelle Präsentation.
 Clé USB. Présentation Individuelle.
 USB Memory. Individuelle Presentatie.

5.2 × 8.3 × 0.3 cm 500 / 50

Print Code: D(4), W





19



04



11

Yemil 32GB

6052 32GB

USB Memory. Individual Presentation.
 USB Speicher. Individuelle Präsentation.
 Clé USB. Présentation Individuelle.
 USB Memory. Individuelle Presentatie.

2 × 5.8 × 1 cm

300 / 50

Print Code: D(4), L1



Rebik 16GB

5071 16GB

USB Memory. Individual Presentation.
 USB Speicher. Individuelle Präsentation.
 Clé USB. Présentation Individuelle.
 USB Memory. Individuelle Presentatie.

2 × 5.8 × 1 cm

300 / 50

Print Code: D(4), L1



Survet 16GB

6236 16GB

USB Memory. Individual Presentation.
 USB Speicher. Individuelle Präsentation.
 Clé USB. Présentation Individuelle.
 USB Memory. Individuelle Presentatie.

2 × 5.8 × 1 cm

300 / 50

Print Code: D(4), L1



SPECIAL
DIGITAL PRINTING



Milen 16GB

6233 16GB

USB Memory. Type C Connection. Individual Presentation.
USB Speicher. Anschluss Micro USB. Individuelle Präsentation.
Clé USB. Connexion Micro USB. Présentation Individuelle.
USB Memory. Micro USB Connectie. Individuele Presentatie.

14.2 x 8.4 x 0.5 cm

500 / 50

Print Code: D(4), W



94



100 Sheets
Lined



USB



03



19

01

04

02

Boltuk

6201

USB Notepad. Hard Cover. 100 Sheets. USB Memory 16GB Included.
USB Notizblock. Hardcover-Abdeckung. 100 Seiten. USB Speicher 16GB Inklusiv.
Bloc Notes USB. Couverture Rigide. 100 Feuilles. Clé USB 16GB Inclus.
USB Notitieblokje. Harde Kaft. 100 Blaadjes. USB Memory 16GB Inclusief.

14.2 x 21 x 1.5 cm

50

Print Code: F(2), T, U, W

Zilak 16GB

6232 16GB

USB Memory. Individual Presentation.
USB Speicher. Individuelle Präsentation.
Clé USB. Présentation Individuelle.
USB Memory. Individuele Presentatie.

2.2 x 5.6 x 0.9 cm

500 / 50

Print Code: D(4), W



01



07



02



19



04



05



11



03

Sivart 16GB

5849 16GB

USB Stylus Touch Ball Pen. Metal. Individual Presentation.
Kugelschreiber Pointer USB. Metall. Individuelle Präsentation.
Stylét Bille USB. Métal. Présentation Individuelle.
USB Touch-Screen Balpen. Metaal. Individuele Presentatie.

Ø 1.4 x 14 cm

100 / 20

Print Code: D(4), L1

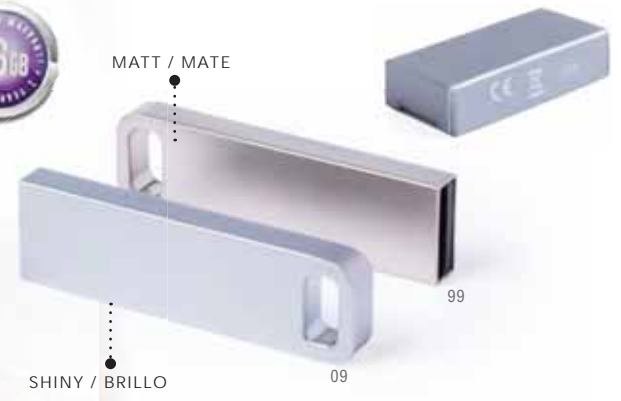

Ditop 16GB
5847 16GB

USB Memory. Metal. Individual Presentation.
 USB Speicher. Metall. Individuelle Präsentation.
 Clé USB. Métal. Présentation Individuelle.
 USB Memory. Metaal. Individuele Presentatie.

1.2 × 4.1 × 0.4 cm 1000 / 100
 Print Code: L1



Drelan 8GB
5761 8GB

USB Memory. Metal. Individual Presentation.
 USB Speicher. Metall. Individuelle Präsentation.
 Clé USB. Métal. Présentation Individuelle.
 USB Memory. Metaal. Individuele Presentatie.

3.9 × 6.1 × 0.4 cm 200 / 50
 Print Code: L1



Krom 16GB
6241 16GB

USB Memory. Metal. Individual Presentation.
 USB Speicher. Metall. Individuelle Präsentation.
 Clé USB. Métal. Présentation Individuelle.
 USB Memory. Metaal. Individuele Presentatie.

2 × 5.2 × 0.7 cm 200 / 50
 Print Code: L1



Blidek 16GB
6240 16GB

USB Memory. Metal. Individual Presentation.
 USB Speicher. Metall. Individuelle Präsentation.
 Clé USB. Métal. Présentation Individuelle.
 USB Memory. Metaal. Individuele Presentatie.

2.4 × 6.1 × 0.5 cm 200 / 50
 Print Code: L1



96



Sleut 16GB 8GB
6237 16GB 5757 8GB

USB Memory. Metal/ Acrylic. Led Lights. Individual Presentation.
USB Speicher. Metall/ Acryl. Led Lichter. Individuelle Präsentation.
Clé USB. Métal/ Acrylique. Lumières Led. Présentation Individuelle.
USB Memory. Metaal/ Acryl. Led Lichten. Individuele Presentatie.

📏 0.9 x 6.2 cm 📦 200 / 50
🖨️ Print Code: L1

Yeren 16GB
6239 16GB

USB Memory. Aluminium/ Acryl. Led Lights. Individual Presentation.
USB Speicher. Aluminium/ Acryl. Led Lichter. Individuelle Präsentation.
Clé USB. Aluminium/ Acrylique. Lumières Led. Présentation Individuelle.
USB Memory. Aluminium/ Acryl. Led Lichten. Individuele Presentatie.

📏 1.2 x 5.8 x 0.4 cm 📦 250 / 50
🖨️ Print Code: L1

Horioc 16GB
6238 16GB

USB Memory. Metal/ Acrylic. Led Lights. Individual Presentation.
USB Speicher. Metall/ Acryl. Led Lichter. Individuelle Präsentation.
Clé USB. Métal/ Acrylique. Lumières Led. Présentation Individuelle.
USB Memory. Metaal/ Acryl. Led Lichten. Individuele Presentatie.

📏 1.5 x 5.5 x 0.9 cm 📦 250 / 50
🖨️ Print Code: L1

PERMANENT STOCK

ACRYLIC / ACRÍLICO

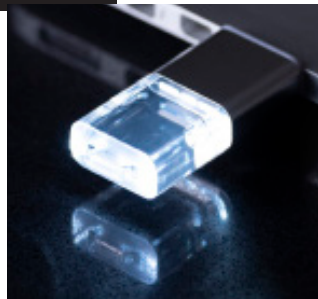
**SPECIAL
WHITE LIGHT LOGO****Hernak 16GB**

6231 16GB

USB Memory. Metal/ Acrylic. Led Lights. Individual Presentation.
 USB Speicher. Metall/ Acryl. Led Lichter. Individuelle Präsentation.
 Clé USB. Métal/ Acrylique. Lumières Led. Présentation Individuelle.
 USB Memory. Metaal/ Acryl. Led Lichten. Individuele Presentatie.

2.2 × 5.3 × 0.6 cm

250 / 50

Print Code: L1

Rantix 16GB

6230 16GB

USB Memory. Aluminium/ Acrylic. Led Lights. Individual Presentation.
 USB Speicher. Aluminium/ Acryl. Led Lichter. Individuelle Präsentation.
 Clé USB. Aluminium/ Acrylique. Lumières Led. Présentation Individuelle.
 USB Memory. Aluminium/ Acryl. Led Lichten. Individuele Presentatie.

2.1 × 5.5 × 1 cm

250 / 50

Print Code: L1

**SPECIAL
LASER ENGRAVING
WHITE LIGHT LOGO**

These items with illuminated interior have an external coating specially designed for laser engraving, with which you will get your advertising or brand originally illuminated with white light. Ideal for pad printing too.

Estos artículos con interior iluminado tienen un recubrimiento exterior especialmente diseñado para grabado láser, con el que conseguiremos que su publicidad o marca quede originalmente iluminada con luz blanca. Ideal para tampografía también.

**Novuk 16GB**

6234 16GB

USB Memory. Led Lights. Individual Presentation.
 USB Speicher. Led Lichter. Individuelle Präsentation.
 Clé USB. Lumières Led. Présentation Individuelle.
 USB Memory. Led Lichten. Individuele Presentatie.

3.7 × 5.9 × 0.9 cm

500 / 50

Print Code: D(4), L1

Ronal 16GB

6235 16GB

USB Memory. Led Lights. Individual Presentation.
 USB Speicher. Led Lichter. Individuelle Präsentation.
 Clé USB. Lumières Led. Présentation Individuelle.
 USB Memory. Led Lichten. Individuele Presentatie.

3 × 5.2 × 0.8 cm

300 / 50

Print Code: D(4), L1

Daclon 16GB

6243 16GB

USB Memory. Led Lights. Individual Presentation.
 USB Speicher. Led Lichter. Individuelle Präsentation.
 Clé USB. Lumières Led. Présentation Individuelle.
 USB Memory. Led Lichten. Individuele Presentatie.

2.2 × 6.2 × 1.3 cm

300 / 50

Print Code: D(4), L1

CONSULTE NUESTRA TARIFA SEMANAL USB

CHECK OUR USB WEEKLY PRICE LIST

CANTIDAD MÍNIMA: 100 PCS / MINIMUM QUANTITY: 100 PCS

USB IMPORT

LOS MEJORES PRECIOS

THE BEST PRICES



ENTREGA EXPRESS / EXPRESS DELIVERY

INCLUIDA IMPRESIÓN A 2 COLORES O LÁSER 1 POSICIÓN
2 COLOR PRINTING INCLUDED OR LASER POSITION

GUARANTEED QUALITY

4GB 8GB 16GB 32GB

CHIPS: SAMSUNG - TOSHIBA - INTEL

*Te lo hacemos fácil!!
we make it easier!!!*

98



COTIZADOR
USB IMPORT

- ✓ OTG
- ✓ VERSION 3.0
- ✓ MODELS TYPE C
- ✓ MODELOS PERSONALIZADOS 2D Y 3D
CUSTOM MODELS 2D AND 3D

*Your Design
no limits*





THE TRANQUILITY
OF ALWAYS FINDING
WHAT YOU NEED

LA TRANQUILIDAD
DE ENCONTRAR SIEMPRE
LO QUE NECESITAS

asiaexpress

TAILOR MADE PROMOTIONAL SOLUTIONS - SOLUCIONES PROMOCIONALES A MEDIDA

QUOTATIONS: 24/48 h. PRESUPUESTOS: 24/48 h.

- ✓ REDUCED MINIMUM QUANTITIES - CANTIDADES MÍNIMAS REDUCIDAS
- ✓ GUARANTEED DELIVERY TIME - GARANTÍA DE PLAZOS
- ✓ COMPETITIVE PRICES - PRECIOS COMPETITIVOS





Kuler

5962
 USB Hub. 3 Hubs. USB 2.0.
 USB Hub. 3 Hubs. USB 2.0.
 Port USB. 3 Ports. USB 2.0.
 USB Hub. 3 Poorten. USB 2.0.

Print Code: D(4), W
 7 x 7 x 1,3 cm
 200 / 50



Yurian

5802
 USB Hub. 3 Hubs. USB 2.0. Charger and Synchronizer Cable. Micro USB, Type C and Lightning Connection.
 USB Hub. 3 Hubs. USB 2.0. Kabel Ladegerät und Sincro. Anschluss Micro USB, Typ C und Lightning.
 Port USB. 3 Ports. USB 2.0. Cable Chargeur et Synchroniseur. Connexion Micro USB, Type C et Lightning.
 USB Hub. 3 Poorten. USB 2.0. Kabel Charger en Synchronizer. Micro USB, Type C en Lightning Connectie.

Print Code: D(4), W
 4,5 x 5,9 x 1 cm
 500 / 50



Ticaro

4858
 USB Hub Lamp. 5 Leds. Flexible. 4 Hubs. USB 2.0.
 USB Hub Lampe. 5 Leds. Flexibel. 4 Hubs. USB 2.0.
 Lampe Port USB. 5 Leds. Flexible. 4 Ports. USB 2.0.
 USB Hub Lamp. 5 Leds. Flexibel. 4 Poorten. USB 2.0.

Print Code: D(1)
 4,5 x 14,4 x 1,6 cm
 400 / 50





Belind

5964

USB Hub Pencil Holder. Led Lights. 2 Light Modes. 4 Hubs. USB 2.0.
 USB Hub Stifthalter. Led Lichter. 2 Leuchtfunktionen. 4 Hubs. USB 2.0.
 Porte-Crayons Port USB. Lumières Led. 2 Modes de Lumière. 4 Ports. USB 2.0.
 USB Hub Pennenbakje. Led Lichten. 2 Licht Posities. 4 Poorten. USB 2.0.

7 × 8 × 7 cm

100 / 50

Print Code: D(4)



USB 2.0



Niyel

5199

USB Hub. 4 Hubs. USB 2.0.
 USB Hub. 4 Hubs. USB 2.0.
 Port USB. 4 Ports. USB 2.0.
 USB Hub. 4 Poorten. USB 2.0.

Ø 5.2 × 1.8 cm

200 / 50

Print Code: D(4), W



Weeper

5201

USB Hub Aluminium. 4 Hubs. USB 2.0.
 USB Hub Aluminium. 4 Hubs. USB 2.0.
 Port USB. Aluminium. 4 Ports. USB 2.0.
 USB Hub Aluminium. 4 Poorten. USB 2.0.

8.9 × 2.1 × 3.7 cm

200 / 50

Print Code: D(4), L1





Steppek

5395

Earphones. Bluetooth Connection. USB Rechargeable. Cable Included.
Kopfhörer. Bluetooth Anschluss. USB Wiederaufladbar. Kabel Inklusiv.
Écouteurs. Connexion Bluetooth. Rechargeable USB. Câble Inclus.
Oordopjes. Bluetooth Verbinding. USB Oplaadbaar. Kabel Inclusief.



5 × 7 × 3 cm

200 / 50

Print Code: E(1), F(4)



Mayun

5337

Earphones. Bluetooth Connection. USB Rechargeable. Cable Included.
Kopfhörer. Bluetooth Anschluss. USB Wiederaufladbar. Kabel Inklusiv.
Écouteurs. Connexion Bluetooth. Rechargeable USB. Câble Inclus.
Oordopjes. Bluetooth Verbinding. USB Oplaadbaar. Kabel Inclusief.



7.5 × 13.6 × 3 cm

100 / 50

Print Code: E(4)



Seida

5070

Earphones. Bluetooth Connection. USB Rechargeable. Cable Included.
Kopfhörer. Bluetooth Anschluss. USB Wiederaufladbar. Kabel Inklusiv.
Écouteurs. Connexion Bluetooth. Rechargeable USB. Câble Inclus.
Oordopjes. Bluetooth Verbinding. USB Oplaadbaar. Kabel Inclusief.

8.8 × 18.3 × 3.7 cm

100 / 50

Print Code: E(1)



Tekren

5944

Earphones. Bluetooth Connection. USB Rechargeable. Cable Included.
Kopfhörer. Bluetooth Anschluss. USB Wiederaufladbar. Kabel Inklusiv.
Écouteurs. Connexion Bluetooth. Rechargeable USB. Câble Inclus.
Oordopjes. Bluetooth Verbinding. USB Oplaadbaar. Kabel Inclusief.

16.5 × 20 × 2.3 cm

50

Print Code: F(4)

Voltar

5787

Earphones. Aluminium. Bluetooth Connection. USB Rechargeable. Cable Included.
Kopfhörer. Aluminium. Bluetooth Anschluss. USB Wiederaufladbar. Kabel Inklusiv.
Écouteurs. Aluminium. Connexion Bluetooth. Rechargeable USB. Câble Inclus.
Oordopjes. Aluminium. Bluetooth Verbinding. USB Oplaadbaar. Kabel Inclusief.

7.5 × 13.6 × 3 cm

100 / 50

Print Code: E(4)



THE BEST PRICE

& THE BEST-SELLER



Sopral

5953

Earphones. Bluetooth Connection. USB Rechargeable. Cable Included.
Kopfhörer. Bluetooth Anschluss. USB Wiederaufladbar. Kabel Inklusiv.
Écouteurs. Connexion Bluetooth. Rechargeable USB. Cable Inclus.
Oordopjes. Bluetooth Verbinding. USB Oplaadbaar. Kabel Inclusief.

▮▮▮▮▮ 08 × 3.9 cm

📦 200 / 50

🌈 Print Code: E(1), G(4)

02



ProMedia

Cort

3551

Earphones. 3.5 mm Jack Socket.
Kopfhörer. 3.5 mm Klinkestecker.
Écouteurs. Connexion Jack 3,5 mm.
Oordopjes. 3,5 mm Jack Aansluiting.

▮▮▮▮▮ 7 × 7 × 2 cm 📦 500 / 50

🌈 Print Code: D(1), W

01

19

04

11

07

05

03



03



4in1

SET 4 PIECES
SET 4 PIEZAS

Kelty

5541

Earphones. 3.5 mm Jack Socket.
Kopfhörer. 3.5 mm Klinkestecker.
Écouteurs. Connexion Jack 3,5 mm.
Oordopjes. 3,5 mm Jack Aansluiting.

▮▮▮▮▮ 02.7 × 11 cm

📦 200 / 50

🌈 Print Code: E(1), F(1)



19

02

01

Hotix

4995

Set. 3.5 mm Jack Socket. Refillable. Liquid Not Included.
Set. 3.5 mm Klinkestecker. Wiederaufladbar. Flüssigkeit Nicht im Lieferumfang.
Set. Connexion Jack 3,5 mm. Rechargeable. Liquide Non Inclus.
Set. 3,5 mm Jack Aansluiting. Navulbaar. Vloeistof Niet Inclusief.

▮▮▮▮▮ 11.5 × 2.2 × 6.7 cm 📦 200 / 50

🌈 Print Code: E(1), W





03

COMFORTABLE
HEADPHONES



Markiz

5142

Headphones. Polar Fleece. 3,5 mm Jack Socket.
Kopfhörer. Polar Fleece. 3,5 mm Klinkenstecker.
Écouteurs. Polaire. Connexion Jack 3,5 mm.
Koptelefoon. Polar Fleece. 3,5 mm Jack Aansluiting.

27 × 6 cm

200 / 50

Print Code: N(8), P



REFLECTIVE

16

Rasum

5682

Earphones. 3,5 mm Jack Socket. Extendable Cable.
Kopfhörer. 3,5 mm Klinkenstecker. Ausziehbar Kabel.
Écouteurs. Connexion Jack 3,5 mm. Câble Extensible.
Oordopjes. 3,5 mm Jack Aansluiting. Verlengbare Kabel.

2 × 8,6 × 2,6 cm

500 / 50

Print Code: D(1)



104

Bluetooth®



Seyer

5364

Hat. Polyester. Bluetooth Connection. USB Rechargeable. Cable Included.
Hut. Polyester. Bluetooth Anschluss. USB Wiederaufladbar. Kabel Inklusive.
Bonnet. Polyester. Connexion Bluetooth. Rechargeable USB. Cable Inclus.
Muts. Polyester. Bluetooth Verbinding. USB Oplaadbaar. Kabel Inclusief.

Consult.

100 / 50

Print Code: N(8), O, P



Luwins

5363

Headband. Polyester. Bluetooth Connection. USB Rechargeable. Cable Included.
Stirnband. Polyester. Bluetooth Anschluss. USB Wiederaufladbar. Kabel Inklusive.
Bandeau Tête. Polyester. Connexion Bluetooth. Rechargeable USB. Cable Inclus.
Hoofdband. Polyester. Bluetooth Verbinding. USB Oplaadbaar. Kabel Inclusief.

25 × 10 cm

200 / 50

Print Code: N(8), O, P





01

03

19

16

02

Neymen

5146

Headphones. 3,5 mm Jack Socket.
Kopfhörer. 3,5 mm Klinenstecker.
Écouteurs. Connexion Jack 3,5 mm.
Koptelefoon. 3,5 mm Jack Aansluiting.

15 × 21 × 6,5 cm

20

Print Code: F(1)



02

Anser

3974

Headphones. 3,5 mm Jack Socket.
Kopfhörer. 3,5 mm Klinenstecker.
Écouteurs. Connexion Jack 3,5 mm.
Koptelefoon. 3,5 mm Jack Aansluiting.

19 × 19 × 9 cm

Print Code: F(1)

20



01



19

03

02

Tabit

7024

Headphones. 3,5 mm Jack Socket.
Kopfhörer. 3,5 mm Klinenstecker.
Écouteurs. Connexion Jack 3,5 mm.
Koptelefoon. 3,5 mm Jack Aansluiting.

15,5 × 21 × 7,5 cm

Print Code: F(1)



01



Briden

5971

Power Bank Backpack. Nylon. 8000 mAh. AC Input. Padded Laptop and Tablet Compartment. Padded Back and Shoulder Straps. Cable Included Micro USB, Type C Connection and USB Output.

Power Bank Rucksack. Nylon. 8000 mAh. AC Eingang. Gepolsterte Laptotasche und Tablet. Gepolsterter Rücken und Schultergurte. Kabel inklusive Anschluss Micro USB, Typ C und USB Ausgang.

Sac à Dos Power Bank. Nylon. 8000 mAh. Entrée AC. Pochette Rembourrée pour Portable et Tablet. Dos et Bretelles Rembourrées. Câble Inclus Connexion Micro USB, Type C et Sortie USB.

Power Bank Ruzgak. Nylon. 8000 mAh. AC Input. Gewatteerd Laptop en Tablet Compartment. Gewatteerde Achterzijde en Schouderbanden. Kabel Inclusief Micro USB, Type C Connectie en USB Output.

30 x 46 x 18 cm

10

Print Code: I(8)



8000 mAh

POWER BANK INCLUDED
POWER BANK INCLUIDO



CHARGE YOUR DEVICES!!
BATTERY NOT INCLUDED

SOLAR ENERGY
ENERGIA SOLAR

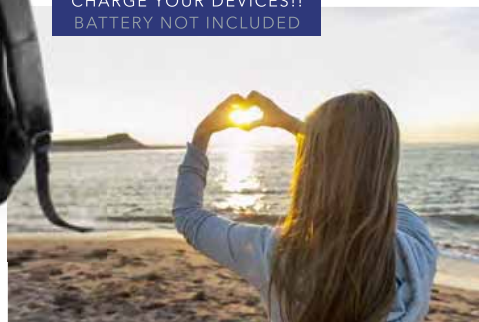

Koneit

6128

Charger Backpack. Polyester 1200D. Solar Panel 6.5W. USB Connection. Padded Laptop and Tablet Compartment. Padded Back and Shoulder Straps. Combination Lock Included.

Ladegerät Rucksack. Polyester 1200D. Sonnenkollektor 6.5W. USB Anschluss. Gepolsterte Laptotasche und Tablet. Gepolsterter Rücken und Schultergurte. Sicherheitsverschluss Inklusiv.

Sac à Dos Chargeur. Polyester 1200D. Panneau Solaire 6.5W. Connexion USB. Pochette Rembourrée pour Portable et Tablet. Dos et Bretelles Rembourrées. Fermeture Sécurité Inclus.

Oplader Ruzgak. Polyester 1200D. Zonnepaneel 6.5W. USB Verbinding. Gewatteerd Laptop en Tablet Compartment. Gewatteerde Achterzijde en Schouderbanden. Veiligheidsluiting Inklusief.

34 x 45 x 16.5 cm

10

Print Code: I(6)



UV STERILIZER



MOBILE CASE

NEW



SAFETY LOCK



Boxny
6674



UV Sterilizer Organizer. Polyester 600D/PU. Ultraviolet Light. RFID Protected. USB Connection. Cable Included.
 UV Sterilisator Ordner. Polyester 600D/PU. Ultraviolett Licht. RFID Schutz. USB Anschluss. Kabel Inklusive.
 Organiseur Stérilisateur UV. Polyester 600D/PU. Ultraviolets. Protecteur RFID. Connexion USB. Câble Inclus.
 UV Sterilisator Organizer. Polyester 600D/PU. Ultraviolet Licht. RFID Bescherming. USB Verbinding. Kabel Inclusief.

12 x 18.5 x 4 cm 50 / 25
 Print Code: G(1), N(8)

ULTRAVIOLET LIGHT:
 DESTROYS MICRO-ORGANISMS
 AND BACTERIAS
 FROM SURFACES AND
 OBJECTS USED ON A DAILY
 BASIS

107



NEW



CONNECT YOUR POWER BANK

Kraps
6750

UV Sterilizer Backpack. Polyester 600D. Padded. Padded Laptop and Tablet Compartment. Ultraviolet Light. USB Connection. Cable Included.
 UV Sterilisator Rucksack. Polyester 600D. Gepolstert. Gepolsterte Laptoptasche und Tablet. Ultraviolett Licht. USB Anschluss. Kabel Inklusive.
 Sac à Dos Stérilisateur UV. Polyester 600D. Rembourré. Pochette Rembourrée pour Portable et Tablet. Ultraviolets. Connexion USB. Câble Inclus.
 UV Sterilisator Rugzak. Polyester 600D. Gewatteerd. Gewatteerd Laptop en Tablet Compartment. Ultraviolet Licht. USB Verbinding. Kabel Inclusief.

30 x 43 x 12 cm 10
 Print Code: I(8)

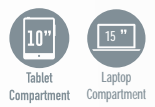



Brigitt

5221

Card Holder. PU. RFID Protected. 8 Compartments.
 Visitenkartenetui. PU. RFID Schutz. 8 Abteilungen.
 Porte-Cartes. Similicuir. Protecteur RFID. 8 Compartiments.
 Kaartjeshouder. PU. RFID Bescherming. 8 Compartimenten.

8.2 x 11.7 x 1.5 cm 200 / 50
 Print Code: E(1), T



Keep Your Card Details Safe With the **RFID** Protection System
 Mantén seguros los datos de tus tarjetas con el sistema de protección **RFID**



02 08 19 04



Serbin

5818

Card Holder. PU. RFID Protected. 5 Compartments.
 Visitenkartenetui. PU. RFID Schutz. 5 Abteilungen.
 Porte-Cartes. Similicuir. Protecteur RFID. 5 Compartiments.
 Kaartjeshouder. PU. RFID Bescherming. 5 Compartimenten.

7.2 x 10.5 x 0.9 cm 500 / 250
 Print Code: E(1), L1, T



03



02



08

03

19



Rupuk

5822

Card Holder Wallet. Polyester. RFID Protected. 6 Compartments.
 Visitenkartenetui Brieftasche. Polyester. RFID Schutz. 6 Abteilungen.
 Porte-Cartes Portefeuille. Polyester. Protecteur RFID. 6 Compartiments.
 Kaartjeshouder Portemonnee. Polyester. RFID Bescherming. 6 Compartimenten.

11 x 8.6 x 1.3 cm 200 / 50
 Print Code: E(1), N(8)





Rainol

5371

Card Holder. Aluminium. RFID Protected. 6 Compartments.
 Visitenkartenetui. Aluminium. RFID Schutz. 6 Abteilungen.
 Porte-Cartes. Aluminium. Protecteur RFID. 6 Compartiments.
 Kaartjeshouder. Aluminium. RFID Bescherming. 6 Compartimenten.

11 x 7.5 x 2 cm

200 / 50

Print Code: D(4), L1

03



04



09



02



19

Keep Your device Details Safe With the **RFID** Protection System
 Mantén seguros los datos de tus dispositivos con el sistema de protección **RFID**



Porlan

5188

Card Holder. Aluminium. RFID Protected. 1 Compartment.
 Visitenkartenetui. Aluminium. RFID Schutz. 1 Abteilung.
 Porte-Cartes. Aluminium. Protecteur RFID. 1 Compartiment.
 Kaartjeshouder. Aluminium. RFID Bescherming. 1 Compartiment.

8.9 x 5.8 x 0.7 cm

400 / 100

Print Code: D(4), L1

09



02

03

19



07

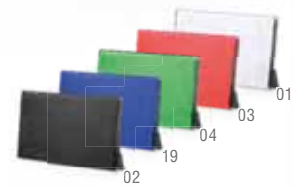

02

19

04

03



Lindrup

6173

Card Holder. RFID Protected. 1 Compartment.
 Visitenkartenetui. RFID Schutz. 1 Abteilung.
 Porte-Cartes. Protecteur RFID. 1 Compartiment.
 Kaartjeshouder. RFID Bescherming. 1 Compartiment.

6.2 x 10 x 1.1 cm

500 / 50

Print Code: D(4), W



SLIDE AND REMOVE
 DESLIZA Y EXTRAE



Recol

6363

Card Holder. RFID Protected. 1 Compartment. Adhesive.
 Visitenkartenetui. RFID Schutz. 1 Abteilung. Haftend.
 Porte-Cartes. Protecteur RFID. 1 Compartiment. Adhésif.
 Kaartjeshouder. RFID Bescherming. 1 Compartment. Klevend.

6.2 × 9 cm

4000 / 100

Print Code: B(1)



POUCH WITH
RFID PROTECTION SYSTEM
 IDEAL FOR MOBILE DEVICES
 FUNDA CON SISTEMA PROTECCIÓN RFID
 IDEAL PARA DISPOSITIVOS MÓVILES

110

Keep Your devices Safe With the **RFID Protection System**
 Mantén seguros los datos de tus dispositivos con el sistema de protección **RFID**

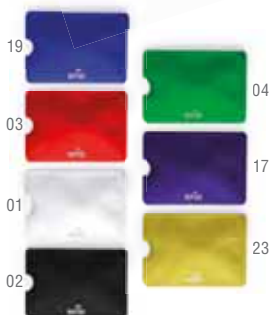

Becam

5637

Card Holder. Aluminium. RFID Protected. 1 Compartment.
 Visitenkartenetui. Aluminium. RFID Schutz. 1 Abteilung.
 Porte-Cartes. Aluminium. Protecteur RFID. 1 Compartiment.
 Kaartjeshouder. Aluminium. RFID Bescherming. 1 Compartment.

6.2 × 9 cm

5000 / 100

Print Code: B(1)

Randy

5187

Card Holder. RFID Protected. 1 Compartment.
 Visitenkartenetui. RFID Schutz. 1 Abteilung.
 Porte-Cartes. Protecteur RFID. 1 Compartiment.
 Kaartjeshouder. RFID Bescherming. 1 Compartment.

6 × 9 × 0.4 cm

1000 / 100

Print Code: C(4), W

Hismal

6007

Protector Pouch. Polyester. RFID Protected.
 Sicherheit Hülle. Polyester. RFID Schutz.
 Etui Sécurité. Polyester. Protecteur RFID.
 Veiligheid Hoes. Polyester. RFID Bescherming.

12.5 × 19 cm

500 / 100

Print Code: E(1), N(8)





19



Nambus

6179

Webcam Cover. Adhesive.
Webcam-Blocker. Haftend.
Bloqueur Webcam. Adhésif.
Webcam Blocker. Klevend.

3.2 x 1.3 x 0.1 cm 10000 / 5000

Print Code: B(1), W

-  01
-  08
-  05
-  04
-  03
-  02
-  07



Pembol

6085

Webcam Cover. Adhesive. 3 Pieces.
Webcam-Blocker. Haftend. 3 Stück.
Bloqueur Webcam. Adhésif. 3 Pièces.
Webcam Blocker. Klevend. 3 Stuks.

3.5 x 3.5 x 1.8 cm 2000 / 1000

Print Code: B(4), W



3 PIECES



02

01



111



02



01



09



JOYSTICK



Maint

5800

Webcam Cover Joystick.
Webcam-Blocker Joystick.
Bloqueur Webcam Joystick.
Webcam Blocker Joystick.

2.7 x 3.4 x 1.5 cm

500 / 100

Print Code: B(1)

Lacol

5801

Webcam Cover. Adhesive.
Webcam-Blocker. Haftend.
Bloqueur Webcam. Adhésif.
Webcam Blocker. Klevend.

4.1 x 1.6 x 0.2 cm

10000 / 5000

Print Code: B(4), W

NEW



Antibacterial



ANTIBACTERIAL



ULTRA SLIM / ULTRA DELGADO

Hislot

6687

Antibacterial Webcam Cover. Adhesive.
Antibakteriell Webcam-Blocker. Haftend.
Bloqueur Webcam Antibactérien. Adhésif.
Antibacterieel Webcam Blocker. Klevend.

3.2 x 1.3 x 0.1 cm

10000 / 5000

Print Code: B(1), W



Anker
4823

USB Lamp. 6 Leds. Flexibel.
 USB Lampe. 6 Leds. Flexibel.
 Lampe USB. 6 Leds. Flexibel.
 USB Lamp. 6 Leds. Flexibel.

1.8 × 16.8 × 1 cm
 Print Code: D(4), L1

200 / 50



03



19

05



02

01

Kinser

4822

USB Lamp. 1 Led.
 USB Lampe. 1 Led.
 Lampe USB. 1 Led.
 USB Lamp. 1 Led.

3.5 × 6.5 cm
 Print Code: D(1)

200 / 50



Vanairix

5285

Lamp. Silicone.
 Lampe. Silikon.
 Lampe. Silicone.
 Lamp. Silliconen.

5.7 × 6 × 4.5 cm
 Print Code: F(1)

400 / 50





Lyster 4624

Mouse. Wireless. Optical. 2 Batteries AAA Not Included.
 Maus. Drahtlos. Optisch. 2 AAA Batterien Nicht im Lieferumfang.
 Souris. Sans Fil. Optique. 2 Piles AAA Non Inclus.
 Muis. Draadloos. Optical. 2 Batterijen AAA Niet Inclusief.

8x2x3.5cm 11.2 x 2.4 x 5.7 cm 200 / 100
 Print Code: E(4), W



Yoiko 3746

Mini Mouse. Optical. Extendable Cable.
 Mini Maus. Optisch. Ausziehbar Kabel.
 Mini Souris. Optique. Cable Extensible.
 Mini Muis. Optical. Verlengbare Kabel.

8 x 2 x 3.5 cm 200 / 50
 Print Code: E(1)



Lenbal 5948

Mouse. Foldable. Wireless. Optical. 2 Batteries AAA Not Included.
 Maus. Faltbar. Drahtlos. Optisch. 2 AAA Batterien Nicht im Lieferumfang.
 Souris. Pliable. Sans Fil. Optique. 2 Piles AAA Non Inclus.
 Muis. Opvouwbaar. Draadloos. Optical. 2 Batterijen AAA Niet Inclusief.

11.3 x 2.9 x 5.6 cm 100
 Print Code: E(4), W



Supot 6689

Antibacterial Mouse. Wireless. Optical. 2 Batteries AAA Not Included.
 Antibakteriell Maus. Drahtlos. Optisch. 2 AAA Batterien Nicht im Lieferumfang.
 Souris Antibactérienne. Sans Fil. Optique. 2 Piles AAA Non Inclus.
 Antibacterieel Muis. Draadloos. Optical. 2 Batterijen AAA Niet Inclusief.

11.2 x 2.4 x 5.7 cm 200 / 100
 Print Code: E(4), W



HOLDER INCLUDED
SOPORTE INCLUIDO



Roktum

6129

Charger Keyboard. Wireless. Bluetooth Connection. USB Rechargeable. Cable Included.
Ladegerät Tastatur. Drahtlos. Bluetooth Anschluss. USB Wiederaufladbar. Kabel Inklusive.
Clavier Chargeur. Sans Fil. Connexion Bluetooth. Rechargeable USB. Câble Inclus.
Oplader Toetsenbord. Draadloos. Bluetooth Verbinding. USB Oplaadbaar. Kabel Inclusief.

24 × 0.6 × 17 cm



Print Code: G(1), W

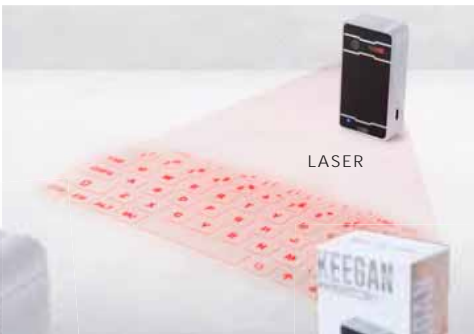

LASER



Keegan

5335

Laser Keyboard. Bluetooth Connection. USB Rechargeable. Cable Included.
Laser Tastatur. Bluetooth Anschluss. USB Wiederaufladbar. Kabel Inklusive.
Clavier Virtuel. Connexion Bluetooth. Rechargeable USB. Câble Inclus.
Laser Keyboard. Bluetooth Verbinding. USB Oplaadbaar. Kabel Inclusief.

4 × 7.8 × 2 cm



Print Code: F(4), W



NEW

UVC
Sterilizer



Nurek

6654

UV Sterilizer Lamp. Ultraviolet Light. USB Rechargeable. Cable Included.
UV Sterilisator Lampe. Ultraviolettes Licht. USB Wiederaufladbar. Kabel Inklusive.
Lampe Stérilisateur UV. Ultraviolets. Rechargeable USB. Câble Inclus.
UV Sterilizer Lamp. Ultraviolet Licht. USB Oplaadbaar. Kabel Inclusief.

3 × 12.5 × 1.4 cm



Print Code: E(4), W





Volks

4935

Keyboard. Bluetooth Connection. USB Rechargeable. Cable Included.
Tastatur. Bluetooth Anschluss. USB Wiederaufladbar. Kabel Inklusive.
Clavier. Connexion Bluetooth. Rechargeable USB. Câble Inclus.
Toetsenbord. Bluetooth Verbinding. USB Oplaadbaar. Kabel Inclusief.

20 × 0.6 × 12.5 cm

50 / 25

Print Code: F(2)

03



TWO VERSIONS:
SPANISH & INTERNATIONAL



01

Dustin

5739

Keyboard Holder. PU. Bluetooth Connection. USB Rechargeable. Cable Included.
Tastatur Halter. PU. Bluetooth Anschluss. USB Wiederaufladbar. Kabel Inklusive.
Clavier Support. Similicuir. Connexion Bluetooth. Rechargeable USB. Câble Inclus.
Toetsenbord Houder. PU. Bluetooth Verbinding. USB Oplaadbaar. Kabel Inclusief.

22 × 2.2 × 14.5 cm

40 / 20

Print Code: F(2), L2



Tyrell

5305

Keyboard Holder. PU. Bluetooth Connection. USB Rechargeable. Cable Included.
Tastatur Halter. PU. Bluetooth Anschluss. USB Wiederaufladbar. Kabel Inklusive.
Clavier Support. Similicuir. Connexion Bluetooth. Rechargeable USB. Câble Inclus.
Toetsenbord Houder. PU. Bluetooth Verbinding. USB Oplaadbaar. Kabel Inclusief.

22 × 1.1 × 14.3 cm

40 / 20

Print Code: F(2), L2





Home / Office



Gregor

5162

USB Charger. 4 USB Outputs. 3100 mA.
USB Ladegerät. 4 USB Ausgänge. 3100 mA.
Chargeur USB. 4 Sorties USB. 3100 mA.
USB Oplader. 4 USB Outputs. 3100 mA.

2.8 × 8.6 × 6.8 cm

100 / 50

Print Code: E(4), W

116



Home / Office



car



Dabol

5578

USB Charger. 2 USB Outputs. 2100 mA.
USB Ladegerät. 2 USB Ausgänge. 2100 mA.
Chargeur USB. 2 Sorties USB. 2100 mA.
USB Oplader. 2 USB Outputs. 2100 mA.

5.9 × 5.9 × 3.9 cm

100 / 50

Print Code: E(4), W



Marsal

5367

Mobile Holder. Sticky Surface.
Handyhalter. Selbsthaftende Oberfläche.
Support Mobile. Surface Adhésive.
Mobiële Houder. Zelfklevende Oppervlakte.

9.3 × 10.4 × 6.7 cm

200 / 50

Print Code: D(4)



02



03



01



Lerix

3778

Mobile Holder.
Handyhalter.
Support Mobile.
Mobiële Houder.

9 × 9.5 × 6 cm

500 / 50

Print Code: D(4)



Usak

3498

Card Reader. Cards: SD, MiniSD, MMC, XD, MS, CF. Felt Tip Pen and Eraser Included.
Karten Leser. Karten: SD, MiniSD, MMC, XD, MS, CF. Filzstift und Radierer Inklusive.
Lecteur Cartes. Cartes: SD, MiniSD, MMC, XD, MS, CF. Feutre et Effaceur Inclus.
Geheugenkaartjeslezer. Kaarten: SD, MiniSD, MMC, XD, MS, CF. Felt Tip Pen en Gum Inclusief.

13 × 3 × 7.5 cm

60

Print Code: D(4)



Secure

3565

Card Reader. USB 2.0. Cards: MS, M2, SD, MiniSD, Smart Card, SIM, MicroSD.
Karten Leser. USB 2.0. Karten: MS, M2, SD, MiniSD, Smart Card, SIM, MicroSD.
Lecteur Cartes. USB 2.0. Cartes: MS, M2, SD, MiniSD, Smart Card, SIM, MicroSD.
Geheugenkaartjeslezer. USB 2.0. Kaart: MS, M2, SD, MiniSD, Smart Card, SIM, MicroSD.

3.1 × 8.1 × 1.3 cm

100 / 25

Print Code: C(4)



Electron

3566

Card Reader. USB 2.0. Smart Card.
Karten Leser. USB 2.0. Smart Card.
Lecteur Cartes. USB 2.0. Smart Card.
Geheugenkaartjeslezer. USB 2.0. Smart Card.

8.2 × 1.5 × 6.5 cm

100 / 25

Print Code: E(4), W

CARD READER



Ares

3509

Card Reader. USB 2.0. Cards: M2, MS Duo, MicroSD, SD.
Karten Leser. USB 2.0. Karten: M2, MS Duo, MicroSD, SD.
Lecteur Cartes. USB 2.0. Cartes: M2, MS Duo, MicroSD, SD.
Geheugenkaartjeslezer. USB 2.0. Kaart: M2, MS Duo, MicroSD, SD.

3.7 × 5.5 × 1.3 cm

600 / 100

Print Code: C(4), W

Hades

3383

Card Reader. USB 2.0. Cards: M2, MS Duo, MS Pro Duo, MS, MS Pro, MicroSD, MiniSD, RS MMC, SD, MMC.
Karten Leser. USB 2.0. Karten: M2, MS Duo, MS Pro Duo, MS, MS Pro, MicroSD, MiniSD, RS MMC, SD, MMC.
Lecteur Cartes. USB 2.0. Cartes: M2, MS Duo, MS Pro Duo, MS, MS Pro, MicroSD, MiniSD, RS MMC, SD, MMC.
Geheugenkaartjeslezer. USB 2.0. Kaart: M2, MS Duo, MS Pro Duo, MS, MS Pro, MicroSD, MiniSD, RS MMC, SD, MMC.

6.5 × 1 × 2 cm

300 / 30

Print Code: C(4), W

Dira

3693

Card Reader. USB 2.0. Cards: MS, MS Duo, MS Pro Duo, Micro SD, MiniSD.
Karten Leser. USB 2.0. Karten: MS, MS Duo, MS Pro Duo, MicroSD, MiniSD.
Lecteur Cartes. USB 2.0. Cartes MS, MS Duo, MS Pro Duo, MicroSD, MiniSD.
Geheugenkaartjeslezer. USB 2.0. Kaart: MS, MS Duo, MS Pro Duo, Micro SD, MiniSD.

7.5 × 1.5 × 2.3 cm

500 / 100

Print Code: C(4), W

WITH MOTION SENSOR
/ CON SENSOR DE
MOVIMIENTO

NEW

naturalcare
Essential Hygiene

45 ml



Bisnal

6698

Automatic Dispenser. 45 ml. USB Rechargeable. Cable Included.
Automatisch Spender. 45 ml. USB Wiederaufladbar. Kabel Inklusiv.
Distributeur Automatique. 45 ml. Rechargeable USB. Câble Inclus.
Automatisch Dispenser. 45 ml. USB Oplaadbaar. Kabel Inclusief.

5.5 × 9 × 7.5 cm

50

Print Code: E(4), W

NEW



Trick

6653

Ozone Generator. USB Rechargeable. Cable Included.
Ozon-Generator. USB Wiederaufladbar. Kabel Inklusiv.
Générateur d'Ozone. Rechargeable USB. Câble Inclus.
Ozon Generator. USB Oplaadbaar. Kabel Inclusief.

11.5 × 4.3 × 11.5 cm

30

Print Code: F(4)



Home / Office



Car

Ozone
Generator

OZONE GENERATOR





130 ml



Festok 6515

Humidifier. Led Lights. 130 ml. 1 Steam Mode. USB Connection. Cable Included.
Luftbefeuchter. Led Lichter. 130 ml. 1 Dampf Funktion. USB Anschluss. Kabel Inklusive.
Humidificateur. Lumières Led. 130 ml. 1 Mode de Vapeur. Connexion USB. Câble Inclus.
Luchtbevochtiger. Led Lichten. 130 ml. 1 Stoom Positie. USB Verbinding. Kabel Inclusief.

▮▮▮▮▮ Ø 10 × 9.5 cm

📦 50

🌈 Print Code: E(1), L2



250 ml



Home / Office



Car



01



19

03



Home / Office



Car

Trudy 6127

Humidifier. Led Lights. 200 ml. 2 Steam Modes. USB Connection. Cable Included.
Luftbefeuchter. Led Lichter. 200 ml. 2 Dampf Funktionen. USB Anschluss. Kabel Inklusive.
Humidificateur. Lumières Led. 200 ml. 2 Modes de Vapeur. Connexion USB. Câble Inclus.
Luchtbevochtiger. Led Lichten. 200 ml. 2 Stoom Posities. USB Verbinding. Kabel Inclusief.

▮▮▮▮▮ Ø 6 × 14.9 cm

📦 50

🌈 Print Code: E(1)



200 ml



Paffil 6265

Humidifier. Led Lights. 250 ml. 1 Steam Mode. USB Connection. Cable Included.
Luftbefeuchter. Led Lichter. 250 ml. 1 Dampf Funktion. USB Anschluss. Kabel Inklusive.
Humidificateur. Lumières Led. 250 ml. 1 Mode de Vapeur. Connexion USB. Câble Inclus.
Luchtbevochtiger. Led Lichten. 250 ml. 1 Stoom Positie. USB Verbinding. Kabel Inclusief.

▮▮▮▮▮ Ø 5 × 18 cm

📦 50

🌈 Print Code: E(1), L2



Celsor

5303

Plug Adapter. 2 USB Outputs. 2100 mA. USA, Europe, Asia, UK, Australia.

Steckeradapter. 2 USB Ausgänge. 2100 mA. USA, Europa, Asien, UK, Australien.

Adaptateur Prises. 2 Sorties USB. 2100 mA. USA, Europe, Asie, Royaume-Uni, Australie.

Stekker Adapter. 2 USB Outputs. 2100 mA. USA, Europa, Azië, UK, Australië.

5 x 4.5 x 6.1 x 5.6 cm

100 / 50

Print Code: D(4), W



Travel

Home / Office



Tyru

3730

Plug Adapter. USA, Europe, Asia, UK, Australia.

Steckeradapter. USA, Europa, Asien, UK, Australien.

Adaptateur Prises. USA, Europe, Asie, Royaume-Uni, Australie.

Stekker Adapter. USA, Europa, Azië, UK, Australië.

5 x 7.4 x 4 cm

100 / 50

Print Code: D(4)



Travel

Home / Office



02

19

04

05

07

11



Travel

Home / Office

Tribox

4698

Plug Adapter. USB Output. 1000 mA. USA, Europe, Asia, UK, Australia.

Steckeradapter. USB Ausgang. 1000 mA. USA, Europa, Asien, UK, Australien.

Adaptateur Prises. Sortie USB. 1000 mA. USA, Europe, Asie, Royaume-Uni, Australie.

Stekker Adapter. USB Output. 1000 mA. USA, Europa, Azië, UK, Australië.

Ø 4.8 x 11.1 cm

100 / 50

Print Code: D(4)



01



03



03

19



Travel

Home / Office

Universal

3086

Plug Adapter. USA, Europe, Asia, UK, Australia.

Steckeradapter. USA, Europa, Asien, UK, Australien.

Adaptateur Prises. USA, Europe, Asie, Royaume-Uni, Australie.

Stekker Adapter. USA, Europa, Azië, UK, Australië.

Ø 4.5 x 8.2 cm

100 / 50

Print Code: D(4)





Nonval 6532

Plug Adapter. 2 USB Outputs 2100 mA. USA, Europe, Asia, UK, Australia.
 Steckeradapter. 2 USB Ausgänge 2100 mA. USA, Europa, Asien, UK, Australien.
 Adaptateur Prises. 2 Sorties USB 2100 mA. USA, Europe, Asie, Royaume-Uni, Australie.
 Stekker Adapter. 2 USB Outputs 2100 mA. USA, Europa, Azie, UK, Australië.

7 × 6.3 × 4.9 cm 100 / 50
 Print Code: D(4), W

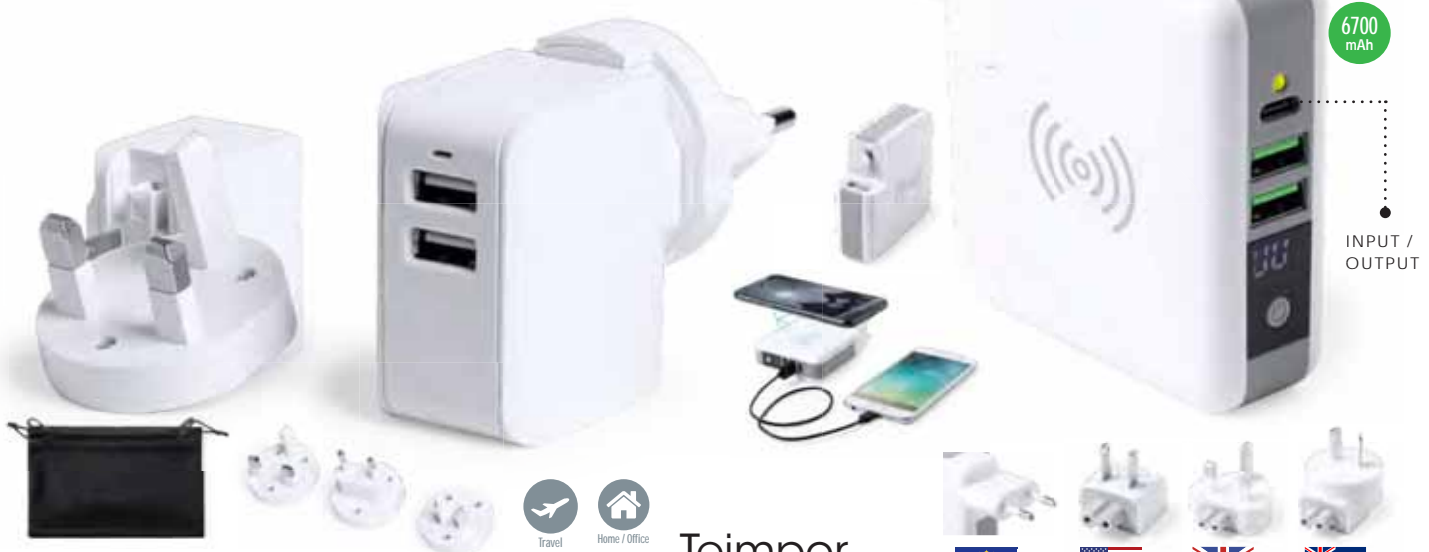

6700 mAh

INPUT / OUTPUT

Teimpor 6141

Multifunction Travel Adapter. Wireless. 6700 mAh. 2 USB Outputs 2400 mA and 1 Type C Output 2400 mA. Type C Input. USA, Europe, Asia, UK, Australia.
 Multifunktion Reise Adapter. Drahtlos. 6700 mAh. 2 USB Ausgänge 2400 mA und 1 Typ C Ausgang 2400 mA. Typ C Eingang. USA, Europa, Asien, UK, Australien.
 Adaptateur Voyage Multifonction. Sans Fil. 6700 mAh. 2 Sorties USB 2400 mA et 1 Sortie Type C 2400 mA. Entrée Type C. USA, Europe, Asie, Royaume-Uni, Australie.
 Multifunctioneel Reis Adapter. Draadloos. 6700 mAh. 2 USB Outputs 2400 mA en 1 Typ C Output 2400 mA. Typ C Input. USA, Europa, Azie, UK, Australië.

2.9 × 8 × 8 cm 40
 Print Code: F(4), W



Duban 6245

Travel Adapter. 2 USB Outputs 2100 mA. USA, Europe, Asia, UK, Australia.
 Reise Adapter. 2 USB Ausgänge 2100 mA. USA, Europa, Asien, UK, Australien.
 Adaptateur Voyage. 2 Sorties USB 2100 mA. USA, Europe, Asie, Royaume-Uni, Australie.
 Reis Adapter. 2 USB Outputs 2100 mA. USA, Europa, Azie, UK, Australië.

4.7 × 3.1 × 5.5 cm 100 / 50
 Print Code: D(4), N(8), W





Gamp

5287

Alcohol Tester. 2 Batteries AAA Not Included.
Alkoholtester. 2 AAA Batterien Nicht im Lieferumfang.
Alcohol Test. 2 Piles AAA Non Inklus.
Alcohol Tester. 2 Batterijen AAA Niet Inklusief.

3.6 x 9.5 x 1.7 cm 200 / 50

Print Code: E(4)



PERSONAL ALARM

EXTRA
LOUD SOUND



Alarm

Birnal

6405

Personal Alarm. Button Batteries Included.
Persönlicher Alarm. Knopfzellen Inklusive.
Alarme personnelle. Piles Bouton Inklus.
Persoonlijk Alarm. Knoopcel Batterijen Inclusief.

3.9 x 6 x 1.9 cm 300 / 50

Print Code: D(4)



Video

COMPATIBLE WITH
ANDROID & IOS

08 19 01

Bluetooth®

03

PARKING SITE SEARCHING
LOCALIZADOR DE APARCAMIENTO

VOICE RECORDING
GRABADORA

REMOTE SHUTTER
DISPARADOR REMOTO

ANTI-LOST
ANTI PERDIDA

TAKE ME TO MY PARKING LOCATION
GUÍAME A LA LOCALIZACIÓN
DE MI APARCAMIENTO



COMPATIBLE WITH
ANDROID & IOS

Bluetooth®

05

01

04 19 02 11 03 07

Jackson

5965

GPS Tracker. Bluetooth Connection. Button Battery Included.
GPS Piepser. Bluetooth Anschluss. Knopfzelle Inklusive.
GPS Traqueur. Connexion Bluetooth. Pile Bouton Inklus.
GPS Locator. Bluetooth Verbinding. Knoopcel Batterij Inclusief.

2.9 x 6 x 1 cm 200 / 50

Print Code: C(4), W



Krosly

5160

Tracker. Bluetooth Connection. Button Battery Included.
Piepser. Bluetooth Anschluss. Knopfzelle Inklusive.
Traqueur. Connexion Bluetooth. Pile Bouton Inklus.
Locator. Bluetooth Verbinding. Knoopcel Batterij Inclusief.

3.1 x 5.2 x 1 cm 200 / 50

Print Code: C(4)



Video





Bercley
5244

Virtual Reality Glasses. Adjustable Lenses. Input Jack 3,5 mm.
Virtual-Reality Brille. Verstellbare Linsen. 3,5 mm Klinkeneingänge.
Lunettes de Réalité Virtuelle. Ajustables Lentilles. Connectique Jack 3,5 mm.
Virtuele Reality Brill. Verstellbare Lenzen. Input Jack 3,5 mm.

19.5 x 10.5 x 13.5 cm 20
Print Code: G(1)

EARPHONES. NOT INCLUDED
AURICULARES NO INCLUIDOS



Morgan
5189

Virtual Reality Glasses. Adjustable Lenses.
Virtual-Reality Brille. Verstellbare Linsen.
Lunettes de Réalité Virtuelle. Ajustables Lentilles.
Virtuele Reality Brill. Verstellbare Lenzen.

12.5 x 6.5 x 6.5 cm 100 / 50
Print Code: D(4), W



Wills
5633

3D Lens.
3D Linse.
Lentille 3D.
3D Lens.

10 x 12 x 3 cm 200 / 50
Print Code: D(4)

REC 3D

3D PHOTOS AND VIDEOS



Station
5157

Gamepad. Bluetooth Connection. USB Rechargeable. Cable Included.
Gamepad. Bluetooth Anschluss. USB Wiederaufladbar. Kabel Inklusiv.
Manette de Jeu. Connexion Bluetooth. Rechargeable USB. Câble Inclus.
Gamepad. Bluetooth Verbinding. USB Oplaadbaar. Kabel Inclusief.

3.1 x 7.3 x 1.5 cm 200 / 50
Print Code: D(4)





Dicson 60X

5134

Microscope. ABS/ Metal. 2 Leds. Ultraviolet Light. Button Batteries Included.
 Mikroskop. ABS/ Metaal. 2 Leds. Ultravioletes Licht. Knopzellen Inclusief.
 Microscope. ABS/ Métal. 2 Leds. Ultravioletes. Piles Bouton Inclusif.
 Microscop. ABS/ Metaal. 2 Leds. Ultraviolet Licht. Knoopcel Batterijen Inclusief.

7 × 8 × 2.2 cm

300 / 100

Print Code: D(4)



124



19

02

04

07

11

05

Paicom

4932

Selfie Stick. Stainless Steel. 3.5 mm Jack Socket. 7 Positions.
 Monopod. Rostfreier Stahl. 3.5 mm Klinckenstecker. 7 Positionen.
 Trepied. Acier Inox. Connexion Jack 3.5 mm. 7 Positions.
 Selfie Stick. Roestvrij Staal. 3.5 mm Jack Aansluiting. 7 Posities.

Ø 2.6 × 60 cm

100 / 50

Print Code: E(1), L1



Altum

4940

Set. Stainless Steel. 3.5 mm Jack Socket. 7 Positions. 3 Glass Lenses/ Aluminium.
 Set. Rostfreier Stahl. 3.5 mm Klinckenstecker. 7 Positionen. 3 Glas Linse/ Aluminium.
 Set. Acier Inox. Connexion Jack 3.5 mm. 7 Positions. 3 Lentilles Verre/ Aluminium.
 Set. Roestvrij Staal. 3.5 mm Jack Aansluiting. 7 Posities. 3 Glas Lenzen/ Aluminium.

8.2 × 15 × 3.4 cm

100 / 50

Print Code: E(1), L1, N(8)



02

01

19

04

05

07

11

Kroper

4855

Selfie Stick. Stainless Steel. 3.5 mm Jack Socket. 7 Positions.
 Monopod. Rostfreier Stahl. 3.5 mm Klinckenstecker. 7 Positionen.
 Trepied. Acier Inox. Connexion Jack 3.5 mm. 7 Positions.
 Selfie Stick. Roestvrij Staal. 3.5 mm Jack Aansluiting. 7 Posities.

2.5 × 108 × 2.5 cm

50 / 25

Print Code: E(4), L1



Drian

4947

Universal Lenses. 2 Glass Lenses/ Aluminium.
 Universal Objektiv. 2 Glas Linse/ Aluminium.
 Lentilles Universelles. 2 Lentilles Verre/ Aluminium.
 Universele Lenzen. 2 Glas Lenzen/ Aluminium.

9 × 12 × 2.5 cm

Print Code: D(1), N(8)

100



Optix

4787

Universal Lenses. 3 Glass Lenses/ Aluminium.
 Universal Objektiv. 3 Glas Linse/ Aluminium.
 Lentilles Universelles. 3 Lentilles Verre/ Aluminium.
 Universele Lenzen. 3 Glas Lenzen/ Aluminium.

9.5 × 13.7 × 2.5 cm

Print Code: D(1), N(8)

100



Bagly

5632

Universal Lenses. 4 Lenses.
 Universal Objektiv. 4 Linse.
 Lentilles Universelles. 4 Lentilles.
 Universele Lenzen. 4 Lenzen.

11 × 14.5 × 3 cm

Print Code: D(1)

200 / 50



02



Yorap 8X

5317

Universal Camera Lens. Glass Lens.
 Universal Objektiv. Glas Linse.
 Objectif Universel. Lentille Verre.
 Universele Camera Lens. Glas Lens.

9.5 × 13.5 × 3.5 cm

Print Code: D(1), N(8)

100 / 50



02

Ryper

3665
Holder.
Halter.
Support.
Houder.



03



19

39 × 30 × 4 cm
Print Code: G(1)

10



Heclan

5882

Holder. Flexible.
Halter. Flexibel.
Support. Flexibel.
Houder. Flexibel.

12.3 × 6.4 × 2.8 cm
Print Code: H(1)



50



08



01

Beltrak

5650
Holder.
Halter.
Support.
Houder.



3.2 × 8 × 2.5 cm
Print Code: C(4), W

400 / 50



Brenom

6065

Holder. Flexible.
Halter. Flexibel.
Support. Flexibel.
Houder. Flexibel.

12.3 × 6.4 × 2.8 cm
Print Code: H(1)



50



DE CORTE DE MADERA NATURAL,
SU TEXTURA, COLOR, TAMAÑO Y GROSOR PUEDEN VARIAR.
UNIQUE PIECES FROM NATURAL CUTS OF WOOD.
THE TEXTURE, COLOR, SIZES AND THICKNESS MAY VARY.



NEW

BAMBOO



BAMBOO



NEW



SUITABLE FOR TABLETS
AND MOBILE PHONES /
VÁLIDO PARA TABLETS Y
TELÉFONOS MÓVILES

Protok

6797

Holder. Bamboo.
Halter. Bambus.
Support. Bambou.
Houder. Bamboe.

8 × 12 × 8.1 cm

100 / 50

Print Code: D(4), L2, W



Light

Delim

6795

Holder. Bamboo.
Halter. Bambus.
Support. Bambou.
Houder. Bamboe.

6 × 2 × 8 cm

200 / 50

Print Code: D(4), L2, W



127



02



11



01



02



03



01



03



04



05



19



03



19

Rapsi

4948

Holder Lamp. 2 Leds. Flexible. Button Batteries Included.
Halter Lampe. 2 Leds. Flexibel. Knopfzellen Inklusive.
Lampe Support. 2 Leds. Flexible. Piles Bouton Inclus.
Houder Lamp. 2 Leds. Flexibel. Knoopcel Batterijen Inclusief.

8.2 × 16 × 1.3 cm

200 / 100

Print Code: L2

Levyn

5388

Holder. Polyester.
Halter. Polyester.
Support. Polyester.
Houder. Polyester.

14 × 9 × 12 cm

50

Print Code: N(8)



19

Laxo

4108

Holder.
Halter.
Support.
Houder.

8.5 × 3 × 8.5 cm

500 / 100

Print Code: C(4), W



Blizz

4679

Multipurpose Pouch. Silicone. Adhesive.
Mehrzweckhülle. Silikon. Haftend.
Étui Multi-Usages. Silicone. Adhésif.
Multifunctionele Hoes. Siliconen. Klevend.

5.6 × 9.5 × 0.5 cm 500 / 100

Print Code: L1



01

03

04

05

19



19



05

04

03

01

02

Quiton

6084

Holder. Adhesive. 4 Functions.
Halter. Haftend. 4 Funktionen.
Support. Adhésif. 4 Fonctions.
Houder. Klevend. 4 Functies.

Ø 3.3 × 0.6 cm 2000 / 1000

Print Code: B(4), W

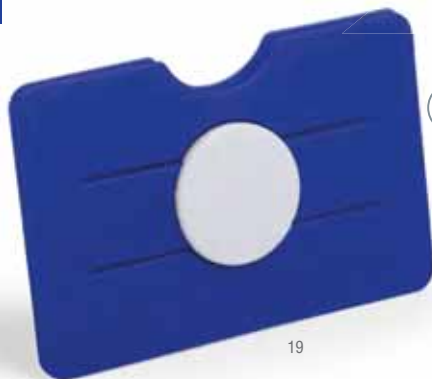

19



04

05

01

11

07

03

02

Tisson

6305

Holder. ABS/ Silicone. Adhesive. 1 Compartment.
Halter. ABS/ Silikon. Haftend. 1 Abteilung.
Support. ABS/ Silicone. Adhésif. 1 Compartiment.
Houder. ABS/ Siliconen. Klevend. 1 Compartment.

8.8 × 5.6 × 0.5 cm 500 / 100

Print Code: D(4)



IDEAL FOR 5 CARDS
ADECUADO PARA 5 TARJETAS

SUITABLE FOR ALL MOBILE DEVICES
VÁLIDO PARA TODOS LOS DISPOSITIVOS MÓVILES



03



Sernel

6304

Protector Holder. ABS/ Silicone.
Unterstützungsschutz. ABS/ Silikon.
Support Protecteur. ABS/ Silicone.
Beschermer met Houder. ABS/ Siliconen.

10.2 × 6.2 × 0.6 cm 500 / 100

Print Code: E(1)



19

01

02

THE BEST PRICE
& THE **BEST-SELLER**



Kafu
6780

Holder. Metal. Adhesive.
Halter. Metall. Haftend.
Support. Metal. Adhésif.
Houder. Metaal. Klevend.

3 × 3 × 0.4 cm
Print Code: B(4), L1

1000 / 100



NEW



Hunabik
6591

Holder. Adhesive.
Halter. Haftend.
Support. Adhésif.
Houder. Klevend.

Ø 4.4 × 2.9 cm
Print Code: B(4), W

1000 / 100



METAL

02

08



SUITABLE FOR MAGNETIC HOLDERS/
VÁLIDO PARA SOPORTES MAGNÉTICOS

Manfix

5999
Holder. Adhesive.
Halter. Haftend.
Support. Adhésif.
Houder. Klevend.

7.5 × 2.2 × 0.5 cm
Print Code: L1



HOLDER

23



Arnold
5551

Holder. Adhesive.
Halter. Haftend.
Support. Adhésif.
Houder. Klevend.

3.5 × 4 × 0.6 cm
Print Code: B(4)



nexinus



07

19

17

05

Sunner
6258

Holder. Adhesive.
Halter. Haftend.
Support. Adhésif.
Houder. Klevend.

Ø 4.1 × 0.6 cm
Print Code: B(4), W

1000 / 250

02

01

04



19



19



01 02 03 04

Itaka

4993

Lanyard. Silicone.
Schlüsselband. Silikon.
Lanyard. Silicone.
Lanyard. Siliconen.

5.5 × 58 cm 500 / 10

Print Code: G(1)



05 03 01 02

Veltux

5638

Lanyard. Silicone.
Schlüsselband. Silikon.
Lanyard. Silicone.
Lanyard. Siliconen.

7 × 58 cm 300 / 50

Print Code: G(1)

130



19

Lotek

4283

Multipurpose Pouch. Silicone.
Mehrzweckhülle. Silikon.
Étui Multi-Usages. Silicone.
Multifunctionele Hoes. Siliconen.

5.6 × 8.9 × 0.5 cm 1000 / 100

Print Code: F(1)

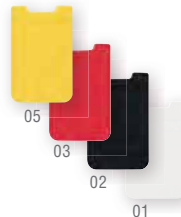

05 03 02 01



19



01 08 02 03



Lepol

5681

Holder Pouch. Silicone. Adhesive.
Halter Hülle. Silikon. Haftend.
Étui Support. Silicone. Adhésif.
Houder Hoes. Siliconen. Klevend.

5.7 × 9.4 × 1 cm 500 / 100

Print Code: L1





Safari

4633

Holder Keyring. Screen Cleaner Included.
Schlüsselanhänger Halter. Displayreiniger Inklusiv.
Porte-Clés Support. Nettoyeur d'Écran Inclus.
Sleutelhanger Houder. Screen Cleaner Inclusief.

2 x 4.8 x 1.3 cm 1000 / 100

Print Code: C(4), W



Walox

4240

Stylus Touch Screen Cleaner.
Touchpad Stift Displayreiniger.
Stylét Nettoyeur d'Écran.
Touchscreen-Pen Schermshoner.

1.5 x 5.3 x 0.8 cm 1000 / 100

Print Code: C(1)



Nopek

4243

Screen Cleaner. Microfibre. Sticky Surface.
Displayreiniger. Mikrofaser. Selbsthaftende.
Nettoyeur d'Écran. Microfibre. Adhésive.
Scherm Schoonmaker. Microfiber. Zelfklevende.

3 x 3 cm 10000 / 100

Print Code: C(1)



SPRAY / SCREEN CLEANER

Clorux

5280

Spray. 15 ml. Refillable. Liquid Not Included. Screen Cleaner Included.
Zerstäuber. 15 ml. Wiederaufladbar. Flüssigkeit Nicht im Lieferumfang. Displayreiniger Inklusiv.
Vaporisateur. 15 ml. Rechargeable. Liquide Non Inclus. Nettoyeur d'Écran Inclus.
Sproeier. 15 ml. Navulbaar. Vloeistof Niet Inclusief. Screen Cleaner Inclusief.

2.7 x 8.8 x 2.7 cm 400 / 100

Print Code: C(4), W



Crislax

5334

Cleaner Cloth. Microfibre.
Putztuch. Mikrofaser.
Chiffon Nettoyant. Microfibre.
Schoonmaakdoekje. Microfiber.

15 x 15 cm 500 / 50

Print Code: E(1), N(8)



TOUCH SCREEN GLOVES



THREE TOUCH SCREEN FINGERTIPS
TRES DEDOS TÁCTILES



Actium
4010

Touchscreen Gloves. Acrylic. One Size. Adult.
Touchpad Handschuhe. Acryl. Einheitsgröße. Erwachsene.
Gant Tactile. Acrylique. Taille Unique. Adulte.
Touchscreen Handschoenen. Acryl. Eén Maat. Volwassen.

Consult.

200 / 10

Print Code: N(8)



132



ALL TOUCH SCREEN FINGERTIPS
TODOS LOS DEDOS TÁCTILES



08



02

Tellar
5131

Touchscreen Gloves. Acrylic. One Size. Adult.
Touchpad Handschuhe. Acryl. Einheitsgröße. Erwachsene.
Gant Tactile. Acrylique. Taille Unique. Adulte.
Touchscreen Handschoenen. Acryl. Eén Maat. Volwassen.

Consult.

200 / 10

Print Code: N(8)



KIDS

TWO TOUCH SCREEN FINGERTIPS
DOS DEDOS TÁCTILES



Pigun
5132

Touchscreen Gloves. Acrylic. One Size. Kids.
Touchpad Handschuhe. Acryl. Einheitsgröße. Kinder.
Gant Tactile. Acrylique. Taille Unique. Enfant.
Touchscreen Handschoenen. Acryl. Eén Maat. Kind.

Consult.

500 / 10

Print Code: N(8)



03



05

19

04



Kelan

5522

Armband. PU. Touch Screen. Reflective.
Armband. PU. Touch Screen. Reflektierend.
Bracelet. Similicuir. Ecran Tactile. Réfléchissant.
Armband. PU. Touch Screen. Reflektierend.

11 × 17 cm 200 / 50

Print Code: E(1), N(8)



Mobile
Compartment



Tactile



Reflective



19



Waterproof



Tactile



Mobile
Compartment



Waterpro

3042

Multipurpose Bag. PVC. Waterproof. Touch Screen.
Mehrzwecktasche. PVC. Wasserdicht. Touch Screen.
Fourre-Tout. PVC. Imperméable. Ecran Tactile.
Multifunctioneel Tasje. PVC. Waterdicht. Touch Screen.

9.5 × 23 cm 500 / 50

Print Code: E(1)



Tactile



Reflective



Mobile
Compartment



05 F



Wanel

5311

Waistbag. Lycra. Touch Screen. Reflective.
Gürteltasche. Lycra. Touch Screen. Reflektierend.
Banane. Lycra. Ecran Tactile. Réfléchissant.
Heuptas. Lycra. Touch Screen. Reflektierend.

24 × 10.5 cm 100 / 50

Print Code: N(8)



TWO POSITIONS AUTO FIT
AJUSTABLE EN DOS POSICIONES



Tecnox
6180

Charger Holder. Wireless. Adjustable. Cable Included.
Ladegerät Halter. Drahtlos. Verstellbar. Kabel Inklusive.
Support Chargeur. Sans Fil. Ajustable. Câble Inclus.
Oplader Houder. Draadloos. Aanpasbaar. Kabel Inclusief.

9.2 × 11 × 6.2 cm

100 / 50

Print Code: E(1)



Vualax
6135

Charger Holder. Wireless. Adjustable. Cable Included.
Ladegerät Halter. Drahtlos. Verstellbar. Kabel Inklusive.
Support Chargeur. Sans Fil. Ajustable. Câble Inclus.
Oplader Houder. Draadloos. Aanpasbaar. Kabel Inclusief.

7.8 × 10.5 × 6.8 cm

50

Print Code: E(1)



ADJUSTABLE
AJUSTABLE



ADJUSTABLE
AJUSTABLE



ADJUSTABLE
AJUSTABLE

ALUMINIUM



ANTI SLIP
ANTIDESLIZANTE



09



Lietor
6483

Holder. Adjustable.
Halter. Verstellbar.
Support. Ajustable.
Houder. Aanpasbaar.

9.2 × 8.9 × 5.5 cm

100 / 50

Print Code: E(1)



02

Seinox
5798

Holder. Aluminium. Adjustable.
Halter. Aluminium. Verstellbar.
Support. Aluminium. Ajustable.
Houder. Aluminium. Aanpasbaar.

11.2 × 9.5 × 5.5 cm

Print Code: E(1), L1

200 / 50



Wantol
5749

Dashboard Holder. Sticky Surface.
Bildschirmträger. Selbsthaftende Oberfläche.
Ecran Support. Surface Adhésive.
Dashboard Houder. Zelfklevende Oppervlakte.

15 × 11 × 10 cm

Print Code: D(1)

50





NEW QUICK FASTENING SYSTEM FOR CAR
NUEVO SISTEMA DE SUJECCION RÁPIDA PARA COCHE



Aragor

5540

Holder. Aluminium. Adhesive and Magnetic.
 Halter. Aluminium. Haftend und Magnetisch.
 Support. Aluminium. Adhésif et Magnétique.
 Houder. Aluminium. Klevend en Magnetisch.

Ø 3.3 × 3 cm

200 / 50

Print Code: F(1), L1



Atosh

6270

Holder. Metal. Adhesive.
 Halter. Metall. Haftend.
 Support. Métal. Adhésif.
 Houder. Metaal. Klevend.

3.2 × 4.8 × 1.2 cm

500 / 100

Print Code: C(1), L1



Kruzol

5954

Holder. Aluminium. Adhesive and Magnetic.
 Halter. Aluminium. Haftend und Magnetisch.
 Support. Aluminium. Adhésif et Magnétique.
 Houder. Aluminium. Klevend en Magnetisch.

Ø 3.5 × 5 cm

200 / 50

Print Code: F(1), L1



Glatix

6224

Holder.
 Halter.
 Support.
 Houder.

Ø 3.6 × 5.3 cm

200 / 50

Print Code: F(1)



Gumbol

6785

Holder. Adjustable.
 Halter. Verstellbar.
 Support. Adjustable.
 Houder. Aanpasbaar.

7.7 × 3.2 × 7.4 cm

300 / 50

Print Code: E(1)

ROTATORY AND
 ADJUSTABLE





COMPATIBLE WITH
ANDROID & iOS

2 SALIDAS USB



PARKING SITE SEARCHING
LOCALIZADOR DE APARCAMIENTO

GPS TRACKERS

Bluetooth®



Breter
5823

GPS USB Car Charger. Bluetooth Connection. 2 USB Outputs. 2400 mA.
GPS USB Autoladegerät. Bluetooth Anschluss. 2 USB Ausgänge. 2400 mA.
GPS Chargeur Voiture USB. Connexion Bluetooth. 2 Sorties USB. 2400 mA.
GPS USB Auto Oplader. Bluetooth Verbinding. 2 USB Outputs. 2400 mA.

2.6 × 5.7 × 3.2 cm 200 / 50

Print Code: C(4)



2-in-1
Multifunction

Kerub
5534

Holder Charger. 2 USB Outputs. 3100 mA.
Halter Ladegerät. 2 USB Ausgänge. 3100 mA.
Chargeur Support. 2 Sorties USB. 3100 mA.
Houder Oplader. 2 USB Outputs. 3100 mA.

8.2 × 11 × 9.4 cm

Print Code: F(1)

50



136



01

02



IDEAL FOR BACK PASSENGERS
IDEAL PARA PASAJEROS DE ATRÁS



Santer
5333

USB Car Charger. 2 USB Outputs. 3000 mA. 3 Functions.
USB Autoladegerät. 2 USB Ausgänge. 3000 mA. 3 Funktionen.
Chargeur Voiture USB. 2 Sorties USB. 3000 mA. 3 Fonctions.
USB Auto Oplader. 2 USB Outputs. 3000 mA. 3 Functies.

2.3 × 8.5 × 5.1 cm 100 / 50

Print Code: C(4), L1

BELT CUTTER
CORTACINTURONES



GLASS BREAKER
ROMPECRISTALES



Yofren
5209

USB Car Charger. 4 USB Outputs. 3100 mA.
USB Autoladegerät. 4 USB Ausgänge. 3100 mA.
Chargeur Voiture USB. 4 Sorties USB. 3100 mA.
USB Auto Oplader. 4 USB Outputs. 3100 mA.

180 cm

Print Code: E(4)

50

Domky
5772

Bluetooth Receiver. Bluetooth Connection. 3.5 mm Jack Socket. USB Connection. Retractable Cable.
Bluetooth-Empfänger. Bluetooth Anschluss. 3.5 mm Klinkenstecker. USB Anschluss. Ausziehbar Kabel.
Récepteur Bluetooth. Connexion Bluetooth. Connexion Jack 3,5 mm. Connexion USB. Câble Extensible.
Ontvanger Bluetooth. Bluetooth Verbinding. 3,5 mm Jack Aansluiting. USB Verbinding. Verlengbare Kabel.

2.2 × 5.6 × 1.1 cm 200 / 100

Print Code: E(4)



Bluetooth Hand-free Micro SD Bluetooth play Microphone Play control Audio out Car reader function

Bluetooth®



Home / Office

Car



Hikal

4210

USB Car Charger. 1000 mA.
USB Autoladegerät. 1000 mA.
Chargeur Voiture USB. 1000 mA.
USB Auto Oplader. 1000 mA.

Ø 2.3 × 5.6 cm

Print Code: C(4)

500 / 50



03



05

Heyon

4211

USB Car Charger. 2 USB Outputs. 2100 mA.
USB Autoladegerät. 2 USB Ausgänge. 2100 mA.
Chargeur Voiture USB. 2 Sorties USB. 2100 mA.
USB Auto Oplader. 2 USB Outputs. 2100 mA.

2.6 × 8 × 3.7 cm 500 / 50

Print Code: C(4)



19



03



04



01

Denom

4950

USB Car Charger. 2 USB Outputs. 2100 mA.
USB Autoladegerät. 2 USB Ausgänge. 2100 mA.
Chargeur Voiture USB. 2 Sorties USB. 2100 mA.
USB Auto Oplader. 2 USB Outputs. 2100 mA.

Ø 3.2 × 6.2 cm

500 / 50

Print Code: C(4)

Kerwin

5579

USB Car Charger. 2 USB Outputs. 2100 mA.
USB Autoladegerät. 2 USB Ausgänge. 2100 mA.
Chargeur Voiture USB. 2 Sorties USB. 2100 mA.
USB Auto Oplader. 2 USB Outputs. 2100 mA.

3.9 × 7.2 × 5.1 cm

200 / 50

Print Code: C(4)



Ridekal

5968

Set. USB Car Charger 2 USB Outputs 2100 mA. Holder Adhesive and Magnetic.
Set. USB Autoladegerät 2 USB Ausgänge 2100 mA. Halter Haftend und Magnetisch.
Set. Chargeur Voiture USB 2 Sorties USB 2100 mA. Support Adhésif et Magnétique.
Set. USB Auto Oplader 2 USB Uitgangen 2100 mA. Houder Klevend en Magnetisch.

9.6 × 3.6 × 9.2 cm 100 / 50

Print Code: E(1), F(1), L2





19



Tablet

50

Osorix

5780

Holder. Adjustable.
Halter. Verstellbar.
Support. Ajustable.
Houder. Aanpasbaar.

18 × 7 × 14 cm

Print Code: E(1)



Tablet

Razter

5648

Holder Pouch. Polyester 600D.
Halter Hülle. Polyester 600D.
Étui Support. Polyester 600D.
Houder Hoes. Polyester 600D.

28 × 22 × 2.5 cm

Print Code: G(1), N(8)

30



03

08

AA/ R06

2308

4 Batteries Pack 1.5V.
Blister 4 Batterien 1.5V.
Blister 4 Piles 1.5V.
4 Batterijen Pak 1.5V.

8.5 × 11.5 × 1.6 cm 240 / 12

Print Code: Consult.



AAA/ R03

2309

4 Batteries Pack 1.5V.
Blister 4 Batterien 1.5V.
Blister 4 Piles 1.5V.
4 Batterijen Pak 1.5V.

8.4 × 11.4 × 1.2 cm 288 / 12

Print Code: Consult.



Prego 9301

Wall Clock. 1 Battery AA Not Included.
Wanduhr. 1 AA Batterie Nicht im Lieferumfang.
Pendule. 1 Pile AA Non Inclus.
Wandklok. 1 Batterij AA Niet Inclusief.

📏 Ø 32 × 2.2 cm
🎨 Print Code: G(1)



02



Cronos 3676

Wall Clock. 1 Battery AA Not Included.
Wanduhr. 1 AA Batterie Nicht im Lieferumfang.
Pendule. 1 Pile AA Non Inclus.
Wandklok. 1 Batterij AA Niet Inclusief.

📏 Ø 29.8 × 4 cm
🎨 Print Code: F(1)



01

19

03



Zelmo 4450

Pot Desk Clock. Button Battery Included.
Blumentopf Tischuhr. Knopfzelle Inklusive.
Horloge Pot. Pile Bouton Inclus.
Bloempot Klok. Knooppcel Batterij Inclusief.

📏 Ø 11 × 9.8 cm
🎨 Print Code: E(1)



19



03

02

05



Proter 3457

Desk Clock. Aluminium. 1 Battery AA Not Included.
Tischuhr. Aluminium. 1 AA Batterie Nicht im Lieferumfang.
Horloge. Aluminium. 1 Pile AA Non Inclus.
Klok. Aluminium. 1 Batterij AA Niet Inclusief.

📏 Ø 8.8 × 5.2 cm
🎨 Print Code: E(1)



19



03

OFFICE & BUSIN- ESS



Kion
PG. 145



WHEAT
STRAW &

BAMBOO

WIRELESS CHARGER



BAMBOO

ORGANIZER

Tongal
6794

Organizer. Bamboo.
Ordner. Bambus.
Organiseur. Bambou.
Organizer. Bamboe.

9 x 16.5 x 0.9 cm 100 / 50
Print Code: D(4), L2, W



Tongal

RPET

The fabric used in the manufacturing process of these items is made of recycled plastic (RPET). Like this, the emission of plastic residues to our planet and the consumption of energy is drastically reduced, resulting in a much more eco-friendly process.

El material de estos productos está fabricado con plástico reciclado (RPET), que, además de ayudar en la disminución de residuos plásticos en el planeta, utiliza menos energía en el proceso de fabricación, haciendo que sea mucho menos dañino para el medio ambiente.



Pirok
pg. 151

STOP **PLASTIC**
POLLUTING
THE OCEAN



Wireless
Charger

Dilfox 6525

Organizer Charger. Natural Cork. Wireless. Cable Included.
Ordner Ladegerät. Naturkork. Drahtlos. Kabel Inklusive.
Chargeur Organiseur. Bouchon Naturel. Sans Fil. Câble Inclus.
Organizer Oplader. Natuurlijk Kurk. Draadloos. Kabel Inclusief.

26.9 × 1.8 × 15 cm

50 / 25

Print Code: F(2), L2, W



142



Toskan 6616

Charger Notepad. Natural Cork. Wireless. 64 Sheets. Cable Included.
Ladegerät Notizblock. Naturkork. Drahtlos. 64 Seiten. Kabel Inklusive.
Bloc Notes Chargeur. Bouchon Naturel. Sans Fil. 64 Feuilles. Câble Inclus.
Oplader Notitieblokje. Natuurlijk Kurk. Draadloos. 64 Bladzjes. Kabel Inclusief.

17.5 × 22.5 × 3 cm

20

Print Code: G(1), L2



Wireless
Charger



64 Sheets
Lined



CORK

WIRELESS CHARGER



Wireless
Charger



Anti Slip



Holder

Relium 6615

Charger Mousepad. Natural Cork/Velvet. Wireless. Cable Included.
Ladegerät Mauspad. Naturkork/ Wildleder. Drahtlos. Kabel Inklusive.
Tapis Souris Chargeur. Bouchon Naturel/ Suedine. Sans Fil. Câble Inclus.
Oplader Muispad. Natuurlijk Kurk/ Fluweel. Draadloos. Kabel Inclusief.

26.5 × 20.5 cm

50

Print Code: F(1), L2



PIECES FROM NATURAL CUTS OF BAMBOO.
THE TEXTURE AND COLOR MAY VARY.PIEZAS PROCEDENTES
DE CORTE DE BAMBÚ NATURAL.
SU TEXTURA Y COLOR PUEDEN VARIAR

WIRELESS CHARGER

ORGANIZER

BAMBOO



Trons 6527

Organizer Charger. Bamboo. Wireless. USB Output. 1000 mA. Cable Included.
 Ordner Ladegerät. Bambus. Drahtlos. USB Ausgang. 1000 mA. Kabel Inklusiv.
 Chargeur Organiseur. Bambou. Sans Fil. Sortie USB. 1000 mA. Câble Inclus.
 Organizer Oplader. Bamboe. Draadloos. USB Output. 1000 mA. Kabel Inclusief.

18.5 × 1.4 × 11.5 cm

50 / 25

Print Code: E(4), L2, W



143



Tankul

6526

Organizer Charger. Bamboo. Wireless. USB Output. 1000 mA. Cable Included.
 Ordner Ladegerät. Bambus. Drahtlos. USB Ausgang. 1000 mA. Kabel Inklusiv.
 Chargeur Organiseur. Bambou. Sans Fil. Sortie USB. 1000 mA. Câble Inclus.
 Organizer Oplader. Bamboe. Draadloos. USB Output. 1000 mA. Kabel Inclusief.

25.5 × 1.4 × 13.5 cm

50 / 25

Print Code: E(4), L2, W



NEW

PIECES FROM NATURAL CUTS OF BAMBOO.
THE TEXTURE AND COLOUR MAY VARY.

PIEZAS PROCEDENTES
DE CORTE DE BAMBU NATURAL.
SU TEXTURA Y COLOR PUEDEN VARIAR

BAMBOO

SUITABLE FOR TABLETS
AND MOBILE PHONES
/ VÁLIDO TABLETS Y
TELÉFONOS MÓVILES

Vartol

6735

Charger. Bamboo. Wireless. Cable Included.
Ladegerät. Bambus. Drahtlos. Kabel inklusive.
Chargeur. Bambou. Sans Fil. Câble Inclus.
Oplader. Bamboe. Draadloos. Kabel Inclusief.

12.5 x 1.6 x 8 cm

100 / 50

Print Code: E(4), L2



Wireless
Charger



Wireless
Charger

Dimper

6521

Charger. Bamboo. Wireless. Cable Included.
Ladegerät. Bambus. Drahtlos. Kabel inklusive.
Chargeur. Bambou. Sans Fil. Câble Inclus.
Oplader. Bamboe. Draadloos. Kabel Inclusief.

7 x 11.5 x 8 cm

50 / 25

Print Code: E(4), L2



NEW

Protok

6797

Holder. Bamboo.
Halter. Bambus.
Support. Bambou.
Houder. Bamboe.

8 x 12 x 8.1 cm

100 / 50

Print Code: D(4), L2, W





NEW

MAGNA

PENCIL HOLDER

Wireless
ChargerFast charge
10W

Kion

6775

Charger Pencil Holder. Bamboo/ Wheat Straw/ ABS. Wireless. Fast Charger 10W. Cable Included.
Ladegerät Stifthalter. Bambou/ Weizenstroh/ ABS. Drahtlos. Schnelle Aufladung 10W. Kabel Inklusiv.
Porte-Crayons Chargeur. Bambou/ Paille de Blé/ ABS. Sans Fil. Charge Rapide 10W. Câble Inclus.
Oplader Pennebakje. Bamboe/ Tarwestro/ ABS. Draadloos. Snellader 10W. Kabel Inclusief.

15 x 11 x 7.5 cm

40 / 20

Print Code: F(4), L2



NEW

Wireless
Charger

Holder

USB HUB



WIRELESS CHARGER



HOLDER / SOPORTE



4 IN 1

Dowex

6709

Multifunction Pencil Holder. Wheat Straw/ ABS. Wireless. 3 Hubs. USB 2.0. Cable Included.
Multifunktion Stifthalter. Weizenstroh/ ABS. Drahtlos. 3 Hubs. USB 2.0. Kabel Inklusiv.
Porte-Crayons Multifonction. Paille de Blé/ ABS. Sans Fil. 3 Ports. USB 2.0. Câble Inclus.
Multifunctioneel Pennebakje. Tarwestro/ ABS. Draadloos. 3 Poorten. USB 2.0. Kabel Inclusief.

8.5 x 10 x 9 cm

50 / 25

Print Code: F(4), W



NEW

Petrox

6807

Multifunction Pencil Holder. Bamboo/ ABS. Button Battery Included.
Multifunktion Stifthalter. Bambou/ ABS. Knopfzelle Inklusiv.
Porte-Crayons Multifonction. Bambou/ ABS. Pile Bouton Inclus.
Multifunctioneel Pennebakje. Bamboe/ ABS. Knoopcel Batterij Inclusief.

10.2 x 11.9 x 5.4 cm

50

Print Code: F(4), L2



Temperature



Alarm



Time & Date

Porem 6328

Charger Folder. PU/ Polyester 300D. Wireless. 40 Sheets Notepad. Cable Included.
Ladegerät Mappe. PU/ Polyester 300D. Drahtlos. 40 Seiten Notizblock. Kabel Inklusive.
Porte-Documents Chargeur. Similicuir/ Polyester 300D. Sans Fil. 40 Feuilles. Cable Inclus.
Oplader Map. PU/ Polyester 300D. Draadloos. 40 Blaadjes Notepad. Kabel Inclusief.

23.5 × 31 × 2 cm

20

Print Code: G(1), N(8)



40 Sheets
Lined



Wireless
Charger



WIRELESS CHARGER

146



Kevant



Wireless
Charger



80 Sheets
Lined



Kevant

6185

Charger Notepad. Polyester 300D. Wireless. Hard Cover. 80 Sheets. Cable Included.
Ladegerät Notizblock. Polyester 300D. Drahtlos. Hardcover-Abdeckung. 80 Seiten. Kabel Inklusive.
Bloc Notes Chargeur. Polyester 300D. Sans Fil. Couverture Rigide. 80 Feuilles. Cable Inclus.
Oplader Notitieblokje. Polyester 300D. Draadloos. Harde Kaft. 80 Blaadjes. Kabel Inclusief.

14.5 × 21.5 × 1.8 cm

40 / 20

Print Code: G(1), N(8)



Wireless
Charger

Merson

6326

Charger Organizer. PU. Wireless. Cable Included.
Ladegerät Ordner. PU. Drahtlos. Kabel Inklusive.
Organiseur Chargeur. Similicuir. Sans Fil. Câble Inclus.
Oplader Organizer. PU. Draadloos. Kabel Inclusief.

11.1 × 21.5 × 2 cm

100 / 20

Print Code: G(1), N(8)



Power Bank

Wireless
Charger4000
mAh

Surey

6327

Power Bank Organizer. PU/ Polyester 300D. Wireless. 4000 mAh. 64 Sheets Notepad. USB Output. Micro USB Input. Cable Included.
Power Bank Ordner. PU/ Polyester 300D. Drahtlos. 4000 mAh. 64 Seiten Notizblock. USB Ausgang. Micro USB Eingang. Kabel Inklusive.
Organiseur Power Bank. Similicuir/ Polyester 300D. Sans Fil. 4000 mAh. Bloc 64 Feuilles. Sortie USB. Entrée Micro USB. Câble Inclus.
Power Bank Organizer. PU/ Polyester 300D. Draadloos. 4000 mAh. 64 Blaadjes Notepad. USB Output. Micro USB Input. Kabel Inclusief.

18.5 × 25.5 × 3.7 cm

20

Print Code: G(1), L2

64 Sheets
Lined

WIRELESS CHARGER

4000
mAh20 Sheets
Lined

USB MEMORY 16GB INCLUDED

Malvet

6025



Power Bank

Wireless
Charger

USB

Multifunction Notepad. Polyester 300D. Wireless. 4000 mAh. USB Output. Micro USB Input. 20 Sheets Notepad. USB Memory 16GB Included. Cable Included.
Multifunktion Notizblock. Polyester 300D. Drahtlos. 4000 mAh. USB Ausgang. Micro USB Eingang. 20 Seiten Notizblock. USB Speicher 16GB Inklusive. Kabel Inklusive.
Bloc Notes Multifonction. Polyester 300D. Sans Fil. 4000 mAh. Sortie USB. Entrée Micro USB. Bloc 20 Feuilles. Clé USB 16GB Inclus. Câble Inclus.
Multifunctioneel Notitieblokje. Polyester 300D. Draadloos. 4000 mAh. USB Output. Micro USB Input. 20 Blaadjes Notepad. USB Memory 16GB Inclusief. Kabel Inclusief.

17.5 × 22.2 × 3 cm

20

Print Code: G(1), L2, N(8)



POWER BANK

Jaiden

5000 mAh

ANTONIO MIRO
Helmux

3000 mAh

Hoopel

148

5000 mAh

TOUCH SCREEN
PANTALLA TÁCTIL



Helmux
7351

Power Bank Folder. Polyester 600D. 5000 mAh. 65 Sheets Notepad. USB Output. Micro USB Input. Cable Included.

Power Bank Mappe. Polyester 600D. 5000 mAh. 65 Seiten Notizblock. USB Ausgang. Micro USB Eingang. Kabel Inklusive.

Porte-Documents Power Bank. Polyester 600D. 5000 mAh. Bloc 65 Feuilles. Sortie USB. Entrée Micro USB. Câble Inclus.

Power Bank Map. Polyester 600D. 5000 mAh. 65 Bładjes Notepad. USB Output. Micro USB Input. Kabel Inklusief.

21.5 × 26.5 × 3 cm

10

Print Code: G(1), N(8)



TOUCH SCREEN
PANTALLA TÁCTIL



Jaiden
5220

Power Bank Folder. PU. 5000 mAh. USB Output. Micro USB Input. 20 Sheets Notepad. Cable Included.

Power Bank Mappe. PU. 5000 mAh. USB Ausgang. Micro USB Eingang. 20 Seiten Notizblock. Kabel Inklusive.

Porte-Documents Power Bank. Similicuir. 5000 mAh. Sortie USB. Entrée Micro USB. Bloc 20 Feuilles. Câble Inclus.

Power Bank Map. PU. 5000 mAh. USB Output. Micro USB Input. 20 Bładjes Notepad. Kabel Inklusief.

26 × 34 × 4 cm

10

Print Code: G(1)

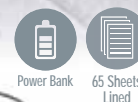

Hoopel
5397

Power Bank Notepad. PU. 3000 mAh. USB Output. Micro USB Input. 65 Sheets Notepad. Cable Included.

Power Bank Notizblock. PU. 3000 mAh. USB Ausgang. Micro USB Eingang. 65 Seiten Notizblock. Kabel Inklusive.

Bloc Notes Power Bank. Similicuir. 3000 mAh. Sortie USB. Entrée Micro USB. Bloc 65 Feuilles. Câble Inclus.

Power Bank Notitieblokje. PU. 3000 mAh. USB Output. Micro USB Input. 65 Bładjes Notepad. Kabel Inklusief.

17.5 × 22.5 × 2.5 cm

20

Print Code: G(1)



4000
mAh4000
mAh20 Sheets
Lined

Power Bank

Boozel
6024



Power Bank Folder. Polyester 300D. 4000 mAh. USB Output. Micro USB Input. 20 Sheets Notepad. Cable Included.
 Power Bank Mappe. Polyester 300D. 4000 mAh. USB Ausgang. Micro USB Eingang. 20 Seiten Notizblock. Kabel Inklusive.
 Porte-Documents Power Bank. Polyester 300D. 4000 mAh. Sortie USB. Entrée Micro USB. Bloc 20 Feuilles. Câble Inclus.
 Power Bank Map. Polyester 300D. 4000 mAh. USB Output. Micro USB Input. 20 Blaadjes Notepad. Kabel Inclusief.

23.5 × 31 × 3 cm



Print Code: G(1), L2, N(8)

20 Sheets
Lined

Power Bank

Kaylox
6023



Power Bank Notepad. Polyester 300D. 4000 mAh. USB Output. Micro USB Input. 20 Sheets Notepad. Cable Included.
 Power Bank Notizblock. Polyester 300D. 4000 mAh. USB Ausgang. Micro USB Eingang. 20 Seiten Notizblock. Kabel Inklusive.
 Bloc Notes Power Bank. Polyester 300D. 4000 mAh. Sortie USB. Entrée Micro USB. Bloc 20 Feuilles. Câble Inclus.
 Power Bank Notitieblokje. Polyester 300D. 4000 mAh. USB Output. Micro USB Input. 20 Blaadjes Notepad. Kabel Inclusief.

17.5 × 22.2 × 3 cm



Print Code: G(1), L2, N(8)



RPET

The fabric used in the manufacturing process of these items is made of recycled plastic (RPET). Like this, the emission of plastic residues to our planet and the consumption of energy is drastically reduced, resulting in a much more eco-friendly process.

El material de estos productos está fabricado con plástico reciclado (RPET), que, además de ayudar en la disminución de residuos plásticos en el planeta, utiliza menos energía en el proceso de fabricación, haciendo que sea mucho menos dañino para el medio ambiente.

STOP PLASTIC POLLUTING THE OCEAN

150



NEW

NEW



Divaz

6846

Document Bag. Polyester 600D RPET.
Dokumententasche. Polyester 600D RPET.
Porte-Documents. Polyester 600D RPET.
Aktentas. Polyester 600D RPET.

39 × 27 × 3.5 cm

100 / 20

Print Code: F(1), N(8)

Hops

6847

Laptop Pouch. Polyester 600D RPET. Padded.
Laptop-Tasche. Polyester 600D RPET. Gepolstert.
Housse pour Ordinateur Portable. Polyester 600D RPET. Rembourée.
Laptoptasje. Polyester 600D RPET. Gewatteerd.

36 × 26 × 4.5 cm

100

Print Code: F(1), N(8)



15"

Laptop
Compartment

RPET

NEW



151

NEW



RPET



Sorgax

6844

Folder. Polyester RPET. 20 Sheets Notepad.

Mappe. Polyester RPET. 20 Seiten Notizblock.

Porte-Documents. Polyester RPET. Bloc 20 Feuilles.

Map. Polyester RPET. 20 Blaadjes Notepad.

24.5 × 32 × 1.5 cm

20

Print Code: G(1), L2, N(8)



20 Sheets Lined



Tablet Compartment



Laptop Compartment



Trolley Strap



RPET

Pirok

6845

Document Bag. Polyester 600D RPET. Padded Laptop and Tablet Compartment.

Dokumenten Tasche. Polyester 600D RPET. Gepolsterte Laptoptasche und Tablet.

Porte-Documents. Polyester 600D RPET. Pochette Rembourrée pour Portable et Tablet.

Aktentas. Polyester 600D RPET. Gewatteerd Laptop en Tablet Compartment.

38 × 28 × 5 cm

40

Print Code: G(1), N(8)





RPET

The fabric used in the manufacturing process of these Items is made of recycled plastic (RPET). Like this, the emission of plastic residues to our planet and the consumption of energy is drastically reduced, resulting in a much more eco-friendly process.

El material de estos productos está fabricado con plástico reciclado (RPET), que, además de ayudar en la disminución de residuos plásticos en el planeta, utiliza menos energía en el proceso de fabricación, haciendo que sea mucho menos dañino para el medio ambiente.

STOP PLASTIC POLLUTING THE OCEAN



NEW

152



NEW



- Anti-theft pocket
- Trolley Strap
- RPET
- 12" Tablet Compartment
- 15" Laptop Compartment

- RPET
- 10" Tablet Compartment
- 15" Laptop Compartment

Bulman

6848
 Anti-Theft Backpack. Polyester 600D RPET. Padded Laptop and Tablet Compartment. Padded Back and Shoulder Straps.
 Anti-Diebstahl Rucksack. Polyester 600D RPET. Gepolsterte Laptoptasche und Tablet. Gepolsterter Rücken und Schultergurte.
 Sac à Dos Antivol. Polyester 600D RPET. Pochette Rembourrée pour Portable et Tablet. Dos et Bretelles Rembourrées.
 Anti-Diefstal Rugzak. Polyester 600D RPET. Gewatteerd Laptop en Tablet Compartiment. Gewatteerde Achterzijde en Schouderbanden.

35 x 47 x 15 cm 20 Print Code: G(1), N(8)



Terrex

6749
 Backpack. Polyester 600D RPET. Padded Laptop and Tablet Compartment. Padded Back and Shoulder Straps.
 Rucksack. Polyester 600D RPET. Gepolsterte Laptoptasche und Tablet. Gepolsterter Rücken und Schultergurte.
 Sac à Dos. Polyester 600D RPET. Pochette Rembourrée pour Portable et Tablet. Dos et Bretelles Rembourrées.
 Rugzak. Polyester 600D RPET. Gewatteerd Laptop en Tablet Compartiment. Gewatteerde Achterzijde en Schouderbanden.

31 x 45 x 13 cm 20 Print Code: G(1), N(8)



UV STERILIZER



RFID Protection UVC Sterilizer NEW

Boxny

6674
 UV Sterilizer Organizer. Polyester 600D/ PU. Ultraviolet Light. RFID Protected. USB Connection. Cable Included.
 UV Sterilisator Ordner. Polyester 600D/ PU. Ultraviolettes Licht. RFID Schutz. USB Anschluss. Kabel Inklusive.
 Organisateur Stérilisateur UV. Polyester 600D/ PU. Ultraviolets. Protecteur RFID. Connexion USB. Câble Inclus.
 UV Sterilisator Organizer. Polyester 600D/ PU. Ultraviolet Licht. RFID Bescherming. USB Verbinding. Kabel Inclusief.

12 x 18.5 x 4 cm 50 / 25
 Print Code: G(1), N(8)



Trolley Strap
 Antibacterial
 15" Laptop Compartment

NEW



NEW



153

Anti Theft pocket Trolley Strap UVC Sterilizer

CONNECT YOUR POWER BANK

Kraps

6750
 UV Sterilizer Backpack. Polyester 600D. Padded. Padded Laptop and Tablet Compartment. Ultraviolet Light. USB Connection. Cable Included.
 UV Sterilisator Rucksack. Polyester 600D. Gepolstert. Gepolsterte Laptotasche und Tablet. Ultraviolettes Licht. USB Anschluss. Kabel Inklusive.
 Sac à Dos Stérilisateur UV. Polyester 600D. Rembourré. Pochette Rembourrée pour Portable et Tablet. Ultraviolets. Connexion USB. Câble Inclus.
 UV Sterilisator Rugzak. Polyester 600D. Gewatteerd. Gewatteerd Laptop en Tablet Compartment. Ultraviolet Licht. USB Verbinding. Kabel Inclusief.

30 x 43 x 12 cm 10
 Print Code: I(8)

Mordux

6704
 Antibacterial Backpack. Polyester 600D. Padded. Padded Laptop Compartment.
 Antibakteriell Rucksack. Polyester 600D. Gepolstert. Gepolsterte Laptotasche.
 Sac à Dos Antibactérienne. Polyester 600D. Rembourré. Pochette Rembourrée pour Portable.
 Antibacterieel Rugzak. Polyester 600D. Gewatteerd. Gewatteerd Laptop Compartment.

30 x 43 x 14 cm 20
 Print Code: G(1), N(8)

ANTIBACTERIAL





Antibacterial



Wireless Mouse

Supot
6689

Antibacterial Mouse. Wireless. Optical. 2 Batteries AAA Not Included.
Antibakteriell Maus. Drahtlos. Optisch. 2 AAA Batterien Nicht im Lieferumfang.
Souris Antibactérienne. Sans Fil. Optique. 2 Piles AAA Non Inclus.
Antibacterieel Muis. Draadloos. Optical. 2 Batterijen AAA Niet Inclusief.

11.2 x 2.4 x 5.7 cm

200 / 100

Print Code: E(4), W

DPI BUTTON
BOTÓN DPI

NEW



Antibacterial

NEW



NEW



Antibacterial

Walin

6764

Antibacterial Mousepad. Polyester/ Silicone.
Antibakteriell Mauspad. Polyester/ Silikon.
Tapis Souris Antibactérien. Polyester/ Silicone.
Antibacterieel Muispad. Polyester/ Siliconen.

22 x 18 cm

250 / 50

Print Code: E(1)



Anti Slip



Anti Slip

Tabun

2606

Antibacterial Mousepad. PP/ EVA.
Antibakteriell Mauspad. PP/ EVA.
Tapis Souris Antibactérien. PP/ EVA.
Antibacterieel Muispad. PP/ EVA.

22 x 16.8 cm

100 / 10

Print Code: E(1)

45 ml



NEW

Bisnal

6698

Automatic Dispenser. 45 ml. USB Rechargeable. Cable Included.
 Automatisch Spender. 45 ml. USB Wiederaufladbar. Kabel Inklusive.
 Distributeur Automatique. 45 ml. Rechargeable USB. Câble Inclus.
 Automatisch Dispenser. 45 ml. USB Opladbaar. Kabel Inclusief.

5.5 x 9 x 7.5 cm

50

Print Code: E(4), W

 WITH MOTION SENSOR
 CON SENSOR DE MOVIMIENTO

NEW

NEW

ANTIBACTERIAL



Antibacterial



Yest

6884

Antibacterial Lanyard. Polyester.
 Antibakteriell Schlüsselband. Polyester.
 Lanyard Antibactérien. Polyester.
 Antibacterieel Lanyard. Polyester.

2 x 50 cm

1000 / 100

Print Code: F(1), N(8), R

CONSULT

NEW



Antibacterial

ANTI BACTERIAL ISO 20743

Nitria

6679

Antibacterial Ruler.
 Antibakteriell Lineal.
 Règle Antibactérienne.
 Antibacterieel Liniaal.

31.5 x 4 x 0.2 cm

Print Code: D(1), W

500 / 100



NEW

DIGITALTREE

YOUR CONTACT SOLUTION

ANTIBACTERIAL



Antibacterial



Adhesive



ULTRA SLIM / ULTRA DELGADO

Hislot

6687

Antibacterial Webcam Cover. Adhesive.
 Antibakteriell Webcam-Blocker. Haftend.
 Bloqueur Webcam Antibactérien. Adhésif.
 Antibacterieel Webcam Blocker. Klevend.

3.2 x 1.3 x 0.1 cm

10000 / 5000

Print Code: B(1), W

Antibacterial material specially processed to inhibit and prevent bacterial growth, due to the incorporation of permanent static microbial agents, which are highly effective in the control against bacterial contamination.

Material antibacteriano, especialmente procesado para inhibir y prevenir las cargas bacterianas, gracias a la incorporación de agentes microbianos permanentes estáticos, con alta efectividad contra la contaminación bacteriana.

NEW

156



NEW

NEW

NEW



Tungol

2593

Antibacterial Notepad. Hard Cover. 80 Sheets.
Antibakteriell Notizblock. Hardcover-Abdeckung. 80 Seiten.
Bloc Notes Antibactérien. Similicuir. Couverture Rigide. 80 Feuilles.
Antibacterieel Notitieblokje. PU. Harde Kaft. 80 Blaadjes.

15.5 × 21 × 1.6 cm

30

Print Code: E(4)



Neltec

2592

Antibacterial Notebook. 80 Sheets.
Antibakteriell Notizbuch. 80 Seiten.
Cahier Antibactérien. 80 Feuilles.
Antibacterieel Notitieboek. 80 Blaadjes.

14.9 × 20.6 × 0.8 cm

30

Print Code: E(4)



Polax

2591

Antibacterial Notebook. 80 Sheets.
Antibakteriell Notizbuch. 80 Seiten.
Cahier Antibactérien. 80 Feuilles.
Antibacterieel Notitieboek. 80 Blaadjes.

15.5 × 21 × 1.6 cm

30

Print Code: E(4)



100 Sheets
Plain

RPET

i The fabric used in the manufacturing process of this notebook is made of recycled plastic (RPET). Like this, the emission of plastic residues to our planet and the consumption of energy is drastically reduced, resulting in a much more eco-friendly process.

El material de este bloc está fabricado con plástico reciclado (RPET), que, además de ayudar en la disminución de residuos plásticos en el planeta, utiliza menos energía en el proceso de fabricación, haciendo que sea mucho menos dañino para el medio ambiente.

STOP **PLASTIC**
POLLUTING
THE OCEAN



157



Meivax

6722

Noteпад. Polyester 600D RPET. Hard Cover. 80 Sheets.

Notizblock. Polyester 600D RPET. Hardcover-Abdeckung. 80 Seiten.

Bloc Notes. Polyester 600D RPET. Couverture Rigide. 80 Feuilles.

Notitieblokje. Polyester 600D RPET. Harde Kaft. 80 Blaadjes.

14.7 × 21 × 1.5 cm

50 / 25

Print Code: E(4)

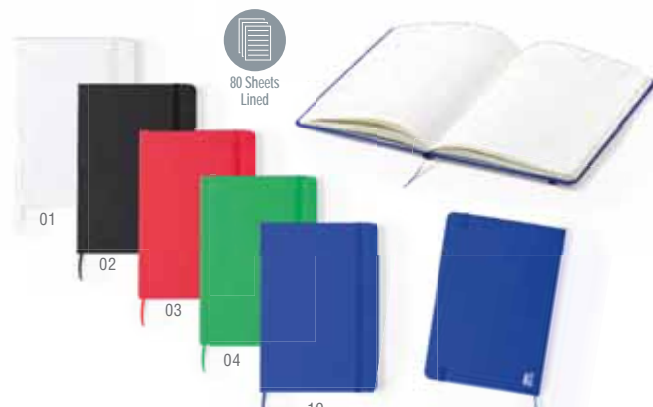

80 Sheets
Lined

Brastel

Hartil

Climer

mini dog

MLK DAY

PEN INCLUDED
BOLIGRAFO INCLUIDO

158



80 Sheets
Plain



Brastel

6394

Notepad. Natural Cork/ Cotton. Hard Cover. 80 Sheets. Natural Cork/ Wheat Straw/ ABS Pen Included. Black Ink.

Notizblock. Naturkork/ Baumwolle. Hardcover-Abdeckung. 80 Seiten. Naturkork/ Weizenstroh/ ABS Kugelschreiber Inklusive. Schwarze Tinte.

Bloc Notes. Bouchon Naturel/ Coton. Couverture Rigide. 80 Feuilles. Stylo Bouchon Naturel/ Paille de Blé/ ABS Inclus. Entree Noire.

Notitieblokje. Natuurlijk Kurk/ Katoen. Harde Kaft. 80 Blaadjes. Pen Natuurlijk Kurk/ Tarwestro/ ABS Inclusief. Zwarte Inkt.

14.5 × 21 × 1.5 cm

50 / 25

Print Code: E(1), B(1), L1, L2, M(8)



80 Sheets
Plain



Climer

5019

Noteпад. Natural Cork. Hard Cover. 80 Sheets.

Notizblock. Naturkork. Hardcover-Abdeckung. 80 Seiten.

Bloc Notes. Bouchon Naturel. Couverture Rigide. 80 Feuilles.

Notitieblokje. Natuurlijk Kurk. Harde Kaft. 80 Blaadjes.

8.9 × 14 × 1.4 cm

100 / 50

Print Code: E(4), L2



80 Sheets
Plain



Hartil

5980

Noteпад. Natural Cork. Hard Cover. 80 Sheets.

Notizblock. Naturkork. Hardcover-Abdeckung. 80 Seiten.

Bloc Notes. Bouchon Naturel. Couverture Rigide. 80 Feuilles.

Notitieblokje. Natuurlijk Kurk. Harde Kaft. 80 Blaadjes.

14 × 21 × 1.5 cm

50 / 25

Print Code: E(4), L2

Coquel

NEW

ULTREX

Bluster

Hemmy

NEW

the Quaker

159



100 Sheets
Plain

Coquel

6729

Notepad. Natural Cork. Hard Cover. 100 Sheets.
Notizblock. Naturkork. Hardcover-Abdeckung. 100 Seiten.
Bloc Notes. Bouchon Naturel. Couverture Rigide. 100 Feuilles.
Notitieblokje. Natuurlijk Kurk. Harde Kaft. 100 Blaadjes.

14.7 × 21 × 1.5 cm

50 / 25

Print Code: E(1), L2, N(8)



80 Sheets
Lined

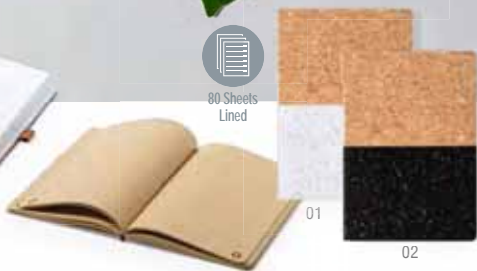

Hemmy

6838

Notepad. Natural Cork. Hard Cover. 80 Sheets.
Notizblock. Naturkork. Hardcover-Abdeckung. 80 Seiten.
Bloc Notes. Bouchon Naturel. Couverture Rigide. 80 Feuilles.
Notitieblokje. Natuurlijk Kurk. Harde Kaft. 80 Blaadjes.

14 × 20 × 1.3 cm

50 / 25

Print Code: E(4), L2, N(8)



100 Sheets
Plain

Bluster

6338

Notepad. Natural Cork/ PU. Hard Cover. 100 Sheets.
Notizblock. Naturkork/ PU. Hardcover-Abdeckung. 100 Seiten.
Bloc Notes. Bouchon Naturel/ Similicuir. Couverture Rigide. 100 Feuilles.
Notitieblokje. Natuurlijk Kurk/ PU. Harde Kaft. 100 Blaadjes.

14.7 × 21 × 1.5 cm

50 / 25

Print Code: E(4), L2, T

Herick

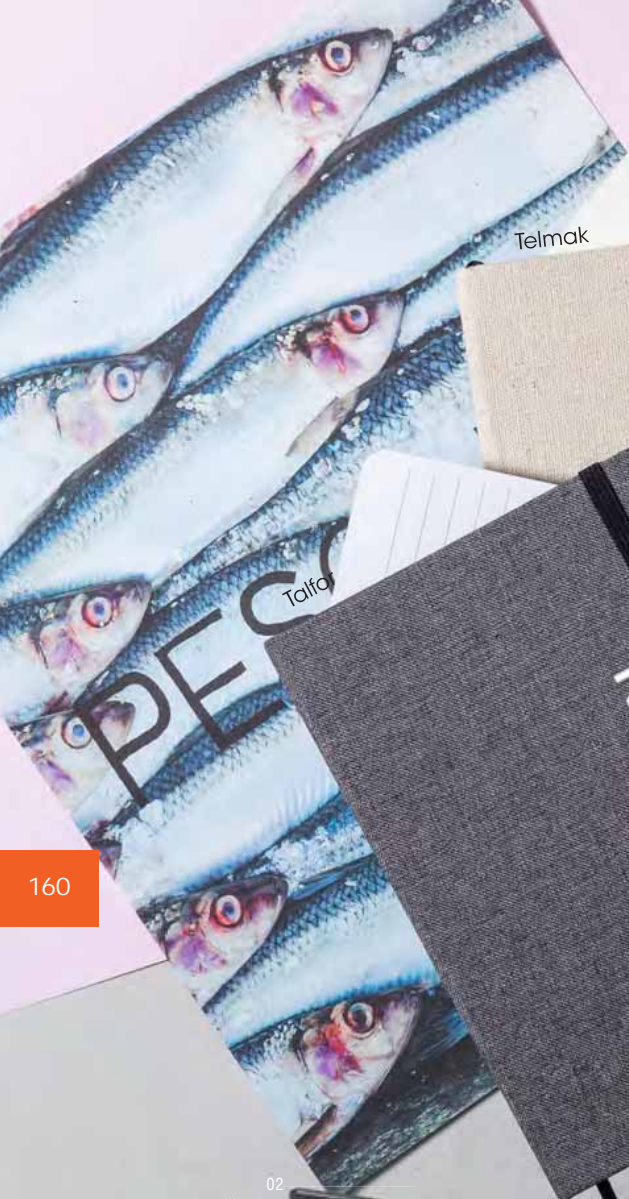

Telmak

Talfor

MEVAIN

BOLTZ

er



160

POCKET
BOLSILLO



Herick
5835

Noteпад. Polyester 300D. Hard Cover. 98 Sheets.
Notizblock. Polyester 300D. Hardcover-Abdeckung. 98 Seiten.
Bloc Notes. Polyester 300D. Couverture Rigide. 98 Feuilles.
Notitieblokke. Polyester 300D. Harde Kaft. 98 Blaadjes.

13.5 × 21.5 × 2 cm

Print Code: E(4)

40 / 20

98 Sheets
Plain



80 Sheets
Plain

Telmak
6159

Noteпад. Cotton. Hard Cover. 80 Sheets.
Notizblock. Baumwolle. Hardcover-Abdeckung. 80 Seiten.
Bloc Notes. Coton. Couverture Rigide. 80 Feuilles.
Notitieblokke. Katoen. Harde Kaft. 80 Blaadjes.

14 × 21 × 1.5 cm

Print Code: E(4), N(8)

50 / 25

80 Sheets
Lined



Talfor
6193

Noteпад. Polyester 300D. Hard Cover. 80 Sheets.
Notizblock. Polyester 300D. Hardcover-Abdeckung. 80 Seiten.
Bloc Notes. Polyester 300D. Couverture Rigide. 80 Feuilles.
Notitieblokke. Polyester 300D. Harde Kaft. 80 Blaadjes.

12.7 × 17.8 × 1.3 cm

Print Code: E(4), N(8)

50 / 25

Raimok

**RECYCLED
CARDBOARD**

161

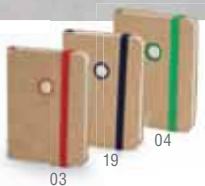

02

100 Sheets
Plain

03

19

04

Surma

3869

Noteepad. Recycled Cardboard. Hard Cover. 100 Sheets.
Notizblock. Recycling Papp. Hardcover-Abdeckung. 100 Seiten.
Bloc Notes. Carton Recyclé. Couverture Rigide. 100 Feuilles.
Notitieblokje. Gerecycled Karton. Harde Kaft. 100 Blaadjes.

7.5 × 10.6 × 1.2 cm

100 / 25

Print Code: D(4), W

100 Sheets
Plain

03

05

04

19

01

02

Bosco

5301

Noteepad. Recycled Cardboard. Hard Cover. 100 Sheets.
Notizblock. Recycling Papp. Hardcover-Abdeckung. 100 Seiten.
Bloc Notes. Carton Recyclé. Couverture Rigide. 100 Feuilles.
Notitieblokje. Gerecycled Karton. Harde Kaft. 100 Blaadjes.

9.3 × 14.3 × 1.5 cm

100 / 50

Print Code: D(4), W

100 Sheets
Plain

03

05

04

19

01

02

Raimok

5302

Noteepad. Recycled Cardboard. Hard Cover. 100 Sheets.
Notizblock. Recycling Papp. Hardcover-Abdeckung. 100 Seiten.
Bloc Notes. Carton Recyclé. Couverture Rigide. 100 Feuilles.
Notitieblokje. Gerecycled Karton. Harde Kaft. 100 Blaadjes.

14.7 × 21 × 1.5 cm

50 / 25

Print Code: E(4)

Ciluxlin

CreativeDesign
YOUR LOGO CONCEPT

Kinelin

Minikine

LINED



02 19 04

Ciluxlin
5300



Noteпад. PU. Hard Cover. 100 Sheets.
Notizblock. PU. Hardcover-Abdeckung. 100 Seiten.
Bloc Notes. Similicuir. Couverture Rigide. 100 Feuilles.
Notitieblokje. PU. Harde Kaft. 100 Blaadjjes.

14.7 × 21 × 1.5 cm

50 / 25

Print Code: E(4), T



03



Minikine
3896

Noteпад. PU. Hard Cover. 100 Sheets.
Notizblock. PU. Hardcover-Abdeckung. 100 Seiten.
Bloc Notes. Similicuir. Couverture Rigide. 100 Feuilles.
Notitieblokje. PU. Harde Kaft. 100 Blaadjjes.

6.5 × 10 × 1.5 cm

150 / 50

Print Code: D(4), T

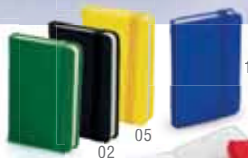

19

05

02

03



Kinelin
5299

Noteпад. PU. Hard Cover. 100 Sheets.
Notizblock. PU. Hardcover-Abdeckung. 100 Seiten.
Bloc Notes. Similicuir. Couverture Rigide. 100 Feuilles.
Notitieblokje. PU. Harde Kaft. 100 Blaadjjes.

9.3 × 14.3 × 1.5 cm

100 / 50

Print Code: E(4), T



04 19 03 02



BEST-SELLER

THE BEST PRICE

Cilux

NEW

Robin

Losvolk

Kine

I Have a Dream
MLK DAY
Martin Luther King



09 07 03 11 16 04 19 18 02

Kine

3393

Noteпад. PU. Hard Cover. 100 Sheets.
Notizblock. PU. Hardcover-Abdeckung. 100 Seiten.
Bloc Notes. Similicuir. Couverture Rigide. 100 Feuilles.
Notitieblokje. PU. Harde Kaft. 100 Blaadjes.

9.3 × 14.3 × 1.5 cm

100 / 50

Print Code: E(4), T



100 Sheets
Plain



Robin

6839

Noteпад. PU. Hard Cover. 100 Sheets. Pen Aluminium Included. Jumbo Refill.

Notizblock. PU. Hardcover-Abdeckung. 100 Seiten.
Kugelschreiber Aluminium Inklusiv. Jumbo Ersatzmine.
Bloc Notes. Similicuir. Couverture Rigide. 100 Feuilles.
Stylo Aluminium Inclus. Recharge Jumbo.

Notitieblokje. PU. Harde Kaft. 100 Blaadjes. Pen Aluminium Inclusief. Jumbo Refill.

15.5 × 21 × 1.5 cm

40 / 20

Print Code: E(4), B(4)



100 Sheets
Lined



19 06 01 02



02 09 19 04 05 07 03

Cilux

4060

Noteпад. PU. Hard Cover. 100 Sheets.
Notizblock. PU. Hardcover-Abdeckung. 100 Seiten.
Bloc Notes. Similicuir. Couverture Rigide. 100 Feuilles.
Notitieblokje. PU. Harde Kaft. 100 Blaadjes.

14.7 × 21 × 1.5 cm

50 / 25

Print Code: E(4), T



100 Sheets
Plain

Daymus

Kaffol



IDEAL FOR DIGITAL PRINTING

164



80 Sheets Plain



04 19 11 07 03



80 Sheets Plain



11 03 07 05 04 19



100 Sheets Plain



03 05 04 07 11 19 02

Yakis

4342



80 Sheets Plain

Noteepad. Hard Cover. 80 Sheets.
Notizblock. Hardcover-Abdeckung. 80 Seiten.
Bloc Notes. Couverture Rigide. 80 Feuilles.
Notitieblokje. Harde Kaft. 80 Blaadjes.

9 × 14 × 1.3 cm

100 / 50

Print Code: E(4), W, T

Daymus

5124

Noteepad. PU. Hard Cover. 80 Sheets.
Notizblock. PU. Hardcover-Abdeckung. 80 Seiten.
Bloc Notes. Similicuir. Couverture Rigide. 80 Feuilles.
Notitieblokje. PU. Harde Kaft. 80 Blaadjes.

14.3 × 21 × 1.3 cm

50 / 25

Print Code: E(4), T

Clibend

5123

Noteepad. PU. Hard Cover. 80 Sheets.
Notizblock. PU. Hardcover-Abdeckung. 80 Seiten.
Bloc Notes. Similicuir. Couverture Rigide. 80 Feuilles.
Notitieblokje. PU. Harde Kaft. 80 Blaadjes.

8.8 × 14.3 × 1.3 cm

100 / 50

Print Code: E(4), T

Kaffol

5672

Noteepad. Hard Cover. 100 Sheets.
Notizblock. Hardcover-Abdeckung. 100 Seiten.
Bloc Notes. Couverture Rigide. 100 Feuilles.
Notitieblokje. Harde Kaft. 100 Blaadjes.

14.7 × 21 × 1.5 cm

50 / 25

Print Code: E(4), T, W

100 Sheets
Lined

Mirvan

6457

Notepad. PU. Hard Cover. 100 Sheets.

Notizblock. PU. Hardcover-Abdeckung. 100 Seiten.

Bloc Notes. Similicuir. Couverture Rigide. 100 Feuilles.

Notitieblokje. PU. Harde Kaft. 100 Blaadjes.

14.7 × 21 × 1.5 cm

50 / 25

Print Code: E(4), T

165

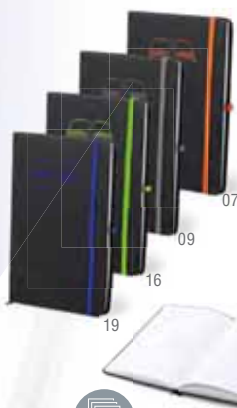

SPECIAL LASER ENGRAVING MATCHING COLOUR

These notebooks with colour interior have an outer coating specially designed for laser engraving which will ensure that your advertising or brand is perfectly engraved in the same colour as the inside of your chosen notebook or pen.

Estos bloc de notas con interior en color tienen un recubrimiento exterior especialmente diseñado para grabado láser, con el que conseguirá que su publicidad o marca quede perfectamente grabada en el mismo color que el interior de su bloc o bolígrafo elegido.



Kefron

6069

100 Sheets
Lined

Notepad. PU. Hard Cover. 100 Sheets.

Notizblock. PU. Hardcover-Abdeckung. 100 Seiten.

Bloc Notes. Similicuir. Couverture Rigide. 100 Feuilles.

Notitieblokje. PU. Harde Kaft. 100 Blaadjes.

14.2 × 21.1 × 1.5 cm

50 / 25

Print Code: E(4), L2, T, U

Sider

5996

Notepad. PU. 80 Sheets.

Notizblock. PU. 80 Seiten.

Bloc Notes. Similicuir. 80 Feuilles.

Notitieblokje. PU. 80 Blaadjes.

15.5 × 21 × 1.3 cm

50 / 25

Print Code: E(4), L2

80 Sheets
Plain

03

70 Sheets
Lined

19 03 18 09

Rasmor

5991

Sticky Notepad. PU. 70 Sheets Notepad. 25 Sticky Notes 7,5 x 7,5 cm. 125 Mini Sticky Notes 1,2 x 4,5 cm. Recycled Cardboard Pen Included.

Notizblock. PU. 70 Seiten Notizblock. 25 Haftnotizen 7,5 x 7,5 cm. 125 Mini Haftnotizen 1,2 x 4,5 cm. Recycling Papp Kugelschreiber Inklusiv.

Bloc Notes. Carton Recycle. Bloc 70 Feuilles. 25 Notes Adhésives 7,5 x 7,5 cm. 125 Mini Notes Adhésives 1,2 x 4,5 cm. Stylo Carton Recycle Inclus.

Plakmemo-Blokje. PU. 70 Blaadjes Notepad. 25 Plakmemo's 7,5 x 7,5 cm. 125 Mini Plakmemo's 1,2 x 4,5 cm. Pen Gerecycled Karton Inclusief.

10.5 × 15.5 × 2.3 cm

50

Print Code: E(1), B(4), L2



... I AM
INTERACTIVE!

100 Sheets
Plain

Taigan

4573

Notepad. PVC. 100 Sheets.
Notizblock. PVC. 100 Seiten.
Bloc Notes. PVC. 100 Feuilles.
Notitieblokje. PVC. 100 Blaadjes.

9.6 × 13.4 × 1.2 cm

200 / 50

Print Code: E(1)

Samish

5600

80 Sheets
Lined

Notepad. PU. Hard Cover. 80 Sheets. Pen Included.
Notizblock. PU. Hardcover-Abdeckung. 80 Seiten. Kugelschreiber Inklusiv.
Bloc Notes. Similicuir. Couverture Rigide. 80 Feuilles. Stylo Inclus.
Notitieblokje. PU. Harde Kaft. 80 Blaadjes. Pen Inclusief.

12.6 × 17.7 × 2.3 cm

50 / 25

Print Code: E(4), T

Velmont

5932

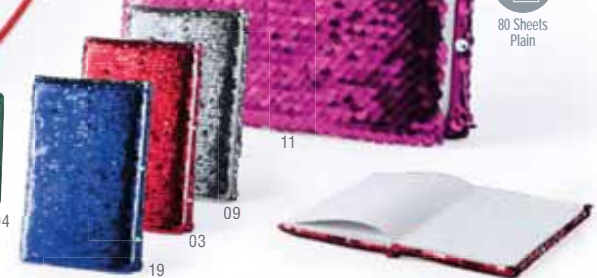
80 Sheets
Plain

Notepad. Hard Cover. 80 Sheets.
Notizblock. Hardcover-Abdeckung. 80 Seiten.
Bloc Notes. Couverture Rigide. 80 Feuilles.
Notitieblokje. Harde Kaft. 80 Blaadjes.

14.5 × 21.5 × 2 cm

40 / 20

Print Code: G(1)



Video



Merton

4865



Notepad. PU. Hard Cover. 80 Sheets.
 Notizblock. PU. Hardcover-Abdeckung. 80 Seiten.
 Bloc Notes. Similicuir. Couverture Rigide. 80 Feuilles.
 Notitieblokje. PU. Harde Kaft. 80 Blaadjes.

14 × 20 × 1.5 cm 50 / 25
 Print Code: E(1)

02



Bodley

5939



Notepad. PU. Hard Cover. 80 Sheets.
 Notizblock. PU. Hardcover-Abdeckung. 80 Seiten.
 Bloc Notes. Similicuir. Couverture Rigide. 80 Feuilles.
 Notitieblokje. PU. Harde Kaft. 80 Blaadjes.

14.7 × 21 × 1.5 cm 50 / 25
 Print Code: E(4)

09

22

23



SOFT COVER



Paldon

6617

Notepad. PU. 100 Sheets.
 Notizblock. PU. 100 Seiten.
 Bloc Notes. Similicuir. 100 Feuilles.
 Notitieblokje. PU. 100 Blaadjes.

14.5 × 21 × 1.3 cm 50 / 25
 Print Code: E(1)

20

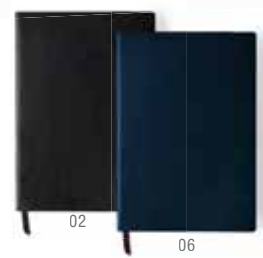

02

06



Botik

4867

Set. Notepad Cardboard. Hard Cover. 80 Sheets Notepad. Pen Aluminium.
 Set. Notizblock Pappe. Hardcover-Abdeckung. 80 Seiten Notizblock. Kugelschreiber Aluminium.
 Set. Bloc Notes Carton. Couverture Rigide. Bloc 80 Feuilles. Stylo Aluminium.
 Set. Notitieblokje Karton. Harde Kaft. 80 Blaadjes Notepad. Pen Aluminium.

17 × 2.5 × 11.4 cm 100 / 50

Print Code: E(1), B(4), L1, T



80 Sheets
Plain

168



Marden

5041

Set. PU. Hard Cover. 100 Sheets Notepad.
 Set. PU. Hardcover-Abdeckung. 100 Seiten Notizblock.
 Set. Similicuir. Couverture Rigide. Bloc 100 Feuilles.
 Set. PU. Harde Kaft. Blok 100 Blaadjes.

24 × 2.2 × 19.7 cm

20

Print Code: E(1), B(4), L1, T



100 Sheets
Plain



Yazil

6397

Set. Notepad PU. Hard Cover. 80 Sheets. Roller Aluminium. Jumbo Refill.
 Set. Notizblock PU. Hardcover-Abdeckung. 80 Seiten. Roller Pen Aluminium. Jumbo Ersatzmine.
 Set. Bloc Notes Similicuir. Couverture Rigide. 80 Feuilles. Roller Aluminium. Recharge Jumbo.
 Set. Notitieblokje PU. Harde Kaft. 80 Blaadjes. Roller Aluminium. Jumbo Refill.

23.5 × 1.8 × 19.5 cm

40 / 20

Print Code: E(1), B(4), L1, T



80 Sheets
Plain



Minsor

6395



Set. Notepad Natural Cork. Hard Cover. 80 Sheets. Pen Natural Cork/Wheat Straw/ABS. Black Ink.

Set. Notizblock Naturkork. Hardcover-Abdeckung. 80 Seiten. Kugelschreiber Naturkork/Weizenstroh/ABS. Schwarze Tinte.

Set. Bloc Notes Bouchon Naturel. Couverture Rigide. 80 Feuilles. Stylo Bouchon Naturel/Paille de Ble/ABS. Encre Noire.

Set. Notitieblokje Natuurlijk Kurk. Harde Kaft. 80 Blaadjes. Pen Natuurlijk Kurk/Tarwestrof/ABS. Zwarte Inkt.

23.5 x 1.8 x 19.5 cm 40 / 20

Print Code: E(1), B(4), L1, L2



80 Sheets
Plain



80 Sheets
Lined

Hecan

6396

Set. Bamboo. Hard Cover. 80 Sheets. Jumbo Refill. Black Ink.

Set. Bambus. Hardcover-Abdeckung. Jumbo Ersatzmine. Schwarze Tinte.

Set. Bambou. Couverture Rigide. 80 Feuilles. Recharge Jumbo. Encre Noire.

Set. Bamboe. Harde Kaft. 80 Blaadjes. Jumbo Refill. Zwarte Inkt.

23.5 x 2 x 21.5 cm

40 / 20

Print Code: E(1), B(1)



RECYCLED CARDBOARD

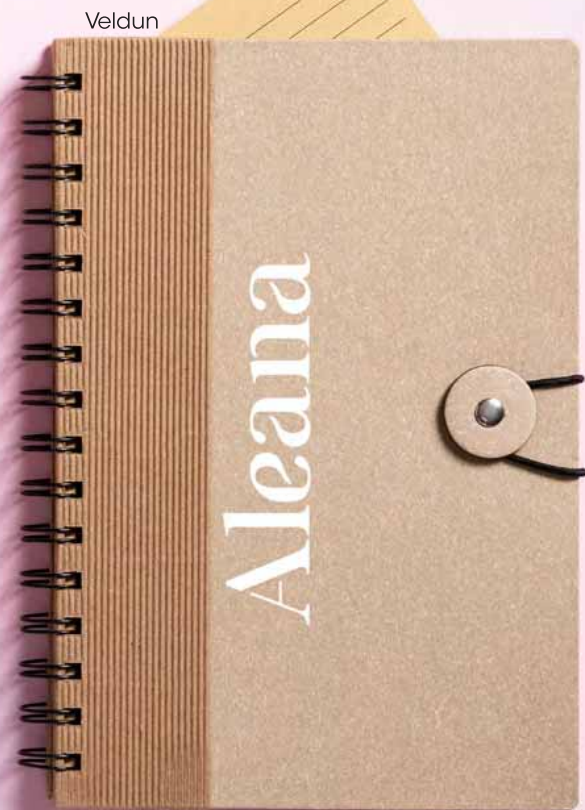

170



Neyla

6398

Notebook. Recycled Cardboard. Hard Cover. 80 Sheets. Recycled Cardboard Pen Included.
Notizbuch. Recycling Pappe. Hardcover-Abdeckung. 80 Seiten. Recycling Pappe Kugelschreiber Inklusive.
Cahier. Carton Recyclé. Couverture Rigide. 80 Feuilles. Stylo Carton Recyclé Inclus.
Notitieboek. Gerecycled Karton. Harde Kaft. 80 Blaadjes. Pen Gerecycled Karton Inclusief.

17.5 × 21 × 1.7 cm

50 / 25

Print Code: E(4), B(4)



80 Sheets
Lined

Zurix

6108

Notebook. Recycled Cardboard. 60 Sheets.
Notizbuch. Recycling Pappe. 60 Seiten.
Cahier. Carton Recyclé. 60 Feuilles.
Notitieboek. Gerecycled Karton. 60 Blaadjes.

14.4 × 21 × 0.8 cm

100 / 10

Print Code: E(1)



60 Sheets
Lined

Veldun

6566

Notebook. Recycled Cardboard. Hard Cover. 80 Sheets.
Notizbuch. Recycling Pappe. Hardcover-Abdeckung. 80 Seiten.
Cahier. Carton Recyclé. Couverture Rigide. 80 Feuilles.
Notitieboek. Gerecycled Karton. Harde Kaft. 80 Blaadjes.

15.7 × 21.5 × 2.2 cm

40 / 20

Print Code: E(4)



80 Sheets
Lined

Ganok

RECYCLED CARDBOARD

Zubar

Esteka



NEW

I Have a Dream
MLK
Martin Luther DAY

EXTRA HARD COVER

171



Zubar
6399



80 Sheets
Lined

Notebook. Recycled Cardboard. Hard Cover. 80 Sheets.
Notizbuch. Recycling Papppe. Hardcover-Abdeckung. 80 Seiten.
Cahier. Carton Recycle. Couverture Rigide. 80 Feuilles.
Notitieboek. Gerecycled Karton. Harde Kaft. 80 Blaadjes.

15.5 x 21 x 1.8 cm 50 / 25
Print Code: E(4)

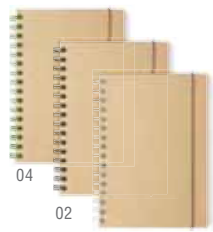

60 Sheets
Plain

Esteka
6837

Notebook. Recycled Cardboard. 60 Sheets. Recycled Cardboard/ Wheat Straw/ ABS Pen Included.
Notizbuch. Recycling Papppe. 60 Seiten. Recycling Papppe/ Weizenstroh/ ABS Kugelschreiber Inklusive.
Cahier. Carton Recycle. 60 Feuilles. Stylo Carton Recycle/ Paille de Ble/ ABS Inclus.
Notitieboek. Gerecycled Karton. 60 Blaadjes. Pen Gerecycled Karton/ Tarwestro/ ABS Inclusief.

15 x 21 x 0.6 cm 50 / 25
Print Code: E(4), B(4)

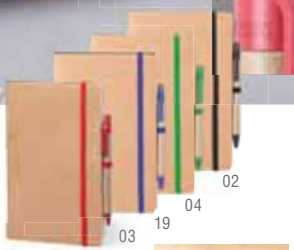

Ganok
5671



50 Sheets
Plain

Sticky Notepad. Recycled Cardboard. 50 Sheets Notepad. 30 Sticky Notes 7,3 x 7,5 cm. 75 Mini Sticky Notes 1,5 x 5 cm. Recycled Cardboard Pen Included.
Notizblock. Recycling Papppe. 50 Seiten Notizblock. 30 Haftnotizen 7,3 x 7,5 cm. 75 Mini Haftnotizen 1,5 x 5 cm. Recycling Papppe Kugelschreiber Inklusive.
Bloc Notes. Carton Recycle. Bloc 50 Feuilles. 30 Notes Adhesives 7,3 x 7,5 cm. 75 Mini Notes Adhesives 1,5 x 5 cm. Stylo Carton Recycle Inclus.
Plakmemo-Blokke. Gerecycled Karton. 50 Blaadjes Notepad. 30 Plakmemo's 7,3 x 7,5 cm. 75 Mini Plakmemo's 1,5 x 5 cm. Pen Gerecycled Karton Inclusief.

14.5 x 21 x 1.8 cm 50 / 25
Print Code: E(4), B(4)



Gulliver

Emerot

Mosku

172

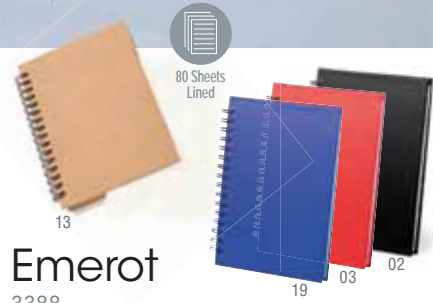

Gulliver

3389

Notebook. Recycled Cardboard. Hard Cover. 80 Sheets.
 Notizbuch. Recycling Papppe. Hardcover-Abdeckung. 80 Seiten.
 Cahier. Carton Recyclé. Couverture Rigide. 80 Feuilles.
 Notitieboek. Gerecycled Karton. Harde Kaft. 80 Blaadjes.

16.4 × 21.7 × 1.6 cm

50 / 25

Print Code: E(4)



Emerot

3388

Notebook. Recycled Cardboard. Hard Cover. 80 Sheets.
 Notizbuch. Recycling Papppe. Hardcover-Abdeckung. 80 Seiten.
 Cahier. Carton Recyclé. Couverture Rigide. 80 Feuilles.
 Notitieboek. Gerecycled Karton. Harde Kaft. 80 Blaadjes.

11.6 × 15.3 × 1.6 cm

100 / 25

Print Code: E(4)



Mosku

5661

Notebook. Recycled Cardboard. Hard Cover. 70 Sheets. Pencil Case Included. 6 Pieces.
 Notizbuch. Recycling Papppe. Hardcover-Abdeckung. 70 Seiten. Estujo Inklusief. 6 Stück.
 Cahier. Carton Recyclé. Couverture Rigide. 70 Feuilles. Pencil Case Included. 6 Pieces.
 Notitieboek. Gerecycled Karton. Harde Kaft. 70 Blaadjes. Etui inclusief. 6 Stück.

15.5 × 21 × 0.9 cm

50 / 25

Print Code: F(1)



RECYCLED CARDBOARD

THE BEST PRICE

& THE BEST-SELLER



173



60 Sheets Plain

Tunel

3437

Notebook. Recycled Cardboard. Hard Cover. 60 Sheets. Recycled Cardboard Pen Included.

Notizbuch. Recycling Pappe. Hardcover-Abdeckung. 60 Seiten. Recycling Pappe Kugelschreiber Inklusive.

Cahier. Carton Recyclé. Couverture Rigide. 60 Feuilles. Stylo Carton Recyclé Inclus.

Notitieboek. Gerecycled Karton. Harde Kaft. 60 Blaadjes. Pen Gerecycled Karton Inclusief.

16.5 x 21 x 1 cm

80 / 20

Print Code: E(4), B(4)



70 Sheets Lined

Ecocard

3190

Notebook. Recycled Cardboard. Hard Cover. 70 Sheets. Recycled Cardboard Pen Included.

Notizbuch. Recycling Pappe. Hardcover-Abdeckung. 70 Seiten. Recycling Pappe Kugelschreiber Inklusive.

Cahier. Carton Recyclé. Couverture Rigide. 70 Feuilles. Stylo Carton Recyclé Inclus.

Notitieboek. Gerecycled Karton. Harde Kaft. 70 Blaadjes. Pen Gerecycled Karton Inclusief.

9.7 x 14.4 x 1 cm

100 / 50

Print Code: D(4), B(4)



60 Sheets Lined

Concern

3041

Notebook. Recycled Cardboard. Hard Cover. 60 Sheets. Recycled Cardboard Pen Included.

Notizbuch. Recycling Pappe. Hardcover-Abdeckung. 60 Seiten. Recycling Pappe Kugelschreiber Inklusive.

Cahier. Carton Recyclé. Couverture Rigide. 60 Feuilles. Stylo Carton Recyclé Inclus.

Notitieboek. Gerecycled Karton. Harde Kaft. 60 Blaadjes. Pen Gerecycled Karton Inclusief.

10.5 x 14.5 x 0.6 cm

200 / 50

Print Code: D(4), B(4)

Kendil



WEEKLY PLANNER

Makron



174



Kendil

6543

Sticky Notepad. Recycled Cardboard. 60 Sheets Notepad. 25 Sticky Notes 5 x 7,5 cm. 125 Mini Sticky Notes 1,5 x 5 cm. Recycled Cardboard Pen Included.

Notizblock. Recycling Pappe. 60 Seiten Notizblock. 25 Haftnotizen 5 x 7,5 cm. 125 Mini Haftnotizen 1,5 x 5 cm. Recycling Pappe Kugelschreiber Inklusiv.

Bloc Notes. Carton Recyclé. Bloc 60 Feuilles. 25 Notes Adhésives 5 x 7,5 cm. 125 Mini Notes Adhésives 1,5 x 5 cm. Stylo Carton Recyclé Inclus.

Plakmemo-Blokje. Gerecycled Karton. 60 Blaadjes Notepad. 25 Plakmemo's 5 x 7,5 cm. 125 Mini Plakmemo's 1,5 x 5 cm. Pen Gerecycled Karton Inclusief.

11.8 x 19 x 1.6 cm

50 / 25

Print Code: E(4), B(4)



Makron

4237

Sticky Notepad. Recycled Cardboard. 70 Sheets Notepad. 25 Sticky Notes 7,5 x 10 cm. 125 Mini Sticky Notes 1,5 x 7,5 cm. Recycled Cardboard Pen Included.

Notizblock. Recycling Pappe. 70 Seiten Notizblock. 25 Haftnotizen 7,5 x 10 cm. 125 Mini Haftnotizen 1,5 x 7,5 cm. Recycling Pappe Kugelschreiber Inklusiv.

Bloc Notes. Carton Recyclé. Bloc 70 Feuilles. 25 Notes Adhésives 7,5 x 10 cm. 125 Mini Notes Adhésives 1,5 x 7,5 cm. Stylo Carton Recyclé Inclus.

Plakmemo-Blokje. Gerecycled Karton. 70 Blaadjes Notepad. 25 Plakmemo's 7,5 x 10 cm. 125 Mini Plakmemo's 1,5 x 7,5 cm. Pen Gerecycled Karton Inclusief.

21 x 20 x 1 cm

50 / 25

Print Code: F(1)



70 Sheets Lined



Tiblan

6109

Sticky Notepad. Recycled Cardboard. 60 Sheets Notepad. 125 Sticky Notes 1,2 x 4,4 cm. Haftender Notizblock. Recycling Pappe. 60 Seiten. 125 Haftnotizen 1,2 x 4,4 cm.

Bloc Notes Adhésif. Carton Recyclé. 60 Feuilles. 125 Notes Adhésives 1,2 x 4,4 cm. Notitieblok Zelfklevend. Gerecycled Karton. 60 Blaadjes. 125 Plakmemo's 1,2 x 4,4 cm.

14.6 x 17.7 x 1.7 cm

100 / 50

Print Code: E(4)



60 Sheets Lined





WHEAT
STRAW

Glicun

6588

Notebook. Wheat Straw/ PP Hard Cover. 80 Sheets. Recycled Cardboard/ Wheat Straw/ PP Pen Included.

Notizbuch. Weizenstroh/ PP. Hardcover-Abdeckung. 80 Seiten. Recycling Papper/ Weizenstroh/ PP Kugelschreiber Inklusiv.

Cahier. Paille de Blé/ PP. Couverture Rigide. 80 Feuilles. Stylo Carton Recyclé/ Paille de Blé/ PP Inclus.

Notitieboek. Tarwestro/ PP. Harde Kaft. 80 Blaadjes. Pen Gerecycled Karton/ Tarwestro/ PP Inclusief.

13.5 × 17.9 × 1.8 cm

50 / 25

Print Code: E(4), B(4)



80 Sheets
Lined

Sulax

6565

Notebook. Natural Cork/ Recycled Cardboard. Hard Cover. 50 Sheets. Recycled Cardboard/ Wheat Straw/ ABS Pen Included.

Notizbuch. Naturkork/ Recycling Papper. Hardcover-Abdeckung. 50 Seiten. Recycling Papper/ Weizenstroh/ ABS Kugelschreiber Inklusiv.

Cahier. Bouchon Naturel/ Carton Recyclé. Couverture Rigide. 50 Feuilles. Stylo Carton Recyclé/ Paille de Blé/ ABS Inclus.

Notitieboek. Natuurlijk Kurk/ Gerecycled Karton. Harde Kaft. 50 Blaadjes. Pen Gerecycled Karton/ Tarwestro/ ABS Inclusief.

8.5 × 11.7 × 1.4 cm

200 / 50

Print Code: D(4), B(4), L2



50 Sheets
Lined



Xiankal

6604

Notebook. Natural Cork. Hard Cover. 100 Sheets.

Notizbuch. Naturkork. Hardcover-Abdeckung. 100 Seiten. Cahier. Bouchon Naturel. Couverture Rigide. 100 Feuilles.

Notitieboek. Natuurlijk Kurk. Harde Kaft. 100 Blaadjes.

16 × 21 × 2.2 cm

40 / 20

Print Code: E(4), L2



100 Sheets
Lined

Bully

6039

Pencil Case. Natural Cork.
Federmappe. Naturkork.
Trousse. Bouchon Naturel.
Etui. Natuurlijk Kurk.

23 × 11 × 2 cm

200 / 50

Print Code: E(1), L2

176



Candel

5018

Notebook. Natural Cork. Hard Cover. 50 Sheets.
Notizbuch. Naturkork. Hardcover-Abdeckung. 50 Seiten.
Cahier. Bouchon Naturel. Couverture Rigide. 50 Feuilles.
Notitieboek. Natuurlijk Kurk. Harde Kaft. 50 Blaadjes.

11.5 × 15.5 × 1.7 cm

100 / 50

Print Code: E(4), L2



50 Sheets
Lined

Hoyeb

5027

Folder. Natural Cork. 20 Sheets Notepad.
Mappe. Naturkork. 20 Seiten Notizblock.
Porte-Documents. Bouchon Naturel. Bloc 20 Feuilles.
Map. Natuurlijk Kurk. 20 Blaadjes Notepad.

24.5 × 32.5 × 1.5 cm

20

Print Code: F(1), L1



20 Sheets
Lined

BAMBOO



Palmex



Polnar



PIEZAS PROCEDENTES DE CORTE DE BAMBU NATURAL. SU TEXTURA Y COLOUR PUEDEN VARIAR

PIECES FROM NATURAL CUTS OF BAMBOO. THE TEXTURE AND COLOUR MAY VARY.

Palmex

6157

Notebook. Bamboo. Hard Cover. 80 Sheets.
Notizbuch. Bambus. Hardcover-Abdeckung. 80 Seiten.
Cahier. Bambou. Couverture Rigide. 80 Feuilles.
Notitieboek. Bamboe. Harde Kaft. 80 Blaadjes.

17 × 21.5 × 1.8 cm

50 / 25

Print Code: E(1)



80 Sheets Lined

Polnar

6401

Notebook. Bamboo. Hard Cover. 80 Sheets. Bamboo Pen Included. Black Ink.
Notizbuch. Bambus. Hardcover-Abdeckung. 80 Seiten. Bambus Kugelschreiber Inklusiv. Schwarze Tinte.
Cahier. Bambou. Couverture Rigide. 80 Feuilles. Stylo Bambou Inclus. Encre Noire.
Notitieboek. Bamboe. Harde Kaft. 80 Blaadjes. Bamboe Pen Inclusief. Zwarte Inkt.

17 × 21.5 × 1.8 cm

50 / 25

Print Code: E(1), B(4)



80 Sheets Lined



Tumiz

6018

Notebook. Bamboo. Hard Cover. 70 Sheets. Bamboo Pen Included. Jumbo Refill.
Notizbuch. Bambus. Hardcover-Abdeckung. 70 Seiten. Bambus Kugelschreiber Inklusiv. Jumbo Ersatzmine.
Cahier. Bambou. Couverture Rigide. 70 Feuilles. Stylo Bambou Inclus. Recharge Jumbo.
Notitieboek. Bamboe. Harde Kaft. 70 Blaadjes. Bamboe Pen Inclusief. Jumbo Refill.

10 × 15 × 1.6 cm

100 / 25

Print Code: E(1), B(1)



80 Sheets Lined

Lemtnun

6017

Notebook. Bamboo. Hard Cover. 80 Sheets.
Notizbuch. Bambus. Hardcover-Abdeckung. 80 Seiten.
Cahier. Bambou. Couverture Rigide. 80 Feuilles.
Notitieboek. Bamboe. Harde Kaft. 80 Blaadjes.

9 × 12 × 1.5 cm

100 / 25

Print Code: E(1)



80 Sheets Lined





80 Sheets
Lined

Lamark

3801

Notebook. 80 Sheets.
Notizbuch. 80 Seiten.
Cahier. 80 Feuilles.
Notitieboek. 80 Bladzjes.

14.6 × 21 × 1 cm

Print Code: E(1)

60



Dienel

5118

Notebook. 40 Sheets.
Notizbuch. 40 Seiten.
Cahier. 40 Feuilles.
Notitieboek. 40 Bladzjes.

14 × 20.5 × 0.4 cm

Print Code: E(1)

100 / 10



40 Sheets
Plain

178

Nazga

5929

Notebook. PP Plastic. 80 Sheets.
Notizbuch. Plastik PP. 80 Seiten.
Cahier. PP Plastique. 80 Feuilles.
Notitieboek. PP Plastic. 80 Bladzjes.

15.5 × 21 × 0.8 cm

Print Code: E(4)

50



80 Sheets
Plain

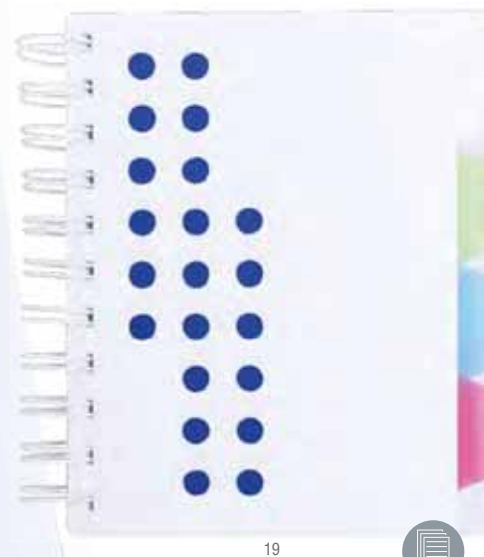
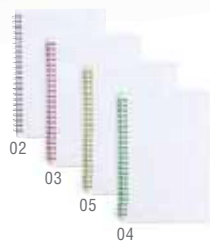

19



116 Sheets
Lined

Bucef

4833

Notebook. PP Plastic. 116 Sheets.
Notizbuch. Plastik PP. 116 Seiten.
Cahier. PP Plastique. 116 Feuilles.
Notitieboek. PP Plastic. 116 Bladzjes.

12.7 × 14.5 × 2.1 cm

Print Code: E(4), B(4)

50 / 25



01



19



03



05



02



60 Sheets
Lined

Duxo

3216

Mini Notebook. PP Plastic. 60 Sheets. Pen Included.
Mini Notizbuch. Plastik PP. 60 Seiten. Kugelschreiber Inklusiv.
Mini Cahier. PP Plastique. 60 Feuilles. Stylo Inclus.
Mini Notitieboek. PP Plastic. 60 Bladzjes. Pen Inclusief.

7 × 9.5 × 0.7 cm

Print Code: D(4), B(4)

300 / 50

RECYCLED CARDBOARD

Tecnar



179



19 05 03 02 04

Pilaf

4670



50 Sheets
Lined

Notebook, Recycled Cardboard, Hard Cover, 50 Sheets.
Recycled Cardboard Pen Included.

Notizbuch, Recycling Pappe, Hardcover-Abdeckung, 50
Seiten, Recycling Pappe Kugelschreiber Inklusiv.

Cahier, Carton Recyclé, Couverture Rigide, 50 Feuilles, Stylo
Carton Recyclé Inclus.

Notitieboek, Gerecycled Karton, Harde Kaft, 50 Blaadjes,
Pen Gerecycled Karton Inclusief.

8.6 × 11.7 × 1.3 cm

200 / 50

Print Code: D(4), B(4)



01 02 04 05 07 03 11 19

Tecnar

4730



80 Sheets
Plain

Notebook, Recycled Cardboard, Hard Cover, 80 Sheets, Recycled Cardboard Pen Included.

Notizbuch, Recycling Pappe, Hardcover-Abdeckung, 80 Seiten, Recycling Pappe
Kugelschreiber Inklusiv.

Cahier, Carton Recyclé, Couverture Rigide, 80 Feuilles, Stylo Carton Recyclé Inclus.

Notitieboek, Gerecycled Karton, Harde Kaft, 80 Blaadjes, Pen Gerecycled Karton Inclusief.

23.7 × 29 × 2 cm

20

Print Code: E(4), B(4)



01 02 19 05 07 03 11 04

Koguel

4729



70 Sheets
Plain

Notebook, Recycled Cardboard, Hard Cover, 70 Sheets,
Recycled Cardboard Pen Included.

Notizbuch, Recycling Pappe, Hardcover-Abdeckung, 70
Seiten, Recycling Pappe Kugelschreiber Inklusiv.

Cahier, Carton Recyclé, Couverture Rigide, 70 Feuilles,
Stylo Carton Recyclé Inclus.

Notitieboek, Gerecycled Karton, Harde Kaft, 70 Blaadjes,
Pen Gerecycled Karton Inclusief.

15 × 18.2 × 1.9 cm

50 / 25

Print Code: E(4), B(4)



Comet

Ecosum

Kelem

Vimaz

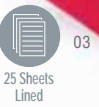

03
25 Sheets
Lined

Comet
4352

Folder. Recycled Cardboard. 25 Sheets Notepad.
Mappe. Recycling Pappe. 25 Seiten Notizblock.
Porte-Documents. Carton Recyclé. Bloc 25 Feuilles.
Map. Gerecycled Karton. 25 Blaadjes Notepad.

25 x 34 x 1.5 cm 50 / 25
Print Code: F(1)



Ecosum
2420

Folder. Recycled Cardboard.
Mappe. Recycling Pappe.
Porte-Documents. Carton Recyclé.
Map. Gerecycled Karton.

25 x 34 x 3.1 cm 60
Print Code: F(1)



Kelem
3640



Folder. Recycled Cardboard. 20 Sheets Notepad. 25 Sticky Notes 7,4 x 7,4 cm. 125 Mini Sticky Notes 1,5 x 7,5 cm. Recycled Cardboard Pen Included.
Mappe. Recycling Pappe. 20 Seiten Notizblock. 25 Haftnotizen 7,4 x 7,4 cm. 125 Mini Haftnotizen 1,5 x 7,5 cm. Recycling Pappe Kugelschreiber Inklusiv.
Porte-Documents. Carton Recyclé. Bloc 20 Feuilles. 25 Notes Adhésives 7,4 x 7,4 cm. 125 Mini Notes Adhésives 1,5 x 7,5 cm. Stylo Carton Recyclé Inclus.
Map. Gerecycled Karton. 20 Blaadjes Notepad. 25 Plakmemo's 7,4 x 7,4 cm. 125 Mini Plakmemo's 1,5 x 7,5 cm. Pen Gerecycled Karton Inclusief.

28.5 x 34.5 x 2.3 cm 50 / 25
Print Code: F(1)

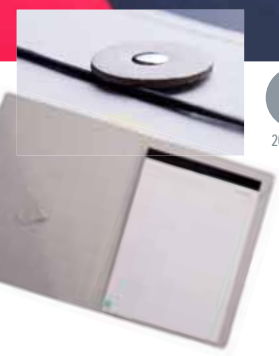

Vimaz
3639

Folder. Recycled Cardboard. 20 Sheets Notepad.
Mappe. Recycling Pappe. 20 Seiten Notizblock.
Porte-Documents. Carton Recyclé. Bloc 20 Feuilles.
Map. Gerecycled Karton. 20 Blaadjes Notepad.

24.5 x 32 x 1 cm 50 / 25
Print Code: F(1)



20 Sheets
Lined



20 Sheets
Lined



181



Haborg

5629
Folder. Recycled Cardboard.
Mappe. Recycling Pappe.
Porte-Documents. Carton Recyclé.
Map. Gerecycled Karton.

23.5 × 31 cm

Print Code: F(1)



50

Damany

5630
Document Bag. Recycled Cardboard.
Dokumententasche. Recycling Pappe.
Porte-Documents. Carton Recyclé.
Aktentas. Gerecycled Karton.

32.6 × 24.5 × 2 cm

Print Code: F(1)



50

Bloguer

5628
Folder. Recycled Cardboard. 20 Sheets Notepad. Recycled Cardboard Pen Included.
Mappe. Recycling Pappe. 20 Seiten Notizblock. Recycling Pappe Kugelschreiber Inklusive.
Porte-Documents. Carton Recyclé. Bloc 20 Feuilles. Stylo Carton Recyclé Inclus.
Map. Gerecycled Karton. 20 Blaadjes Notepad. Pen Gerecycled Karton Inclusief.

23 × 32 × 1.5 cm

Print Code: F(1), B(1)



50



20 Sheets
Plain



Cravis
4887



Sticky Notepad. Recycled Cardboard. 70 Sheets Notepad. 25 Sticky Notes 7,6 x 9 cm. 25 Sticky Notes 3,8 x 6 cm. 100 Mini Sticky Notes 1,2 x 4,8 cm. Recycled Cardboard Pen Included.
 Notizblock. Recycling Pappe. 70 Seiten Notizblock. 25 Haftnotizen 7,6 x 9 cm. 25 Haftnotizen 3,8 x 6 cm. 100 Mini Haftnotizen 1,2 x 4,8 cm. Recycling Pappe Kugelschreiber Inklusive.
 Bloc Notes. Carton Recyclé. Bloc 70 Feuilles. 25 Notes Adhésives 7,6 x 9 cm. 25 Notes Adhésives 3,8 x 6 cm. 100 Mini Notes Adhésives 1,2 x 4,8 cm. Stylo Carton Recyclé Inclus.
 Plakmemo-Blokje. Gerecycled Karton. 70 Blaadjes Notepad. 25 Plakmemo's 7,6 x 9 cm. 25 Plakmemo's 3,8 x 6 cm. 100 Mini Plakmemo's 1,2 x 4,8 cm. Pen Gerecycled Karton Inclusief.

10.2 x 14.2 x 1.3 cm 50 / 25
 Print Code: D(4), B(4)

182



Leryl
6471

Notepad. Recycled Cardboard. 200 Sheets 7,5 x 8 cm. 125 Mini Sticky Notes 1,5 x 5 cm.
 Notizzettelbox. Recycling Pappe. 200 Seiten 7,5 x 8 cm. 125 Mini Haftnotizen 1,5 x 5 cm.
 Porte Notes. Carton Recyclé. 200 Feuilles 7,5 x 8 cm. 125 Mini Notes Adhésives 1,5 x 5 cm.
 Plakmemohouder. Gerecycled Karton. 200 Blaadjes 7,5 x 8 cm. 125 Mini Plakmemo's 1,5 x 5 cm.

8.1 x 2.6 x 8.3 cm 100 / 50
 Print Code: D(2)

Econote
3339

Sticky Notepad. Recycled Cardboard. 75 Sticky Notes 7,8 x 10 cm. 25 Sticky Notes 5 x 7,5 cm. 125 Mini Sticky Notes 1,3 x 4,6 cm. Recycled Cardboard Pen Included.
 Notizblock. Recycling Pappe. 75 Haftnotizen 7,8 x 10 cm. 25 Haftnotizen 5 x 7,5 cm. 125 Mini Haftnotizen 1,3 x 4,6 cm. Recycling Pappe Kugelschreiber Inklusive.
 Bloc Notes. Carton Recyclé. 75 Notes Adhésives 7,8 x 10 cm. 25 Notes Adhésives 5 x 7,5 cm. 125 Mini Notes Adhésives 1,3 x 4,6 cm. Stylo Carton Recyclé Inclus.
 Plakmemo-Blokje. Gerecycled Karton. 75 Plakmemo's 7,8 x 10 cm. 25 Plakmemo's 5 x 7,5 cm. 125 Mini Plakmemo's 1,3 x 4,6 cm. Gerecycleerd Kartonnen Pen Inclusief.

9.5 x 10.5 x 1 cm 200 / 50
 Print Code: D(4), B(4)





RECYCLED CARDBOARD



50 Sheets
Lined

Diser

5670

Sticky Notepad, Recycled Cardboard. 50 Sheets Notepad. 15 Sticky Notes 4,4 x 7,5 cm. 75 Mini Sticky Notes 1,4 x 4,4 cm. Recycled Cardboard Pen Included.
Haftender Notizblock. Recycling Pappé. 50 Seiten. 15 Haftnotizen 4,4 x 7,5 cm. 75 Mini Haftnotizen 1,4 x 4,4 cm. Recycling Pappé Kugelschreiber Inklusiv.
Bloc Notes Adhésif. Carton Recyclé. 50 Feuilles. 15 Notes Adhésives 4,4 x 7,5 cm. 75 Mini Notes Adhésives 1,4 x 4,4 cm. Stylo Carton Recyclé Inclus.
Notitieblok Zelfklevend. Gerecycled Karton. 50 Blaadjes. 15 Plakmemo's 4,4 x 7,5 cm. 75 Mini Plakmemo's 1,4 x 4,4 cm. Pen Gerecycled Karton Inclusief.

9.5 x 13.2 x 1.5 cm

200 / 50

Print Code: D(4), B(4)



Laska

4859

Sticky Notepad, Recycled Cardboard. 75 Sticky Notes 5 x 7,5 cm. 125 Mini Sticky Notes 1,5 x 5 cm.

Notizblock. Recycling Pappé. 75 Haftnotizen 5 x 7,5 cm. 125 Mini Haftnotizen 1,5 x 5 cm.

Bloc Notes. Carton Recyclé. 75 Notes Adhésives 5 x 7,5 cm. 125 Mini Notes Adhésives 1,5 x 5 cm.

Plakmemo-Blokje. Gerecycled Karton. 75 Plakmemo's 5 x 7,5 cm. 125 Mini Plakmemo's 1,5 x 5 cm.

8.3 x 7.6 x 2.2 cm

100 / 50

Print Code: D(4)



Lazza

5668

Sticky Notepad, Recycled Cardboard. 100 Sticky Notes 5,1 x 7,5 cm. 125 Mini Sticky Notes 1,5 x 5,1 cm.

Notizblock. Recycling Pappé. 100 Haftnotizen 5,1 x 7,5 cm. 125 Mini Haftnotizen 1,5 x 5,1 cm.

Bloc Notes. Carton Recyclé. 100 Notes Adhésives 5,1 x 7,5 cm. 125 Mini Notes Adhésives 1,5 x 5,1 cm.

Plakmemo-Blokje. Gerecycled Karton. 100 Plakmemo's 5,1 x 7,5 cm. 125 Mini Plakmemo's 1,5 x 5,1 cm.

10.8 x 8.5 x 2.5 cm

100 / 50

Print Code: D(4)



REGLA /
RULER

Blasco

6400

Ruler Bookmark. Recycled Cardboard. 15 Sticky Notes 4 x 4,5 cm. 75 Mini Sticky Notes 1,2 x 4,5 cm.

Lineal Lesezeichen. Recycling Pappe. 15 Haftnotizen 4 x 4,45 cm. 75 Mini Haftnotizen 1,2 x 4,5 cm.

Règle Marque Pages. Carton Recyclé. 15 Notes Adhésives 4 x 4,5 cm. 75 Mini Notes Adhésives 1,2 x 4,5 cm.

Liniaal Bladwijzer. Gerecycled Karton. 15 Plakmemo's 4 x 4,5 cm. 75 Mini Plakmemo's 1,2 x 4,5 cm.

6 x 21,5 cm

500 / 100

Print Code: B(4)

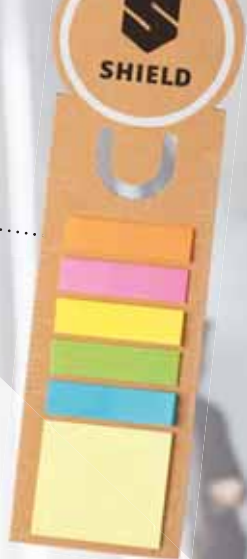

RECYCLED CARDBOARD



184

Hirdox

5669

Bookmark. Recycled Cardboard. 15 Sticky Notes 1,2 x 3,8 cm.

Lesezeichen. Recycling Pappe. 15 Haftnotizen 1,2 x 3,8 cm.

Marque Pages. Carton Recyclé. 15 Notes Adhésives 1,2 x 3,8 cm.

Bladwijzer. Gerecycled Karton. 15 Plakmemo's 1,2 x 3,8 cm.

5,4 x 8,2 cm

3000 / 200

Print Code: B(4)



EVERLASTING DIARY /
AGENDA PERPETUA

Ronux

6110

Sticky Notepad. Recycled Cardboard. 20 Sticky Notes 5,5 x 6,2 cm. 60 Mini Sticky Notes 3,2 x 4,3 cm.

Notizblock. Recycling Pappe. 20 Haftnotizen 5,5 x 6,2 cm. 60 Mini Haftnotizen 3,2 x 4,3 cm.

Bloc Notes. Carton Recyclé. 20 Notes Adhésives 5,5 x 6,2 cm. 60 Mini Notes Adhésives 3,2 x 4,3 cm.

Plakmemo-Blokje. Gerecycled Karton. 20 Plakmemo's 5,5 x 6,2 cm. 60 Mini Plakmemo's 3,2 x 4,3 cm.

10,2 x 9,2 x 0,3 cm

1000 / 100

Print Code: C(4)



01

13

Kromax

5794

Everlasting Diary. Recycled Cardboard. 26 Sheets. Weekly Page.

Tagebuch. Recycling Pappe. 26 Seiten. Wochenkalender.

Agenda. Carton Recyclé. 26 Feuilles. Page Hebdomadaire.

Agenda. Gerecycled Karton. 26 Blaadjes. Weekoverzicht.

8 x 17,3 x 0,3 cm

400 / 100

Print Code: D(4)





Covet

3191

Sticky Notepad. Recycled Cardboard. 25 Sticky Notes 7,6 x 7,6 cm. 125 Mini Sticky Notes 1,5 x 5 cm.
 Notizblock. Recycling Pappe. 25 Haftnotizen 7,6 x 7,6 cm. 125 Mini Haftnotizen 1,5 x 5 cm.
 Bloc Notes. Carton Recyclé. 25 Notes Adhésives 7,6 x 7,6 cm. 125 Mini Notes Adhésives 1,5 x 5 cm.
 Plakmemo-Blokje. Gerecycled Karton. 25 Plakmemo's 7,6 x 7,6 cm. 125 Mini Plakmemo's 1,5 x 5 cm.

8.3 x 8.6 x 0.5 cm

500 / 25

Print Code: C(4)



01

13

02

Zinko

3142

Sticky Notepad. Recycled Cardboard. 100 Sticky Notes 1,5 x 5 cm.
 Notizblock. Recycling Pappe. 100 Haftnotizen 1,5 x 5 cm.
 Bloc Notes. Carton Recyclé. 100 Notes Adhésives 1,5 x 5 cm.
 Plakmemo-Blokje. Gerecycled Karton. 100 Plakmemo's 1,5 x 5 cm.

8.2 x 6 x 0.3 cm

500 / 25

Print Code: C(4)



01

02

Selide

5453

Sticky Notepad. Cardboard. 125 Sticky Notes 1,2 x 4,7 cm.
 Notizblock. Pappe. 125 Haftnotizen 1,2 x 4,7 cm.
 Bloc Notes. Carton. 125 Notes Adhésives 1,2 x 4,7 cm.
 Plakmemo-Blokje. Karton. 125 Plakmemo's 1,2 x 4,7 cm.

7.5 x 5.5 x 0.3 cm

1000 / 50

Print Code: C(4)



Karlen

4889

Sticky Notepad. Cardboard. 40 Sticky Notes 2,5 x 4,3 cm. 100 Mini Sticky Notes 1,2 x 4,3 cm.
 Notizblock. Pappe. 40 Haftnotizen 2,5 x 4,3 cm. 100 Mini Haftnotizen 1,2 x 4,3 cm.
 Bloc Notes. Carton. 40 Notes Adhésives 2,5 x 4,3 cm. 100 Mini Notes Adhésives 1,2 x 4,3 cm.
 Plakmemo-Blokje. Karton. 40 Plakmemo's 2,5 x 4,3 cm. 100 Mini Plakmemo's 1,2 x 4,3 cm.

11.3 x 5 x 0.3 cm

500 / 50

Print Code: C(4)





Dosan 5667

Sticky Notepad. Recycled Cardboard. 100 Sticky Notes 5,5 x 9,5 cm. 25 Sticky Notes 5 x 7,6 cm. 125 Mini Sticky Notes 1,2 x 4,9 cm.
 Notizblock. Recycling Pappe. 100 Haftnotizen 5,5 x 9,5 cm. 25 Haftnotizen 5 x 7,6 cm. 125 Mini Haftnotizen 1,2 x 4,9 cm.
 Bloc Notes. Carton Recyclé. 100 Notes Adhésives 5,5 x 9,5 cm. 25 Notes Adhésives 5 x 7,6 cm. 125 Mini Notes Adhésives 1,2 x 4,9 cm.
 Plakmemo-Blokje. Gerecycled Karton. 100 Plakmemo's 5,5 x 9,5 cm. 25 Plakmemo's 5 x 7,6 cm. 125 Mini Plakmemo's 1,2 x 4,9 cm.

8 x 10,9 x 1,8 cm

100 / 50

Print Code: D(4), W

Novich 5795

Notepad. Cardboard. 30 Sticky Notes 4,5 x 6 cm. 50 Mini Sticky Notes 1,2 x 4,5 cm.
 Notizzettelbox. Pappe. 30 Haftnotizen 4,5 x 6 cm. 50 Mini Haftnotizen 1,2 x 4,5 cm.
 Porte Notes. Carton. 30 Notes Adhésives 4,5 x 6 cm. 50 Mini Notes Adhésives 1,2 x 4,5 cm.
 Plakmemohouder. Karton. 30 Plakmemo's 4,5 x 6 cm. 50 Mini Plakmemo's 1,2 x 4,5 cm.

5,4 x 10 x 6,5 cm

500 / 100

Print Code: C(4)



Prent 4888

Sticky Notepad. Cardboard. 70 Sheets Notepad. 25 Sticky Notes 7,6 x 7,6 cm. 125 Mini Sticky Notes 1,2 x 4,4 cm. Recycled Cardboard Pen Included.
 Notizblock. Pappe. 70 Seiten Notizblock. 25 Haftnotizen 7,6 x 7,6 cm. 125 Mini Haftnotizen 1,2 x 4,4 cm. Recycling Pappe Kugelschreiber Inklusiv.
 Bloc Notes. Carton. Bloc 70 Feuilles. 25 Notes Adhésives 7,6 x 7,6 cm. 125 Mini Notes Adhésives 1,2 x 4,4 cm. Stylo Carton Recyclé Inclus.
 Plakmemo-Blokje. Karton. 70 Blaadjes Notepad. 25 Plakmemo's 7,6 x 7,6 cm. 125 Mini Plakmemo's 1,2 x 4,4 cm. Pen Gerecycled Karton Inclusief.

10,3 x 15,5 x 1,1 cm

100 / 50

Print Code: D(4), B(4)

Codex 3805

Notepad. Cardboard. 200 Sheets 7,6 x 7,6 cm. 125 Mini Sticky Notes 1,5 x 5 cm.
 Notizzettelbox. Pappe. 200 Seiten 7,6 x 7,6 cm. 125 Mini Haftnotizen 1,5 x 5 cm.
 Porte Notes. Carton. 200 Feuilles 7,6 x 7,6 cm. 125 Mini Notes Adhésives 1,5 x 5 cm.
 Plakmemohouder. Karton. 200 Blaadjes 7,6 x 7,6 cm. 125 Mini Plakmemo's 1,5 x 5 cm.

8 x 2,9 x 8 cm

100 / 50

Print Code: D(2)



Kostner

5223

Stylus Touch Ball Pen. Jumbo Refill.
Kugelschreiber Pointer. Jumbo Ersatzmine.
Styllet Bille. Recharge Jumbo.
Touch-Screen Balpen. Jumbo Refill.

Ø 1 × 14.7 cm

1000 / 50

Print Code: A(4)



03 01 02 19 07



SCREEN CLEANER
LIMPIA PANTALLAS



11 05 04 19 01 03

Alzar

4661

Stylus Touch Ball Pen. Screen Cleaner Included.
Kugelschreiber Pointer. Displayreiniger Inklusiv.
Styllet Bille. Nettoyeur d'Écran Inclus.
Touch-Screen Balpen. Screen Cleaner Inclusief.

Ø 3.8 × 12.5 cm

500 / 25

Print Code: C(4)



02



03

ADHESIVE BASE
BASE ADHESIVA



19 01 02

Henk

4910

Pen.
Kugelschreiber.
Stylo.
Pen.

5.6 × 17 × 5.6 cm

100 / 10

Print Code: C(4)





Kery

2569

Sticky Notepad. Recycled Paper. 50 Sheets.
Haftender Notizblock. Recycling Papier. 50 Seiten.
Bloc Notes Adhésif. Papier Recyclé. 50 Feuilles.
Notitieblok Zelfklevend. Gerecycled Paper. 50 Blaadjes.

7.5 × 7.5 × 0.5 cm

250 / 10

Print Code: Consult.



Cocux

2567

Sticky Notepad. Recycled Paper. 50 Sheets.
Haftender Notizblock. Recycling Papier. 50 Seiten.
Bloc Notes Adhésif. Papier Recyclé. 50 Feuilles.
Notitieblok Zelfklevend. Gerecycled Paper. 50 Blaadjes.

10 × 10 × 0.5 cm

250 / 10

Print Code: Consult.



Ninax

2570

Sticky Notepad. Recycled Paper. 50 Sheets.
Haftender Notizblock. Recycling Papier. 50 Seiten.
Bloc Notes Adhésif. Papier Recyclé. 50 Feuilles.
Notitieblok Zelfklevend. Gerecycled Paper. 50 Blaadjes.

10 × 7.5 × 0.5 cm

250 / 10

Print Code: Consult.



Jarax

2558

Memo Block. Recycled Paper. 150 Sheets.
Memo Block. Recycling Papier. 150 Seiten.
Bloc Notes Encollé. Papier Recyclé. 150 Feuilles.
Memo Block. Gerecycled Paper. 150 Blaadjes.

8 × 11 × 1.5 cm

150

Print Code: Consult.



Native

2560

Memo Block. Recycled Paper. 150 Sheets.
Memo Block. Recycling Papier. 150 Seiten.
Bloc Notes Encollé. Papier Recyclé. 150 Feuilles.
Memo Block. Gerecycled Paper. 150 Blaadjes.

10 × 10 × 1.5 cm

150

Print Code: Consult.



Gerdon

2557

Sticky Notepad. Recycled Paper. 50 Sheets.
Haftender Notizblock. Recycling Papier. 50 Seiten.
Bloc Notes Adhésif. Papier Recyclé. 50 Feuilles.
Notitieblok Zelfklevend. Gerecycled Paper. 50 Blaadjes.

7.5 × 7.5 × 0.5 cm

250 / 10

Print Code: Consult.

PAPER



Raid

2561

Sticky Notepad, Recycled Cardboard. 50 Sticky Notes 7,5 x 10 cm. 25 Sticky Notes 5 x 7,5 cm. 125 Mini Sticky Notes 1,2 x 4,9 cm.

Notizblock, Recycling Pappe. 50 Haftnotizen 7,5 x 10 cm. 25 Haftnotizen 5 x 7,5 cm. 125 Mini Haftnotizen 1,2 x 4,9 cm.

Bloc Notes, Carton Recyclé. 50 Notes Adhésives 7,5 x 10 cm. 25 Notes Adhésives 5 x 7,5 cm. 125 Mini Notes Adhésives 1,2 x 4,9 cm.

Plakmemo-Blokje, Gerecycled Karton. 50 Plakmemo's 7,5 x 10 cm. 25 Plakmemo's 5 x 7,5 cm. 125 Mini Plakmemo's 1,2 x 4,9 cm.

10.2 x 7.8 x 0.9 cm



50

Print Code: Consult.

Jarbux

2562

Sticky Notepad, Recycled Cardboard. 50 Sticky Notes 7,5 x 10 cm. 25 Sticky Notes 5 x 7,5 cm. 125 Mini Sticky Notes 1,2 x 4,9 cm.

Notizblock, Recycling Pappe. 50 Haftnotizen 7,5 x 10 cm. 25 Haftnotizen 5 x 7,5 cm. 125 Mini Haftnotizen 1,2 x 4,9 cm.

Bloc Notes, Carton Recyclé. 50 Notes Adhésives 7,5 x 10 cm. 25 Notes Adhésives 5 x 7,5 cm. 125 Mini Notes Adhésives 1,2 x 4,9 cm.

Plakmemo-Blokje, Gerecycled Karton. 50 Plakmemo's 7,5 x 10 cm. 25 Plakmemo's 5 x 7,5 cm. 125 Mini Plakmemo's 1,2 x 4,9 cm.

10.6 x 8.2 x 1.8 cm



50

Print Code: Consult.



189



50 Sheets
Plain

Mirix

2564

Notebook, Recycled Cardboard. 50 Sheets.

Notizbuch, Recycling Pappe. 50 Seiten.

Cahier, Carton Recyclé. 50 Feuilles.

Notitieboek, Gerecycled Karton. 50 Blaadjes.

15.8 x 21 x 1.6 cm



50

Print Code: Consult.

Meyik

2565

Notebook, Recycled Cardboard. Hard Cover. 50 Sheets.

Notizbuch, Recycling Pappe. Hardcover-Abdeckung. 50 Seiten.

Cahier, Carton Recyclé. Couverture Rigide. 50 Feuilles.

Notitieboek, Gerecycled Karton. Harde Kaft. 50 Blaadjes.

16.5 x 21.5 x 2.2 cm



20

Print Code: Consult.

Baylek

2566

Notebook, Recycled Cardboard. Hard Cover. 50 Sheets.

Notizbuch, Recycling Pappe. Hardcover-Abdeckung. 50 Seiten.

Bloc Notes, Carton Recyclé. Couverture Rigide. 50 Feuilles.

Notitieboekje, Gerecycled Karton. Harde Kaft. 50 Blaadjes.

15.4 x 21.3 x 1.3 cm



25

Print Code: Consult.



50 Sheets
Plain



50 Sheets
Plain



MÍNIMO 500 UDS

Tander
2529

Sticky Notepad. 50 Sheets.
Haftender Notizblock. 50 Seiten.
Bloc Notes Adhésif. 50 Feuilles.
Notitieblok Zelfklevend. 50 Blaadjes.

7.5 × 7.5 × 0.5 cm 250 / 10
Print Code: Consult.



MÍNIMO 500 UDS

Samko
2530

Sticky Notepad. 50 Sheets.
Haftender Notizblock. 50 Seiten.
Bloc Notes Adhésif. 50 Feuilles.
Notitieblok Zelfklevend. 50 Blaadjes.

10 × 7.5 × 0.5 cm 200 / 10
Print Code: Consult.

190



MÍNIMO 250 UDS

Navil
2534

Notebook. 50 Sheets.
Notizbuch. 50 Seiten.
Cahier. 50 Feuilles.
Notitieboek. 50 Blaadjes.

15 × 21 × 1.6 cm 50
Print Code: Consult.



MÍNIMO 250 UDS

Leray
2535

Notebook. 50 Sheets.
Notizbuch. 50 Seiten.
Cahier. 50 Feuilles.
Notitieboek. 50 Blaadjes.

13 × 18 × 0.7 cm 50
Print Code: Consult.



MÍNIMO 250 UDS

Yolan

2531

Memo Block. 150 Sheets.
Memo Block. 150 Seiten.
Bloc Notes Encollé. 150 Feuilles.
Memo Block. 150 Blaadjes.

10 × 10 × 1.5 cm

Print Code: Consult.



MÍNIMO 250 UDS

Maran

2532

Memo Block. 150 Sheets.
Memo Block. 150 Seiten.
Bloc Notes Encollé. 150 Feuilles.
Memo Block. 150 Blaadjes.

8 × 11 × 1.5 cm

Print Code: Consult.



Marseg

2533

Memo Block. 250 Sheets.
Memo Block. 250 Seiten.
Bloc Notes Encollé. 250 Feuilles.
Memo Block. 250 Blaadjes.

10 × 10 × 2.5 cm

Print Code: Consult.



MÍNIMO 250 UDS

RPET

The fabric used in the manufacturing process of these items is made of recycled plastic (RPET). Like this, the emission of plastic residues to our planet and the consumption of energy is drastically reduced, resulting in a much more eco-friendly process.

El material de estos productos está fabricado con plástico reciclado (RPET), que, además de ayudar en la disminución de residuos plásticos en el planeta, utiliza menos energía en el proceso de fabricación, haciendo que sea mucho menos dañino para el medio ambiente.

STOP PLASTIC
POLLUTING
THE OCEAN



Nespon

6416

Lanyard. Polyester RPET.
Schlüsselband. Polyester RPET.
Lanyard. Polyester RPET.
Lanyard. Polyester RPET.

2 x 50 cm

Print Code: F(1), N(8)

800 / 100

100%
COTTON



Mirok

6196

Lanyard. 100% Cotton.
Schlüsselband. 100% Baumwolle.
Lanyard. 100% Cotton.
Lanyard. 100% Katoen.

2 x 50 cm

Print Code: F(1), N(8)

800 / 100

100% COTTON
100% ALGODÓN





WHEAT STRAW/
CAÑA DE TRIGO

eco-friendly
LANYARD

NEW

100% COTTON/
100% ALGODÓN

SAFETY CATCH / CIERRE
SEGURIDAD

Troix

6778

Lanyard. 100% Cotton/ Wheat Straw/ PP. Safety Catch.

Schlüsselband. 100% Baumwolle/ Weizenstroh/ PP. Sicherheitsverschluss.

Lanyard. 100% Coton/ Paille de Blé/ PP. Fermeture Sécurité.

Lanyard. 100% Katoen/ Tarwestro/ PP. Veiligheidsluiting.

2 × 52 cm

500 / 100

Print Code: F(1), N(8)

193



SAFETY CATCH / CIERRE
SEGURIDAD

NEW

WHEAT STRAW/
CAÑA DE TRIGO

WHEAT STRAW/
CAÑA DE TRIGO

NATURAL CORK/
CORCHO NATURAL

NATURAL CORK/
CORCHO NATURAL

Bespal

6779

Lanyard. Natural Cork/ Wheat Straw/ PP. Safety Catch.

Schlüsselband. Naturkork/ Weizenstroh/ PP. Sicherheitsverschluss.

Lanyard. Bouchon Naturel/ Paille de Blé/ PP. Fermeture Sécurité.

Lanyard. Natuurlijk Kurk/ Tarwestro/ PP. Veiligheidsluiting.

2 × 48 cm

600 / 100

Print Code: F(1), N(8)

Merul

6885

Lanyard. Natural Cork/ Wheat Straw/ PP. Safety Catch.

Schlüsselband. Naturkork/ Weizenstroh/ PP. Sicherheitsverschluss.

Lanyard. Bouchon Naturel/ Paille de Blé/ PP. Fermeture Sécurité.

Lanyard. Natuurlijk Kurk/ Tarwestro/ PP. Veiligheidsluiting.

2 × 50 cm

1000 / 100

Print Code: D(1)



SAFETY CATCH / CIERRE
SEGURIDAD



Kappin 6102

Lanyard. Polyester. Safety Catch.
Schlüsselband. Polyester. Sicherheitsverschluss.
Lanyard. Polyester. Fermeture Sécurité.
Lanyard. Polyester. Veiligheidsluiting.

2 × 50 cm

800 / 100

Print Code: F(1), N(8), R



SAFETY CATCH
CIERRE SEGURIDAD

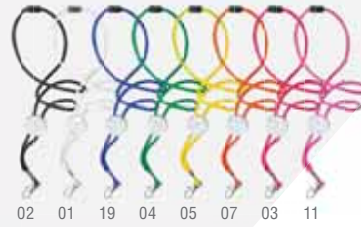

Perux 5047

Lanyard. Polyester. Safety Catch.
Schlüsselband. Polyester. Sicherheitsverschluss.
Lanyard. Polyester. Fermeture Sécurité.
Lanyard. Polyester. Veiligheidsluiting.

3.2 × 50 cm

600 / 100

Print Code: D(1), V

SUBLIMATION

SPECIAL SUBLIMATION



Nopak 5454

Sublimation Lanyard. Polyester.
Sublimations Schlüsselband. Polyester.
Lanyard Sublimation. Polyester.
Sublimatie Lanyard. Polyester.

2.5 × 50 cm

500 / 100

Print Code: R



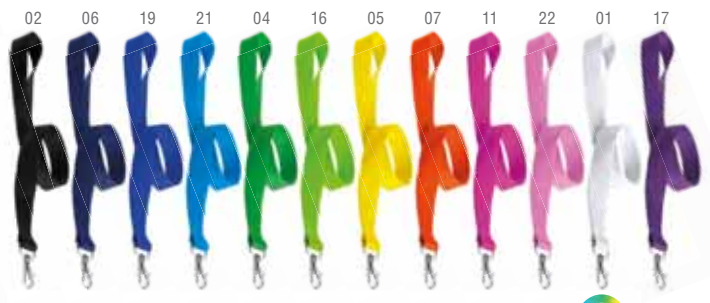

Kunel

6415
Lanyard. Polyester.
Schlüsselband. Polyester.
Lanyard. Polyester.
Lanyard. Polyester.

2 x 55 cm 600 / 100
Print Code: F(1), N(8), R



Neck

8780
Lanyard. Polyester.
Schlüsselband. Polyester.
Lanyard. Polyester.
Lanyard. Polyester.

2 x 50 cm 800 / 100
Print Code: F(1), N(8), R



Tremen

5288
Lanyard. Polyester.
Schlüsselband. Polyester.
Lanyard. Polyester.
Lanyard. Polyester.

2 x 50 cm 800 / 100
Print Code: F(1), N(8), R



BICOLOUR

11



Duble

8846

Lanyard. Polyester.
Schlüsselband. Polyester.
Lanyard. Polyester.
Lanyard. Polyester.

2 x 55 cm 600 / 100
Print Code: F(1), N(8), R



SUITABLE FOR ALL MOBILES
VÁLIDO PARA TODOS LOS MOVILES

01 03 02 04



19
SILICONE
SILICONA

Veltux
5638

Lanyard. Silicone.
Schlüsselband. Silikon.
Lanyard. Silicone.
Lanyard. Siliconen.

7 x 58 cm
Print Code: G(1)

300 / 50

Menfix
6716

Mask Holder Lanyard. Polyester. Adjustable.
Halterung für Maske Schlüsselband. Polyester. Verstellbar.
Lanyard Porte-Masques. Polyester. Ajustable.
Maskerhouder Lanyard. Polyester. Aanpasbaar.

1.5 x 48 cm
Print Code: D(1)

2000 / 100

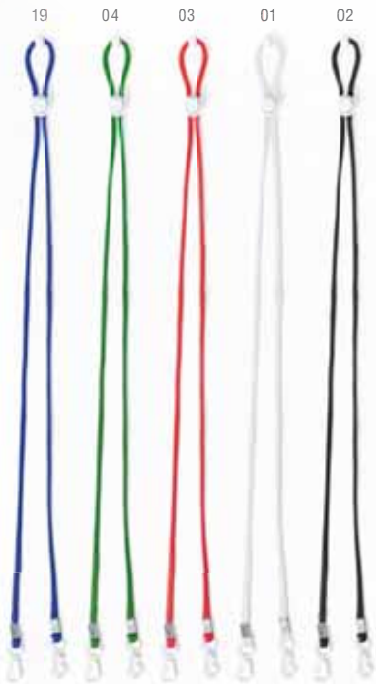

NEW





SAFETY CATCH
CIERRE SEGURIDAD



01



Ideal
Sublimation

Zornit

5930

Id Badge Lanyard. Polyester/ PU. Safety Catch.
Namensschild Schlüsselband. Polyester/ PU. Sicherheitsverschluss.
Lanyard Porte-Badge. Polyester/ Similicuir. Fermeture Sécurité.
Badge Lanyard. Polyester/ PU. Veiligheidsluiting.

7 × 60 cm

500 / 20

Print Code: D(1), F(1), N(8), R



02



03



19



07

Cail

5289

Badge Lanyard. Polyester/ PVC.
Namensschild Schlüsselband. Polyester/ PVC.
Lanyard Porte-Badge. Polyester/ PVC.
Badge Lanyard. Polyester/ PVC.

11 × 59 cm

800 / 100

Print Code: F(1), D(1)



01

02

19

Maes

3709

Id Badge Lanyard. Polyester/ PVC.
Namensschild Schlüsselband. Polyester/ PVC.
Lanyard Porte-Badge. Polyester/ PVC.
Badge Lanyard. Polyester/ PVC.

11 × 58 cm

1000 / 100

Print Code: G(1), D(1)



04



01



03



05

SAFETY CATCH
CIERRE SEGURIDAD



ID BADGE NOT INCLUDED
IDENTIFICADOR NO INCLUIDO



EXTENDABLE 100 CM
100 CM EXTENDIDO

Melak

3806

Id Holder. Clip and Tape Measure 1 m Included.
Namensschild Halter. Clip und Maßband 1 m Inklusive.
Porte Badge. Clip et Lanîère 1 m Inclus.
Id Houder. Clip en Meetlint 1 m Inclusief.

Ø 3.7 × 0.8 cm

500 / 100

Print Code: C(4), V



EXTENDABLE 58 CM
58 CM EXTENDIDO

Lemer

6169

Lanyard. Polyester. Extendable. Safety Catch.
Schlüsselband. Polyester. Ausziehbar. Sicherheitsverschluss.
Lanyard. Polyester. Extensible. Fermeture Sécurité.
Lanyard. Polyester. Verlengbaar. Veiligheidsluiting.

1.5 × 5 cm

600 / 50

Print Code: D(4), F(1), N(8), R, V

198



EXTENDABLE 65 CM
65 CM EXTENDIDO

Bosur

6489

Id Holder. Extendable. Clip Included.
Namensschild Halter. Ausziehbar. Gürtelclip Inklusive.
Porte Badge. Extensible. Clip Inclus.
Id Houder. Verlengbaar. Clip Inclusief.

Ø 3.2 × 1.5 cm

1000 / 100

Print Code: C(4), V



EXTENDABLE 75 CM
75 CM EXTENDIDO

Napper

6490

Id Holder. Extendable. Clip Included.
Namensschild Halter. Ausziehbar. Gürtelclip Inklusive.
Porte Badge. Extensible. Clip Inclus.
Id Houder. Verlengbaar. Clip Inclusief.

3.3 × 5.5 × 1 cm

1000 / 100

Print Code: C(4)



Solip

4824
 Id Badge. PVC.
 Namensschild. PVC.
 Badge. PVC.
 Id Badge. PVC.

📄 Consult.
 🖨️ Print Code: C(1)

📦 1000 / 100



Ifem

9169
 Id Badge. PVC.
 Namensschild. PVC.
 Badge. PVC.
 Id Badge. PVC.

📄 10 × 9 cm
 🖨️ Print Code: C(1)

📦 2000 / 200



Bizzot

4826
 Id Badge. PVC.
 Namensschild. PVC.
 Badge. PVC.
 Id Badge. PVC.

📄 8,4 × 12,1 cm
 🖨️ Print Code: C(1)

📦 2000 / 200



Alter

4344
 Id Badge. PVC.
 Namensschild. PVC.
 Badge. PVC.
 Id Badge. PVC.

📄 11 × 9,5 cm
 🖨️ Print Code: C(1)

📦 1000 / 100





Bindel

3726

Id Badge. Aluminium.
Namensschild. Aluminium.
Badge. Aluminium.
Id Badge. Aluminium.

7 × 2.5 × 0.4 cm

1000 / 40

Print Code: C(4), L1



Upsin

5516

Id Badge.
Namensschild.
Badge.
Id Badge.

6.8 × 3.4 × 0.9 cm

1000 / 100

Print Code: C(4), L1



Sinvet

5518

Id Badge.
Namensschild.
Badge.
Id Badge.

7.4 × 2.4 × 0.9 cm

1000 / 100

Print Code: C(4)



Venkal

5517

Id Badge. Aluminium.
Namensschild. Aluminium.
Badge. Aluminium.
Id Badge. Aluminium.

7 × 2.5 × 0.7 cm

1000 / 100

Print Code: C(4)



19



02

09

03

Bonus 3410

Card Holder. Aluminium. 1 Compartment.
Visitenkartenetui. Aluminium. 1 Abteilung.
Porte-Cartes. Aluminium. 1 Compartment.
Kaartjeshouder. Aluminium. 1 Compartment.

9.4 × 6 × 0.7 cm

400 / 50

Print Code: D(4), L1, W



19

Hektar 4496

Card Holder. Aluminium. 6 Compartments.
Visitenkartenetui. Aluminium. 6 Abteilungen.
Porte-Cartes. Aluminium. 6 Compartiments.
Kaartjeshouder. Aluminium. 6 Compartimenten.

11 × 7.5 × 2 cm

200 / 50

Print Code: D(4), L1



02



01



03

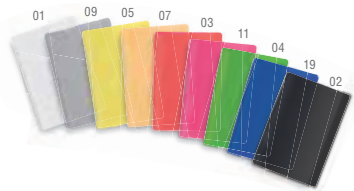

Kazak 4224

Card Holder. PVC. 1 Compartment.
Visitenkartenetui. PVC. 1 Abteilung.
Porte-Cartes. PVC. 1 Compartment.
Kaartjeshouder. PVC. 1 Compartment.

6.6 × 9.5 × 0.1 cm

5000 / 100

Print Code: C(1)

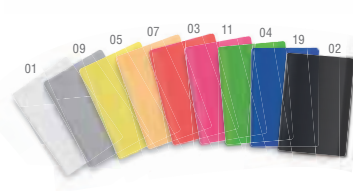

Letrix 4225

Card Holder. PVC. 2 Compartments.
Visitenkartenetui. PVC. 2 Abteilungen.
Porte-Cartes. PVC. 2 Compartiments.
Kaartjeshouder. PVC. 2 Compartimenten.

6.7 × 9.5 × 0.2 cm

2000 / 100

Print Code: C(1)

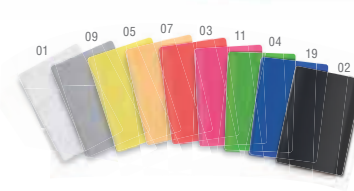

Mitux 4226

Card Holder. PVC. 6 Compartments.
Visitenkartenetui. PVC. 6 Abteilungen.
Porte-Cartes. PVC. 6 Compartiments.
Kaartjeshouder. PVC. 6 Compartimenten.

7.5 × 10.3 × 0.4 cm

1000 / 50

Print Code: C(1)



WEBCAM COVER



SCREEN CLEANER
LIMPIAPANTALLAS



03

Fewek

5740

Webcam Cover. Screen Cleaner Included.
Webcam-Blocker. Displayreiner Inklusiv.
Bloqueur Webcam. Nettoyeur d'Écran Inclus.
Webcam Blocker. Screen Cleaner Inclusif.

3 x 2.4 x 1.8 cm

1000 / 100

Print Code: B(4), V



3 PIECES

Pembol

6085

Webcam Cover. Adhesive. 3 Pieces.
Webcam-Blocker. Haftend. 3 Stück.
Bloqueur Webcam. Adhésif. 3 Pièces.
Webcam Blocker. Klevend. 3 Stuks.

3.5 x 3.5 x 1.8 cm

2000 / 1000

Print Code: B(4), W



02

01

202



Fildon

6575

Webcam Cover. Wheat Straw/ ABS. Adhesive.
Webcam-Blocker. Weizenstroh/ ABS. Haftend.
Bloqueur Webcam. Paille de Blé/ ABS. Adhésif.
Webcam Blocker. Tarwestro/ ABS. Klevend.

4.1 x 1.6 x 0.2 cm

10000 / 5000

Print Code: B(4), W



19



Nambus

6179

Webcam Cover. Adhesive.
Webcam-Blocker. Haftend.
Bloqueur Webcam. Adhésif.
Webcam Blocker. Klevend.

3.2 x 1.3 x 0.1 cm

10000 / 5000

Print Code: B(1), W



01

08

05

04

03

02

07



02



01



09



01

09

01

Lacol

5801

Webcam Cover. Adhesive.
Webcam-Blocker. Haftend.
Bloqueur Webcam. Adhésif.
Webcam Blocker. Klevend.

4.1 x 1.6 x 0.2 cm

10000 / 5000

Print Code: B(4), W



DPI BUTTON

01



05

19

02

03

Lyster

4624

Mouse. Wireless. Optical. 2 Batteries AAA Not Included.
 Maus. Drahtlos. Optisch. 2 AAA Batterien Nicht im Lieferumfang.
 Souris. Sans Fil. Optique. 2 Piles AAA Non Inclus.
 Muis. Draadloos. Optical. 2 Batterijen AAA Niet Inclusief.

Wireless
Mouse

11.2 x 2.4 x 5.7 cm

200 / 100

Print Code: E(4), W

203



19

Yoiko

3746

Mini Mouse. Optical. Extendable Cable.
 Mini Maus. Optisch. Ausziehbar Kabel.
 Mini Souris. Optique. Cable Extensible.
 Mini Muis. Optical. Verlengbare Kabel.

8 x 2 x 3.5 cm

200 / 50

Print Code: E(1)

03

02

05



03

FOLDABLE
PLEGABLE

01

02

19

Lenbal

5948

Mouse. Foldable. Wireless. Optical. 2 Batteries AAA Not Included.
 Maus. Faltbar. Drahtlos. Optisch. 2 AAA Batterien Nicht im Lieferumfang.
 Souris. Pliable. Sans Fil. Optique. 2 Piles AAA Non Inclus.
 Muis. Opvouwbaar. Draadloos. Optical. 2 Batterijen AAA Niet Inclusief.

11.3 x 2.9 x 5.6 cm

100

Print Code: E(4), W

Wireless
Mouse

ANTI SLIP



Anti Slip

02 19 04 05 07 11 03 01



Vaniat 4387

Mousepad. Polyester/ Silicone.
Mauspad. Polyester/ Silikon.
Tapis Souris. Polyester/ Silicone.
Muispad. Polyester/ Siliconen.

22 x 18 cm

Print Code: E(1), R

250 / 50

Roland

5520

Mousepad. Polyester/ Silicone.
Mauspad. Polyester/ Silikon.
Tapis Souris. Polyester/ Silicone.
Muispad. Polyester/ Siliconen.

Ø 20 cm

Print Code: E(1), R



Anti Slip

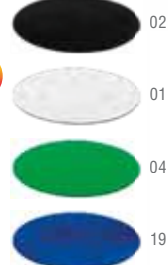

ANTI SLIP

204



03

ANTI SLIP



19

04

05

03

01

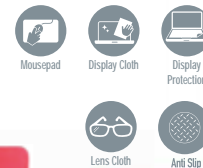

ANTI SLIP



Pictium

4242

Mousepad Photo Frame. PVC/ EVA. Photos Size: 15 x 10 cm.
Mauspad Bilderrahmen. PVC/ EVA. Photos: 15 x 10 cm.
Tapis Souris Porte Photos. PVC/ EVA. Photos: 15 x 10 cm.
Muispad Fotolijst. PVC/ EVA. Foto's Maat: 15 x 10 cm.

23 x 18 cm

Print Code: E(4)

400 / 100



Anti Slip

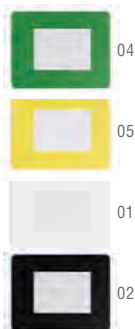

04

05

01

02

Serfat

5781

Mousepad. Microfibre/ Silicone.
Mauspad. Mikrofaser/ Silikon.
Tapis Souris. Microfibre/ Silicone.
Muispad. Microfibre/ Siliconen.

22 x 18 cm

Print Code: E(1), R

400 / 50



19



HOLDER
SOPORTE

WIRELESS
CHARGE

ANTI SLIP

19



Anti Slip



Ideal
Sublimation



03



01



02



04

Dropol

5946

Charger Mousepad. PU. Wireless. Cable Included.
Ladegerät Mauspad. PU. Drahtlos. Kabel Inklusiv.
Tapis Souris Chargeur. Similicuir. Sans Fil. Câble Inclus.
Oplader Muispad. PU. Draadloos. Kabel Inclusief.

30 x 21 cm

25

Print Code: F(1), L2



Minet

6140

Mousepad. Polyester/ Silicone. Padded Wrist Rest.
Mauspad. Polyester/ Silikon. Gepolsterte Pamrest.
Tapis Souris. Polyester/ Silicone. Repose-Mains Rembourrée.
Muispad. Polyester/ Siliconen. Gewatteerd Polsteun.

20.5 x 24.3 cm

100

Print Code: E(1), N(8), R



REMOVE THE STRESS AND
REDUCE THE PAIN
ELIMINA EL ESTRÉS Y REDUCE
EL DOLOR

205



SILICONE
ANTI SLIP

03

ANTI SLIP

03



Anti Slip

Exfera

4577

Mousepad. Silikon.
Mauspad. Silikon.
Tapis Souris. Silicoune.
Muispad. Siliconen.

Ø 19.3 cm

250 / 50

Print Code: F(1)



05



04



19



Gong

9850

Mousepad. PU. Padded Wrist Rest.
Mauspad. PU. Gepolsterte Pamrest.
Tapis Souris. Similicuir. Repose-Mains Rembourrée.
Muispad. PU. Gewatteerd Polsteun.

18.5 x 22.5 cm

50 / 25

Print Code: E(1), L2, T



Anti Slip



02



19

 Bluetooth®



Francy

6126

Multifunction Mousepad. Wireless. 4000 mAh. USB Output. Micro USB Input. Bluetooth Connection. Power 2Wx2. USB Rechargeable. Cable Included.

Multifunktion Mauspad. Drahtlos. 4000 mAh. USB Ausgang. Micro USB Eingang. Bluetooth Anschluss. Power 2Wx2. USB Wiederaufladbar. Kabel Inklusive.

Tapis Souris Multifonction. Sans Fil. 4000 mAh. Sortie USB. Entrée Micro USB. Connexion Bluetooth. Puissance 2Wx2. Rechargeable USB. Cable Inclus.

Multifunctioneel Muispad. Draadloos. 4000 mAh. USB Output. Micro USB Input. Bluetooth Verbinding. Vermogen 2Wx2. USB Opladbaar. Kabel Inclusief.

29.2 x 21.1 cm

20

Print Code: G(1), W



4000 mAh

● SPEAKER

206



Roktum

6129

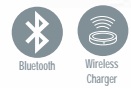

Charger Keyboard. Wireless. Bluetooth Connection. USB Rechargeable. Cable Included. Ladegerät Tastatur. Drahtlos. Bluetooth Anschluss. USB Wiederaufladbar. Kabel Inklusive. Clavier Chargeur. Sans Fil. Connexion Bluetooth. Rechargeable USB. Cable Inclus. Oplader Toetsenbord. Draadloos. Bluetooth Verbinding. USB Opladbaar. Kabel Inclusief.

24 x 0.6 x 17 cm

20

Print Code: G(1), W



HOLDER INCLUDED
SOPORTE INCLUIDO

Keegan

5335



Laser Keyboard. Bluetooth Connection. USB Rechargeable. Cable Included. Laser Tastatur. Bluetooth Anschluss. USB Wiederaufladbar. Kabel Inklusive. Clavier Virtuel. Connexion Bluetooth. Rechargeable USB. Cable Inclus. Laser Keyboard. Bluetooth Verbinding. USB Opladbaar. Kabel Inclusief.

4 x 7.8 x 2 cm

100

Print Code: F(4), W





Tyrell

5305

Keyboard Holder. PU. Bluetooth Connection. USB Rechargeable. Cable Included.
 Tastatur Halter. PU. Bluetooth Anschluss. USB Wiederaufladbar. Kabel Inklusive.
 Clavier Support. Similicuir. Connexion Bluetooth. Rechargeable USB. Cable Inclus.
 Toetsenbord Houder. PU. Bluetooth Verbinding. USB Oplaadbaar. Kabel Inclusief.

22 x 1.1 x 14.3 cm 40 / 20
 Print Code: F(2), L2



Dustin

5739

Keyboard Holder. PU. Bluetooth Connection. USB Rechargeable. Cable Included.
 Tastatur Halter. PU. Bluetooth Anschluss. USB Wiederaufladbar. Kabel Inklusive.
 Clavier Support. Similicuir. Connexion Bluetooth. Rechargeable USB. Cable Inclus.
 Toetsenbord Houder. PU. Bluetooth Verbinding. USB Oplaadbaar. Kabel Inclusief.

22 x 2.2 x 14.5 cm 40 / 20
 Print Code: F(2), L2



TWO VERSIONS:
 SPANISH & INTERNATIONAL

Volks

4935

Keyboard. Bluetooth Connection. USB Rechargeable. Cable Included.
 Tastatur. Bluetooth Anschluss. USB Wiederaufladbar. Kabel Inklusive.
 Clavier. Connexion Bluetooth. Rechargeable USB. Cable Inclus.
 Toetsenbord. Bluetooth Verbinding. USB Oplaadbaar. Kabel Inclusief.

20 x 0.6 x 12.5 cm 50 / 25
 Print Code: F(2)





LOCK AND ERASER BUTTON INCLUDED
BOTON DE BORRADO Y BLOQUEO INCLUIDO



Boltuk

6201

USB Notepad. Hard Cover. 100 Sheets. USB Memory 16GB Included.
USB Notizblock. Hardcover-Abdeckung. 100 Seiten. USB Speicher 16GB Inklusiv.
Bloc Notes USB. Couverture Rigide. 100 Feuilles. Clé USB 16GB Inclus.
USB Notitieblokje. Harde Kaft. 100 Blaadjes. USB Memory 16GB Inclusief.

14.2 × 21 × 1.5 cm

50

Print Code: F(2), T, U, W



100 Sheets
Lined



USB



Koptul

6247

LCD Writing Tablet. Magnetic. Pen and Button Battery Included.
LCD Schreibtablett. Magnetisch. Bleistift und Knopfzelle Inklusiv.
Tablette d'écriture LCD. Magnétique. Crayon et Pile Bouton Inclus.
LCD Tablet om te Schrijven. Magnetisch. Potlood en Knopcel Batterij Inclusief.

14.7 × 22.5 × 0.5 cm

100 / 50

Print Code: F(1), W



01



2500
mAh

Spencer

5242

USB Power Bank. 2500 mAh. USB Output. Micro USB Input. 8GB. Cable Included.
USB Power Bank. 2500 mAh. USB Ausgang. Micro USB Eingang. 8GB. Kabel Inklusiv.
Power Bank USB. 2500 mAh. Sortie USB. Entrée Micro USB. 8GB. Câble Inclus.
USB Power Bank. 2500 mAh. USB Output. Micro USB Input. 8GB. Kabel Inclusief.

6.2 × 11.4 × 0.8 cm

100 / 50

Print Code: E(4), W





1L



NEW



Calpy 6724

Electric Lunch Box. 1 L. Cable Included.
Elektrische Lunch Box. 1 L. Kabel Inklusive.
Electrique Gamelle. 1 L. Câble Inclus.
Elektrische Lunch Box. 1 L. Kabel Inclusief.

23.5 x 16.5 x 11 cm
Print Code: G(1)

20



Bluetooth

350 ml



Home / Office



Wireless Charger



Fast charge 10W

Kalan 6533

SPECIALY DESIGNED HEATING MUG

Charger Cup Warmer. Ceramic/ ABS. 350 ml. Wireless. Fast Charger 10W. USB Connection. Cable Included.
Tasse Warmer Ladegerät. Keramik/ ABS. 350 ml. Drahtlos. Schnelle Aufladung 10W. Anschluss USB. Kabel Inklusive.
Chauffe Tasses Chargeur. Céramique/ ABS. 350 ml. Sans Fil. Charge Rapide 10W. Connexion USB. Câble Inclus.
Warmhoudplaatje Oplader. Keramiek/ ABS. 350 ml. Draadloos. Snellader 10W. USB Connectie. Kabel Inclusief.

11 x 12.5 x 11 cm
Print Code: G(4), L2

20



209



03



Mug 9528

Cup Warmer. USB Connection. Cable Included.
Tasse Warmer. USB Anschluss. Kabel Inklusive.
Chauffe Tasses. Connexion USB. Câble Inclus.
Warmhoudplaatje. USB Verbinding. Kabel Inclusief.

Ø 10 x 2.1 cm
Print Code: D(4)

100 / 25



11

09

19

01



03



Home / Office

Tolman 6191

Cup Warmer. PVC. USB Connection. Cable Included.
Tasse Warmer. PVC. USB Anschluss. Kabel Inklusive.
Chauffe Tasses. PVC. Connexion USB. Câble Inclus.
Warmhoudplaatje. PVC. USB Verbinding. Kabel Inclusief.

Ø 9 x 0.5 cm
Print Code: L2

200 / 100



02

19

01



**WIRELESS
FAST CHARGE**



Holder

Wireless
Charger

NEW

Wireless
ChargerFast charge
10W

Pekon | WIRELESS CHARGER

6737

Multifunction Pencil Holder. Wireless. 2 USB Outputs 2000 mA. 1 Hub USB 2.0. Cable Included.

Multifunktion Stifthalter. Drahtlos. 2 USB Ausgänge 2000 mA. 1 Hub USB 2.0. Kabel Inklusiv.

Porte-Crayons Multifonction. Sans Fil. 2 Sorties USB 2000 mA. 1 Port USB 2.0. Câble Inclus.

Multifunctioneel Pennenbakje. Draadloos. 2 USB Outputs 2000 mA. 1 Poorten USB 2.0. Kabel Inclusief.

8.8 × 9.8 × 8.9 cm

50

Print Code: F(4)



Tarmix 6544

Charger. Wireless. Fast Charger 10W. Cable Included.

Ladegerät. Drahtlos. Schnelle Aufladung 10W. Kabel Inklusiv.

Chargeur. Sans Fil. Charge Rapide 10W. Câble Inclus.

Oplader. Draadloos. Snellader 10W. Kabel Inclusief.

7 × 10.9 × 8.5 cm

50 / 25

Print Code: E(4)





USB 2.0

Belind

5964

USB Hub Pencil Holder. Led Lights. 2 Light Modes. 4 Hubs. USB 2.0.
 USB Hub Stifthalter. Led Lichter. 2 Leuchtfunktionen. 4 Hubs. USB 2.0.
 Porte-Crayons Port USB. Lumières Led. 2 Modes de Lumière. 4 Ports. USB 2.0.
 USB Hub Pennenbakje. Led Lichten. 2 Licht Posities. 4 Poorten. USB 2.0.

7 × 8 × 7 cm

100 / 50

Print Code: D(4)



Wireless
Charger

Mandux

5955

Charger. Wireless. 3 USB Outputs. 3100 mA. Cable Included.
 Ladegerät. Drahtlos. 3 USB Ausgänge. 3100 mA. Kabel Inklusive.
 Chargeur. Sans Fil. 3 Sorties USB. 3100 mA. Câble Inclus.
 Oplader. Draadloos. 3 USB Uitgangen. 3100 mA. Kabel Inclusief.

Ø 9.4 × 3.9 cm

40 / 20

Print Code: F(4), W



SPECIAL LASER ENGRAVING WHITE LIGHT LOGO

This item with illuminated interior has a printing area specially designed for laser engraving, with which you will see your advertising or brand illuminated with white light.

Este artículo con interior iluminado tiene un área de marcaje especialmente diseñada para grabado láser, con el que conseguirá que su publicidad o marca quede originalmente iluminada con luz blanca.



USB 2.0

Delawer

5993

USB Hub. Led Lights. 3 Hubs. USB 2.0.
 USB Hub. Led Lichter. 3 Hubs. USB 2.0.
 Port USB. Lumières Led. 3 Ports. USB 2.0.
 USB Hub. Led Lichten. 3 Poorten. USB 2.0.

7.6 × 3.4 × 6 cm

200 / 50

Print Code: D(1), L1



Kuler

5962

USB Hub. 3 Hubs. USB 2.0.

USB Hub. 3 Hubs. USB 2.0.

Port USB. 3 Ports. USB 2.0.

USB Hub. 3 Poorten. USB 2.0.

7 × 7 × 1.3 cm

Print Code: D(4), W

200 / 50



03



01

02

19



Yurian

5802

USB Hub. 3 Hubs. USB 2.0. Charger and Synchronizer Cable. Micro USB, Type C and Lightning Connection.

USB Hub. 3 Hubs. USB 2.0. Kabel Ladegerät und Sincro. Anschluss Micro USB, Typ C und Lightning.

Port USB. 3 Ports. USB 2.0. Câble Chargeur et Synchroniseur. Connexion Micro USB, Type C et Lightning.

USB Hub. 3 Poorten. USB 2.0. Kabel Charger en Synchronizer. Micro USB, Type C en Lightning Connectie.

4.5 × 5.9 × 1 cm

Print Code: D(4), W

500 / 50



Charger



Data Transfer



Type-C Connection



Micro USB & Lightning

ALUMINIUM



03

Weeper

5201

USB Hub. Aluminium. 4 Hubs. USB 2.0.

USB Hub. Aluminium. 4 Hubs. USB 2.0.

Port USB. Aluminium. 4 Ports. USB 2.0.

USB Hub. Aluminium. 4 Poorten. USB 2.0.

8.9 × 2.1 × 3.7 cm

Print Code: D(4), L1

200 / 50



19



02



09



05

02

19

11

03



Dix

4635

USB Hub. 4 Hubs. USB 2.0.

USB Hub. 4 Hubs. USB 2.0.

Port USB. 4 Ports. USB 2.0.

USB Hub. 4 Poorten. USB 2.0.

5.4 × 4 × 5.4 cm

Print Code: D(4), W

200 / 50



Revolt
6518

USB Hub. Bamboo. 3 Hubs. USB 2.0.
 USB Hub. Bambus. 3 Hubs. USB 2.0.
 Port USB. Bambou. 3 Ports. USB 2.0.
 USB Hub. Bamboe. 3 Poorten. USB 2.0.

8 x 1.5 x 4 cm 200 / 50
 Print Code: D(4), L1, W



Niyel

5199
 USB Hub. 4 Hubs. USB 2.0.
 USB Hub. 4 Hubs. USB 2.0.
 Port USB. 4 Ports. USB 2.0.
 USB Hub. 4 Poorten. USB 2.0.

Ø 5.2 x 1.8 cm 200 / 50
 Print Code: D(4), W



Brunox
6574

USB Hub. Wheat Straw/ ABS. 4 Hubs. USB 2.0.
 USB Hub. Weizenstroh/ ABS. 4 Hubs. USB 2.0.
 Port USB. Paille de Blé/ ABS. 4 Ports. USB 2.0.
 USB Hub. Tarwestro/ ABS. 4 Poorten. USB 2.0.

Ø 5.2 x 1.8 cm 200 / 50
 Print Code: D(4), W



Proc
9523

USB Hub. 4 Hubs. USB 2.0.
USB Hub. 4 Hubs. USB 2.0.
Port USB. 4 Ports. USB 2.0.
USB Hub. 4 Poorten. USB 2.0.

14,5 × 1,7 × 3,5 cm

100 / 50

Print Code: D(4)



60 CM CABLE ●.....

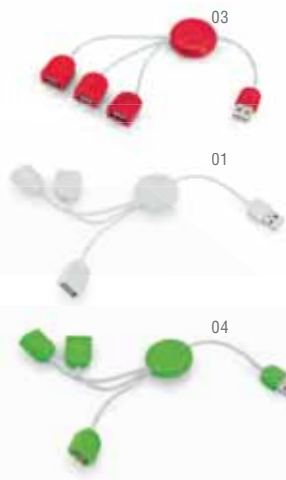

Pod
3899

USB Hub. 3 Hubs. USB 2.0.
USB Hub. 3 Hubs. USB 2.0.
Port USB. 3 Ports. USB 2.0.
USB Hub. 3 Poorten. USB 2.0.

3,5 × 24 × 1 cm

Print Code: D(4)

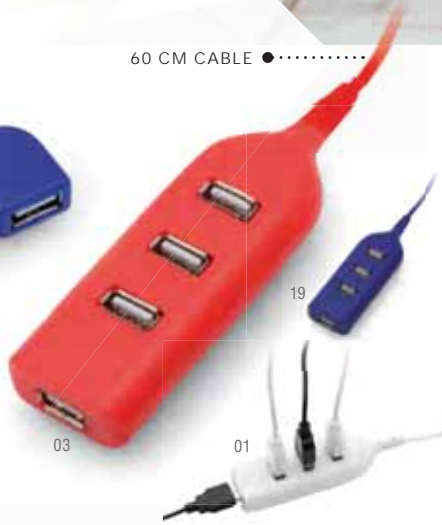

Ohm
3898

USB Hub. 4 Hubs. USB 2.0.
USB Hub. 4 Hubs. USB 2.0.
Port USB. 4 Ports. USB 2.0.
USB Hub. 4 Poorten. USB 2.0.

9,6 × 2 × 3 cm

Print Code: D(4)



Geby
3385

USB Hub. 4 Hubs. USB 2.0.
USB Hub. 4 Hubs. USB 2.0.
Port USB. 4 Ports. USB 2.0.
USB Hub. 4 Poorten. USB 2.0.

5,5 × 2 × 2 cm

Print Code: D(4)

200 / 50

200 / 50

300 / 30



02 01 03



19

Snarry

4654

Laser Pen. Metal. 1 Led. Button Batteries Included.
Kugelschreiber Laser. Metall. 1 Led. Knopfzellen Inklusiv.
Stylo Laser. Métal. 1 Led. Piles Bouton Inclus.
Laser Pen. Metaal. 1 Led. Knopcel Batterijen Inclusief.

Ø 1 × 12.3 cm

100 / 20

Print Code: D(4), L1, W



Prev / Next

Report

9790

Laser Pointer. Wireless. USB Connection. PowerPoint Slideshows. Forward/ Back Buttons. Button Batteries Included.

Laser Pointer. Optisch. USB Anschluss. PowerPoint Präsentationen. Tasten Forward/ Reverse. Knopfzellen Inklusiv.

Pointeur Laser. Optique. Connexion USB. Présentation PowerPoint. Bouton de Commande. Piles Bouton Inclus.

Laser Pointer. Optical. USB Verbinding. PowerPoint Slideshows. Vooruit-Achteruit Knoppen. Knopcel Batterijen Inclusief.

Ø 1.5 × 12 cm

60 / 20

Print Code: D(4), W



01

HQ
HIGH QUALITY

02



Prev / Next

Haslam

5202

Laser Pointer. Wireless. USB Connection. PowerPoint Slideshows. Forward/ Back Buttons. 1 Battery AAA/ R03 Included.

Laser Pointer. Optisch. USB Anschluss. PowerPoint Präsentationen. Tasten Forward/ Reverse. 1 AAA/ R03 Batterie Inklusiv.

Pointeur Laser. Optique. Connexion USB. Présentation PowerPoint. Bouton de Commande. 1 Pile AAA/ R03 Inclus.

Laser Pointer. Optical. USB Verbinding. PowerPoint Slideshows. Vooruit-Achteruit Knoppen. 1 Batterij AAA/ R03 Inclusief.

1.7 × 13.9 × 1.5 cm

50

Print Code: D(4), W

215



Video ▶



Video ▶



USB HUB



Ticaro

4858

USB Hub Lamp. 5 Leds. Flexible. 4 Hubs. USB 2.0.
 USB Hub Lampe. 5 Leds. Flexibel. 4 Hubs. USB 2.0.
 Lampe Port USB. 5 Leds. Flexible. 4 Ports. USB 2.0.
 USB Hub Lamp. 5 Leds. Flexibel. 4 Poorten. USB 2.0.

▮▮▮▮▮ 4.5 × 14.4 × 1.6 cm

📦 400 / 50

🌈 Print Code: D(1)



Anker

4823

USB Lamp. 6 Leds. Flexible.
 USB Lampe. 6 Leds. Flexibel.
 Lampe USB. 6 Leds. Flexible.
 USB Lamp. 6 Leds. Flexibel.

▮▮▮▮▮ 1.8 × 16.8 × 1 cm

📦 200 / 50

🌈 Print Code: D(4), L1



Loras

5389

Fan. USB Connection. Cable Included.
 Ventilator. USB Anschluss. Kabel Inklusive.
 Ventilateur. Connexion USB. Cable Inclus.
 Ventilator. USB Verbinding. Kabel Inclusief.

▮▮▮▮▮ 10 × 22 × 12 cm

📦 50

🌈 Print Code: E(4)



Miclox

4389

Mini Fan. USB Connection. Cable Included.
 Mini Ventilator. USB Anschluss. Kabel Inklusive.
 Mini Ventilateur. Connexion USB. Cable Inclus.
 Mini Ventilator. USB Verbinding. Kabel Inclusief.

▮▮▮▮▮ 14.9 × 14 × 9.5 cm

📦 40

🌈 Print Code: E(1)

Wireless
Charger

Speaker



Bluetooth

THREE LIGHT MODES
TRES MODOS DE LUZ

MULTIFUNCTION

Lerex

6268

Multifunction Lamp. 14 Leds. Flexible. 3 Light Modes. Adjustable Brightness. Wireless. Bluetooth Connection. Power 3W. USB Connection. Cable Included.

Ladegerät Lautsprecher. 14 Leds. Flexibel. 3 Leuchtfunktionen. Einstellbare Lichtintensität. Drahtlos. Bluetooth Anschluss. Power 3W. USB Anschluss. Kabel Inklusiv.

Haut-Parleurs Chargeur. 14 Leds. Flexible. 3 Modes de Lumière. Lumière à Intensité Réglable. Sans Fil. Connexion Bluetooth. Puissance 3W. Connexion USB. Câble Inclus.

Oplader Luidspreker. 14 Leds. Flexibel. 3 Licht Posities. Lamp met Instelbare Lichtintensiteit. Draadloos. Bluetooth Verbinding. Vermogen 3W. USB Verbinding. Kabel Inclusief.

12 x 32 x 12 cm

30

Print Code: F(1)



217

ADJUSTABLE INTENSITY
INTENSIDAD AJUSTABLE

MULTIFUNCTION



Speaker



Bluetooth



Hands-free



Line III



5 Watts

Zhilang

6347

Lamp Speaker. 18 Leds. Flexible. Adjustable Brightness. Bluetooth Connection. Power 5W. USB Rechargeable. Cable Included.

Lampe Lautsprecher. 18 Leds. Flexibel. Einstellbare Lichtintensität. Bluetooth Anschluss. Power 5W. USB Wiederaufladbar. Kabel Inklusiv.

Lampe Haut-Parleurs. 18 Leds. Flexible. Lumière à Intensité Réglable. Connexion Bluetooth. Puissance 5W. Rechargeable USB. Câble Inclus.

Lamp Luidspreker. 18 Leds. Flexibel. Lamp met Instelbare Lichtintensiteit. Bluetooth Verbinding. Vermogen 5W. USB Opladbaar. Kabel Inclusief.

10 x 53 cm

30

Print Code: F(1)





03



Charger
Connection

Data Transfer

Type-C
Connection

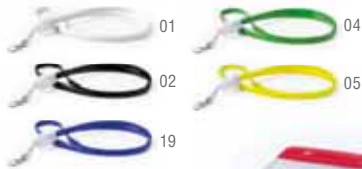

01

04

02

05

19

LANYARD

Doffer

5785

Charger Synchronizer. Type C Connection.
Ladegerät Sincro. Anschluss Typ C.
Chargeur Synchroniseur. Connexion Type C.
Oplader Synchronizer. Type C Connectie.

1.5 × 43.5 × 1.1 cm 500 / 50

Print Code: C(1)

218



LANYARD



01



02

MICRO USB INPUT

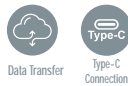

Data Transfer

Type-C
Connection

Litor

5765

Adapter. Type C Connection.
Adapter. Anschluss Typ C.
Adaptateur. Connexion Type C.
Adapter. Type C Connectie.

1 × 2.4 × 0.5 cm 5000 / 1000

Print Code: C(4)



Charger
Connection

Type-C
Connection

Micro USB
& Lightning

Glusol

6145

Lanyard Charger. Polyester. Micro USB, Type C and Lightning Connection.
Schlüsselband Ladegerät. Polyester. Anschluss Micro USB, Typ C und Lightning.
Chargeur Lanyard. Polyester. Connexion Micro USB, Type C et Lightning.
Lanyard Oplader. Polyester. Micro USB, Type C en Lightning Connectie.

3.2 × 52 cm 500 / 50

Print Code: D(4), F(1)

TYPE C
MICRO USB
& LIGHTNING



TYPE C

MICRO USB & LIGHTNING

120CM

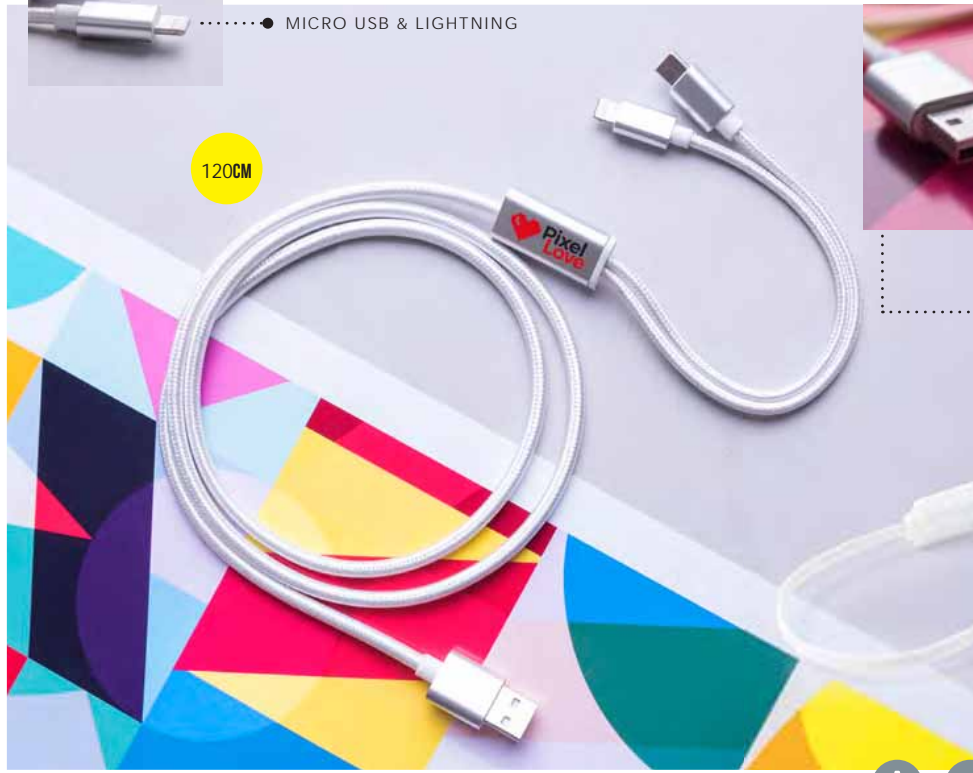

Britian

5786



Charger. Aluminium. Micro USB, Type C and Lightning Connection.
Ladegerät. Aluminium. Anschluss Micro USB, Typ C und Lightning.
Chargeur. Aluminium. Connexion Micro USB, Type C et Lightning.
Oplader. Aluminium. Micro USB, Type C en Lightning Connectie.

120 x 1.8 x 0.8 cm 200 / 50
Print Code: D(1), L1



EXTENDABLE/
EXTENSIBLE

TYPE C

MICRO USB
& LIGHTNING

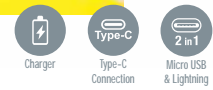

219

Grets

6576

Charger. Bamboo. Micro USB, Type C and Lightning Connection. Extendable Cable.
Ladegerät. Bambus. Anschluss Micro USB, Typ C und Lightning. Ausziehbar Kabel.
Chargeur. Bambou. Connexion Micro USB, Type C et Lightning. Câble Extensible.
Oplader. Bamboe. Micro USB, Type C en Lightning Connectie. Verlengbare Kabel.

100 x 4.1 x 1.6 cm 400 / 100
Print Code: E(4), L1



MICRO USB
& LIGHTNING

TYPE C

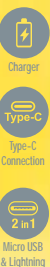

TYPE C
MICRO USB
& LIGHTNING

100CM



Drimon

6177

19

Charger. Aluminium. Micro USB, Type C and Lightning Connection.
Ladegerät. Aluminium. Anschluss Micro USB, Typ C und Lightning.
Chargeur. Aluminium. Connexion Micro USB, Type C et Lightning.
Oplader. Aluminium. Micro USB, Type C en Lightning Connectie.

Ø 4.7 x 10.3 cm 100 / 50
Print Code: E(1), L1, F(1)



Pikat

6259

WIRELESS CHARGER

Charger. Wireless. Micro USB, Type C and Lightning Connection.
Ladegerät. Drahtlos. Anschluss Micro USB, Typ C und Lightning.
Chargeur. Sans Fil. Connexion Micro USB, Type C et Lightning.
Oplader. Draadloos. Micro USB, Type C en Lightning Connectie.

110 cm 300 / 100
Print Code: E(4)



TABLET CASE



Cora

4137

Tablet Folder Case. PU/ Polyester 300D. 20 Sheets Notepad.
 Mappe Tablet Tasche. PU/ Polyester 300D. 20 Seiten Notizblock.
 Porte-Documents Étui Tablet. Similicuir/ Polyester 300D. Bloc 20 Feuilles.
 Map Tablet Hoes. PU/ Polyester 300D. 20 Blaadjes Notepad.

24 × 31.5 × 2 cm

20

Print Code: G(1)



20 Sheets
Lined



10"
Tablet
Compartment



220



Razter

5648

Holder Pouch. Polyester 600D.
 Halter Hülle. Polyester 600D.
 Etui Support. Polyester 600D.
 Houder Hoes. Polyester 600D.

28 × 22 × 2.5 cm

30

Print Code: G(1), N(8)



12"
Tablet
Compartment



Mega

3731

Tablet Case. Microfibre.
 Tablet Hülle. Mikrofaser.
 Étui Tablet. Microfibre.
 Tablet Hoes. Microfiber.

23 × 28 cm

Print Code: F(1), N(8)



12"
Tablet
Compartment

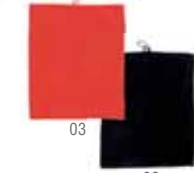

100 / 20

02

Tarlex

4112

Tablet Case. Felt.
 Tablet Hülle. Filz.
 Étui Tablet. Feutrine.
 Tablet Hoes. Vilt.

21 × 27.5 cm

Print Code: F(1), N(8), T



10"
Tablet
Compartment



100 / 50

02

19



12"
Tablet
Compartment

RPET

The fabric used in the manufacturing process of this item is made of recycled plastic (RPET). Like this, the emission of plastic residues to our planet and the consumption of energy is drastically reduced, resulting in a much more eco-friendly process.

El material de este producto está fabricado con plástico reciclado (RPET), que, además de ayudar en la disminución de residuos plásticos en el planeta, utiliza menos energía en el proceso de fabricación, haciendo que sea mucho menos dañino para el medio ambiente.

STOP PLASTIC POLLUTING THE OCEAN



NEW



Laptop Compartment



RPET

Hops

6847

Laptop Pouch. Polyester 600D RPET. Padded.
Laptop-Tasche. Polyester 600D RPET. Gepolstert.
Housse pour Ordinateur Portable. Polyester 600D RPET. Rembourré.
Laptoptasje. Polyester 600D RPET. Gewatteerd.

36 × 26 × 4.5 cm

100

Print Code: F(1), N(8)

221

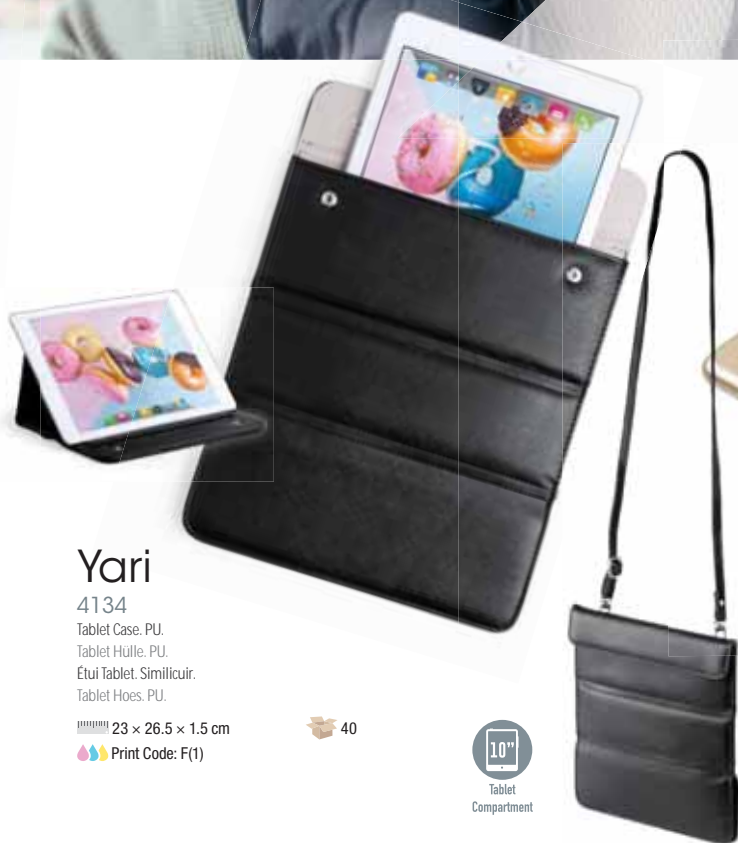

Yari

4134

Tablet Case. PU.
Tablet Hülle. PU.
Etui Tablet. Similicuir.
Tablet Hoes. PU.

23 × 26.5 × 1.5 cm

Print Code: F(1)

40



Tablet Compartment



Wireless Charger

Merson

6326

Charger Organizer. PU. Wireless. Cable Included.
Ladegerät Ordner. PU. Drahtlos. Kabel Inklusive.
Organiseur Chargeur. Similicuir. Sans Fil. Câble Inclus.
Oplader Organizer. PU. Draadloos. Kabel Inclusief.

11.1 × 21.5 × 2 cm

Print Code: G(1), N(8)

100 / 20

WIRELESS CHARGER



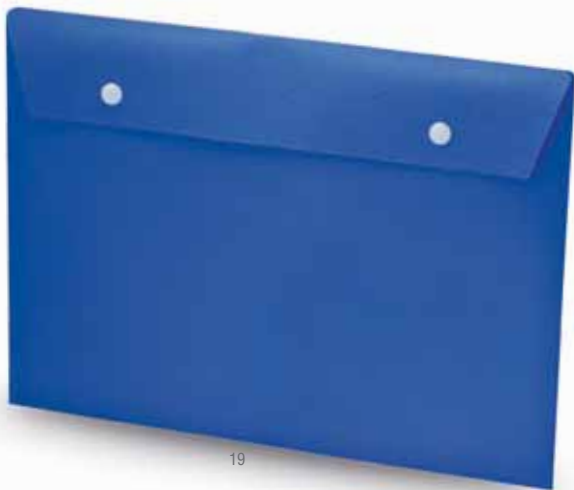

19

Alice

3871

Document Holder. PP Plastic.
Dokumententasche. Plastik PP.
Porte-Documents. PP Plastique.
Aktentas. PP Plastic.

33 x 24 cm

Print Code: F(1)

200 / 50



03

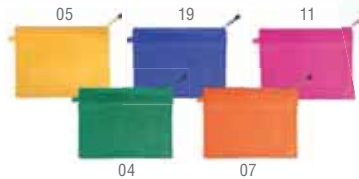

Bonx

4576

Document Bag. PVC.
Dokumententasche. PVC.
Porte-Documents. PVC.
Aktentas. PVC.

33.5 x 24.5 cm

Print Code: F(1)

300 / 10



03

Dago

4130

Document Holder. Felt.
Dokumententasche. Filz.
Porte-Documents. Feutrine.
Aktentas. Vilt.

35 x 25 cm

Print Code: F(1), N(8)

80 / 20



06

Galba

3862

Document Bag. Polyester 600D.
Dokumententasche. Polyester 600D.
Porte-Documents. Polyester 600D.
Aktentas. Polyester 600D.

34,5 x 24 cm

Print Code: F(1)

200 / 25



RPET

The fabric used in the manufacturing process of this item is made of recycled plastic (RPET). Like this, the emission of plastic residues to our planet and the consumption of energy is drastically reduced, resulting in a much more eco-friendly process.

El material de este producto está fabricado con plástico reciclado (RPET), que, además de ayudar en la disminución de residuos plásticos en el planeta, utiliza menos energía en el proceso de fabricación, haciendo que sea mucho menos dañino para el medio ambiente.

STOP PLASTIC POLLUTING THE OCEAN



NEW



Divaz
6846

Document Bag. Polyester 600D RPET.
Dokumententasche. Polyester 600D RPET.
Porte-Documents. Polyester 600D RPET.
Aktentas. Polyester 600D RPET.

39 × 27 × 3.5 cm

100 / 20

Print Code: F(1), N(8)



03



19



Cyrus
3921

Document Bag. Polyester 600D.
Dokumententasche. Polyester 600D.
Porte-Documents. Polyester 600D.
Aktentas. Polyester 600D.

36.5 × 29 × 6 cm

100 / 20

Print Code: F(1), N(8)



Kein
4090

Document Bag. Non-Woven.
Dokumententasche. Non-Woven.
Porte-Documents. T.N.T.
Aktentas. Non-Woven.

36 × 26 cm

400 / 20

Print Code: F(1)



02

Radson

5581

Document Bag. Polyester 600D.
 Dokumententasche. Polyester 600D.
 Porte-Documents. Polyester 600D.
 Aktentas. Polyester 600D.

||||||| 35 × 30 × 2 cm

Print Code: F(1), N(8)

📦 50

03

19

05



19

Norton

5129

Document Bag. Polyester 300D.
 Dokumententasche. Polyester 300D.
 Porte-Documents. Polyester 300D.
 Aktentas. Polyester 300D.

||||||| 37 × 30 cm

Print Code: F(1), N(8)

📦 100 / 50

02

08

03



02



13



11



03



19



07



06



04

Join

9751

Document Bag. Polyester 600D.
 Dokumententasche. Polyester 600D.
 Porte-Documents. Polyester 600D.
 Aktentas. Polyester 600D.

||||||| 38 × 32 cm

Print Code: F(1), N(8)

📦 100 / 20



02



18

Kani

4119

Document Bag. Microfibre.
Dokumententasche. Mikrofaser.
Porte-Documents. Microfibre.
Aktentas. Microfibrer.

38 x 39 cm

Print Code: N(8)



19



04



05



02



03



19



02



13



03

Lendys

4470

Document Bag. Polyester 600D.
Dokumententasche. Polyester 600D.
Porte-Documents. Polyester 600D.
Aktentas. Polyester 600D.

36 x 28 x 4 cm

Print Code: F(1), N(8)



Jecks

5455

Document Bag. Polyester 600D. Padded.
Dokumententasche. Polyester 600D. Gepolstert.
Porte-Documents. Polyester 600D. Rembourrée.
Aktentas. Polyester 600D. Gewatteert.

37 x 30 x 4 cm

Print Code: F(1), N(8)



02

06

03

Xenac

4371

Document Bag. Soft Shell.
Dokumententasche. Soft Shell.
Porte-Documents. Soft Shell.
Aktentas. Soft Shell.

38 x 27 cm

Print Code: G(1), N(8)





06

Hirkop

4613

Document Bag, Polyester 600D.
Dokumententasche, Polyester 600D.
Porte-Documents, Polyester 600D.
Aktentas, Polyester 600D.

38 × 29.5 × 9 cm

Print Code: F(1), N(8)



50



226



06

Konfer

3208

Document Bag, Polyester 600D.
Dokumententasche, Polyester 600D.
Porte-Documents, Polyester 600D.
Aktentas, Polyester 600D.

38 × 29.5 × 9 cm

Print Code: F(1), N(8)



50



13

02



19

Celmar

5582

Document Bag, Polyester 600D.
Dokumententasche, Polyester 600D.
Porte-Documents, Polyester 600D.
Aktentas, Polyester 600D.

40 × 29 × 11.5 cm

Print Code: G(1), N(8)



25



03

08



19



13



02



19



04



03

Verse

3103

Document Bag, Polyester 600D.
Dokumententasche, Polyester 600D.
Porte-Documents, Polyester 600D.
Aktentas, Polyester 600D.

39 x 32 x 9 cm



25

Print Code: G(1), N(8)



03

02

13

Amazon

3477

Document Bag, Polyester 600D.
Dokumententasche, Polyester 600D.
Porte-Documents, Polyester 600D.
Aktentas, Polyester 600D.

37 x 29 x 9 cm



50

Print Code: G(1), N(8)



13



13

Escorpio

9294

Document Bag, Polyester 600D.
Dokumententasche, Polyester 600D.
Porte-Documents, Polyester 600D.
Aktentas, Polyester 600D.

32 x 28 x 10.5 cm



40

Print Code: G(1), N(8)



06

03

Java

8948

Document Bag, Polyester 600D.
Dokumententasche, Polyester 600D.
Porte-Documents, Polyester 600D.
Aktentas, Polyester 600D.

36.5 x 29.5 x 6.5 cm



50

Print Code: G(1), N(8)



02



07



06



03



02



08



Space 9765

Briefcase. Polyester 600D. Padded Laptop Compartment.
Aktentasche. Polyester 600D. Gepolsterte Laptoptasche.
Malette. Polyester 600D. Pochette Rembourrée pour Portable.
Aktentas. Polyester 600D. Gewatteerd Laptop Compartment.

30 × 35 × 7 cm

25

Print Code: G(1), N(8)



Laptop
Compartment

228



07



06



03



Bernice 3768

Document Bag. Non-Woven.
Dokumententasche. Non-Woven.
Porte-Documents. T.N.T..
Aktentas. Non-Woven.

36.2 × 30 × 9 cm

Print Code: F(1)

100 / 20



13



02

03

Casual 3249

Shoulder Bag. Polyester 600D.
Umhängetasche. Polyester 600D.
Bandoulière. Polyester 600D.
Schoudertas. Polyester 600D.

25 × 34 × 5 cm

Print Code: F(1), N(8)

100 / 20



02

03

13

Milán 8652

Document Bag. Polyester 600D.
Dokumententasche. Polyester 600D.
Porte-Documents. Polyester 600D.
Aktentas. Polyester 600D.

24 × 32 × 4 cm

Print Code: F(1), N(8)

50

100% COTTON



Karmul

NATUREBRAND
company slogan

NATUREBRAND
company slogan

Telmak
Pg. 160

NATUREBRAND
company slogan



Herkal

229



Herkal

5664

Document Bag. 100% Cotton.
Dokumententasche. 100% Baumwolle.
Porte-Documents. 100% Coton.
Aktentas. 100% Katoen.

40 x 30 cm

50 / 10

Print Code: F(6), N(8), P

Karmul

5665

Document Bag. 100% Cotton.
Dokumententasche. 100% Baumwolle.
Porte-Documents. 100% Coton.
Aktentas. 100% Katoen.

40 x 30 cm

50 / 10

Print Code: F(6), N(8), P

Kultor

5663

Document Bag. 100% Cotton.
Dokumententasche. 100% Baumwolle.
Porte-Documents. 100% Coton.
Aktentas. 100% Katoen.

37 x 29 x 4 cm

50 / 10

Print Code: F(1), N(8)

Kinsky

6121

Pencil Case. 100% Cotton.
Federmappe. 100% Baumwolle.
Trousse. 100% Coton.
Etui. 100% Katoen.

Ø 7 x 22 cm

500 / 50

Print Code: E(1), N(8)



LAPTOP BAG



Baldony

5591

Document Bag. Polyester 600D. USB Connection. Padded Laptop and Tablet Compartment.
 Dokumententasche. Polyester 600D. USB Anschluss. Gepolsterte Laptop- und Tablet-
 Porte-Documents. Polyester 600D. Connexion USB. Pochette Rembourrée pour Portable et Tablet.
 Aktentas. Polyester 600D. USB Verbindung. Gewatteerd Laptop und Tablet Compartment.

38 × 29.5 × 8.5 cm

40

Print Code: G(1), N(8)



230



18



06

08

02



Laptop
Compartment



Sektor

3402

Briefcase. Polyester 1680D. Padded Laptop Compartment.
 Aktentasche. Polyester 1680D. Gepolsterte Laptop- und Tablet-
 Malette. Polyester 1680D. Pochette Rembourrée pour Portable.
 Aktentas. Polyester 1680D. Gewatteerd Laptop Compartment.

38.5 × 31 × 14.5 cm

20 / 5

Print Code: G(1), N(8)



Laptop
Compartment

37 × 29 × 7.5 cm

20

Print Code: G(1), N(8)

LAPTOP BAG



Lenket

6216



Document Bag. Polyester 300D. RFID Protected. USB Connection. Padded Laptop and Tablet Compartment.
Dokumententasche. Polyester 300D. RFID Schutz. USB Anschluss. Gepolsterte Laptoptasche und Tablet.
Porte-Documents. Polyester 300D. Protecteur RFID. Connexion USB. Pochette Rembourrée pour Portable et Tablet.
Aktentas. Polyester 300D. RFID Bescherming. USB Verbinding. Gewatteerd Laptop en Tablet Compartment.

38 x 29.5 x 8.5 cm

40

Print Code: G(1), N(8)



Zestar

5063

Document Bag. Polyester 600D.
Dokumententasche. Polyester 600D.
Porte-Documents. Polyester 600D.
Aktentas. Polyester 600D.

38 x 29.5 x 8.5 cm

40

Print Code: G(1), N(8)



NEW



Pirok

6845

Document Bag. Polyester 600D RPET. Padded Laptop and Tablet Compartment.
Dokumententasche. Polyester 600D RPET. Gepolsterte Laptoptasche und Tablet.
Porte-Documents. Polyester 600D RPET. Pochette Rembourrée pour Portable et Tablet.
Aktentas. Polyester 600D RPET. Gewatteerd Laptop en Tablet Compartment.

38 x 28 x 5 cm

40

Print Code: G(1), N(8)





MORE BACKPACK
AT BACKPACK SECTION

PG 344 - 387



Laptop Compartment



INNER POCKET RFID PROTECTION
BOLSILLO INTERIOR PROTECCIÓN RFID

Keep Your device Details Safe With the **RFID** Protection System
Mantén seguros los datos de tus dispositivos con el sistema de protección **RFID**

Rigal 6215

Backpack. Polyester 300D. RFID Protected. USB Connection. Padded Back and Shoulder Straps.
Rucksack. Polyester 300D. RFID Schutz. USB Anschluss. Gepolsterter Rücken und Schultergurte.
Sac à Dos. Polyester 300D. Protecteur RFID. Connexion USB. Dos et Bretelles Rembourrées.
Rugzak. Polyester 300D. RFID Bescherming. USB Verbinding. Gewatteerde Achterzijde en Schouderbanden.

30 x 43 x 14 cm



Print Code: G(1), N(8)



Laptop Compartment



02

Nevium 5446

08



Trolley Strap

Backpack. Polyester 600D. Padded Laptop Compartment. Padded Back and Shoulder Straps.
Rucksack. Polyester 600D. Gepolsterte Laptotasche. Gepolsterter Rücken und Schultergurte.
Sac à Dos. Polyester 600D. Pochette Rembourrée pour Portable. Dos et Bretelles Rembourrées.
Rugzak. Polyester 600D. Gewatteerd Laptop Compartment. Gewatteerde Achterzijde en Schouderbanden.

30 x 43 x 14 cm



Print Code: G(1), N(8)



Laptop Compartment



06

02

Zircan 5307



Anti Theft pocket



Water Repellent



USB Connection

Backpack. Nylon. USB Connection. Padded Laptop Compartment. Padded Back and Shoulder Straps.
Rucksack. Nylon. USB Anschluss. Gepolsterte Laptotasche. Gepolsterter Rücken und Schultergurte.
Sac à Dos. Nylon. Connexion USB. Pochette Rembourrée pour Portable. Dos et Bretelles Rembourrées.
Rugzak. Nylon. USB Verbinding. Gewatteerd Laptop Compartment. Gewatteerde Achterzijde en Schouderbanden.

30 x 45 x 20 cm



Print Code: G(1), N(8)



Video



Laptop
CompartmentAnti Theft
pocketUSB
ConnectionTrolley
StrapFULLY
PADDEDFULLY
PADDED

233

Laptop
Compartment

Hurkon

6509

Document Bag Backpack. Polyester 300D/ PU. Padded. Padded Laptop Compartment.
 Dokumententasche Rucksack. Polyester 300D/ PU. Gepolstert. Gepolsterte Laptoptasche.
 Sac à Dos Porte-Documents. Polyester 300D/ Similicuir. Rembourré. Pochette Rembourrée pour Portable.
 Aktentas Ruzgak. Polyester 300D/ PU. Gewatteerd. Gewatteerd Laptop Compartment.

32 × 41 × 12,5 cm



Print Code: I(8)

Trolley
Strap

Sulkan

6620

Document Bag Backpack. Polyester 600D. USB Connection. Padded. Padded Laptop Compartment.

Dokumententasche Rucksack. Polyester 600D. USB Anschluss. Gepolstert. Gepolsterte Laptoptasche.

Sac à Dos Porte-Documents. Polyester 600D. Connexion USB. Rembourré. Pochette Rembourrée pour Portable.

Aktentas Ruzgak. Polyester 600D. USB Verbinding. Gewatteerd. Gewatteerd Laptop Compartment.

32 × 46 × 20 cm



Print Code: G(1), N(8)





234



Zoidel

5238

Trolley. Nylon. 8 Rotating Wheels. Padded Laptop Compartment. Combination Lock Included.
 Trolley. Nylon. 8 Drehende Räder. Gepolsterte Laptoptasche. Sicherheitsverschluss Inklusive.
 Trolley. Nylon. 8 Roues Tournantes. Pochette Rembourrée pour Portable. Fermeture Sécurité Inclus.
 Trolley. Nylon. 8 Draaiende Wielen. Gewatteerd Laptop Compartment. Veiligheidsluiting Inclusief.

38 x 48 x 25 cm



Print Code: K(8)



03



02

Cubic

3107

Trolley. Polyester 600D. Padded Laptop Compartment.
 Trolley. Polyester 600D. Gepolsterte Laptoptasche.
 Trolley. Polyester 600D. Pochette Rembourrée pour Portable.
 Trolley. Polyester 600D. Gewatteerd Laptop Compartment.

43 x 38 x 18 cm



Print Code: K(8)



Ibex

9977

Trolley. Polyester 1680D. Padded Laptop Compartment. Metal Padlock Included.
 Trolley. Polyester 1680D. Gepolsterte Laptoptasche. Metallschloss Inklusive.
 Trolley. Polyester 1680D. Pochette Rembourrée pour Portable. Cadenas Metal Inclus.
 Trolley. Polyester 1680D. Gewatteerd Laptop Compartment. Metalen Hangslot Inclusief.

42.5 x 40 x 24 cm



Print Code: K(8)



TSA Combination Lock



17" Laptop Compartment



Video



ROTATING WHEELS
RUEDAS GIRATORIAS

Kleintor

6044

Trolley. ABS. Rigid. 8 Rotating Wheels. Padded Laptop Compartment. TSA Combination Lock Included.

Trolley. ABS. Starre. 8 Drehende Räder. Gepolsterte Laptoptasche. TSA Sicherheitsverschluss Inklusiv.

Trolley. ABS. Rigide. 8 Roues Tournantes. Pochette Rembourrée pour Portable. Fermeture Sécurité TSA Inclus.

Trolley. ABS. Hard. 8 Draaiende Wielen. Gewatteerd Laptop Compartment. TSA Veiligheidsluiting Inclusief.

40 × 51 × 21.5 cm



Print Code: K(1)



Haltrix

6047

BACKPACK / MOCHILA

11" Tablet Compartment

15" Laptop Compartment

Trolley Backpack. Polyester 300D. USB Connection. Padded Laptop Compartment. Padded Shoulder Straps. Trolley Rucksack. Polyester 300D. USB Anschluss. Gepolsterte Laptoptasche. Gepolsterte Schultergurte. Sac à Dos Trolley. Polyester 300D. Connexion USB. Pochette Rembourrée pour Portable. Bretelles Rembourrées. Trolley Ruzgak. Polyester 300D. USB Verbindung. Gewatteerd Laptop. Gewatteerde Schouderbanden.

33 × 47 × 22.5 cm



Print Code: I(8)

2in1 Multifunction

USB Connection



06

02

BACKPACK / MOCHILA



01

19

15" Laptop Compartment



Kuman

3488

Trolley Backpack. Polyester 1680D. Padded Laptop Compartment. Padded Shoulder Straps. Trolley Rucksack. Polyester 1680D. Gepolsterte Laptoptasche. Gepolsterte Schultergurte. Sac à Dos Trolley. Polyester 1680D. Pochette Rembourrée pour Portable. Bretelles Rembourrées. Trolley Ruzgak. Polyester 1680D. Gewatteerd Laptop Compartment. Gewatteerde Schouderbanden.

36 × 47 × 25 cm



Print Code: K(8)

2in1 Multifunction



02

Combination Lock



03

Sucan

4376

Trolley. ABS. Rigid. Combination Lock Included. Trolley. ABS. Starre. Sicherheitsverschluss Inklusiv. Trolley. ABS. Rigide. Fermeture Sécurité Inclus. Trolley. ABS. Hard. Veiligheidsluiting Inclusief.

46 × 40 × 19 cm



Print Code: K(1)



Video



20 Sheets
Lined

Ginsky

4868

Folder. PU. 20 Sheets Notepad.
Mappe. PU. 20 Seiten Notizblock.
Porte-Documents. Similicuir. Bloc 20 Feuilles.
Map. PU. 20 Blaadjes Notepad.

24 × 32 × 2.5 cm

Print Code: G(1), L2



Video



20 Sheets
Lined



02

19

03



Meryan

5396

Folder. PU. 20 Sheets Notepad.
Mappe. PU. 20 Seiten Notizblock.
Porte-Documents. Similicuir. Bloc 20 Feuilles.
Map. PU. 20 Blaadjes Notepad.

23.5 × 31 × 2 cm

Print Code: G(1), L2



IDEAL FOR TABLET
AND MOBILE
IDEAL PARA TABLET
Y MÓVIL



50 Sheets
Lined

Eiros

4319

Folder. PU. 50 Sheets Notepad.
Mappe. PU. 50 Seiten Notizblock.
Porte-Documents. Similicuir. Bloc 50 Feuilles.
Map. PU. 50 Blaadjes Notepad.

17.5 × 22 × 1 cm

Print Code: F(1), L1, T



03

19

01

05



Lanto

4367

Wallet. PU.
Brieftasche. PU.
Portefeuille. Similicuir.
Portemonnee. PU.

8.5 × 10.5 × 2 cm

Print Code: E(1), L1



03



05

01

19

20 Sheets
Lined

08

Neco

9587

Folder. Polyester/ Microfibre. 20 Sheets Notepad.
 Mappe. Polyester/ Mikrofaser. 20 Seiten Notizblock.
 Porte-Documents. Polyester/ Microfibre. Bloc 20 Feuilles.
 Map. Polyester/ Microfibre. 20 Blaadjes Notepad.

24.5 × 32 × 1.5 cm

20

Print Code: G(1), N(8), L2

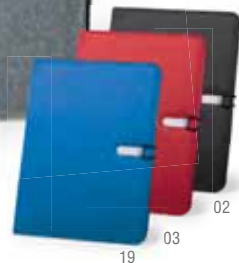

19

03

02



NEW



RPET

20 Sheets
Lined

Sorgax

6844

Folder. Polyester RPET. 20 Sheets Notepad.
 Mappe. Polyester RPET. 20 Seiten Notizblock.
 Porte-Documents. Polyester RPET. Bloc 20 Feuilles.
 Map. Polyester RPET. 20 Blaadjes Notepad.

24.5 × 32 × 1.5 cm

20

Print Code: G(1), L2, N(8)

237

TOUCH SCREEN
PANTALLA TÁCTIL

Bretux

4869

Folder. PU/ Polyester. 20 Sheets Notepad.
 Mappe. PU/ Polyester. 20 Seiten Notizblock.
 Porte-Documents. Similicuir/ Polyester. Bloc 20 Feuilles.
 Map. PU/ Polyester. 20 Blaadjes Notepad.

24 × 31 × 2 cm

20

Print Code: G(1), L2

20 Sheets
Lined



19



02

03

Mokai

3205

Folder. Microfibre/ Polyester. 20 Sheets Notepad.
Mappe. Mikrofaser/ Polyester. 20 Seiten Notizblock.
Porte-Documents. Microfibre/ Polyester. Bloc 20 Feuilles.
Map. Microfiber/ Polyester. 20 Blaadjes Notepad.

25.3 × 31.5 × 1.3 cm



Print Code: G(1), N(8)



20 Sheets Lined

238

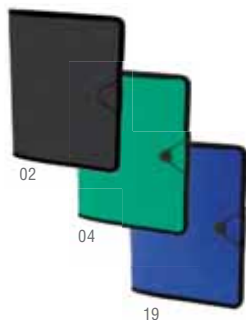

02

04

19

Columbya

3519

Folder. PP Plastic. 30 Sheets Notepad.
Mappe. Plastik PP. 30 Seiten Notizblock.
Porte-Documents. PP Plastique. Bloc 30 Feuilles.
Map. PP Plastic. 30 Blaadjes Notepad.

24 × 31 × 1 cm



Print Code: F(1)



03



30 Sheets Lined



20 Sheets Lined



Ideal Sublimation

SUBLIMATION

Basion

5742

Folder. Polyester 600D. 20 Sheets Notepad.
Mappe. Polyester 600D. 20 Seiten Notizblock.
Porte-Documents. Polyester 600D. Bloc 20 Feuilles.
Map. Polyester 600D. 20 Blaadjes Notepad.

23.5 × 32.5 × 1.7 cm



Print Code: F(1), N(8), R



20 Sheets
Plain

02

06

Mato

8950

Folder. Polyester 600D. 20 Sheets Notepad.
 Mappe. Polyester 600D. 20 Seiten Notizblock.
 Porte-Documents. Polyester 600D. Bloc 20 Feuilles.
 Map. Polyester 600D. 20 Blaadjes Notepad.

24 × 33 × 1.3 cm

30

Print Code: F(1), N(8)

13



03

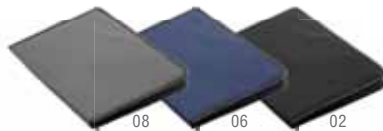

08

06

02

Tendex

4517

Folder. Polyester 600D. 20 Sheets Notepad.
 Mappe. Polyester 600D. 20 Seiten Notizblock.
 Porte-Documents. Polyester 600D. Bloc 20 Feuilles.
 Map. Polyester 600D. 20 Blaadjes Notepad.

24.5 × 32.3 × 3 cm

20

Print Code: F(1), N(8)

20 Sheets
Lined

04

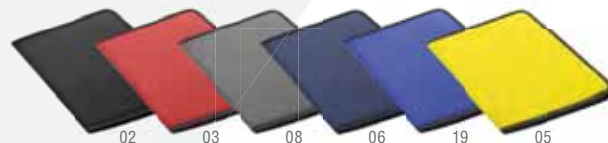

02

03

08

06

19

05

Roffel

4516

Folder. Polyester 600D. 20 Sheets Notepad.
 Mappe. Polyester 600D. 20 Seiten Notizblock.
 Porte-Documents. Polyester 600D. Bloc 20 Feuilles.
 Map. Polyester 600D. 20 Blaadjes Notepad.

24.8 × 32.3 × 1 cm

40

Print Code: F(1), N(8)

20 Sheets
Lined

Holisk

6613

Organizer. MDF.
Ordner. MDF.
Organiseur. MDF.
Organizer. MDF.

22.5 × 32 × 1.1 cm

50 / 25

Print Code: F(1), L2

240



Alpin

3157

Folder. PP Plastic.
Mappe. Plastik PP.
Porte-Documents. PP Plastique.
Map. PP Plastic.

23.8 × 31.5 × 1.7 cm

100 / 25

Print Code: F(1)



Clasor

3774

Folder. PVC.
Mappe. PVC.
Porte-Documents. PVC.
Map. PVC.

23 × 31.5 × 0.5 cm

50

Print Code: F(1)



Lemek

3873

Organizer. PP Plastic. 12 Dividers.
Ordner. Plastik PP. 12 Fächer.
Organiseur. PP Plastique. 12 Intercalaires.
Organizer. PP Plastic. 12 Dividers.

26 × 14 × 2 cm

100 / 25

Print Code: F(1)





Extend 9908

Folder. PU. 20 Sheets Notepad.
Mappe. PU. 20 Seiten Notizblock.
Porte-Documents. Similicuir. Bloc 20 Feuilles.
Map. PU. 20 Blaadjes Notepad.

25.5 × 32.3 × 1.5 cm
Print Code: G(1), L2, T



20 Sheets
Lined



Index 3526

Folder. Microfibre. 20 Sheets Notepad.
Mappe. Mikrofaser. 20 Seiten Notizblock.
Porte-Documents. Microfibre. Bloc 20 Feuilles.
Map. Microfibre. 20 Blaadjes Notepad.

24.5 × 32.5 × 2 cm



Print Code: G(1), N(8), L2



20 Sheets
Lined



02



20 Sheets
Lined

Conquer 3646

Folder. Polyester 600D. 20 Sheets Notepad.
Mappe. Polyester 600D. 20 Seiten Notizblock.
Porte-Documents. Polyester 600D. Bloc 20 Feuilles.
Map. Polyester 600D. 20 Blaadjes Notepad.

25.4 × 33.5 × 1.5 cm

Print Code: F(1), N(8)



03



19



Talent 9588

Card Holder. Polyester/ Microfibre. 72 Compartments.
Visitenkartenetui. Polyester/ Mikrofaser. 72 Abteilungen.
Porte-Cartes. Polyester/ Microfibre. 72 Compartiments.
Kaartjeshouder. Polyester/ Microfibre. 72 Compartimenten.

12.3 × 25.1 × 1.8 cm

Print Code: G(1), N(8), L2





01



19

03



Okam
3728

Ruler Magnifier Bookmark.
Lineal Lupe Lesezeichen.
Règle Loupe Marque Pages.
Liniaal Vergrootglas Bladwijzer.

13.9 x 3.7 x 0.2 cm 2500 / 500
Print Code: C(4)

242



ALUMINIUM

19



03

MAGNETIC



01

02

19

05



11

05

02

03

Melby
4548

Bookmark. Aluminium.
Lesezeichen. Aluminium.
Marque Pages. Aluminium.
Bladwijzer. Aluminium.

5.5 x 13.5 x 1.5 cm 200 / 20
Print Code: D(4), L1

Sumit
3932

Bookmark. Magnetic.
Lesezeichen. Magnetisch.
Marque Pages. Magnétique.
Bladwijzer. Magnetisch.

2 x 6 x 0.2 cm 2000 / 500
Print Code: C(4)



07

01

03



BOOKMARK
MARCAPAGINAS

Toble
3602

Pen Bookmark.
Lesezeichen Kugelschreiber.
Stylo Marque Pages.
Pen-Bladwijzer.

2.4 x 12 x 0.7 cm 2000 / 100
Print Code: B(4), W

19





02

Tipel

4574
Pencil Holder. Metal.
Stifthalter. Metall.
Porte-Crayons. Métal.
Pennnenbakje. Metaal.

8 × 9,7 × 8 cm
Print Code: F(4), L1

100 / 25



05



19



03



09



Organic

2421
Pencil Holder.
Stifthalter.
Porte-Crayons.
Pennnenbakje.

7.2 × 13.8 × 9.1 cm
Print Code: D(4)

100



08

243



01

19

03



MAGNETIC

02

Pingus

3453
Photo Frame. Magnetic Frame. Photos Size: 3,5 x 5 cm.
Bilderrahmen. Magnetischer Rahmen. Photos: 3,5 x 5 cm.
Porte Photos. Cadre Magnétique. Photos: 3,5 x 5 cm.
Fotolijst. Magnetisch Lijst. Foto's Maat: 3,5 x 5 cm.

5.2 × 13.5 × 4.8 cm
Print Code: D(1)

100 / 20



EVERLASTING CALENDAR /
CALENDARIO PERPETUO



Lider

3424
Everlasting Calendar.
Ewiger Kalender.
Calendrier Perpétuel.
Eeuwige Kalender.

14 × 9 × 4 cm
Print Code: D(2)

300 / 50



Beltrak

5650

Holder.
Halter.
Support.
Houder.



3.2 × 8 × 2.5 cm

400 / 50

Print Code: C(4), W



Mita

3540

Holder. Adhesive.
Halter. Haftend.
Support. Adhésif.
Houder. Klevend.

Ø 2.8 × 1.6 cm

2000 / 200

Print Code: Consultar

244



Naibel

4014

Cleaning Set. 2 Accessories.
Reinigungsset. 2 Teile.
Set Nettoyage. 2 Accessoires.
Schoonmaak Set. 2 Accessoires.

8.9 × 2.9 × 8.4 cm

200 / 100

Print Code: C(4), W



Landi

3701

Organizer Band. Nylon.
Ordner Band. Nylon.
Range Organiseur. Nylon.
Organizer Band. Nylon.

2 × 18 × 0.2 cm

2000 / 100

Print Code: D(1)



19

03

02

19

05

08

01

01

02



05

Myd

9574

Calculator. Button Battery Included.
Taschenrechner. Knopfzelle Inklusiv.
Calculatrice. Pile Bouton Inclus.
Rekenmachine. Knopcel Batterij Inclusief.

10.5 × 16.5 × 3.5 cm
Print Code: D(4)

50 / 25



19

07



Result

9851

19

Calculator. Button Battery Included.
Taschenrechner. Knopfzelle Inklusiv.
Calculatrice. Pile Bouton Inclus.
Rekenmachine. Knopcel Batterij Inclusief.

6.7 × 11.5 × 0.6 cm

200 / 20

Print Code: D(4)



07

03



05

Nebet

4299

Calculator. Button Battery Included.
Taschenrechner. Knopfzelle Inklusiv.
Calculatrice. Pile Bouton Inclus.
Rekenmachine. Knopcel Batterij Inclusief.

8 × 12.4 × 2.6 cm

100 / 50

Print Code: D(4)



19

03

02



WATER POWERED

WATER POWERED
FUNCIONA CON AGUA

Water

9711

Calculator. Water Powered.
Taschenrechner. Funktioniert mit Wasser.
Calculatrice. Fonctionne avec de l'Eau.
Rekenmachine. Water Energie.

8.7 × 12.1 × 2 cm

100 / 50

Print Code: D(4)



WATER POWERED
FUNCIONA CON AGUA



03

Ozone

9736

Calculator. Water Powered. Dispenser Included.
Taschenrechner. Funktioniert mit Wasser. Austeiler Inklusiv.
Calculatrice. Fonctionne avec de l'Eau. Doseur Inclus.
Rekenmachine. Water Energie. Dispenser Inclusief.

7.4 × 12.6 × 1.7 cm

200 / 20

Print Code: D(4)



19



20 CLIPS

Bomtel

5612

Clips Holder. 20 Clips Included.
 Büroklammernhalter. 20 Büroklammern Inklusive.
 Porte-Trombones. 20 Clips Inclus.
 Paperclipschaaltje. 20 Clips Inclusief.

9.3 × 2.1 × 4.6 cm 300 / 50

Print Code: B(1), D(4), L1, W



20 CLIPS

Oky

5613

Clips Holder. 20 Clips Included.
 Büroklammernhalter. 20 Büroklammern Inklusive.
 Porte-Trombones. 20 Clips Inclus.
 Paperclipschaaltje. 20 Clips Inclusief.

9.3 × 2.1 × 4.6 cm 300 / 50

Print Code: B(1), D(4), L1, W



Rhydor

4812

Clips Holder. 100 Clips Included.
 Büroklammernhalter. 100 Büroklammern Inklusive.
 Porte-Trombones. 100 Clips Inclus.
 Paperclipschaaltje. 100 Clips Inclusief.

5.1 × 7.5 × 6.9 cm 200 / 20

Print Code: C(1)



19

03



01

02

05

07

11

16

Yonsy

4708

Clip.
 Clip.
 Clip.
 Clip.

3.5 × 5.6 × 1.2 cm 1000 / 500

Print Code: C(4)

Thirty

9774

Scalimeter. Aluminium. 30 cm. Scales: 1:20, 1:25, 1:50, 1:75, 1:100.
 Maßstab. Aluminium. 30 cm. Skala: 1:20, 1:25, 1:50, 1:75, 1:100.
 Règle. Aluminium. 30 cm. Échelle: 1:20, 1:25, 1:50, 1:75, 1:100.
 Lineaal. Aluminium. 30 cm. Schaal: 1:20, 1:25, 1:50, 1:75, 1:100.

32 × 2 × 2 cm

200 / 20

Print Code: F(4), L1



03

02

19

05

Mars

9510

Cutter.
Cutter.
Cutter.
Cutter.

2 × 13.5 × 0.8 cm

1000 / 50

Print Code: C(4)

ALUMINIUM



ALUMINIUM

Gruesly

5549

Cutter. Aluminium.
Cutter. Aluminium.
Cutter. Aluminium.
Cutter. Aluminium.

4 × 15.5 × 2.2 cm

100 / 25

Print Code: C(1)



STAINLESS STEEL

Fainel

5550

Cutter. Stainless Steel.
Cutter. Rostfreier Stahl.
Cutter. Acier Inox.
Cutter. Roestvrij Staal.

1.2 × 12.7 × 1.1 cm

800 / 100

Print Code: L1



Eding

8738

Ruler. Transparent.
Lineal. Durchsichtig.
Règle. Transparent.
Lineaal. Transparent.

31.4 × 3.5 × 0.2 cm

600 / 100

Print Code: D(1), W



Dekot

6057

Eraser.
Radiergummi.
Gomme.
Cum.

2.5 x 5.4 x 1.3 cm

Print Code: B(4)

600 / 50



Hindal

6404

Highlighter Set. 5 Ink Colours.
Textmarker Set. 5 Farben Tinte.
Set Surligneurs. Ecriture 5 Couleurs.
Markers Set. 5 Kleuren Inkt.

Ø 9.8 x 1.8 cm

Print Code: C(4), W

250 / 50



248



Bolings

5640

Highlighter Set. 3 Pieces. 100 Sticky Notes 1,2 x 3,8 cm.
Textmarker Set. 3 Stück. 100 Haftnotizen 1,2 x 3,8 cm.
Set Surligneurs. 3 Pièces. 100 Notes Adhésives 1,2 x 3,8 cm.
Markers Set. 3 Stuks. 100 Plakmemo's 1,2 x 3,8 cm.

7 x 5.3 x 6.5 cm

200 / 50

Print Code: C(4)



Dinku

6209

Highlighter Set. 5 Pieces.
Textmarker Set. 5 Peças.
Set Surligneurs. 5 Pièces.
Markers Set. 5 Stuks.

10.8 x 8.7 x 1.8 cm

Print Code: C(4), W

250 / 50



HIGHLIGHTER



Trico 3201

Highlighter. 3 Ink Colours.
Textmarker. 3 Farben Tinte.
Surligneur. Ecriture 3 Couleurs.
Marker. 3 Kleuren Inkt.

- 9 x 8 x 1.2 cm 500 / 50
- Print Code: C(4), W



Rankap 4898

Highlighter.
Textmarker.
Surligneur.
Marker.

- 2.3 x 6 x 1.4 cm 2000 / 50
- Print Code: B(4)



Layax 5024

Highlighter Set. 5 Pieces.
Textmarker Set. 5 Peças.
Set Surligneurs. 5 Pièces.
Markers Set. 5 Stuks.

- 5.7 x 7.8 x 7.4 cm 200 / 20
- Print Code: C(1)



Nadol 4340

Highlighter.
Textmarker.
Surligneur.
Marker.

- 4.4 x 7.5 x 1.6 cm 500 / 50
- Print Code: C(4), W



Zoldak 4906

Highlighter.
Textmarker.
Surligneur.
Marker.

- 0.7 x 17.5 cm 2000 / 50
- Print Code: A(4)



Ener 2320

Desktop Calendar. Cardboard.
Tischkalender. Pappe.
Calendrier Bureau. Carton.
Kalender. Karton.

11 × 13.8 × 6 cm

500 / 25

Print Code: E(4)



Feber 2321

Desktop Calendar. Cardboard.
Tischkalender. Pappe.
Calendrier Bureau. Carton.
Kalender. Karton.

22 × 13.8 × 6 cm

300 / 25

Print Code: E(4)

Larip 2509

Magnet Calendar. Cardboard.
Magnet Kalender. Pappe.
Calendrier Aimanté. Carton.
Magneet Kalender. Karton.

10 × 19 cm

300 / 50

Print Code: C(4)



250



Anti Slip

ANTI SLIP

Rendux 3892

Mousepad Calendar. PVC/ EVA. 12 Months.
Mauspad Kalender. PVC/ EVA. 12 Monate.
Tapis Souris Calendrier. PVC/ EVA. 12 Mois.
Muispad Kalender. PVC/ EVA. 12 Maanden.

23 × 18 cm

100 / 50

Print Code: E(4)

8 IDIOMAS:
Castellano, Català, Euskera, Galego,
Português, English, Français, Italiano.



NEW

14,7 x 21 CM



04

13

Fredex 2596

Diary. Paper. Daily Page.
Tagebuch. Papier. Tag Seite.
Agenda. Papier. Page Journalier.
Agenda. Papier. Dagpagina.

14.7 × 21 × 2 cm

20

Print Code: E(1)





8 IDIOMAS:
Castellano, Catala, Euskera, Galego,
Portugués, English, Français, Italiano.



18 x 24,5 CM

17,5 x 24,5 CM

Wayro

Toulouse

17,5 x 24,5 CM

Versalles



Toulouse

2283

Diary. PU. Daily Page.
Tagebuch. PU. Tag Seite.
Agenda. Similicuir. Page Journalier.
Agenda. PU. Dagpagina.

17,5 x 24,5 x 2,5 cm

Print Code: E(1), T, U

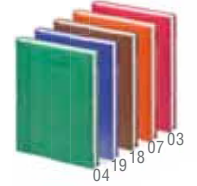

20

Wayro

2525

Diary. PU. Daily Page.
Tagebuch. PU. Tag Seite.
Agenda. Similicuir. Page Journalier.
Agenda. PU. Dagpagina.

19 x 24,5 x 2,9 cm

Print Code: E(1), T, U

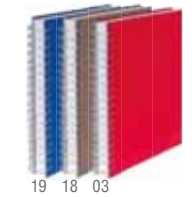

20

Versalles

2101

Diary. PU. Daily Page.
Tagebuch. PU. Tag Seite.
Agenda. Similicuir. Page Journalier.
Agenda. PU. Dagpagina.

17,5 x 24,5 x 2 cm

Print Code: E(1), T, U



20

Witra

2547

Diary. PU. Daily Page.
Tagebuch. PU. Tag Seite.
Agenda. Similicuir. Page Journalier.
Agenda. PU. Dagpagina.

15,8 x 21 x 2,4 cm

Print Code: E(1), T, U



251

20

Witra

2022

15,8 x 21 CM

CREATIVE AGENCY

MAGN



14,7 x 21 CM

Cannes

15 x 21 CM

Waltrex

Cannes

2497

Diary. PU. Daily Page.
Tagebuch. PU. Tag Seite.
Agenda. Similicuir. Page Journalier.
Agenda. PU. Dagpagina.

14,7 x 21 x 2 cm

Print Code: E(1), T, U



20

Waltrex

2546

Diary. PU. Daily Page.
Tagebuch. PU. Tag Seite.
Agenda. Similicuir. Page Journalier.
Agenda. PU. Dagpagina.

15 x 21 x 2,5 cm

Print Code: E(1), T, U



20

WRITING

RPET

i The fabric used in the manufacturing process of these products is made of recycled plastic (RPET). Like this, the emission of plastic residues to our planet and the consumption of energy is drastically reduced, resulting in a much more eco-friendly process.

El material de estos productos está fabricado con plástico reciclado (RPET), que, además de ayudar en la disminución de residuos plásticos en el planeta, utiliza menos energía en el proceso de fabricación, haciendo que sea mucho menos dañino para el medio ambiente.

STOP PLASTIC POLLUTING THE OCEAN



Hispar 6731

Pen. Polyester RPET.
Kugelschreiber. Polyester RPET.
Stylo. Polyester RPET.
Pen. Polyester RPET.



Ø 1 × 13.6 cm

1000 / 50

Print Code: A(4)



RPET

NEW





+10.000 pcs
PRINTING 30% DIS

Harry 6772

Pen. Wheat Straw/ PP.
Kugelschreiber. Weizenstroh/ PP.
Stylo. Paille de Blé/ PP.
Pen. Tarwestro/ PP.



Ø 1 x 14 cm

1000 / 50

Print Code: A(4)



Blacks 5557

Pen.
Kugelschreiber.
Stylo.
Pen.



Ø 1 x 13.8 cm

1000 / 50

Print Code: A(4)

+10.000 pcs
PRINTING 30% DIS

RPET

i The fabric used in the manufacturing process of these products is made of recycled plastic (RPET). Like this, the emission of plastic residues to our planet and the consumption of energy is drastically reduced, resulting in a much more eco-friendly process.

El material de estos productos está fabricado con plástico reciclado (RPET), que, además de ayudar en la disminución de residuos plásticos en el planeta, utiliza menos energía en el proceso de fabricación, haciendo que sea mucho menos dañino para el medio ambiente.

STOP PLASTIC POLLUTING THE OCEAN

254

Tinzo



Hispar



Andrio



NEW



RPET

01



19

Tinzo

6330

Pen. RPET. Jumbo Refill.
Kugelschreiber. RPET. Jumbo Ersatzmine.
Stylo. RPET. Recharge Jumbo.
Pen. RPET. Jumbo Refill.

Ø 1.2 x 14 cm

1000 / 50

Print Code: A(4)



RPET



01



19



04



03

Andrio

6730

Pen. Polyester RPET.
Kugelschreiber. Polyester RPET.
Stylo. Polyester RPET.
Pen. Polyester RPET.

Ø 1.1 x 14.1 cm

1000 / 50

Print Code: A(4)



RPET



01



03



04



19

Hispar

6731

Pen. Polyester RPET.
Kugelschreiber. Polyester RPET.
Stylo. Polyester RPET.
Pen. Polyester RPET.

Ø 1 x 13.6 cm

1000 / 50

Print Code: A(4)

PLA

These products are manufactured with PLA material, from renewable raw materials, with important qualities such as versatility and strength, but prevailing all, it is compostable.

**USE ME,
I AM ECO-FRIENDLY
100% COMPOSTABLE**

Estos productos están fabricados con material PLA, procedente de materias primas renovables, con importantes propiedades como la versatilidad y la resistencia pero prevaleciendo entre ellas la de compostabilidad.



NEW

NEW

Heloix

Vatum



Heloix



6771

Pen. Bamboo/ PLA 100% Compostable.
Kugelschreiber. Bambus/ PLA 100% Kompostierbar.
Stylo. Bambou/ PLA 100% Compostable.
Pen. Bamboe/ PLA 100% Composteerbaar.



Ø 1.1 × 14 cm

1000 / 50

Print Code: B(4)



02 19 03 01



Vatum



6770

Pen. Recycled Cardboard/ PLA 100% Compostable.
Kugelschreiber. Recycling Papper/ PLA 100% Kompostierbar.
Stylo. Carton Recycle/ PLA 100% Compostable.
Pen. Gerecycled Karton/ PLA 100% Composteerbaar.



Ø 0.9 × 13.7 cm

1000 / 50

Print Code: A(4), W



01 07 04 19 02

WHEAT STRAW

THE BEST PRICE

+10.000 pcs
PRINTING 30% DIS



Rosdy

network



Fertol

SARGASSO

NEW



Harry

ULTREX



Radun

avana

+10.000 pcs
PRINTING 30% DIS

256



13 07 03 05 04
19

Rosdy
6334

Pen. Wheat Straw/ ABS.
Kugelschreiber. Weizenstroh/ ABS.
Stylo. Paille de Blé/ ABS.
Pen. Tarwestro/ ABS.

Ø 1 × 14.5 cm

1000 / 50

Print Code: A(4)



05 03 07 13 19 04

Fertol
6322

Pen. Wheat Straw/ ABS.
Kugelschreiber. Weizenstroh/ ABS.
Stylo. Paille de Blé/ ABS.
Pen. Tarwestro/ ABS.

Ø 1.2 × 14.7 cm

1000 / 50

Print Code: A(4), W

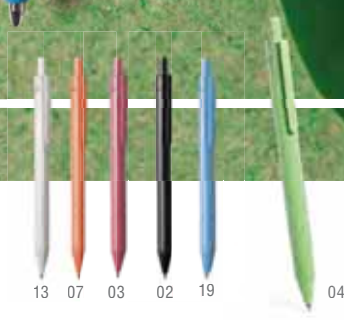

13 07 03 02 19 04

Harry
6772

Pen. Wheat Straw/ PP.
Kugelschreiber. Weizenstroh/ PP.
Stylo. Paille de Blé/ PP.
Pen. Tarwestro/ PP.

Ø 1 × 14 cm

1000 / 50

Print Code: A(4)



03 04 19 13

Radun
6567

Mini Pen. Wheat Straw/ ABS.
Mini Kugelschreiber. Weizenstroh/ ABS.
Mini Stylo. Paille de Blé/ ABS.
Minipen. Tarwestro/ ABS.

Ø 1 × 9.2 cm

2000 / 50

Print Code: A(4), W

WHEAT STRAW



Wipper

Nukot

Prodox

SARGASSO

ULTRAX

network

Wipper 6605

Pen. Wheat Straw/ ABS.
Kugelschreiber. Weizenstroh/ ABS.
Stylo. Paille de Blé/ ABS.
Pen. Tarwestro/ ABS.

Ø 1 × 13.8 cm
Print Code: A(4)



+10.000 pcs
PRINTING 30% DIS

1000 / 50



Prodox 6213

Pen. Wheat Straw/ ABS. Jumbo Refill.
Kugelschreiber. Weizenstroh/ ABS. Jumbo Ersatzmine.
Stylo. Paille de Blé/ ABS. Recharge Jumbo.
Pen. Tarwestro/ ABS. Jumbo Refill.

Ø 1.3 × 14 cm
Print Code: A(4)



1000 / 50



Nukot 6335

Pen. Wheat Straw/ ABS. Jumbo Refill.
Kugelschreiber. Weizenstroh/ ABS. Jumbo Ersatzmine.
Stylo. Paille de Blé/ ABS. Recharge Jumbo.
Pen. Tarwestro/ ABS. Jumbo Refill.

Ø 1 × 13.7 cm
Print Code: A(4)



1000 / 50



+10.000 pcs
PRINTING 30% DIS

BAM- BOO

258



01 02 03 19

Unkox
6081

Pen. Bamboo.
Kugelschreiber. Bambus.
Stylo. Bambou.
Pen. Bamboe.

▬▬▬▬▬ Ø 0.9 × 14.7 cm

Print Code: B(4)



04



19 04 02 03

Sydor
6495

Pen. Bamboo/ Wheat Straw/ ABS.
Kugelschreiber. Bambus/ Weizenstroh/ ABS.
Stylo. Bambou/ Paille de Blé/ ABS.
Pen. Bamboe/ Tarwestro/ ABS.

▬▬▬▬▬ Ø 1.1 × 14 cm

Print Code: B(4)



13



02 01 03 16

Dafen
6369

Pen. Bamboo.
Kugelschreiber. Bambus.
Stylo. Bambou.
Pen. Bamboe.

▬▬▬▬▬ Ø 1.3 × 14.2 cm

Print Code: B(4)



19

+10.000 pcs
PRINTING 30% DIS

▬▬▬▬▬ 1000 / 50



04 03 02 01

Heldon
5605

Pen. Bamboo.
Kugelschreiber. Bambus.
Stylo. Bambou.
Pen. Bamboe.

▬▬▬▬▬ Ø 1.1 × 14.1 cm

Print Code: B(4)



19

▬▬▬▬▬ 1000 / 50

BAM- BOO

WHEAT STRAW



Holder

Clarion

6614

Holder Pen. Bamboo/ Wheat Straw/ ABS. Jumbo Refill.
Kugelschreiber Halter. Bambus/ Weizenstroh/ ABS. Jumbo Ersatzmine.
Stylo. Bambou/ Paille de Blé/ ABS. Recharge Jumbo.
Pen-Houder. Bamboe/ Tarwestro/ ABS. Jumbo Refill.

Ø 1.1 × 14.2 cm

1000 / 50

Print Code: B(4)

Clarion

Patrok

Larkin

Trepol

Lettek

259

Trepol

6609

Pen. Bamboo/ Wheat Straw/ ABS. Jumbo Refill.
Kugelschreiber. Bambus/ Weizenstroh/ ABS. Jumbo Ersatzmine.
Stylo. Bambou/ Paille de Blé/ ABS. Recharge Jumbo.
Pen. Bamboe/ Tarwestro/ ABS. Jumbo Refill.

Ø 1.1 × 13.7 cm

1000 / 50

Print Code: B(4)

Patrok

6608

Pen. Bamboo/ Wheat Straw/ ABS. Jumbo Refill.
Kugelschreiber. Bambus/ Weizenstroh/ ABS. Jumbo Ersatzmine.
Stylo. Bambou/ Paille de Blé/ ABS. Recharge Jumbo.
Pen. Bamboe/ Tarwestro/ ABS. Jumbo Refill.

Ø 1.3 × 14 cm

1000 / 50

Print Code: B(4)

Larkin

6331

Pen. Bamboo/ Wheat Straw/ ABS.
Kugelschreiber. Bambus/ Weizenstroh/ ABS.
Stylo. Bambou/ Paille de Blé/ ABS.
Pen. Bamboe/ Tarwestro/ ABS.

Ø 1.2 × 14.3 cm

1000 / 50

Print Code: B(4)

Lettek

6610

Pen. Bamboo/ Wheat Straw/ ABS. Jumbo Refill.
Kugelschreiber. Bambus/ Weizenstroh/ ABS. Jumbo Ersatzmine.
Stylo. Bambou/ Paille de Blé/ ABS. Recharge Jumbo.
Pen. Bamboe/ Tarwestro/ ABS. Jumbo Refill.

Ø 1.1 × 13.9 cm

1000 / 50

Print Code: B(4)

+10.000 pcs
PRINTING 30% DIS

04

13

BAM- BOO

NEW



Zharu

6886

Stylus Touch Ball Pen. Bamboo. Jumbo Refill.
Kugelschreiber Pointer. Bambus. Jumbo Ersatzmine.
Stylét Bille. Bambou. Recharge Jumbo.
Touch-Screen Balpen. Bamboe. Jumbo Refill.

Ø 1.1 × 14.1 cm

1000 / 50

Print Code: B(4)



Sirim

5261

Stylus Touch Ball Pen. Bamboo. Jumbo Refill.
Kugelschreiber Pointer. Bambus. Jumbo Ersatzmine.
Stylét Bille. Bambou. Recharge Jumbo.
Touch-Screen Balpen. Bamboe. Jumbo Refill.

Ø 1.1 × 13.8 cm

1000 / 50

Print Code: B(4)



Locen

6611

Pen Pouch. Cardboard.
Kugelschreiber Hülle. Pappe.
Étui Stylo. Carton.
Pennehoes. Karton.

4 × 15.5 cm

4000 / 400

Print Code: B(4)

Heleon

5262

Set. Bamboo. Jumbo Refill Pen. Mechanical Pencil: 0,7 mm Leads Included.
Set. Bambus. Kugelschreiber Jumbo Ersatzmine. Bleistift: Minen 0,7 mm Inklusiv.
Set. Bambou. Stylo Recharge Jumbo. Portemines: Mines 0,7 mm Inclus.
Set. Bamboe. Jumbo Refill Pen. Vulpotlood: 0,7 mm Stifjes Inclusief.

Ø 1.1 × 13.8 cm

300 / 25

Print Code: D(4)





BAM-BOO



Reycan

6612
 Pen. Bamboo.
 Kugelschreiber. Bambus.
 Stylo. Bambou.
 Pen. Bamboe.

1000 / 50
 Print Code: B(4)



Yiagan

5260
 Pen. Bamboo. Jumbo Refill.
 Kugelschreiber. Bambus. Jumbo Ersatzmine.
 Stylo. Bambou. Recharge Jumbo.
 Pen. Bamboe. Jumbo Refill.

1000 / 50
 Print Code: B(4)



Glindery

5604
 Pen. Bamboo. Jumbo Refill.
 Kugelschreiber. Bambus. Jumbo Ersatzmine.
 Stylo. Bambou. Recharge Jumbo.
 Pen. Bamboe. Jumbo Refill.

1000 / 50
 Print Code: B(4)



Nikox

6072
 Pen. Bamboo. Jumbo Refill. Black Ink.
 Kugelschreiber. Bambus. Jumbo Ersatzmine. Schwarze Tinte.
 Stylo. Bambou. Recharge Jumbo. Encre Noire.
 Pen. Bamboe. Jumbo Refill. Zwarte Inkt.

1000 / 50
 Print Code: B(4)

+10.000 pcs
 PRINTING 30% DIS



Tori
3564



Pen. Recycled Cardboard.
Kugelschreiber. Recycling Papper.
Stylo. Carton Recycle.
Pen. Gerecycled Karton.

Ø 0.9 × 13.7 cm
Print Code: A(4), W

+10.000 pcs
PRINTING 30% DIS

1000 / 50

19

RECYCLED
CARBOARD



262



04



Compo
9696



Pen. Recycled Cardboard. Black Ink.
Kugelschreiber. Recycling Papper. Schwarze Tinte.
Stylo. Carton Recycle. Encre Noire.
Pen. Gerecycled Karton. Zwarte Inkt.

Ø 1 × 14 cm
Print Code: A(4), W

1000 / 50

+10.000 pcs
PRINTING 30% DIS

19



Than
4903



Stylus Touch Ball Pen. Recycled Cardboard.
Kugelschreiber Pointer. Recycling Papper.
Stylet Bille. Carton Recycle.
Touch-Screen Balpen. Gerecycled Karton.

Ø 1 × 13.8 cm
Print Code: A(4), W

1000 / 50

CONVIERTE RESIDUOS DE COCINA

WHEAT STRAW &

RECYCLED CARBOARD

Desok

Filax

Salcen

eramos que podáis
ar nueva vida a
vuestros residuos al
reutilizarlos y
reciclarlos.



Desok
6773

Pen. Recycled Cardboard/ Wheat Straw/ ABS.
Kugelschreiber. Recycling Pappel/ Weizenstroh/ ABS.
Stylo. Carton Recycle/ Paille de Blé/ ABS.
Pen. Gercycled Karton/ Tarwestro/ ABS.

Ø 0.9 × 13.7 cm 1000 / 50
Print Code: A(4), W



07

Filax
6320

Pen. Recycled Cardboard/ Wheat Straw/ ABS.
Kugelschreiber. Recycling Pappel/ Weizenstroh/ ABS.
Stylo. Carton Recycle/ Paille de Blé/ ABS.
Pen. Gercycled Karton/ Tarwestro/ ABS.

Ø 1 × 13.9 cm 1000 / 50
Print Code: A(4), W



04

Salcen
6496

Pen. Recycled Cardboard/ Wheat Straw/ ABS.
Kugelschreiber. Recycling Pappel/ Weizenstroh/ ABS.
Stylo. Carton Recycle/ Paille de Blé/ ABS.
Pen. Gercycled Karton/ Tarwestro/ ABS.

Ø 1 × 14 cm 1000 / 50
Print Code: A(4), W



13



Torel

5606

Pen. Recycled Cardboard.
Kugelschreiber. Recycling Papper.
Stylo. Carton Recyclé.
Pen. Gerecycled Karton.

Ø 1.1 x 16.2 cm

Print Code: A(4), W

1000 / 50



16



264

Tundra

9885

Pencil. Recycled Cardboard.
Bleistift. Recycling Papper.
Crayon. Carton Recyclé.
Potlood. Gerecycled Karton.

Ø 0.7 x 17.5 cm

Print Code: A(4), W

2000 / 100



Sharpened



Valvek

6321

Pen. Recycled Cardboard.
Kugelschreiber. Recycling Papper.
Stylo. Carton Recyclé.
Pen. Gerecycled Karton.

Ø 0.8 x 14.2 cm

Print Code: A(4), W

1000 / 50



13



Ferrel

6214

Notepad Holder. Wheat Straw/ PP. 125 Sheets. Wood Pen Included.
Notizzettelbox. Weizenstroh/ PP. 125 Seiten. Holz Kugelschreiber Inklusive.
Porte Notes. Paille de Blé/ PP. 125 Feuilles. Stylo Bois Inclus.
Notitieblokjehouder. Tarwestro/ PP. 125 Blaadjes. Pen Hout Inclusief.

11.5 x 14.5 x 6.5 cm

Print Code: D(1), L1

100 / 50



WHEAT STRAW / CORK

Hound. Quizá dicho predominio de las crias de esta productora se pueda deber al gran poder icónico que la mayor parte de su grafismo les confiere, lo que les llevó a gozar de una enorme popularidad entre los años sesenta y ochenta. No obstante, también hay lienzos protagónicos por personajes de la Warner -el pato Lucas-, de la MGM -el ratón- y de Disney -Bambi-, del japonés -Pucca- o incluso de los orígenes de la animación -el gato Félix-. Lo habitual es que uno de estos personajes protagónicos de la escena, tanto por tamaño como por definición y detalle en la línea y el color, se parezca a una de las figuras más famosas de la historia del cine, apareciendo otros a modo de borrador, tan solo esbozados u ocultos tras una mancha de pintura a modo de borrador. Igualmente, cuando irrumpen en la escena personajes o figuras que no pertenecen al mundo de los videojuegos suelen ser personajes o productos gráficos que se han creado en lo que parece un intento de subvertir su condición de producto gráfico creado por ordenador.

Pero la gran novedad de esta serie pictórica radica en la aparición de largas operaciones matemáticas, relaciones, problemas de geometría...-, así como en la mayor presencia, en las imágenes, de textos escritos. En este sentido, encontramos desde la detallada descripción de un personaje o situación -siempre realizadas en inglés- hasta los que parecen ser notas recordatorias, acompañadas



+10.000 pcs
PRINTING 30% DIS

Yarden
6774

Pen. Natural Cork/ Wheat Straw/ ABS.
Kugelschreiber. Naturkork/ Weizenstroh/ ABS.
Stylo. Bouchon Naturel/ Paille de Blé/ ABS.
Pen. Natuurlijk Kurk/ Tarwestro/ ABS.

Ø 0.9 × 13.7 cm 1000 / 50
Print Code: A(4)

02 13

04

Pevex
6606

Pen. Natural Cork/ Wheat Straw/ ABS.
Kugelschreiber. Naturkork/ Weizenstroh/ ABS.
Stylo. Bouchon Naturel/ Paille de Blé/ ABS.
Pen. Natuurlijk Kurk/ Tarwestro/ ABS.

Ø 1 × 14 cm 1000 / 50
Print Code: A(4), L1

Clover
6332

Pen. Natural Cork/ Wheat Straw/ ABS.
Kugelschreiber. Naturkork/ Weizenstroh/ ABS.
Stylo. Bouchon Naturel/ Paille de Blé/ ABS.
Pen. Natuurlijk Kurk/ Tarwestro/ ABS.

Ø 1 × 13.5 cm 1000 / 50
Print Code: A(4), L1, W

13

04

WOOD

266



Bontol

6037

Pen. Wood.
Kugelschreiber. Holz.
Stylo. Bois.
Pen. Hout.



Ø 1.2 × 14 cm

500 / 50

Print Code: B(1), L1



Lobart

6036

Pen. Wood.
Kugelschreiber. Holz.
Stylo. Bois.
Pen. Hout.



Ø 1.1 × 13.8 cm

500 / 50

Print Code: B(1), L1



CORK

... SECO SUELE SER
 ... ABEN GENIAL Y SE PUEDE
 ... SOLAS CRUJIENTES DE
 ... AR CON TODO TIPO DE
 ... PUEDES DISTINTAS, EN FLU
 ... ESTUPENDO ACOMPAÑAR
 ... BUENA COPA DE
 ... DO SECO

... DE
 ... SECO
 ... CON VINAGRETA DE MANZANA



Vamet

NEW

Siliax



267

Vamet

6333

Pen. Natural Cork/ Metal.
 Kugelschreiber. Naturkork/ Metall.
 Stylo. Bouchon Naturel/ Métal.
 Pen. Natuurlijk Kurk/ Metaal.



██████████ Ø 1 × 13.5 cm

Print Code: D(1), L1

📦 100 / 50



Siliax

6728

Pen. Natural Cork/ Metal.
 Kugelschreiber. Naturkork/ Metall.
 Stylo. Bouchon Naturel/ Métal.
 Pen. Natuurlijk Kurk/ Metaal.



██████████ Ø 1.2 × 13.7 cm

Print Code: B(4), L1

📦 300 / 50





Zonet
3523

Pen.
Kugelschreiber.
Stylo.
Pen.



Ø 1 × 14.5 cm
Print Code: A(4)

1000 / 50

+10.000 pcs
PRINTING 30% DIS



Haftar
5167

Pen.
Kugelschreiber.
Stylo.
Pen.



Ø 1 × 13.8 cm
Print Code: A(4)

1000 / 50

+10.000 pcs
PRINTING 30% DIS



Zufer
4345

Pen.
Kugelschreiber.
Stylo.
Pen.



Ø 1 × 14.5 cm
Print Code: A(4)

1000 / 50

+10.000 pcs
PRINTING 30% DIS





19



17 11 07 05 04 03 02

Kific 6410

Pen.
Kugelschreiber.
Stylo.
Pen.
Ø 1 × 13.8 cm
Print Code: A(4)

1000 / 50



02 01 19 04 05 07 03 11 22 21 17

Blacks 5557

Pen.
Kugelschreiber.
Stylo.
Pen.
Ø 1 × 13.8 cm
Print Code: A(4)

+10.000 pcs
PRINTING 30% DIS

1000 / 50



04

Clexton

5014

Pen.
Kugelschreiber.
Stylo.
Pen.

+10.000 pcs
PRINTING 30% DIS



Ø 1.3 x 14 cm

Print Code: A(4)

1000 / 50



02 03 04 05 07 11 19

Tinkin

6074

Pen.
Kugelschreiber.
Stylo.
Pen.

+10.000 pcs
PRINTING 30% DIS



Ø 1.3 x 14 cm

Print Code: A(4)

1000 / 50



21



02 19 16 05 07 03 01

Karium

5168

Pen. Black Ink.
Kugelschreiber. Schwarze Tinte.
Stylo. Encre Noire.
Pen. Zwarte Inkt.

+10.000 pcs
PRINTING 30% DIS



Ø 1.3 x 14 cm

Print Code: A(4)

1000 / 50



11

270



Holder



01 02 03 04 19



05

Croppix

5576

Holder Pen.
Kugelschreiber Halter.
Stylo Support.
Pen-Houder.



Ø 1.3 x 14 cm

Print Code: A(4)

1000 / 50



02 19 04 07 03 01

Fatrus

5015

Stylus Touch Ball Pen.
Kugelschreiber Pointer.
Stylolet Bille.
Touch-Screen Balpen.



Ø 1.3 x 14 cm

Print Code: A(4)

1000 / 50



02 01 19 04 05 03 07 11

Zeril

6075

Stylus Touch Ball Pen.
Kugelschreiber Pointer.
Stylolet Bille.
Touch-Screen Balpen.



Ø 1.3 x 14 cm

Print Code: A(4)

1000 / 50



16 02 07 11 21 01 03 22

05

Lombys

4647

Stylus Touch Ball Pen.
Kugelschreiber Pointer.
Stylolet Bille.
Touch-Screen Balpen.



Ø 1.3 x 14 cm

Print Code: A(4)

1000 / 50



Fatrus •••••



Zeril •••••



Lombys •••••



Clexton •••••



Tinkin •••••



Karium •••••



Cropix •••••



Topen 6693



Antibacterial Stylus Touch Ball Pen. Jumbo Refill.
Antibakteriell Kugelschreiber Pointer. Jumbo Ersatzmine.
Styllet Bille Antibactérien. Recharge Jumbo.
Antibacterieel Touch-Screen Balpen. Jumbo Refill.

Ø 1 × 13.9 cm

1000 / 50

Print Code: B(4)

NEW



NEW



Unsharpened

Antibacterial



272

+10.000 pcs
PRINTING 30% DIS



NEW

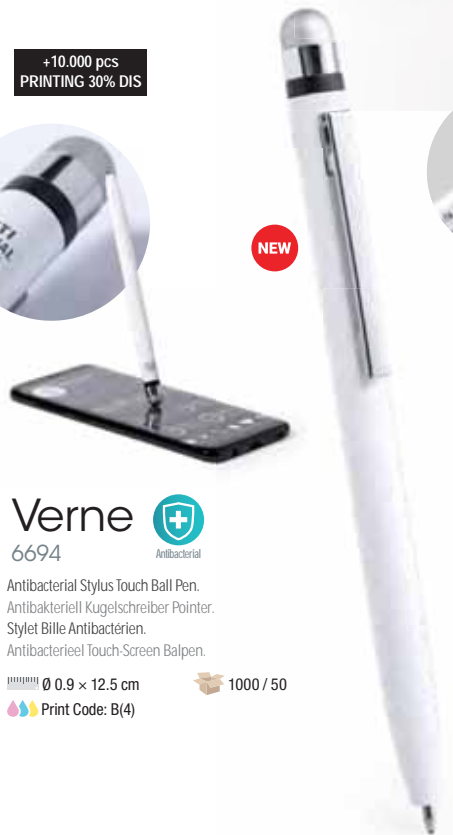

Verne 6694



Antibacterial Stylus Touch Ball Pen.
Antibakteriell Kugelschreiber Pointer.
Styllet Bille Antibactérien.
Antibacterieel Touch-Screen Balpen.

Ø 0.9 × 12.5 cm

1000 / 50

Print Code: B(4)

Sukon 6766



Antibacterial Pencil. Wood.
Antibakteriell Bleistift. Holz.
Crayon Antibactérien. Bois.
Antibacterieel Potlood. Hout.

Ø 0.7 × 18.6 cm

2000 / 100

Print Code: B(4), L1



NEW

Riply 6765



Antibacterial Set. PP Plastic. 4 Pieces. Pen. Mechanical Pencil. 0.5 mm Leads Included.
Antibakteriell Set. Plastik PP. 4 Stück. Kugelschreiber. Bleistift. Minen 0,5 mm Inklusiv.
Set Antibactérien. PP Plastique. 4 Pièces. Stylo. Portemines: Mines 0,5 mm Inclus.
Antibacterieel Set. PP Plastic. 4 Stuks. Pen. Vulpotlood: 0.5 mm Stijfjes Inclusief.

3.4 × 16.5 × 1.5 cm

300 / 50

Print Code: B(4), W



Antibacterial



NEW



02 03 04 19 05 01

Licter
6659



Antibacterial Pen.
Antibakteriell Kugelschreiber.
Stylo Antibactérien.
Antibacterieel Pen.

+10.000 pcs
PRINTING 30% DIS

Ø 1 × 13.8 cm
Print Code: B(4)

1000 / 50

273

3 ml

NEW



Ramix
6692



Antibacterial Pen.
Antibakteriell Kugelschreiber.
Stylo Antibactérien.
Antibacterieel Pen.

Ø 1.1 × 14 cm
Print Code: B(4)

1000 / 50

Yak
6656



Multifunction Antibacterial Pen. 3 ml. Refillable. Liquid Not Included.
Multifunktion Antibakteriell Kugelschreiber. 3 ml. Wiederaufladbar. Flüssigkeit Nicht im Lieferumfang.
Stylo Antibactérien Multifonction. 3 ml. Rechargeable. Liquide Non Inclus.
Multifunctioneel Antibacterieel Balpen. 3 ml. Navulbaar. Vloeistof Niet Inclusief.

Ø 1.4 × 15.7 cm
Print Code: B(4)

1000 / 50

NEW



+10.000 pcs
PRINTING 30% DIS

Flom
6640



Antibacterial Pen.
Antibakteriell Kugelschreiber.
Stylo Antibactérien.
Antibacterieel Pen.

Ø 1.3 × 14 cm
Print Code: B(4)

1000 / 50



19 01 02 03 05



Sipuk

5348

Holder Pen.
Kugelschreiber Halter.
Stylo Support.
Pen-Houder.

Ø 1.1 × 14.6 cm

Print Code: A(4), W

1000 / 50



Holder

04



HOLDER PEN



274



SCREEN CLEANER
LIMPIAPANTALLAS



Holder

19



Finex

4972

Holder Pen. Black Ink. Screen Cleaner Included.
Kugelschreiber Halter. Schwarze Tinte. Displayreiniger Inklusiv.
Stylo Support. Encre Noire. Nettoyeur d'Écran Inclus.
Pen-Houder. Zwarte Inkt. Screen Cleaner Inclusief.

Ø 1.1 × 14.6 cm

Print Code: A(4)

1000 / 50



04

Mobix

4912

Holder Pen.
Kugelschreiber Halter.
Stylo Support.
Pen-Houder.

Ø 1.2 × 14 cm

Print Code: A(4)

1000 / 50



Holder





+10.000 pcs
PRINTING 30% DIS



Sagur

4037
Stylus Touch Ball Pen.
Kugelschreiber Pointer.
Styllet Bille.
Touch-Screen Balpen.



Ø 1 × 13.5 cm
Print Code: A(4)

1000 / 50



Sagursilver

4662

Stylus Touch Ball Pen.
Kugelschreiber Pointer.
Styllet Bille.
Touch-Screen Balpen.



Ø 1 × 13.5 cm
Print Code: A(4)

+10.000 pcs
PRINTING 30% DIS

1000 / 50

03



19

+10.000 pcs
PRINTING 30% DIS



Sagurwhite

4663

Stylus Touch Ball Pen.
Kugelschreiber Pointer.
Styllet Bille.
Touch-Screen Balpen.



Ø 1 × 13.5 cm
Print Code: A(4)

1000 / 50

MULTICOLOUR PEN



03



Clessin

6336

Pen. 4 Ink Colours.
Kugelschreiber. 4 Farben Tinte.
Stylo. Écriture 4 Couleurs.
Pen. 4 Kleuren Inkt.



Ø 1.3 × 14.1 cm
Print Code: A(4)

1000 / 50



Multifour

3131

Pen. 4 Ink Colours.
Kugelschreiber. 4 Farben Tinte.
Stylo. Écriture 4 Couleurs.
Pen. 4 Kleuren Inkt.



Ø 1.2 × 14 cm
Print Code: A(4), W

1000 / 50



04



07

03

19



19

03

Betsi

5120

Stylus Touch Ball Pen. 3 Ink Colours.
Kugelschreiber Pointer. 3 Farben Tinte.
Styler Bille. Écriture 3 Couleurs.
Touch-Screen Balpen. 3 Kleuren Inkt.



Ø 1.1 × 14.8 cm
Print Code: A(4)

500 / 50

09



02

Serux

6364

Pen.
Kugelschreiber.
Stylo.
Pen.

Ø 1.1 × 13.1 cm

Print Code: B(4)



01

19

03

1000 / 50



Parlex

6346

Stylus Touch Ball Pen. Jumbo Refill.
Kugelschreiber Pointer. Jumbo Ersatzmine.
Stylo Bille. Recharge Jumbo.
Touch-Screen Balpen. Jumbo Refill.

Ø 1 × 14.5 cm

Print Code: A(4)

1000 / 50

19



01

02

11

19

04

05

07

Yomil

6073

Pen. Jumbo Refill.
Kugelschreiber. Jumbo Ersatzmine.
Stylo. Recharge Jumbo.
Pen. Jumbo Refill.

Ø 1 × 13.7 cm

Print Code: B(4)

1000 / 50

03



ROLLER



01

02

03

04

05

17

19

Kasty

6350

Roller. Jumbo Refill.
Roller Pen. Jumbo Ersatzmine.
Roller. Recharge Jumbo.
Roller. Jumbo Refill.

Ø 1 × 14.5 cm

Print Code: A(4)

1000 / 50



21

23

Mitch

5121

Stylus Touch Ball Pen. Aluminium. Jumbo Refill.
Kugelschreiber Pointer. Aluminium. Jumbo Ersatzmine.
Stylét Bille. Aluminium. Recharge Jumbo.
Touch-Screen Balpen. Aluminium. Jumbo Refill.



Ø 1 x 13.9 cm

500 / 50

Print Code: B(4), L1



Minox

3960

+5.000 pcs
PRINTING 30% DIS

Stylus Touch Ball Pen. Aluminium.
Kugelschreiber Pointer. Aluminium.
Stylét Bille. Aluminium.
Touch-Screen Balpen. Aluminium.



Ø 0.9 x 12.5 cm

1000 / 50

Print Code: B(4), L1

19



278



SCREEN CLEANER
LIMPIAPANTALLAS



02 19 04 09

Idris

5792

Holder Pen. Aluminium. Screen Cleaner Included.
Kugelschreiber Halter. Aluminium. Displayreiniger Inklusiv.
Stylo Support. Aluminium. Nettoyeur d'Écran Inclus.
Pen-Houder. Aluminium. Screen Cleaner Inclusief.



Ø 1 x 14.1 cm

500 / 50

Print Code: B(4), L1

03



Holder

ALUMINIUM PEN
& THE BEST-SELLER



02 03 04 09 07 08 11 23

Trocum
5418

Pen. Aluminium. Jumbo Refill.
Kugelschreiber. Aluminium. Jumbo Ersatzmine.
Stylo. Aluminium. Recharge Jumbo.
Pen. Aluminium. Jumbo Refill.



Ø 1 × 13.7 cm

500 / 50

Print Code: B(4), L1

METALLIC
FINISH



19



01 02 19 04 05 03

Laindok
6071

Pen. Aluminium. Jumbo Refill.
Kugelschreiber. Aluminium. Jumbo Ersatzmine.
Stylo. Aluminium. Recharge Jumbo.
Pen. Aluminium. Jumbo Refill.



Ø 1 × 13.7 cm

500 / 50

Print Code: B(4), L1

SOLID FINISH



Zardox



02

23



09 01 03 04 05 07 11 19

Zardox

5255

Pen. Aluminium.
Kugelschreiber. Aluminium.
Stylo. Aluminium.
Pen. Aluminium.

+5.000 pcs
PRINTING 30% DIS



Ø 0.8 × 12.9 cm

1000 / 50

Print Code: B(4), L1



02 09 19 05 03

SPECIAL LASER ENGRAVING SILVER LOGO



These pens have an outer coating specially designed for laser engraving, which will ensure that your advertising or brand is perfectly engraved in shining silver to match the rest of the pen.

Estos bolígrafos tienen un recubrimiento exterior especialmente diseñado para grabado láser, con el que conseguirá que su publicidad o marca quede perfectamente grabada en color plata brillo a juego con el resto del bolígrafo.

SUITABLE FOR PAD PRINTING /
VÁLIDO PARA TAMPOGRAFÍA

Bizol 5977

Pen. Aluminium. Jumbo Refill.
Kugelschreiber. Aluminium. Jumbo Ersatzmine.
Stylo. Aluminium. Recharge Jumbo.
Pen. Aluminium. Jumbo Refill.



Ø 1 × 13.7 cm

500 / 50

Print Code: B(4), L1



SUITABLE FOR PAD PRINTING /
VÁLIDO PARA TAMPOGRAFÍA

Polkat 6034

Pen. Aluminium.
Kugelschreiber. Aluminium.
Stylo. Aluminium.
Pen. Aluminium.



Ø 1 × 13.8 cm

500 / 50

Print Code: B(4), L1



04



Sidrox 6032

Pen. Aluminium.
Kugelschreiber. Aluminium.
Stylo. Aluminium.
Pen. Aluminium.



Ø 1.1 × 13.6 cm

500 / 50

Print Code: B(4), L1



03

09

19



16



SUITABLE FOR PAD PRINTING /
VÁLIDO PARA TAMPOGRAFÍA

SPECIAL LASER ENGRAVING COLOUR LOGO



This pen has an outer coating specially designed for laser engraving, which will ensure that your advertising or brand is perfectly engraved to match the colour of the chosen pen.

Este bolígrafo tiene un recubrimiento exterior especialmente diseñado para grabado láser, con el que conseguirá que su publicidad o marca quede perfectamente grabada a juego con el color del bolígrafo elegido.

RUBBER FINISH

SPECIAL LASER ENGRAVING SILVER LOGO



This pen has an outer coating specially designed for laser engraving, which will ensure that your advertising or brand is perfectly engraved in a shining silver colour.

Este bolígrafo tiene un recubrimiento exterior especialmente diseñado para grabado láser, con el que conseguirá que su publicidad o marca quede perfectamente grabada en color plata brillo.



01 02 03 04 07 19



05



01 03 19 02 05 07



04



06 01 19 02 03



04

Lektor

6367

Stylus Touch Ball Pen. Aluminium. Jumbo Refill.
Kugelschreiber Pointer. Aluminium. Jumbo Ersatzmine.
Styllet Bille. Aluminium. Recharge Jumbo.
Touch-Screen Balpen. Aluminium. Jumbo Refill.

▬▬▬▬▬ Ø 1 × 14.5 cm

📦 500 / 50

🌈 Print Code: B(4), L1

Zromen

6366

Pen. Aluminium. Jumbo Refill.
Kugelschreiber. Aluminium. Jumbo Ersatzmine.
Stylo. Aluminium. Recharge Jumbo.
Pen. Aluminium. Jumbo Refill.

▬▬▬▬▬ Ø 1 × 13.9 cm

📦 500 / 50

🌈 Print Code: B(4), L1

Blavix

6368

Pen. Aluminium. Jumbo Refill.
Kugelschreiber. Aluminium. Jumbo Ersatzmine.
Stylo. Aluminium. Recharge Jumbo.
Pen. Aluminium. Jumbo Refill.

▬▬▬▬▬ Ø 1 × 13.7 cm

📦 500 / 50

🌈 Print Code: B(4), L1

SPECIAL
LASER ENGRAVED
MATCHING COLOUR

These notebooks and pens with colour interior have an outer coating specially designed for laser engraved, which will ensure that your advertising or brand is perfectly recorded in the same colour as the inside of your chosen notebook or pen.

Estos bloc de notas y bolígrafos con interior en color tiene un recubrimiento exterior especialmente diseñado para grabado láser, con el que conseguirá que su publicidad o marca quede perfectamente grabada en el mismo color que el interior de su bloc o bolígrafo elegido.



02

282



11 07 05 04 03 02



02 04 05 07 09 19

03

Sider

5996
Notepad. PU. 80 Sheets.
Notizblock. PU. 80 Seiten.
Bloc Notes. Similicuir. 80 Feuilles.
Notitieblokje. PU. 80 Blaadjes.

15.5 × 21 × 1.3 cm

Print Code: E(4), L2



80 Sheets
Plain

50 / 25



PEN NOT INCLUDED
BOLIGRAFO NO INCLUIDO



Wencex

6033
Pen. Aluminium.
Kugelschreiber. Aluminium.
Stylo. Aluminium.
Pen. Aluminium.

Ø 1.1 × 14.1 cm

Print Code: B(4), L1

500 / 50

19

Woner

6078
Stylus Touch Ball Pen. Aluminium. Jumbo Refill.
Kugelschreiber Pointer. Aluminium. Jumbo Ersatzmine.
Styler Bille. Aluminium. Recharge Jumbo.
Touch-Screen Balpen. Aluminium. Jumbo Refill.

Ø 1 × 14.2 cm

Print Code: B(4), L1

500 / 50

SPECIAL

LASER ENGRAVING MATCHING COLOUR

These notebooks and pens with colour interior have an outer coating specially designed for laser engraving, which will ensure that your advertising or brand is perfectly engraved in the same colour as the inside of your chosen notebook or pen.

Estos bloc de notas y bolígrafos con interior en color tienen un recubrimiento exterior especialmente diseñado para grabado láser, con el que conseguirá que su publicidad o marca quede perfectamente grabada en el mismo color que el interior de su bloc o bolígrafo elegido.



03

283



19 09 04 07 03

03 07 09 19 04

Kefron

6069

100 Sheets
Lined

Noteпад. PU. Hard Cover. 100 Sheets.
Notizblock. PU. Hardcover-Abdeckung. 100 Seiten.
Bloc Notes. Similicuir. Couverture Rigide. 100 Feuilles.
Notitieblokje. PU. Harde Kaft. 100 Blaadjes.

14.2 × 21.1 × 1.5 cm

50 / 25

Print Code: E(4), L2, T, U

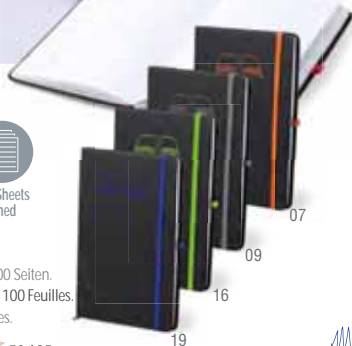

07

09

16

19

Telgar

6030

Pen. Aluminium. Jumbo Refill.
Kugelschreiber. Aluminium. Jumbo Ersatzmine.
Stylo. Aluminium. Recharge Jumbo.
Pen. Aluminium. Jumbo Refill.

Ø 1 × 13.9 cm

500 / 50

Print Code: B(4), L1

Yaret

5975

Stylus Touch Ball Pen. Aluminium. Jumbo Refill.
Kugelschreiber Pointer. Aluminium. Jumbo Ersatzmine.
Stylét Bille. Aluminium. Recharge Jumbo.
Touch-Screen Balpen. Aluminium. Jumbo Refill.

Ø 1 × 14.2 cm

500 / 50

Print Code: L1

STYLISH LASER ENGRAVING WHITE LIGHT LOGO



These pens with illuminated interior have a marking area specially designed for laser engraving, with which you will see your advertising or brand illuminated with white light.

Estos bolígrafos con interior iluminado tienen un área de marcaje especialmente diseñada para grabado láser, con el que conseguirá que su publicidad o marca quede originalmente iluminada con luz blanca.

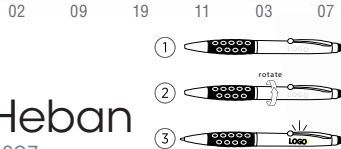

Heban 5807

Stylus Touch Ball Pen. Led Lights. Button Batteries Included.
Kugelschreiber Pointer. Led Lichter. Knopfzellen Inklusive.
Stylét Bille. Lumières Led. Piles Bouton Inclus.
Touch-Screen Balpen. Led Lichten. Knopcel Batterijen Inclusief.

Ø 1.3 x 13.8 cm 1000 / 50
Print Code: B(4), L1

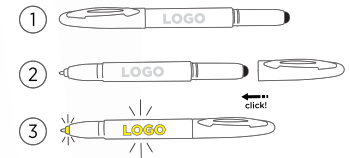

Renseix 5584

Stylus Touch Ball Pen. Led Lights. Button Batteries Included.
Kugelschreiber Pointer. Led Lichter. Knopfzellen Inklusive.
Stylét Bille. Lumières Led. Piles Bouton Inclus.
Touch-Screen Balpen. Led Lichten. Knopcel Batterijen Inclusief.

Ø 1.3 x 14.7 cm 500 / 50
Print Code: B(4), L1



284



Besk 5845

Stylus Touch Ball Pen. Led Lights. Button Batteries Included.
Kugelschreiber Pointer. Led Lichter. Knopfzellen Inklusive.
Stylét Bille. Lumières Led. Piles Bouton Inclus.
Touch-Screen Balpen. Led Lichten. Knopcel Batterijen Inclusief.

Ø 1.3 x 13.5 cm 500 / 50
Print Code: B(4), L1

Norway 6011

Stylus Touch Ball Pen. Aluminium. Led Lights. Button Batteries Included.
Kugelschreiber Pointer. Aluminium. Led Lichter. Knopfzellen Inklusive.
Stylét Bille. Aluminium. Lumières Led. Piles Bouton Inclus.
Touch-Screen Balpen. Aluminium. Led Lichten. Knopcel Batterijen Inclusief.

Ø 1.2 x 14.8 cm 500 / 50
Print Code: B(4), L1

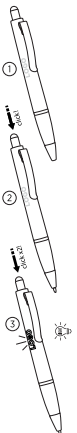
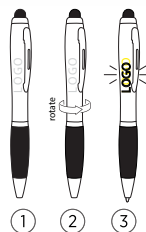

Runer 6211

Stylus Touch Ball Pen. Led Lights. Button Batteries Included.
Kugelschreiber Pointer. Led Lichter. Knopfzellen Inklusive.
Stylét Bille. Lumières Led. Piles Bouton Inclus.
Touch-Screen Balpen. Led Lichten. Knopcel Batterijen Inclusief.

Ø 1.3 x 14.1 cm 1000 / 50
Print Code: B(4), L1



19

SPECIAL LASER ENGRAVING COLOUR LIGHT LOGO

This pen with illuminated interior with coloured LEDs has a coating especially designed for laser engraving, with which you will see your advertising or brand lit with colour light to match the touch ball of the pen.

Este bolígrafo con interior iluminado con ledes de colores tiene un recubrimiento especialmente diseñado para grabado láser, con el que conseguirá que su publicidad o marca quede originalmente iluminada con luz de color a juego con el puntero de su bolígrafo.



ONE COLOUR LIGHT / LUZ DE COLOR

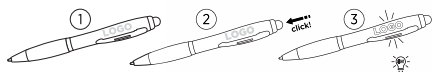

Corden
5973

Stylus Touch Ball Pen. Led Lights. Button Batteries Included.
Kugelschreiber Pointer. Led Lichter. Knopfzellen Inklusiv.
Stylét Bille. Lumières Led. Piles Bouton Inclus.
Touch-Screen Balpen. Led Lichten. Knopcel Batterijen Inclusief.

1.3 x 14.2 cm

1000 / 50

Print Code: B(4), L1

LIGHT PEN



Corden



285

MULTICOLOUR LIGHT / LUZ MULTICOLOR



Reblok
5974

Stylus Touch Ball Pen. Led Lights. 2 Light Modes. Button Batteries Included.
Kugelschreiber Pointer. Led Lichter. 2 Leuchtfunktionen. Knopfzellen Inklusiv.
Stylét Bille. Lumières Led. 2 Modes de Lumière. Piles Bouton Inclus.
Touch-Screen Balpen. Led Lichten. 2 Licht Posities. Knopcel Batterijen Inclusief.

1.3 x 14.2 cm

1000 / 50

Print Code: B(4), L1



SPECIAL LASER ENGRAVING 1 LED - 5 COLOURS

This interior illuminated pen with 1 led of 5 colours and 2 light modes has a coating especially designed for laser engraving. Your advertising or brand will light up in 5 alternating colours when in use.

Este bolígrafo con interior iluminado con 1 led de 5 colores y 2 modos de luz tiene un recubrimiento especialmente diseñado para grabado láser, con el que conseguirá que su publicidad o marca quede originalmente iluminada en 5 colores que se alternarán durante su funcionamiento.



1 LED ¡5 COLORES!
1 LED ¡5 COLOURS!





01 02 19 05 03

Bidmon

5558

Pen.
Kugelschreiber.
Stylo.
Pen.

+10.000 pcs
PRINTING 30% DIS



Ø 1.3 × 15.3 cm

1000 / 50

Print Code: A(4), W

04



09 03 04 19

Klinch

3958

Pen.
Kugelschreiber.
Stylo.
Pen.

+10.000 pcs
PRINTING 30% DIS



Ø 1.1 × 14.7 cm

1000 / 50

Print Code: A(4), W

05

286



04 01 02 03 07 05 11

Barrox

4365

Stylus Touch Ball Pen.
Kugelschreiber Pointer.
Styler Bille.
Touch-Screen Balpen.

+10.000 pcs
PRINTING 30% DIS



Ø 1.3 × 15.3 cm

500 / 50

Print Code: A(4), W

19



16



07 03 02 08 05 19

Zalem

5601

Stylus Touch Ball Pen.
Kugelschreiber Pointer.
Styler Bille.
Touch-Screen Balpen.

+10.000 pcs
PRINTING 30% DIS



Ø 1.1 × 14.7 cm

1000 / 50

Print Code: A(4), W

COLOUR STYLUS TOUCH





01 02 19 04 05 07 11 03

Velny

5294

Pen. Jumbo Refill.
Kugelschreiber, Jumbo Ersatzmitel.
Stylo. Recharge Jumbo.
Pen. Jumbo Refill.



Ø 1.1 x 14 cm
Print Code: A(4)

+10.000 pcs
PRINTING 30% DIS

1000 / 50



11 03 05 04 19 09 01 02

Halibix

5293

Pen.
Kugelschreiber.
Stylo.
Pen.



Ø 1.1 x 14 cm
Print Code: A(4)

+10.000 pcs
PRINTING 30% DIS

1000 / 50



07



02 01 19 16 05 07 03 11

Banik

5416

Pen.
Kugelschreiber.
Stylo.
Pen.



Ø 1.1 x 13.7 cm
Print Code: A(4), W

1000 / 50

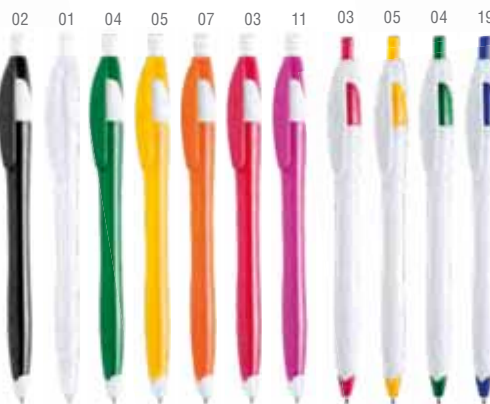

02 01 04 05 07 03 11 03 05 04 19

Finball

3128

Pen.
Kugelschreiber.
Stylo.
Pen.



Ø 1 x 14.5 cm
Print Code: A(4)

+10.000 pcs
PRINTING 30% DIS

1000 / 50



19



01 02 04 19 05 07 03 11

Hurban

5574



Pen.
Kugelschreiber.
Stylo.
Pen.

Ø 1.1 × 14 cm
Print Code: A(4)

+10.000 pcs
PRINTING 30% DIS

1000 / 50



19



03 02 04 05 11

Fisok

4295



Pen. Jumbo Refill.
Kugelschreiber. Jumbo Ersatzmine.
Stylo. Recharge Jumbo.
Pen. Jumbo Refill.

Ø 1.1 × 14.8 cm
Print Code: A(4)

1000 / 50



01 05 19 02

Britox

4449

Pen. Jumbo Refill.
Kugelschreiber. Jumbo Ersatzmine.
Stylo. Recharge Jumbo.
Pen. Jumbo Refill.

Ø 1.1 × 15 cm

Print Code: A(4), V

1000 / 50



03



19 01 05 07

Píxel

9777

Pen. Jumbo Refill.
Kugelschreiber. Jumbo Ersatzmine.
Stylo. Recharge Jumbo.
Pen. Jumbo Refill.

Ø 1.5 × 13 cm

Print Code: A(4)

1000 / 50





02
01
19
04
05
07
03
11

EXTRA SMOOTH
EXTRA SUAVE

Lachem

5833

Pen.
Kugelschreiber.
Stylo.
Pen.



Ø 1.1 × 14.4 cm
Print Code: A(4)

1000 / 50



02 01 19 04 05 07 11

Lucke

4727

Pen.
Kugelschreiber.
Stylo.
Pen.



Ø 1 × 14.5 cm
Print Code: A(4)

+10.000 pcs
PRINTING 30% DIS

1000 / 50



11
03
05
01
04
02

Morek

5010

Pen.
Kugelschreiber.
Stylo.
Pen.



Ø 1 × 13.8 cm
Print Code: A(4), W

1000 / 50

19



03 05 02 07 01 11 16

Dexir

4897

Pen.
Kugelschreiber.
Stylo.
Pen.



Ø 0.9 × 13.7 cm
Print Code: A(4)

1000 / 50

21



Vite
9046

Pen.
Kugelschreiber.
Stylo.
Pen.



Ø 1 × 14.2 cm

Print Code: A(4)

+10.000 pcs
PRINTING 30% DIS

1000 / 50



Buke
4366

Pen. Jumbo Refill.
Kugelschreiber. Jumbo Ersatzmine.
Stylo. Recharge Jumbo.
Pen. Jumbo Refill.



Ø 1.2 × 13.5 cm

Print Code: A(4)

+10.000 pcs
PRINTING 30% DIS

1000 / 50

290



03 07 19 04 01 02

Gallery

9663

Pen. Jumbo Refill.
Kugelschreiber. Jumbo Ersatzmine.
Stylo. Recharge Jumbo.
Pen. Jumbo Refill.



Ø 1.5 × 14 cm

Print Code: A(4)

1000 / 50



19 04 03 02

Vamux

4297

Stylus Touch Ball Pen. Jumbo Refill.
Kugelschreiber Pointer. Jumbo Ersatzmine.
Stylo Bille. Recharge Jumbo.
Touch-Screen Balpen. Jumbo Refill.



Ø 1.5 × 14 cm

Print Code: A(4)

1000 / 50

11





Karsol
6027

Pen. Jumbo Refill.
Kugelschreiber. Jumbo Ersatzmine.
Stylo. Recharge Jumbo.
Pen. Jumbo Refill.



3.9 x 13.9 x 1.9 cm 500 / 50
Print Code: B(4)



07



11
03
05
16
19
02

Tullen

5602

Pen.
Kugelschreiber.
Stylo.
Pen.



Ø 0.9 x 14 cm
Print Code: B(1)

1000 / 50



07



ANTISTRESS
ANTIESTRÉS

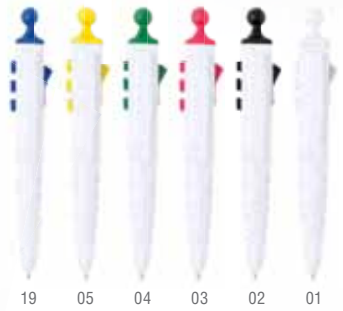

19 05 04 03 02 01

Lennox

5825

Antistress Pen.
Antistress Kugelschreiber.
Stylo Antistress.
Antistress Pen.



1.8 x 12.4 x 1.8 cm 500 / 50
Print Code: B(4)



05



02 19 11 03 07

Teins

5812

Pen.
Kugelschreiber.
Stylo.
Pen.



Ø 1.2 x 14.2 cm
Print Code: B(4)

500 / 50



01 04 19 03

Bolmar

5449

Pen.
Kugelschreiber.
Stylo.
Pen.



Ø 1.2 x 14.6 cm
Print Code: A(4)

1000 / 50

02



Flixon

6028

Pen. Jumbo Refill.
Kugelschreiber. Jumbo Ersatzmine.
Stylo. Recharge Jumbo.
Pen. Jumbo Refill.



1.3 x 14.5 x 1 cm
Print Code: A(4), W

1000 / 50

01



02



05 03 01 04



19



11 01 04 05 19 03

Kimon

4272

Pen. Jumbo Refill.
Kugelschreiber. Jumbo Ersatzmine.
Stylo. Recharge Jumbo.
Pen. Jumbo Refill.



Ø 1 x 13 cm
Print Code: A(4)

1000 / 50

Boder

5006

Pen.
Kugelschreiber.
Stylo.
Pen.



Ø 1.1 x 13.5 cm
Print Code: A(4)

1000 / 50



02



Horten

3861

Pen. Jumbo Refill.
Kugelschreiber. Jumbo Ersatzmine.
Stylo. Recharge Jumbo.
Pen. Jumbo Refill.



Ø 1.1 x 14.2 cm
Print Code: A(4)

1000 / 50





02 09 19 04 03

Olimpia

3707

Pen. Jumbo Refill.
Kugelschreiber. Jumbo Ersatzmine.
Stylo. Recharge Jumbo.
Pen. Jumbo Refill.

+10.000 pcs
PRINTING 30% DIS

Ø 1 × 13.8 cm
Print Code: A(4)

500 / 50



07

Yein

3460

Pen.
Kugelschreiber.
Stylo.
Pen.

Ø 1 × 13.5 cm
Print Code: A(4)

1000 / 50



02 09 03 04



19

Strait

3057

Pen. Jumbo Refill.
Kugelschreiber. Jumbo Ersatzmine.
Stylo. Recharge Jumbo.
Pen. Jumbo Refill.

+10.000 pcs
PRINTING 30% DIS

Ø 1.1 × 14 cm
Print Code: A(4)

1000 / 50



02 19 03 01



09



04

Balu

3847

Pen.
Kugelschreiber.
Stylo.
Pen.

Ø 1 × 14 cm
Print Code: A(4)

+10.000 pcs
PRINTING 30% DIS

1000 / 50



02 19 03 07



Kolder

3522

Pen.
Kugelschreiber.
Stylo.
Pen.

Ø 1 × 14 cm
Print Code: A(4)

+10.000 pcs
PRINTING 30% DIS

1000 / 50



02 19 04 07 03



02 01 19 04 05 07 11

Dafnel

6035

Pen.
Kugelschreiber.
Stylo.
Pen.

1 × 14.5 × 0.8 cm
Print Code: A(4), W

2000 / 100



03



MINI PEN

01



03
07
05
04
19
02
11
17

Hall

3147

Mini Pen.
Mini Kugelschreiber.
Mini Stylo.
Minipen.

Ø 1 × 9.6 cm

2000 / 100

Print Code: A(4), W



05
03
02
01

Acrel

4356

Pen.
Kugelschreiber.
Stylo.
Pen.

Ø 0.8 × 14.6 cm
Print Code: A(1)

2000 / 50



19

03



02
04
05
01
19

Elky

4355

Pen.
Kugelschreiber.
Stylo.
Pen.

Ø 0.8 × 14.6 cm
Print Code: Consultar

2000 / 50





Lane +5.000 pcs
PRINTING 30% DIS

3773

Pen. Aluminium/ABS. Jumbo Refill.
Kugelschreiber. Aluminium/ABS. Jumbo Ersatzmine.
Stylo. Aluminium/ABS. Recharge Jumbo.
Pen. Aluminium/ABS. Jumbo Refill.

Ø 1 × 14 cm 1000 / 50
Print Code: B(4), L1

03



Tikel

6029

Pen.
Kugelschreiber.
Stylo.
Pen.

Ø 1 × 13.8 cm 1000 / 50
Print Code: A(4)

04



Tanety

5832

Pen.
Kugelschreiber.
Stylo.
Pen.

Ø 1.2 × 13.5 cm 1000 / 50
Print Code: B(4), L1

02



Karpel 
4712

Pencil. Wood.
Bleistift. Holz.
Crayon. Bois.
Potlood. Hout.

Ø 0.7 × 17.7 cm 2000 / 100
Print Code: B(4), L1

23

09



GEL INK / TINTA GEL



295



Delray

5908

Pen. Jumbo Refill.
Kugelschreiber. Jumbo Ersatzmine.
Stylo. Recharge Jumbo.
Pen. Jumbo Refill.

Ø 0.8 × 15.5 cm 1000 / 50
Print Code: A(4)

02

ROLLER PEN



296

Kasty

6350

Roller. Jumbo Refill.
Roller Pen. Jumbo Ersatzmine.
Roller. Recharge Jumbo.
Roller. Jumbo Refill.

▬ 01 × 14.5 cm

Print Code: A(4)



1000 / 50

Estrim

9303

Roller. Jumbo Refill.
Roller Pen. Jumbo Ersatzmine.
Roller. Recharge Jumbo.
Balpen. Jumbo Refill.

▬ 01 × 14 cm

Print Code: A(4)



1200 / 50

Alecto

3856

Roller.
Roller Pen.
Roller.
Balpen.

▬ 01 × 13.7 cm

Print Code: A(4)



1000 / 50



ROLLER PEN



02 01 04 07 03 19

Hembrock

5608

Roller.
Roller Pen.
Roller.
Roller.

Ø 1.1 × 13.5 cm

1000 / 50

Print Code: B(4)



02
01

Delbrux

6210

Roller. Aluminium. Jumbo Refill.
Roller Pen. Aluminium. Jumbo Ersatzmine.
Roller. Aluminium. Recharge Jumbo.
Roller. Aluminium. Jumbo Refill.

Ø 1 × 14.5 cm

500 / 50

Print Code: B(4), L1



09

Leyco

4096

Roller. Jumbo Refill.
Roller Pen. Jumbo Ersatzmine.
Roller. Recharge Jumbo.
Balpen. Jumbo Refill.

Ø 1.1 × 13.5 cm

1000 / 50

Print Code: B(4)



19 05 02 01 03

STYB

Made in Spain



01

03

04

19

Oasis

2541

Pen.
Kugelschreiber.
Stylo.
Pen.



Ø 1 × 13.6 cm

Print Code: A(4)

1000 / 50



298



03

02

19

Glider

2543

Roller.
Roller Pen.
Roller.
Balpen.



Ø 1 × 12.6 cm

Print Code: A(4)

1000 / 50



ROLLER



19

04

01

03

02

Atlas

2542

Pen. Jumbo Refill.
Kugelschreiber. Jumbo Ersatzmine.
Stylo. Recharge Jumbo.
Pen. Jumbo Refill.



Ø 1.4 × 13 cm

Print Code: A(4), W

1000 / 50





03

19



01
02
04
05
19
21



04



02 19 01 05 03



01
02
04
05
03

Universal
2469

Pen.
Kugelschreiber.
Stylo.
Pen.



Ø 0.8 × 14.5 cm

1200 / 50

Print Code: Consultar

Glamour
2545

Pen.
Kugelschreiber.
Stylo.
Pen.



Ø 1.1 × 13.3 cm

1000 / 100

Print Code: A(4)

Spinning
2544

Pen.
Kugelschreiber.
Stylo.
Pen.



Ø 1 × 14 cm

1000 / 100

Print Code: A(4), W



19 16 11 07 05 02 01 03

Monds

6022

Stylus Touch Ball Pen.
Kugelschreiber Pointer.
Stylt Bille.
Touch-Screen Balpen.

Ø 1.2 × 13.4 cm

Print Code: A(4), W

+10.000 pcs
PRINTING 30% DIS

1000 / 50



300



03 01 02 19

07

Kostner

5223

Stylus Touch Ball Pen. Jumbo Refill.
Kugelschreiber Pointer. Jumbo Ersatzmine
Stylt Bille. Recharge Jumbo.
Touch-Screen Balpen. Jumbo Refill.

Ø 1 × 14.7 cm

Print Code: A(4)

1000 / 50



09 02 04 03 11

+10.000 pcs
PRINTING 30% DIS

Naitel

4307

Stylus Touch Ball Pen.
Kugelschreiber Pointer.
Stylt Bille.
Touch-Screen Balpen.

Ø 1 × 14.3 cm

Print Code: A(4)



19

03

1000 / 50



02 19 01 04 05 07 11

Rulets

5206

Stylus Touch Ball Pen.
Kugelschreiber Pointer.
Stylt Bille.
Touch-Screen Balpen.

Ø 1 × 14 cm

Print Code: A(4)

+10.000 pcs
PRINTING 30% DIS

1000 / 50



01 02 03 04 19

Haspor
5417

Stylus Touch Ball Pen.
Kugelschreiber Pointer.
Styllet Bille.
Touch-Screen Balpen.

Ø 0.9 × 12.5 cm
Print Code: A(4)

+10.000 pcs
PRINTING 30% DIS

1000 / 50



11 03 07 05 04 02 01

Nilf
4646

Stylus Touch Ball Pen.
Kugelschreiber Pointer.
Styllet Bille.
Touch-Screen Balpen.

Ø 0.9 × 12.5 cm
Print Code: A(4)

+10.000 pcs
PRINTING 30% DIS

1000 / 50

05



19



03



02 04 05 09 11 19

Stek
4658

Stylus Touch Ball Pen.
Kugelschreiber Pointer.
Styllet Bille.
Touch-Screen Balpen.

Ø 1 × 12.5 cm
Print Code: A(4)

1000 / 50



Alfil
5926

Stylus Touch Ball Pen.
Kugelschreiber Pointer.
Styllet Bille.
Touch-Screen Balpen.

Ø 0.8 × 13.2 cm
Print Code: A(4)

1000 / 50



02 19 01 09 04 03



19



02 04 05 07 03 01

Yeiman
6076

Stylus Touch Ball Pen. Jumbo Refill.
Kugelschreiber Pointer. Jumbo Ersatzmine.
Styllet Bille. Recharge Jumbo.
Touch-Screen Balpen. Jumbo Refill.

Ø 1.2 × 14.2 cm
Print Code: A(4)

1000 / 50



SCREEN CLEANER
LIMPIAPANTALLAS



Tesku

4890

19



Stylus Touch Ball Pen. Black Ink. Screen Cleaner Included.
Kugelschreiber Pointer. Schwarze Tinte. Displayreiner Inklusiv.
Stylét Bille. Encre Noire. Nettoyeur d'Écran Inclus.
Touch-Screen Balpen. Zwarte Inkt. Screen Cleaner Inclusief.

Ø 1 × 14.3 cm

1000 / 50

Print Code: A(4)

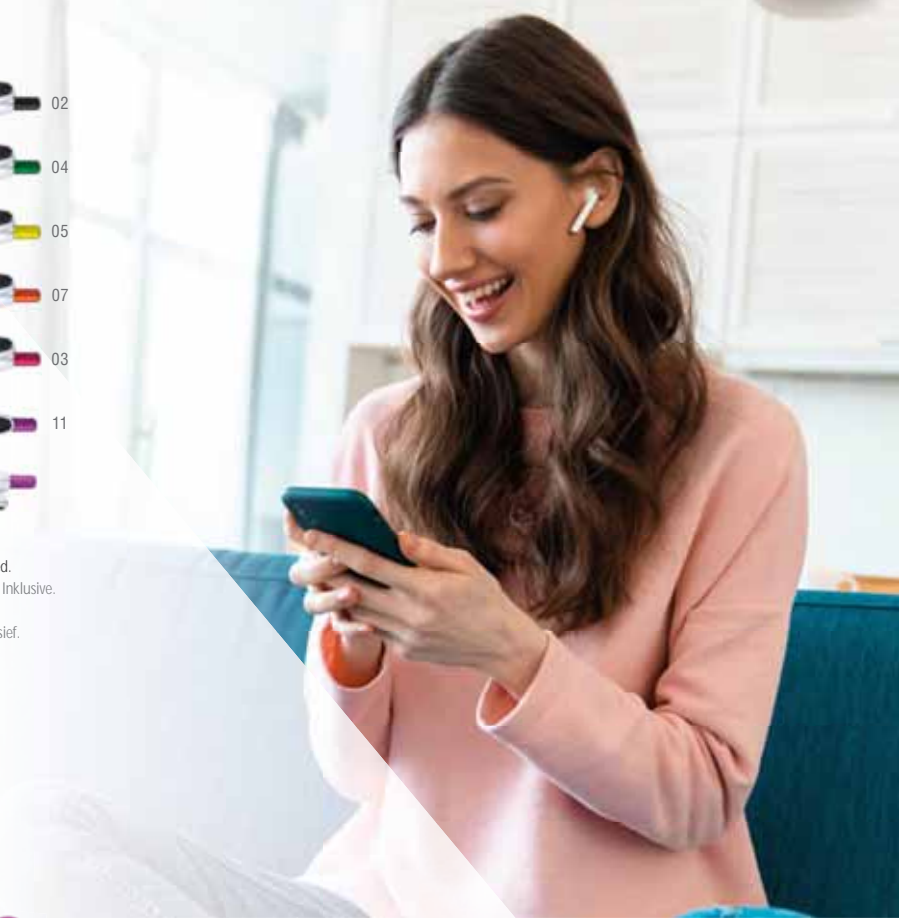

302



01

02

19

04

05

07

03

Motul

4895



Stylus Touch Ball Pen. Black Ink.
Kugelschreiber Pointer. Schwarze Tinte.
Stylét Bille. Encre Noire.
Touch-Screen Balpen. Zwarte Inkt.

Ø 1 × 14 cm

1000 / 50

Print Code: A(1)

11



19



02

03

04

09

Miclas

4326



Stylus Touch Ball Pen.
Kugelschreiber Pointer.
Stylét Bille.
Touch-Screen Balpen.

Ø 0.9 × 11.5 cm

1000 / 50

Print Code: A(4)

+10.000 pcs
PRINTING 30% DIS

ALUMINIUM TOUCH PEN



Neyax
4598

+5.000 pcs
PRINTING 30% DIS

Stylus Touch Ball Pen. Aluminium.
Kugelschreiber Pointer. Aluminium.
Styllet Bille. Aluminium.
Touch-Screen Balpen. Aluminium.

Ø 0.9 x 12.5 cm 1000 / 50
Print Code: B(4), L1



Minox
3960

+5.000 pcs
PRINTING 30% DIS

Stylus Touch Ball Pen. Aluminium.
Kugelschreiber Pointer. Aluminium.
Styllet Bille. Aluminium.
Touch-Screen Balpen. Aluminium.

Ø 0.9 x 12.5 cm 1000 / 50
Print Code: B(4), L1



Balki
4597

+5.000 pcs
PRINTING 30% DIS

Stylus Touch Ball Pen. Aluminium.
Kugelschreiber Pointer. Aluminium.
Styllet Bille. Aluminium.
Touch-Screen Balpen. Aluminium.

Ø 0.9 x 12.5 cm 1000 / 50
Print Code: B(4), L1

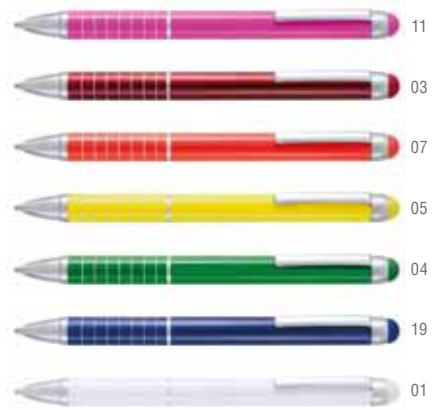

Lisden
5016

+5.000 pcs
PRINTING 30% DIS

Stylus Touch Ball Pen. Aluminium.
Kugelschreiber Pointer. Aluminium.
Styllet Bille. Aluminium.
Touch-Screen Balpen. Aluminium.

Ø 0.9 x 12.5 cm 1000 / 50
Print Code: B(4), L1





Fisar

5122

Stylus Touch Ball Pen. Aluminium.
Kugelschreiber Pointer. Aluminium.
Styllet Bille. Aluminium.
Touch-Screen Balpen. Aluminium.

▬▬▬▬▬▬▬ Ø 1 × 13.7 cm  500 / 50
 Print Code: B(4), L1

19





304



Silum

3980

Stylus Touch Ball Pen. Aluminium.
Kugelschreiber Pointer. Aluminium.
Styllet Bille. Aluminium.
Touch-Screen Balpen. Aluminium.

▬▬▬▬▬▬▬ Ø 0.9 × 11.2 cm  1000 / 50
 Print Code: B(4), L1



03



Balty

4659

Stylus Touch Ball Pen. Aluminium.
Kugelschreiber Pointer. Aluminium.
Styllet Bille. Aluminium.
Touch-Screen Balpen. Aluminium.

▬▬▬▬▬▬▬ Ø 1 × 12.5 cm  1000 / 50
 Print Code: B(4), L1



04



02





01

Nisha

4084

Stylus Touch Ball Pen. Aluminium.
Kugelschreiber Pointer. Aluminium.
Styllet Bille. Aluminium.
Touch-Screen Balpen. Aluminium.

▬▬▬▬▬▬▬ Ø 0.9 × 14 cm  1000 / 50
 Print Code: B(4), L1





07 05 04 19 09 02 01

Rondex 5224

Stylus Touch Ball Pen. Aluminium. Black Ink.
Kugelschreiber Pointer. Aluminium. Schwarze Tinte.
Styllet Bille. Aluminium. Encre Noire.
Touch-Screen Balpen. Aluminium. Zwarte Inkt.



03

1000 / 50
Print Code: B(4), L1



01 09 02 19 04 07 03 11

Mitch 5121

Stylus Touch Ball Pen. Aluminium. Jumbo Refill.
Kugelschreiber Pointer. Aluminium. Jumbo Ersatzmine.
Styllet Bille. Aluminium. Recharge Jumbo.
Touch-Screen Balpen. Aluminium. Jumbo Refill.

21



1 x 13.9 cm
Print Code: B(4), L1

500 / 50

23



02 16 05 03

Duser 5575

+5.000 pcs
PRINTING 30% DIS

Stylus Touch Ball Pen. Aluminium.
Kugelschreiber Pointer. Aluminium.
Styllet Bille. Aluminium.
Touch-Screen Balpen. Aluminium.



1000 / 50
Print Code: B(4), L1



19



19 01 04 05 07 03 11

Byzar 4660

+5.000 pcs
PRINTING 30% DIS

Stylus Touch Ball Pen. Aluminium.
Kugelschreiber Pointer. Aluminium.
Styllet Bille. Aluminium.
Touch-Screen Balpen. Aluminium.



1000 / 50
Print Code: B(4), L1



02

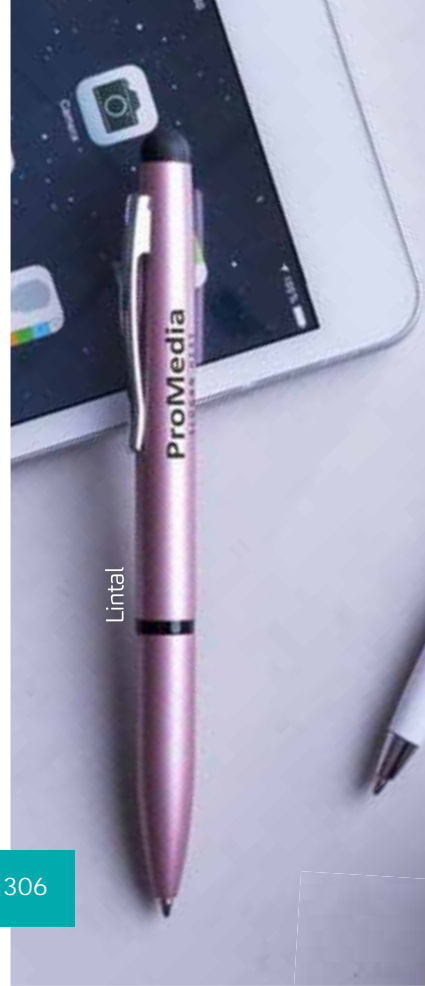

Lintal



Mulent



23

Lintal

5910

Stylus Touch Ball Pen. Aluminium.
Kugelschreiber Pointer. Aluminium.
Stylt Bille. Aluminium.
Touch-Screen Balpen. Aluminium.



▬ 1 × 12.9 cm

📦 1000 / 50

🌈 Print Code: B(4), L1

23



22 02 01 09

Mulent

6019

Stylus Touch Ball Pen. Aluminium.
Kugelschreiber Pointer. Aluminium.
Stylt Bille. Aluminium.
Touch-Screen Balpen. Aluminium.



▬ 0.9 × 14.1 cm

📦 500 / 50

🌈 Print Code: B(4), L1

306



23



09



05



04

02

03

19

Nuhax

4904

Pen. Aluminium. Jumbo Refill.
Kugelschreiber. Aluminium. Jumbo Ersatzmine.
Stylo. Aluminium. Recharge Jumbo.
Pen. Aluminium. Jumbo Refill.



▬ 1 × 14 cm

📦 500 / 50

🌈 Print Code: B(4), L1

Ploder

6026

Pen. Aluminium. Jumbo Refill.
Kugelschreiber. Aluminium. Jumbo Ersatzmine.
Stylo. Aluminium. Recharge Jumbo.
Pen. Aluminium. Jumbo Refill.



▬ 1 × 14 cm

📦 500 / 50

🌈 Print Code: B(4), L1



Xenik
6077

Pen. Aluminium. Jumbo Refill.
Kugelschreiber. Aluminium. Jumbo Ersatzmine.
Stylo. Aluminium. Recharge Jumbo.
Pen. Aluminium. Jumbo Refill.

1.7 x 14.8 x 1 cm
Print Code: B(4), L1



Matrix
5001

Pen. Aluminium.
Kugelschreiber. Aluminium.
Stylo. Aluminium.
Pen. Aluminium.

0.9 x 13.8 cm
Print Code: B(4), L1



Walik
4882

Stylus Touch Ball Pen. Metal.
Kugelschreiber Pointer. Metall.
Stylo Bille. Métal.
Touch-Screen Balpen. Metaal.

1 x 14 cm
Print Code: B(4), L1



Malko
5013

Pen. Aluminium.
Kugelschreiber. Aluminium.
Stylo. Aluminium.
Pen. Aluminium.

1 x 13.8 cm
Print Code: B(4), L1





Gavin

3218

Pen. Aluminium. Jumbo Refill. PU Pouch Included.
Kugelschreiber. Aluminium. Jumbo Ersatzmine. PU Etui Inklusive.
Stylo. Aluminium. Recharge Jumbo. Étui Similiticuir Inclus.
Pen. Aluminium. Jumbo Refill. PU Zakje Inclusief.

Ø 1.1 × 13.5 cm  500 / 50
Print Code: C(4), L1



05



Hasten

4798

Stylus Touch Ball Pen. Metal. Jumbo Refill.
Kugelschreiber Pointer. Metall. Jumbo Ersatzmine.
Stylet Bille. Métal. Recharge Jumbo.
Touch-Screen Balpen. Metaal. Jumbo Refill.

Ø 2.4 × 15.6 cm  250 / 25
Print Code: C(4), L1



05



Bolsin

4545

Pen. Aluminium.
Kugelschreiber. Aluminium.
Stylo. Aluminium.
Pen. Aluminium.

Ø 2.1 × 15 cm  250 / 25
Print Code: C(4), L1



11

03

Bolcon

4546

Stylus Touch Ball Pen. Aluminium.
Kugelschreiber Pointer. Aluminium.
Stylet Bille. Aluminium.
Touch-Screen Balpen. Aluminium.

Ø 2.1 × 15 cm  250 / 25
Print Code: C(4), L1





01 02 03 05



19

Fokus

3527

Pen. Aluminium. Jumbo Refill.
Kugelschreiber. Aluminium. Jumbo Ersatzmine.
Stylo. Aluminium. Recharge Jumbo.
Pen. Aluminium. Jumbo Refill.

Ø 1.1 x 13.5 cm 500 / 50
Print Code: B(4), L1



02 04 03 09

Beikmon

5622

Pen. Aluminium.
Kugelschreiber. Aluminium.
Stylo. Aluminium.
Pen. Aluminium.

Ø 1 x 14.2 cm 500 / 50
Print Code: B(4), L1



19



03



01 02 19 04 05 07 11

Pirke

4973

Pen. Aluminium. Jumbo Refill.
Kugelschreiber. Aluminium. Jumbo Ersatzmine.
Stylo. Aluminium. Recharge Jumbo.
Pen. Aluminium. Jumbo Refill.

Ø 0.8 x 13.9 cm 1000 / 50
Print Code: B(4), L1



11



09 02 19 04 07 03

Danus

5012

Pen. Aluminium.
Kugelschreiber. Aluminium.
Stylo. Aluminium.
Pen. Aluminium.

Ø 0.8 x 13.5 cm 1000 / 50
Print Code: B(4), L1



03



01 02 19 04 05 07 11

Sufit

4714

Pen. Aluminium.
Kugelschreiber. Aluminium.
Stylo. Aluminium.
Pen. Aluminium.

Ø 0.9 x 13.4 cm 1000 / 50
Print Code: B(4), L1



Latro

4012

Stylus Touch Ball Pen. 1 Led. Button Batteries Included.
Kugelschreiber Pointer. 1 Led. Knopfzellen Inklusiv.
Stylét Bille. 1 Led. Piles Bouton Inclus.
Touch-Screen Balpen. 1 Led. Knoopcel Batterijen Inclusief.

Ø 1.2 × 13 cm

500 / 50

Print Code: B(4), L1



Light

03



07

02

19

04

05

11

03



01

650
mAh

02



Power Bank

Solius

5144

Power Bank Stylus Touch Ball Pen. Metal. 650 mAh. USB Output. Micro USB Input. Black Ink. Cable Included.
Power Bank Kugelschreiber Pointer. Metall. 650 mAh. USB Ausgang. Micro USB Eingang. Schwarze Tinte. Kabel Inklusiv.
Stylét Bille Power Bank. Metal. 650 mAh. Sortie USB. Entrée Micro USB. Encre Noire. Câble Inclus.
Power Bank Touch-Screen Balpen. Metaal. 650 mAh. USB Output. Micro USB Input. Zwarte Inkt. Kabel Inclusief.

Ø 1.5 × 15.2 cm

150 / 25

Print Code: D(4), L1

PERMANENT STOCK

Sivart 16GB

5849 16GB

USB Stylus Touch Ball Pen. Metal. Individual Presentation.
Kugelschreiber Pointer USB. Metall. Individuelle Präsentation.
Stylét Bille USB. Metal. Présentation Individuelle.
USB Touch-Screen Balpen. Metaal. Individuele Presentatie.

Ø 1.4 × 14 cm

100 / 20

Print Code: D(4), L1



Video



01 03



19

Menit

4222

Pen Pouch. Cardboard.
Kugelschreiber Hülle. Pappe.
Étui Stylo. Carton.
Pennehoes. Karton.

4 × 15.5 cm

Print Code: B(4)

4000 / 400

02

Recycard

3340

Pen Pouch. Recycled Cardboard.
Kugelschreiber Hülle. Recycling Pappe.
Étui Stylo. Carton Recyclé.
Pennehoes. Gerecycled Karton.

4 × 15.5 cm

Print Code: B(4)

4000 / 400



Locen

6611

Pen Pouch. Cardboard.
Kugelschreiber Hülle. Pappe.
Étui Stylo. Carton.
Pennehoes. Karton.

4 × 15.5 cm

Print Code: B(4)

4000 / 400

311



19

Velvex

4223

Pen Pouch. Velvet.
Kugelschreiber Hülle. Wildleder.
Étui Stylo. Suédine.
Pennehoes. Fluweel.

2.5 × 15.5 cm

Print Code: B(1)

8000 / 200



08 02 03



Individual Flow Pack

4772

Plastic Pouch.
Plastik Hülle.
Étui Plastique.
Plastic Zak.

Consult.

Print Code: Consult.



Kinsy 6121

Pencil Case. 100% Cotton.
 Federmappe. 100% Baumwolle.
 Trousse. 100% Coton.
 Etui. 100% Katoen.

▬ 07 × 22 cm

📦 500 / 50

🌈 Print Code: E(1), N(8)



Bulty 6039

Pencil Case. Natural Cork.
 Federmappe. Naturkork.
 Trousse. Bouchon Naturel.
 Etui. Natuurlijk Kurk.

▬ 23 × 11 × 2 cm

📦 200 / 50

🌈 Print Code: E(1), L2

Yubesk 6038

Pencil Case. Laminated Paper.
 Federmappe. Laminiertes Papier.
 Trousse. Papier Laminé.
 Etui. Gelamineerd Papier.

▬ 22.3 × 8.8 cm

📦 200 / 50

🌈 Print Code: E(1)

COTTON



Sulpox

PENCIL CASE
+ 5 PIECES
ESTUCHE + 5 PIEZAS

PENCIL CASE
+ 5 PIECES
ESTUCHE + 5 PIEZAS

Marfik

Sulpox 6166



Unsharpened

Pencil Case. Jute/ Cotton. 5 Pieces.
 Federmappe. Jutesstoff/ Baumwolle. 5 Stück.
 Trousse. Jute/ Cotton. 5 Pièces.
 Etui. Jute/ Katoen. 5 Stuks.

20 x 20 cm 200 / 50
 Print Code: E(1), N(8)



Marfik 6167



Unsharpened

Pencil Case. Jute/ Cotton. 5 Pieces.
 Federmappe. Jutesstoff/ Baumwolle. 5 Stück.
 Trousse. Jute/ Cotton. 5 Pièces.
 Etui. Jute/ Katoen. 5 Stuks.

19 x 8.5 cm 200 / 50
 Print Code: F(1)





03



04



19



07



01



02



11

01

02

03

05



19

Finit

3649



Set. PU/Metal. Pen. Mechanical Pencil: 0,7 mm Leads Included.
 Set. PU/Metall. Kugelschreiber. Bleistift: Minen 0,7 mm Inklusive.
 Set. Similicuir/ Métal. Stylo. Portemines: Mines 0,7 mm Inclus.
 Set. PU/Metaal. Pen. Vulpotlood: 0,7 mm Stifjes Inclusief.

██████████ Ø 1 × 13 cm

📦 100 / 50

🎨 Print Code: D(4), L1



Velus

4357



Set. Jumbo Refill Pen. Mechanical Pencil: 0,7 mm Leads Included.
 Set. Kugelschreiber Jumbo Ersatzmine. Bleistift: Minen 0,7 mm Inklusive.
 Set. Stylo Recharge Jumbo. Portemines: Mines 0,7 mm Inclus.
 Set. Jumbo Refill Pen. Vulpotlood: 0,7 mm Stifjes Inclusief.

██████████ Ø 1.1 × 14.2 cm

📦 250 / 25

🎨 Print Code: C(4)



03

05

04

19

01

02



01



04



05

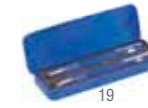

19



03

Yeray

4353



Set. Aluminium. Pen. Mechanical Pencil: 0,7 mm Leads Included.
 Set. Aluminium. Kugelschreiber. Bleistift: Minen 0,7 mm Inklusive.
 Set. Aluminium. Stylo. Portemines: Mines 0,7 mm Inclus.
 Set. Aluminium. Pen. Vulpotlood: 0,7 mm Stifjes Inclusief.

██████████ Ø 0.9 × 13.8 cm

📦 100 / 50

🎨 Print Code: D(4), L1

Sheridan

3338



Set. Aluminium. Jumbo Refill Pen. Mechanical Pencil: 0,7 mm Leads Included.
 Set. Aluminium. Kugelschreiber Jumbo Ersatzmine. Bleistift: Minen 0,7 mm Inklusive.
 Set. Aluminium. Stylo Recharge Jumbo. Portemines: Mines 0,7 mm Inclus.
 Set. Aluminium. Jumbo Refill Pen. Vulpotlood: 0,7 mm Stifjes Inclusief.

██████████ Ø 1.1 × 13.2 cm

📦 100 / 50

🎨 Print Code: D(4), L1



Yodel

5385

Pen. Metal. Jumbo Refill.
Kugelschreiber. Metall. Jumbo Ersatzmine.
Stylo. Métal. Recharge Jumbo.
Pen. Metaal. Jumbo Refill.



▄▄▄▄▄ Ø 1 × 14.1 cm



Print Code: D(1), L1



Darius

5384

Set. Metal. Pen and Roller. Jumbo Refill.
Set. Metall. Kugelschreiber und Roller Pen. Jumbo Ersatzmine.
Set. Métal. Stylo et Roller. Recharge Jumbo.
Set. Metaal. Pen en Balpen. Jumbo Refill.



▄▄▄▄▄ Ø 1.3 × 14 cm



Print Code: D(1), L1



Dacox

4349

Pen. Metal. Jumbo Refill. Refill Included.
Kugelschreiber. Metall. Jumbo Ersatzmine. Ersatzmine Inklusief.
Stylo. Métal. Recharge Jumbo. Recharge Inclus.
Pen. Metaal. Jumbo Refill. Refill Inclusief.



▄▄▄▄▄ Ø 1.2 × 13.8 cm



Print Code: D(1), L1



08



01

02

Lumix

4348

Set. Aluminium. Pen and Roller. Jumbo Refill.
Set. Aluminium. Kugelschreiber und Roller Pen. Jumbo Ersatzmine.
Set. Aluminium. Stylo et Roller. Recharge Jumbo.
Set. Aluminium. Pen en Balpen. Jumbo Refill.



▄▄▄▄▄ Ø 1.1 × 14 cm



Print Code: D(1), L1



SCREEN CLEANER
LIMPIA PANTALLAS



Alzar

4661



Stylus Touch Ball Pen, Screen Cleaner Included.
Kugelschreiber Pointer, Displayreiniger Inklusive.
Stylét Bille, Nettoyeur d'Écran Inclus.
Touch-Screen Balpen, Screen Cleaner Inclusief.

Ø 3.8 x 12.5 cm 500 / 25
Print Code: C(4)



02



03

ADHESIVE BASE
BASE ADHESIVA



19

01

02



SCREEN CLEANER
LIMPIA PANTALLAS



Henk

4910

Pen.
Kugelschreiber.
Stylo.
Pen.



5.6 x 17 x 5.6 cm

100 / 10

Print Code: C(4)

Siria

4281

Stylus Touch Ball Pen, Screen Cleaner Included.
Kugelschreiber Pointer, Displayreiniger Inklusive.
Stylét Bille, Nettoyeur d'Écran Inclus.
Touch-Screen Balpen, Screen Cleaner Inclusief.



Ø 3 x 10.5 cm

1000 / 50

Print Code: C(4)

Khim

4453

Set. 6 Pieces.
Set. 6 Stück.
Set. 6 Pièces.
Set. 6 Stuks.



7 x 17.4 x 1.5 cm

Print Code: D(1), W

200 / 50





19
05
04



Mustap

4524

Pen Torch. 2 Leds. Button Batteries Included.
Kugelschreiber Lampe. 2 Leds. Knopfzellen Inklusive.
Stylo Lampe. 2 Leds. Piles Bouton Inclus.
Pen-Zaklamp. 2 Leds. Knoopcel Batterijen Inclusief.

Ø 2.1 x 13 cm
500 / 50
Print Code: B(4)

03



Krujer

5035

Pen Torch. 1 Led. Button Batteries Included.
Kugelschreiber Lampe. 1 Led. Knopfzellen Inklusive.
Stylo Lampe. 1 Led. Piles Bouton Inclus.
Pen-Zaklamp. 1 Led. Knoopcel Batterijen Inclusief.

Ø 1 x 11 cm
500 / 50
Print Code: C(4)



09
19
02



03



MAGNET

Solek

5048

Felt Tip Pen. Magnetic.
Filzstift. Magnetisch.
Feutre. Magnétique.
Felt Tip Pen. Magnetisch.

Ø 1 x 11.4 cm
2000 / 50
Print Code: B(4)

09

01

02



19



03

Sauris

4402

Pen. 4 Accessories.
Kugelschreiber. 4 Teile.
Stylo. 4 Accessoires.
Pen. 4 Accessoires.

Ø 1 x 14.9 cm
1000 / 50
Print Code: B(4)



Contal

5119

Pen.
Kugelschreiber.
Stylo.
Pen.

Ø 1.1 x 14.8 cm
1000 / 50
Print Code: B(4)



Payro

5791

7 in 1 Pen. 7 Accessories.
7 in 1 Kugelschreiber. 7 Teile.
Stylo 7 en 1. 7 Accessoires.
7 in 1 Pen. 7 Accessoires.

1.6 x 15.5 x 1.2 cm
500 / 50
Print Code: B(4)



09 04 02 03





Lovit
5044

Stylus Touch Ball Pen.
Kugelschreiber Pointer.
Stylét Bille.
Touch-Screen Balpen.

Ø 1.6 × 7.2 × 1.6 cm
Print Code: B(4), W

03

1000 / 50

02

01

11

Lipsy
3390

Pen.
Kugelschreiber.
Stylo.
Pen.

Ø 1.7 × 10 cm
Print Code: B(4)



03

02

22

21

1000 / 100



19

03

02

01

Globix
4405

Stylus Touch Ball Pen. Metal.
Kugelschreiber Pointer. Metall.
Stylét Bille. Métal.
Touch-Screen Balpen. Metaal.

Ø 1 × 12.8 cm
Print Code: B(4)

1000 / 50



01

22

Ladys
5909

Pen. Jumbo Refill.
Kugelschreiber_Jumbo Ersatzmine.
Stylo. Recharge Jumbo.
Pen. Jumbo Refill.

Ø 0.8 × 17.2 cm
Print Code: B(4)

1000 / 50



05

04

07

11

Consut
4425

Highlighter.
Textmarker.
Surligneur.
Marker.

2.5 × 7 × 2.5 cm
Print Code: B(1), W

500 / 25





Gradox

5735

Pen.
Kugelschreiber.
Stylo.
Pen.

Ø 2.3 × 17.5 cm
Print Code: B(4)

1000 / 50

03



Basley

6443

Pen.
Kugelschreiber.
Stylo.
Pen.

Ø 2 × 15.3 cm
Print Code: B(4)

1000 / 50

04



Fricum

5402

Pen.
Kugelschreiber.
Stylo.
Pen.

Ø 0.9 × 14 cm
Print Code: B(4)

1000 / 50



D

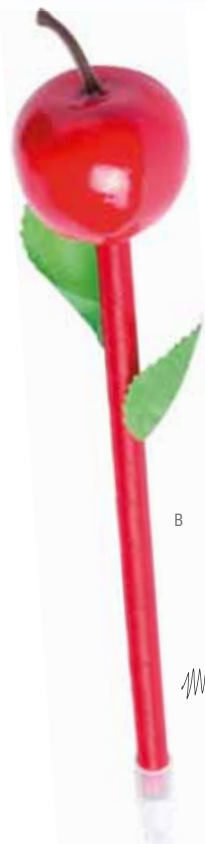

Ximor

4793

Pen. Black Ink.
Kugelschreiber. Schwarze Tinte.
Stylo. Encre Noire.
Pen. Zwarte Inkt.

Ø 3.5 × 20 cm
Print Code: B(1)

500 / 100

B



Crisant

4792

Pen.
Kugelschreiber.
Stylo.
Pen.

Consult.
Print Code: B(1)

500 / 100

03

05



Paipen

5911

Pai Pai Pen.
Pay-Pay Kugelschreiber.
Stylo Pai Pai.
Pai Pai Pen.

10.3 × 19.4 × 0.9 cm
Print Code: C(4)



1000 / 50



03

11

01

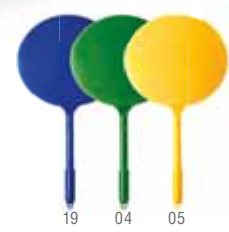

19

04

05



Miniature

9607

Pencil. Wood.
Bleistift. Holz.
Crayon. Bois.
Potlood. Hout.

Ø 0.5 × 10 cm

2000 / 100

Print Code: A(4), L1



320

Ramsy

5440

Pencil. Wood.
Bleistift. Holz.
Crayon Golf. Bois.
Potlood. Hout.

Ø 0.7 × 8.7 cm

3000 / 100

Print Code: A(4), L1



04



01



03



05



19



Graf

3851

Pencil. Wood.
Bleistift. Holz.
Crayon. Bois.
Potlood. Hout.

Ø 0.7 × 19 cm

2000 / 100

Print Code: A(4)

05

03



Sharpened

Minik

3850

Pencil. Wood.
Bleistift. Holz.
Crayon. Bois.
Potlood. Hout.

Ø 0.7 × 10 cm

2000 / 100

Print Code: A(4), L1



Sharpened



05



04



01



19



03



02



02



19

04

01



Koby

4711



Pencil. Wood.
Bleistift. Holz.
Crayon. Bois.
Potlood. Hout.

Ø 0.7 × 17.7 cm

2000 / 100

Print Code: A(4), L1

11

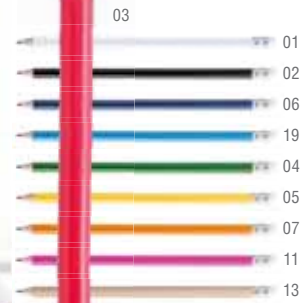
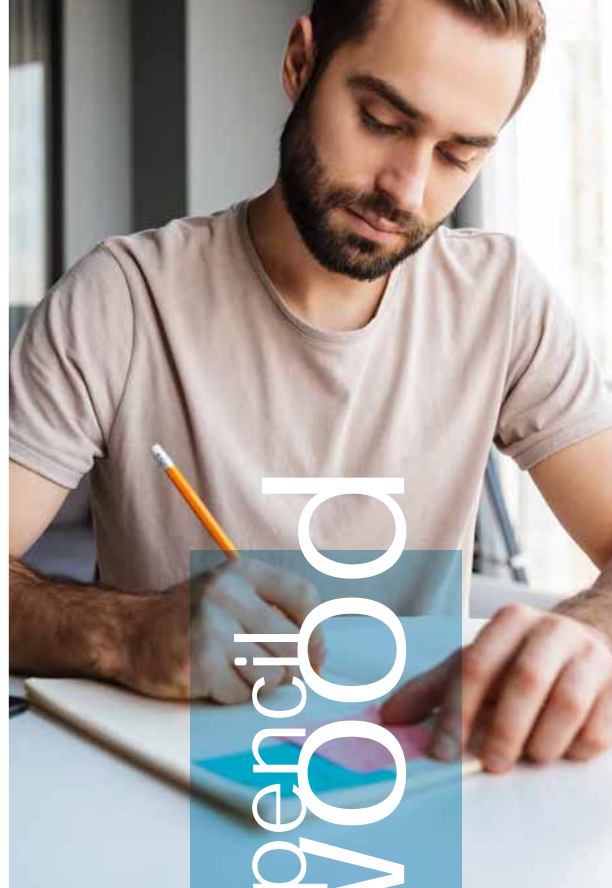

+10.000 pcs
PRINTING 30% DIS

Godiva

8587



Pencil. Wood.
Bleistift. Holz.
Crayon. Bois.
Potlood. Hout.

Ø 0.7 × 18.6 cm

2000 / 100

Print Code: A(4), L1

THE BEST PRICE

321



ERASER COLOUR /
GOMA DE COLOR

Togi

4173



Pencil. Wood.
Bleistift. Holz.
Crayon. Bois.
Potlood. Hout.

Ø 0.7 × 19 cm

2000 / 100

Print Code: A(4), L1



ERASER COLOUR /
GOMA DE COLOR

21

02 06 19 04 16 05 07 03 11

Melart

5643



Pencil. Wood.
Bleistift. Holz.
Crayon. Bois.
Potlood. Hout.

Ø 0.7 × 18.6 cm

2000 / 100

Print Code: A(4), L1



ERASER COLOUR /
GOMA DE COLOR

17

11

07

05

04

19

02

Naftar

6070



Pencil. Wood.
Bleistift. Holz.
Crayon. Bois.
Potlood. Hout.

Ø 0.7 × 18.6 cm

2000 / 100

Print Code: A(4), L1



ANTIBACTERIAL
ISO 22196
CERTIFIED



Sukon

6766



Antibacterial Pencil. Wood.
Antibakterieel Bleistift. Holz.
Crayon Antibactérien. Bois.
Antibacterieel Potlood. Hout.

Ø 0.7 × 18.6 cm

2000 / 100

Print Code: B(4), L1

NEW

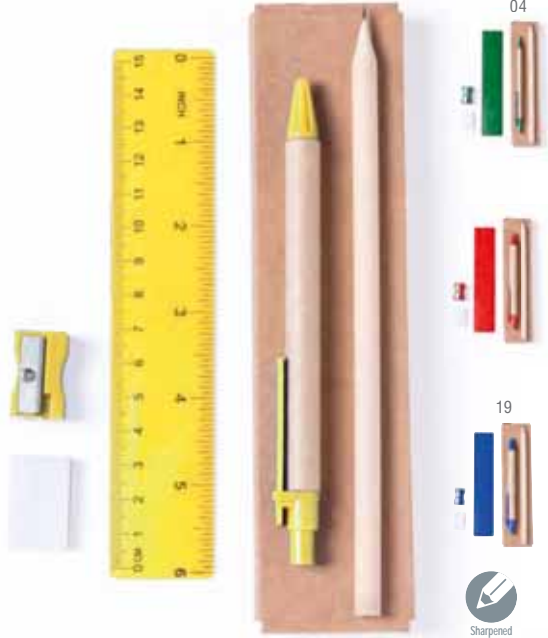

Gabon

5647

Set. 5 Pieces.
Set. 5 Stück.
Set. 5 Pièces.
Set. 5 Stuks.



4.5 × 17.7 × 1.5 cm

Print Code: B(4), W

05

400 / 50



Sharpened



Dernol

6607

Set. 5 Pieces.
Set. 5 Stück.
Set. 5 Pièces.
Set. 5 Stuks.



3.5 × 19 cm

Print Code: C(4), W

200 / 50



Unsharpened



x 3 pcs

Dony

3643

Set. 6 Pieces.
Set. 6 Stück.
Set. 6 Pièces.
Set. 6 Stuks.

4.5 × 17.7 × 1.3 cm

Print Code: B(4), W

240 / 20



Sharpened

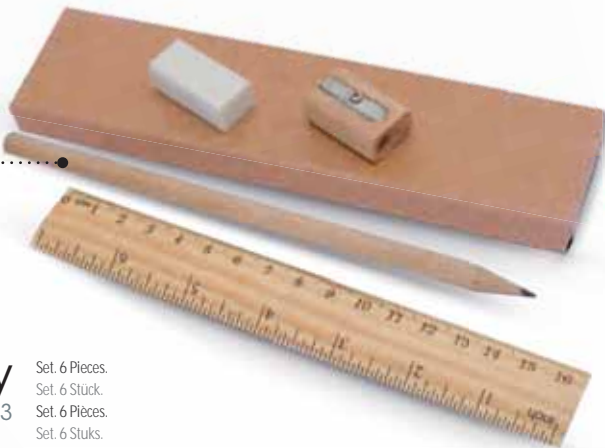

Laptan

4709

Set. 4 Pieces.
Set. 4 Stück.
Set. 4 Pièces.
Set. 4 Stuks.

6.5 × 22 × 1 cm

Print Code: C(1)



Unsharpened

400 / 20

07

05

11

01

02

04

21





Dragon 3386
Pencil Set. Wood. 6 Pencils.
Bleistiftbox. Holz. 6 Stifte.
Boite Crayons. Bois. 6 Crayons.
Potlood Set. Hout. 6 Potloden.



Sharpened

20.5 x 2.5 x 3.5 cm
Print Code: D(2), L2
200 / 50



Lumar 5997

Set. 6 Pieces. 60 Sheets Notepad.
Set. 6 Stück. 60 Seiten Notizblock.
Set. 6 Pièces. Bloc 60 Feuilles.
Set. 6 Stuks. 60 Blaadjes Notepad.

10.4 x 10.4 x 1.3 cm
Print Code: D(1)
200 / 100

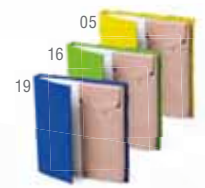

60 Sheets Plain

323



Rudex 5564

Colouring Book. 48 Sheets. 96 Designs.
Malbuch. 48 Seiten. 96 Skizze.
Cahier Dessin. 48 Feuilles. 96 Dessins.
Kleurboek. 48 Blaadjes. 96 Ontwerpen.

15 x 15 x 0.7 cm
Print Code: C(2)
100 / 50



Boltex 5645

Mandala Set. 12 Pencils and 12 Sheets Included.
Mandala Set. 12 Stifte und 12 Seiten Inklusiv.
Set Mandala. 12 Crayons et 12 Feuilles Inclus.
Mandala Set. 12 Potloden en 12 Blaadjes Inclusief.

9 x 9 x 1 cm
Print Code: C(4), W
300 / 20

12 DESIGNS



96 DESIGNS
96 DISEÑOS



STYLUS TOUCH

Dilio

5644

Stylus Touch Pencil. Wood.
Bleistift Pointer. Holz.
Stylét Crayon. Bois.
Touch-Screen Potlood. Hout.

Ø 0.7 × 19 cm

2000 / 100

Print Code: B(4), L1



Sharpened

01

13

02



324



01

04

05

19

03

Castle

3040

Magic Mechanical Pencil. 0,7 mm Leads Included.
Magischer Mechanischer Bleistift. Minen 0,7 mm Inklusiv.
Portemines Magique. Mines 0,7 mm Inclus.
Magisch Vulpotlood. 0,7 mm Stiftjes Inclusief.

Ø 0.8 × 13 cm

2000 / 100

Print Code: A(4)

02



05



19

01

02

03

Penzil

9311

Mechanical Pencil. 0,5 mm Leads Included.
Mechanischer Bleistift. Minen 0,5 mm Inklusiv.
Portemines. Mines 0,5 mm Inclus.
Vulpotlood. 0,5 mm Stiftjes Inclusief.

Ø 0.7 × 15.1 cm

1000 / 50

Print Code: A(4)

Special finish

325



23

09

01



Unsharpened

Vikin 5205

Pencil Set. 5 Pencils.
Bleistiftbox. 5 Stifte.
Boite Crayons. 5 Crayons.
Potlood Set. 5 Potlooden.

3.9 × 19.2 × 0.8 cm

300 / 20

Print Code: B(4), L1, W



Sharpened

Karpel 4712

Pencil. Wood.
Bleistift. Holz.
Crayon. Bois.
Potlood. Hout.

0.7 × 17.7 cm

Print Code: B(4), L1

2000 / 100



Unsharpened

Kenti 3959

Pencil. Wood.
Bleistift. Holz.
Crayon. Bois.
Potlood. Hout.

0.7 × 17.7 cm

Print Code: A(4), L1

1000 / 100

01

03

19



Baby

9162

Set. 7 Pieces.
Set. 7 Stück.
Set. 7 Pièces.
Set. 7 Potloden.

▬▬▬▬▬▬ Ø 2.7 × 10.2 cm

🌈 Print Code: B(4), W

📦 400 / 50



03



Pixi

3641

Set. 13 Pieces.
Set. 13 Stück.
Set. 13 Pièces.
Set. 13 Stuks.

▬▬▬▬▬▬ Ø 4.6 × 10 cm

🌈 Print Code: B(4), W

📦 200 / 10

Aladín

8722

Set. 19 Pieces.
Set. 19 Stück.
Set. 19 Pièces.
Set. 19 Stuks.

▬▬▬▬▬▬ 7.8 × 18.5 × 1.2 cm

🌈 Print Code: C(4)

📦 200 / 25



Remix

6083

Chalk Set. 4 Chalks.
Kreiden Set. 4 Kreiden.
Craies Crayons. 4 Craies.
Krijtjes Set. 4 Krijtjes.

▬▬▬▬▬▬ 9.5 × 11 × 2.5 cm

🌈 Print Code: B(4)

📦 100 / 50

THE BEST PRICE
& THE BEST-SELLER



Tynie
4456

Pencil Set. 4 Pencils.
Bleistiftbox. 4 Stifte.
Boite Crayons. 4 Crayons.
Potlood Set. 4 Potlood.

3 x 9 x 0.8 cm
Print Code: B(4), W

1000 / 50

Girls
8585

Pencil Set. 6 Pencils.
Bleistiftbox. 6 Stifte.
Boite Crayons. 6 Crayons.
Potlood Set. 6 Potlooden.

4.5 x 9 x 0.8 cm
Print Code: B(4), W

500 / 25



recycled
cardboard



Pichi
8719

Crayon Set. 6 Crayons.
Wachsmalstifte Set. 6 Wachsmalstifte.
Boite Crayons. 6 Crayons.
Wasco Set. 6 Krijtjes.

5.3 x 9 x 0.9 cm
Print Code: B(4), W

250 / 25



Boys
8584

Pencil Set. 12 Pencils.
Bleistiftbox. 12 Stifte.
Boite Crayons. 12 Crayons.
Potlood Set. 12 Potlood.

9 x 9 x 1 cm
Print Code: C(4), W



250 / 25



Miney

9161

Crayon Set. 6 Interchangeable Leads.
Wachsmalstift. 6 Austauschbare Minen.
Crayons de Cire. 6 Mines Interchangeables.
Wasco Set. 6 Verwisselbare Leds.

1.8 x 9.8 x 1.5 cm

500 / 100

Print Code: D(1)



328

Garten

9830

Pencil Set. 6 Pencils.
Bleistiftbox. 6 Stifte.
Boîte Crayons. 6 Crayons.
Pottlood Set. 6 Pottlooden.

5 x 9.3 x 0.8 cm

500 / 50

Print Code: B(4), W



02 01 19 04 05 07 03

Tune

9831

Crayon Set. 6 Crayons.
Wachsmalstift. 6 Wachsmalstift.
Boîte Crayons. 6 Crayons.
Wasco Set. 6 Krijtjes.

5 x 8.3 x 0.8 cm

400 / 50

Print Code: B(4), W



19



02 01 04 05 07 03



01 05 03 04



19



19

Palty

4710

Set. 7 Pieces.
Set. 7 Stück.
Set. 7 Pieces.
Set. 7 Stuks.

Ø 2.7 x 10.2 cm

400 / 50

Print Code: B(4), W



11 07 05 04 03 02 01

Migal

5139

Pencil Case. Polyester 420D. 10 Pieces.
Federmappe. Polyester 420D. 10 Stück.
Trousse. Polyester 420D. 10 Pièces.
Etui. Polyester 420D. 10 Stuks.

4.5 x 10 x 4 cm

400 / 10

Print Code: D(1), N(8)



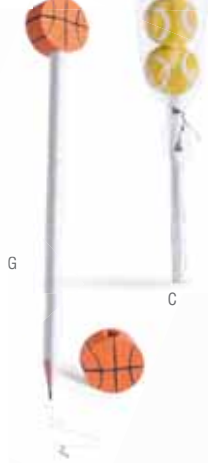

Tercel

5218

Pencil. Wood. 3 Erasers Included.
Bleistift. Holz. 3 Radiergummis Inklusiv.
Crayon. Bois. 3 Gommies Inclus.
Potlood. Hout. 3 Gummien Inclusief.

Unsharpened
2.7 × 18.7 × 1.2 cm
Print Code: B(4), L1

300 / 50



Zhilian

6442

Pencil. Wood.
Bleistift. Holz.
Crayon. Bois.
Potlood. Hout.

Unsharpened
8 × 22 × 4.6 cm
Print Code: B(4), L1

500 / 25



LIGHT PEN

Nicky

4707

Pen. Led Lights. Button Batteries Included.
Kugelschreiber. Led Lichter. Knopfzellen Inklusiv.
Stylo. Lumières Led. Piles Bouton Inclus.
Pen. Led Lichten. Knoopcel Batterijen Inclusief.

Multicolor light
2.8 × 18.5 cm
Print Code: B(1)

500 / 50



03



FLEXIBLE PENCIL



04



32 cm



Unsharpened

Flexi

3095

Pencil. PVC. Flexible.
Bleistift. PVC. Flexibel.
Crayon. PVC. Flexible.
Potlood. PVC. Flexibel.

0.6 × 32 cm
Print Code: B(1)

1000 / 100

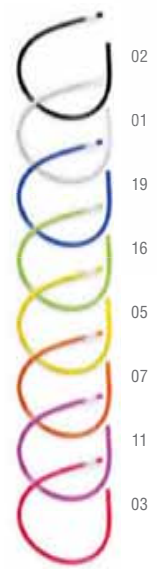

03



18 cm



Unsharpened

Pimbur

5128

Pencil. PVC. Flexible.
Bleistift. PVC. Flexibel.
Crayon. PVC. Flexible.
Potlood. PVC. Flexibel.

0.6 × 18 cm
Print Code: B(1)

1000 / 100

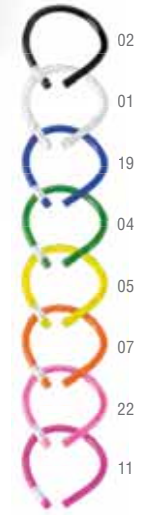

HIGHLIGHTER

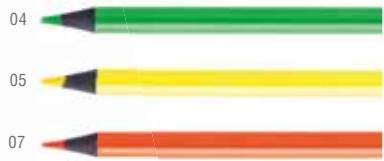

Zoldak

4906

- Highlighter.
- Textmarker.
- Surligneur.
- Marker.

Ø 0.7 × 17.5 cm 2000 / 50

Print Code: A(4)



Lakan

6365

Pen. Marker Included.
Kugelschreiber. Textmarker Inklusive.
Stylo. Marqueur Inclus.
Pen. Marker Inclusief.

Ø 1.3 × 15 cm 1000 / 50

- Print Code: A(4)
-
-
-

11

05

330



Nadol

4340

- Highlighter.
- Textmarker.
- Surligneur.
- Marker.

4.4 × 7.5 × 1.6 cm 500 / 50

Print Code: C(4), W

Rankap

4898

- Highlighter.
- Textmarker.
- Surligneur.
- Marker.

2.3 × 6 × 1.4 cm 2000 / 50

Print Code: B(4)

Layax

5024

Highlighter Set. 5 Pieces.
Textmarker Set. 5 Pieces.
Set Surligneurs. 5 Pièces.
Markers Set. 5 Stuks.

5.7 × 7.8 × 7.4 cm 200 / 20

Print Code: C(1)

-
-
-
-
-

HIGHLIGHTER



Dinku

6209

Highlighter Set. 5 Pieces.
Textmarker Set. 5 Peças.
Set Surligneurs. 5 Pièces.
Markers Set. 5 Stuks.

10.8 x 8.7 x 1.8 cm

Print Code: C(4), W

250 / 50



Hindal

6404

Highlighter Set. 5 Ink Colours.
Textmarker Set. 5 Farben Tinte.
Set Surligneurs. Ecriture 5 Couleurs.
Markers Set. 5 Kleuren Inkt.

9.8 x 1.8 cm

Print Code: C(4), W

250 / 50



Trico

3201

Highlighter. 3 Ink Colours.
Textmarker. 3 Farben Tinte.
Surligneur. Ecriture 3 Couleurs.
Marker. 3 Kleuren Inkt.

9 x 8 x 1.2 cm

Print Code: C(4), W

500 / 50



Bolings

5640

Highlighter Set. 3 Pieces. 100 Sticky Notes 1,2 x 3,8 cm.
Textmarker Set. 3 Stück. 100 Haftnotizen 1,2 x 3,8 cm.
Set Surligneurs. 3 Pièces. 100 Notes Adhésives 1,2 x 3,8 cm.
Markers Set. 3 Stuks. 100 Plakmemo's 1,2 x 3,8 cm.

7 x 5.3 x 6.5 cm

Print Code: C(4)

200 / 50



HOLDER /
SOPORTE

Special Pharma



Whiter 3961



Pen Torch. 1 Led. Button Batteries Included.
Kugelschreiber Lampe. 1 Led. Knopfzellen Inklusive.
Stylo Lampe. 1 Led. Piles Bouton Inclus.
Pen-Zaklamp. 1 Led. Knoopcel Batterijen Inclusief.

Ø 1.4 × 14.2 cm 500 / 25
Print Code: B(4)

Senter 3714



Pen Torch. 1 Led. Button Batteries Included.
Kugelschreiber Lampe. 1 Led. Knopfzellen Inklusive.
Stylo Lampe. 1 Led. Piles Bouton Inclus.
Pen-Zaklamp. 1 Led. Knoopcel Batterij Inclusief.

Ø 1.5 × 12.7 cm 500 / 50
Print Code: B(4)



19

Medic 3708

Pen.
Kugelschreiber.
Stylo.
Pen.

Ø 1.1 × 12.7 cm
Print Code: B(4)



03 01 04

1000 / 50

Bunny 5610

Highlighter.
Textmarker.
Surfligneur.
Marker.

Ø 1.1 × 13.7 cm
Print Code: B(4)



04 F



11 F 05 F



HIGHLIGHTER
MARCADOR
FLUORESCENTE

1000 / 50



03



01 21 22

Jering 5609

Pen.
Kugelschreiber.
Stylo.
Pen.

Ø 1.3 × 13.2 cm
Print Code: B(4)

1000 / 50



NEW

3 ml



Tromix

6655

Spray Pen. 3 ml. Refillable. Liquid Not Included.
 Zerstäuber Kugelschreiber. 3 ml. Wiederaufladbar. Flüssigkeit Nicht im Lieferumfang.
 Stylo Vaporisateur. 3 ml. Rechargeable. Liquide Non Inclus.
 Sproeier Pen. 3 ml. Navulbaar. Vloeistof Niet Inclusief.

19



Ø 1.4 × 15.7 cm
 Print Code: B(4)

1000 / 50

LIQUID NOT INCLUDED/ REFILLABLE
 LIQUIDO NO INCLUIDO/ RELLENABLE

NEW

10 ml



Dixter

6657

Spray Pen. 10 ml. Refillable. Liquid Not Included.
 Zerstäuber Kugelschreiber. 10 ml. Wiederaufladbar. Flüssigkeit Nicht im Lieferumfang.
 Stylo Vaporisateur. 10 ml. Rechargeable. Liquide Non Inclus.
 Sproeier Pen. 10 ml. Navulbaar. Vloeistof Niet Inclusief.



Ø 1.2 × 18 cm
 Print Code: B(4)

1000 / 50



Miko

3949

Pencil. Wood.
 Bleistift. Holz.
 Crayon. Bois.
 Potlood. Hout.

3.7 × 21.5 × 1.5 cm
 Print Code: B(4), L1

600 / 50



Tib

3715

Pen.
 Kugelschreiber.
 Stylo.
 Pen.

Ø 1.8 × 12 cm
 Print Code: B(4)

1000 / 50



Tormil

6082

Pocket Protector. PVC.
 Taschenschutz. PVC.
 Protecteur de Poche. PVC.
 Zakbeschermer. PVC.

8.5 × 15 cm
 Print Code: C(1)

1000 / 50

BAK PACKS, BAGS & LEISURE



Parks

6840

Waistbag. Polyester 600D RPET.

Gürteltasche. Polyester 600D RPET.

Banane. Polyester 600D RPET.

Heuptas. Polyester 600D RPET.

25 x 17 x 8 cm

200 / 50

Print Code: E(1), N(8)



NEW



RPET



The fabric used in the manufacturing process of this backpack is made of recycled plastic (RPET). Like this, the emission of plastic residues to our planet and the consumption of energy is drastically reduced, resulting in a much more eco-friendly process.

El material de esta mochila está fabricado con plástico reciclado (RPET), que, además de ayudar en la disminución de residuos plásticos en el planeta, utiliza menos energía en el proceso de fabricación, haciendo que sea mucho menos dañino para el medio ambiente.

STOP PLASTIC POLLUTING THE OCEAN

NEW



Terrex

6749

Backpack. Polyester 600D RPET. Padded Laptop and Tablet Compartment. Padded Back and Shoulder Straps.

Rucksack. Polyester 600D RPET. Gepolsterte Laptoptasche und Tablet. Gepolsterter Rücken und Schultergurte.

Sac à Dos. Polyester 600D RPET. Pochette Rembourrée pour Portable et Tablet. Dos et Bretelles Rembourrées.

Rugzak. Polyester 600D RPET. Gewatteerd Laptop en Tablet Compartment. Gewatteerde Achterzijde en Schouderbanden.

31 × 45 × 13 cm



Print Code: G(1), N(8)

335

100% RECYCLED COTTON



NEW



140 g/m²

03

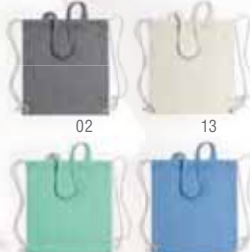

Fenin

6833

Drawstring Bag. 100% Recycled Cotton 140 g/ m2.

Rucksack. 100% Recycling Baumwolle 140 g/ m2.

Sac à Dos. 100% Coton Recycle 140 g/ m2.

Rugzak. 100% Gerecycled Katoen 140 g/ m2.

38 × 42 cm



Print Code: F(6), N(8), O, P

Recycled Cotton

336



02

13

19

03

Konim

6392

Drawstring Bag. 100% Recycled Cotton.
Rucksack. 100% Recycling Baumwolle.
Sac à Dos. 100% Coton Recyclé.
Rugzak. 100% Gerecycled Katoen.

38 × 42 cm 100 / 50

Print Code: F(6), N(8), O, P



Recycled
Cotton

NEW



Tibak

6390

Drawstring Bag. 100% Organic Cotton.
Rucksack. 100% Organische Baumwolle.
Sac à Dos. 100% Coton Organique.
Rugzak. 100% Organisch Katoen.

38 × 42 cm 100 / 50

Print Code: F(6), N(8), O, P



Organic
Cotton



03

02

13

04

19

Fenin

6833

Drawstring Bag. 100% Recycled Cotton.
Rucksack. 100% Recycling Baumwolle.
Sac à Dos. 100% Coton Recyclé.
Rugzak. 100% Gerecycled Katoen.

38 × 42 cm

100 / 50

Print Code: F(6), N(8), O, P



Recycled
Cotton

RPET



STOP PLASTIC POLLUTING THE OCEAN

i The fabric used in the manufacturing process of these drawstring bags is made of recycled plastic (RPET). Like this, the emission of plastic residues to our planet and the consumption of energy is drastically reduced, resulting in a much more eco-friendly process.

El material de estas mochilas está fabricado con plástico reciclado (RPET), que, además de ayudar en la disminución de residuos plásticos en el planeta, utiliza menos energía en el proceso de fabricación, haciendo que sea mucho menos dañino para el medio ambiente.



Lambur
6430

Drawstring Bag. Polyester RPET.
Rucksack. Polyester RPET.
Sac à Dos. Polyester RPET.
Rugzak. Polyester RPET.

34 x 42 cm 300 / 50

Print Code: F(1), R



337

Tyvek®

RECYCLE 100%



Esta mochila está fabricada con material Tyvek®, que ofrece las características físicas que combinan lo mejor del papel y los tejidos, además de ser reciclable, formando una estructura ligera, flexible, suave, opaca, de extraordinaria resistencia y durabilidad.

This drawstring bag is made of Tyvek material which offers the physical characteristics that combine together the best of paper and fabrics. Furthermore it is recyclable, lightweight, flexible, soft, opaque and of extraordinarily strength and durability.



LONG LIFE REUSABLE

SOFT AND LIGHTWEIGHT

Sandal
6429

Drawstring Bag. Tyvek® Material.
Rucksack. Tyvek® Material.
Sac à Dos. Tyvek® Material.
Rugzak. Tyvek® Material.

34 x 42 cm 200 / 20

Print Code: F(1)



network
LOGO TEMPLATE





Curtis 3323

Drawstring Bag. 100% Cotton.
Rucksack. 100% Baumwolle.
Sac à Dos. 100% Coton.
Rugzak. 100% Katoen.

37 × 41 cm 250 / 50

Print Code: F(6), N(8), O, P

Be conscious



NATURAL CORK
/ COTTON

JUTE /
COTTON



Badix 5982

Drawstring Bag. Jute/ Cotton.
Rucksack. Jutestoff/ Baumwolle.
Sac à Dos. Jute/ Coton.
Rugzak. Jute/ Katoen.

34 × 43 cm 100 / 10

Print Code: F(6), N(8), O, P



Galsin

6386

Drawstring Bag. Natural Cork/ Cotton.
Rucksack. Naturkork/ Baumwolle.
Sac à Dos. Bouchon Naturel/ Coton.
Rugzak. Natuurlijk Kurk/ Katoen.

38 × 41 cm 100 / 10

Print Code: F(6), N(8), O, P

COTTON



04

Bass

9727

Drawstring Bag. 100% Cotton.
Rucksack. 100% Baumwolle.
Sac à Dos. 100% Coton.
Rugzak. 100% Katoen.

37 x 41 cm 100 / 10

Print Code: F(6), N(8), M, O, P



03



02



03

Selcam

5723

Drawstring Bag. 100% Cotton.
Rucksack. 100% Baumwolle.
Sac à Dos. 100% Coton.
Rugzak. 100% Katoen.

37 x 41 cm 200 / 50

Print Code: F(6), N(8), O, P



Simaro

5724

Bag. 100% Cotton.
Tasche. 100% Baumwolle.
Sac. 100% Coton.
Tas. 100% Katoen.

25 x 50 cm 100 / 5

Print Code: F(6), N(8), O, P



Tianax

6119

Drawstring Bag. 100% Cotton.
Rucksack. 100% Baumwolle.
Sac à Dos. 100% Coton.
Rugzak. 100% Katoen.

37 x 41 cm 250 / 50

Print Code: F(6), N(8), O, P





Blades 4780

Drawstring Bag. Polyester 210D.
Rucksack. Polyester 210D.
Sac à Dos. Polyester 210D.
Rugzak. Polyester 210D.

34.5 x 45 cm 200 / 10

Print Code: F(1), N(8), R



340



COMFORTABLE
ADJUSTABLE



Telner 5621

Drawstring Bag. Polyester 190T.
Rucksack. Polyester 190T.
Sac à Dos. Polyester 190T.
Rugzak. Polyester 190T.

34 x 42 cm 300 / 50

Print Code: F(1), N(8), R



04

04

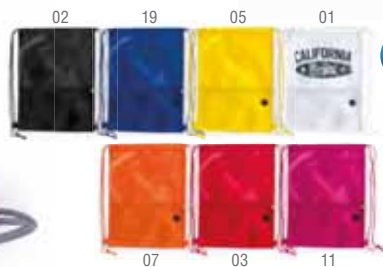

Bicalz 5588

Drawstring Bag. Polyester 210D.
Rucksack. Polyester 210D.
Sac à Dos. Polyester 210D.
Rugzak. Polyester 210D.

31 x 43 cm 200 / 10

Print Code: F(1), N(8), R



Dual 3325

Drawstring Bag. Polyester 190T.
Rucksack. Polyester 190T.
Sac à Dos. Polyester 190T.
Rugzak. Polyester 190T.

28 x 37 x 9 cm 400 / 20

Print Code: F(1), N(8)

Video





Nabar

6458

Drawstring Bag. Polyester 210D.
Rucksack. Polyester 210D.
Sac à Dos. Polyester 210D.
Rugzak. Polyester 210D.

31 x 43 cm 200 / 10
Print Code: F(1), N(8)

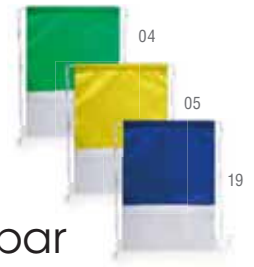

COMFORTABLE
ADJUSTABLE



Spook

3164

Drawstring Bag. Polyester 210T.
Rucksack. Polyester 210T.
Sac à Dos. Polyester 210T.
Rugzak. Polyester 210T.

34 x 42 cm 300 / 50
Print Code: F(1), N(8), R



THICK CORD
CORDÓN GRUESO

Shauden

5620

Drawstring Bag. Polyester 210D.
Rucksack. Polyester 210D.
Sac à Dos. Polyester 210D.
Rugzak. Polyester 210D.

34 x 42 cm 100 / 10
Print Code: F(1), N(8), R



Sibert

4592

Drawstring Bag. Polyester 210T.
Rucksack. Polyester 210T.
Sac à Dos. Polyester 210T.
Rugzak. Polyester 210T.

35 x 45 cm 200 / 10
Print Code: F(1), N(8), R





03



19



01



07

Cobra

3038

Drawstring Bag. Polyester 210T.
Rucksack. Polyester 210T.
Sac à Dos. Polyester 210T.
Rugzak. Polyester 210T.

34 × 41 cm 200 / 10

Print Code: F(1), N(8), R



Reinforced
Corners

342



03



03

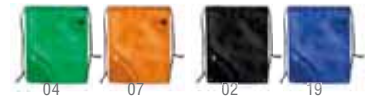

04

07

02

19

Fiter

3630

Drawstring Bag. Polyester 210D.
Rucksack. Polyester 210D.
Sac à Dos. Polyester 210D.
Rugzak. Polyester 210D.

34 × 43 cm 200 / 10

Print Code: F(1), N(8)



Reinforced
Corners



02

19

05

04

07

11

01

Vesnap

5254

Drawstring Bag. Non-Woven.
Rucksack. Non-Woven.
Sac à Dos. T.N.T.
Rugzak. Non-Woven.

34.5 × 45 cm 200 / 10

Print Code: F(1)



Reinforced
Corners



09



23

Alexin

5580

Drawstring Bag. Polyester 210T.
Rucksack. Polyester 210T.
Sac à Dos. Polyester 210T.
Rugzak. Polyester 210T.

34 × 42 cm 200

Print Code: F(1)

NEW



Trecel



2608

Antibacterial Drawstring Bag. Polyester.
 Antibakteriell Rucksack Iasche. Polyester.
 Sac à Dos Antibactérien. Polyester.
 Antibakterieel Rugzak Tas. Polyester.

34 x 42 cm 200 / 10

Print Code: F(1), N(8), R



ANTIBACTERIAL AND WATER RESISTANT FABRIC

343



05



Nofler



4362

Drawstring Bag. Polyester 210T.
 Rucksack. Polyester 210T.
 Sac à Dos. Polyester 210T.
 Rugzak. Polyester 210T.

34 x 42 cm 300 / 20

Print Code: F(1), N(8), R



04

07

03

02

19

03

02



Hera

4049

Drawstring Bag. Non-Woven.
 Rucksack. Non-Woven.
 Sac à Dos. T.N.T..
 Rugzak. Non-Woven.

36 x 42 cm 300 / 10

Print Code: F(1)



11

19

02

01



03

07

05

04



Lizcom



6432

Sublimation Drawstring Bag. Polyester.
 Sublimations Rucksack. Polyester.
 Sac à Dos Sublimation. Polyester.
 Sublimatie Rugzak. Polyester.

34 x 42 cm 100 / 10

Print Code: F(4), N(8), R



REFLECTIVE BAND

05

Lemap

4520

Drawstring Bag. Polyester 190T. Reflective.
Rucksack. Polyester 190T. Reflektierender.
Sac à Dos. Polyester 190T. Réflécteur.
Rugzak. Polyester 190T. Reflecterende.

35 x 41 cm 300 / 10

Print Code: F(1), N(8), R

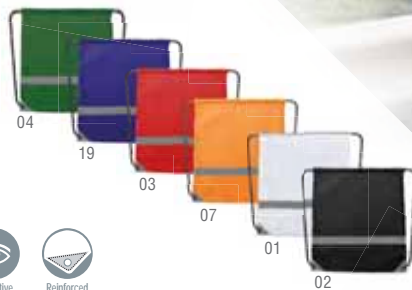

Reflective



Reinforced
Corners

02

01

07

03

19

04

344



19

03

02

01

Tinax

6274



Light



Blink

Security Light. 1 Led. 2 Light Modes. Button Batteries Included.
Sicherheitslicht. 1 Led. 2 Leuchtfunktionen. Knopfzellen Inklusive.
Lumière de Sécurité. 1 Led. 2 Modes de Lumière. Piles Bouton Inclus.
Veiligheidslicht. 1 Led. 2 Licht Posities. Knoopcel Batterijen Inclusief.

1.9 x 5.6 x 1.8 cm 1000 / 250

Print Code: C(1)



02

03

05

01



19

REFLECTIVE

BruX

4530

Strap Keyring. PVC/ Aluminium. Reflective.
Schlüsselanhänger. PVC/ Aluminium. Reflektierender.
Porte-Clés. PVC/ Aluminium. Réflécteur.
Band Sleutelhanger. PVC/ Aluminium. Reflecterende.

3.2 x 28 cm 300 / 50

Print Code: D(1)



04F

FLUORESCENT

Gadex

4394

Drawstring Bag. Polyester 210T.
Rucksack. Polyester 210T.
Sac à Dos. Polyester 210T.
Rugzak. Polyester 210T.

34 x 42 cm 300 / 10

Print Code: F(1), N(8)

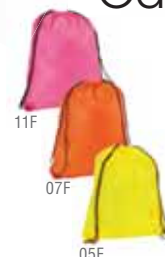

11F

07F

05F



Reinforced
Corners



Naiper
5889

Drawstring Bag. Polyester 210D.
Rucksack. Polyester 210D.
Sac à Dos. Polyester 210D.
Rugzak. Polyester 210D.

42 x 43 cm 300 / 20
Print Code: F(1), N(8)



Paxer
6632

Drawstring Bag. Polyester 210D.
Rucksack. Polyester 210D.
Sac à Dos. Polyester 210D.
Rugzak. Polyester 210D.

56 x 42 cm 300 / 10
Print Code: F(1), N(8), R



IDEAL FOR MOTOBIKE HELMETS AND BALLS
IDEAL PARA CASCO DE MOTO Y BALONES

345



Nonce
5174

Drawstring Bag. Polyester 210D.
Rucksack. Polyester 210D.
Sac à Dos. Polyester 210D.
Rugzak. Polyester 210D.

30 x 41 x 15.5 cm 100 / 20
Print Code: F(1), G(1), H(1)



Yersay
5092

Drawstring Bag. Polyester 210D.
Rucksack. Polyester 210D.
Sac à Dos. Polyester 210D.
Rugzak. Polyester 210D.

50 x 45 cm 200 / 20
Print Code: F(1), N(8)



01





Nipex

5234

Drawstring Cool Bag. Polyester 210D/ Aluminium.
Kühltasche Rucksack. Polyester 210D/ Aluminium.
Sac à Dos Glacière. Polyester 210D/ Aluminium.
Koeltas-Rugzak. Polyester 210D/ Aluminium.

32 x 42 cm 200 / 10

Print Code: G(1), N(8)



05



02

01

19

04

11

07

03

346



05

02

19

16



03

Polys

5419

Cool Bag Backpack. Polyester 600D/ Aluminium. Padded Shoulder Straps.
Kühltasche Rucksack. Polyester 600D/ Aluminium. Gepolsterte Schultergurte.
Sac à Dos Glacière. Polyester 600D/ Aluminium. Bretelles Rembourrées.
Koeltas-Rugzak. Polyester 600D/ Aluminium. Gewatteerde Schouderbanden.

31 x 40 x 18.5 cm 50

Print Code: G(1), N(8)



Tradan

5235

Drawstring Cool Bag. Polyester 210D/ Aluminium.
Kühltasche Rucksack. Polyester 210D/ Aluminium.
Sac à Dos Glacière. Polyester 210D/ Aluminium.
Koeltas-Rugzak. Polyester 210D/ Aluminium.

27 x 33 cm

200 / 10

Print Code: G(1), N(8)



02

01

04

05

07

03

11



19



RIPSTOP



Mathis

5381

Foldable Backpack. Polyester 210D.

Faltbarer Rucksack. Polyester 210D.

Sac à Dos Pliable. Polyester 210D.

Opvouwbare Rugzak. Polyester 210D.

30 x 42 x 12 cm 200 / 50

Print Code: F(1), G(1)



04



16



19



03

347



02

19

05



Ideal Sublimation



01

02

04

05

07

03

11

Ledor

4886

Foldable Backpack. Ripstop.

Faltbarer Rucksack. Ripstop.

Sac à Dos Pliable. Ripstop.

Opvouwbare Rugzak. Ripstop.

30 x 42 x 11 cm 100 / 50

Print Code: F(1), G(1), H(1)



03

REFLECTIVE

Signal

5567

Foldable Backpack. Polyester 210D.

Faltbar Rucksack. Polyester 210D.

Sac à Dos Pliable. Polyester 210D.

Opvouwbare Rugzak. Polyester 210D.

22 x 40 x 16 cm 200 / 50

Print Code: F(1), N(8), R

Mendy

6344

Foldable Backpack. Ripstop.

Faltbarer Rucksack. Ripstop.

Sac à Dos Pliable. Ripstop.

Opvouwbare Rugzak. Ripstop.

32 x 43 x 12 cm 100 / 20

Print Code: F(1), G(1)



04

19

01

02



Humus

4057

Backpack. Polyester 600D. Padded Shoulder Straps.
Rucksack. Polyester 600D. Gepolsterte Schultergurte.
Sac à Dos. Polyester 600D. Bretelles Rembourrées.
Rugzak. Polyester 600D. Gewatteerde Schouderbanden.

30 x 40 x 18 cm 40

Print Code: F(1), N(8), 0



Yobren

5236

Backpack. Polyester 600D. Padded Shoulder Straps.
Rucksack. Polyester 600D. Gepolsterte Schultergurte.
Sac à Dos. Polyester 600D. Bretelles Rembourrées.
Rugzak. Polyester 600D. Gewatteerde Schouderbanden.

30 x 40 x 10 cm 50

Print Code: F(1), N(8), O, P

348



REFLECTIVE

Lendross

4734

Backpack. Polyester 600D. Padded Back and Shoulder Straps.
Rucksack. Polyester 600D. Gepolsterter Rücken und Schultergurte.
Sac à Dos. Polyester 600D. Dos et Bretelles Rembourrées.
Rugzak. Polyester 600D. Gewatteerde Achterzijde en Schouderbanden.

29 x 43 x 15 cm 40

Print Code: F(1), N(8), 0



Empire

3627

Backpack. Polyester 600D. Padded Shoulder Straps.
Rucksack. Polyester 600D. Gepolsterte Schultergurte.
Sac à Dos. Polyester 600D. Bretelles Rembourrées.
Rugzak. Polyester 600D. Gewatteerde Schouderbanden.

35 x 45 x 11 cm 40

Print Code: G(1), N(8), 0



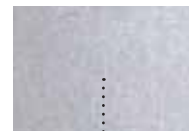

DENIM LINE
LÍNEA VAQUERA



Wilfek

5229

Backpack. Polyester 600D. Padded Back and Shoulder Straps.
Rucksack. Polyester 600D. Gepolsterter Rücken und Schultergurte.
Sac à Dos. Polyester 600D. Dos et Bretelles Rembourrées.
Rugzak. Polyester 600D. Gewatteerde Achterzijde en Schouderbanden.

28 x 38 x 12 cm

40

Print Code: F(1), N(8), O, P

Harter

5031

Backpack. Polyester 600D. Padded Back and Shoulder Straps.
Rucksack. Polyester 600D. Gepolsterter Rücken und Schultergurte.
Sac à Dos. Polyester 600D. Dos et Bretelles Rembourrées.
Rugzak. Polyester 600D. Gewatteerde Achterzijde en Schouderbanden.

28 x 38 x 12 cm

40

Print Code: F(1), N(8), O, P

350



TWO-TONE
BICOLOR



Chens

5589

Backpack. Polyester 600D. Padded Back and Shoulder Straps.
Rucksack. Polyester 600D. Gepolsterter Rücken und Schultergurte.
Sac à Dos. Polyester 600D. Dos et Bretelles Rembourrées.
Rugzak. Polyester 600D. Gewatteerde Achterzijde en Schouderbanden.

28 x 38 x 12 cm

40

Print Code: F(1), N(8), O, P

Toynix

4922

Backpack. Polyester 600D. Padded Shoulder Straps.
Rucksack. Polyester 600D. Gepolsterter Schultergurte.
Sac à Dos. Polyester 600D. Bretelles Rembourrées.
Rugzak. Polyester 600D. Gewatteerde Schouderbanden.

28 x 39 x 18 cm

30

Print Code: G(1), N(8), O, P





16 06 02 03 22 07

Ventix

6814

Backpack. Polyester 600D. Padded Back and Shoulder Straps.
Rucksack. Polyester 600D. Gepolsterter Rücken und Schultergurte.
Sac à Dos. Polyester 600D. Dos et Bretelles Rembourrées.
Rugzak. Polyester 600D. Gewatteerde Achterzijde en Schouderbanden.

31 x 41 x 16 cm 40
Print Code: F(1), N(8), O, P

19



16



03

BIG SIZE



03

351



03 07 11 04 05 21 19 13 01 02



91 41 31 71

Discovery

9012

Backpack. Polyester 600D. Padded Back and Shoulder Straps.
Rucksack. Polyester 600D. Gepolsterter Rücken und Schultergurte.
Sac à Dos. Polyester 600D. Dos et Bretelles Rembourrées.
Rugzak. Polyester 600D. Gewatteerde Achterzijde en Schouderbanden.

28 x 38 x 12 cm 50
Print Code: F(1), N(8), O, P, R



02 05 04 11 19

Soken

5400

Backpack. Polyester 600D.
Rucksack. Polyester 600D.
Sac à Dos. Polyester 600D.
Rugzak. Polyester 600D.

29 x 39 x 19 cm 30
Print Code: F(1), N(8), O, P



Yondix

4735

Backpack. Polyester 600D. Padded Back and Shoulder Straps.
Rucksack. Polyester 600D. Gepolsterter Rücken und Schultergurte.
Sac à Dos. Polyester 600D. Dos et Bretelles Rembourrées.
Rugzak. Polyester 600D. Gewatteerde Achterzijde en Schouderbanden.

32.5 x 43 x 23.5 cm 30
Print Code: G(1), N(8), O



06

19

02



Kissa

4788

Foldable Drawstring Bag. Polyester 190T.

Faltbarer Rucksack. Polyester 190T.

Sac à Dos Pliable. Polyester 190T.

Opvouwbare Rugzak. Polyester 190T.

26.5 x 32.5 cm

500 / 10

Print Code: F(1), G(1)

01



19

07

05



Llorel

5705

Drawstring Bag. Polyester 210T.

Rucksack. Polyester 210T.

Sac à Dos. Polyester 210T.

Rugzak. Polyester 210T.

26 x 30 cm

500 / 10

Print Code: F(1), N(8)

B



I

J

352



Backys

4893

Drawstring Bag. Non-Woven. 5 Markers Included.

Rucksack. Non-Woven. 5 Markers Inklusiv.

Sac à Dos. T.N.T.. 5 Marqueur Inclus.

Rugzak. Non-Woven. 5 Stiften Inclusief.

25 x 30 cm

200 / 50

Print Code: G(1)



Wizzy

5701

Drawstring Bag. Non-Woven. 5 Crayons Included.

Rucksack. Non-Woven. 5 Wachsmalstifte Inklusiv.

Sac à Dos. T.N.T.. 5 Crayons Inclus.

Rugzak. Non-Woven. 5 Krijtjes Inclusief.

25 x 30 cm

200 / 50

Print Code: G(1)



KIDS



Susdal

6424

Backpack. Polyester 600D. Padded Back and Shoulder Straps.
Rucksack. Polyester 600D. Gepolsterter Rücken und Schultergurte.
Sac à Dos. Polyester 600D. Dos et Bretelles Rembourrées.
Rugzak. Polyester 600D. Gewatteerde Achterzijde en Schouderbanden.

25 × 30 × 12 cm

50

Print Code: F(1), N(8), O, P



02

04

05

19



11



Reinforced
Corners

Dinki

5091

Drawstring Bag. Polyester 210D.
Rucksack. Polyester 210D.
Sac à Dos. Polyester 210D.
Rugzak. Polyester 210D.

27 × 32 cm

500 / 50

Print Code: F(1), N(8), R



05

07

03

02

19

04

01



19

Kiddy

3257

Backpack. Polyester 600D.
Rucksack. Polyester 600D.
Sac à Dos. Polyester 600D.
Rugzak. Polyester 600D.

22 × 26.5 × 8 cm

100 / 20

Print Code: F(1), N(8), O

05

03





Dons

6371

Backpack. Laminated Paper 130 g/ m2. Padded Shoulder Straps.
Rucksack. Laminiertes Papier 130 g/ m2. Gepolsterte Schultergurte.
Sac à Dos. Papier Laminé 130 g/ m2. Bretelles Rembourrées.
Rugzak. Gelamineerd Paper 130 g/ m2. Gewatteerde Schouderbanden.

30 x 40 x 14 cm 50

Print Code: F(1)



354



Kizon

6370

Backpack. Laminated Paper 130 g/ m2. Padded Shoulder Straps.
Rucksack. Laminiertes Papier 130 g/ m2. Gepolsterte Schultergurte.
Sac à Dos. Papier Laminé 130 g/ m2. Bretelles Rembourrées.
Rugzak. Gelamineerd Paper 310 g/ m2. Gewatteerde Schouderbanden.

30 x 40 x 14 cm 50

Print Code: F(1)

Flicker

6319

Drawstring Bag. Natural Cork/ Polyester 210D.
Rucksack. Naturkork/ Polyester 210D.
Sac à Dos. Bouchon Naturel/ Polyester 210D.
Rugzak. Natuurlijk Kurk/ Polyester 210D.

34 x 42 cm 200 / 10

Print Code: F(1), N(8)

Lorcan

6339

Backpack. Natural Cork/ Polyester 600D. Padded Back and Shoulder Straps.
Rucksack. Naturkork/ Polyester 600D. Gepolsterter Rücken und Schultergurte.
Sac à Dos. Bouchon Naturel/ Polyester 600D. Dos et Bretelles Rembourrées.
Rugzak. Natuurlijk Kurk/ Polyester 600D. Gewatteerde Achterzijde en Schouderbanden.

28 x 38 x 12 cm 50

Print Code: F(1), N(8), O, P





NEW



Marnel

6818

Backpack. Jute/ Cotton.
Rucksack. Jutestoff/ Baumwolle.
Sac à Dos. Jute/ Coton.
Rugzak. Jute/ Katoen.

32 x 40 x 7 cm

Print Code: F(1), N(8), 0

50 / 10



NEW

Lopso

6817

Duffel Bag. Jute/ Cotton.
Seesack. Jutestoff/ Baumwolle.
Balluchon. Jute/ Coton.
Plunjezak. Jute/ Katoen.

23 x 45 cm

Print Code: F(1), N(8)

50 / 10



Rover

9726

Duffel Bag. 100% Cotton.
Seesack. 100% Baumwolle.
Balluchon. 100% Coton.
Plunjezak. 100% Katoen.

25 x 43.5 cm

Print Code: F(6), N(8), 0, P

01



06

02

03

07



356

RPET

i The fabric used in the manufacturing process of these backpacks is made of recycled plastic (RPET). Like this, the emission of plastic residues to our planet and the consumption of energy is drastically reduced, resulting in a much more eco-friendly process.

El material de estas mochilas está fabricado con plástico reciclado (RPET), que, además de ayudar en la disminución de residuos plásticos en el planeta, utiliza menos energía en el proceso de fabricación, haciendo que sea mucho menos dañino para el medio ambiente.

STOP PLASTIC POLLUTING THE OCEAN



Konor 6451

Backpack. Polyester 600D RPET. USB Connection. Padded Laptop and Tablet Compartment. Padded Back and Shoulder Straps.

Rucksack. Polyester 600D RPET. USB Anschluss. Gepolsterte Laptoptasche und Tablet. Gepolsterter Rücken und Schultergurte.

Sac à Dos. Polyester 600D RPET. Connexion USB. Pochette Rembourrée pour Portable et Tablet. Dos et Bretelles Rembourrées.

Rugzak. Polyester 600D RPET. USB Verbinding. Gewatteerd Laptop en Tablet Compartment. Gewatteerde Achterzijde en Schouderbanden.

29 × 43 × 13 cm



Print Code: F(1), N(8), O, P



08

02

Caldy 6452

Backpack. Polyester 600D RPET. Padded Back and Shoulder Straps.

Rucksack. Polyester 600D RPET. Gepolsterter Rücken und Schultergurte.

Sac à Dos. Polyester 600D RPET. Dos et Bretelles Rembourrées.

Rugzak. Polyester 600D RPET. Gewatteerde Achterzijde en Schouderbanden.

28 × 38 × 12 cm



Print Code: F(1), N(8), O, P





NEW

Parks 6840

Waistbag. Polyester 600D RPET.
Gürteltasche. Polyester 600D RPET.
Banane. Polyester 600D RPET.
Heuptas. Polyester 600D RPET.

25 × 17 × 8 cm

200 / 50

Print Code: E(1), N(8)



RPET

RPET

The fabric used in the manufacturing process of these products is made of recycled plastic (RPET). Like this, the emission of plastic residues to our planet and the consumption of energy is drastically reduced, resulting in a much more eco-friendly process.

El material de estos productos está fabricado con plástico reciclado (RPET), que, además de ayudar en la disminución de residuos plásticos en el planeta, utiliza menos energía en el proceso de fabricación, haciendo que sea mucho menos dañino para el medio ambiente.

STOP PLASTIC POLLUTING THE OCEAN



357

NEW



Terrex 6749

Backpack. Polyester 600D RPET. Padded Laptop and Tablet Compartment. Padded Back and Shoulder Straps.

Rucksack. Polyester 600D RPET. Gepolsterte Laptoptasche und Tablet. Gepolsterter Rücken und Schultergurte.

Sac à Dos. Polyester 600D RPET. Pochette Rembourrée pour Portable et Tablet. Dos et Bretelles Rembourrées.

Rugzak. Polyester 600D RPET. Gewatteerd Laptop en Tablet Compartment. Gewatteerde Achterzijde en Schouderbanden.

31 × 45 × 13 cm

20

Print Code: G(1), N(8)



RPET



Tablet Compartment



Laptop Compartment



Tablet Compartment

NEW



Laptop Compartment



Bulman

6848

Anti-Theft Backpack. Polyester 600D RPET. Padded Laptop and Tablet Compartment. Padded Back and Shoulder Straps.

Anti-Diebstahl Rucksack. Polyester 600D RPET. Gepolsterte Laptoptasche und Tablet. Gepolsterter Rücken und Schultergurte.

Sac à Dos Antivol. Polyester 600D RPET. Pochette Rembourrée pour Portable et Tablet. Dos et Bretelles Rembourrées.

Anti-Diefstal Rugzak. Polyester 600D RPET. Gewatteerd Laptop en Tablet Compartment. Gewatteerde Achterzijde en Schouderbanden.

35 × 47 × 15 cm

20

Print Code: G(1), N(8)



Anti Theft pocket



Trolley Strap



RPET



Cuper

5438

Bag, Non-Woven.
Tasche, Non-Woven.
Sac, T.N.T.
Tas, Non-Woven.

46 x 59 cm

Print Code: F(1)

01



02

200 / 20



03

13

19

Xede

4303



Laptop
Compartment

02



Backpack, Polyester 840D, Padded Laptop Compartment, Padded Back and Shoulder Straps.

Rucksack, Polyester 840D, Gepolsterte Laptoptasche, Gepolsterter Rücken und Schultergurte.

Sac à Dos, Polyester 840D, Pochette Rembourrée pour Portable, Dos et Bretelles Rembourrées.

Rugzak, Polyester 840D, Gewatteerd Laptop Compartment, Gewatteerde Achterzijde en Schouderbanden.

28 x 38 x 6 cm

20

Print Code: G(1), N(8)

358



Halnok

5590

Backpack, Polyester 600D, USB Connection, Padded Laptop and Tablet Compartment, Padded Back and Shoulder Straps.

Rucksack, Polyester 600D, USB Anschluss, Gepolsterte Laptoptasche und Tablet, Gepolsterter Rücken und Schultergurte.

Sac à Dos, Polyester 600D, Connexion USB, Pochette Rembourrée pour Portable et Tablet, Dos et Bretelles Rembourrées.

Rugzak, Polyester 600D, USB Verbinding, Gewatteerd Laptop en Tablet Compartment, Gewatteerde Achterzijde en Schouderbanden.

32 x 42 x 15 cm

30

Print Code: G(1), N(8)



Tablet
Compartment



Laptop
Compartment



USB
Connection

Bradd

5399

Backpack, Polyester 600D, Padded Laptop Compartment, Padded Back and Shoulder Straps.

Rucksack, Polyester 600D, Gepolsterte Laptoptasche, Gepolsterter Rücken und Schultergurte.

Sac à Dos, Polyester 600D, Pochette Rembourrée pour Portable, Dos et Bretelles Rembourrées.

Rugzak, Polyester 600D, Gewatteerd Laptop Compartment, Gewatteerde Achterzijde en Schouderbanden.

28 x 40 x 8 cm

30

Print Code: G(1), N(8)



Laptop
Compartment





Verbel 5232

Backpack. Polyester 600D. Padded Laptop Compartment. Padded Back and Shoulder Straps.
 Rucksack. Polyester 600D. Gepolsterte Laptoptasche. Gepolsterter Rücken und Schultergurte.
 Sac à Dos. Polyester 600D. Pochette Rembourrée pour Portable. Dos et Bretelles Rembourrées.
 Ruzgak. Polyester 600D. Gewatteerd Laptop Compartment. Gewatteerde Achterzijde en Schouderbanden.

32 x 42 x 15 cm 30
 Print Code: G(1), N(8)



Laptop
Compartment

Shamer 5445

Backpack. Nylon 600D. Padded Laptop Compartment. Padded Back and Shoulder Straps.
 Rucksack. Nylon 600D. Gepolsterte Laptoptasche. Gepolsterter Rücken und Schultergurte.
 Sac à Dos. Nylon 600D. Pochette Rembourrée pour Portable. Dos et Bretelles Rembourrées.
 Ruzgak. Nylon 600D. Gewatteerd Laptop Compartment. Gewatteerde Achterzijde en Schouderbanden.

29 x 41 x 18 cm 20
 Print Code: G(1), N(8)



Laptop
Compartment

359



Eris 3668

Backpack. Nylon 900D. Padded Laptop Compartment. Padded Back and Shoulder Straps.
 Rucksack. Nylon 900D. Gepolsterte Laptoptasche. Gepolsterter Rücken und Schultergurte.
 Sac à Dos. Nylon 900D. Pochette Rembourrée pour Portable. Dos et Bretelles Rembour.
 Ruzgak. Nylon 900D. Gewatteerd Laptop Compartment. Gewatteerde Achterzijde en Schouderbanden.

30 x 41 x 14 cm 20
 Print Code: G(1), N(8)



Laptop
Compartment

Donovan 5155

Backpack. Polyester 600D. Padded Laptop Compartment. Padded Back and Shoulder Straps.
 Rucksack. Polyester 600D. Gepolsterte Laptoptasche. Gepolsterter Rücken und Schultergurte.
 Sac à Dos. Polyester 600D. Pochette Rembourrée pour Portable. Dos et Bretelles Rembour.
 Ruzgak. Polyester 600D. Gewatteerd Laptop Compartment. Gewatteerde Achterzijde en Schouderbanden.

32 x 44 x 18 cm 20
 Print Code: G(1), N(8)



Laptop
Compartment

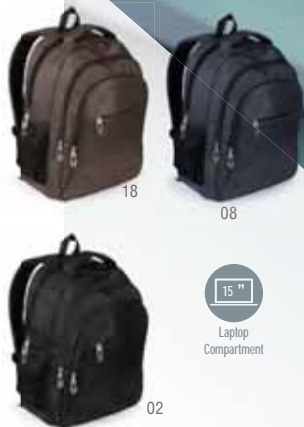

18

08

02

Laptop
Compartment

06

Arcano

4591

Backpack. Nylon 600D. Padded Laptop Compartment. Padded Back and Shoulder Straps.

Rucksack. Nylon 600D. Gepolsterte Laptoptasche. Gepolsterter Rücken und Schultergurte.

Sac à Dos. Nylon 600D. Pochette Rembourrée pour Portable. Dos et Bretelles Rembourrées.

Rugzak. Nylon 600D. Gewatteerd Laptop Compartment. Gewatteerde Achterzijde en Schouderbanden.

32.5 × 44 × 25 cm

20 / 5

Print Code: G(1), N(8)



LAPTOP BACKPACK



360



Howar

6596

Backpack. Polyester 600D/ PEVA. Padded Shoulder Straps.

Rucksack. Polyester 600D/ PEVA. Gepolsterte Schultergurte.

Sac à Dos. Polyester 600D/ PEVA. Bretelles Rembourrées.

Rugzak. Polyester 600D/ PEVA. Gewatteerde Schouderbanden.

30 × 62 × 13 cm

20

Print Code: G(1), N(8)



COOL



02



08

Nevium

5446

Backpack. Polyester 600D. Padded Laptop Compartment. Padded Back and Shoulder Straps.

Rucksack. Polyester 600D. Gepolsterte Laptoptasche. Gepolsterter Rücken und Schultergurte.

Sac à Dos. Polyester 600D. Pochette Rembourrée pour Portable. Dos et Bretelles Rembourrées.

Rugzak. Polyester 600D. Gewatteerd Laptop Compartment. Gewatteerde Achterzijde en Schouderbanden.

30 × 43 × 14 cm

10

Print Code: G(1), N(8)

Laptop
CompartmentTrolley
Strap



Tablet Compartment



Laptop Compartment



USB Connection



08

Mispat

6453

Backpack. Polyester 600D. USB Connection. Padded Laptop and Tablet Compartment. Padded Back and Shoulder Straps.
Rucksack. Polyester 600D. USB Anschluss. Gepolsterte Lapttasche und Tablet. Gepolsterter Rücken und Schultergurte.
Sac à Dos. Polyester 600D. Connexion USB. Pochette Rembourrée pour Portable et Tablet. Dos et Bretelles Rembourrées.
Rugzak. Polyester 600D. USB Verbinding. Gewatteerd Laptop en Tablet Compartment. Gewatteerde Achterzijde en Schouderbanden.

Print Code: G(1), N(8)

30

32 x 42 x 15 cm

Print Code: G(1), N(8)



08

Noren

6454

Backpack. Polyester 600D. USB Connection. Padded Back and Shoulder Straps.
Rucksack. Polyester 600D. USB Anschluss. Gepolsterter Rücken und Schultergurte.
Sac à Dos. Polyester 600D. Connexion USB. Dos et Bretelles Rembourrées.
Rugzak. Polyester 600D. USB Verbinding. Gewatteerde Achterzijde en Schouderbanden.

Print Code: F(1), N(8)

40

28 x 38 x 12 cm

Print Code: F(1), N(8)



USB Connection



Kacen

6455



USB Connection

08

Backpack. Polyester 600D. USB Connection. Padded Laptop and Tablet Compartment. Padded Back and Shoulder Straps.
Rucksack. Polyester 600D. USB Anschluss. Gepolsterte Lapttasche und Tablet. Gepolsterter Rücken und Schultergurte.
Sac à Dos. Polyester 600D. Connexion USB. Pochette Rembourrée pour Portable et Tablet. Dos et Bretelles Rembourrées.
Rugzak. Polyester 600D. USB Verbinding. Gewatteerd Laptop en Tablet Compartment. Gewatteerde Achterzijde en Schouderbanden.

Print Code: G(1), N(8)

20

32.5 x 44 x 25 cm

Print Code: G(1), N(8)



Tablet Compartment



Laptop Compartment



RFID



INNER POCKET RFID PROTECTION
BOLSILLO INTERIOR PROTECCIÓN
RFID

Rigal
6215



Backpack. Polyester 300D. RFID Protected. USB Connection. Padded Back and Shoulder Straps.
Rucksack. Polyester 300D. RFID Schutz. USB Anschluss. Gepolsterter Rücken und Schultergurte.
Sac à Dos. Polyester 300D. Protecteur RFID. Connexion USB. Dos et Bretelles Rembourrées.
Rugzak. Polyester 300D. RFID Bescherming. USB Verbinding. Gewatteerde Achterzijde en Schouderbanden.

30 x 43 x 14 cm 40

Print Code: G(1), N(8)



INNER POCKET RFID PROTECTION
BOLSILLO INTERIOR PROTECCIÓN
RFID



362



10" Tablet Compartment



15" Laptop Compartment

INNER POCKET RFID PROTECTION
BOLSILLO INTERIOR PROTECCIÓN
RFID



02



08

Kropel
6598

Backpack. Polyester 300D. RFID Protected. Padded Laptop Compartment. Padded Back and Shoulder Straps.
Rucksack. Polyester 300D. RFID Schutz. Gepolsterter Laptopfach. Gepolsterter Rücken und Schultergurte.
Sac à Dos. Polyester 300D. Protecteur RFID. Pochette Rembourrée pour Portable. Dos et Bretelles Rembourrées.
Rugzak. Polyester 300D. RFID Bescherming. Gewatteerd Laptop Compartment. Gewatteerde Achterzijde en Schouderbanden.

37 x 64 x 20 cm

20

Print Code: G(1), N(8)



Lenket
6216

Document Bag. Polyester 300D. RFID Protected. USB Connection. Padded Laptop and Tablet Compartment.
Dokumententasche. Polyester 300D. RFID Schutz. USB Anschluss. Gepolsterter Laptopfach und Tablet.
Porte-Documents. Polyester 300D. Protecteur RFID. Connexion USB. Pochette Rembourrée pour Portable et Tablet.
Aktentas. Polyester 300D. RFID Bescherming. USB Verbinding. Gewatteerd Laptop en Tablet Compartment.

38 x 29.5 x 8.5 cm

40

Print Code: G(1), N(8)



15" Laptop Compartment



ANTI-THEFT
ZIPPER/
CREMALLERA
ANTIRROBO



02



12" Tablet
Compartment



15" Laptop
Compartment

Vectom

6220

Anti-Theft Backpack. Polyester 300D. USB Connection. Padded Laptop and Tablet Compartment. Padded Back and Shoulder Straps.

Anti-Diebstahl Rucksack. Polyester 300D. USB Anschluss. Gepolsterte Laptoptasche und Tablet. Gepolsterter Rücken und Schultergurte.

Sac à Dos Antivol. Polyester 300D. Connexion USB. Pochette Rembourrée pour Portable et Tablet. Dos et Bretelles Rembourrées.

Anti-Diefstal Rugzak. Polyester 300D. USB Verbinding. Gewatteerd Laptop en Tablet Compartment. Gewatteerde Achterzijde en Schouderbanden.

35 x 47 x 15 cm

20

Print Code: G(1), N(8)



Anti-theft
pocket



USB
Connection



Trolley
Strap



Anti-theft



USB
Connection



Anti-theft
pocket



Trolley
Strap



Water
Repellent



Transport
Card Pocket



Anti-theft



Combination
Lock

Brinem

6217

Backpack. Polyester 300D. USB Connection. Padded Laptop Compartment. Padded Back and Shoulder Straps. Combination Lock Included.

Rucksack. Polyester 300D. USB Anschluss. Gepolsterte Laptoptasche. Gepolsterter Rücken und Schultergurte. Sicherheitsverschluss Inklusiv.

Sac à Dos. Polyester 300D. Connexion USB. Pochette Rembourrée pour Portable. Dos et Bretelles Rembourrées. Fermeture Sécurité Inclus.

Rugzak. Polyester 300D. USB Verbinding. Gewatteerd Laptop Compartment. Gewatteerde Achterzijde en Schouderbanden. Veiligheidsluiting Inclusief.

30 x 44 x 17 cm

20

Print Code: G(1), N(8)



15" Laptop
Compartment



08

ANTI-THEFT



ANTI-THEFT
POCKET/
BOLSILLO
ANTIRROBO

Versox

6218

Shoulder Bag. Polyester 300D. USB Connection. Padded. Umhängetasche. Polyester 300D. USB Anschluss. Gepolsterte. Bandoulière. Polyester 300D. Connexion USB. Rembourrée. Schoudertas. Polyester 300D. USB Verbinding. Gewatteerd.

20 x 29 x 6.5 cm

50

Print Code: F(1), N(8)



10" Tablet
Compartment



USB
Connection

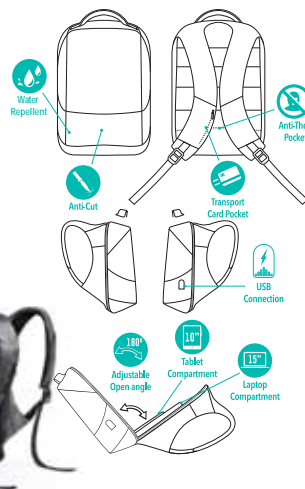

Biltrix

5947

Anti-Theft Backpack. Nylon 1200D. USB Connection. Padded Laptop and Tablet Compartment. Padded Back and Shoulder Straps.
 Anti-Diebstahl Rucksack. Nylon 1200D. USB Anschluss. Gepolsterte Laptotasche und Tablet. Gepolsterter Rücken und Schultergurte.
 Sac à Dos Antivol. Nylon 1200D. Connexion USB. Pochette Rembourrée pour Portable et Tablet. Dos et Bretelles Rembourrées.
 Anti-Diefstal Rugzak. Nylon 1200D. USB Verbinding. Gewatteerd Laptop en Tablet Compartiment. Gewatteerde Achterzijde en Schouderbanden.

30 × 44 × 16 cm

10

Print Code: G(1), N(8)

364

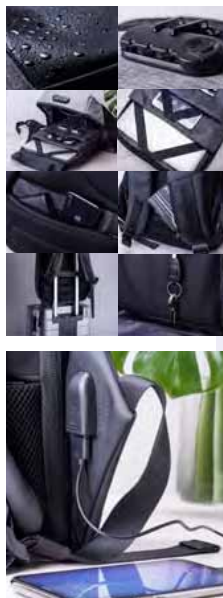
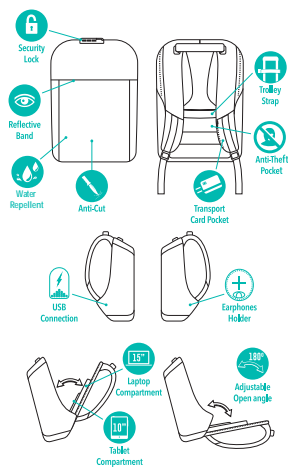

Ranley

5949

Anti-Theft Backpack. Polyester 900D. USB Connection. Padded Laptop and Tablet Compartment. Padded Back and Shoulder Straps. Combination Lock Included.
 Anti-Diebstahl Rucksack. Polyester 900D. USB Anschluss. Gepolsterte Laptotasche und Tablet. Gepolsterter Rücken und Schultergurte. Sicherheitsverschluss Inklusiv.
 Sac à Dos Antivol. Polyester 900D. Connexion USB. Pochette Rembourrée pour Portable et Tablet. Dos et Bretelles Rembourrées. Fermeture Sécurité Inclus.
 Anti-Diefstal Rugzak. Polyester 900D. USB Verbinding. Gewatteerd Laptop en Tablet Compartiment. Gewatteerde Achterzijde en Schouderbanden. Veiligheidsluiting Inclusief.

30 × 49 × 16.5 cm

10

Print Code: G(1), N(8)





USB CONNECTION/
CONEXION USB

02



03



19



06



08



RFID PROTECTION
POCKET /
BOLSILLO PROTECCION
RFID



Komplete 6345



Anti-Theft Backpack. Polyester 300D. RFID Protected. USB Connection. Padded Laptop and Tablet Compartment. Padded Back and Shoulder Straps.

Anti-Diebstahl Rucksack. Polyester 300D. RFID Schutz. USB Anschluss. Gepolsterte Laptoptasche und Tablet. Gepolsterter Rücken und Schultergurte.

Sac à Dos Antivol. Polyester 300D. Protecteur RFID. Connexion USB. Pochette Rembourrée pour Portable et Tablet. Dos et Bretelles Rembourrées.

Anti-Diefstal Rugzak. Polyester 300D. RFID Bescherming. USB Verbinding. Gewatteerd Laptop en Tablet Compartment. Gewatteerde Achterzijde en Schouderbanden.

28 x 40 x 12 cm



30

Print Code: G(1), N(8), O, P



365



02



Laptop
Compartment



19



08



03

Prikan 6473

Backpack. Polyester 600D. USB Connection. Padded. Padded Laptop Compartment.

Rucksack. Polyester 600D. USB Anschluss. Gepolstert. Gepolsterte Laptoptasche.

Sac à Dos. Polyester 600D. Connexion USB. Rembourré. Pochette Rembourrée pour Portable.

Rugzak. Polyester 600D. USB Verbinding. Gewatteerd. Gewatteerd Laptop Compartment.

31 x 40 x 13 cm



20

Print Code: N(8)



DOCUMENT bag backpack

366



17" Laptop Compartment



FULLY PADDED



15" Laptop Compartment

FULLY PADDED



Sulkan
6620



Document Bag Backpack. Polyester 600D. USB Connection. Padded. Padded Laptop Compartment.
Dokumententasche Rucksack. Polyester 600D. USB Anschluss. Gepolstert. Gepolsterte Lapptasche.
Sac à Dos Porte-Documents. Polyester 600D. Connexion USB. Rembourré. Pochette Rembourrée pour Portable.
Aktentas Ruzgak. Polyester 600D. USB Verbindung. Gewatteerd. Gewatteerd Laptop Compartment.

32 x 46 x 20 cm



Print Code: G(1), N(8)

Hurkon
6509



Document Bag Backpack. Polyester 300D/PU. Padded. Padded Laptop Compartment.
Dokumententasche Rucksack. Polyester 300D/PU. Gepolstert. Gepolsterte Lapptasche.
Sac à Dos Porte-Documents. Polyester 300D/Similicuir. Rembourré. Pochette Rembourrée pour Portable.
Aktentas Ruzgak. Polyester 300D/PU. Gewatteerd. Gewatteerd Laptop Compartment.

32 x 41 x 12.5 cm



Print Code: I(8)



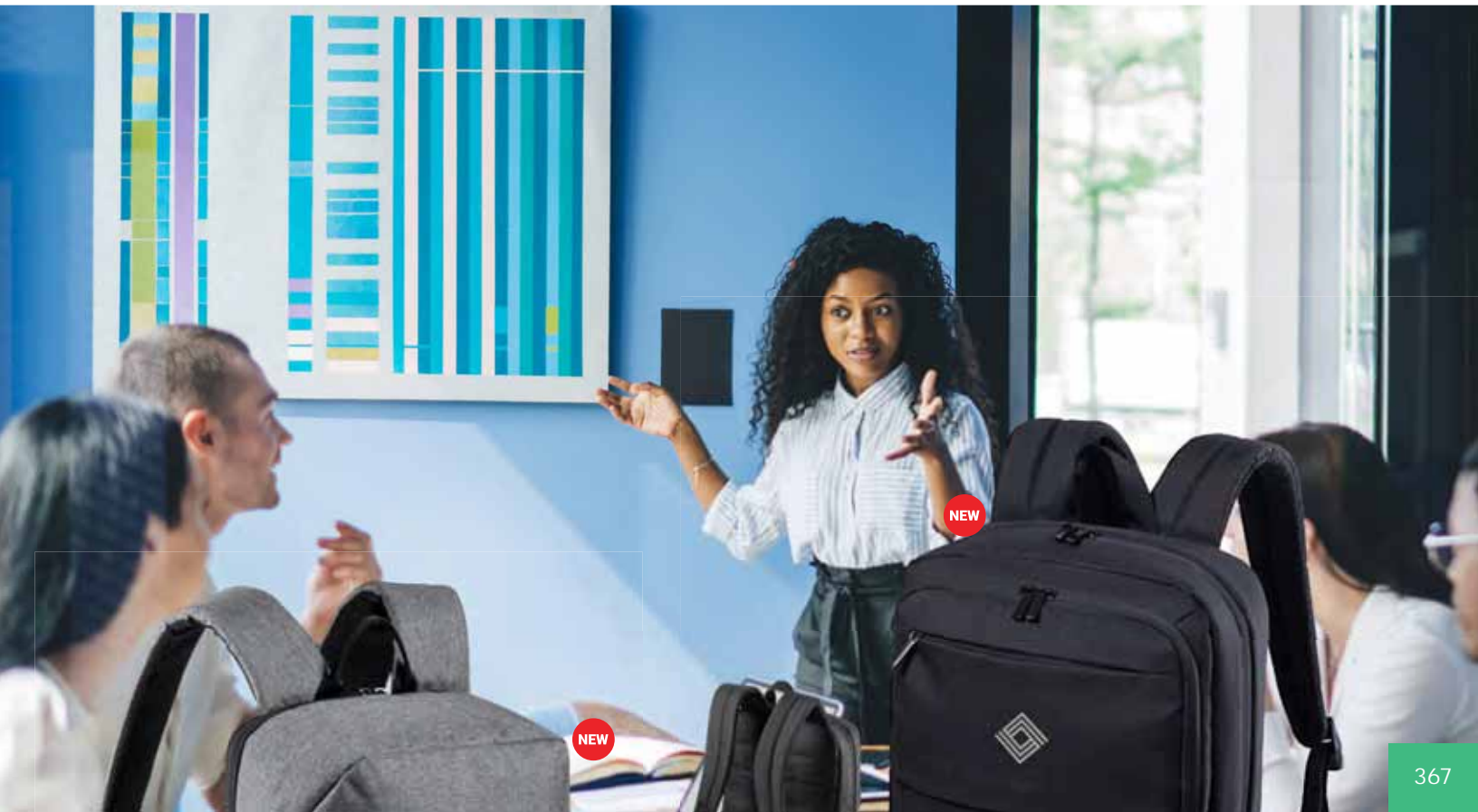

NEW



NEW



Mordux 6704



Laptop
Compartment

Antibacterial Backpack. Polyester 600D. Padded. Padded Laptop Compartment.
Antibakteriell Rucksack. Polyester 600D. Gepolstert. Gepolsterte Laptotasche.
Sac à Dos Antibactérienne. Polyester 600D. Rembourré. Pochette Rembourrée pour Portable.
Antibacterieel Rugzak. Polyester 600D. Gewatteerd. Gewatteerd Laptop Compartment.

30 × 43 × 14 cm
Print Code: G(1), N(8)



Tablet
Compartment



Laptop
Compartment



Kraps 6750

CONNECT YOUR POWER
BANK

UV Sterilizer Backpack. Polyester 600D. Padded. Padded Laptop and Tablet Compartment. Ultraviolet Light. USB Connection. Cable Included.

UV Sterilisator Rucksack. Polyester 600D. Gepolstert. Gepolsterte Laptotasche und Tablet. Ultraviolettes Licht. USB Anschluss. Kabel Inklusiv.

Sac à Dos Stérilisateur UV. Polyester 600D. Rembourré. Pochette Rembourrée pour Portable et Tablet. Ultraviolets. Connexion USB. Câble Inclus.

UV Sterilisator Rugzak. Polyester 600D. Gewatteerd. Gewatteerd Laptop en Tablet Compartment. Ultraviolet Licht. USB Verbinding. Kabel Inclusief.

30 × 43 × 12 cm
Print Code: I(8)



Anti Theft
pocket



Trolley
Strap



UVC
Sterilizer

LAPTOP Backpack

ANTI-THEFT POCKET
BOLSILLO ANTI-ROBO

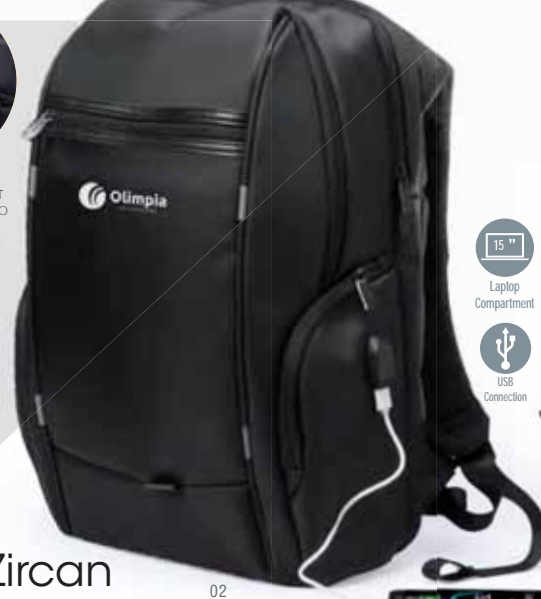

15"

Laptop
Compartment

USB
Connection

06

POWER BANK NOT INCLUDED
POWER BANK NO INCLUIDO

Anti Theft
pocket

Water
Repellent

Zircan 5307

02

Backpack. Nylon. USB Connection. Padded Laptop Compartment. Padded Back and Shoulder Straps.
Rucksack. Nylon. USB Anschluss. Gepolsterte Laptotasche. Gepolsterter Rücken und Schultergurte.
Sac à Dos. Nylon. Connexion USB. Pochette Rembourrée pour Portable. Dos et Bretelles Rembourrées.
Rugzak. Nylon. USB Verbinding. Gewatteerd Laptop Compartment. Gewatteerde Achterzijde en Schouderbanden.

30 × 45 × 20 cm

10

Print Code: G(1), N(8)



Video



10"

Tablet
Compartment

15"

Laptop
Compartment

Merlak 5306

Backpack. Polyester 1680D/ PU. USB Connection. Padded Laptop and Tablet Compartment. Padded Back and Shoulder Straps.

Rucksack. Polyester 1680D/ PU. USB Anschluss. Gepolsterte Laptotasche und Tablet. Gepolsterter Rücken und Schultergurte.

Sac à Dos. Polyester 1680D/ Similicuir. Connexion USB. Pochette Rembourrée pour Portable et Tablet. Dos et Bretelles Rembourrées.

Rugzak. Polyester 1680D/ PU. USB Verbinding. Gewatteerd Laptop en Tablet Compartment. Gewatteerde Achterzijde en Schouderbanden.

30 × 44 × 14 cm

10

Print Code: G(1), N(8)



Video

Water
Repellent

USB
Connection



POWER BANK NOT INCLUDED
POWER BANK NO INCLUIDO

Manthium 5532

Backpack. Polyester 900D. USB Connection. Padded Laptop Compartment. Padded Shoulder Straps.

Rucksack. Polyester 900D. USB Anschluss. Gepolsterte Laptotasche. Gepolsterte Schultergurte.

Sac à Dos. Polyester 900D. Connexion USB. Pochette Rembourrée pour Portable. Bretelles Rembourrées.

Rugzak. Polyester 900D. USB Verbinding. Gewatteerd Laptop Compartment. Gewatteerde Schouderbanden.

32 × 53 × 17 cm

10

Print Code: G(1), N(8)

USB
Connection

10"

Tablet
Compartment

15"

Laptop
Compartment



06



11" Tablet Compartment



15" Laptop Compartment



02

BACKPACK / MOCHILA

Haltrix 6047

Trolley Backpack. Polyester 300D. USB Connection. Padded Laptop Compartment. Padded Shoulder Straps.

Trolley Rucksack. Polyester 300D. USB Anschluss. Gepolsterte Laptoptasche. Gepolsterte Schultergurte.

Sac à Dos Trolley. Polyester 300D. Connexion USB. Pochette Rembourrée pour Portable. Bretelles Rembourrées.

Trolley Rugzak. Polyester 300D. USB Verbinding. Gewatteerd Laptop. Gewatteerde Schouderbanden.

33 x 47 x 22.5 cm

8

Print Code: I(8)



Multifunction



USB Connection

TROLLEY
backpack

369



BACKPACK / MOCHILA



Multifunction



15" Laptop Compartment



Kuman 3488

Trolley Backpack. Polyester 1680D. Padded Laptop Compartment. Padded Shoulder Straps.

Trolley Rucksack. Polyester 1680D. Gepolsterte Laptoptasche. Gepolsterte Schultergurte.

Sac à Dos Trolley. Polyester 1680D. Pochette Rembourrée pour Portable. Bretelles Rembourrées.

Trolley Rugzak. Polyester 1680D. Gewatteerd Laptop Compartment. Gewatteerde Schouderbanden.

36 x 47 x 25 cm

4

Print Code: K(8)





POWER BANK INCLUDED
POWER BANK INCLUIDO

8000
mAh

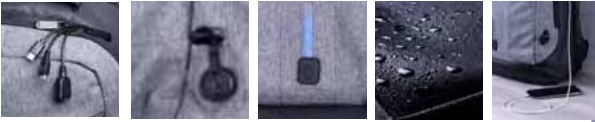

Briden

5971



Power Bank



Type-C
Connection



Water
Repellent



USB
Connection

Power Bank Backpack. Nylon. 8000 mAh. AC Input. Padded Laptop and Tablet Compartment. Padded Back and Shoulder Straps. Cable Included Micro USB, Type C Connection and USB Output.

Power Bank Rucksack. Nylon. 8000 mAh. AC Eingang. Gepolsterte Laptoplasche und Tablet. Gepolsterter Rücken und Schultergurte. Kabel Inklusive Anschluss Micro USB, Typ C und USB Ausgang.

Sac à Dos Power Bank. Nylon. 8000 mAh. Entrée AC. Pochette Rembourrée pour Portable et Tablet. Dos et Bretelles Rembourrées. Câble Inclus Connexion Micro USB, Type C et Sortie USB.

Power Bank Rugzak. Nylon. 8000 mAh. AC Input. Gewatteerd Laptop en Tablet Compartment. Gewatteerde Achterzijde en Schouderbanden. Kabel Inclusief Micro USB, type C Connectie en USB Output.

30 × 46 × 18 cm

10

Print Code: I(8)



12" Tablet
Compartment



17" Laptop
Compartment

LAPTOP backpack



CHARGE YOUR MOBILE DEVICES
AND POWERBANKS
BATTERY NOT INCLUDED



SOLAR ENERGY
ENERGIA SOLAR



10" Tablet
Compartment



15" Laptop
Compartment

Koneit

6128



Solar Panel



Anti Theft
pocket



Combination
Lock



Transport
Card Pocket



USB
Connection

Charger Backpack. Polyester 1200D. Solar Panel 6.5W. USB Connection. Padded Laptop and Tablet Compartment. Padded Back and Shoulder Straps. Combination Lock Included.

Ladegerät Rucksack. Polyester 1200D. Sonnenkollektor 6.5W. USB Anschluss. Gepolsterte Laptoplasche und Tablet. Gepolsterter Rücken und Schultergurte. Sicherheitsverschluss Inklusiv.

Sac à Dos Chargeur. Polyester 1200D. Panneau Solaire 6.5W. Connexion USB. Pochette Rembourrée pour Portable et Tablet. Dos et Bretelles Rembourrées. Fermeture Sécurité Inclus.

Oplader Rugzak. Polyester 1200D. Zonnepaneel 6.5W. USB Verbinding. Gewatteerd Laptop en Tablet Compartment. Gewatteerde Achterzijde en Schouderbanden. Veiligheidsluiting Inclusief.

34 × 45 × 16.5 cm

10

Print Code: I(8)



AN EXTERNAL BATTERY IS REQUIRED, USE OUR POWER BANKS!!
REQUIERE USO DE BATERIA EXTERNA, USE NUESTROS POWER BANKS!

Halton
5972



INDICATOR backpack

Indicator Backpack. Polyester 600D. Led Lights. Padded Laptop Compartment. Padded Back and Shoulder Straps. USB Connection. Cable Included.

Rucksack-Anzeiger. Polyester 600D. Led Lichter. Gepolsterte Laptoptasche. Gepolsterter Rücken und Schultergurte. Anschluss USB. Kabel Inklusiv.

Sac à Dos Indicateur. Polyester 600D. Lumières Led. Pochette Rembourrée pour Portable. Dos et Bretelles Rembourrées. Connexion USB. Câble Inclus.

Ruzgak Richtingaangever. Polyester 600D. Led Lichten. Gewatteerd Laptop Compartment. Gewatteerde Achterzijde en Schouderbanden. USB Connectie. Kabel Inclusief.

28 x 44 x 14 cm

15

Print Code: G(1), N(8)



CONTROL



371

BLINK
PARPADEANTE



15"
Laptop
Compartment



Krepak
6597



Indicator Backpack. Polyester 600D. 4 Leds. 3 Light Modes. Padded Laptop Compartment. Padded Back and Shoulder Straps. Button Batteries Included.
Rucksack-Anzeiger. Polyester 600D. 4 Leds. 3 Leuchtfunktionen. Gepolsterte Laptoptasche. Gepolsterter Rücken und Schultergurte. Knopfzellen Inklusiv.
Sac à Dos Indicateur. Polyester 600D. 4 Leds. 3 Modes de Lumière. Pochette Rembourrée pour Portable. Dos et Bretelles Rembourrées. Piles Bouton Inclus.
Ruzgak Richtingaangever. Polyester 600D. 4 Leds. 3 Licht Posities. Gewatteerd Laptop Compartment. Gewatteerde Achterzijde en Schouderbanden. Knopcel Batterijen Inclusief.

30 x 43 x 13.5 cm

20

Print Code: G(1), N(8)



Video

15"
Laptop
Compartment

31 x 45 x 17 cm
Print Code: G(1), N(8)

20



IDEAL EXTENSION FOR
BACKPACK
PROLONGACIÓN IDEAL
PARA MOCHILAS



PONGEE

104 x 118 cm

02

Kolper

6155

Extendable Umbrella. Pongee. Automatic. Windproof.
Ausziehbarer Regenschirm. Pongee. Automatisch. Antiwindsystem.
Parapluie Extensible. Pongee. Automatique. Système Anti-Vent.
Uitbreidbare Paraplu. Pongee. Automatisch. Windbestendig.

104 x 118 cm

30 / 10

Print Code: G(1), N(8)



06 19 03



Windproof



02 03 05

2L



19

Hydrax

4372



BPA FREE



Transpirable

Sports Backpack. Polyester 600D. Padded Back. Breathable.
Reflective. 2 l Hydration Bladder Included.

Sport Rucksack. Polyester 600D. Gepolsteter Rücken.
Atmungsaktiv. Reflektierend. 2 l Blase Inklusive.

Sac à Dos Sport. Polyester 600D. Dos Rembourrées.
Respirant. Réfléchissant. Réservoir Eau 2 l Inclus.

Sport Rugzak. Polyester 600D. Gewatteerde Achterzijde.
Ademend. Reflecterend. 2 l Waterhouder Inclusief.

32 x 50 cm

20

Print Code: G(1), N(8)

372



04



19



03



Laptop
Compartment



Tablet
Compartment



Rasmusx
6329



Charger Backpack. Ripstop. Solar Panel 6.5W. USB Connection. Padded Laptop
Compartment. Padded Back and Shoulder Straps.

Ladegerät Rucksack. Ripstop. Sonnenkollektor 6.5W. USB Anschluss. Gepolsterte
Laptoptasche. Gepolsteter Rücken und Schultergurte.

Sac à Dos Chargeur. Ripstop. Panneau Solaire 6.5W. Connexion USB. Pochette Rembourrée
pour Portable. Dos et Bretelles Rembourrées.

Oplader Rugzak. Ripstop. Zonnepaneel 6.5W. USB Verbinding. Gewatteerd Laptop
Compartment. Gewatteerde Achterzijde en Schouderbanden.

33 x 52 x 23 cm

10

Print Code: J(8)



03



02

19

05

Trecy
5809

Backpack Cover. Polyester 190T. Adjustable.

Rucksack Hülle. Polyester 190T. Verstellbar.

Etui Sac à Dos. Polyester 190T. Adjustable.

Rugzak Hoes. Polyester 190T. Aanpasbaar.

Consult.

300 / 10

Print Code: G(1)



Water
Repellent

BACKPACK COVER



FOLDABLE
PLEGABLE

Hedux

6194

Foldable Backpack. Polyester 210D/ Ripstop.
Faltbarer Rucksack. Polyester 210D/ Ripstop.
Sac à Dos Pliable. Polyester 210D/ Ripstop.
Opvouwbare Rugzak. Polyester 210D/ Ripstop.

37 x 61 x 20.5 cm 100 / 50

Print Code: G(1), N(8)



Water
Repellent



02

373

swiscent
ORIZONS[®]
adventure



03



02



19



19

03



16

Virtux

7295

Backpack. Polyester 420D. Padded Back and Shoulder Straps.
Rucksack. Polyester 420D. Gepolsterter Rücken und Schultergurte.
Sac à Dos. Polyester 420D. Dos et Bretelles Rembourrées.
Rugzak. Polyester 420D. Gewatteerde Achterzijde en Schouderbanden.

35 x 53 x 28 cm

20

Print Code: J(8)



Water
Repellent

Densul

6168

Backpack. Polyester 210D/ Ripstop. Padded Back and Shoulder Straps.
Rucksack. Polyester 210D/ Ripstop. Gepolsterter Rücken und Schultergurte.
Sac à Dos. Polyester 210D/ Ripstop. Dos et Bretelles Rembourrées.
Rugzak. Polyester 210D/ Ripstop. Gewatteerde Achterzijde en Schouderbanden.

32 x 47 x 28 cm

20

Print Code: G(1), N(8)



Water
Repellent



374



RFID Protection

Kanit 6426

Bag. Polyester 600D. RFID Protected. Shoe Compartment.
Tasche. Polyester 600D. RFID Schutz. Schuh Staufach.
Sac. Polyester 600D. Protecteur RFID. Compartiment Porte-Chaussures.
Tas. Polyester 600D. Protecteur RFID. Schoen Compartment.

50 × 38 × 24 cm

20

Print Code: G(1), N(8)

SHOE COMPARTMENT

POWER BANK NOT INCLUDED
POWER BANK NO INCLUIDO



USB Connection

Donatox 6043

Bag. Polyester 600D. USB Connection. Shoe Compartment.
Tasche. Polyester 600D. USB Anschluss. Schuh Staufach.
Sac. Polyester 600D. Connexion USB. Compartiment Porte-Chaussures.
Tas. Polyester 600D. USB Verbindung. Schoen Compartment.

50 × 30 × 28.5 cm

25

Print Code: G(1), N(8), P

SHOES COMPARTMENT



Lutux 6493

Bag. Polyester 600D.
Tasche. Polyester 600D.
Sac. Polyester 600D.
Tas. Polyester 600D.

45 × 22 × 21 cm

30

Print Code: G(1), N(8)



NEW



02

Melbor 6815

Bag. Polyester 600D.
Tasche. Polyester 600D.
Sac. Polyester 600D.
Tas. Polyester 600D.

65 × 34 × 33 cm

Print Code: G(1), N(8)

10



03



06

19

16



375

RPET

 The fabric used in the manufacturing process of this bag is made of recycled plastic (RPET). Like this, the emission of plastic residues to our planet and the consumption of energy is drastically reduced, resulting in a much more eco-friendly process.

El material de esta bolsa está fabricado con plástico reciclado (RPET), que, además de ayudar en la disminución de residuos plásticos en el planeta, utiliza menos energía en el proceso de fabricación, haciendo que sea mucho menos dañino para el medio ambiente.

STOP PLASTIC POLLUTING THE OCEAN

NEW



Holtrum 6841

Bag. Polyester 600D RPET.
Tasche. Polyester 600D RPET.
Sac. Polyester 600D RPET.
Tas. Polyester 600D RPET.

48.5 × 28 × 27.5 cm

Print Code: G(1), N(8)

30





Drako

3632

Bag. Polyester 600D.
Tasche. Polyester 600D.
Sac. Polyester 600D.
Tas. Polyester 600D.

52 × 27 × 25 cm 30

Print Code: G(1), N(8)

03



IDEAL SPORT

376



19

Novo

9146

Bag. Polyester 600D.
Tasche. Polyester 600D.
Sac. Polyester 600D.
Tas. Polyester 600D.

42 × 24 × 20 cm 50

Print Code: G(1), N(8)



19

Lai

9931

Bag. Polyester 600D.
Tasche. Polyester 600D.
Sac. Polyester 600D.
Tas. Polyester 600D.

62 × 35 × 25 cm 25

Print Code: G(1), N(8)



03



03

19

02

SHOE COMPARTMENT

Divux

6494

Backpack Bag. Nylon 420D. Padded Back and Shoulder Straps. Shoe Compartment.
Rucksack Tasche. Nylon 420D. Gepolsterter Rücken und Schultergurte. Schuh Staufach.
Sac à Dos. Nylon 420D. Dos et Bretelles Rembourrées. Compartiment Porte-Chaussures.
Rugzak. Nylon 420D. Gewatteerde Achterzijde en Schouderbanden. Schoen Compartment.

47 x 25 x 24 cm 20

Print Code: G(1), N(8)



02

SHOE COMPARTMENT



03

19

05

Dorian

4466

Backpack. Polyester 600D. Padded Back and Shoulder Straps. Shoe Compartment.
Rucksack. Polyester 600D. Gepolsterter Rücken und Schultergurte. Schuh Staufach.
Sac à Dos. Polyester 600D. Dos et Bretelles Rembourrées. Compartiment Porte-Chaussures.
Rugzak. Polyester 600D. Gewatteerde Achterzijde en Schouderbanden. Schoen Compartment.

30 x 46 x 15 cm 40

Print Code: G(1), N(8)



RIPSTOP



03

FOLDABLE



Ribuk

4779

Backpack Bag. Ripstop. Foldable.
Rucksack Tasche. Ripstop. Faltpbar.
Sac à Dos. Ripstop. Pliable.
Rugzak. Ripstop. Opvouwbaar.

52 x 27 x 26 cm 50 / 10

Print Code: F(1), G(1), H(1)



02

11

19



Kenny

5789

Drawstring Bag. 15% Cotton/ 85% Polyester.
 Rucksack. 15% Baumwolle/ 85% Polyester.
 Sac à Dos. 15% Coton/ 85% Polyester.
 Rugzak. 15% Katoen/ 85% Polyester.

📏 0 26 × 62 cm 📦 50

🎨 Print Code: F(1), N(8), O, P

02



03

CONVERTS INTO BACKPACK
 CONVERTIBLE EN MOCHILA



19

Sinpac

3638

Duffel Backpack. Polyester 600D.
 Seesack Rucksack. Polyester 600D.
 Sac à Dos Balluchon. Polyester 600D.
 Plunje-Rugzak. Polyester 600D.

📏 0 29 × 40 cm 📦 50

🎨 Print Code: F(1), N(8), O, P



02

03

Kenit

3931

Foldable Bag. Polyester 210T.
 Faltbare Tasche. Polyester 210T.
 Sac Pliable. Polyester 210T.
 Opvouwbare Tas. Polyester 210T.

📏 25 x 50 cm 📦 50
 🎨 Print Code: F(1), G(1), H(1)



19

02



03



Sofet

4593

Foldable Bag. Ripstop.
 Faltbare Tasche. Ripstop.
 Sac Pliable. Ripstop.
 Opvouwbare Tas. Ripstop.

📏 42 x 32.5 x 17 cm 📦 100 / 10
 🎨 Print Code: F(1), G(1), H(1)



19



RIPSTOP



05



03



FOLDABLE



06

02

03

11

Curcox

4736

Bag. Polyester 600D.
 Tasche. Polyester 600D.
 Sac. Polyester 600D.
 Tas. Polyester 600D.

📏 40 x 29 x 13 cm 📦 50
 🎨 Print Code: G(1), N(8)



19

Kisu

4150

Bag. Non-Woven.
 Tasche. Non-Woven.
 Sac. T.N.T.
 Tas. Non-Woven.

📏 46 x 26 x 26 cm 📦 150
 🎨 Print Code: F(1)



03

19

05



02



03



04

Mendel

6375

Waistbag. Ripstop.
Gürteltasche. Ripstop.
Banane. Ripstop.
Heuptas. Ripstop.

31 × 11.5 cm 100 / 50

Print Code: E(1), N(8)



02



19



16



02



01



03



19

Inxul

4374

Waistbag. Polyester 600D.
Gürteltasche. Polyester 600D.
Banane. Polyester 600D.
Heuptas. Polyester 600D.

35 × 15 cm 200 / 10

Print Code: E(1), N(8)

380



BOTTLE NOT INCLUDED
BOTE NO INCLUIDO

19



03

Tildak

5502

Waistbag. Polyester 210D. Padded Back.
Gürteltasche. Polyester 210D. Gepolsterter Rücken.
Banane. Polyester 210D. Dos Rembourrés.
Heuptas. Polyester 210D. Gewatteerde Achterzijde.

27 × 18 cm 200 / 10

Print Code: F(1), N(8)



04



02



03

Crown

9639

Waistbag. Polyester 420D.
Gürteltasche. Polyester 420D.
Banane. Polyester 420D.
Heuptas. Polyester 420D.

29 × 10 × 6 cm 200 / 10

Print Code: E(1), N(8)



19



02

RPET

i The fabric used in the manufacturing process of this waistbag is made of recycled plastic (RPET). Like this, the emission of plastic residues to our planet and the consumption of energy is drastically reduced, resulting in a much more eco-friendly process.

El material de esta riñonera está fabricado con plástico reciclado (RPET), que, además de ayudar en la disminución de residuos plásticos en el planeta, utiliza menos energía en el proceso de fabricación, haciendo que sea mucho menos dañino para el medio ambiente.

STOP PLASTIC
POLLUTING
THE OCEAN



Versox
6218

Shoulder Bag. Polyester 300D. USB Connection. Padded.
Umhängetasche. Polyester 300D. USB Anschluss. Gepolstert.
Bandoulière. Polyester 300D. Connexion USB. Rembourrée.
Schoudertas. Polyester 300D. USB Verbinding. Gewatteerd.

20 x 29 x 6.5 cm 200 / 50
Print Code: F(1), N(8)



Parks
6840

Waistbag. Polyester 600D RPET.
Gürteltasche. Polyester 600D RPET.
Banane. Polyester 600D RPET.
Heuptas. Polyester 600D RPET.

25 x 17 x 8 cm 200 / 50
Print Code: E(1), N(8)



02



2 COMPARTMENTS

Nussa
6505

Waistbag. Natural Cork.
Gürteltasche. Naturkork.
Banane. Bouchon Naturel.
Heuptas. Natuurlijk Kurk.

31 x 13 cm 200 / 10
Print Code: E(1)

Zunder
6219

Waistbag. Polyester 600D.
Gürteltasche. Polyester 600D.
Banane. Polyester 600D.
Heuptas. Polyester 600D.

25 x 17 x 8 cm 200 / 50
Print Code: E(1), N(8)



06

07

16

19

03

SHOULDER BAGS



Zukar
4606

Shoulder Bag. Polyester 420D.
Umhängetasche. Polyester 420D.
Bandoulière. Polyester 420D.
Schoudertas. Polyester 420D.

■■■■■■■■ 34 × 27 × 10 cm 📦 50 / 5
🌈 Print Code: G(1), N(8)



Scarlett
5233

Shoulder Bag. Polyester 600D.
Umhängetasche. Polyester 600D.
Bandoulière. Polyester 600D.
Schoudertas. Polyester 600D.

■■■■■■■■ 43 × 31 × 11 cm 📦 30
🌈 Print Code: F(1), N(8)



Maytol
4918

Shoulder Bag. Polyester 600D. Padded Back.
Umhängetasche. Polyester 600D. Gepolsteter Rücken.
Bandoulière. Polyester 600D. Dos Rembourrées.
Schoudertas. Polyester 600D. Gewatteerde Achterzijde.

■■■■■■■■ 35 × 30 × 12 cm 📦 40
🌈 Print Code: F(6), N(8), R

SUBLIMATION



Shoulder BAGS



Isis
3558

Shoulder Bag. Polyester 600D.
Umhängetasche. Polyester 600D.
Bandoulière. Polyester 600D.
Schoudertas. Polyester 600D.
16.5 x 23 cm 100 / 10
Print Code: F(1), N(8)

03



13



02

03



02

07

19

Casual
3249

Shoulder Bag. Polyester 600D.
Umhängetasche. Polyester 600D.
Bandoulière. Polyester 600D.
Schoudertas. Polyester 600D.
25 x 34 x 5 cm 100 / 20
Print Code: F(1), N(8)

Jasmine
9843

Shoulder Bag. Non-Woven.
Umhängetasche. Non-Woven.
Bandoulière. T.N.T.
Schoudertas. Non-Woven.
30 x 37 x 7 cm 250 / 50
Print Code: F(1)



03

shoulder BAGS



07

Piluto
8547

Shoulder Bag. Polyester 600D.
Umhängetasche. Polyester 600D.
Bandoulière. Polyester 600D.
Schoudertas. Polyester 600D.

14 × 18.5 × 7.5 cm 100 / 20

Print Code: E(1), N(8), O



19

Karan
9675

Shoulder Bag. Polyester 600D.
Umhängetasche. Polyester 600D.
Bandoulière. Polyester 600D.
Schoudertas. Polyester 600D.

10 × 15.5 × 8 cm 100 / 10

Print Code: E(1), N(8), O





04

Pooler

4527

Multipurpose Bag. Soft Shell.
 Mehrzwecktasche. Soft Shell.
 Fourre-Tout. Soft Shell.
 Multifunctioneel Tasje. Soft Shell.

9 x 14 x 2 cm 200 / 50
 Print Code: E(1), N(8)



02 19 07 03



02



01 03
 05 19

Yobok

4521

Multipurpose Bag. Non-Woven.
 Mehrzwecktasche. Non-Woven.
 Fourre-Tout. T.N.T.
 Multifunctioneel Tasje. Non-Woven.

17 x 22 x 6.2 cm 500 / 100
 Print Code: D(1)



SUITABLE FOR ALL MOBILE SIZES
 VÁLIDO PARA TODOS LOS TAMAÑOS DE MÓVIL



19

Idolf

4533

Multipurpose Bag. Polyester.
 Mehrzwecktasche. Polyester.
 Fourre-Tout. Polyester.
 Multifunctioneel Tasje. Polyester.

7.5 x 13.5 cm 1000 / 50
 Print Code: D(1), N(8), R



01 02 03 04 05
 11

REDUCE REUSE RECYCLE



#ecco-friendly



EN The eco-sustainable trend and the most original designs shape this collection of bottles, mugs, thermos and reusable containers. Get inspired by the most innovative, natural, and environmentally friendly materials to avoid single-use products in our everyday life.

DE Der ökologisch nachhaltige Trend und die originellsten Designs, prägen diese Kollektion von Trinkflaschen, Tassen, Thermoskannen und wiederverwendbaren Behältern. Lassen Sie sich von den innovativsten, natürlichsten und umweltfreundlichsten Materialien inspirieren, um Einwegprodukte in unserem täglichen Leben zu vermeiden.

FR Tendance éco-responsable et designs audacieux sont les maîtres-mots de cette collection de gourdes, tasses, thermos et divers contenants réutilisables. Inspirez-vous de ses matériaux innovants, naturels et respectueux de l'environnement pour bannir les produits à usage unique de notre vie quotidienne.

NL De eco-duurzame trend en de meest originele ontwerpen geven vorm aan deze collectie van vaten, bekere, thermosflessen en herbruikbare containers. Laat u inspireren door de meest innovatieve, natuurlijke en milieuvriendelijke materialen om producten voor eenmalig gebruik in ons dagelijks leven te vermijden.



MUGS, BOTTLES & THER- MOS MOS

NEW



Rekka
PG. 423

NEW



Syrma
PG. 423



Yotel
PG. 399



Impex
PG. 391

Durnox
PG. 411



NEW



Plibun
PG. 404



NEW

CERAMIC

MATT
COLLECTION
ACABADO MATE

Bercom

6312

Mug, Ceramic, 300 ml, Individual Presentation.
Tasse, Keramik, 300 ml, Individuelle Präsentation.
Tasse, Céramique, 300 ml, Présentation Individuelle.
Mok, Keramiek, 300 ml, Individuele Presentatie.

██████████ Ø 8.6 × 8.5 cm

📦 36

🌈 Print Code: F(4)

300 ml



390



Ideal
Sublimation

350 ml

Talmex

6286

Sublimation Mug, Ceramic, 350 ml, Individual Presentation.
Sublimations Tasse, Keramik, 350 ml, Individuelle Präsentation.
Tasse Sublimation, Céramique, 350 ml, Présentation Individuelle.
Sublimatie Mok, Keramiek, 350 ml, Individuele Presentatie.

██████████ Ø 8.2 × 9.6 cm

📦 36

🌈 Print Code: Q



480 ml

Korpus

6311

Mug, Ceramic, 480 ml, Individual Presentation.
Tasse, Keramik, 480 ml, Individuelle Präsentation.
Tasse, Céramique, 480 ml, Présentation Individuelle.
Mok, Keramiek, 480 ml, Individuele Presentatie.

██████████ Ø 8.8 × 14.9 cm

📦 20

🌈 Print Code: F(4)



CERAMIC

BEST-SELLER
SHINY FINISH

THE BEST PRICE

Impex

3144

Mug, Ceramic. 370 ml. Individual Presentation.
Tasse, Keramik. 370 ml. Individuelle Präsentation.
Tasse, Céramique. 370 ml. Présentation Individuelle.
Mok, Keramiek. 370 ml. Individuele Presentatie.

Ø 8.2 × 9.8 cm

36

Print Code: F(4)

370 ml

250 ml

380 ml

80 ml

391

Daimy

5182

Mug, Ceramic. 250 ml. Individual Presentation.
Tasse, Keramik. 250 ml. Individuelle Präsentation.
Tasse, Céramique. 250 ml. Présentation Individuelle.
Mok, Keramiek. 250 ml. Individuele Presentatie.

Ø 7.4 × 8.4 cm

48

Print Code: F(4)

Lutin

5194

Mug, Ceramic. 80 ml. Individual Presentation.
Tasse, Keramik. 80 ml. Individuelle Präsentation.
Tasse, Céramique. 80 ml. Présentation Individuelle.
Mok, Keramiek. 80 ml. Individuele Presentatie.

Ø 5.4 × 6.3 cm

72

Print Code: F(4)

Tarbox

4749

Mug, Ceramic. 380 ml. Individual Presentation.
Tasse, Keramik. 380 ml. Individuelle Präsentation.
Tasse, Céramique. 380 ml. Présentation Individuelle.
Mok, Keramiek. 380 ml. Individuele Presentatie.

Ø 9 × 8.6 cm

36

Print Code: F(4)

CERAMIC



Loom

9464

Mug. Ceramic. 370 ml. Individual Presentation.
Tasse. Keramik. 370 ml. Individuelle Präsentation.
Tasse. Céramique. 370 ml. Présentation Individuelle.
Mok. Keramiek. 370 ml. Individuele Presentatie.

Print Code: F(4) 36

Print Code: F(4)

370 ml

vertrio

392

350 ml



02

380 ml

02



Passak

4706

Mug. Ceramic. 380 ml. Individual Presentation.
Tasse. Keramik. 380 ml. Individuelle Präsentation.
Tasse. Céramique. 380 ml. Présentation Individuelle.
Mok. Keramiek. 380 ml. Individuele Presentatie.

Print Code: G(4) 36

Print Code: G(4)

Samay

5688

Mug. Ceramic. 300 ml. Individual Presentation.
Tasse. Keramik. 300 ml. Individuelle Präsentation.
Tasse. Céramique. 300 ml. Présentation Individuelle.
Mok. Keramiek. 300 ml. Individuele Presentatie.

Print Code: F(4) 36

Print Code: F(4)

Cotes

9459

Mug. Ceramic. 350 ml. Individual Presentation.
Tasse. Keramik. 350 ml. Individuelle Präsentation.
Tasse. Céramique. 350 ml. Présentation Individuelle.
Mok. Keramiek. 350 ml. Individuele Presentatie.

Print Code: F(4) 36

Print Code: F(4)

350 ml

03

07

19

04

Plesik

4705

Mug. Ceramic. 350 ml. Individual Presentation.
Tasse. Keramik. 350 ml. Individuelle Präsentation.
Tasse. Céramique. 350 ml. Présentation Individuelle.
Mok. Keramiek. 350 ml. Individuele Presentatie.

Print Code: F(4) 36

Print Code: F(4)



CERAMIC

470 ml



01

Mabery

5686

Mug. Ceramic. 470 ml. Individual Presentation.
Tasse. Keramik. 470 ml. Individuelle Präsentation.
Tasse. Céramique. 470 ml. Présentation Individuelle.
Mok. Keramiek. 470 ml. Individuele Presentatie.

Ø 9.6 × 10.5 cm

36

Print Code: F(4)

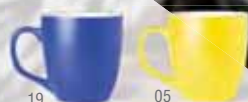

19

05



04

03



02

370 ml



02

Zifor

3963

Mug. Ceramic. 370 ml. Individual Presentation.
Tasse. Keramik. 370 ml. Individuelle Präsentation.
Tasse. Céramique. 370 ml. Présentation Individuelle.
Mok. Keramiek. 370 ml. Individuele Presentatie.

Ø 8.2 × 9.8 cm

36

Print Code: F(4)



05

07

03

19



04

300 ml



01

Sinor

5685

Mug. Ceramic. 300 ml. Individual Presentation.
Tasse. Keramik. 300 ml. Individuelle Präsentation.
Tasse. Céramique. 300 ml. Présentation Individuelle.
Mok. Keramiek. 300 ml. Individuele Presentatie.

Ø 8.6 × 8.5 cm

36

Print Code: F(4)



03

02

21

16

350 ml



02

Margot

3189

Mug. Ceramic. 350 ml. Individual Presentation.
Tasse. Keramik. 350 ml. Individuelle Präsentation.
Tasse. Céramique. 350 ml. Présentation Individuelle.
Mok. Keramiek. 350 ml. Individuele Presentatie.

Ø 9 × 10.5 cm

36

Print Code: F(4)



07

19

04

03

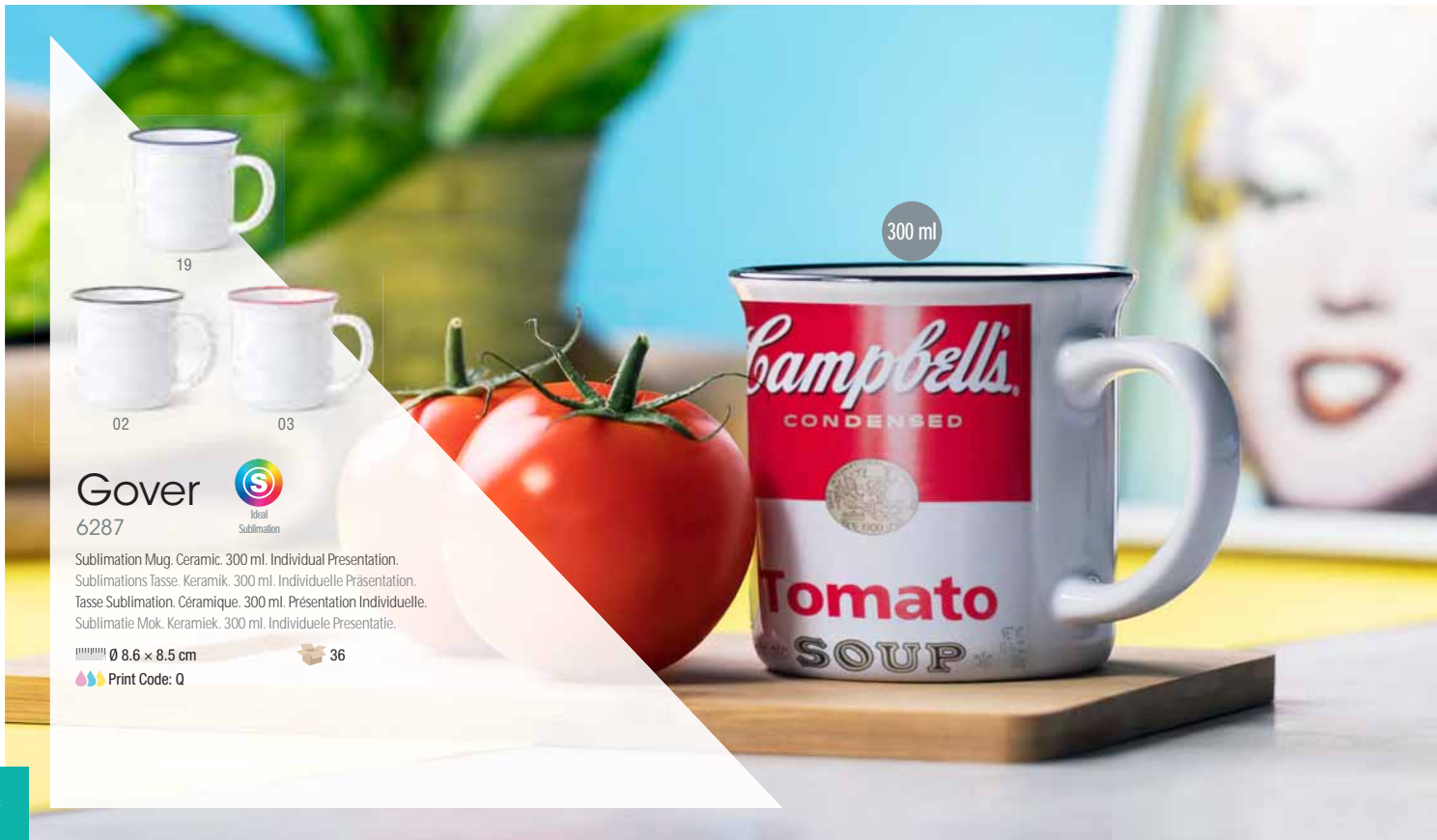

300 ml

Gover
6287



Sublimation Mug. Ceramic. 300 ml. Individual Presentation.
 Sublimations Tasse. Keramik. 300 ml. Individuelle Präsentation.
 Tasse Sublimation. Céramique. 300 ml. Présentation Individuelle.
 Sublimatie Mok. Keramiek. 300 ml. Individuele Presentatie.

Ø 8.6 x 8.5 cm

36

Print Code: Q



HOT LIQUID



MAGIC MUG
SUBLIMATION

This mug has an outer coating specially designed for sublimation printing, its marking will be imperceptible by the black coating, and will magically appear on contact with the hot liquid. wow!

Este taza tiene un recubrimiento exterior especialmente diseñado para su impresión en sublimación, su marcaje quedará imperceptible por el recubrimiento negro, y mágicamente aparecerá al contacto con el líquido caliente. wow!



Bardot
5837



Sublimation Mug. Ceramic. 350 ml. Individual Presentation.
 Sublimations Tasse. Keramik. 350 ml. Individuelle Präsentation.
 Tasse Sublimation. Céramique. 350 ml. Présentation Individuelle.
 Sublimatie Mok. Keramiek. 350 ml. Individuele Presentatie.

Ø 8.2 x 9.6 cm

36

Print Code: F(1), Q

Video



SUBLIMATION



Dolten
5183

Sublimation Mug. Ceramic. 250 ml. Individual Presentation.
Sublimations tasse. Keramik. 250 ml. Individuelle Präsentation.
Tasse Sublimation. Céramique. 250 ml. Présentation Individuelle.
Sublimatie Mok. Keramiek. 250 ml. Individuele Presentatie.

Ø 7.4 × 8.4 cm

48

Print Code: Q

250 ml Dolten

350 ml

Harnet

395

350 ml

Bornel

350 ml

Kaffir

Bornel
3893



Sublimation Mug. Ceramic. 350 ml. Individual Presentation.
Sublimations Tasse. Keramik. 350 ml. Individuelle Präsentation.
Tasse Sublimation. Céramique. 350 ml. Présentation Individuelle.
Sublimatie Mok. Keramiek. 350 ml. Individuele Presentatie.

Ø 8.2 × 9.6 cm

36

Print Code: Q

Kaffir
5184



Sublimation Mug. Ceramic. 350 ml. Individual Presentation.
Sublimations Tasse. Keramik. 350 ml. Individuelle Präsentation.
Tasse Sublimation. Céramique. 350 ml. Présentation Individuelle.
Sublimatie Mok. Keramiek. 350 ml. Individuele Presentatie.

Ø 9 × 10 cm

36

Print Code: Q



19

02

04

03

07

05

Harnet
3894

Sublimation Mug. Ceramic. 350 ml. Individual Presentation.
Sublimations Tasse. Keramik. 350 ml. Individuelle Präsentation.
Tasse Sublimation. Céramique. 350 ml. Présentation Individuelle.
Sublimatie Mok. Keramiek. 350 ml. Individuele Presentatie.

Ø 8.2 × 9.6 cm

36

Print Code: Q



REGISTERED DESIGN
DISEÑO REGISTRADO

Ashley

Dariel

Nermon

Colorful

396



Ashley

5425

Mug. Ceramic. 370 ml. Individual Presentation.
Tasse. Keramik. 370 ml. Individuelle Präsentation.
Tasse. Céramique. 370 ml. Présentation Individuelle.
Mok. Keramiek. 370 ml. Individuele Presentatie.

Ø 8.2 × 9.8 cm

36

Print Code: F(4)

Dariel

5038

Mug. Ceramic. 370 ml. Individual Presentation. Chalk Included.
Tasse. Keramik. 370 ml. Individuelle Präsentation. Kreide Inklusiv.
Tasse. Céramique. 370 ml. Présentation Individuelle. Craie Inclus.
Mok. Keramiek. 370 ml. Individuele Presentatie. Krijtje Inclusief.

Ø 8.2 × 9.8 cm

36

Print Code: F(1)

Nermon

5165

Cup. Ceramic. 460 ml. Individual Presentation. Chalk Included.
Trinkbecher. Keramik. 460 ml. Individuelle Präsentation. Kreide Inklusiv.
Verre. Céramique. 460 ml. Présentation Individuelle. Craie Inclus.
Beker. Keramiek. 460 ml. Individuele Presentatie. Krijtje Inclusief.

Ø 8.8 × 13.5 cm

36

Print Code: F(1)

Colorful

3272

Mug. Ceramic. 350 ml. Individual Presentation. Chalk Included.
Tasse. Keramik. 350 ml. Individuelle Präsentation. Kreide Inklusiv.
Tasse. Céramique. 350 ml. Présentation Individuelle. Craie Inclus.
Mok. Keramiek. 350 ml. Individuele Presentatie. Krijtje Inclusief.

Ø 8.2 × 9.6 cm

36

Print Code: F(1)

SPECIAL LASER ENGRAVING



These mugs have an outer coating especially designed for laser engraving. This will ensure that your advertising or brand is perfectly engraved to match the interior colour of your chosen mug.

Estas tazas tienen un recubrimiento exterior especialmente diseñado para grabado láser, con el que conseguirá que su publicidad o marca quede perfectamente grabada a juego con el color del interior de la taza elegida.



Renkur 5984

Mug. Ceramic. 350 ml. Individual Presentation.
Tasse. Keramik. 350 ml. Individuelle Präsentation.
Tasse. Céramique. 350 ml. Présentation Individuelle.
Mok. Keramiek. 350 ml. Individuele Presentatie.

Ø 8.2 x 9.6 cm



Print Code: F(4), L2

350 ml

09

23

350 ml



11



Lousa 5291

Mug. Ceramic. 350 ml. Individual Presentation.
Tasse. Keramik. 350 ml. Individuelle Präsentation.
Tasse. Céramique. 350 ml. Présentation Individuelle.
Mok. Keramiek. 350 ml. Individuele Presentatie.

Ø 8.2 x 9.6 cm



Print Code: F(4), L2



19

350 ml



Kulmer 5836

Mug. Ceramic. 350 ml. Individual Presentation.
Tasse. Keramik. 350 ml. Individuelle Präsentation.
Tasse. Céramique. 350 ml. Présentation Individuelle.
Mok. Keramiek. 350 ml. Individuele Presentatie.

Ø 8.2 x 9.6 cm



Print Code: F(4), L2



05

350 ml



Bafy 5290

Mug. Ceramic. 350 ml. Individual Presentation.
Tasse. Keramik. 350 ml. Individuelle Präsentation.
Tasse. Céramique. 350 ml. Présentation Individuelle.
Mok. Keramiek. 350 ml. Individuele Presentatie.

Ø 8.2 x 9.6 cm



Print Code: F(4), L2



397

BOROSILICATE
GLASS

BOROSILICATE GLASS



180 ml



Morkel

6482

Set. Borosilicate Glass/ Bamboo. 180 ml. 3 Pieces.

Set. Borosilikat Glas/ Bambus. 180 ml. 3 Stück.

Set. Verre Borosilicate/ Bambou. 180 ml. 3 Pièces.

Set. Borosilicate Glas/ Bamboe. 180 ml. 3 Stuks.

16.4 x 8 x 12.3 cm

50

Print Code: F(1), C(4), L2

398

BOROSILICATE
GLASS

450 ml



420 ml

BOROSILICATE
GLASS

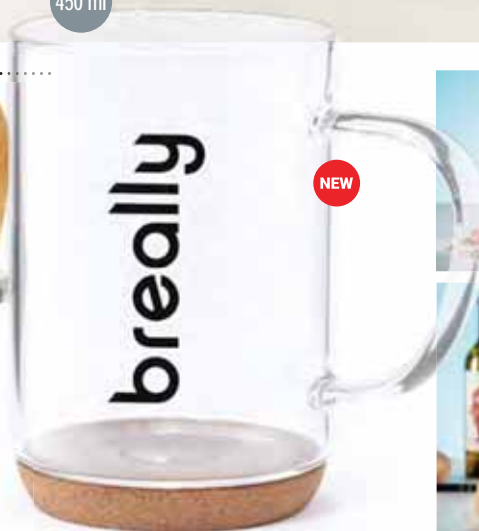

NEW



1L

IDEAL TO
WATER AND WINE

Kipal

6481

Mug. Borosilicate Glass/ Bamboo. 420 ml. Individual Presentation.

Tasse. Borosilikat Glas/ Bambus. 420 ml. Individuelle Präsentation.

Tasse. Verre Borosilicate/ Bambou. 420 ml. Présentation Individuelle.

Mok. Borosilicate Glas/ Bamboe. 420 ml. Individuele Presentatie.

8.7 x 10.6 cm

50

Print Code: F(1), C(4), L2

Hindras

6865

Mug. Borosilicate Glass/ Natural Cork. 450 ml. Individual Presentation.

Tasse. Borosilikat Glas/ Naturkork. 450 ml. Individuelle Präsentation.

Tasse. Verre Borosilicate/ Bouchon Naturel. 450 ml. Présentation Individuelle.

Mok. Borosilicate Glas/ Natuurlijk Kurk. 450 ml. Individuele Presentatie.

8 x 11.5 cm

36

Print Code: F(1), L2

Lonpel

6580

Bottle. Glass/ Natural Cork. 1 L. Individual Presentation.

Trinkflasche. Glas/ Naturkork. 1 L. Individuelle Präsentation.

Bouteille. Verre/ Bouchon Naturel. 1 L. Présentation Individuelle.

Fles. Glas/ Natuurlijk Kurk. 1 L. Individuele Presentatie.

9.3 x 27.2 cm

20

Print Code: G(1), L2

MATT COLLECTION



399



420 ml

02

01

Bokun
6585

Mug. Ceramic/ Natural Cork. 420 ml. Individual Presentation.
Tasse. Keramik/ Naturkork. 420 ml. Individuelle Präsentation.
Tasse. Céramique/ Bouchon Naturel. 420 ml. Présentation Individuelle.
Mok. Keramiek/ Natuurlijk Kurk. 420 ml. Individuele Presentatie.

▄▄▄▄▄ Ø 9 × 11 cm

📦 36

🌈 Print Code: F(4)



370 ml

Yotel
6586

Mug. Ceramic/ Bamboo. 370 ml. Individual Presentation.
Tasse. Keramik/ Bambus. 370 ml. Individuelle Präsentation.
Tasse. Céramique/ Bambou. 370 ml. Présentation Individuelle.
Mok. Keramiek/ Bamboe. 370 ml. Individuele Presentatie.

▄▄▄▄▄ Ø 8.2 × 10.5 cm

📦 36

🌈 Print Code: F(4), L2

GLASS

SPECIAL

LASER ENGRAVING C02 & SUBLIMATION

This glass has an external coating specially designed for laser engraving and sublimation printing, with which you will see your advertising or brand printed in a striking and lasting way.

Este vaso tiene un recubrimiento exterior especialmente diseñado para grabado láser e impresión en sublimación, con las que conseguirá que su publicidad o marca quede impresa de forma impactante y duradera.



Raptol

SUBLIMATION PRINTING /
RESULTADO EN SUBLIMACIÓN

LASER ENGRAVING /
RESULTADO EN GRABADO LÁSER

400

480 ml



23

09

GLASS

300 ml



19



04

03

05

Kisla
4245

Glass. Glas. 300 ml.
Glas. Glas. 300 ml.
Verre. Verre. 300 ml.
Glas. Glas. 300 ml.

▬▬▬▬▬ Ø 7.7 × 12 cm

Print Code: F(1), L2

📦 48 / 6

Raptol
5985

Glass. Glas. 480 ml. Individual Presentation.
Glas. Glas. 480 ml. Individuelle Präsentation.
Verre. Verre. 480 ml. Présentation Individuelle.
Glas. Glas. 480 ml. Individuelle Presentatie.

▬▬▬▬▬ Ø 8.8 × 15 cm

Print Code: F(4), Q, L2

📦 36



..... SILICONE



16

19

03

Keylor

6288

Cup. Ceramic/ Silicone. 400 ml. Individual Presentation.
 Trinkbecher. Keramik/ Silikon. 400 ml. Individuelle Präsentation.
 Verre. Céramique/ Silicone. 400 ml. Présentation Individuelle.
 Beker. Keramiek/ Siliconen. 400 ml. Individuele Presentatie.

..... Ø 9.5 × 14.9 cm

📦 36

🌈 Print Code: F(4)



400 ml

360
degrees

CERAMIC

02

401



03

05

Nelo

3789

Cup. Ceramic/ Silicone. 350 ml. Individual Presentation.
 Trinkbecher. Keramik/ Silikon. 350 ml. Individuelle Präsentation.
 Verre. Céramique/ Silicone. 350 ml. Présentation Individuelle.
 Beker. Keramiek/ Siliconen. 350 ml. Individuele Presentatie.

..... Ø 8 × 11.2 cm

📦 48

🌈 Print Code: F(4)

350 ml

19

420 ml



19

04

05

07

03

11

01



BPA FREE



Kimstar

2515

Cup. PP. 420 ml.
 Trinkbecher. PP. 420 ml.
 Verre. PP. 420 ml.
 Beker. PP. 420 ml.

..... Ø 9.1 × 13 cm

📦 100

🌈 Print Code: D(1)



Wireless
Charger



Fast charge
10W



Type-C
Connection



350 ml

SPECIALLY DESIGNED
HEATING MUG

Kalan
6533

Charger Cup Warmer, Ceramic/ ABS, 350 ml. Wireless. Fast Charger 10W. Type C Connection. Cable Included.

Tasse Warmer Ladegerät. Keramik/ ABS, 350 ml. Drahtlos. Schnelle Aufladung 10W. Anschluss Typ C. Kabel Inklusiv.

Chauffe Tasses Chargeur. Céramique/ ABS, 350 ml. Sans Fil. Charge Rapide 10W. Connexion Type C. Cable Inclus.

Warmhoudplaatje Oplader. Keramiek/ ABS, 350 ml. Draadloos. Snellader 10W. Type C Connectie. Kabel Inclusief.

11 × 12.5 × 11 cm

20

Print Code: G(4), L2

Video



402



03



03

Tolman

6191

Cup Warmer. PVC. USB Connection. Cable Included.

Tasse Warmer. PVC. USB Anschluss. Kabel Inklusiv.

Chauffe Tasses. PVC. Connexion USB. Cable Inclus.

Warmhoudplaatje. PVC. USB Verbinding. Kabel Inclusief.

Ø 9 × 0.5 cm

200 / 100

Print Code: L2



02

19

01

Mug

9528

Cup Warmer. USB Connection. Cable Included.

Tasse Warmer. USB Anschluss. Kabel Inklusiv.

Chauffe Tasses. Connexion USB. Cable Inclus.

Warmhoudplaatje. USB Verbinding. Kabel Inclusief.

Ø 10 × 2.1 cm

100 / 25

Print Code: D(4)



11

19

09

01

CHARGING
STATION

 **Bluetooth®**



580 ml



Husod

6004

Earphones Bottle, Stainless Steel, 580 ml, Bluetooth Connection, USB Rechargeable, Individual Presentation, Cable Included.

Kopfhörer Trinkflasche, Rostfreier Stahl, 580 ml, Bluetooth Anschluss, USB Wiederaufladbar, Individuelle Präsentation, Kabel Inklusiv.

Bidon Ecouteurs, Acier Inox, 580 ml, Connexion Bluetooth, Rechargeable USB, Présentation Individuelle, Cable Inclusif.

Oordop Fles, Roestvrij Staal, 580 ml, Bluetooth Verbinding, USB Oplaadbaar, Individuele Presentatie, Kabel Inclusief.

■■■■■■■■ 0 7.2 x 25 cm

📦 30

🌈 Print Code: K(1), L2



500 ml

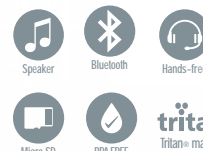

403



Padow

5819

Speaker Bottle, Tritan, 500 ml, Bluetooth Connection, Power 3W, USB Rechargeable, Individual Presentation, Cable Included.

Lautsprecher Trinkflasche, Tritan, 500 ml, Bluetooth Anschluss, Power 3W, USB Wiederaufladbar, Individuelle Präsentation, Kabel Inklusiv.

Bidon Haut-Parleurs, Tritan, 500 ml, Connexion Bluetooth, Puissance 3W, Rechargeable USB, Présentation Individuelle, Cable Inclusif.

Luidspreker Fles, Tritan, 500 ml, Bluetooth Verbinding, Vermogen 3W, USB Oplaadbaar, Individuele Presentatie, Kabel Inclusief.

■■■■■■■■ 0 6.9 x 25.5 cm

📦 50

🌈 Print Code: G(1)

CORK



350 ml



BPA FREE

Plibun

6562

Cup. Natural Cork/ PP. 350 ml.
Trinkbecher. Naturkork/ PP. 350 ml.
Verre. Bouchon Naturel/ PP. 350 ml.
Beker. Natuurlijk Kurk/ PP. 350 ml.

Ø 9.2 × 14.5 cm

Print Code: E(1), L2



30

404

BAMBOO FIBRE , BAMBOO & CORK



450 ml



BPA FREE

Zoplen

6569

Cup. Bamboo Fibre/ PP/ Bamboe/ Natural Cork. 450 ml. Individual Presentation.
Trinkbecher. Bambusfaser/ PP/ Bambus/ Naturkork. 450 ml. Individuelle Präsentation.
Verre. Fibre Bambou/ PP/ Bamboe/ Bouchon Naturel. 450 ml. Présentation Individuelle.
Beker. Bamboe Fibre/ PP/ Bamboe/ Natuurlijk Kurk. 450 ml. Individuele Presentatie.

Ø 8.7 × 13.1 cm



50

Print Code: F(1), L2



350 ml



BPA FREE

Hoplar

6568

Cup. Bamboo Fibre/ PP/ Bamboe/ Natural Cork. 350 ml. Individual Presentation.
Trinkbecher. Bambusfaser/ PP/ Bambus/ Naturkork. 350 ml. Individuelle Präsentation.
Verre. Fibre Bambou/ PP/ Bamboe/ Bouchon Naturel. 350 ml. Présentation Individuelle.
Beker. Bamboe Fibre/ PP/ Bamboe/ Natuurlijk Kurk. 350 ml. Individuele Presentatie.

Ø 8.7 × 10.8 cm



50

Print Code: F(1), L2



BAMBOO FIBRE



450 ml

Zally



6384

Cup. Bamboo Fibre/ PP. 450 ml.
Trinkbecher. Bambusfaser/ PP. 450 ml.
Verre. Fibre Bambou/ PP. 450 ml.
Beker. Bamboe Fibre/ PP. 450 ml.

Ø 9.3 × 13.4 cm

Print Code: E(1)

50



405



480 ml

Garlax

6548

Cup. Bamboo Fibre/ PP. 480 ml.
Trinkbecher. Bambusfaser/ PP. 480 ml.
Verre. Fibre Bambou/ PP. 480 ml.
Beker. Bamboe Fibre/ PP. 480 ml.

Ø 9.4 × 17.5 cm

Print Code: E(1)



30



● SILICONE

700 ml

Keton

6385

Cup. Bamboo Fibre/ PP/ Silicone. 700 ml.
Trinkbecher. Bambusfaser/ PP/ Silikon. 700 ml.
Verre. Fibre Bambou/ PP/ Silicone. 700 ml.
Beker. Bamboe Fibre/ PP/ Siliconen. 700 ml.

Ø 9.8 × 15 cm

Print Code: E(1)



50





BAMBOO FIBRE



03

05

19

13

Fliker



6376

Cup. Bamboo Fibre/ PP/ Silicone. 380 ml.
 Trinkbecher. Bambusfaser/ PP/ Silikon. 380 ml.
 Verre. Fibre Bambou/ PP/ Silicone. 380 ml.
 Beker. Bamboe Fibre/ PP/ Siliconen. 380 ml.

Ø 9.5 × 11.4 cm

100 / 10

Print Code: E(1)



16

380 ml

Fliker

18



380 ml



BPA FREE

Fidex

6012

Cup. Bamboo Fibre/ PP/ Silicone. 380 ml.
 Trinkbecher. Bambusfaser/ PP/ Silikon. 380 ml.
 Verre. Fibre Bambou/ PP/ Silicone. 380 ml.
 Beker. Bamboe Fibre/ PP/ Siliconen. 380 ml.

Ø 9 × 10 cm

200 / 10

Print Code: E(1)



03



19



01



380 ml



BPA FREE

Tokken

6013

Cup. Bamboo Fibre/ PP/ Silicone. 380 ml.
 Trinkbecher. Bambusfaser/ PP/ Silikon. 380 ml.
 Verre. Fibre Bambou/ PP/ Silicone. 380 ml.
 Beker. Bamboe Fibre/ PP/ Siliconen. 380 ml.

Ø 9.4 × 11.2 cm

100 / 10

Print Code: E(1)



01



03



19

Zaurak

6154

Cup. Bamboo Fibre/ PP. 380 ml.
Trinkbecher. Bambusfaser/ PP. 380 ml.
Verre. Fibre Bambou/ PP. 380 ml.
Beker. Bamboe Fibre/ PP. 380 ml.

▬▬▬▬▬▬▬▬ Ø 9.5 × 11.2 cm

🌈 Print Code: E(1)

📦 50

380 ml



BPA FREE

SARGASSO

407

400 ml

350 ml



220 ml

Zedal

6472

Foldable Cup. Bamboo Fibre/ PP. 220 ml.
Faltbarer Trinkbecher. Bambusfaser/ PP. 220 ml.
Verre Pliable. Fibre Bambou/ PP. 220 ml.
Opvouwbare Beker. Bamboe Fibre/ PP. 220 ml.

▬▬▬▬▬▬▬▬ Ø 6.8 × 9 cm

🌈 Print Code: D(4), W

📦 100 / 50



BPA FREE

ORINOCO

Teplan

6549

Mug. Bamboo Fibre/ PP. 400 ml.
Tasse. Bambusfaser/ PP. 400 ml.
Tasse. Fibre Bambou/ PP. 400 ml.
Mok. Bamboe Fibre/ PP. 400 ml.

▬▬▬▬▬▬▬▬ Ø 8.4 × 10.4 cm

🌈 Print Code: E(4)



BPA FREE

📦 48

Meridal

6152

Mug. Bamboo Fibre/ PP. 350 ml.
Tasse. Bambusfaser/ PP. 350 ml.
Tasse. Fibre Bambou/ PP. 350 ml.
Mok. Bamboe Fibre/ PP. 350 ml.

▬▬▬▬▬▬▬▬ Ø 7.9 × 8.8 cm

🌈 Print Code: E(4)

📦 100 / 50



BPA FREE

NATURE
BRAND
company slogan



ANTIBACTERIAL



Antibacterial material specially processed to inhibit and prevent bacterial growth, due to the incorporation of permanent static microbial agents, which are highly effective in the control against bacterial contamination.

Material antibacteriano, especialmente procesado para inhibir y prevenir las cargas bacterianas, gracias a la incorporación de agentes microbianos permanentes estáticos, con alta efectividad contra la contaminación bacteriana.



NEW

ORIGINAL 1185
TOWN

450 ml



Antibacterial



BPA FREE

Koton 6707

Antibacterial Cup. PP. 450 ml.
Antibakteriell Trinkbecher. PP. 450 ml.
Verre Antibactérien. PP. 450 ml.
Antibacterieel Beker. PP. 450 ml.

Ø 9.3 × 13.4 cm

Print Code: F(1)

50



NEW

350 ml



Antibacterial



BPA FREE

Plantex 6706

Antibacterial Mug. PP. 350 ml.
Antibakteriell Tasse. PP. 350 ml.
Tasse Antibactérienne. PP. 350 ml.
Antibacterieel Mok. PP. 350 ml.

Ø 7.9 × 8.8 cm

Print Code: E(4)

100 / 50

Copil 6769

Antibacterial Bottle. PE. 500 ml.
Antibakteriell Trinkflasche. PE. 500 ml.
Bidon Antibactérien. PE. 500 ml.
Antibacterieel Fles. PE. 500 ml.

Ø 6.5 × 19.5 cm

Print Code: F(1)

100 / 10

500 ml



Antibacterial



BPA FREE

Gliter 6768

Antibacterial Bottle. PE. 600 ml.
Antibakteriell Trinkflasche. PE. 600 ml.
Bidon Antibactérien. PE. 600 ml.
Antibacterieel Fles. PE. 600 ml.

Ø 6.5 × 21.2 cm

Print Code: F(1)

50

Copil



NEW

600 ml



Antibacterial



BPA FREE

Gliter



NEW

PLA



These products are manufactured with PLA material, from renewable raw materials, with important qualities such as versatility and strength, but prevailing all, it is compostable.

USE ME, I AM ECO-FRIENDLY 100% COMPOSTABLE

Estos productos están fabricados con material PLA, procedente de materias primas renovables, con importantes propiedades como la versatilidad y la resistencia pero prevaleciendo entre ellas la de compostabilidad.



Pioka 6677

Mug. PLA 100% Compostable. 350 ml.
Tasse. PLA 100% Kompostierbar. 350 ml.
Tasse. PLA 100% Compostable. 350 ml.
Mok. PLA 100% Composteerbaar. 350 ml.

Ø 7.9 × 8.8 cm

Print Code: E(4)

100 / 50



Petel 6676

Cup. PLA 100% Compostable. 450 ml.
Trinkbecher. PLA 100% Kompostierbar. 450 ml.
Verre. PLA 100% Compostable. 450 ml.
Beker. PLA 100% Composteerbaar. 450 ml.

Ø 9.3 × 13.4 cm

Print Code: E(1)

50





320 ml

Haser

5597

Bottle. Glas. 260 ml. Individual Presentation.
 Trinkflasche. Glas. 260 ml. Individuelle Präsentation.
 Bouteille. Verre. 260 ml. Présentation Individuelle.
 Fles. Glas. 260 ml. Individuele Presentatie.

■■■■■■■■■■ Ø 6 × 20 cm

📦 48

🌈 Print Code: F(1), L2

260 ml

500 ml



19

Abalon

5495

Jar. Glas. 320 ml. Individual Presentation.
 Einmachglas. Glas. 320 ml. Individuelle Präsentation.
 Pot. Verre. 320 ml. Présentation Individuelle.
 Pot. Glas. 320 ml. Individuele Presentatie.

■■■■■■■■■■ 6.3 × 15.4 × 6.3 cm

📦 48

🌈 Print Code: F(1), L2



11

Heisond

5494

Jar. Glas. 500 ml. Individual Presentation.
 Einmachglas. Glas. 500 ml. Individuelle Präsentation.
 Pot. Verre. 500 ml. Présentation Individuelle.
 Pot. Glas. 500 ml. Individuele Presentatie.

■■■■■■■■■■ 7.6 × 13.4 × 7.3 cm

📦 36

🌈 Print Code: F(1), L2



350 ml

19

Bitrok

5790

Mug. Glas. 350 ml. Individual Presentation.
 Tasse. Glas. 350 ml. Individuelle Präsentation.
 Tasse. Verre. 350 ml. Présentation Individuelle.
 Mok. Glas. 350 ml. Individuele Presentatie.

■■■■■■■■■■ Ø 8 × 9.5 cm

📦 36

🌈 Print Code: F(1), L2



GLASS

THE BEST PRICE

NEW



350 ml



411

Durnox

6869

Cup. Glass/ Silicone. 350 ml. Individual Presentation.
Trinkbecher. Glas/ Silikon. 350 ml. Individuelle Präsentation.
Verre. Verre/ Silicone. 350 ml. Présentation Individuelle.
Beker. Glas/ Siliconen. 350 ml. Individuele Presentatie.

Ø 9.5 × 12.4 cm

30

Print Code: F(4)



16

19

03

02

01



Meltik



Tilton



Drunax

412



Meltik

5732

Jug. Glas. 500 ml. Individual Presentation.
Krug. Glas. 500 ml. Individuelle Präsentation.
Carafe. Verre. 500 ml. Présentation Individuelle.
Kan. Glas. 500 ml. Individuelle Presentatie.

7.8 × 13 × 7.8 cm



36

Print Code: F(1), L2



Drunax

5733

Jar. Glas. 450 ml. Individual Presentation.
Einmachglas. Glas. 450 ml. Individuelle Präsentation.
Pot. Verre. 450 ml. Présentation Individuelle.
Pot. Glas. 450 ml. Individuelle Presentatie.

Ø 7.8 × 12.7 cm



36

Print Code: F(1), L2



Tilton

6313

Mug. Ceramic. 700 ml. Individual Presentation.
Krug. Keramik. 700 ml. Individuelle Präsentation.
Carafe. Céramique. 700 ml. Présentation Individuelle.
Kan. Keramik. 700 ml. Individuelle Presentatie.

Ø 10.3 × 13.8 cm



20

Print Code: F(4)



380 ml



06

Kirpal

6861

Mug. Stainless Steel. 380 ml. Individual Presentation.
Tasse. Rostfreier Stahl. 380 ml. Individuelle Präsentation.
Tasse. Acier Inox. 380 ml. Présentation Individuelle.
Mok. Roestvrij Staal. 380 ml. Individuele Presentatie.

Ø 8.8 × 7.9 cm

50

Print Code: F(1), L2



01

02

03



VINTAGE DESIGN
IMPERFECT FINISH /
DISEÑO VINTAGE CON
ACABADO IMPERFECTO

380 ml



Wilem

5571

Mug. Metal. 380 ml. Individual Presentation.
Tasse. Metall. 380 ml. Individuelle Präsentation.
Tasse. Metal. 380 ml. Présentation Individuelle.
Mok. Metaal. 380 ml. Individuele Presentatie.

Ø 8.8 × 7.9 cm

50

Print Code: F(4), L2



03

210 ml



19



05

03

04

02

Beltan

5978

Cup. Stainless Steel. 500 ml. Individual Presentation.
Trinkbecher. Rostfreier Stahl. 500 ml. Individuelle Präsentation.
Verre. Acier Inox. 500 ml. Présentation Individuelle.
Beker. Roestvrij Staal. 500 ml. Individuele Presentatie.

Ø 8.8 × 12.8 cm

50

Print Code: F(4), L2



500 ml

02

03

04

09

Bastic

4509

Mug. Stainless Steel. 210 ml. Individual Presentation.
Tasse. Rostfreier Stahl. 210 ml. Individuelle Präsentation.
Tasse. Acier Inox. 210 ml. Présentation Individuelle.
Mok. Roestvrij Staal. 210 ml. Individuele Presentatie.

Ø 7 × 8 cm

50

Print Code: F(4), L2



280 ml

Yozax

4656

Mug. Stainless Steel. 280 ml. Individual Presentation.
Tasse. Rostfreier Stahl. 280 ml. Individuelle Präsentation.
Tasse. Acier Inox. 280 ml. Présentation Individuelle.
Mok. Roestvrij Staal. 280 ml. Individuele Presentatie.

Ø 7.6 × 8.9 cm

50

Print Code: F(4), L2



09

03

02

19

11

04

330 ml
Double Wall



Alirox 6409

Sublimation Vacuum Flask. Stainless Steel. 330 ml. Individual Presentation.
Sublimations Thermoskanne. Rostfreier Stahl. 330 ml. Individuelle Präsentation.
Thermo Sublimation. Acier Inox. 330 ml. Présentation Individuelle.
Sublimatie Thermosfles. Roestvrij Staal. 330 ml. Individuele Presentatie.

Ø 5.7 × 23 cm

Print Code: F(1), L2, Q

30



Bayron 6164



Sublimation Bottle. Stainless Steel. 700 ml. Individual Presentation.
Sublimations Trinkflasche. Rostfreier Stahl. 700 ml. Individuelle Präsentation.
Bidon Sublimation. Acier Inox. 700 ml. Présentation Individuelle.
Sublimatie Fles. Roestvrij Staal. 700 ml. Individuele Presentatie.

Ø 7 × 25.7 cm

Print Code: F(1), L2, Q

50



700 ml

414

Bayron



Cleikon

500 ml



Cleikon

6165

Sublimation Vacuum Flask. Stainless Steel. 500 ml. Individual Presentation.
Sublimations Thermoskanne. Rostfreier Stahl. 500 ml. Individuelle Präsentation.
Thermo Sublimation. Acier Inox. 500 ml. Présentation Individuelle.
Sublimatie Thermosfles. Roestvrij Staal. 500 ml. Individuele Presentatie.

Ø 7 × 24.6 cm

Print Code: F(1), L2, Q

30



400 ml



Greims

5341

Sublimation Bottle. Aluminium. 400 ml. Individual Presentation.
Sublimations Trinkflasche. Aluminium. 400 ml. Individuelle Präsentation.
Bidon Sublimation. Aluminium. 400 ml. Présentation Individuelle.
Sublimatie Fles. Aluminium. 400 ml. Individuele Presentatie.

Ø 6.6 × 17.5 cm

Print Code: F(1), L2, Q

100 / 20





380 ml



Neyms

6111
Sublimation Mug. Metal. 380 ml. Individual Presentation.
Sublimations Tasse. Metall. 380 ml. Individuelle Präsentation.
Tasse Sublimation. Metal. 380 ml. Présentation Individuelle.
Sublimatie Mok. Metaal. 380 ml. Individuele Presentatie.

Ø 8.8 × 7.9 cm
Print Code: F(1), L2, Q

VINTAGE DESIGN
IMPERFECT FINISH /
DISEÑO VINTAGE CON
ACABADO IMPERFECTO



380 ml

Kantol

6359
Sublimation Mug. Metal. 380 ml. Individual Presentation.
Sublimations Tasse. Metall. 380 ml. Individuelle Präsentation.
Tasse Sublimation. Metal. 380 ml. Présentation Individuelle.
Sublimatie Mok. Metaal. 380 ml. Individuele Presentatie.

Ø 8.8 × 7.9 cm
Print Code: L2, Q

VINTAGE DESIGN
IMPERFECT FINISH /
DISEÑO VINTAGE CON
ACABADO IMPERFECTO



420 ml

Dokath

SOFT SHELL POUCH



SUBLIMATION POUCH

Flaber

6870
Bottle. Glass. 600 ml. Individual Presentation. Soft Shell Pouch Included.
Trinkflasche. Glas. 600 ml. Individuelle Präsentation. Soft Shell Etui Inklusiv.
Bidon. Verre. 600 ml. Présentation Individuelle. Etui Soft Shell Inclus.
Fles. Glas/ Bamboe. 600 ml. Individuele Presentatie. Soft Shell Zakje Inclusief.

Ø 8.5 × 16 cm
Print Code: F(1), L2, N(8), R



NEW



600 ml

Flaber

SOFT SHELL POUCH

Dokath

5513
Bottle. Glass. 420 ml. Individual Presentation. Soft Shell Pouch Included.
Trinkflasche. Glas. 420 ml. Individuelle Präsentation. Soft Shell Etui Inklusiv.
Bidon. Verre. 420 ml. Présentation Individuelle. Etui Soft Shell Inclus.
Fles. Glas. 420 ml. Individuele Presentatie. Soft Shell Zakje Inclusief.

Ø 6.4 × 19 cm
Print Code: F(1), L2, N(8), R



MATT FINISH

EASY OPENING

POUCH / FUNDA

Delhy

Tancher

500 ml

500 ml

Hosban

Poltax

330 ml

416



Delhy

6010

Pouch. PVC.
Hulle. PVC.
Étui. PVC.
Hoes. PVC.

Ø 7.6 × 26.5 cm

Print Code: F(1)

150 / 10



09 02 01 04 03

Tancher

6009

Vacuum Flask. Stainless Steel. 500 ml. Individual Presentation.
Thermoskanne. Rostfreier Stahl. 500 ml. Individuelle Präsentation.
Thermo. Acier Inox. 500 ml. Présentation Individuelle.
Thermosfles. Roestvrij Staal. 500 ml. Individuele Presentatie.

Ø 7 × 24.5 cm

Print Code: F(1), L2

30



11 08 05 01 19 03 04

Hosban

4875

Vacuum Flask. Stainless Steel. 500 ml. Individual Presentation.
Thermoskanne. Rostfreier Stahl. 500 ml. Individuelle Präsentation.
Thermo. Acier Inox. 500 ml. Présentation Individuelle.
Thermosfles. Roestvrij Staal. 500 ml. Individuele Presentatie.

Ø 7 × 24.5 cm

Print Code: F(1), L2

30



Poltax

6281

Vacuum Flask. Stainless Steel. 330 ml. Individual Presentation.
Thermoskanne. Rostfreier Stahl. 330 ml. Individuelle Präsentation.
Thermo. Acier Inox. 330 ml. Présentation Individuelle.
Thermosfles. Roestvrij Staal. 330 ml. Individuele Presentatie.

Ø 5.7 × 23 cm

Print Code: F(1), L2

30



01 19 02



Double Wall



Double Wall



Double Wall

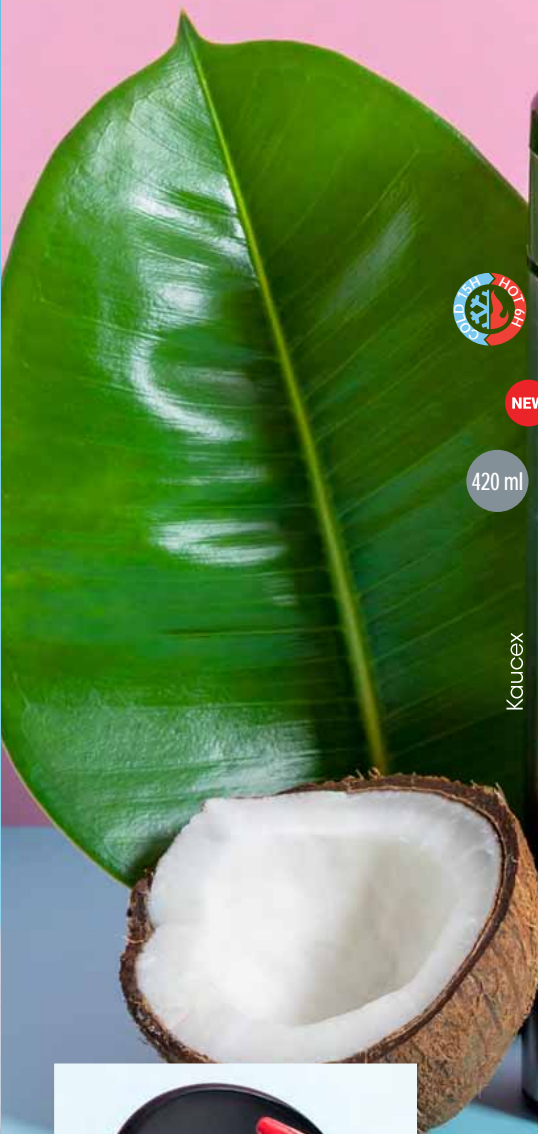

NEW

420 ml

Kaucex



NEW

500 ml

Plusek



417



INFUSER INCLUDED -
TOUCH TEMPERATURE
DISPLAY



Kaucex

6863



Double Wall

Vacuum Flask. Stainless Steel. 420 ml. Touch Temperature Display. Individual Presentation. Infuser Included. Button Battery Included.

Thermoskanne. Rostfreier Stahl. 420 ml. Anzeige der Berührungstemperatur. Individuelle Präsentation. Inklusive Teesieb. Knopfzelle inklusive.

Thermo. Acier Inox. 420 ml. Mesure de Température Tactile. Présentation Individuelle. Infuseur Inclus. Pile Bouton Inclus.

Thermosfles. Roestvrij Staal. 420 ml. Touch Temperatuur weergave. Individuele Presentatie. Thee-Ei Inclusief. Knopcel Batterij Inclusief.

Ø 6.5 × 24 cm

30

Print Code: G(1), L2



Double Wall



Plusek

6862

Vacuum Flask. Stainless Steel. 500 ml. Individual Presentation. Infuser Included.

Thermoskanne. Rostfreier Stahl. 500 ml. Individuelle Präsentation. Inklusive Teesieb.

Thermo. Acier Inox. 500 ml. Présentation Individuelle. Infuseur Inclus.

Thermosfles. Roestvrij Staal. 470 ml. Individuele Presentatie. Thee-Ei Inclusief.

Ø 6 × 22.5 cm

30

Print Code: F(1), L2



INFUSER INCLUDED

COPPER VACUUM INSULATED



Copper insulated vacuum, double wall structure with copper interior layer that has isothermal properties, allowing you to maintain the temperature of your drinks for a longer period of time, up to 48 hours.

Aislamiento de cobre al vacío, estructuras de doble capa con pared interior de cobre, con propiedades isotérmicas, que le permitirá mantener la temperatura de sus bebidas durante un tiempo más prolongado, de hasta 48 horas.

650 ml



NEW



minimog

NEW

350 ml



minimog

418



08

01

02



Staver

6859



Insulated Bottle. Stainless Steel. 650 ml. Copper Vacuum Insulated. Individual Presentation.
 Warme Flasche. Rostfreier Stahl. 650 ml. Kupfer Vakuumisoliert. Individuelle Präsentation.
 Bidon Thermique. Acier Inox. 650 ml. Isolation sous Vide en Cuivre. Présentation Individuelle.
 Thermoskan-Fles. Roestvrij Staal. 650 ml. Koperen Vacuum Geïsoleerd. Individuele Presentatie.

Ø 7.3 × 27 cm

30

Print Code: F(1), L2

COPPER VACUUM INSULATED / AISLAMIENTO DE COBRE AL VACÍO



02

09

01

23

Blur

6860



Insulated Cup. Stainless Steel. 350 ml. Copper Vacuum Insulated. Individual Presentation.
 Warme Trinkbecher. Rostfreier Stahl. 350 ml. Kupfer Vakuumisoliert. Individuelle Präsentation.
 Verre Thermique. Acier Inox. 350 ml. Isolation sous Vide en Cuivre. Présentation Individuelle.
 Beker-Fles. Roestvrij Staal. 350 ml. Koperen Vacuum Geïsoleerd. Individuele Presentatie.

Ø 8.5 × 12.4 cm

30

Print Code: F(1), L2



COPPER VACUUM INSULATED / AISLAMIENTO DE COBRE AL VACÍO

COPPER VACUUM INSULATED



Kungel 6858

Insulated Bottle. Stainless Steel. 500 ml. Copper Vacuum Insulated. Individual Presentation.
 Warme Flasche. Rostfreier Stahl. 500 ml. Kupfer Vakuumisoliert. Individuelle Präsentation.
 Bidon Thermique. Acier Inox. 500 ml. Isolation sous Vide en Cuivre. Présentation Individuelle.
 Thermoskan-Fles. Roestvrij Staal. 500 ml. Koperen Vacuum Geïsoleerd. Individuele Presentatie.

Ø 7 × 26.3 cm
 Print Code: F(1), L2

COPPER VACUUM
 INSULATED /
 AISLAMIENTO DE COBRE
 AL VACÍO

- 03
- 04
- 02
- 19
- 09
- 23

STAINLESS STEEL

850 ml



750 ml

NEW

740 ml

420

Rockorn

I Have a Dream
MLK
Martin Luther King DAY

ORIGINAL 1966
TOWN



01



02



02



08



01

Zolop

4976



Double Wall



Insulated Bottle. Stainless Steel. 850 ml. Individual Presentation.
Warme Flasche. Rostfreier Stahl. 850 ml. Individuelle Präsentation.
Bidon Thermique. Acier Inox. 850 ml. Présentation Individuelle.
Thermoskan-Fles. Roestvrij Staal. 850 ml. Individuele Presentatie.

▄▄▄▄▄ Ø 8 × 30.5 cm

📦 30

🌈 Print Code: F(1), L2

Pernal

6531

Bottle. Stainless Steel. 750 ml. Individual Presentation.
Trinkflasche. Rostfreier Stahl. 750 ml. Individuelle Präsentation.
Bidon. Acier Inox. 750 ml. Présentation Individuelle.
Fles. Roestvrij Staal. 750 ml. Individuele Presentatie.

▄▄▄▄▄ Ø 7 × 24.2 cm

📦 50 / 25

🌈 Print Code: F(1), L2

Raltex

6882

Bottle. Stainless Steel. 740 ml. Individual Presentation.
Trinkflasche. Rostfreier Stahl. 740 ml. Individuelle Präsentation.
Bidon. Acier Inox. 740 ml. Présentation Individuelle.
Fles. Roestvrij Staal. 740 ml. Individuele Presentatie.

▄▄▄▄▄ Ø 7 × 24.5 cm

📦 30

🌈 Print Code: F(1), L2

STAINLESS STEEL

800 ml



790 ml



630 ml



421



Tulman

6162

Bottle. Stainless Steel/ Bamboo. 800 ml. Individual Presentation.
 Trinkflasche. Rostfreier Stahl/ Bambus. 800 ml. Individuelle Präsentation.
 Bidon. Acier Inox/ Bambou. 800 ml. Présentation Individuelle.
 Fles. Roestvrij Staal/ Bamboe. 800 ml. Individuele Presentatie.

Ø 7.2 × 24.2 cm

30

Print Code: F(1), L2



Rextan

6163

Bottle. Stainless Steel. 790 ml. Individual Presentation.
 Trinkflasche. Rostfreier Stahl. 790 ml. Individuelle Präsentation.
 Bidon. Acier Inox. 790 ml. Présentation Individuelle.
 Fles. Roestvrij Staal. 790 ml. Individuele Presentatie.

Ø 7.4 × 25.7 cm

50

Print Code: F(1), L2



Herilox

5827

Bottle. Stainless Steel. 630 ml. Individual Presentation.
 Trinkflasche. Rostfreier Stahl. 630 ml. Individuelle Präsentation.
 Bidon. Acier Inox. 630 ml. Présentation Individuelle.
 Fles. Roestvrij Staal. 630 ml. Individuele Presentatie.

Ø 7 × 26 cm

50

Print Code: F(1), L2

800 ml



NEW

600 ml



STAINLESS STEEL & BAMBOO



Rangler

6878

Bottle. Stainless Steel/ Bamboo. 800 ml. Individual Presentation.
 Trinkflasche. Rostfreier Stahl/ Bambus. 800 ml. Individuelle Präsentation.
 Bidon. Acier Inox/ Bambou. 800 ml. Présentation Individuelle.
 Fles. Roestvrij Staal/ Bamboe. 800 ml. Individuele Presentatie.

▬▬▬▬▬▬ Ø 7.2 × 24.2 cm

📦 30

🌈 Print Code: F(1), L2

Dropun

6877

Bottle. Stainless Steel/ Bamboo. 600 ml. Individual Presentation.
 Trinkflasche. Rostfreier Stahl/ Bambus. 600 ml. Individuelle Präsentation.
 Bidon. Acier Inox/ Bambou. 600 ml. Présentation Individuelle.
 Fles. Roestvrij Staal/ Bamboe. 600 ml. Individuele Presentatie.

▬▬▬▬▬▬ Ø 6.3 × 21.7 cm

📦 50

🌈 Print Code: F(1), L2



STAINLESS STEEL

NEW

750 ml



Rockorn

770 ml

ORIGINAL 1986

TOWN

750 ml

NEW



Gillink

BAMBOO
SUITABLE FOR LASER
ENGRAVED LOGO

CORK
SUITABLE FOR LASER
ENGRAVED LOGO

423



Syrma

6879

Bottle. Stainless Steel/ Bamboo. 750 ml. Individual Presentation.
Trinkflasche. Rostfreier Stahl/ Bambus. 750 ml. Individuelle Präsentation.
Bidon. Acier Inox/ Bambou. 750 ml. Présentation Individuelle.
Fles. Roestvrij Staal/ Bamboe. 750 ml. Individuele Presentatie.

▬▬▬▬▬ Ø 7.4 × 25.7 cm

📦 50

🌈 Print Code: F(1), L2

Anukin

6530

Bottle. Stainless Steel. 770 ml. Individual Presentation.
Trinkflasche. Rostfreier Stahl. 770 ml. Individuelle Präsentation.
Bidon. Acier Inox. 770 ml. Présentation Individuelle.
Fles. Roestvrij Staal. 770 ml. Individuele Presentatie.

▬▬▬▬▬ Ø 7.4 × 25.4 cm

📦 50 / 25

🌈 Print Code: F(1), L2



01

02

Rekka

6880

Bottle. Stainless Steel/ Natural Cork. 750 ml. Individual Presentation.
Trinkflasche. Rostfreier Stahl/ Naturkork. 750 ml. Individuelle Präsentation.
Bidon. Acier Inox/ Bouchon Naturel. 750 ml. Présentation Individuelle.
Fles. Roestvrij Staal/ Natuurlijk Kurk. 750 ml. Individuele Presentatie.

▬▬▬▬▬ Ø 7.4 × 25.7 cm

📦 50

🌈 Print Code: F(1), L2



BAMBOO

STAINLESS STEEL

420 ml

500 ml



vertrio

work

network



Double Wall

Tiaky

6603

Vacuum Flask. Bamboo/ Stainless Steel. 420 ml. Individual Presentation.
 Thermoskanne. Bambus/ Rostfreier Stahl. 420 ml. Individuelle Präsentation.
 Thermo. Bambou/ Acier Inox. 420 ml. Présentation Individuelle.
 Thermosfles. Bamboe/ Roestvrij Staal. 420 ml. Individuele Presentatie.

Ø 6.5 × 25.5 cm

30

Print Code: F(1), L2

Moltex

6156

Vacuum Flask. Bamboo/ Stainless Steel. 500 ml. Individual Presentation.
 Thermoskanne. Bambus/ Rostfreier Stahl. 500 ml. Individuelle Präsentation.
 Thermo. Bambou/ Acier Inox. 500 ml. Présentation Individuelle.
 Thermosfles. Bamboe/ Roestvrij Staal. 500 ml. Individuele Presentatie.

Ø 6.9 × 24.5 cm

30

Print Code: F(1), L2



Double Wall



Marcex

6624

Bottle Bag. 100% Cotton 105 g/ m2.
 Trinkflasche Tasche. 100% Baumwolle 105 g/ m2.
 Sac Bouteille. 100% Coton 105 g/ m2.
 Fles Tas. 100% Katoen 105 g/ m2.

12 × 33 cm

500 / 50

Print Code: F(6), N(8), O, P



BAMBOO

STAINLESS STEEL



Lubon

6875

Cup. Bamboo/ Stainless Steel. 300 ml. Individuelle Präsentation.
Trinkbecher. Bambus/ Rostfreier Stahl. 300 ml. Individuelle Präsentation.
Verre. Bambou/ Acier Inox. 300 ml. Présentation Individuelle.
Beker. Bamboe/ Roestvrij Staal. 300 ml. Individuele Presentatie.

Ø 8 × 10.5 cm

Print Code: F(1), L2

50



Double Wall

Ariston

6170

Cup. Bamboo/ Stainless Steel. 500 ml. Individuelle Präsentation.
Trinkbecher. Bambus/ Rostfreier Stahl. 500 ml. Individuelle Präsentation.
Verre. Bambou/ Acier Inox. 500 ml. Présentation Individuelle.
Beker. Bamboe/ Roestvrij Staal. 500 ml. Individuele Presentatie.

Ø 8.2 × 17.5 cm

Print Code: F(1), L2

50



Double Wall

Vanatin

6876

Mug. Bamboo/ Stainless Steel. 300 ml. Individuelle Präsentation.
Tasse. Bambus/ Rostfreier Stahl. 300 ml. Individuelle Präsentation.
Tasse. Bambou/ Acier Inox. 300 ml. Présentation Individuelle.
Mok. Bamboe/ Roestvrij Staal. 300 ml. Individuele Presentatie.

Ø 8 × 10.5 cm

Print Code: F(1), L2

50



Double Wall

425

ALUMINIUM

426



400 ml

04



02 09 01 19 05 07 11 03

Mento

3384

Bottle. Aluminium. 400 ml. Individual Presentation.
Trinkflasche. Aluminium. 400 ml. Individuelle Präsentation.
Bidon. Aluminium. 400 ml. Présentation Individuelle.
Fles. Aluminium. 400 ml. Individuele Presentatie.



Ø 6.6 × 17.5 cm 100 / 20
Print Code: F(1), L2



05 01



02 19



Henzo

4821

Bottle. Aluminium. 330 ml. Individual Presentation.
Trinkflasche. Aluminium. 330 ml. Individuelle Präsentation.
Bidon. Aluminium. 330 ml. Présentation Individuelle.
Fles. Aluminium. 330 ml. Individuele Presentatie.

Ø 6.6 × 15 cm 100 / 20
Print Code: F(1), L2

330 ml



03



05

400 ml



03 04 19

Halvar

6456

Bottle. Aluminium. 400 ml. Individual Presentation.
Trinkflasche. Aluminium. 400 ml. Individuelle Präsentation.
Bidon. Aluminium. 400 ml. Présentation Individuelle.
Fles. Aluminium. 400 ml. Individuele Presentatie.

Ø 6.6 × 17.5 cm 100 / 20
Print Code: F(1), L2

ALUMINIUM



650 ml



02 19 05 03

Tukel

5986

Bottle. Aluminium. 650 ml.
Trinkflasche. Aluminium. 650 ml.
Bidon. Aluminium. 650 ml.
Fles. Aluminium. 650 ml.

Ø 6.6 × 23 cm

Print Code: F(1), L2



800 ml



16



02 04 09 03



02 01 19 05 04

Delby

5491

Bottle. Aluminium. 800 ml. Individual Presentation.
Trinkflasche. Aluminium. 800 ml. Individuelle Präsentation.
Bidon. Aluminium. 800 ml. Présentation Individuelle.
Fles. Aluminium. 800 ml. Individuele Presentatie.

Ø 7.3 × 25.3 cm

Print Code: F(1), L2



700 ml

427

Cartex

6323

Bottle. Aluminium. 700 ml. Individual Presentation.
Trinkflasche. Aluminium. 700 ml. Individuelle Präsentation.
Bidon. Aluminium. 700 ml. Présentation Individuelle.
Fles. Aluminium. 700 ml. Individuele Presentatie.

Ø 6.9 × 25 cm

Print Code: F(1), L2



428



800 ml

19

EASY OPENING



01 02 03 04 07

Smaly

6280

Bottle. Stainless Steel. 800 ml. Individual Presentation.
 Trinkflasche. Rostfreier Stahl. 800 ml. Individuelle Präsentation.
 Bidon. Acier Inox. 800 ml. Présentation Individuelle.
 Fles. Roestvrij Staal. 800 ml. Individuele Presentatie.

Ø 7.1 × 28 cm

30

Print Code: F(1), L2



19



02 03 04

Barrister

5099

Bottle. Aluminium. 650 ml. Individual Presentation.
 Trinkflasche. Aluminium. 650 ml. Individuelle Präsentation.
 Bidon. Aluminium. 650 ml. Présentation Individuelle.
 Fles. Aluminium. 650 ml. Individuele Presentatie.

Ø 7.3 × 20.7 cm

50

Print Code: F(1), L2



650 ml



09

ALUMINIUM

NEW

550 ml



NEW

600 ml



429

Raican

6883

Bottle. Aluminium. 550 ml. Individual Presentation.
 Trinkflasche. Aluminium. 550 ml. Individuelle Präsentation.
 Bidon. Aluminium. 550 ml. Présentation Individuelle.
 Fles. Aluminium. 550 ml. Individuele Presentatie.

Ø 6.6 × 22 cm

Print Code: F(1), L2



09

03

11

04



01

19

02

07

Runtex

6881

Bottle. Aluminium. 600 ml. Individual Presentation.
 Trinkflasche. Aluminium. 600 ml. Individuelle Präsentation.
 Bidon. Aluminium. 600 ml. Présentation Individuelle.
 Fles. Aluminium. 600 ml. Individuele Presentatie.

Ø 6.6 × 25 cm

Print Code: F(1), L2



19

09

05



04

02

01

03

GLASS

SILICONE POUCH
/ FUNDA SILICONA

NEW

540 ml



420 ml

430

GLASS / SOFT SHELL POUCH
CRISTAL / FUNDA SOFT SHELL



NEW

600 ml

GLASS / SOFT SHELL POUCH
CRISTAL / FUNDA SOFT SHELL



07 04 11 03 02 17



05 01 19

Dokath

5513

Bottle. Glass. 420 ml. Individual Presentation. Soft Shell Pouch Included.
Trinkflasche. Glas. 420 ml. Individuelle Präsentation. Soft Shell Etui Inklusiv.
Bidon. Verre. 420 ml. Présentation Individuelle. Étui Soft Shell Inclus.
Fles. Glas. 420 ml. Individuele Presentatie. Soft Shell Zakje Inclusief.

▬▬▬▬ Ø 6.4 × 19 cm

📦 50

🌈 Print Code: F(1), L2, N(8), R



02



01

Teltox

6866

Bottle. Glass/ Bamboo. 540 ml. Individual Presentation. Silicone Pouch Included.
Trinkflasche. Glas/ Bambus. 540 ml. Individuelle Präsentation. Silikon Etui Inklusiv.
Bidon. Verre/ Bambou. 540 ml. Présentation Individuelle. Étui Silicone Inclus.
Fles. Glas/ Bamboe. 540 ml. Individuele Presentatie. Siliconen Zakje Inclusief.

▬▬▬▬ Ø 6.7 × 23 cm

📦 30

🌈 Print Code: G(1)



11 19 07 05 04



03 02 01

Flaber

6870

Bottle. Glass. 600 ml. Individual Presentation. Soft Shell Pouch Included.
Trinkflasche. Glas. 600 ml. Individuelle Präsentation. Soft Shell Etui Inklusiv.
Bidon. Verre. 600 ml. Présentation Individuelle. Étui Soft Shell Inclus.
Fles. Glas/ Bamboe. 600 ml. Individuele Presentatie. Soft Shell Zakje Inclusief.

▬▬▬▬ Ø 8.5 × 16 cm

📦 40

🌈 Print Code: F(1), L2, N(8), R

GLASS



500 ml

500 ml

430 ml

530 ml

431

GLASS / NATURAL CORK POUCH
CRISTAL / FUNDA CORCHO NATURAL

GLASS / SOFT SHELL POUCH
CRISTAL / FUNDA SOFT SHELL

Kasfol

6581

Bottle. Glass/ Bamboo. 500 ml. Individual Presentation. Polyester Pouch Included.

Trinkflasche. Glas/ Bambus. 500 ml. Individuelle Präsentation. Polyester Etui Inklusiv.

Bidon. Verre/ Bambou. 500 ml. Présentation Individuelle. Etui Polyester Inclus.

Fles. Glas/ Bamboe. 500 ml. Individuele Presentatie. Zakje inclusief.

Ø 6.3 × 22.5 cm

30

Print Code: F(1), L2, N(8)

Trupak

6864

Bottle. Glass/ Bamboo. 500 ml. Individual Presentation. Natural Cork Pouch Included.

Trinkflasche. Glas/ Bambus. 500 ml. Individuelle Präsentation. Naturkork Etui Inklusiv.

Bidon. Verre/ Bambou. 500 ml. Présentation Individuelle. Etui Bouchon Naturel Inclus.

Fles. Glas/ Bamboe. 500 ml. Individuele Presentatie. Natuurlijk Kurk Zakje Inclusief.

Ø 6.3 × 22.5 cm

30

Print Code: F(1), L2, N(8)

Burdis

6198

Bottle. Glass/ Bamboo. 430 ml. Individual Presentation.

Trinkflasche. Glas/ Bambus. 430 ml. Individuelle Präsentation.

Bidon. Verre/ Bambou. 430 ml. Présentation Individuelle.

Fles. Glas/ Bamboe. 430 ml. Individuele Presentatie.

Ø 6.3 × 19 cm

50

Print Code: F(1), L2

Lurok

6582



Bottle. Glass/ Bamboo. 530 ml. Individual Presentation. Soft Shell Pouch Included.

Trinkflasche. Glas/ Bambus. 530 ml. Individuelle Präsentation. Soft Shell Etui Inklusiv.

Bidon. Verre/ Bambou. 530 ml. Présentation Individuelle. Etui Soft Shell Inclus.

Fles. Glas/ Bamboe. 530 ml. Individuele Presentatie. Soft Shell Zakje Inclusief.

Ø 6.3 × 22.5 cm

30

Print Code: F(1), L2, N(8), R



19 01 04 11 07 03

Terkol 6314

Bottle. Glass. 500 ml. Individual Presentation.
Trinkflasche. Glas. 500 ml. Individuelle Präsentation.
Bidon. Verre. 500 ml. Présentation Individuelle.
Fles. Glas. 500 ml. Individuele Presentatie.

Ø 6.3 × 22 cm

50

Print Code: F(1), L2

500 ml

GLASS



432

610 ml



Londor 6578

Bottle. Glass. 610 ml. Individual Presentation.
Trinkflasche. Glas. 610 ml. Individuelle Präsentation.
Bidon. Verre. 610 ml. Présentation Individuelle.
Fles. Glas. 610 ml. Individuele Presentatie.

Ø 7 × 26 cm

30

Print Code: F(1), L2



04 01 19 02

Helux 6583

Bottle. Glass. 420 ml. Individual Presentation.
Trinkflasche. Glas. 420 ml. Individuelle Präsentation.
Bidon. Verre. 420 ml. Présentation Individuelle.
Fles. Glas. 420 ml. Individuele Presentatie.

Ø 5.9 × 19 cm

30

Print Code: F(1), L2

420 ml



GLASS

470 ml



NEW



Tinof
6868

Bottle. Glass. 470 ml. Individual Presentation.
Trinkflasche. Glas. 470 ml. Individuelle Präsentation.
Bidon. Verre. 470 ml. Présentation Individuelle.
Fles. Glas. 470 ml. Individuele Presentatie.

Ø 6.3 × 25 cm
Print Code: F(1)

30

433

NEW

650 ml



19

07

02

01

03

Sunsox
6867

Bottle. Glass. 650 ml. Individual Presentation.
Trinkflasche. Glas. 650 ml. Individuelle Präsentation.
Bidon. Verre. 650 ml. Présentation Individuelle.
Fles. Glas. 650 ml. Individuele Presentatie.

Ø 7.1 × 25.8 cm
Print Code: F(1), L2

30



RPET



The fabric used in the manufacturing process of these bottles is made of recycled plastic (RPET). Like this, the emission of plastic residues to our planet and the consumption of energy is drastically reduced, resulting in a much more eco-friendly process.

El material de estos bidones está fabricado con plástico reciclado (RPET), que, además de ayudar en la disminución de residuos plásticos en el planeta, utiliza menos energía en el proceso de fabricación, haciendo que sea mucho menos dañino para el medio ambiente.

STOP PLASTIC POLLUTING THE OCEAN

434



Lecit

NEW

600 ml



16

01

19

03

Lecit
6871

Bottle. RPET. 600 ml.
Trinkflasche. RPET. 600 ml.
Bidon. RPET. 600 ml.
Fles. RPET. 600 ml.



BPA FREE



RPET

▬▬▬▬▬ Ø 6.5 × 21 cm

🌈 Print Code: F(1), L2



50

NEW



600 ml



Solarix
6874



BPA FREE



RPET

Bottle. RPET/ Bamboo. 600 ml. Individual Presentation.
Trinkflasche. RPET/ Bambus. 600 ml. Individuelle Präsentation.
Bidon. RPET/ Bambou. 600 ml. Présentation Individuelle.
Fles. RPET/ Bamboe. 600 ml. Individuele Presentatie.

▬▬▬▬▬ Ø 7.2 × 20.8 cm

🌈 Print Code: F(1), L2



50

PLA

100%



830 ml

ECO REUSABLE BOTTLE
100% PLA COMPOSTABLE

THE BEST PRICE

BAMBOO FIBRE



600 ml

435



04

13

03

02

19



BPA FREE



Kutyl
6563



PLA Material



BPA FREE

Bottle. PLA 100% Compostable. 830 ml. Individual Presentation.
Trinkflasche. PLA 100% Kompostierbar. 830 ml. Individuelle Präsentation.
Bidon. PLA 100% Compostable. 830 ml. Présentation Individuelle.
Fles. PLA 100% Composteerbaar. 830 ml. Individuele Presentatie.

▬▬▬▬▬▬ Ø 7 × 25.8 cm

📦 30

🌈 Print Code: F(1)

Dolken
6550

Bottle. Bamboo Fibre/LDPE. 600 ml.
Trinkflasche. Bambusfaser/ LDPE. 600 ml.
Bidon. Fibre Bambou/LDPE. 600 ml.
Fles. Bamboe Fibre/ LDPE. 600 ml.

▬▬▬▬▬▬ Ø 6.5 × 21.2 cm

📦 50

🌈 Print Code: F(1), L2



700 ml



700 ml



780 ml



580 ml



Raltox tritan® material BPA FREE
5998

Bottle. Tritan. 700 ml. Individual Presentation.
Trinkflasche. Tritan. 700 ml. Individuelle Präsentation.
Bidon. Tritan. 700 ml. Présentation Individuelle.
Fles. Tritan. 700 ml. Individuele Presentatie.

▬▬▬▬▬ Ø 7.3 × 22 cm  50
🌈 Print Code: F(1)

Kelit tritan® material BPA FREE
5017

Bottle. Tritan. 700 ml. Individual Presentation.
Trinkflasche. Tritan. 700 ml. Individuelle Präsentation.
Bidon. Tritan. 700 ml. Présentation Individuelle.
Fles. Tritan. 700 ml. Individuele Presentatie.

▬▬▬▬▬ Ø 7 × 24.5 cm  50
🌈 Print Code: F(1)

Raensen tritan® material BPA FREE
5499

Juicer Bottle. Tritan. 780 ml. Individual Presentation.
Trinkflasche Fruchtsaftpresse. Tritan. 780 ml. Individuelle Präsentation.
Bidon Presse-agrumes. Tritan. 780 ml. Présentation Individuelle.
Fles Sinaasappelpers. Tritan. 780 ml. Individuele Presentatie.

▬▬▬▬▬ Ø 7.5 × 26.5 cm  50
🌈 Print Code: F(1)

Nelsin tritan® material BPA FREE
6174

Bottle. Tritan. 580 ml.
Trinkflasche. Tritan. 580 ml.
Bidon. Tritan. 580 ml.
Fles. Tritan. 580 ml.

▬▬▬▬▬ Ø 6.7 × 22.4 cm  50
🌈 Print Code: F(1)

600 ml



NEW

500 ml



NEW

700 ml



437



01 02 21 16 07 03



01 02 21 16 07 03



16 19 03



Hanicol
6873

Bottle. Tritan. 600 ml.
Trinkflasche. Tritan. 600 ml.
Bidon. Tritan. 600 ml.
Fles. Tritan. 600 ml.

▬▬▬▬▬ Ø 7.2 × 20 cm
Print Code: F(1), L2



Rizbo
6872

Bottle. Tritan. 500 ml.
Trinkflasche. Tritan. 500 ml.
Bidon. Tritan. 500 ml.
Fles. Tritan. 500 ml.

▬▬▬▬▬ Ø 6.5 × 19.5 cm
Print Code: F(1), L2



Selmy
5555

Juicer Bottle. Tritan. 700 ml. Individual Presentation.
Trinkflasche Fruchtsaftpresse. Tritan. 700 ml. Individuelle Präsentation.
Bidon Presse-agrumes. Tritan. 700 ml. Présentation Individuelle.
Fles Sinaasappelpers. Tritan. 700 ml. Individuele Presentatie.

▬▬▬▬▬ Ø 7.3 × 25 cm
Print Code: F(1), L2





Suduk

6296

Bottle, Tritan, 550 ml.
Trinkflasche, Tritan, 550 ml.
Bidon, Tritan, 550 ml.
Fles, Tritan, 550 ml.

Ø 6.5 × 20 cm

Print Code: F(1), L2



tritan™
Tritan® material

550 ml



50



438



780 ml



tritan™
Tritan® material



01

03

05

04

19

Lobrok

5559

Bottle, Tritan, 780 ml. Individual Presentation.
Trinkflasche, Tritan, 780 ml. Individuelle Präsentation.
Bidon, Tritan, 780 ml. Présentation Individuelle.
Fles, Tritan, 780 ml. Individuele Presentatie.

Ø 7 × 24.7 cm

Print Code: F(1)



50



530 ml



tritan™
Tritan® material



01

19

03

07

Pruler

6297

Bottle, Tritan, 530 ml.
Trinkflasche, Tritan, 530 ml.
Bidon, Tritan, 530 ml.
Fles, Tritan, 530 ml.

Ø 6.5 × 22 cm

Print Code: F(1)



50



700 ml



19

01

03

EQUA

Keiler

5343

Bottle. Plastic/ Stainless Steel. 700 ml. Individual Presentation.
 Trinkflasche. Plastik/ Rostfreier Stahl. 700 ml. Individuelle Präsentation.
 Bidon. Plastique/ Acier Inox. 700 ml. Présentation Individuelle.
 Fles. Plastic/ Roestvrij Staal. 700 ml. Individuele Presentatie.

Ø 7 × 26.8 cm

30

Print Code: F(1), L2



600 ml



07

03

11



01

19

05

21

Zanip

4596

Bottle. PS. 600 ml.
 Trinkflasche. PS. 600 ml.
 Bidon. PS. 600 ml.
 Fles. PS. 600 ml.



Ø 7.2 × 22.5 cm

Print Code: F(1)

100 / 50



439



500 ml



01

19

03

04

Dirlam

5493

Bottle. 500 ml.
 Trinkflasche. 500 ml.
 Bidon. 500 ml.
 Fles. 500 ml.

Ø 6.8 × 20.5 cm

Print Code: F(1)

100 / 50

700 ml



01

02

04

03



Kroken

5492

Bottle. 700 ml. Individual Presentation.
 Trinkflasche. 700 ml. Individuelle Präsentation.
 Bidon. 700 ml. Présentation Individuelle.
 Fles. 700 ml. Individuele Presentatie.

Ø 7.2 × 25 cm

Print Code: F(1)



4in1
Multifunction

BPA FREE

Cold



19

16

08

650 ml

Doltin

5631

Holder Bottle. 650 ml. Individual Presentation. Towel Included 160 g/ m2. UV50 Protection.
Trinkflasche. 650 ml. Individuelle Präsentation. Handtuch Inklusiv 160 g/ m2. UV50 Schutz.
Bidon. 650 ml. Présentation Individuelle. Serviette Inclus 160 g/ m2. Protection UV50.
Fles. 650 ml. Individuele Presentatie. Handdoek Inclusief 160 g/ m2. UV50 Bescherming.

Ø 7 × 27.2 cm

30

Print Code: F(1), N(8)

COOLING TOWEL /
TOALLA ENFRIADORA



01

02



04

03

820 ml

19

BPA FREE

Rudix

6584

Bottle. Tritan. 820 ml.
Trinkflasche. Tritan. 820 ml.
Bidon. Tritan. 820 ml.
Fles. Tritan. 820 ml.

Ø 7.4 × 24.5 cm

Print Code: F(1)

tritan®
Tritan® material

50



440



01

03

1,89 L

Rumper

5979

Bottle. PET. 1.89 L.
Trinkflasche. PET. 1.89 L.
Bidon. PET. 1.89 L.
Fles. PET. 1.89 L.

Ø 12.5 × 23.5 cm

Print Code: F(1)

BPA FREE

30



04

08

19

2in1
Multifunction

BPA FREE

390 ml

Scout

5498

Holder Bottle. PP. 390 ml. Individual Presentation.
Trinkflasche Halter. PP. 390 ml. Individuelle Präsentation.
Bidon Support. PP. 390 ml. Présentation Individuelle.
Fles Houder. PP. 390 ml. Individuele Presentatie.

Ø 7 × 19.5 cm

Print Code: F(1)

50



03



600 ml



440 ml

650 ml



tritan™
Tritan® material

650 ml



tritan™
Tritan® material

441



Deldye

5560
Bottle. Tritan. 440 ml. Individual Presentation.
Trinkflasche. Tritan. 440 ml. Individuelle Präsentation.
Bidon. Tritan. 440 ml. Présentation Individuelle.
Fles. Tritan. 440 ml. Individuele Presentatie.

■■■■■■■■ 07 x 16 cm 50
Print Code: F(1)



Bore

3982
Bottle. PS. 600 ml. Ice Stick.
Trinkflasche. PS. 600 ml. Kühl Zubehor.
Bidon. PS. 600 ml. Accessoire Isotherme.
Fles. PS. 600 ml. Ijsstaaf.

■■■■■■■■ 07.5 x 22 cm 50
Print Code: F(1)



Vandix

5695
Bottle. Tritan. 650 ml. Individual Presentation.
Trinkflasche. Tritan. 650 ml. Individuelle Präsentation.
Bidon. Tritan. 650 ml. Présentation Individuelle.
Fles. Tritan. 650 ml. Individuele Presentatie.

■■■■■■■■ 07 x 23 cm 50
Print Code: F(1)



Halmik

5887
Bottle. Tritan. 650 ml.
Trinkflasche. Tritan. 650 ml.
Bidon. Tritan. 650 ml.
Fles. Tritan. 650 ml.

■■■■■■■■ 06.7 x 25 cm 50
Print Code: F(1), L2





03

04

02



19



350 ml

01

Ripon

6283

Cup. Stainless Steel. 350 ml. Individual Presentation.
 Trinkbecher. Rostfreier Stahl. 350 ml. Individuelle Präsentation.
 Verre. Acier Inox. 350 ml. Présentation Individuelle.
 Beker. Roestvrij Staal. 350 ml. Individuele Presentatie.

Ø 8.3 × 12 cm

50

Print Code: F(1), L2

442



380 ml



Double Wall



Nerux

6298

Cup. Stainless Steel/ Natural Cork. 380 ml. Individual Presentation.
 Trinkbecher. Rostfreier Stahl/ Naturkork. 380 ml. Individuelle Präsentation.
 Verre. Acier Inox/ Bouchon Naturel. 380 ml. Présentation Individuelle.
 Beker. Roestvrij Staal/ Natuurlijk Kurk. 380 ml. Individuele Presentatie.

Ø 8.7 × 13.4 cm

30

Print Code: F(1), L2



500 ml



Double Wall



Shifen

6299

Cup. Stainless Steel/ Natural Cork. 500 ml. Individual Presentation.
 Trinkbecher. Rostfreier Stahl/ Naturkork. 500 ml. Individuelle Präsentation.
 Verre. Acier Inox/ Bouchon Naturel. 500 ml. Présentation Individuelle.
 Beker. Roestvrij Staal/ Natuurlijk Kurk. 500 ml. Individuele Presentatie.

Ø 8 × 17.5 cm

30

Print Code: F(1), L2





09

310 ml

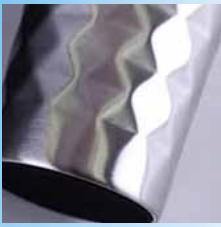

02

03

19



04



Double Wall

Dritox 5806

Cup. Stainless Steel. 310 ml. Individual Presentation.
 Trinkbecher. Rostfreier Stahl. 310 ml. Individuelle Präsentation.
 Verre. Acier Inox. 310 ml. Présentation Individuelle.
 Beker. Roestvrij Staal. 310 ml. Individuele Presentatie.

Ø 7.2 x 16.7 cm

50

Print Code: F(1), L2



07

04

03

11



Double Wall



01

19

Domex

6403

Cup. Stainless Steel. 450 ml. Individual Presentation.
 Trinkbecher. Rostfreier Stahl. 450 ml. Individuelle Präsentation.
 Verre. Acier Inox. 450 ml. Présentation Individuelle.
 Beker. Roestvrij Staal. 450 ml. Individuele Presentatie.

Ø 8.4 x 17.9 cm

50

Print Code: F(1), L2



450 ml



02



400 ml

Lessim

470 ml

Colcer

450 ml

Shary



Double Wall



02

19

03



Double Wall



09

03

19

01

02



07

01

11

16

05

02

19

03

Shary

4163

Mug. Stainless Steel. 450 ml. Individual Presentation.
Tasse. Rostfreier Stahl. 450 ml. Individuelle Präsentation.
Tasse. Acier Inox. 450 ml. Présentation Individuelle.
Mok. Roestvrij Staal. 450 ml. Individuele Presentatie.

Ø 8 × 17 cm

50

Print Code: F(1), L2

Lessim

4738

Mug. Stainless Steel. 400 ml. Individual Presentation.
Tasse. Rostfreier Stahl. 400 ml. Individuelle Präsentation.
Tasse. Acier Inox. 400 ml. Présentation Individuelle.
Mok. Roestvrij Staal. 400 ml. Individuele Presentatie.

Ø 7 × 16.5 cm

25

Print Code: F(1), L2

Colcer

4691

Mug. PP. 470 ml.
Tasse. PP. 470 ml.
Tasse. PP. 470 ml.
Mok. PP. 470 ml.

Ø 8.5 × 16 cm

25

Print Code: F(1)



Carson 5101

Mug. Stainless Steel. 450 ml. Individual Presentation.
 Tasse. Rostfreier Stahl. 450 ml. Individuelle Präsentation.
 Tasse. Acier Inox. 450 ml. Présentation Individuelle.
 Mok. Roestvrij Staal. 450 ml. Individuele Presentatie.

Ø 8.6 × 18 cm

Print Code: F(1), L2

50



Double Wall



03

07

19

16

11

450 ml



450 ml



Double Wall

Fresno

5100

Cup. Stainless Steel. 450 ml. Individual Presentation.
 Trinkbecher. Rostfreier Stahl. 450 ml. Individuelle Präsentation.
 Verre. Acier Inox. 450 ml. Présentation Individuelle.
 Beker. Roestvrij Staal. 450 ml. Individuele Presentatie.

Ø 8.6 × 18 cm

Print Code: F(1), L2

50



19

07

04

400 ml

Zicox 4508

Cup. Stainless Steel. 400 ml. Individual Presentation.
 Trinkbecher. Rostfreier Stahl. 400 ml. Individuelle Präsentation.
 Verre. Acier Inox. 400 ml. Présentation Individuelle.
 Beker. Roestvrij Staal. 400 ml. Individuele Presentatie.

Ø 7.6 × 18.2 cm

Print Code: F(1)

50



Double Wall



290 ml

04

03

19

09

Citrox 4880

Cup. Stainless Steel. 290 ml. Individual Presentation.
 Trinkbecher. Rostfreier Stahl. 290 ml. Individuelle Präsentation.
 Verre. Acier Inox. 290 ml. Présentation Individuelle.
 Beker. Roestvrij Staal. 290 ml. Individuele Presentatie.

Ø 7.3 × 14.4 cm

Print Code: F(1), L2

50



Double Wall



02



700 ml



Bravux

4528

Bottle. PP. 700 ml.
Trinkflasche. PP. 700 ml.
Bidon. PP. 700 ml.
Fles. PP. 700 ml.



BPA FREE

██████████ Ø 9.6 × 21 cm

📦 50 / 25

🌈 Print Code: F(1)



19

446



16



01

19

03

400 ml



BPA FREE

Triad

4692

Bottle. PP. 400 ml.
Trinkflasche. PP. 400 ml.
Bidon. PP. 400 ml.
Fles. PP. 400 ml.

██████████ Ø 9.3 × 22 cm

📦 50

🌈 Print Code: F(1)



730 ml



tritan™
Tritan® material



BPA FREE

Gazuk

5884

Pillbox Bottle. Tritan. 730 ml. 7 Compartments.
Trinkflasche Pillendose. Tritan. 730 ml. 7 Abteilungen.
Bidon Pilulier. Tritan. 730 ml. 7 Compartiments.
Fles Pillendoosje. Tritan. 730 ml. 7 Compartimenten.

██████████ Ø 7.5 × 23.3 cm

📦 50

🌈 Print Code: F(1)



500 ml



11

03

05

04

Norok
4926

Bottle. PE. 500 ml.
Trinkflasche. PE. 500 ml.
Bidon. PE. 500 ml.
Fles. PE. 500 ml.



Ø 6.5 × 19.5 cm

100 / 10

Print Code: F(1)

19



500 ml



02

01

19

04

05

07

11

Iskan



3837

Bottle. PE. 500 ml.
Trinkflasche. PE. 500 ml.
Bidon. PE. 500 ml.
Fles. PE. 500 ml.

Ø 6.5 × 19.5 cm

100 / 10

Print Code: F(1)

03

447



FOLDABLE
PLEGABLE

570 ml



05

Luns

4529

Foldable Bottle. PE. 570 ml.
Faltbare Trinkflasche. PE. 570 ml.
Bidon Pliable. PE. 570 ml.
Opvouwbare Fles. PE. 570 ml.

Ø 9.3 × 18.5 cm

50

Print Code: E(1)



02

01

19

03



04

01

05

03



550 ml

Sports

9342

Bottle. PE. 550 ml.
Trinkflasche. PE. 550 ml.
Bidon. PE. 550 ml.
Fles. PE. 550 ml.

Ø 7.5 × 20.5 cm

100 / 10

Print Code: F(1)



19



D



G

480 ml



A



C



B



Match

5296

Bottle. PET. 480 ml.

Trinkflasche. PET. 480 ml.

Bidon. PET. 480 ml.

Fles. PET. 480 ml.

16 × 21 × 3.3 cm

400 / 50

Print Code: E(1)



19



470 ml



19

05

04

01

Zablex

5297

Bottle. PET. 470 ml.

Trinkflasche. PET. 470 ml.

Bidon. PET. 470 ml.

Fles. PET. 470 ml.

17 × 25.5 × 3.3 cm

400 / 50

Print Code: E(1)



03



19

Boxter

3584

Bottle. PET. 400 ml.

Trinkflasche. PET. 400 ml.

Bidon. PET. 400 ml.

Fles. PET. 400 ml.

11.5 × 26.5 × 3 cm

400 / 50

Print Code: E(1)



BPA FREE



07



01



02



03



05



04

Luthor

4381

Bottle Cooler. PET. 400 ml.

Trinkflaschen Kühler. PET. 400 ml.

Bidon Refroidisseur. PET. 400 ml.

Flessenkoeler. PET. 400 ml.

12 × 26.5 × 3 cm

100

Print Code: E(1)

BPA FREE

400 ml



01

03



420 ml



03



BPA FREE

Yoplait

5572

Cup. PS. 420 ml.
Trinkbecher. PS. 420 ml.
Verre. PS. 420 ml.
Beker. PS. 420 ml.

Print Code: E(1)

Print Code: E(1)

50



16

01

19



04

11

01

19

IDEAL FOR LIQUIDS
IDEAL PARA LÍQUIDOS

710 ml



BPA FREE

Gorex

4873

Jar. 710 ml.
Einmachglas. 710 ml.
Pot. 710 ml.
Pot. 710 ml.

Print Code: F(1)

Print Code: F(1)

40



03



03

19

Fresher

3074

Cool Bottle. Polyester 600D/ PVC. Suitable for Bottle 1,5 l.
Flaschenkühlflasche. Polyester 600D/ PVC. Flaschen bis Größe 1,5 l.
Glacière Bouteille. Polyester 600D/ PVC. Bouteilles Jusqu'à 1,5 l.
Flessenkoeler. Polyester 600D/ PVC. Geschikt voor 1,5 l Fles.

Print Code: F(1), N(8)

Print Code: F(1), N(8)

100 / 20



02

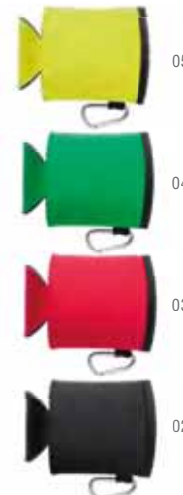

05

04

03

02

EXTENDABLE
EXTENSIBLE

449

Blesk

5636

Pouch. Soft Shell.
Estojo. Soft Shell.
Étui. Soft Shell.
Hoes. Soft Shell.

Print Code: E(1), N(8)

Print Code: E(1), N(8)

500 / 50



19



750 ml

450



Trinox
4874

Cup. PS. 750 ml.
Trinkbecher. PS. 750 ml.
Verre. PS. 750 ml.
Beker. PS. 750 ml.

Ø 10 × 17.5 cm
Print Code: F(1)



650 ml



600 ml

Partys
4702

Cup. PET. 650 ml.
Trinkbecher. PET. 650 ml.
Verre. PET. 650 ml.
Beker. PET. 650 ml.

Ø 8.9 × 42 cm
Print Code: D(1)



Sirex
4820

Jar. PS. 600 ml.
Einmachglas. PS. 600 ml.
Pot. PS. 600 ml.
Pot. PS. 600 ml.

Ø 8.5 × 13.5 cm
Print Code: F(1)



100% BIODEGRADABLE
AND COMPOSTABLE



13

500 ml



BPA FREE

Hecox 6161

Cup. Paper/ PLA 100% Compostable. 500 ml.
Trinkbecher. Papier/ PLA 100% Kompostierbar. 500 ml.
Verre. Papier/ PLA 100% Compostable. 500 ml.
Beker. Paper/ PLA 100% Composteerbaar. 500 ml.

📏 Ø 9 × 13.6 cm

📦 1000 / 50

🌈 Print Code: C(1)

18

500 ml



BPA FREE



BPA FREE

400 ml

Yonrax 2555

Cup. PP. 400 ml.
Trinkbecher. PP. 400 ml.
Verre. PP. 400 ml.
Beker. PP. 400 ml.

📏 Ø 7.5 × 14 cm

📦 490 / 14

🌈 Print Code: C(1)

Nirmal 2554

Cup. PP. 500 ml.
Trinkbecher. PP. 500 ml.
Verre. PP. 500 ml.
Beker. PP. 500 ml.

📏 Ø 8.7 × 11.8 cm

🌈 Print Code: C(1)

📦 384 / 16



BPA FREE



BPA FREE

Ginbert 2494

Cup. PP. 500 ml.
Trinkbecher. PP. 500 ml.
Verre. PP. 500 ml.
Beker. PP. 500 ml.

📏 Ø 9.2 × 11.6 cm

🌈 Print Code: C(1)

📦 500 / 25

01

500 ml



03

FLEXIBLE

05

04

19

02

01

Pevic 2493

Long Drink Glass. PP. 300 ml.
Longdrinkglas. PP. 300 ml.
Verre. PP. 300 ml.
Long Drink Glas. PP. 300 ml.

📏 Ø 5.9 × 15.2 cm

🌈 Print Code: C(1)

📦 500 / 10

Frinly 6595

Lanyard Cup Holder. Polyester/ Silicone.
Schlüsselband Getränkehalter. Polyester/ Silikon.
Lanyard Porte Verre. Polyester/ Silicône.
Lanyard Getränkehalter. Polyester/ Siliconen.

📏 6 × 45 cm

🌈 Print Code: F(1), N(8), R

📦 800 / 100



452



Chiko
3171

Cup. PP. 380 ml.
Trinkbecher. PP. 380 ml.
Verre. PP. 380 ml.
Beker. PP. 380 ml.

▬▬▬▬▬ Ø 9 × 10.6 cm
Print Code: E(1)

📦 300 / 10



Fraguen
4688

Cup. PP. 400 ml.
Trinkbecher. PP. 400 ml.
Verre. PP. 400 ml.
Beker. PP. 400 ml.

▬▬▬▬▬ Ø 8.3 × 12.5 cm
Print Code: E(1)

📦 300 / 10



Witar
2495

Mug. PP. 370 ml.
Tasse. PP. 370 ml.
Tasse. PP. 370 ml.
Mok. PP. 370 ml.

▬▬▬▬▬ Ø 8.5 × 9 cm
Print Code: E(1)

📦 75



Fesient
6020

Mug. PS/PP. 320 ml. Individual Presentation. 4 Pencils and 4 Sheets Included.
Tasse. PS/PP. 320 ml. Individuelle Präsentation. 4 Stifte und 4 Seiten Inklusiv.
Tasse. PS/PP. 320 ml. Présentation Individuelle. 4 Crayons et 4 Feuilles Inclus.
Mok. PS/PP. 320 ml. Individuele Presentatie. 4 Potloden en 4 Blaadjes Inclusief.

▬▬▬▬▬ Ø 8.6 × 10.2 cm
Print Code: E(1)

📦 36

4 DIFFERENT DESIGNS INCLUDED
4 LÁMINAS DIFERENTES INCLUIDAS

KIDS

440 ml

Deldye



Bore

600 ml

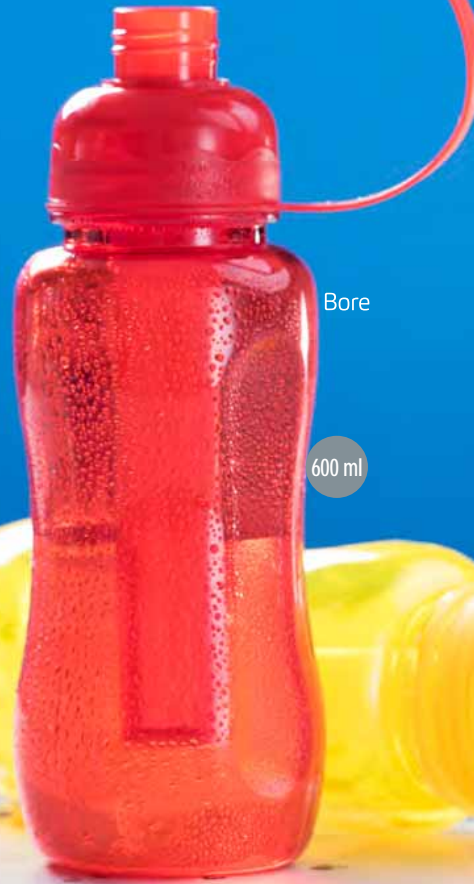

453



05

03

19

Deldye
5560

tritan™
Tritan® material BPA FREE

Bottle. Tritan. 440 ml. Individual Presentation.
Trinkflasche. Tritan. 440 ml. Individuelle Präsentation.
Bidon. Tritan. 440 ml. Présentation Individuelle.
Fles. Tritan. 440 ml. Individuele Presentatie.

██████████ Ø 7 × 16 cm



Print Code: F(1)



19

05

03

BPA FREE

Bore
3982

Bottle. PS. 600 ml. Ice Stick.
Trinkflasche. PS. 600 ml. Kühl Zubehör.
Bidon. PS. 600 ml. Accessoire Isotherme.
Fles. PS. 600 ml. Ijsstaaf.

██████████ Ø 7.5 × 22 cm



Print Code: F(1)

TAKE AWAY

NEW

Corpax
6887

Cutlery Set. Bamboo. 5 Pieces.
Besteckset. Bambus. 5 Stück.
Set Couverts. Bambou. 5 Pièces.
Bestek Set. Bamboe. 5 Stuks.

6.5 × 22 × 2.5 cm

Print Code: N(8), B(4), L1

100

CANVAS POUCH



455

Zayka

6812



BPA FREE

NEW

Cool Bag. Laminated Paper/ Aluminium.
Kühltasche. Laminiertes Papier/ Aluminium.
Glacière. Papier Laminé/ Aluminium.
Koelttas. Gelamineerd Paper/ Aluminium.

17.2 x 15 x 15 cm

200 / 25

Print Code: F(1)



Bejar

6799

Lunch Box. Glass/ Bamboo. 700 ml.

Lunch Box. Glas/ Bambus. 700 ml.

Gamelle. Verre/ Bambou. 700 ml.

Lunch Box. Glas/ Bamboe. 700 ml.

17.2 x 6.7 x 12.7 cm

Print Code: E(1)

700 ml

NEW

20





700 ml



Taxlam
6153

Lunch Box. Bamboo Fibre/ PP. 700 ml.
Lunch Box. Bambusfaser/ PP. 700 ml.
Gamelle. Fibre Bambou/ PP. 700 ml.
Lunch Box. Bamboe Fibre/ PP. 700 ml.

16.5 x 7 x 11.2 cm

50

Print Code: E(1)

BAMBOO FIBRE

456



1L

Galix

6553

Lunch Box. Bamboo Fibre/ PP. 1 L.
Lunch Box. Bambusfaser/ PP. 1 L.
Gamelle. Fibre Bambou/ PP. 1 L.
Lunch Box. Bamboe Fibre/ PP. 1 L.

19 x 9 x 12 cm

50

Print Code: E(1), W



HOLDER
SOPORTE

1L



13

Konpel
6309

Lunch Box. Bamboo Fibre/ PP. 1 L.
Lunch Box. Bambusfaser/ PP. 1 L.
Gamelle. Fibre Bambou/ PP. 1 L.
Lunch Box. Bamboe Fibre/ PP. 1 L.

18.8 x 7.8 x 12.9 cm

20

Print Code: E(1), W



03

19

04

BAMBOO FIBRE



REAL BAMBOO



700 ml

Bilsoc

6551

- Lunch Box. Bamboo Fibre/ PP/ Bamboo. 700 ml.
- Lunch Box. Bambusfaser/ PP/ Bambus. 700 ml.
- Gamelle. Fibre Bambou/ PP/ Bambou. 700 ml.
- Lunch Box. Bamboe Fibre/ PP/ Bamboe. 700 ml.

16.5 x 8 x 11.2 cm

48

Print Code: E(1), W



457



450 ml



Dredon

6294

- Sandwich Lunch Box. Bamboo Fibre/ PP. 450 ml.
- Sandwich Lunch Box. Bambusfaser/ PP. 450 ml.
- Gamelle Sandwich. Fibre Bambou/ PP. 450 ml.
- Boterhammen-Lunchbox. Bamboe Fibre/ PP. 450 ml.

12.5 x 3.8 x 12.9 cm

200 / 50

Print Code: E(1)



1,4 L



REAL BAMBOO

Yebix

6552

- Lunch Box. Bamboo Fibre/ PP/ Bamboo. 2 Compartments 700 ml.
- Lunch Box. Bambusfaser/ PP/ Bambus. 2 Abteilungen 700 ml.
- Gamelle. Fibre Bambou/ PP/ Bambou. 2 Compartiments 700 ml.
- Lunch Box. Bamboe Fibre/ PP/ Bamboe. 2 Compartimenten 700 ml.

18.7 x 12.1 x 10.6 cm

30

Print Code: E(1), W



STAINLESS STEEL / BAMBOO



NEW

600 ml



Sariul
6695

Lunch Box. Stainless Steel/ Bamboo. 600 ml.
Lunch Box. Rostfreier Stahl/ Bambus. 600 ml.
Gamelle. Acier Inox/ Bambou. 600 ml.
Lunch Box. Roeststrij Staal/ Bamboe. 600 ml.

16.4 × 5.6 × 11.5 cm

30

Print Code: E(1), L2

458

NEW



700 ml

Bejar
6799

Lunch Box. Glass/ Bamboo. 700 ml.
Lunch Box. Glas/ Bambus. 700 ml.
Gamelle. Verre/ Bambou. 700 ml.
Lunch Box. Glas/ Bamboe. 700 ml.

17.2 × 6.7 × 12.7 cm

20

Print Code: E(1)

GLASS / BAMBOO

PICK'S

It's attempted. Just
be working, doesn't
right and work the
over life for other





NEW



1L

Calpy

6724

Electric Lunch Box. 1 L. Cable Included.
Elektrische Lunch Box. 1 L. Kabel Inklusive.
Électrique Gamelle. 1 L. Câble Inclus.
Elektrische Lunch Box. 1 L. Kabel Inclusief.

23.5 x 16.5 x 11 cm

20

Print Code: G(1)

FAST HEATING

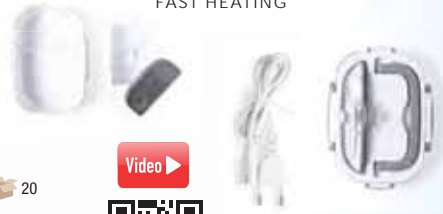

Video



459



1L

PLA

Molkas

6675

Lunch Box. PLA 100% Compostable. 1 L.
Lunch Box. PLA 100% Kompostierbar. 1 L.
Gamelle. PLA 100% Compostable. 1 L.
Lunch Box. PLA 100% Composteerbaar. 1 L.

19 x 8.5 x 11 cm

20

Print Code: E(1), W



NEW



1,4 L

Fandex

6708

Antibacterial Lunch Box. PP. 2 Compartments 700 ml.
Antibakteriell Lunch Box. PP. 2 Abteilungen 700 ml.
Gamelle Antibactérienne. PP. 2 Compartiments 700 ml.
Antibacterieel Lunch Box. PP. 2 Compartimenten 700 ml.

18.7 x 12.1 x 10.6 cm

30

Print Code: E(1), W

ANTIBACTERIAL



420 ml



Yoplast 5572

Cup. PS. 420 ml.
Trinkbecher. PS. 420 ml.
Verre. PS. 420 ml.
Beker. PS. 420 ml.

Ø 9 × 16.3 cm
Print Code: E(1)



50 03

IDEAL FOR LIQUIDS /
IDEAL PARA LIQUIDOS

710 ml



Gorex 4873

Jar. 710 ml.
Einmachglas. 710 ml.
Pot. 710 ml.
Pot. 710 ml.

Ø 11.5 × 12.5 cm
Print Code: F(1)



40 03



460

450 ml



01

300 ml



19

1 L



03

05

Noix 2500

Sandwich Lunch Box. 450 ml.
Sandwich Lunch Box. 450 ml.
Gamelle Sandwich. 450 ml.
Boterhammen-Lunchbox. 450 ml.

13 × 5 × 13.5 cm
Print Code: E(1)

160 / 40



04



05



19



03

Fantiel 5413

Lunch Box. Lunch Box 1 L. Bottle 300 ml.
Lunch Box. Lunch Box 1 L. Flasche 300 ml.
Gamelle. Gamelle 1 L. Bouteille 300 ml.
Lunch Box. Lunch Box 1 L. Fles 300 ml.

14.5 × 8.7 × 20 cm
Print Code: E(1)

20



04

Dusky 4876

Multipurpose Bag. LDPE.
Mehrzwecktasche. LDPE.
Fourre-Tout. LDPE.
Multifunctioneel Tasje. LDPE.

23 × 18 × 6.5 cm
Print Code: E(1)

1000 / 100

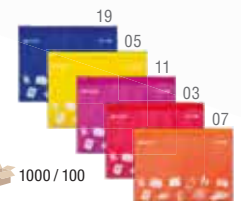

19

05

11

03

07



1L

Griva

4025

- Lunch Box. 1 L.
- Lunch Box. 1 L.
- Gamelle. 1 L.
- Lunch Box. 1 L.



19

15.5 × 6 × 22.5 cm



40

Print Code: E(1)



1L



BPA FREE

16

Trekitt

6293

- Lunch Box. 1 L.
- Lunch Box. 1 L.
- Gamelle. 1 L.
- Lunch Box. 1 L.

19 × 6.6 × 12 cm

Print Code: E(1)



MOBILE HOLDER
SOPORTE MÓVIL

03

19

07

50 / 25



03

1.2L

Kaprex

4872

- Salad Container. 1,2 L.
- Salatbehälter. 1,2 L.
- Boîte Salade. 1,2 L.
- Salade-Bakje. 1,2 L.

18 × 11.5 × 22.5 cm

Print Code: E(1)



BPA FREE

19

40



750 ml



BPA FREE

19

Dinder

4294

- Salad Container. 750 ml.
- Salatbehälter. 750 ml.
- Boîte Salade. 750 ml.
- Salade-Bakje. 750 ml.

Ø 11.5 × 19.5 cm

Print Code: E(1)



40

03

11

04



BPA FREE

BAMBOO FIBRE

Klaran

6600

Straw, Bamboo Fibre/ PP. Reusable. Cleaner Included.
Strohalm. Bambusfaser/ PP. Wiederverwendbar. Reiniger Inklusiv.
Paille. Fibre Bambou/ PP. Réutilisable. Nettoyant Inclus.
Rietje. Bamboe Fibre/ PP. Herbruikbaar. Cleaner Inclusief.

Ø 2.3 x 12.5 cm

500 / 50

Print Code: E(4)

462



EXTENDABLE /
EXTENSIBLE

01



02

Timex

6306

Straw, Stainless Steel/ Silicone. Extendable. Reusable. Cleaner Included.
Strohalm. Rostfreier Stahl/ Silikon. Ausziehbar. Wiederverwendbar. Reiniger Inklusiv.
Paille. Acier Inox/ Silicône. Extensible. Réutilisable. Nettoyant Inclus.
Rietje. Roestvrij Staal/ Siliconen. Verlengbaar. Herbruikbaar. Cleaner Inclusief.

Ø 1.6 x 10.5 cm

500 / 100

Print Code: E(1), L1

Parix

6291

Straw, Silicone. Reusable.
Strohalm. Silikon. Wiederverwendbar.
Paille. Silicône. Réutilisable.
Rietje. Siliconen. Herbruikbaar.

Ø 5.4 x 2 cm

500 / 100

Print Code: C(4), W

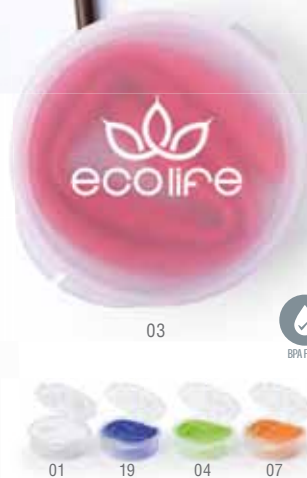

03



BPA FREE



01

19

04

07



Antibacterial

ANTIBACTERIAL
PRODUCT



BPA FREE

NEW



Ladix

6682

Antibacterial Straw, Silicone. Reusable.
Antibakteriell Strohalm. Silikon. Wiederverwendbar.
Paille Antibactérienne. Silicône. Réutilisable.
Antibacterieel Rietje. Siliconen. Herbruikbaar.

Ø 5.4 x 2 cm

500 / 100

Print Code: B(4), W

Say No
to
Plastic

COTTON
POUCH

Piltu

6800

Straw Set. Bamboo. 2 Pieces. Reusable. Cleaner Included.
Strohalm Set. Bambus. 2 Stück. Wiederverwendbar. Reiniger Inklusive.
Set Paille. Bambou. 2 Pièces. Réutilisable. Nettoyant Inclus.
Rietjes Set. Bamboe. 2 Stuks. Herbruikbaar. Cleaner Inclusief.

3.5 x 24.5 cm 400 / 200

Print Code: E(1), L1, N(8)

REUSABLE
straw



463

COTTON
POUCH

Kalux

6282

Straw Set. Stainless Steel. 2 Pieces. Reusable. Cleaner Included.
Strohalm Set. Rostfreier Stahl. 2 Stück. Wiederverwendbar. Reiniger Inklusive.
Set Paille. Acier Inox. 2 Pièces. Réutilisable. Nettoyant Inclus.
Rietjes Set. Roestvrij Staal. 2 Stuks. Herbruikbaar. Cleaner Inclusief.

3.5 x 24.5 cm 400 / 100

Print Code: E(1), L1, N(8)

Lantux

6290

Straw Set. Paper. 10 Pieces. 10 PIECES
Strohalm Set. Papier. 10 Stück.
Set Paille. Papier. 10 Pièces.
Rietjes Set. Papier. 10 Stuks.

3.2 x 20 x 1.3 cm 500 / 100

Print Code: A(1), B(4), W

13

18

10 PIECES



REUSABLE Cutlery Set

COTTON POUCH

Plusin 6361

Cutlery Set. Bamboo. 3 Pieces.
Besteckset. Bambus. 3 Stück.
Set Couverts. Bambou. 3 Pièces.
Bestek Set. Bamboe. 3 Stuks.

6.5 × 22 × 1 cm 300 / 100
Print Code: F(1), B(4), L1, N(8)

464

NEW

CANVAS POUCH

Corpax 6887

Cutlery Set. Bamboo. 5 Pieces.
Besteckset. Bambus. 5 Stück.
Set Couverts. Bambou. 5 Pièces.
Bestek Set. Bamboe. 5 Stuks.

6.5 × 22 × 2.5 cm 100
Print Code: N(8), B(4), L1

100

Hartul

6547
Cutlery Set. Bamboo Fibre/ PP. 3 Pieces.
Besteckset. Bambusfaser/ PP. 3 Stück.
Set Couverts. Fibre Bambou/ PP. 3 Pièces.
Bestek Set. Bamboe Fibre/ PP. 3 Stuks.

3.1 × 17.7 × 2.2 cm 400 / 50
Print Code: D(1)

BPA FREE

BAMBOO FIBRE

BPA FREE

Beylom 6356

Cutlery Set. Bamboo Fibre/ PP. 3 Pieces.
Besteckset. Bambusfaser/ PP. 3 Stück.
Set Couverts. Fibre Bambou/ PP. 3 Pièces.
Bestek Set. Bamboe Fibre/ PP. 3 Stuks.

21 × 2.6 × 5.6 cm 100 / 50
Print Code: D(4), B(4), W

100 / 50

THERMAL BAG



ALUMINIUM
INTERIOR



NEW

Zayka

6812

Cool Bag. Laminated Paper/ Aluminium.
Kühltasche. Laminiertes Papier/ Aluminium.
Glacière. Papier Laminé/ Aluminium.
Koelttas. Gelamineerd Paper/ Aluminium.

21 × 15 × 15 cm

200 / 25

Print Code: F(1)



BPA FREE

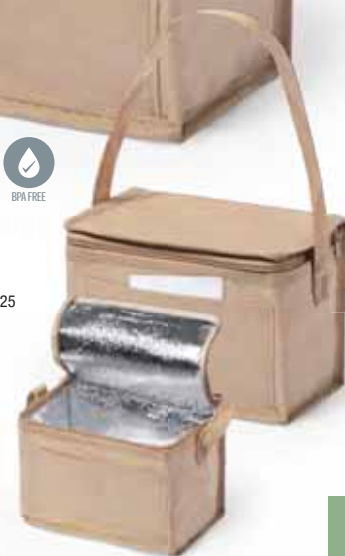

465



BPA FREE



BPA FREE



Rumbix

6092

Cool Bag. Laminated Paper/ Aluminium.
Kühltasche. Laminiertes Papier/ Aluminium.
Glacière. Papier Laminé/ Aluminium.
Koelttas. Gelamineerd Paper/ Aluminium.

20 × 25 × 10 cm

100 / 50

Print Code: F(1)

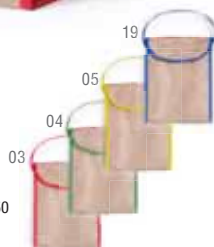

Laral

6063

Thermal Bag. Laminated Paper/ Aluminium.
Wärme Tasche. Laminiertes Papier/ Aluminium.
Sac Thermique. Papier Laminé/ Aluminium.
Thermo-Tasje. Gelamineerd Paper/ Aluminium.

30 × 30 × 15 cm

100 / 50

Print Code: F(1)



BPA FREE

Bapom

6064

Thermal Bag. Laminated Paper/ Aluminium.
Wärme Tasche. Laminiertes Papier/ Aluminium.
Sac Thermique. Papier Laminé/ Aluminium.
Thermo-Tasje. Gelamineerd Paper/ Aluminium.

19 × 32 × 12 cm

100 / 50

Print Code: F(1)

NEW



Sindy

03

6813

Cool Bag. Polyester 420D/ PEVA.
Kühltasche. Polyester 420D/ PEVA.
Glacière. Polyester 420D/ PEVA.
Koeltas. Polyester 420D/ PEVA.

37 × 29 × 21 cm

20

Print Code: G(1), N(8)



BPA FREE



19

05

04

02

01

466



BPA FREE



02

Bemel

4364

Cool Bag. Polyester 600D/ PEVA.
Kühltasche. Polyester 600D/ PEVA.
Glacière. Polyester 600D/ PEVA.
Koeltas. Polyester 600D/ PEVA.

25 × 24 × 15 cm

20

Print Code: G(1), N(8)

19



03



19



02

Wilbert

3505

Cool Bag. Polyester 420D/ PEVA.
Kühltasche. Polyester 420D/ PEVA.
Glacière. Polyester 420D/ PEVA.
Koeltas. Polyester 420D/ PEVA.

20 × 25 × 13.5 cm

30

Print Code: G(1), N(8)



03



BPA FREE



NEW



Botum

6849

Cool Bag. Polyester 600D RPET/ PEVA.
Kühltasche. Polyester 600D RPET/ PEVA.
Glacière. Polyester 600D RPET/ PEVA.
Koelttas. Polyester 600D RPET/ PEVA.

31 × 24.5 × 20 cm

Print Code: G(1), N(8)

30



03



01



04

19

30

Kardil

6285

Cool Bag. Polyester 600D/ PEVA.
Kühltasche. Polyester 600D/ PEVA.
Glacière. Polyester 600D/ PEVA.
Koelttas. Polyester 600D/ PEVA.

31 × 24.5 × 20 cm

Print Code: G(1), N(8)



Howar

6596

Backpack. Polyester 600D/ PEVA. Padded Shoulder Straps.
Rucksack. Polyester 600D/ PEVA. Gepolsterte Schultergurte.
Sac à Dos. Polyester 600D/ PEVA. Bretelles Rembourrées.
Ruzgak. Polyester 600D/ PEVA. Gewatteerde Schouderbanden.

30 × 62 × 13 cm

Print Code: G(1), N(8)

20

COOL
COMPARTMENT





02



03



04

19

Listak

5593

Cool Bag. Polyester 210D/ PEVA.
Kühltasche. Polyester 210D/ PEVA.
Glacière. Polyester 210D/ PEVA.
Koeltas. Polyester 210D/ PEVA.

20 x 27 x 13 cm

Print Code: G(1), N(8)



50

COOL BAG

468



19

01

07

03



BPA FREE

Artirian

5298

Cool Bag. Polyester 210D/ PEVA.
Kühltasche. Polyester 210D/ PEVA.
Glacière. Polyester 210D/ PEVA.
Koeltas. Polyester 210D/ PEVA.

26 x 27 x 17.5 cm

Print Code: G(1), N(8)



50



16



05



BPA FREE

Lans

5173

Cool Bag. Non-Woven/ Aluminium.
Kühltasche. Non-Woven/ Aluminium.
Glacière. T.N.T./ Aluminium.
Koeltas. Non-Woven/ Aluminium.

27 x 31 x 15 cm

Print Code: G(1), N(8)



100 / 25



03

11

16

19



NEW



Ponix 6816

Cool Bag. Laminated Jute/ Cotton/ Aluminium.
Kühltasche. Laminiertes Jutestoff/ Baumwolle/ Aluminium.
Glacière. Jute Lamine/ Coton/ Aluminium.
Koeltas. Gelamineerd Jute/ Katoen/ Aluminium.

21 x 23 x 16 cm  50
Print Code: F(1), N(8)

COOL BAG



19

Hertum 5737

Cool Bag. Non-Woven/ Aluminium.
Kühltasche. Non-Woven/ Aluminium.
Glacière. T.N.T./ Aluminium.
Koeltas. Non-Woven/ Aluminium.

21 x 15 x 15 cm
Print Code: F(1), N(8)



469



19

 200 / 25



Coolcan 3072

Cool Bag. PVC/ Aluminium.
Kühltasche. PVC/ Aluminium.
Glacière. PVC/ Aluminium.
Koeltas. PVC/ Aluminium.

21 x 15 x 15 cm  200 / 25
Print Code: F(1), N(8)



04

Tivex

4147
Cool Bag. PVC/ Aluminium.
Kühltasche. PVC/ Aluminium.
Glacière. PVC/ Aluminium.
Koeltas. PVC/ Aluminium.

15 x 13 x 15 cm
Print Code: F(1), N(8)



 200 / 25

03



BPA FREE



16

19



02

05



03

Polys

5419

Cool Bag Backpack. Polyester 600D/ Aluminium. Padded Shoulder Straps.
Kühltasche Rucksack. Polyester 600D/ Aluminium. Gepolsterte Schultergurte.
Sac à Dos Glacière. Polyester 600D/ Aluminium. Bretelles Rembourrées.
Koeltas-Rugzak. Polyester 600D/ Aluminium. Gewatteerde Schouderbanden.

31 × 40 × 18.5 cm

50

Print Code: G(1), N(8)

470

COOL BAG backpack



02

01

19

04

11

07

03



BPA FREE



05

Nipex

5234

Drawstring Cool Bag. Polyester 210D/ Aluminium.
Kühltasche Rucksack. Polyester 210D/ Aluminium.
Sac à Dos Glacière. Polyester 210D/ Aluminium.
Koeltas-Rugzak. Polyester 210D/ Aluminium.

32 × 42 cm

200 / 10

Print Code: G(1), N(8)



Video



19



BPA FREE

Tradan

5235

Drawstring Cool Bag. Polyester 210D/ Aluminium.
Kühltasche Rucksack. Polyester 210D/ Aluminium.
Sac à Dos Glacière. Polyester 210D/ Aluminium.
Koeltas-Rugzak. Polyester 210D/ Aluminium.

27 × 33 cm

200 / 10

Print Code: G(1), N(8)

KIDS



02

01

04

05

07

03

11



1.5 L

Kranch

3515

Cool Bag. Polyester 600D/ PEVA. Airtight Container 1,5 L Included.
 Kühltasche. Polyester 600D/ PEVA. 1,5 L Hermetisch Behälter Inklusive.
 Glacière. Polyester 600D/ PEVA. Récipient Hermétique 1,5 L Inclus.
 Koeltas. Polyester 600D/ PEVA. Luchtdichte Container 1,5 L Inclusief.

24 x 32.5 x 17 cm
 Print Code: G(1), N(8)

LUNCH BOX INCLUDED
 FIAMBRERA INCLUIDA

15

ID COMPARTMENT



1 L

BPA FREE

Parlik

6060

Cool Bag. Polyester 210D/ Aluminium. Lunch Box 1 L Included.
 Kühltasche. Polyester 210D/ Aluminium. Lunch Box 1 L Inklusive.
 Glacière. Polyester 210D/ Aluminium. Gamelle 1 L Inclus.
 Koeltas. Polyester 210D/ Aluminium. Lunch Box 1 L Inclusief.

26 x 22 x 18 cm
 Print Code: F(1)

30

LUNCH BOX INCLUDED
 FIAMBRERA INCLUIDA



19

LUNCH BOX INCLUDED
 FIAMBRERA INCLUIDA



04

02

471



19

BPA FREE

Palen

4308

Cool Bag. PVC/ PEVA.
 Kühltasche. PVC/ PEVA.
 Glacière. PVC/ PEVA.
 Koeltas. PVC/ PEVA.

27 x 8 x 21 cm
 Print Code: F(1)

100 / 20



02

03

05

11



02

BPA FREE

Rufus

4028

Sandwich Holder. PVC/ Aluminium.
 Lunch Box Tasche. PVC/ Aluminium.
 Lunch-Box. PVC/ Aluminium.
 Boterhammentrommel. PVC/ Aluminium.

21 x 7.5 x 8 cm
 Print Code: E(1), N(8)

300 / 25



03

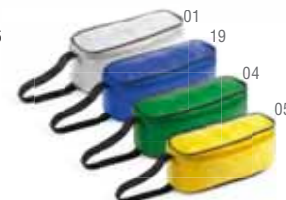

01

19

04

05

Buck

3073

Cool Bag. PVC/ Aluminium.
Kühltasche. PVC/ Aluminium.
Glacière. PVC/ Aluminium.
Koeltas. PVC/ Aluminium.

Ø 25 × 29 cm

Print Code: G(1), N(8)

80



BPA FREE



03



19

02

ALUMINIUM
INTERIOR

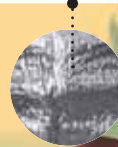

COOL
BAG

472



11



BPA FREE



19



16



07

01



03



05

Hobart

4690

Cool Bag. Laminated Non-Woven/ Aluminium.
Kühltasche. Laminiertes Non-Woven/ Aluminium.
Glacière. T.N.T. Lamine/ Aluminium.
Koeltas. Gelamineerd Non-Woven/ Aluminium.

37 × 34 × 15 cm

200 / 50

Print Code: G(1)

COOL BAG CONVERTS
INTO PICNIC BLANKET
BOLSA NEVERA CONVERTIBLE
EN MANTA DE PICNIC

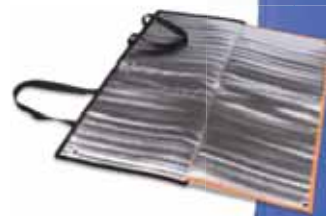

19

Klab

4644

Cool Bag. Polyester 600D/ Aluminium.
Kühltasche. Polyester 600D/ Aluminium.
Glacière. Polyester 600D/ Aluminium.
Koeltas. Polyester 600D/ Aluminium.

44 × 39 cm

50

Print Code: G(1), N(8)



04



03



07



Thermal BAG

ALUMINIUM INTERIOR



POCKET

Saban
6372

Thermal Bag. Laminated Paper/ Aluminium.
Wärme Tasche. Laminiertes Papier/ Aluminium.
Sac Thermique. Papier Laminé/ Aluminium.
Thermo-Tasje. Gelamineerd Paper/ Aluminium.

43 × 33 × 14 cm

100 / 50

Print Code: F(1)

473



19

Daniels
3311

Cool Bag. Polyester 190T/ Aluminium.
Kühltasche. Polyester 190T/ Aluminium.
Glacière. Polyester 190T/ Aluminium.
Koeltas. Polyester 190T/ Aluminium.

45 × 36 × 9 cm

100 / 20

Print Code: G(1)



FOLDABLE
PLEGABLE



03



19

02

Yonner
6277

FOLDABLE
PLEGABLE

Thermal Picnic Basket. Polyester 600D/ Aluminium. Foldable.
Wärme Tasche. Polyester 600D/ Aluminium. Faltbar.
Sac Thermique. Polyester 600D/ Aluminium. Pliable.
Thermo-Tasje. Polyester 600D/ Aluminium. Opvouwbaar.

47 × 25 × 28 cm

20

Print Code: G(1), N(8)

SPORT & ADVENTURE



NEW



Zhiax
6790

Fitness Set. TPE/ EVA. 2 Pieces. Band Resistance Medium.
Fitness Set. TPE/ EVA. 2 Stück. Gummiband Widerstand Mittel.
Set Fitness. TPE/ EVA. 2 Pieces. Bande Résistance Moyenne.
Fitness Set. TPE/ EVA. 2 Stuks. Band Weerstand Gemiddeld.

11.5 × 25 × 6 cm

100

Print Code: F(1), N(8)





NEW

EQUA

Leven

6725

Bike Bag. Polyester 600D.
Fahrradtasche. Polyester 600D.
Sac à Velo. Polyester 600D.
Fietstas. Polyester 600D.

20 × 18 × 7,5 cm

100 / 10

Print Code: F(1), N(8)



475



02

19



03

FLINT SCRAPER
CUCHILLO RASCADOR

COMPASS
BRÜJULA

OPENER
ABRIDOR

5 in 1
Multifunction

WHISTLE
SILBATO

FIRE STARTER
PEDERNAL

04

Kupra

6374

Multifunction Arm Strap. Nylon.
Multifunktion Armband. Nylon.
Bracelet Multifonction. Nylon.
Multifunctioneel Armband. Nylon.

25.5 × 3.4 × 1.1 cm

300 / 50

Print Code: L1





16

03

19

Nodal

6373

Mat. PVC.
Matte. PVC.
Natte. PVC.
Mat. PVC.

60 × 180 cm

Print Code: G(1)



02

20



Galtax

5904

Skipping Rope. Wood.
Sprungseil. Holz.
Corde à Sauter. Bois.
Springtouw. Hout.

Ø 0.7 × 260 cm

Print Code: D(1), L1

03



19



04



07



05

02

19



03

Derix

4639

Skipping Rope.
Sprungseil.
Corde à Sauter.
Springtouw.

Ø 0.7 × 257 cm

Print Code: D(1)

Let's go!

Resistance Band



477



04

01

03

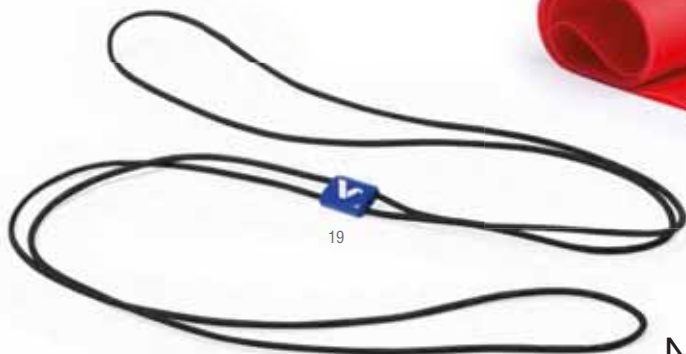

19



03



02

04

19



NEW



HEAVY

MEDIUM

LIGHT

Mansat

5820

Exercise Band.
Gummiband.
Bande de Résistance.
Fitness-Band.

72 × 1.2 cm 400 / 50

Print Code: C(1)

Nayan

6059

Exercise Band. TPE. Resistance Medium.
Gummiband. TPE. Widerstand Mittel.
Bande de Résistance. TPE. Résistance Moyenne.
Fitness-Band. TPE. Weerstand Gemiddeld.

50 × 5 cm

Print Code: F(1)

1000 / 100

Bork

6789

Exercise Bands Set. TPE. 3 Pieces. Resistance Light, Medium and Heavy.
Gummiband Set. TPE. 3 Stück. Widerstand Leicht, Mittel und Schwer.
Set Bandes de Résistance. TPE. 3 Pièces. Résistance Faible, Moyenne et Elevée.
Fitness-Band Set. TPE. 3 Stuks. Weerstand Licht, Gemiddeld en Zwaar.

9 × 22 × 1 cm

Print Code: F(1), N(8)

200 / 100

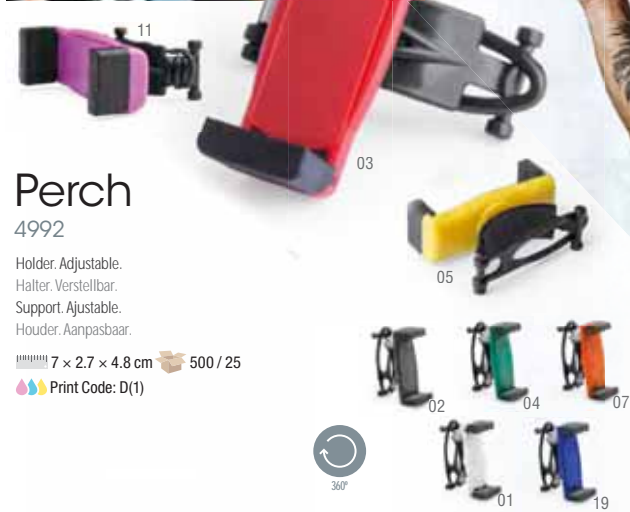

Perch

4992

Holder. Adjustable.
Halter. Verstellbar.
Support. Adjustable.
Houder. Aanpasbaar.

7 × 2.7 × 4.8 cm 500 / 25

Print Code: D(1)



478



Bravux

4528

Bottle. PP. 700 ml.
Trinkflasche. PP. 700 ml.
Bidon. PP. 700 ml.
Fles. PP. 700 ml.

9.6 × 21 cm 50 / 25

Print Code: F(1)



19



Triad

4692

Bottle. PP. 400 ml.
Trinkflasche. PP. 400 ml.
Bidon. PP. 400 ml.
Fles. PP. 400 ml.

9.3 × 22 cm 50

Print Code: F(1)

400 ml



05



SOFT-COOL EXTREME



New fabric SoftCool Extreme with UV protection. Quick and instant cooling at contact with moisture and movement.

Nuevo tejido SoftCool Extreme con protección UV, de enfriamiento rápido e instantáneo al contacto con la humedad y el movimiento.

how does it work?
discover more!!!

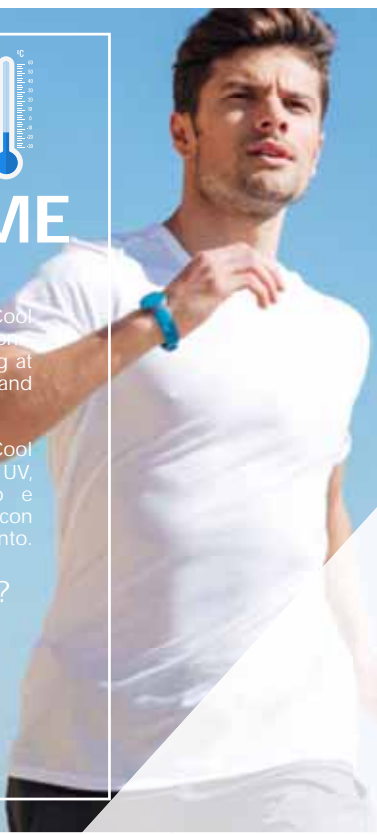

03



Cold



UV Protection

Rikat

5510



08

19

01

Towel: 55% Nylon/ 45% Polyester 160 g/ m2. Folded Ø 6,5 x 16,8 cm. UV50 Protection.
Handtuch: 55% Nylon/ 45% Polyester 160 g/ m2. Faltung Ø 6,5 x 16,8 cm. UV50 Schutz.
Serviette: 55% Nylon/ 45% Polyester 160 g/ m2. Pliée Ø 6,5 x 16,8 cm. Protection UV50.
Handdoek: 55% Nylon/ 45% Polyester 160 g/ m2. Gewouven Ø 6,5 x 16,8 cm. UV50 Bescherming.

30 x 90 cm 100

Print Code: F(1), G(1), N(8)

30 x 90 cm
160 g/m²



COOLING TOWEL
TOALLA ENFRIADORA



Cold



Ideal Sublimation

Kraley

5747

5748

Adult T-Shirt. 100% Polyester 120 g/ m2.
Erwachsene T-Shirt. 100% Polyester 120 g/ m2.
T-Shirt Adulte. 100% Polyester 120 g/ m2.
T-Shirt Volwassene. 100% Polyester 120 g/ m2.

4-5, 6-8, 10-12, S, M, L, XL, XXL 80 / 10

Print Code: F(6), M, N(8), O, P, R 100 / 10



08



Cold



UV Protection



19



11



03



16

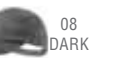

08 DARK

Fandol

5554

Cap. 55% Nylon/ 45% Polyester. UV50 Protection.
Mütze: 55% Nylon/ 45% Polyester. UV50 Schutz.
Casquette: 55% Nylon/ 45% Polyester. Protection UV50.
Pet: 55% Nylon/ 45% Polyester. UV50 Bescherming.

Consult. 200 / 25

Print Code: E(1), N(8), O, P



ADULT 5747

KIDS 5748



03



Heart Rate Monitor



Calories Counter



Stopwatch



Alarm



Time & Date

Lewis

9690

Watch. TPU Strap.
Uhr. TPU Armband.
Montre. Bracelet TPU.
Horloge. TPU Band.



08



04



19

25 × 4.6 × 1.5 cm 50

Print Code: F(1)

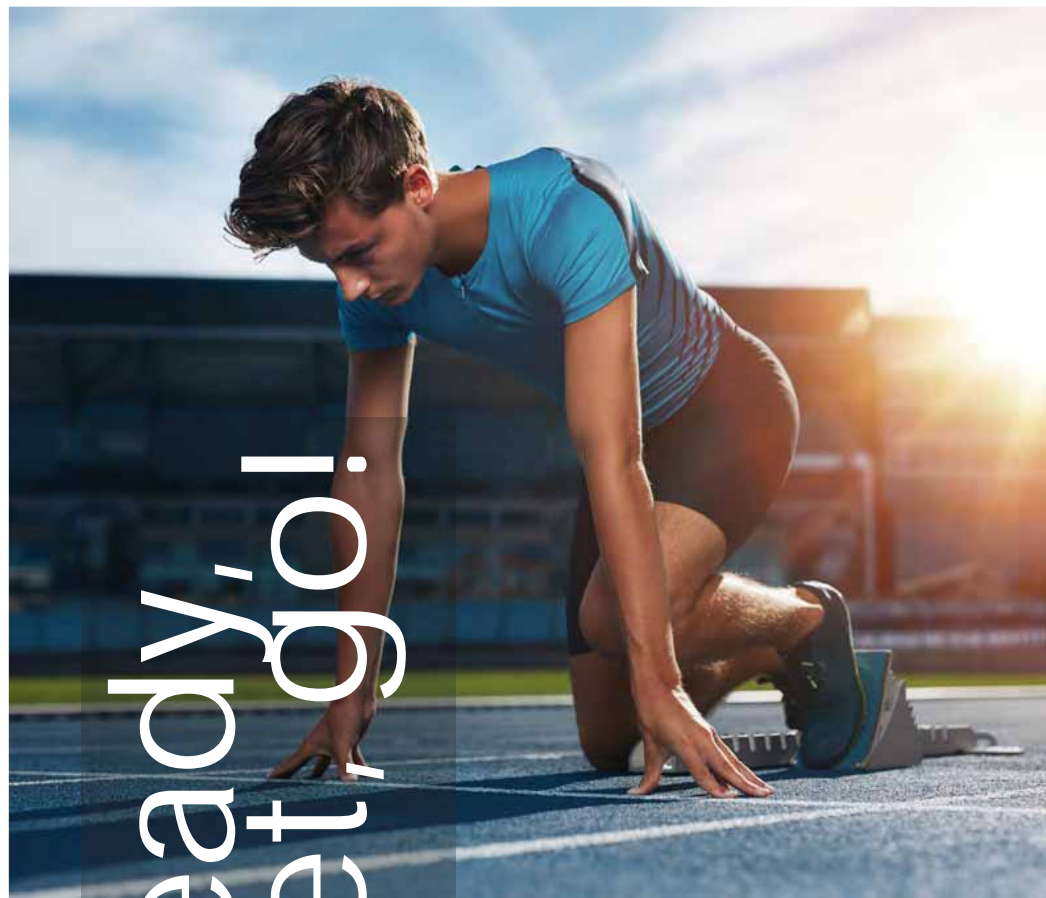

ready, go!

480



Pedometer



01



04



05



02



03



19

Ferrium

5026

Pedometer. Calculates Steps. Button Battery Included.
Schrittzähler. Berechnet Schritte. Knopfzelle Inklusive.
Podomètre. Calcule Pas. Pile Bouton Inclus.
Stappenteller. Telt Stappen. Knoopcel Batterij Inclusief.

4.1 × 6.6 × 2.5 cm 200 / 100

Print Code: C(4)



19



03



07

Step

9382

Pedometer. Calculates Steps, Distance Covered and Calories Burned. Button Batteries Included.

Schrittzähler. Berechnet Schritte, Strecke und Verbrannte Kalorien. Knopfzellen Inklusive.

Podomètre. Calcule Pas, Distance Parcourue et Calories Brûlées. Piles Bouton Inclus.

Stappenteller. Telt Stappen, Afstand en Calorieën. Knoopcel Batterij Inclusief.

5 × 7 × 2 cm 200 / 100

Print Code: C(4)



Pedometer



Calories Counter



Distance Covered



05



07



03



02



01



19



04



11

Neiva

4298

Pedometer. Calculates Steps, Distance Covered and Calories Burned. Button Battery Included.

Schrittzähler. Berechnet Schritte, Strecke und Verbrannte Kalorien. Knopfzelle Inklusive.

Podomètre. Calcule Pas, Distance Parcourue et Calories Brûlées. Pile Bouton Inclus.

Stappenteller. Telt Stappen, Afstand en Calorieën. Knoopcel Batterij Inclusief.

3.6 × 5.6 × 2 cm 200 / 100

Print Code: C(4)



Pedometer



Calories Counter



Distance Covered

Smart Band SPORT



NEW



COMPATIBLE WITH
ANDROID & IOS

COLOR SCREEN /
PANTALLA COLOR

AUTOMATIC
TEMPERATURE
MEASUREMENT

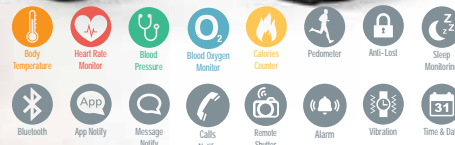

Droy
6651

Smart Bracelet. TPU Strap. Bluetooth Connection. 0.96" TFT Screen. USB Rechargeable. Cable Included.
Intelligente Armband. TPU Armband. Bluetooth Anschluss. 0,96" TFT Screen. USB Wiederaufladbar. Kabel Inklusiv.
Bracelet Intelligent. Bracelet TPU. Connexion Bluetooth. Ecran TFT 0,96". Rechargeable USB. Cable Inclus.
Smart Armband. TPU Band. Bluetooth Verbinding. 0,96" TFT Scherm. USB Oplaadbaar. Kabel Inclusief.

25.5 × 2.2 × 1.1 cm

100 / 50

Print Code: I(1), L2

481



19

05

01

03

04

02

Dragon

5313

Watch. Silicone Strap.
Uhr. Silikonarmband.
Montre. Bracelet Silicone.
Horloge. Siliconen Band.

25 × 2.8 × 1.5 cm 100 / 50

Print Code: F(1)



02

19

16

05

03

Beytel

5599

Smart Bracelet. TPU Strap. Bluetooth Connection. 0.42" LCD Screen. USB Rechargeable. Cable Included.

Intelligente Uhr. TPU Armband. Bluetooth Anschluss. 0,42" LCD Screen. USB Wiederaufladbar. Kabel Inklusiv.

Bracelet Intelligent. Bracelet TPU. Connexion Bluetooth. Ecran LCD 0,42". Rechargeable USB. Cable Inclus.

Smart Armband. TPU Band. Bluetooth Verbinding. 0,42" LCD Scherm. USB Oplaadbaar. Kabel Inclusief.

24.5 × 2 × 0.9 cm 100 / 50

Print Code: I(1), L2





Tactile



Anti Slip

Vanzox 5917

Touchscreen Sport Gloves. Polyester/ Lycra. One Size. Adult.
Touchpad Sport Handschuhe. Polyester/ Lycra. Einheitsgrösse. Erwachsene.
Gant Sportif Tactile. Polyester/ Lycra. Taille Unique. Adulte.
Touchscreen Sport Handschoenen. Polyester/ Lycra. Eén Maat. Volwassen.

Consult. 200 / 10

Print Code: E(1), N(8)



08

TWO TOUCH SCREEN FINGERTIPS
DOS DEDOS TÁCTILES
IDEAL FOR SPORT
IDEAL PARA DEPORTE



03



19



05F



Reflective



Picton

6402

Reflective Armband. Polyester/ Elastane. Ajustable.
Reflektierend Armband. Polyester/ Elastan. Verstellbar.
Bracelet Réfléchissant. Polyester/ Elasthane. Ajustable.
Reflektierend Armband. Polyester/ Elastaan. Aanpasbaar.

35 x 5 cm 500 / 50

Print Code: E(1), N(8)



07F



02



19

Donic

5804

Purse Holder. Lycra. Padded.
Portemonnaie Halter. Lycra. Gepolstert.
Support Porte Monnaie. Lycra. Rembourrée.
Portemonnee Houder. Lycra. Gewalteerd.

13.5 x 7 x 1.4 cm 500 / 100

Print Code: N(8)



19

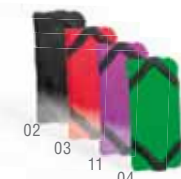

02

03

11

04



Reflective

9550

Bracelet. PVC. Reflective.
Armband. PVC. Reflektierend.
Bracelet. PVC. Réfléchissant.
Armband. PVC. Reflektierend.

23 x 2.9 cm 1000 / 50

Print Code: D(1)



05



02

01



19

03



19

Kelan

5522

Armband. PU. Touch Screen. Reflective.
 Armband. PU. Touch Screen. Reflektierend.
 Bracelet. Similicuir. Ecran Tactile. Réfléchissant.
 Armband. PU. Touch Screen. Reflecterend.

11 x 17 cm 200 / 50
 Print Code: E(1), N(8)



483

Wanel

5311



Waistbag. Lycra. Touch Screen. Reflective.
 Gürteltasche. Lycra. Touch Screen. Reflektierend.
 Banane. Lycra. Ecran Tactile. Réfléchissant.
 Heuplas. Lycra. Touch Screen. Reflecterend.

24 x 10.5 cm 100 / 50
 Print Code: N(8)



03
 19
 02



05 F



11

Tracxu

4149

Armband. Soft Shell. Touch Screen.
 Armband. Soft Shell. Touch Screen.
 Bracelet. Soft Shell. Ecran Tactile.
 Armband. Soft Shell. Touch Screen.

7.5 x 13 x 2 cm 200 / 50
 Print Code: E(1), N(8)



02 19
 03 05



484



Rapik

4914

Race Number Holder Waistbag. Polyester/ Spandex.
 Startnummernträger. Polyester/ Spandex.
 Sac-Ceinture avec Porte Numero. Polyester/ Spandex.
 Racenummerhouder Heuptas. Polyester/ Spandex.

22 x 3.5 cm 200 / 10

Print Code: N(8)



Misbiz

5127

Mat. PE.
 Mokett. PE.
 Tapis. PE.
 Mat. PE.

45 x 45 cm 100 / 10

Print Code: G(1)



Micra

3572

Swim Hat. Polyester/ Spandex.
 Badekappe. Polyester/ Spandex.
 Bonet de Piscine. Polyester/ Spandex.
 Zwemmuts. Polyester/ Spandex.

21.5 x 14 cm 400 / 10

Print Code: E(1), N(8), R



Video



RIPSTOP

Mendel

6375

Waistbag. Ripstop.
Gürteltasche. Ripstop.
Banane. Ripstop.
Heuptas. Ripstop.

31 × 11.5 cm

Print Code: E(1), N(8)

100 / 50

03

19

16

02



19

BOTTLE NOT INCLUDED
BOTE NO INCLUIDO

04

03

19

19

02

05F



03



01



02

Tildak

5502

Waistbag. Polyester 210D. Padded Back.
Gürteltasche. Polyester 210D. Gepolsterter Rücken.
Banane. Polyester 210D. Dos Rembourrées.
Heuptas. Polyester 210D. Gewatteerde Achterzijde.

27 × 18 cm 200 / 10

Print Code: F(1), N(8)

Inxul

4374

Waistbag. Polyester 600D.
Gürteltasche. Polyester 600D.
Banane. Polyester 600D.
Heuptas. Polyester 600D.

35 × 15 cm 200 / 10

Print Code: E(1), N(8)

Taskin

4866

Waistbag. Polyester/ Spandex.
Gürteltasche. Polyester/ Spandex.
Banane. Polyester/ Spandex.
Heuptas. Polyester/ Spandex.

22 × 3.5 cm 200 / 10

Print Code: N(8)



04

02

03



Tekren



5944

Earphones. Bluetooth Connection. USB Rechargeable. Cable Included.
Kopfhörer. Bluetooth Anschluss. USB Wiederaufladbar. Kabel Inklusiv.
Écouteurs. Connexion Bluetooth. Rechargeable USB. Câble Inclus.
Oordopjes. Bluetooth Verbinding. USB Oplaadbaar. Kabel Inclusief.

16.5 x 20 x 2.3 cm 50

Print Code: F(4)



Hoos

7028

Earphones. 3.5 mm Jack Socket.
Kopfhörer. 3.5 mm Klinkestecker.
Écouteurs. Connexion Jack 3.5 mm.
Oordopjes. 3.5 mm Jack Aansluiting.

15 x 21 x 1.5 cm 500 / 100

Print Code: E(1)



REFLECTIVE 16



Rasum

5682

Earphones. 3.5 mm Jack Socket. Retractable Cable.
Kopfhörer. 3.5 mm Klinkestecker. Ausziehbar Kabel.
Écouteurs. Connexion Jack 3.5 mm. Câble Extensible.
Oordopjes. 3.5 mm Jack Aansluiting. Verlengbare Kabel.

2 x 8.6 x 2.6 cm 500 / 50

Print Code: D(1)



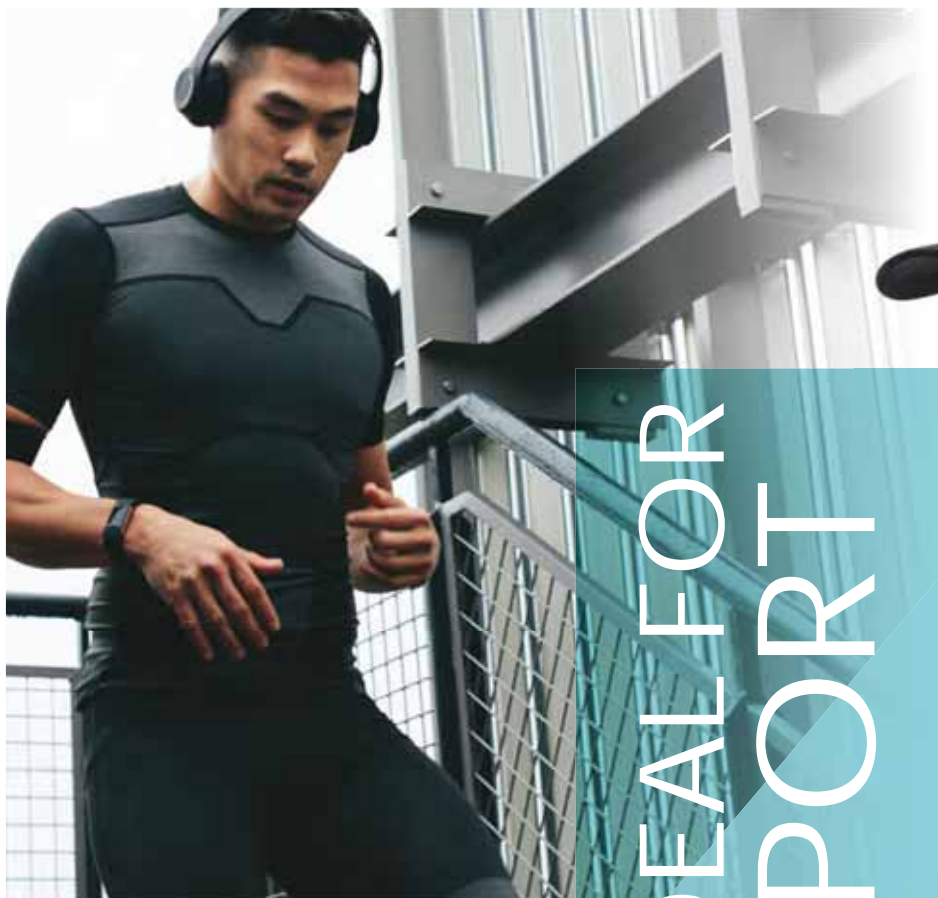

IDEALFOR SPORT



02



05

03

11

07



01

19

04

Laimbur

5565

Cap. Microfibre.

Mütze. Mikrofaser.

Casquette. Microfibre.

Pet. Microfibre.

Consult.

200 / 25

Print Code: E(1), N(8), O, P, R



01



Gonnax

4900

Sun Visor. Polyester.

Sonnenblende. Polyester.

Visière. Polyester.

Zonneklep. Polyester.

Consult.

250 / 25

Print Code: E(1), N(8), O, P, R



03

02

19

05



02



03



19



01

Harum

6208

Cap. Microfibre/ Polyester. 5 Panels.

Mütze. Mikrofaser/ Polyester. 5 Panels.

Casquette. Microfibre/ Polyester. 5 Panneaux.

Pet. Microfibre/ Polyester. 5 Panelen.

Consult.

200 / 50

Print Code: E(1), N(8), O, P, R



5 Panels



Luwins 5363



Headband. Polyester. Bluetooth Connection. USB Rechargeable. Cable Included.
Stirmband. Polyester. Bluetooth Anschluss. USB Wiederaufladbar. Kabel Inklusive.
Bandeau Tête. Polyester. Connexion Bluetooth. Rechargeable USB. Cable Inclus.
Hoofdband. Polyester. Bluetooth Verbinding. USB Oplaadbaar. Kabel Inclusief.

25 x 10 cm 200 / 50

Print Code: N(8), O, P

Special unisex HAT

488



Seyer 5364

Hat. Polyester. Bluetooth Connection. USB Rechargeable. Cable Included.
Hut. Polyester. Bluetooth Anschluss. USB Wiederaufladbar. Kabel Inklusive.
Bonnet. Polyester. Connexion Bluetooth. Rechargeable USB. Cable Inclus.
Muts. Polyester. Bluetooth Verbinding. USB Oplaadbaar. Kabel Inclusief.

Consult.

100 / 50

Print Code: N(8), O, P

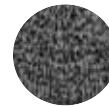

ULTRA
REFLECTIVE
EXTRA
REFLECTANTE

Terban 6440

Hat. Outside: Acrylic. Inside: Polar Fleece. Reflective.
Hut. Außere: Acryl. Innen: Polar Fleece. Reflektierender.
Bonnet. Extérieure: Acrylique. Intérieur: Polaire. Réflecteur.
Muts. Buitenzijde: Acryl. Binnenzijde: Polar Fleece. Reflecterende.

Consult.

100 / 10

Print Code: N(8), O, P



Reflective

03

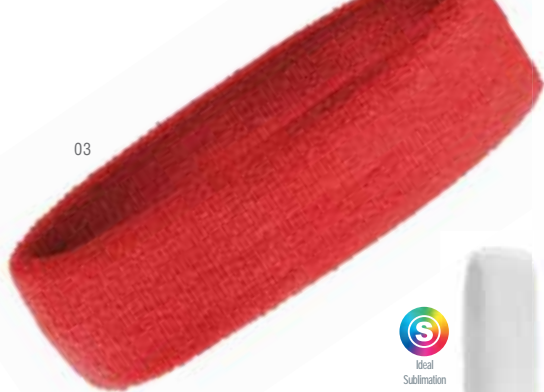

Ranster

4580

Headband. Cotton/ Polyester.
Stirnband. Baumwolle/ Polyester.
Bandeau Tête. Coton/ Polyester.
Hoofdband. Katoen/ Polyester.

19 × 6 cm 400 / 10

Print Code: N(8), O, P, R



01

19

05



19

02

03

05

Beker

9340

Wristband. 100% Cotton.
Armbandtasche. 100% Baumwolle.
Tour de Poignet. 100% Coton.
Armband. 100% Katoen.

6.4 × 7.3 cm

Print Code: N(8), O, R



01

1000 / 100



489

Oakley

3618

Wristband. Microfibre.
Armbandtasche. Mikrofaser.
Tour de Poignet. Microfibre.
Armband. Microfibre.

10 × 9 cm 1000 / 100

Print Code: E(1), N(8), R



19



03

02

01



11

05

04

Cobik

4916

Headband. Polyester/ Spandex.
Stirnband. Polyester/ Spandex.
Bandeau Tête. Polyester/ Spandex.
Hoofdband. Polyester/ Spandex.

24.5 × 5.7 cm 500 / 10

Print Code: F(1), N(8)



05F

08

Duttier

5125

Arm Sleeves. Polyester/ Elastane.
 Armelschoner. Polyester/ Elastan.
 Manchon Bras. Polyester/ Elasthanne.
 Arm Warmer. Polyester/ Elastaan.

43 cm 200 / 100

Print Code: F(1), N(8), R



490

UNISEX

Lowis

4913

Shorts. 92% Polyester/ 8% Elastane 180 g/ m2. Unisex.
 Sporthose. 92% Polyester/ 8% Elastan 180 g/ m2. Unisex.
 Short Sportif. 92% Polyester/ 8% Elasthanne 180 g/ m2. Unisex.
 Sportbroek. 92% Polyester/ 8% Elastaan 180 g/m2. Unisex.

S, M, L, XL, XXL 50

Print Code: F(1), N(8)



02

Tecnic Gerox

4472



Shorts. 100% Polyester 145 g/ m2. Breathable.
 Shorts. 100% Polyester 145 g/ m2. Atmungsaktiv.
 Shorts. 100% Polyester 145 g/ m2. Respirant.
 Shorts. 100% Polyester 145 g/ m2. Ademend.

8-10, 12-14, S, M, L, XL 100 / 10

Print Code: F(6), N(8), O, P, R



01



19



03



NECK WARMER TBS & TBP



01
SPECIAL WHITE COLOUR
FOR SUBLIMATION/
COLOR BLANCO IDEAL PARA
SUBLIMACION



Cherin

4215
Neck Warmer. Polyester.
Schlauchschal. Polyester.
Tour de Cou. Polyester.
Colsjaal. Polyester.

25 x 50 cm
Print Code: F(1), N(8), R

300 / 100



NEW



06

Suanix

Neck Warmer. Polyester RPET.
Nacken Wärmer. Polyester RPET.
Tour de Cou. Polyester RPET.
Colsjaal. Polyester RPET.

25 x 50 cm
Print Code: F(1), N(8)

300 / 100



08

02



NEW

Nical

Antibacterial Neck Warmer. Polyester.
Antibakteriell Schlauchschal. Polyester.
Tour de Cou Antibactérien. Polyester.
Antibacterieel Colsjaal. Polyester.

26 x 48 cm
Print Code: F(1), N(8), R

300 / 10



ANTIBACTERIAL AND WATER
RESISTANT FABRIC
TEJIDO ANTIBACTERIANO
E HIDRÓFUGO





NEW



30 x 80 cm
200 g/m²

08

Klonet

6851

Absorbent Towel. Polyester RPET 200 g/ m2. Folded 11,5 x 15,5 x 4 cm.

Saugfähiges Handtuch. Polyester RPET 200 g/ m2. Faltung 11,5 x 15,5 x 4 cm.

Serviette Absorbante. Polyester RPET 200 g/ m2. Pliée 11,5 x 15,5 x 4 cm.

Absorberende Handdoek. Polyester RPET 200 g/ m2. Gevouwen 11,5 x 15,5 x 4 cm.

30 x 80 cm

200 / 100

Print Code: F(1), N(8), O, P

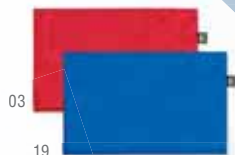

03

19

SPORT Towel



492



19

Kirk

4563

Drawstring Towel Bag. Microfibre 160 g/ m2. Folded 37 x 37 cm.

Rucksack Handtuch. Mikrofaser 160 g/ m2. Faltung 37 x 37 cm.

Sac à Dos Serviette. Microfibre 160 g/ m2. Pliée 37 x 37 cm.

Handdoek Rugzak. Microfibre 160 g/ m2. Gevouwen 37 x 37 cm.

70 x 150 cm

50

Print Code: F(1), N(8), O, P

DRAWSTRING TOWEL BAG
MOCHILA CONVERTIBLE EN TOALLA

70 x 150 cm
160 g/m²



03

07

04

05



19

Yarg

7065

Absorbent Towel. Microfibre 200 g/ m2. Folded Ø 9 x 17 cm.

Saugfähiges Handtuch. Mikrofaser 200 g/ m2. Faltung Ø 9 x 17 cm.

Serviette Absorbante. Microfibre 200 g/ m2. Pliée Ø 9 x 17 cm.

Absorberende Handdoek. Microfibre 200 g/ m2. Gevouwen Ø 9 x 17 cm.

72 x 138 cm
200 g/m²

72 x 138 cm

50

Print Code: F(1), N(8), O, P



03

11

04



SPORT Towel



40 x 90 cm
160 g/m²

Kefan 5920

Absorbent Towel. Microfibre 160 g/m².
Saugfähiges Handtuch. Mikrofaser 160 g/m².
Serviette Absorbante. Microfibre 160 g/m².
Absorbierende Handdoek. Microfibre 160 g/m².

40 x 90 cm 100
Print Code: F(1), N(8), P, R



30 x 45 cm
345 g/m²

Kotto 4554

Absorbent Towel. Microfibre 345 g/m².
Saugfähiges Handtuch. Mikrofaser 345 g/m².
Serviette Absorbante. Microfibre 345 g/m².
Absorbierende Handdoek. Microfibre 345 g/m².

30 x 45 cm 100
Print Code: F(1), N(8), O, P, R



Gymnasio 4567

50 x 100 cm
185 g/m²

Absorbent Towel. Microfibre 185 g/m². Folded Ø 9 x 17 cm.
Saugfähiges Handtuch. Mikrofaser 185 g/m². Faltung Ø 9 x 17 cm.
Serviette Absorbante. Microfibre 185 g/m². Pliee Ø 9 x 17 cm.
Absorbierende Handdoek. Microfibre 185 g/m². Gevouwen Ø 9 x 17 cm.

50 x 100 cm 100
Print Code: F(1), N(8), O, P, R



NEW



Leven 6725

Bike Bag. Polyester 600D.
Fahrradtasche. Polyester 600D.
Sac à Vélo. Polyester 600D.
Fietstas. Polyester 600D.

20 × 18 × 7.5 cm

100 / 10

Print Code: F(1), N(8)



494

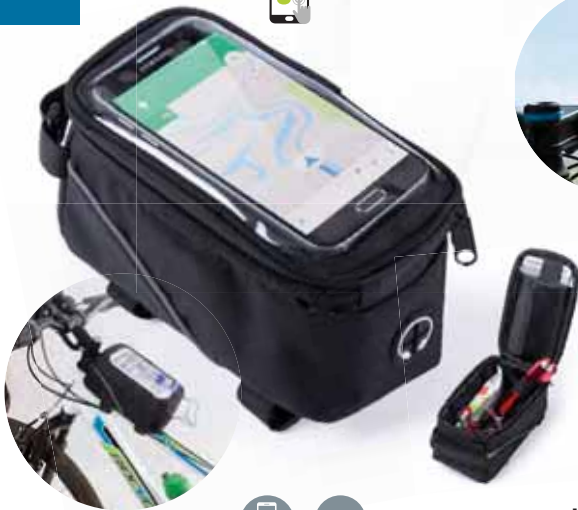

Rigon 5523

Bike Bag. Polyester 600D. Touch Screen. Reflective. Padded.
Fahrradtasche. Polyester 600D. Touch Screen. Reflektierend. Gepolstert.
Sac à Vélo. Polyester 600D. Ecran Tactile. Réfléchissant. Rembourrée.
Fietstas. Polyester 600D. Touch Screen. Reflectorend. Gewatteerd.

19 × 10.5 × 9 cm

50 / 10

Print Code: N(8)



Lonter 5883

Holder.
Halter.
Support.
Houder.

10.8 × 9.9 × 12 cm

100 / 50

Print Code: E(1)



ADJUSTABLE
AJUSTABLE



Triyo 6491

Padlock. PVC/ Metal.
Kofferschloss. PVC/ Metall.
Cadenas. PVC/ Metal.
Hangslot. PVC/ Metaal.

Ø 1.2 × 69 cm

100 / 50

Print Code: E(1)

FOLDABLE



RPET

i The fabric used in the manufacturing process of this product is made of recycled plastic (RPET). Like this, the emission of plastic residues to our planet and the consumption of energy is drastically reduced, resulting in a much more eco-friendly process.

El material de este producto está fabricado con plástico reciclado (RPET), que, además de ayudar en la disminución de residuos plásticos en el planeta, utiliza menos energía en el proceso de fabricación, haciendo que sea mucho menos dañino para el medio ambiente.

STOP PLASTIC POLLUTING THE OCEAN

ULTREX



19



08



02



03

Mapol
6853

Saddle Cover. Polyester 190T RPET. Adjustable.
Fahrradsattel Hülle. Polyester 190T RPET. Verstellbar.
Étui Selle. Polyester 190T RPET. Ajustable.
Zadel Hoes. Polyester 190T RPET. Aanpasbaar.

Consult.

1000 / 500

Print Code: D(1)



495

BACKPACK COVER
CUBRE Mochila



03



Water Repellent

Lespley

6172

Saddle Cover. Polyester 190T. Adjustable.
Fahrradsattel Hülle. Polyester 190T. Verstellbar.
Étui Selle. Polyester 190T. Ajustable.
Zadel Hoes. Polyester 190T. Aanpasbaar.

Consult.

1000 / 500

Print Code: D(1), N(8), R



Ideal Sublimation



01



19



05



04



02

Trecy
5809

Backpack Cover. Polyester 190T. Adjustable.
Rucksack Hülle. Polyester 190T. Verstellbar.
Étui Sac à Dos. Polyester 190T. Ajustable.
Rugzak Hoes. Polyester 190T. Aanpasbaar.

Consult.

300 / 50

Print Code: G(1)



Water Repellent



03



02

19

05



Moltar 4616

Torch. 3 Leds. 2 Light Modes. 3 Functions. 3 Batteries AAA Not Included.
Lampe. 3 Leds. 2 Leuchtfunktionen. 3 Funktionen. 3 AAA Batterien Nicht im Lieferumfang.
Lampe. 3 Leds. 2 Modes de Lumière. 3 Fonctions. 3 Piles AAA Non Inclus.
Zaklamp. 3 Leds. 2 Licht Posities. 3 Functies. 3 Batterijen AAA Niet Inclusief.

7.6 × 13.6 × 6.4 cm 100 / 50

Print Code: E(1)



Myrto 3685

Torch. 2 Leds. 3 Light Modes. Button Batteries Included.
Lampe. 2 Leds. 3 Leuchtfunktionen. Knopfzellen Inklusiv.
Lampe. 2 Leds. 3 Modes de Lumière. Piles Bouton Inclus.
Zaklamp. 2 Leds. 3 Licht Posities. Knopcel Batterijen Inclusief.

3.1 × 3.1 × 4.3 cm 500 / 50

Print Code: G(1)



Video

496



Tinax 6274



Security Light. 1 Led. 2 Light Modes. Button Batteries Included.
Sicherheitslicht. 1 Led. 2 Leuchtfunktionen. Knopfzellen Inklusiv.
Lumière de Sécurité. 1 Led. 2 Modes de Lumière. Piles Bouton Inclus.
Veiligheidslicht. 1 Led. 2 Licht Posities. Knopcel Batterijen Inclusief.

1.9 × 5.6 × 1.8 cm 1000 / 250

Print Code: C(1)



Terrier 4984



Security Light. 2 Leds. 2 Light Modes. Button Batteries Included.
Sicherheitslicht. 2 Leds. 2 Leuchtfunktionen. Knopfzellen Inklusiv.
Lumière de Sécurité. 2 Leds. 2 Modes de Lumière. Piles Bouton Inclus.
Veiligheidslicht. 2 Leds. 2 Licht Posities. Knopcel Batterijen Inclusief.

6 × 3 × 8.5 cm 200 / 50

Print Code: D(1)



Vilox 6246



Torch. 8 COB Lights. 3 Light Modes. 3 Batteries AAA Not Included.
Lampe. 8 COB Lichten. 3 Leuchtfunktionen. 3 AAA Batterien Nicht im Lieferumfang.
Lampe. 8 Lumières COB. 3 Modes de Lumière. 3 Piles AAA Non Inclus.
Zaklamp. 8 COB Lichten. 3 Licht Posities. 3 Batterijen AAA Niet Inclusief.

6.1 × 4 × 1.7 cm 500 / 100

Print Code: E(1)





Laptop
Compartment

AN EXTERNAL BATTERY IS REQUIRED,
USE OUR POWER BANKS!



Water
Repellent



USB
Connection



Blink

Dontax

6251

Indicator Backpack. Polyester 600D. Led Lights. Padded Laptop Compartment. Padded Back and Shoulder Straps. USB Connection. Cable Included.

Rucksack-Anzeiger. Polyester 600D. Led Lichter. Gepolsterte Laptotasche. Gepolsterter Rücken und Schultergurte. Anschluss USB. Kabel Inklusiv.

Sac à Dos Indicateur. Polyester 600D. Lumières Led. Pochette Rembourrée pour Portable. Dos et Bretelles Rembourrées. Connexion USB. Câble Inclus.

Rugzak Richtingaangever. Polyester 600D. Led Lichten. Gewatteerd Laptop Compartment. Gewatteerde Achterzijde en Schouderbanden. Micro USB Connectie. Kabel Inclusief.

31 x 45 x 17 cm

20

Print Code: G(1), N(8)



Laptop
Compartment



Blink



USB
Connection

AN EXTERNAL BATTERY IS REQUIRED,
USE OUR POWER BANKS!

Halton

5972

Indicator Backpack. Polyester 600D. Led Lights. Padded Laptop Compartment. Padded Back and Shoulder Straps. USB Connection. Cable Included.

Rucksack-Anzeiger. Polyester 600D. Led Lichter. Gepolsterte Laptotasche. Gepolsterter Rücken und Schultergurte. Anschluss USB. Kabel Inklusiv.

Sac à Dos Indicateur. Polyester 600D. Lumières Led. Pochette Rembourrée pour Portable. Dos et Bretelles Rembourrées. Connexion USB. Câble Inclus.

Rugzak Richtingaangever. Polyester 600D. Led Lichten. Gewatteerd Laptop Compartment. Gewatteerde Achterzijde en Schouderbanden. USB Connectie. Kabel Inclusief.

28 x 44 x 14 cm

15

Print Code: G(1), N(8)



Video



Video



02



Light



Blink

Koppy

6558

Hat. Acrylic. 4 Leds. 4 Light Modes. USB Rechargeable.

Hut. Acryl. 4 Leds. 4 Leuchtfunktionen. USB Wiederaufladbar.

Bonnet. Acrylique. 4 Leds. 4 Modes de Lumière. Rechargeable USB.

Muts. Acryl. 4 Leds. 4 Licht Posities. USB Oplaadbaar.

Consult.

100 / 50

Print Code: N(8)



08

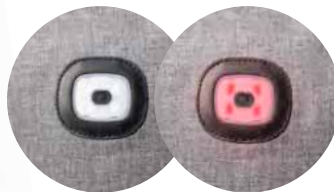

Light



Blink

Krepak

6597

Indicator Backpack. Polyester 600D. 4 Leds. 3 Light Modes. Padded Laptop Compartment. Padded Back and Shoulder Straps. Button Batteries Included.

Rucksack-Anzeiger. Polyester 600D. 4 Leds. 3 Leuchtfunktionen. Gepolsterte Laptotasche. Gepolsterter Rücken und Schultergurte. Knopfzellen Inklusiv.

Sac à Dos Indicateur. Polyester 600D. 4 Leds. 3 Modes de Lumière. Pochette Rembourrée pour Portable. Dos et Bretelles Rembourrées. Piles Bouton Inclus.

Rugzak Richtingaangever. Polyester 600D. 4 Leds. 3 Licht Posities. Gewatteerd Laptop Compartment. Gewatteerde Achterzijde en Schouderbanden. Knopcel Batterijen Inclusief.

30 x 43 x 13.5 cm

20

Print Code: G(1), N(8)



Laptop
Compartment

Grent
5444

Golf Set. 4 Accessoires.
Golf Set. 4 Teile.
Set Golf. 4 Accessoires.
Golf Set. 4 Accessoires.

11.6 x 3 x 9.5 cm 50
Print Code: B(4), D(4), L1

498

Zebber
5442

Divot.
Divot.
Divot.
Divot.

2.6 x 7 x 0.5 cm 2000 / 100
Print Code: C(4), W

SPECIAL
golf

Budyx
4393

Golf Umbrella. Pongee. Windproof.
Golf Regenschirm. Pongee. Antiwindsystem.
Parapluie Golf. Pongee. Système Anti-Vent.
Golf Paraplu. Pongee. Windbestendig.

Ø 135 cm 20 / 10
Print Code: H(1), N(8), R



Ø 135 cm

WINDPROOF
ANTI-VIENTO

Tarkyl
4403

Golf Towel. 100% Cotton 650 g/ m2. Folded 19 x 40 cm.
Golf Handtuch. 100% Baumwolle 650 g/ m2. Faltung 19 x 40 cm.
Serviette Golf. 100% Coton 650 g/ m2. Pliée 19 x 40 cm.
Golf Handdoek. 100% Katoen 650 g/ m2. Gevouwen 19 x 40 cm.

40 x 50 cm 100
Print Code: F(1), N(8), P

40 x 50 cm
650 g/m²





SPECIAL golf



19 05 03 01

Ramsy
5440

Pencil. Wood.
Bleistift. Holz.
Crayon Golf. Bois.
Potlood. Hout.

Ø 0.7 × 8.7 cm 3000 / 100
Print Code: A(4), L1



04



Sharpened



Stym
5443

Divot Indicator. Metal.
Divot Indikator. Metall.
Divot Indicateur. Métal.
Divot Indicator. Metaal.

3.2 × 7.5 × 0.6 cm 300 / 50
Print Code: D(4), L1



Nessa
4410

Golf Ball.
Golftball.
Balle Golf.
Golftbal.

Ø 4.2 cm 300 / 10
Print Code: D(4)



01



05



03

Hydor
4411

Golf Tee. Wood.
Golf Tee. Holz.
Tee Golf. Bois.
Golf Tee. Hout.

Ø 1.1 × 7 cm 10000 / 100
Print Code: A(4)



03



05

01

19

2 PIECES
2 PIEZAS

Tunker
5441

Golf Tee Card. 2 Pieces.
Golf Tee Karten. 2 Stück.
Carte Tee Golf. 2 Pièces.
Golf Tee Kaart. 2 Stuks.

5 × 9.5 × 0.2 cm 1000 / 100
Print Code: C(4), W

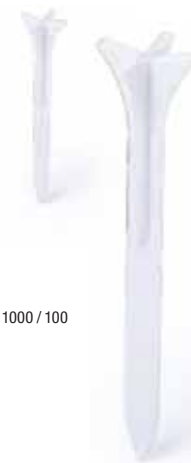



Edward

5387

Plaque. Stainless Steel.
Plakette. Rostfreier Stahl.
Plaque. Acier Inox.
Plaque. Roestvrij Staal.

9 × 16 × 8 cm 50
Print Code: F(4), L2



500



Depor

4981

Keyring. Metal.
Schlüsselanhänger. Metall.
Porte-Clés. Métal.
Sleutelhanger. Metaal.

2.2 × 5.5 × 0.4 cm 200 / 50
Print Code: D(1), L1



Corum

3743

Medal. Metal.
Medaille. Metall.
Médaille. Métal.
Medaille. Metaal.

Ø 5 × 48 cm 500 / 50
Print Code: F(1), L1



RO/PLATA

RO/BRONCE

ESP/PLATA

ESP/BRONCE



19



Cambex

4531

Vest. Non-Woven. One Size. Adult.
 Weste. Non-Woven. Einheitsgröße. Erwachsene.
 Plastron. T.N.T. Taille Unique. Adulte.
 Vest. Non-Woven. Een Maat. Volwassen.

38 x 45 cm 600 / 50

Print Code: F(1)

501



19

Wiki

3317

Vest. Polyester 190T. One Size. Kids.
 Weste. Polyester 190T. Einheitsgröße. Kinder.
 Plastron. Polyester 190T. Taille Unique. Enfant.
 Vest. Polyester 190T. Een Maat. Kind.

38 x 45 cm 600 / 50

Print Code: F(1)

KIDS
 NIÑOS



04

03

05



03



19

05

04

Sporter

3316

Vest. Polyester 190T. One Size. Adult.
 Weste. Polyester 190T. Einheitsgröße. Erwachsene.
 Plastron. Polyester 190T. Taille Unique. Adulte.
 Vest. Polyester 190T. Een Maat. Volwassen.

52 x 63 cm 300 / 25

Print Code: F(1)



02



19



03



01

Delko

4086

Ball. PU/ PVC. Size: 5.

Ball. PU/ PVC. Größe: 5.

Ballon. Similicuir/ PVC. Taille: 5.

Voetbal. PU/ PVC. Maat: 5.

Consult. 40

Print Code: G(1)

Football



502



Bentul

5352

Goal Post. PVC. Special Folded for Printing.

Strandfussballtor. PVC. Spezielle Faltung für Einfachen Aufdruck.

Cage de Buts. PVC. Plîée Spécial pour Impression.

Doel. PVC. Speciaal Gevouwen voor Bedrukking.

126 x 72 x 50 cm

20

Print Code: H(1)



02



01



03



19

Zubigol

3115

Goal Post. Nylon. Foldable.

Strandfussballtor. Nylon. Faltbar.

Cage de Buts. Nylon. Pliable.

Doel. Nylon. Opvouwbaar.

141 x 80 x 80 cm

20

Print Code: I(6)





Basley
6443

Pen.
Kugelschreiber.
Stylo.
Pen.
Ø 2 × 15.3 cm 1000 / 50
Print Code: B(4)



TOWEL



Spica
5292

Towel. 100% Cotton 245 g/ m2. Folded Ø 4,5 cm.
Handtuch. 100% Baumwolle 245 g/ m2. Faltung Ø 4,5 cm.
Serviette. 100% Cotton 245 g/ m2. Pliee Ø 4,5 cm.
Handdoek. 100% Katoen 245 g/ m2. Gevouwen Ø 4,5 cm.
30 × 30 cm 300
Print Code: D(1), N(8)



30 × 30 cm
245 g/m²



D



G

Naiper
5889

Drawstring Bag. Polyester 210D.
Rucksack. Polyester 210D.
Sac à Dos. Polyester 210D.
Rugzak. Polyester 210D.
42 × 43 cm 300 / 20
Print Code: F(1), N(8)



C



03

Paxer
6632

Drawstring Bag. Polyester 210D.
Rucksack. Polyester 210D.
Sac à Dos. Polyester 210D.
Rugzak. Polyester 210D.
56 × 42 cm 300 / 10
Print Code: F(1), N(8), R



Visser

4807

Back Support Belt.
Rückenstützgurtel.
Ceinture Lombarie.
Nierband.

98 × 18 cm 100
Print Code: F(1), N(8)



19



02

03

Energy

3569

Bracelet.
Armband.
Bracelet.
Armband.



19 01 03

7 × 1.4 cm 500 / 10
Print Code: F(1)



02

504



03



Cold



Hot



19

01

04



Hot



11

03



04

05

01

19



400 ml

19



Debbly

5639

Hot-Cold Pack. Cold and Warm. Reusable.
Wärme-Kälte Pflaster. Kalt und Warm. Wiederverwendbar.
Patch Chaud-Froid. Chaud et Froid. Réutilisable.
Thermisch Pakket. Koud en Warm. Herbruikbaar.

11 × 20 × 1.3 cm 100 / 50
Print Code: C(1)

Kison

4970

Heat Pack. Reusable.
Taschenwärmer. Wiederverwendbar.
Patch Chaleur. Réutilisable.
Wärmte Pakket. Herbruikbaar.

10 × 1 cm 150 / 50
Print Code: C(1)

Liman

4302

Thermal Bag. 400 ml. Cold and Warm. Reusable.
Thermische Tasche. 400 ml. Kalt und Warm. Wiederverwendbar.
Sac Thermique. 400 ml. Chaud et Froid. Réutilisable.
Thermische Tas. 400 ml. Koud en Warm. Wiederverwendbaar.

14 × 3 cm 200 / 50
Print Code: E(1)



Cold



Hot



03



05



02

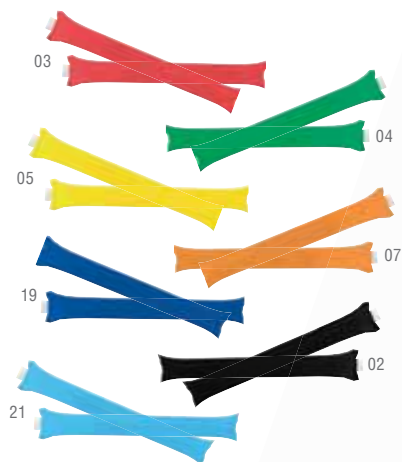

Stick

9075

Cheering Sticks. LDPE. Reusable. Inflating Valve Included.
Klatschstange. LDPE. Wiederverwendbar. Inflation Ventil Inklusive.
Tap Tap. LDPE. Réutilisable. Valve pour Gonfler Inclus.
Cheering Sticks. LDPE. Herbruikbaar. Opblaasriletje Inclusief.

60 x 10 cm 500 / 25

Print Code: G(1)



01

IDEAL FOR DIGITAL PRINTING
IDEAL PARA IMPRESIÓN DIGITAL



Zamur

4234

Glasses.
Brille.
Lunettes.
Bril.

Consult. 300 / 10

Print Code: D(4), W



19

03



07



Yopet

4649

Whistle.
Pfeife.
Sifflet.
Fluitje.

1.9 x 5 x 2.4 cm 1000 / 250

Print Code: C(1)



01

02

05

04

19

03

Colour

9768

Painting Set.
Fan Schminckset.
Set Peinture.
Schilder Set.

9.2 x 5 x 0.9 cm

Print Code: D(4)

400 / 50



07

01

03

04

19

ESP

Maracanã

8774

Animation Hand.
Klatschhand.
Main Animation.
Animatie-Hand.

8.5 x 18.5 x 2 cm

Print Code: E(4)

200 / 100



480 ml

Match

5296

Bottle. PET. 480 ml.
Trinkflasche. PET. 480 ml.
Bidon. PET. 480 ml.
Fles. PET. 480 ml.

16 x 21 x 3.3 cm 400 / 50

Print Code: E(1)

D

FOLDABLE
PLEGABLE

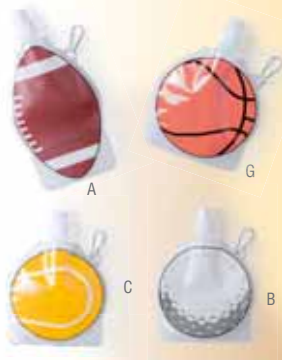

506

470 ml



03



FOLDABLE
PLEGABLE

Zablex

5297

Bottle. PET. 470 ml.
Trinkflasche. PET. 470 ml.
Bidon. PET. 470 ml.
Fles. PET. 470 ml.

17 x 25.5 x 3.3 cm 400 / 50

Print Code: E(1)



04

01

19

05



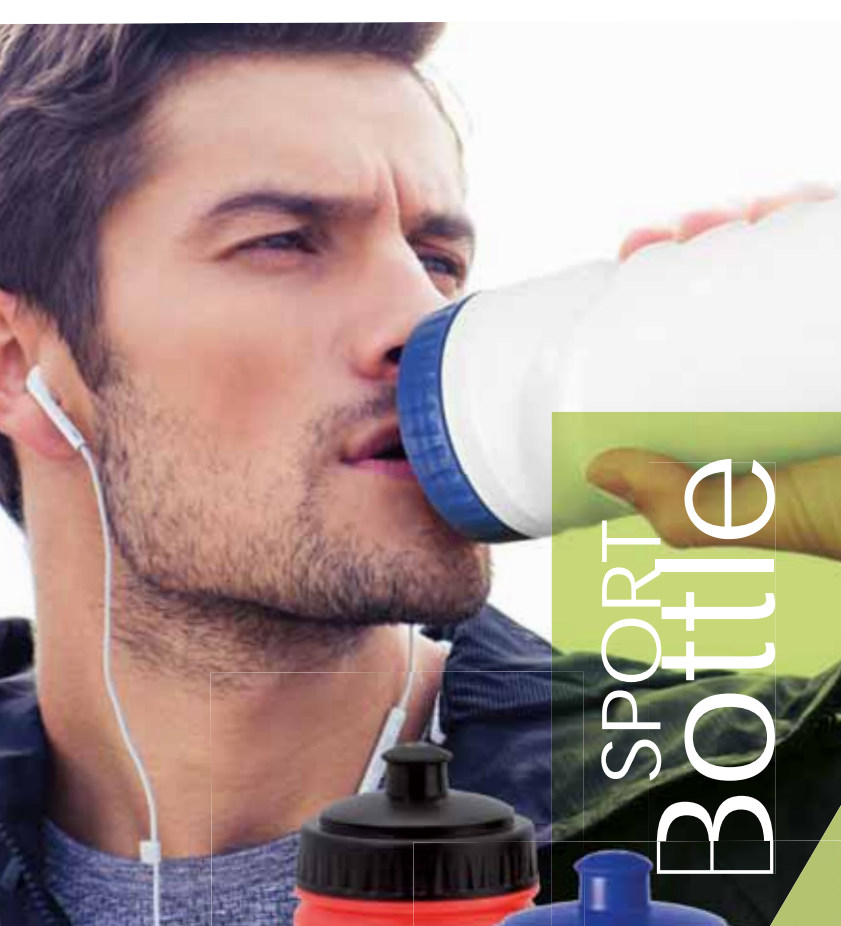

SPORT Bottle

Copil
6769



Antibacterial



BPA FREE



500 ml

Antibacterial Bottle. PE. 500 ml.
Antibakteriell Trinkflasche. PE. 500 ml.
Bidon Antibactérien. PE. 500 ml.
Antibacterieel Fles. PE. 500 ml.

Ø 6.5 × 19.5 cm

100 / 10

Print Code: F(1)



BPA FREE

500 ml



500 ml



BPA FREE

11

03

05

04

Norok
4926

Bottle. PE. 500 ml.
Trinkflasche. PE. 500 ml.
Bidon. PE. 500 ml.
Fles. PE. 500 ml.

Ø 6.5 × 19.5 cm

Print Code: F(1)

19

Iskan
3837

Bottle. PE. 500 ml.
Trinkflasche. PE. 500 ml.
Bidon. PE. 500 ml.
Fles. PE. 500 ml.

Ø 6.5 × 19.5 cm

Print Code: F(1)

03



04

01



05

03

Sports
9342

Bottle. PE. 550 ml.
Trinkflasche. PE. 550 ml.
Bidon. PE. 550 ml.
Fles. PE. 550 ml.

Ø 7.5 × 20.5 cm

Print Code: F(1)

100 / 10

100 / 10

100 / 10

507

500 ml



BPA FREE



Quality

19



01

08

02

NEW



740 ml

Raltex

6882

Bottle. Stainless Steel. 740 ml. Individual Presentation.
 Trinkflasche. Rostfreier Stahl. 740 ml. Individuelle Präsentation.
 Bidon. Acier Inox. 740 ml. Présentation Individuelle.
 Fles. Roestvrij Staal. 740 ml. Individuele Presentatie.

Ø 7 × 24.5 cm

30

Print Code: F(1), L2

EASY OPENING ...

508



800 ml



01

02

03

04

07

800 ml

Smaly

6280

Bottle. Stainless Steel. 800 ml. Individual Presentation.
 Trinkflasche. Rostfreier Stahl. 800 ml. Individuelle Präsentation.
 Bidon. Acier Inox. 800 ml. Présentation Individuelle.
 Fles. Roestvrij Staal. 800 ml. Individuele Presentatie.

Ø 7.1 × 28 cm

30

Print Code: F(1), L2



03

SPORT
BOTTLE

02

01

19

05

04

Delby

5491

Bottle. Aluminium. 800 ml. Individual Presentation.
 Trinkflasche. Aluminium. 800 ml. Individuelle Präsentation.
 Bidon. Aluminium. 800 ml. Présentation Individuelle.
 Fles. Aluminium. 800 ml. Individuele Presentatie.

Ø 7.3 × 25.3 cm

Print Code: F(1), L2



16



02

19

05

03

Tukel

5986

Bottle. Aluminium. 650 ml.
 Trinkflasche. Aluminium. 650 ml.
 Bidon. Aluminium. 650 ml.
 Fles. Aluminium. 650 ml.

Ø 6.6 × 23 cm

Print Code: F(1), L2

50

650 ml



19



1,89 L



Rumper 5979

Bottle. PET. 1,89 L.
Trinkflasche. PET. 1,89 L.
Bidon. PET. 1,89 L.
Fles. PET. 1,89 L.

📦 12.5 x 23.5 cm 30

🌈 Print Code: F(1)



650 ml



Vandix 5695

Bottle. Tritan. 650 ml. Individual Presentation.
Trinkflasche. Tritan. 650 ml. Individuelle Präsentation.
Bidon. Tritan. 650 ml. Présentation Individuelle.
Fles. Tritan. 650 ml. Individuele Presentatie.

📦 7 x 23 cm

🌈 Print Code: F(1)

30



650 ml

20x80 cm
160 g/m²

COOLING TOWEL INCLUDED
TOALLA ENFRIADORA INCLUIDA



Doltin 5631

Holder Bottle. 650 ml. Individual Presentation. Towel Included 160 g/ m2. UV50 Protection.
Trinkflasche. 650 ml. Individuelle Präsentation. Handtuch Inklusiv 160 g/ m2. UV50 Schutz.
Bidon. 650 ml. Présentation Individuelle. Serviette Inclus 160 g/ m2. Protection UV50.
Fles. 650 ml. Individuele Presentatie. Handdoek Inclusief 160 g/ m2. UV50 Bescherming.

📦 7 x 27.2 cm 30

🌈 Print Code: F(1), N(8)



650 ml



Halmik 5887

Bottle. Tritan. 650 ml.
Trinkflasche. Tritan. 650 ml.
Bidon. Tritan. 650 ml.
Fles. Tritan. 650 ml.

📦 6.7 x 25 cm

🌈 Print Code: F(1), L2

50





NEW



RPET



EQUA

REFLECTIVE 02

Fabax 6850

Backpack. Polyester 600D RPET. Padded Back and Shoulder Straps. Reflective.
Rucksack. Polyester 600D RPET. Gepolsterter Rücken und Schultergurte. Reflektierend.
Sac à Dos. Polyester 600D RPET. Dos et Bretelles Rembourrées. Réfléchissant.
Rugzak. Polyester 600D RPET. Gewatteerde Achterzijde en Schouderbanden. Reflecterend.

28 × 38 × 12 cm

50

Print Code: F(1), N(8)

510



19

01

07



02

05

03

11

Humus 4057

Backpack. Polyester 600D. Padded Shoulder Straps.
Rucksack. Polyester 600D. Gepolsterter Schultergurte.
Sac à Dos. Polyester 600D. Bretelles Rembourrées.
Rugzak. Polyester 600D. Gewatteerde Schouderbanden.

30 × 40 × 18 cm

40

Print Code: F(1), N(8), 0



04



Dorian 4466

Backpack. Polyester 600D. Padded Back and Shoulder Straps. Shoe Compartment.
Rucksack. Polyester 600D. Gepolsterter Rücken und Schultergurte. Schuh Staufach.
Sac à Dos. Polyester 600D. Dos et Bretelles Rembourrées. Compartiment Porte-Chaussures.
Rugzak. Polyester 600D. Gewatteerde Achterzijde en Schouderbanden. Schoen Compartiment.

30 × 46 × 15 cm 40

Print Code: G(1), N(8)



19

05

03



FRONT POCKET



Galpox

6343

Backpack. Polyester 600D. Padded Back and Shoulder Straps.
Rucksack. Polyester 600D. Gepolsterter Rücken und Schultergurte.
Sac à Dos. Polyester 600D. Dos et Bretelles Rembourrées.
Rugzak. Polyester 600D. Gewatteerde Achterzijde en Schouderbanden.

23 × 36 × 13.5 cm

50

Print Code: F(1), N(8), P, R



Decath

5228

Backpack. Polyester 600D. Padded Back and Shoulder Straps.
Rucksack. Polyester 600D. Gepolsterter Rücken und Schultergurte.
Sac à Dos. Polyester 600D. Dos et Bretelles Rembourrées.
Rugzak. Polyester 600D. Gewatteerde Achterzijde en Schouderbanden.

23 × 40 × 12 cm

50

Print Code: F(1), N(8), O, R



07

511

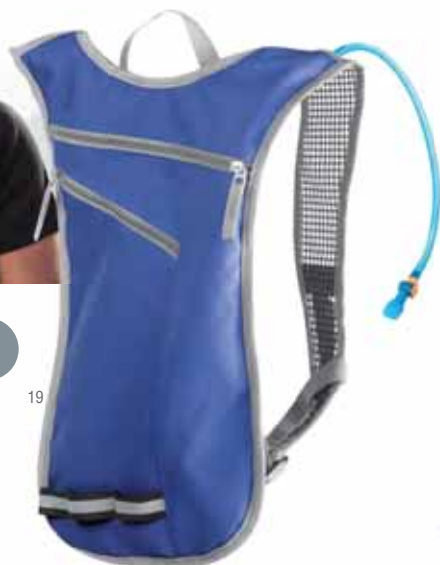

19

Hydrax

4372

Sports Backpack. Polyester 600D. Padded Back. Breathable. Reflective. 2 l Hydration Bladder Included.
Sport Rucksack. Polyester 600D. Gepolsterter Rücken. Atmungsaktiv. Reflektierend. 2 l Blase Inklusiv.
Sac à Dos Sport. Polyester 600D. Dos Rembourrées. Respirant. Réfléchissant. Réservoir Eau 2 l Inclus.
Sport Rugzak. Polyester 600D. Gewatteerde Achterzijde. Ademend. Reflecterend. 2 l Waterhouder Inclusief.

32 × 50 cm

20

Print Code: G(1), N(8)



02

03

05

COMFORTABLE & ADJUSTABLE



Telner

5621

Drawstring Bag. Polyester 190T.
Rucksack. Polyester 190T.
Sac à Dos. Polyester 190T.
Rugzak. Polyester 190T.

34 × 42 cm

300 / 50

Print Code: F(1), N(8), R

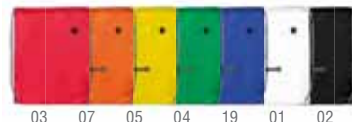

03

07

05

04

19

01

02





02

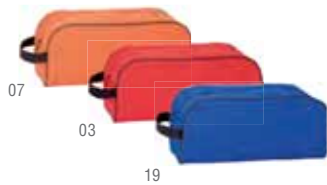

07

03

19

Pirlo

3250

Shoe Bag. Polyester 600D.
Schuhtasche. Polyester 600D.
Sac Chaussures. Polyester 600D.
Schoenentas. Polyester 600D.

35 × 16 × 15 cm 100 / 25

Print Code: F(1), N(8), 0



06

Shoe

9139

Shoe Bag. Polyester 420D.
Schuhtasche. Polyester 420D.
Sac Chaussures. Polyester 420D.
Schoenentas. Polyester 420D.

35 × 17.5 × 14.5 cm 100 / 20

Print Code: F(1), N(8), 0



07



03



19



11

Recco

4182

Shoe Bag. Non-Woven.
Schuhtasche. Non-Woven.
Sac Chaussures. T.N.T.
Schoenentas. Non-Woven.

42 × 20 × 14.5 cm 400 / 10

Print Code: F(1)



02

19

03

05



06

02

03

Filen

6117

Beauty Bag. Polyester 600D.
Kosmetik Tasche. Polyester 600D.
Nécessaire. Polyester 600D.
Toiletas. Polyester 600D.

17 × 15 × 5.5 cm 200 / 10

Print Code: F(1), N(8)



13

02



07

03

19

13

Trevi

3178

Beauty Bag. Polyester 600D.
Kosmetik Tasche. Polyester 600D.
Nécessaire. Polyester 600D.
Toiletas. Polyester 600D.

21.5 × 14 × 10 cm 200 / 10

Print Code: F(1), N(8), 0



02

Melbor

6815

Bag. Polyester 600D.
Tasche. Polyester 600D.
Sac. Polyester 600D.
Tas. Polyester 600D.

65 x 34 x 33 cm

Print Code: G(1), N(8)

10



03

16

06

19

NEW



Holtrum

6841

Bag. Polyester 600D RPET.
Tasche. Polyester 600D RPET.
Sac. Polyester 600D RPET.
Tas. Polyester 600D RPET.

48.5 x 28 x 27.5 cm

Print Code: G(1), N(8)

30



Curcox

4736

19

Bag. Polyester 600D.
Tasche. Polyester 600D.
Sac. Polyester 600D.
Tas. Polyester 600D.

40 x 29 x 13 cm

50

Print Code: G(1), N(8)



11

02

06

03

Sendur

4054

02

Bag. Polyester 600D. Shoe Compartment.
Tasche. Polyester 600D. Schuh Staufach.
Sac. Polyester 600D. Compartiment Porte-Chaussures.
Tas. Polyester 600D. Schoen Compartment.

50 x 38 x 17.5 cm

20

Print Code: G(1), N(8)



19

03



04

19



Rasmus

6329

Charger Backpack. Ripstop. Solar Panel 6,5W. USB Connection. Padded Laptop Compartment. Padded Back and Shoulder Straps.
 Ladegerät Rucksack. Ripstop. Sonnenkollektor 6,5W. USB Anschluss. Gepolsterte Laptotasche. Gepolsterter Rücken und Schultergurte.
 Sac à Dos Chargeur. Ripstop. Panneau Solaire 6,5W. Connexion USB. Pochette Rembourrée pour Portable. Dos et Bretelles Rembourrées.
 Oplader Rugzak. Ripstop. Zonnepaneel 6,5W. USB Verbinding. Gewatteerd Laptop Compartment. Gewatteerde Achterzijde en Schouderbanden.

33 × 52 × 23 cm
 Print Code: J(8)

10



10"
 Tablet
 Compartment

15"
 Laptop
 Compartment



03



SOLAR

charge

514



4000 mAh

19



02



03



09

Rudder

6307

Power Bank. Aluminium. 4000 mAh. USB Output. Micro USB Input. Cable Included.
 Power Bank. Aluminium. 4000 mAh. USB Ausgang. Micro USB Eingang. Kabel Inklusive.
 Power Bank. Aluminium. 4000 mAh. Sortie USB. Entrée Micro USB. Câble Inclus.
 Power Bank. Aluminium. 4000 mAh. USB Output. Micro USB Input. Kabel Inclusief.

7.8 × 12.5 × 1.4 cm
 Print Code: E(4), L2, W

50 / 25



4000 mAh



02



03



01



04



19



05

Lenard

4939

Power Bank. 1 Led. 4000 mAh. 2 USB Outputs. Micro USB Input. Cable Included.
 Power Bank. 1 Led. 4000 mAh. 2 USB Ausgänge. Micro USB Eingang. Kabel Inklusive.
 Power Bank. 1 Led. 4000 mAh. 2 Sorties USB. Entrée Micro USB. Câble Inclus.
 Power Bank. 1 Led. 4000 mAh. 2 USB Outputs. Micro USB Input. Kabel Inclusief.

7.5 × 14.5 × 1.5 cm
 Print Code: E(4)

50 / 25





02

FOLDABLE
PLEGABLE

03

19

16

Hedux

6194

Foldable Backpack. Polyester 210D/ Ripstop.
Faltbarer Rucksack. Polyester 210D/ Ripstop.
Sac à Dos Pliable. Polyester 210D/ Ripstop.
Opvouwbare Rugzak. Polyester 210D/ Ripstop.

37 × 61 × 20.5 cm 100 / 50

Print Code: G(1), N(8)

Water
Repellent

swisent
ORIZONS[®]
adventure



03



02

19



19

03



16

Virtux

7295

Backpack. Polyester 420D. Padded Back and Shoulder Straps.
Rucksack. Polyester 420D. Gepolsterter Rücken und Schultergurte.
Sac à Dos. Polyester 420D. Dos et Bretelles Rembourrées.
Rugzak. Polyester 420D. Gewatteerde Achterzijde en Schouderbanden.

35 × 53 × 28 cm 20

Print Code: J(8)

Water
Repellent

Densul

6168

Backpack. Polyester 210D/ Ripstop. Padded Back and Shoulder Straps.
Rucksack. Polyester 210D/ Ripstop. Gepolsterter Rücken und Schultergurte.
Sac à Dos. Polyester 210D/ Ripstop. Dos et Bretelles Rembourrées.
Rugzak. Polyester 210D/ Ripstop. Gewatteerde Achterzijde en Schouderbanden.

32 × 47 × 28 cm 20

Print Code: G(1), N(8)

Water
Repellent

02



Graker

4436

Ice Grippers. Adjustable.
Antirutsch Greifer. Verstellbar.
Crampons Antidérapants. Ajustable.
Ijs Spikes. Aanpasbaar.

12.7 x 1.1 x 5.2 cm 100 / 50

Print Code: N(8)

2 PIECES



03

19

516

Clark

4439

Compass.
Kompass.
Boussole.
Kompas.

3 x 6.9 x 1.1 cm 1000 / 50

Print Code: C(1)



03

02

04

19

05



Blink

Floykin

5369

Whistle. 1 Led. Button Batteries Included.
Pfeife. 1 Led. Knopfzellen Inklusiv.
Sifflet. 1 Led. Piles Bouton Inclus.
Fluitje. 1 Led. Knoopcel Batterijen Inclusief.

3.7 x 6.7 x 1.5 cm 500 / 100

Print Code: C(1)



16



03

05

10



Brulen

6492

Walking Poles Set. Aluminium. 2 Pieces. Foldable. Adjustable Height. Antishock. Snow Accessory.
Gehstocke. Aluminium. 2 Stück. Falten. Höhenverstellbar. AntiShock. Zubehör für Schnee.
Set Bâtons. Aluminium. 2 Pièces. Pliable. Hauteur Réglable. Antishock. Accessoire Neige.
Wandelstokken. Aluminium. 2 Stuks. opvouwbaar. Aanpasbaar hoogte. Antishock. Sneeuw-Accessoir.

140 cm

20

Print Code: G(1), L2, N(8)



TELESCOPIC
/ TELESÓPICO

19



517



Calix

4541

Sleeping Bag.
Schlafsack.
Sac couchage.
Slaapzak.

75 x 185 cm

Print Code: H(1), N(8)



02

03

19

04



04

Kupra

6374

Multifunction Arm Strap. Nylon.
Multifunktion Armband. Nylon.
Bracelet Multifonction. Nylon.
Multifunctioneel Armband. Nylon.

25.5 x 3.4 x 1.1 cm

300 / 50

Print Code: L1



02

19



COMPASS
BRÚJULA



FIRE STARTER
PEDERNAL

WHISTLE
SILBATO

FLINT SCRAPER
CUCHILLO RASCADOR



OPENER
ABRIDOR



03



19

Redcross

9496

Emergency Kit. Polyester 600D. 17 Accessories.
 Erste Hilfe Set. Polyester 600D. 17 Teile.
 Kit Urgence. Polyester 600D. 17 Accessoires.
 Ehbo-Set. Polyester 600D. 17 Accessoires.

18 x 12 x 6 cm 100 / 20

Print Code: E(1)



518



19

ULTRASOUND



03

01

05

Telfin

5762

Mosquito Repellent Bracelet. Button Battery Included.
 Anti-Mücken-Armband. Knopfzelle Inklusive.
 Bracelet Antimosquitos. Pile Bouton Inclus.
 Mug Afstotende Armband. Knopcel Batterij Inclusief.

24.4 x 2.8 x 1.3 cm 400 / 50

Print Code: D(1)

USES



Quint

4915

Space Blanket. Metallized PET.
 Rettungsdecke. Aluminiumiertes PET.
 Couverture Thermique. PET Aluminiumé.
 Heelal Deken. Aluminium Coated PET.

130 x 210 cm 200 / 50

Print Code: D(1)



EXTENDABLE

03

Fillex

4640

Torch. 1 Led. 3 Batteries AAA Not Included.
 Lampe. 1 Led. 3 AAA Batterien Nicht im Lieferumfang.
 Lampe. 1 Led. 3 Piles AAA Non Inclus.
 Zaklamp. 1 Led. 3 Batterijen AAA Niet Inclusief.

📏 Ø 3.9 × 10.1 cm 📦 100 / 50

🌈 Print Code: E(1)



02

04

19



COB Led

Demil

6250

Lamp. 30 COB Lights. 3 Batteries AAA Not Included.
 Lampe. 30 COB Lichter. 3 AAA Batterien Nicht im Lieferumfang.
 Lampe. 30 Lumières COB. 3 Piles AAA Non Inclus.
 Lamp. 30 COB Lichten. 3 Batterijen AAA Niet Inclusief.

📏 Ø 6.9 × 13.9 cm

📦 100 / 50

🌈 Print Code: F(1)

519

280 ml

19

02

03

09

04

11

210 ml

19



02



05



03



04

Yozax

4656

Mug. Stainless Steel. 280 ml. Individual Presentation.
 Tasse. Rostfreier Stahl. 280 ml. Individuelle Präsentation.
 Tasse. Acier Inox. 280 ml. Présentation Individuelle.
 Mok. Roestvrij Staal. 280 ml. Individuele Presentatie.

📏 Ø 7.6 × 8.9 cm 📦 50

🌈 Print Code: F(4), L2

Bastic

4509

Mug. Stainless Steel. 210 ml. Individual Presentation.
 Tasse. Rostfreier Stahl. 210 ml. Individuelle Präsentation.
 Tasse. Acier Inox. 210 ml. Présentation Individuelle.
 Mok. Roestvrij Staal. 210 ml. Individuele Presentatie.

📏 Ø 7 × 8 cm 📦 50

🌈 Print Code: F(4), L2



03



Lokys

5148



Light



Blink

Torch. Aluminium. 5 Leds. 3 Light Modes. 3 Batteries AAA Not Included.
 Lampe. Aluminium. 5 Leds. 3 Leuchtfunktionen. 3 AAA Batterien Nicht im Lieferumfang.
 Lampe. Aluminium. 5 Leds. 3 Modes de Lumière. 3 Piles AAA Non Inclus.
 Zaklamp. Aluminium. 5 Leds. 3 Licht Posities. 3 Batterijen AAA Niet Inclusief.

6 × 4.5 × 3.8 cm 200 / 20

Print Code: F(1)



19

09



520



03



Vilox

6246



Light



Blink



COB Led

Torch. 8 COB Lights. 3 Light Modes. 3 Batteries AAA Not Included.
 Lampe. 8 COB Lichter. 3 Leuchtfunktionen. 3 AAA Batterien Nicht im Lieferumfang.
 Lampe. 8 Lumières COB. 3 Modes de Lumière. 3 Piles AAA Non Inclus.
 Zaklamp. 8 COB Lichten. 3 Licht Posities. 3 Batterijen AAA Niet Inclusief.

6.1 × 4 × 1.7 cm

500 / 100

Print Code: E(1)



19

02

01

04



03



Lyena

4990

Lamp. 1 Led. 3 Batteries AAA Not Included.
 Lampe. 1 Led. 3 AAA Batterien Nicht im Lieferumfang.
 Lampe. 1 Led. 3 Piles AAA Non Inclus.
 Lamp. 1 Led. 3 Batterijen AAA Niet Inclusief.

Ø 5.5 × 15.4 cm 100 / 25

Print Code: D(4)



01

19

05

Video



COMPATIBLE WITH
ANDROID & iOS4K
4k

Wi-Fi

MICRO SD

2" SCREEN

HDMI

Garrix 5528



Wi-Fi Support

Waterproof

Micro SD

Action Camera. 4K. Wifi. 2" LCD Screen. 16 Accessories. Multilingual. USB Rechargeable. Cable Included.
Sportkamera. 4K. Wifi. 2" LCD Screen. 16 Teile. In Mehreren Sprachen. USB Wiederaufladbar. Kabel Inklusiv.
Camera Sportive. 4K. Wifi. Ecran LCD 2". 16 Accessoires. Multilingue. Rechargeable USB. Cable Inclus.
Sport Camara. 4K. Wifi. 2" LCD Scherm. 16 Accessoires. Meertalig. USB Oplaadbaar. Kabel Inclusief.

16 x 23 x 6 cm 20

Print Code: K(4)



521

HDMI
MICRO SD

01

08



MICRO SD

2" SCREEN

Logans 5529



Camera 360°

Wi-Fi Support

2448P
Resolution

Waterproof

Micro SD

COMPATIBLE WITH
APP
ANDROID & iOS

Action Camera 360°. 2448P. Wifi. 0,96" LCD Screen. 10 Accessories. Multilingual. USB Rechargeable. Cable Included.
Sportkamera 360°. 2448P. Wifi. 0,96" LCD Screen. 10 Teile. In Mehreren Sprachen. USB Wiederaufladbar. Kabel Inklusiv.
Camera Sportive 360°. 2448P. Wifi. Ecran LCD 0,96". 10 Accessoires. Multilingue. Rechargeable USB. Cable Inclus.
Sport Camara 360°. 2448P. Wifi. 0,96" LCD Scherm. 10 Accessoires. Meertalig. USB Oplaadbaar. Kabel Inclusief.

13 x 13 x 11 cm

18

Print Code: K(1)



Video

Komir 5246

Action Camera. 720P. 2" LCD Screen. 14 Accessories. Multilingual. USB Rechargeable. Cable Included.
Sportkamera. 720P. 2" LCD Screen. 14 Teile. In Mehreren Sprachen. USB Wiederaufladbar. Kabel Inklusiv.
Camera Sportive. 720P. Ecran LCD 2". 14 Accessoires. Multilingue. Rechargeable USB. Cable Inclus.
Sport Camara. 720P. 2" LCD Scherm. 14 Accessoires. Meertalig. USB Oplaadbaar. Kabel Inclusief.

12 x 23 x 5.8 cm 20

Print Code: K(4)



Waterproof

High
Definition

Micro SD





Reizon

6589

Raincoat. PLA 100% Compostable. One Size. Adult. 127 x 102 cm.

Poncho. PLA 100% Kompostierbar. Einheitsgröße. Erwachsene. 127 x 102 cm.

Poncho. PLA 100% Compostable. Taille Unique. Adulte. 127 x 102 cm.

Regenjas. PLA 100% Composteerbaar. Eén Maat. Volwassen. 127 x 102 cm.

10 × 13.5 cm

200 / 20

Print Code: E(1)



This raincoat is manufactured with PLA material, from renewable raw materials, with important qualities such as versatility and strength, but prevailing all, it is compostable.

**USE ME,
I AM ECO-FRIENDLY
100% COMPOSTABLE**

Este poncho está fabricado con material PLA, procedente de materias primas renovables, con importantes propiedades como la versatilidad y la resistencia pero prevaleciendo entre ellas la de compostabilidad.



03

Domin

5810

Raincoat. LDPE. One Size. Adult. 120 x 95 cm.

Poncho. LDPE. Einheitsgröße. Erwachsene. 120 x 95 cm.

Poncho. LDPE. Taille Unique. Adulte. 120 x 95 cm.

Regenjas. LDPE. Eén Maat. Volwassen. 120 x 95 cm.

9 × 11 × 5 cm

200 / 25

Print Code: F(1)



02



03

Birtox

6357

Raincoat. LDPE. One Size. Adult. 127 x 102 cm.

Poncho. LDPE. Einheitsgröße. Erwachsene. 127 x 102 cm.

Poncho. LDPE. Taille Unique. Adulte. 127 x 102 cm.

Regenjas. LDPE. Eén Maat. Volwassen. 127 x 102 cm.

0.5 × 5.1 cm

200 / 50

Print Code: D(4), W



01

19

05

04

2 L

Mobile
Compartment

Waterproof



Tactile



Kambax

6564

Bag. Ripstop. Waterproof.
Tasche. Ripstop. Wasserdicht.
Sac. Ripstop. Imperméable.
Tas. Ripstop. Waterdicht.

📏 11 × 29.5 cm

🎨 Print Code: G(1)

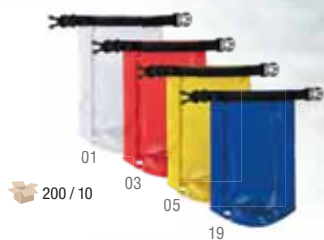

Waterproof



523



Tayrux

6513

Backpack. Ripstop. Waterproof.
Rucksack. Ripstop. Wasserdicht.
Sac à Dos. Ripstop. Imperméable.
Rugzak. Ripstop. Waterdicht.

📏 23 × 63 cm

🎨 Print Code: G(1)

20 L



Waterproof

20

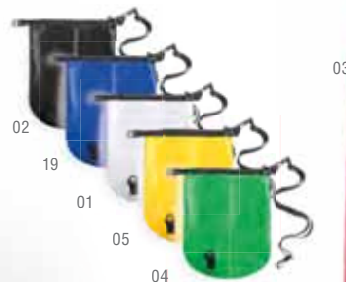

Tinsul

4848

Bag. Ripstop. Waterproof.
Tasche. Ripstop. Wasserdicht.
Sac. Ripstop. Imperméable.
Tas. Ripstop. Waterdicht.

📏 18.5 × 36 cm

🎨 Print Code: G(1)

9 L



Waterproof

100 / 10





13

Soviet

9487

Vest. 35% Cotton/ 65% Polyester.
 Weste. 35% Baumwolle/ 65% Polyester.
 Gilet. 35% Coton/ 65% Polyester.
 Vest. 35% Katoen/ 65% Polyester.

Print Code: G(6), N(8), O, P

50



03



06

14



Inner Band

14



Safari

9335

Hat. 100% Cotton.
 Hut. 100% Baumwolle.
 Bonnet. 100% Coton.
 Muts. 100% Katoen.

Consult.

200 / 50

Print Code: F(1), N(8), O, P



04



Draken

6207

Hat. Microfibre.
 Hut. Mikrofaser.
 Bonnet. Microfibre.
 Muts. Microfibre.

Consult.

200 / 50

Print Code: F(1), N(8), O, P



Inner Band

BAMBOO

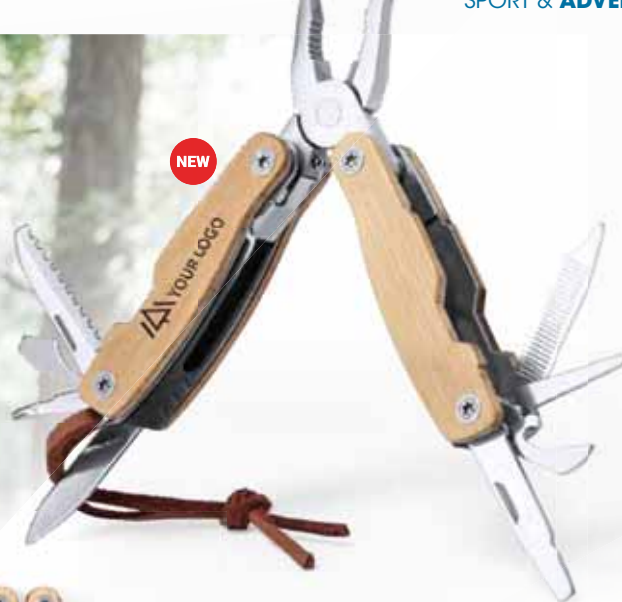

Folnax

6805

Multitool. Bamboo/ Stainless Steel. 12 Functions.
Multiwerkzeug. Bambus/ Rostfreier Stahl. 12 Funktionen.
Multi Outils. Bambou/ Acier Inox. 12 Fonctions.
Multitool. Bamboe/ Roestvrij Staal. 12 Functies.

5 × 10.5 × 1.7 cm

100 / 10

Print Code: E(4), L1

525

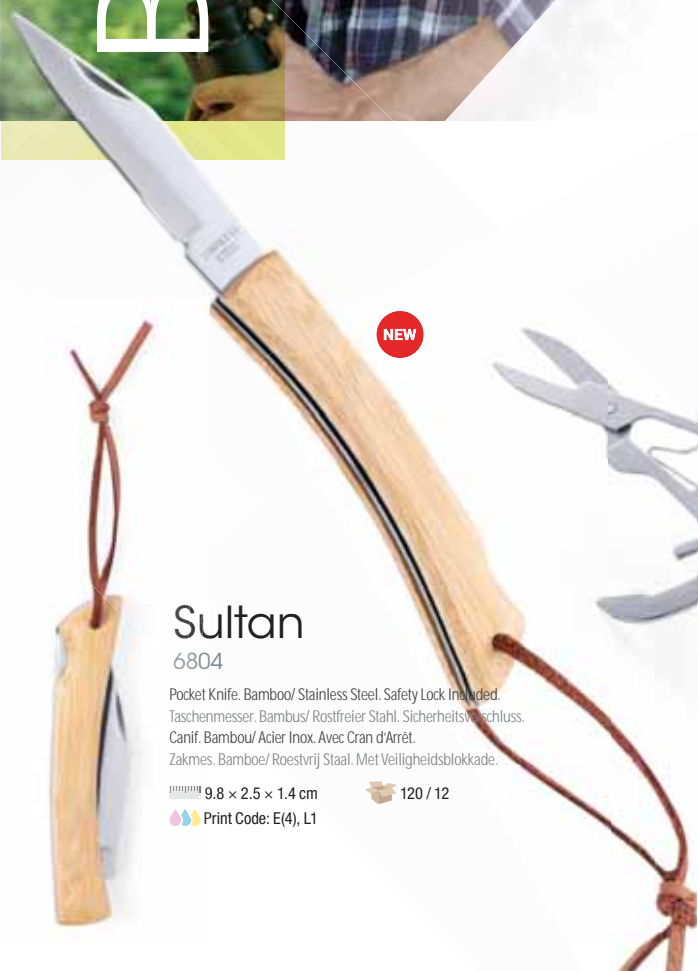

Sultan

6804

Pocket Knife. Bamboo/ Stainless Steel. Safety Lock Included.
Taschenmesser. Bambus/ Rostfreier Stahl. Sicherheitsverschluss.
Canif. Bambou/ Acier Inox. Avec Cran d'Arrêt.
Zakmes. Bamboe/ Roestvrij Staal. Met Veiligheidsblokkade.

9.8 × 2.5 × 1.4 cm

120 / 12

Print Code: E(4), L1

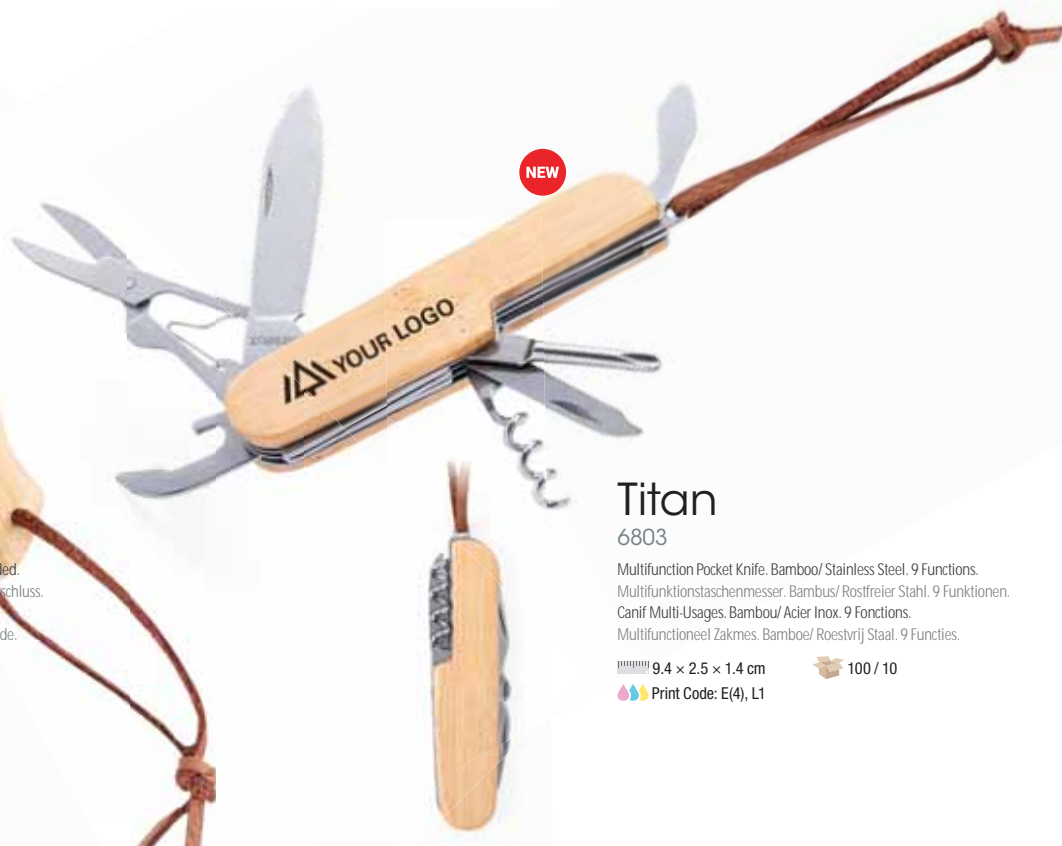

Titan

6803

Multifunction Pocket Knife. Bamboo/ Stainless Steel. 9 Functions.
Multifunktions-taschenmesser. Bambus/ Rostfreier Stahl. 9 Funktionen.
Canif Multi-Usages. Bambou/ Acier Inox. 9 Fonctions.
Multifunctioneel Zakmes. Bamboe/ Roestvrij Staal. 9 Functies.

9.4 × 2.5 × 1.4 cm

100 / 10

Print Code: E(4), L1



526



Wicax 4208

Multitool. Stainless Steel. 11 Functions.
Multiwerkzeug. Rostfreier Stahl. 11 Funktionen.
Multi Outils. Acier Inox. 11 Fonctions.
Multitool. Roestvrij Staal. 11 Functies.

8 × 5.5 × 0.3 cm 400 / 100

Print Code: D(1), L1

11 FUNCTIONS



Roseca 5660

Multitool. Aluminium/ Stainless Steel. 13 Functions.
Multiwerkzeug. Aluminium/ Rostfreier Stahl. 13 Funktionen.
Multi Outils. Aluminium/ Acier Inox. 13 Fonctions.
Multitool. Aluminium/ Roestvrij Staal. 13 Functies.

3.9 × 8.1 × 1 cm 300 / 50

Print Code: D(1)

Thiam 5457

Pocket Knife. Aluminium/ Stainless Steel. Safety Lock Included.
Taschenmesser. Aluminium/ Rostfreier Stahl. Sicherheitsverschluss.
Canif. Aluminium/ Acier Inox. Avec Cran d'Arrêt.
Zakmes. Aluminium/ Roestvrij Staal. Met Veiligheidsblokkade.

8.9 × 2.6 × 1.2 cm 100 / 10

Print Code: E(4), L1



Skabix 6041

Snow Shovel. Carbon Steel. Foldable.
Schneeschaufel. Kohlenstoff Stahl. Falten.
Pelle à Neige. Acier Carbone. Pliable.
Sneeuwschep. Carbon-Staal. opvouwbaar.

11.5 × 46.5 × 5 cm 20

Print Code: I(8), L2



19

Blauden

3450

Multitool. Aluminium/ Stainless Steel. 12 Functions.
 Multiwerkzeug. Aluminium/ Rostfreier Stahl. 12 Funktionen.
 Multi Outils. Aluminium/ Acier Inox. 12 Fonctions.
 Multitool. Aluminium/ Roestvrij Staal. 12 Functies.

5 × 10.5 × 1.7 cm 100 / 10

Print Code: E(4), L1



03



02



527



Talos

3687

Multitool. 4 Leds. 12 Functions. 3 Batteries AAA Not Included.
 Multiwerkzeug. 4 Leds. 12 Funktionen. 3 AAA Batterien Nicht im Lieferumfang.
 Multi Outils. 4 Leds. 12 Fonctions. 3 Piles AAA Non Inclus.
 Multitool. 4 Leds. 12 Functies. 3 Batterijen AAA Niet Inclusief.

4.5 × 14 cm 50 / 25

Print Code: E(1), L1



19

Brerax

5036

Multitool. Aluminium/ Stainless Steel. 1 Led. 9 Functions. 1 Battery AAA Not Included.
 Multiwerkzeug. Aluminium/ Rostfreier Stahl. 1 Led. 9 Funktionen. 1 Batterie AAA Nicht im Lieferumfang.
 Multi Outils. Aluminium/ Acier Inox. 1 Led. 9 Fonctions. 1 Pile AAA Non Inclus.
 Multitool. Aluminium/ Roestvrij Staal. 1 Led. 9 Accessoires. 1 Batterij AAA Niet Inclusief.

3.2 × 12.5 cm 50 / 25

Print Code: E(1), L1



04

03

02



Yunaz 7338



Set. Aluminium/ Stainless Steel. 1 Led. 3 Light Modes. Pocket Knife 15 Functions. 3 Batteries AAA Not Included.
 Set. Aluminium/ Rostfreier Stahl. 1 Led. 3 Leuchtfunktionen. Taschenmesser 15 Funktionen. 3 AAA Batterien Nicht im Lieferumfang.
 Set. Aluminium/ Acier Inox. 1 Led. 3 Modes de Lumière. Canif 15 Fonctions. 3 Piles AAA Non Inclus.
 Set. Aluminium/ Roestvrij Staal. 1 Led. 3 Licht Posities. Zakmes 15 Functies. 3 Batterijen AAA Niet Inclusief.

15 × 4.7 × 9.7 cm 50 / 10

Print Code: F(4), L1

528



Lumosh 7287

Torch. Aluminium. 9 Leds. 3 Batteries AAA Not Included.
 Lampe. Aluminium. 9 Leds. 3 AAA Batterien Nicht im Lieferumfang.
 Lampe. Aluminium. 9 Leds. 3 Piles AAA Non Inclus.
 Zaklamp. Aluminium. 9 Leds. 3 Batterijen AAA Niet Inclusief.

Ø 3.2 × 10 cm 100 / 50

Print Code: E(4), L1



Norfolk 7288

Torch. Aluminium. 28 Leds. 3 Batteries AAA Not Included.
 Lampe. Aluminium. 28 Leds. 3 AAA Batterien Nicht im Lieferumfang.
 Lampe. Aluminium. 28 Leds. 3 Piles AAA Non Inclus.
 Zaklamp. Aluminium. 28 Leds. 3 Batterijen AAA Niet Inclusief.

Ø 4.7 × 11.2 cm 100 / 50

Print Code: E(4), L1



Saida

7286

Compass. Aluminium.
 Kompass. Aluminium.
 Boussole. Aluminium.
 Kompas. Aluminium.

11.4 x 6.5 x 3 cm 100 / 10

Print Code: F(1), L1



Ketor

7285

Monocular. Aluminium.
 Monokulare. Aluminium.
 Monoculaire. Aluminium.
 Enkele Verrekijker. Aluminium.

5 x 6.5 x 11 cm 50 / 25

Print Code: I(1)



529



Damok

7340

Pocket Knife. Metal/ Stainless Steel. 1 Led. Safety Lock Included. Button Batteries Included.
 Taschenmesser. Metall/ Rostfreier Stahl. 1 Led. Sicherheitsverschluss. Knopfzellen Inklusiv.
 Canif. Métal/ Acier Inox. 1 Led. Avec Cran d'Arrêt. Piles Bouton Inclus.
 Zakmes. Metaal/ Roestvrij Staal. 1 Led. Met Veiligheidsblokkade. Knopcel Batterijen Inclusief.

11.4 x 3 x 1 cm 100 / 10

Print Code: E(1), L1



03

Borth

7291

Multitool. Aluminium/ Stainless Steel. 6 Functions.
 Multiwerkzeug. Aluminium/ Rostfreier Stahl. 6 Funktionen.
 Multi Outils. Aluminium/ Acier Inox. 6 Fonctions.
 Multitool. Aluminium/ Roestvrij Staal. 6 Functies.

2.8 x 8.4 x 1.5 cm 100 / 10

Print Code: E(1), L1





URBAN TRAVEL



Hessok 6556

Trolley, PC, Rigid, 8 Rotating Wheels, TSA Combination Lock Included.
Trolley, PC, Starre, 8 Drehende Räder, TSA Sicherheitsverschluss Inklusiv.
Trolley, PC, Rigide, 8 Roues Tourmantes, Fermeture Sécurité TSA Inclus.
Trolley, PC, Hard, 8 Draaiende Wielen, TSA Veiligheidsluiting Inclusief.

34 × 54 × 23 cm  1

 Print Code: K(1)

01



TSA Combination Lock



Bandel
PG 535



Flaut
PG 541



Munds
6579

Globe. Natural Cork/ Metal. 12 Markers Included.
Erdkugel. Naturkork/ Metall. 12 Marker inklusive.
Globe Terrestre. Bouchon Nature/ Métal. 12 Marqueurs Inclus.
Wereldbol Globe. Natuurlijk Kurk/ Staal. 12 Stiffen inclusief.

10 15 x 20 cm

Print Code: G(1), L2



Condord

5556

Pillow. Polyester.
Kissen. Polyester.
Coussin. Polyester.
Kussen. Polyester.

30 x 9.5 x 29 cm 20

Print Code: N(8)



08



19

03

04

EPS

SUPER COMFORTABLE



05

11

03

02



19

Sould

4538

Pillow. Polyester.
Kissen. Polyester.
Coussin. Polyester.
Kussen. Polyester.

Ø 9 x 21 cm 50

Print Code: D(1)

Comfort
Travel

EPS SUPER COMFORTABLE



Comfort
Travel



02

08

03

16

11

Traveller

8772

Pillow. Microfibre.
Kissen. Mikrofaser.
Coussin. Microfibre.
Kussen. Microfibre.

33 x 9 x 25 cm 200 / 20

Print Code: F(1)



19

Plonet

4171

Travel Set. Microfibre/ EVA. 3 Accessories.
Reise Set. Mikrofaser/ EVA. 3 Teile.
Set Voyage. Microfibre/ EVA. 3 Accessoires.
Reis Set. Microfibre/ EVA. 3 Accessoires.

17.5 x 11 cm 100 / 20

Print Code: F(1), N(8)



3 PIECES

08



03



02

IDEAL SIZE for travel



85 × 115 cm
180 g/m²

Elowin

5744

Blanket. Polar Fleece 180 g/ m2. Anti-Pilling.
Decke. Polar Fleece 180 g/ m2. Anti-Pilling.
Couverture. Polaire 180 g/ m2. Anti-Pilling.
Deken. Polar Fleece 180 g/ m2. Anti-Pilling.

85 × 115 cm 20

Print Code: N(8), O, P

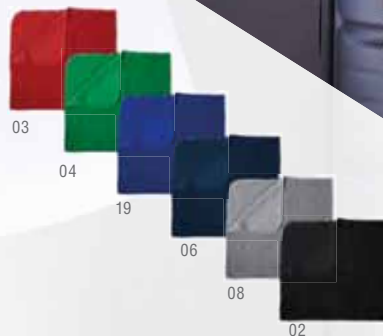

533



03

Panoss

4677

Earplugs. EVA.
Ohrstopfset. EVA.
Bouchons Antibruit. EVA.
Oordopjes. EVA.

Ø 2.2 × 6.4 cm 1000 / 200

Print Code: C(1)



02

Yorder

4998

2 PIECES

Travel Set. Microfibre/ EVA. 2 Accessories.
Reise Set. Mikrofaser/ EVA. 2 Teile.
Set Voyage. Microfibre/ EVA. 2 Accessoires.
Reis Set. Microfiber/ EVA. 2 Accessoires.

19 × 9 cm 500 / 100

Print Code: D(1), N(8), R



02

Asleep

9800

Travel Eye Mask. Microfibre.
Reise Augenmaske. Mikrofaser.
Masque Voyage. Microfibre.
Slaapmasker. Microfiber.

18.5 × 9 cm 1000 / 100

Print Code: D(1), N(8)



08



Ideal
Sublimation

Dakar

8946

Travel Document Holder. Polyester 600D.
Reise Dokumententasche. Polyester 600D.
Porte-Documents Voyage. Polyester 600D.
Reisdocumentenhouder. Polyester 600D.

25 × 13.5 cm 100 / 25

Print Code: E(1), N(8)



Lisboa

9188

Travel Document Holder. Polyester 600D.
Reise Dokumententasche. Polyester 600D.
Porte-Documents Voyage. Polyester 600D.
Reisdocumentenhouder. Polyester 600D.

27 × 13 cm 400 / 40

Print Code: E(1), N(8)



534

Dusky

4876

Multipurpose Bag. LDPE.
Mehrzwecktasche. LDPE.
Fourre-Tout. LDPE.
Multifunctioneel Tasje. LDPE.

23 × 18 × 6.5 cm 1000 / 100

Print Code: E(1)



Rinok

5163

Travel Document Holder. Polyester 420D.
Reise Dokumententasche. Polyester 420D.
Porte-Documents Voyage. Polyester 420D.
Reisdocumentenhouder. Polyester 420D.

27 × 14.5 cm 200 / 50

Print Code: E(1)





Klimba

3927

Passport Holder. PVC.
Reisepasshülle. PVC.
Étui Passeport. PVC.
Paspoorthouder. PVC.

10 × 13.8 cm 300 / 25
Print Code: E(1)

Raner

4159

Luggage Tag. PVC.
Kofferanhänger. PVC.
Identificateur Valise. PVC.
Bagage Label. PVC.

7 × 11.5 × 0.5 cm 250 / 50
Print Code: E(1)

Mufix

5264

Luggage Tag.
Kofferanhänger.
Identificateur Valise.
Bagage Label.

9.5 × 6 × 0.4 cm 500 / 50
Print Code: D(4)

Bandel

4278

Luggage Tag.
Kofferanhänger.
Identificateur Valise.
Bagage Label.

Ø 2.6 × 7.6 cm 500 / 50
Print Code: D(1)

Cloris

3816

Luggage Tag.
Kofferanhänger.
Identificateur Valise.
Bagage Label.

5.5 × 9.5 × 0.4 cm 500 / 50
Print Code: D(4)

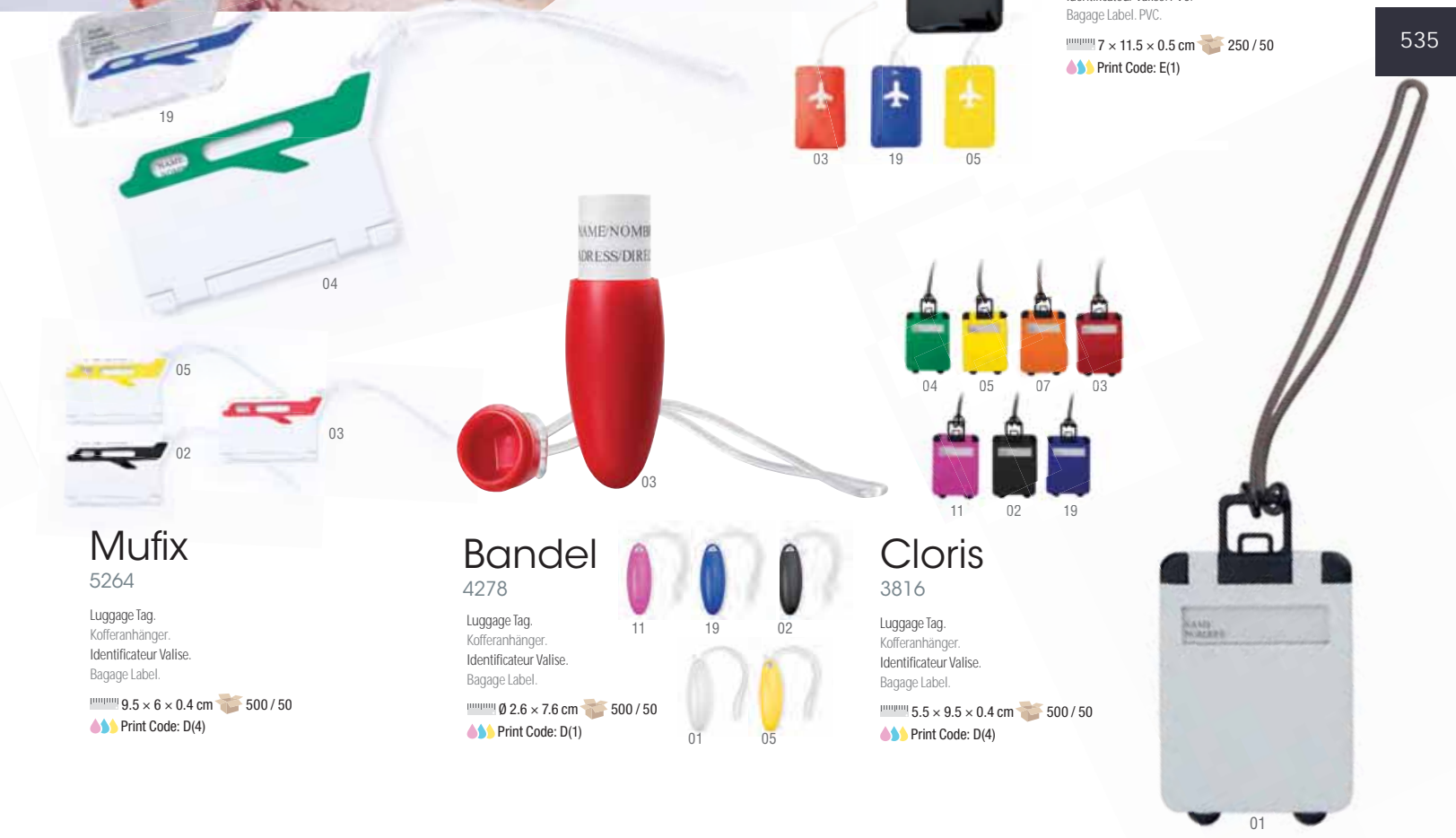

536



Plug Adapter



03



02

19

04

05

07

11

Tribox

4698



01

Plug Adapter. USB Output. 1000 mA. USA, Europe, Asia, UK, Australia.
 Steckeradapter. USB Ausgang. 1000 mA. USA, Europa, Asien, UK, Australien.
 Adaptateur Prises. Sortie USB. 1000 mA. USA, Europe, Asie, Royaume-Uni, Australie.
 Stekker Adapter. USB Output. 1000 mA. USA, Europa, Azie, UK, Australien.

⚡ ⌀ 4.8 × 11.1 cm 📦 100 / 50

🌈 Print Code: D(4)



Travel



Home / Office



Tyru

3730

Plug Adapter. USA, Europe, Asia, UK, Australia.
 Steckeradapter. USA, Europa, Asien, UK, Australien.
 Adaptateur Prises. USA, Europe, Asie, Royaume-Uni, Australie.
 Stekker Adapter. USA, Europa, Azie, UK, Australien.

⚡ 5 × 7.4 × 4 cm 📦 100 / 50

🌈 Print Code: D(4)



Travel



Home / Office



19



03

Universal

3086



Travel



Home / Office

Plug Adapter. USA, Europe, Asia, UK, Australia.
 Steckeradapter. USA, Europa, Asien, UK, Australien.
 Adaptateur Prises. USA, Europe, Asie, Royaume-Uni, Australie.
 Stekker Adapter. USA, Europa, Azie, UK, Australien.

⚡ ⌀ 4.5 × 8.2 cm 📦 100 / 50

🌈 Print Code: D(4)

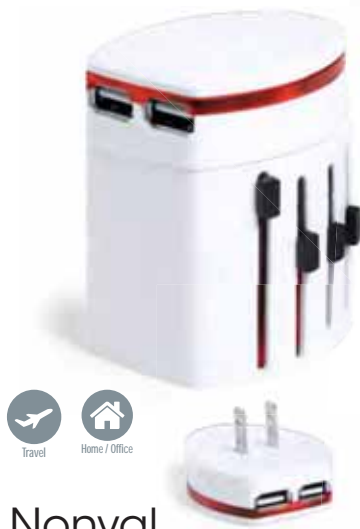

Nonval 6532

Plug Adapter. 2 USB Outputs 2100 mA. USA, Europe, Asia, UK, Australia.
Steckeradapter. 2 USB Ausgänge 2100 mA. USA, Europa, Asien, UK, Australien.
Adaptateur Prises. 2 Sorties USB 2100 mA. USA, Europe, Asie, Royaume-Uni, Australie.
Stekker Adapter. 2 USB Outputs 2100 mA. USA, Europa, Azie, UK, Australie.

7 × 6.3 × 4.9 cm 100 / 50

Print Code: D(4), W



Plug Adapter



537



Duban 6245

Plug Adapter. 2 USB Outputs 2100 mA.
USA, Europe, Asia, UK, Australia.
Steckeradapter. 2 USB Ausgänge 2100 mA.
USA, Europa, Asien, UK, Australien.
Adaptateur Prises. 2 Sorties USB 2100 mA.
USA, Europe, Asie, Royaume-Uni, Australie.
Stekker Adapter. 2 USB Outputs 2100 mA.
USA, Europa, Azie, UK, Australie.

4.7 × 3.1 × 5.5 cm 100 / 50

Print Code: D(4), N(8), W



Celsor 5303

Plug Adapter. 2 USB Outputs. 2100 mA. USA, Europe, Asia, UK, Australia.
Steckeradapter. 2 USB Ausgänge. 2100 mA. USA, Europa, Asien, UK, Australien.
Adaptateur Prises. 2 Sorties USB. 2100 mA. USA, Europe, Asie, Royaume-Uni, Australie.
Stekker Adapter. 2 USB Outputs. 2100 mA. USA, Europa, Azie, UK, Australie.

4.5 × 6.1 × 5.6 cm 100 / 50

Print Code: D(4), W



Dutian

5966



Power Bank Set. Power Bank 2000 mAh, USB Output, Micro USB Input, USB Chargers 1000 mA. Cable Included Micro USB, Type C and Lightning Connection.

Power Bank Set. Power Bank 2000 mAh, USB Ausgang, Micro USB Eingang, USB Ladegerät 1000 mA. Kabel Inklusive Anschluss Micro USB, Typ C und Lightning.

Set Power Bank. Power Bank 2000 mAh, Sortie USB, Entrée Micro USB, Chargeurs USB 1000 mA. Câble Inclus Connexion Micro USB, Type C et Lightning.

Power Bank Set. Power Bank 2000 mAh, USB Output, Micro USB Input, USB Chargers 1000 mA. Inclusief Kabel Micro USB, Type C en Lightning Connectie.

11.5 x 4 x 7.5 cm 100 / 50

Print Code: E(1), F(4)



2000 mAh

900CM

TYPE C
MICRO USB & LIGHTNING



538



2200 mAh



Power Bank

02

Slatham

5200

Power Bank Selfie Stick. Aluminium/ Stainless Steel. 2200 mAh. USB Output. Micro USB Input. 3,5 mm Jack Socket. 7 Positions. Cable Included.

Power Bank Monopod. Aluminium/ Rostfreier Stahl. 2200 mAh. USB Ausgang. Micro USB Eingang. 3,5 mm Klinckenstecker. 7 Positionen. Kabel Inklusive.

Tripod Power Bank. Aluminium/ Acier Inox. 2200 mAh. Sortie USB. Entrée Micro USB. Connexion Jack 3,5 mm. 7 Positions. Câble Inclus.

Power Bank Selfie Stick. Aluminium/ Roestrij Staal. 2200 mAh. USB Output. Micro USB Input. 3,5 mm Jack Aansluiting. 7 Posities. Kabel Inclusief.

Ø 2.2 x 69 cm 50 / 25

Print Code: E(1), L1



19



Sinkord

6090

USB Chargers Set. USB Charger 1000 mA. Cable Included Micro USB, Type C and Lightning Connection.

USB Ladegerät Set. USB Ladegerät 1000 mA. Kabel Inklusive Anschluss Micro USB, Typ C und Lightning.

Set Chargeurs USB. Chargeur USB 1000 mA. Câble Inclus Connexion Micro USB, Type C et Lightning.

USB Opladers Set. USB Oplader 1000 mA. Inclusief Kabel Micro USB, Type C en Lightning Connectie.

11.5 x 3.5 x 8.5 cm 100 / 50

Print Code: E(1), F(4)



Brenom

6065

Holder. Flexible.

Halter. Flexibel.

Support. Flexible.

Houder. Flexibel.

12.3 x 6.4 x 2.8 cm 50

Print Code: H(1)





CHARGING STATION

580 ml



Husod

6004



Earphones Bottle. Stainless Steel. 580 ml. Bluetooth Connection. USB Rechargeable. Individual Presentation. Cable Included.

Kopfhörer Trinkflasche. Rostfreier Stahl. 580 ml. Bluetooth Anschluss. USB Wiederaufladbar. Individuelle Präsentation. Kabel Inklusiv.

Bidon Écouteurs. Acier Inox. 580 ml. Connexion Bluetooth. Rechargeable USB. Présentation Individuelle. Câble Inclus.

Oordop Fles. Roesstrijl Staal. 580 ml. Bluetooth Verbinding. USB Oplaadbaar. Individuele Presentatie. Kabel Inclusief.

Ø 7.2 × 25 cm 30

Print Code: K(1), L2



5200 mAh



Molik

6302



Power Bank Earphones. Wireless. 5200 mAh. USB Output. Type C Input. Bluetooth Connection. USB Rechargeable. Cable Included.

Power Bank Kopfhörer. Drahtlos. 5200 mAh. USB Ausgang. Typ C Eingang. Bluetooth Anschluss. USB Wiederaufladbar. Kabel Inklusiv.

Écouteurs Power Bank. Sans Fil. 5200 mAh. Sortie USB. Entrée Type C. Connexion Bluetooth. Rechargeable USB. Câble Inclus.

Power Bank Oordopjes. Draadloos. 5200 mAh. USB Output. Typ C Input. Micro USB Input. Bluetooth Verbinding. USB Oplaadbaar. Kabel Inclusief.

8.4 × 9.8 × 2.6 cm 50 / 25

Print Code: F(4), W



TYPE C IN / OUT

6700 mAh



Teimpor

6141

Multifunction Travel Adapter. Wireless. 6700 mAh. 2 USB Outputs 2400 mA and 1 Type C Output 2400 mA. Type C Input. USA, Europe, Asia, UK, Australia.

Multifunktion Reise Adapter. Drahtlos. 6700 mAh. 2 USB Ausgänge 2400 mA und 1 Typ C Ausgang 2400 mA. Typ C Eingang. USA, Europa, Asien, UK, Australien.

Adaptateur Voyage Multifonction. Sans Fil. 6700 mAh. 2 Sorties USB 2400 mA et 1 Sortie Type C 2400 mA. Entrée type C. USA, Europe, Asie, Royaume-Uni, Australie.

Multifunctioneel Reis Adapter. Draadloos. 6700 mAh. 2 USB Outputs 2400 mA en 1 Typ C Output 2400 mA. Typ C Input. USA, Europa, Azie, UK, Australië.

2.9 × 8 × 8 cm 40

Print Code: F(4), W





NEW

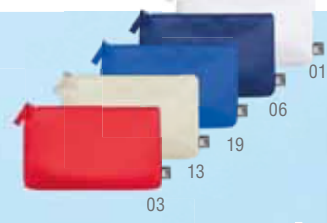

Akilax
6842

02
Beauty Bag. Polyester 600D RPET.
Kosmetik Tasche. Polyester 600D RPET.
Nécessaire. Polyester 600D RPET.
Toiletas. Polyester 600D RPET.

21 x 12 x 3 cm

500 / 50

Print Code: E(1), N(8)

540



Kopel
6423

Beauty Bag. Polyester 600D RPET.
Kosmetik Tasche. Polyester 600D RPET.
Nécessaire. Polyester 600D RPET.
Toiletas. Polyester 600D RPET.

21 x 13 x 8 cm

100 / 10

Print Code: F(1), N(8), 0



Objetive:
ZERO WASTE

RPET

The fabric used in the manufacturing process of these products is made of recycled plastic (RPET). Like this, the emission of plastic residues to our planet and the consumption of energy is drastically reduced, resulting in a much more eco-friendly process.

El material de estos productos está fabricado con plástico reciclado (RPET), que, además de ayudar en la disminución de residuos plásticos en el planeta, utiliza menos energía en el proceso de fabricación, haciendo que sea mucho menos dañino para el medio ambiente.

STOP PLASTIC POLLUTING THE OCEAN



13

Espi
4055

Beauty Bag. Polyester 600D.
Kosmetik Tasche. Polyester 600D.
Nécessaire. Polyester 600D.
Toiletas. Polyester 600D.

25 x 16 x 8 cm

100 / 10

Print Code: F(1), N(8), 0



Trevi
3178

Beauty Bag. Polyester 600D.
Kosmetik Tasche. Polyester 600D.
Nécessaire. Polyester 600D.
Toiletas. Polyester 600D.

21.5 x 14 x 10 cm

200 / 10

Print Code: F(1), N(8), 0



Flaut



5 PIECES + BEAUTY BAG

Beauty Bag Travel

Flaut

6104

Beauty Bag Travel. PVC/ PP. 5 Accessories.
Reise Kosmetik Tasche. PVC/ PP. 5 Teile.
Nécessaire Voyage. PVC/ PP. 5 Accessoires.
Toiletas. PVC/ PP. 5 Accessoires.

20 x 18 x 4 cm 100

Print Code: E(1)

541



01

01

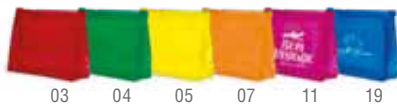

03 04 05 07 11 19

Iriam

5064

Beauty Bag. PVC.
Kosmetik Tasche. PVC.
Nécessaire. PVC.
Toiletas. PVC.

17 x 12.5 x 4.5 cm 400 / 50

Print Code: E(1)

Losut

4778

Beauty Bag. PVC.
Kosmetik Tasche. PVC.
Nécessaire. PVC.
Toiletas. PVC.

29 x 21 x 9 cm 200 / 50

Print Code: F(1)



19

03



02



Lopix

6594

Travel Set. PP. 3 Accessories.
Reise Set. PP. 3 Teile.
Set Voyage. PP. 3 Accessoires.
Reis Set. PP. 3 Accessoires.

5.2 x 9 cm 200 / 50

Print Code: D(4)





REFILLABLE. LIQUID
NOT INCLUDED /
RELENNABLE. LIQUIDO
NO INCLUIDO



NEW

3 ml



Fruk

6723

Multifunction Antibacterial Pen. 3 ml. Refillable. Liquid Not Included.
Multifunktion Antibakteriell Kugelschreiber. 3 ml. Wiederaufladbar. Flüssigkeit Nicht im Lieferumfang.
Stylét Antibactérien Multifonction. 3 ml. Rechargeable. Liquide Non Inclus.
Multifunctioneel Antibacterieel Balpen. 3 ml. Navulbaar. Vloeistof Niet Inclusief.

Ø 1.4 × 11.3 cm

1000 / 50

Print Code: B(4)



Antibacterial

542



03

02

19

09

Cimак

6697

Keyring Anticontact. Stylus Touch Ball Pen Included.
Schlüsselanhänger Anticontact. Kugelschreiber Pointer Inklusive.
Porte-Clés Anticontact. Stylét Bille Inclus.
Sleutelhanger Anticontact. Touch Bal Pen Inclusief.

3 × 7.3 × 0.5 cm

1000 / 50

Print Code: D(4)



05

Veltor

5272

Toothbrush. Foldable.
Zahnbürste. Faltbar.
Brosse à Dents. Pliable.
Tandenborstel. Opvouwbaar.

1.8 × 18 × 2.6 cm

500 / 50

Print Code: C(1)



04

01

07

03

19

02

19

01

03

Hyron

3825

Toothbrush. Foldable.
Zahnbürste. Faltbar.
Brosse à Dents. Pliable.
Tandenborstel. Opvouwbaar.

1.5 × 17.5 × 2.3 cm

500 / 50

Print Code: C(1), W



**MORE
HYDROALCOHOLIC
GEL**

PG 888



15 ml

Bradul

6571

Hydroalcoholic Gel. 15 ml. Hand cleansing gel.
Hydroalkoholisches Gel. 15 ml. Hautreinigungslösung.
Gel Hydroalcoholic. 15 ml. Solution pour le lavage des mains.
Hydroalcoholic Gel. 15 ml. Huidreinigende oplossing.

 3 × 6.3 × 1.8 cm

 500 / 250

 Print Code: C(4), W

Hydroalcoholic GEL



543

10 ml



SPRAY

03 01 04 17 02

19



30 ml



19

04

05

07

02

01



03

NEW



Aloe Vera

NEW

NEW



30 ml



Aloe Vera

NEW

Flaix

6719

Hydroalcoholic Gel. Silicone. 30 ml. Hand cleansing gel.
Hydroalkoholisches Gel. Silikon. 30 ml. Hautreinigungslösung.
Gel Hydroalcoholic. Silicone. 30 ml. Solution pour le lavage des mains.
Hydroalcoholic Gel. Siliconen. 30 ml. Huidreinigende oplossing.

 4 × 8.2 × 2.4 cm

 200 / 50

 Print Code: C(4)

Bustan

6325

Hydroalcoholic Gel. 10 ml. Hand cleansing gel.
Hydroalkoholisches Gel. 10 ml. Hautreinigungslösung.
Gel Hydroalcoholic. 10 ml. Solution pour le lavage des mains.
Hydroalcoholic Gel. 10 ml. Huidreinigende oplossing.

 Ø 1.6 × 14.2 cm

 500 / 50

 Print Code: B(4)

Trikel

6718

Hydroalcoholic Gel. 30 ml. Hand cleansing gel.
Hydroalkoholisches Gel. 30 ml. Hautreinigungslösung.
Gel Hydroalcoholic. 30 ml. Solution pour le lavage des mains.
Hydroalcoholic Gel. 30 ml. Huidreinigende oplossing.

 4 × 9.8 × 2.5 cm

 200 / 50

 Print Code: C(4)



02

Kibix

4235

Garment Bag. PEVA.
Kleidertasche. PEVA.
Porte-Costumes. PEVA.
Kledinghoes. PEVA.

60 × 100 cm 100 / 25

Print Code: F(1)



03



19

URBAN TRAVEL



02

01

Wizzel

5391

Shoehorn Polisher.
Schuhanzieher Putzer.
Chausse-Pied.
Shoentepel met Schoenpoets.

4.7 × 22 × 2.2 cm 200 / 50

Print Code: C(4)



Recco

4182

Shoe Bag. Non-Woven.
Schuhtasche. Non-Woven.
Sac Chaussures. T.N.T..
Schoenentas. Non-Woven.

42 × 20 × 14.5 cm 400 / 10

Print Code: F(1)



11



19



03



05

02



19

05

01

Blanax

4424



Weight

Luggage Scales. Max 40 Kg. Button Battery Included.
 Gepäckwaage. Max 40 Kg. Knopfzelle Inklusive.
 Pèse-Bagages. Max 40 Kg. Pile Bouton Inclus.
 Bagage Weegschaal. Max 40 Kg. Knoopcel Batterij Inclusief.

10 × 18 × 3.7 cm 150 / 50

Print Code: D(4)



03



2200 mAh



02



Hargol

5336



Power Bank



Weight



Multifunction

Power Bank Luggage Scales. 2200 mAh. USB Output. Micro USB Input. Max 50 Kg. USB Rechargeable. Cable Included.
 Power Bank Gepäckwaage. 2200 mAh. USB Ausgang. Micro USB Eingang. Max 50 Kg. USB Wiederaufladbar. Kabel Inklusive.
 Pèse-Bagages Power Bank. 2200 mAh. Sortie USB. Entrée Micro USB. Max 50 Kg. Rechargeable USB. Cable Inclus.
 Power Bank Bagage Weegschaal. 2200 mAh. USB Output. Micro USB Input. Max 50 Kg. USB Oplaadbaar. Kabel Inclusief.

14.3 × 22 × 3.2 cm 50

Print Code: E(4)



19

Ripley

5373

Luggage Strap. Polyester.
 Koffer Band. Polyester.
 Sangle Bagage. Polyester.
 Koffer Riem. Polyester.

180 × 5 cm 100 / 20

Print Code: F(1), N(8)



02



03



05



01



09

01

02

03

05

Zanex

4377

Padlock. Metal.
 Kofferschloss. Metall.
 Cadenas. Metal.
 Hangslot. Metaal.

2 × 6.5 × 0.8 cm 500 / 50

Print Code: D(4), L1



19



03

02

11

Rumax

7087



Combination
Lock

01

Trolley. ABS. Rigid. 4 Rotating Wheels. Combination Lock Included.
Trolley. ABS. Starre. 4 Drehende Räder. Sicherheitsverschluss Inklusiv.
Trolley. ABS. Rigide. 4 Roues Tourmantes. Fermeture Sécurité Inclus.
Trolley. ABS. Hard. 4 Draaiende Wielen. Veiligheidssluiting Inclusief.

36 × 55 × 23 cm 3

Print Code: K(1)

Alexluca

Italy



546

ANTONIO MIRO



Kafal

7247



Combination
Lock

Trolley. ABS. Rigid. 4 Rotating Wheels. Combination Lock Included.
Trolley. ABS. Starre. 4 Drehende Räder. Sicherheitsverschluss Inklusiv.
Trolley. ABS. Rigide. 4 Roues Tourmantes. Fermeture Sécurité Inclus.
Trolley. ABS. Hard. 4 Draaiende Wielen. Veiligheidssluiting Inclusief.

43 × 68 × 26 cm 1

Print Code: K(1)

Tugart

7123

Trolley. ABS. Rigid. 4 Rotating Wheels.
Trolley. ABS. Starre. 4 Drehende Räder.
Trolley. ABS. Rigide. 4 Roues Tourmantes.
Trolley. ABS. Hard. 4 Draaiende Wielen.

36 × 60 × 22 cm 1

Print Code: K(1)

ANTONIO MIRO





547

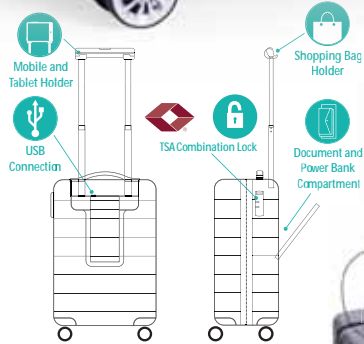

Silmour 6016

Trolley. ABS. USB Connection. Rigid. 8 Rotating Wheels. TSA Combination Lock Included.
 Trolley. ABS. USB Anschluss. Starre. 8 Drehende Räder. TSA Sicherheitsverschluss Inklusiv.
 Trolley. ABS. Connexion USB. Rigide. 8 Roues Tournantes. Fermeture Sécurité TSA Inclus.
 Trolley. ABS. USB Verbindung. Hard. 8 Draaiende Wielen. TSA Veiligheidsluiting Inclusief.

37.5 x 57 x 23 cm 1
 Print Code: K(1)



02



Hessok 6556

Trolley. PC. Rigid. 8 Rotating Wheels. TSA Combination Lock Included.
 Trolley. PC. Starre. 8 Drehende Räder. TSA Sicherheitsverschluss Inklusiv.
 Trolley. PC. Rigide. 8 Roues Tournantes. Fermeture Sécurité TSA Inclus.
 Trolley. PC. Hard. 8 Draaiende Wielen. TSA Veiligheidsluiting Inclusief.

34 x 54 x 23 cm 1
 Print Code: K(1)



Kleintor 6044

Trolley. ABS. Rigid. 8 Rotating Wheels. Padded Laptop Compartment. TSA Combination Lock Included.
 Trolley. ABS. Starre. 8 Drehende Räder. Gepolsterte Laptoptasche. TSA Sicherheitsverschluss Inklusiv.
 Trolley. ABS. Rigide. 8 Roues Tournantes. Pochette Rembourrée pour Portable. Fermeture Sécurité TSA Inclus.
 Trolley. ABS. Hard. 8 Draaiende Wielen. Gewatteerd Laptop Compartment. TSA Veiligheidsluiting Inclusief.

40 x 51 x 21.5 cm 1
 Print Code: K(1)





06

FOLDABLE



02

07

11

03



03

FOLDABLE



07



06



03

2in1
Multifunction

19



02

Nevis

4373

Trolley Bag. Polyester 600D.
Trolley Tasche. Polyester 600D.
Sac Trolley. Polyester 600D.
Trolley Tas. Polyester 600D.

📏 26 × 51 × 26 cm 📦 10

🌈 Print Code: G(1), N(8)



05

11

19

02



03

Dunant

4733

Foldable Trolley. Polyester 300D.
Faltbarer Trolley. Polyester 300D.
Trolley Pliable. Polyester 300D.
Opvouwbare Trolley. Polyester 300D.

📏 35 × 50 × 20 cm 📦 6

🌈 Print Code: K(8)



Soch

9924

Foldable Trolley. Polyester 600D.
Faltbarer Trolley. Polyester 600D.
Trolley Pliable. Polyester 600D.
Opvouwbare Trolley. Polyester 600D.

📏 35.5 × 50 × 19 cm 📦 8

🌈 Print Code: K(8)

Bertox

4737

Trolley Bag. Polyester 600D.
Trolley Tasche. Polyester 600D.
Sac Trolley. Polyester 600D.
Trolley Tas. Polyester 600D.

📏 27 × 55 × 27 cm 📦 6

🌈 Print Code: G(1), N(8)

2in1
Multifunction

URBAN Trolley Backpack

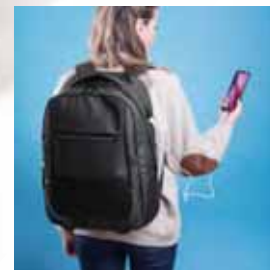

Tablet
Compartment



Laptop
Compartment

549



06



Multifunction



Laptop
Compartment



BACKPACK /
MOCHILA

02



Multifunction



USB
Connection

BACKPACK /
MOCHILA



02

Kuman
3488

Trolley Backpack. Polyester 1680D. Padded Laptop Compartment. Padded Shoulder Straps.
Trolley Rucksack. Polyester 1680D. Gepolsterte Laptoptasche. Gepolsterte Schultergurte.
Sac à Dos Trolley. Polyester 1680D. Pochette Rembourrée pour Portable. Bretelles Rembourrées.
Trolley Ruzgak. Polyester 1680D. Gewatteerd Laptop Compartment. Gewatteerde Schouderbanden.

36 × 47 × 25 cm 4

Print Code: K(8)



Haltrix
6047

Trolley Backpack. Polyester 300D. USB Connection. Padded Laptop Compartment. Padded Shoulder Straps.
Trolley Rucksack. Polyester 300D. USB Anschluss. Gepolsterte Laptoptasche. Gepolsterte Schultergurte.
Sac à Dos Trolley. Polyester 300D. Connexion USB. Pochette Rembourrée pour Portable. Bretelles Rembourrées.
Trolley Ruzgak. Polyester 300D. USB Verbinding. Gewatteerd Laptop. Gewatteerde Schouderbanden.

33 × 47 × 22.5 cm 8

Print Code: I(8)



Lutux

6493

Bag. Polyester 600D.
Tasche. Polyester 600D.
Sac. Polyester 600D.
Tas. Polyester 600D.

45 × 22 × 21 cm 30

Print Code: G(1), N(8)



URBAN
LIFESTYLE



550



Donatox

6043

Bag. Polyester 600D. USB Connection. Shoe Compartment.
Tasche. Polyester 600D. USB Anschluss. Schuh Staufach.
Sac. Polyester 600D. Connexion USB. Compartiment Porte-Chaussures.
Tas. Polyester 600D. USB Verbindung. Schoen Compartment.

50 × 30 × 28.5 cm 25

Print Code: G(1), N(8), P

SHOE
COMPARTMENT



POWER BANK NOT INCLUDED
POWER BANK NO INCLUIDO



Kanit

6426

Bag. Polyester 600D. RFID Protected. Shoe Compartment.
Tasche. Polyester 600D. RFID Schutz. Schuh Staufach.
Sac. Polyester 600D. Protecteur RFID. Compartiment Porte-Chaussures.
Tas. Polyester 600D. RFID Bescherming. Schoen Compartment.

50 × 38 × 24 cm 20

Print Code: G(1), N(8)



SHOE
COMPARTMENT





NEW



RPET

Holtrum

6841

Bag. Polyester 600D RPET.
Tasche. Polyester 600D RPET.
Sac. Polyester 600D RPET.
Tas. Polyester 600D RPET.

||||||| 48.5 × 28 × 27.5 cm

Print Code: G(1), N(8)

30

RPET



Drako

3632

03

Bag. Polyester 600D.
Tasche. Polyester 600D.
Sac. Polyester 600D.
Tas. Polyester 600D.

||||||| 52 × 27 × 25 cm

Print Code: G(1), N(8)



02

19

04

07



NEW

02

Melbor

6815

Bag. Polyester 600D.
Tasche. Polyester 600D.
Sac. Polyester 600D.
Tas. Polyester 600D.

||||||| 65 × 34 × 33 cm

Print Code: G(1), N(8)

10



06

16

03

19

551



19

03



02

SHOE
COMPARTMENT

Divux 6494

Backpack Bag. Nylon 420D. Padded Back and Shoulder Straps. Shoe Compartment.
Rucksack Tasche. Nylon 420D. Gepolsterter Rücken und Schultergurte. Schuh Staufach.
Sac à Dos. Nylon 420D. Dos et Bretelles Rembourrées. Compartiment Porte-Chaussures.
Rugzak. Nylon 420D. Gewatteerde Achterzijde en Schouderbanden. Schoen Compartiment.

47 × 25 × 24 cm  20 Print Code: G(1), N(8)

02

SHOE
COMPARTMENT

Sendur 4054

Bag. Polyester 600D. Shoe Compartment.
Tasche. Polyester 600D. Schuh Staufach.
Sac. Polyester 600D. Compartiment Porte-Chaussures.
Tas. Polyester 600D. Schoen Compartiment.

50 × 38 × 17.5 cm  20 Print Code: G(1), N(8)

03

19

552



19



06

04

07

Novo 9146

Bag. Polyester 600D.
Tasche. Polyester 600D.
Sac. Polyester 600D.
Tas. Polyester 600D.

42 × 24 × 20 cm  50 Print Code: G(1), N(8)

11

02

03



06



08



02

03

19

Tarok 6342

Bag. Polyester 600D.
Tasche. Polyester 600D.
Sac. Polyester 600D.
Tas. Polyester 600D.

42 × 34 × 16 cm  40 Print Code: G(1), N(8)Trolley
Strap



ANTI-THEFT
POSITION



NEW

Parks

6840

Waistbag. Polyester 600D RPET.
Gürteltasche. Polyester 600D RPET.
Banane. Polyester 600D RPET.
Heuptas. Polyester 600D RPET.



25 x 17 x 8 cm

200 / 50

Print Code: E(1), N(8)



02

553



03

Zunder

6219

Waistbag. Polyester 600D.
Gürteltasche. Polyester 600D.
Banane. Polyester 600D.
Heuptas. Polyester 600D.

25 x 17 x 8 cm

200 / 50

Print Code: E(1), N(8)



07



06



16



19



Tablet
Compartment



USB
Connection



Versox

6218

Shoulder Bag. Polyester 300D. USB Connection. Padded.
Umhängetasche. Polyester 300D. USB Anschluss. Gepolstert.
Bandoulière. Polyester 300D. Connexion USB. Rembourrée.
Schoudertas. Polyester 300D. USB Verbinding. Gewatteerd.

20 x 29 x 6.5 cm

50

Print Code: F(1), N(8)



POUCH WITH
RFID PROTECTION SYSTEM
IDEAL FOR MOBILE DEVICES
FUNDA CON SISTEMA PROTECCIÓN RFID
IDEAL PARA DISPOSITIVOS MÓVILES



RFID
Protection



Hismal

6007

Protector Pouch. Polyester. RFID Protected.
Sicherheit Hülle. Polyester. RFID Schutz.
Étui Sécurité. Polyester. Protecteur RFID.
Veiligheid Hoes. Polyester. RFID Bescherming.

12.5 x 19 cm

500 / 100

Print Code: E(1), N(8)



03



19



01



02

eco-friendly
BAGS



EN A universe with infinite combinations of shapes and sizes. Sustainable and natural materials - organic cotton, recycled, RPET, jute, cork, paper... - blend with the more traditional ones - pp-woven, non-woven, fabric... - shaping a collection of bags with the **3XR** as motto: **Reusing, Reduction** of emissions and **Recycling** of materials.

DE Ein Universum mit unendlichen Kombinationen von Formen und Größen. Nachhaltige und natürliche Materialien - Bio-Baumwolle, Recycling, RPET, Jute, Kork, Papier... - vermischen sich mit den traditionelleren - Grafik, Vlies, Stoff... - und formen eine Taschenkollektion mit den Slogans: **Wiederverwendung, Reduktion** von Emissionen und **Recycling** von Materialien.

FR Un univers aux multiples combinaisons de formes et de tailles. Des matériaux durables et naturels tels que le coton biologique ou recyclé, le RPET, la jute, le liège ou encore le papier... combinés à des matériaux plus traditionnels tels que le raphia, le non tissé, le tissu... Une collection de sacs avec le **3XR** comme fer de lance : **Réutilisation, Réduction** des émissions et **Recyclage** des matériaux.

NL Een universum met oneindige combinaties van vormen en maten. Duurzame en natuurlijke materialen - organisch katoen, gerecycled, RPET, jute, kurk, papier... - mengen zich met de meer traditionele - pp-geweven, non-woven, stof... - het vormgeven van een collectie tassen met de mottos: **Hergebruik, Vermindering** van de uitstoot en **Recycleren** van materialen.



BAGS

Objective.
zero
waste

RPET



The fabric used in the manufacturing process of these bags is made of recycled plastic (RPET). Like this, the emission of plastic residues to our planet and the consumption of energy is drastically reduced, resulting in a much more eco-friendly process.

El material de estas bolsas está fabricado con plástico reciclado (RPET), que, además de ayudar en la disminución de residuos plásticos en el planeta, utiliza menos energía en el proceso de fabricación, haciendo que sea mucho menos dañino para el medio ambiente.

STOP PLASTIC
POLLUTING
THE OCEAN

NEW

MEVAQIN
typography



Topin
PG. 566

3 PIECES 25 X 30 CM



NEW

ORGANIC COTTON



Casim
6835

Bag. 100% Organic Cotton 140 g/ m2.
Tasche. 100% Organische Baumwolle 140 g/ m2.
Sac. 100% Coton Organique 140 g/ m2.
Tas. 100% Organisch Katoen 140 g/ m2.

140 g/m²

||||||| 38 × 42 × 8 cm

📦 150 / 50

🌈 Print Code: F(6), N(8), O, P

557



ANTIBACTERIAL

Antibacterial material specially processed to inhibit and prevent bacterial growth, due to the incorporation of permanent static microbial agents, which are highly effective in the control against bacterial contamination.

Material antibacteriano, especialmente procesado para inhibir y prevenir las cargas bacterianas, gracias a la incorporación de agentes microbianos permanentes estáticos, con alta efectividad contra la contaminación bacteriana.



01

NEW



Antibacterial



02

03

19

Kiarax
6767

Antibacterial Bag. Laminated Non-Woven.
Antibakteriell Tasche. Laminiertes Non-Woven.
Sac Antibactérien. T.N.T. Laminé.
Antibacterieel Tas. Gelamineerd Non-Woven.

||||||| 38 × 40 × 12 cm

📦 200 / 10

🌈 Print Code: F(1)



RPET

Kaiso

6341

Bag, Laminated Polyester RPET.
Tasche, Laminiertes Polyester RPET.
Sac, Polyester RPET Lamine.
Tas, Gelamineerd Polyester RPET.

42 × 35 × 15 cm

200 / 10

Print Code: F(1)



01

19

04

03

Objective: ZERO WASTE

RPET



The fabric used in the manufacturing process of these bags is made of recycled plastic (RPET). Like this, the emission of plastic residues to our planet and the consumption of energy is drastically reduced, resulting in a much more eco-friendly process.

El material de estas bolsas está fabricado con plástico reciclado (RPET), que, además de ayudar en la disminución de residuos plásticos en el planeta, utiliza menos energía en el proceso de fabricación, haciendo que sea mucho menos dañino para el medio ambiente.

STOP PLASTIC POLLUTING THE OCEAN



03



RPET

Restun

6422

Foldable Bag, Polyester RPET.
Fallbare Tasche, Polyester RPET.
Sac Pliable, Polyester RPET.
Opvouwbare Tas, Polyester RPET.

45 × 38.5 cm

400 / 20

Print Code: F(1), G(1), R

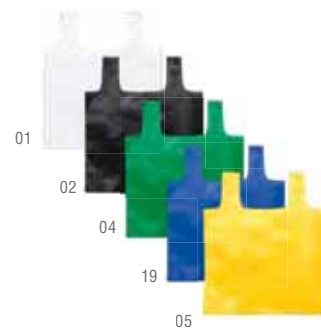

01

02

04

19

05

RPET



The fabric used in the manufacturing process of these bags is made of recycled plastic (RPET). Like this, the emission of plastic residues to our planet and the consumption of energy is drastically reduced, resulting in a much more eco-friendly process.

El material de estas bolsas está fabricado con plástico reciclado (RPET), que, además de ayudar en la disminución de residuos plásticos en el planeta, utiliza menos energía en el proceso de fabricación, haciendo que sea mucho menos dañino para el medio ambiente.

STOP PLASTIC POLLUTING THE OCEAN



Helena

9848

Bag. Laminated Polyester RPET.
Tasche. Laminiertes Polyester RPET.
Sac. Polyester RPET Laminé.
Tas. Gelamineerd Polyester RPET.

37.5 × 40.5 cm 100 / 10

Print Code: F(1)



04



RPET



Kelmar

6197

Bag. Polyester RPET.
Tasche. Polyester RPET.
Sac. Polyester RPET.
Tas. Polyester RPET.

38 × 42 cm

Print Code: F(1), R



01

200 / 10 04

03

02



Frilend

6340

Bag. Laminated Polyester RPET.
Tasche. Laminiertes Polyester RPET.
Sac. Polyester RPET Laminé.
Tas. Gelamineerd Polyester RPET.

37 × 41 cm

Print Code: F(1)

250 / 10

Print Code: F(1)



19



RPET

140 g/m²



Organic Cotton

NEW



Casim

6835

Bag. 100% Organic Cotton 140 g/ m2.
Tasche. 100% Organische Baumwolle 140 g/ m2.
Sac. 100% Coton Organique 140 g/ m2.
Tas. 100% Organisch Katoen 140 g/ m2.

38 x 42 x 8 cm

150 / 50

Print Code: F(6), N(8), O, P

560

100% ORGANIC COTTON



Organic Cotton

120 g/m²

Nepax

6391

Foldable Bag. 100% Organic Cotton 120 g/ m2.
Fallbare Tasche. 100% Organische Baumwolle 120 g/ m2.
Sac Pliable. 100% Coton Organique 120 g/ m2.
Opvouwbare Tas. 100% Organisch Katoen 120 g/ m2.

38 x 42 cm

200 / 10

Print Code: F(6), G(6), N(8)



FOLDABLE PLEGABLE

120 g/m²



Organic Cotton

Missam

6389

Bag. 100% Organic Cotton 120 g/ m2.
Tasche. 100% Organische Baumwolle 120 g/ m2.
Sac. 100% Coton Organique 120 g/ m2.
Tas. 100% Organisch Katoen 120 g/ m2.

38 x 42 cm

250 / 50

Print Code: F(4), N(8), O, P

100% RECYCLED
COTTON



Graket 6393



Bag. 100% Recycled Cotton 120 g/ m².
Tasche. 100% Recycling Baumwolle 120 g/ m².
Sac. 100% Coton Recyclé 120 g/ m².
Tas. 100% Gerecycled Katoen 120 g/ m².

38 × 42 cm 250 / 50
Print Code: F(6), N(8), O, P

120 g/m²



02

561



NEW

ULTREX



03



140 g/m²

Fenin 6833

Drawstring Bag. 100% Recycled Cotton 140 g/ m².
Rucksack. 100% Recycling Baumwolle 140 g/ m².
Sac à Dos. 100% Coton Recyclé 140 g/ m².
Rugzak. 100% Gerecycled Katoen 140 g/ m².

38 × 42 cm 100 / 50
Print Code: F(6), N(8), O, P



04

ANTI-BACTERIAL



Antibacterial material specially processed to inhibit and prevent bacterial growth, due to the incorporation of permanent static microbial agents, which are highly effective in the control against bacterial contamination.

Material antibacteriano, especialmente procesado para inhibir y prevenir las cargas bacterianas, gracias a la incorporación de agentes microbianos permanentes estáticos, con alta efectividad contra la contaminación bacteriana.

Day-to-day PROTECTION

ANTIBACTERIAL FABRIC



ANTIBACTERIAL AND WATER RESISTANT FABRIC
TEJIDO ANTIBACTERIANO E HIDRÓFUGO



NEW



Maxcron
2607

Antibacterial Bag. Polyester.
Antibakteriell Tasche. Polyester.
Sac Antibactérien. Polyester.
Antibacterieel Tas. Polyester.

37 × 41 cm

300 / 10

Print Code: F(1), N(8), R

562



Antibacterial

NEW

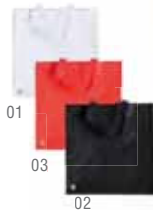

Kiarax
6767

Antibacterial Bag. Laminated Non-Woven.
Antibakteriell Tasche. Laminiertes Non-Woven.
Sac Antibactérien. T.N.T. Laminé.
Antibacterieel Tas. Gelamineerd Non-Woven.

38 × 40 × 12 cm

200 / 10

Print Code: F(1)



Recycle
9771

Bag. Biodegradable.
Tasche. Kompostierbare.
Sac. Biodegradable.
Tas. Biologisch Afbreekbaar.

38 × 38 × 12.5 cm 100 / 20

Print Code: F(1)

04



#eco-friendly
BAGS

Bamtox

6158

Bag. Bamboo Fibre 105 g/ m2.
Tasche. Bambusfaser 105 g/ m2.
Sac. Fibre Bambou 105 g/ m2.
Tas. Bamboe Fibre 105 g/ m2.

37 x 41 cm

200 / 50

Print Code: F(1)



COTTON TOUCH
TACTO ALGODÓN



Biosafe

3112

Bag. Natural Fibre.
Tasche. Naturfaser.
Sac. Fibre Naturelle.
Tas. Natural Fibre.

NATURAL FIBRE
FIBRA NATURAL

35.5 x 39 cm 250 / 50

Print Code: F(1)



Naisa

6428

Bag. Tyvek® Material.
Tasche. Tyvek® Material.
Sac. Tyvek® Material.
Tas. Tyvek® Material.

Tyvek®
RECYCLE 100%
LONG LIFE
REUSABLE

38 x 42 cm 200 / 20

Print Code: F(1)

Moltux

6438

Bag. PLA 100% Compostable.
Tasche. PLA 100% Kompostierbar.
Sac. PLA 100% Compostable.
Tas. PLA 100% Composteerbaar.

36 x 40 cm 200 / 50

Print Code: F(1)



PLA

100% COMPOSTABLE





NEW

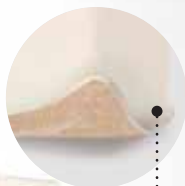

COTTON - JUTE
ALGODÓN - YUTE



FOLDABLE
PLEGABLE

Dylan

6727

110 g/m²

Foldable Bag. 100% Cotton 110 g/ m²/ Jute.
Faltbare Tasche. 100% Baumwolle 110 g/ m²/ Jutestoff.
Sac Pliable. 100% Coton 110 g/ m²/ Jute.
Opvouwbare Tas. 100% Katoen 110 g/ m²/ Jutestoff.

34.5 × 39 × 10 cm 100 / 10

Print Code: G(6), N(8), H(6)



120 g/m²

Lerkal

5983

Bag. 100% Cotton 120 g/ m²/ Jute.
Tasche. 100% Baumwolle 120 g/ m²/ Jutestoff.
Sac. 100% Coton 120 g/ m²/ Jute.
Tas. 100% Katoen 120 g/ m²/ Jutestoff.

37 × 41 cm 200 / 10

Print Code: F(6), N(8), O, P

COTTON - JUTE
ALGODÓN - YUTE



13

Dhar

3047

Bag. Jute/ Cotton.
Tasche. Jutestoff/ Baumwolle.
Sac. Jute/ Coton.
Tas. Jute/ Katoen.

38 × 42 cm 100 / 20

Print Code: F(1)



04

NATURAL JUTE

i Natural jute stands out among sustainable materials because the manufacturing processes have a low impact on the environment, together with its rapid regeneration. The natural aspect, together with its resistance and durability, makes it a sustainable material reference.

El yute natural ocupa un lugar destacado entre los materiales sostenibles, debido a que los procesos empleados para su fabricación suponen un bajo impacto para el medio ambiente, junto a su rápida regeneración. El aspecto natural, unido a su resistencia y durabilidad, lo convierten en un material sostenible de referencia.

100% COTTON & JUTE
NATURAL JUTE



100% COTTON &
CORK

NEW

FOLDABLE
PLEGABLE

COTTON - CORK
ALGODÓN - CORCHO

110 g/m²

Charel

6726

Foldable Bag. 100% Cotton 110 g/ m2/ Natural Cork.
Faltbare Tasche. 100% Baumwolle 110 g/ m2/ Naturkork.
Sac Pliable. 100% Coton 110 g/ m2/ Bouchon Naturel.
Opvouwbare Tas. 100% Katoen 110 g/ m2/ Natuurlijk Kurk.

34,5 × 39 × 10 cm 100 / 10
Print Code: G(6), N(8), H(6)

565

NEW

Yulia

6829

180 g/m²

Bag. 100% Cotton 180 g/ m2/ Natural Cork.
Tasche. 100% Baumwolle 180 g/ m2/ Naturkork.
Sac. 100% Coton 180 g/ m2/ Bouchon Naturel.
Tas. 100% Katoen 180 g/ m2/ Natuurlijk Kurk.

37 × 41 cm 100 / 10
Print Code: F(6), N(8), P

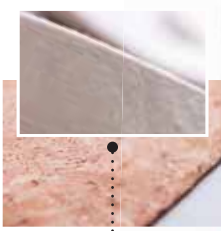

COTTON - CORK
ALGODÓN - CORCHO



SEGMENTS
concept design

NEW

Tarlam

5831

145 g/m²

Bag. 100% Cotton 145 g/ m2/ Natural Cork.
Tasche. 100% Baumwolle 145 g/ m2/ Naturkork.
Sac. 100% Coton 145 g/ m2/ Bouchon Naturel.
Tas. 100% Katoen 145 g/ m2/ Natuurlijk Kurk.

35 × 40 cm 100 / 10
Print Code: F(6), N(8), P

Tuarey

6830

180 g/m²

Bag. 100% Cotton 180 g/ m2/ Natural Cork.
Tasche. 100% Baumwolle 180 g/ m2/ Naturkork.
Sac. 100% Coton 180 g/ m2/ Bouchon Naturel.
Tas. 100% Katoen 180 g/ m2/ Natuurlijk Kurk.

45 × 40 × 9 cm 100 / 10
Print Code: F(6), N(8), O, P

NEW



3 PIECES 25 X 30 CM



Topin

6852

Bag Set. Polyester RPET. 3 Pieces.
 Taschen Set. Polyester RPET. 3 Stück.
 Set Sacs. Polyester RPET. 3 Pièces.
 Tas Set. Polyester RPET. 3 Stuks.

25 x 30 cm

250 / 50

Print Code: F(1), R



eco-friendly
BAGS



566



Kortal

6570

Bag Set. Polyester. 2 Pieces.
 Taschen Set. Polyester. 2 Stück.
 Set Sacs. Polyester. 2 Pièces.
 Tas Set. Polyester. 2 Stuks.

Consult. 400 / 100

Print Code: D(1)

2 PIECES
 1 : 25X30 CM
 1 : 30X35 CM

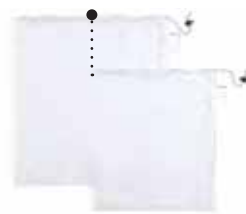

BACK SIDE

ONE FLAT SIDE FOR
 PRINTING
 UNA CARA LISA
 PARA IMPRESIÓN

FRONT SIDE

Tolmen

6625

Bag. 100% Cotton 120 g/m².
 Tasche. 100% Baumwolle 120 g/m².
 Sac. 100% Coton 120 g/m².
 Tas. 100% Katoen 120 g/m².

25 x 30 cm 250 / 50

Print Code: F(6), N(8)

120 g/m²



170 g/m²

NEW



Martha

6834

Bag. 100% Cotton 170 g/ m2.
Tasche. 100% Baumwolle 170 g/ m2.
Sac. 100% Coton 170 g/ m2.
Tas. 100% Katoen 170 g/ m2.

39 × 41 × 8 cm

150 / 50

Print Code: F(6), N(8), P



#eco-friendly
BAGS
100% COTTON

220 g/m²

Trobax

6572

Bag. 100% Cotton 220 g/ m2.
Tasche. 100% Baumwolle 220 g/ m2.
Sac. 100% Coton 220 g/ m2.
Tas. 100% Katoen 220 g/ m2.

41 × 45 cm

100 / 10

Print Code: F(6), N(8)



Nacry

6577

Foldable Bag. 100% Cotton.
Faltbare Tasche. 100% Baumwolle.
Sac Pliable. 100% Coton.
Opvouwbare Tas. 100% Katoen.

44 × 33 cm

200 / 10

Print Code: F(6), N(8)



FOLDABLE
100% COTTON



567



NEW

PAPER - COTTON

Curiel 6821

105 g/m²

Bag. Laminated Paper 105 g/ m2/ Cotton.
Tasche. Laminiertes Papier 105 g/ m2/ Baumwolle.
Sac. Papier Laminé 105 g/ m2/ Coton.
Tas. Gelamineerd Paper 105 g/ m2/ Katoen.

37 × 41 cm

100 / 10

Print Code: F(1)

#eco-friendly
PAPER BAGS



568



NEW

105 g/m²

PAPER - COTTON

Palzim 6822

Bag. Laminated Paper 105 g/ m2/ Cotton.
Tasche. Laminiertes Papier 105 g/ m2/ Baumwolle.
Sac. Papier Laminé 105 g/ m2/ Coton.
Tas. Gelamineerd Paper 105 g/ m2/ Katoen.

48 × 35 × 15 cm

100 / 10

Print Code: F(1)

PAPER



Kolsar 6175

140 g/m²

Bag. Paper 140 g/ m2.
Tasche. Papier 140 g/ m2.
Sac. Papier 140 g/ m2.
Tas. Paper 140 g/ m2.

40 × 30.5 × 15.5 cm

200 / 10

Print Code: F(1)

100% COTTON



105 g/m²

Larsen

3322

Bag. 100% Cotton 105 g/ m2.
Tasche. 100% Baumwolle 105 g/ m2.
Sac. 100% Coton 105 g/ m2.
Tas. 100% Katoen 105 g/ m2.

37 × 41 cm 250 / 50
Print Code: F(6), N(8), O, P



Siltex

6048

140 g/m²

Bag. 100% Cotton 140 g/ m2.
Tasche. 100% Baumwolle 140 g/ m2.
Sac. 100% Coton 140 g/ m2.
Tas. 100% Katoen 140 g/ m2.

37 × 41 cm 250 / 50
Print Code: F(6), N(8), O, P



569

FOLDABLE
PLEGABLE

Helakel

6118

105 g/m²

Foldable Bag. 100% Cotton 105 g/ m2.
Faltbare Tasche. 100% Baumwolle 105 g/ m2.
Sac Pliable. 100% Coton 105 g/ m2.
Opvouwbare Tas. 100% Katoen 105 g/ m2.

37 × 41 cm 200 / 10
Print Code: F(6), G(6), N(8), P



Ponkal

6049

180 g/m²

Bag. 100% Cotton 180 g/ m2.
Tasche. 100% Baumwolle 180 g/ m2.
Sac. 100% Coton 180 g/ m2.
Tas. 100% Katoen 180 g/ m2.

37 × 41 cm 150 / 50
Print Code: F(6), N(8), O, P





Daytona 3321

Bag. 100% Cotton 105 g/ m2.
Tasche. 100% Baumwolle 105 g/ m2.
Sac. 100% Coton 105 g/ m2.
Tas. 100% Katoen 105 g/ m2.

37 × 41 cm 250 / 50
Print Code: F(6), N(8), O, P

105 g/m²



REUS
100% COTTON

570

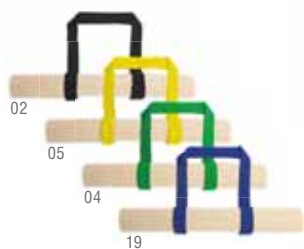

Fuzox 4621

105 g/m²

Bag. 100% Cotton 105 g/ m2.
Tasche. 100% Baumwolle 105 g/ m2.
Sac. 100% Coton 105 g/ m2.
Tas. 100% Katoen 105 g/ m2.

37 × 41 cm 250 / 50
Print Code: F(6), N(8), O, P



220 g/m²



Daypok 6621

Bag. 100% Cotton 220 g/ m2/ PU.
Tasche. 100% Baumwolle 220 g/ m2/ PU.
Sac. 100% Coton 220 g/ m2/ Similicuir.
Tas. 100% Katoen 220 g/ m2/ PU.

37 × 41 cm 100 / 10
Print Code: F(6), N(8), O, P

100% COTTON

DAOS

NEW

140 g/m²

Helfy

6836

Bag. 100% Cotton 140 g/m².
Tasche. 100% Baumwolle 140 g/m².
Sac. 100% Coton 140 g/m².
Tas. 100% Katoen 140 g/m².

45 × 38 × 11 cm

100 / 10

Print Code: F(6), N(8), O, P



105 g/m²

Lakous

5451

Bag. 100% Cotton 105 g/m².
Tasche. 100% Baumwolle 105 g/m².
Sac. 100% Coton 105 g/m².
Tas. 100% Katoen 105 g/m².

37 × 41 × 8 cm

200 / 50

Print Code: F(6), N(8), O, P



140 g/m²

Aloe

9844

Bag. 100% Organic Cotton 145 g/m².
Tasche. 100% Organische Baumwolle 145 g/m².
Sac. 100% Coton Organique 145 g/m².
Tas. 100% Organisch Katoen 145 g/m².

40 × 40 × 10 cm

200 / 10

Print Code: F(6), N(8), O, P



Organic
Cotton



105 g/m²

Welrop

5738

Bag. 100% Cotton 105 g/m².
Tasche. 100% Baumwolle 105 g/m².
Sac. 100% Coton 105 g/m².
Tas. 100% Katoen 105 g/m².

41.5 × 37 × 7 cm

200 / 10

Print Code: F(6), N(8), O, P

571

NEW



NEW



Lesky

6823

Bag. Jute.
Tasche. Jutestoff.
Sac. Jute.
Tas. Jute.

16 x 20 cm

Print Code: F(1)

300 / 50

Vagan

6824

Bag. Jute.
Tasche. Jutestoff.
Sac. Jute.
Tas. Jute.

25 x 30 cm

Print Code: F(1)

200 / 50



572

25 x 30 cm
105 g/m²

Jardix

Jardix

6623

Bag. 100% Cotton 105 g/m².
Tasche. 100% Baumwolle 105 g/m².
Sac. 100% Coton 105 g/m².
Tas. 100% Katoen 105 g/m².

25 x 30 cm

Print Code: F(6), N(8), O, P

500 / 50



oxygea
alphabet

Fergut

6622

Bag. 100% Cotton 105 g/m².
Tasche. 100% Baumwolle 105 g/m².
Sac. 100% Coton 105 g/m².
Tas. 100% Katoen 105 g/m².

15 x 21 cm

Print Code: F(6), N(8), O, P

500 / 50



15 x 21 cm
105 g/m²

Fergut

ORINOCO

SARGASSO

12 x 33 cm
105 g/m²

Marcex

6624

Bottle Bag. 100% Cotton 105 g/m².
Trinkflasche tasche. 100% Baumwolle 105 g/m².
Sac. Bouteille. 100% Coton 105 g/m².
Fles Tas. 100% Katoen 105 g/m².

12 x 33 cm

Print Code: F(6), N(8), O, P

500 / 50



NEW COLOR



06 11 21 22



17 07 08

Turkal

140 g/m²

6050
 Bag. 100% Cotton 140 g/ m2.
 Tasche. 100% Baumwolle 140 g/ m2.
 Sac. 100% Coton 140 g/ m2.
 Tas. 100% Katoen 140 g/ m2.

36 x 40 cm 250 / 50
 Print Code: F(6), N(8), O, P



16



19 05 03 01 02 04



573



03

105 g/m²



19 02 01

Coina

5452

Bag. 100% Cotton 105 g/ m2.
 Tasche. 100% Baumwolle 105 g/ m2.
 Sac. 100% Coton 105 g/ m2.
 Tas. 100% Katoen 105 g/ m2.

36 x 40 x 8 cm 200 / 50
 Print Code: F(4), N(8), M, O, P



05 07 03 11 01 02 19

Geiser

3210

105 g/m²

Bag. 100% Cotton 105 g/ m2.
 Tasche. 100% Baumwolle 105 g/ m2.
 Sac. 100% Coton 105 g/ m2.
 Tas. 100% Katoen 105 g/ m2.

36 x 40 cm 250 / 50
 Print Code: F(4), N(8), M, O, P



04



03

Dayfan

6122

Foldable Bag. Polyester 190T.
 Falltbare Tasche. Polyester 190T.
 Sac Pliable. Polyester 190T.
 Opvouwbare Tas. Polyester 190T.

40 × 38 cm 400 / 20

Print Code: F(1), G(1), R



FOLDABLE BAGS



574



Karent

6123

Foldable Bag. Polyester 190T.
 Falltbare Tasche. Polyester 190T.
 Sac Pliable. Polyester 190T.
 Opvouwbare Tas. Polyester 190T.

46 × 33 × 8 cm 400 / 20

Print Code: F(1), G(1), R



04



A



B

D

C



Sukrem

5424

Foldable Bag. Polyester 190T.
 Falltbare Tasche. Polyester 190T.
 Sac Pliable. Polyester 190T.
 Opvouwbare Tas. Polyester 190T.

40 × 38 cm 400 / 10

Print Code: F(1), G(1)



LOGOS
BAGS



Corni 3365
 Foldable Bag. Polyester 190T.
 Faltbare Tasche. Polyester 190T.
 Sac Pliable. Polyester 190T.
 Opvouwbare Tas. Polyester 190T.
 40 x 38 cm 400 / 10
 Print Code: F(1), G(1)

575



SANDÍA



LIMÓN

Velia 3976
 Foldable Bag. Polyester 170T.
 Faltbare Tasche. Polyester 170T.
 Sac Pliable. Polyester 170T.
 Opvouwbare Tas. Polyester 170T.
 40 x 42 cm 400 / 10
 Print Code: F(1), G(1)



Rous 3380
 Foldable Bag. Polyester 190T.
 Faltbare Tasche. Polyester 190T.
 Sac Pliable. Polyester 190T.
 Opvouwbare Tas. Polyester 190T.
 40 x 42 cm 400 / 10
 Print Code: F(1), G(1)



19



02 03 05 16 11

Blastar

5448

Foldable Bag. Non-Woven.
 Faltbare Tasche. Non-Woven.
 Sac Pliable. T.N.T.
 Opvouwbare Tas. Non-Woven.

36 × 40 × 8 cm 200 / 10
 Print Code: F(1), G(1)

576

Foldable BAGS



01



02



07



03



19



04



03



19



01



02



Austen

3246

Foldable Bag. Non-Woven.
 Faltbare Tasche. Non-Woven.
 Sac Pliable. T.N.T.
 Opvouwbare Tas. Non-Woven.

45 × 33 × 12 cm 200 / 10
 Print Code: F(1), G(1), H(1)



Conel

4781

Foldable Bag. Polyester 190T.
 Faltbare Tasche. Polyester 190T.
 Sac Pliable. Polyester 190T.
 Opvouwbare Tas. Polyester 190T.

38 x 41 cm 400 / 20
 Print Code: F(1), G(1), R



577



Persey

4468

Foldable Bag. Polyester 190T.
 Faltbare Tasche. Polyester 190T.
 Sac Pliable. Polyester 190T.
 Opvouwbare Tas. Polyester 190T.

42.5 x 38 x 7 cm 400 / 20
 Print Code: E(1), G(1), H(1), R



01



FLUORESCENT



11F

04F

05F

Altair

4467

Foldable Bag. Polyester 190T.
 Faltbare Tasche. Polyester 190T.
 Sac Pliable. Polyester 190T.
 Opvouwbare Tas. Polyester 190T.

42.5 x 38 x 7 cm 400 / 20
 Print Code: E(1), G(1), H(1), R



03

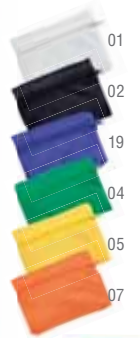

Kima

3184

Foldable Bag. Polyester 190T.
 Faltbare Tasche. Polyester 190T.
 Sac Pliable. Polyester 190T.
 Opvouwbare Tas. Polyester 190T.

40 x 37 x 6 cm 400 / 10
 Print Code: F(1), G(1), H(1)





Kinam

6436

Bag. Non-Woven.
Tasche. Non-Woven.
Sac. T.N.T.
Tas. Non-Woven.

25 × 31 × 11 cm 200 / 25

Print Code: F(1)



Nazzer

6434

Bag. Non-Woven.
Tasche. Non-Woven.
Sac. T.N.T.
Tas. Non-Woven.

36 × 40 cm 250 / 25

Print Code: F(1)



Fesor

6437

Foldable Bag. Non-Woven.
Faltbare Tasche. Non-Woven.
Sac. Pliable. T.N.T.
Opvouwbare Tas. Non-Woven.

38 × 42 cm

Print Code: F(1), G(1)

200 / 50



FOLDABLE

Bayson

6435

Bag. Non-Woven.
Tasche. Non-Woven.
Sac. T.N.T.
Tas. Non-Woven.

40 × 32 × 11 cm 200 / 50

Print Code: F(1)

NON-WOVEN
BAGS





Cention

5483

Bag. Paper 100 g/ m².
Tasche. Papier 100 g/ m².
Sac. Papier 100 g/ m².
Tas. Paper 100 g/ m².

22 x 23 x 9 cm 200
Print Code: F(1)

Cention
22 x 23 cm

Loiles
25 x 31 cm

Nauska
32 x 40 cm

Loiles

5484

Bag. Paper 100 g/ m².
Tasche. Papier 100 g/ m².
Sac. Papier 100 g/ m².
Tas. Paper 100 g/ m².

25 x 31 x 11 cm 200
Print Code: F(1)



Take Away
30 x 29 cm

Nauska

5485

Bag. Paper 100 g/ m².
Tasche. Papier 100 g/ m².
Sac. Papier 100 g/ m².
Tas. Paper 100 g/ m².

32 x 40 x 12 cm 200
Print Code: F(1)

Take Away

5482

Bag. Paper 80 g/ m².
Tasche. Papier 80 g/ m².
Sac. Papier 80 g/ m².
Tas. Paper 80 g/ m².

30 x 29 x 18 cm 200
Print Code: F(1)

Tobin

5486

Bag. Paper 100 g/ m².
Tasche. Papier 100 g/ m².
Sac. Papier 100 g/ m².
Tas. Paper 100 g/ m².

41 x 32 x 12 cm 200
Print Code: F(1)



Tobin
41 x 32 cm

Ragnar
11 x 36 cm

Ragnar

5487

Bag. Paper 100 g/ m².
Tasche. Papier 100 g/ m².
Sac. Papier 100 g/ m².
Tas. Paper 100 g/ m².

11 x 36 x 10 cm 500/ 100
Print Code: F(1)

579



04 05



07 03



02 01

SEWN
COSIDO



Fair

9290

Bag. Non-Woven.
Tasche. Non-Woven.
Sac. T.N.T.
Tas. Non-Woven.

36 x 40 cm 250 / 50

Print Code: F(1)

11



19 21

WOMEN
ZAGS
ZAGS



HEAT SEALED
TERMOSELLADO



02



02 03 04



19 11 07 01

Catty

5252

Bag. Non-Woven.
Tasche. Non-Woven.
Sac. T.N.T.
Tas. Non-Woven.

32 x 49 x 15 cm 200 / 10

Print Code: F(1)



05



19 04 05 07 03 11

Rostar

5684

Bag. Non-Woven.
Tasche. Non-Woven.
Sac. T.N.T.
Tas. Non-Woven.

36 x 40 cm 250 / 25

Print Code: F(1)

NON-WOVEN
THE BEST PRICE



Jazzin



02 01 19 21 04 05 07 03 11 17 06

Jazzin
4622

Bag. Non-Woven.
Tasche. Non-Woven.
Sac. T.N.T..
Tas. Non-Woven.
36 x 40 cm 250 / 25
Print Code: F(1)

HEAT SEALED
TERMOSELLADO



Desmond

3307
Bag. Non-Woven.
Tasche. Non-Woven.
Sac. T.N.T..
Tas. Non-Woven.
23 x 35 cm 400 / 20
Print Code: F(1)



02

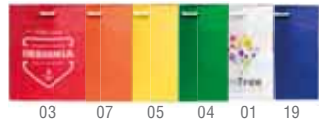

03 07 05 04 01 19

Blaster

3200
Bag. Non-Woven.
Tasche. Non-Woven.
Sac. T.N.T..
Tas. Non-Woven.
34 x 43 cm 400 / 20
Print Code: F(1)



11



02 01 19 04 05 07 03

Nox

4170
Bag. Non-Woven.
Tasche. Non-Woven.
Sac. T.N.T..
Tas. Non-Woven.
38 x 35 cm 250 / 50
Print Code: F(1)



01

19

04

05

03

02

Shopper

3244

Bag. Non-Woven.
Tasche. Non-Woven.
Sac. T.N.T.
Tas. Non-Woven.

40 × 35 × 10 cm 200 / 10

Print Code: F(1)

NON-WOVEN BAGS



582



11

Karean

5253

Bag. Non-Woven.
Tasche. Non-Woven.
Sac. T.N.T.
Tas. Non-Woven.

52 × 40.5 × 15 cm 200 / 10

Print Code: F(1)



19

01



03

Bagster

9989

Bag. Non-Woven.
Tasche. Non-Woven.
Sac. T.N.T.
Tas. Non-Woven.

45 × 35 × 10 cm 200 / 10

Print Code: F(1)



07

19



02

Tucson

3209

Bag. Thick Non-Woven.
Tasche. Dickes Non-Woven.
Sac. T.N.T. Epais.
Tas. Dicke Non-Woven.

40 × 32 × 11 cm 200 / 50

Print Code: F(1)



04

19

07

03

NON-WOVEN

ZIPPER
CREMALLERA

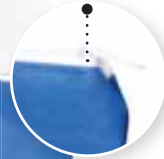

Kastel

5098
Bag. Non-Woven.
Tasche. Non-Woven.
Sac. T.N.T..
Tas. Non-Woven.

39 x 42 x 11 cm 200 / 10

Print Code: F(1)



19

SUBLIMATION



Wercal
6115

Sublimation Bag. Non-Woven.
Sublimations Tasche. Non-Woven.
Sac Sublimation. T.N.T..
Sublimatie Tas. Non-Woven.



34 x 43 cm 400 / 20

Print Code: F(1), N(8), R



Mirtal
4478

Sublimation Bag. Non-Woven.
Sublimations Tasche. Non-Woven.
Sac Sublimation. T.N.T..
Sublimatie Tas. Non-Woven.



36 x 40 cm 400 / 20

Print Code: F(1), N(8), R



Prosum
6431

Sublimation Bag. Polyester.
Sublimations Tasche. Polyester.
Sac Sublimation. Polyester.
Sublimatie Tas. Polyester.



38 x 42 cm 100 / 10

Print Code: F(4), N(8), R

**SOFT TOUCH
NEW MATERIAL**



Flubber 3306

Bag. Laminated Non-Woven.
Tasche. Laminiertes Non-Woven.
Sac. T.N.T. Laminé.
Tas. Gelamineerd Non-Woven.

40 × 35 × 11.5 cm 200 / 20
Print Code: F(1)



Decal 19

Flubber 05



Decal 4923

Bag. Laminated Non-Woven.
Tasche. Laminiertes Non-Woven.
Sac. T.N.T. Laminé.
Tas. Gelamineerd Non-Woven.

38 × 38 × 12 cm 200 / 10
Print Code: F(1)



11

Yermen 4519

Bag. Laminated Non-Woven.
Tasche. Laminiertes Non-Woven.
Sac. T.N.T. Laminé.
Tas. Gelamineerd Non-Woven.

35 × 37.5 × 20 cm 100 / 10
Print Code: F(1)



Fimel



Kustal



Fimel
5376

Bag. Laminated Non-Woven.
Tasche. Laminiertes Non-Woven.
Sac. T.N.T. Laminé.
Tas. Gelamineerd Non-Woven.

35 × 40 × 15 cm 200 / 10
Print Code: F(1)



Kustal
5375

Bag. Laminated Non-Woven.
Tasche. Laminiertes Non-Woven.
Sac. T.N.T. Laminé.
Tas. Gelamineerd Non-Woven.

30 × 34 × 12 cm 300 / 10
Print Code: F(1)



Divia
4422

Bag. Laminated Non-Woven.
Tasche. Laminiertes Non-Woven.
Sac. T.N.T. Laminé.
Tas. Gelamineerd Non-Woven.

38 × 40 × 12 cm 200 / 10
Print Code: F(1)



GLOSS / BRILLO

MATTE / MATE



Natia
4775

Bag. Laminated Non-Woven.
Tasche. Laminiertes Non-Woven.
Sac. T.N.T. Laminé.
Tas. Gelamineerd Non-Woven.

38 × 38 × 12.5 cm 200 / 10
Print Code: F(1)

Divia



03



07

Natia



03

Kuzor 4776

Bag. Laminated Non-Woven.
Tasche. Laminiertes Non-Woven.
Sac. T.N.T. Lamine.
Tas. Gelamineerd Non-Woven.

38 x 38 x 12.5 cm 200 / 10

Print Code: F(1)



07

19

02

11

GLASS
BAG



23

Splentor 9988

Bag. Laminated Non-Woven.
Tasche. Laminiertes Non-Woven.
Sac. T.N.T. Lamine.
Tas. Gelamineerd Non-Woven.

45 x 35.5 x 10.5 cm 200 / 10

Print Code: F(1)



09

19

03



11



03

19

23

Mison 5190

Bag. Laminated Non-Woven.
Tasche. Laminiertes Non-Woven.
Sac. T.N.T. Lamine.
Tas. Gelamineerd Non-Woven.

40 x 33 x 16 cm 100 / 10

Print Code: F(1)



09



22

Poznan

5938
 Bag. Laminated Non-Woven.
 Tasche. Laminiertes Non-Woven.
 Sac. T.N.T. Laminé.
 Tas. Gelamineerd Non-Woven.
 45 x 44 cm 200 / 10
 Print Code: F(1)



23

09



02



03



19

587

Rubby

4133
 Bag. Felt.
 Tasche. Filz.
 Sac. Feutrine.
 Tas. Vilt.
 39 x 33 x 8 cm 60 / 10
 Print Code: F(1), N(8)



07

11

19

03

FELT
 FIELTRO

Carole

3501

Bag. Jute Fibre/ PET.
 Tasche. Jutestoff Faser/ PET.
 Sac. Fibre Jute/ PET.
 Tas. Jute Fibre/ PET.
 33.5 x 30 x 13 cm
 Print Code: F(1)

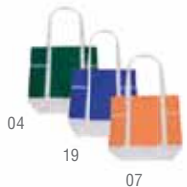

04

19

07

100 / 10

Ides

3167

Bag. Laminated Non-Woven.
 Tasche. Laminiertes Non-Woven.
 Sac. T.N.T. Laminé.
 Tas. Gelamineerd Non-Woven.
 31 x 40 x 10 cm 200 / 10
 Print Code: F(1)



03

09

02

105 g/m²

Bread

9728

Bag. 100% Cotton 105 g/ m².
Tasche. 100% Baumwolle 105 g/ m².
Sac. 100% Coton 105 g/ m².
Tas. 100% Katoen 105 g/ m².

20 × 58 cm 500 / 10

Print Code: F(6), N(8), O, P

100% COTTON



Harin

3886

Bag. Non-Woven.
Tasche. Non-Woven.
Sac. T.N.T.
Tas. Non-Woven.

21 × 57 cm 250 / 50

Print Code: F(1)

03

01

07

ZIPPER
CREMALLERA

Varien

4774

Bag. Non-Woven.
Tasche. Non-Woven.
Sac. T.N.T.
Tas. Non-Woven.

16 × 40 × 6.5 cm 1000 / 50

Print Code: F(1)



18



02



06



02



20



18



04

Bidul

5345

Ham Cover. Non-Woven.
Schinken Hülle. Non-Woven.
Étui Jambon. T.N.T.
Hoes voor Ham. Non-Woven.

68 × 41 cm 100 / 50

Print Code: F(1)

THERMAL BAG

ALUMINIUM
INTERIOR

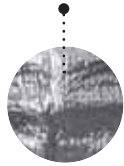

Saban

6372

Thermal Bag. Laminated Paper/ Aluminium.
Wärme Tasche. Laminiertes Papier/ Aluminium.
Sac Thermique. Papier Lamine/ Aluminium.
Thermo-Tasje. Gelamineerd Paper/ Aluminium.

43 x 33 x 14 cm 100 / 50

Print Code: F(1)



POCKET

FOLDABLE



03

THERMAL BASKET

ALUMINIUM
INTERIOR

Yonner

6277

Thermal Picnic Basket. Polyester 600D/ Aluminium. Foldable.
Wärme Tasche. Polyester 600D/ Aluminium. Fallbar.
Sac Thermique. Polyester 600D/ Aluminium. Pliable.
Thermo-Tasje. Polyester 600D/ Aluminium. Opvouwbaar.

47 x 25 x 28 cm

Print Code: G(1), N(8)

20



19

02

ALUMINIUM
INTERIOR

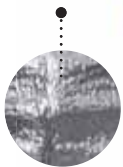

19

02

04

05

03



Daniels

3311

Cool Bag. Polyester 190T/ Aluminium.
Kühltasche. Polyester 190T/ Aluminium.
Glacière. Polyester 190T/ Aluminium.
Koeltas. Polyester 190T/ Aluminium.

45 x 36 x 9 cm

Print Code: G(1)

100 / 20



ZIPPER
CREMALLERA



07



01

03

11

19

16

Vargax

5237

Bag. Polyester 210D. Padded. With Inner Lining.
Tasche. Polyester 210D. Gepolstert. Mit Innenfutter.
Sac. Polyester 210D. Rembourré. Avec Doublure Antérieure.
Tas. Polyester 210D. Gewatteerd. Met Voering aan de Binnenzijde.

48 x 41 x 11 cm 50

Print Code: G(1)

589



Video

BIG SIZE
GRAN CAPACIDAD



04

Shop XL

6106

Bag. Non-Woven.
Tasche. Non-Woven.
Sac. T.N.T.
Tas. Non-Woven.

33 x 38 x 25 cm 200 / 10

Print Code: F(1)



01 02 03 07 19

ZIPPER
CREMALLER



Daryan

5586

Bag. Polyester 600D.
Tasche. Polyester 600D.
Sac. Polyester 600D.
Tas. Polyester 600D.

44 x 36 x 11 cm 50

Print Code: F(1), N(8)



16

05

03

11

19

EASY SHOPPING



03



360°

05

NEW



Portis

6684

Antibacterial Keyring Coin.
Antibakteriell Schlüsselanhänger EK-Chip.
Porte-Clés Monnaie Antibactérien.
Antibacterieel Munt-Sleutelhanger.

4.1 x 5.2 x 1.1 cm 1000 / 100

Print Code: C(4), W



11

19

04

05

07

02

03

01

Euromarket

3298

Keyring Coin. Metal.
Schlüsselanhänger EK-Chip. Metall.
Porte-Clés Monnaie. Métal.
Munt-Sleutelhanger. Metaal.

Ø 2.3 x 6 cm 1000 / 100

Print Code: D(1)

Perch

4992

Holder. Adjustable.
Halter. Verstellbar.
Support. Ajustable.
Houder. Aanpasbaar.

7 x 2.7 x 4.8 cm 500 / 25

Print Code: D(1)



02

07

19

11



01

04



Antibacterial



FOLDABLE
PLEGABLE

Fasty

4612
Shopping Trolley. Polyester 600D. Foldable.
Einkaufstrolley. Polyester 600D. Faltbar.
Caddie Course. Polyester 600D. Pliable.
Inkoopwagentje. Polyester 600D. Opvouwbaar.

03 32 x 54 x 13.5 cm 30
 Print Code: H(1), N(8)

591



02

Max

3228
Shopping Trolley. Polyester 600D. Foldable.
Einkaufstrolley. Polyester 600D. Faltbar.
Caddie Course. Polyester 600D. Pliable.
Inkoopwagentje. Polyester 600D. Opvouwbaar.

30 x 52 x 20 cm 6
 Print Code: H(1), N(8)



EXTENDABLE
EXTENSIBLE



05

Texco

3229
Extendable Bag. Polyester 600D.
Ausziehbare Tasche. Polyester 600D.
Sac Extensible. Polyester 600D.
Uitbreidbare Tas. Polyester 600D.

30 x 50 x 20 cm 20
 Print Code: G(1)



02

NATURAL JUTE

i Natural jute stands out among sustainable materials because the manufacturing processes have a low impact on the environment, together with its rapid regeneration. The natural aspect, together with its resistance and durability, makes of it a sustainable material reference.

El yute natural ocupa un lugar destacado entre los materiales sostenibles, debido a que los procesos empleados para su fabricación suponen un bajo impacto para el medio ambiente, junto a su rápida regeneración. El aspecto natural, unido a su resistencia y durabilidad, lo convierten en un material sostenible de referencia.

NATURAL JUTE



Rotin
6387

Bag. Laminated Jute/ Laminated Cotton.
Tasche. Laminiertes Jutestoff/ Laminiertes Baumwolle.
Sac. Jute Laminé/ Coton Laminé.
Tas. Gelamineerd Jute/ Gelamineerd Katoen.

39 × 31.5 × 16 cm 50 / 10
Print Code: F(6)

592



Solux
5736

Bag. Laminated Jute/ Cotton.
Tasche. Laminiertes Jutestoff/ Baumwolle.
Sac. Jute Laminé/ Coton.
Tas. Gelamineerd Jute/ Katoen.

38 × 42 × 16 cm 50 / 10
Print Code: F(1)



Hintol
4883

Bag. Laminated Jute/ Cotton.
Tasche. Laminiertes Jutestoff/ Baumwolle.
Sac. Jute Laminé/ Coton.
Tas. Gelamineerd Jute/ Katoen.

44.5 × 35 × 14 cm 60 / 5
Print Code: F(1)

13

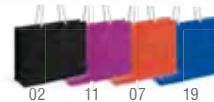

03

Kalkut
5808

Bag. Jute/ Cotton.
Tasche. Jutestoff/ Baumwolle.
Sac. Jute/ Coton.
Tas. Jute/ Katoen.

38 × 41 cm 100 / 10
Print Code: F(1)

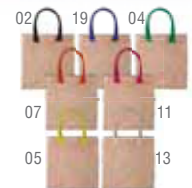



NEW

Ramet

6819

Bag. Jute/ Cotton.

Tasche. Jutestoff/ Baumwolle.

Sac. Jute/ Coton.

Tas. Jute/ Katoen.

48 × 35 × 15 cm

Print Code: F(1)

50 / 10



593



Farus

5726

Bag. Jute/ Cotton.

Tasche. Jutestoff/ Baumwolle.

Sac. Jute/ Coton.

Tas. Jute/ Katoen.

48 × 35 × 15 cm 100 / 10

Print Code: F(6), N(8)

Cekon

5725

Bag. Laminated Jute/ Cotton.

Tasche. Laminiertes Jutestoff/ Baumwolle.

Sac. Jute Laminé/ Coton.

Tas. Gelamineerd Jute/ Katoen.

44.5 × 34 × 15 cm 50 / 10

Print Code: F(6), N(8)

Triex

6820

Bag. Laminated Jute/ Cotton.

Tasche. Laminiertes Jutestoff/ Baumwolle.

Sac. Jute Laminé/ Coton.

Tas. Gelamineerd Jute/ Katoen.

44.5 × 35 × 14 cm

Print Code: F(1)

50 / 10



Adapta

2428

Trash Bag Holder. Extendable.
 Mülltütenthalter. Ausziehbar.
 Support pour Sac Plastique. Extensible.
 Vuiliszakkenhouder. Verlengbaar.

34 x 2,6 x 18,3 cm 40

Print Code: E(1)

REUSE BAG
 REUTILIZA BOLSAS



Lopack

4264

Bag Set. Laminated Non-Woven. 3 Bags 23 x 45 x 23 cm.
 Taschen Set. Laminiertes Non-Woven. 3 Taschen 23 x 45 x 23 cm.
 Set Sacs. T.N.T. Laminé. 3 Sacs 23 x 45 x 23 cm.
 Tassen Set. Gelamineerd Non-Woven. 3 Tassen 23 x 45 x 23 cm.

69 x 45 x 23 cm 50

Print Code: F(1)



03



19

04

02

Doxen

4925

Plastic Bag Holder. Polyester 210D.
 Recycling Tasche. Polyester 210D.
 Sac de Recyclage. Polyester 210D.
 Recycle Tas. Polyester 210D.

Ø 14 x 39 cm 1000 / 50

Print Code: F(1)

KEEP THE BAGS
 GUARDA BOLSAS

We have more than 1000 different models for you...

...or create your own design

asiaexpress

Special designs

MINIMUM ORDER QUANTITY: 2000 UNITS



GIFTS & PRE- MIUMS



NEW

BAMBOO

Maros
6796

Holder Keyring. Bamboo.
Schlüsselanhänger Halter. Bambus.
Porte-Clés Support. Bambou.
Sleutelhanger Houder. Bamboe.

2.6 × 6 × 1.5 cm

500 / 100

Print Code: D(4), L1, W

wooden



NEW

Bruffy
PG. 598



597

NEW

RPET

i The fabric used in the manufacturing process of this item is made of recycled plastic (RPET). Like this, the emission of plastic residues to our planet and the consumption of energy is drastically reduced, resulting in a much more eco-friendly process.

El material de este producto está fabricado con plástico reciclado (RPET), que, además de ayudar en la disminución de residuos plásticos en el planeta, utiliza menos energía en el proceso de fabricación, haciendo que sea mucho menos dañino para el medio ambiente.

STOP PLASTIC POLLUTING THE OCEAN

Nelsom
PG. 659



COTTON POUCH

Tayex

6782

Skill Game. Wood. 7 Pieces.
Geschicklichkeitsspiel. Holz. 7 Stück.
Jeu d'Habileté. Bois. 7 Piéces.
Behendigheidsspel. Hout. 7 Stuks.

4.5 × 4.5 × 4.5 cm

200 / 100

Print Code: G(1), N(8)



SKILL GAMES



598



COTTON POUCH

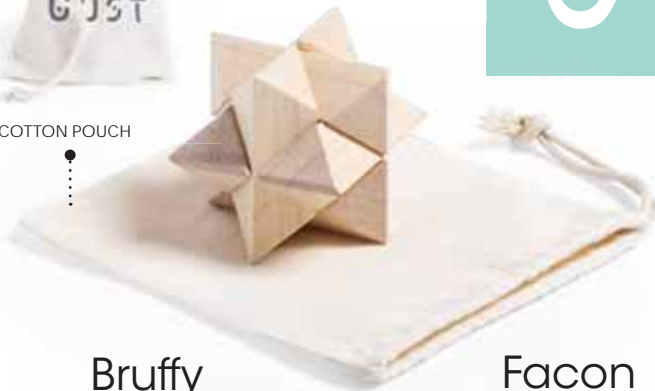

Bruffy

6781

Skill Game. Wood. 6 Pieces.
Geschicklichkeitsspiel. Holz. 6 Stück.
Jeu d'Habileté. Bois. 6 Piéces.
Behendigheidsspel. Hout. 6 Stuks.

5 × 5 × 5 cm

200 / 100

Print Code: G(1), N(8)

Facon

5903

Skill Games Set. Metal. 4 Games.
Geschicklichkeitsspiele Set. Metall. 4 Spiele.
Set Jeux d'Habiletés. Métal. 4 Jeux.
Behendigheidsspel Set. Metaal. 4 Spelen.

8 × 11.5 × 1 cm

200 / 50

Print Code: E(1), N(8)



4 GAME SET /
SET 4 JUEGOS



Soirok

5478

Skill Game. Metal.
Geschicklichkeitsspiel. Metall.
Jeu d'Habileté. Métal.
Behendigheidsspel. Metaal.

7.3 × 9.8 × 3 cm

200 / 50

Print Code: D(1)

skill games

Did you know these games improve your skills and enhance brainwork? Learning to overcome challenges sharpens intelligence. Moreover, a positive correlation between these kind of games and the IQ levels of the people who play them regularly has been observed.

¿Sabías que estos juegos mejoran las habilidades de pensamiento y perfeccionan la capacidad de razonamiento?

Aprender a superar los desafíos agudiza la inteligencia, además se ha demostrado una relación positiva entre los juegos y los niveles de coeficiente intelectual de las personas que se entretienen con ellos de forma regular.

wooden



599



Grapex

6417

Game. Wood. 9 Pieces.
Spiel. Holz. 9 Stück.
Jeu. Bois. 9 Pièces.
Spel. Hout. 9 Stuks.

7.3 × 3.1 × 7.3 cm

200 / 50

Print Code: D(4), L2, W



Sabix

6419

Game. Wood. 45 Pieces.
Spiel. Holz. 45 Stück.
Jeu. Bois. 45 Pièces.
Spel. Hout. 45 Stuks.

5.7 × 17 × 5.7 cm

50

Print Code: G(1), N(8), L1



COTTON POUCH
INCLUDED

SKILL GAMES

600

Prakon

6112

Dominoes. Wood. 28 Pieces.
Domino. Holz. 28 Stück.
Dominos. Bois. 28 Pièces.
Domino. Hout. 28 Stuks.



 14.7 x 5 x 3.1 cm  100 / 50

 Print Code: E(2), L2, W

Mikado

5718

Skill Game. Wood. 41 Pieces.
Geschicklichkeitsspiel. Holz. 41 Stück.
Jeu d'Habileté. Bois. 41 Pièces.
Behendigheidsspel. Hout. 41 Stuks.

 19.3 x 2.5 x 4.1 cm  100 / 50

 Print Code: D(2), L2, W



Set GAMES



Pelkat

6418
Game Set. Wood. 2 Games.
Spiel Set. Holz. 2 Spiele.
Set Jeu. Bois. 2 Jeux.
Spel Set. Hout. 2 Spelen.

10.5 × 2.8 × 9.7 cm 100 / 50

Print Code: D(4), L2, W



601

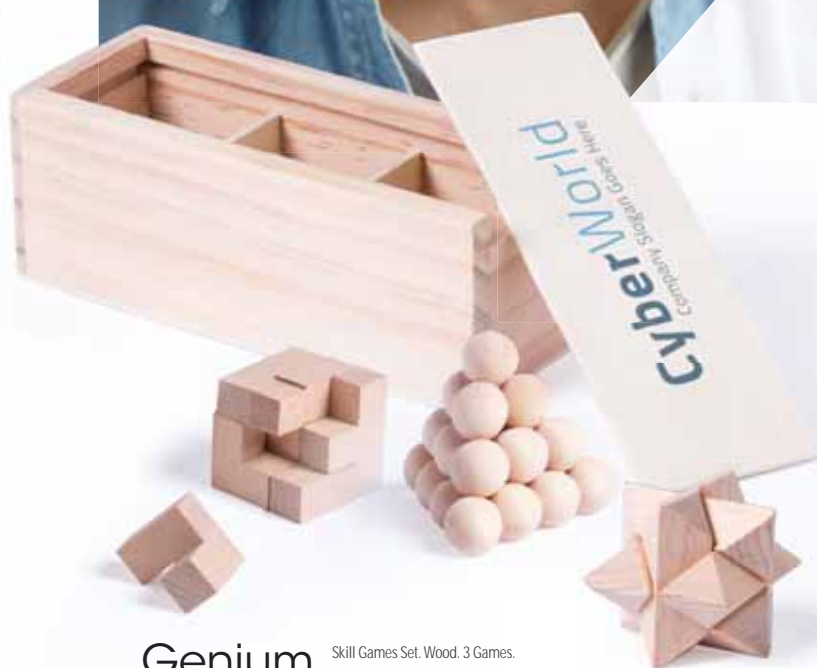

Genium

5525

Skill Games Set. Wood. 3 Games.
Geschicklichkeitsspiele Set. Holz. 3 Spiele.
Set Jeux d'Habillités. Bois. 3 Jeux.
Behendigheidsspel Set. Hout. 3 Spelen.

16.3 × 6 × 6.4 cm 50

Print Code: D(4), L2, W



Xigral

6113
Game Set. Wood. 4 Games.
Spiel Set. Holz. 4 Spiele.
Set Jeu. Bois. 4 Jeux.
Spel Set. Hout. 4 Spelen.

16.3 × 3 × 16.3 cm 50

Print Code: E(2), L2, W



CHESS, DRAUGHTS,
DOMINOES AND MIKADO
AJEDREZ, DAMAS, DOMINÓ Y MIKADO



PIECES FROM NATURAL CUTS OF BAMBOO.
THE TEXTURE AND COLOR MAY VARY.

PIEZAS PROCEDENTES
DE CORTE DE BAMBÚ NATURAL.
SU TEXTURA Y COLOR PUEDEN VARIAR

Weather STATION



Helein
6516

Weather Station. Bamboo. 2 Batteries AAA Not Included.
Wetterstation. Bambus. 2 AAA Batterien Nicht im Lieferumfang.
Station Météo. Bambou. 2 Piles AAA Non Inclus.
Weerstation. Bamboe. 2 Batterijen AAA Niet Inclusief.

10.2 x 11.9 x 5.4 cm

50 / 25

Print Code: F(4), L1, W



NEW

Petrox
6807

Multifunction Pencil Holder. Bamboo/ABS. Button Battery Included.
Multifunktion Stifthalter. Bambus/ABS. Knopfzelle Inklusive.
Porte-Crayons Multifonction. Bambou/ABS. Pile Bouton Inclus.
Multifunctioneel Pennebakje. Bamboe/ABS. Knopcel Batterij Inclusief.

10.2 x 11.9 x 5.4 cm

50

Print Code: F(4), L2



NEW

Behox
6806

Weather Station. Bamboo. 2 Batteries AAA Not Included.
Wetterstation. Bambus. 2 AAA Batterien Nicht im Lieferumfang.
Station Météo. Bambou. 2 Piles AAA Non Inclus.
Weerstation. Bamboe. 2 Batterijen AAA Niet Inclusief.

13 x 13 x 2.4 cm

50 / 25

Print Code: F(4), L2, W



Sebrin

6441

Flip Flops. EVA/ PVC.

Flip Flop. EVA/ PVC.

Tongues. EVA/ PVC.

Flip Flops. EVA/ PVC.

📏 36-38, 42-44 📦 60 / 10

🌈 Print Code: D(1), E(1)



CORK



604



Loriok

6439



Cap. Natural Cork/ Polyester. 5 Panels.

Mütze. Naturkork/ Polyester. 5 Panels.

Casquette. Bouchon Naturel/ Polyester. 5 Panneaux.

Pet. Natuurlijk Kurk/ Polyester. 5 Panelen.

📏 Consult. 📦 200 / 25

🌈 Print Code: E(1)



Flicken

6319

Drawstring Bag. Natural Cork/ Polyester 210D.

Rucksack. Naturkork/ Polyester 210D.

Sac à Dos. Bouchon Naturel/ Polyester 210D.

Rugzak. Natuurlijk Kurk/ Polyester 210D.

📏 34 × 42 cm

🌈 Print Code: F(1), N(8)

📦 200 / 10

Lorcan

6339

Backpack. Natural Cork/ Polyester 600D. Padded Back and Shoulder Straps.

Rucksack. Naturkork/ Polyester 600D. Gepolsterter Rücken und Schultergurte.

Sac à Dos. Bouchon Naturel/ Polyester 600D. Dos et Bretelles Rembourrées.

Rugzak. Natuurlijk Kurk/ Polyester 600D. Gewatteerde Achterzijde en Schouderbanden.

📏 28 × 38 × 12 cm

🌈 Print Code: F(1), N(8), O, P

📦 50





12 MARKERS
INCLUDED



Munds

6579

Globe. Natural Cork/ Metal. 12 Markers Included.
Erdkugel. Naturkork/ Metall. 12 Marker Inklusive.
Globe Terrestre. Bouchon Naturel/ Métal. 12 Marqueurs Inclus.
Wereldbol Globe. Natuurlijk Kurk/ Staal. 12 Stiften inclusief.

15 x 20 cm

10

Print Code: G(1), L2

605



Palsy

6590

Map. Laminated Paper. Scraper Included.
Karte. Laminiertes Papier. Schaber Inklusive.
Mappemonde. Papier Laminé. Grattoir Inclus.
Map. Gelamineerd Paper. Krabber Inclusief.

43 x 28.5 cm

Print Code: D(1), E(1)

43 X 28,5 CM



SCRAPER
INCLUDED



your colour
YOUR BRAND



Mirvan
6457



Notepad. PU. Hard Cover. 100 Sheets.
Notizblock. PU. Hardcover-Abdeckung. 100 Seiten.
Bloc Notes. Similicuir. Couverture Rigide. 100 Feuilles.
Notitieblokje. PU. Harde Kaft. 100 Blaadjes.

14.7 × 21 × 1.5 cm 50 / 25

Print Code: E(4), T

SPECIAL
LASER ENGRAVING
MATCHING COLOUR



05



02 03 07 11 04 19

Wencex
6033

Pen. Aluminium.
Kugelschreiber. Aluminium.
Stylo. Aluminium.
Pen. Aluminium.



1.1 × 14.1 cm 500 / 50

Print Code: B(4), L1



03

19

05

04



19

Kafin

6413

Speaker. Bluetooth Connection. Power 3W. USB Rechargeable. Cable Included.
 Lautsprecher. Bluetooth Anschluss. Power 3W. USB Wiederaufladbar. Kabel Inklusiv.
 Haut-Parleurs. Connexion Bluetooth. Puissance 3W. Rechargeable USB. Câble Inclus.
 Luidspreker. Bluetooth Verbinding. Vermogen 3W. USB Oplaadbaar. Kabel Inclusief.

11.1 x 8.3 x 4.1 cm 50

Print Code: F(4), N(8)



KAFIN

607



Vildrey

5945

Headphones. Bluetooth Connection. 3.5 mm Jack Socket. USB Rechargeable. Cable Included.
 Kopfhörer. Bluetooth Anschluss. 3.5 mm Klinkenstecker. USB Wiederaufladbar. Kabel Inklusiv.
 Écouteurs. Connexion Bluetooth. Connexion Jack 3.5 mm. USB Rechargeable. Câble Inclus.
 Koptelefoon. Bluetooth Verbinding. 3.5 mm Jack Aansluiting. USB Oplaadbaar. Kabel Inclusief.

17.5 x 20.5 x 9 cm 20

Print Code: F(1), L2



19





NETPAK

6300 C



03



19



04

05

17

02

Netpak

6300

Speaker. Bluetooth Connection. Power 3W. USB Rechargeable. Cable Included.
 Lautsprecher. Bluetooth Anschluss. Power 3W. USB Wiederaufladbar. Kabel Inklusive.
 Haut-Parleurs. Connexion Bluetooth. Puissance 3W. Rechargeable USB. Câble Inclus.
 Luidspreker. Bluetooth Verbinding. Vermogen 3W. USB Oplaadbaar. Kabel Inclusief.

Ø 6.2 × 9.2 cm 50 / 25

Print Code: F(4)



Bluetooth



Hands-free



Micro SD



Radio



USB Player



Line IN



NABAR

6458 C

03



19



04



05

Nabar

6458

Drawstring Bag. Polyester 210D.
 Rucksack. Polyester 210D.
 Sac à Dos. Polyester 210D.
 Rugzak. Polyester 210D.

31 × 43 cm 200 / 10

Print Code: F(1), N(8)



19 05 03 04



HALVAR

6456 C



400 ml

Halvar

6456

Bottle. Aluminium. 400 ml. Individual Presentation.
 Trinkflasche. Aluminium. 400 ml. Individuelle Präsentation.
 Bidon. Aluminium. 400 ml. Présentation Individuelle.
 Fles. Aluminium. 400 ml. Individuele Presentatie.

Ø 6.6 × 17.5 cm 100 / 20
 Print Code: F(1), L2



609



04



01 02 07 11 19 05 03

Sodel

4479

Cap. Polyester. 5 Panels.
 Mütze. Polyester. 5 Panels.
 Casquette. Polyester. 5 Panneaux.
 Pet. Polyester. 5 Panelen.



Consult. 200 / 25
 Print Code: E(1), N(8), O, P, R

LOCK AND
ERASER BUTTON
INCLUDED



01

Koptul

6247

LCD Writing Tablet. Magnetic. Pen and Button Battery Included.
LCD-Schreibtablett. Magnetisch. Bleistift und Knopfzelle Inklusive.
Tablette d'écriture LCD. Magnétique. Crayon et Pile Bouton Inclus.
LCD Tablet om te Schrijven. Magnetisch. Potlood en Knoopcel Batterij Inclusief.

14.7 x 22.5 x 0.5 cm 100 / 50

Print Code: F(1), W



02



610

96 DESIGNS

Rudex

5564

Colouring Book. 48 Sheets. 96 Designs.
Malbuch. 48 Seiten. 96 Skizze.
Cahier Dessin. 48 Feuilles. 96 Dessins.
Kleurboek. 48 Blaadjes. 96 Ontwerpen.

15 x 15 x 0.7 cm 100 / 50

Print Code: C(2)

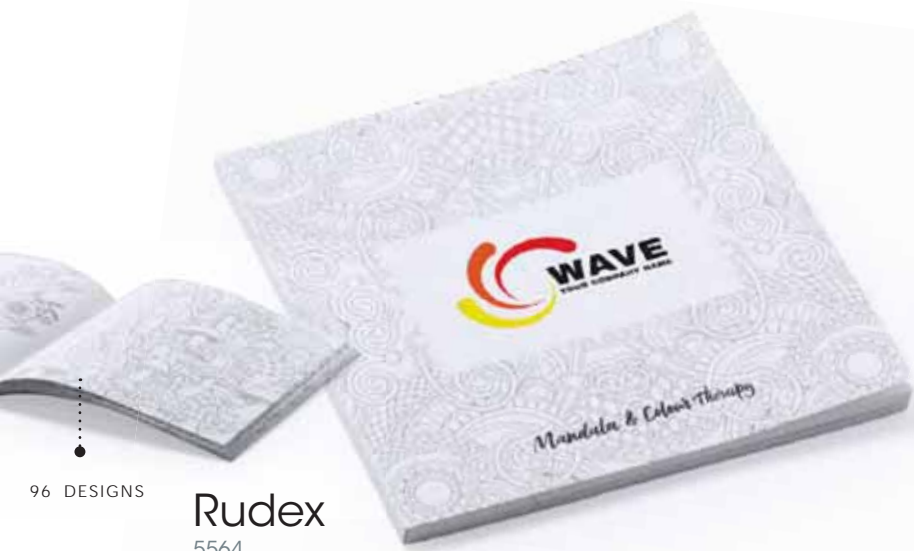

Boltex

5645

Mandala Set. 12 Pencils and 12 Sheets Included.
Mandala Set. 12 Stifte und 12 Seiten Inklusive.
Set Mandala. 12 Crayons et 12 Feuilles Inclus.
Mandala Set. 12 Potloden en 12 Blaadjes Inclusief.

9 x 9 x 1 cm 300 / 20

Print Code: C(4), W

12 DESIGNS





Light



Katrin 6317

Message Hanger. Led Lights. Felt Tip Pen and Eraser Included. 3 Batteries AAA Not Included.
Nachrichtenaufhänger. Led Lichter. Filzstift und Radierer Inklusiv. 3 AAA Batterien Nicht im Lieferumfang.
Ardoise Message. Lumières Led. Feutre et Effaceur Inclus. 3 Piles AAA Non Inclus.
Berichten Hanger. Led Lichten. Felt Tip Pen en Gum Inklusief. 3 Batterijen AAA Niet Inclusief.

15 8.3 × 22.3 × 2.7 cm 📦 100 / 50

🌈 Print Code: D(1)



Light



Cinemax 5981

Light Box. Led Lights. 82 Pieces. 4 Batteries AAA Not Included.
Leuchtkasten. Led Lichter. 82 Stück. 4 AAA Batterien Nicht im Lieferumfang.
Ecran Lumineux. Lumières Led. 82 Pièces. 4 Piles AAA Non Inclus.
Lightbox. Led Lichten. 82 Stuks. 4 Batterijen AAA Niet Inclusief.

15 15 × 10.7 × 4.1 cm 📦 50 / 25

🌈 Print Code: D(1)



Light

Kadilar 5990

Keyring. Led Lights. 75 Pieces. Button Battery Included.
Schlüsselanhänger. Led Lichter. 75 Stück. Knopfzelle Inklusiv.
Porte-Clés. Lumières Led. 75 Pièces. Pile Bouton Inclus.
Sleutelhanger. Led Lichten. 75 Stuks. Knopcel Batterij Inklusief.

15 2.8 × 5 × 1.4 cm 📦 500 / 100

🌈 Print Code: C(1)



Light

Nathan 5573

Message Board. Led Lights. 3 Felt Tip Pens and Erasers Included. 3 Batteries AAA Not Included.
Meldungstafel. Led Lichter. 3 Filzstift und Radierer Inklusiv. 3 AAA Batterien Nicht im Lieferumfang.
Ardoise Message. Lumières Led. 3 Feutres et Effaceur Inclus. 3 Piles AAA Non Inclus.
Berichten Bord. Led Lichten. 3 Felt Tips Pen en Gummen Inklusief. 3 Batterijen AAA Niet Inclusief.

15 15 × 11 × 3.5 cm 📦 50 / 25

🌈 Print Code: D(1)





Carlo

8850

Skill Games. 24 Assorted Games.
Geschicklichkeitsspiele. 24 Spiele Sortiert.
Jeux d'Habillités. 24 Jeux Assortis.
Behendigkeitsspiel. 24 Verzamelde Spelen.

4 × 4 × 4 cm 576 / 24
Print Code: C(4)

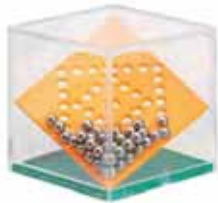

Hability

4327

Stylus Touch Pen.
Touchpad Stift.
Stylét.
Touchscreen-Pen.

Ø 3.4 × 11.6 cm 1000 / 50
Print Code: C(1)



19

GAMES

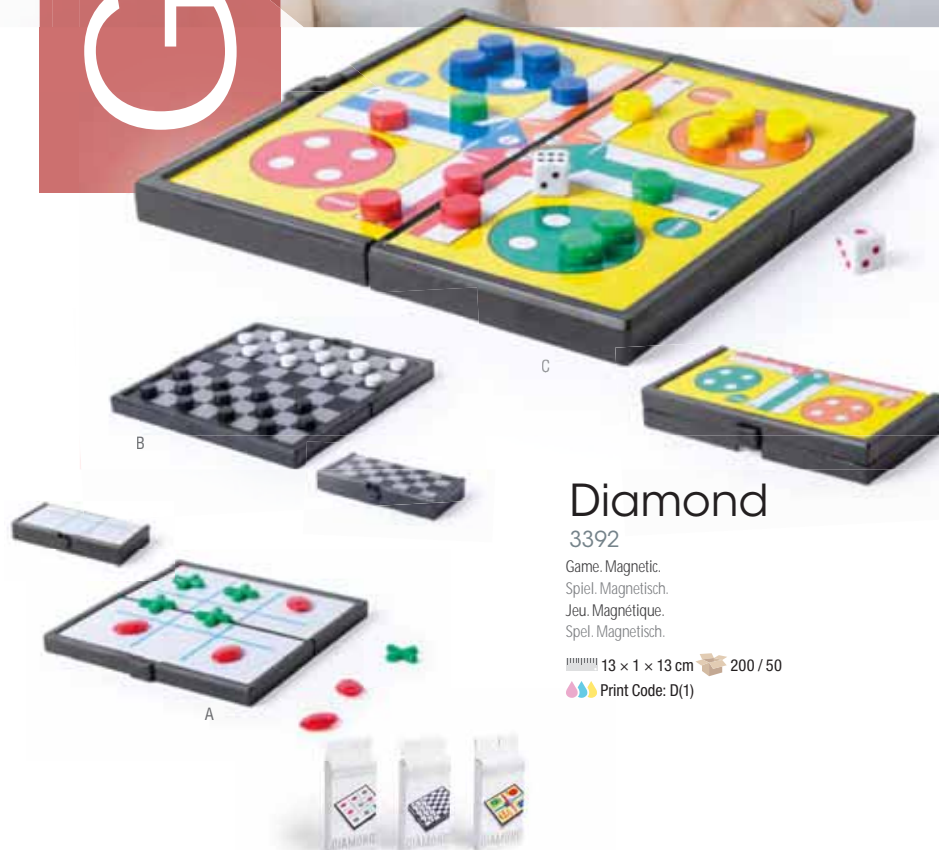

Diamond

3392

Game. Magnetic.
Spiel. Magnetisch.
Jeu. Magnétique.
Spiel. Magnetisch.

13 × 1 × 13 cm 200 / 50
Print Code: D(1)



Tangram

3704

Puzzle. Wood. 7 Pieces.

Puzzle. Holz. 7 Stück.

Puzzle. Bois. 7 Pièces.

Puzzel. Hout. 7 Stuks.

9.8 × 9.8 × 0.7 cm 400 / 100

Print Code: E(1), L2

GAMES



613

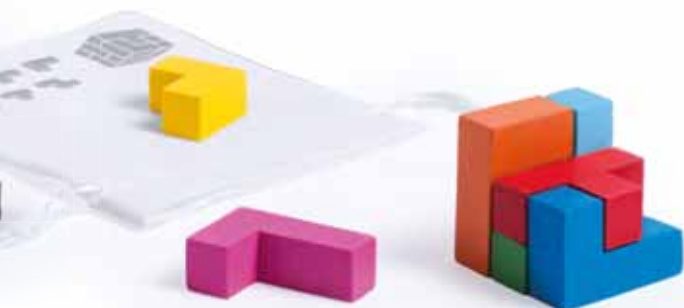

Jetex

5117

Skill Game. Wood. 7 Pieces.

Geschicklichkeitsspiel. Holz. 7 Stück.

Jeu d'Habileté. Bois. 7 Pièces.

Behendigheidsspel. Hout. 7 Stuks.

4.5 × 4.5 × 4.5 cm 200 / 100

Print Code: E(1), N(8)

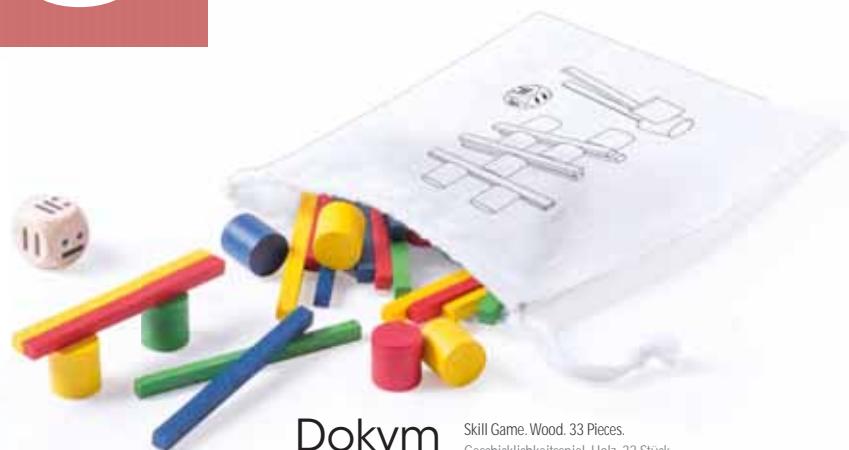

Dokym

5717

Skill Game. Wood. 33 Pieces.

Geschicklichkeitsspiel. Holz. 33 Stück.

Jeu d'Habileté. Bois. 33 Pièces.

Behendigheidsspel. Hout. 33 Stuks.

12.5 × 17 cm 300 / 50

Print Code: E(1), N(8)



01 19 04 05

Zairem
5563

Fidget Spinner. Metal.
Fidget Spinner. Metall.
Fidget Spinner. Metal.
Fidget Spinner. Metaal.

7.5 x 7.5 x 1.2 cm 200 / 50

Print Code: C(1), V



03



anti-stress

614



19

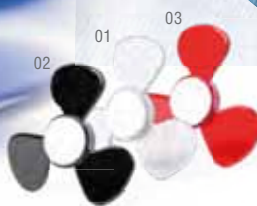

02

01

03

Bolty
5816

Fidget Spinner.
Fidget Spinner.
Fidget Spinner.
Fidget Spinner.

7.9 x 7.9 x 1.2 cm 500 / 50

Print Code: C(1), V



J1

03

04

05

19



Fredd
5805

Fidget Spinner.
Fidget Spinner.
Fidget Spinner.
Fidget Spinner.

7.5 x 7.5 x 1.5 cm 200 / 50

Print Code: C(1), V



03



04

19

05

Lennox
5825

Antistress Pen.
Antistress Kugelschreiber.
Stylo Antistress.
Antistress Pen.

1.8 x 12.4 x 1.8 cm 500 / 50

Print Code: B(4)



anti-stress



02



Mandery

5657

Antistress Keyring. TPR.
Antistress Schlüsselanhänger. TPR.
Porte-Clés Antistress. TPR.
Antistress Sleutelhanger. TPR.

6.9 × 11 × 1.7 cm 200 / 50

Print Code: E(1), L1



PLA

TOMA

LIM



FRE

MAN

NARA

Fruty

4397

Antistress Keyring. PU.
Antistress Schlüsselanhänger. PU.
Porte-Clés Antistress. PU.
Antistress Sleutelhanger. PU.

Consult. 1000 / 10

Print Code: E(1), L1



SAN

Lireo

3179

Antistress Keyring. PU.
Antistress Schlüsselanhänger. PU.
Porte-Clés Antistress. PU.
Antistress Sleutelhanger. PU.

Ø 4 cm 1000 / 20

Print Code: E(1), L1



02

19

03

05

Silene

3658

Antistress Keyring. PU.
Antistress Schlüsselanhänger. PU.
Porte-Clés Antistress. PU.
Antistress Sleutelhanger. PU.

3.6 × 3.6 × 2.7 cm 1000 / 20

Print Code: E(1), L1





19

03

Gotin

5257

Antistress. PU.
Antistress. PU.
Antistress. PU.
Antistress. PU.

📏 Ø 6 × 8 cm 📦 400 / 10

🎨 Print Code: E(1), L1

anti-stress



616

BOUNCING ANTISTRESS BALL
PELOTA SALTARINA ANTI ESTRÉS



05

Kasac

5824

Antistress Ball. PU.
Antistress Ball. PU.
Balle Antistress. PU.
Antistress Bal. PU.

📏 Ø 6.7 cm 📦 100 / 50

🎨 Print Code: E(1), L1



03

04



01

19



Kidea

4270

Antistress. PU.
Antistress. PU.
Antistress. PU.
Antistress. PU.

📏 Ø 6 × 10 cm 📦 250 / 50

🎨 Print Code: E(1), L1



01

03

Ventry

5699

Antistress. PU.
Antistress. PU.
Antistress. PU.
Antistress. PU.

📏 7.1 × 7 × 5 cm 📦 400 / 10

🎨 Print Code: E(1), L1



anti-stress



Kubo
4271

Antistress. PU.
Antistress. PU.
Antistress. PU.
Antistress. PU.
6.2 x 6.2 x 6.2 cm 250 / 50
Print Code: E(1), L1

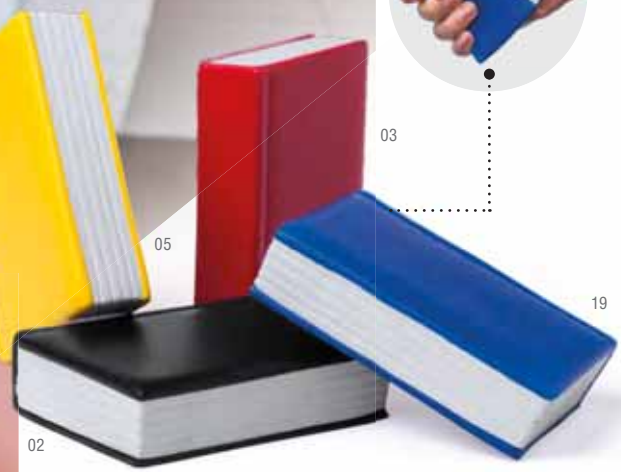

Libron
5258

Antistress. PU.
Antistress. PU.
Antistress. PU.
Antistress. PU.
6.2 x 8.9 x 2.3 cm 300 / 10
Print Code: E(1), L1

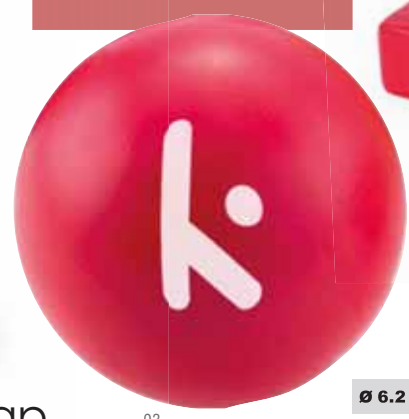

Lasap
4605

Antistress Ball. PU.
Antistress Ball. PU.
Balle Antistress. PU.
Antistress Bal. PU.
Ø 6.2 cm 400 / 10
Print Code: E(1), L1



Redit
5256

Antistress. PU.
Antistress. PU.
Antistress. PU.
Antistress. PU.
15.2 x 3.7 x 1.8 cm 300 / 50
Print Code: E(1), L1



Nailex

4840

Aromatic Diffuser. Jasmine Aroma. 15 ml.
 Duft Diffusor. Jasmine Duft. 15 ml.
 Diffuseur Aromatique. Arôme Jasmin. 15 ml.
 Luchtverfrisser. Jasmijn Aroma. 15 ml.

9 x 15.7 x 4.2 cm

100 / 50

Print Code: E(1)



Incienso

9944

Candle Set. Aromatic.
 Kerzen Set. Duft.
 Set Bougies. Aromatiques.
 Kaarsen Set. Geurkaars.

20.3 x 3.5 x 7.6 cm

50 / 10

Print Code: E(1)



Flowcan

3369

03

Can. Assorted Coloured Flowers. 6-8 Petunia Seeds Included.
 Dose. Verschiedenfarbige. 6-8 Petuniensamen Inklusive.
 Boite Conserve. Fleurs Couleurs Diverses. 6-8 Semences de Petunia Inclus.
 Blik. Assortiment Van Gekleurde Bloemen. 6-8 Petunia Zaden Inclusief.

Ø 6.5 x 9 cm

150 / 10

Print Code: E(1)



Advert

9966

13

Flowerpot. Biodegradable Pot. Assorted Coloured Flowers. 5-8 Petunia Seeds Included.
 Blumentopf. Kompostierbarer Topf. Verschiedenfarbige. 5-8 Petuniensamen Inklusive.
 Pot de Fleurs. Pot Biodégradable. Fleurs Couleurs Diverses. 5-8 Graine de Petunia Inclus.
 Bloempot. Biodegradable Pot. Assortiment van gekleurde bloemen. 5-8 Petunia Zaden Inclusief.

Ø 6.5 x 6.2 cm

200 / 25

Print Code: E(4)

Pranger

4301

Air Freshener. 40 ml.
 Lufferrfrischer. 40 ml.
 Parfum Ambiance. 40 ml.
 Luchtverfrisser. 40 ml.

Ø 5.7 x 8.2 cm

Print Code: E(1)

200 / 20

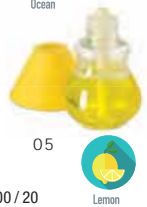



NEW

Soltax

6791

Flowerpot. Terracotta. Assorted Coloured Flowers. 5-8 Petunia Seeds Included.
 Blumentopf. Terrakotta. Verschiedenfarbige. 5-8 Petuniensamen Inklusive.
 Pot de Fleurs. Terre Cuite. Fleurs Couleurs Diverses. 5-8 Graine de Pétunia Inclus.
 Bloempot. Terracotta. Assortiment van gekleurde bloemen. 5-8 Petunia Zaden Inclusief.

📏 Ø 5.8 × 5.2 cm 📦 150 / 50
 🌈 Print Code: E(1)

Tempo de floração em condições ótimas de luz y temperatura: Primavera – verano: 5-7 días. Otoño – invierno: 20-25 días.
 Presentación en caja con bolsita de sustrato y semillas separadas.
 Flowering period in optimum conditions of light exposure and temperature: Spring - summer: 5-7 days. Autumn - winter: 20-25 days.
 Presented in box including substrate and seeds packed separately in a bag.
 Periodo di fioritura in condizioni ottimali di luce, esposizione e temperatura: Primavera - estate: 5-7 Giorni. Autunno - inverno: 20-25 Giorni.
 Presentata in scatola includendo terriccio e semi confezionati separatamente in un sacchetto.
 Tempo de floração em condições ótimas de luz e temperatura: Primavera – verão: 5-7 dias. Outono – inverno: 20-25 dias.
 Apresentação em caixa com bolsa de substrato e sementes separadas.
 Temps de floraison en conditions optimales de lumiere et temperature: Printemps – été 5-7 Jours. Automne – hiver: 20-25 Jours.
 Presentation en caisse avec sachet de substrat et graines separes.
 Blütezeit unter optimalen Bedingungen der Belichtung und Temperatur: Frühling-Sommer: 5-7 Tage. Herbst - Winter: 20-25 Tage.
 Präsentiert in Kisten mit Substrat und Samen in einem Beutel verpackt.



619



PARSLEY/PEREJIL

MINT/MENTA

SET 2 PIECES

Nertel

5113

Flowerpot Set. Biodegradable Pot. 2 Pieces. Seeds Included.
 Blumentopf Set. Kompostierbarer Topf. 2 Stück. Samen Inklusive.
 Set Pot de Fleurs. Pot Biodégradable. 2 Pièces. Graines Inclus.
 Bloempot Set. Biologisch Afbreekbare Pot. 2 Stuks. Zaden Inclusief.

📏 15 × 7 × 7 cm 📦 100 / 50
 🌈 Print Code: E(4)



Merin

6223

Flowerpot. Wood. Biodegradable Pot. Mint Seeds Included.
 Blumentopf. Holz. Kompostierbarer Topf. Minzensamen Inklusive.
 Pot de Fleurs. Bois. Pot Biodégradable. Semences de Menthe.
 Bloempot. Hout. Biologisch Afbreekbare Pot. Munt Zaden Inclusief.

📏 8 × 8 × 8 cm 📦 60
 🌈 Print Code: E(4), L1



Sober

6484

Grow Pouch. Paper. Assorted Coloured Flowers. 5-8 Petunia Seeds Included.
 Blumentopf. Papier. Verschiedenfarbige. 5-8 Petuniensamen Inklusive.
 Pot de Fleurs. Papier. Fleurs Couleurs Diverses. 5-8 Graine de Pétunia Inclus.
 Bloempot. Paper. Assortiment van gekleurde bloemen. 5-8 Petunia Zaden Inclusief.

📏 11 × 13 × 5 cm 📦 500 / 50
 🌈 Print Code: D(1)



RPET

i The fabric used in the manufacturing process of this item is made of recycled plastic (RPET). Like this, the emission of plastic residues to our planet and the consumption of energy is drastically reduced, resulting in a much more eco-friendly process.

El material de este producto está fabricado con plástico reciclado (RPET), que, además de ayudar en la disminución de residuos plásticos en el planeta, utiliza menos energía en el proceso de fabricación, haciendo que sea mucho menos dañino para el medio ambiente.

STOP PLASTIC POLLUTING THE OCEAN



**MORE
HAND FANS**

IN SUMMER & BEACH
SECTION

PG 998-1001



Lencer

6468

BAMBOO FIBRE / RPET

Hand Fan. Bamboo Fibre/ PP/ Polyester RPET.

Fächer. Bambusfaser/ PP/ Polyester RPET.

Éventail. Fibre Bamboo/ PP/ Polyester RPET.

Waaier. Bamboe Fibre/ PP/ Polyester RPET.

42.5 x 23 cm 250 / 25

Print Code: D(1), E(2), L1



620



Tela

8096

Hand Fan. PP/ Polyester.

Fächer. PP/ Polyester.

Éventail. PP/ Polyester.

Waaier. PP/ Polyester.

43 x 23 cm 250 / 25

Print Code: D(1), E(2)



Folklore

8863

Hand Fan. Wood/ Cotton/ Polyester.

Fächer. Holz/ Baumwolle/ Polyester.

Éventail. Bois/ Coton/ Polyester.

Waaier. Houten/ Katoen/ Polyester.

42.5 x 23 cm 250 / 25

Print Code: D(1), E(2), L1





NEW

05
MIRRORED
EFECTO ESPEJO

Mitrox 6810

Sunglasses. Bamboo/ PC. UV400 Protection.
Sonnenbrille. Bambus/ PC. UV400 Schutz.
Lunettes de Soleil. Bambou/ PC. Protection UV400.
Zonnebril. Bamboe/ PC. UV400 Bescherming.

Consult. 300 / 10
Print Code: D(4), L1



08



19

621



02

Xaloc 7000

Sunglasses. UV400 Protection.
Sonnenbrille. UV400 Schutz.
Lunettes de Soleil. Protection UV400.
Zonnebril. UV400 Bescherming.

Consult. 300 / 10
Print Code: D(4)



NEW

03

Sigma 6811

Sunglasses. RPET. UV400 Protection.
Sonnenbrille. RPET. UV400 Schutz.
Lunettes de Soleil. RPET. Protection UV400.
Zonnebril. RPET. UV400 Bescherming.

Consult. 300 / 10
Print Code: D(4)





Holnier

5741
Charger Synchronizer. Micro USB and Lightning Connection.
Ladegerät Sincro. Anschluss Micro USB und Lightning.
Chargeur Synchroniseur. Connexion Micro USB et Lightning.
Oplader Synchronizer. Micro USB Connectie en Lightning.

1.3 x 5.3 x 1.1 cm 500 / 250
Print Code: C(4)

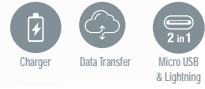

Hedul

5969
Charger Synchronizer. Micro USB, Type C and Lightning Connection.
Ladegerät Sincro. Anschluss Micro USB, Typ C und Lightning.
Chargeur Synchroniseur. Connexion Micro USB, Type C et Lightning.
Oplader Synchronizer. Micro USB, Type C en Lightning Connectie.

1.2 x 6.7 x 1 cm 500 / 250
Print Code: C(4)

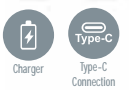

Ceyban

6088
Bracelet Charger. Aluminium/TPE. Type C Connection.
Armband Ladegerät. Aluminium/TPE. Anschluss Typ C.
Chargeur Bracelet. Aluminium/TPE. Connexion Type C.
Armband Oplader. Aluminium/TPE. Type C Connectie.

22 x 1.2 x 0.8 cm 300 / 50
Print Code: L1



Zaref

5956
Keyring Charger. Led Lights. Micro USB, Type C and Lightning Connection.
Schlüsselanhänger Ladegerät. Led Lichter. Anschluss Micro USB, Typ C und Lightning.
Chargeur Porte-Clés. Lumières Led. Connexion Micro USB, Type C et Lightning.
Sleutelhanger Oplader. Led Lichten. Micro USB, Type C en Lightning Connectie.

1.4 x 1.3 x 1.4 cm 500 / 100
Print Code: D(4), L1



SPECIAL LASER ENGRAVING WHITE LIGHT LOGO

This item with an illuminated interior have an external coating specially designed for laser engraving, with which you will see your advertising or brand illuminated with white light. Ideal for pad printing too.

Este artículo con interior iluminado tienen un recubrimiento exterior especialmente diseñado para grabado láser, con el que conseguirá que su publicidad o marca quede originalmente iluminada con luz blanca. Ideales para tampografía también.

SUITABLE FOR PAD PRINTING
VÁLIDO PARA TAMPOGRAFÍA



HOLDER



NEW

Tolem 6798

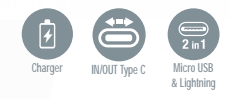

Multifunction Charger. Bamboo. Micro USB, Type C and Lightning Connection.
 Multifunktion Ladegerät. Bambus. Anschluss Micro USB, Typ C und Lightning.
 Chargeur Multifonction. Bambou. Connexion Micro USB, Type C et Lightning.
 Multifunctioneel Oplader. Bamboe. Micro USB, Type C en Lightning Connectie.

2.7 x 15.5 x 1.5 cm 300 / 50
 Print Code: D(4), L1, W

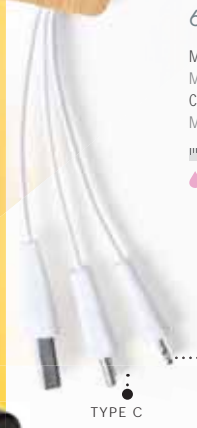

MICRO USB & LIGHTNING
 TYPE C

623



HOLDER SOPORTE



SCREEN CLEANER
 LIMPIA PANTALLAS

Safari 4633



Holder Keyring. Screen Cleaner Included.
 Schlüsselanhänger Halter. Displayreiniger Inklusiv.
 Porte-Clés Support. Nettoyeur d'Écran Inclus.
 Sleutelhanger Houder. Screen Cleaner Inclusief.

2 x 4.8 x 1.3 cm 1000 / 100
 Print Code: C(4), W



Holys 4636



Speaker Keyring.
 Lautsprecher Schlüsselanhänger.
 Haut-Parleurs Porte-Clés.
 Luidspreker Sleutelhanger.

2.8 x 6.3 x 2.8 cm 500 / 50
 Print Code: C(4), W



NEW

Maros 6796

Holder Keyring. Bamboo.
 Schlüsselanhänger Halter. Bambus.
 Porte-Clés Support. Bambou.
 Sleutelhanger Houder. Bamboe.

2.6 x 6 x 1.5 cm 500 / 100
 Print Code: D(4), L1, W





05

HOLDER
SOPORTE

19

SCREEN CLEANER
LIMPIA PANTALLASTOUCH
PUNTERORontil
48524in1
MultifunctionStylus Touch Pen Mobile Holder. Screen Cleaner Included.
Touchpad Stift Handyhalter. Displayreiniger Inklusive.
Styllet Support Mobile. Nettoyeur d'Écran Inclus.
Touchscreen-Pen Houder. Screen Cleaner Inclusief.

1.6 × 8.4 × 2 cm 1000 / 100

Print Code: C(4)



01

03

02

624

HOLDER



03



03

04

05

19

01

Walox
4240Stylus Touch Screen Cleaner.
Touchpad Stift Displayreiniger.
Styllet Nettoyeur d'Écran.
Touchscreen-Pen Schermeschoner.

1.5 × 5.3 × 0.8 cm 1000 / 100

Print Code: C(1)



02

01

19

05

Cirex
4343Stylus Touch Pen.
Touchpad Stift.
Styllet.
Touchscreen-Pen.

Ø 1.4 × 9 cm 500 / 25

Print Code: B(4)

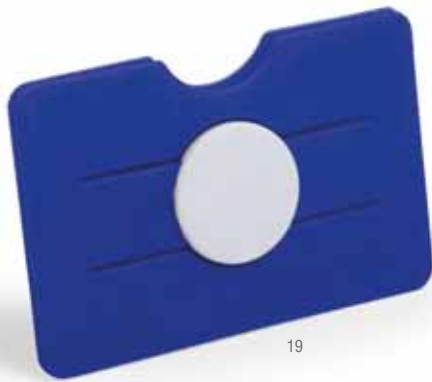

19



04 05 01 11 07 03 02

Tisson

6305

Holder. ABS/ Silicone. Adhesive. 1 Compartment.
 Halter. ABS/ Silikon. Haftend. 1 Abteilung.
 Support. ABS/ Silicone. Adhésif. 1 Compartment.
 Houder. ABS/ Siliconen. Klevend. 1 Compartment.

8.8 × 5.6 × 0.5 cm 500 / 100

Print Code: D(4)



IDEAL FOR 5 CARDS
 ADECUADO PARA 5 TARJETAS

SUITABLE FOR ALL MOBILE DEVICES
 VALIDO PARA TODOS LOS DISPOSITIVOS



03



19 01 02

Sernel

6304



Protector Holder. ABS/ Silicone.
 Unterstützungsschutz. ABS/ Silikon.
 Support Protecteur. ABS/ Silicone.
 Beschermers met Houder. ABS/ Siliconen.

10.2 × 6.2 × 0.6 cm 500 / 100

Print Code: E(1)



11



03 04 05 19 01



Blizz

4679

Multipurpose Pouch. Silicone. Adhesive.
 Mehrzweckhülle. Silikon. Haftend.
 Etui Multi-Usages. Silicone. Adhésif.
 Multifunctionele Hoes. Siliconen. Klevend.

5.6 × 9.5 × 0.5 cm 500 / 100

Print Code: L1



03

Smaner

5022

Holder. Silicone. Adhesive.
 Halter. Silikon. Haftend.
 Support. Silicone. Adhésif.
 Houder. Siliconen. Klevend.

5 × 10.1 × 0.5 cm 1000 / 100

Print Code: D(1)



01 19 02

NEW

Kumol

6686

Antibacterial Holder. Adhesive.
Antibakteriell Halter. Haftend.
Support Antibactérien. Adhésif.
Antibacterieel Houder. Klevend.

Ø 4.4 × 2.9 cm

1000 / 100

Print Code: B(4), W



the price

626

Hunabik

6591

Holder. Adhesive.
Halter. Haftend.
Support. Adhésif.
Houder. Klevend.

Ø 4.4 × 2.9 cm

1000 / 100

Print Code: B(4), W



03

Sunner

6258

Holder. Adhesive.
Halter. Haftend.
Support. Adhésif.
Houder. Klevend.

Ø 4.1 × 0.6 cm

1000 / 250

Print Code: B(4), W

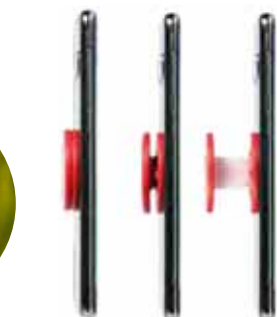



NEW

Kafu

6780

Holder. Metal. Adhesive.
 Halter. Metall. Haftend.
 Support. Metal. Adhésif.
 Houder. Metaal. Klevend.

3 x 3 x 0.4 cm
 Print Code: B(4), L1

1000 / 100



Sustre

6685

Antibacterial Holder. Adhesive. 4 Functions.
 Antibakteriell Halter. Haftend. 4 Funktionen.
 Support Antibactérien. Adhésif. 4 Fonctions.
 Antibacterieel Houder. Klevend. 4 Functies.

Ø 3.3 x 0.6 cm
 Print Code: B(4), W

2000 / 1000

NEW



SELFIES

627



Quiton

6084

Holder. Adhesive. 4 Functions.
 Halter. Haftend. 4 Funktionen.
 Support. Adhésif. 4 Fonctions.
 Houder. Klevend. 4 Functies.

Ø 3.3 x 0.6 cm
 Print Code: B(4), W

2000 / 1000

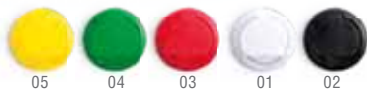

Arnold

5551

Holder. Adhesive.
 Halter. Haftend.
 Support. Adhésif.
 Houder. Klevend.

3.5 x 4 x 0.6 cm
 Print Code: B(4)

2000 / 1000



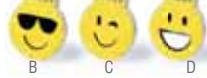

Winlon

5403

Notebook. Hard Cover. 40 Sheets.
Notizbuch. Hardcover-Abdeckung. 40 Seiten.
Cahier. Couverture Rigide. 40 Feuilles.
Notitieboek. Harde Kaft. 40 Bladzjes.

8 × 9 × 1.1 cm 500 / 50

Print Code: D(4)



40 Sheets
Plain



Registered
design



A

Mateky

5594

Eraser Set. 4 Pieces.
Radiergummi Set. 4 Stück.
Set Gommies. 4 Pièces.
Gummen Set. 4 Stuks.

7.7 × 7.5 × 0.7 cm 500 / 50

Print Code: C(1)



Registered
design



4 PIECES



628

370 ml



D



A

B

C

Ashley

5425

Mug. Ceramic. 370 ml. Individual Presentation.
Tasse. Keramik. 370 ml. Individuelle Präsentation.
Tasse. Céramique. 370 ml. Présentation Individuelle.
Mok. Keramik. 370 ml. Individuele Presentatie.

Ø 8.2 × 9.8 cm 36

Print Code: F(4)



Registered
design

Fricum

5402

Pen.
Kugelschreiber.
Stylo.
Pen.

Ø 0.9 × 14 cm 1000 / 50

Print Code: B(4)



Registered
design



A

B

C



D



A



Registered
design

Sukrem

5424

Foldable Bag. Polyester 190T.
Faltbare Tasche. Polyester 190T.
Sac. Pliable. Polyester 190T.
Opvouwbare Tas. Polyester 190T.

40 × 38 cm 400 / 10

Print Code: F(1), G(1)



D



C



B





photo BOOTH



Carrey

5471
 Selfie Set. 5 Pieces.
 Selfie Set. 5 Stuks.
 Set Selfie. 5 Pieces.
 Selfie Set. 5 Stuks.

20 x 25 cm 200 / 20
 Print Code: B(1)

SET 5 PIECES

629

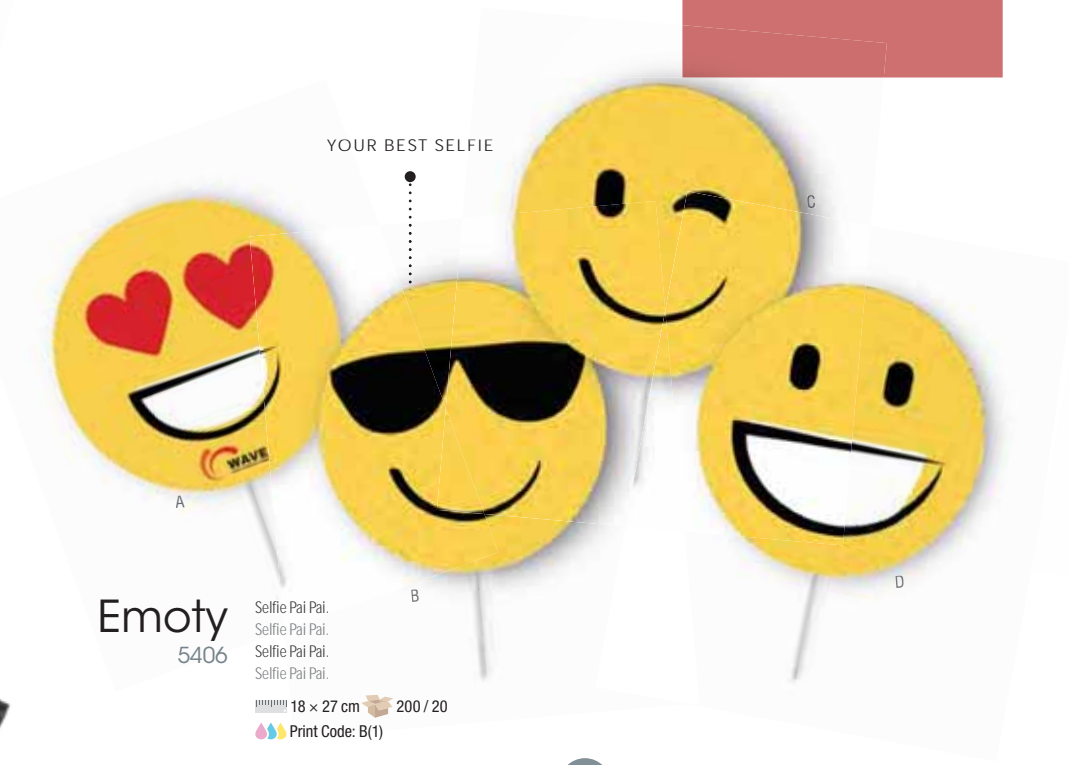

Emoty

5406

Selfie Pai Pai.
 Selfie Pai Pai.
 Selfie Pai Pai.
 Selfie Pai Pai.

18 x 27 cm 200 / 20
 Print Code: B(1)

YOUR BEST SELFIE



Kraliem

5472

Selfie.
 Selfie.
 Selfie.
 Selfie.

17 x 21 cm 2000 / 200
 Print Code: B(1)





19



Lavander



Strawberry



Vanilla



03



01



07



04



Orange



Apple

Persy

6485

Aromatic Candle. Glass.
Duftkerze. Glas.
Bougie Aromatique. Verre.
Geurkaars. Glas.

Ø 5 × 6.3 cm

Print Code: F(1), L1

100 / 50

CANDLES



630



Vanilla

03



01



02



04



19



05



07



11

Sioko

4819

Aromatic Candle. Metal. Vanilla Aroma.
Duftkerze. Metall. Vanille Duft.
Bougie Aromatique. Metal. Arôme Vanille.
Geurkaars. Metaal. Vanille Aroma.

Ø 6.3 × 3 cm

Print Code: E(1), L1

100 / 50



18



Chocolat

07



Orange

Shiva

9718

Aromatic Candle. Metal.
Duftkerze. Metall.
Bougie Aromatique. Metal.
Geurkaars. Metaal.

Ø 6.4 × 5 cm

Print Code: E(1), L1

100 / 50

13



Vanilla

HOME

SWEET HOME



NEW



Trivak
6792

Aromatic Candle. Glass/ Bamboo. Vanilla Aroma.
Dufikerze. Glas/ Bambou. Vanille Duft.
Bougie Aromatique. Verre/ Bambou. Arôme Vanille.
Geurkaars. Glas/ Bamboe. Vanille Aroma.

Ø 7 × 8.7 cm 50
Print Code: E(1), L1



Tepor
6348

Aromatic Candle. Glass/ Natural Cork.
Dufikerze. Glas/ Naturkork.
Bougie Aromatique. Verre/ Bouchon Naturel.
Geurkaars. Glas/ Natuurlijk Kurk.

Ø 5.6 × 7.6 cm 100 / 25
Print Code: E(1), L1

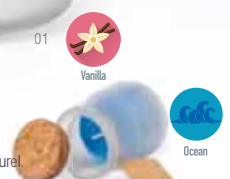

19



03

Nettax
5828

Aromatic Candle. Glass.
Dufikerze. Glas.
Bougie Aromatique. Verre.
Geurkaars. Glas.

Ø 5.6 × 6.7 cm 50
Print Code: F(1), L1



09



02



01



Temul
6408

Aromatic Candle. Glass. Vanilla Aroma. Chalk Included.
Dufikerze. Glas. Vanille Duft. Kreide Inklusie.
Bougie Aromatique. Verre. Arôme Vanille. Craie Inclus.
Geurkaars. Glas. Vanille Aroma. Krijtje Inclusief.

Ø 7 × 7.8 cm 50
Print Code: E(1), L1



WRITE YOUR MESSAGES AND WISHES /
ESCRIBE TUS MENSAJES Y DESEOS

Shoilen

6310

Wish Bottle. Glass.
Wunsch-Dose. Glas.
Bouteille à Souhails. Verre.
Wens fles. Glas.

📏 Ø 3 × 7.4 cm 📦 200 / 50

🖨️ Print Code: E(1), L1



niceresito

632



23



09

Yefry

5937

Bell. Metal.
Klingel. Metall.
Cloche. Métal.
Bel. Metaal.

📏 Ø 4 × 6.2 cm 📦 500

🖨️ Print Code: L1, D(1)



Lupok

6249

Bottle Lights. 10 Leds. Button Batteries Included.
Lichtstecker. 10 Leds. Knopfzellen Inklusiv.
Bec Lumineux. 10 Leds. Piles Bouton Inclus.
Sfeerlichtjes. 10 Leds. Knoopcel Batterijen Inclusief.

📏 Ø 2.2 × 4.8 cm 📦 500 / 100

🖨️ Print Code: C(1)





633

ASSORTED FLAVOURS: ORANGE, LEMON, STRAWBERRY, APPLE AND COLA / SABORES SURTIDOS: NARANJA, LIMÓN, FRESA, MANZANA Y COLA
 PRICE INCLUDES UP TO TWO COLOR PRINT, SET UP COST NOT INCLUDED / ESTOS PRECIOS INCLUYEN IMPRESIÓN HASTA DOS COLORES, CLICHÉS NO INCLUIDOS

Lazo

2522
 Candy.
 Bonbon.
 Bonbon.
 Snoep.

Print Code: Consult.



PRICE X KG:
 240PCS/KG APROX.

Piruleta

2523
 Candy.
 Bonbon.
 Bonbon.
 Snoep.

Print Code: Consult.



PRICE X KG:
 150PCS/KG APROX.

Sobre

2521
 Candy.
 Bonbon.
 Bonbon.
 Snoep.

Print Code: Consult.



PRICE X KG:
 325PCS/KG APROX.



02

Corkey 5136

Braces. Polyester. One Size. Adult.
Hosenträger. Polyester. Einheitsgröße. Erwachsene.
Bretelles. Polyester. Taille Unique. Adulte.
Bretels. Polyester. Een Maat. Volwassen.

11 × 31 × 0.9 cm 100 / 10

Print Code: E(1), L1



01

Accessories



634



02

Serq 7056

Tie. Polyester.
Krawatte. Polyester.
Cravate. Polyester.
Stropdas. Polyester.

9 × 148 cm 100 / 10

Print Code: N(8), R



01



19



03



04



02



07



03



19



14



01

Look

9476

Belt. Polyester.
Gürtel. Polyester.
Ceinture. Polyester.
Riem. Polyester.

110 × 4 × 0.3 cm 100

Print Code: L1, R



Accessories



02

18

Mudson
4590

Wallet. PU.
Brieftasche. PU.
Portefeuille. Similicuir.
Portemonnee. PU.

11.2 × 9.3 × 1 cm  400 / 10
Print Code: E(1), L1

635



Belo
3938

Watch Set. Metal.
Uhrenset. Metall.
Set Montres. Métal.
Horloge Set. Metaal.

9.8 × 5.8 × 9.5 cm  50
Print Code: L2

MAN AND WOMAN
HOMBRE Y MUJER



06



Mirtox
4830

Scarf. Cotton/ Polyester.
Schal. Baumwolle/ Polyester.
Foulard. Coton/ Polyester.
Sjaal. Katoen/ Polyester.

180 × 50 cm  200 / 10
Print Code: F(1), N(8)

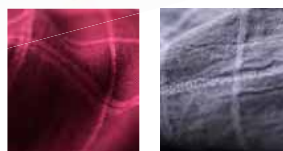

What TIME is it?



02



Belex
3838

Watch. Silicone Strap.
Uhr. Silikonarmband.
Montre. Bracelet Silicone.
Horloge. Siliconen Band.

24 × 4.5 × 1.7 cm 200 / 50

Print Code: F(1)

03

01

19



POR

Enki
3680

Watch. Silicone Strap.
Uhr. Silikonarmband.
Montre. Bracelet Silicone.
Horloge. Siliconen Band.

26 × 4.9 × 1.3 cm 200 / 20

Print Code: L1



FRA



01

19

03

Balder
3679

Watch. Silicone Strap.
Uhr. Silikonarmband.
Montre. Bracelet Silicone.
Horloge. Siliconen Band.

26 × 4.5 × 1.3 cm 200 / 20

Print Code: L1



02

What
TIME is it?



03

Terax

4584

Watch. Silicone. Ultra Slim.
Uhr. Silikon. Ultradünn.
Montre. Silicone. Ultra Fin.
Horloge. Siliconen. Ultra Dun.

25.8 x 4 x 0.7 cm 200 / 20

Print Code: F(1)



19



02



07



05



04



04

05

07

11



02

01

19

Fobex

3678

Watch. Silicone Strap.
Uhr. Silikonarmband.
Montre. Bracelet Silicone.
Horloge. Siliconen Band.

24.5 x 4 x 1.2 cm 200 / 20

Print Code: L1



03



11

03

04



19

05

Hyspol

4475

Watch. Silicone Strap.
Uhr. Silikonarmband.
Montre. Bracelet Silicone.
Horloge. Siliconen Band.

24.5 x 4 x 1.2 cm 200 / 20

Print Code: L1



07



Cirlam

5043

Paperweight. Glas.
Briefbeschwerer. Glas.
Presse-Papier. Verre.
Presse-Papier. Glas.

📏 8 × 4 cm 📦 30 / 10

🎨 Print Code: L2, W



IDEAL FOR
DIGITAL PRINTING
AND
LASER ENGRAVING



Congratulations!

638



World

3661

Ball. Glas.
Kugel. Glas.
Sphere. Verre.
Wereldbol. Glas.

📏 6 × 10 × 6 cm 📦 30

🎨 Print Code: F(2), L2



IDEAL FOR
DIGITAL PRINTING
AND
LASER ENGRAVING



Cudor

5042

Paperweight. Glas.
Briefbeschwerer. Glas.
Presse-Papier. Verre.
Presse-Papier. Glas.

📏 5 × 5 × 5 cm 📦 30 / 10

🎨 Print Code: L2, W



Congratulations!



Owen
5175

Plaque. Glass.
Plakette. Glas.
Plaque. Verre.
Plaque. Glas.

10 × 11 × 6 cm 20
Print Code: F(2), L2



Recsum

5176

Plaque. Glass.
Plakette. Glas.
Plaque. Verre.
Plaque. Glas.

14 × 19 × 4.5 cm 20
Print Code: F(2), L2



Nelum

4429

Plaque. Glass.
Plakette. Glas.
Plaque. Verre.
Plaque. Glas.

14 × 14 × 6.3 cm 40
Print Code: F(2), L2, W



Honey
5691

Plaque. Glass.
Plakette. Glas.
Plaque. Verre.
Plaque. Glas.

6.6 × 11.8 × 1.9 cm 40
Print Code: F(2), L2, W

MAGNET
YOUR DESIGN



MAGNET

YOUR DESIGN

minimum 300 pcs - mínimo 300 pcs

Full colour printing included,
set up cost not included.

Impresión a todo color incluida
cliché no incluido.

Hadrix
2520

Magnet. PVC.
Magnet. PVC.
Magnet. PVC.
Magneet. PVC.



DOMING MAGNET

YOUR DESIGN

minimum 300 pcs - mínimo 300 pcs

Full colour printing + Doming included,
set up cost not included.

Impresión a todo color + Doming incluido
cliché no incluido.

Frigor
2519

Magnet. Resinated PVC.
Magnet. Harzgebund PVC.
Magnet. PVC Résiné.
Magneet. Geharst PVC.



Cuatico

2528

Magnet. Felt Tip Pen Not Included.
Magnet. Filzstift Nicht im Lieferumfang.
Magnet. Feutre Non Inclus.
Magneet. Felt Tip Pen Niet Inclusief.

10.5 x 15 cm

Print Code: Consult.

MAGNET

YOUR DESIGN

minimum 300 pcs - mínimo 300 pcs

Full colour printing included,
set up cost not included.

Impresión a todo color incluida
cliché no incluido.



Solek

5048

Felt Tip Pen. Magnetic.
Filzstift. Magnetisch.
Feutre. Magnétique.
Felt Tip Pen. Magnetisch.

Ø 1 x 11.4 cm 2000 / 50

Print Code: B(4)



04



Turmi
3741

Pin.
Pin.
Pin.
Speld.

📏 Ø 3 cm 📦 4000 / 200
🎨 Print Code: B(1)



PIN DOMING



Batler
4607

Pin. Metal.
Pin. Metall.
Pin. Métal.
Speld. Metaal.

📏 Consult. 📦 1000 / 500
🎨 Print Code: Consult.

YOUR DESIGN
minimum 300 pcs - mínimo 300 pcs
Full colour printing + Doming included,
set up cost not included.

Impresión a todo color + Doming incluido
cliché no incluido.

PIN DOMING



641

Formix
4762

Pin.
Pin.
Pin.
Speld.

📏 Consult. 📦 5000 / 100
🎨 Print Code: Consult.

YOUR DESIGN

minimum 300 pcs - mínimo 300 pcs
Full colour printing + Doming included,
set up cost not included.

Impresión a todo color + Doming incluido
cliché no incluido.



Hirion

4336

Bracelet.

Armband.

Bracelet.

Armband.

▬ 06 × 0.8 cm 📦 2000 / 100

🌈 Print Code: D(1)

02



11



03



19



05



01



11

19



04

02

01

05

03



03

Quilex

5480

Bracelet. PU/ Polyester. Adjustable.

Armband. PU/ Polyester. Verstelbaar.

Bracelet. Similicuir/ Polyester. Ajustable.

Armband. PU/ Polyester. Aanpasbaar.

▬ 08 × 1.2 cm 📦 2000 / 10

🌈 Print Code: D(1)



05

19

02

01



05F

FLUORESCENT ●.....

Katil

4398

Bracelet. PU. Adjustable.

Armband. PU. Verstelbaar.

Bracelet. Similicuir. Ajustable.

Armband. PU. Aanpasbaar.

▬ 08 × 1 cm 📦 2000 / 10

🌈 Print Code: D(1)



11F

07F

04F



Plasker

5061

Bracelet. Polyester. Adjustable. Safety Catch.
Armband. Polyester. Verstellbaar. Sicherheitsverschluss.
Bracelet. Polyester. Ajustable. Fermeture Sécurité.
Armband. Polyester. Aanpasbaar. Veiligheidsluiting.

35 x 1.5 cm 2000 / 500

Print Code: D(1), R



11



05

Mendol

5060

Bracelet. Polyester. Adjustable.
Armband. Polyester. Verstellbaar.
Bracelet. Polyester. Ajustable.
Armband. Polyester. Aanpasbaar.

34,5 x 1.2 cm 2000 / 500

Print Code: D(1), R



Neliam

4313

Multipurpose Bracelet. Polyester.
Mehrzweck Armband. Polyester.
Bracelet Multi-Usages. Polyester.
Multifunctionele Armband. Polyester.

40 x 3 cm 20000 / 1000

Print Code: D(1), R



03



SUBLIMATION PRINTING



Waylen

5852

Sublimation Bracelet. Polyester.
Sublimations Armband. Polyester.
Bracelet Sublimation. Polyester.
Sublimatie Armband. Polyester.

30 x 1.5 cm

Print Code: R





Delbin

3737

Torch. Aluminium. 6 Leds. Button Batteries Included.
Lampe. Aluminium. 6 Leds. Knopfzellen Inklusive.
Lampe. Aluminium. 6 Leds. Piles Bouton Inclus.
Zaklamp. Aluminium. 6 Leds. Knoopcelbatterij Inclusief.

Ø 2.5 × 5 cm 200 / 100

Print Code: D(4), L1



19

03

02

05

MAGNET

Thelix

4247

Torch. 2 Leds. Magnetic. Button Batteries Included.
Lampe. 2 Leds. Magnétisch. Knopfzellen Inklusive.
Lampe. 2 Leds. Magnétique. Piles Bouton Inclus.
Zaklamp. 2 Leds. Magnetisch. Knoopcelbatterij Inclusief.

3.8 × 12.5 × 0.5 cm 300 / 50

Print Code: D(4)



11

07

02

03

04

19

Shika

4497

Keyring Torch. 1 Led. Button Batteries Included.
Schlüsselanhänger Lampe. 1 Led. Knopfzellen Inklusive.
Porte-Clés Lampe. 1 Led. Piles Bouton Inclus.
Sleutelhanger Zaklamp. 1 Led. Knoopcel Batterijen Inclusief.

2.4 × 6 × 0.9 cm 1000 / 50

Print Code: C(4)



19



02



09



03

Krujer

5035

Pen Torch. 1 Led. Button Batteries Included.
Kugelschreiber Lampe. 1 Led. Knopfzellen Inklusive.
Stylo Lampe. 1 Led. Piles Bouton Inclus.
Pen-Zaklamp. 1 Led. Knoopcel Batterijen Inclusief.

Ø 1 × 11 cm 500 / 50

Print Code: C(4)

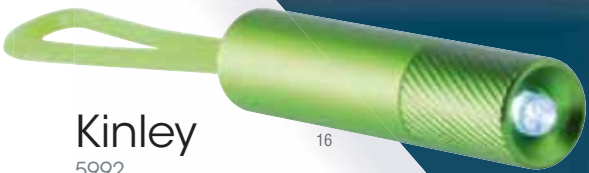

Kinley

16

5992

Torch. Aluminium. 1 Led. Button Batteries Included.
Lampe. Aluminium. 1 Led. Knopfzellen Inklusive.
Lampe. Aluminium. 1 Led. Piles Bouton Inclus.
Zaklamp. Aluminium. 1 Led. Knoopcelbatterij Inclusief.

██████████ Ø 1.3 x 5.5 cm 📦 500 / 100

🌈 Print Code: D(4), L1



Zola

3406

Torch. Aluminium. 1 Led. Button Batteries Included.
Lampe. Aluminium. 1 Led. Knopfzellen Inklusive.
Lampe. Aluminium. 1 Led. Piles Bouton Inclus.
Zaklamp. Aluminium. 1 Led. Knoopcel Batterijen Inclusief.

██████████ Ø 1.5 x 6 cm 📦 600 / 100

🌈 Print Code: D(4), L1



645

Zaro

4982

Torch. Aluminium. 3 Leds. Button Batteries Included.
Lampe. Aluminium. 3 Leds. Knopfzellen Inklusive.
Lampe. Aluminium. 3 Leds. Piles Bouton Inclus.
Zaklamp. Aluminium. 3 Leds. Knoopcel Batterijen Inclusief.

██████████ Ø 1.7 x 7.1 cm 📦 500 / 10

🌈 Print Code: D(4), L1



Flonse

5207

Keyring Torch. 1 Led. Button Batteries Included.
Schlüsselanhänger Lampe. 1 Led. Knopfzellen Inklusive.
Porte-Clés Lampe. 1 Led. Piles Bouton Inclus.
Sleutelhanger Zaklamp. 1 Led. Knoopcel Batterijen Inclusief.

██████████ Ø 1.4 x 6.5 cm 📦 1000 / 50

🌈 Print Code: C(4)



Fairox

5172

Torch. Aluminium. 1 Led. Button Batteries Included.
Lampe. Aluminium. 1 Led. Knopfzellen Inklusive.
Lampe. Aluminium. 1 Led. Piles Bouton Inclus.
Zaklamp. Aluminium. 1 Led. Knoopcel Batterijen Inclusief.

██████████ Ø 1.3 x 5.9 cm 📦 200 / 50

🌈 Print Code: E(1), L1



Opener



03



Vaygox

4845

Lighter. Refillable.
Feuerzeug. Wiederaufladbar.
Briquet. Rechargeable.
Aansteker. Navulbaar.

2.4 x 8 x 0.9 cm 1000 / 50

Print Code: A(4)



19

Plain

9943

Lighter. Refillable.
Feuerzeug. Wiederaufladbar.
Briquet. Rechargeable.
Aansteker. Navulbaar.

2.4 x 8 x 0.9 cm 1000 / 50

Print Code: A(4)



646



Mundi

3906

Lighter. Refillable.
Feuerzeug. Wiederaufladbar.
Briquet. Rechargeable.
Aansteker. Navulbaar.

2.5 x 6.4 x 1.2 cm 1000 / 50

Print Code: A(4)



23

Ronels

2548

Lighter. Refillable.
Feuerzeug. Wiederaufladbar.
Briquet. Rechargeable.
Aansteker. Navulbaar.

2.4 x 8.1 x 1.1 cm 1000 / 50

Print Code: A(4)



09

Deuston

2537

Lighter. Metal. Refillable.
Feuerzeug. Metall. Wiederaufladbar.
Briquet. Métal. Rechargeable.
Aansteker. Metaal. Navulbaar.

3.9 x 5.8 x 1.3 cm 360 / 12

Print Code: L1



MATTE



02

Rosser

2553

Kitchen Lighter. Refillable.
Küchen Feuerzeug. Wiederaufladbar.
Briquet Cuisine. Rechargeable.
Keuken Aansteker. Navulbaar.

2.7 x 12.3 x 1.4 cm 600 / 50

Print Code: B(4)



01



19

Parsok
2552

Lighter.
Feuerzeug.
Briquet.
Aansteker.

2.3 x 8.1 x 1.1 cm 1000 / 50
Print Code: A(4)



04 05 03 02 01

647

Minicricket
2483

Lighter.
Feuerzeug.
Briquet.
Aansteker.

2.2 x 5.8 x 1 cm 500 / 25
Print Code: A(4)



19 01 03 02 05 04



Ferroc
2526

Lighter.
Feuerzeug.
Briquet.
Aansteker.

2.3 x 8.1 x 1.1 cm 1000 / 50
Print Code: A(4)

NOT FOR INDIVIDUAL SALE
ASSORTED COLOURS
VENTA POR CAJAS COMPLETAS
EN SURTIDO DE COLORES



Fenick
2536

Lighter.
Feuerzeug.
Briquet.
Aansteker.

2.4 x 8 x 1.1 cm 1000 / 50
Print Code: A(4)

NEON COLOUR



NEON COLOUR

NOT FOR INDIVIDUAL SALE
ASSORTED COLOURS
VENTA POR CAJAS COMPLETAS
EN SURTIDO DE COLORES

Stromber

2549

Lighter. Refillable.
Feuerzeug. Wiederaufladbar.
Briquet. Rechargeable.
Aansteker. Navulbaar.

2.2 x 8 x 1.7 cm 1152 / 48

Print Code: A(4)



smoking
set



648



03

04

19

Morris

4785

Filling Machine.
Strahlpumpe.
Machine à Injecter.
Vulmaschine.

12.4 x 4.1 x 3.2 cm 200 / 50

Print Code: D(4)



19

Kapnos

4784

Grinder.
Grinder.
Broyeur.
Grinder.

Ø 4.2 x 2 cm 500 / 20

Print Code: C(4)



03



01



04



Cleansand 2453

Ashtray.
Aschenbecher.
Cendrier.
Asbak.

Ø 5.8 x 8.1 cm 500 / 50
Print Code: C(4)



02



03

649



A B C D



Straik 5412

Cigarette Pack Cover. Cardboard.
Zigarretten Hülle. Pappe.
Étui Cigarettes. Carton.
Sigaretten Hoes. Karton.

5.8 x 9 x 2.3 cm 2000 / 100
Print Code: A(4)

SIDE 2 - CARA 2



SIDE 1 - CARA 1



19

03

04

Kyan 3843

Pocket Ashtray. PVC/ Aluminium.
Tasche Aschenbecher. PVC/ Aluminium.
Cendrier Poche. PVC/ Aluminium.
Zak-Asbak. PVC/ Aluminium.

7.5 x 8.5 x 1.2 cm 500 / 50
Print Code: C(1)



04

19

09

02

Berko 5696

Pocket Ashtray. PVC/ Aluminium.
Tasche Aschenbecher. PVC/ Aluminium.
Cendrier Poche. PVC/ Aluminium.
Zak-Asbak. PVC/ Aluminium.

8 x 8 x 1.1 cm 500 / 50
Print Code: C(1)



RFID Protection System



19



02

03

09

04

01

Recol
6363

Card Holder. RFID Protected. 1 Compartment. Adhesive.
Visitenkartenetui. RFID Schutz. 1 Abteilung. Haftend.
Porte-Cartes. Protecteur RFID. 1 Compartiment. Adhésif.
Kaartjeshouder. RFID Bescherming. 1 Compartiment. Klevend.

6.2 x 9 cm 4000 / 100

Print Code: B(1)



650



19



03

02

01

11

Randy
5187

Card Holder. RFID Protected. 1 Compartment.
Visitenkartenetui. RFID Schutz. 1 Abteilung.
Porte-Cartes. Protecteur RFID. 1 Compartiment.
Kaartjeshouder. RFID Bescherming. 1 Compartiment.

6 x 9 x 0.4 cm 1000 / 100

Print Code: C(4), W



03

01

02

23

17

04

19

Becam
5637

Card Holder. Aluminium. RFID Protected. 1 Compartment.
Visitenkartenetui. Aluminium. RFID Schutz. 1 Abteilung.
Porte-Cartes. Aluminium. Protecteur RFID. 1 Compartiment.
Kaartjeshouder. Aluminium. RFID Bescherming. 1 Compartiment.

6.2 x 9 cm 5000 / 100

Print Code: B(1)



09

RFID



RFID Protection System



Rainol

5371

Card Holder. Aluminium. RFID Protected. 6 Compartments.
 Visitenkartenetui. Aluminium. RFID Schutz. 6 Abteilungen.
 Porte-Cartes. Aluminium. Protecteur RFID. 6 Compartiments.
 Kaartjeshouder. Aluminium. RFID Bescherming. 6 Compartimenten.

11 x 7.5 x 2 cm 200 / 50

Print Code: D(4), L1



RFID Protection



POUCH WITH
RFID PROTECTION SYSTEM
 IDEAL FOR MOBILE DEVICES
 FUNDA CON SISTEMA PROTECCIÓN RFID
 IDEAL PARA DISPOSITIVOS MÓVILES



651



Lindrup

6173

Card Holder. RFID Protected. 1 Compartment.
 Visitenkartenetui. RFID Schutz. 1 Abteilung.
 Porte-Cartes. Protecteur RFID. 1 Compartiment.
 Kaartjeshouder. RFID Bescherming. 1 Compartiment.

6.2 x 10 x 1.1 cm 500 / 50

Print Code: D(4), W



RFID Protection



SLIDE AND REMOVE
 DESLIZA Y EXTRAE

Porlan

5188

Card Holder. Aluminium. RFID Protected. 1 Compartment.
 Visitenkartenetui. Aluminium. RFID Schutz. 1 Abteilung.
 Porte-Cartes. Aluminium. Protecteur RFID. 1 Compartiment.
 Kaartjeshouder. Aluminium. RFID Bescherming. 1 Compartiment.

8.9 x 5.8 x 0.7 cm 400 / 100

Print Code: D(4), L1



RFID Protection



Hismal

6007

Protector Pouch. Polyester. RFID Protected.
 Sicherheit Hülle. Polyester. RFID Schutz.
 Etui Sécurité. Polyester. Protecteur RFID.
 Veiligheid Hoes. Polyester. RFID Bescherming.

12.5 x 19 cm 500 / 100

Print Code: E(1), N(8)



RFID Protection





RFID Protection System

652



Brigit

5221

Card Holder. PU. RFID Protected. 8 Compartments.
Visitenkartenetui. PU. RFID Schutz. 8 Abteilungen.
Porte-Cartes. Similicuir. Protecteur RFID. 8 Compartiments.
Kaartjeshouder. PU. RFID Bescherming. 8 Compartimenten.

8.2 x 11.7 x 1.5 cm 200 / 50

Print Code: E(1), T



02 08 19 04



Serbin

5818



Card Holder. PU. RFID Protected. 5 Compartments.
Visitenkartenetui. PU. RFID Schutz. 5 Abteilungen.
Porte-Cartes. Similicuir. Protecteur RFID. 5 Compartiments.
Kaartjeshouder. PU. RFID Bescherming. 5 Compartimenten.

7.2 x 10.5 x 0.9 cm 500 / 250

Print Code: E(1), L1, T



03



Rupuk

5822

Card Holder Wallet. Polyester. RFID Protected. 6 Compartments.
Visitenkartenetui Brieftasche. Polyester. RFID Schutz. 6 Abteilungen.
Porte-Cartes Portefeuille. Polyester. Protecteur RFID. 6 Compartiments.
Kaartjeshouder Portemonnee. Polyester. RFID Bescherming. 6 Compartimenten.

11 x 8.6 x 1.3 cm 200 / 50

Print Code: E(1), N(8)





18



02

Mudson

4590

Wallet. PU.
Brieftasche. PU.
Portefeuille. Similicuir.
Portemonnee. PU.

11.2 x 9.3 x 1 cm 400 / 10

Print Code: E(1), L1

WALLET & card holder



19

Lanto

4367

Wallet. PU.
Brieftasche. PU.
Portefeuille. Similicuir.
Portemonnee. PU.

8.5 x 10.5 x 2 cm 300 / 50

Print Code: E(1), L1



03



05



01



Midel

4571

Card Holder. PU. 10 Compartments.
Visitenkartenetui. PU. 10 Abteilungen.
Porte-Cartes. Similicuir. 10 Compartiments.
Kaartjeshouder. PU. 10 Compartimenten.

8 x 10.7 x 1 cm 200 / 100

Print Code: D(1)



02



19



03



05



07



11



03

Besing

5734

Card Holder Wallet. PU. 2 Compartments.
 Visitenkartenetui Brieftasche. PU. 2 Abteilungen.
 Porte-Cartes Portefeuille. Similicuir. 2 Compartiments.
 Kaartjeshouder Portemonnee. PU. 2 Compartimenten.

11 × 7.2 × 0.4 cm 500 / 50

Print Code: E(1)



02

01

19

CARDholder



03

Twelve

3143

Card Holder. PU. 12 Compartments.
 Visitenkartenetui. PU. 12 Abteilungen.
 Porte-Cartes. Similicuir. 12 Compartiments.
 Kaartjeshouder. PU. 12 Compartimenten.

7.6 × 10.7 × 0.8 cm 400 / 50

Print Code: E(1), L1



19

02



19

Hektar

4496

Card Holder. Aluminium. 6 Compartments.
 Visitenkartenetui. Aluminium. 6 Abteilungen.
 Porte-Cartes. Aluminium. 6 Compartiments.
 Kaartjeshouder. Aluminium. 6 Compartimenten.

11 × 7.5 × 2 cm 200 / 50

Print Code: D(4), L1



03

02

01



CARDholder

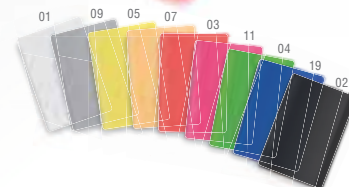

Kazak

4224

Card Holder. PVC. 1 Compartment.
 Visitenkartenetui. PVC. 1 Abteilung.
 Porte-Cartes. PVC. 1 Compartiment.
 Kaartjeshouder. PVC. 1 Compartment.

6.6 × 9.5 × 0.1 cm 5000 / 100

Print Code: C(1)

655



Letrix

4225

Card Holder. PVC. 2 Compartments.
 Visitenkartenetui. PVC. 2 Abteilungen.
 Porte-Cartes. PVC. 2 Compartiments.
 Kaartjeshouder. PVC. 2 Compartimenten.

6.7 × 9.5 × 0.2 cm 2000 / 100

Print Code: C(1)

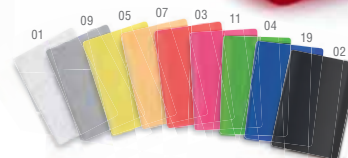

Mitux

4226

Card Holder. PVC. 6 Compartments.
 Visitenkartenetui. PVC. 6 Abteilungen.
 Porte-Cartes. PVC. 6 Compartiments.
 Kaartjeshouder. PVC. 6 Compartimenten.

7.5 × 10.3 × 0.4 cm 1000 / 50

Print Code: C(1)



Babel



01



Babel
4203

Purse. Silicone.
Portemonnaie. Silikon.
Porte Monnaie. Silicone.
Portemonnee. Siliconen.

9.5 x 9 x 4.5 cm 300 / 10

Print Code: F(1)

656



22

09

23

Faudok

5934

Purse. PU.
Portemonnaie. PU.
Porte Monnaie. Similicuir.
Portemonnee. PU.

12 x 8.5 x 0.5 cm 1000 / 10

Print Code: D(1)



11

16

19

03

05

01

Zirplan

5243

Purse. PVC. With Inner Lining.
Portemonnaie. PVC. Mit Innenfutter.
Porte Monnaie. PVC. Avec Doublure Antérieure.
Portemonnee. PVC. Met Voering aan de Binnenzijde.

10 x 8 x 1.8 cm 500 / 10

Print Code: D(1)

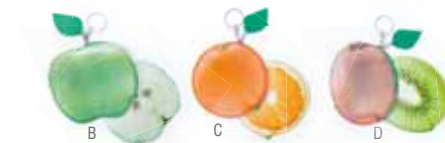

Kumba

5501

Purse. PU.
Portemonnaie. PU.
Porte Monnaie. Similicuir.
Portemonnee. PU.

Ø 12 cm 300 / 10

Print Code: D(1)



Film

9266

Wallet. Polyester 300D.
Brieftasche. Polyester 300D.
Portefeuille. Polyester 300D.
Portemonnee. Polyester 300D.

7.7 x 12.6 x 1 cm 400 / 10

Print Code: N(8)



02 07 19



Trizip

3374

Purse. Leather.
Portemonnaie. Leder.
Porte Monnaie. Cuir.
Portemonnee. Leer.

10 x 6 x 1 cm 500 / 50

Print Code: D(1)

SILICONE



19



02



19



02



03

11

01

Tagu

3967

Purse. Silicone.
Portemonnaie. Silikon.
Porte Monnaie. Silicône.
Portemonnee. Siliconen.

7 x 7.5 x 1.6 cm 300 / 10

Print Code: F(1)

Jared

3777

Purse. PVC.
Portemonnaie. PVC.
Porte Monnaie. PVC.
Portemonnee. PVC.

Ø 6 x 2.8 cm 500 / 25

Print Code: E(1)



07

03

19



03

04

Motok

5102

Keyring Purse. Polyester 600D.
Schlüsselanhänger Portemonnaie. Polyester 600D.
Porte-Clés Porte Monnaie. Polyester 600D.
Sleutelhanger-Tasje. Polyester 600D.

6 x 10.5 x 0.7 cm 500 / 10

Print Code: N(8)

purse



Kaner

5880

Purse: Canvas.
Portemonnaie: Segeltuch.
Porte Monnaie: Toile.
Portemonnaie: Canvas.

11 × 9,5 × 2 cm 1000 / 10

Print Code: D(1), N(8)

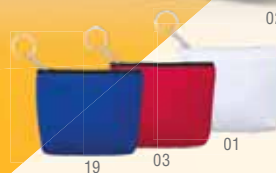

Zesh

4091

Purse: Microfibre.
Portemonnaie: Mikrofaser.
Porte Monnaie: Microfibre.
Portemonnaie: Microfibre.

8,5 × 6 × 0,5 cm 1000 / 10

Print Code: D(1)



Dramix

5095

Purse: PU.
Portemonnaie: PU.
Porte Monnaie: Similicuir.
Portemonnaie: PU.

10,5 × 7,5 × 0,5 cm 1000 / 20

Print Code: D(1), L1

Ralf

5096

Purse: PU.
Portemonnaie: PU.
Porte Monnaie: Similicuir.
Portemonnaie: PU.

10,5 × 9 × 0,8 cm 500 / 10

Print Code: D(1), L1





NEW

Nelsom

6843

Purse. Polyester 600D RPET.
 Portemonnaie. Polyester 600D RPET.
 Porte Monnaie. Polyester 600D RPET.
 Portemonnee. Polyester 600D RPET.

11 x 8 cm

1000 / 20

Print Code: D(1), N(8)



Dabey

5881

Purse. Natural Cork. With Inner Lining.
 Portemonnaie. Naturkork. Mit Innenfutter.
 Porte Monnaie. Bouchon Naturel. Avec Doublure Antérieure.
 Portemonnee. Natuurlijk Kurk. Met Voering aan de Binnenzijde.

10 x 9 x 2 cm

500 / 10

Print Code: D(1), L2

NATURAL CORK
 CORCHO NATURAL



100% COTTON
 100% ALGODÓN



Rultex

5722

Purse. 100% Cotton.
 Portemonnaie. 100% Baumwolle.
 Porte Monnaie. 100% Coton.
 Portemonnee. 100% Katoen.

12 x 9.5 x 1 cm

500 / 50

Print Code: E(1), N(8)



Narse

6475

Purse. Cotton/ Polyester.
 Portemonnaie. Baumwolle/ Polyester.
 Porte Monnaie. Coton/ Polyester.
 Portemonnee. Katoen/ Polyester.

11 x 8.5 x 2 cm

1000 / 10

Print Code: E(1), N(8)

PURSE: TO BE CONSCIOUS



Telsox

6015

Keyring. Natural Cork.
Schlüsselanhänger. Naturkork.
Porte-Clés. Bouchon Naturel.
Sleutelhanger. Natuurlijk Kurk.

📏 $\emptyset 2.3 \times 4.4 \text{ cm}$ 📦 1000 / 50

🌈 Print Code: D(1), L1

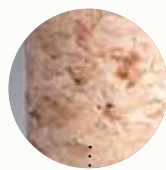

NATURAL CORK
CORCHO NATURAL

Branko

6486

Keyring. Natural Cork/ Metal.
Schlüsselanhänger. Naturkork/ Metall.
Porte-Clés. Bouchon Naturel/ Métal.
Sleutelhanger. Natuurlijk Kurk/ Staal.

📏 $2.7 \times 10.5 \times 0.7 \text{ cm}$ 📦 500 / 50

🌈 Print Code: D(1), L1

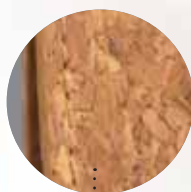

NATURAL CORK
CORCHO NATURAL

Bonscious



660



3.2 X 5.1 X 0.7 CM

B



2.4 X 4.8 X 0.60 CM

$\emptyset 4 \times 0.5 \text{ CM}$

A

Pelton

6204

Keyring. Wood.
Schlüsselanhänger. Holz.
Porte-Clés. Bois.
Sleutelhanger. Hout.

📏 Consult. 📦 1000 / 100

🌈 Print Code: D(4), L1



$\emptyset 3.9 \times 0.7 \text{ CM}$

A

Vitolok

5796

Keyring. Metal/ Wood.
Schlüsselanhänger. Metall/ Holz.
Porte-Clés. Métal/ Bois.
Sleutelhanger. Metaal/ Hout.

📏 Consult. 📦 400 / 50

🌈 Print Code: D(4), L1



BEconscious

Kimbox

6205

Keyring. Natural Cork.
Schlüsselanhänger. Naturkork.
Porte-Clés. Bouchon Naturel.
Sleutelhanger. Natuurlijk Kurk.

Consult. 1000 / 100

Print Code: D(4), L1



661



Selton

6186

Keyring. Wood.
Schlüsselanhänger. Holz.
Porte-Clés. Bois.
Sleutelhanger. Hout.

Consult. 800 / 200

Print Code: D(4), L1



C - 4,5 X 4,5 X 0,2 CM



A - Ø 5,5 X 0,2 CM

Sonek

6809

Keyring. Bamboo.
Schlüsselanhänger. Bambus.
Porte-Clés. Bambou.
Sleutelhanger. Bamboe.

Consult.

Print Code: D(4), L1

1000 / 100



B - 3,9 X 5,9 X 0,2 CM



PIEZAS ÚNICAS PROCEDENTES DE CORTE DE MADERA NATURAL. SU TEXTURA, COLOR, TAMAÑO Y GROSOR PUEDEN VARIAR

UNIQUE PIECES FROM NATURAL CUTS OF WOOD. THE TEXTURE, COLOR, SIZES AND THICKNESS MAY VARY.



19

Persal

4978

Keyring, Stainless Steel.
Schlüsselanhänger, Rostfreier Stahl.
Porte-Clés, Acier Inox.
Sleutelhanger, Roestvrij Staal.

2.9 × 4 × 0.4 cm 200 / 50

Print Code: D(1), L1



05



16



03



01

662



09

19

23

04

Madison

5037

Keyring, Aluminium/ Polyester.
Schlüsselanhänger, Aluminium/ Polyester.
Porte-Clés, Aluminium/ Polyester.
Sleutelhanger, Aluminium/ Polyester.

2.7 × 6.8 × 0.6 cm 200 / 50

Print Code: D(4), L1



03



03

Hokey

5359

Keyring, Stainless Steel.
Schlüsselanhänger, Rostfreier Stahl.
Porte-Clés, Acier Inox.
Sleutelhanger, Roestvrij Staal.

2.3 × 5.2 × 0.8 cm 300 / 50

Print Code: D(1), L1



19



05



03



11

the BEST-SELLER

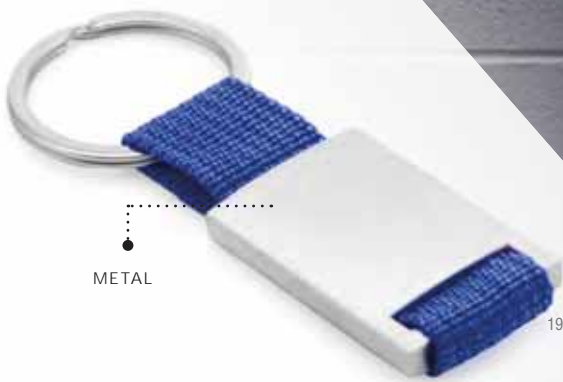

METAL

19



Yip
9274

Keyring. Metal/ Polyester.
Schlüsselanhänger. Metall/ Polyester.
Porte-Clés. Métal/ Polyester.
Sleutelhanger. Metaal/ Polyester.

2.8 x 6.5 x 0.6 cm 300 / 50
Print Code: D(4), L1

Slayter
6062

Keyring. Aluminium/ Polyester.
Schlüsselanhänger. Aluminium/ Polyester.
Porte-Clés. Aluminium/ Polyester.
Sleutelhanger. Aluminium/ Polyester.

2.7 x 6.8 x 0.6 cm 200 / 50
Print Code: D(4), L1



ALUMINIUM

19





05

01

02

19

Rizet

4611

Keyring. Metal/ Silicone.
Schlüsselanhänger. Metall/ Silikon.
Porte-Clés. Métal/ Silicone.
Sleutelhanger. Metaal/ Siliconen.

4 × 2 × 1 cm 400 / 50

Print Code: D(1), L1



03



19



Rader

5358

Keyring. Stainless Steel.
Schlüsselanhänger. Rostfreier Stahl.
Porte-Clés. Acier Inox.
Sleutelhanger. Roestvrij Staal.

4.2 × 3 × 0.4 cm 300 / 50

Print Code: D(1), L1



01

03

05

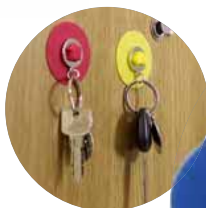

Engine

9642

Keyring. Metal.
Schlüsselanhänger. Metall.
Porte-Clés. Métal.
Sleutelhanger. Metaal.

4.3 × 3 × 0.5 cm 400 / 50

Print Code: D(1), L1



Trailer

9272

Keyring. Metal.
Schlüsselanhänger. Metall.
Porte-Clés. Métal.
Sleutelhanger. Metaal.

2.9 × 7.5 × 0.3 cm 400 / 50

Print Code: D(4), L1



KEYRING COIN

05

01

03

19

Coltax

4704

Keyring Coin. Metal/ Silicone.
Schlüsselanhänger EK-Chip. Metall/ Silikon.
Porte-Clés Monnaie. Métal/ Silicone.
Munt-Sleutelhanger. Metaal/ Siliconen.

Ø 5.2 × 11.5 cm 400 / 50

Print Code: D(1), L1

Video





Bolky

4610

Keyring. Metal/ Silicone.
Schlüsselanhänger. Metall/ Silikon.
Porte-Clés. Métal/ Silicone.
Steutelhanger. Metaal/ Siliconen.

2.8 x 2.7 x 1 cm 400 / 50
Print Code: D(1), L1



Zosin

6061

Keyring. Stainless Steel.
Schlüsselanhänger. Rostfreier Stahl.
Porte-Clés. Acier Inox.
Steutelhanger. Roestvrij Staal.

4.2 x 3.7 x 0.4 cm 400 / 100
Print Code: D(1), L1



Inmo

9271

Keyring. Metal.
Schlüsselanhänger. Metall.
Porte-Clés. Métal.
Steutelhanger. Metaal.

3.6 x 3.6 x 0.5 cm 400 / 50
Print Code: D(1), L1



KEYRING COIN



Halman

4703

Keyring Coin. Metal/ Silicone.
Schlüsselanhänger EK-Chip. Metall/ Silikon.
Porte-Clés Monnaie. Métal/ Silicone.
Munt-Steutelhanger. Metaal/ Siliconen.

5.2 x 11.5 cm 400 / 50
Print Code: D(1), L1



Lladel

5797

Keyring. Metal/ Silicone.
Schlüsselanhänger. Metall/ Silikon.
Porte-Clés. Métal/ Silicone.
Steutelhanger. Metaal/ Siliconen.

2.8 x 4.2 x 1 cm 400 / 50
Print Code: D(1), L1





Alumpill

3168

Keyring Pillbox. Aluminium. 1 Compartment.
Schlüsselanhänger Pillendose. Aluminium. 1 Abteilung.
Porte-Clés Pilulier. Aluminium. 1 Compartiment.
Sleutelhanger Pillendoosje. Aluminium. 1 Compartment.

📏 1.4 × 5.2 cm 📦 500 / 50

🎨 Print Code: D(1), L1



Vairel

4427

Keyring. Metal.
Schlüsselanhänger. Metall.
Porte-Clés. Métal.
Sleutelhanger. Metaal.

📏 3.7 × 5 × 0.7 cm 📦 300 / 50

🎨 Print Code: C(1)



666

KEYRING



Vinger

4034

Keyring. Metal/ Polyester.
Schlüsselanhänger. Metall/ Polyester.
Porte-Clés. Métal/ Polyester.
Sleutelhanger. Metaal/ Polyester.

📏 3.2 × 6 × 0.6 cm 📦 300 / 50

🎨 Print Code: D(1), L1



01



Kipion

5355

Organizer Keyring. Aluminium.
Ordner Schlüsselanhänger. Aluminium.
Porte-Clés Organiseur. Aluminium.
Organizer Sleutelhanger. Aluminium.

📏 1.6 × 7.3 × 1.2 cm 📦 500 / 50

🎨 Print Code: D(4), L1



02

09



Depor

4981

Keyring. Metal.
Schlüsselanhänger. Metall.
Porte-Clés. Métal.
Sleutelhanger. Metaal.

📏 2.2 × 5.5 × 0.4 cm 📦 200 / 50

🎨 Print Code: D(1), L1





KEYRING



Nevek

11

4207

Keyring. Aluminium.
Schlüsselanhänger. Aluminium.
Porte-Clés. Aluminium.
Sleutelhanger. Aluminium.

2.9 x 5.4 x 0.1 cm 1000 / 100

Print Code: D(4), L1



09

03

19

04

02



09

Cliff

3901

Opener Keyring. Aluminium.
Schlüsselanhänger Flaschenöffner. Aluminium.
Porte-Clés Ouvre Bouteille. Aluminium.
Sleutelhanger Opener. Aluminium.

3 x 6.7 x 0.3 cm 800 / 200

Print Code: D(4), L1



19

02

03



Opener



02



04

Teruk

5626



Opener

Opener Keyring. Aluminium.
Schlüsselanhänger Flaschenöffner. Aluminium.
Porte-Clés Ouvre Bouteille. Aluminium.
Sleutelhanger Opener. Aluminium.

2.3 x 6.1 x 0.2 cm 1000 / 200

Print Code: D(4), L1



09

03



19

04

Stiked

6446



Opener

Opener Keyring. Aluminium.
Schlüsselanhänger Flaschenöffner. Aluminium.
Porte-Clés Ouvre Bouteille. Aluminium.
Sleutelhanger Opener. Aluminium.

1.1 x 6 x 1.5 cm 1000 / 100

Print Code: D(4), L1



05



02

03

19

Zoko

3857

Carabiner. Aluminium.
Karabiner. Aluminium.
Mousqueton. Aluminium.
Karabijnhaak. Aluminium.

3 x 6 x 0.5 cm 1000 / 200

Print Code: D(1), L1



09

19

02

03

Zokrex 6754



Opener Keyring. Aluminium.
Schlüsselanhänger Flaschenöffner. Aluminium.
Porte-Clés Ouvre Bouteille. Aluminium.
Sleutelhanger Opener. Aluminium.

3 × 6.6 × 0.4 cm

1000 / 200

Print Code: Consult.



NEW



08

KEYRING

668



19

Blicher 5627



Opener Keyring. Aluminium.
Schlüsselanhänger Flaschenöffner. Aluminium.
Porte-Clés Ouvre Bouteille. Aluminium.
Sleutelhanger Opener. Aluminium.

3 × 6.6 × 0.4 cm

1000 / 200

Print Code: D(4), L1



02

09

03

Ciclex 4589

Keyring. Aluminium.
Schlüsselanhänger. Aluminium.
Porte-Clés. Aluminium.
Sleutelhanger. Aluminium.

3.5 × 5.7 × 0.4 cm

1000 / 200

Print Code: D(1), L1



03



02



09



19



02

03

05



19



Nazir 4609

Keyring. Metal.
Schlüsselanhänger. Metall.
Porte-Clés. Métal.
Sleutelhanger. Metaal.

2.7 × 3 × 2.9 cm

200 / 50

Print Code: D(1), L1



OPENER



Ibik
5891

Opener Keyring. Aluminium.
Schlüsselanhänger Flaschenöffner. Aluminium.
Porte-Clés Ouvre Bouteille. Aluminium.
Sleutelhanger Opener. Aluminium.

3.5 x 6.4 x 0.5 cm 1000 / 200
Print Code: D(4), L1



Singe
3900

Opener Keyring. Aluminium.
Schlüsselanhänger Flaschenöffner. Aluminium.
Porte-Clés Ouvre Bouteille. Aluminium.
Sleutelhanger Opener. Aluminium.

2.7 x 7.5 x 0.3 cm 800 / 200
Print Code: D(4), L1



03

04



Samo
3911

Opener Keyring. Aluminium.
Schlüsselanhänger Flaschenöffner. Aluminium.
Porte-Clés Ouvre Bouteille. Aluminium.
Sleutelhanger Opener. Aluminium.

1.1 x 6.7 x 1.5 cm 1000 / 200
Print Code: D(4), L1



Clevon
6058

Opener Keyring. Aluminium.
Schlüsselanhänger Flaschenöffner. Aluminium.
Porte-Clés Ouvre Bouteille. Aluminium.
Sleutelhanger Opener. Aluminium.

3 x 8.9 x 0.2 cm 1000 / 100
Print Code: D(4), L1



Milter
5500

Opener Keyring. Aluminium.
Schlüsselanhänger Flaschenöffner. Aluminium.
Porte-Clés Ouvre Bouteille. Aluminium.
Sleutelhanger Opener. Aluminium.

0.9 x 7.9 x 1.5 cm 1000 / 200
Print Code: D(4), L1

KEYRING COIN



04



01

02

19

07

05

11

03

Kipor
4637

Keyring Coin. 2 Leds. Button Batteries Included.
Schlüsselanhänger EK-Chip. 2 Leds. Knopfzellen Inklusiv.
Porte-Clés Monnaie. 2 Leds. Piles Bouton Inclus.
Munt-Sleutelhanger. 2 Leds. Knoopcelbatterij Inclusief.

2.5 × 7 × 1 cm 1000 / 100

Print Code: C(4)



07



11

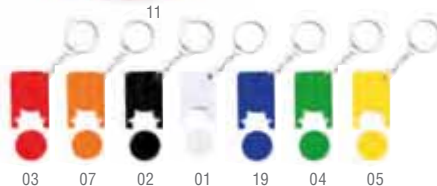

03

07

02

01

19

04

05

Zabax

4669

Keyring Coin.
Schlüsselanhänger EK-Chip.
Porte-Clés Monnaie.
Munt-Sleutelhanger.

2.8 × 5.1 × 0.4 cm 1000 / 100

Print Code: C(4)

Beka

3771

Keyring Coin.
Schlüsselanhänger EK-Chip.
Porte-Clés Monnaie.
Munt-Sleutelhanger.

2.8 × 5.1 × 0.4 cm 1000 / 500

Print Code: C(4)



03

01

02

04

05

07

11

19

Ibershop

2451

Keyring Coin.
Schlüsselanhänger EK-Chip.
Porte-Clés Monnaie.
Munt-Sleutelhanger.

3.1 × 6 × 0.2 cm 4000 / 500

Print Code: B(4)



05

11

03

04

19

02

01

antibacterial



NEW

Portis
6684

Antibacterial Keyring Coin.
Antibakteriell Schlüsselanhänger EK-Chip.
Porte-Clés Monnaie Antibactérien.
Antibacterieel Munt-Sleutelhanger.

4.1 × 5.2 × 1.1 cm 1000 / 100
Print Code: C(4), W

KEYRING
COIN



671



STYLUS TOUCH
PUNTERO



Euromarket

3298

Keyring Coin. Metal.
Schlüsselanhänger EK-Chip. Metall.
Porte-Clés Monnaie. Métal.
Munt-Sleutelhanger. Metaal.

Ø 2.3 × 6 cm 1000 / 100
Print Code: D(1)



Frits

4853

Keyring Coin.
Schlüsselanhänger EK-Chip.
Porte-Clés Monnaie.
Munt-Sleutelhanger.

3 × 5.7 × 0.7 cm 1000 / 100
Print Code: C(4)



Fliant

5656

Keyring Coin.
Schlüsselanhänger EK-Chip.
Porte-Clés Monnaie.
Munt-Sleutelhanger.

3.5 × 5 × 0.8 cm 300 / 50
Print Code: C(4)



03



19



11

01

02

05

Tofin

6488

Keyring. Metal/ Polyester.

Schlüsselanhänger. Metall/ Polyester.

Porte-Clés. Métal/ Polyester.

Sleutelhanger. Metaal/ Polyester.



03

04

07

2.5 x 12 x 0.2 cm 1000 / 100

Print Code: D(1), N(8), R

KEYRING



672



Nicles

4131

Keyring. Felt.

Schlüsselanhänger. Filz.

Porte-Clés. Feutrine.

Sleutelhanger. Vilt.

Ø 5.5 x 0.3 cm 2000 / 50

Print Code: N(8)

Yeko

4116

Keyring. Felt.

Schlüsselanhänger. Filz.

Porte-Clés. Feutrine.

Sleutelhanger. Vilt.

3 x 7.3 x 0.4 cm 1000 / 500

Print Code: N(8)



KEYRING



05



03 02 19 01

Boriem
5655

Keyring: Metal/ PU.
Schlüsselanhänger: Metall/ PU.
Porte-Clés: Métal/ Similicuir.
Sleutelhanger: Metaal/ PU.

2.5 x 8 x 1 cm 200 / 50

Print Code: D(1), L1



02



19 18 01 04 03

Pelcu
3724

Keyring: PU.
Schlüsselanhänger: PU.
Porte-Clés: Similicuir.
Sleutelhanger: PU.

3.8 x 5.5 x 0.7 cm 1000 / 100

Print Code: D(1), L1

673

YOUR DESIGN

minimum 200 pcs - mínimo 200 pcs

Full colour printing 2 sides + Doming included, set up cost not included.

Impresión a todo color 2 caras + Doming incluido, cliché no incluido.



03

SPECIAL FOR DOMING

Dagor

4442

Keyring: Metal/ Polyester.
Schlüsselanhänger: Metall/ Polyester.
Porte-Clés: Métal/ Polyester.
Sleutelhanger: Metaal/ Polyester.

2.7 x 6 x 0.6 cm 300 / 50

Print Code: L1, V



11 05



02 19



SPECIAL FOR DOMING

19

Harper

4443

Keyring: Metal.
Schlüsselanhänger: Metall.
Porte-Clés: Métal.
Sleutelhanger: Metaal.

2 x 5.5 x 0.5 cm 500 / 50

Print Code: L1, V



11 03 01



05 02



SPECIAL FOR DOMING

Aktual

4569

Keyring.
Schlüsselanhänger.
Porte-Clés.
Sleutelhanger.

Consult. 3000 / 1000

Print Code: Consult.



KEYRING



BACK SIDE /
PARTE TRASERA

23

09

02

I AM
INTERACTIVE!

Evelen
5902

Keyring. Polyester.
Schlüsselanhänger. Polyester.
Porte-Clés. Polyester.
Sleutelhanger. Polyester.

📏 $\varnothing 7 \times 1.4$ cm 📦 500 / 10
🖨️ Print Code: N(8)

03

674



02

03

01

11

Ladriel
5811

Keyring. Polyester.
Schlüsselanhänger. Polyester.
Porte-Clés. Polyester.
Sleutelhanger. Polyester.

📏 $\varnothing 7$ cm 📦 500 / 50
🖨️ Print Code: L1



19

04

05



22

01



Timpax

6068

Keyring.
Schlüsselanhänger.
Porte-Clés.
Sleutelhanger.

📏 $4 \times 6.2 \times 0.3$ cm 📦 1000 / 100
🖨️ Print Code: D(4)

03

FLOATING Keyring



19

05

11



03



16



Komber

5115
Keyring. EVA/ PVC.
Schlüsselanhänger. EVA/ PVC.
Porte-Clés. EVA/ PVC.
Sleutelhanger. EVA/ PVC.

4 × 7.2 × 3.6 cm 500 / 10
Print Code: D(1)

Soke

3583
Keyring. EVA.
Schlüsselanhänger. EVA.
Porte-Clés. EVA.
Sleutelhanger. EVA.

3.3 × 6.8 × 1.4 cm 1000 / 50
Print Code: E(1)



ESP

19

05

04

03

02



03



05

19

02

04



03



11

02

01

05

19

Islan

4420
Keyring. PU.
Schlüsselanhänger. PU.
Porte-Clés. PU.
Sleutelhanger. PU.

3.5 × 8.2 × 1.9 cm 500 / 100
Print Code: E(1)

Perle

3914
Keyring. EVA.
Schlüsselanhänger. EVA.
Porte-Clés. EVA.
Sleutelhanger. EVA.

3.3 × 8 × 2.3 cm 1000 / 50
Print Code: D(1)



Telox

4250

Air Freshener. Glass. 5 ml. Ocean Aroma.
 Luftfrischer. Glas. 5 ml. Ozeanduft.
 Parfum Ambiance. Verre. 5 ml. Arôme Océan.
 Luchtverfrisser. Glas. 5 ml. Oceaan Aroma.

▮▮▮▮▮ Ø 2.2 × 4.5 cm 📦 400 / 100

🌈 Print Code: D(4)



Koreflec

5659

Keyring. PVC. Reflective.
 Schlüsselanhänger. PVC. Reflektierend.
 Porte-Clés. PVC. Réfléchissant.
 Steutelhanger. PVC. Reflectorend.

▮▮▮▮▮ 6.1 × 5.3 × 0.2 cm 📦 1000 / 100

🌈 Print Code: C(4)

676



Visibility

811401

Keyring. PVC. Reflective.
 Schlüsselanhänger. PVC. Reflektierend.
 Porte-Clés. PVC. Réfléchissant.
 Steutelhanger. PVC. Reflectorend.

▮▮▮▮▮ 4.5 × 5.6 × 0.3 cm 📦 1000 / 100

🌈 Print Code: C(4)

CAR ACCESSORIES



Becrux

6292

Air Freshener. Aluminium/ ABS. Lemon Aroma.
 Luftfrischer. Aluminium/ ABS. Zitronenduft.
 Parfum Ambiance. Aluminium/ ABS. Arôme Citron.
 Luchtverfrisser. Aluminium/ ABS. Citroen Aroma.

▮▮▮▮▮ 5.7 × 4.2 × 3 cm 📦 400 / 50

🌈 Print Code: D(4), L1





Hoinzo
4979

Keyring Coin. Metal.
Schlüsselanhänger EK-Chip. Metall.
Porte-Clés Monnaie. Métal.
Munt-Sleutelhanger. Metaal.

Consult. 200 / 50
Print Code: D(1), L1



IDEAL FOR PUBLIC
TRANSPORT

IDEAL PARA
TRANSPORTE PÚBLICO



Piggy
9641

Keyring. Metal.
Schlüsselanhänger. Metall.
Porte-Clés. Métal.
Sleutelhanger. Metaal.

1.9 x 4.1 x 0.4 cm 250 / 50
Print Code: D(1), L1

677



STYLUS TOUCH BALL
PEN INCLUDED/
BOLÍGRAFO PUNTERO
INCLUIDO

Cimak
6697

Keyring Anticontact. Stylus Touch Ball Pen Included.
Schlüsselanhänger Anticontact. Kugelschreiber Pointer Inklusive.
Porte-Clés Anticontact. Stylét Bille Inklus.
Sleutelhanger Anticontact. Touch Bal Pen Inclusief.

3 x 7.3 x 0.5 cm 1000 / 50
Print Code: D(4)



Kozko
6658

Keyring Anticontact. Aluminium.
Schlüsselanhänger Anticontact. Aluminium.
Porte-Clés Anticontact. Aluminium.
Sleutelhanger Anticontact. Aluminium.

5.1 x 7.8 x 0.5 cm 800 / 200
Print Code: D(4), L1



Bigox
6644

Keyring Anticontact. Stainless Steel.
Schlüsselanhänger Anticontact. Rostfreier Stahl.
Porte-Clés Anticontact. Acier Inox.
Sleutelhanger Anticontact. Roestvrij Staal.

3.2 x 7.6 x 0.2 cm 400 / 200
Print Code: D(1), L1



MAR- KAS

the elegance
of brands

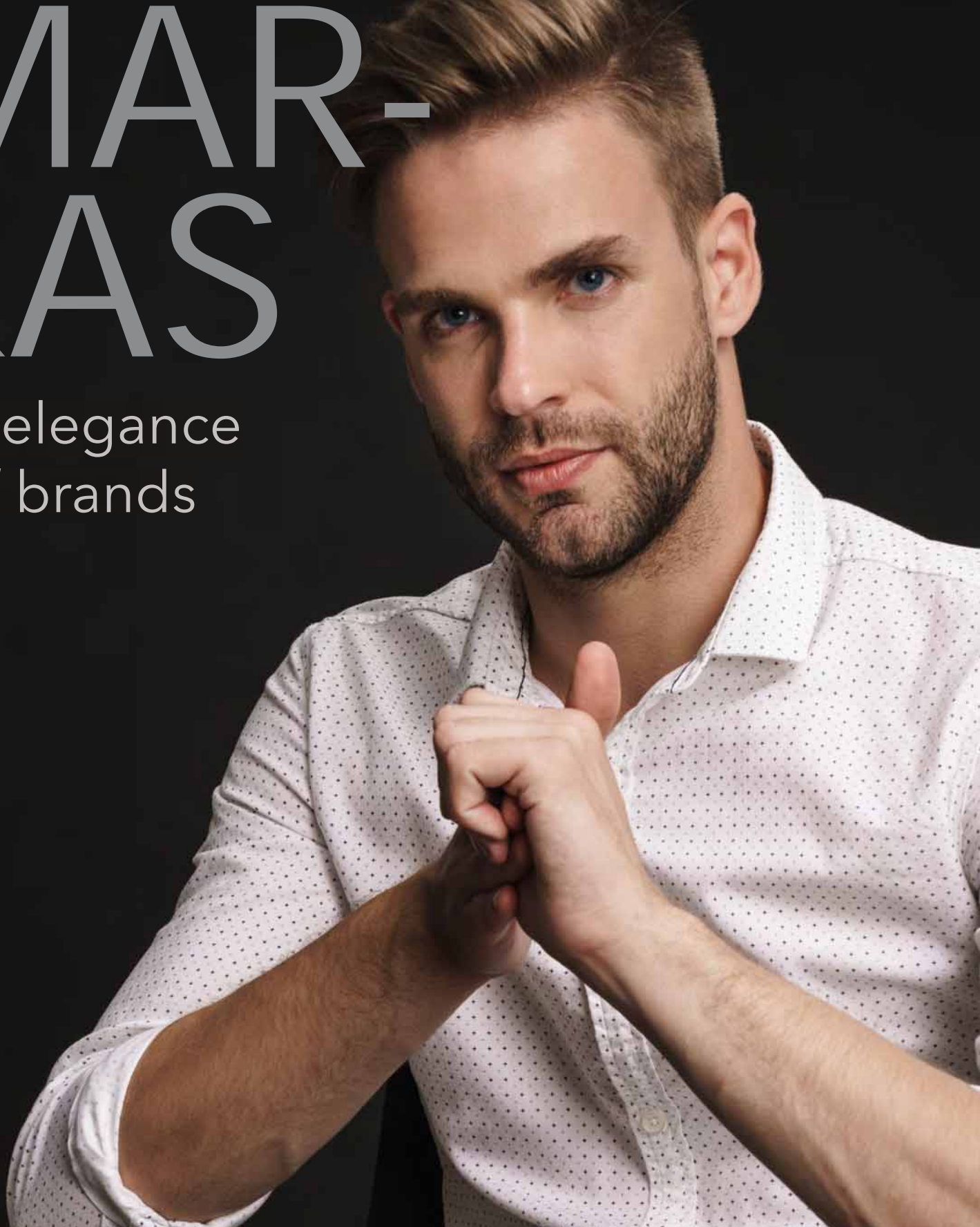

DESIGNERS



ANTONIO MIRO



Alexluca
Italy



PERTEGAZ



AGATHA RUIZ DE LA PRADA



swisent
ORIZONS[®]
adventure



SHEAFFER



BALENCIAGA
PARIS





CROSS



Pierre Cardin

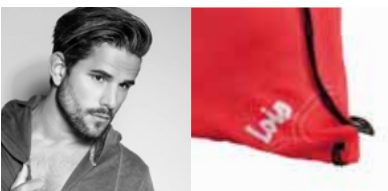

HelloKitty







SWAROVSKI

Helox

7166

Roller. Metal. Jumbo Refill.
 Roller Pen. Metall. Jumbo Ersatzmine.
 Roller. Métal. Recharge Jumbo.
 Balpen. Metaal. Jumbo Refill.



Ø 1.3 × 13.8 cm

100 / 25

Print Code: D(1), L1



680



Dayo

7163

Pen. Metal. Jumbo Refill.
 Kugelschreiber. Metall. Jumbo Ersatzmine.
 Stylo. Métal. Recharge Jumbo.
 Pen. Metaal. Jumbo Refill.



Ø 1.3 × 13.5 cm

100 / 25

Print Code: D(1), L1



Antonio Miro



Tario

7237

Roller. Metal. Jumbo Refill.
 Roller Pen. Metall. Jumbo Ersatzmine.
 Roller. Métal. Recharge Jumbo.
 Balpen. Metaal. Jumbo Refill.



Ø 1.1 × 14 cm

100 / 25

Print Code: D(1), L1





Antonio Miro



GameX

7068

Stylus Touch Ball Pen. Metal. Jumbo Refill.
Kugelschreiber Pointer. Metall. Jumbo Ersatzmine.
Stylet Bille. Métal. Recharge Jumbo.
Touch-Screen Balpen. Metaal. Jumbo Refill.



Ø 1.3 × 14 cm

100 / 25

Print Code: D(1), L1



681



Norey

7311

Stylus Touch Ball Pen. Metal. Jumbo Refill.
Kugelschreiber Pointer. Metall. Jumbo Ersatzmine.
Stylet Bille. Métal. Recharge Jumbo.
Touch-Screen Balpen. Metaal. Jumbo Refill.



Ø 1.1 × 14 cm

200 / 100

Print Code: D(1), L1



Yago

7160

Stylus Touch Ball Pen. Metal.
Kugelschreiber Pointer. Metall.
Stylet Bille. Métal.
Touch-Screen Balpen. Metaal.



Ø 1 × 14 cm

200 / 100

Print Code: D(1), L1



Samber



Helmor



Kashem

682



02

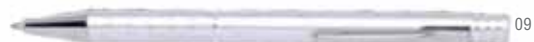

09



Samber

7336

Pen. Aluminium.
Kugelschreiber. Aluminium.
Stylo. Aluminium.
Pen. Aluminium.



Ø 1 × 13.9 cm

200 / 50

Print Code: D(4), L1



09



01



Helmor

7335

Pen. Aluminium.
Kugelschreiber. Aluminium.
Stylo. Aluminium.
Pen. Aluminium.



Ø 1 × 14 cm

200 / 50

Print Code: D(4), L1



Kashem

7337

Pen. Aluminium.
Kugelschreiber. Aluminium.
Stylo. Aluminium.
Pen. Aluminium.



Ø 1 × 13.7 cm

200 / 50

Print Code: D(4), L1



04 09 19 03

Sultik

7353

Pen. Aluminium.
Kugelschreiber. Aluminium.
Stylo. Aluminium.
Pen. Aluminium.

Ø 1 × 14 cm

Print Code: B(4), L1

500 / 50



02

683

BB
BALENCIAGA
PARIS



Cinemo

7109

Pencil Set. Elastic Band Leather Finishing. 3 Pencils.
Bleistift Set. Elastischer Clip Lederveredelung. 3 Stifte.
Set Crayons. Pince Elastique Finition Cuir. 3 Crayons.
Potlood Set. Elastische Knijper Met Leer Afgewerkt. 3 Potloden.

Ø 2.7 × 19 cm

200 / 50

Print Code: B(4), D(1)



ANTONIO MIRO



Sentel

7236

Pencil Set. 3 Pencils.
Bleistift Set. 3 Stück.
Set Crayons. 3 Crayons.
Potlood Set. 3 Potloden.

2.2 × 18 × 1 cm

Print Code: B(1), D(1)

600 / 30



Akota
7204

Pencil Case. PU.
Federmappe. PU.
Trousse. Similicuir.
Etui. PU.

19 x 7 cm

Print Code: F(1), L1

200 / 50



Antonio Miro



684



Worden
7293

Set. Metal. Pen and Roller.
Set. Metall. Kugelschreiber und Roller Pen.
Set. Métal. Stylo et Roller.
Set. Metaal. Pen en Balpen.



Ø 1.1 x 13.8 cm

Print Code: D(1), L1

100 / 50

Nilka
7294

Set. Metal. Pen and Roller.
Set. Metall. Kugelschreiber und Roller Pen.
Set. Métal. Stylo et Roller.
Set. Metaal. Pen en Balpen.



Ø 1.2 x 14.1 cm

Print Code: D(1), L1

100 / 50





Salend 4406

Stylus Touch Ball Pen. Aluminium.
Kugelschreiber Pointer. Aluminium.
Styllet Bille. Aluminium.
Touch-Screen Balpen. Aluminium.



Ø 1.1 × 14.3 cm 200 / 100
Print Code: D(1), L1



Lantey 4407

Stylus Touch Ball Pen. Metal.
Kugelschreiber Pointer. Metall.
Styllet Bille. Métal.
Touch-Screen Balpen. Metaal.



Ø 1.1 × 14 cm 200 / 100
Print Code: D(1), L1





Smart
3154

Pen. Metal.
Kugelschreiber. Metall.
Stylo. Métal.
Pen. Metaal.



Ø 1.1 × 13.5 cm

200 / 100

Print Code: D(4), L1



Siodo
4460

Set. Metal. Jumbo Refill Pen. Mechanical Pencil: 0,7 mm Leads Included.
Set. Metall. Kugelschreiber Jumbo Ersatzmine. Bleistift: Minen 0,7 mm Inklusiv.
Set. Métal. Stylo Recharge Jumbo. Portemines: Mines 0,7 mm Inclus.
Set. Metaal. Jumbo Refill Pen. Vulpotlood: 0,7 mm Stijfjes Inclusief.



Ø 1 × 14.2 cm

100 / 50

Print Code: D(4), L1



Pilman
3554

Pen. Aluminium. Jumbo Refill.
Kugelschreiber. Aluminium. Jumbo Ersatzmine.
Stylo. Aluminium. Recharge Jumbo.
Pen. Aluminium. Jumbo Refill.



Ø 1.2 × 13 cm

400 / 50

Print Code: C(4), L1





Parma

3294

Pen. Jumbo Refill.
Kugelschreiber. Jumbo Ersatzmine.
Stylo. Recharge Jumbo.
Pen. Jumbo Refill.



Ø 1 × 13.4 cm
Print Code: A(4)

500 / 50



Pierre Cardin



Swing

2433

Pen. Jumbo Refill.
Kugelschreiber. Jumbo Ersatzmine.
Stylo. Recharge Jumbo.
Pen. Jumbo Refill.



Ø 1.1 × 15 cm
Print Code: A(1)

1000 / 50



Nakel

3461

Pen. Jumbo Refill.
Kugelschreiber. Jumbo Ersatzmine.
Stylo. Recharge Jumbo.
Pen. Jumbo Refill.



Ø 1 × 14 cm
Print Code: A(1)

1000 / 50



Rasert

5755

Pen.
Kugelschreiber.
Stylo.
Pen.



Ø 1.3 × 14 cm
Print Code: A(4)

1000 / 50



CROSS



Tech 2

7331

Stylus Touch Ball Pen. Metal. Black Ink.
Kugelschreiber Pointer. Metall. Schwarze Tinte.
Styllet Bille. Métal. Encre Noire.
Touch-Screen Balpen. Metaal. Zwarte Inkt.

Ø 1 × 13.5 cm

72 / 36

Print Code: D(4), L1

09



19

02

03



Century

7358

Set. PU/ Metal. Hard Cover. 80 Sheets Notepad. Black Ink.
Set, PU/ Metall. Hardcover-Abdeckung. 80 Seiten Notizblock. Schwarze Tinte.
Set. Similicuir/ Métal. Couverture Rigide. Bloc 80 Feuilles. Encre Noire.
Set. PU/ Metaal. Harde Kaft. 80 Blaadjes Notepad. Zwarte Inkt.

23 × 4.5 × 22.5 cm

24 / 12

Print Code: E(4), L1



80 Sheets
Lined

688



09

02



Nile

7332

Pen. Metal. Black Ink.
Kugelschreiber. Metall. Schwarze Tinte.
Stylo. Métal. Encre Noire.
Pen. Metaal. Zwarte Inkt.

Ø 1.2 × 13.6 cm

72 / 36

Print Code: D(4), L1



02

99

09



Stratford

7357

Pen. Metal. Black Ink.
Kugelschreiber. Metall. Schwarze Tinte.
Stylo. Métal. Encre Noire.
Pen. Metaal. Zwarte Inkt.

Ø 1.2 × 13.7 cm

72 / 36

Print Code: D(4), L1





SHEAFFER



19

02

03

09

VFM

7330

Pen. Metal. Jumbo Refill. Black Ink.
Kugelschreiber. Metall. Jumbo Ersatzmine. Schwarze Tinte.
Stylo. Métal. Recharge Jumbo. Encre Noire.
Pen. Metaal. Jumbo Refill. Zwarte Inkt.

Ø 1.1 × 14 cm

64

Print Code: D(4), L1



689



19

20

02

Sentinel

7328

Pen. Metal. Jumbo Refill. Black Ink.
Kugelschreiber. Metall. Jumbo Ersatzmine. Schwarze Tinte.
Stylo. Métal. Recharge Jumbo. Encre Noire.
Pen. Metaal. Jumbo Refill. Zwarte Inkt.

Ø 1 × 13.3 cm

64

Print Code: D(4), L1

100 Sheets
Plain

Rodum

7321



Set. Notepad Leather. Hard Cover. 100 Sheets Notepad. Pen Leather/ Metal.
 Set. Notizblock Leder. Hardcover-Abdeckung. 100 Seiten Notizblock. Kugelschreiber Leder/ Metall.
 Set. Bloc Notes Cuir. Couverture Rigide. Bloc 100 Feuilles. Stylo Cuir/ Métal.
 Set. Notitieblokje Leer. Harde Kaft. Blok 100 Blaadjes. Pen Leer/ Metaal.

18.5 x 3.5 x 16.5 cm

40 / 10

Print Code: E(1), L1, T

690



Latrex 32GB

7359 32GB

USB Stylus Touch Ball Pen. Metal. Black Ink. Individual Presentation.
 Kugelschreiber Pointer USB. Metall. Schwarze Tinte. Individuelle Präsentation.
 Stylet Bille USB. Metal. Encre Noire. Présentation Individuelle.
 USB Touch-Screen Balpen. Metaal. Zwarte Inkt. Individuele Presentatie.

Ø 1.4 x 13.8 cm

100 / 20

Print Code: D(1), L1

PERTEGAZ



Hertes

3907

Notepad. PU. Hard Cover. 80 Sheets.
 Notizblock. PU. Hardcover-Abdeckung. 80 Seiten.
 Bloc Notes. Similicuir. Couverture Rigide. 80 Feuilles.
 Notitieblokje. PU. Harde Kaft. 80 Blaadjes.

9.5 x 14.5 x 1.5 cm

100

Print Code: E(1), T

80 Sheets
Plain

Helmux

7351

Power Bank Folder, Polyester 600D, 5000 mAh, 65 Sheets Notepad, USB Output, Micro USB Input, Cable Included.

Power Bank Mappe, Polyester 600D, 5000 mAh, 65 Seiten Notizblock, USB Ausgang, Micro USB Eingang, Kabel Inklusiv.

Porte-Documents Power Bank, Polyester 600D, 5000 mAh, Bloc 65 Feuilles, Sortie USB, Entrée Micro USB, Cable Inclus.

Power Bank Map, Polyester 600D, 5000 mAh, 65 Blaadjes Notepad, USB Output, Micro USB Input, Kabel Inclusief.

21.5 × 26.5 × 3 cm

10

Print Code: G(1), N(8)



Power Bank



5000 mAh



65 Sheets Plain



691



2200 mAh

Drospen

7320

Set. Leather/ Metal, 2200 mAh, USB Output, Micro USB Input, Cable Included.

Set. Leder/ Metall, 2200 mAh, USB Ausgang, Micro USB Eingang, Kabel Inklusiv.

Set. Cuir/ Métal, 2200 mAh, Sortie USB, Entrée Micro USB, Cable Inclus.

Set. Leer/ Metaal, 2200 mAh, USB Output, Micro USB Input, Kabel Inclusief.



18.5 × 3.5 × 12 cm

50 / 10

Print Code: E(1), L1



Dermop

7307

Set. Leather/ Metal.

Set. Leder/ Metall.

Set. Cuir/ Métal.

Set. Leer/ Metaal.



18.5 × 3.5 × 12 cm

50 / 10

Print Code: E(1), L1



5000 mAh



Torlem

7341

Power Bank. PU. 5000 mAh. 2 USB and 1 Type C Outputs. Micro USB and Type C Inputs. Cable Not Included.
 Power Bank. PU. 5000 mAh. 2 USB und 1 Typ C Ausgänge. Micro USB und Typ C Eingänge. Kabel Nicht im Lieferumfang.
 Power Bank. Similicuir. 5000 mAh. 2 Sorties USB et 1 Type C. Entrées Micro USB et Type C. Cable Non Inclus.
 Power Bank. PU. 5000 mAh. 2 USB en 1 Typ C Outputs. Micro USB and Typ C Inputs. Kabel Niet Inclusief.

8 × 8 × 2.3 cm

50 / 25

Print Code: F(1), L2



5000 mAh

Tormund

7342

Power Bank. 1 Led. 5000 mAh. 2 USB Outputs. Micro USB Input. Cable Included.
 Power Bank. 1 Led. 5000 mAh. 2 USB Ausgänge. Micro USB Eingang. Kabel Inklusive.
 Power Bank. 1 Led. 5000 mAh. 2 Sorties USB. Entrée Micro USB. Cable Inclus.
 Power Bank. 1 Led. 5000 mAh. 2 USB Outputs. Micro USB Input. Kabel Inclusief.

7 × 14.6 × 1.8 cm

50 / 25

Print Code: F(4)



Light



Caltex

7020

Card Reader. Aluminium/ ABS. Cards: MS, M2, TF, XD, SD, CF.
 Karten Leser. Aluminium/ ABS. Karten: MS, M2, TF, XD, SD, CF.
 Lecteur Cartes. Aluminium/ ABS. Cartes: MS, M2, TF, XD, SD, CF.
 Geheugenkaartjeslezer. Aluminium/ ABS. Kaarten: MS, M2, TF, XD, SD, CF.

7.2 × 1.6 × 4.2 cm

100 / 25

Print Code: F(4)



Cosik

7019

USB Hub. 4 Hubs. Multicolour Led Lighting.
 USB Hub. 4 Hubs. Mehrfarbige Led Anzeige.
 Port USB. 4 Ports. Eclairage Led Multicolor.
 USB Hub. 4 Poorten. Meerkleurige Led-Verlichting.

4.5 × 3.5 × 10 cm

80 / 20

Print Code: F(4)



Multicolor light

Antonio Miro



Antonio Miro



CAMERA

Bluetooth®



- Camera
- Micro SIM
- Calls
- Hands-free
- Music Player
- Sound Recorder
- Remote Shutter
- Image Viewer
- Phone Book
- Bluetooth
- App Notify
- Message Notify
- Calculator
- Alarm
- Vibration
- Time & Date
- Anti-Lost
- Calories Counter
- Pedometer
- Sleep Monitoring
- Micro SD

Kesford

7347

Smart Watch. TPU Strap. Bluetooth Connection. 1,44" LCD Screen. Multilingual. USB Rechargeable. Cable Included.

Intelligente Uhr. TPU Armband. Bluetooth Anschluss. 1,44" LCD Screen. In Mehreren Sprachen. USB Wiederaufladbar. Kabel Inklusiv.

Montre Intelligente. Bracelet TPU. Connexion Bluetooth. Ecran LCD 1,44". Multilingue. Rechargeable USB. Cable Inclus.

Smartwatch. TPU Band. Bluetooth Verbinding. 1,44" LCD Scherm. Meertalig. USB Oplaadbaar. Kabel Inclusief.

25 × 4,2 × 1,4 cm

50

Print Code: (1), L2



- Nano SIM
- Calls
- Hands-free
- Music Player
- Sound Recorder
- Remote Shutter
- Image Viewer
- Phone Book
- Bluetooth
- App Notify
- Message Notify
- Calculator
- Alarm
- Vibration
- Time & Date
- Anti-Lost
- Calories Counter
- Pedometer
- Sleep Monitoring
- Micro SD

Kirnon

7346

Smart Watch. TPU Strap. Bluetooth Connection. 1,22" LCD Screen. Multilingual. USB Rechargeable. Cable Included. Intelligente Uhr. TPU Armband. Bluetooth Anschluss. 1,22" LCD Screen. In Mehreren Sprachen. USB Wiederaufladbar. Kabel Inklusiv. Montre Intelligente. Bracelet TPU. Connexion Bluetooth. Ecran LCD 1,22". Multilingue. Rechargeable USB. Cable Inclus. Smartwatch. TPU Band. Bluetooth Verbinding. 1,22" LCD Scherm. Meertalig. USB Oplaadbaar. Kabel Inclusief.

26 × 4,6 × 1,4 cm

50

Print Code: L2





02



09

Kerpan

7352

Headphones. Bluetooth Connection. 3,5 mm Jack Socket. USB Rechargeable. Cable Included.
Kopfhörer. Bluetooth Anschluss. 3,5 mm Klinkestecker. USB Wiederaufladbar. Kabel Inklusive.
Écouteurs. Connexion Bluetooth. Connexion Jack 3,5 mm. USB Rechargeable. Câble Inclus.
Koptelefoon. Bluetooth Verbinding. 3,5 mm Jack Aansluiting. USB Oplaadbaar. Kabel Inclusief.

18 × 18,3 × 8,6 cm



20

Print Code: G(1), L2



Bluetooth



Hands-free



Micro SD



Radio



Line III



Lemenk

7345

Headphones. Bluetooth Connection. 3,5 mm Jack Socket. USB Rechargeable. Cable Included.
Kopfhörer. Bluetooth Anschluss. 3,5 mm Klinkestecker. USB Wiederaufladbar. Kabel Inklusive.
Écouteurs. Connexion Bluetooth. Connexion Jack 3,5 mm. USB Rechargeable. Câble Inclus.
Koptelefoon. Bluetooth Verbinding. 3,5 mm Jack Aansluiting. USB Oplaadbaar. Kabel Inclusief.

17 × 18,5 × 7,7 cm



20

Print Code: G(1)



Bluetooth



Hands-free



Micro SD



Radio



Line III

Kelsi

7011

Headphones. 3,5 mm Jack Socket.
Kopfhörer. 3,5 mm Klinkestecker.
Écouteurs. Connexion Jack 3,5 mm.
Koptelefoon. 3,5 mm Jack Aansluiting.

16 × 17 × 7,5 cm



20/5

Print Code: G(1)



Bluetooth



Hands-free



Micro SD



Radio



Line III



02



09



Brenner 7343

Speaker. Bluetooth Connection. Power 3W. USB Rechargeable. Cable Included.
Lautsprecher. Bluetooth Anschluss. Power 3W. USB Wiederaufladbar. Kabel Inklusive.
Haut-Parleurs. Connexion Bluetooth. Puissance 3W. Rechargeable USB. Cable Inclus.
Luidspreker. Bluetooth Verbinding. Vermogen 3W. USB Oplaadbaar. Kabel Inclusief.



7.9 x 9 x 7.9 cm
Print Code: L2

50

695



Holsux 7344

Speaker. Bluetooth Connection. Power 8W. USB Rechargeable. Cable Included.
Lautsprecher. Bluetooth Anschluss. Power 8W. USB Wiederaufladbar. Kabel Inklusive.
Haut-Parleurs. Connexion Bluetooth. Puissance 8W. Rechargeable USB. Cable Inclus.
Luidspreker. Bluetooth Verbinding. Vermogen 8W. USB Oplaadbaar. Kabel Inclusief.

17 x 17 x 7.5 cm
Print Code: L2

30



Rolder 7016

Earphones. 3.5 mm Jack Socket.
Kopfhörer. 3,5 mm Klinkenstecker.
Écouteurs. Connexion Jack 3,5 mm.
Oordopjes. 3.5 mm Jack Aansluiting.

13.5 x 15 x 3 cm
Print Code: E(1), G(1)

80





Mukar

7309

Folder. Nylon 1200D/ PU. 50 Sheets Notepad.
 Mappe. Nylon 1200D/ PU. 50 Seiten Notizblock.
 Porte-Documents. Nylon 1200D/ Similicuir. Bloc 50 Feuilles.
 Map. Nylon 1200D/ PU. 50 Blaadjes Notepad.

23.5 × 31 × 1.5 cm

20 / 10

Print Code: G(1), L2



50 Sheets
Lined

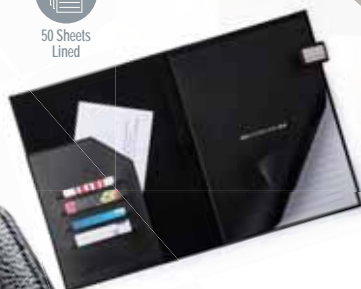

Antonio Miro



Tailplus

7127

Folder. Microfiber/ PU. 20 Sheets Notepad.
 Mappe. Mikrofaser/ PU. 20 Seiten Notizblock.
 Porte-Documents. Microfibre/ Similicuir. Bloc 20 Feuilles.
 Map. Microfiber/ PU. 20 Blaadjes Notepad.

18.5 × 23.5 × 1.5 cm

40

Print Code: L1



20 Sheets
Lined



ANTONIO MIRO

Roden

7296

Folder. PU. 20 Sheets Notepad.
 Mappe. PU. 20 Seiten Notizblock.
 Porte-Documents. Similicuir. Bloc 20 Feuilles.
 Map. PU. 20 Blaadjes Notepad.

24 × 32 × 1.5 cm

20 / 5

Print Code: G(1)



20 Sheets
Lined

ANTONIO MIRO



20 Sheets
Plain



Alexluca
Italy



Gore
7207

Folder. Nylon 1680D/ PU. 50 Sheets Notepad.
Mappe. Nylon 1680D/ PU. 50 Seiten Notizblock
Porte-Documents. Nylon 1680D/ Similicuir. Bloc 50 Feuilles.
Map. Nylon 1680D/ PU. 50 Blaadjes Notepad.

25 x 32 x 1.5 cm

20 / 5

Print Code: F(1), L1

Milano
3335

Folder. Microfibre/ PU. 20 Sheets Notepad.
Mappe. Mikrofaser/ PU. 20 Seiten Notizblock.
Porte-Documents. Microfibre/ Similicuir. Bloc 20 Feuilles.
Map. Microfibre/ PU. 20 Blaadjes Notepad.

27 x 33 x 2.5 cm

20

Print Code: G(1)



50 Sheets
Plain

ANTONIO MIRO



Ruans
7242

Briefcase. Nylon. Padded Laptop Compartment.
Aktentasche. Nylon. Gepolsterte Laptoptasche.
Malette. Nylon. Pochette Rembourrée pour Portable.
Aktentas. Nylon. Gewatteerd Laptop Compartment.

37 x 28 x 6 cm

25

Print Code: G(1), N(8)



ANTONIO MIRO

Sysko
7074

Briefcase. Polyester 1680D. Padded Laptop Compartment.
Aktentasche. Polyester 1680D. Gepolsterte Laptoptasche.
Malette. Polyester 1680D. Pochette Rembourrée pour Portable.
Aktentas. Polyester 1680D. Gewatteerd Laptop Compartment.

42 x 31 x 6 cm

10

Print Code: G(1), N(8)



Laptop





Bolman

7348

Backpack. Polyester 1680D. Padded Laptop and Tablet Compartment. Padded Back and Shoulder Straps.
Rucksack. Polyester 1680D. Gepolsterte Laptop tasche und Tablet. Gepolsterter Rücken und Schultergurte.
Sac à Dos. Polyester 1680D. Pochette Rembourrée pour Portable et Tablet. Dos et Bretelles Rembourrées.
Rugzak. Polyester 1680D. Gewatteerd Laptop en Tablet Compartment. Gewatteerde Achterzijde en Schouderbanden.

30 × 40 × 14 cm

10

Print Code: G(1), N(8)



12" Tablet Compartment



15" Laptop Compartment



Regent

7350

Document Bag. Polyester 1680D. Padded.
Dokumenten tasche. Polyester 1680D. Gepolstert.
Porte-Documents. Polyester 1680D. Rembourrée.
Aktentas. Polyester 1680D. Gewatteerd.

35 × 26 × 2 cm

50

Print Code: G(1), N(8)



Ascott

7073

Briefcase. Polyester 1680D. Padded Tablet Compartment.
Aktentasche. Polyester 1680D. Gepolsterte Tablet Tasche.
Malette. Polyester 1680D. Pochette Rembourrée pour Tablet.
Aktentas. Polyester 1680D. Gewatteerd Tablet Compartment.

28 × 21 × 5 cm

20

Print Code: G(1), N(8)



10" Tablet Compartment



Boral 7241



Laptop
Compartment

Backpack. Nylon 600D. Padded Laptop Compartment. Padded Back and Shoulder Straps.

Rucksack. Nylon 600D. Gepolsterte Laptoptasche. Gepolsterter Rücken und Schultergurte.

Sac à Dos. Nylon 600D. Pochette Rembourrée pour Portable. Dos et Bretelles Rembourrées.

Rugzak. Nylon 600D. Gewatteerd Laptop Compartment. Gewatteerde Achterzijde en Schouderbanden.

36 x 46 x 14 cm

Print Code: G(1), N(8)



Pilxu

7026

Backpack. Polyester 1680D/ PU. Padded Laptop Compartment. Padded Back and Shoulder Straps.

Rucksack. Polyester 1680D/ PU. Gepolsterte Laptoptasche. Gepolsterter Rücken und Schultergurte.

Sac à Dos. Polyester 1680D/ Similicuir. Pochette Rembourrée pour Portable. Dos et Bretelles Rembourrées.

Rugzak. Polyester 1680D/ PU. Gewatteerd Laptop Compartment. Gewatteerde Achterzijde en Schouderbanden.

36 x 46 x 14 cm

Print Code: G(1), N(8)



Laptop
Compartment



Selut

7169

Backpack. Polyester 40D/ PU Coating. Padded Laptop Compartment. Padded Back and Shoulder Straps.

Rucksack. Polyester 40D/ PU Beschichtung. Gepolsterte Laptoptasche. Gepolsterter Rücken und Schultergurte.

Sac à Dos. Polyester 40D/ Revêtement Similicuir. Pochette Rembourrée pour Portable. Dos et Bretelles Rembourrées.

Rugzak. Polyester 40D/ PU Coating. Gewatteerd Laptop Compartment. Gewatteerde Achterzijde en Schouderbanden.

30 x 43 x 16.5 cm

Print Code: G(1), N(8)



Laptop
Compartment



Karpal

7075

Backpack. Polyester 1680D. Padded Laptop Compartment. Padded Back and Shoulder Straps.

Rucksack. Polyester 1680D. Gepolsterte Laptoptasche. Gepolsterter Rücken und Schultergurte.

Sac à Dos. Polyester 1680D. Pochette Rembourrée pour Portable. Dos et Bretelles Rembourrées.

Rugzak. Polyester 1680D. Gewatteerd Laptop Compartment. Gewatteerde Achterzijde en Schouderbanden.

32 x 46 x 13 cm

Print Code: G(1), N(8)



Laptop
Compartment

699

Vincal

7240

Bag. Polyester 1680D.
Tasche. Polyester 1680D.
Sac. Polyester 1680D.
Tas. Polyester 1680D.

47 x 28 x 22 cm
Print Code: I(8)

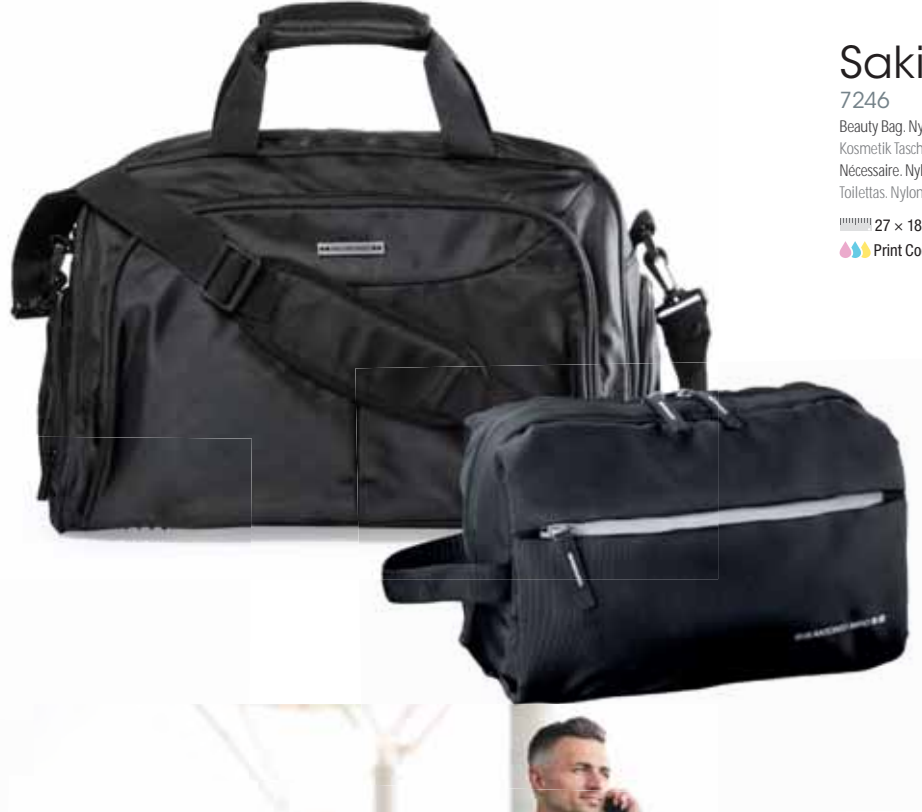

Sakia

7246

Beauty Bag. Nylon. With Inner Lining.
Kosmetik Tasche. Nylon. Mit Innenfutter.
Nécessaire. Nylon. Avec Doublure Antérieure.
Toiletas. Nylon. Met Voering aan de Binnenzijde.

27 x 18 x 17 cm
Print Code: N(8)



700

Sandley



Forum

7124

Trolley. Polyester 900D/ PU. Padded Laptop Compartment.
Trolley. Polyester 900D/ PU. Gepolsterte Laptoptasche.
Trolley. Polyester 900D/ Similicuir. Pochette Rembourrée pour Portable.
Trolley. Polyester 900D/ PU. Gewatteerd Laptop Compartment.

42 x 45 x 19 cm
Print Code: K(8)



Sandley

7299

Trolley. PU. 8 Rotating Wheels.
Trolley. PU. 8 Drehende Räder.
Trolley. Similicuir. 8 Roues Tournantes.
Trolley. PU. 8 Draaiende Wielen.

35 x 60 x 28 cm
Print Code: I(1), L2



Forum



Alexluca
Italy

701



Tugart
7123

Trolley.ABS. Rigid. 4 Rotating Wheels.
Trolley.ABS. Starre. 4 Drehende Räder.
Trolley.ABS. Rigide. 4 Roues Tourantes.
Trolley.ABS. Hard. 4 Draaiende Wielen.

36 × 60 × 22 cm

Print Code: K(1)



Kafal
7247

Trolley.ABS. Rigid. 4 Rotating Wheels. Combination Lock Included.
Trolley.ABS. Starre. 4 Drehende Räder. Sicherheitsverschluss Inklusiv.
Trolley.ABS. Rigide. 4 Roues Tourantes. Fermeture Sécurité Inclus.
Trolley.ABS. Hard. 4 Draaiende Wielen. Veiligheidsluiting Inclusief.

43 × 68 × 26 cm

Print Code: K(1)



Rumax
7087

Trolley.ABS. Rigid. 4 Rotating Wheels. Combination Lock Included.
Trolley.ABS. Starre. 4 Drehende Räder. Sicherheitsverschluss Inklusiv.
Trolley.ABS. Rigide. 4 Roues Tourantes. Fermeture Sécurité Inclus.
Trolley.ABS. Hard. 4 Draaiende Wielen. Veiligheidsluiting Inclusief.

36 × 55 × 23 cm

Print Code: K(1)



Combination
Lock



Combination
Lock

Antonio Miro



Orion

7181

Watch. Metal/ PU. Japanese Quartz Movement. Water Resistant. Mineral Glass.

Uhr. Metall/ PU. Japanische Quarzwerk. Wasserdicht. Mineralglas.

Montre. Métal/ Similicuir. Mouvement à Quartz Japonais. Etanche. Verre Minéral.

Horloge. Metaal/ PU. Japans Quartz Binnenwerk. Waterbestendig. Mineraal Glas.

25 x 4.5 x 1 cm

100 / 25

Print Code: L2



Kanok

7184

Watch. Metal/ PU. Japanese Quartz Movement. Water Resistant. Mineral Glass.

Uhr. Metall/ PU. Japanische Quarzwerk. Wasserdicht. Mineralglas.

Montre. Métal/ Similicuir. Mouvement à Quartz Japonais. Etanche. Verre Minéral.

Horloge. Metaal/ PU. Japans Quartz Binnenwerk. Waterbestendig. Mineraal Glas.

24 x 4.5 x 1 cm

100 / 25

Print Code: L2



Osiel

7183

Watch. Metal/ PU. Japanese Quartz Movement. Water Resistant. Mineral Glass.

Uhr. Metall/ PU. Japanische Quarzwerk. Wasserdicht. Mineralglas.

Montre. Métal/ Similicuir. Mouvement à Quartz Japonais. Etanche. Verre Minéral.

Horloge. Metaal/ PU. Japans Quartz Binnenwerk. Waterbestendig. Mineraal Glas.

24.5 x 4.8 x 1.8 cm

100 / 25

Print Code: L2



Lintus

7225

Card Holder Wallet. Leather. 8 Compartments.
Visitenkartenetui Brieftasche. Leder. 8 Abteilungen.
Porte-Cartes Portefeuille. Cuir. 8 Compartiments.
Kaartjeshouder Portemonnee. Leer. 8 Compartimenten.

10 × 7.7 × 1 cm

100 / 10

Print Code: F(1), L1

ANTONIO MIRO

Sartil

Sartil

7324

Wallet. Leather.
Brieftasche. Leder.
Portefeuille. Cuir.
Portemonnee. Leer.

11 × 9 × 1 cm

200 / 50

Print Code: F(1), L1, T



Kunlap

7325

Card Holder. Leather. 20 Compartments.
Visitenkartenetui. Leder. 20 Abteilungen.
Porte-Cartes. Cuir. 20 Compartiments.
Kaartjeshouder. Leer. 20 Compartimenten.

8.5 × 11 × 1.3 cm

100 / 50

Print Code: F(1), L1, T

703



Fagus

7224

Wallet. Leather.
Brieftasche. Leder.
Portefeuille. Cuir.
Portemonnee. Leer.

10.5 × 8.5 × 1 cm

100 / 10

Print Code: F(1), L1, T



Tuzzi

3174

Wallet. Leather.
Brieftasche. Leder.
Portefeuille. Cuir.
Portemonnee. Leer.

11 × 9 × 0.8 cm

50

Print Code: F(1), L1

Alexluca
Italy



Alexluca

Italy



Boccaccio

9802

Hat. Polyester.
Hut. Polyester.
Chapeau. Polyester.
Hoed. Polyester.

Print Code: Consultar

Print Code: Consultar

60 / 30



Keman

7164

Hat. 100% Cotton.
Hut. 100% Baumwolle.
Bonnet. 100% Coton.
Muts. 100% Katoen.

Consult.

Print Code: G(1), N(8), P

100 / 10



PERTEGAZ



Brook

7114

Tie. 100% Silk.
Krawatte. 100% Seide.
Cravate. 100% Soie.
Stropdas. 100% Zijde.

8 x 148 cm

Print Code: J(8)

50

704



Alexluca

Italy

Luomo

9804

Scarf. Cotton/Viscose.
Schal. Baumwolle/Viskose.
Echarpe. Coton/Viscose.
Sjaal. Katoen/Viscose.

160 x 21 cm

Print Code: N(8), P

40



02



PERTEGAZ

Coty

7115

Reversible Scarf. Acrylic/Viscose.
Wendeschal. Acryl/Viskose.
Echarpe Réversible. Acrylique/Viscose.
Omkeerbare Sjaal. Acryl/Viscose.

180 x 26 cm

Print Code: J(8), P

50



Antonio Miro



PONGEE

Ø 100 cm

Royal
7157

Umbrella. Pongee. Automatic. PU Handle.
Regenschirm. Pongee. Automatisch. PU Griff.
Parapluie. Pongée. Automatique. Poignée Similicuir.
Paraplu. Pongee. Automatisch. PU Handvat.

☂ Ø 100 cm 📦 25
🌈 Print Code: H(1), N(8)



PONGEE

Ø 120 cm

Campbell
7153

Umbrella. Pongee. Automatic. Windproof.
Regenschirm. Pongee. Automatisch. Antiwindsystem.
Parapluie. Pongée. Automatique. Système Anti-Vent.
Paraplu. Pongee. Automatisch. Windbestendig.

☂ Ø 120 cm 📦 25
🌈 Print Code: H(1), N(8)



PONGEE

Ø 95 cm

Telfox
7154

Umbrella. Pongee. Automatic Opening and Closing. Windproof.
Regenschirm. Pongee. Automatisch Öffnen und Schließen. Antiwindsystem.
Parapluie. Pongée. Ouverture et Fermeture Automatiques. Système Anti-Vent.
Paraplu. Pongee. Automatisch Öffnen en Sluiten. Windbestendig.

☂ Ø 95 cm 📦 30 / 10
🌈 Print Code: H(1), N(8)

705





Yumax

7096

iPhone Pouch. PU.
iPhone Hülle. PU.
Étui iPhone. Similicuir.
iPhone Hoes. PU.

7 × 12 × 2 cm

200 / 50

Print Code: E(4), L1



Antonio Miro



706

Gasper

7077

Stylus Touch Pen. Metal. Conductive Fibre Pointer.
Touchpad Stift. Metall. Touchpad Stift Leitfähige Fasern.
Stylét. Metal. Pointeur Fibre Conducteur.
Touchscreen-Pen. Metaal. Punt van Geleidendes Fibers.

Ø 1 × 6.5 cm

400 / 50

Print Code: Consultar



Kanyi

7092

Card Holder. PU. 1 Compartment.
Visitenkartenetui. PU. 1 Abteilung.
Porte-Cartes. Similicuir. 1 Compartment.
Kaartjeshouder. PU. 1 Compartment.

10 × 6 × 1.7 cm

200 / 50

Print Code: E(4), L1



Sofil

7093

Card Holder Mirror. PU. 1 Compartment.
Visitenkartenetui Spiegel. PU. 1 Abteilung.
Porte-Cartes Miroir. Similicuir. 1 Compartment.
Kaartjeshouder Spiegel. PU. 1 Compartment.

10 × 6.5 × 1 cm

200 / 50

Print Code: E(4), L1





Antonio Miro



Prax
7218

Letter Opener. Metal.
Brieföffner. Metall.
Coupe Papier. Métal.
Briefopener. Metaal.

2.8 × 15.8 × 0.4 cm

200 / 20

Print Code: E(4), L1



Baloo
7227

Bookmark. Metal.
Lesezeichen. Metall.
Marque Pages. Métal.
Bladwijzer. Metaal.

2.4 × 14.2 × 0.4 cm

200 / 50

Print Code: E(4), L1

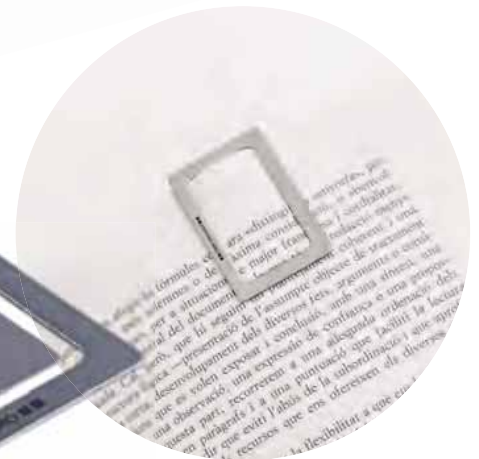

Carex
7217

Clip Bookmark. Metal.
Clip Lesezeichen. Metall.
Clip Marque Pages. Métal.
Clip Boeklegger. Metaal.

3 × 4.5 cm

500 / 50

Print Code: E(4), L1

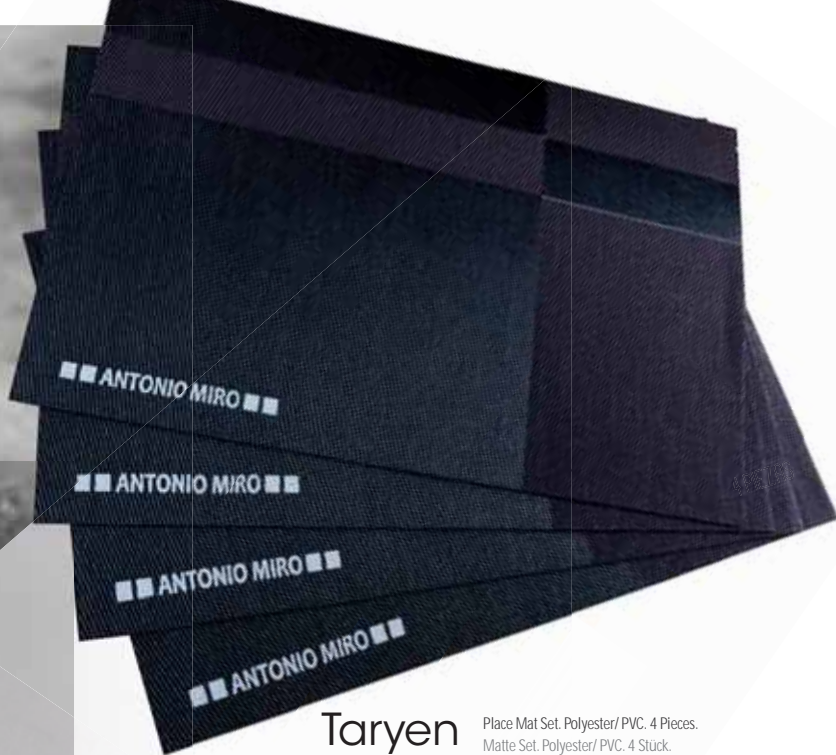

Antonio Miro

Taryen
7145

Place Mat Set. Polyester/ PVC. 4 Pieces.
Matte Set. Polyester/ PVC. 4 Stück.
Set Table. Polyester/ PVC. 4 Pieces.
Placemat Set. Polyester/ PVC. 4 Stuks.

48.5 × 33 × 0.5 cm

Print Code: F(1), N(8)



708



500 ml



Kabol

7170

Vacuum Bottle. Stainless Steel. 500 ml. Individual Presentation.
Thermoskanne. Rostfreier Stahl. 500 ml. Individuelle Präsentation.
Bidon Thermo. Acier Inox. 500 ml. Présentation Individuelle.
Thermoskan. Roestvrij Staal. 500 ml. Individuele Presentatie.

Ø 7.5 × 24.2 cm

Print Code: F(1), L2



Misko

7250

Pot Holder. 100% Cotton. One Flat Side for Printing.
Topflappen. 100% Baumwolle. Eine Fläche Seite zum Bedrucken.
Manique. 100% Coton. Un Côté Lisse pour Impression.
Pannenvlap. 100% Katoen. Een Platte Zijde Voor Bedrukking.

18 × 18 cm

Print Code: E(1), N(8)



Krassy

7249

Kitchen Mitten. 100% Cotton. One Flat Side for Printing.
Küchenhandschuh. 100% Baumwolle. Eine Fläche Seite zum Bedrucken.
Gant Cuisine. 100% Coton. Un Côté Lisse pour Impression.
Overwant. 100% Katoen. Een Platte Zijde Voor Bedrukking.

18 × 30 cm

Print Code: E(1), N(8)





Antonio Miro

Bradimor

7355

Wine Set. Wood. 4 Accessories.
Wein Set. Holz. 4 Teile.
Set Vin. Bois. 4 Accessoires.
Wijn Set. Hout. 4 Accessoires.

17 x 6.3 x 18.4 cm

Print Code: F(1), L2

20



709



Luxur

7149

Fork Set. Stainless Steel. 4 Pieces.
Gabelset. Rostfreier Stahl. 4 Stück.
Set Fourchettes. Acier Inox. 4 Pièces.
Vorken Set. Roestvrij Staal. 4 Stuks.

10.3 x 1.3 x 16 cm

Print Code: F(1), L1

50 / 10

Gambel

7150

Kitchen Set. Stainless Steel. 2 Pieces.
Küchen Set. Rostfreier Stahl. 2 Stück.
Set Cuisine. Acier Inox. 2 Pièces.
Keuken Set. Roestvrij Staal. 2 Stuks.

35.6 x 2.6 x 11 cm

Print Code: I(1), L2

40



Totens

7354

Wine Set. Wood. 4 Accessories.
Wein Set. Holz. 4 Teile.
Set Vin. Bois. 4 Accessoires.
Wijn Set. Hout. 4 Accessoires.

23 x 5.1 x 13.2 cm

Print Code: F(1), L2

20



ANTONIO MIRO

Antonio Miro



Hazor 7174

Hair Straightener. Ceramic Coating. AC 220-240V.
Glätteisen. Keramikbeschichtung. AC 220-240V.
Lisseur. Revêtement Céramique. AC 220-240V.
Haarstijler. Keramische Coating. AC 220-240V.

21 × 3.2 × 2.8 cm

20

Print Code: G(1)

710



08

Naidux 7161

Flip Flops. EVA/ Polyester.
Flip Flop. EVA/ Polyester.
Tongues. EVA/ Polyester.
Flip Flops. EVA/ Polyester.

36-38, 42-44

60 / 10

Print Code: F(1), N(8), 0



03



Karpiox 7175

Ear/ Nose Trimmer. 2 Batteries AAA Not Included.
Hals/ Nase Trimmer. 2 AAA Batterien Nicht im Lieferumfang.
Tondeuse Précision. 2 Piles AAA Non Inclus.
Oor/Neus Trimmer. 2 Batterijen AAA Niet Inclusief.

3 × 13.8 × 1.5 cm

50

Print Code: G(1)

Nextar

7122

Bag, Natural Fibre.
Tasche, Naturfaser.
Sac, Fibre Naturelle.
Tas, Natural Fibre.

30 × 38 × 12 cm

200 / 10

Print Code: F(1)



Yumex

7121

Bag, Natural Fibre.
Tasche, Naturfaser.
Sac, Fibre Naturelle.
Tas, Natural Fibre.

40 × 36 × 12 cm

200 / 10

Print Code: F(1)

711



08

02

Kira

7248

Blanket, Polar Fleece 260 g/ m2, Anti-Pilling.
Decke, Polar Fleece 260 g/ m2, Anti-Pilling.
Couverture, Polaire 260 g/ m2, Anti-Pilling.
Deken, Polar Fleece 260 g/ m2, Anti-Pilling.

130 × 160 cm

20

Print Code: P

130 × 160 cm
260 g/m²

Neptun

7134

Blanket, Polar Fleece 260 g/ m2, Anti-Pilling.
Decke, Polar Fleece 260 g/ m2, Anti-Pilling.
Couverture, Polaire 260 g/ m2, Anti-Pilling.
Deken, Polar Fleece 260 g/ m2, Anti-Pilling.

125 × 150 cm

10

Print Code: N(8), P

125 × 150 cm
260 g/m²





Borth

7291



Multitool. Aluminium/ Stainless Steel. 6 Functions.
 Multiwerkzeug. Aluminium/ Rostfreier Stahl. 6 Funktionen.
 Multi Outils. Aluminium/ Acier Inox. 6 Fonctions.
 Multitool. Aluminium/ Roestvrij Staal. 6 Functies.

2.8 × 8.4 × 1.5 cm

100 / 10

Print Code: E(1), L1

712



Korgon

7339

Multifunction Pocket Knife. Stainless Steel. 8 Functions.
 Multifunktions Taschenmesser. Rostfreier Stahl. 8 Funktionen.
 Canif Multi-Usages. Acier Inox. 8 Fonctions.
 Multifunctioneel Zakmes. Roestvrij Staal. 8 Functies.

11 × 3 × 1.5 cm

100 / 10

Print Code: E(4), L1



Klent

7292

Multifunction Pocket Knife. Aluminium/ Stainless Steel. 10 Functions.
 Multifunktions Taschenmesser. Aluminium/ Rostfreier Stahl. 10 Funktionen.
 Canif Multi-Usages. Aluminium/ Acier Inox. 10 Fonctions.
 Multifunctioneel Zakmes. Aluminium/ Roestvrij Staal. 10 Functies.

10.1 × 2.7 × 1.3 cm

100 / 10

Print Code: E(1), L1



Damok

7340

Pocket Knife. Metal/ Stainless Steel. 1 Led. Safety Lock Included. Button Batteries Included.
 Taschenmesser. Metall/ Rostfreier Stahl. 1 Led. Sicherheitsverschluss. Knopfzellen Inklusiv.
 Canif. Métal/ Acier Inox. 1 Led. Avec Cran d'Arrêt. Piles Bouton Inclus.
 Zakmes. Metaal/ Roestvrij Staal. 1 Led. Met Veiligheidsblokkade. Knopcel Batterijen Inclusief.

11.4 × 3 × 1 cm

100 / 10

Print Code: E(1), L1





Ketor

7285

Monocular. Aluminium.
Monokulare. Aluminium.
Monoculaire. Aluminium.
Enkele Verrekijker. Aluminium.

5 × 6.5 × 11 cm 50 / 25

Print Code: I(1)



Saida

7286

Compass. Aluminium.
Kompass. Aluminium.
Boussole. Aluminium.
Kompas. Aluminium.

5.7 × 16 × 3 cm 100 / 10

Print Code: F(1), L1



713



Yunaz

7338

Set. Aluminium/ Stainless Steel. 1 Led. 3 Light Modes. Pocket Knife 15 Functions. 3 Batteries AAA Not Included.

Set. Aluminium/ Rostfreier Stahl. 1 Led. 3 Leuchtfunktionen. Taschenmesser 15 Funktionen. 3 AAA Batterien Nicht im Lieferumfang.

Set. Aluminium/ Acier Inox. 1 Led. 3 Modes de Lumière. Canif 15 Fonctions. 3 Piles AAA Non Inclus.

Set. Aluminium/ Roestvrij Staal. 1 Led. 3 Licht Posities. Zakmes 15 Functies. 3 Batterijen AAA Niet Inclusief.

15 × 4.7 × 9.7 cm 50 / 10

Print Code: F(4), L1



Norfolk

7288

Torch. Aluminium. 28 Leds. 3 Batteries AAA Not Included.
Lampe. Aluminium. 28 Leds. 3 AAA Batterien Nicht im Lieferumfang.
Lampe. Aluminium. 28 Leds. 3 Piles AAA Non Inclus.
Zaklamp. Aluminium. 28 Leds. 3 Batterijen AAA Niet Inclusief.

Ø 4.7 × 11.2 cm 100 / 50

Print Code: E(4), L1

Lumosh

7287

Torch. Aluminium. 9 Leds. 3 Batteries AAA Not Included.
Lampe. Aluminium. 9 Leds. 3 AAA Batterien Nicht im Lieferumfang.
Lampe. Aluminium. 9 Leds. 3 Piles AAA Non Inclus.
Zaklamp. Aluminium. 9 Leds. 3 Batterijen AAA Niet Inclusief.

Ø 3.2 × 10 cm 100 / 50

Print Code: E(4), L1



swisent
ORIZONS[®]
adventure

714



03



11

19

02

05



02

19



03

Hanaix

7283

Drawstring Bag. Nylon 210D.
Rucksack. Nylon 210D.
Sac à Dos. Nylon 210D.
Rugzak. Nylon 210D.

34 × 42 cm

Print Code: F(1)

300 / 50

Virtux

7295

Backpack. Polyester 420D. Padded Back and Shoulder Straps.
Rucksack. Polyester 420D. Gepolsterter Rücken und Schultergurte.
Sac à Dos. Polyester 420D. Dos et Bretelles Rembourrées.
Rugzak. Polyester 420D. Gewatteerde Achterzijde en Schouderbanden.

35 × 53 × 28 cm

Print Code: J(8)

20



Water
Repellent



Ø 104 cm

Vera

7140

Umbrella. Automatic.
Regenschirm. Automatisch.
Parapluie. Automatique.
Paraplu. Automatisch.

Ø 104 cm

Print Code: G(1), N(8)

30 / 10



Ø 98 cm

Mara

7147

Umbrella.
Regenschirm.
Parapluie.
Paraplu.

Ø 98 cm

Print Code: G(1), N(8)

50 / 10



Nabel

7263

Multipurpose Bag. Polyester 600D.
Mehrzwecktasche. Polyester 600D.
Fourre-Tout. Polyester 600D.
Multifunctioneel Tasje. Polyester 600D.

18.5 x 10.5 cm

Print Code: E(1), N(8), O

500 / 10

Bintex

7264

Notebook. Hard Cover. 80 Sheets.
Notizbuch. Hardcover-Abdeckung. 80 Seiten.
Cahier. Couverture Rigide. 80 Feuilles.
Nolittieboek. Harde Kaft. 80 Blaadjjes.

12.5 x 14.3 x 1 cm

Print Code: E(1)

100 / 25



Ventol

7257

Hand Fan. Wood/ Cotton.
Fächer. Holz/ Baumwolle.
Éventail. Bois/ Coton.
Waaier. Houten/ Katoen.

42 x 21 cm

Print Code: D(1), E(1), L1

250



80 Sheets
Lined

716



Helant

7312

Adjustable Ring.
Verstellbarer Ring.
Bague Ajustable.
Aanpasbare Ring.

■■■■■■ Consult.

🌈 Print Code: E(1)

📦 200 / 20



Pleus

7188

Adjustable Ring.
Verstellbarer Ring.
Bague Ajustable.
Aanpasbare Ring.

■■■■■■ Consult.

🌈 Print Code: Consultar

📦 200 / 20



Hansok

7314

Adjustable Ring.
Verstellbarer Ring.
Bague Ajustable.
Aanpasbare Ring.

■■■■■■ Consult.

🌈 Print Code: E(1)

📦 200 / 20



Zook

7313

Adjustable Ring.
Verstellbarer Ring.
Bague Ajustable.
Aanpasbare Ring.

■■■■■■ Consult.

🌈 Print Code: Consultar

📦 200 / 20



Lantha

Bawox

Malva



Lantha

7315

Necklace.
Collier.
Collier.
Ketting.

▬▬▬▬▬▬ 4 × 24 cm

🎨 Print Code: E(1)

📦 200 / 20

Bawox

7230

Necklace.
Collier.
Collier.
Ketting.

▬▬▬▬▬▬ 51 cm

🎨 Print Code: Consultar

📦 100 / 10

Malva

7316

Necklace.
Collier.
Collier.
Ketting.

▬▬▬▬▬▬ 4 × 25 cm

🎨 Print Code: Consultar

📦 200 / 20

717



Loffy

7318

Bracelet.
Armband.
Bracelet.
Armband.

▬▬▬▬▬▬ Ø 7 × 2.5 cm

🎨 Print Code: E(1)

📦 100 / 20



Neysa

7317

Bracelet.
Armband.
Bracelet.
Armband.

▬▬▬▬▬▬ Ø 5.5 × 1.3 cm

🎨 Print Code: E(1)

📦 200 / 20



718



Taris

7186

Earrings.
Ohrringe.
Boucles d'Oreille.
Oorbellen.

Ø 2 cm

200 / 20

Print Code: Consultar



Moss

7185

Earrings.
Ohrringe.
Boucles d'Oreille.
Oorbellen.

1.8 x 2.2 cm

200 / 20

Print Code: Consultar



Carole

7155

Beauty Bag. Microfibre/ Nylon. With Inner Lining.
Kosmetik Tasche. Mikrofaser/ Nylon. Mit Innenfutter.
Nécessaire. Microfibre/ Nylon. Avec Doublure Antérieure.
Toiletas. Microfiber/ Nylon. Met Voering aan de Binnenzijde.

20 x 12 x 6.5 cm

200 / 50

Print Code: N(8), 0



Ferni

7254

Purse. PU.
Portemonnaie. PU.
Porte Monnaie. Similicuir.
Portemonnee. PU.

13.5 x 8 x 0.8 cm

360 / 20

Print Code: E(1), L1



Fiyil

7193

Necklace.
Collier.
Collier.
Ketting.

2.6 x 23 cm

Print Code: Consultar

200 / 20

01

03

01

02

03

Cotla

7199

Bracelet. Adjustable.
Armband. Verstellbar.
Bracelet. Ajustable.
Armband. Aanpasbaar.

Ø 5 x 0.4 cm

Print Code: Consultar

200 / 20

Nolton

7195

Adjustable Ring.
Verstellbarer Ring.
Bague Ajustable.
Aanpasbare Ring.

Consult.

Print Code: Consultar

200 / 20

Itish

7196

Adjustable Ring.
Verstellbarer Ring.
Bague Ajustable.
Aanpasbare Ring.

Consult.

Print Code: Consultar

200 / 20





PERTEGAZ

pertegaZ



Cercles

7104

Bracelet.
Armband.
Bracelet.
Armband.

Ø 6.8 × 2.5 cm

Print Code: Consultar

100 / 10



720



Atlan

7105

Necklace.
Collier.
Collier.
Ketting.

1.7 × 49 cm

Print Code: Consultar

100



Carla

7101

Necklace.
Collier.
Collier.
Ketting.

3.5 × 54.5 cm

Print Code: Consultar

50

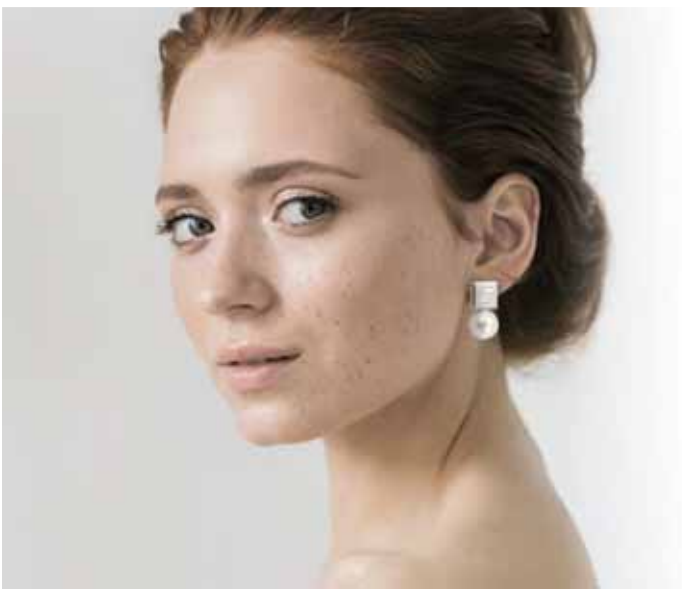

Llum

7100

Earrings.
Ohrringe.
Boucles d'Oreille.
Oorbellen.

1.3 x 2.5 cm

Print Code: Consultar



200 / 10

Tegux

7266

Adjustable Ring.
Verstellbarer Ring.
Bague Ajustable.
Aanpasbare Ring.

Consult.

Print Code: Consultar



200



Elaya

7326

Bracelet. Adjustable.
Armband. Verstellbar.
Bracelet. Ajustable.
Armband. Aanpasbaar.

5.5 x 1.3 cm

Print Code: Consultar

100 / 12

Drems

7327

Earrings.
Ohrringe.
Boucles d'Oreille.
Oorbellen.

1.5 cm

Print Code: Consultar

200 / 12

PERTEGAZ



CORAZÓN

Ilussion

7111

Bag Hanger. Metal.
Handtaschenhalter. Metall.
Porte-Sac. Métal.
Tas Hanger. Metaal.

6.5 × 12.2 × 0.5 cm

150

Print Code: E(1), L1



ESTRELLA



FLOR



NUBE



Aunix

7271

Earrings.
Ohrringe.
Boucles d'Oreille.
Oorbellen.

1.8 × 1.8 cm

200

Print Code: Consultar



Donix

7270

Adjustable Ring.
Verstellbarer Ring.
Bague Ajustable.
Aanpasbare Ring.

Consult.

100

Print Code: Consultar





Aure

7083

Necklace.
Collier.
Collier.
Ketting.

88 cm

50

Print Code: Consultar



Astra

7081

Necklace.
Collier.
Collier.
Ketting.

7 x 44 cm

100

Print Code: Consultar



Rousse

7082

Earrings.
Ohrringe.
Boucles d'Oreille.
Oorbellen.

Ø 4 cm

200

Print Code: Consultar

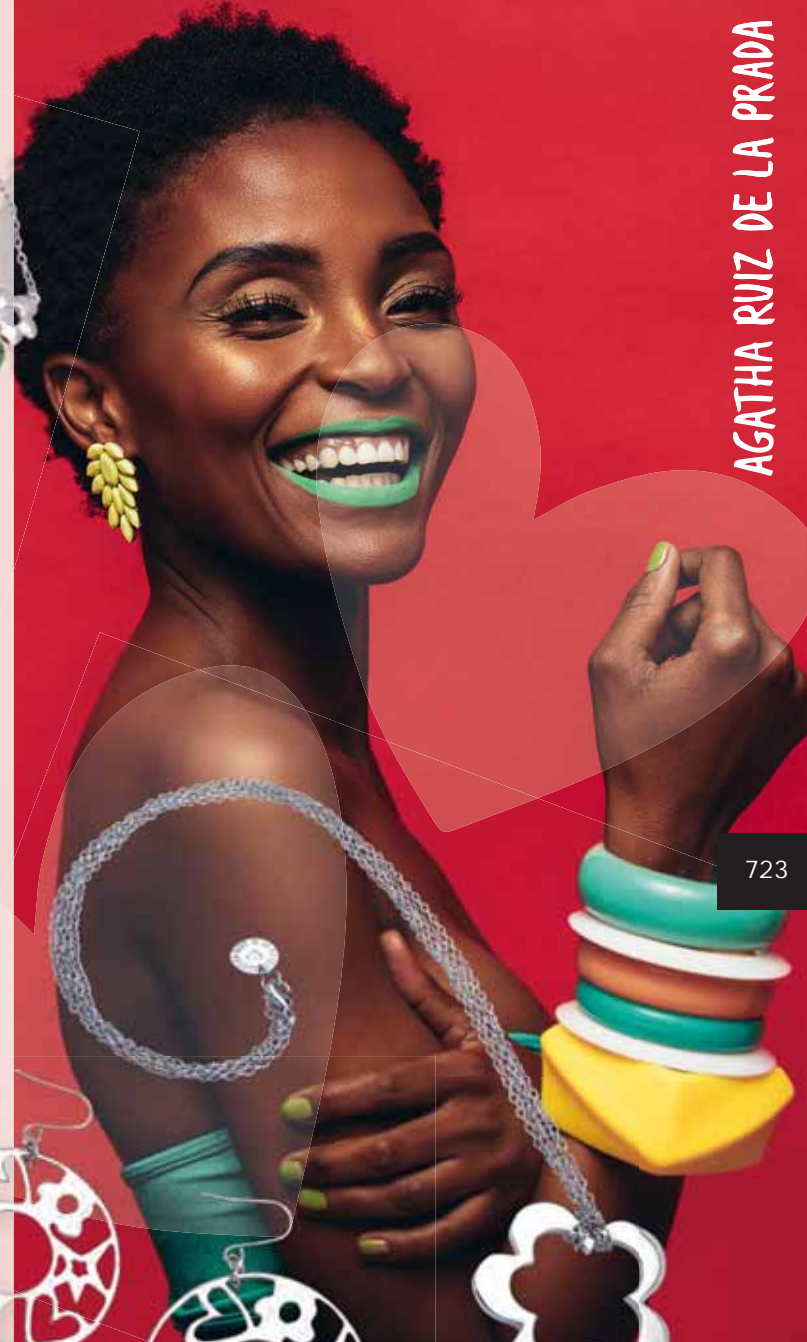

723

Margaret

7102

Necklace.
Collier.
Collier.
Ketting.

6 x 51.5 cm

100

Print Code: Consultar

SPECIAL PACKAGING



Lesky

6823

Bag. Jute.
Tasche. Jutesstoff.
Sac. Jute.
Tas. Jute.

16 x 20 cm

Print Code: F(1)

300 / 50



Vagan

6824

Bag. Jute.
Tasche. Jutesstoff.
Sac. Jute.
Tas. Jute.

25 x 30 cm

Print Code: F(1)

200 / 50



COTTON 100%

25 x 30 cm
105 g/m²

Jardix

12 x 33 cm
105 g/m²

Marcex

15 x 21 cm
105 g/m²

Fergut

725

Jardix

6623

Bag. 100% Cotton 105 g/ m².
Tasche. 100% Baumwolle 105 g/ m².
Sac. 100% Coton 105 g/ m².
Tas. 100% Katoen 105 g/ m².

500 / 50

Print Code: F(6), N(8), O, P

Fergut

6622

Bag. 100% Cotton 105 g/ m².
Tasche. 100% Baumwolle 105 g/ m².
Sac. 100% Coton 105 g/ m².
Tas. 100% Katoen 105 g/ m².

500 / 50

Print Code: F(6), N(8), O, P

Marcex

6624

Bottle Bag. 100% Cotton 105 g/ m².
Trinkflasche Tasche. 100% Baumwolle 105 g/ m².
Sac Bouteille. 100% Coton 105 g/ m².
Fles Tas. 100% Katoen 105 g/ m².

500 / 50

Print Code: F(6), N(8), O, P

IDEAL FOR BOTTLES AND VACUUM FLASK
IDEAL PARA BOTES Y TERMOS

SUITABLE FOR ALL KINDS OF MASKS
BREATHABLE, WASHABLE AND REUSABLE
VÁLIDO PARA TODO TIPO DE MASCARILLAS
TRANSPIRABLE, LAVABLE Y REUTILIZABLE



Yator

2613

Mask Pouch. Non-Woven.
Halterung für Maske. Non-Woven.
Porte-Masques. T.N.T.
Maskerhouder. Non-Woven.

15 x 16 cm

1000 / 100

Print Code: E(1)

BREATHABLE, WASHABLE AND HIGH-RESISTANCE FABRIC
SUITABLE FOR ALL KINDS OF MASKS
TEJIDO TRANSPIRABLE Y LAVABLE DE ALTA RESISTENCIA
VÁLIDO PARA TODO TIPO DE MASCARILLAS



Claver

2611

Mask Pouch. 50% Cotton/ 50% Polyester.
Halterung für Maske. 50% Baumwolle/ 50% Polyester.
Porte-Masques. 50% Coton/ 50% Polyester.
Maskerhouder. 50% Katoen/ 50% Polyester.

15 x 18 cm

500

Print Code: E(1), N(8)



726



Ekain

4390

Pouch. Polyester.
Hülle. Polyester.
Étui. Polyester.
Hoes. Polyester.



9 x 18 cm

1000 / 50

Print Code: D(1), N(8), R

Yisan

4877

Gift Box. Laminated Cardboard.
Geschenk-Box. Laminiertes Pappe.
Boite de Présentation. Carton Laminé.
Geschenkeendoos. Gelamineerd Karton.

7.8 x 11.5 x 3.2 cm

2000 / 100

Print Code: C(1)



Milla

9994

Pouch. Polyester.
Hülle. Polyester.
Étui. Polyester.
Hoes. Polyester.

9 x 18 cm

1000 / 50

Print Code: D(1), N(8)





Louis
7036

Bag. Polyester.
Tasche. Polyester.
Sac. Polyester.
Tas. Polyester.

10 x 15 cm

5000 / 100

Print Code: N(8)



Dacrok
5901

Bag. Polyester.
Tasche. Polyester.
Sac. Polyester.
Tas. Polyester.

10 x 14 cm

1000 / 50

Print Code: E(1), N(8)



Kiping
4221

Bag. Polyester.
Tasche. Polyester.
Sac. Polyester.
Tas. Polyester.

9.5 x 10 cm

3000 / 100

Print Code: D(1), N(8)



Hidra
4227

Bag. Velvet.
Tasche. Wildleder.
Sac. Suédine.
Tas. Fluweel.

8 x 10 cm

2000 / 50

Print Code: D(1), N(8)



08



02



19



01

03



19

Menit

4222

Pen Pouch. Cardboard.
Kugelschreiber Hülle. Pappe.
Étui Stylo. Carton.
Pennehoes. Karton.

4 × 15.5 cm

Print Code: B(4)

4000 / 400



02



Recycard

3340

Pen Pouch. Recycled Cardboard.
Kugelschreiber Hülle. Recycling Pappe.
Étui Stylo. Carton Recyclé.
Pennehoes. Gerecycled Karton.

4 × 15.5 cm

Print Code: B(4)

4000 / 400



Locen

6611

Pen Pouch. Cardboard.
Kugelschreiber Hülle. Pappe.
Étui Stylo. Carton.
Pennehoes. Karton.

4 × 15.5 cm

Print Code: B(4)

4000 / 400

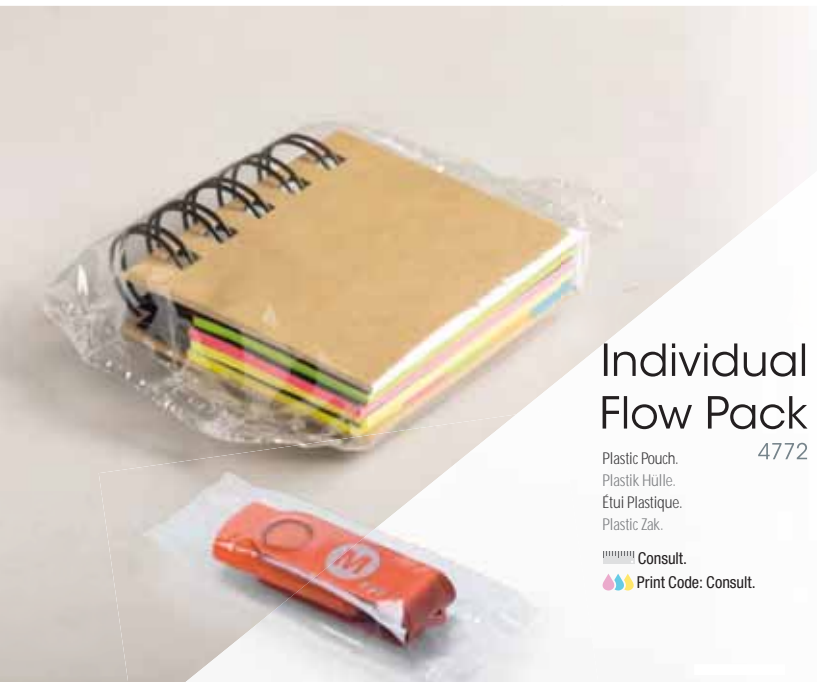

Individual Flow Pack

4772

Plastic Pouch.
Plastik Hülle.
Étui Plastique.
Plastic Zak.

Consult.

Print Code: Consult.



19



08

02

03

Velvex

4223

Pen Pouch. Velvet.
Kugelschreiber Hülle. Wildleder.
Étui Stylo. Suédine.
Pennehoes. Fluweel.

2.5 × 15.5 cm

Print Code: B(1)

8000 / 200



Shilay

4630

Pouch. PU.
Hülle. PU.
Étui. Similicuir.
Hoes. PU.
9 x 9 x 2 cm
Print Code: D(4)



500 / 100

Kibal

4761

Pouch.
Hülle.
Étui.
Etui.
9 x 9 x 2 cm
Print Code: D(4)

200 / 50



Hamlet

5083

Gift Box.
Geschenk-Box.
Boîte de Présentation.
Geschenkendoos.
6 x 1.2 x 2.5 cm
Print Code: B(4)

5000

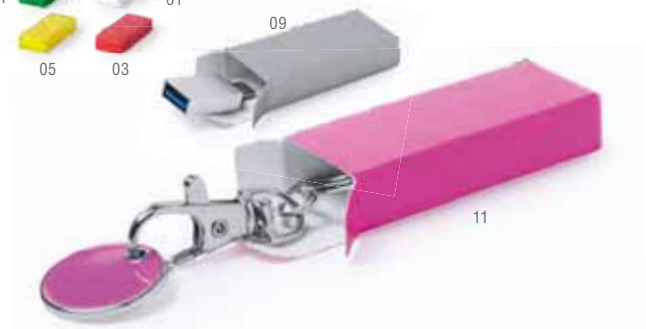

Shrink Wrapping

Retractable

ASK FOR PRICES
CONSULTAR PRECIO



Flow Pack

ASK FOR PRICES
CONSULTAR PRECIO



Individual Flow pack

ASK FOR PRICES
CONSULTAR PRECIO



Tecly

4595

Bag. LDPE.
Tasche. LDPE.
Sac. LDPE.
Tas. LDPE.

27.5 x 37 cm
Print Code: D(1)

1000 / 100

01

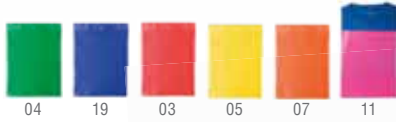

Desmond

3307

Bag. Non-Woven.
Tasche. Non-Woven.
Sac. T.N.T.
Tas. Non-Woven.

23 x 35 cm
Print Code: F(1)

400 / 20

730



01

02

IDEAL FOR BACKPACKS
IDEAL PARA MOCHILAS



Cuper

5438

Bag. Non-Woven.
Tasche. Non-Woven.
Sac. T.N.T.
Tas. Non-Woven.

46 x 59 cm
Print Code: F(1)

200 / 20



Delhy

6010

Pouch. PVC.
Hülle. PVC.
Etui. PVC.
Hoes. PVC.

Ø 7.6 x 26.5 cm
Print Code: F(1)

150 / 10



IDEAL FOR BOTTLES AND VACUUM FLASK
IDEAL PARA BOTES Y TERMOS

SPECIAL
PACKAGING

Your Brand.

asiaexpress

MAKE A DIFFERENCE, CUSTOMIZE YOUR PACKAGING

MARCA LA DIFERENCIA, MARCA TU PACKAGING.

· 100% customizable design and size · 250 pcs minimum order quantity · Delivery from 15 days



①

Choose an item from the catalogue
Escoge un producto del catálogo



②

Design your corporate packaging
Diseña tu packing corporativo



③

Send us the design
Envíanos el diseño

SUBLI MA TION LINE

Flaber
pg 743



SOFT TOUCH

MATERIAL



Prosum 6431

Sublimation Bag. Polyester.
Sublimations Tasche. Polyester.
Sac Sublimation. Polyester.
Sublimatie Tas. Polyester.

38 x 42 cm

100 / 10

Print Code: F(4), N(8), R



Lizcom 6432

Sublimation Drawstring Bag. Polyester.
Sublimations Rucksack. Polyester.
Sac à Dos Sublimation. Polyester.
Sublimatie Rugzak. Polyester.

34 x 42 cm

100 / 10

Print Code: F(4), N(8), R



Kreston 6433

Sublimation Beauty Bag. Polyester.
Sublimations Kosmetik Tasche. Polyester.
Nécessaire Sublimation. Polyester.
Sublimatie Toilettas. Polyester.

22 x 14 x 6.5 cm

500 / 10

Print Code: E(1), N(8), R



734

RPET

i The fabric used in the manufacturing process of these products is made of recycled plastic (RPET). Like this, the emission of plastic residues to our planet and the consumption of energy is drastically reduced, resulting in a much more eco-friendly process.

El material de estos productos está fabricado con plástico reciclado (RPET), que, además de ayudar en la disminución de residuos plásticos en el planeta, utiliza menos energía en el proceso de fabricación, haciendo que sea mucho menos dañino para el medio ambiente.

STOP PLASTIC POLLUTING THE OCEAN



01



Tecnic Markus

6461

Adult T-Shirt. 100% Polyester RPET 135 g/ m2. Breathable.
 Erwachsene T-Shirt. 100% Polyester RPET 135 g/ m2. Atmungsaktiv.
 T-Shirt Adulte. 100% Polyester RPET 135 g/ m2. Respirant.
 T-Shirt Volwassenen. 100% Polyester RPET 135 g/ m2. Ademend.

XS, S, M, L, XL, XXL 80 / 10

Print Code: F(6), M, N(8), O, P, R



NEW



Dekrom

6755

Polo Shirt. 100% Polyester RPET 180 g/ m2. Breathable.
 Polo-Shirt. 100% Polyester RPET 180 g/ m2. Atmungsaktiv.
 Polo. 100% Polyester RPET 180 g/ m2. Respirant.
 Polo Shirt. 100% Polyester RPET 180 g/ m2. Ademend.

S, M, L, XL, XXL

60

Print Code: F(6), N(8), O, P, R

01

RPET

i The fabric used in the manufacturing process of these products is made of recycled plastic (RPET). Like this, the emission of plastic residues to our planet and the consumption of energy is drastically reduced, resulting in a much more eco-friendly process.

El material de estos productos está fabricado con plástico reciclado (RPET), que, además de ayudar en la disminución de residuos plásticos en el planeta, utiliza menos energía en el proceso de fabricación, haciendo que sea mucho menos dañino para el medio ambiente.

STOP PLASTIC POLLUTING THE OCEAN



Restun

6422

Foldable Bag. Polyester RPET.
 Faltbare Tasche. Polyester RPET.
 Sac Pliable. Polyester RPET.
 Opvouwbare Tas. Polyester RPET.

45 x 38.5 cm
 Print Code: F(1), G(1), R



01



Keifax

6420

Cap. Polyester RPET. 5 Panels.
 Mütze. Polyester RPET. 5 Panels.
 Casquette. Polyester RPET. 5 Panneaux.
 Pet. Polyester RPET. 5 Panelen.

Consult.
 Print Code: E(1), N(8), O, P, R



01



Kelmar

6197

Bag. Polyester RPET.
 Tasche. Polyester RPET.
 Sac. Polyester RPET.
 Tas. Polyester RPET.

38 x 42 cm
 Print Code: F(1), R



01



Lambur

6430

Drawstring Bag. Polyester RPET.
 Rucksack. Polyester RPET.
 Sac à Dos. Polyester RPET.
 Rugzak. Polyester RPET.

34 x 42 cm
 Print Code: F(1), R



01



Mendol

5060

Bracelet. Polyester. Adjustable.
Armband. Polyester. Verstellbar.
Bracelet. Polyester. Ajustable.
Armband. Polyester. Aanpasbaar.

34.5 × 1.2 cm

Print Code: D(1), R

2000 / 500

01



01

Plus

3029

Neckerchief. Polyester 170T.
Halstuch. Polyester 170T.
Foulard. Polyester 170T.
Bandana. Polyester 170T.

100 × 70 cm

Print Code: E(1), N(8), R

1000 / 10

Plasker

5061

Bracelet. Polyester. Adjustable. Safety Catch.
Armband. Polyester. Verstellbar. Sicherheitsverschluss.
Bracelet. Polyester. Ajustable. Fermeture Sécurité.
Armband. Polyester. Aanpasbaar. Veiligheidsluiting.

35 × 1.5 cm

Print Code: D(1), R

2000 / 500

01



SAFETY CATCH
CIERRE SEGURIDAD



Safety Catch

736

Gildor

4386

Cleaner Cloth. Microfibre/ Polyester.
Putztuch. Mikrofaser/ Polyester.
Chiffon Nettoyant. Microfibre/ Polyester.
Schoonmaakdoekje. Microfibre/ Polyester.

18 × 15 cm

Print Code: E(1), R

2000 / 100



Ekain

4390

Pouch. Polyester.
Hülle. Polyester.
Étui. Polyester.
Hoes. Polyester.

9 × 18 cm

Print Code: D(1), N(8), R

1000 / 50





Nopak

5454

Sublimation Lanyard. Polyester.
 Sublimations Schlüsselband. Polyester.
 Lanyard Sublimation. Polyester.
 Sublimatie Lanyard. Polyester.

2.5 × 50 cm

500 / 100

Print Code: R



737



Lerop

2598

Mask Holder Lanyard. Polyester.
 Halterung für Maske Schlüsselband. Polyester.
 Lanyard Porte-Masques. Polyester.
 Maskerhouder Lanyard. Polyester.

2.6 × 39 cm

500

Print Code: F(1), N(8), R



Waylen

5852

Sublimation Bracelet. Polyester.
 Sublimations Armband. Polyester.
 Bracelet Sublimation. Polyester.
 Sublimatie Armband. Polyester.

30 × 1.5 cm

Print Code: R





01

cotton
TOUCH

738



Krusly

5250

Adult T-Shirt. 100% Polyester 140 g/m2. Cotton Touch. Breathable.
 Erwachsene T-Shirt. 100% Polyester 140 g/m2. Cotton Touch. Atmungsaktiv.
 T-Shirt Adulte. 100% Polyester 140 g/m2. Cotton Touch. Respirant.
 T-Shirt Volwassene. 100% Polyester 140 g/m2. Cotton Touch. Ademend.

■■■■■■ S, M, L, XL, XXL

📦 80 / 10

🎨 Print Code: F(6), N(8), M, O, P, R



Krusly

5251

Kids T-Shirt. 100% Polyester 140 g/m2. Cotton Touch. Breathable.
 Kinder T-Shirt. 100% Polyester 140 g/m2. Cotton Touch. Atmungsaktiv.
 T-Shirt Enfant. 100% Polyester 140 g/m2. Cotton Touch. Respirant.
 Kinder T-Shirt. 100% Polyester 140 g/m2. Cotton Touch. Ademend.

■■■■■■ 4-5, 6-8, 10-12

📦 100 / 10

🎨 Print Code: F(6), N(8), M, O, P, R





NON-WOVEN

Wercal 01
6115
Sublimation Bag. Non-Woven.
Sublimations Tasche. Non-Woven.
Sac Sublimation. T.N.T.
Sublimatie Tas. Non-Woven.
34 x 43 cm
Print Code: F(1), N(8), R



Mirtal 01
4478
Sublimation Bag. Non-Woven.
Sublimations Tasche. Non-Woven.
Sac Sublimation. T.N.T.
Sublimatie Tas. Non-Woven.
36 x 40 cm
Print Code: F(1), N(8), R



01
POLYESTER 190T

Karent
6123
Foldable Bag. Polyester 190T.
Fallbare Tasche. Polyester 190T.
Sac Pliable. Polyester 190T.
Opvouwbare Tas. Polyester 190T.
46 x 33 x 8 cm
Print Code: F(1), G(1), R

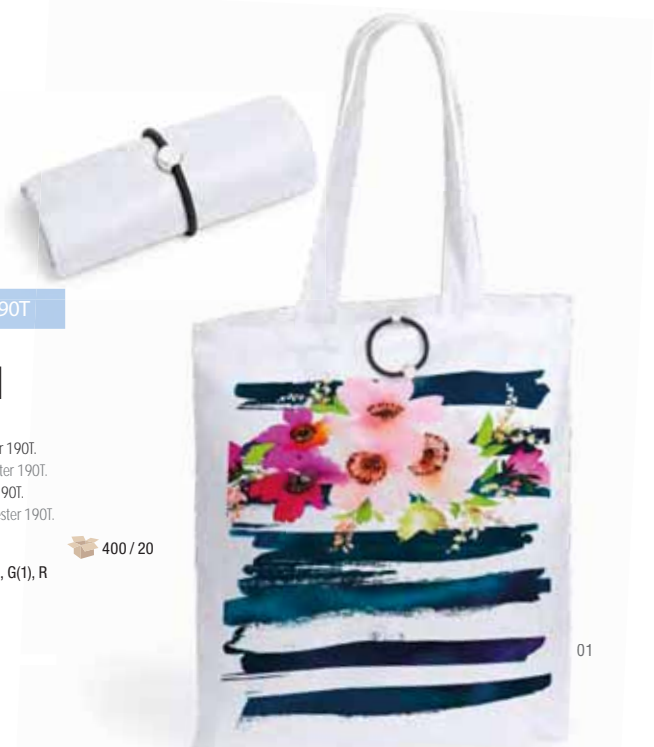

POLYESTER 190T

Conel
4781
Foldable Bag. Polyester 190T.
Fallbare Tasche. Polyester 190T.
Sac Pliable. Polyester 190T.
Opvouwbare Tas. Polyester 190T.
38 x 41 cm
Print Code: F(1), G(1), R

01



IDEAL FABRIC
FOR PRINTING
TEJIDO IDEAL
PARA IMPRESIÓN

POLYESTER / SPANDEX
CORAL FLEECE

POLYESTER / SPANDEX
CORAL FLEECE

01

01



Cherin 4215

Neck Warmer. Polyester.
Schlauchschal. Polyester.
Tour de Cou. Polyester.
Colsjaal. Polyester.

25 × 50 cm

Print Code: F(1), N(8), R

300 / 100

Ponkar 5913

Neck Warmer and Hat. Outside: Polyester/ Spandex. Inside: Coral Fleece. 280 g/ m2.
Schlauchschal und Hut. Außere: Polyester/ Spandex. Innen: Coral Fleece. 280 g/ m2.
Tour de Cou et Bonnet. Extérieur: Polyester/ Spandex. Intérieur: Coral Fleece. 280 g/ m2.
Colsjaal en Muts. Buitenzijde: Polyester/ Spandex. Binnenzijde: Coral Fleece. 280 g/ m2.

25 × 28 cm

Print Code: F(1), N(8), O, P, R

100 / 10

Folten 5914

Hat. Outside: Polyester/ Spandex. Inside: Coral Fleece. 280 g/ m2.
Hut. Außere: Polyester/ Spandex. Innen: Coral Fleece. 280 g/ m2.
Bonnet. Extérieur: Polyester/ Spandex. Intérieur: Coral Fleece. 280 g/ m2.
Muts. Buitenzijde: Polyester/ Spandex. Binnenzijde: Coral Fleece. 280 g/ m2.

Consult.

Print Code: F(1), N(8), O, P, R

100 / 10

740



5 Panels



01

Clipak 6337

Cap. Polyester. 5 Panels.
Mütze. Polyester. 5 Panels.
Casquette. Polyester. 5 Panneaux.
Pet. Polyester. 5 Panelen.

Consult.

Print Code: E(1), N(8), O, P, R

200 / 25



5 Panels

Sodel 4479

Cap. Polyester. 5 Panels.
Mütze. Polyester. 5 Panels.
Casquette. Polyester. 5 Panneaux.
Pet. Polyester. 5 Panelen.

Consult.

Print Code: E(1), N(8), O, P, R

200 / 25



19



02

01

04



07

03

11

05

Yobs 5360

Cap. Polyester. 5 Panels.
Mütze. Polyester. 5 Panels.
Casquette. Polyester. 5 Panneaux.
Pet. Polyester. 5 Panelen.

Consult.

Print Code: E(1), N(8), O, P, R

200 / 25



5 Panels

Decath

5228

Backpack. Polyester 600D. Padded Back and Shoulder Straps.

Rucksack. Polyester 600D. Gepolsterter Rücken und Schultergurte.

Sac à Dos. Polyester 600D. Dos et Bretelles Rembourrées.

Rugzak. Polyester 600D. Gewatteerde Achterzijde en Schouderbanden.

📏 23 × 40 × 12 cm

📦 50

🎨 Print Code: F(1), N(8), O, R



01



01

Lespley

6172

Saddle Cover. Polyester 190T. Adjustable.

Fahrradsattel Hülle. Polyester 190T. Verstellbar.

Etui Selle. Polyester 190T. Ajustable.

Zadel Hoes. Polyester 190T. Aanpasbaar.



Water Repellent

📏 Consult.

📦 1000 / 500

🎨 Print Code: D(1), N(8), R



01



05



01

Blades

4780

Drawstring Bag. Polyester 210D.

Rucksack. Polyester 210D.

Sac à Dos. Polyester 210D.

Rugzak. Polyester 210D.

📏 34.5 × 45 cm

📦 200 / 10

🎨 Print Code: F(1), N(8), R



Reinforced Corners

Nofler

4362

Drawstring Bag. Polyester 210T.

Rucksack. Polyester 210T.

Sac à Dos. Polyester 210T.

Rugzak. Polyester 210T.

📏 34 × 42 cm

📦 300 / 20

🎨 Print Code: F(1), N(8), R



Reinforced Corners

Spook

3164

Drawstring Bag. Polyester 210T.

Rucksack. Polyester 210T.

Sac à Dos. Polyester 210T.

Rugzak. Polyester 210T.

📏 34 × 42 cm

📦 300 / 50

🎨 Print Code: F(1), N(8), R



Reinforced Corners

700 ml



Bayron

6164

Sublimation Bottle. Stainless Steel. 700 ml. Individual Presentation.
 Sublimations Trinkflasche. Rostfreier Stahl. 700 ml. Individuelle Präsentation.
 Bidon Sublimation. Acier Inox. 700 ml. Présentation Individuelle.
 Sublimatie Fles. Roestvrij Staal. 700 ml. Individuele Presentatie.

Ø 7 × 25.7 cm

50

Print Code: F(1), L2, Q



330 ml



Double Wall



EASY OPENING

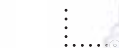

Alirox

6409

Sublimation Vacuum Flask. Stainless Steel. 330 ml. Individual Presentation.

Sublimations Thermoskanne. Rostfreier Stahl. 330 ml. Individuelle Präsentation.

Thermo Sublimation. Acier Inox. 330 ml. Présentation Individuelle.

Sublimatie Thermosfles. Roestvrij Staal. 330 ml. Individuele Presentatie.

Ø 5.7 × 23 cm

30

Print Code: F(1), L2, Q

742



Cleikon

6165

Sublimation Vacuum Flask. Stainless Steel. 500 ml. Individual Presentation.
 Sublimations Thermoskanne. Rostfreier Stahl. 500 ml. Individuelle Präsentation.
 Thermo Sublimation. Acier Inox. 500 ml. Présentation Individuelle.
 Sublimatie Thermosfles. Roestvrij Staal. 500 ml. Individuele Presentatie.

Ø 7 × 24.6 cm

30

Print Code: F(1), L2, Q



500 ml



Double Wall



400 ml



Greims

5341

Sublimation Bottle. Aluminium. 400 ml. Individual Presentation.
 Sublimations Trinkflasche. Aluminium. 400 ml. Individuelle Präsentation.
 Bidon Sublimation. Aluminium. 400 ml. Présentation Individuelle.
 Sublimatie Fles. Aluminium. 400 ml. Individuele Presentatie.

Ø 6.6 × 17.5 cm

100 / 20

Print Code: F(1), L2, Q



BOTTLES



NEW

600 ml



SOFT SHELL POUCH

Flaber
6870

Bottle: Glass. 600 ml. Individual Presentation. Soft Shell Pouch Included.
Trinkflasche: Glas. 600 ml. Individuelle Präsentation. Soft Shell Etui Inklusiv.
Bidon: Verre. 600 ml. Présentation Individuelle. Etui Soft Shell Inclus.
Fles: Glas/ Bamboe. 600 ml. Individuele Presentatie. Soft Shell Zakje Inclusief.

Ø 8.5 × 16 cm 40
Print Code: F(1), L2, N(8), R

01



420 ml

SOFT SHELL POUCH

380 ml



Dokath
5513

Bottle: Glass. 420 ml. Individual Presentation. Soft Shell Pouch Included.
Trinkflasche: Glas. 420 ml. Individuelle Präsentation. Soft Shell Etui Inklusiv.
Bidon: Verre. 420 ml. Présentation Individuelle. Etui Soft Shell Inclus.
Fles: Glas. 420 ml. Individuele Presentatie. Soft Shell Zakje Inclusief.

Ø 6.4 × 19 cm 50
Print Code: F(1), L2, N(8), R



Neyms
6111

VINTAGE DESIGN
IMPERFECT FINISH /
DISEÑO VINTAGE CON
ACABADO IMPERFECTO

Sublimation Mug. Metal. 380 ml. Individual Presentation.
Sublimations Tasse. Metall. 380 ml. Individuelle Präsentation.
Tasse Sublimation. Métal. 380 ml. Présentation Individuelle.
Sublimatie Mok. Metaal. 380 ml. Individuele Presentatie.

Ø 8.8 × 7.9 cm 50
Print Code: F(1), L2, Q



380 ml

VINTAGE DESIGN
IMPERFECT FINISH /
DISEÑO VINTAGE CON
ACABADO IMPERFECTO

Kantol
6359

Sublimation Mug. Metal. 380 ml. Individual Presentation.
Sublimations Tasse. Metall. 380 ml. Individuelle Präsentation.
Tasse Sublimation. Métal. 380 ml. Présentation Individuelle.
Sublimatie Mok. Metaal. 380 ml. Individuele Presentatie.

Ø 8.8 × 7.9 cm 50
Print Code: L2, Q

Dolten

5183

Sublimation Mug. Ceramic. 250 ml. Individual Presentation.
Sublimations Tasse. Keramik. 250 ml. Individuelle Präsentation.
Tasse Sublimation. Céramique. 250 ml. Présentation Individuelle.
Sublimatie Mok. Keramiek. 250 ml. Individuele Presentatie.

Ø 7.4 × 8.4 cm

48

Print Code: Q

250 ml Dolten

350 ml

350 ml

Bornel

Kaffir

350 ml

Harnet

744



Bornel

3893

Sublimation Mug. Ceramic. 350 ml. Individual Presentation.
Sublimations Tasse. Keramik. 350 ml. Individuelle Präsentation.
Tasse Sublimation. Céramique. 350 ml. Présentation Individuelle.
Sublimatie Mok. Keramiek. 350 ml. Individuele Presentatie.

Ø 8.2 × 9.6 cm

36

Print Code: Q

Kaffir

5184

Sublimation Mug. Ceramic. 350 ml. Individual Presentation.
Sublimations Tasse. Keramik. 350 ml. Individuelle Präsentation.
Tasse Sublimation. Céramique. 350 ml. Présentation Individuelle.
Sublimatie Mok. Keramiek. 350 ml. Individuele Presentatie.

Ø 9 × 10 cm

36

Print Code: Q

Harnet

3894

Sublimation Mug. Ceramic. 350 ml. Individual Presentation.
Sublimations Tasse. Keramik. 350 ml. Individuelle Präsentation.
Tasse Sublimation. Céramique. 350 ml. Présentation Individuelle.
Sublimatie Mok. Keramiek. 350 ml. Individuele Presentatie.

Ø 8.2 × 9.6 cm

36

Print Code: Q

MATT FINISH

350 ml



Talmex

6286

Sublimation Mug. Ceramic. 350 ml. Individual Presentation.
 Sublimations Tasse. Keramik. 350 ml. Individuelle Präsentation.
 Tasse Sublimation. Céramique. 350 ml. Présentation Individuelle.
 Sublimatie Mok. Keramiek. 350 ml. Individuele Presentatie.

Ø 8.2 × 9.6 cm

36

Print Code: Q

300 ml

Gover

6287

Sublimation Mug. Ceramic. 300 ml. Individual Presentation.
 Sublimations Tasse. Keramik. 300 ml. Individuelle Präsentation.
 Tasse Sublimation. Céramique. 300 ml. Présentation Individuelle.
 Sublimatie Mok. Keramiek. 300 ml. Individuele Presentatie.

Ø 8.6 × 8.5 cm

36

Print Code: Q



02



19

03

350 ml

HOT LIQUID

MAGIC CUP SUBLIMATION

This cup has an outer coating specially designed for sublimation printing. Its marking will be imperceptible by the black coating, and will magically appear on contact with the hot liquid. wow!

Este taza tiene un recubrimiento exterior especialmente diseñado para su impresión en sublimación, su marcaje quedará imperceptible por el recubrimiento negro, y mágicamente aparecerá al contacto con el líquido caliente. wow!



480 ml

SPECIAL LASER ENGRAVING C02 & SUBLIMATION

This glass has an external coating specially designed for laser engraving and sublimation printing, with which you will see your advertising or brand printed in a striking and lasting way.

Este vaso tiene un recubrimiento exterior especialmente diseñado para grabado láser e impresión en sublimación, con las que conseguirá que su publicidad o marca quede impresa de forma impactante y duradera.

SUBLIMATION PRINTING / RESULTADO EN SUBLIMACIÓN

LASER ENGRAVING / RESULTADO EN GRABADO LÁSER



745

Bardot

5837

Sublimation Mug. Ceramic. 350 ml. Individual Presentation.
 Sublimations Tasse. Keramik. 350 ml. Individuelle Präsentation.
 Tasse Sublimation. Céramique. 350 ml. Présentation Individuelle.
 Sublimatie Mok. Keramiek. 350 ml. Individuele Presentatie.

Ø 8.2 × 9.6 cm

36

Print Code: F(1), Q



Video



Raptol

5985

Glass. Glas. 480 ml. Individual Presentation.
 Glas. Glas. 480 ml. Individuelle Präsentation.
 Verre. Verre. 480 ml. Présentation Individuelle.
 Glas. Glas. 480 ml. Individuele Presentatie.

Ø 8.8 × 15 cm

36

Print Code: F(4), Q, L2



09

23



Nayxo

4921

Pencil Case. Polyester 600D.
Federmappe. Polyester 600D.
Trousse. Polyester 600D.
Etui. Polyester 600D.

21 × 12.5 cm

250 / 50

Print Code: E(6), N(8), R



Basion

5742



20 Sheets
Lined

Folder. Polyester 600D. 20 Sheets Notepad.
Mappe. Polyester 600D. 20 Seiten Notizblock.
Porte-Documents. Polyester 600D. Bloc 20 Feuilles.
Map. Polyester 600D. 20 Blaadjes Notepad.

23.5 × 32.5 × 1.7 cm

25

Print Code: F(1), N(8), R

746



Serfat

5781

Mousepad. Microfibre/ Silicone.
Mauspad. Mikrofaser/ Silikon.
Tapis Souris. Microfibre/ Silicone.
Muispad. Microfiber/ Siliconen.

22 × 18 cm

400 / 50

Print Code: E(1), R



Mousepad



Display Cloth



Display Protection



Lens Cloth



Anti Slip

Vaniat

4387

Mousepad. Polyester/ Silicone.
Mauspad. Polyester/ Silikon.
Tapis Souris. Polyester/ Silicone.
Muispad. Polyester/ Siliconen.

22 × 18 cm

250 / 50

Print Code: E(1), R



Anti Slip

Roland

5520

Mousepad. Polyester/ Silicone.
Mauspad. Polyester/ Silikon.
Tapis Souris. Polyester/ Silicone.
Muispad. Polyester/ Siliconen.

Ø 20 cm

250 / 50

Print Code: E(1), R



Anti Slip

NEW

3 PIECES 25 X 30 CM



Topin

6852



Bag Set. Polyester RPET. 3 Pieces.
Taschen Set. Polyester RPET. 3 Stück.
Set Sacs. Polyester RPET. 3 Pieces.
Tas Set. Polyester RPET. 3 Stuks.

25 x 30 cm
Print Code: F(1), R

250 / 50

Lebron

6116

Sublimation Place Mat. Non-Woven.
Sublimations Matte. Non-Woven.
Set Table Sublimation. T.N.T..
Sublimatie Placemat. Non-Woven.

40 x 30 x 0.1 cm
Print Code: E(1), N(8), R

1000 / 50



02



19

03

Kalmont

5214

Pot Holder. 100% Polyester. One Flat Side for Printing.
Topflappen. 100% Polyester. Eine flache Seite zum Bedrucken.
Manique. 100% Polyester. Un Côté Lisse pour Impression.
Pannenvlap. 100% Polyester. Een Platte Zijde Voor Bedrukking.

17 x 17 cm
Print Code: E(1), N(8), R

200 / 50



03

02

Silax

5215

Kitchen Mitten. 100% Polyester. One Flat Side for Printing.
Küchenhandschuh. 100% Polyester. Eine flache Seite zum Bedrucken.
Gant Cuisine. 100% Polyester. Un Côté Lisse pour Impression.
Ovenwant. 100% Polyester. Een Platte Zijde Voor Bedrukking.

18 x 28 cm
Print Code: E(1), N(8), R

200 / 50

Salmux

6114

Sublimation Apron. Non-Woven.
Sublimations Schürze. Non-Woven.
Tablier Sublimation. T.N.T..
Sublimatie Schort. Non-Woven.

50 x 73 cm
Print Code: E(1), N(8), R

200 / 50



19



Romid

6046

Absorbent Towel. Microfibre 260 g/ m2.
Saugfähiges Handtuch. Mikrofaser 260 g/ m2.
Serviette Absorbante. Microfibre 260 g/ m2.
Absorbierende Handdoek. Microfiber 260 g/ m3.

75 × 150 cm

Print Code: F(1), N(8), P, R

50



19

05

748



01



01

Bayalax

5919

Absorbent Towel. Microfibre 310 g/ m2.
Saugfähiges Handtuch. Mikrofaser 310 g/ m2.
Serviette Absorbante. Microfibre 310 g/ m2.
Absorbierende Handdoek. Microfiber 310 g/ m2.

90 × 170 cm

30

Print Code: F(1), N(8), P, R

Gymnasio

4567

Absorbent Towel. Microfibre 185 g/ m2. Folded Ø 9 x 17 cm.
Saugfähiges Handtuch. Mikrofaser 185 g/ m2. Faltung Ø 9 x 17 cm.
Serviette Absorbante. Microfibre 185 g/ m2. Pliée Ø 9 x 17 cm.
Absorbierende Handdoek. Microfiber 185 g/ m2. Gevouwen Ø 9 x 17 cm.

50 × 100 cm

100

Print Code: F(1), N(8), O, P, R



01

Kefan

5920

Absorbent Towel. Microfibre 160 g/ m2.
Saugfähiges Handtuch. Mikrofaser 160 g/ m2.
Serviette Absorbante. Microfibre 160 g/ m2.
Absorbierende Handdoek. Microfiber 160 g/ m2.

40 × 90 cm

100

Print Code: F(1), N(8), P, R





Mojácar

Beach Umbrella. Nylon.
Sonnenschirm. Nylon.
Pare-Soleil. Nylon.
Strandparasol. Nylon.

8448

Ø 150 cm

Print Code: H(1), N(8), R



01



Vent

Sunshade. Polyester. 2 Pieces.
Autosonnenschutz. Polyester. 2 Stück.
Pare-Soleil. Polyester. 2 Pièces.
Zonnescherm. Polyester. 2 Stuks.

Print Code: F(1), R



01



Panan XL

6105

Umbrella. Automatic. Windproof. EVA Handle.
Regenschirm. Automatisch. Antiwindsystem. EVA Griff.
Parapluie. Automatique. Système Anti-Vent. Poignée Eva.
Paraplu. Automatisch. Windbeständig. EVA Handvat.

Ø 130 cm



Print Code: G(1), N(8), R



01

MANGO ACOLCHADO/
PADDED HANDLE

749



Meslop

4674

Umbrella. Automatic.
Regenschirm. Automatisch.
Parapluie. Automatique.
Paraplu. Automatisch.

Print Code: G(1), N(8), R



01

Ø 105 cm



Ziant

4673

Umbrella.
Regenschirm.
Parapluie.
Paraplu.

Print Code: G(1), N(8), R



01

Ø 96 cm

HOME & DECO- RATION



NEW

Trivak
PG. 799

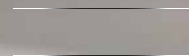



751

02



13 04 03 19

RECYCLED
COTTON

Pissek

6831

Apron. 100% Recycled Cotton.
Schürze. 100% Recycling Baumwolle.
Tablier. 100% Coton Recyclé.
Schort. 100% Gerecycled Katoen.

65 × 90 cm

100 / 10

Print Code: E(4), N(8), P



Recycled
Cotton



Delim

6795

Holder. Bamboo.
Halter. Bambus.
Support. Bambou.
Houder. Bamboe.

6 × 2 × 8 cm

200 / 50

Print Code: D(4), L2, W

NEW



SUITABLE FOR TABLETS
AND MOBILE PHONES /
VÁLIDO PARA TABLETS Y
TELÉFONOS MÓVILES



Calen

ORGANIC
COTTON

6469

Kitchen Mitten. 100% Organic Cotton. One Flat Side for Printing.
Küchenhandschuh. 100% Organische Baumwolle. Eine flache Seite zum Bedrucken.
Gant Cuisine. 100% Coton Organique. Un Côté Lisse pour Impression.
Ovenwant. 100% Organisch Katoen. Een Platte Zijde Voor Bedrukking.

18 x 28.5 cm 200 / 25

Print Code: E(1), N(8)



752

ORGANIC
COTTON

Riffo

6425

Apron. 100% Organic Cotton.
Schürze. 100% Organische Baumwolle.
Tablier. 100% Coton Organique.
Schort. 100% Organisch Katoen.

65 x 93 cm 100 / 10

Print Code: E(4), N(8), P



14

Vurcex

6295

Apron. 100% Cotton/PU.
Schürze. 100% Baumwolle/PU.
Tablier. 100% Coton/ Similicuir.
Schort. 100% Katoen/PU.

68 x 80 cm 50

Print Code: E(4), N(8), P



02

THE BEST PRICE

Maylon
6206

Apron. 100% Cotton.
Schürze. 100% Baumwolle.
Tablier. 100% Coton.
Schort. 100% Katoen.

65 × 90 cm 100 / 10

Print Code: E(4), N(8), P



100% COTTON

vertrio

753



19 16 05



07 01 11 03

Xigor
4746

Apron. TC. 35% Cotton/ 65% Polyester.
Schürze. TC. 35% Baumwolle/ 65% Polyester.
Tablier. TC. 35% Coton/ 65% Polyester.
Schort. TC. 35% Katoen/ 65% Polyester.

65 × 90 cm 100 / 10

Print Code: E(4), N(8), P

Konner
6051

Apron. TC. 20% Cotton/ 80% Polyester.
Schürze. TC. 20% Baumwolle/ 80% Polyester.
Tablier. TC. 20% Coton/ 80% Polyester.
Schort. TC. 20% Katoen/ 80% Polyester.

70 × 95 cm 100 / 10

Print Code: E(4), N(8), P, R



02

01

06

04

02





NEW

RECYCLED COTTON



02



13 04 03 19

Pissek 6831

Apron. 100% Recycled Cotton.
Schürze. 100% Recycling Baumwolle.
Tablier. 100% Coton Recycle.
Schort. 100% Gerecycled Katoen.

65 × 90 cm

100 / 10

Print Code: E(4), N(8), P



01

19

03

Bacatus 3897

Apron. TC. 35% Cotton/ 65% Polyester.
Schürze. TC. 35% Baumwolle/ 65% Polyester.
Tablier. TC. 35% Coton/ 65% Polyester.
Schort. TC. 35% Katoen/ 65% Polyester.

65 × 90 cm 100 / 50

Print Code: E(4), N(8), P



Argos 3211

Apron. 100% Cotton.
Schürze. 100% Baumwolle.
Tablier. 100% Coton.
Schort. 100% Katoen.

53 × 85 cm 200 / 50

Print Code: E(4), N(8), P



03

19



04

754

02



Vanur
4168

Apron. Non-Woven.
Schürze. Non-Woven.
Tablier. T.N.T.
Schort. Non-Woven.

50 x 73 cm 200 / 10

Print Code: E(1)



01 02 19 05 04 03



FOLDABLE



19 07 02 04

Sopex

4169

Foldable Apron. Non-Woven.
Fallbare Schürze. Non-Woven.
Tablier Pliable. T.N.T.
Opvouwbare Schort. Non-Woven.

50 x 73 cm 200 / 10

Print Code: E(1), F(1), G(1)



03



Salmux

6114

Sublimation Apron. Non-Woven.
Sublimations Schürze. Non-Woven.
Tablier Sublimation. T.N.T.
Sublimatie Schort. Non-Woven.

50 x 73 cm 200 / 50

Print Code: E(1), N(8), R

IDEAL FOR SUBLIMATION



Chef

9288

Apron. Non-Woven.
Schürze. Non-Woven.
Tablier. T.N.T.
Schort. Non-Woven.

50 x 73 cm 200 / 50

Print Code: E(1)



02

03

13

21

07

11

755

HQ
HIGH QUALITY



02

Calcis

4536

Kitchen Mitten. 100% Cotton.
Küchenhandschuh. 100% Baumwolle.
Gant Cuisine. 100% Coton.
Ovenwant. 100% Katoen.

19.5 x 31 cm 200 / 50

Print Code: E(1), N(8)

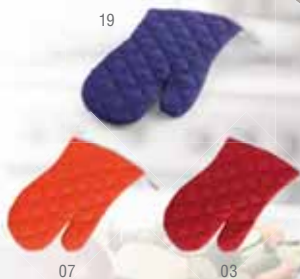

19

07

03

756

ONE FLAT SIDE FOR PRINTING
UNA CARA LISA PARA IMPRESION



01



03

2 PIECES



06

05

07

04

11

Piper

9063

Kitchen Mitten. 100% Cotton. One Flat Side for Printing.
Küchenhandschuh. 100% Baumwolle. Eine Fläche Seite zum Bedrucken.
Gant Cuisine. 100% Coton. Un Côté Lisse pour Impression.
Ovenwant. 100% Katoen. Een Platte Zijde Voor Bedrukking.

18 x 28.5 cm 200 / 25

Print Code: E(1), N(8)



19

03

Leston

5021

Kitchen Set. TC. 35% Cotton/ 65% Polyester. 2 Pieces. One Flat Side for Printing.
Küchen Set. TC. 35% Baumwolle/ 65% Polyester. 2 Stück. Eine Fläche Seite zum Bedrucken.
Set Cuisine. TC. 35% Coton/ 65% Polyester. 2 Pièces. Un Côté Lisse pour Impression.
Keuken Set. TC. 35% Katoen/ 65% Polyester. 2 Stuks. Een Platte Zijde Voor Bedrukking.

Consult. 100 / 10

Print Code: E(1), N(8)



757

Hisa

4535

Pot Holder. Polyester/ Neoprene. One Flat Side for Printing.
 Topflappen. Polyester/ Neopren. Eine Fläche Seite zum Bedrucken.
 Manique. Polyester/ Néoprène. Un Côté Lisse pour Impression.
 Pannenvlap. Polyester/ Neopreen. Eén Platte Zijde Voor Bedrukking.

17.5 × 21 cm 200 / 50

Print Code: E(1), N(8)

Tosha

4537

Kitchen Mitten. Polyester/ Neoprene. One Flat Side for Printing.
 Küchenhandschuh. Polyester/ Neopren. Eine Fläche Seite zum Bedrucken.
 Gant Cuisine. Polyester/ Néoprène. Un Côté Lisse pour Impression.
 Ovenwant. Polyester/ Neopreen. Eén Platte Zijde Voor Bedrukking.

18 × 26 cm 200 / 50

Print Code: E(1), N(8)

Silax

5215

Kitchen Mitten. 100% Polyester. One Flat Side for Printing.
 Küchenhandschuh. 100% Polyester. Eine Fläche Seite zum Bedrucken.
 Gant Cuisine. 100% Polyester. Un Côté Lisse pour Impression.
 Ovenwant. 100% Polyester. Eén Platte Zijde Voor Bedrukking.

18 × 28 cm 200 / 50

Print Code: E(1), N(8), R

Kalmont

5214

Pot Holder. 100% Polyester. One Flat Side for Printing.
 Topflappen. 100% Polyester. Eine Fläche Seite zum Bedrucken.
 Manique. 100% Polyester. Un Côté Lisse pour Impression.
 Pannenvlap. 100% Polyester. Eén Platte Zijde Voor Bedrukking.

17 × 17 cm 200 / 50

Print Code: E(1), N(8), R

Serly

6498

Spatula. Bamboo.
Küchenkelle. Bambus.
Spatule de Cuisine. Bambou.
Keukenspatel. Bamboe.

6 x 30 x 0.9 cm 200 / 50

Print Code: C(4), L1



758

Selma

5181

Spoon. Bamboo.
Löffel. Bambus.
Cuillère. Bambou.
Lepel. Bamboe.

6 x 30 x 0.9 cm

200 / 50

Print Code: C(4), L1

I LOVE TO COOK



Hinfex

6514

Weighing Scales. Bamboo. Button Battery Included.
Waage. Bambus. Knopfzelle Inklusiv.
Balance. Bambou. Pile Bouton Inclus.
Weegschaal. Bamboe. Knoopcel Batterij Inclusief.

Ø 19.3 x 1.7 cm 20

Print Code: E(1), L2, W

BAMBOO line

NEW

759

4 PIECES ●●●●



Kappal 6801

Coaster Set. Bamboo. 4 Pieces.
Untersetzer Set. Bambus. 4 Stück.
Set Sous-Verre. Bambou. 4 Pièces.
Onderzetter Set. Bamboe. 4 Stuks.

11.2 × 3.6 × 11.2 cm



Print Code: E(1), L2



Saraby

6802

Kitchen Cutting Board. Bamboo.
Brett. Bambus.
Planche à Découper. Bambou.
Keuken Snijplank. Bamboe.

13.5 × 40 × 1 cm



Print Code: E(4), L2



01



02

Nesty

5180

Chopsticks Set. Bamboo.
Stäbchen Set. Bambus.
Set Baguettes. Bambou.
Eetstokjes Set. Bamboe.

22.5 cm 500 / 50

Print Code: B(4), L1

BAMBOO line



760



02

03

19

Orient

3368

Chopsticks Set. Bamboo.
Stäbchen Set. Bambus.
Set Baguettes. Bambou.
Eetstokjes Set. Bamboe.

22.5 cm 1000 / 100

Print Code: B(4), L1



07



18

Jakarta

9316

Place Mat. Bamboo.
Matte. Bambus.
Set Table. Bambou.
Placemat. Bamboe.

45 x 30 x 0.3 cm 100 / 20

Print Code: E(1)



13

45 x 30 cm



Koet

3440

Cheese Knife Set. Wood/ Stainless Steel. 4 Pieces.
Käse Set. Holz/ Rostfreier Stahl. 4 Stück.
Set Fromages. Bois/ Acier Inox. 4 Pièces.
Kaas Set. Hout/ Roestvrij Staal. 4 Stuks.

19 × 2.3 × 16 cm 40 / 10

Print Code: F(1), L1



Boletus

3444

Serving Dishes. Ceramic.
Vorspeisenteller. Keramik.
Plat Entrées. Céramique.
Schaaltjes. Keramiek.

Ø 8.8 × 3.4 cm 60 / 20

Print Code: F(4)



Roldic

5561

Cheese Knife Set. Wood/ Stainless Steel/ PP. 6 Pieces.
Käse Set. Holz/ Rostfreier Stahl/ PP. 6 Stück.
Set Fromages. Bois/ Acier Inox/ PP. 6 Pièces.
Kaas Set. Hout/ Roestvrij Staal/ PP. 6 Stuks.

13 × 15 × 5.6 cm 30

Print Code: F(2), L2



761

Pizax

4862

Platter Plate. Ceramic.
Brett. Keramik.
Plat. Céramique.
Plaat. Keramiek.

20 × 1.2 × 10 cm 36 / 6

Print Code: F(1)



180 ml

BOROSILICATE
GLASS



Morkel

6482

Set. Borosilicate Glass/ Bamboo. 180 ml. 3 Pieces.
Set. Borosilikat Glas/ Bambus. 180 ml. 3 Stück.
Set. Verre Borosilicate/ Bambou. 180 ml. 3 Pièces.
Set. Borosilicate Glas/ Bamboe. 180 ml. 3 Stuks.

16.4 × 8 × 12.3 cm 50

Print Code: F(1), C(4), L2



BOROSILICATE
GLASS

NEW

762

BOROSILICATE
GLASS

420 ml



Kipal

6481

Mug. Borosilicate Glass/ Bamboo. 420 ml. Individual Presentation.
Tasse. Borosilikat Glas/ Bambus. 420 ml. Individuelle Präsentation.
Tasse. Verre Borosilicate/ Bambou. 420 ml. Présentation Individuelle.
Mok. Borosilicate Glas/ Bamboe. 420 ml. Individuele Presentatie.

Ø 8.7 × 10.6 cm 50

Print Code: F(1), C(4), L2



Hindras

6865

Mug. Borosilicate Glass/ Natural Cork. 450 ml. Individual Presentation.
Tasse. Borosilikat Glas/ Naturkork. 450 ml. Individuelle Präsentation.
Tasse. Verre Borosilicate/ Bouchon Naturel. 450 ml. Présentation Individuelle.
Mok. Borosilicate Glas/ Natuurlijk Kurk. 450 ml. Individuele Presentatie.

Ø 8 × 11.5 cm

Print Code: F(1), L2

450 ml

36



IDEAL FOR WATER
AND WINE

Lonpel

6580

Bottle. Glass/ Natural Cork. 1 L. Individual Presentation.
Trinkflasche. Glas/ Naturkork. 1 L. Individuelle Präsentation.
Bouteille. Verre/ Bouchon Naturel. 1 L. Présentation Individuelle.
Fles. Glas/ Natuurlijk Kurk. 1 L. Individuele Presentatie.

Ø 9.3 × 27.2 cm 20

Print Code: G(1), L2

1L



MATT COLLECTION



763

420 ml



01

02

Bokun
6585

Mug. Ceramic/ Natural Cork. 420 ml. Individuelle Präsentation.
Tasse. Keramik/ Naturkork. 420 ml. Individuelle Präsentation.
Tasse. Céramique/ Bouchon Naturel. 420 ml. Présentation Individuelle.
Mok. Keramiek/ Natuurlijk Kurk. 420 ml. Individuele Presentatie.

Ø 9 × 11 cm

36

Print Code: F(4)

370 ml



Yotel
6586

Mug. Ceramic/ Bamboo. 370 ml. Individuelle Präsentation.
Tasse. Keramik/ Bambou. 370 ml. Individuelle Präsentation.
Tasse. Céramique/ Bambou. 370 ml. Présentation Individuelle.
Mok. Keramiek/ Bamboe. 370 ml. Individuele Presentatie.

Ø 8.2 × 10.5 cm

36

Print Code: F(4), L2

380 ml



Passak
4706

02

Video ▶



Mug. Ceramic. 380 ml. Individual Presentation.
Tasse. Keramik. 380 ml. Individuelle Präsentation.
Tasse. Céramique. 380 ml. Présentation Individuelle.
Mok. Keramiek. 380 ml. Individuele Presentatie.

▮▮▮▮▮▮ Ø 9.4 × 12 cm 📦 36

🌈 Print Code: G(4)



RELAX AT
HOME
CERAMIC

350 ml



Kaffir
5184

Sublimation Mug. Ceramic. 350 ml. Individual Presentation.
Sublimations Tasse. Keramik. 350 ml. Individuelle Präsentation.
Tasse Sublimation. Céramique. 350 ml. Présentation Individuelle.
Sublimatie Mok. Keramiek. 350 ml. Individuele Presentatie.

▮▮▮▮▮▮ Ø 9 × 10 cm

📦 36

🌈 Print Code: Q



350 ml



Cotes
9459

Mug. Ceramic. 350 ml. Individual Presentation.
Tasse. Keramik. 350 ml. Individuelle Präsentation.
Tasse. Céramique. 350 ml. Présentation Individuelle.
Mok. Keramiek. 350 ml. Individuele Presentatie.

▮▮▮▮▮▮ Ø 8.5 × 10.5 cm 📦 36

🌈 Print Code: F(4)





RELAXAT
HOME



.....● BAMBOO FIBRE

350 ml

400 ml



Teplan
6549



Mug. Bamboo Fibre/ PP. 400 ml.
Tasse. Bambusfaser/ PP. 400 ml.
Tasse. Fibre Bambou/ PP. 400 ml.
Mok. Bamboe Fibre/ PP. 400 ml.

■■■■■■■■ Ø 8.4 × 10.4 cm
Print Code: E(4)

📦 48

Meridal
6152



Mug. Bamboo Fibre/ PP. 350 ml.
Tasse. Bambusfaser/ PP. 350 ml.
Tasse. Fibre Bambou/ PP. 350 ml.
Mok. Bamboe Fibre/ PP. 350 ml.

■■■■■■■■ Ø 7.9 × 8.8 cm
Print Code: E(4)

📦 100 / 50

765

ANTIBACTERIAL

● BPA FREE 350 ml



NEW



Plantex
6706

Antibacterial Mug. PP. 350 ml.
Antibakteriell Tasse. PP. 350 ml.
Tasse Antibactérienne. PP. 350 ml.
Antibacterieel Mok. PP. 350 ml.

■■■■■■■■ Ø 7.9 × 8.8 cm
Print Code: E(4)

📦 100 / 50

PLA

NEW

● BPA FREE 350 ml



Pioka
6677

Mug. PLA 100% Compostable. 350 ml.
Tasse. PLA 100% Kompostierbar. 350 ml.
Tasse. PLA 100% Compostable. 350 ml.
Mok. PLA 100% Composteerbaar. 350 ml.

■■■■■■■■ Ø 7.9 × 8.8 cm
Print Code: E(4)

📦 100 / 50





Palet

6275

Coaster. Wood.
Untersetzer. Holz.
Sous-Verre. Bois.
Onderzetter. Hout.

11.5 × 1.5 × 7.5 cm 200 / 100

Print Code: D(1), L2

Kappal

6801

Coaster Set. Bamboo. 4 Pieces.
Untersetzer Set. Bambus. 4 Stück.
Set Sous-Verre. Bambou. 4 Pièces.
Onderzetter Set. Bamboe. 4 Stuks.

11.2 × 3.6 × 11.2 cm

Print Code: E(1), L2

4 PIECES



50



Brunex

6005

Coaster. Natural Cork.
Untersetzer. Naturkork.
Sous-Verre. Bouchon Naturel.
Onderzetter. Natuurlijk Kurk.

Ø 10 × 0.3 cm

2000 / 500

Print Code: D(1), L2



PIEZAS ÚNICAS PROCEDENTES
DE CORTE DE MADERA NATURAL.
SU TEXTURA, COLOR, TAMAÑO Y GROSOR PUEDEN VARIAR

UNIQUE PIECES FROM NATURAL CUTS OF WOOD.
THE TEXTURE, COLOR, SIZES AND THICKNESS MAY VARY.

Yantic

6487

Coaster Set. Wood. 4 Pieces.
Untersetzer Set. Holz. 4 Stück.
Set Sous-Verre. Bois. 4 Pièces.
Onderzetter Set. Hout. 4 Stuks.

Ø 10 × 4 cm 50 / 25

Print Code: E(1), L1



4 PIECES





Ruban

5178

Kitchen Cutting Board. Bamboo.
Brett. Bambus.
Planche à Découper. Bambou.
Keuken Snijplank. Bamboe.

15.3 × 20 × 1 cm

Print Code: E(1), L1

50



Fanin

6377

Kitchen Cutting Board. Bamboo Fibre/ PP.
Brett. Bambusfaser/ PP.
Planche à Découper. Fibre Bambou/ PP.
Keuken Snijplank. Bamboe Fibre/ PP.

14 × 23.8 × 0.4 cm

Print Code: E(1)



BAMBOO FIBRE



NEW

Saraby

6802

Kitchen Cutting Board. Bamboo.
Brett. Bambus.
Planche à Découper. Bambou.
Keuken Snijplank. Bamboe.

13.5 × 40 × 1 cm

Print Code: E(4), L2

30

CERAMIC

Levian 5273

Knife Peeler Set. Ceramic.
Schälmesser. Keramik.
Couteau Epluche-Légume. Céramique.
Aardappelschil Mesje. Keramiek.

2.6 × 18.6 × 1.9 cm 200 / 50

Print Code: D(4)



768



Kai 4003

Knife. Stainless Steel.
Messer. Rostfreier Stahl.
Couteau. Acier Inox.
Mes. Roestvrij Staal.

3 × 20.5 × 1.5 cm 300 / 100

Print Code: D(1)



Yulix 5277



Kitchen Set. 2 Pieces.
Küchen Set. 2 Stück.
Set Cuisine. 2 Pièces.
Keuken Set. 2 Stuks.

18.5 × 27.8 × 1.7 cm 40 / 20

Print Code: F(1)



01

07

19



Bakiser

4861

Knife Set. Stainless Steel. 4 Pieces.
Messer Set. Rostfreier Stahl. 4 Stück.
Set Couteaux. Acier Inox. 4 Pièces.
Messen Set. Roestvrij Staal. 4 Stuks.

25 × 22 × 8.5 cm 12

Print Code: G(1)

769



Galton

4300

Knife Set. Stainless Steel. 5 Pieces.
Messer Set. Rostfreier Stahl. 5 Stück.
Set Couteaux. Acier Inox. 5 Pièces.
Messen Set. Roestvrij Staal. 5 Stuks.

Ø 7.3 × 23 cm 30

Print Code: F(1)



SUITABLE FOR TABLETS AND MOBILE PHONES /
VÁLIDO PARA TABLETS Y
TELÉFONOS MÓVILES



NEW



Delim
6795

Holder. Bamboo.
Halter. Bambus.
Support. Bamboo.
Houder. Bamboe.

6 × 2 × 8 cm

200 / 50

Print Code: D(4), L2, W

HOLDER COOK



770



Heclan
5882



Holder. Flexible.
Halter. Flexibel.
Support. Flexible.
Houder. Flexibel.

12.3 × 6.4 × 2.8 cm

50

Print Code: H(1)



Clotin
5069

Multipurpose Bag. PVC. Touch Screen.
Mehrzwecktasche. PVC. Touch Screen.
Fourre-Tout. PVC. Ecran Tactile.
Multifunctioneel Tasje. PVC. Touch Screen.

11 × 19 × 9.5 cm

300 / 50

Print Code: F(1)

Tuzar
5068

Multipurpose Bag. PVC. Touch Screen.
Mehrzwecktasche. PVC. Touch Screen.
Fourre-Tout. PVC. Ecran Tactile.
Multifunctioneel Tasje. PVC. Touch Screen.

21 × 27.5 × 14.3 cm

200 / 50

Print Code: F(1)





I LOVE TO COOK

SILICONE

05 04 19

Kerman
4002

Spatula. Silicone.
Spatel. Silikon.
Spatule. Silicone.
Spatel. Siliconen.

3.5 × 23 × 1 cm 500 / 50

Print Code: D(1)

05 19

Kolam
4001

Brush. Silicone.
Pinsel. Silikon.
Pinceau. Silicone.
Kwast. Siliconen.

3 × 17.5 × 1 cm 600 / 50

Print Code: D(1)

03



SILICONE
4 PIECES

19 07

01

Toor
4492

Measuring Set. 500 ml. 7 Pieces.
Messbecherset. 500 ml. 7 Stück.
Set Mesure. 500 ml. 7 Pieces.
Meet Set. 500 ml. 7 Stuks.

500 ml

08.2 × 13 cm 40

Print Code: E(1)

03

Lexa
3983

Mold Set. Silicone. 4 Pieces. Maximum Temperature 240°C.
Backform Set. Silikon. 4 Stück. Maximale Temperatur 240°C.
Set de Moules. Silicone. 4 Pièces. Température Maxi 240°C.
Vormen Set. Siliconen. 4 Stuks. Maximum Temperatur 240°C.

07.5 × 5.5 cm 200 / 100

Print Code: E(1)





01



03

05

Nimans

4304

Infuser.
Teesleb.
Infuseur.
Thee-Ei.

📏 Ø 3.1 × 15 cm 📦 1000 / 50

🌈 Print Code: C(1)



19



BPA FREE



03

05

19

Jandres

4273

Vaporizer.
Zerstäuber.
Vaporisateur.
Sproeier.

📏 Ø 2.5 × 9.3 cm 📦 1000 / 50

🌈 Print Code: C(4)



Video



BPA FREE

772



11

19

03

Sekiop

4671

Place Mat. ABS/ Silicone. Foldable.
Matte. ABS/ Silikon. Faltbar.
Set Table. ABS/ Silicone. Pliable.
Placemat. ABS/ Siliconen. Opvouwbaar.

📏 21.5 × 21.5 × 1.2 cm 📦 200 / 50

🌈 Print Code: F(1)

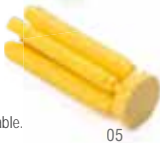

05



Sizok

4842

Holder. Silicone.
Halter. Silikon.
Support. Silicone.
Houder. Siliconen.

📏 9.5 × 19 × 3 cm 📦 300 / 50

🌈 Print Code: F(1)

19



05



03



HQ
HIGH QUALITY

Soltex

4565

Place Mat. Silicone.
Matte. Silikon.
Set Table. Silicone.
Placemat. Siliconen.

📏 17.3 × 17.3 × 0.4 cm 📦 300 / 100

🌈 Print Code: F(1)

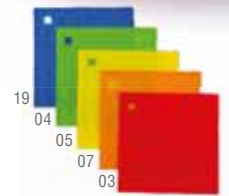

19

04

05

07

03



I LOVE TO COOK



Chesil
4249

Grater. Stainless Steel.
Reibe. Rostfreier Stahl.
Râpe. Acier Inox.
Rasp. Roestvrij Staal.
9 x 20.2 x 1.2 cm 300 / 50
Print Code: E(1)



Popic
5211

Cutlery Set. 5 Functions.
Besteckset. 5 Funktionen.
Set Couverts. 5 Fonctions.
Bestek Set. 5 Functies.
3.5 x 17.8 x 2.4 cm 400 / 50
Print Code: E(4)

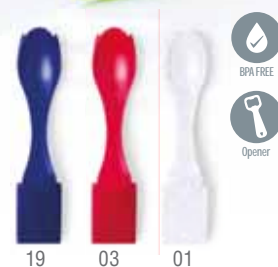

19 03 01

Bawel
2503

Kitchen Skimmer.
Schaumlöffel.
Appareil Ecumoir.
Schuimspan.
11 x 33 cm 180 / 45
Print Code: D(1)



03 04 19

773

Kranp
3794

Kitchen Tongs. Metal.
Küchenzange. Metall.
Pince. Metal.
Saladebestek. Metaal.
3.5 x 17.5 x 2.5 cm 200 / 25
Print Code: L1



19 04



Scale
3933

Pizza Cutter.
Pizzamesser.
Coupe-Pizzas.
Pizza Snijder.
9 x 16 x 1 cm 500 / 50
Print Code: D(1)



19 03 01



03



Dacix

6593

Dispenser Clip.
Spender Clip.
Clip Distributeur.
Dispenser Clip.

14.3 x 4.5 x 6.5 cm 200 / 50

Print Code: D(4), W



03

Flint

5793

Clip.
Klammer.
Pince.
Knijper.

10 x 6.2 x 2.3 cm 500 / 50

Print Code: C(1)



01

19

04



774

EASY OPEN /
ABRE FÁCIL



Victus

5651

Opener. Magnetic.
Glasöffner. Magnetisch.
Ouvre Bocal. Magnétique.
Opener. Magnetisch.

12.6 x 1.6 x 8 cm 300 / 50

Print Code: D(1)

MAGNET



Rucco

4098

Multipurpose Hook. PET. Adhesive. Reusable.
Mehrzweck Haken. PET. Haftend. Wiederverwendbar.
Crochet Multi-Usages. PET. Adhésif. Réutilisable.
Multifunctionele Haak. PET. Klevend. Herbruikbaar.

8 x 9 cm 1000 / 50

Print Code: C(1)



03

19

02



01



19

Yatax

4291

Wall Clock. Button Battery Included.
Wanduhr. Knopfzelle Inklusive.
Pendule. Pile Bouton Inclus.
Wandklok. Knoopcel Batterij Inclusief.

Ø 8.8 x 2.5 cm 100

Print Code: F(1)



01



03



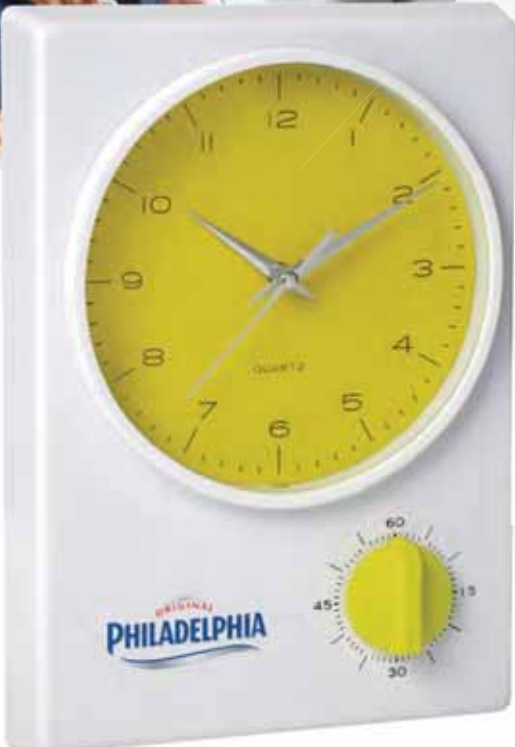

Tekel

4290

Wall Clock Timer. 1 Battery AA Not Included.
Wanduhr Timer. 1 AA Batterie Nicht im Lieferumfang.
Pendule Minuteur. 1 Pile AA Non Inclus.
Klok. 1 Batterij AA Niet Inclusief.

17.8 x 24.7 x 4.4 cm 20
Print Code: F(1)



19 03



11 19 04 05 03 07



01

Revey

3779

Timer.
Eieruhr.
Minuteur.
Eierwecker.

Ø 6 x 7.5 cm 100 / 20
Print Code: D(4)

775



MAGNET

03



19



01 05 19



02 01 03 07 11

Bulix

4253

Timer. Magnetic. Stopwatch Function. Button Battery Included.
Eieruhr. Magnetisch. Stopuhr Funktion. Knopfzelle Inklusive.
Minuteur. Magnétique. Fonction Chronomètre. Pile Bouton Inclus.
Eierwecker. Magnetisch. Stopwatch Functie. Knopcel Batterij Inclusief.

6 x 6 x 1.6 cm 300 / 50
Print Code: D(4)

Holly

4543

Timer. Stopwatch Function. 1 Battery AAA Not Included.
Eieruhr. Stopuhr Funktion. 1 AAA Batterie Nicht im Lieferumfang.
Minuteur. Fonction Chronomètre. 1 Pile AAA Non Inclus.
Eierwecker. Stopwatch Functie. 1 Batterij AAA Niet Inclusief.

Ø 5.5 x 7 cm 100 / 20
Print Code: D(4)



Cuatrico

2528

Magnet. Felt Tip Pen Not Included.
Magnet. Filzstift Nicht im Lieferumfang.
Magnet. Feutre Non Inclus.
Magneet. Felt Tip Pen Niet Inclusief.

10.5 × 15 cm

Print Code: Consult.

MAGNET

YOUR DESIGN

minimum 300 pcs - mínimo 300 pcs

Full colour printing included,
set up cost not included.

Impresión a todo color incluida
cliché no incluido.



776



Solek

5048

Felt Tip Pen. Magnetic.
Filzstift. Magnetisch.
Feutre. Magnétique.
Felt Tip Pen. Magnetisch.

1 × 11.4 cm 2000 / 50

Print Code: B(4)



Nietix

4645

Magnet. Felt Tip Pen and Eraser Included.
Magnet. Filzstift und Radierer Inklusiv.
Magnet. Feutre et Effaceur Inclus.
Magneet. Felt Tip Pen en Gum Inclusief.

29 × 21 cm 100 / 50

Print Code: D(4)



FRIDGE MAGNET



03
Yupit
3922

Magnetic Whiteboard. Felt Tip Pen and Eraser Included.
Magnet Tafel. Filzstift und Radierer Inklusie.
Ardoise Magnétique. Feutre et Effaceur Inclus.
Magnetisch Whiteboard. Felt Tip Pen en Gum Inclusief.

10.5 x 15 cm 200 / 25
Print Code: D(4)



11
Sylox
4811

Magnet. 40 Sheets Notepad.
Magnet. 40 Seiten Notizblock.
Magnet. Bloc 40 Feuilles.
Magneet. 40 Blaadjes Notepad..
6 x 14.6 cm 400 / 100
Print Code: C(2)



03
Magneto
3213

Photo Frame. Magnetic. Photos Size: 9 x 13 cm.
Bilderrahmen. Magnetisch. Photos: 9 x 13 cm.
Porte Photos. Magnétique. Photos: 9 x 13 cm.
Fotolijst. Magnetisch. Foto's Maat: 9 x 13 cm.
11.5 x 16.5 cm 300 / 50
Print Code: D(4)



04
Yakari
4582

Magnet. 40 Sheets Notepad. Pencil Included.
Magnet. 40 Seiten Notizblock. Bleistift Inklusie.
Magnet. Bloc 40 Feuilles. Crayon Inclus.
Magneet. 40 Blaadjes Notepad. Potlood Inclusief.
9.9 x 14 cm 200 / 50
Print Code: C(2)



Frigor

2519
Magnet. Resinated PVC.
Magnet. Harzgebund PVC.
Magnet. PVC Résiné.
Magneet. Geharst PVC.

DOMING MAGNET

YOUR DESIGN

minimum 300 pcs - mínimo 300 pcs
Full colour printing + Doming included,
set up cost not included.

Impresión a todo color + Doming incluido
cliché no incluido.



778



Hadrix

Magnet. PVC.
Magnet. PVC.
Magnet. PVC.
Magneet. PVC.

MAGNET

YOUR DESIGN

minimum 300 pcs - mínimo 300 pcs
Full colour printing included,
set up cost not included.

Impresión a todo color incluida
cliché no incluido.

FRIDGE MAGNET

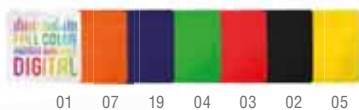

01 07 19 04 03 02 05



03

01

19

05

Daken

4514
Magnet.
Magnet.
Magnet.
Magneet.

6 × 6 cm 2000 / 1000
Print Code: C(4), W

Kisto

4515
Magnet.
Magnet.
Magnet.
Magneet.

6 × 4 cm 2000 / 1000
Print Code: C(4), W

Fico

3227
Magnet. PVC.
Magnet. PVC.
Magnet. PVC.
Magneet. PVC.

Ø 5.5 cm 1000 / 50
Print Code: D(4)





FRIDGE
MAGNET

MAGNET



02



Lambra
4894

Clip Opener. Magnetic.
Clip Flaschenöffner. Magnetisch.
Ouvre Bouteille Clip. Magnétique.
Clip Opener. Magnetisch.

300 / 50
Print Code: D(4), W



01

Tronic
3403

Opener. Magnetic.
Flaschenöffner. Magnetisch.
Ouvre Bouteille. Magnétique.
Opener. Magnetisch.

600 / 100
Print Code: D(4), W



19



19

05



03

Thelix
4247

Torch. 2 Leds. Magnetic. Button Batteries Included.
Lampe. 2 Leds. Magnetisch. Knopfzellen Inklusive.
Lampe. 2 Leds. Magnétique. Piles Bouton Inclus.
Zaklamp. 2 Leds. Magnetisch. Knopcelbatterij Inclusief.

300 / 50
Print Code: D(4)



02

Nolix
3793

Corkscrew. Magnetic.
Korkenzieher. Magnetisch.
Tire-Bouchon. Magnétique.
Kurketrekker. Magnetisch.

200 / 20
Print Code: D(1)



22

02

01

Wine Corkscrew & OPENER

NEW

Lavip

6788

Corkscrew Opener. Bamboo Fibre/ ABS.
Korkenzieher Flaschenöffner. Bambusfaser/ ABS.
Tire-Bouchon Ouvre Bouteille. Fibre Bambou/ ABS.
Kurkretrekker Opener. Bamboe Fibre/ ABS.

4 × 13.6 × 2 cm

100 / 10

Print Code: D(4)



03



Mac

9514

Corkscrew.
Korkenzieher.
Tire-Bouchon.
Kurkretrekker.

2.2 × 11 × 1.2 cm

240 / 10

Print Code: D(1)



19



02



07

Kiblack

6094

Corkscrew Opener. Stainless Steel.
Korkenzieher Flaschenöffner. Rostfreier Stahl.
Tire-Bouchon Ouvre Bouteille. Acier Inox.
Kurkretrekker Opener. Roestvrij Staal.

2.1 × 12 × 1.3 cm

200 / 10

Print Code: D(4), L1

02



02



20



01

Joval

6095

Corkscrew Opener.
Korkenzieher Flaschenöffner.
Tire-Bouchon Ouvre Bouteille.
Kurkretrekker Opener.

4 × 13.6 × 2 cm

100 / 10

Print Code: D(4)

20



01



02





OPENER



NEW



Kiray
6710

MAGNET
Magnet

Opener. Wood. Magnetic.
Flaschenöffner. Holz. Magnetisch.
Ouvre Bouteille. Bois. Magnétique.
Opener. Hout. Magnetisch.

■■■■■■■■■■ 0 6.5 x 1.5 cm

📦 200 / 50

🌈 Print Code: D(4), L1, W

781



Nacul

6478

Opener. Wood.
Flaschenöffner. Holz.
Ouvre Bouteille. Bois.
Opener. Hout.

■■■■■■■■■■ 4 x 14.4 x 2.2 cm 📦 200 / 50

🌈 Print Code: D(4), L1, W



Ferdy

6477

Opener. Wood.
Flaschenöffner. Holz.
Ouvre Bouteille. Bois.
Opener. Hout.

■■■■■■■■■■ 4 x 17.9 x 1 cm 📦 100 / 50

🌈 Print Code: D(4), L1, W

782

OPENER



Antibacterial

ANTIBACTERIAL
PRODUCT

Zazu

6683

Antibacterial Opener.
Antibakteriell Flaschenöffner.
Ouvre Bouteille Antibactérien.
Antibacterieel Opener.

4 × 9 × 1 cm

600 / 200

Print Code: D(4), W

NEW



19

Kyo

3050

Opener.
Flaschenöffner.
Ouvre Bouteille.
Opener.

4 × 9 × 1 cm 600 / 200

Print Code: D(4), W



03



05



01



02



Sorbip

4680

Opener.
Flaschenöffner.
Ouvre Bouteille.
Opener.

4.7 × 14.8 × 1 cm 400 / 100

Print Code: D(4)

Yenka

4132

Place Mat. Felt.
Matte. Filz.
Set Table. Feutrine.
Placemat. Vilt.

40 × 30 × 0.3 cm 150 / 10

Print Code: E(1), N(8)

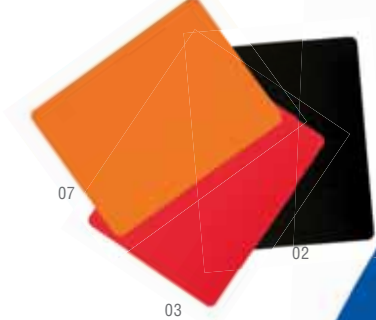

Lebron

6116

Sublimation Place Mat. Non-Woven.
Sublimations Matte. Non-Woven.
Set Table Sublimation. I.N.T.
Sublimatie Placemat. Non-Woven.

40 × 30 × 0.1 cm 1000 / 50

Print Code: E(1), N(8), R



783

Olmux

5652

Opener Coaster.
Flaschenöffner Untersetzer.
Sous-Verre Ouvre Bouteille.
Opener Onderzetter.

8.2 × 8.2 × 0.4 cm 500 / 100

Print Code: C(4), W



ANTI-SLIP /
ANTIDESLIZANTE



Naibel

4014

Cleaning Set. 2 Accessories.
Reinigungsset. 2 Teile.
Set Nettoyage. 2 Accessoires.
Schoonmaak Set. 2 Accessoires.

8.9 × 2.9 × 8.4 cm 200 / 100

Print Code: C(4), W





Opener

Duvinax

6040

Barbecue Set. Stainless Steel. 6 Functions.
Grillset. Rostfreier Stahl. 6 Funktionen.
Set Barbecue. Acier Inox. 6 Fonctions.
Barbecue Set. Roestvrij Staal. 6 Functies.

8.8 × 27 × 2.2 cm 20

Print Code: E(1), L2



North

3382

Barbecue Set. Stainless Steel/ Polyester 600D. 7 Accessories.
Grillset. Rostfreier Stahl/ Polyester 600D. 7 Teile.
Set Barbecue. Acier Inox/ Polyester 600D. 7 Accessoires.
Barbecue Set. Roestvrij Staal/ Polyester 600D. 7 Accessoires.

43 × 60 cm 20

Print Code: I(8)

784



Vissla

4504

Barbecue. Metal.
Grill. Metall.
Barbecue. Métal.
Barbecue. Metaal.

Ø 36 × 36 cm 4

Print Code: J(1)



Drakar

5690

Meat Branding Iron. Metal. 65 Pieces.
Fleisch-Marker. Metall. 65 Stück.
Marqueur de Grillade. Métal. 65 Pièces.
Vlees Brandmerker. Metaal. 65 Stuks.

8.7 × 43 × 5 cm 50

Print Code: F(1), L2



KIDS HOME

Legox
4754

Set. Non-Woven. One Size. Kids.
Set. Non-Woven. Einheitsgröße. Kinder.
Set. T.N.T. Taille Unique. Enfant.
Set. Non-Woven. Eén Maat. Kind.

Consult. 200 / 50
Print Code: F(1)

01



19

03

785



03



19

Zeka
4146



Serving Dishes.
Vorspeisen Schale.
Plateau Apéritif.
Schaaltjes.

Ø 25.5 x 2 cm 100
Print Code: E(1)



07



01



Tizy
4892

Apron. Non-Woven. One Size. Kids. 5 Markers Included.
Schürze. Non-Woven. Einheitsgröße. Kinder. 5 Markers Inklusiv.
Tablier. T.N.T. Taille Unique. Enfant. 5 Marqueurs Inclus.
Schort. Non-Woven. Eén Maat. Kind. 5 Stiften inclusief.

43 x 43 cm 200 / 50
Print Code: G(1)



Adapta

2428

Trash Bag Holder. Extendable.
Mülltütenhalter. Ausziehbar.
Support pour Sac Plastique. Extensible.
Vuilszakkenhouder. Verlengbaar.

34 × 2.6 × 18.3 cm 40

Print Code: E(1)

REUSE BAG
REUTILIZA BOLSAS



19 04 02

KEEP THE BAGS
GUARDA BOLSAS

Doxen

4925

Plastic Bag Holder. Polyester 210D.
Recycling Tasche. Polyester 210D.
Sac de Recyclage. Polyester 210D.
Recycle Tas. Polyester 210D.

Ø 14 × 39 cm 1000 / 50

Print Code: F(1)



03



786



BIG SIZE
GRAN CAPACIDAD

04



Lopack

4264

Bag Set. Laminated Non-Woven. 3 Bags 23 x 45 x 23 cm.
Taschen Set. Laminiertes Non-Woven. 3 Taschen 23 x 45 x 23 cm.
Set Sacs. T.N.T. Laminé. 3 Sacs 23 x 45 x 23 cm.
Tassen Set. Gelamineerd Non-Woven. 3 Tassen 23 x 45 x 23 cm.

69 × 45 × 23 cm 50

Print Code: F(1)

Shop XL

6106

Bag. Non-Woven.
Tasche. Non-Woven.
Sac. T.N.T.
Tas. Non-Woven.

33 × 38 × 25 cm 200 / 10

Print Code: F(1)



01 02 03



07 19



02

Max 3228

Shopping Trolley. Polyester 600D. Foldable.
Einkaufstrolley. Polyester 600D. Faltpar.
Caddie Course. Polyester 600D. Pliable.
Inkoopwagentje. Polyester 600D. Opvouwbaar.

30 × 52 × 20 cm

Print Code: H(1), N(8)

6



19

03



03

Fasty 4612

Shopping Trolley. Polyester 600D. Foldable.
Einkaufstrolley. Polyester 600D. Faltpar.
Caddie Course. Polyester 600D. Pliable.
Inkoopwagentje. Polyester 600D. Opvouwbaar.

32 × 54 × 13.5 cm

Print Code: H(1), N(8)

30

FOLDABLE
PLEGABLE



04

19

06



02

01

04

07

19

11

Perch 4992

Holder. Adjustable.
Halter. Verstellbar.
Support. Ajustable.
Houder. Aanpasbaar.



7 × 2.7 × 4.8 cm

500 / 25

Print Code: D(1)



BPA FREE

Yonner 6277

Thermal Picnic Basket. Polyester 600D/ Aluminium. Foldable.
Wärme Tasche. Polyester 600D/ Aluminium. Faltpar.
Sac Thermique. Polyester 600D/ Aluminium. Pliable.
Thermo-Tasje. Polyester 600D/ Aluminium. Opvouwbaar.

47 × 25 × 28 cm

Print Code: G(1), N(8)

20



03



19

02

RPET

i The fabric used in the manufacturing process of these products is made of recycled plastic (RPET). Like this, the emission of plastic residues to our planet and the consumption of energy is drastically reduced, resulting in a much more eco-friendly process.

El material de estos productos están fabricado con plástico reciclado (RPET), que, además de ayudar en la disminución de residuos plásticos en el planeta, utiliza menos energía en el proceso de fabricación, haciendo que sea mucho menos dañino para el medio ambiente.

STOP PLASTIC POLLUTING THE OCEAN



NEW

120 x 150 cm
200 g/m²



02

06

08

13

Kayla
6748

Blanket. Polyester RPET 200 g/ m2.
Decke. Polyester RPET 200 g/ m2.
Couverture. Polyester RPET 200 g/ m2.
Deken. Polyester RPET 200 g/ m2.



120 x 150 cm

Print Code: G(1), H(1), N(8), O, P



20



788



08

hiQ
HIGH QUALITY

Lerten
6045

125 x 160 cm
380 g/m²

Blanket. Coral Fleece/ Sherpa 380 g/ m2.
Decke. Coral Fleece/ Sherpa 380 g/ m2.
Couverture. Coral Fleece/ Sherpa 380 g/ m2.
Deken. Coral Fleece/ Sherpa 380 g/ m2.

125 x 160 cm



10

Print Code: F(1), N(8), O, P

CORAL FLEECE &
SHERPA



06



ANTI SLIP /
ANTIDESLIZANTE



Anti Slip

Molbik
5507

Sock. Polyester. One Size 36-43. Anti-Slip.
Socken. Polyester. Einheitsgröße 36-43. Rutschfest.
Chaussette. Polyester. Taille Unique 36-43. Antidérapante.
Sok. Polyester. Een Maat 36-43. Anti-Slip.

Consult.



100 / 10

Print Code: N(8)



03



11



19

Brenom

6065

Holder. Flexible.
 Halter. Flexibel.
 Support. Flexible.
 Houder. Flexibel.

12.3 x 6.4 x 2.8 cm 50

Print Code: H(1)

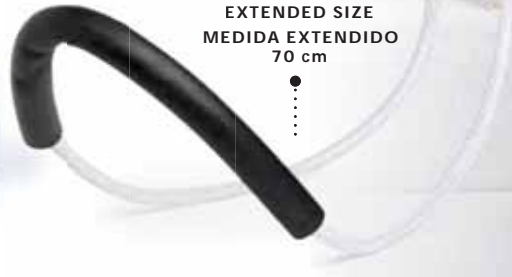

EXTENDED SIZE
 MEDIDA EXTENDIDO
 70 cm



02

Ryper

3665

Holder.
 Halter.
 Support.
 Houder.

39 x 30 x 4 cm 10

Print Code: G(1)



19



03



COMFORTABLE
 HEADPHONES
 CONFORTABLES
 AURICULARES

789



03



Markiz

5142

Headphones. Polar Fleece. 3,5 mm Jack Socket.
 Kopfhörer. Polar Fleece. 3,5 mm Klinckenstecker.
 Écouteurs. Polaire. Connexion Jack 3,5 mm.
 Koptelefoon. Polar Fleece. 3,5 mm Jack Aansluiting.

27 x 6 cm 200 / 50

Print Code: N(8), P



02

19



NEW

45 ml



Bisnal
6698

Automatic Dispenser. 45 ml. USB Rechargeable. Cable Included.
Automatisch Spender. 45 ml. USB Wiederaufladbar. Kabel Inklusive.
Distributeur Automatique. 45 ml. Rechargeable USB. Câble Inclus.
Automatisch Dispenser. 45 ml. USB Oplaadbaar. Kabel Inclusief.

5.5 x 9 x 7.5 cm

Print Code: E(4), W

50



WITH MOTION SENSOR
/ CON SENSOR DE
MOVIMIENTO

AUTOMATIC ALCOHOL DISPENSER

790



- Wi-Fi Support
- HD High Definition
- Photo Camera
- Video Recording
- Day & Night Vision
- Motion Detection
- Remote Control & Viewing
- Push Notifications
- Remote Talkback
- Simple Setup
- Micro SD



COMPATIBLE WITH
ANDROID & IOS

Baldrick
5533

Smart Camera. AC 220-240V. Cable Included.
Smart Kamera. AC 220-240V. Kabel Inklusive.
Videosurveillance Intelligente. AC 220-240V. Câble Inclus.
Smart Camera. AC 220-240V. Kabel Inclusief.

9.5 x 11.5 cm

Print Code: J(1)

20



REMOTE CONTROL MOVEMENT
MOVIMIENTO POR CONTROL REMOTO

NEW



OZONE GENERATOR

Trick
6653

Ozone Generator. USB Rechargeable. Cable Included.
Ozon-Generator. USB Wiederaufladbar. Kabel Inklusive.
Générateur d'Ozone. Rechargeable USB. Câble Inclus.
Ozon Generator. USB Oplaadbaar. Kabel Inclusief.

11.5 x 4.3 x 11.5 cm

Print Code: F(4)

30



Car

Home / Office





Home / Office



Multicolor light

Festok

6515

Humidifier. Led Lights. 130 ml. 1 Steam Mode. USB Connection. Cable Included.
 Luftbefeuchter. Led Lichter. 130 ml. 1 Dampf Funktion. USB Anschluss. Kabel Inklusive.
 Humidificateur. Lumières Led. 130 ml. 1 Mode de Vapeur. Connexion USB. Câble Inclus.
 Luchtbevochtiger. Led Lichten. 130 ml. 1 Stoom Positie. USB Verbinding. Kabel Inclusief.

📏 10 × 9.5 cm 📦 50

🌈 Print Code: E(1), L2



250 ml



19 03



Car



Home / Office

Paffil

6265

Humidifier. Led Lights. 250 ml. 1 Steam Mode. USB Connection. Cable Included.
 Luftbefeuchter. Led Lichter. 250 ml. 1 Dampf Funktion. USB Anschluss. Kabel Inklusive.
 Humidificateur. Lumières Led. 250 ml. 1 Mode de Vapeur. Connexion USB. Câble Inclus.
 Luchtbevochtiger. Led Lichten. 250 ml. 1 Stoom Positie. USB Verbinding. Kabel Inclusief.

📏 5 × 18 cm 📦 50

🌈 Print Code: E(1), L2



01

Yoner

2597

Sanitizer Doormat. PVC.
 Desinfektionsmatte. PVC.
 Tapis Désinfectant. PVC.
 Tapijtdesinfectiemiddel. PVC.

📏 80 × 40 cm

🌈 Print Code: G(1)

📦 10



791



Nailex

4840

Aromatic Diffuser. Jasmine Aroma. 15 ml.
Duft Diffusor. Jasmine Duft. 15 ml.
Diffuseur Aromatique. Arôme Jasmin. 15 ml.
Luchtverfrisser. Jasmijn Aroma. 15 ml.

9 × 15.7 × 4.2 cm 100 / 50

Print Code: E(1)



05

Lemon

19



Ocean



03



Strawberry

Pranger

4301

Air Freshener. 40 ml.
Lufterfrischer. 40 ml.
Parfum Ambiance. 40 ml.
Luchtverfrisser. 40 ml.

Ø 5.7 × 8.2 cm 200 / 20

Print Code: E(1)

792



Apple
cinnamon

H

F

Krum

6284

Aromatic Diffuser. Glass. Apple Cinnamon Aroma. 30 ml.
Duft Diffusor. Glas. Zimtapfel-Aroma. 30 ml.
Diffuseur Aromatique. Verre. Senteur Pomme Cannelle. 30 ml.
Luchtverfrisser. Glas. Appel Cinnamon Aroma. 30 ml.

3.7 × 14 × 3.7 cm 100 / 25

Print Code: E(1)



19



Ocean

Incienso

9944

Candle Set. Aromatic.
Kerzen Set. Duft.
Set Bougies. Aromatiques.
Kaarsen Set. Geurkaars.

20.3 × 3.5 × 7.6 cm 50 / 10

Print Code: E(1)

03



Strawberry

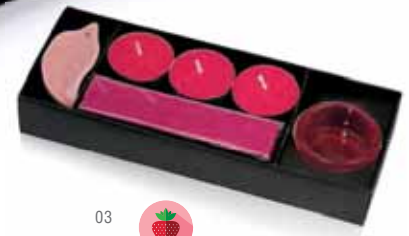



MAGNET
Magnet



Pingus

3453

Photo Frame. Magnetic Frame. Photos Size: 3,5 x 5 cm.
Bilderrahmen. Magnetischer Rahmen. Photos: 3,5 x 5 cm.
Porte Photos. Cadre Magnétique. Photos: 3,5 x 5 cm.
Fotolijst. Magnetisch Lijst. Foto's Maat: 3,5 x 5 cm.

5.2 x 13.5 x 4.8 cm 100 / 20
Print Code: D(1)

02

Stan

3195

Photo Frame. MDF. Photos Size: 10 x 15 cm.
Bilderrahmen. MDF. Photos: 10 x 15 cm.
Porte Photos. MDF. Photos: 10 x 15 cm.
Fotolijst. MDF. Foto's Maat: 10 x 15 cm.

14 x 19 x 0.9 cm 40
Print Code: L1



04



03

Miclox

4389

Mini Fan. USB Connection. Cable Included.
Mini Ventilator. USB Anschluss. Kabel Inklusive.
Mini Ventilateur. Connexion USB. Câble Inclus.
Mini Ventilator. USB Verbinding. Kabel Inclusief.

14.9 x 14 x 9.5 cm 40
Print Code: E(1)



Loras

5389

Fan. USB Connection. Cable Included.
Ventilator. USB Anschluss. Kabel Inklusive.
Ventilateur. Connexion USB. Câble Inclus.
Ventilator. USB Verbinding. Kabel Inclusief.

10 x 22 x 12 cm 50
Print Code: E(4)



Temperature



Time



Humidity



Helein

6516

Weather Station. Bamboo. 2 Batteries AAA Not Included.

Wetterstation. Bambus. 2 AAA Batterien Nicht im Lieferumfang.

Station Météo. Bambou. 2 Piles AAA Non Inclus.

Weerstation. Bamboe. 2 Batterijen AAA Niet Inclusief.

8.5 × 12 × 6 cm

50 / 25

Print Code: F(4), L1, W



PIECES FROM NATURAL CUTS OF BAMBOO.
THE TEXTURE AND COLOR MAY VARY.

PIEZAS PROCEDENTES
DE CORTE DE BAMBÚ NATURAL.
SU TEXTURA Y COLOR PUEDEN VARIAR

794

NEW



Temperature



Alarm



Time & Date



Humidity



Behox

6806

Weather Station. Bamboo. 2 Batteries AAA Not Included.

Wetterstation. Bambus. 2 AAA Batterien Nicht im Lieferumfang.

Station Météo. Bambou. 2 Piles AAA Non Inclus.

Weerstation. Bamboe. 2 Batterijen AAA Niet Inclusief.

13 × 13 × 2.4 cm

50 / 25

Print Code: F(4), L2, W



02



03



19

Etna

3740

Weather Station. Button Battery Included.

Wetterstation. Knopfzelle Inklusive.

Station Météo. Pile Bouton Inclus.

Weerstation. Knoopcel Batterij Inclusief.

7 × 11 × 1.5 cm

100 / 20

Print Code: E(4), W



Temperature



Alarm



Time & Date



Humidity



PIECES FROM NATURAL CUTS OF BAMBOO.
THE TEXTURE AND COLOR MAY VARY.

PIEZAS PROCEDENTES
DE CORTE DE BAMBÚ NATURAL.
SU TEXTURA Y COLOR PUEDEN VARIAR



Alarm



Time & Date



Temperature



Radio

Tulax 6517

Radio Alarm Clock. Bamboo. 2 Batteries AAA Not Included.
Radio Tischuhr. Bambus. 2 AAA Batterien Nicht im Lieferumfang.
Horloge Radio. Bambou. 2 Piles AAA Non Inclus.
Radio Klok. Bamboe. 2 Batterijen AAA Niet Inclusief.

12.5 x 8.5 x 4.7 cm

50 / 25

Print Code: F(4), L1, W



12 MARKERS
INCLUDED



43 X 28,5 CM



SCRAPER
INCLUDED

795



Munds 6579

Globe. Natural Cork/ Metal. 12 Markers Included.
Erdkugel. Naturkork/ Metall. 12 Markers Inklusive.
Globe Terrestre. Bouchon Naturel/ Metal. 12 Marqueurs Inclus.
Wereldbol Globe. Natuurlijk Kurk/ Staal. 12 Stiften Inclusief.

15 x 20 cm

10

Print Code: G(1), L2

Palsy 6590

Map. Laminated Paper. Scraper Included.
Karte. Laminiertes Papier. Schaber Inklusive.
Mappemonde. Papier Laminé. Grattoir Inclus.
Map. Gelamineerd Paper. Krabber Inclusief.

43 x 28.5 cm

50

Print Code: D(1), E(1)



Katrin

6317

Message Hanger. Led Lights. Felt Tip Pen and Eraser Included. 3 Batteries AAA Not Included.
Nachrichtenaufhänger. Led Lichter. Filzstift und Radierer Inklusiv. 3 AAA Batterien Nicht im Lieferumfang.
Ardoise Message. Lumières Led. Feutre et Effaceur Inclus. 3 Piles AAA Non Inclus.
Berichten Hanger. Led Lichten. Felt Tip Pen en Gum Inclusief. 3 Batterijen AAA Niet Inclusief.

8.3 × 22.3 × 2.7 cm 100 / 50

Print Code: D(1)



Cinemax

5981

Light Box. Led Lights. 82 Pieces. 4 Batteries AAA Not Included.
Leuchtkasten. Led Lichter. 82 Stück. 4 AAA Batterien Nicht im Lieferumfang.
Ecran Lumineux. Lumières Led. 82 Pièces. 4 Piles AAA Non Inclus.
Lightbox. Led Lichten. 82 Stuks. 4 Batterijen AAA Niet Inclusief.

15 × 10.7 × 4.1 cm 50 / 25

Print Code: D(1)



796

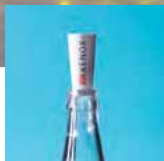

Lupok

6249

Bottle Lights. 10 Leds. Button Batteries Included.
Lichtstecker. 10 Leds. Knopfzellen Inklusiv.
Bec Lumineux. 10 Leds. Piles Bouton Inclus.
Sfeerlichtjes. 10 Leds. Knoopcel Batterijen Inclusief.

Ø 2.2 × 4.8 cm 500 / 100

Print Code: C(1)



SPEAKER



Trobel

6255

Ice Bucket Speaker. Smart Leds. Bluetooth Connection. Power 5W. USB Rechargeable. Cable Included.
Lautsprecher Eiskübel. Intelligente Leds. Bluetooth Anschluss. Power 5W. USB Wiederaufladbar. Kabel Inklusiv.
Sac Glaçons Haut-Parleurs. Leds Intelligentes. Connexion Bluetooth. Puissance 5W. Rechargeable USB. Câble Inclus.
Luidspreker Ijs Emmer. Smart Leds. Bluetooth Verbinding. Vermogen 5W. USB Oplaadbaar. Kabel Inclusief.

24.5 × 29 × 23.5 cm

Print Code: I(1)

4



Speaker

Bluetooth 5.0

Multicolor light

5 Watts

Kottel

5320

Lamp. 18 Leds. Flexible. 3 Light Modes. USB Connection. Cable Included. 3 Batteries AA Not Included.
 Lampe. 18 Leds. Flexibel. 3 Leuchtfunktionen. USB Anschluss. Kabel Inklusiv. 3 AA Batterien Nicht im Lieferumfang.
 Lampe. 18 Leds. Flexible. 3 Modes de Lumière. Connexion USB. Câble Inclus. 3 Piles AA Non Inclus.
 Lamp. 18 Leds. Flexibel. 3 Licht Posities. USB Verbinding. Kabel Inclusief. 3 Batterijen AA Niet Inclusief.

📏 11 x 4.3 cm 📦 20
 🎨 Print Code: F(1)



Slanky

5386

Lamp. 1 Led. 4 Batteries AA Not Included.
 Lampe. 1 Led. 4 AA Batterien Nicht im Lieferumfang.
 Lampe. 1 Led. 4 Piles AA Non Inclus.
 Lamp. 1 Led. 4 Batterijen AA Niet Inclusief.

📏 13 x 24 cm 📦 20
 🎨 Print Code: F(1)



19



THREE LIGHT MODES
 TRES MODOS DE LUZ

MULTIFUNCTION



Lerex

6268

Multifunction Lamp. 14 Leds. Flexible. 3 Light Modes. Adjustable Brightness. Wireless. Bluetooth Connection. Power 3W. USB Connection. Cable Included.
 Ladegerät Lautsprecher. 14 Leds. Flexibel. 3 Leuchtfunktionen. Einstellbare Lichtintensität. Drahtlos. Bluetooth Anschluss. Power 3W. USB Anschluss. Kabel Inklusiv.
 Haut-Parleurs Chargeur. 14 Leds. Flexible. 3 Modes de Lumière. Lumière à Intensité Réglable. Sans Fil. Connexion Bluetooth. Puissance 3W. Connexion USB. Câble Inclus.
 Oplader Luidspreker. 14 Leds. Flexibel. 3 Licht Posities. Lamp met Instelbare Lichtintensiteit. Draadloos. Bluetooth Verbinding. Vermogen 3W. USB Verbinding. Kabel Inclusief.

📏 12 x 32 x 12 cm 📦 30
 🎨 Print Code: F(1)



797



Zhilang

6347

Lamp Speaker. 18 Leds. Flexible. Adjustable Brightness. Bluetooth Connection. Power 5W. USB Rechargeable. Cable Included.
 Lampe Lautsprecher. 18 Leds. Flexibel. Einstellbare Lichtintensität. Bluetooth Anschluss. Power 5W. USB Wiederaufladbar. Kabel Inklusiv.
 Lampe Haut-Parleurs. 18 Leds. Flexible. Lumière à Intensité Réglable. Connexion Bluetooth. Puissance 5W. Rechargeable USB. Câble Inclus.
 Lamp Luidspreker. 18 Leds. Flexibel. Lamp met Instelbare Lichtintensiteit. Bluetooth Verbinding. Vermogen 5W. USB Opladbaar. Kabel Inclusief.

📏 10 x 53 cm 📦 30
 🎨 Print Code: F(1)



Sioko

Aromatic Candle. Metal. Vanilla Aroma.
Dufikerze. Metall. Vanille Duft.
Bougie Aromatique. Métal. Arôme Vanille.
Geurkaars. Metaal. Vanille Aroma.

Ø 6.3 × 3 cm 100 / 50

Print Code: E(1), L1



Sioko

798



23



Coffee

02



Pine

09

03



Strawberry

Nettax

5828

Aromatic Candle. Glass.
Dufikerze. Glas.
Bougie Aromatique. Verre.
Geurkaars. Glas.

Ø 5.6 × 6.7 cm 50

Print Code: F(1), L1

01



Lavander

Persy

6485

Aromatic Candle. Glass.
Dufikerze. Glas.
Bougie Aromatique. Verre.
Geurkaars. Glas.

Ø 5 × 6.3 cm 100 / 50

Print Code: F(1), L1



19



07

03



01



04

Shiva

9718

Aromatic Candle. Metal.
Dufikerze. Metall.
Bougie Aromatique. Métal.
Geurkaars. Metaal.

Ø 6.4 × 5 cm 100 / 50

Print Code: E(1), L1



18



Chocolat



07



Orange



13



Vanilla



NEW



Trivak

6792

Aromatic Candle. Glass/ Bamboo. Vanilla Aroma.
Duftkerze. Glas/ Bambus. Vanille Duft.
Bougie Aromatique. Verre/ Bambou. Arôme Vanille.
Geurkaars. Glas/ Bamboe. Vanille Aroma.

██████████ Ø 7 × 8.7 cm

📦 50

🌈 Print Code: E(1), L1



799



F
9,5 X 1,5 X 9,5 CM



01



Deram

6279

Candle. Wood.
Kerze. Holz.
Bougie. Bois.
Kaars. Hout.

██████████ Consult. 📦 200 / 100

🌈 Print Code: E(1), L1



B
9,5 X 1,5 X 8,8 CM

Tepor

6348

Aromatic Candle. Glass/ Natural Cork.
Duftkerze. Glas/ Naturkork.
Bougie Aromatique. Verre/ Bouchon Naturel.
Geurkaars. Glas/ Natuurlijk Kurk.

██████████ Ø 5.6 × 7.6 cm 📦 100 / 25

🌈 Print Code: E(1), L1



19



03

Temul

6408

Aromatic Candle. Glass. Vanilla Aroma. Chalk Included.
Duftkerze. Glas. Vanille Duft. Kreide Inklusive.
Bougie Aromatique. Verre. Arôme Vanille. Craie Inclus.
Geurkaars. Glas. Vanille Aroma. Krijtje Inclusief.

██████████ Ø 7 × 7.8 cm 📦 50

🌈 Print Code: E(1), L1





04

19



03

Flowcan

3369

Can. Assorted Coloured Flowers. 6-8 Petunia Seeds Included.

Dose. Verschiedenfarbige. 6-8 Petuniensamen Inklusiv.

Boîte Conserve. Fleurs Couleurs Diverses. 6-8 Semences de Petunia Inclus.

Blik. Assortiment Van Gekleurde Bloemen. 6-8 Petunia Zaden Inclusief.

📏 Ø 6.5 × 9 cm 📦 150 / 10

🌈 Print Code: E(1)



03

04

13

Advert

9966

Flowerpot. Biodegradable Pot. Assorted Coloured Flowers. 5-8 Petunia Seeds Included.

Blumentopf. Kompostierbarer Topf. Verschiedenfarbige. 5-8 Petuniensamen Inklusiv.

Pot de Fleurs. Pot Biodégradable. Fleurs Couleurs Diverses. 5-8 Graine de Pétunia Inclus.

Bloempot. Biodegradable Pot. Assortiment van gekleurde bloemen. 5-8 Petunia Zaden Inclusief.

📏 Ø 6.5 × 6.2 cm 📦 200 / 25

🌈 Print Code: E(4)

800



19



03

02

05

Zelmo

4450

Pot Desk Clock. Button Battery Included.

Blumentopf Tischuhr. Knopfzelle Inklusiv.

Horloge Pot. Pile Bouton Inclus.

Bloempot Klok. Knoopcel Batterij Inclusief.

📏 Ø 11 × 9.8 cm 📦 40 / 20

🌈 Print Code: E(1)



E

B

Chupon

5905

Flowerpot. Ceramic. 10-12 Petunia Seeds Included.

Blumentopf. Keramik. 10-12 Petuniensamen Inklusiv.

Pot de Fleurs. Céramique. 10-12 Semences de Petunia Inclus.

Bloempot. Keramiek. 10-12 Petunia Zaden Inclusief.

📏 6 × 11 × 7 cm 📦 100 / 50

🌈 Print Code: F(1)

INSTRUCCIONES

Tiempo de floración en condiciones óptimas de luz y temperatura: Primavera - verano: 5-7 días. Otoño - invierno: 20-25 días.
Presentación en caja individual con bolsita de sustrato y semillas separadas.

Flowering period in optimum conditions of light exposure and temperature: Spring - summer: 5-7 days. Autumn - winter: 20-25 days.
Presented in individual box including substrate and seeds packed separately in a bag.

Temps de floraison en conditions optimales de lumiere et temperature: Printemps - été: 5-7 Jours. Automne - hiver: 20-25 Jours.
Presentation en caisse individuelle avec sachet de substrat et graines separees.

Blütezeit unter optimalen Bedingungen der Belichtung und Temperatur: Frühling - Sommer: 5-7 Tage. Herbst - Winter: 20-25 Tage.
Präsentiert in einzelnen Kisten mit Substrat und Samen einzeln in einem Beutel verpackt.

Período de floritura in condizioni ottimali di luce, esposizione e temperatura: Primavera - estate: 5-7 Giorni. Autunno - inverno: 20-25 Giorni.
Presentata in scatola individuale includendo terriccio e semi confezionati separatamente in un sacchetto.

Tempo de floração em condições óptimas de luz e temperatura: Primavera - verão: 5-7 dias. Outono - inverno: 20-25 dias.
Apresentação em caixa individual com bolsa de substrato e sementes separadas.



NEW

minimog

TERRACOTTA

Soltax

6791

Flowerpot. Terracotta. Assorted Coloured Flowers. 5-8 Petunia Seeds Included.

Blumentopf. Terrakotta. Verschiedenfarbige. 5-8 Petuniensamen Inklusive.

Pot de Fleurs. Terre Cuite. Fleurs Couleurs Diverses. 5-8 Graine de Petunia Inclus.

Bloempot. Terracotta. Assortiment van gekleurde bloemen. 5-8 Petunia Zaden Inclusief.

Ø 5.8 x 5.2 cm

150 / 50

Print Code: E(1)



MINT/MENTA

PARSLEY/
PEREJIL

SET 2 PIECES

Sober

6484

Grow Pouch. Paper. Assorted Coloured Flowers. 5-8 Petunia Seeds Included.

Blumentopf. Papier. Verschiedenfarbige. 5-8 Petuniensamen Inklusive.

Pot de Fleurs. Papier. Fleurs Couleurs Diverses. 5-8 Graine de Petunia Inclus.

Bloempot. Paper. Assortiment van gekleurde bloemen. 5-8 Petunia Zaden Inclusief.

11 x 13 x 5 cm 500 / 50

Print Code: D(1)



Nertel

5113

Flowerpot Set. Biodegradable Pot. 2 Pieces. Seeds Included.

Blumentopf Set. Kompostierbarer Topf. 2 Stück. Samen Inklusive.

Set Pot de Fleurs. Pot Biodegradable. 2 Pièces. Graines Inclus.

Bloempot Set. Biologisch Afbreekbare Pot. 2 Stuks. Zaden Inclusief.

15 x 7 x 7 cm 100 / 50

Print Code: E(4)

Merin

6223

Flowerpot. Wood. Biodegradable Pot. Mint Seeds Included.

Blumentopf. Holz. Kompostierbarer Topf. Minzensamen Inklusive.

Pot de Fleurs. Bois. Pot Biodegradable. Semences de Menthe.

Bloempot. Hout. Biologisch Afbreekbare Pot. Munt Zaden Inclusief.

8 x 8.5 x 8 cm 60

Print Code: E(4), L1



801



WINE, BAR & HOTEL accessories



NEW

Saraby
PG.824

BAMBOO

CORK

Bribal 6098

Wine Set. Natural Cork. 4 Accessories.
 Wein Set. Naturkork. 4 Teile.
 Set Vin. Bouchon Naturel. 4 Accessoires.
 Wijn Set. Natuurlijk Kurk. 4 Accessoires.

📏 Ø 15 × 4 cm 📦 20
 🎨 Print Code: F(1), L2



803

BAMBOO



Kappal 6801

Coaster Set. Bamboo. 4 Pieces.
 Untersetzer Set. Bambus. 4 Stück.
 Set Sous-Verre. Bambou. 4 Pieces.
 Onderzetter Set. Bamboe. 4 Stuks.

📏 11.2 × 3.6 × 11.2 cm 📦 50
 🎨 Print Code: E(1), L2



4 PIECES



WINE set wood

804



Baco 9648

Wine Set. Wood. 5 Accessories.
Wein Set. Holz. 5 Teile.
Set Vin. Bois. 5 Accessoires.
Wijn Set. Hout. 5 Accessoires.

▬▬▬▬▬ Ø 17 × 3.5 cm

🌈 Print Code: F(1), L2

📦 20



Chess

9647

Wine Set. Wood. 4 Accessories.
Wein Set. Holz. 4 Teile.
Set Vin. Bois. 4 Accessoires.
Wijn Set. Hout. 4 Accessoires.

▬▬▬▬▬ 16.9 × 4.9 × 16.9 cm

🌈 Print Code: F(1), L2

📦 20



WINE set bamboo



Nitol
6099

Wine Set. Bamboo. 3 Accessories.
Wein Set. Bambus. 3 Teile.
Set Vin. Bambou. 3 Accessoires.
Wijn Set. Bamboe. 3 Accessoires.

16 × 4.9 × 10 cm
Print Code: F(1), L2

20



Boriac

6100

Wine Set. Bamboo. 4 Accessories.
Wein Set. Bambus. 4 Teile.
Set Vin. Bambou. 4 Accessoires.
Wijn Set. Bamboe. 4 Accessoires.

36 × 12 × 11 cm
Print Code: F(1), L2

10





WINE set

Kazan 6101

Wine Set. 2 Accessories.
Wein Set. 2 Teile.
Set Vin. 2 Accessoires.
Wijn Set. 2 Accessoires.

9.7 × 5.3 × 13.6 cm

Print Code: E(1)

50

806



03



02

Sarap 3783

Wine Set. 3 Accessories.
Wein Set. 3 Teile.
Set Vin. 3 Accessoires.
Wijn Set. 3 Accessoires.

Ø 6 × 24 cm

Print Code: E(1)



Quantium 5841

Wine Set. 5 Accessories.
Wein Set. 5 Teile.
Set Vin. 5 Accessoires.
Wijn Set. 5 Accessoires.

Ø 7.3 × 32.5 cm

Print Code: E(1)



20 / 10



Sousky 5840

Wine Set. 3 Accessories.
Wein Set. 3 Teile.
Set Vin. 3 Accessoires.
Wijn Set. 3 Accessoires.

Ø 6.4 × 24 cm

Print Code: E(1)



20 / 10



WINE accessories



Hoxmar
6097

Vacuum Bottle Stopper.
Deckel Vakuumpumpe.
Bec Pompe à Vide.
Stop Vacuum Pump.

■■■■■■ Ø 4.6 × 7.2 cm 📦 200 / 50

🎨 Print Code: D(1)

807



Renis

2427

Wine Decanter. Blown Glass.
Wein Dekanter. Geblasenes Glas.
Décanteur. Verre Soufflé.
Decanteerder. Blown Glas.

■■■■■■ Ø 7.7 × 11.2 cm 📦 48 / 12

🎨 Print Code: G(1), L2

Crianz

4975

Wine Aerator. Acrylic.
Wein Belüfter. Acryl.
Aérateur Vin. Acrylique.
Decanteer Wijnschenker. Acryl.

■■■■■■ Ø 2.2 × 16.2 cm 📦 200 / 50

🎨 Print Code: E(1)

Kabalt

6096

Vacuum Bottle Stopper.
Deckel Vakuumpumpe.
Bec Pompe à Vide.
Stop Vacuum Pump.

■■■■■■ Ø 2.8 × 8.2 cm 📦 300 / 50

🎨 Print Code: E(1)



03

02

21

Nuisant

9691

Bottle Cooler. PVC.
Flaschenkühler. PVC.
Refrroidisseur Bouteilles. PVC.
Flessenkoeler. PVC.

34 x 18 cm 50 / 25

Print Code: E(1)



Cold



08

Bottle cooler



808



03



19

Pusko

3833

Bottle Holder.
Flaschenhalter.
Porte-Bouteilles.
Flessenhouder.

11.5 x 23.5 cm 12

Print Code: F(1)



19



03



Cold

Raycon

4232

Bottle Cooler. PVC.
Flaschenkühler. PVC.
Refrroidisseur Bouteilles. PVC.
Flessenkoeler. PVC.

10 x 25 x 10 cm 80 / 20

Print Code: F(1)



01



Pikerson

6599

Wine Decanter. Glass. 1,8 L. Individual Presentation.
Wein Dekanter. Glas. 1,8 L. Individuelle Präsentation.
Décanteur. Verre. 1,8 L. Présentation Individuelle.
Decanteerder. Glas. 1,8 L. Individuele Presentatie.

▬▬▬▬▬ Ø 20 × 28 cm 📦 6

🌈 Print Code: G(1), L2

1,8 L

Wine decanter



1L

IDEAL FOR WATER AND WINE
IDEAL PARA AGUA Y VINO

Lonpel

6580

Bottle. Glass/ Natural Cork. 1 L. Individual Presentation.
Trinkflasche. Glas/ Naturkork. 1 L. Individuelle Präsentation.
Bouteille. Verre/ Bouchon Naturel. 1 L. Présentation Individuelle.
Fles. Glas/ Natuurlijk Kurk. 1 L. Individuele Presentatie.

▬▬▬▬▬ Ø 9,3 × 27,2 cm 📦 20

🌈 Print Code: G(1), L2





Telsox

6015

Keyring. Natural Cork.
Schlüsselanhänger. Naturkork.
Porte-Clés. Bouchon Naturel.
Steuflhänger. Natuurlijk Kurk.

📏 2.3 × 4.4 cm 📦 1000 / 50

🎨 Print Code: D(1), L1



Wine accessories



810

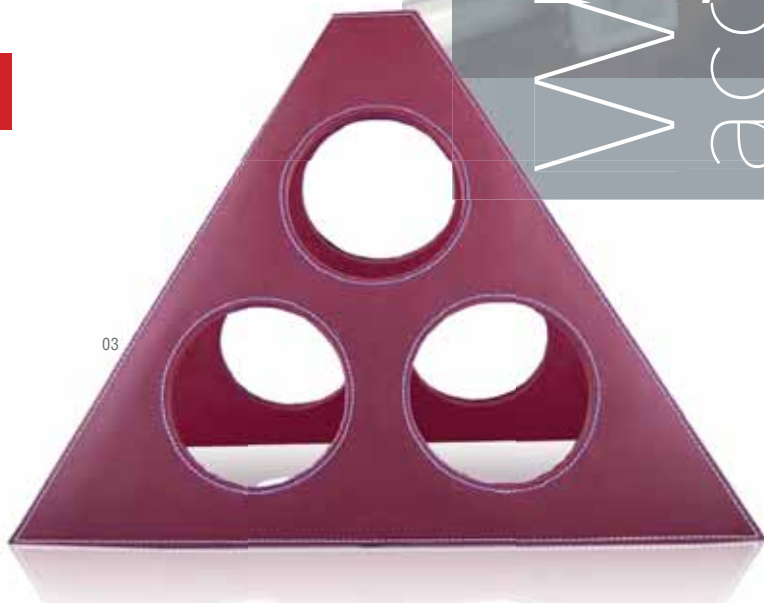

03

Conde

9554

Wine Rack. PU. 3 Bottles.
Flaschenhalter. PU. 3 Flaschen.
Porte-Bouteilles. Similicuir. 3 Bouteilles.
Wijnrek. PU. 3 Flessen.

📏 41 × 31 × 21 cm 📦 30

🎨 Print Code: F(1), L2

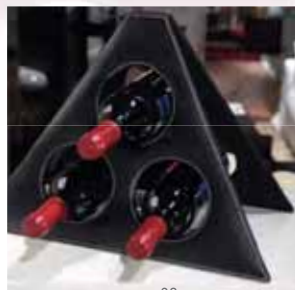

02



1L

2233

Wineskin. Leather. Food Grade Certified.
Weinschlauch. Leder. Für die Verwendung für Lebensmitteln Zugelassen.
Gourde à Vin. Cuir. Homologué pour Usage Alimentaire.
Lapzak. Leer. Voor Voedselgebruik Gecertificeerd.

📏 16.7 × 30 cm 📦 100

🎨 Print Code: E(1)



Wine BAG



Ragnar

5487

Bag. Paper 100 g/ m2.
Tasche. Papier 100 g/ m2.
Sac. Papier 100 g/ m2.
Tas. Paper 100 g/ m2.

11 × 36 × 10 cm 500 / 100
Print Code: F(1)



811



Koop

3481

Bag. Laminated Jute.
Tasche. Laminiertes Jutestoff.
Sac. Jute Laminé.
Tas. Gelamineerd Jute.

20 × 34.5 × 10 cm 100 / 25
Print Code: G(1)



Holden

3480

Bag. Laminated Jute.
Tasche. Laminiertes Jutestoff.
Sac. Jute Laminé.
Tas. Gelamineerd Jute.

10.5 × 35.5 × 10 cm 150 / 25
Print Code: G(1)

Holden

.....● NATURAL JUTE ●.....

Varien

4774

Bag. Non-Woven.
Tasche. Non-Woven.
Sac. T.N.T.
Tas. Non-Woven.

16 × 40 × 6.5 cm 1000 / 50
Print Code: F(1)



THE BEST PRICE
& THE BEST-SELLER



02

Nolix
3793

Corkscrew. Magnetic.
Korkenzieher. Magnetisch.
Tire-Bouchon. Magnétique.
Kurkretrekker. Magnetisch.

0 2.5 x 11.5 cm 200 / 20

Print Code: D(1)



01

MAGNET
Magnet

22



Wine Corkscrew

812



03

Mac
9514

Corkscrew.
Korkenzieher.
Tire-Bouchon.
Kurkretrekker.

2.2 x 11 x 1.2 cm 240 / 10

Print Code: D(1)



02

07

19



19



02

05

03



Trolex
4503

Corkscrew.
Korkenzieher.
Tire-Bouchon.
Kurkretrekker.

15 x 15.2 x 4 cm 20

Print Code: F(1)



Wine corkscrew

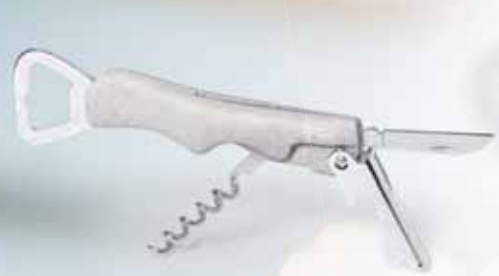

NEW

**BAMBOO
FIBRE**

Lavip
6788

Corkscrew Opener. Bamboo Fibre/ ABS.
Korkenzieher Flaschenöffner. Bambusfaser/ ABS.
Tire-Bouchon Ouvre Bouteille. Fibre Bamboo/ ABS.
Kurkretrekker Opener. Bamboe Fibre/ ABS.

4 x 13.6 x 2 cm 100 / 10
Print Code: D(4)

813



Plaquen
6093

Corkscrew Opener. Stainless Steel.
Korkenzieher Flaschenöffner. Rostfreier Stahl.
Tire-Bouchon Ouvre Bouteille. Acier Inox.
Kurkretrekker Opener. Roestvrij Staal.

2.2 x 12.2 x 1.2 cm 200 / 20
Print Code: L1

Kiblack
6094

Corkscrew Opener. Stainless Steel.
Korkenzieher Flaschenöffner. Rostfreier Stahl.
Tire-Bouchon Ouvre Bouteille. Acier Inox.
Kurkretrekker Opener. Roestvrij Staal.

2.1 x 12 x 1.3 cm 200 / 10
Print Code: D(4), L1

02



Joval
6095

Corkscrew Opener.
Korkenzieher Flaschenöffner.
Tire-Bouchon Ouvre Bouteille.
Kurkretrekker Opener.

4 x 13.6 x 2 cm 100 / 10
Print Code: D(4)

02

Gadux

5062

Opener. Aluminium.
Flaschenöffner. Aluminium.
Ouvre Bouteille. Aluminium.
Opener. Aluminium.

3.8 × 8.5 × 0.3 cm 1000 / 100

Print Code: D(4), L1



Clevon

6058

Opener Keyring. Aluminium.
Schlüsselanhänger Flaschenöffner. Aluminium.
Porte-Clés Ouvre Bouteille. Aluminium.
Sleutelhanger Opener. Aluminium.

3 × 8.9 × 0.2 cm 1000 / 100

Print Code: D(4), L1



Slack

5814

Opener Fidget Spinner.
Flaschenöffner Fidget Spinner.
Fidget Spinner Ouvre Bouteille.
Opener Fidget Spinner.

3.6 × 8.5 × 1.2 cm 400 / 50

Print Code: D(1)



Sorbip

4680

Opener.
Flaschenöffner.
Ouvre Bouteille.

4.7 × 14.8 × 1 cm 400 / 100

Print Code: D(4)





OPENER



NEW

MAGNET
Magnet

Kiray
6710

Opener. Wood. Magnetic.
Flaschenöffner. Holz. Magnetisch.
Ouvre Bouteille. Bois. Magnétique.
Opener. Hout. Magnetisch.

▮▮▮▮▮▮ Ø 6.5 x 1.5 cm 📦 200 / 50
🌈 Print Code: D(4), L1, W

815



Nacul
6478

Opener. Wood.
Flaschenöffner. Holz.
Ouvre Bouteille. Bois.
Opener. Hout.

▮▮▮▮▮▮ 4 x 14.4 x 2.2 cm 📦 200 / 50
🌈 Print Code: D(4), L1, W



Ferdy
6477

Opener. Wood.
Flaschenöffner. Holz.
Ouvre Bouteille. Bois.
Opener. Hout.

▮▮▮▮▮▮ 4 x 17.9 x 1 cm 📦 100 / 50
🌈 Print Code: D(4), L1, W

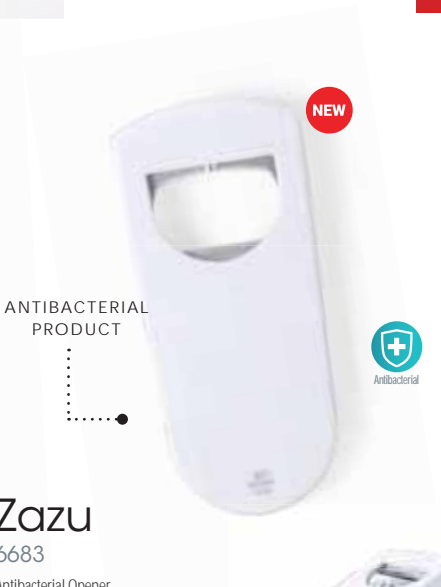

NEW

ANTIBACTERIAL
PRODUCT

Antibacterial

Zazu
6683

Antibacterial Opener.
Antibakteriell Flaschenöffner.
Ouvre Bouteille Antibactérien.
Antibacterieel Opener.

▮▮▮▮▮▮ 4 x 9 x 1 cm 📦 600 / 200
🌈 Print Code: D(4), W



COTTON
POUCH

Piltu

6800

Straw Set. Bamboo. 2 Pieces. Reusable. Cleaner Included.
Strohalm Set. Bambus. 2 Stück. Wiederverwendbar. Reiniger Inklusiv.
Set Paille. Bambou. 2 Pièces. Réutilisable. Nettoyant Inclus.
Rietjes Set. Bamboe. 2 Stuks. Herbruikbaar. Cleaner Inclusief.

3.5 × 24.5 cm

400 / 200

Print Code: E(1), L1, N(8)

816

COTTON
POUCH

Kalux

6282

Straw Set. Stainless Steel. 2 Pieces. Reusable. Cleaner Included.
Strohalm Set. Rostfreier Stahl. 2 Stück. Wiederverwendbar. Reiniger Inklusiv.
Set Paille. Acier Inox. 2 Pièces. Réutilisable. Nettoyant Inclus.
Rietjes Set. Roestvrij Staal. 2 Stuks. Herbruikbaar. Cleaner Inclusief.

3.5 × 24.5 cm

400 / 100

Print Code: E(1), L1, N(8)

REUSABLE
straw

Lantux

6290

Straw Set. Paper. 10 Pieces.
Strohalm Set. Papier. 10 Stück.
Set Paille. Papier. 10 Pièces.
Rietjes Set. Paper. 10 Stuks.

3.2 × 20 × 1.3 cm

500 / 100

Print Code: A(1), B(4), W

Ladix

6682

Antibacterial Straw. Silicone. Reusable.
Antibakteriell Strohalm. Silikon. Wiederverwendbar.
Paille Antibactérienne. Silicone. Réutilisable.
Antibacterieel Rietje. Siliconen. Herbruikbaar.

Ø 5.4 × 2 cm

500 / 100

Print Code: B(4), W

Say No
to
Plastic

NEW



ANTIBACTERIAL
PRODUCT

BPA FREE

Antibacterial

COASTER



Palet
6275

Coaster. Wood.
Untersetzer. Holz.
Sous-Verre. Bois.
Onderzetter. Hout.

11.5 × 1.5 × 7.5 cm
Print Code: D(1), L2

200 / 100



817



Yantic
6487

Coaster Set. Wood. 4 Pieces.
Untersetzer Set. Holz. 4 Stück.
Set Sous-Verre. Bois. 4 Pièces.
Onderzetter Set. Hout. 4 Stuks.

Ø 10 × 4 cm

Print Code: E(1), L1

50 / 25



4 PIECES

UNIQUE PIECES FROM NATURAL CUTS
OF WOOD.
THE TEXTURE, COLOR, SIZES AND
THICKNESS MAY VARY.

PIEZAS ÚNICAS PROCEDENTES
DE CORTE DE MADERA NATURAL.
SU TEXTURA, COLOR, TAMAÑO Y GRO-
SOR PUEDEN VARIAR



4 PIECES



Kappal
6801

Coaster Set. Bamboo. 4 Pieces.
Untersetzer Set. Bambus. 4 Stück.
Set Sous-Verre. Bambou. 4 Pièces.
Onderzetter Set. Bamboe. 4 Stuks.

11.2 × 3.6 × 11.2 cm

Print Code: E(1), L2

50



Brunex
6005

Coaster. Natural Cork.
Untersetzer. Naturkork.
Sous-Verre. Bouchon Naturel.
Onderzetter. Natuurlijk Kurk.

Ø 10 × 0.3 cm

Print Code: D(1), L2

2000 / 500



818



Kubits

2514

Tongs.
Zange.
Pincers.
Ijsblokjes-Tang.

2.4 × 15.5 × 3.5 cm 100

Print Code: C(4)

Crusiam

2511

Drink Stirrer.
Drink Rührer.
Agitateur.
Roerstaafje.

3 × 21 × 0.4 cm 1200 / 100

Print Code: B(4)

Charax

2513

Drink Stirrer.
Drink Rührer.
Agitateur.
Roerstaafje.

2.8 × 25.5 × 1.7 cm 800 / 100

Print Code: B(1), V



Blake

5332



Opener

Bucket. Metal. 6 L. Opener Included.
Eimer. Metall. 6 L. Flaschenöffner Inklusive.
Seau. Métal. 6 L. Ouvrir Bouteille Inclus.
Emmer. Metaal. 6 L. Opener Inclusief.

📏 Ø 22.5 × 18.5 cm 📦 20

🌈 Print Code: G(1)



6L



550 ml

Tobassy

5689

Cocktail Shaker. Stainless Steel. 550 ml. Individual Presentation.
Shaker. Rostfreier Stahl. 550 ml. Individuelle Präsentation.
Shaker. Acier Inox. 550 ml. Présentation Individuelle.
Shaker. Roestvrij Staal. 550 ml. Individuele Presentatie.

📏 Ø 8.6 × 21 cm 📦 50

🌈 Print Code: F(1), L2



Micux

6479

Drink Stirrer. Stainless Steel.
Drink Rührer. Rostfreier Stahl.
Agitateur. Acier Inox.
Roerstaafje. Roestvrij Staal.

📏 2.7 × 25.6 × 1.2 cm 📦 400 / 50

🌈 Print Code: L1



30 ml

15 ml

Roley

4843

Jigger. Stainless Steel.
Messbecher für Alkohol. Rostfreier Stahl.
Mesureur de Boisson. Acier Inox.
Jigger. Roestvrij Staal.

📏 Ø 3.9 × 6.5 cm 📦 200 / 50

🌈 Print Code: F(4), L1



Takone

4265

Cocktail Shaker. 300 ml.
Shaker. 300 ml.
Shaker. 300 ml.
Shaker. 300 ml.

▬▬▬▬▬▬ Ø 8 × 16.5 cm 📦 80 / 40
🌈 Print Code: F(1)



Mojits

4672

Muddler.
Stößel.
Pilon.
Stamper.

▬▬▬▬▬▬ Ø 2.5 × 20.5 cm 📦 200 / 50
🌈 Print Code: E(1)

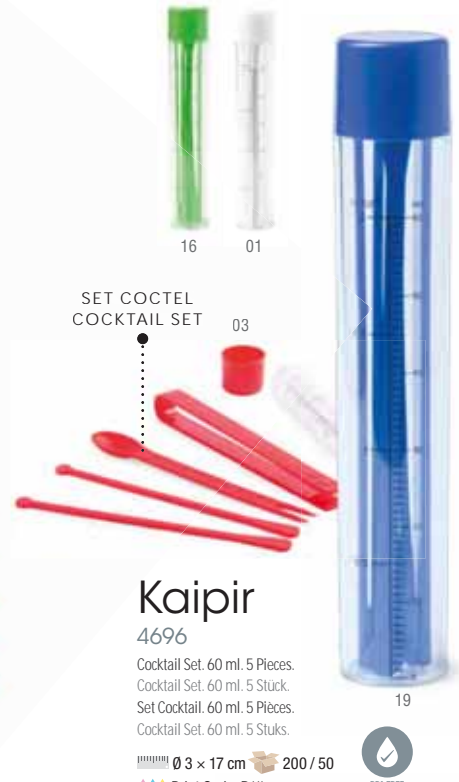

Kaipir

4696

Cocktail Set. 60 ml. 5 Pieces.
Cocktail Set. 60 ml. 5 Stück.
Set Cocktail. 60 ml. 5 Pieces.
Cocktail Set. 60 ml. 5 Stuks.

▬▬▬▬▬▬ Ø 3 × 17 cm 📦 200 / 50
🌈 Print Code: D(1)

820



Jubex

4525

Juicer. 125 ml.
Fruchtsaftpresse. 125 ml.
Presse-agrumes. 125 ml.
Sinaasappelpers. 125 ml.

▬▬▬▬▬▬ Ø 7 × 10.5 cm 📦 100 / 50
🌈 Print Code: E(1)



Jandres

4273

Vaporizer.
Zerstäuber.
Vaporisateur.
Sproeier.

▬▬▬▬▬▬ Ø 2.5 × 9.3 cm 📦 1000 / 50
🌈 Print Code: C(4)



Nimans

4304

Infuser.
Teesieb.
Infuseur.
Thee-Ei.

▬▬▬▬▬▬ Ø 3.1 × 15 cm 📦 1000 / 50
🌈 Print Code: C(1)





Trobel

6255

Ice Bucket Speaker. Smart Leds. Bluetooth Connection. Power 5W. USB Rechargeable. Cable Included.

Lautsprecher Eiskübel. Intelligente Leds. Bluetooth Anschluss. Power 5W. USB Wiederaufladbar. Kabel Inklusiv.

Sac Glaçons Haut-Parleurs. Leds Intelligentes. Connexion Bluetooth. Puissance 5W. Rechargeable USB. Cable Inclus.

Luidspreker Ijs Emmer. Smart Leds. Bluetooth Verbinding. Vermogen 5W. USB Opladbaar. Kabel Inclusief.

24.5 × 29 × 23.5 cm



Print Code: I(1)

821



10000 mAh

Tandem

5171



Power Bank

Power Bank Display Stand. 10000 mAh. 4 USB Outputs. Micro USB Input. Cables Included.

Power Bank Graphic Rahmen. 10000 mAh. 4 USB Ausgänge. Micro USB Eingang. Kabel Inklusiv.

Support Graphique Power Bank. 10000 mAh. 4 Sorties USB. Entrée Micro USB. Câbles Inclus.

Power Bank Display Standaard. 10000 mAh. 4 USB Outputs. Micro USB Input. Inclusief Kabels.

16 × 27.5 × 7.8 cm



Print Code: J(4), W



Video



Meltik



Drunax



Haser



Meltik

5732

Jug. Glas. 500 ml. Individual Presentation.
Krug. Glas. 500 ml. Individuelle Präsentation.
Carafe. Verre. 500 ml. Présentation Individuelle.
Kan. Glas. 500 ml. Individuelle Presentatie.

7.8 × 13 × 7.8 cm 36

Print Code: F(1), L2



Drunax

5733

Jar. Glas. 450 ml. Individual Presentation.
Einmachglas. Glas. 450 ml. Individuelle Präsentation.
Pot. Verre. 450 ml. Présentation Individuelle.
Pot. Glas. 450 ml. Individuelle Presentatie.

7.8 × 12.7 cm 36

Print Code: F(1), L2



Haser

5597

Bottle. Glas. 260 ml. Individual Presentation.
Trinkflasche. Glas. 260 ml. Individuelle Präsentation.
Bouteille. Verre. 260 ml. Présentation Individuelle.
Fles. Glas. 260 ml. Individuelle Presentatie.

6 × 20 cm 48

Print Code: F(1), L2





Tilton

6313

Mug. Ceramic. 700 ml. Individual Presentation.
 Krug. Keramik. 700 ml. Individuelle Präsentation.
 Carafe. Céramique. 700 ml. Présentation Individuelle.
 Kan. Keramiek. 700 ml. Individuele Presentatie.

☞ Ø 10.3 × 13.8 cm 📦 20

🌈 Print Code: F(4)



700 ml

823

380 ml



Tarbox

4749

Mug. Ceramic. 380 ml. Individual Presentation.
 Tasse. Keramik. 380 ml. Individuelle Präsentation.
 Tasse. Céramique. 380 ml. Présentation Individuelle.
 Mok. Keramiek. 380 ml. Individuele Presentatie.

☞ Ø 9 × 8.6 cm 📦 36

🌈 Print Code: F(4)

80 ml



Lutin

5194

Mug. Ceramic. 80 ml. Individual Presentation.
 Tasse. Keramik. 80 ml. Individuelle Präsentation.
 Tasse. Céramique. 80 ml. Présentation Individuelle.
 Mok. Keramiek. 80 ml. Individuele Presentatie.

☞ Ø 5.4 × 6.3 cm 📦 72

🌈 Print Code: F(4)

NEW

Saraby

6802

Kitchen Cutting Board. Bamboo.
Brett. Bambus.
Planche à Découper. Bambou.
Keuken Snijplank. Bamboe.

13.5 × 40 × 1 cm

Print Code: E(4), L2

30

FOOD presentation

824



03

Boletus

3444

Serving Dishes. Ceramic.
Vorspeisenteller. Keramik.
Plat Entrées. Céramique.
Schaaltjes. Keramiek.

Ø 8.8 × 3.4 cm

60 / 20

Print Code: F(4)

19



02



01



Pizax

4862

Platter Plate. Ceramic.
Brett. Keramik.
Plat. Céramique.
Plaat. Keramiek.

20 × 1.2 × 10 cm

36 / 6

Print Code: F(1)





Irsan

3223
Place Mat. 100% Cotton.
Matte. 100% Baumwolle.
Set Table. 100% Coton.
Placemat. 100% Katoen.

40 x 30 x 0.2 cm 400 / 10
Print Code: E(1), N(8)

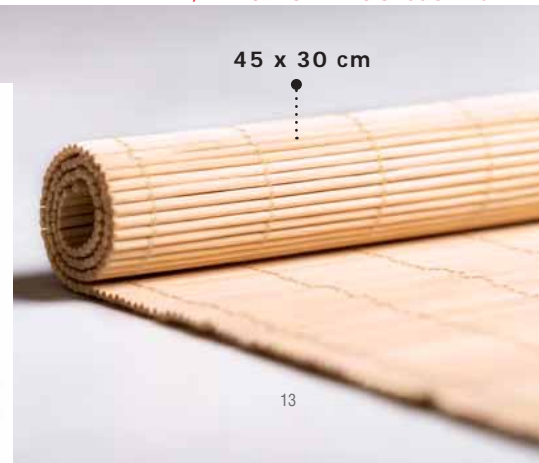
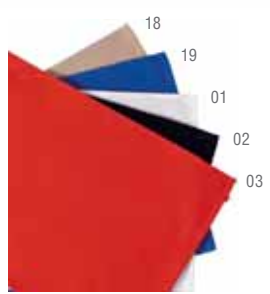

Jakarta

9316
Place Mat. Bamboo.
Matte. Bambus.
Set Table. Bambou.
Placemat. Bamboe.

45 x 30 x 0.3 cm 100 / 20
Print Code: E(1)

KIDS



Rozim

5702
Place Mat. Non-Woven. 5 Crayons Included.
Matte. Non-Woven. 5 Wachsmalstifte Inklusive.
Set Table. T.N.T.. 5 Crayons Inclus.
Placemat. Non-Woven. 5 Krijtjes Inclusief.

40 x 30 x 0.1 cm 200 / 50
Print Code: F(1)



SUBLIMATION

Lebron

6116
Ideal Sublimation

Sublimation Place Mat. Non-Woven.
Sublimations Matte. Non-Woven.
Set Table Sublimation. T.N.T.
Sublimatie Placemat. Non-Woven.
40 x 30 x 0.1 cm 1000 / 50
Print Code: E(1), N(8), R



Yenka

4132
Place Mat. Felt.
Matte. Filz.
Set Table. Feutrine.
Placemat. Vilt.

40 x 30 x 0.3 cm 150 / 10
Print Code: E(1), N(8)

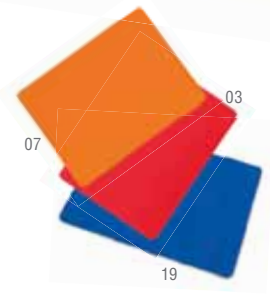



65 PIECES

Drakar

5690

Meat Branding Iron. Metal. 65 Pieces.

Fleisch-Marker. Metall. 65 Stück.

Marqueur de Grillade. Métal. 65 Pièces.

Vlees Brandmerker. Metaal. 65 Stuks.

8.7 × 43 × 5 cm 50

Print Code: F(1), L2

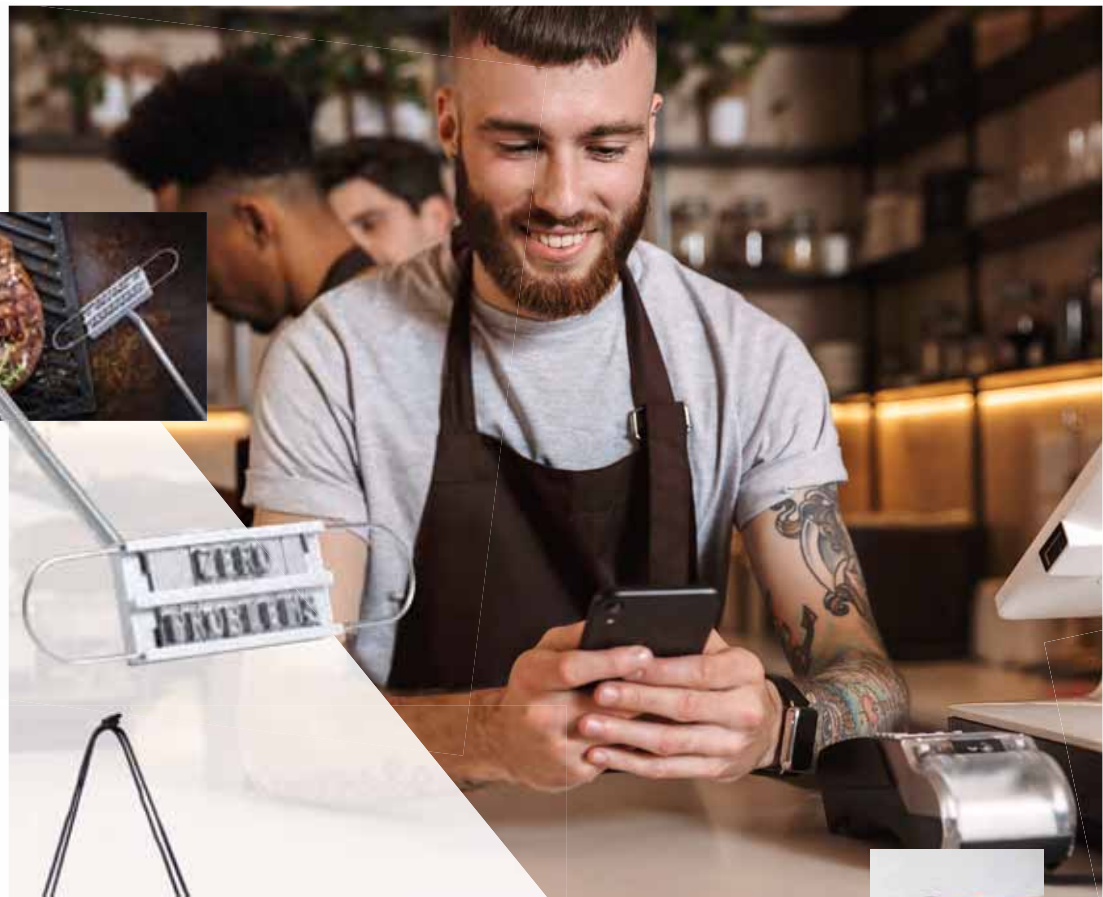

826



TWO SIDES / DOS CARAS

Marnik

5479

Whiteboard. 3 Chalks, Felt Tip Pen and Eraser Included.

Tafel. 3 Kreiden, Filzstift und Radierer Inklusiv.

Ardoise. 3 Craies, Feutre et Effaceur Inclus.

Whiteboard. 3 Krijtjes, Felt Tip Pen en Gum Inclusief.

31 × 21 × 1.2 cm 50

Print Code: D(1), L2

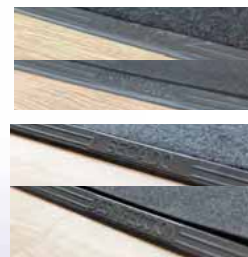

Yoner

2597

Sanitizer Doormat. PVC.

Desinfectionsmatte. PVC.

Tapis Désinfectant. PVC.

Tapijdesinfectiemiddel. PVC.

80 × 40 cm

Print Code: G(1)



10



Vurcex

6295

Apron: 100% Cotton/PU.
Schürze: 100% Baumwolle/PU.
Tablier: 100% Coton/Similicuir.
Schort: 100% Katoen/PU.

68 x 80 cm 50
Print Code: E(4), N(8), P



827



Organic Cotton

Riffox

6425

Apron: 100% Organic Cotton.
Schürze: 100% Organische Baumwolle.
Tablier: 100% Coton Organique.
Schort: 100% Organisch Katoen.

65 x 93 cm 100 / 10
Print Code: E(4), N(8), P



NEW



Recycled Cotton

Pissek

6831

Apron: 100% Recycled Cotton.
Schürze: 100% Recycling Baumwolle.
Tablier: 100% Coton Recyclé.
Schort: 100% Gerecycled Katoen.

65 x 90 cm 100 / 10
Print Code: E(4), N(8), P





Javess

5029

Apron. 100% Polyester.
Schürze. 100% Polyester.
Tablier. 100% Polyester.
Schort. 100% Polyester.

54 × 73 cm 50
Print Code: F(1), N(8)



PROFESSIONAL
APRON

828

Bremor

4871

Apron. 100% Polyester.
Schürze. 100% Polyester.
Tablier. 100% Polyester.
Schort. 100% Polyester.

90 × 90 cm 60 / 10
Print Code: F(1), N(8)



Milty

4870

Apron. 100% Polyester.
Schürze. 100% Polyester.
Tablier. 100% Polyester.
Schort. 100% Polyester.

54 × 30 cm 200 / 25
Print Code: F(1), N(8)





CHEF
HAT



02

01

Nilson
4747

Chef Hat. TC. 35% Cotton/ 65% Polyester. Adjustable.
Kochmütze. TC. 35% Baumwolle/ 65% Polyester. Verstellbar.
Toque Cuisinier. TC. 35% Coton/ 65% Polyester. Ajustable.
Koksmuts. TC. 35% Katoen/ 65% Polyester. Aanpasbaar.

Consult. 250 / 50

Print Code: E(1), N(8)

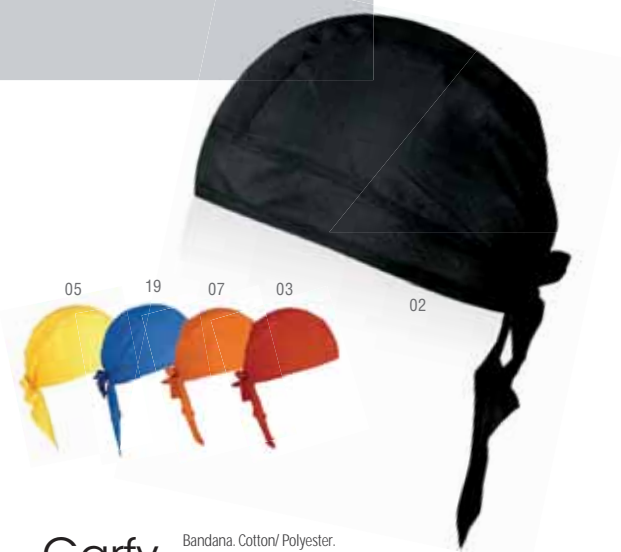

Garfy
9212

Bandana. Cotton/ Polyester.
Kopftuch. Baumwolle/ Polyester.
Bandana. Coton/ Polyester.
Bandana. Katoen/ Polyester.

Consult. 600 / 10

Print Code: E(1), N(8), 0



MESH / REJILLA

03

19

01

02

Painer
5286

Hat. TC. 35% Cotton/ 65% Polyester. Adjustable.
Hut. TC. 35% Baumwolle/ 65% Polyester. Verstellbar.
Bonnet. TC. 35% Coton/ 65% Polyester. Ajustable.
Muts. TC. 35% Katoen/ 65% Polyester. Aanpasbaar.

Consult. 300 / 50

Print Code: E(1), N(8)



Osill

4751

Place Mat. Non-Woven.

Matte. Non-Woven.

Set Table. T.N.T..

Placemat. Non-Woven.

40 × 30 × 0.1 cm 1000 / 50

Print Code: D(1)

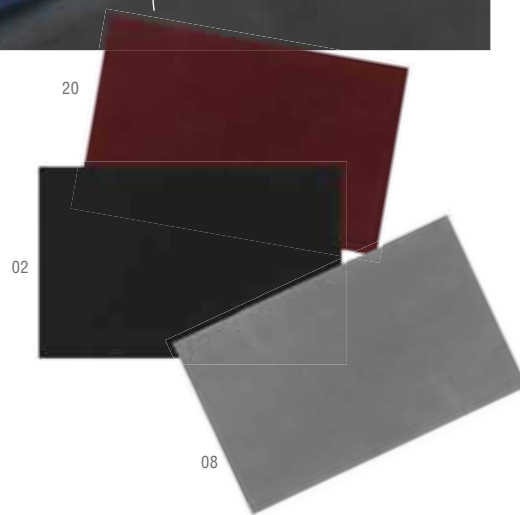

Napkei

3068

Napkin Ring. 4 Pieces Set.
Serviettenring. Set 4 Stück.
Rond Serviette. Set 4 Unites.
Servetten Ring. 4 Stuks Set.

7.5 × 4.3 cm 600 / 50

Print Code: D(1)

830



Hiners

4539

Chair Band.

Stuhl Band.

Bande Chaise.

Hoofdsteenbescherm.

35 × 15 cm 400 / 100

Print Code: F(1), N(8)



Compac

3243

Wipes. Cellulose. 10 Pieces. Unfolded Wipe 23 x 23 cm.

Feuchttücher. Zellstoff. 10 Stück. Feuchttücher Ausgefaltet 23 x 23 cm.

Lingettes. Cellulose. 10 Pièces. Lingette Dépliée 23 x 23 cm.

Poetsdoekjes. Cellulose. 10 Stuks. Poetsdoekje Doekje 23 x 23 cm.

Ø 2.3 × 11 cm 400 / 50

Print Code: D(1)





831



Lezel

4750

Table Runner. Non-Woven.
Tischläufer. Non-Woven.
Chemin Table. T.N.T.
Serveerplatform. Non-Woven.

120 x 40 cm 100 / 25

Print Code: D(1)

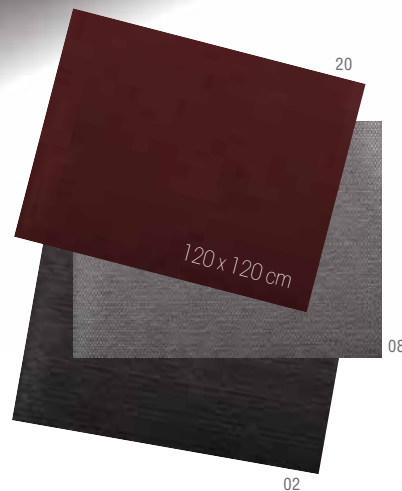

Salrix

4752

Tablecloth. Non-Woven.
Tischdecke. Non-Woven.
Nappe. T.N.T.
Tafelkleed. Non-Woven.

120 x 120 cm 100 / 10

Print Code: D(1)

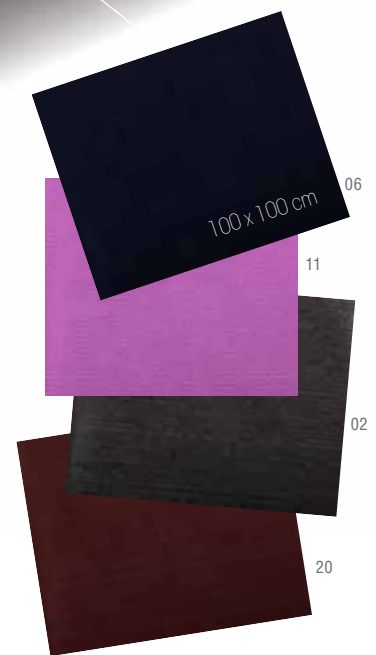

Nolug

4763

Tablecloth. Non-Woven.
Tischdecke. Non-Woven.
Nappe. T.N.T.
Tafelkleed. Non-Woven.

100 x 100 cm 100 / 25

Print Code: D(1)

SPECIAL HOTEL

832

01

Tarkun

6501

Slippers. Cotton/ Polyester. One Size 36-43.
Pantoufeln. Baumwolle/ Polyester. Einheitsgröße 36-43.
Pantoufles. Coton/ Polyester. Taille Unique 36-43.
Slippers. Katoen/ Polyester. Een Maat 36-43.

Consult. 200 / 10

Print Code: E(1), N(8)



02

Sukon

6766

Antibacterial Pencil. Wood.
Antibakteriell Bleistift. Holz.
Crayon Antibactérien. Bois.
Antibacterieel Potlood. Hout.

Ø 0.7 × 18.6 cm

Print Code: B(4), L1



Unsharpened

2000 / 100

Radun

6567

Mini Pen. Wheat Straw/ ABS.
Mini Kugelschreiber. Weizenstroh/ ABS.
Mini Stylo. Paille de Blé/ ABS.
Minipen. Tarwestra/ ABS.

Ø 1 × 9.2 cm

Print Code: A(4), W



03

04

19

WHEAT STRAW

13



SPECIAL HOTEL

NEW

NEW

833



Ledis

6717



Sanitizer Wipes. 10 Pieces.
Hygienisch Feuchttücher. 10 Stück.
Lingettes Hygiéniques. 10 Pièces.
Hygiënisch Poetsdoekjes. 10 Stuks.

15 × 8 × 1.5 cm

200 / 100

Print Code: C(1)

Talso

6825

Beauty Bag. 100% Cotton.
Kosmetik Tasche. 100% Baumwolle.
Nécessaire. 100% Coton.
Toilettas. 100% Katoen.

Ø 15 × 25 cm

200 / 10

Print Code: F(6), N(8), O, P

Lencix

6362

Toothbrush. Bamboo.
Zahnbürste. Bambus.
Brosse à Dents. Bamboue.
Tandenborstel. Bamboe.

1.3 × 17.5 × 1.6 cm

500 / 50

Print Code: C(4), L1

Garet

6504

Comb. Bamboo.
Kamm. Bambus.
Peigne. Bambou.
Kam. Bamboe.

3.1 × 18.7 × 0.5 cm

500 / 100

Print Code: C(4), L1



BAMBOO



Korol

6601

Toothbrush. Bamboo.
Zahnbürste. Bambus.
Brosse à Dents. Bambou.
Tandenborstel. Bamboe.

Ø 3.9 × 20.3 cm 📦 200 / 50

Print Code: C(4), L1



SPECIAL
HOTEL

834



Cleidol

6278

Toothbrush. Wheat Straw/ PP.
Zahnbürste. Weizenstroh/ PP.
Brosse à Dents. Paille de Blé/ PP.
Tandenborstel. Tarwestro/ PP.

1.2 × 18 × 1.6 cm 📦 500 / 50

Print Code: C(4)

WHEAT
STRAW



WHEAT
STRAW



Wofel

6503

Comb. Wheat Straw/ PP.
Kamm. Weizenstroh/ PP.
Peigne. Paille de Blé/ PP.
Kam. Tarwestro/ PP.

2.8 × 17 × 0.3 cm 📦 1000 / 50

Print Code: C(4)

SPECIAL
HOTELNalton
6502

Slippers. Cotton/ Polyester. One Size 36-43.
Pantoffeln. Baumwolle/ Polyester. Einheitsgröße 36-43.
Pantoufles. Coton/ Polyester. Taille Unique 36-43.
Slippers. Katoen/ Polyester. Eén Maat 36-43.

Consult. 200 / 10

Print Code: E(1), N(8)

IDEAL FOR NEWSPAPER /
IDEAL PARA PRENSA

835



Varien

4774

Bag. Non-Woven.
Tasche. Non-Woven.
Sac. T.N.T.
Tas. Non-Woven.

16 x 40 x 6.5 cm 1000 / 50

Print Code: F(1)



02



01

Yommy

5830

Flip Flops. EVA. One Size 36-43.
Flip Flop. EVA. Einheitsgröße 36-43.
Flip Flops. EVA. Taille Unique 36-43.
Flip Flops. EVA. Eén Maat 36-43.

Consult. 300 / 10

Print Code: D(1), E(1)



19

03



05

04



01

Hall

3147

Mini Pen.
Mini Kugelschreiber.
Mini Stylo.
Minipen.

Ø 1 × 9.6 cm 2000 / 100

Print Code: A(4), W



03

07

05

04

19

02

11

17

Miniature

9607

Pencil. Wood.
Bleistift. Holz.
Crayon. Bois.
Potlood. Hout.

Ø 0.5 × 10 cm 2000 / 100

Print Code: A(4), L1



Sharpened



NEW

NEW

Ramix

6692

Antibacterial Pen.
Antibakteriell Kugelschreiber.
Stylo Antibactérien.
Antibacterieel Pen.

Ø 1.1 × 14 cm

1000 / 50

Print Code: B(4)



01

Licter

6659

Antibacterial Pen.
Antibakteriell Kugelschreiber.
Stylo Antibactérien.
Antibacterieel Pen.

Ø 1 × 13.8 cm

1000 / 50

Print Code: B(4)



02

03

04

19

05



The Best-Seller
HOTEL

SPECIAL
HOTEL

Wipper

6605

Pen. Wheat Straw/ ABS.
Kugelschreiber. Weizenstroh/ ABS.
Stylo. Paille de Blé/ ABS.
Pen. Tarwestro/ ABS.

Ø 1 × 13.8 cm 1000 / 50

Print Code: A(4)

04



837



07 04 02 01 03 19

NEW

Vatum
6770



Pen. Recycled Cardboard/ PLA 100% Compostable.
Kugelschreiber. Recycling Pappe/ PLA 100% Kompostierbar.
Stylo. Carton Recycle/ PLA 100% Compostable.
Pen. Gerecycled Karton/ PLA 100% Composteerbaar.

Ø 0.9 × 13.7 cm 1000 / 50

Print Code: A(4), W

 PEN INCLUDED/
BOLÍGRAFO INCLUIDO

 20 Sheets
Plain

Blogger

5628

Folder. Recycled Cardboard. 20 Sheets Notepad.
Recycled Cardboard Pen Included.

Mappe. Recycling Pappe. 20 Seiten Notizblock.
Recycling Pappe Kugelschreiber Inklusiv.

Porte-Documents. Carton Recyclé. Bloc 20 Feuilles.
Stylo Carton Recyclé Inclus.

Map. Gerecycled Karton. 20 Blaadjes Notepad. Pen
Gerecycled Karton Inclusief.

23 × 32 × 1.5 cm 50

Print Code: F(1), B(1)



ANTIBACTERIAL LINE



What are the antibacterials additive used in the products?

A major source of infections for humans is bacterial contamination. Under certain environmental conditions, bacteria are capable of proliferating exponentially, forming large colonies and producing unhealthy situations for humans.

To ensure a hygienic environment it is important to control microbial growth. That is why nowadays products with antibacterial treatments are increasingly in demand, aimed at environments in which hygiene is particularly important: in public environments such as transport, in the field of education, or for the personal use as articles of daily use, are the areas where they begin to have an increasing relevance.

Products with antibacterial treatments are capable of drastically reducing the bacterial loads present on the surfaces of the materials, thanks to the incorporation of static permanent microbial agents, highly effective in inhibiting and preventing bacterial contamination.

The ISO 22196 and ISO 20743 standards determine antibacterial activity on plastic materials and non-porous surfaces and on textile products, respectively. These analyzes allow to know the effectiveness of microbial inhibition that the additives have on the treated objects through a quantitative evaluation.



antibac- tech



Supot 6689

Antibacterial Mouse. Wireless. Optical. 2 Batteries AAA Not Included.
Antibakteriell Maus. Drahtlos. Optisch. 2 AAA Batterien Nicht im Lieferumfang.
Souris Antibactérienne. Sans Fil. Optique. 2 Piles AAA Non Inclus.
Antibacterieel Muis. Draadloos. Optical. 2 Batterijen AAA Niet Inclusief.

11.2 × 2.4 × 5.7 cm

200 / 100

Print Code: E(4), W



Wireless
Mouse



Antibacterial



DPI BUTTON
BOTÓN DPI

NEW

TOUCH SENSITIVE
BUTTON
BOTÓN TÁCTIL

839



NEW

CHARGING STATION



Antibacterial

Kiskey 6688

Antibacterial Earphones. Bluetooth Connection. USB Rechargeable. Cable Included.
Antibakteriell Kopfhörer. Bluetooth Anschluss. USB Wiederaufladbar. Kabel Inklusiv.
Écouteurs Antibactérien. Connexion Bluetooth. Rechargeable USB. Câble Inclus.
Antibacterieel Oordopjes. Bluetooth Verbinding. USB Oplaadbaar. Kabel Inclusief.

4.5 × 6.8 × 2.2 cm

100 / 50

Print Code: E(4), W



Bluetooth 5.0



Hands-free

wireless charger

NEW



Halby
6670



Charger UV Sterilizer Box. Wireless. Ultraviolet Light. USB Connection. Cable Included.
Ladegerät UV Sterilisator Kasten. Drahtlos. Ultraviolettes Licht. USB Anschluss. Kabel Inklusive.
Boîte Stérilisateur UV Chargeur. Sans Fil. Ultraviolets. Connexion USB. Câble Inclus.
Oplader UV Sterilisator Kist. Draadloos. Ultraviolet Licht. USB Verbinding. Kabel Inclusief.

20.5 x 4.5 x 12.5 cm
Print Code: F(2), W

30



ULTRAVIOLET LIGHT:
DESTROYS MICRO-ORGA-
NISMS AND BACTERIAS
FROM SURFACES AND
OBJECTS USED ON A DAILY
BASIS

UV
STERILIZER



840



NEW

Strey
6889

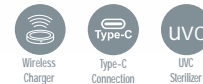

Charger UV Sterilizer Box. Bamboo/ ABS. Wireless. Ultraviolet Light. USB Connection. Cable Included.
Ladegerät UV Sterilisator Kasten. Bambus/ ABS. Drahtlos. Ultraviolettes Licht. USB Anschluss. Kabel Inklusive.
Boîte Stérilisateur UV Chargeur. Bamboo/ ABS. Sans Fil. Ultraviolets. Connexion USB. Câble Inclus.
Oplader UV Sterilisator Kist. Bamboe/ ABS. Draadloos. Ultraviolet Licht. USB
20.5 x 4.5 x 12.5 cm
Print Code: F(2), L2, W



wireless charger

Klas

6649

UV Sterilizer Lamp. Ultraviolet Light. 2 Batteries AAA Not Included.
UV Sterilisator Lampe. Ultraviolettes Licht. 2 AAA Batterien Nicht im Lieferumfang.
Lampe Stérilisateur UV. Ultraviolets. 2 Piles AAA Non Inclus.
UV Sterilisator Lamp. Ultraviolet Licht. 2 Batterijen AAA Niet Inclusief.

3.1 x 17.5 x 3.1 cm 200 / 100

Print Code: E(4)



NEW

ULTRAVIOLET LIGHT:
DESTROYS MICRO-ORGANISMS AND BACTERIAS
FROM SURFACES AND
OBJECTS USED ON A DAILY BASIS

NEW



UV STERILIZER



Nurek

6654



UV Sterilizer Lamp. Ultraviolet Light. USB Rechargeable. Cable Included.
UV Sterilisator Lampe. Ultraviolettes Licht. USB Wiederaufladbar. Kabel Inklusive.
Lampe Stérilisateur UV. Ultraviolets. Rechargeable USB. Cable Inclus.
UV Sterilisator Lamp. Ultraviolet Licht. USB Oplaadbaar. Kabel Inclusief.

3 x 12.5 x 1.4 cm 100 / 50

Print Code: E(4), W



wireless charger



NEW



Blay

6671

Charger UV Sterilizer Lamp. Wireless. USB Output. 1000 mA. Fast Charger 10W. Ultraviolet Light. USB Connection. Cable Included.
Ladegerät UV Sterilisator Lampe. Drahtlos. USB Ausgang. 1000 mA. Schnelle Aufladung 10W. Ultraviolettes Licht. USB Anschluss. Kabel Inklusive.
Lampe Stérilisateur UV Chargeur. Sans Fil. Sortie USB. 1000 mA. Charge Rapide 10W. Ultraviolets. Connexion USB. Cable Inclus.
Oplader UV Sterilisator Lamp. Draadloos. USB Output. 1000 mA. Snellader 10W. Ultraviolet Licht. USB Verbinding. Kabel Inclusief.

11 x 12 x 11 cm 30

Print Code: F(2)



NEW



Trick

6653



Ozone Generator. USB Rechargeable. Cable Included.
Ozon-Generator. USB Wiederaufladbar. Kabel Inklusive.
Générateur d'Ozone. Rechargeable USB. Cable Inclus.
Ozon Generator. USB Oplaadbaar. Kabel Inclusief.

11.5 x 4.3 x 11.5 cm 30

Print Code: F(4)



NEW

CONSULT
LABOR TEMPLATE

Anti Slip

Tabun

2606



Antibacterial

Antibacterial Mousepad. PP/EVA.
Antibakteriell Mauspad. PP/EVA.
Tapis Souris Antibactérien. PP/EVA.
Antibacterieel Muispad. PP/EVA.

22 × 16.8 cm

100 / 10

Print Code: E(1)

842

Walin

6764



Antibacterial

Antibacterial Mousepad. Polyester/ Silicone.
Antibakteriell Mauspad. Polyester/ Silikon.
Tapis Souris Antibactérien. Polyester/ Silicone.
Antibacterieel Muispad. Polyester/ Siliconen.

22 × 18 cm

250 / 50

Print Code: E(1)

NEW

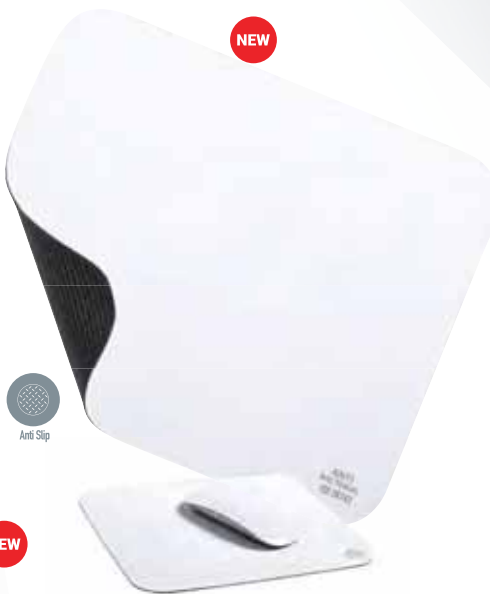

Anti Slip

NEW

DIGITALTREE



Antibacterial

Hislot

6687

Antibacterial Webcam Cover. Adhesive.
Antibakteriell Webcam-Blocker. Haftend.
Bloqueur Webcam Antibactérien. Adhésif.
Antibacterieel Webcam Blocker. Klevend.

3.2 × 1.3 × 0.1 cm

10000 / 5000

Print Code: B(1), W



Adhesive



ULTRA SLIM /
ULTRA DELGADO



antibac-
office

Yest

6884



Antibacterial

Antibacterial Lanyard. Polyester.
Antibakteriell Schlüsselband. Polyester.
Lanyard Antibactérien. Polyester.
Antibacterieel Lanyard. Polyester.

2 × 50 cm

1000 / 100

Print Code: F(1), N(8), R

NEW



ANTI BACTERIAL
ISO 20743



NEW



10" Tablet Compartment



15" Laptop Compartment

CONNECT YOUR POWER BANK



Kraps

6750



UV Sterilizer Backpack. Polyester 600D. Padded. Padded Laptop and Tablet Compartment. Ultraviolet Light. USB Connection. Cable Included.

UV Sterilisor Rucksack. Polyester 600D. Gepolstert. Gepolsterte Laptoptasche und Tablet. Ultraviolett Licht. USB Anschluss. Kabel Inklusiv.

Sac à Dos Stérilisateur UV. Polyester 600D. Rembourré. Pochette Rembourrée pour Portable et Tablet. Ultraviolets. Connexion USB. Câble Inclus.

UV Sterilisor Ruqzak. Polyester 600D. Gewatteerd. Gewatteerd Laptop en Tablet Compartment. Ultraviolet Licht. USB Verbindung. Kabel Inklusief.

30 x 43 x 12 cm

Print Code: I(8)

10



NEW



ULTRAVIOLET LIGHT: DESTROYS MICRO-ORGANISMS AND BACTERIAS FROM SURFACES AND OBJECTS USED ON A DAILY BASIS



SAFETY LOCK



NEW

Boxny

6674



UV Sterilizer Organizer. Polyester 600D/ PU. Ultraviolet Light. RFID Protected. USB Connection. Cable Included.

UV Sterilisor Ordner. Polyester 600D/ PU. Ultraviolett Licht. RFID Schutz. USB Anschluss. Kabel Inklusiv.

Organiseur Stérilisateur UV. Polyester 600D/ PU. Ultraviolets. Protecteur RFID. Connexion USB. Câble Inclus.

UV Sterilisor Organizer. Polyester 600D/ PU. Ultraviolet Licht. RFID Bescherming. USB Verbindung. Kabel Inklusief.

12 x 18.5 x 4 cm

Print Code: G(1), N(8)

50 / 25



Mordux

6704

Antibacterial Backpack. Polyester 600D. Padded. Padded Laptop Compartment.
Antibakteriell Rucksack. Polyester 600D. Gepolstert. Gepolsterte Laptoptasche.
Sac à Dos Antibactérienne. Polyester 600D. Rembourré. Pochette Rembourrée pour Portable.
Antibacterieel Rugzak. Polyester 600D. Gewatteerd. Gewatteerd Laptop Compartment.

30 x 43 x 14 cm

Print Code: G(1), N(8)

20



15" Laptop Compartment



Trolley Strap



Antibacterial

NEW

antibac- BAGS



NEW

Kiarax 6767

Antibacterial Bag. Laminated Non-Woven.
Antibakteriell Tasche. Laminiertes Non-Woven.
Sac Antibactérien. T.N.T. Laminé.
Antibacterieel Tas. Gelamineerd Non-Woven.

38 x 40 x 12 cm

200 / 10

Print Code: F(1)



03

02

01



Antibacterial

ANTIBACTERIAL FABRIC



ANTIBACTERIAL AND WATER
RESISTANT FABRIC
TEJIDO ANTIBACTERIANO
E HIDRÓFUGO

Maxcron 2607

Antibacterial Bag. Polyester.
Antibakteriell Tasche. Polyester.
Sac Antibactérien. Polyester.
Antibacterieel Tas. Polyester.

37 x 41 cm

300 / 10

Print Code: F(1), N(8), R



Antibacterial

Ideal
Sublimation

NEW

Trecel 2608

Antibacterial Drawstring Bag. Polyester.
Antibakteriell Rucksack Tasche. Polyester.
Sac a Dos Antibactérien. Polyester.
Antibacterieel Rugzak Tas. Polyester.

34 x 42 cm

200 / 10

Print Code: F(1), N(8), R



Antibacterial

Ideal
Sublimation

THREE TOUCH SCREEN FINGERTIPS
TRES DEDOS TÁCTILES

NEW



Tenex

6703

Antibacterial Touchscreen Gloves. Acrylic. One Size. Adult.

Antibakteriell Touchpad Handschuhe. Acryl. Einheitsgröße. Erwachsene.

Gant Tactile Antibactérien. Acrylique. Taille Unique. Adulte.

Antibacterieel Touchscreen Handschoenen. Acryl. Een Maat. Volwassen.

■■■■■■ Consult.

📦 200 / 10

🌈 Print Code: N(8)



845

NEW



ANTIBACTERIAL AND WATER
RESISTANT FABRIC
TEJIDO ANTIBACTERIANO
E HIDRÓFUGO

Nical

2599

Antibacterial Neck Warmer. Polyester.

Antibakteriell Schlauchschal. Polyester.

Tour de Cou Antibactérien. Polyester.

Antibacterieel Colsjaal. Polyester.

■■■■■■ 26 x 48 cm

📦 300 / 10

🌈 Print Code: F(1), N(8), R





NEW

1,4 L

Fandex 6708



Antibacterial Lunch Box. PP. 2 Compartments 700 ml.
 Antibakteriell Lunch Box. PP. 2 Abteilungen 700 ml.
 Gamelle Antibactérienne. PP. 2 Compartiments 700 ml.
 Antibacterieel Lunch Box. PP. 2 Compartimenten 700 ml.

18.7 × 12.1 × 10.6 cm

30

Print Code: E(1), W



846



NEW

600 ml

Gliter 6768

Antibacterial Bottle. PE. 600 ml.
 Antibakteriell Trinkflasche. PE. 600 ml.
 Bidon Antibactérien. PE. 600 ml.
 Antibacterieel Fles. PE. 600 ml.

Ø 6.5 × 21.2 cm

50

Print Code: F(1)



NEW

500 ml



Copil 6769

Antibacterial Bottle. PE. 500 ml.
 Antibakteriell Trinkflasche. PE. 500 ml.
 Bidon Antibactérien. PE. 500 ml.
 Antibacterieel Fles. PE. 500 ml.

Ø 6.5 × 19.5 cm

100 / 10

Print Code: F(1)





antibac-
take away

NEW

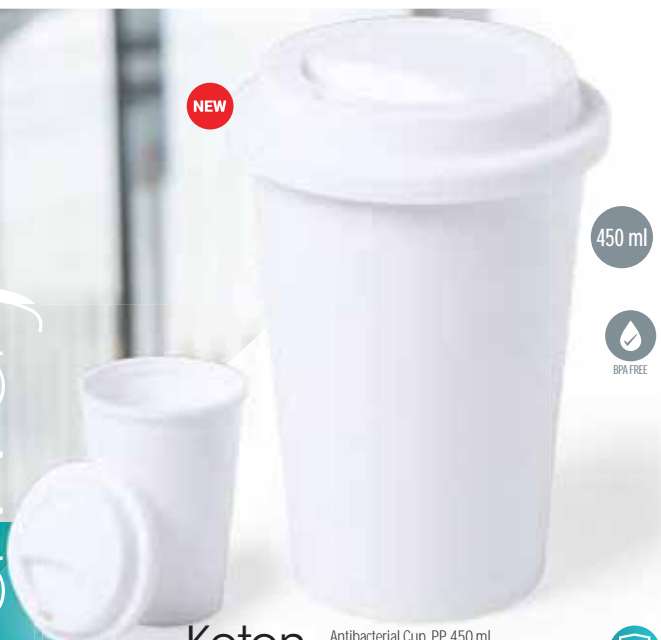

450 ml



BPA FREE

Koton
6707

Antibacterial Cup. PP. 450 ml.
Antibakteriell Trinkbecher. PP. 450 ml.
Verre Antibactérien. PP. 450 ml.
Antibacterieel Beker. PP. 450 ml.



Antibacterial

Ø 9.3 × 13.4 cm
Print Code: F(1)

50



NEW

350 ml



BPA FREE



Plantex
6706

Antibacterial Mug. PP. 350 ml.
Antibakteriell Tasse. PP. 350 ml.
Tasse Antibactérienne. PP. 350 ml.
Antibacterieel Mok. PP. 350 ml.

Ø 7.9 × 8.8 cm
Print Code: E(4)

100 / 50



Antibacterial

NEW



BPA FREE

Ladix
6682

Antibacterial Straw. Silicone. Reusable.
Antibakteriell Strohhalm. Silikon. Wiederverwendbar.
Paille Antibactérienne. Silicone. Réutilisable.
Antibacterieel Rietje. Siliconen. Herbruikbaar.

Ø 5.4 × 2 cm
Print Code: B(4), W

500 / 100



Antibacterial

SAFE MEASURES IN SHARED AREAS
GESTOS SEGUROS EN SUPERFICIES COMPARTIDAS



NEW

Verne



6694

Antibacterial Stylus Touch Ball Pen.
Antibakteriell Kugelschreiber Pointer.
Styllet Bille Antibactérien.
Antibacterieel Touch-Screen Balpen.

Ø 0.9 × 12.5 cm

1000 / 50

Print Code: B(4)

NEW



Topen



6693

Antibacterial Stylus Touch Ball Pen. Jumbo Refill.
Antibakteriell Kugelschreiber Pointer. Jumbo Ersatzmine.
Styllet Bille Antibactérien. Recharge Jumbo.
Antibacterieel Touch-Screen Balpen. Jumbo Refill.

Ø 1 × 13.9 cm

1000 / 50

Print Code: B(4)

848

NEW

NEW

NEW



Ramix

6692

Antibacterial Pen.
Antibakteriell Kugelschreiber.
Stylo Antibactérien.
Antibacterieel Pen.

Ø 1.1 × 14 cm

1000 / 50

Print Code: B(4)



Flom

6640

Antibacterial Pen.
Antibakteriell Kugelschreiber.
Stylo Antibactérien.
Antibacterieel Pen.

Ø 1.3 × 14 cm

1000 / 50

Print Code: B(4)



02

03

04

19

05

Licter



6659

Antibacterial Pen.
Antibakteriell Kugelschreiber.
Stylo Antibactérien.
Antibacterieel Pen.

Ø 1 × 13.8 cm

1000 / 50

Print Code: B(4)

01

SAFE MEASURES IN SHARED AREAS
GESTOS SEGUROS EN
SUPERFICIES COMPARTIDAS

LIQUID NOT INCLUDED/
REFILLABLE

LIQUIDO NO INCLUIDO/
RELLENABLE



NEW

3 ml



Yak
6656



Antibacterial

Multifunction Antibacterial Pen. 3 ml. Refillable. Liquid Not Included.
Multifunktion Antibakteriell Kugelschreiber. 3 ml. Wiederaufladbar. Flüssigkeit Nicht im Lieferumfang.
Styler Antibacterien Multifonction. 3 ml. Rechargeable. Liquide Non Inclus.
Multifunctioneel Antibacterieel Balpen. 3 ml. Navulbaar. Vloeistof Niet Inclusief.



Ø 1.4 x 15.7 cm

1000 / 50

Print Code: B(4)

SAFE
measures

849



Antibacterial



NEW

3 ml



Fruk
6723

Multifunction Antibacterial Pen. 3 ml. Refillable. Liquid Not Included.

Multifunktion Antibakteriell Kugelschreiber. 3 ml. Wiederaufladbar. Flüssigkeit Nicht im Lieferumfang.

Styler Antibacterien Multifonction. 3 ml. Rechargeable. Liquide Non Inclus.

Multifunctioneel Antibacterieel Balpen. 3 ml. Navulbaar. Vloeistof Niet Inclusief.

Ø 1.4 x 11.3 cm

1000 / 50

Print Code: B(4)

NEW

Doret
6721

Antibacterial Pen. Thermometer Function.
Antibakteriell Kugelschreiber. Thermometer Funktion.
Stylo Antibacterien. Fonction Thermomètre.
Antibacterieel Pen. Thermometer Functie.

Ø 1.1 x 14.5 cm

1000 / 50

Print Code: B(4)



Body
Temperature



Antibacterial



Riply

6765



Antibacterial Set. PP Plastic. 4 Pieces. Pen. Mechanical Pencil: 0.5 mm Leads Included.
Antibakteriell Set. Plastik PP. 4 Stück. Kugelschreiber. Bleistift: Minen 0,5 mm Inklusiv.
Set Antibactérien. PP Plastique. 4 Pièces. Stylo. Portemines: Mines 0,5 mm Inclus.
Antibacterieel Set. PP Plastic. 4 Stuks. Pen. Vulpotlood: 0,5 mm Stijfjes Inclusief.
Print Code: B(4), W

3.4 x 16.5 x 1.5 cm

300 / 50

NEW



850



NEW

Sukon

6766



Antibacterial Pencil. Wood.
Antibakteriell Bleistift. Holz.
Crayon Antibactérien. Bois.
Antibacterieel Potlood. Hout.

0.7 x 18.6 cm

2000 / 100

Print Code: B(4), L1



NEW



Nitria

6679



Antibacterial Ruler.
Antibakteriell Lineal.
Règle Antibactérienne.
Antibacterieel Lijnaal.

31.5 x 4 x 0.2 cm

500 / 100

Print Code: D(1), W





NEW



03



Antibacterial

Kioto
6763



Antibacterial Notepad. PU. Hard Cover. 100 Sheets.
Antibakteriell Notizblock. PU. Hardcover-Abdeckung. 100 Seiten.
Bloc Notes Antibactérien. Similicuir. Couverture Rigide. 100 Feuilles.
Antibacterieel Notitieblokje. PU. Harde Kaft. 100 Blaadjes.

14.7 × 21 × 1.5 cm 50 / 25
Print Code: E(4)

NEW



80 Sheets
Plain

NEW



80 Sheets
Plain



Antibacterial



PEFC

NEW



80 Sheets
Plain



Antibacterial

Tungol
2593

Antibacterial Notepad. Hard Cover. 80 Sheets.
Antibakteriell Notizblock. Hardcover-Abdeckung. 80 Seiten.
Bloc Notes Antibactérien. Couverture Rigide. 80 Feuilles.
Antibacterieel Notitieblokje. Harde Kaft. 80 Blaadjes.

15.5 × 21 × 1.6 cm 30
Print Code: E(4)



Neltec
2592



Antibacterial

Antibacterial Notebook. 80 Sheets.
Antibakteriell Notizbuch. 80 Seiten.
Cahier Antibactérien. 80 Feuilles.
Antibacterieel Notitieboek. 80 Blaadjes.

14.9 × 20.6 × 0.8 cm 30
Print Code: E(4)



Polax
2591

Antibacterial Notebook. 80 Sheets.
Antibakteriell Notizbuch. 80 Seiten.
Cahier Antibactérien. 80 Feuilles.
Antibacterieel Notitieboek. 80 Blaadjes.

15.5 × 21 × 1.6 cm 30
Print Code: E(4)



NEW



Kumol

6686



Antibacterial Holder. Adhesive.
Antibakteriell Halter. Haftend.
Support Antibactérien. Adhésif.
Antibacterieel Houder. Klevend.

Ø 4.4 x 2.9 cm

1000 / 100

Print Code: B(4), W



852

NEW



Sustre

6685



Antibacterial Holder. Adhesive. 4 Functions.
Antibakteriell Halter. Haftend. 4 Funktionen.
Support Antibactérien. Adhésif. 4 Fonctions.
Antibacterieel Houder. Klevend. 4 Functies.

Ø 3.3 x 0.6 cm

2000 / 1000

Print Code: B(4), W



Portis

6684



Antibacterial Keyring Coin.
Antibakteriell Schlüsselanhänger EK-Chip.
Porte-Clés Monnaie Antibactérien.
Antibacterieel Munt-Sleutelhanger.

4.1 x 5.2 x 1.1 cm

1000 / 100

Print Code: C(4), W

NEW



NEW



IDEA!



Riken

6662



Antibacterial Keyring Anticontact.
Antibakteriell Schlüsselanhänger Anticontact.
Porte-Clés Antibactérien Anticontact.
Antibacterieel Sleutelhanger Anticontact.

3 x 10 x 0.5 cm

1000 / 200

Print Code: C(4)



Hempix 6680

Antibacterial Pillbox. 3 Compartments.
Antibakteriell Pillendose. 3 Abteilungen.
Pilulier Antibactérien. 3 Compartiments.
Antibacterieel Pillendoosje. 3 Compartimenten.

6 x 1.3 x 3.9 cm  1000 / 100
Print Code: C(4), W



Wabik 6681

15 BIODEGRADABLE
BAGS INCLUDED

Antibacterial Waste Bag Dispenser. 15 Biodegradable Bags Included.
Antibakteriell Abfall Bag Spender. 15 Kompostierbarer Beutel Inklusive.
Distributeur de Sacs Antibactérien. 15 Sacs Biodégradable Inclusif.
Antibacterieel Zakjes Dispenser. 15 Biologisch Afbreekbare Tassen Inclusief.

Ø 4 x 10 cm  200 / 20
Print Code: D(4)



Tesam 6678

Antibacterial Yoyo.
Antibakteriell Yoyo.
Yoyo Antibactérien.
Antibacterieel Jojo.

Ø 5 x 1.5 cm  500 / 100
Print Code: C(4), W



Zazu 6683

Antibacterial Opener.
Antibakteriell Flaschenöffner.
Ouvre Bouteille Antibactérien.
Antibacterieel Opener.

4 x 9 x 1 cm  600 / 200
Print Code: D(4), W



PERSONAL CARE AND PHARMACY



ANTI BACTERIAL
100 22186



NEW



Hempix

6680

Antibacterial Pillbox. 3 Compartments.
Antibakteriell Pillendose. 3 Abteilungen.
Pilulier Antibactérien. 3 Compartiments.
Antibacterieel Pillendoosje. 3 Compartimenten.

6 x 1.3 x 3.9 cm 1000 / 100
Print Code: C(4), W





Lencix
6362



Zarqa
6783





BAMBOO FIBRE



13



04

Fledar
6447

Lip Balm. Bamboo Fibre/ ABS. SPF15. Vanille Aroma.
Lippenbalsam. Bambustaser/ ABS. SPF15. Vanille Duft.
Baume Lèvres. Fibre Bamboo/ ABS. SPF15. Arôme Vanille.
Lippenbalsem. Bamboe Fibre/ ABS. SPF15. Vanille Aroma.

Ø 1.9 x 7 cm

500 / 25

Print Code: C(1)



Vanilla



03

04

05

01

11

Nirox

5053

Lip Balm. SPF15. Vanille Aroma.
Lippenbalsam. SPF15. Vanille Duft.
Baume Lèvres. SPF15. Arôme Vanille.
Lippenbalsem. SPF15. Vanille Aroma.

Ø 1.9 x 7 cm 500 / 25

Print Code: C(1)



Vanilla

19



01



03

19



05

Bolic

5052

Lip Balm. SPF15. Vanille Aroma.
Lippenbalsam. SPF15. Vanille Duft.
Baume Lèvres. SPF15. Arôme Vanille.
Lippenbalsem. SPF15. Vanille Aroma.

Ø 3.8 cm 500 / 50

Print Code: C(1)



Vanilla

Take care
Of your LIPS
DERMATOLOGICALLY
TESTED

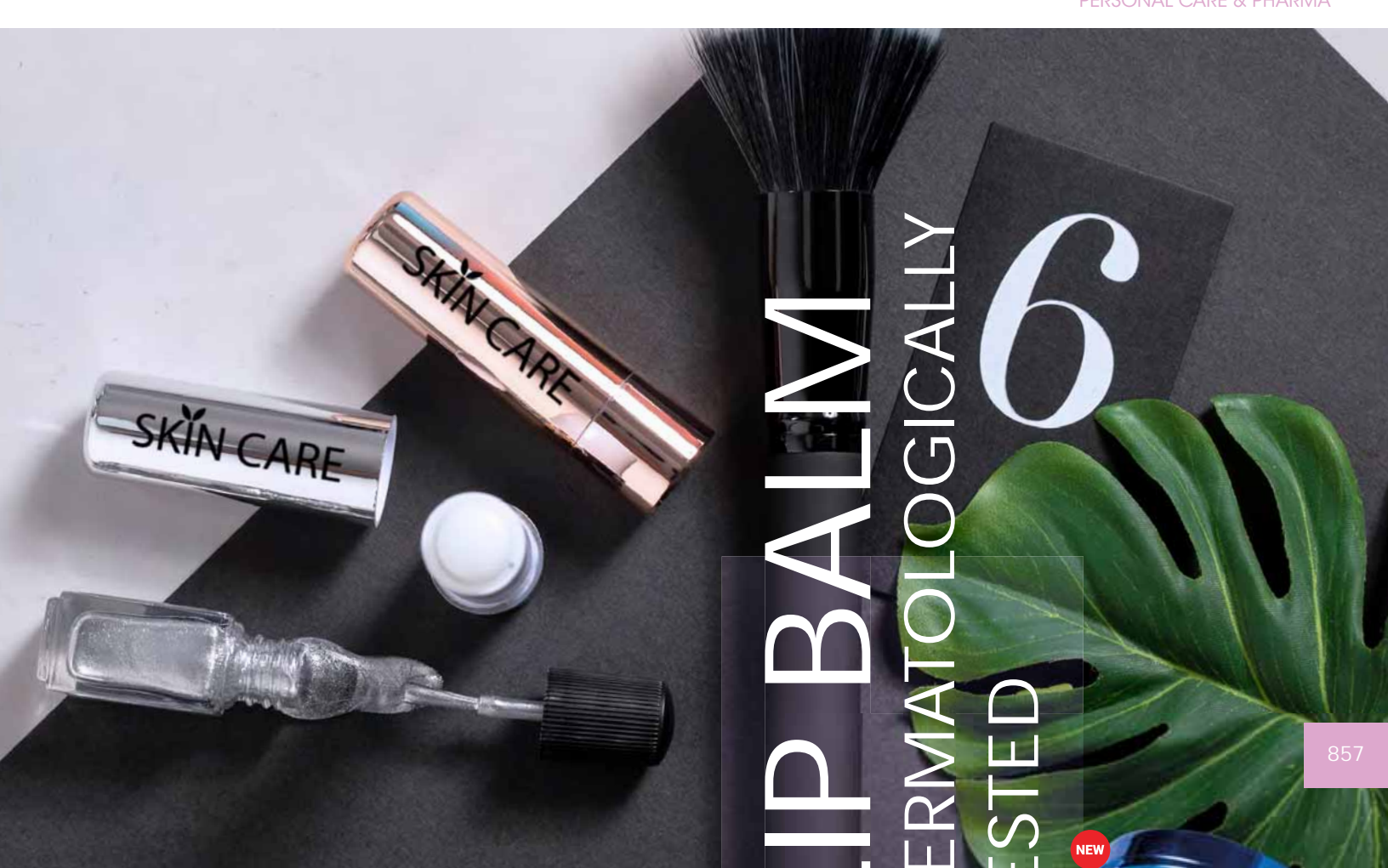

857

LIP BALM
DERMATOLOGICALLY
TESTED

NEW



19 03 23 22 09

UV FINISH

Tarian
6324



Lip Balm. SPF15. Vanilla Aroma.
Lippenbalsam. SPF15. Vanille Duft.
Baume Lèvres. SPF15. Arôme Vanille.
Lippenbalsem. SPF15. Vanille Aroma.

1.9 x 7 cm 500 / 25
Print Code: C(1)



Epson
5942



09
23



UV FINISH 22

Lip Balm. SPF15. Vanilla Aroma.
Lippenbalsam. SPF15. Vanille Duft.
Baume Lèvres. SPF15. Arôme Vanille.
Lippenbalsem. SPF15. Vanille Aroma.

3.8 cm 500 / 50
Print Code: C(1)



19

UV FINISH - MIRROR-...
INCLUDED

Zendal
6784



Lip Balm. SPF15. Vanilla Aroma. Mirror Included.
Lippenbalsam. SPF15. Vanille Duft. Spiegel Inklusiv.
Baume Lèvres. SPF15. Arôme Vanille. Miroir Inclus.
Lippenbalsem. SPF15. Vanille Aroma. Spiegel Inclusief.

4.8 x 1.6 cm 500 / 100
Print Code: C(1), V



09
22
23



Hyron 3825

Toothbrush. Foldable.
Zahnbürste. Faltbar.
Brosse à Dents. Pliable.
Tandenborstel. Opvouwbaar.

1.5 × 17.5 × 2.3 cm 500 / 50
Print Code: C(1), W



Veltor 5272

Toothbrush. Foldable.
Zahnbürste. Faltbar.
Brosse à Dents. Pliable.
Tandenborstel. Opvouwbaar.

1.8 × 18 × 2.6 cm 500 / 50
Print Code: C(1)



Siapax 5275

Timer. 2 Minutes.
Eieruhr. 2 Minuten.
Minuteur. 2 Minutes.
Eierwekker. 2 Minuten.

1.8 × 6 × 2.5 cm 1000 / 100
Print Code: C(4)



KIDS



Keko 3824

Toothbrush.
Zahnbürste.
Brosse à Dents.
Tandenborstel.

3 × 14.6 × 1 cm 500 / 50
Print Code: F(1), L1



Fident 5032

Set. Toothbrush and Sand Timer. 2 Minutes.
Set. Zahnbürste und Sanduhr. 2 Minuten.
Set. Brosse à Dents et Sablier. 2 Minutes.
Set. Tandenborstel en zandloper. 2 Minuten.

8 × 20 × 2 cm 200 / 10
Print Code: F(1), L1



eco-Friendly Toothbrush



Lencix
6362

Toothbrush. Bamboo.
Zahnbürste. Bambus.
Brosse à Dents. Bambou.
Tandenborstel. Bamboe.

1.3 × 17.5 × 1.6 cm
Print Code: C(4), L1

500 / 50

859

**WHEAT
STRAW**



Cleidol
6278

Toothbrush. Wheat Straw/ PP.
Zahnbürste. Weizenstroh/ PP.
Brosse à Dents. Paille de Blé/ PP.
Tandenborstel. Tarwestro/ PP.

1.2 × 18 × 1.6 cm
Print Code: C(4)

500 / 50



BAMBOO

Korol
6601

Toothbrush. Bamboo.
Zahnbürste. Bambus.
Brosse à Dents. Bambou.
Tandenborstel. Bamboe.

3.9 × 20.3 cm
Print Code: C(4), L1

200 / 50





08



02

Asleep 9800

Travel Eye Mask. Microfibre.
Reise Augenmaske. Mikrofaser.
Masque Voyage. Microfibre.
Slaapmasker. Microfiber.

18.5 × 9 cm 1000 / 100

Print Code: D(1), N(8)

860

take care
of your
EYES



03



01

19

04

05

07

11



02



03



11



19

Milora 5170

Cool Eye Mask. Nylon.
Kühl Augenmaske. Nylon.
Masque Froid. Nylon.
Verkoelend Oogmasker. Nylon.

21.5 × 6 cm 200 / 10

Print Code: D(1), N(8)



Calm 9799

Cool Eye Mask. PVC.
Kühl Augenmaske. PVC.
Masque Froid. PVC.
Verkoelend Oogmasker. PVC.

21 × 5.5 cm 200 / 10

Print Code: D(1)

Adorix 4687

Eye Protector. Silicone.
Augenschutz. Silikon.
Protecteur Yeux. Silicon.
Oogbeschermer. Siliconen.

15.1 × 3 × 4.6 cm 200 / 25

Print Code: D(1)



11

03



Hot



04

05

01

19

Kison
4970

Heat Pack. Reusable.
Taschenwärmer. Wiederverwendbar.
Patch Chaleur. Réutilisable.
Warmte Pakket. Herbruikbaar.

📏 Ø 10 × 1 cm 📦 150 / 50

🎨 Print Code: C(1)



Hot

Zaroa
6783

Heat Pack. Reusable.
Taschenwärmer. Wiederverwendbar.
Patch Chaleur. Réutilisable.
Warmte Pakket. Herbruikbaar.

📏 8 × 10 × 1 cm 📦 150 / 50

🎨 Print Code: C(1)



400 ml



Liman
4302

19



Cold



Hot

Thermal Bag. 400 ml. Cold and Warm. Reusable.
Thermische Tasche. 400 ml. Kalt und Warm. Wiederverwendbar.
Sac Thermique. 400 ml. Chaud et Froid. Réutilisable.
Thermische Tas. 400 ml. Koud en Warm. Wiederverwendbar.

📏 Ø 14 × 3 cm 📦 200 / 50

🎨 Print Code: E(1)



03

05

02



19



Cold



Hot



05

04

11

03

01



03



Cold



Hot



19

01

04

Pikur
4971

Hot-Cold Pack. Cold and Warm. Reusable.
Wärme-Kälte Pflaster. Kalt und Warm. Wiederverwendbar.
Patch Chaud-Froid. Chaud et Froid. Réutilisable.
Thermisch Pakket. Koud en Warm. Herbruikbaar.

📏 6.5 × 13.5 × 1.5 cm 📦 150 / 50

🎨 Print Code: Consultar

Debbly
5639

Hot-Cold Pack. Cold and Warm. Reusable.
Wärme-Kälte Pflaster. Kalt und Warm. Wiederverwendbar.
Patch Chaud-Froid. Chaud et Froid. Réutilisable.
Thermisch Pakket. Koud en Warm. Herbruikbaar.

📏 11 × 20 × 1.3 cm 📦 100 / 50

🎨 Print Code: C(1)

861

5
5 minutes



Samin
5278

Timer. 5 Minutes.
Eieruhr. 5 Minuten.
Minuteur. 5 Minutes.
Eierwecker. 5 Minuten.

6 × 12 × 3.1 cm 300 / 50
Print Code: C(1)

Cleaning & Water Saving

862



19

County
5642

Shoe Polisher.
Schuhputzer.
Nettoyeur de Chaussures.
Shoenpoets.

Ø 6 × 1.8 cm 500 / 50
Print Code: C(4), W



03

02

01

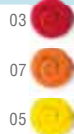

03

07

05

19

01



04

02



11

CONVERTS INTO TOWEL
CONVERTIBLE EN TOALLA

20 × 20 cm
260 g/m²



03

20 × 20 cm
310 g/m²



11

05

04

19

CONVERTS INTO TOWEL
CONVERTIBLE EN TOALLA



Wizzel
5391

Shoehorn Polisher.
Schuhanzieher Putzer.
Chausse-Pied.
Shoenlepel met Shoenpoets.

4.7 × 22 × 2.2 cm 200 / 50
Print Code: C(4)



01

Nalex
4829

Absorbent Towel. Microfibre 260 g/m². Folded 5.5 x 14.5 x 3 cm.
Saugfähiges Handtuch. Mikrofaser 260 g/m². Faltung 5,5 x 14,5 x 3 cm.
Serviette Absorbante. Microfibre 260 g/m². Pliée 5,5 x 14,5 x 3 cm.
Absorbierende Handdoek. Microfibre 260 g/m². Gevouwen 5,5 x 14,5 x 3 cm.

20 × 20 cm 500 / 50
Print Code: C(4)

Rustuff
4513

Absorbent Towel. Microfibre 310 g/m². Folded 6 x 8 x 6 cm.
Saugfähiges Handtuch. Mikrofaser 310 g/m². Faltung 6 x 8 x 6 cm.
Serviette Absorbante. Microfibre 310 g/m². Pliée 6 x 8 x 6 cm.
Absorbierende Handdoek. Microfibre 310 g/m². Gevouwen 6 x 8 x 6 cm.

20 × 20 cm 200 / 50
Print Code: D(1)



Panda

3625

Ears Cleaner. 1 Led. 3 Accessories. Button Batteries Included.
 Ohrenreiniger. 1 Led. 3 Teile. Knopfzellen Inklusive.
 Lave Oreille. 1 Led. 3 Accessoires. Piles Bouton Inclus.
 Oorschoonmaker. 1 Led. 3 Accessoires. Knopcelbatterij Inclusief.

1.8 x 14 x 1.1 cm 500 / 100

Print Code: D(4), W



Redcross

9496

Emergency Kit. Polyester 600D. 17 Accessories.
 Erste Hilfe Set. Polyester 600D. 17 Teile.
 Kit Urgence. Polyester 600D. 17 Accessoires.
 Ehbo-Set. Polyester 600D. 17 Accessoires.

18 x 12 x 6 cm 100 / 20

Print Code: E(1)

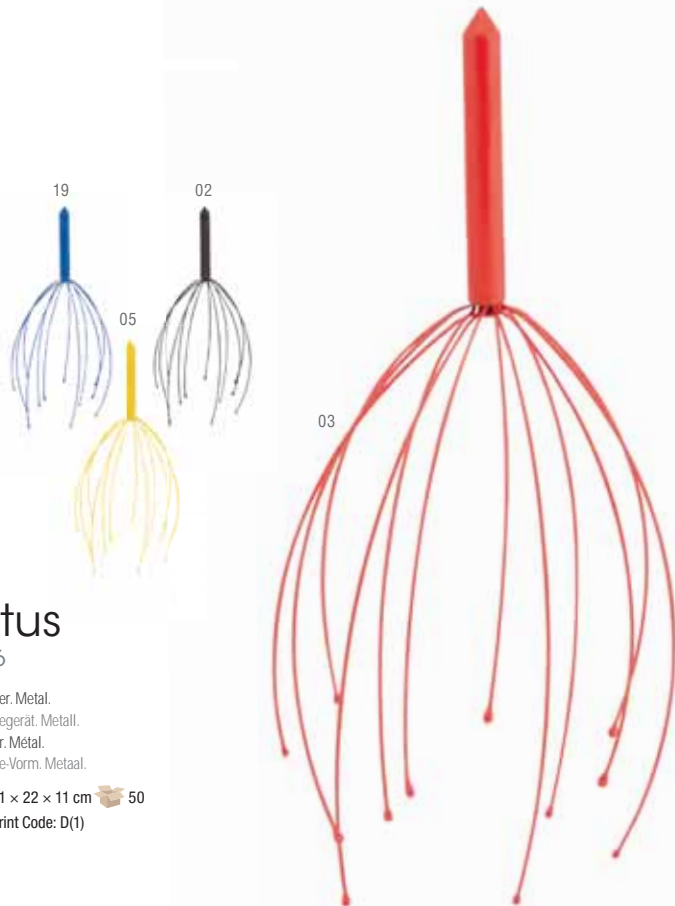

Citrus

3996

Massager. Metal.
 Massagegerät. Metall.
 Masseur. Métal.
 Massage-Vorm. Metaal.

11 x 22 x 11 cm 50

Print Code: D(1)



Telfin

5762

Mosquito Repellent Bracelet. Button Battery Included.
 Anti-Mücken-Armband. Knopfzelle Inklusive.
 Bracelet Antimosques. Pile Bouton Inclus.
 Mug Afstotende Armband. Knopcel Batterij Inclusief.

24.4 x 2.8 x 1.3 cm 400 / 50

Print Code: D(1)





Siluet Tape Measure. Adjustable Tape 157 cm.
 Korpermaßband. Selbsteinstellende Gürtel 157 cm.
 9543 Metre. Ruban Auto-Ajustable 157 cm.
 Lichaam-Meellint. Aanpasbaar Meetlint 157 cm.

8.5 x 5.5 x 2 cm 240 / 24
 Print Code: C(4)

Healthy Lifestyle



864



Emir
 3787

Body Tape Measure. BMI Scales. Tape 150 cm.
 BMI Maßband Messer. BMI Indikatoren. Gürtel 150 cm.
 Mesureur IMC. Indicateur IMC. Ruban 150 cm.
 Lichaam Meetlint. BMI Schaal. Meetlint 150 cm.

5.5 x 6.3 x 2 cm 400 / 20
 Print Code: C(4)



Lizzos
 5265

Measurer.
 Messbecher.
 Mesureur.
 Vetmeter.

9.8 x 16.3 x 0.9 cm 500 / 50
 Print Code: C(4)



Thermometer

03

19

01

Kelvin

3696

Digital Thermometer. Button Battery Included.
 Digitales Thermometer. Knopfzelle Inklusiv.
 Thermomètre Digital. Pile Bouton Inclus.
 Digitale Thermometer. Knoopcel Batterij Inclusief.

2.5 x 14.4 x 1 cm 400 / 50

Print Code: D(1)

865

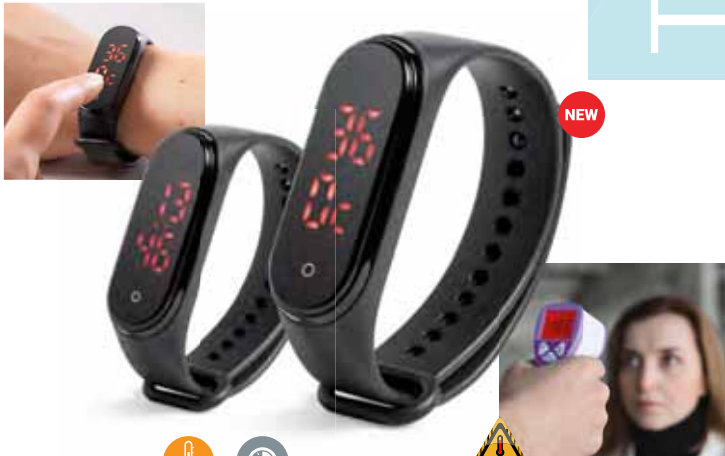

NEW



Body Temperature



Time



HIGH TEMPERATURE ALERT
 AVISO TEMPERATURA ALTA

Leroux

6652

Thermometer Watch. TPU Strap. 0.96" LED Screen. USB Rechargeable. Cable Included.
 Thermometer Uhr. TPU Armband. 0.96" LED Screen. USB Wiederaufladbar. Kabel Inklusiv.
 Montre Thermomètre. Bracelet TPU. Écran LED 0.96". Rechargeable USB. Câble Inclus.
 Thermometer Horloge. TPU Band. 0.96" LED Scherm. USB Opladbaar. Kabel Inclusief.

25 x 2.1 x 1 cm

200 / 50

Print Code: I(1), L2



Doret

6721

Antibacterial Pen. Thermometer Function.
 Antibakteriell Kugelschreiber. Thermometer Funktion.
 Stylo Antibactérien. Fonction Thermomètre.
 Antibacterieel Pen. Thermometer Functie.

1.1 x 14.5 cm

1000 / 50

Print Code: B(4)



Body Temperature

NEW



Antibacterial



15 ml



Bradul
6571

Hydroalcoholic Gel. 15 ml. Hand cleansing gel.
Hydroalkoholisches Gel. 15 ml. Hautreinigungslösung.
Gel Hydroalcoholic. 15 ml. Solution pour le lavage des mains.
Hydroalcoholic Gel. 15 ml. Huidreinigende oplossing.

3 x 6.3 x 1.8 cm 500 / 250
Print Code: C(4), W



**MORE
HYDROALCOHOLIC
GEL
PG 888**

Hydroalcoholic GEL



866

SPRAY

10 ml



01 17 04 03 02

Bustan
6325



Hydroalcoholic Gel. 10 ml. Hand cleansing gel.
Hydroalkoholisches Gel. 10 ml. Hautreinigungslösung.
Gel Hydroalcoholic. 10 ml. Solution pour le lavage des mains.
Hydroalcoholic Gel. 10 ml. Huidreinigende oplossing.

Ø 1.6 x 14.2 cm 500 / 50
Print Code: B(4)

NEW



19 04 05 07 02 01

Trikel
6718



Hydroalcoholic Gel. 30 ml. Hand cleansing gel.
Hydroalkoholisches Gel. 30 ml. Hautreinigungslösung.
Gel Hydroalcoholic. 30 ml. Solution pour le lavage des mains.
Hydroalcoholic Gel. 30 ml. Huidreinigende oplossing.

4 x 9.8 x 2.5 cm 200 / 50
Print Code: C(4)



03

30 ml



NEW

30 ml



19



02 01 04 05 03 07

Vixel
6720



Hydroalcoholic Gel. 30 ml. Hand cleansing gel.
Hydroalkoholisches Gel. 30 ml. Hautreinigungslösung.
Gel Hydroalcoholic. 30 ml. Solution pour le lavage des mains.
Hydroalcoholic Gel. 30 ml. Huidreinigende oplossing.

3.9 x 8.3 x 2.3 cm 200 / 50
Print Code: C(4)

NEW



10 TOALLITAS

ULTREX

Ledis

6717

Sanitizer Wipes. 10 Pieces.
Hygienisch Feuchttücher. 10 Stück.
Lingettes Hygiéniques. 10 Pièces.
Hygienisch Poetsdoekjes. 10 Stuks.



15 x 8 x 1.5 cm

200 / 100

Print Code: C(1)



Masup

2571

Sanitizer Wipe. Wipe 100% Compostable.
Hygienisch Feuchttüch. Feuchttüch 100% Kompostierbar.
Lingette Hygiénique. Lingette 100% Compostable.
Hygienisch Poetsdoekj. Poetsdoekj 100% Composteerbaar.



6.7 x 8 cm

3000 / 100

Print Code: A(1)



100 TISSUES
100 PAÑUELOS

867



19

02

01

Winton

5509

Tissues. 100 Tissues. 3 Layers.
Taschentuch. 100 Taschentücher. 3 Schichten.
Mouchoir. 100 Mouchoirs. 3 Couches.
Zakdoekjes. 100 Tissues. 3 Lagen.

13 x 6 x 9 cm 100 / 10

Print Code: D(1)

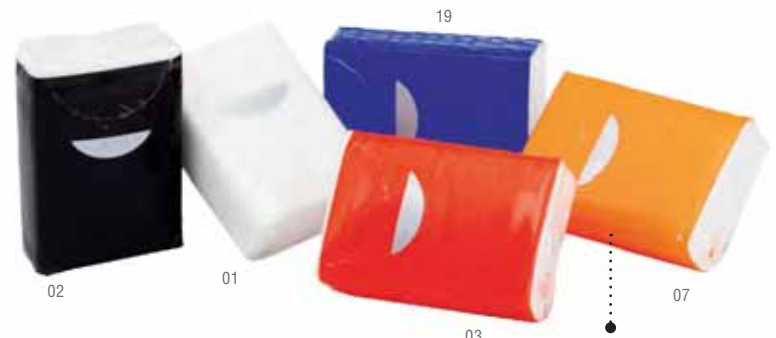

02

01

19

03

07

Custom

3173

Tissues. 10 Tissues. 3 Layers.
Taschentuch. 10 Taschentücher. 3 Schichten.
Mouchoir. 10 Mouchoirs. 3 Couches.
Zakdoekjes. 10 Tissues. 3 Lagen.

5.3 x 7.5 x 2.5 cm 300 / 10

Print Code: Consulzar

10 TISSUES
10 PAÑUELOS

Lucam

5034

Pillbox. 7 Compartments.
Pillendose. 7 Abteilungen.
Pilulier. 7 Compartiments.
Pillendoosje. 7 Compartimenten.

15 x 1.6 x 3.3 cm 500 / 50

Print Code: D(1)

01

03

Edmor

6067

Pillbox. 4 Compartments.
Pillendose. 4 Abteilungen.
Pilulier. 4 Compartiments.
Pillendoosje. 4 Compartimenten.

6 x 1.8 x 6 cm 1000 / 100

Print Code: C(4), W

868

Pillbox



Ziprik

5150



19

Pillbox. 2 Compartments. Button Battery Included.
Pillendose. 2 Abteilungen. Knopfzelle Inklusiv.
Pilulier. 2 Compartiments. Pile Bouton Inclus.
Pillendoosje. 2 Compartimenten. Knoopcel Batterij Inclusief.

9.1 x 2 x 4.8 cm 200 / 50

Print Code: C(4)



01

Elyan

4279

Pillbox. 4 Compartments.
Pillendose. 4 Abteilungen.
Pilulier. 4 Compartiments.
Pillendoosje. 4 Compartimenten.

7.8 x 1.6 x 6.3 cm 400 / 50

Print Code: C(4), W

02

19

03



Astrid

3284

Pillbox. 4 Compartments.
Pillendose. 4 Abteilungen.
Pilulier. 4 Compartiments.
Pillendoosje. 4 Compartimenten.

Ø 7 x 2.1 cm 500 / 50

Print Code: C(4), W

19

03



03



Pillbox



Hempix
6680

Antibacterial Pillbox. 3 Compartments.
Antibakteriell Pillendose. 3 Abteilungen.
Pilulier Antibactérien. 3 Compartiments.
Antibacterieel Pillendoosje. 3 Compartimenten.

6 × 1.3 × 3.9 cm 1000 / 100
Print Code: C(4), W



BAMBOO FIBRE



Varsum
6382

Pillbox. Bamboo Fibre/ PP. 3 Compartments.
Pillendose. Bambusfaser/ PP. 3 Abteilungen.
Pilulier. Fibre Bambou/ PP. 3 Compartiments.
Pillendoosje. Bamboe Fibre/ PP. 3 Compartimenten.

6 × 1.3 × 3.9 cm 1000 / 100
Print Code: C(4), W

01

03

19



TRANS



Betur
6383

Pillbox. Bamboo Fibre/ PP. 3 Compartments.
Pillendose. Bambusfaser/ PP. 3 Abteilungen.
Pilulier. Fibre Bambou/ PP. 3 Compartiments.
Pillendoosje. Bamboe Fibre/ PP. 3 Compartimenten.

Ø 7.5 × 1.7 cm 500 / 100
Print Code: C(4), W

Trizone
3283

Pillbox. 3 Compartments.
Pillendose. 3 Abteilungen.
Pilulier. 3 Compartiments.
Pillendoosje. 3 Compartimenten.

6 × 1.3 × 3.9 cm 1000 / 100
Print Code: C(4), W



BAMBOO FIBRE



Alumpill

3168

Keyring Pillbox. Aluminium. 1 Compartment.
Schlüsselanhänger Pillendose. Aluminium. 1 Abteilung.
Porte-Clés Pilulier. Aluminium. 1 Compartiment.
Sleutelhanger Pillendoosje. Aluminium. 1 Compartment.

Ø 1.4 × 5.2 cm 500 / 50

Print Code: D(1), L1



Aspi

8781

Pillbox. 2 Compartments.
Pillendose. 2 Abteilungen.
Pilulier. 2 Compartments.
Pillendoosje. 2 Compartimenten.

9.5 × 1.6 × 4.8 cm 400 / 100

Print Code: C(4), W



Notil

4419

Pillbox. 3 Compartments.
Pillendose. 3 Abteilungen.
Pilulier. 3 Compartments.
Pillendoosje. 3 Compartimenten.

Ø 4.1 × 6.4 cm 200 / 50

Print Code: C(4)

870



Berty

6006

Foldable Cup. 220 ml.
Faltbarer Trinkbecher. 220 ml.
Verre Pliable. 220 ml.
Opvouwbare Beker. 220 ml.

Ø 6.8 × 9 cm 100

Print Code: D(4), W



220 ml

PILL COMPARTMENT

tritan®
Tritan® material



BPA FREE



730 ml

Gazuk

5884

Pillbox Bottle. Tritan. 730 ml. 7 Compartments.
Trinkflasche Pillendose. Tritan. 730 ml. 7 Abteilungen.
Bidon Pilulier. Tritan. 730 ml. 7 Compartiments.
Fles Pillendoosje. Tritan. 730 ml. 7 Compartimenten.

Ø 7.5 × 23.3 cm 50

Print Code: F(1)





Heat Pack



Hot

Zaroa
6783

Heat Pack. Reusable.
Taschenwärmer. Wiederverwendbar.
Patch Chaleur. Réutilisable.
Warmte Pakket. Herbruikbaar.

8 × 10 × 1 cm
Print Code: C(1)

150 / 50

Antistress



Ventry
5699

Antistress. PU.
Antistress. PU.
Antistress. PU.
Antistress. PU.

7.1 × 7 × 5 cm 400 / 10
Print Code: E(1), L1



Silene
3658

Antistress Keyring. PU.
Antistress Schlüsselanhänger. PU.
Porte-Clés Antistress. PU.
Antistress Sleutelhanger. PU.

3.6 × 3.6 × 2.7 cm 1000 / 20
Print Code: E(1), L1



Gotin
5257

Antistress. PU.
Antistress. PU.
Antistress. PU.
Antistress. PU.

∅ 6 × 8 cm 400 / 10
Print Code: E(1), L1



Doctor 9735

Torch. 1 Led. Button Batteries Included.
Lampe. 1 Led. Knopfzellen Inklusive.
Lampe. 1 Led. Piles Bouton Inclus.
Zaklamp. 1 Led. Knoopcel Batterijen Inclusief.

Ø 1.4 × 12.5 cm 500 / 50
Print Code: C(4)

872

Medical Torch



Whiter 3961

Pen Torch. 1 Led. Button Batteries Included.
Kugelschreiber Lampe. 1 Led. Knopfzellen Inklusive.
Stylo Lampe. 1 Led. Piles Bouton Inclus.
Pen-Zaklamp. 1 Led. Knoopcel Batterijen Inclusief.

Ø 1.4 × 14.2 cm 500 / 25
Print Code: B(4)



Senter 3714

Pen Torch. 1 Led. Button Batteries Included.
Kugelschreiber Lampe. 1 Led. Knopfzellen Inklusive.
Stylo Lampe. 1 Led. Piles Bouton Inclus.
Pen-Zaklamp. 1 Led. Knoopcel Batterij Inclusief.

Ø 1.5 × 12.7 cm 500 / 50
Print Code: B(4)



SAFETY CATCH
CIERRE DE SEGURIDAD



EXTENDABLE 58 CM
58 CM EXTENDIDO



Lemer 6169

Lanyard. Polyester. Extendable. Safety Catch.
Schlüsselband. Polyester. Ausziehbar. Sicherheitsverschluss.
Lanyard. Polyester. Extensible. Fermeture Sécurité.
Lanyard. Polyester. Verlengbaar. Veiligheidsluiting.

1.5 × 55 cm 600 / 50
Print Code: D(4), F(1), N(8), R, V



01

SAFE MEASURES IN SHARED AREAS
GESTOS SEGUROS EN
SUPERFICIES COMPARTIDAS



LIQUID NOT INCLUDED/
REFILLABLE

LIQUIDO NO INCLUIDO/
RELLENABLE



NEW

3 ml



Antibacterial



873

Medical accessories



Yak

6656

Multifunction Antibacterial Pen. 3 ml. Refillable. Liquid Not Included.
Multifunktion Antibakteriell Kugelschreiber. 3 ml. Wiederaufladbar. Flüssigkeit Nicht im Lieferumfang.
Stylt Antibactérien Multifonction. 3 ml. Rechargeable. Liquide Non Inclus.
Multifunctioneel Antibacterieel Balpen. 3 ml. Navulbaar. Vloeistof Niet Inclusief.

Ø 1.4 × 15.7 cm

1000 / 50

Print Code: B(4)



EXTENDABLE 65 CM
65 CM EXTENDIDO

Bosur

6489

Id Holder. Extendable. Clip Included.
Namensschild Halter. Ausziehbar. Gürtelclip Inklusive.
Porte Badge. Extensible. Clip Inclus.
Id Houder. Verlengbaar. Clip Inclusief.

Ø 3.2 × 1.5 cm

1000 / 100

Print Code: C(4), V



Ania

3674

Watch.
Uhr.
Montre.
Horloge.

3 × 9 cm 400 / 50

Print Code: C(4)



Tormil

6082

Pocket Protector. PVC.
Taschenschutz. PVC.
Protecteur de Poche. PVC.
Zakbeschermer. PVC.

8.5 × 15 cm 1000 / 50

Print Code: C(1)





Hindal

6404

Highlighter Set. 5 Ink Colours.
Textmarker Set. 5 Farben Tinte.
Set Surligneurs. Écriture 5 Couleurs.
Markers Set. 5 Kleuren Inkt.

Ø 9.8 × 1.8 cm

250 / 50

Print Code: C(4), W



Highlighter



874



Dinku

6209

Highlighter Set. 5 Pieces.
Textmarker Set. 5 Peças.
Set Surligneurs. 5 Pièces.
Markers Set. 5 Stuks.

10.8 × 8.7 × 1.8 cm

250 / 50

Print Code: C(4), W

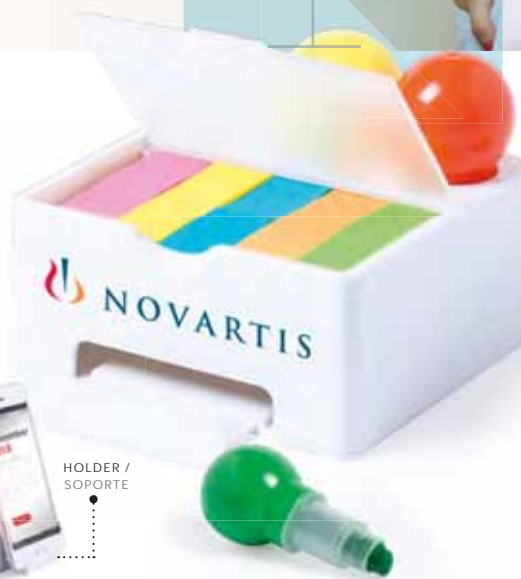

Bolings

5640

Highlighter Set. 3 Pieces. 100 Sticky Notes 1,2 x 3,8 cm.
Textmarker Set. 3 Stück. 100 Haftnotizen 1,2 x 3,8 cm.
Set Surligneurs. 3 Pièces. 100 Notes Adhésives 1,2 x 3,8 cm.
Markers Set. 3 Stuks. 100 Plakmemo's 1,2 x 3,8 cm.

7 × 5.3 × 6.5 cm

200 / 50

Print Code: C(4)



11 F 05 F 04 F

HIGHLIGHTER
MARCADOR FLUORESCENTE

Bunny

5610

Highlighter.
Textmarker.
Surligneur.
Marker.

Ø 1.1 × 13.7 cm

1000 / 50

Print Code: B(4)





Medic

3708



Pen.
Kugelschreiber.
Stylo.
Pen.

▬▬▬▬▬ Ø 1.1 × 12.7 cm 1000 / 50

Print Code: B(4)

875



Tib

3715

Pen.
Kugelschreiber.
Stylo.
Pen.



▬▬▬▬▬ Ø 1.8 × 12 cm 1000 / 50

Print Code: B(4)



Ursharpened

Miko

3949

Pencil. Wood.
Bleistift. Holz.
Crayon. Bois.
Potlood. Hout.

▬▬▬▬▬ 3.7 × 21.5 × 1.5 cm 600 / 50

Print Code: B(4), L1



Jering

5609



Pen.
Kugelschreiber.
Stylo.
Pen.

▬▬▬▬▬ Ø 1.3 × 13.2 cm 1000 / 50

Print Code: B(4)



HYGIE-
NIC
PROTEC-
TION

The best protection is prevention

SAFE MEASURES IN SHARED AREAS
 GESTOS SEGUROS EN SUPERFICIES COMPARTIDAS



03

19

09

02



30 ml

03

NEW



04

02

01

05

07

19

Cimak

6697

Keyring Anticontact. Stylus Touch Ball Pen Included.
 Schlüsselanhänger Anticontact. Kugelschreiber Pointer Inklusive.
 Porte-Clés Anticontact. Stylet Bille Inclus.
 Sleutelhanger Anticontact. Touch Bal Pen Inclusief.

3 x 7.3 x 0.5 cm

1000 / 50

Print Code: D(4)



STYLUS TOUCH BALL
 PEN INCLUDED/
 BOLÍGRAFO PUNTERO
 INCLUIDO

Trikel

6718



Hydroalcoholic Gel. 30 ml. Hand cleansing gel.
 Hydroalkoholisches Gel. 30 ml. Hautreinigungslösung.
 Gel Hydroalcohlique. 30 ml. Solution pour le lavage des mains.
 Hydroalcoholisch Gel. 30 ml. Huidreinigende oplossing.

4 x 9.8 x 2.5 cm

200 / 50

Print Code: C(4)

NEW

comfortable
Soft Shell

02



BFE ≥ 90%
BACTERIAL FILTRATION
EFFICIENCY
EN 14683: 2019+AC: 2019



Lermix

2614

Reusable Hygienic Mask. Soft Shell. 92% Polyester/ 8% Elastane.
Wiederverwendbar Hygienemaske. Soft Shell. 92% Polyester/ 8% Elastan.
Masque Hyg enique R utilisable. Soft Shell. 92% Polyester/ 8% Elasthane.
Herbruikbaar Hyg enisch Masker. Soft Shell. 92% Polyester/ 8% Elastaan.

35 × 14 cm

1000 / 10

Print Code: E(1), N(8), P, R

Leik

2590

Reusable Hygienic Mask. 100% Polyester.
Wiederverwendbar Hygienemaske. 100% Polyester.
Masque Hyg enique R utilisable. 100% Polyester.
Herbruikbaar Hyg enisch Masker. 100% Polyester.

28 × 14.2 cm

1000 / 10

Print Code: D(1), E(1), N(8), P, R

OEKO-TEX®
CONFIDENCE IN TEXTILES
STANDARD 100



CWA 17553

Ideal
Sublimation

ANTIBACTERIAL &
WATER RESISTANT FABRIC

WATER REPELLENT FABRIC
/ TEJIDO HIDR FUGO



SIZE
S

IDEAL SIZE FOR WOMAN
AND TEENAGERS
TALLA IDEAL PARA MUJER
Y ADOLESCENTES

BFE ≥ 90%
BACTERIAL FILTRATION
EFFICIENCY
EN 14683: 2019-AC: 2019



OEKO-TEX®
CONFIDENCE IN TEXTILES
STANDARD 100



OEKO-TEX®
CONFIDENCE IN TEXTILES
STANDARD 100



Liriox Medium

2609

Reusable Hygienic Mask. Outside: 50% Cotton/ 50% Polyester. Inside: 100% Cotton.
Wiederverwendbar Hygienemaske. Außere: 50% Baumwolle/ 50% Polyester. Innen: 100% Baumwolle.
Masque Hyg nienne R utilisable. Ext rieur: 50% Coton/ 50% Polyester. Int rieur: 100% Coton.
Herbruikbaar Hygi nisch Masker. Buitenzijde: 50% Katoen/ 50% Polyester. Binnenzijde: 100% Katoen.

21 × 14 cm

400 / 10

Print Code: E(1), N(8), P

Liriox 2577

Reusable Hygienic Mask. Outside: 50% Cotton/ 50% Polyester. Inside: 100% Cotton.
Wiederverwendbar Hygienemaske. Außere: 50% Baumwolle/ 50% Polyester. Innen: 100% Baumwolle.
Masque Hyg nienne R utilisable. Ext rieur: 50% Coton/ 50% Polyester. Int rieur: 100% Coton.
Herbruikbaar Hygi nisch Masker. Buitenzijde: 50% Katoen/ 50% Polyester. Binnenzijde: 100% Katoen.

24 × 15 cm

400 / 10

Print Code: E(1), N(8), P

BFE ≥ 90%
BACTERIAL FILTRATION
EFFICIENCY
EN 14683: 2019-AC: 2019

Antiviral & Antibacterial treatment

HeiQ Viroblock NPJ03 technology

879



06

INDIVIDUAL PACKING
EMBOLSADO INDIVIDUAL

Plexcom 2600



Reusable Hygienic Mask. Outside: 50% Cotton/ 50% Polyester. Inside: 100% Cotton.
Wiederverwendbar Hygienemaske. Außere: 50% Baumwolle/ 50% Polyester. Innen: 100% Baumwolle.
Masque Hyg nienne R utilisable. Ext rieur: 50% Coton/ 50% Polyester. Int rieur: 100% Coton.
Herbruikbaar Hygi nisch Masker. Buitenzijde: 50% Katoen/ 50% Polyester. Binnenzijde: 100% Katoen.

24 × 15 cm

400 / 10

Print Code: E(1), N(8), P

BFE ≥ 90%
BACTERIAL FILTRATION
EFFICIENCY
EN 14683: 2019-AC: 2019

OEKO-TEX®
CONFIDENCE IN TEXTILES
STANDARD 100



Kolgar 2604



Reusable Hygienic Mask. Outside: 50% Cotton/ 50% Polyester. Inside: 100% Cotton.
Wiederverwendbar Hygienemaske. Außere: 50% Baumwolle/ 50% Polyester. Innen: 100% Baumwolle.
Masque Hyg nienne R utilisable. Ext rieur: 50% Coton/ 50% Polyester. Int rieur: 100% Coton.
Herbruikbaar Hygi nisch Masker. Buitenzijde: 50% Katoen/ 50% Polyester. Binnenzijde: 100% Katoen.

24 × 15 cm

400 / 10

Print Code: E(1), N(8), P

BFE ≥ 90%
BACTERIAL FILTRATION
EFFICIENCY
EN 14683: 2019-AC: 2019

OEKO-TEX®
CONFIDENCE IN TEXTILES
STANDARD 100



SUITABLE FOR MEDICAL
AND PERSONAL USE

NEW



Quirúrgica IIR /
Surgical Mask IIR

Davir

6752

Surgical Mask IIR, 3 Layers, Outside 1: Non-Woven (Polypropylene) Middle Layer: Blown Non-Woven (Meltblown), Outside 2: Non-Woven (Polypropylene).

Chirurgische Maske IIR, 3 Schichten, Außere 1: Non-Woven (Polypropylen) Mittlere Schicht: Geblasenes Non-Woven (Meltblown), Außere 2: Non-Woven (Polypropylen).

Masque Chirurgical IIR, 3 Couches, Extérieur 1: T.N.T. (Polypropylène) Couche intermédiaire: T.N.T. Soufflé (Meltblown), Extérieur 2: T.N.T. (Polypropylène).

Chirurgisch Masker IIR, 3 Lagen, Buitenzijde 1: Non-Woven (Polypropyleen) Middelste Laag: Blown Non-Woven (Meltblown), Buitenzijde 2: Non-Woven (Polypropyleen).

17.5 x 9.5 cm

2500 / 50

BFE ≥ 98%
BACTERIAL FILTRATION
EFFICIENCY
EN 14683: 2019-AC: 2019

BOX
50 PIECES

01

10 PIECES



830



22



19



03



01



02



BFE ≥ 95%
BACTERIAL FILTRATION
EFFICIENCY
EN 14683: 2019-AC: 2019

Nagax

6711



INDIVIDUAL PACKING
EMBOLSADO INDIVIDUAL

Hygienic Mask, 3 Layers, Outside 1: Non-Woven (Polypropylene) Middle Layer: Meltblown (90% Polypropylene/ 10% Viscose), Outside 2: Non-Woven (Polypropylene).

Hygienemaske, 3 Schichten, Außere 1: Non-Woven (Polypropylen) Mittlere Schicht: Meltblown (90% Polypropylen/ 10% Viskose), Außere 2: Non-Woven (Polypropylen).

Masque Hygienne, 3 Couches, Extérieur 1: T.N.T. (Polypropylène) Couche intermédiaire: Meltblown (90% Polypropylène/ 10% Viscose), Extérieur 2: T.N.T. (Polypropylène).

Hygienisch Masker, 3 Lagen, Buitenzijde 1: Non-Woven (Polypropyleen) Middelste Laag: (90% Polypropyleen/ 10% Viscose), Buitenzijde 2: Non-Woven (Polypropyleen).

17.5 x 9.5 cm

3000 / 50

Print Code: A(1)

BOX
50 PIECES

Nombix

6634



Hygienic Mask, 3 Layers, Outside 1: Non-Woven (Polypropylene) Middle Layer: Meltblown (90% Polypropylene/ 10% Viscose), Outside 2: Non-Woven (Polypropylene).

Hygienemaske, 3 Schichten, Außere 1: Non-Woven (Polypropylen) Mittlere Schicht: Meltblown (90% Polypropylen/ 10% Viskose), Außere 2: Non-Woven (Polypropylen).

Masque Hygienne, 3 Couches, Extérieur 1: T.N.T. (Polypropylène) Couche intermédiaire: Meltblown (90% Polypropylène/ 10% Viscose), Extérieur 2: T.N.T. (Polypropylène).

Hygienisch Masker, 3 Lagen, Buitenzijde 1: Non-Woven (Polypropyleen) Middelste Laag: Meltblown (90% Polypropyleen/ 10% Viscose), Buitenzijde 2: Non-Woven (Polypropyleen).

17.5 x 9.5 cm

3000 / 50

BOX
50 PIECES





INDIVIDUAL PACKING
EMBOLSADO INDIVIDUAL

Tensil   

6753

Auto Filtering Mask FFP2 Color. 5 Layers. 43% Non-Woven (2 Layers)/ 28,5% Meltblown (2 Layers)/ 28,5% Hot Air Cotton (1 Layer).
Selbstfilternde Maske FFP2 Farbe. 5 Schichten. 43% Non-Woven (2 Schichten)/ 28,5% Meltblown (2 Schicht)/ 28,5% Baumwolle (1 Schichten).
Masque Auto-Filtrante FFP2 Couleur. 5 Couches. 43% T.N.T. (2 Couches)/ 28,5% Meltblown (2 Couches)/ 28,5% Coton (1 Couche).
Zelf Filterende Masker FFP2 Kleuren. 5 Lagen. 43% Non-Woven (2 Lagen)/ 28,5% Meltblown (2 Lagen)/ 28,5% Katoen (1 Laag).

 21 x 15.5 cm

 1000 / 20

 Print Code: Consult.

881

IDEAL FOR PERSONAL, HOSPITALITY
AND COMMERCIAL USE
IDEAL PARA USO CIVIL, HOSTELERÍA
Y COMERCIO



INDIVIDUAL PACKING
EMBOLSADO INDIVIDUAL

Leiban
2573

Mouth-Nose Shield. PET.
Einatemungs Abwehrschild für Nase und Mund. PET.
Masque Bouche-Nez. PET.
Beademingsbescherming voor Neus en Mond. PET.

 17 x 8.5 cm

 1000 / 100

 Print Code: D(1)

Video 



NEW



INDIVIDUAL PACKING
EMBOLSADO INDIVIDUAL

Tensil   

6751

Auto Filtering Mask FFP2 White. 5 Layers. 43% Non-Woven (2 Layers)/ 28,5% Meltblown (2 Layers)/ 28,5% Hot Air Cotton (1 Layer).
Selbstfilternde Maske FFP2 Weiß. 5 Schichten. 43% Non-Woven (2 Schichten)/ 28,5% Meltblown (2 Schicht)/ 28,5% Baumwolle (1 Schichten).
Masque Auto-Filtrante FFP2 Blanc. 5 Couches. 43% T.N.T. (2 Couches)/ 28,5% Meltblown (2 Couches)/ 28,5% Coton (1 Couche).
Zelf Filterende Masker FFP2 Wit. 5 Lagen. 43% Non-Woven (2 Lagen)/ 28,5% Meltblown (2 Lagen)/ 28,5% Katoen (1 Laag).

 21 x 15.5 cm

 1000 / 20

 Print Code: Consult.

EN149:2001+A1:2009 FFP2 NR



882

AJUSTABLE AND LIFT UP/
AJUSTABLE Y ABATIBLE



COMFORTABLE
PADDING INSIDE
COMFORTABLE
ALMOHADILLA INTERIOR



Derol

2574

Face Shield. PET/ PP. Adjustable and Lift Up.
Gesichtsmaske. PET/ PP. Verstellbar und Falten.
Visière de Protection. PET/ PP. Ajustable et Pliage.
Gezichtsscherm. PET/ PP. Aanpasbaar en Vouwen.

35 × 23,7 cm



75

Print Code: D(1)

Muns

2583

Face Shield. PET/ Laminated Cardboard 250 g/ m2. Adjustable.
Gesichtsmaske. PET/ Laminiertes Pappe 250 g/ m2. Verstellbar.
Visière de Protection. PET/ Carton Lamine 250 g/ m2. Ajustable.
Gezichtsscherm. PET/ Gelamineerd Karton 250 g/ m2. Aanpasbaar.

31 × 24 cm



50 / 5

Print Code: D(2)



COMFORTABLE
PADDING INSIDE
COMFORTABLE
ALMOHADILLA INTERIOR



Hezal

6636

Safety Glasses. PC.
Schutzbrille. PC.
Lunettes de Protection. PC.
Veiligheidsbril. PC.

15,5 × 5,7 × 15 cm



200 / 10

Print Code: D(4)

Bison

6635

Safety Glasses. PC/ PVC.
Schutzbrille. PC/ PVC.
Lunettes de Protection. PC/ PVC.
Veiligheidsbril. PC/ PVC.

17 × 8 × 6 cm



200 / 10

Print Code: D(4)





Galant 2578



OEKO-TEX®
CONFIDENCE IN TEXTILES
STANDARD 100

Reusable Kids Hygienic Mask. Outside: 50% Cotton/ 50% Polyester. Inside: 100% Cotton.
Wiederverwendbar Kinder Hygienemaske. Außere: 50% Baumwolle/ 50% Polyester. Innen: 100% Baumwolle.
Masque Hyg nrique Enfant R utilisable. Ext rieur: 50% Coton/ 50% Polyester. Int rieur: 100% Coton.
Herbruikbaar Kinder Hygienisch Masker. Buitenzijde: 50% Katoen/ 50% Polyester. Binnenzijde: 100% Katoen.

20 x 11.5 cm

400 / 10

Print Code: E(1), N(8), P

BFE ≥ 90%
BACTERIAL FILTRATION
EFFICIENCY
EN 14683: 2019-AC: 2019

883



COMFORTABLE
PADDING INSIDE
COMFORTABLE
ALMOHADILLA INTERIOR

Tundex

2575

Kids Face Shield. PET/ PP. Adjustable.
Kinder Gesichtsmaske. PET/ PP. Verstellbar.
Visi re de Protection Enfant. PET/ PP. Ajustable.
Kinder Gezichtsscherm. PET/ PP. Aanpasbaar.

30 x 14.8 cm

150

Print Code: D(1)



19



IDEAL FOR COLOURING
CRAYONS NOT INCLUDED
IDEAL PARA PINTAR
CERAS NO INCLUIDAS



Binky

2584

Kids Face Shield. PET/ Cardboard 250 g/ m2. Adjustable.
Kinder Gesichtsmaske. PET/ Pappe 250 g/ m2. Verstellbar.
Visi re de Protection Enfant. PET/ Carton 250 g/ m2. Ajustable.
Kinder Gezichtsscherm. PET/ Karton 250 g/ m2. Aanpasbaar.

28 x 20.5 cm

100 / 5

Print Code: D(2)



COMFORTABLE
PADDING INSIDE
COMFORTABLE
ALMOHADILLA INTERIOR



SET 3 PIECES

Resil



2605

Sanitizer Set. Mask Case PP Wipe 100% Compostable. Hygienic Mask 3 Layers. Outside 1: Non-Woven (Polypropylene) Middle Layer: Meltblown (90% Polypropylene/ 10% Viscose). Outside 2: Non-Woven (Polypropylene).

Hygienisch Set. Halterung für Maske PP. Feuchttuch 100% Kompostierbar. Hygienemaske 3 Schichten. Äußere 1: Non-Woven (Polypropylen) Mittlere Schicht: Meltblown (90% Polypropylen/ 10% Viskose). Äußere 2: Non-Woven (Polypropylen).

Set Hygiénique. Porte-Masques PP. Lingette 100% Compostable. Masque Hygiénique 3 Couches. Extérieur 1: T.N.T. (Polypropylène) Couche intermédiaire: Meltblown (90% Polypropylène/ 10% Viscose). Extérieur 2: T.N.T. (Polypropylène).

Hygienisch Set. Maskerhouder PP. Poetsdoekj 100% Composteerbaar. Hygienisch Masker 3 Lagen. Buitenzijde 1: Non-Woven (Polypropyleen) Middelste Laag: (90% Polypropyleen/ 10% Viscose). Buitenzijde 2: Non-Woven (Polypropyleen).

8,5 × 6 × 1 cm

400 / 20

Print Code: B(1), C(4)

834



SET 4 PIECES

Hotax

2580

Sanitizer Set. Strap PP. Wipes 100% Compostable. Auto Filtering Mask FFP2 5 Layers. 50% Non-Woven (2 Layers)/ 50% Meltblown (3 Layers).

Hygienisch Set. Halterung PP. Feuchttücher 100% Kompostierbar. Selbstfilternde Maske FFP2 5 Schichten. 50% Non-Woven (2 Schichten)/ 50% Meltblown (3 Schichten).

Set Hygiénique. Attache PP. Lingettes 100% Compostable. Masque Auto-Filtrante FFP2 5 Couches. 50% T.N.T. (2 Couches)/ 50% Meltblown (3 Couches).

Hygienisch Set. Band PP. Poetsdoekjes 100% Composteerbaar. Zelf Filterende Masker FFP2 5 Lagen. 50% Non-Woven (2 Lagen)/ 50% Meltblown (3 Lagen).

12,5 × 18 × 1 cm

500

Print Code: B(1), B(4), C(1)



SET 4 PIECES

Emme

2579

Sanitizer Set. Strap PP. Wipes 100% Compostable. Hygienic Mask 3 Layers. Outside 1: Non-Woven (Polypropylene) Middle Layer: Meltblown (90% Polypropylene/ 10% Viscose). Outside 2: Non-Woven (Polypropylene).

Hygienisch Set. Halterung PP. Feuchttücher 100% Kompostierbar. Hygienemaske 3 Schichten. Äußere 1: Non-Woven (Polypropylen) Mittlere Schicht: Meltblown (90% Polypropylen/ 10% Viskose). Äußere 2: Non-Woven (Polypropylen).

Set Hygiénique. Attache PP. Lingettes 100% Compostable. Masque Hygiénique 3 Couches. Extérieur 1: T.N.T. (Polypropylène) Couche intermédiaire: Meltblown (90% Polypropylène/ 10% Viscose). Extérieur 2: T.N.T. (Polypropylène).

Hygienisch Set. Band PP. Poetsdoekjes 100% Composteerbaar. Hygienisch Masker 3 Lagen. Buitenzijde 1: Non-Woven (Polypropyleen) Middelste Laag: (90% Polypropyleen/ 10% Viscosë). Buitenzijde 2: Non-Woven (Polypropyleen).

12,5 × 18 × 1 cm

500

Print Code: B(1), B(4), C(1)





19

Dinsol

2576

Face Mask Strap. PP.
Halterung für Schutzmaske. PP.
Ajusteur de Masque. PP.
Band voor Gezichtsmasker. PP.

16.5 × 4 × 0.1 cm

1000 / 100

Print Code: A(4)

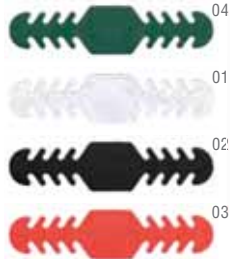

IDEAL SIZE FOR KIDS
AND ADULTS

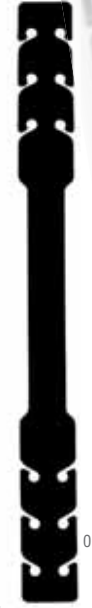

02

SILICONE

01



Haper

6660

Face Mask Strap. PVC.
Halterung für Schutzmaske. PVC.
Attache pour Masque. PVC.
Band voor Gezichtsmasker. PVC.

10.1 × 2.1 × 0.1 cm

10000 / 5000

Print Code: A(4)

Sivin

6645

Face Mask Strap. Silicone.
Halterung für Schutzmaske. Silikon.
Attache pour Masque. Silicone.
Band voor Gezichtsmasker. Siliconen.

19.4 × 1.8 × 0.2 cm

1000 / 100

Print Code: F(1)



NEW

03



Menfix

6716

Mask Holder Lanyard. Polyester. Adjustable.
Halterung für Maske Schlüsselband. Polyester. Verstellbar.
Lanyard Porte-Masques. Polyester. Ajustable.
Maskerhouder Lanyard. Polyester. Aanpasbaar.

1.5 × 48 cm

2000 / 100

Print Code: D(1)



Lerop

2598

Mask Holder Lanyard. Polyester.
Halterung für Maske Schlüsselband. Polyester.
Lanyard Porte-Masques. Polyester.
Maskerhouder Lanyard. Polyester.

2.6 × 39 cm

500

Print Code: F(1), N(8), R



Ruix
2601

Mask Case. PP.
Halterung für Maske. PP.
Porte-Masques. PP.
Maskerhouder. PP.

8.5 × 6 × 1 cm
Print Code: C(4)

1200 / 100

TRANS

FACE MASK NOT INCLUDED/
MASCARILLA NO INCLUIDA



Censol
2594

Mask Case. PP.
Halterung für Maske. PP.
Porte-Masques. PP.
Maskerhouder. PP.

10.2 × 10.2 cm
Print Code: C(4)

1000 / 20

IDEAL FOR ALL TYPES OF
FACE MASKS/
IDEAL PARA TODO TIPO
DE MASCARILLAS

FACE MASK NOT INCLUDED/
MASCARILLA NO INCLUIDA



Linek
2612

Mask Case. PP.
Halterung für Maske. PP.
Porte-Masques. PP.
Maskerhouder. PP.

13 × 1.6 × 13 cm
Print Code: D(1), W

150

SUITABLE TO CREATE
YOUR OWN KIT/
IDEAL PARA CREAR
TUS KIT



Kloe
2586

Mask Case. PP.
Halterung für Maske. PP.
Porte-Masques. PP.
Maskerhouder. PP.

19 × 1.2 × 10.5 cm
Print Code: D(1), W

125

IDEAL FOR ALL TYPES OF
FACE MASKS/
IDEAL PARA TODO TIPO
DE MASCARILLAS

FACE MASK NOT INCLUDED/
MASCARILLA NO INCLUIDA

MASK case

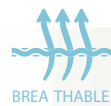

BREA THABLE



FACE MASK NOT INCLUDED/
MASCARILLA NO INCLUIDA

Yator
2613

Mask Pouch. Non-Woven.
Halterung für Maske. Non-Woven.
Porte-Masques. T.N.T.
Maskerhouder. Non-Woven.

15 x 16 cm

1000 / 100

Print Code: E(1)



BREA THABLE



02

01

IDEAL FOR ALL TYPES OF
FACE MASKS/
IDEAL PARA TODO TIPO
DE MASCARILLAS

FACE MASK NOT INCLUDED/
MASCARILLA NO INCLUIDA

XL

Big Size



Liven
2602

Mask Case XL. PP.
Halterung für Maske XL. PP.
Porte-Masques XL. PP.
Maskerhouder XL. PP.

14.6 x 14.1 cm

500 / 25

Print Code: C(2)

Claver
2611

Mask Pouch. 50% Cotton/ 50% Polyester.
Halterung für Maske. 50% Baumwolle/ 50% Polyester.
Porte-Masques. 50% Coton/ 50% Polyester.
Maskerhouder. 50% Katoen/ 50% Polyester.

15 x 18 cm

500

Print Code: E(1), N(8)



13

30 ml



Hincy

2587



Hydroalcoholic Gel. 30 ml. Hand cleansing gel.
Hydroalkoholisches Gel. 30 ml. Hautreinigungslösung.
Gel Hydroalchologique. 30 ml. Solution pour le lavage des mains.
Hydroalcoholic Gel. 30 ml. Huidreinigende oplossing.

Ø 2.5 × 8 cm 400 / 200
Print Code: C(4), W

Bustan

6325



Hydroalcoholic Gel. 10 ml. Hand cleansing gel.
Hydroalkoholisches Gel. 10 ml. Hautreinigungslösung.
Gel Hydroalchologique. 10 ml. Solution pour le lavage des mains.
Hydroalcoholic Gel. 10 ml. Huidreinigende oplossing.

Ø 1.6 × 14.2 cm 500 / 50
Print Code: B(4)

10 ml



03 01 17 04 02



19

15 ml



Bradul

6571



Hydroalcoholic Gel. 15 ml. Hand cleansing gel.
Hydroalkoholisches Gel. 15 ml. Hautreinigungslösung.
Gel Hydroalchologique. 15 ml. Solution pour le lavage des mains.
Hydroalcoholic Gel. 15 ml. Huidreinigende oplossing.

3 × 6.3 × 1.8 cm 500 / 250
Print Code: C(4), W

240 ml



100 ml

888

60 ml



Rokal

6639



Hydroalcoholic Gel. 60 ml. Hand cleansing gel.
Hydroalkoholisches Gel. 60 ml. Hautreinigungslösung.
Gel Hydroalchologique. 60 ml. Solution pour le lavage des mains.
Hydroalcoholic Gel. 60 ml. Huidreinigende oplossing.

Ø 3.3 × 11 cm 200 / 50
Print Code: C(1)

Tassi

6637



Hydroalcoholic Gel. 240 ml. Hand cleansing gel.
Hydroalkoholisches Gel. 240 ml. Hautreinigungslösung.
Gel Hydroalchologique. 240 ml. Solution pour le lavage des mains.
Hydroalcoholic Gel. 240 ml. Huidreinigende oplossing.

6.8 × 15.5 × 4.3 cm 40
Print Code: D(1)

Safer

2588



Hydroalcoholic Gel. 100 ml. Hand cleansing gel.
Hydroalkoholisches Gel. 100 ml. Hautreinigungslösung.
Gel Hydroalchologique. 100 ml. Solution pour le lavage des mains.
Hydroalcoholic Gel. 100 ml. Huidreinigende oplossing.

Ø 3.6 × 13.3 cm 35
Print Code: D(1)



Karlux

6762

Pouch. Soft Shell. Adaptable.
 Estujo. Soft Shell. Anpassungsfähig.
 Etui. Soft Shell. Adaptable.
 Hoes. Soft Shell. Aanpasbaar.

6.8 × 11.4 × 0.5 cm 1000 / 100
 Print Code: E(1), N(8)



02 03 04 19

ADAPTABLE

01

BOTTLE NOT INCLUDED/
 BOTELLA NO INCLUIDA



Lidem

6643



Hydroalcoholic Gel. 30 ml. Hand cleansing gel.
 Hydroalkoholisches Gel. 30 ml. Hautreinigungslösung.
 Gel Hydroalcholiique. 30 ml. Solution pour le lavage des mains.
 Hydroalcoholic Gel. 30 ml. Huidreinigende oplossing.

3.5 × 10 × 2.2 cm 200 / 50
 Print Code: C(1)

30 ml



NEW

30 ml

19



01 05 07 04 03 02

Vixel

6720



Hydroalcoholic Gel. 30 ml. Hand cleansing gel.
 Hydroalkoholisches Gel. 30 ml. Hautreinigungslösung.
 Gel Hydroalcholiique. 30 ml. Solution pour le lavage des mains.
 Hydroalcoholic Gel. 30 ml. Huidreinigende oplossing.

3.9 × 8.3 × 2.3 cm 200 / 50
 Print Code: C(4)



NEW



03

30 ml



04 02 01 05 07 19

Trikel

6718



Hydroalcoholic Gel. 30 ml. Hand cleansing gel.
 Hydroalkoholisches Gel. 30 ml. Hautreinigungslösung.
 Gel Hydroalcholiique. 30 ml. Solution pour le lavage des mains.
 Hydroalcoholic Gel. 30 ml. Huidreinigende oplossing.

4 × 9.8 × 2.5 cm 200 / 50
 Print Code: C(4)

30 ml

Flaix

6719



Hydroalcoholic Gel. Silicone. 30 ml. Hand cleansing gel.
 Hydroalkoholisches Gel. Silikon. 30 ml. Hautreinigungslösung.
 Gel Hydroalcholiique. Silicone. 30 ml. Solution pour le lavage des mains.
 Hydroalcoholic Gel. Siliconen. 30 ml. Huidreinigende oplossing.

4 × 8.2 × 2.4 cm 200 / 50
 Print Code: C(4)



WITH MOTION SENSOR
CON SENSOR DE MOVIMIENTO



890



NEW

45 ml

Bisnal

6698

Automatic Dispenser. 45 ml. USB Rechargeable. Cable Included.
Automatisch Spender. 45 ml. USB Wiederaufladbar. Kabel Inklusiv.
Distributeur Automatique. 45 ml. Rechargeable USB. Câble Inclus.
Automatisch Dispenser. 45 ml. USB Oplaadbaar. Kabel Inclusief.

5.5 × 9 × 7.5 cm

50

Print Code: E(4), W



TALLY COUNTER / CONTADOR DE AFORO

Yoksy

6705

Tally Counter.
Taschenrechner.
Compteur.
Teller.

4 × 5.1 × 3.2 cm

200 / 50

Print Code: C(4)



NEW



TALLY COUNTER / CONTADOR DE AFORO

Dolim

6691

Tally Counter. Button Battery Included.
Taschenrechner. Knopfzelle Inklusiv.
Compteur. Pile Bouton Inclus.
Teller. Knopcel Batterij Inclusief.

3.4 × 6.2 × 2 cm

200 / 50

Print Code: C(4)



NEW



NEW



HIGH TEMPERATURE ALERT
AVISO TEMPERATURA ALTA

Leroux

6652

Thermometer Watch. TPU Strap. 0.96" LED Screen. USB Rechargeable. Cable Included.
Thermometer Uhr. TPU Armband. 0.96" LED Screen. USB Wiederaufladbar. Kabel Inklusiv.
Montre Thermomètre. Bracelet TPU. Écran LED 0.96". Rechargeable USB. Câble Inclus.
Thermometer Horloge. TPU Band. 0.96" LED Scherm. USB Oplaadbaar. Kabel Inclusief.

25 × 2.1 × 1 cm

200 / 50

Print Code: I(1), L2



Body
Temperature



Time





Boxton

2589

Sanitizer Spray. Aluminium. 20 ml. Surface cleaning solution.
 Hygienisch Spray. Aluminium. 20 ml. Lösung für die Reinigung von Oberflächen.
 Spray Hygiénique. Aluminium. 20 ml. Solution pour le lavage des surfaces.
 Hygienisch Spray. Aluminium. 20 ml. Oplossing voor het reinigen van oppervlakken.

Ø 2.3 × 8.8 cm

400 / 50

Print Code: C(1)



20 ml



NEW



Ledis

6717

Sanitizer Wipes. 10 Pieces.
 Hygienisch Feuchttücher. 10 Stück.
 Lingettes Hygiéniques. 10 Pièces.
 Hygienisch Poetsdoekjes. 10 Stuks.

15 × 8 × 1.5 cm

200 / 100

Print Code: C(1)



891



Masup

2571

Sanitizer Wipe. Wipe 100% Compostable.
 Hygienisch Feuchttuch. Feuchttuch 100% Kompostierbar.
 Lingette Hygiénique. Lingette 100% Compostable.
 Hygienisch Poetsdoekje. Poetsdoekje 100% Composteerbaar.

6.7 × 8 cm

3000 / 100

Print Code: A(1)



COMPOSTABLE



Complex

2572

SET 12 PIECES

Sanitizer Wipes. Wipes 100% Compostable. 12 Pieces.
 Hygienisch Feuchttücher. Feuchttücher 100% Kompostierbar. 12 Stück.
 Lingettes Hygiéniques. Lingettes 100% Compostable. 12 Pièces.
 Hygienisch Poetsdoekjes. Poetsdoekjes 100% Composteerbaar. 12 Stuks.

6.2 × 8.5 × 3.1 cm

100

Print Code: C(2), A(1)



x 12 PCS



COMPOSTABLE



SCREEN CLEANER /
 LIMPIAPANTALLAS

19

15 ml

Clorux

5280

01

Spray. 15 ml. Refillable. Liquid Not Included. Screen Cleaner Included.
 Zerstäuber. 15 ml. Wiederaufladbar. Flüssigkeit Nicht im Lieferumfang. Displayreiniger Inklusiv.
 Vaporisateur. 15 ml. Rechargeable. Liquide Non Inclus. Nettoyeur d'Écran Inclus.
 Sproeier. 15 ml. Navulbaar. Vloeistof Niet Inclusief. Screen Cleaner Inclusief.

2.7 × 8.8 × 2.7 cm

400 / 100

Print Code: C(4), W



05

03

DOUBLE-SIDED EXTRA STRONG ADHESIVE /
ADHESIVO EXTRA FUERTE DOBLE CARA



SUITABLE FOR HOME, HOSPITALITY AND OFFICE
IDEAL PARA HOGAR, HOSTELERÍA Y OFICINA

Deblon

2603

Face Mask Hanger. PVC. Adhesive.
Maskenhalter. PVC. Haftend.
Porte-Masques. PVC. Adhésif.
Maskerhouder. PVC. Klevend.

40 × 5 × 1.5 cm

150 / 25

Print Code: C(2)

HORIZONTAL AND VERTICAL POSITION



892



Yoner

2597

Sanitizer Doormat. PVC.
Desinfektionsmatte. PVC.
Tapis Désinfectant. PVC.
Tapijtdesinfectiemiddel. PVC.

80 × 40 cm

10

Print Code: G(1)



Redfly

2595

Hanging Screen. PET/ PVC.
Transparente Trennwand. PET/ PVC.
Écran Suspendu. PET/ PVC.
Hangend Scherm. PET/ PVC.

98 × 68 cm

1

Print Code: G(4)



SAFE MEASURES IN SHARED AREAS GESTOS SEGUROS EN SUPERFICIES COMPARTIDAS



Bigox
6644

Keyring Anticontact. Stainless Steel.
Schlüsselanhänger Anticontact. Rostfreier Stahl.
Porte-Clés Anticontact. Acier Inox.
Sleutelhanger Anticontact. Roestvrij Staal.

3.2 x 7.6 x 0.2 cm 400 / 200
Print Code: D(1), L1



IDEAL FOR PUBLIC
TRANSPORT
IDEAL PARA
TRANSPORTE PÚBLICO



Kozko
6658

Keyring Anticontact. Aluminium.
Schlüsselanhänger Anticontact. Aluminium.
Porte-Clés Anticontact. Aluminium.
Sleutelhanger Anticontact. Aluminium.

5.1 x 7.8 x 0.5 cm 800 / 200
Print Code: D(4), L1



893



STYLUS TOUCH BALL
PEN INCLUDED/
BOLÍGRAFO PUNTERO
INCLUIDO

Cimak
6697

Keyring Anticontact. Stylus Touch Ball Pen Included.
Schlüsselanhänger Anticontact. Kugelschreiber Pointer Inklusive.
Porte-Clés Anticontact. Stylet Bille Inclus.
Sleutelhanger Anticontact. Touch Bal Pen Inclusief.

3 x 7.3 x 0.5 cm 1000 / 50
Print Code: D(4)



Napil
6690

Keyring Anticontact.
Schlüsselanhänger Anticontact.
Porte-Clés Anticontact. Stylet Bille Inclus.
Sleutelhanger Anticontact.

3.1 x 7.2 x 0.4 cm 2000 / 1000
Print Code: C(4)

Riken
6662

Antibacterial Keyring Anticontact.
Antibakteriell Schlüsselanhänger Anticontact.
Porte-Clés Antibactérien Anticontact.
Antibacterieel Sleutelhanger Anticontact.

3 x 10 x 0.5 cm 1000 / 200
Print Code: C(4)



W O - M A N

CORK



Alunax
PG.897

NATURAL JUTE /
COTTON

Ribbon
PG.909

NEW

Halim
PG.915

EQUA

BODY SOAP

DISPLACE B...

feeling blue
I know m...
in the b...
that b...

300ml



Thiny

3052

Pocket Mirror.
Taschenspiegel.
Miroir.
Zakspiegel.

▮ 6 × 0.5 cm

Print Code: C(4), W

500 / 50

Bilof

5906

Pocket Mirror. Metal. 2 Magnifying Mirror.
Taschenspiegel. Metall. 2 Fach Vergrößerung.
Miroir. Métal. 2 Augmentations.
Zakspiegel. Metaal. 2 Vergrotingen.

▮ 6 × 6 × 0.7 cm

Print Code: C(4), L1, W

300 / 50



1X ●
2X ●
.....

896

03



Naza

3192

Pocket Mirror. 2 Magnifying Mirror.
Taschenspiegel. 2 Fach Vergrößerung.
Miroir. 2 Augmentations.
Zakspiegel. 2 Vergrotingen.

▮ 6.7 × 1.3 cm

Print Code: C(4)

400 / 50

1X ●
2X ●
.....

Pocket MIRROR

WHEAT
STRAW



Gradiox
6554

Pocket Mirror. Wheat Straw/ ABS.
Taschenspiegel. Weizenstroh/ ABS.
Miroir. Paille de Blé/ ABS.
Zakspiegel. Tarwestro/ ABS.

▬▬▬▬▬ Ø 7 × 0.5 cm

🌈 Print Code: C(4), W

📦 500 / 50



Plumiex
5907

Pocket Mirror. PU. 2 Magnifying Mirror.
Taschenspiegel. PU. 2 Fach Vergrößerung.
Miroir. Similicuir. 2 Augmentations.
Zakspiegel. PU. 2 Vergrotingen.

▬▬▬▬▬ Ø 6.5 × 0.9 cm

📦 300 / 50

🌈 Print Code: C(4), L1, W



NEW



CORK

Alunax
6793

Pocket Mirror. Natural Cork. 2 Magnifying Mirror.
Taschenspiegel. Naturkork. 2 Fach Vergrößerung.
Miroir. Bouchon Naturel. 2 Augmentations.
Zakspiegel. Natuurlijk Kurk. 2 Vergrotingen.

▬▬▬▬▬ Ø 6.2 × 2 cm

📦 200 / 50

🌈 Print Code: C(4), L1, W





22



23

09

Faudok 5934

Purse. PU.
Portemonnaie. PU.
Porte Monnaie. Similiicuir.
Portemonnee. PU.

12 × 8.5 × 0.5 cm

Print Code: D(1)

1000 / 10



09



22

23

Tramux 6001

Hairbrush. Anti-Tangle.
Bürste. Anti-Wirrwarr.
Brosse. Démêlante.
Haarborstel. Antiklit.

6.7 × 9 × 4.5 cm

Print Code: D(1)

200 / 50

Delray 5908

Pen. Jumbo Refill.
Kugelschreiber. Jumbo Ersatzmine.
Stylo. Recharge Jumbo.
Pen. Jumbo Refill.

Ø 0.8 × 15.5 cm

Print Code: A(4)

1000 / 50



22

23

09

GEL INK

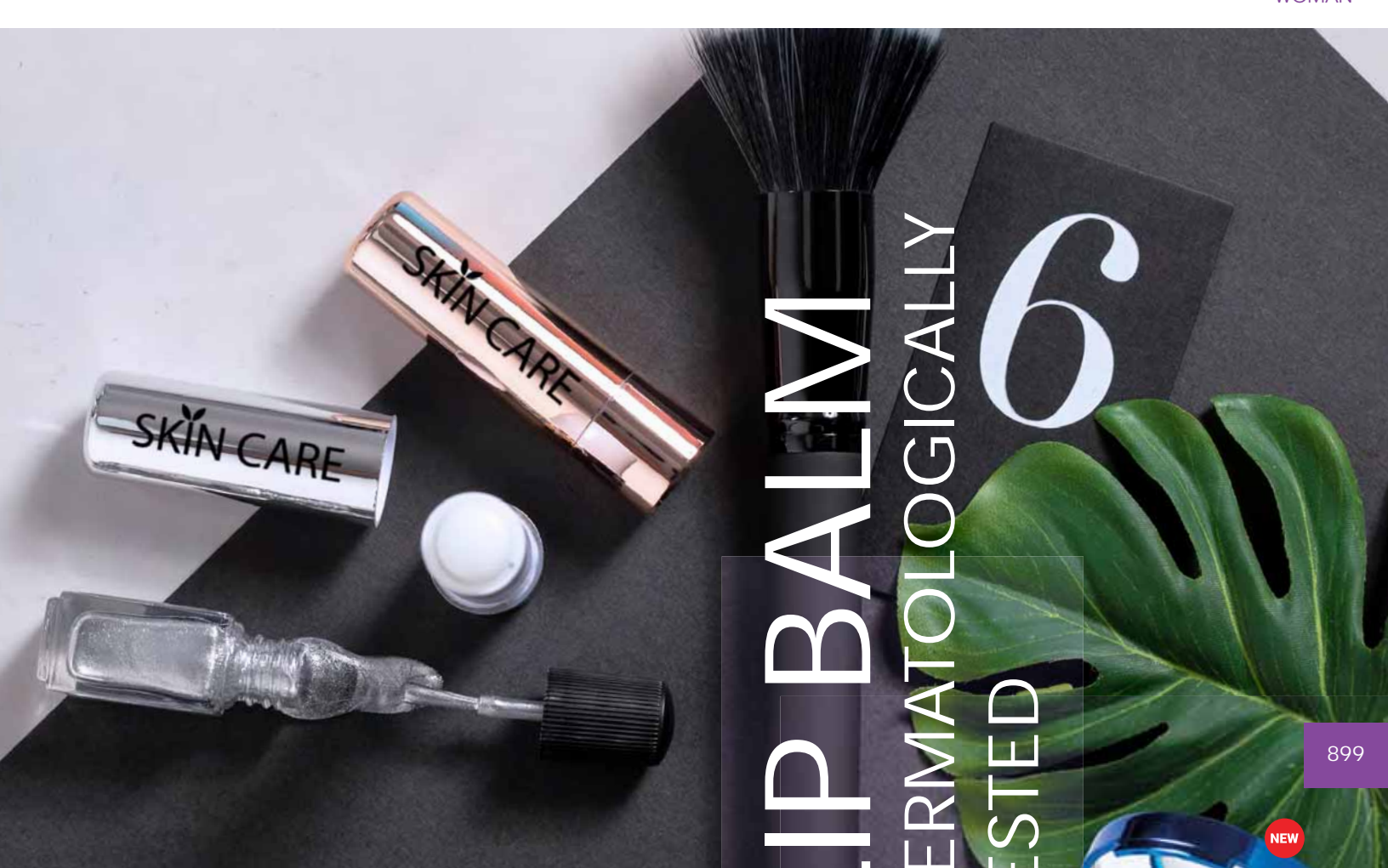

899



19 03 23 22 09

UV FINISH

Tarian

6324



Lip Balm. SPF15. Vanilla Aroma.
 Lippenbalsam. SPF15. Vanille Duft.
 Baume Lèvres. SPF15. Arôme Vanille.
 Lippenbalsam. SPF15. Vanille Aroma.

▬▬▬▬▬ Ø 1.9 × 7 cm  500 / 25
 Print Code: C(1)



09
23

Epson

5942



Lip Balm. SPF15. Vanilla Aroma.
 Lippenbalsam. SPF15. Vanille Duft.
 Baume Lèvres. SPF15. Arôme Vanille.
 Lippenbalsam. SPF15. Vanille Aroma.

▬▬▬▬▬ Ø 3.8 cm  500 / 50
 Print Code: C(1)



UV FINISH 22





19

Zendal

6784



Lip Balm. SPF15. Vanilla Aroma. Mirror Included.
 Lippenbalsam. SPF15. Vanille Duft. Spiegel Inklusive.
 Baume Lèvres. SPF15. Arôme Vanille. Miroir Inclus.
 Lippenbalsam. SPF15. Vanille Aroma. Spiegel Inclusief.

▬▬▬▬▬ Ø 4.8 × 1.6 cm  500 / 100
 Print Code: C(1), V



09
22
23

UV FINISH - MIRROR INCLUDED



Yunkai

5411

Hairbrush with Mirror.
Bürste mit Spiegel.
Brosse avec Miroir.
Haarborstel Met Spiegel.

Ø 6.6 × 2.8 cm

Print Code: C(4)

200 / 50

Zilam

5829

Hairbrush Anti-Tangle.
Bürste Anti-Wirrwarr.
Brosse Démêlante.
Haarborstel Antiklit.

6.7 × 9 × 4.5 cm

Print Code: D(1)

200 / 50



Dolty

5353

Hairbrush Anti-Tangle.
Bürste Anti-Wirrwarr.
Brosse Démêlante.
Haarborstel Antiklit.

7.3 × 18.5 × 3.6 cm

Print Code: D(1)

100 / 20



Tauron

4216

Hair Clip. Velvet.
Haarspange. Wildleder.
Barrette. Suedine.
Haar Clip. Fluweel.

Ø 5.5 × 2.4 cm

Print Code: D(1)

1200 / 120



19



03



05



11



02

ANTI-TANGLE



Glance

9884

Hairbrush with Mirror.
Bürste mit Spiegel.
Brosse avec Miroir.
Haarborstel Met Spiegel.

Ø 6.6 × 2.8 cm

Print Code: C(4)

200 / 50

03



07



01



19

eco-friendly HAIRBRUSH



WHEAT
STRAW



Dantel
6557

Hairbrush. Wheat Straw/ PP.
Bürste. Weizenstroh/ PP.
Brosse. Paille de Blé/ PP.
Haarborstel. Tarwestro/ PP.

5 × 17.3 × 3.4 cm

Print Code: D(4)

200 / 20



Garet

6504

Comb. Bamboo.
Kamm. Bambus.
Peigne. Bambou.
Kam. Bamboe.

3.1 × 18.7 × 0.5 cm

Print Code: C(4), L1

500 / 100



WHEAT
STRAW

Wofel
6503

Comb. Wheat Straw/ PP.
Kamm. Weizenstroh/ PP.
Peigne. Paille de Blé/ PP.
Kam. Tarwestro/ PP.

2.8 × 17 × 0.3 cm

Print Code: C(4)

1000 / 50

Dalik

5408

Eyeshadow Applicator Set. 4 Pieces.

Set Make-up Pinsel. 4 Stück.

Set Broches Maquillage. 4 Pièces.

Oogschaduw Kwasten Set. 4 Stuks.

8.5 × 6.5 × 0.6 cm  1000 / 50

 Print Code: A(1), D(1)

MAKE-UP

902



02



19

Lolu

3472

Cosmetic Set. Microfibre. 3 Accessories.

Kosmetik Set. Mikrofaser. 3 Teile.

Set Cosmétique. Microfibre. 3 Accessoires.

Cosmetic Set. Microfiber. 3 Accessoires.

7 × 11.5 × 1 cm  300 / 50

 Print Code: D(1)



03



19



02

Yosie

3473

Cosmetic Set. 5 Accessories.

Kosmetik Set. 5 Teile.

Set Cosmétique. 5 Accessoires.

Cosmetic Set. 5 Accessoires.

Ø 1.8 × 15.5 cm  600 / 50

 Print Code: C(1)



03



Beluchi
3470

Manicure Set. PU. 5 Accessories.
Maniküre Set. PU. 5 Teile.
Set Manicure. Similicuir. 5 Accessoires.
Manicure Set. PU. 5 Accessoires.

5 × 10.5 × 2 cm
Print Code: E(1)

200 / 50



Silbix
4783

Tweezers. Stainless Steel.
Pinzette. Rostfreier Stahl.
Pince. Acier Inox.
Pincet. Roestvrij Staal.

1.5 × 10 × 1.1 cm
Print Code: B(1)

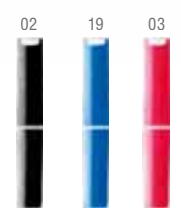

1000 / 100



Fucsox
4446

Nail File Set. 4 Accessories.
Nagelpfeilen Set. 4 Teile.
Set Limes. 4 Accessoires.
Nagelvijl Set. 4 Accessoires.

2.2 × 6.7 × 1.3 cm
Print Code: C(4), W

1000 / 100



Silton
4782

Manicure Set. PVC. 3 Accessories.
Maniküre Set. PVC. 3 Teile.
Set Manicure. PVC. 3 Accessoires.
Manicure Set. PVC. 3 Accessoires.

5.7 × 10.1 × 1.4 cm
Print Code: E(1)

300 / 50





02

Gara 7010

Bag. PVC.
Tasche. PVC.
Sac. PVC.
Tas. PVC.

41.5 x 21.5 x 10 cm
Print Code: G(1)

50



01



03



09

Galea 3722

Hat. PVC. Waterproof.
Hut. PVC. Wasserdicht.
Bonnet. PVC. Imperméable.
Muts. PVC. Waterdicht.

Consult.
Print Code: F(1)

200 / 10



01



03



13

Danae 7060

Cap. Linen.
Mutze. Leinen.
Casquette. Lin.
Pet. Linnen.

Consult.
Print Code: N(8)

200 / 50



08



02



PERSONAL ALARM

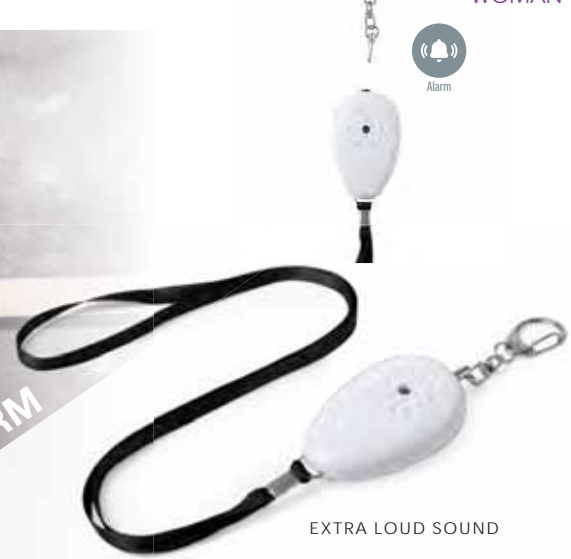

EXTRA LOUD SOUND

Birnal
6405

Personal Alarm. Button Batteries Included.
 Persönlicher Alarm. Knopfzellen Inklusive.
 Alarme personnelle. Piles Bouton Inclus.
 Persoonlijk Alarm. Knopcel Batterijen Inclusief.

3.9 x 6 x 1.9 cm 300 / 50
 Print Code: D(4)



905



WOW!
 YOUR KEYS ALWAYS
 CLOSE TO HAND
 TUS LLAVES SIEMPRE A MANO



Lysia
4526

Bag Hanger Key Finder. Metal/ PU.
 Taschenhalter-Schlüsselanhänger. Metall/ PU.
 Porte-Sac Porte-Clés. Metal/ Similicuir.
 Tas Sleutelhanger. Metaal/ PU.

2.7 x 7.5 cm 200 / 50
 Print Code: D(4), L1



Skype
9416

Foldable Bag Hanger. Metal/ PU.
 Faltbarer Handtaschenhalter. Metall/ PU.
 Porte-Sac Pliable. Metal/ Similicuir.
 Opvouwbare Tassenhanger. Metaal/ PU.

3.3 x 8 cm 200 / 100
 Print Code: D(4), L1



JEWELLERY accessories

906



Didy
7070

Jewellery Wrap.
Schmuckbox.
Boîte Bijoux.
Sieradendoosje.

16 × 7 × 2.7 cm

Print Code: N(8)

04

400 / 10



Louis
7036

Bag, Polyester.
Tasche, Polyester.
Sac, Polyester.
Tas, Polyester.

10 × 15 cm

Print Code: N(8)



5000 / 100



GATO



CISNE

Salma
4323

Ring Holder, Metal.
Ringhalter, Metall.
Porte-Bagues, Métal.
Ring Houder, Metaal.

3.5 × 7 × 7 cm

Print Code: F(1), L1

100 / 50

JEWELLERY



23



09

Diliap

4816

Bracelet. Adjustable.
Armband. Verstellbar.
Bracelet. Ajustable.
Armband. Aanpasbaar.

Ø 5.5 × 2 cm
Print Code: C(1)

1000 / 10



02



23



09

Many

7032

Bracelet.
Armband.
Bracelet.
Armband.

20.5 × 2.6 cm
Print Code: E(1)

1000 / 50



01

08

Dala

7040

Bracelet. Adjustable.
Armband. Verstellbar.
Bracelet. Ajustable.
Armband. Aanpasbaar.

Ø 6.5 × 0.8 cm
Print Code: Consultar

500 / 100



03



Ideal
Sublimation



01



06

Elguix

5135

Scarf. Viskose/ Polyester.
Schal. Viskose/ Polyester.
Foulard. Viskose/ Polyester.
Sjaal. Viskose/ Polyester.

180 x 95 cm

500 / 20

Print Code: F(1), R

Rosix

4831

Foulard Pareo. Viskose/ Polyester. Beauty Bag Included.
Foulard Pareo. Viskose/ Polyester. Kosmetik Tasche Inklusive.
Pareo Foulard. Viskose/ Polyester. Nécessaire Inclus.
Foulard. Viskose/ Polyester. Toilettes Inclusief.

180 x 95 cm

50

Print Code: F(1), N(8), G(1)

02



19



03



05



01



908

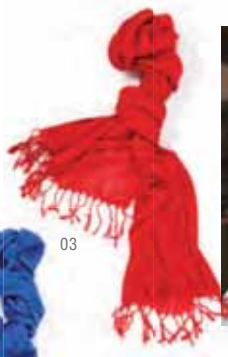

03



02



19

Magnolia

3613

Pashmina. Viskose/ Polyester.
Pashmina. Viskose/ Polyester.
Pashmina. Viskose/ Polyester.
Sjawl. Viskose/ Polyester.

185 x 70 cm

100 / 10

Print Code: F(1), N(8)



C



B



A

Petra

7063

Foulard. Polyester.
Foulard. Polyester.
Foulard. Polyester.
Sjaaltje. Polyester.

150 x 50 cm

200 / 10

Print Code: N(8)



22



Ribban

5916

Foulard. Viscose.
Foulard. Viskose.
Foulard. Viscose.
Sjaaltje. Viscose.

180 × 70 cm

100 / 10

Print Code: F(1), N(8)

909



19

03

Instint

3612

Foulard. Viscose/ Polyester.
Foulard. Viskose/ Polyester.
Foulard. Viscose/ Polyester.
Sjaaltje. Viscose/ Polyester.

155 × 35 cm

400 / 20

Print Code: F(1), N(8)



02



08

02



21



13



22

Pilik

4832

Foulard. Viscose/ Polyester.
Foulard. Viskose/ Polyester.
Foulard. Viscose/ Polyester.
Sjaaltje. Viscose/ Polyester.

150 × 75 cm

100 / 10

Print Code: F(1), N(8)



I AM
INTERACTIVE!

80 Sheets
Plain



11 19 03

Velmont
5932

Notepad. Hard Cover. 80 Sheets.
Notizblock. Hardcover-Abdeckung. 80 Seiten.
Bloc Notes. Couverture Rigide. 80 Feuilles.
Notitieblokje. Harde Kaft. 80 Blaadjes.

14.5 × 21.5 × 2 cm

40 / 20

Print Code: G(1)



BACK SIDE /
PARTE TRASERA

23

09

02

Evelen
5902

Keyring. Polyester.
Schlüsselanhänger. Polyester.
Porte-Clés. Polyester.
Sleutelhanger. Polyester.

Ø 7 × 1.4 cm

500 / 10

03

Print Code: N(8)



I AM
INTERACTIVE!



02

03



02



01



11

Lovit
5044



Stylus Touch Ball Pen.
Kugelschreiber Pointer.
Styllet Bille.
Touch-Screen Balpen.

1.6 × 7.2 × 1.6 cm

1000 / 50

Print Code: B(4), W



Ladriel
5811

Keyring. Polyester.
Schlüsselanhänger. Polyester.
Porte-Clés. Polyester.
Sleutelhanger. Polyester.

Ø 7 cm

500 / 50

Print Code: L1



03

01

11

Video



LADY PEN

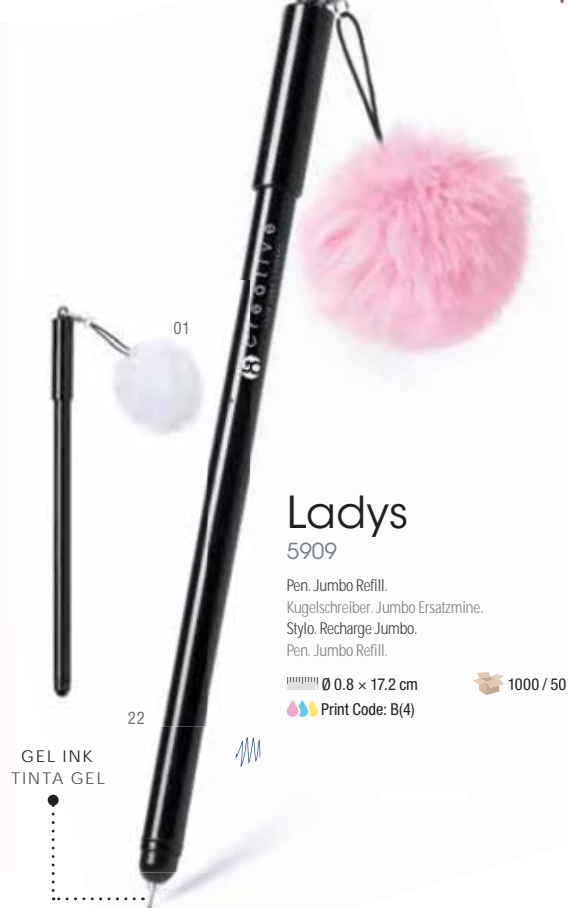

Ladys 5909

Pen. Jumbo Refill.
Kugelschreiber. Jumbo Ersatzmine.
Stylo. Recharge Jumbo.
Pen. Jumbo Refill.

Ø 0.8 × 17.2 cm
Print Code: B(4)

1000 / 50

GEL INK
TINTA GEL



911



Consut

4425

Highlighter.
Textmarker.
Surigneur.
Marker.

2.5 × 7 × 2.5 cm

500 / 25

Print Code: B(1), W



11



Globix

4405

Stylus Touch Ball Pen. Metal.
Kugelschreiber Pointer. Metall.
Stylet Bille. Metal.
Touch-Screen Balpen. Metaal.

Ø 1 × 12.8 cm

1000 / 50

Print Code: B(4)



03

02

22

Lipsy

3390

Pen.
Kugelschreiber.
Stylo.
Pen.

Ø 1.7 × 10 cm

Print Code: B(4)



21





SAFETY CATCH / CIERRE
SEGURIDAD

NEW



Merul
6885

Lanyard. Natural Cork/ Wheat Straw/ PP. Safety Catch.
Schlüsselband. Naturkork/ Weizenstroh/ PP. Sicherheitsverschluss.
Lanyard. Bouchon Naturel/ Paille de Blé/ PP. Fermeture Sécurité.
Lanyard. Natuurlijk Kurk/ Tarwestro/ PP. Veiligheidsluiting.

2 x 50 cm

1000 / 100

Print Code: D(1)

BE
CONSCIOUS



912



WOOD
& POLYESTER RPET



WOOD &
NATURAL CORK

Kasol
6476

Hand Fan. Wood/ Natural Cork.
Fächer. Holz/ Naturkork.
Éventail. Bois/ Bouchon Naturel.
Waaier. Houten/ Natuurlijk Kurk.

41,5 x 23 cm

250 / 25

Print Code: D(1), E(2), L1

BAMBOO FIBRE
& POLYESTER RPET



Lencer
6468

Hand Fan. Bamboo Fibre/ PP/ Polyester RPET.
Fächer. Bambusfaser/ PP/ Polyester RPET.
Éventail. Fibre Bambou/ PP/ Polyester RPET.
Waaier. Bamboe Fibre/ PP/ Polyester RPET.

42,5 x 23 cm

250 / 25

Print Code: D(1), E(2), L1

Water
6467

Hand Fan. Wood/ Polyester RPET.
Fächer. Holz/ Polyester RPET.
Éventail. Bois/ Polyester RPET.
Waaier. Houten/ Polyester RPET.

42,5 x 23 cm

250 / 25

Print Code: D(1), E(2), L1



Beauty BAG



NATURAL CORK & COTTON

Subrum
6619

Beauty Bag. Natural Cork/ Cotton.
Kosmetik Tasche. Naturkork/ Baumwolle.
Nécessaire. Bouchon Naturel/ Coton.
Toilettas. Natuurlijk Kurk/ Katoen.

21.5 x 16 x 5 cm 200 / 10
Print Code: E(1), N(8)



NATURAL CORK

913



NATURAL JUTE

Singla
5727

Beauty Bag. Laminated Jute.
Kosmetik Tasche. Laminiertes Jutestoff.
Nécessaire. Jute Laminé.
Toilettas. Gelamineerd Jute.

25 x 15 cm 300 / 10
Print Code: E(1)

NATURAL JUTE



Lindak
6626

Beauty Bag. Laminated Jute.
Kosmetik Tasche. Laminiertes Jutestoff.
Nécessaire. Jute Laminé.
Toilettas. Gelamineerd Jute.

25 x 16 x 6 cm 200 / 50
Print Code: E(1), N(8)

Yinbex
6474

Beauty Bag. Natural Cork.
Kosmetik Tasche. Naturkork.
Nécessaire. Bouchon Naturel.
Toilettas. Natuurlijk Kurk.

24 x 14 x 7 cm 500 / 50
Print Code: E(1)

Talso

6825

Beauty Bag. 100% Cotton.
Kosmetik Tasche. 100% Baumwolle.
Nécessaire. 100% Coton.
Toiletas. 100% Katoen.

Ø 15 × 25 cm

200 / 10

Print Code: F(6), N(8), O, P



100% COTTON



914

NEW



03



02

Halgar

6832

Beauty Bag. 100% Recycled Cotton.
Kosmetik Tasche. 100% Recycling Baumwolle.
Nécessaire. 100% Coton Recyclé.
Toiletas. 100% Gerecycled Katoen.

21 × 12.5 cm

300 / 50

Print Code: E(1), N(8), O

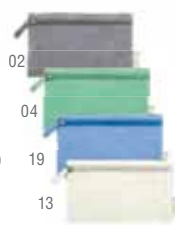

Recycled Cotton

Karoky

5164

Beauty Bag. 100% Cotton.
Kosmetik Tasche. 100% Baumwolle.
Nécessaire. 100% Coton.
Toiletas. 100% Katoen.

22 × 15 × 7.5 cm

300 / 50

Print Code: E(1), N(8), O



01

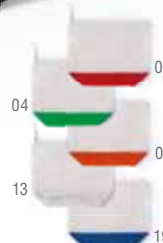

Lendil

6120

Beauty Bag. 100% Cotton.
Kosmetik Tasche. 100% Baumwolle.
Nécessaire. 100% Coton.
Toiletas. 100% Katoen.

23 × 18 × 8 cm

300 / 50

Print Code: E(1), N(8)

100% COTTON & NATURAL JUTE

NEW

NEW

EQUA

915

Halim

6826

Beauty Bag. Laminated Jute/ Cotton.
Kosmetik Tasche. Laminiertes Jutesstoff/ Baumwolle.
Nécessaire. Jute Laminé/ Coton.
Toiletta. Gelamineerd Jute/ Katoen.

21 × 12 × 8 cm

250 / 50

Print Code: E(1), N(8)



Ringok

6828

Beauty Bag. Laminated Jute/ Cotton.
Kosmetik Tasche. Laminiertes Jutesstoff/ Baumwolle.
Nécessaire. Jute Laminé/ Coton.
Toiletta. Gelamineerd Jute/ Katoen.

20 × 15 × 6 cm

250 / 50

Print Code: E(1), N(8)

Tays

6827

Beauty Bag. Laminated Jute/ Cotton.
Kosmetik Tasche. Laminiertes Jutesstoff/ Baumwolle.
Nécessaire. Jute Laminé/ Coton.
Toiletta. Gelamineerd Jute/ Katoen.

21.5 × 16.5 × 5 cm

250 / 50

Print Code: E(1), N(8)





Kreston 6433

Sublimation Beauty Bag. Polyester.
Sublimations Kosmetik Tasche. Polyester.
Nécessaire Sublimation. Polyester.
Sublimatie Toilettas. Polyester.

22 x 14 x 6.5 cm 500 / 10
Print Code: E(1), N(8), R

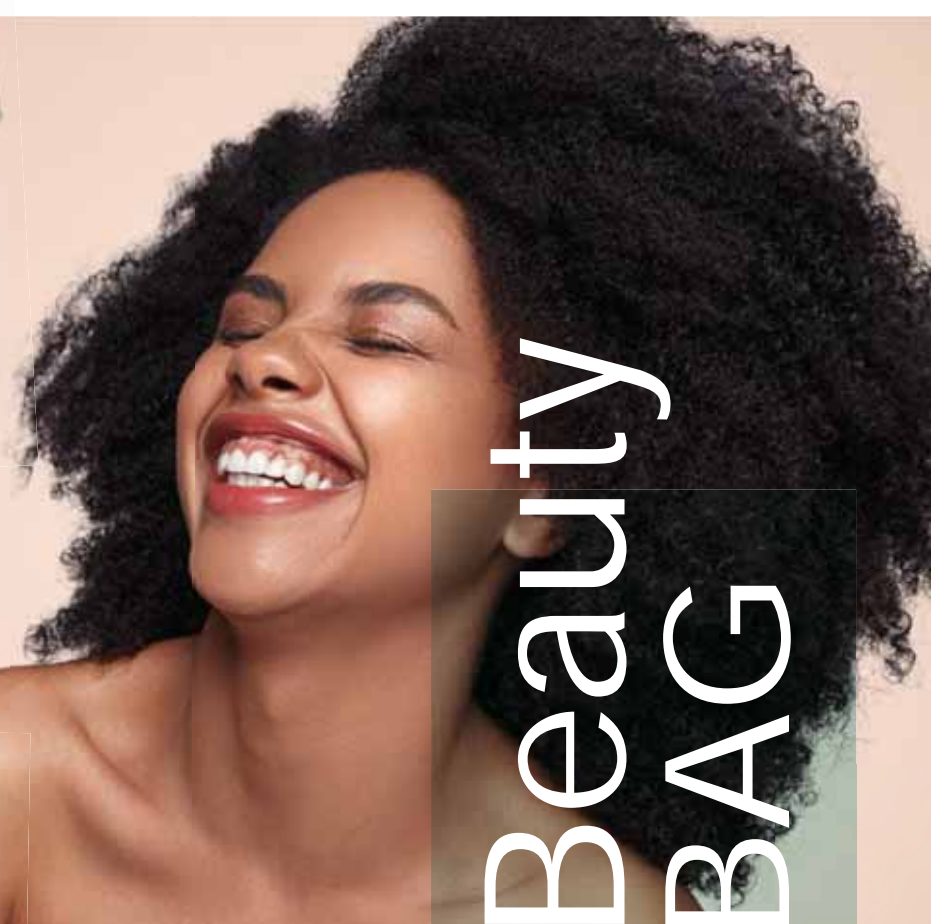

Beauty BAG

916



03

02

11

13

19

Conakar

5729

Beauty Bag. Polyester.
Kosmetik Tasche. Polyester.
Nécessaire. Polyester.
Toilettas. Polyester.

22 x 14 x 6.5 cm 500 / 10
Print Code: E(1), N(8)

Babit

5879

Beauty Bag. Cotton/ Polyester. With Inner Lining.
Kosmetik Tasche. Baumwolle/ Polyester. Mit Innenfutter.
Nécessaire. Coton/ Polyester. Avec Doublure Antérieure.
Toilettas. Katoen/ Polyester. Met Voering aan de Binnenzijde.

20 x 11 x 5.5 cm 200 / 10
Print Code: E(1), N(8)



Siony

5895

Multipurpose Bag. Polyester. With Inner Lining.
Mehrzwecktasche. Polyester. Mit Innenfutter.
Fourre-Tout. Polyester. Avec Doublure Antérieure.
Multifunctioneel Tasje. Polyester. Met Voering aan de Binnenzijde.

25 x 16 cm 200 / 10
Print Code: E(1), N(8)

RPET

The fabric used in the manufacturing process of these products is made of recycled plastic (RPET). Like this, the emission of plastic residues to our planet and the consumption of energy is drastically reduced, resulting in a much more eco-friendly process.

El material de estos productos está fabricado con plástico reciclado (RPET), que, además de ayudar en la disminución de residuos plásticos en el planeta, utiliza menos energía en el proceso de fabricación, haciendo que sea mucho menos dañino para el medio ambiente.

STOP PLASTIC POLLUTING THE OCEAN

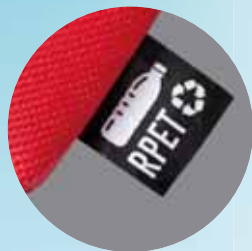

19



Kopel
6423

Beauty Bag. Polyester 600D RPET.
Kosmetik Tasche. Polyester 600D RPET.
Nécessaire. Polyester 600D RPET.
Toiletas. Polyester 600D RPET.

21 × 13 × 8 cm

100 / 10

Print Code: F(1), N(8), O



03

NEW

Akilax
6842

Beauty Bag. Polyester 600D RPET.
Kosmetik Tasche. Polyester 600D RPET.
Nécessaire. Polyester 600D RPET.
Toiletas. Polyester 600D RPET.

21 × 12 × 3 cm

500 / 50

Print Code: E(1), N(8)



13



19

NEW

Nelsom
6843

Purse. Polyester 600D RPET.
Portemonnaie. Polyester 600D RPET.
Porte Monnaie. Polyester 600D RPET.
Portemonnee. Polyester 600D RPET.

11 × 8 cm

1000 / 20

Print Code: D(1), N(8)



03



13



02



02

Losut

4778

Beauty Bag. PVC.
Kosmetik Tasche. PVC.
Nécessaire. PVC.
Toiletas. PVC.

29 × 21 × 9 cm

Print Code: F(1)

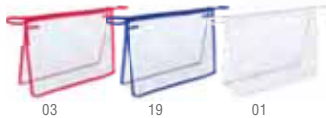

03

19

01

200 / 50



11

Bracyn

5933

Beauty Bag. PVC.
Kosmetik Tasche. PVC.
Nécessaire. PVC.
Toiletas. PVC.

24.5 × 20 × 6 cm

Print Code: F(1)



07

04

19

200 / 10



03

01



19

05

11

Saeki

5378

Beauty Bag. EVA.
Kosmetik Tasche. EVA.
Nécessaire. EVA.
Toiletas. EVA.

16.5 × 14 × 5 cm

Print Code: E(1)

300 / 25

01



Pelvar

6160

Beauty Bag. EVA.
Kosmetik Tasche. EVA.
Nécessaire. EVA.
Toiletas. EVA.

20.5 × 15 × 6 cm

Print Code: E(1)

200 / 50

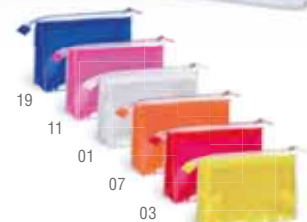

19

11

01

07

03



01



Beauty BAG



03

Britney

9147

Beauty Bag. Polyester 600D.
Kosmetik Tasche. Polyester 600D.
Nécessaire. Polyester 600D.
Toiletta. Polyester 600D.

22 x 14 x 6 cm

300 / 20

Print Code: E(1), N(8), 0



Trevi

3178

Beauty Bag. Polyester 600D.
Kosmetik Tasche. Polyester 600D.
Nécessaire. Polyester 600D.
Toiletta. Polyester 600D.

21.5 x 14 x 10 cm

200 / 10

Print Code: F(1), N(8), 0



13



06

03

Filen

6117

Beauty Bag. Polyester 600D.
Kosmetik Tasche. Polyester 600D.
Nécessaire. Polyester 600D.
Toiletta. Polyester 600D.

17 x 15 x 5.5 cm

200 / 10

Print Code: F(1), N(8)



919

02



01

Xana

3727

Beauty Bag. PVC. Mirror Included.
Kosmetik Tasche. PVC. Spiegel Inklusiv.
Nécessaire. PVC. Miroir Inclus.
Toiletas. PVC. Spiegel Inclusief.

18 × 10 × 2.5 cm

300 / 10

Print Code: E(1)

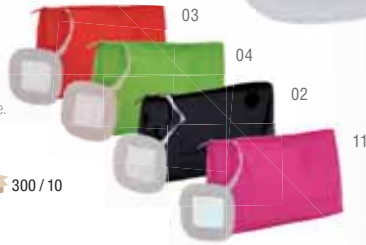

920

FLUORESCENT



11F

Valax

4477

Beauty Bag. PVC.
Kosmetik Tasche. PVC.
Nécessaire. PVC.
Toiletas. PVC.

19.5 × 10 × 2.5 cm

300 / 10

Print Code: E(1)

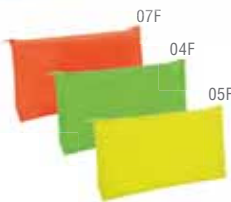

07F

04F

05F

Beauty BAG



02

Rarox

5097

Beauty Bag. Microfibre.
Kosmetik Tasche. Mikrofaser.
Nécessaire. Microfibre.
Toiletas. Microfiber.

19 × 10 × 2.5 cm

500 / 10

Print Code: E(1), N(8), 0

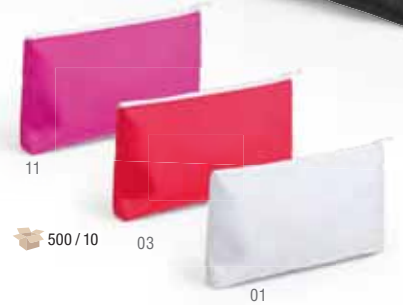

11

03

01



The Best Price Beauty BAG



19



Iriam
5064

Beauty Bag. PVC.
Kosmetik Tasche. PVC.
Nécessaire. PVC.
Toiletas. PVC.

17 × 12.5 × 4.5 cm

400 / 50

Print Code: E(1)



03

Lobe
3431

Beauty Bag. PVC.
Kosmetik Tasche. PVC.
Nécessaire. PVC.
Toiletas. PVC.

17 × 12.5 × 4.5 cm

400 / 50

Print Code: E(1)



19

Fergi
3429

Beauty Bag. PVC.
Kosmetik Tasche. PVC.
Nécessaire. PVC.
Toiletas. PVC.

24 × 21 × 6.5 cm

200 / 50

Print Code: E(1)





05F

07F

11F

04F



FLUORESCENT

Clexy

4396

Purse. PVC.
Portemonnaie. PVC.
Porte Monnaie. PVC.
Portemonnee. PVC.

8.6 × 8.6 × 0.5 cm

Print Code: D(1)

1000 / 10



A

B

C

D

Kumba

5501

Purse. PU.
Portemonnaie. PU.
Porte Monnaie. Similicuir.
Portemonnee. PU.

Ø 12 cm

Print Code: D(1)

300 / 10

922



04



11



01

Becky

7014

Purse. PVC. With Inner Lining.
Portemonnaie. PVC. Mit Innenfutter.
Porte Monnaie. PVC. Avec Doublure Antérieure.
Portemonnee. PVC. Met Voering aan de Binnenzijde.

17 × 11 × 2 cm

Print Code: D(1)

200 / 10



05



03



01



16

19

03

05

01

Zirplan

5243

Purse. PVC. With Inner Lining.
Portemonnaie. PVC. Mit Innenfutter.
Porte Monnaie. PVC. Avec Doublure Antérieure.
Portemonnee. PVC. Met Voering aan de Binnenzijde.

10 × 8 × 1.8 cm

Print Code: D(1)

500 / 10



03

07

11

19

05

Babel

4203

Purse. Silicone.
Portemonnaie. Silikon.
Porte Monnaie. Silicone.
Portemonnee. Siliconen.

9.5 × 9 × 4.5 cm

Print Code: F(1)

300 / 10



Narse
6475

Purse. Cotton/ Polyester.
Portemonnaie. Baumwolle/ Polyester.
Porte Monnaie. Coton/ Polyester.
Portemonnee. Katoen/ Polyester.

11 x 8.5 x 2 cm 1000 / 10
Print Code: E(1), N(8)

PURSE

923



Dyna
3671

Keyring Purse. PVC.
Schlüsselanhänger Portemonnaie. PVC.
Porte-Clés Porte Monnaie. PVC.
Sleutelhanger-Tasje. PVC.

4.5 x 6 x 3 cm 1000 / 10
Print Code: D(1)



Wobis
5090

Multipurpose Bag Purse. PVC. With Inner Lining.
Mehrzwecktasche Portemonnaie. PVC. Mit Innenfutter.
Fourre-Tout Porte Monnaie. PVC. Avec Doublure Antérieure.
Multifunctioneel Tasje Portemonnee. PVC. Met Voering aan de Binnenzijde.

14 x 11 x 3.5 cm 400 / 10
Print Code: E(1), N(8)



Richen
5894

Multipurpose Bag. Polyester. With Inner Lining.
Mehrzwecktasche. Polyester. Mit Innenfutter.
Fourre-Tout. Polyester. Avec Doublure Antérieure.
Multifunctioneel Tasje. Polyester. Met Voering aan de Binnenzijde.

14.5 x 10 cm 500 / 10
Print Code: E(1), N(8)



KIDS



#eco-friendly

STOP
USING PLASTIC



- EN** Environmental education and respect for the environment as essential values in the education of children, through a collection of the most entertaining items, which encourage learning and creativity from an early age.
- DE** Umwelterziehung und Respekt für die Umwelt als wesentliche Werte in der Erziehung von Kindern durch eine Sammlung der unterhaltsamsten Artikel, die das Lernen und die Kreativität von frühester Kindheit an fördern.
- FR** La sensibilisation au respect de l'environnement est aujourd'hui une valeur essentielle dans l'éducation des enfants, on la retrouvera ici au travers d'une collection d'articles des plus drôles qui favoriseront l'apprentissage et la créativité dès le plus jeune âge.
- NL** Umwelterziehung und Respekt für die Umwelt als wesentliche Werte in der Erziehung von Kindern durch eine Sammlung der unterhaltsamsten Artikel, die das Lernen und die Kreativität von frühester Kindheit an fördern.



ANTIBACTERIAL

Antibacterial material specially processed to inhibit and prevent bacterial growth, due to the incorporation of permanent static microbial agents, which are highly effective in the control against bacterial contamination.

Material antibacteriano, especialmente procesado para inhibir y prevenir las cargas bacterianas, gracias a la incorporación de agentes microbianos permanentes estáticos, con alta efectividad contra la contaminación bacteriana.

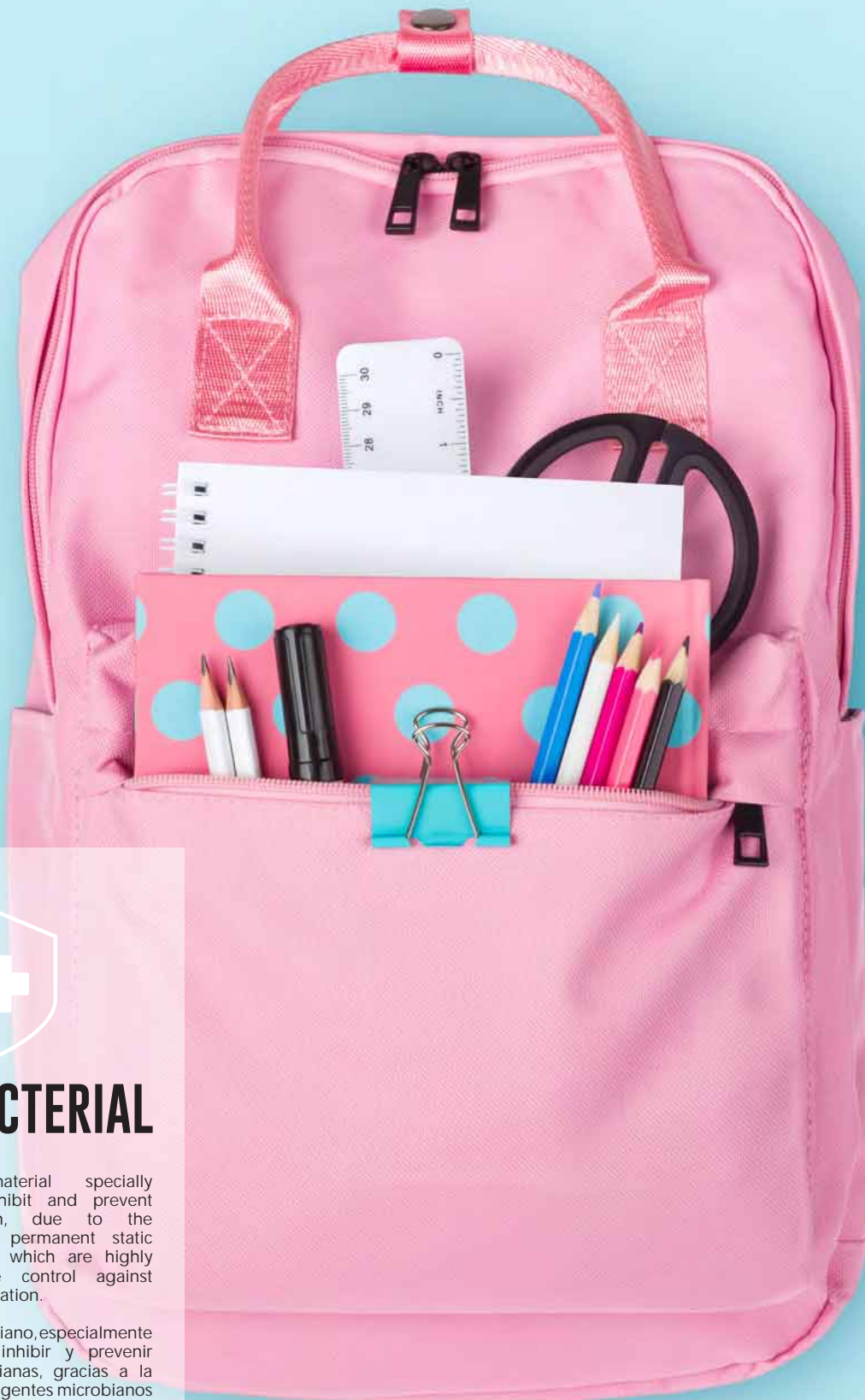

antibacteriana



Antibacterial

NEW

Tesam 6678

Antibacterial Yoyo.
Antibakteriell Yoyo.
Yoyo Antibactérien.
Antibacterieel Jojo.

▬▬▬▬▬ 0.5 × 1.5 cm

🎨 Print Code: C(4), W

📦 500 / 100



CHILD PROTECTION



927



Antibacterial



Unsharpened

Sukon 6766

Antibacterial Pencil. Wood.
Antibakteriell Bleistift. Holz.
Crayon Antibactérien. Bois.
Antibacterieel Potlood. Hout.

▬▬▬▬▬ 0.7 × 18.6 cm

🎨 Print Code: B(4), L1

📦 2000 / 100

NEW



NEW



80 Sheets
Plain



Antibacterial

Polax 2591

Antibacterial Notebook. 80 Sheets.
Antibakteriell Notizbuch. 80 Seiten.
Cahier Antibactérien. 80 Feuilles.
Antibacterieel Notitieboek. 80 Blaadjes.

▬▬▬▬▬ 15.5 × 21 × 1.6 cm

🎨 Print Code: E(4)

📦 30

simple
Idea.

Lorem ipsum dolor sit amet, consectetur
adipiscing elit, sed diam.

Nitria 6679



Antibacterial

Antibacterial Ruler.
Antibakteriell Lineal.
Regle Antibactérienne.
Antibacterieel Linaal.

▬▬▬▬▬ 31.5 × 4 × 0.2 cm

🎨 Print Code: D(1), W

📦 500 / 100

NEW



30 cm





Dredon

6294

Sandwich Lunch Box. Bamboo Fibre/ PP. 450 ml.
Sandwich Lunch Box. Bambusfaser/ PP. 450 ml.
Gamelle Sandwich. Fibre Bambou/ PP. 450 ml.
Boterhammen-Lunchbox. Bamboe Fibre/ PP. 450 ml.

12.5 × 3.8 × 12.9 cm 200 / 50

Print Code: E(1)



BPA FREE



450 ml

bamboo
fibre



Beylom

6356

Cutlery Set. Bamboo Fibre/ PP. 3 Pieces.
Besteckset. Bambusfaser/ PP. 3 Stück.
Set Couverts. Fibre Bambou/ PP. 3 Pièces.
Bestek Set. Bamboe Fibre/ PP. 3 Stuks.

21 × 2.6 × 5.6 cm 100 / 50

Print Code: D(4), B(4), W



BPA FREE



Meridal

6152

Mug. Bamboo Fibre/ PP. 350 ml.
Tasse. Bambusfaser/ PP. 350 ml.
Tasse. Fibre Bambou/ PP. 350 ml.
Mok. Bamboe Fibre/ PP. 350 ml.

Ø 7.9 × 8.8 cm

Print Code: E(4)



BPA FREE



350 ml

100 / 50

bamboo fibre



929



Ditul

6381

Frisbee. Bamboo Fibre/ PP.
Frisbie. Bambusfaser/ PP.
Frisbee. Fibre Bambou/ PP.
Frisbie. Bamboe Fibre/ PP.

▬▬▬▬▬ Ø 22.8 × 2.5 cm 📦 200 / 100

🌈 Print Code: D(1)



Darfil

6379

Money Box. Bamboo Fibre/ ABS.
Sparschwein. Bambusfaser/ ABS.
Tirelire. Fibre Bambou/ ABS.
Spaarpot. Bamboe Fibre/ ABS.

▬▬▬▬▬ 10 × 6.8 × 7.1 cm 📦 100 / 10

🌈 Print Code: D(4)



Runux

6380

Yoyo. Bamboo Fibre/ PP.
Yoyo. Bambusfaser/ PP.
Yoyo. Fibre Bambou/ PP.
Jojo. Bamboe Fibre/ PP.

▬▬▬▬▬ Ø 5 × 1.5 cm 📦 500 / 100

🌈 Print Code: C(4), W





Sutrox

5719

Puzzle. Wood. 9 Pieces.
Puzzle. Holz. 9 Stück.
Puzzle. Bois. 9 Pièces.
Puzzel. Hout. 9 Stuks.

14.6 × 14.6 × 0.5 cm 200 / 50

Print Code: D(1), W



wood
fun

930



Cretium

5715

Yoyo. Wood.
Yoyo. Holz.
Yoyo. Bois.
Jojo. Hout.

Ø 5 × 2.8 cm 300 / 50

Print Code: C(4), L1, W



Grapex

6417

Game. Wood. 9 Pieces.
Spiel. Holz. 9 Stück.
Jeu. Bois. 9 Pièces.
Spel. Hout. 9 Stuks.

7.3 × 3.1 × 7.3 cm 200 / 50

Print Code: D(4), L2, W



skill game

WOOD

Did you know these games improve your skills and enhance brainwork? Learning to overcome challenges sharpens intelligence. Moreover, a positive correlation between these kind of games and the IQ levels of the people who play them regularly has been observed.

¿Sabías que estos juegos mejoran las habilidades de pensamiento y perfeccionan la capacidad de razonamiento?.

Aprender a superar los desafíos agudiza la inteligencia, además se ha demostrado una relación positiva entre los juegos y los niveles de coeficiente intelectual de las personas que se entretienen con ellos de forma regular.



Sabix



COTTON POUCH

Bruffy

6781

Skill Game. Wood. 6 Pieces.
Geschicklichkeitsspiel. Holz. 6 Stück.
Jeu d'Habileté. Bois. 6 Pièces.
Behendigheidsspel. Hout. 6 Stuks.

5 × 5 × 5 cm

200 / 100

Print Code: G(1), N(8)



COTTON POUCH

Tayex

6782

Skill Game. Wood. 7 Pieces.
Geschicklichkeitsspiel. Holz. 7 Stück.
Jeu d'Habileté. Bois. 7 Pièces.
Behendigheidsspel. Hout. 7 Stuks.

4.5 × 4.5 × 4.5 cm

200 / 100

Print Code: G(1), N(8)



COTTON POUCH

Sabix

6419

Game. Wood. 45 Pieces.
Spiel. Holz. 45 Stück.
Jeu. Bois. 45 Pièces.
Spel. Hout. 45 Stuks.

5.7 × 17 × 5.7 cm

50

Print Code: G(1), N(8), L1



3 GAME SET /
SET 3 JUEGOS

Genium

5525

Skill Games Set. Wood. 3 Games.
Geschicklichkeitsspiele Set. Holz. 3 Spiele.
Set Jeux d'Habiletés. Bois. 3 Jeux.
Behendigheidsspel Set. Hout. 3 Spelen.

16.3 × 6 × 6.4 cm 50

Print Code: D(4), L2, W



WOOD
FUN

932



Kelpet

5716

Dominoes. Wood. 28 Pieces.
Domino. Holz. 28 Stück.
Dominoes. Bois. 28 Pièces.
Domino. Hout. 28 Stuks.

15 × 3 × 5 cm 100 / 50

Print Code: D(4), L2, W



Mikado

5718

Skill Game. Wood. 41 Pieces.
Geschicklichkeitsspiel. Holz. 41 Stück.
Jeu d'Habileté. Bois. 41 Pièces.
Behendigheidsspel. Hout. 41 Stuks.

19.3 × 2.5 × 4.1 cm 100 / 50

Print Code: D(2), L2, W

Jetex

5117

Skill Game. Wood. 7 Pieces.
Geschicklichkeitsspiel. Holz. 7 Stück.
Jeu d'Habileté. Bois. 7 Pièces.
Behendigheidsspel. Hout. 7 Stuks.

4.5 x 4.5 x 4.5 cm 200 / 100
Print Code: E(1), N(8)



WOOD
FUN

Dokym

5717

Skill Game. Wood. 33 Pieces.
Geschicklichkeitsspiel. Holz. 33 Stück.
Jeu d'Habileté. Bois. 33 Pièces.
Behendigheidsspel. Hout. 33 Stuks.

12.5 x 17 cm 300 / 50
Print Code: E(1), N(8)



933



05

03

19

Pent

9482

Pencil. Wood.
Bleistift. Holz.
Crayon. Bois.
Potlood. Hout.



Unsharpened

1.9 x 21 cm 600 / 50

Print Code: B(4), L1



Unsharpened

Zhilian

6442

Pencil. Wood.
Bleistift. Holz.
Crayon. Bois.
Potlood. Hout.

8 x 22 x 4.6 cm 500 / 25

Print Code: B(4), L1



Tangram

3704

Puzzle. Wood. 7 Pieces.
Puzzle. Holz. 7 Stück.
Puzzle. Bois. 7 Pièces.
Puzzel. Hout. 7 Stuks.

9.8 x 9.8 x 0.7 cm 400 / 100

Print Code: E(1), L2



Yumbi

6360

Kite. Polyester 190T. 4 Crayons Included.
 Drachen. Polyester 190T. 4 Wachsmalstifte Inklusive.
 Cerf-Volant. Polyester 190T. 4 Crayons Inclus.
 Vlieger. Polyester 190T. 4 Krijtjes Inclusief.

49 x 60 cm 200 / 10

Print Code: G(1)



934



Tizy

4892

Apron. Non-Woven. One Size. Kids. 5 Markers Included.
 Schürze. Non-Woven. Einheitsgröße. Kinder. 5 Markers Inklusive.
 Tablier. T.N.T.. Taille Unique. Enfant. 5 Marqueurs Inclus.
 Schort. Non-Woven. Eén Maat. Kind. 5 Stiften inclusief.

43 x 43 cm 200 / 50

Print Code: G(1)



Rozim

5702

Place Mat. Non-Woven. 5 Crayons Included.
 Matte. Non-Woven. 5 Wachsmalstifte Inklusive.
 Set Table. T.N.T.. 5 Crayons Inclus.
 Placemat. Non-Woven. 5 Krijtjes Inclusief.

40 x 30 x 0.1 cm 200 / 50

Print Code: F(1)



Backys
4893

Drawstring Bag. Non-Woven. 5 Markers Included.
Rucksack. Non-Woven. 5 Markers Inklusive.
Sac à Dos. T.N.T. 5 Marqueur Inclus.
Rugzak. Non-Woven. 5 Stiften Inclusief.

25 x 30 cm 200 / 50

Print Code: G(1)



Wizzy
5701

Drawstring Bag. Non-Woven. 5 Crayons Included.
Rucksack. Non-Woven. 5 Wachsmalstifte Inklusive.
Sac à Dos. T.N.T. 5 Crayons Inclus.
Rugzak. Non-Woven. 5 Krijtjes Inclusief.

25 x 30 cm 200 / 50

Print Code: G(1)



Mosby
5439

Bag. Non-Woven. 5 Crayons Included.
Tasche. Non-Woven. 5 Wachsmalstifte Inklusive.
Sac. T.N.T. 5 Crayons Inclus.
Tas. Non-Woven. 5 Krijtjes Inclusief.

20.5 x 22 cm 100 / 50

Print Code: F(1)



Skinga
5703

Pencil Case. Non-Woven. 5 Crayons Included.
Federmappe. Non-Woven. 5 Wachsmalstifte Inklusive.
Trousse. T.N.T. 5 Crayons Inclus.
Etui. Non-Woven. 5 Krijtjes Inclusief.

22 x 11 cm 200 / 50

Print Code: F(1)

colouring fun



Zeta 3301

Puzzle. 24 Pieces. 4 Crayons Included.
Puzzle. 24 Stück. 4 Wachsmalstifte Inklusiv.
Puzzle. 24 Pièces. 4 Crayons Inclus.
Puzzel. 24 Stuks. 4 Krijtjes Inclusief.

15 x 10 x 0.3 cm 200 / 20

Print Code: D(1), W



936

4 STICKERS /
4 PEGATINAS



Varnils 6003

Set. 4 Markers and 4 Stickers Included.
Set. 4 Stifte und 4 Aufkleber Inklusiv.
Set. 4 Feutres et 4 Adhésifs Inclus.
Set. 4 Markers en 4 Stickers Inclusief.

13.8 x 23 cm 200 / 50

Print Code: C(1)



Fesient 6020

Mug. PS/PP. 320 ml. Individual Presentation. 4 Pencils and 4 Sheets Included.
Tasse. PS/PP. 320 ml. Individuelle Präsentation. 4 Stifte und 4 Seiten Inklusiv.
Tasse. PS/PP. 320 ml. Présentation Individuelle. 4 Crayons et 4 Feuilles Inclus.
Mok. PS/PP. 320 ml. Individuele Presentatie. 4 Potloden en 4 Blaadjes Inclusief.

Ø 8.6 x 10.2 cm 36

Print Code: E(1)



320 ml



4 DIFFERENT DESIGNS INCLUDED
4 LÁMINAS DIFERENTES INCLUIDAS



60 Sheets
Plain

Lumar

5997

Set. 6 Pieces. 60 Sheets Notepad.
Set. 6 Stück. 60 Seiten Notizblock.
Set. 6 Pièces. Bloc 60 Feuilles.
Set. 6 Stuks. 60 Blaadjes Notepad.

10.4 × 10.4 × 1.3 cm 200 / 100

Print Code: D(1)

03



05

16

19



20 DESIGNS INCLUDED
20 LÁMINAS INCLUIDAS

Figgy

4455

Set. 8 Pieces. 20 Sheets Notepad.
Set. 8 Stück. 20 Seiten Notizblock.
Set. 8 Pièces. Bloc 20 Feuilles.
Set. 8 Stuks. 20 Blaadjes Notepad.

7.4 × 9 × 1.5 cm 400 / 50

Print Code: C(4), W



19



03

01

05

Yisus

5203

Set. 7 Pieces. 20 Sheets Notepad.
Set. 7 Stück. 20 Seiten Notizblock.
Set. 7 Pièces. Bloc 20 Feuilles.
Set. 7 Stuks. 20 Blaadjes Notepad.

9.2 × 13.1 × 1.5 cm 400 / 100

Print Code: C(4), W

20 DESIGNS INCLUDED
20 LÁMINAS INCLUIDAS



12 DESIGNS INCLUDED
12 LÁMINAS INCLUIDAS



Boltex

5645

Mandala Set. 12 Pencils and 12 Sheets Included.
Mandala Set. 12 Stifte und 12 Seiten Inklusiv.
Set Mandala. 12 Crayons et 12 Feuilles Inclus.
Mandala Set. 12 Potloden en 12 Blaadjes Inclusief.

9 × 9 × 1 cm 300 / 20

Print Code: C(4), W





19



05



03

Learning

3139

Whiteboard. Felt Tip Pen and Eraser Included.

Tafel. Filzstift und Radierer Inklusief.

Ardoise. Feutre et Effaceur Inclus.

Whiteboard. Felt Tip Pen en Gum Inclusief.

19.8 x 17 x 1.4 cm 200 / 50

Print Code: D(1)

938



borrar y
empezar

TWO SIDES
2 CARAS



Marnik

5479

Whiteboard. 3 Chalks, Felt Tip Pen and Eraser Included.

Tafel. 3 Kreiden, Filzstift und Radierer Inklusief.

Ardoise. 3 Craies, Feutre et Effaceur Inclus.

Whiteboard. 3 Krijtjes, Felt Tip Pen en Gum Inclusief.

31 x 21 x 1.2 cm 50

Print Code: D(1), L2



01

LOCK AND ERASER BUTTON INCLUDED



02

Koptul

6247



LCD Writing Tablet. Magnetic. Pen and Button Battery Included.

LCD-Schreibtablett. Magnetisch. Bleistift und Knopfzelle Inklusief.

Tablette d'écriture LCD. Magnétique. Crayon et Pile Bouton Inclus.

LCD Tablet om te Schrijven. Magnetisch. Potlood en Knopcel Batterij Inclusief.

14.7 x 22.5 x 0.5 cm 100 / 50

Print Code: F(1), W



colouring fun



Miney 9161

Crayon Set. 6 Interchangeable Leads.
Wachsmalstiftlee. 6 Austauschbare Minen.
Crayons de Cire. 6 Mines Interchangeables.
Wasco Set. 6 Verwisselbare Leds.

1.8 x 9.8 x 1.5 cm 500 / 100

Print Code: D(1)



01

Clown 9710

Pencil Case. 14 Pieces.
Federmappe. 14 Stück.
Trousse. 14 Pieces.
Etui. 14 Stuks.

9.6 x 13.8 x 2.5 cm 144 / 24

Print Code: D(4)



03



19



19

Trinen 4907

Pencil Case. 29 Pieces.
Federmappe. 29 Stück.
Trousse. 29 Pieces.
Etui. 29 Stuks.

18 x 18.5 x 3.5 cm 50

Print Code: D(1)



05



03

recycled cardboard

Aladín



8722

Set. 19 Pieces.

Set. 19 Stück.

Set. 19 Pièces.

Set. 19 Stuks.

 7,8 × 18,5 × 1,2 cm  200 / 25

 Print Code: C(4)

LOVE
PLANET

Pichi

8719

Crayon Set. 6 Crayons.

Wachsmalstifte Set. 6 Wachsmalstifte.

Boite Crayons. 6 Crayons.

Wasco Set. 6 Krijtjes.

 5,3 × 9 × 0,9 cm  250 / 25

 Print Code: B(4), W

Pixi



3641

Set. 13 Pieces.

Set. 13 Stück.

Set. 13 Pièces.

Set. 13 Stuks.

 Ø 4,6 × 10 cm  200 / 10

 Print Code: B(4), W

Remix

6083

Chalk Set. 4 Chalks.

Kreiden Set. 4 Kreiden.

Craies Crayons. 4 Craies.

Krijtjes Set. 4 Krijtjes.

 9,5 × 11 × 2,5 cm  100 / 50

 Print Code: B(4)



Tynie

4456

Pencil Set. 4 Pencils.
Bleistiftbox. 4 Stifte.
Boite Crayons. 4 Crayons.
Potlood Set. 4 Potlood.

3 × 9 × 0.8 cm 1000 / 50

Print Code: B(4), W

Girls

8585

Pencil Set. 6 Pencils.
Bleistiftbox. 6 Stifte.
Boite Crayons. 6 Crayons.
Potlood Set. 6 Potlooden.

4.5 × 9 × 0.8 cm 500 / 25

Print Code: B(4), W

THE BEST PRICE
& THE BEST-SELLER

Baby

9162

Set. 7 Pieces.
Set. 7 Stück.
Set. 7 Pièces.
Set. 7 Potlooden.

∅ 2.7 × 10.2 cm 400 / 50

Print Code: B(4), W



recycled
cardboard

Boys

8584

Pencil Set. 12 Pencils.
Bleistiftbox. 12 Stifte.
Boite Crayons. 12 Crayons.
Potlood Set. 12 Potlood.

9 × 9 × 1 cm 250 / 25

Print Code: C(4), W



941

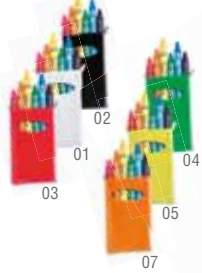

Tune

9831

Crayon Set. 6 Crayons.
Wachsmalstifte Set. 6 Wachsmalstifte.
Boite Crayons. 6 Crayons.
Wasco Set. 6 Krijtjes.

5 × 8.3 × 0.8 cm 400 / 50

Print Code: B(4), W



19



05

942

Garten

9830

Pencil Set. 6 Pencils.
Bleistiftbox. 6 Stifte.
Boite Crayons. 6 Crayons.
Potlood Set. 6 Potlooden.

5 × 9.3 × 0.8 cm 500 / 50

Print Code: B(4), W



03

07

04

19

02

01



21

Palty

4710

Set. 7 Pieces.
Set. 7 Stuck.
Set. 7 Pieces.
Set. 7 Stuks.

∅ 2.7 × 10.2 cm 400 / 50

Print Code: B(4), W



07

05

04

03

02

01

11



FUN COLORING



19

Migal

5139

Pencil Case. Polyester 420D. 10 Pieces.
Federmappe. Polyester 420D. 10 Stück.
Trousse. Polyester 420D. 10 Pieces.
Etui. Polyester 420D. 10 Stuks.

4.5 × 10 × 4 cm 400 / 10

Print Code: D(1), N(8)



01

05

03

04



ts

love



Dragon 3386

Pencil Set. Wood. 6 Pencils.
Bleistiftbox. Holz. 6 Stifte.
Boîte Crayons. Bois. 6 Crayons.
Potlood Set. Hout. 6 Potlooden.

20.5 x 2.5 x 3.5 cm 200 / 50
Print Code: D(2), L2



Gabon 5647

Set. 5 Pieces.
Set. 5 Stück.
Set. 5 Pièces.
Set. 5 Stuks.

4.5 x 17.7 x 1.5 cm 400 / 50
Print Code: B(4), W

943



x 3 pcs

Dony 3643

Set. 6 Pieces.
Set. 6 Stück.
Set. 6 Pièces.
Set. 6 Stuks.

4.5 x 17.7 x 1.3 cm 240 / 20
Print Code: B(4), W



Laptan 4709

Set. 4 Pieces.
Set. 4 Stück.
Set. 4 Pièces.
Set. 4 Stuks.

6.5 x 22 x 1 cm 400 / 20
Print Code: C(1)





944



18 cm



32 cm



Pimbur
5128



Pencil. PVC. Flexible.
Bleistift. PVC. Flexibel.
Crayon. PVC. Flexible.
Potlood. PVC. Flexibel.

Ø 0.6 × 18 cm 1000 / 100
Print Code: B(1)

Flexi
3095



Pencil. PVC. Flexible.
Bleistift. PVC. Flexibel.
Crayon. PVC. Flexible.
Potlood. PVC. Flexibel.

Ø 0.6 × 32 cm 1000 / 100
Print Code: B(1)

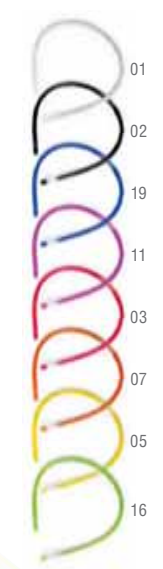

Zhilian
6442

Pencil. Wood.
Bleistift. Holz.
Crayon. Bois.
Potlood. Hout.

8 × 22 × 4.6 cm 500 / 25
Print Code: B(4), L1



Tercel
5218

Pencil. Wood. 3 Erasers Included.
Bleistift. Holz. 3 Radiergummis Inklusiv.
Crayon. Bois. 3 Gommies Inclusif.
Potlood. Hout. 3 Gummien Inclusief.

2.7 × 18.7 × 1.2 cm 300 / 50
Print Code: B(4), L1



Minik
3850

Pencil. Wood.
Bleistift. Holz.
Crayon. Bois.
Potlood. Hout.

Ø 0.7 × 10 cm 2000 / 100
Print Code: A(4), L1



Koby

4711

Pencil. Wood.
Bleistift. Holz.
Crayon. Bois.
Potlood. Hout.

▮▮▮▮▮▮ Ø 0.7 × 17.7 cm 📦 2000 / 100

🎨 Print Code: A(4), L1



Unsharpened

11



WOOD

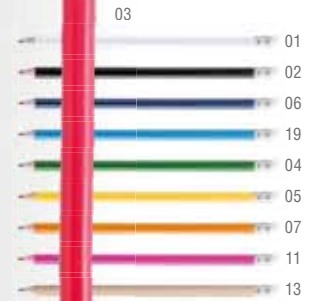

+10.000 uds
PRINTING 30% Dto.

Godiva

8587

Pencil. Wood.
Bleistift. Holz.
Crayon. Bois.
Potlood. Hout.

▮▮▮▮▮ Ø 0.7 × 18.6 cm 📦 2000 / 100

🎨 Print Code: A(4), L1



Sharpened

THE BEST PRICE



ERASER COLOR /
GOMA DE COLOR



ERASER COLOR /
GOMA DE COLOR

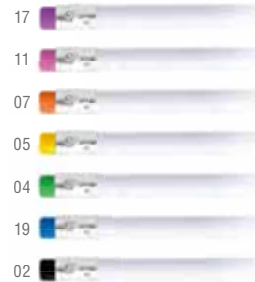

Togi

4173

Pencil. Wood.
Bleistift. Holz.
Crayon. Bois.
Potlood. Hout.

▮▮▮▮▮ Ø 0.7 × 19 cm 📦 2000 / 100

🎨 Print Code: A(4), L1



Unsharpened

Melart

5643

Pencil. Wood.
Bleistift. Holz.
Crayon. Bois.
Potlood. Hout.

▮▮▮▮▮ Ø 0.7 × 18.6 cm 📦 2000 / 100

🎨 Print Code: A(4), L1



Sharpened

Naftar

6070

Pencil. Wood.
Bleistift. Holz.
Crayon. Bois.
Potlood. Hout.

▮▮▮▮▮ Ø 0.7 × 18.6 cm 📦 2000 / 100

🎨 Print Code: A(4), L1



Unsharpened

Sukon

6766

Antibacterial Pencil. Wood.
Antibakteriell Bleistift. Holz.
Crayon Antibactérien. Bois.
Antibacterieel Potlood. Hout.

▮▮▮▮▮ Ø 0.7 × 18.6 cm 📦 2000 / 100

🎨 Print Code: B(4), L1



Unsharpened



Antibacterial

NEW

945



03

Dekot

6057

Eraser.
Radiergummi.
Gomme.
Gum.

2.5 × 5.4 × 1.3 cm 600 / 50

Print Code: B(4)



Crats

4808

Eraser Set. 4 Pieces.
Radiergummi Set. 4 Stück.
Set Gomme. 4 Pieces.
Gummen Set. 4 Stuks.

3.4 × 3.7 × 2.8 cm 200 / 50

Print Code: B(4)



19

03

05

Cafey

3337

Set. Eraser and Sharpener.
Set. Radiergummi und Anspitzer.
Set. Gomme et Taille-Crayon.
Set. Gum en Potlood Slijper.

6 × 2.1 × 3 cm 600 / 20

Print Code: B(4)



03

04

19

Longi

3425

Sharpener.
Anspitzer.
Taille-Crayons.
Potlood Slijper.

3.7 × 6 × 4.2 cm 600 / 50

Print Code: C(1)

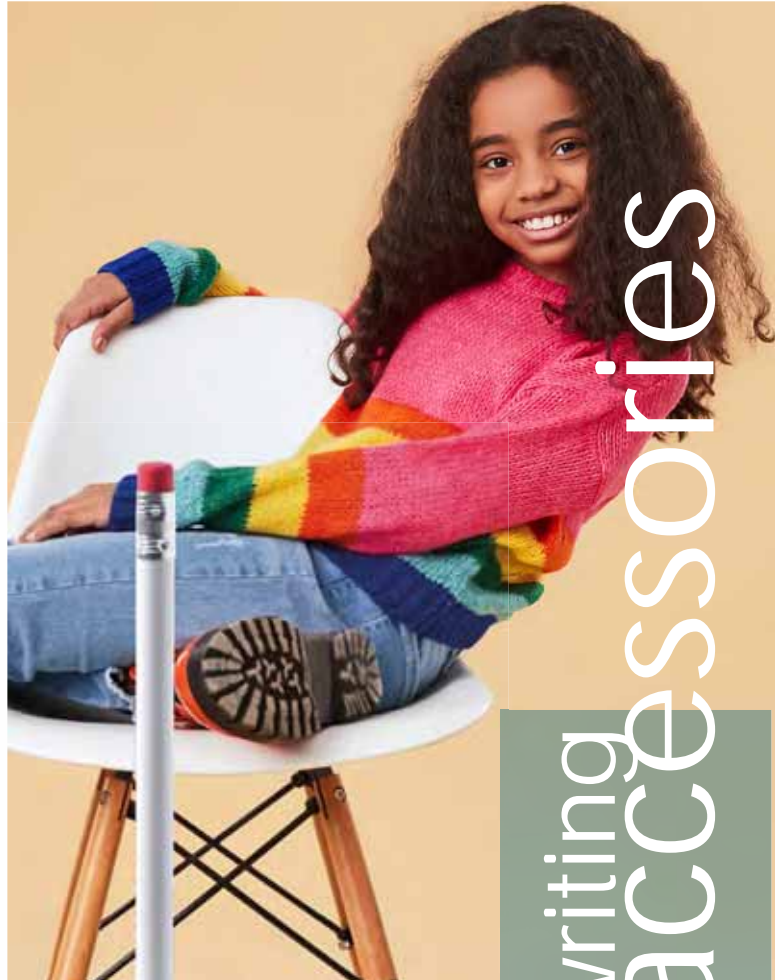

writing accessories



Layax

5024

Highlighter Set. 5 Pieces.
Textmarker Set. 5 Peças.
Set Surligneurs. 5 Pièces.
Markers Set. 5 Stuks.

5.7 × 7.8 × 7.4 cm 200 / 20

Print Code: C(1)





LIGHT PEN

Nicky
4707

Pen. Led Lights. Button Batteries Included.
Kugelschreiber. Led Lichter. Knopfzellen Inklusive.
Stylo. Lumières Led. Piles Bouton Inclus.
Pen. Led Lichten. Knopcel Batterijen Inclusief.

Ø 2.8 x 18.5 cm 500 / 50
Print Code: B(1)



Gradox
5735

Pen. Kugelschreiber.
Stylo. Pen.
Ø 2.3 x 17.5 cm 1000 / 50
Print Code: B(4)



Mustap
4524

Pen Torch. 2 Leds. Button Batteries Included.
Kugelschreiber Lampe. 2 Leds. Knopfzellen Inklusive.
Stylo Lampe. 2 Leds. Piles Bouton Inclus.
Pen-Zaklamp. 2 Leds. Knopcelbatterij Inclusief.
Ø 2.1 x 13 cm 500 / 50
Print Code: B(4)



Tinga
3818

Torch Pen. 1 Led. Button Batteries Included.
Lampe Kugelschreiber. 1 Led. Knopfzellen Inklusive.
Lampe Stylo. 1 Led. Piles Bouton Inclus.
Zaklamp Pen. 1 Led. Knopcel Batterijen Inclusief.
Ø 2.2 x 12 cm 500 / 50
Print Code: B(4)





Okam

3728

Ruler Magnifier Bookmark.
Lineal Lupe Lesezeichen.
Règle Loupe Marque Pages.
Liniaal Vergrootglas Bladwijzer.

13.9 × 3.7 × 0.2 cm 2500 / 500

Print Code: C(4)

948



03

MAGNET

Magnet

Sumit

3932

Bookmark. Magnetic.
Lesezeichen. Magnetisch.
Marque Pages. Magnétique.
Bladwijzer. Magnetisch.

2 × 6 × 0.2 cm

Print Code: C(4)

2000 / 500



writing accessories

Vilatak

5390

Lamp. 1 Led. Button Batteries Included.
Lampe. 1 Led. Knopfzellen Inklusive.
Lampe. 1 Led. Piles Bouton Inclus.
Lamp. 1 Led. Knoopcel Batterijen Inclusief.

4 × 10 × 9.5 cm 400 / 50

Print Code: E(4)

03



Lektura

3585

Lamp. 1 Led. Flexible. Button Batteries Included.
Lampe. 1 Led. Flexibel. Knopfzellen Inklusive.
Lampe. 1 Led. Flexible. Piles Bouton Inclus.
Lamp. 1 Led. Flexibel. Knoopcel Batterijen Inclusief.

3 × 25 × 2 cm 200 / 50

Print Code: E(1)

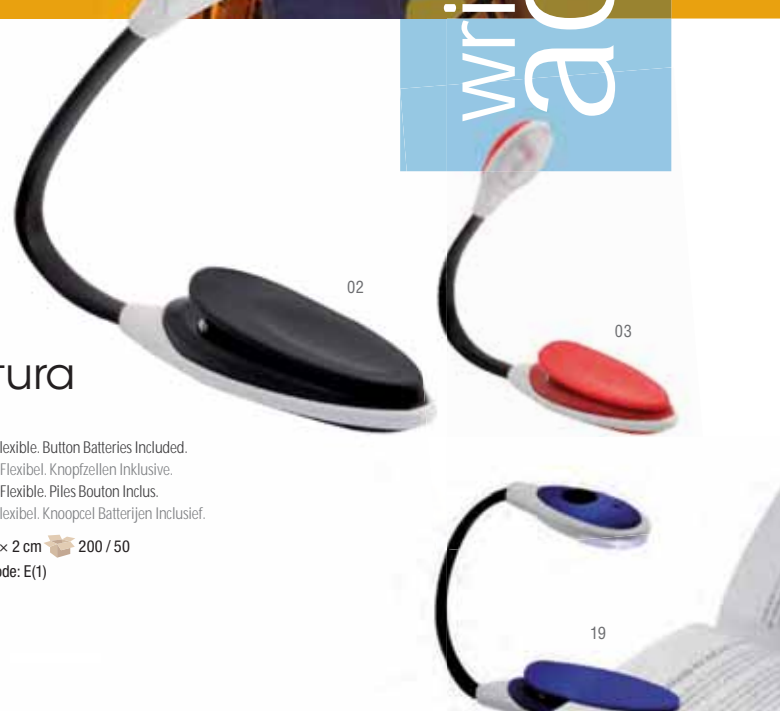

02

03

19

ANTIBACTERIAL

ISO
22196
CERTIFIED



NEW



Nitria

6679

Antibacterial Ruler.
Antibakterieel Lineal.
Règle Antibactérienne.
Antibacterieel Lijntaal.

31.5 × 4 × 0.2 cm

500 / 100

Print Code: D(1), W



FLEXIBLE

Flexor

3055

Ruler. Flexible.
Lineal. Flexibel.
Règle. Flexible.
Lijntaal. Flexibel.

30.5 × 3 × 0.3 cm

500 / 125

Print Code: D(1)

07

03

30 cm

19

05

Ruler

CONSULT



30 cm

Eding

8738

Ruler. Transparent.
Lineal. Durchsichtig.
Règle. Transparent.
Lijntaal. Transparent.

31.4 × 3.5 × 0.2 cm

600 / 100

Print Code: D(1), W

19

03

05



15 cm

Hebe

3811

Ruler.
Lineal.
Règle.
Lijntaal.

16 × 4.2 × 0.2 cm

1000 / 100

Print Code: D(4), W



Yubesk

6038

Pencil Case. Laminated Paper.
 Federmappe. Laminiertes Papier.
 Trousse. Papier Laminé.
 Etui. Gelamineerd Paper.

22.3 x 8.8 cm 200 / 50

Print Code: E(1)

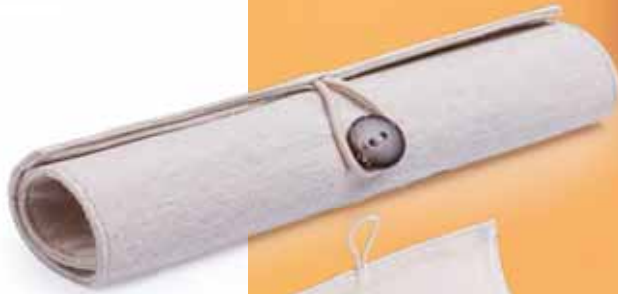

PENCIL CASE
 + 5 PIECES
 ESTUCHE + 5 PIEZAS



950

Sulpox

6166

Pencil Case. Jute/ Cotton. 5 Pieces.
 Federmappe. Jutesstoff/ Baumwolle. 5 Stück.
 Trousse. Jute/ Coton. 5 Pièces.
 Etui. Jute/ Katoen. 5 Stuks.

20 x 20 cm 200 / 50

Print Code: E(1), N(8)



PENCIL CASE
 + 5 PIECES
 ESTUCHE + 5 PIEZAS



Marfik

6167

Pencil Case. Jute/ Cotton. 5 Pieces.
 Federmappe. Jutesstoff/ Baumwolle. 5 Stück.
 Trousse. Jute/ Coton. 5 Pièces.
 Etui. Jute/ Katoen. 5 Stuks.

19 x 8.5 cm 200 / 50

Print Code: F(1)



Kinsy

6121

Pencil Case. 100% Cotton.
 Federmappe. 100% Baumwolle.
 Trousse. 100% Coton.
 Etui. 100% Katoen.

7 x 22 cm 500 / 50

Print Code: E(1), N(8)

eco-friendly
 pencil case





19



Celes 3987

Pencil Case. Polyester 600D.
Federmappe. Polyester 600D.
Trousse. Polyester 600D.
Etui. Polyester 600D.

Ø 6.5 × 22.5 cm 250 / 10

Print Code: E(1), N(8), 0



05



03

03



04

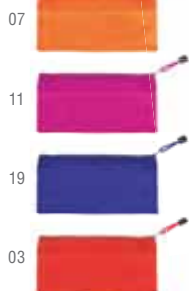

Latber

4575

Pencil Case. PVC.
Federmappe. PVC.
Trousse. PVC.
Etui. PVC.

24.5 × 11.5 cm 500 / 10

Print Code: E(1)

Tage

9976

Pencil Case. Polyester 600D.
Federmappe. Polyester 600D.
Trousse. Polyester 600D.
Etui. Polyester 600D.

22 × 11.5 cm 500 / 10

Print Code: E(1), N(8), 0



Atecx

5514

Pencil Case. Polyester 600D.
Federmappe. Polyester 600D.
Trousse. Polyester 600D.
Etui. Polyester 600D.

5 × 20 × 4.5 cm 500 / 10

Print Code: E(1), N(8), 0



05

19

13

02

special design



80 Sheets
Lined



HelloKitty

Nabel 7263

Multipurpose Bag. Polyester 600D.
Mehrzwecktasche. Polyester 600D.
Fourre-Tout. Polyester 600D.
Multifunctioneel Tasje. Polyester 600D.

18.5 × 10.5 cm 500 / 10
Print Code: E(1), N(8), 0

Bintex 7264

Notebook. Hard Cover. 80 Sheets.
Notizbuch. Hardcover-Abdeckung. 80 Seiten.
Cahier. Couverture Rigide. 80 Feuilles.
Notitieboek. Harde Kaft. 80 Blaadjes.

12.5 × 14.3 × 1 cm 100 / 25
Print Code: E(1)



80 Sheets
Plain

I AM
INTERACTIVE!



09

09



11

19

03

Velmont 5932

Noteпад. Hard Cover. 80 Sheets.
Notizblock. Hardcover-Abdeckung. 80 Seiten.
Bloc Notes. Couverture Rigide. 80 Feuilles.
Notitieblokje. Harde Kaft. 80 Blaadjes.

14.5 × 21.5 × 2 cm 40 / 20

Print Code: G(1)



Video



03

19

11

Bellagios 5927

Multipurpose Bag. Polyester. With Inner Lining.
Mehrzwecktasche. Polyester. Mit Innenfutter.
Fourre-Tout. Polyester. Avec Doubleure Antérieure.
Multifunctioneel Tasje. Polyester. Met Voering aan de Binnenzijde.

21 × 9 × 4.5 cm 300 / 10
Print Code: G(1)



19



05

Felty

4129

Pencil Case. Felt.
 Federmappe. Filz.
 Trousse. Feutrine.
 Etui. Viilt.

20 × 9 cm 400 / 100

Print Code: E(1), N(8)



05



02



Nayxo

4921

Pencil Case. Polyester 600D.
 Federmappe. Polyester 600D.
 Trousse. Polyester 600D.
 Etui. Polyester 600D.

21 × 12.5 cm 250 / 50

Print Code: E(6), N(8), R



05

19

02

03



01



03



03

05



19

Landi

3701

Organizer Band. Nylon.
 Ordner Band. Nylon.
 Range Organiseur. Nylon.
 Organizer Band. Nylon.

2 × 18 × 0.2 cm 2000 / 100

Print Code: D(1)

Delia

9776

Set. 5 Pieces.
 Set. 5 Stück.
 Set. 5 Pièces.
 Set. 5 Stuks.

15.5 × 4 × 1.3 cm 500 / 50

Print Code: D(1)



19

Baiku

3616

Pencil Case Set. Non-Woven/ PVC. 7 Pieces.
 Federmappe Set. Non-Woven/ PVC. 7 Stück.
 Set Trousse. T.N.T./ PVC. 7 Pièces.
 Schooletui. Non-Woven/ PVC. 7 Stuks.

22 × 11.8 cm 200 / 50

Print Code: F(1)

Gulliver

Emerot

Mosku

954



13

03



80 Sheets
Lined

Gulliver

3389

Notebook. Recycled Cardboard. Hard Cover. 80 Sheets.
Notizbuch. Recycling Papppe. Hardcover-Abdeckung. 80 Seiten.
Cahier. Carton Recyclé. Couverture Rigide. 80 Feuilles.
Notitieboek. Gerecycled Karton. Harde Kaft. 80 Blaadjjes.

16.4 × 21.7 × 1.6 cm

50 / 25

Print Code: E(4)



13

19



80 Sheets
Lined

Emerot

3388

Notebook. Recycled Cardboard. Hard Cover. 80 Sheets.
Notizbuch. Recycling Papppe. Hardcover-Abdeckung. 80 Seiten.
Cahier. Carton Recyclé. Couverture Rigide. 80 Feuilles.
Notitieboek. Gerecycled Karton. Harde Kaft. 80 Blaadjjes.

11.6 × 15.3 × 1.6 cm

100 / 25

Print Code: E(4)

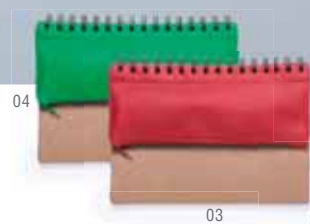

04

03



70 Sheets
Plain

Mosku

5661

Notebook. Recycled Cardboard. Hard Cover. 70 Sheets. Pencil Case Included. 6 Pieces.
Notizbuch. Recycling Papppe. Hardcover-Abdeckung. 70 Seiten. Estojto Includido. 6 Stuck.
Cahier. Carton Recyclé. Couverture Rigide. 70 Feuilles. Pencil Case Included. 6 Piéces.
Notitieboek. Gerecycled Karton. Harde Kaft. 70 Blaadjjes. Etui Inclusief. 6 Stuck.

15.5 × 21 × 0.9 cm

50 / 25

Print Code: F(1)



EXTRA HARD COVER
PORTADA EXTRA RIGIDA



80 Sheets
Lined



Zubar

6399

Notebook. Recycled Cardboard. Hard Cover. 80 Sheets.
Notizbuch. Recycling Pappe. Hardcover-Abdeckung. 80 Seiten.
Cahier. Carton Recyclé. Couverture Rigide. 80 Feuilles.
Notitieboek. Gerecycled Karton. Harde Kaft. 80 Blaadjjes.

15.5 × 21 × 1.8 cm 50 / 25

Print Code: E(4)

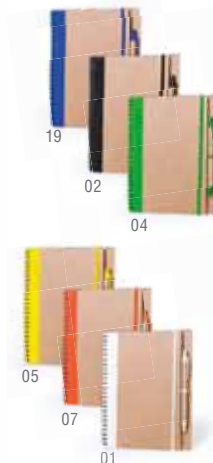
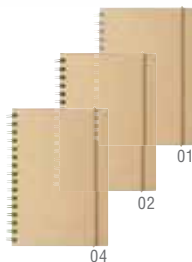

Tunel

3437



60 Sheets
Plain

Notebook. Recycled Cardboard. Hard Cover. 60 Sheets. Recycled Cardboard Pen Included.
Notizbuch. Recycling Pappe. Hardcover-Abdeckung. 60 Seiten. Recycling Pappe Kugelschreiber Inklusiv.
Cahier. Carton Recyclé. Couverture Rigide. 60 Feuilles. Stylo Carton Recyclé Inclus.
Notitieboek. Gerecycled Karton. Harde Kaft. 60 Blaadjjes. Pen Gerecycled Karton Inclusief.

16.5 × 21 × 1 cm 80 / 20

Print Code: E(4), B(4)



955



Zurix

6108

Notebook. Recycled Cardboard. 60 Sheets.
Notizbuch. Recycling Pappe. 60 Seiten.
Cahier. Carton Recyclé. 60 Feuilles.
Notitieboek. Gerecycled Karton. 60 Blaadjjes.

14.4 × 21 × 0.8 cm 100 / 10

Print Code: E(1)



60 Sheets
Lined

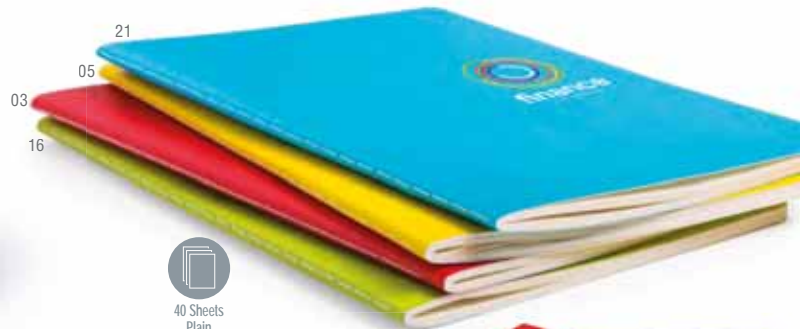

40 Sheets
Plain

Dienel

5118

Notebook. 40 Sheets.
Notizbuch. 40 Seiten.
Cahier. 40 Feuilles.
Notitieboek. 40 Blaadjjes.

14 × 20.5 × 0.4 cm 100 / 10

Print Code: E(1)



NEW

ANTIBACTERIAL
COVERS

Polax

2591

Antibacterial Notebook. 80 Sheets.
Antibakteriell Notizbuch. 80 Seiten.
Cahier Antibactérien. 80 Feuilles.
Antibacterieel Notitieboek. 80 Blaadjes.



15.5 x 21 x 1.6 cm

30

Print Code: E(4)



956



01

19

02

03

05



PP - FLEXIBLE



Duxo

3216



Mini Notebook. PP Plastic. 60 Sheets. Pen Included.
Mini Notizbuch. Plastik PP. 60 Seiten. Kugelschreiber Inklusive.
Mini Cahier. PP Plastique. 60 Feuilles. Stylo Inclus.
Mini Notitieboek. PP Plastic. 60 Blaadjes. Pen Inclusief.

7 x 9.5 x 0.7 cm 300 / 50

Print Code: D(4), B(4)

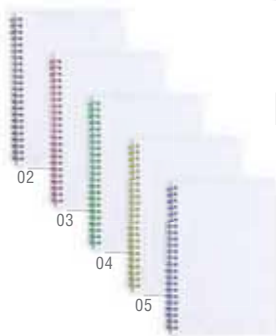

02

03

04

05

19

Nazga

5929

Notebook. PP Plastic. 80 Sheets.
Notizbuch. Plastik PP. 80 Seiten.
Cahier. PP Plastique. 80 Feuilles.
Notitieboek. PP Plastic. 80 Blaadjes.

15.5 x 21 x 0.8 cm 50

Print Code: E(4)



Pilaf

4670



Notebook. Recycled Cardboard. Hard Cover. 50 Sheets. Recycled Cardboard Pen Included.

Notizbuch. Recycling Pappe. Hardcover-Abdeckung. 50 Seiten. Recycling Pappe Kugelschreiber Inklusiv.

Cahier. Carton Recyclé. Couverture Rigide. 50 Feuilles. Stylo Carton Recyclé Inclus.

Notitieboek. Gerecycled Karton. Harde Kaft. 50 Blaadjes. Pen Gerecycled Karton Inclusief.

8.6 × 11.7 × 1.3 cm 200 / 50

Print Code: D(4), B(4)



50 Sheets
Lined

Tecnar

4730

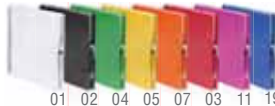

Notebook. Recycled Cardboard. Hard Cover. 80 Sheets. Recycled Cardboard Pen Included.

Notizbuch. Recycling Pappe. Hardcover-Abdeckung. 80 Seiten. Recycling Pappe Kugelschreiber Inklusiv.

Cahier. Carton Recyclé. Couverture Rigide. 80 Feuilles. Stylo Carton Recyclé Inclus.

Notitieboek. Gerecycled Karton. Harde Kaft. 80 Blaadjes. Pen Gerecycled Karton Inclusief.

23.7 × 29 × 2 cm 20

Print Code: E(4), B(4)



80 Sheets
Plain

Koguel

4729



Notebook. Recycled Cardboard. Hard Cover. 70 Sheets. Recycled Cardboard Pen Included.

Notizbuch. Recycling Pappe. Hardcover-Abdeckung. 70 Seiten. Recycling Pappe Kugelschreiber Inklusiv.

Cahier. Carton Recyclé. Couverture Rigide. 70 Feuilles. Stylo Carton Recyclé Inclus.

Notitieboek. Gerecycled Karton. Harde Kaft. 70 Blaadjes. Pen Gerecycled Karton Inclusief.

15 × 18.2 × 1.9 cm 50 / 25

Print Code: E(4), B(4)



70 Sheets
Plain

notebook



02

Susdal 6424

Backpack. Polyester 600D. Padded Back and Shoulder Straps.
Rucksack. Polyester 600D. Gepolsterter Rücken und Schultergurte.
Sac à Dos. Polyester 600D. Dos et Bretelles Rembourrées.
Rugzak. Polyester 600D. Gewatteerde Achterzijde en Schouderbanden.

25 × 30 × 12 cm 50

Print Code: F(1), N(8), O, P



03

19

05

04



Back-
pack

958



03

Multifunction



19

07

Fibri 9448

Trolley Backpack. Polyester 600D. Padded Back and Shoulder Straps.
Trolley Rucksack. Polyester 600D. Gepolsterter Rücken und Schultergurte.
Sac à Dos Trolley. Polyester 600D. Dos et Bretelles Rembourrées.
Trolley Rugzak. Polyester 600D. Gewatteerde Achterzijde en Schouderbanden.

29 × 50 × 18 cm 6

Print Code: H(8)



19

Kiddy 3257

Backpack. Polyester 600D.
Rucksack. Polyester 600D.
Sac à Dos. Polyester 600D.
Rugzak. Polyester 600D.

22 × 26.5 × 8 cm 100 / 20

Print Code: F(1), N(8), O



05

03



03



01 02 04 05 07 19

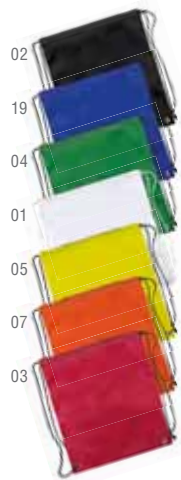

02
19
04
01
05
07
03



Local
Sublimation



11

Trokyn

6449

Drawstring Bag. Polyester 210D.
Rucksack. Polyester 210D.
Sac à Dos. Polyester 210D.
Rugzak. Polyester 210D.

31.5 × 42 cm

Print Code: F(1), R

300 / 10

Dinki

5091

Drawstring Bag. Polyester 210D.
Rucksack. Polyester 210D.
Sac à Dos. Polyester 210D.
Rugzak. Polyester 210D.

27 × 32 cm 500 / 50

Print Code: F(1), N(8), R



Reinforced
Corners



01



Kissa

4788

Foldable Drawstring Bag. Polyester 190T.
Faltbarer Rucksack. Polyester 190T.
Sac à Dos Pliable. Polyester 190T.
Opvouwbare Rugzak. Polyester 190T.

26.5 × 32.5 cm 500 / 10

Print Code: F(1), G(1)



19



05

07



B

Llorel

5705

Drawstring Bag. Polyester 210T.
Rucksack. Polyester 210T.
Sac à Dos. Polyester 210T.
Rugzak. Polyester 210T.

26 × 30 cm 500 / 10

Print Code: F(1), N(8)



I

J



Tradan 5235

Drawstring Cool Bag. Polyester 210D/ Aluminium.
Kühltasche Rucksack. Polyester 210D/ Aluminium.
Sac à Dos Glacière. Polyester 210D/ Aluminium.
Koeltas-Rugzak. Polyester 210D/ Aluminium.

19 27 × 33 cm 200 / 10

Print Code: G(1), N(8)

cool bag

960



19



11

Keixa 4111

Cool Bag. Non-Woven/ Aluminium.
Kühltasche. Non-Woven/ Aluminium.
Glacière. T.N.T./ Aluminium.
Koeltas. Non-Woven/ Aluminium.

18 × 25 × 11 cm 100 / 25

Print Code: F(1)



Rumbix 6092

Cool Bag. Laminated Paper/ Aluminium.
Kühltasche. Laminiertes Papier/ Aluminium.
Glacière. Papier Laminé/ Aluminium.
Koeltas. Gelamineerd Paper/ Aluminium.

20 × 25 × 10 cm 100 / 50

Print Code: F(1)



03

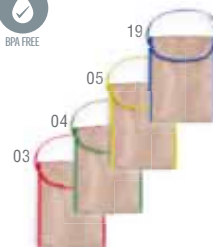

Bapom 6064

Thermal Bag. Laminated Paper/ Aluminium.
Wärme Tasche. Laminiertes Papier/ Aluminium.
Sac Thermique. Papier Laminé/ Aluminium.
Thermo-Tasje. Gelamineerd Paper/ Aluminium.

19 × 32 × 12 cm 100 / 50

Print Code: F(1)





Noix

2500

Sandwich Lunch Box. 450 ml.
Sandwich Lunch Box. 450 ml.
Gamelle Sandwich. 450 ml.
Boterhammen-Lunchbox. 450 ml.

13 × 5 × 13.5 cm 160 / 40

Print Code: E(1)



01

450 ml



BPA FREE



take
away

961

420 ml

Rufus

4028

Sandwich Holder. PVC/ Aluminium.
Lunch Box Tasche. PVC/ Aluminium.
Lunch-Box. PVC/ Aluminium.
Boterhammentrommel. PVC/ Aluminium.

21 × 7.5 × 8 cm 300 / 25

Print Code: E(1), N(8)



02



01

19

04

05

03



300ML



04



1L

Dusky

4876

Multipurpose Bag. LDPE.
Mehrzwecktasche. LDPE.
Fourre-Tout. LDPE.
Multifunctioneel Tasje. LDPE.

23 × 18 × 6.5 cm 1000 / 100

Print Code: E(1)

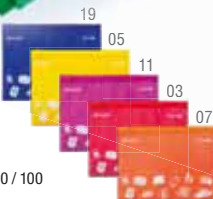

19

05

11

03

07

Fantiel

5413

Lunch Box. Lunch Box 1 L. Bottle 300 ml.
Lunch Box. Lunch Box 1 L. Flasche 300 ml.
Gamelle. Gamelle 1 L. Bouteille 300 ml.
Lunch Box. Lunch Box 1 L. Fles 300 ml.

14.5 × 8.7 × 20 cm 20

Print Code: E(1)



BPA FREE



03

05



03



BPA FREE

Yoplat

5572

Cup. PS. 420 ml.
Trinkbecher. PS. 420 ml.
Verre. PS. 420 ml.
Beker. PS. 420 ml.

Ø 9 × 16.3 cm 50

Print Code: E(1)



01

16

19



400 ml



19

04

03

Fraguen

4688

Cup. PP. 400 ml.
Trinkbecher. PP. 400 ml.
Verre. PP. 400 ml.
Beker. PP. 400 ml.

Ø 8.3 × 12.5 cm 300 / 10

Print Code: E(1)

962



380 ml

19

Chiko

3171

Cup. PP. 380 ml.
Trinkbecher. PP. 380 ml.
Verre. PP. 380 ml.
Beker. PP. 380 ml.

Ø 9 × 10.6 cm 300 / 10

Print Code: E(1)



01
03
02
07
04
05

Boxter

3584

Bottle. PET. 400 ml.
Trinkflasche. PET. 400 ml.
Bidon. PET. 400 ml.
Fles. PET. 400 ml.

11.5 × 26.5 × 3 cm 400 / 50

Print Code: E(1)

19

400 ml



440 ml

19

tritan
Tritan® material



Deldye

5560

Bottle. Tritan. 440 ml. Individual Presentation.
Trinkflasche. Tritan. 440 ml. Individuelle Präsentation.
Bidon. Tritan. 440 ml. Presentation Individuelle.
Fles. Tritan. 440 ml. Individuele Presentatie.

Ø 7 × 16 cm 50

Print Code: F(1)



05

03



Witar
2495

Mug. PP. 370 ml.
Tasse. PP. 370 ml.
Tasse. PP. 370 ml.
Mok. PP. 370 ml.

Ø 8.5 × 9 cm 36

Print Code: E(1)



370 ml



Fesient
6020

Mug. PS/PP. 320 ml. Individual Presentation. 4 Pencils and 4 Sheets Included.
Tasse. PS/PP. 320 ml. Individuelle Präsentation. 4 Stifte und 4 Seiten Inklusiv.
Tasse. PS/PP. 320 ml. Présentation Individuelle. 4 Crayons et 4 Feuilles Inclus.
Mok. PS/PP. 320 ml. Individuele Presentatie. 4 Potloden en 4 Blaadjes Inclusief.

Ø 8.6 × 10.2 cm 36

Print Code: E(1)

4 DIFFERENT DESIGNS INCLUDED
4 LÁMINAS DIFERENTES INCLUIDAS

320 ml



Nermon
5165

Cup. Ceramic. 460 ml. Individual Presentation. Chalk Included.
Trinkbecher. Keramik. 460 ml. Individuelle Präsentation. Kreide Inklusiv.
Verre. Céramique. 460 ml. Présentation Individuelle. Craie Inclus.
Beker. Keramiek. 460 ml. Individuele Presentatie. Krijtje Inclusief.

Ø 8.8 × 13.5 cm 36

Print Code: F(1)

460 ml



Dariel
5038

Mug. Ceramic. 370 ml. Individual Presentation. Chalk Included.
Tasse. Keramik. 370 ml. Individuelle Präsentation. Kreide Inklusiv.
Tasse. Céramique. 370 ml. Présentation Individuelle. Craie Inclus.
Mok. Keramiek. 370 ml. Individuele Presentatie. Krijtje Inclusief.

Ø 8.2 × 9.8 cm 36

Print Code: F(1)

370 ml



Colorful
3272

Mug. Ceramic. 350 ml. Individual Presentation. Chalk Included.
Tasse. Keramik. 350 ml. Individuelle Präsentation. Kreide Inklusiv.
Tasse. Céramique. 350 ml. Présentation Individuelle. Craie Inclus.
Mok. Keramiek. 350 ml. Individuele Presentatie. Krijtje Inclusief.

Ø 8.2 × 9.6 cm 36

Print Code: F(1)

350 ml

NEW



Ledis

6717

Sanitizer Wipes. 10 Pieces.
Hygiënisch Feuchttücher. 10 Stück.
Lingettes Hygiéniques. 10 Pièces.
Hygiënisch Poetsdoekjes. 10 Stuks.



15 × 8 × 1,5 cm

200 / 100

Print Code: C(1)

TOWEL
TOALLA



Spica

5292

Towel. 100% Cotton 245 g/ m². Folded Ø 4,5 cm.
Handtuch. 100% Baumwolle 245 g/ m². Faltung Ø 4,5 cm.
Serviette. 100% Coton 245 g/ m². Pliée Ø 4,5 cm.
Handdoek. 100% Katoen 245 g/ m². Gevouwen Ø 4,5 cm.

30 × 30 cm 300

Print Code: D(1), N(8)

964



Kotto

4554



Absorbent Towel. Microfibre 345 g/ m².
Saugfähiges Handtuch. Mikrofaser 345 g/ m².
Serviette Absorbante. Microfibre 345 g/ m².
Absorbierende Handdoek. Microfibre 345 g/ m².

30 × 45 cm 100

Print Code: F(1), N(8), O, P, R



Nalex

4829

Absorbent Towel. Microfibre 260 g/ m². Folded 5,5 x 14,5 x 3 cm.
Saugfähiges Handtuch. Mikrofaser 260 g/ m². Faltung 5,5 x 14,5 x 3 cm.
Serviette Absorbante. Microfibre 260 g/ m². Pliée 5,5 x 14,5 x 3 cm.
Absorbierende Handdoek. Microfibre 260g/ m². Gevouwen 5,5 x 14,5 x 3 cm.

20 × 20 cm 500 / 50

Print Code: C(4)



Rustuff

4513

Absorbent Towel. Microfibre 310 g/ m². Folded 6 x 8 x 6 cm.
Saugfähiges Handtuch. Mikrofaser 310 g/ m². Faltung 6 x 8 x 6 cm.
Serviette Absorbante. Microfibre 310 g/ m². Pliée 6 x 8 x 6 cm.
Absorbierende Handdoek. Microfibre 310 g/ m². Gevouwen 6 x 8 x 6 cm.

20 × 20 cm 200 / 50

Print Code: D(1)



01 05 03 19



Siapax 5275

Timer. 2 Minutes.
Eieruhr. 2 Minuten.
Minuteur. 2 Minutes.
Eierwecker. 2 Minuten.

1.8 x 6 x 2.5 cm 1000 / 100

Print Code: C(4)



04 02 05 19 01

Trikel 6718

NEW



Hydroalcoholic Gel. 30 ml. Hand cleansing gel.
Hydroalkoholisches Gel. 30 ml. Hautreinigungslösung.
Gel Hydroalcoholic. 30 ml. Solution pour le lavage des mains.
Hydroalcoholic Gel. 30 ml. Huidreinigende oplossing.

4 x 9.8 x 2.5 cm

200 / 50

Print Code: C(4)



NEW

30 ml

03

07



03 07 19 22

Keko 3824

Toothbrush.
Zahnbürste.
Brosse à Dents.
Tandenborstel.

3 x 14.6 x 1 cm 500 / 50

Print Code: F(1), L1



03

Fident 5032

Set. Toothbrush and Sand Timer. 2 Minutes.
Set. Zahnbürste und Sanduhr. 2 Minuten.
Set. Brosse à Dents et Sablier. 2 Minutes.
Set. Tandenborstel en zandloper. 2 Minuten.

8 x 20 x 2 cm 200 / 10

Print Code: F(1), L1



05

04



19

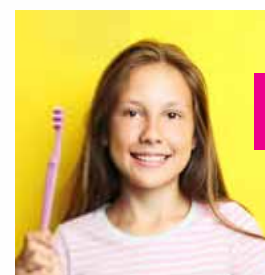

965

Cleidol 6278

Toothbrush. Wheat Straw/ PP.
Zahnbürste. Weizenstroh/ PP.
Brosse à Dents. Paille de Blé/ PP.
Tandenborstel. Tarwestro/ PP.

1.2 x 18 x 1.6 cm

Print Code: C(4)

500 / 50



Lexa

3983

4 PIECES

Mold Set. Silicone. 4 Pieces. Maximum Temperature 240°C.
 Backform Set. Silikon. 4 Stück. Maximale Temperatur 240°C.
 Set de Moules. Silicone. 4 Pièces. Température Maxi 240°C.
 Vormen Set. Siliconen. 4 Stuks. Maximum Temperatuur 240°C.

Ø 7.5 × 5.5 cm

200 / 100

Print Code: E(1)



05

19

Kolam

4001

Brush. Silicone.
 Pinsel. Silikon.
 Pinceau. Silicone.
 Kwast. Siliconen.

3 × 17.5 × 1 cm

600 / 50

Print Code: D(1)



BPA FREE



03



03



07



19



BPA FREE



01

500 ml

Toor

4492

Measuring Set. 500 ml. 7 Pieces.
 Messbecherset. 500 ml. 7 Stück.
 Set Mesure. 500 ml. 7 Pièces.
 Meet Set. 500 ml. 7 Stuks.

Ø 8.2 × 13 cm

Print Code: E(1)

40



love COOKING chef



Legox 4754

Set. Non-Woven. One Size. Kids.
Set. Non-Woven. Einheitsgröße. Kinder.
Set. T.N.T.. Taille Unique. Enfant.
Set. Non-Woven. Een Maat. Kind.

Consult. 200 / 50

Print Code: F(1)

01



03

19

Nono 3887

Apron. Non-Woven. One Size. Kids.
Schürze. Non-Woven. Einheitsgröße. Kinder.
Tablier. T.N.T.. Taille Unique. Enfant.
Schort. Non-Woven. Een Maat. Kind.

40 x 60 cm 200 / 50

Print Code: E(1)



19

03

967



Tizy 4892

Apron. Non-Woven. One Size. Kids. 5 Markers Included.
Schürze. Non-Woven. Einheitsgröße. Kinder. 5 Markers Inklusiv.
Tablier. T.N.T.. Taille Unique. Enfant. 5 Marqueurs Inclus.
Schort. Non-Woven. Een Maat. Kind. 5 Stiften inclusief.

43 x 43 cm 200 / 50

Print Code: G(1)





03

01



21



05

Koldy

6151

Duck. PVC.
Ente. PVC.
Canard. PVC.
Eend. PVC.

8.4 × 7.7 × 7 cm 100 / 50

Print Code: D(1)



968



11



01

04

05

07



03

Donax

4615

Money Box.
Sparschwein.
Tirelire.
Sparpot.

10 × 7.5 × 8 cm 100 / 10

Print Code: D(1)



BAMBOO FIBRE

Darfil

6379

Money Box. Bamboo Fibre/ ABS.
Sparschwein. Bambusfaser/ ABS.
Tirelire. Fibre Bambou/ ABS.
Sparpot. Bamboe Fibre/ ABS.

10 × 6.8 × 7.1 cm 100 / 10

Print Code: D(4)

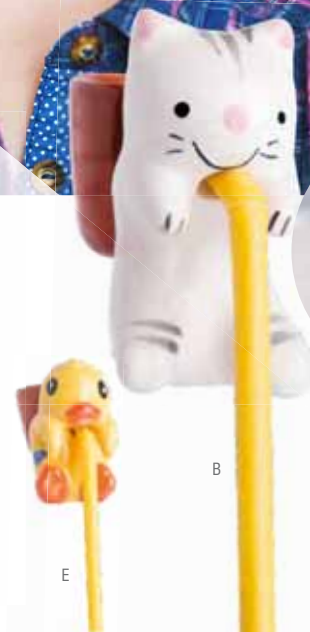

E

B



Chupon

5905

Flowerpot. Ceramic. 10-12 Petunia Seeds Included.
Blumentopf. Keramik. 10-12 Petuniensamen Inklusive.
Pot de Fleurs. Céramique. 10-12 Semences de Petunia Inclus.
Bloempot. Keramiek. 10-12 Petunia Zaden Inclusief.

6 × 11 × 7 cm 100 / 50

Print Code: F(1)

Video



Mazinger

9321

Mini Puzzle.
Mini Puzzle.
Mini Puzzle.
Mini Puzzle.

7.5 × 9 × 0.6 cm 500 / 50

Print Code: D(4), W



Diamond

3392

Game. Magnetic.
Spiel. Magnetisch.
Jeu. Magnétique.
Spiel. Magnetisch.

13 × 1 × 13 cm 200 / 50

Print Code: D(1)



kids fun

970



05



01

19



04

03



19



02



03



01



05



04



19



01



03

Zairem

5563

Fidget Spinner. Metal.
Fidget Spinner. Metall.
Fidget Spinner. Métal.
Fidget Spinner. Metaal.

7.5 × 7.5 × 1.2 cm 200 / 50

Print Code: C(1), V

Bolty

5816

Fidget Spinner.
Fidget Spinner.
Fidget Spinner.
Fidget Spinner.

7.9 × 7.9 × 1.2 cm 500 / 50

Print Code: C(1), V

Kasac

5824

Antistress Ball. PU.
Antistress Ball. PU.
Balle Antistress. PU.
Antistress Bal. PU.

Ø 6.7 cm 100 / 50

Print Code: E(1), L1



Carlo

8850

Skill Games. 24 Assorted Games.
Geschicklichkeitsspiele. 24 Spiele Sortiert.
Jeux d'Habiletés. 24 Jeux Assortis.
Behendigheidsspel. 24 Verzamelde Spelen.

4 x 4 x 4 cm 576 / 24

Print Code: C(4)



04

Milux

4418

Yoyo.
Yoyo.
Yoyo.
Jojo.

Ø 5 x 1.5 cm 500 / 100

Print Code: C(4), W



WOOD /
MADERA



03

Curl

9483

Yoyo. Wood.
Yoyo. Holz.
Yoyo. Bois.
Jojo. Hout.

Ø 5.5 x 2.8 cm 400 / 50

Print Code: C(4), W, L1



05

03

19

Barón

9670

IDEAL FOR PRINTING

Aircraft. EVA. Board: 17 x 13,5 x 0,3 cm. Aircraft: 12,7 x 4 x 15 cm.
Sportflugzeug. EVA. Puzzelbrett: 17 x 13,5 x 0,3 cm. Flugzeug: 12,7 x 4 x 15 cm.
Avion. EVA. Plaque: 17 x 13,5 x 0,3 cm. Avion: 12,7 x 4 x 15 cm.
Vliegtuig. EVA. Board: 17 x 13,5 x 0,3 cm. Vliegtuig: 12,7 x 4 x 15 cm.

Consult. 720 / 20

Print Code: D(1)



16

VirioK

4681

Game.
Spiel.
Jeu.
Spiel.

4.6 x 5 x 1.2 cm 1000 / 100

Print Code: B(1)



05

01

21

03

Buddy

4682

Spinning Top.
Kreisel.
Touppie.
Tol.

Ø 3.7 x 3.4 cm 2000 / 1000

Print Code: B(1)

3in1

Multifunction



03

Dylam

5126

Game Set. 3 Games.

Spiel Set. 3 Spiele.

Set Jeu. 3 Jeux.

Spel Set. 3 Spelen.



04



05



19

22.5 x 43.5 cm

50

Print Code: E(1)

Delko

4086

Ball. PU/ PVC. Size: 5.

Ball. PU/ PVC. Größe: 5.

Ballon. Similicuir/ PVC. Taille: 5.

Voetbal. PU/ PVC. Maat: 5.

Consult.

Print Code: G(1)

40



02

19

03

01



05

03

04



Wiki

3317

Vest. Polyester 190T. One Size. Kids.

Weste. Polyester 190T. Einheitsgröße. Kinder.

Plastron. Polyester 190T. Taille Unique. Enfant.

Vest. Polyester 190T. Een Maat. Kind.

38 x 45 cm

600 / 50

Print Code: F(1)



19



03

Zubigol

3115

Goal Post. Nylon. Foldable.

Strandfussballtor. Nylon. Fallbar.

Cage de Buts. Nylon. Pliable.

Doel. Nylon. Opvouwbaar.

141 x 80 x 80 cm

20

Print Code: I(6)



19

01

02





Galtax

5904

Skipping Rope. Wood.
Sprungseil. Holz.
Corde à Sauter. Bois.
Springtouw. Hout.

Ø 0.7 × 260 cm 200

Print Code: D(1), L1



Derix

4639

Skipping Rope.
Sprungseil.
Corde à Sauter.
Springtouw.

Ø 0.7 × 257 cm 200 / 50

Print Code: D(1)

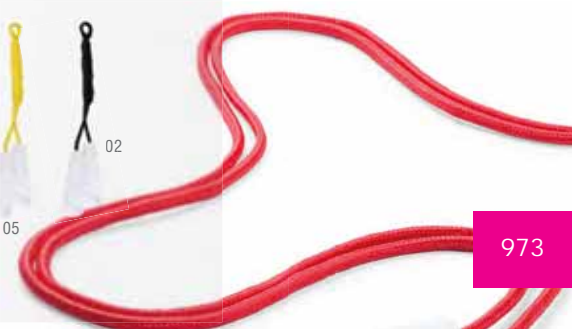

973



Jordan

3920

Basket. PVC. Ball Included.
Basketball. PVC. Ball Inklusiv.
Panier de Basket. PVC. Sphère Inclus.
Mand. PVC. Bal Inclusief.

20 × 16 cm 100 / 50

Print Code: E(1)



Aracno

3290

Dartball Board. Ball Included.
Dartschreibe. Ball Inklusiv.
Cible. Sphère Inclus.
Dartbal Bord. Bal Inclusief.

12.5 × 15 × 0.5 cm 600 / 50

Print Code: N(8)

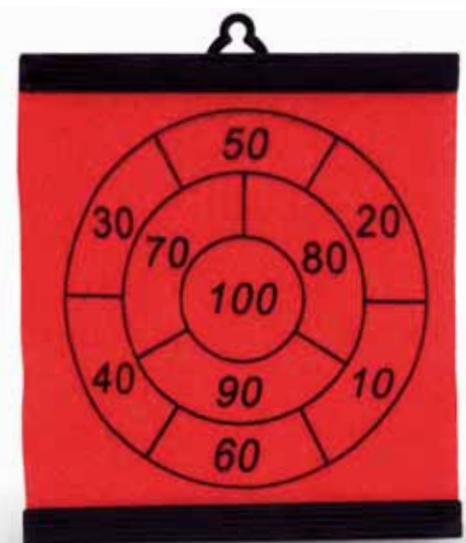

water games

974



Bujass

4686

Bubbles. Refillable. Liquid Not Included.
Seifenblasen. Wiederaufladbar. Flüssigkeit Nicht im Lieferumfang.
Jeu Bulles Savon. Rechargeable. Liquide Non Inclus.
Belleblaas. Navulbaar. Vloeistof Niet Inclusief.

Ø 3.7 × 11.2 cm 500 / 50
Print Code: C(4)



Pump

3136

Pen. Refillable. Liquid Not Included.
Kugelschreiber. Wiederaufladbar. Flüssigkeit Nicht im Lieferumfang.
Stylo. Rechargeable. Liquide Non Inclus.
Pen. Navulbaar. Vloeistof Niet Inclusief.

15.5 × 3 × 1.7 cm 500 / 50
Print Code: C(4)



Bonney

4683

Water Pistol.
Wasserpistole.
Pistolet à Eau.
Waterpistol.

5.3 × 4.1 × 2.2 cm 1000 / 100
Print Code: B(1)



Fabulak

5943

Bubbles. 30 ml. Safety Catch. Liquid Included.
Seifenblasen. 30 ml. Sicherheitsverschluss. Flüssigkeit im Lieferumfang.
Jeu Bulles Savon. 30 ml. Fermeture Sécurité. Liquide Inclus.
Belleblaas. 30 ml. Veiligheidssluiting. Vloeistof Inclusief.

6.1 × 8.4 × 2.6 cm 200 / 50
Print Code: C(4)



kids Summer



05

Sportkid 3329

Kids Cap. 100% Cotton. 5 Panels.
Kinder Mütze. 100% Baumwolle. 5 Panels.
Casquette Enfant. 100% Coton. 5 Panneaux.
Kinder Pet. 100% Katoen. 5 Panelen.

Consult. 300 / 30
Print Code: E(1), N(8), O, P



03

Spike 7003

Kids Sunglasses. UV400 Protection.
Kindersonnenbrille. UV400 Schutz.
Lunettes de Soleil Enfant. Protection UV400.
Kinder Zonnebril. UV400 Bescherming.

Consult. 400 / 10
Print Code: D(4)



05

19

01

975



IDEAL FOR PRINTING
10PCS



19

03

05

Mawi 3842

Bracelet. Tyvek® Material. One Size. Kids.
Armband. Tyvek® Material. Einheitsgröße. Kinder.
Bracelet. Tyvek® Material. Taille Unique. Enfant.
Armband. Tyvek® Material. Een Maat. Kind.

23 × 2.5 cm 20000 / 1000
Print Code: A(1)



Tyvek®
Tyvek® material

ULTRASOUND /
ULTRASONIDO



19

Telfin 5762

Mosquito Repellent Bracelet. Button Battery Included.
Anti-Mücken-Armband. Knopfzelle Inklusiv.
Bracelet Antimousques. Pile Bouton Inclus.
Mug Afstotende Armband. Knoopcel Batterij Inclusief.

24.4 × 2.8 × 1.3 cm 400 / 50
Print Code: D(1)



05

01

03

accessories video games

976



01



02



Station 5157



Game

Bluetooth

Gamepad. Bluetooth Connection. USB Rechargeable. Cable Included.
Gamepad. Bluetooth Anschluss. USB Wiederaufladbar. Kabel Inklusiv.
Manette de Jeu. Connexion Bluetooth. Rechargeable USB. Câble Inclus.
Gamepad. Bluetooth Verbinding. USB Oplaadbaar. Kabel Inclusief.

3.1 × 7.3 × 1.5 cm 200 / 50

Print Code: D(4)

Video



WEB CAM
COVER

JOYSTICK

Maint 5800

Webcam Cover Joystick.
Webcam-Blocker Joystick.
Bloqueur Webcam Joystick.
Webcam Blocker Joystick.

2.7 × 3.4 × 1.5 cm 500 / 100

Print Code: B(1)



Game



02

03

09



19

Hability 4327

Stylus Touch Pen.
Touchpad Stift.
Stylet.
Touchscreen-Pen.

3.4 × 11.6 cm 1000 / 50

Print Code: C(1)



Razter 5648

Holder Pouch. Polyester 600D.
Halter Hülle. Polyester 600D.
Étui Support. Polyester 600D.
Houder Hoes. Polyester 600D.

28 × 22 × 2.5 cm

Print Code: G(1), N(8)



Tablet
Compartment

30



Winlon

5403

Notebook. Hard Cover. 40 Sheets.
Notizbuch. Hardcover-Abdeckung. 40 Seiten.
Cahier. Couverture Rigide. 40 Feuilles.
Notitieboek. Harde Kaft. 40 Blaadjes.

8 x 9 x 1.1 cm 500 / 50
Print Code: D(4)

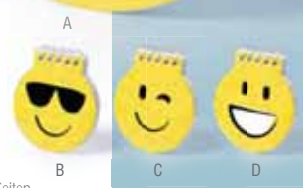

i love emojis

977

Fricum

5402

Pen.
Kugelschreiber.
Stylo.
Pen.

Ø 0.9 x 14 cm 1000 / 50
Print Code: B(4)



370 ml

Mateky

5594

Eraser Set. 4 Pieces.
Radiergummi Set. 4 Stück.
Set Gommies. 4 Pièces.
Gummen Set. 4 Stuks.

7.7 x 7.5 x 0.7 cm 500 / 50
Print Code: C(1)



Ashley

5425

Mug. Ceramic. 370 ml. Individual Presentation.
Tasse. Keramik. 370 ml. Individuelle Präsentation.
Tasse. Céramique. 370 ml. Présentation Individuelle.
Mok. Keramiek. 370 ml. Individuele Presentatie.

Ø 8.2 x 9.8 cm 36
Print Code: F(4)





HelloKitty



Mara

7147

Umbrella.
Regenschirm.
Parapluie.
Paraplu.

Ø 98 cm

☞ Ø 98 cm ☞ 50 / 10
☞ Print Code: G(1), N(8)



05



Rany

3149

Keyring Raincoat. LDPE. One Size. Kids. 88 x 63 cm.
Schlüsselanhänger Poncho. LDPE. Einheitsgröße. Kinder. 88 x 63 cm.
Porte-Clés Poncho. LDPE. Taille Unique. Enfant. 88 x 63 cm.
Sleutelhanger Regenjas. LDPE. Een Maat. Kind. 88 x 63 cm.

☞ Ø 6.4 cm ☞ 200 / 25

☞ Print Code: D(4)



03



01



19

978



HelloKitty

Vera

7140

Umbrella. Automatic.
Regenschirm. Automatisch.
Parapluie. Automatique.
Paraplu. Automatisch.

Ø 104 cm

☞ Ø 104 cm ☞ 30 / 10
☞ Print Code: G(1), N(8)



03



19



05

Espinete

8754

Umbrella. Automatic.
Regenschirm. Automatisch.
Parapluie. Automatique.
Paraplu. Automatisch.

Ø 71 cm

☞ Ø 71 cm ☞ 60 / 12
☞ Print Code: G(1), N(8)



Teo

3221

Raincoat. PVC. One Size. Kids. 90 x 64 cm.
Poncho. PVC. Einheitsgröße. Kinder. 90 x 64 cm.
Poncho. PVC. Taille Unique. Enfant. 90 x 64 cm.
Kinder-Regenjas. PVC. Een Maat. Kind. 90 x 64 cm.

☞ 18 x 15 cm ☞ 100 / 25

☞ Print Code: F(1), H(1)





02 19 04 03 07 11

Holiam

5506

Neck Warmer. Polyester.
Schlauchschal. Polyester.
Tour de Cou. Polyester.
Colsjaal. Polyester.

21 x 40 cm 500 / 100

Print Code: F(1), N(8), R



01

SPECIAL WHITE COLOUR FOR SUBLIMATION
COLOR BLANCO VALIDO PARA SUBLIMACIÓN

979



Tactile



03

TWO TOUCH SCREEN FINGERTIPS /
DOS DEDOS TÁCTILES

Pigun

5132

Touchscreen Gloves. Acrylic. One Size. Kids.
Touchpad Handschuhe. Acryl. Einheitsgröße. Kinder.
Gant Tactile. Acrylique. Taille Unique. Enfant.
Touchscreen Handschoenen. Acryl. Eén Maat. Kind.

Consult. 500 / 10

Print Code: N(8)



19

04

05



19

05

03

Siku

3720

Mitten. Polar Fleece 180 g/ m2. One Size. Kids.
Handschuh. Polar Fleece 180 g/ m2. Einheitsgröße. Kinder.
Gant. Polaire 180 g/ m2. Taille Unique. Enfant.
Wanten. Polar Fleece 180 g/ m2. Eén Maat. Kind.

8 x 12 cm 400 / 10

Print Code: N(8), O



03

Anut

3721

Scarf. Polar Fleece 180 g/ m2.
Schal. Polar Fleece 180 g/ m2.
Echarpe. Polaire 180 g/ m2.
Sjaal. Polar Fleece 180 g/ m2. Eén Maat. Kind.

91 x 12 cm 400 / 10

Print Code: N(8), O, P



21

04

19

22

05



reflective SECURITY



Reflective 9550

Bracelet. PVC. Reflective.
Armband. PVC. Reflektierend.
Bracelet. PVC. Réfléchissant.
Armband. PVC. Reflectorend.

23 x 2.9 cm 1000 / 50
Print Code: D(1)



980



Visibility

811401

Keyring. PVC. Reflective.
Schlüsselanhänger. PVC. Reflektierend.
Porte-Clés. PVC. Réfléchissant.
Steutelhanger. PVC. Reflectorend.

4.5 x 5.6 x 0.3 cm 1000 / 100
Print Code: C(4)



Koreflec

5659

Keyring. PVC. Reflective.
Schlüsselanhänger. PVC. Reflektierend.
Porte-Clés. PVC. Réfléchissant.
Steutelhanger. PVC. Reflectorend.

6.1 x 5.3 x 0.2 cm 1000 / 100
Print Code: C(4)



Brux

4530

Strap Keyring. PVC/ Aluminium. Reflective.
Schlüsselanhänger. PVC/ Aluminium. Reflektierend.
Porte-Clés. PVC/ Aluminium. Reflector.
Band Steutelhanger. PVC/ Aluminium. Reflectorende.

3.2 x 28 cm 300 / 50
Print Code: D(1)



reflective
security



05



19



03

Eli
3264

Vest. Polyester. One Size. Kids.
Weste. Polyester. Einheitsgrösse. Kinder.
Plastron. Polyester. Taille Unique. Enfant.
Vest. Polyester. Eén Maat. Kind.

39 × 46 cm 100 / 20

Print Code: F(1)

5 PIECES



Jarol
5159

Safety Set. 5 Accessories. Vest Polyester. One Size. Kids.
Sicherheits Set. 5 Teile. Weste Polyester. Einheitsgrösse. Kinder.
Kit de Sécurité. 5 Accessoires. Gilet Polyester. Taille Unique. Enfant.
Veiligheids Set. 5 Accessoires. Vest Polyester. Eén Maat. Kind.

27.5 × 19.5 × 1.5 cm 50

Print Code: F(1)



Plaup

4678

Torch. Silicone. 4 Leds. 2 Light Modes. Button Batteries Included.
Lampe. Silikon. 4 Leds. 2 Leuchtfunktionen. Knopfzellen Inklusiv.
Lampe. Silicone. 4 Leds. 2 Modes de Lumière. Piles Bouton Inclus.
Zaklamp. Siliconen. 4 Leds. 2 Licht Posities. Knoopcelbatterij Inclusief.

3 x 12 x 1.1 cm 500 / 50

Print Code: E(1)



Myrto

3685

Torch. 2 Leds. 3 Light Modes. Button Batteries Included.
Lampe. 2 Leds. 3 Leuchtfunktionen. Knopfzellen Inklusiv.
Lampe. 2 Leds. 3 Modes de Lumière. Piles Bouton Inclus.
Zaklamp. 2 Leds. 3 Licht Posities. Knoopcel Batterijen Inclusief.

3.1 x 3.1 x 4.3 cm 500 / 50

Print Code: G(1)



982



Moltar

4616

Torch. 3 Leds. 2 Light Modes. 3 Functions. 3 Batteries AAA Not Included.
Lampe. 3 Leds. 2 Leuchtfunktionen. 3 Funktionen. 3 AAA Batterien Nicht im Lieferumfang.
Lampe. 3 Leds. 2 Modes de Lumière. 3 Fonctions. 3 Piles AAA Non Inclus.
Zaklamp. 3 Leds. 2 Licht Posities. 3 Functies. 3 Batterijen AAA Niet Inclusief.

7.6 x 13.6 x 6.4 cm 100 / 50

Print Code: E(1)



Video

Terrier

4984

Security Light. 2 Leds. 2 Light Modes. Button Batteries Included.
Sicherheitslicht. 2 Leds. 2 Leuchtfunktionen. Knopfzellen Inklusiv.
Lumière de Sécurité. 2 Leds. 2 Modes de Lumière. Piles Bouton Inclus.
Veiligheidslicht. 2 Leds. 2 Licht Posities. Knoopcel Batterijen Inclusief.

6 x 3 x 8.5 cm 200 / 50

Print Code: D(1)





Tinax

6274

Security Light. 1 Led. 2 Light Modes. Button Batteries Included.
 Sicherheitslicht. 1 Led. 2 Leuchtfunktionen. Knopfzellen Inklusive.
 Lumière de Sécurité. 1 Led. 2 Modes de Lumière. Piles Bouton Inclus.
 Veiligheidslicht. 1 Led. 2 Licht Posities. Knopcel Batterijen Inclusief.

1.9 × 5.6 × 1.8 cm 1000 / 250
 Print Code: C(1)



16

Floykin

5369

Whistle. 1 Led. Button Batteries Included.
 Pfeife. 1 Led. Knopfzellen Inklusive.
 Sifflet. 1 Led. Piles Bouton Inclus.
 Fluitje. 1 Led. Knopcel Batterijen Inclusief.



3.7 × 6.7 × 1.5 cm 500 / 100
 Print Code: C(1)



03 05 19



05



Flash

3025

Security Light. 1 Led. Button Batteries Included.
 Sicherheitslicht. 1 Led. Knopfzellen Inklusive.
 Lumière de Sécurité. 1 Led. Piles Bouton Inclus.
 Veiligheidslicht. 1 Led. Knopcel Batterijen Inclusief.

Ø 4.9 × 1.5 cm 500 / 50
 Print Code: C(1)



19



03



19



03 01 05 04

Hespar

5680

Security Light. 2 Leds. 2 Light Modes. Button Batteries Included.
 Sicherheitslicht. 2 Leds. 2 Leuchtfunktionen. Knopfzellen Inklusive.
 Lumière de Sécurité. 2 Leds. 2 Modes de Lumière. Piles Bouton Inclus.
 Veiligheidslicht. 2 Leds. 2 Licht Posities. Knopcel Batterijen Inclusief.

3.1 × 6.2 × 1.8 cm 500 / 50
 Print Code: C(1)



SUMMER & BEACH

BAMBOO

NEW



19

Mitrox

6810

Sunglasses. Bamboo/PC. UV400 Protection.
Sonnenbrille. Bambus/PC. UV400 Schutz.
Lunettes de Soleil. Bambou/PC. Protection UV400.
Zonnebril. Bamboe/PC. UV400 Bescherming.

Consult.

300 / 10

Print Code: D(4), L1



08



05

NEW

GARDEN

NATURAL JUTE & COTTON

ORGANIC COTTON



Lencer

6468

Hand Fan. Bamboo Fibre/ PP/ Polyester RPET.
Fächer. Bambusfaser/ PP/ Polyester RPET.
Eventail. Fibre Bambou/ PP/ Polyester RPET.
Waaier. Bamboe Fibre/ PP/ Polyester RPET.

42.5 × 23 cm 250 / 25

Print Code: D(1), E(2), L1



RPET & BAMBOO FIBRE

Lopso

6817

Duffel Bag. Jute/ Cotton.
Seesack. Jutestoff/ Baumwolle.
Balluchon. Jute/ Coton.
Plunjezak. Jute/ Katoen.

Ø 23 × 45 cm

Print Code: F(1), N(8)

50 / 10

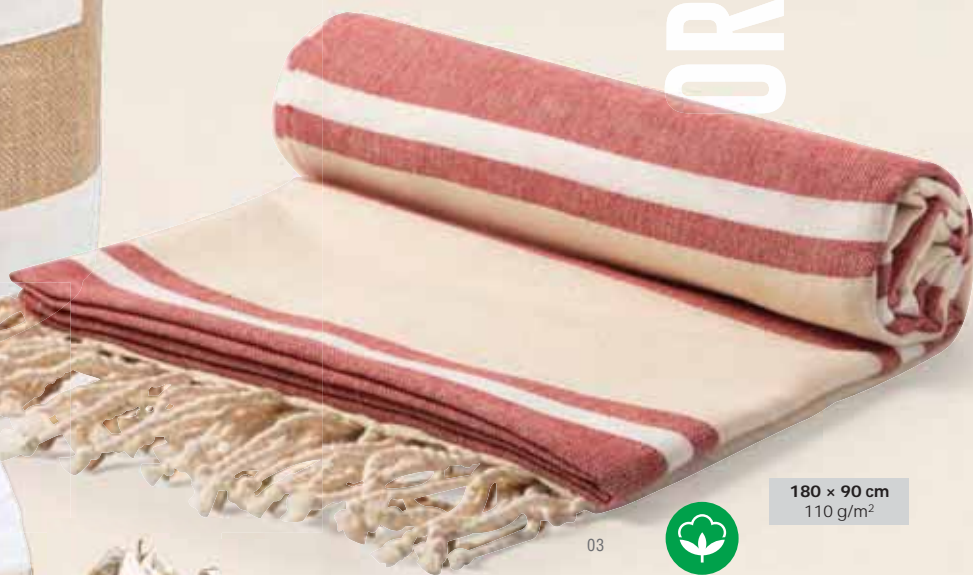

180 × 90 cm
110 g/m²



Organic
Cotton

Yistal

6427

Towel Pareo. 100% Organic Cotton 110 g/ m2.
Handluch Pareo. 100% Organische Baumwolle 110 g/ m2.
Paréo Serviette. 100% Coton Organique 110 g/ m2.
Omslag Handdoek. 100% Organisch Katoen 110 g/ m2.

180 × 90 cm

Print Code: F(1), N(8), O, P

50



19



11



08



01

Brasileira

9343

Flip Flops. EVA/ PVC.
 Flip Flop. EVA/ PVC.
 Tongues. EVA/ PVC.
 Flip Flops. EVA/ PVC.

36-38, 42-44 40 / 10

Print Code: E(1)



986



02

Caimán

9860

Flip Flops. EVA/ Polyester.
 Flip Flop. EVA/ Polyester.
 Tongues. EVA/ Polyester.
 Flip Flops. EVA/ Polyester.

36-38, 42-44 60 / 10

Print Code: E(1), N(8)



The Best Prices FLIP-FLOPS UNISEX



Salti

02

987



Sebrin
6441

Flip Flops. EVA/ PVC.
Flip Flop. EVA/ PVC.
Tongues. EVA/ PVC.
Flip Flops. EVA/ PVC.

36-38, 42-44 60 / 10

Print Code: D(1), E(1)



Salti
8884

Flip Flops. EVA/ PVC.
Flip Flop. EVA/ PVC.
Tongues. EVA/ PVC.
Flip Flops. EVA/ PVC.

36-38, 42-44 60 / 10

Print Code: D(1), E(1)

REAL BAMBOO

BAMBOO FIBRE

Tinex

6355

Sunglasses. Bamboo/ Bamboo Fibre/ PP. UV400 Protection.
Sonnenbrille. Bambus/ Bambusfaser/ PP. UV400 Schutz.
Lunettes de Soleil. Bambou/ Fibre Bambou/ PP. Protection UV400.
Zonnebril. Bamboe/ Bamboe Fibre/ PP. UV400 Bescherming.

Consult.

300 / 10

Print Code: D(4), L1



BAMBOO FIBRE



Kilpan

6354

Sunglasses. Bamboo Fibre/ PP. UV400 Protection.
Sonnenbrille. Bambusfaser/ PP. UV400 Schutz.
Lunettes de Soleil. Fibre Bambou/ PP. Protection UV400.
Zonnebril. Bamboe Fibre/ PP. UV400 Bescherming.

Consult.

300 / 10

Print Code: D(4)



POUCH



Haris

4748

Sunglasses. UV400 Protection.
Sonnenbrille. UV400 Schutz.
Lunettes de Soleil. Protection UV400.
Zonnebril. UV400 Bescherming.

Consult. 300 / 10

Print Code: D(4)



23



18

Silmax

6629

Pouch. Polyester.
Hülle. Polyester.
Étui. Polyester.
Hoes. Polyester.

9 x 18 cm

1000 / 50

Print Code: D(1), N(8)

eco-friendly
SUNGLASSES

REAL BAMBOO

NEW



19

Mitrox 6810

Sunglasses. Bamboo/ PC. UV400 Protection.
Sonnenbrille. Bambus/ PC. UV400 Schutz.
Lunettes de Soleil. Bambou/ PC. Protection UV400.
Zonnebril. Bamboe/ PC. UV400 Bescherming.

Consult.

300 / 10

Print Code: D(4), L1



08



05

SUNGLASSES



989



SUNGLASSES

NEW

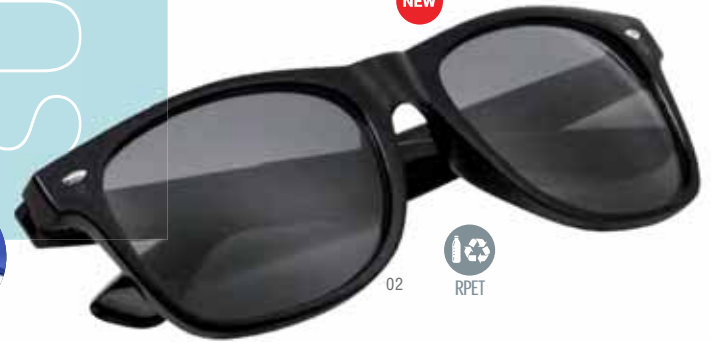

02



Sigma 6811

Sunglasses. RPET. UV400 Protection.
Sonnenbrille. RPET. UV400 Schutz.
Lunettes de Soleil. RPET. Protection UV400.
Zonnebril. RPET. UV400 Bescherming.

Consult.

300 / 10

Print Code: D(4)

RPET



04



19



03



03

Leychan

5923

Sunglasses. UV400 Protection.
 Sonnenbrille. UV400 Schutz.
 Lunettes de Soleil. Protection UV400.
 Zonnebril. UV400 Bescherming.

Consult. 300 / 10

Print Code: D(4)



SUNGLASSES



990



FOLDABLE

19

Stifel

4310

Sunglasses. Foldable. UV400 Protection.
 Sonnenbrille. Faltbar. UV400 Schutz.
 Lunettes de Soleil. Pliable. Protection UV400.
 Zonnebril. Opvouwbaar. UV400 Bescherming.

Consult. 300 / 10

Print Code: D(4)



03

Saimon

5354

Sunglasses. UV400 Protection.
 Sonnenbrille. UV400 Schutz.
 Lunettes de Soleil. Protection UV400.
 Zonnebril. UV400 Bescherming.

Consult. 300 / 10

Print Code: D(4)



The Best Price SUNGLASSES



02



07



04



03



01



19



11



05



22

Xaloc 7000

Sunglasses. UV400 Protection.
Sonnenbrille. UV400 Schutz.
Lunettes de Soleil. Protection UV400.
Zonnebril. UV400 Bescherming.

Consult. 300 / 10

Print Code: D(4)



03

Musin

5282

Sunglasses. UV400 Protection.
Sonnenbrille. UV400 Schutz.
Lunettes de Soleil. Protection UV400.
Zonnebril. UV400 Bescherming.

Consult. 300 / 10

Print Code: D(4)



07



04



19



01



02

Malter 4094

Sunglasses. UV400 Protection.
Sonnenbrille. UV400 Schutz.
Lunettes de Soleil. Protection UV400.
Zonnebril. UV400 Bescherming.

Consult. 300 / 10

Print Code: D(4)



05



19



04



11



01



03

SUNGLASSES

992



Zarem

5925

Sunglasses. UV400 Protection.
Sonnenbrille. UV400 Schutz.
Lunettes de Soleil. Protection UV400.
Zonnebril. UV400 Bescherming.

Consult. 300 / 10

Print Code: D(4)



02



04



11



05



19



03



04

Salvit

5521

Sunglasses. UV400 Protection.
Sonnenbrille. UV400 Schutz.
Lunettes de Soleil. Protection UV400.
Zonnebril. UV400 Bescherming.

Consult. 300 / 10

Print Code: D(4)



05



03



19



Harvey



Gredel



Nival



Harvey
4217

Sunglasses. UV400 Protection.
Sonnenbrille. UV400 Schutz.
Lunettes de Soleil. Protection UV400.
Zonnebril. UV400 Bescherming.

Consult. 300 / 10
Print Code: D(4)

Gredel
4799

Sunglasses. UV400 Protection.
Sonnenbrille. UV400 Schutz.
Lunettes de Soleil. Protection UV400.
Zonnebril. UV400 Bescherming.

Consult. 300 / 10
Print Code: D(4)

Nival
4581

Sunglasses. UV400 Protection.
Sonnenbrille. UV400 Schutz.
Lunettes de Soleil. Protection UV400.
Zonnebril. UV400 Bescherming.

Consult. 300 / 10
Print Code: D(4)



02

Nixtu

5284

Sunglasses. UV400 Protection.
Sonnenbrille. UV400 Schutz.
Lunettes de Soleil. Protection UV400.
Zonnebril. UV400 Bescherming.

Consult. 300 / 10

Print Code: D(4)



04



03



01



19



SUNGLASSES



994



04



03

Tunak

5924

Sunglasses. UV400 Protection.
Sonnenbrille. UV400 Schutz.
Lunettes de Soleil. Protection UV400.
Zonnebril. UV400 Bescherming.

Consult. 300 / 10

Print Code: D(4)



19



01



05



03

Bella

7001

Sunglasses. UV400 Protection.
Sonnenbrille. UV400 Schutz.
Lunettes de Soleil. Protection UV400.
Zonnebril. UV400 Bescherming.

Consult. 300 / 10

Print Code: D(4)



02



01

SUNGLASSES



02



03



19



01



05

Bunner

4214

Sunglasses. UV400 Protection.
Sonnenbrille. UV400 Schutz.
Lunettes de Soleil. Protection UV400.
Zonnebril. UV400 Bescherming.

Consult. 300 / 10

Print Code: D(4)

995

BEFORE



MAGIC!!

THE COLOUR CHANGES WITH THE SUNLIGHT

MAGIA!!

EL COLOR CAMBIA CON LA LUZ DEL SOL

AFTER



19

05

11

Lantax

5283

Sunglasses. UV400 Protection.
Sonnenbrille. UV400 Schutz.
Lunettes de Soleil. Protection UV400.
Zonnebril. UV400 Bescherming.

Consult. 300 / 10

Print Code: D(4)



Premia

9993

Sunglasses. UV400 Protection.
Sonnenbrille. UV400 Schutz.
Lunettes de Soleil. Protection UV400.
Zonnebril. UV400 Bescherming.

Consult. 300 / 10

Print Code: D(4)



19



03



02



05F

FLUORESCENT

Kathol

4413

Glasses.

Brille.

Lunettes.

Bril.

Consult. 300 / 10

Print Code: D(4)



11F



04F



07F



SPECIAL SUNGLASSES

996



03



COMBINE AS YOU PLEASE
COMBINALAS COMO QUIERAS



03

2 PIECES

Galvis

4803

Sunglasses. UV400 Protection.

Sonnenbrille. UV400 Schutz.

Lunettes de Soleil. Protection UV400.

Zonnebril. UV400 Bescherming.

Consult. 300 / 10

Print Code: D(2)



19



05



01

Options

5049

Frame.

Brillengestell.

Monture de Lunettes.

Brillemontuur.

Consult. 300 / 10

Print Code: D(4)

Options

5050

Lenses. UV400 Protection.

Lente. UV400 Schutz.

Lentilles. Protection UV400.

Lenzen. UV400 Bescherming.

Consult. 300 / 10

Print Code: Consult.



Accessories SUNGLASSES



Shenzy

4452

Multipurpose Glasses Strap. Microfibre.
Mehrzweck Brillenband. Mikrofaser.
Bandelette Lunettes Multi-Usages. Microfibre.
Multifunctionele Brillenband. Microfibre.

2 x 46 x 1 cm 1000 / 100

Print Code: F(1)

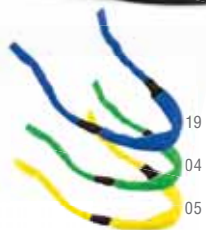

Naplin

3956

Glasses Strap. Soft Shell.
Brillenband. Soft Shell.
Bandelette Lunettes. Soft Shell.
Brilleband. Soft Shell.

35 x 2.5 cm 1000 / 20

Print Code: F(1), N(8)



Milla

9994

Pouch. Polyester.
Hülle. Polyester.
Étui. Polyester.
Hoes. Polyester.

9 x 18 cm 1000 / 50

Print Code: D(1), N(8)



Ekain

4390

Pouch. Polyester.
Hülle. Polyester.
Étui. Polyester.
Hoes. Polyester.

9 x 18 cm 1000 / 50

Print Code: D(1), N(8), R



Balian

5623

Glasses Strap. Polyester.
Brillenband. Polyester.
Bandelette Lunettes. Polyester.
Brilleband. Polyester.

58 x 0.5 cm 1000 / 100

Print Code: D(1)





11



04

Tela

8096

Hand Fan. PP/ Polyester.
Fächer. PP/ Polyester.
Éventail. PP/ Polyester.
Waaier. PP/ Polyester.

43 x 23 cm 250 / 25

Print Code: D(1), E(2)



Folklore

8863

Hand Fan. Wood/ Cotton/ Polyester.
Fächer. Holz/ Baumwolle/ Polyester.
Éventail. Bois/ Coton/ Polyester.
Waaier. Houten/ Katoen/ Polyester.

42.5 x 23 cm 250 / 25

Print Code: D(1), E(2), L1



998



19

Kronix

6406

Hand Fan. Bamboo/ Polyester.
Fächer. Bambus/ Polyester.
Éventail. Bambou/ Polyester.
Waaier. Bamboe/ Polyester.

38 x 21 cm 600 / 100

Print Code: D(1), E(2), L1

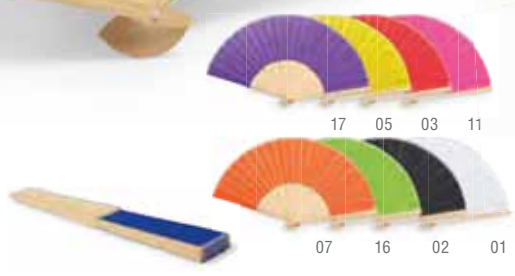

Madera

8097

Hand Fan. Wood.
Fächer. Holz.
Éventail. Bois.
Waaier. Hout.

35 x 20 cm 250 / 25

Print Code: D(1), E(1), L1



BAMBOO FIBRE/
POLYESTER RPET

WOOD/
POLYESTER RPET



Lencer

6468

Hand Fan. Bamboo Fibre/ PP/ Polyester RPET.
Fächer. Bambusfaser/ PP/ Polyester RPET.
Eventail. Fibre Bambou/ PP/ Polyester RPET.
Waaier. Bamboe Fibre/ PP/ Polyester RPET.

42.5 x 23 cm 250 / 25

Print Code: D(1), E(2), L1



Woter

6467

Hand Fan. Wood/ Polyester RPET.
Fächer. Holz/ Polyester RPET.
Eventail. Bois/ Polyester RPET.
Waaier. Houten/ Polyester RPET.

42.5 x 23 cm 250 / 25

Print Code: D(1), E(2), L1



WOOD/
NATURAL CORK

WOOD/
COTTON



Kasol

6476

Hand Fan. Wood/ Natural Cork.
Fächer. Holzs/ Naturkork.
Eventail. Bois/ Bouchon Naturel.
Waaier. Houten/ Natuurlijk Kurk.

41.5 x 23 cm 250 / 25

Print Code: D(1), E(2), L1



Dubert

6407

Hand Fan. Wood/ Cotton.
Fächer. Holz/ Baumwolle.
Eventail. Bois/ Coton.
Waaier. Hout/ Katoen.

42.5 x 23 cm 250 / 25

Print Code: D(1), E(2), L1



BIG SIZE

19

Tetex

4977

Hand Fan. PS/ Polyester.
Fächer. PS/ Polyester.
Eventail. PS/ Polyester.
Waaier. PS/ Polyester.

51 x 27 cm 100 / 25

Print Code: D(1), E(2)



1000

23



Mikar

5989

Hand Fan. Wood/ Polyester.
Fächer. Holz/ Polyester.
Eventail. Bois/ Polyester.
Waaier. Houten/ Polyester.

42 x 23 cm 250 / 25

Print Code: D(1), E(2), L1



HelloKitty



Ventol

7257

Hand Fan. Wood/ Cotton.
Fächer. Holz/ Baumwolle.
Eventail. Bois/ Coton.
Waaier. Houten/ Katoen.

42 x 21 cm 250

Print Code: D(1), E(1), L1





Liyox
4474

Pai Pai. Foldable.
Pay-Pay. Faltpaar.
Pai Pai. Pliable.
Pai Pai. Opvouwbaar.

20 × 25 × 1.4 cm 400 / 100
Print Code: D(1)



Stilo
3132

Pai Pai. Foldable.
Pay-Pay. Faltpaar.
Pai Pai. Pliable.
Pai Pai. Opvouwbaar.

24.5 × 26 cm 500 / 125
Print Code: C(4)



1001



Emoty
5406

Selfie Pai Pai.
Selfie Pai Pai.
Selfie Pai Pai.
Selfie Pai Pai.

18 × 27 cm 200 / 20
Print Code: B(1)



Lelex
6631

Pai Pai. Wood/ Recycled Cardboard.
Pay-Pay. Holz/ Recycling Pappé.
Pai Pai. Bois/ Carton Recycle.
Pai Pai. Hout/ Gerecycled Karton.

13 × 28 cm 500 / 100
Print Code: C(1)



Kerry
8864

Pai Pai. Translucent.
Pay-Pay. Transluzent.
Pai Pai. Translucide.
Pai Pai. Doorschijnend.

18 × 24.2 cm 500 / 100
Print Code: D(1)





01
02
07
19



03

Adorix 4687

Eye Protector. Silicone.
Augenschutz. Silikon.
Protecteur Yeux. Silicone.
Oogbeschermer. Siliconen.

15.1 x 3 x 4.6 cm 200 / 25
Print Code: D(1)



UV METER

Rado

3599
UV Meter.
UV-Strahlenmesser.
Mesureur Rayons UV.
UV Meter.

20.2 x 4 cm 2000 / 200
Print Code: D(4)

1002



19



ULTRASOUND



03 01 05

Telfin

5762
Mosquito Repellent Bracelet. Button Battery Included.
Anti-Mücken-Armband. Knopfzelle Inklusiv.
Bracelet Antimosques. Pile Bouton Inclus.
Mug Afstotende Armband. Knoopcel Batterij Inclusief.

24.4 x 2.8 x 1.3 cm 400 / 50
Print Code: D(1)



01 11 05 07 04 19

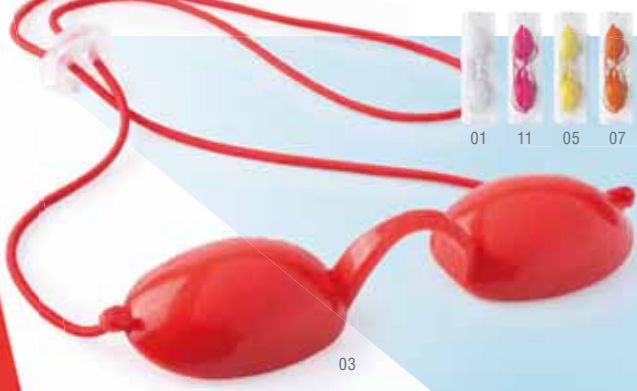

03



SUMMER accessories



03

70 ml



01



Bangui 19

3593
Vaporizer. 70 ml.
Zerstäuber. 70 ml.
Vaporisateur. 70 ml.
Sproeier. 70 ml.

3.2 x 21.5 cm 100 / 25
Print Code: D(4)



03 04 07

35 ml

Video



Hendry

6014
Vaporizer Fan. 35 ml. 2 Batteries AA Not Included.
Zerstäuber Ventilator. 35 ml. 2 AA Batterien Nicht im Lieferumfang.
Ventilateur Vaporisateur. 35 ml. 2 Piles AA Non Inclus.
Sproeier Ventilator. 35 ml. 2 Batterijen AA Niet Inclusief.

8.5 x 16 x 8 cm 100 / 50
Print Code: D(4)



19



PARTY



Trobel
6255



Ice Bucket Speaker. Smart Leds. Bluetooth Connection. Power 5W. USB Rechargeable. Cable Included.
Lautsprecher Eiskübel. Intelligente Leds. Bluetooth Anschluss. Power 5W. USB Wiederaufladbar. Kabel Inklusiv.
Sac Glaçons Haut-Parleurs. Leds Intelligentes. Connexion Bluetooth. Puissance 5W. Rechargeable USB. Câble Inclus.
Luidspreker Ijs Emmer. Smart Leds. Bluetooth Verbinding. Vermogen 5W. USB Oplaadbaar. Kabel Inclusief.

24.5 × 29 × 23.5 cm

Print Code: I(1)



Haclix
6444



FLLOATABLE
FLOTANTE

Speaker. PVC/ ABS. Bluetooth Connection. Power 3W. USB Rechargeable. Cable Included.
Lautsprecher. PVC/ ABS. Bluetooth Anschluss. Power 3W. USB Wiederaufladbar. Kabel Inklusiv.
Haut-Parleurs. PVC/ ABS. Connexion Bluetooth. Puissance 3W. Rechargeable USB. Câble Inclus.
Luidspreker. PVC/ ABS. Bluetooth Verbinding. Vermogen 3W. USB Oplaadbaar. Kabel Inclusief.

Ø 17 × 6 cm

Print Code: F(1)



1003



WATERPROOF



Mobile
Compartment

TACTILE

Livion
5774



Speaker Multipurpose Bag. PVC. Bluetooth Connection. Power 1.1W. USB Rechargeable. Waterproof. Touch Screen. Cable Included.
Lautsprecher Mehrzwecktasche. PVC. Bluetooth Anschluss. Power 1.1W. USB Wiederaufladbar. Wasserdicht. Touch Screen. Kabel Inklusiv.
Fourre-Tout Haut-Parleurs. PVC. Connexion Bluetooth. Puissance 1.1W. Rechargeable USB. Impermeable. Ecran Tactile. Câble Inclus.
Luidspreker Multifunctioneel Tasje. PVC. Bluetooth Verbinding. Vermogen 1.1W. USB Oplaadbaar. Waterdicht. Touch Screen. Kabel Inclusief.

12.8 × 22 cm

Print Code: G(1)



2 L

Mobile
Compartment

Tactile

Kambax

6564

Bag. Ripstop. Waterproof.
Tasche. Ripstop. Wasserdicht.
Sac. Ripstop. Imperméable.
Tas. Ripstop. Waterdicht.

01 03 05 19
 Ø 11 × 29.5 cm  200 / 10

 Print Code: G(1)



Waterproof

9 L



Waterproof

Tinsul

4848

Bag. Ripstop. Waterproof.
Tasche. Ripstop. Wasserdicht.
Sac. Ripstop. Imperméable.
Tas. Ripstop. Waterdicht.

02 19 01 05 04
 Ø 18.5 × 36 cm  100 / 10

 Print Code: G(1)

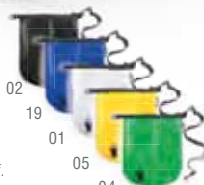

2.3 L



Waterproof

Kinser

4847

Bag. Ripstop. Waterproof.
Tasche. Ripstop. Wasserdicht.
Sac. Ripstop. Imperméable.
Tas. Ripstop. Waterdicht.

05 02 01 03
 Ø 11.5 × 26 cm  200 / 10

 Print Code: G(1)



20 L



Waterproof

Tayrux

6513

Backpack. Ripstop. Waterproof.
Rucksack. Ripstop. Wasserdicht.
Sac à Dos. Ripstop. Imperméable.
Rugzak. Ripstop. Waterdicht.

03 01 05 19
 Ø 23 × 63 cm  20

 Print Code: G(1)



1004

Video





19

Kirot 4860

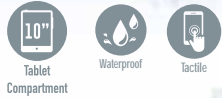

Multipurpose Bag. PVC. Waterproof. Touch Screen.
 Mehrzwecktasche. PVC. Wasserdicht. Touch Screen.
 Fourre-Tout. PVC. Imperméable. Ecran Tactile.
 Multifunctioneel Tasje. PVC. Waterdicht. Touch Screen.

21 x 31 cm

300 / 50

Print Code: F(1)



19



Waterpro 3042



Multipurpose Bag. PVC. Waterproof. Touch Screen.
 Mehrzwecktasche. PVC. Wasserdicht. Touch Screen.
 Fourre-Tout. PVC. Imperméable. Ecran Tactile.
 Multifunctioneel Tasje. PVC. Waterdicht. Touch Screen.

9.5 x 23 cm

500 / 50

Print Code: E(1)



04

19

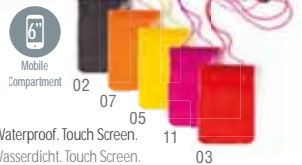

Arsax 4777



Multipurpose Bag. PVC. Waterproof. Touch Screen.
 Mehrzwecktasche. PVC. Wasserdicht. Touch Screen.
 Fourre-Tout. PVC. Imperméable. Ecran Tactile.
 Multifunctioneel Tasje. PVC. Waterdicht. Touch Screen.

13 x 24.5 cm

300 / 50

Print Code: E(1)

1005



19

Tamy 4097

Multipurpose Bag. PVC. Waterproof. Touch Screen.
 Mehrzwecktasche. PVC. Wasserdicht. Touch Screen.
 Fourre-Tout. PVC. Imperméable. Ecran Tactile.
 Multifunctioneel Tasje. PVC. Waterdicht. Touch Screen.

13 x 24.5 cm

300 / 50

Print Code: E(1)

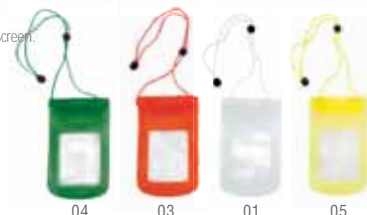

FLOATABLE FLOTANTE



04



Flextar 5524

Multipurpose Bag. PVC. Waterproof. Touch Screen.
 Mehrzwecktasche. PVC. Wasserdicht. Touch Screen.
 Fourre-Tout. PVC. Imperméable. Ecran Tactile.
 Multifunctioneel Tasje. PVC. Waterdicht. Touch Screen.

13.2 x 24 x 1.2 cm

300 / 50

Print Code: E(1)



BAMBOO FIBRE**Ditul**

6381

Frisbee. Bamboo Fibre/ PP.
 Frisbee. Bambusfaser/ PP.
 Frisbee. Fibre Bambou/ PP.
 Frisbee. Bamboe Fibre/ PP.

Ø 22.8 × 2.5 cm 200 / 100

Print Code: D(1)

**Girox**

4579

Frisbee. PP Plastic.
 Frisbie. Plastik PP.
 Frisbee. PP Plastique.
 Frisbie. PP Plastic.

Ø 23 × 1.8 cm 200 / 100

Print Code: D(1)

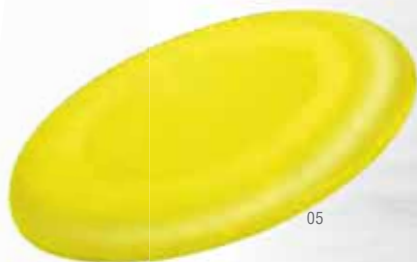

05



01

04

03

19

FUN BEACH
 on the



1006



04



03

19

Watson

9156

Frisbee. Polyester. Foldable.
 Frisbie. Polyester. Faltpar.
 Frisbee. Polyester. Pliabile.
 Frisbie. Polyester. Opvouwbaar.

Ø 24.5 cm 800 / 200

Print Code: E(1), F(1)



05



03

3in1
 Multifunction

05



04

19

Dylam

5126

Game Set. 3 Games.
 Spiel Set. 3 Spiele.
 Set Jeu. 3 Jeux.
 Spel Set. 3 Spelen.

22.5 × 43.5 cm 50

Print Code: E(1)



BEACH RACKETS

WOOD
THICKNESS: 0,6 cm



Cupsol
4578

Beach Rackets. Wood.
Strand Schläger. Holz.
Raquette Plage. Bois.
Strand Rackets. Hout.

19 x 33 x 0,6 cm 36
Print Code: F(1)

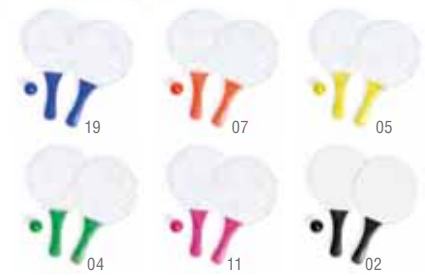

1007



Faluk
4804
WOOD
THICKNESS: 0,6 cm

Beach Rackets. Wood.
Strand Schläger. Holz.
Raquette Plage. Bois.
Strand Rackets. Hout.

19 x 33 x 0,6 cm 36
Print Code: F(1)

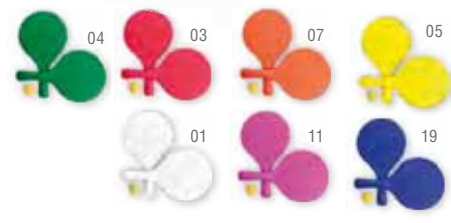

WOOD
THICKNESS: 0,8 cm

Kongal
5922

Beach Rackets. Wood.
Strand Schläger. Holz.
Raquette Plage. Bois.
Strand Rackets. Hout.

23,5 x 38 x 0,8 cm 24
Print Code: F(1)

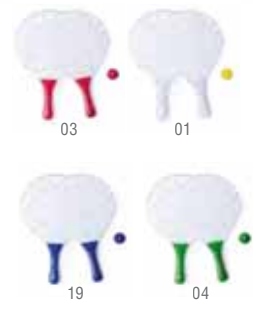



BEACH ball

Nemon
4409

Beach Ball. PVC. Deflated Size: 37 cm. Inflated Size: 28 cm.
Strandball. PVC. Entleerte Größe: 37 cm. Aufgepumpte Größe: 28 cm.
Ballon. PVC. Dimensions Dégonflé: 37 cm. Gonflé: 28 cm.
Strandbal. PVC. Onopgeblazen Maat: 37 cm. Opgeblazen Maat: 28 cm.

Consult. 200 / 100
Print Code: E(1), F(1)

1008



● BIG SIZE

ONE PLAIN SIDE FOR PRINTING
UNA CARA LISA PARA IMPRESIÓN



Magno
3261

Beach Ball. PVC. Deflated Size: 47 cm. Inflated Size: 40 cm.
Strandball. PVC. Entleerte Größe: 47 cm. Aufgepumpte Größe: 40 cm.
Ballon. PVC. Dimensions Dégonflé: 47 cm. Gonflé: 40 cm.
Strandbal. PVC. Onopgeblazen Maat: 47 cm. Opgeblazen Maat: 40 cm.

Consult. 200 / 100
Print Code: E(1), F(1)



Wembley
9576

Beach Ball. PVC. Deflated Size: 33 cm. Inflated Size: 25 cm.
Strandball. PVC. Entleerte Größe: 33 cm. Aufgepumpte Größe: 25 cm.
Ballon. PVC. Dimensions Dégonflé: 33 cm. Gonflé: 25 cm.
Strandbal. PVC. Onopgeblazen Maat: 33 cm. Opgeblazen Maat: 25 cm.

Consult. 400 / 100
Print Code: E(1)



19

Bennick 5618

Beach Ball. PVC. Deflated Size: 37 cm. Inflated Size: 28 cm.
 Strandball. PVC. Entleerte Größe: 37 cm. Aufgepumpte Größe: 28 cm.
 Ballon. PVC. Dimensions Dégonflé: 37 cm. Gonflé: 28 cm.
 Strandbal. PVC. Onopgeblazen Maat: 37 cm. Opgeblazen Maat: 28 cm.

Consult. 200 / 100
 Print Code: E(1), F(1)

TRANSPARENT
TRANSPARENTE

OPAQUE
OPACO



01

04

05

03

07

11



19

TRANSPARENT
TRANSPARENTE

Zeusty 5617

Beach Ball. PVC. Deflated Size: 37 cm. Inflated Size: 28 cm.
 Strandball. PVC. Entleerte Größe: 37 cm. Aufgepumpte Größe: 28 cm.
 Ballon. PVC. Dimensions Dégonflé: 37 cm. Gonflé: 28 cm.
 Strandbal. PVC. Onopgeblazen Maat: 37 cm. Opgeblazen Maat: 28 cm.

Consult. 200 / 100
 Print Code: E(1), F(1)

OPAQUE
OPACO



03

04

05

07

11

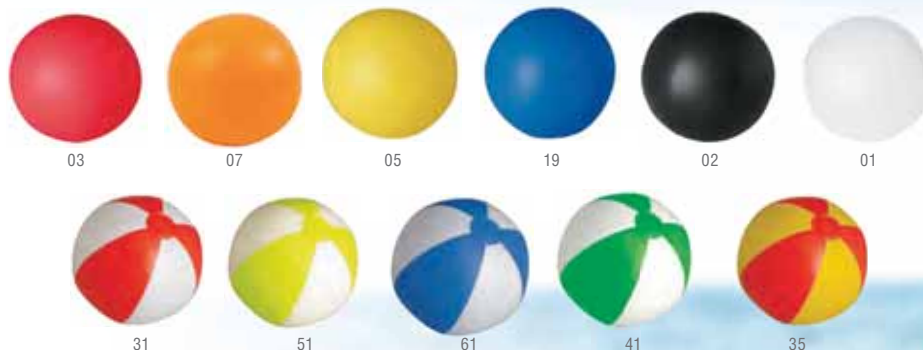

Portobello 8094

Beach Ball. PVC. Deflated Size: 37 cm. Inflated Size: 28 cm.
 Strandball. PVC. Entleerte Größe: 37 cm. Aufgepumpte Größe: 28 cm.
 Ballon. PVC. Dimensions Dégonflé: 37 cm. Gonflé: 28 cm.
 Strandbal. PVC. Onopgeblazen Maat: 37 cm. Opgeblazen Maat: 28 cm.

Consult. 200 / 100
 Print Code: E(1), F(1)





02



19



03



01

Delko

4086

Ball. PU/ PVC. Size: 5.

Ball. PU/ PVC. Größe: 5.

Ballon. Similiticuir/ PVC. Taille: 5.

Voetbal. PU/ PVC. Maat: 5.

Consult.

40

Print Code: G(1)



1010



Bentul

5352

Goal Post. PVC. Special Folded for Printing.

Strandfussballtor. PVC. Spezielle Faltung für Einfachen Aufdruck.

Cage de Buts. PVC. Pliée Spécial pour Impression.

Doel. PVC. Speciaal Gevouwen voor Bedrukking.

126 × 72 × 50 cm 20

Print Code: H(1)



02



01



03



19

Zubigol

3115

Goal Post. Nylon. Foldable.

Strandfussballtor. Nylon. Faltbar.

Cage de Buts. Nylon. Pliable.

Doel. Nylon. Opvouwbaar.

141 × 80 × 80 cm 20

Print Code: I(6)





KIDS PLAY BEACH



Mikey

5114

Tube. PVC.
Stange. PVC.
Stick. PVC.
Stang. PVC.

📏 13 × 86 cm 📦 200 / 100

🎨 Print Code: E(1)

03



1011



EXTENDABLE
EXTENSIBLE

Yumak

6555

Water Pistol.
Wasserpistole.
Pistolet à Eau.
Waterpistol.

📏 31.5 × 11.5 × 3 cm 📦 100 / 50

🎨 Print Code: D(1)



19



05



03



04

Bonney

4683

Water Pistol.
Wasserpistole.
Pistolet à Eau.
Waterpistol.

📏 5.3 × 4.1 × 2.2 cm 📦 1000 / 100

🎨 Print Code: B(1)



03

Sanvi

8854

Armbands. PVC.
Schwimmflügel. PVC.
Brassards. PVC.
Armbanden. PVC.

📏 22 × 13 cm 📦 100 / 10

🎨 Print Code: E(1)



05



19



01

XXL SIZE



Donutk

5350

Air Mattress. PVC. Special Folded for Printing.
Luftmatratze. PVC. Spezielle Faltung für Einfachen Aufdruck.
Matelas. PVC. Plîée Spécial pour Impression.
Luchtbed. PVC. Speciaal Gevouwen voor Bedrukking.

📏 107 × 30 cm 📦 20

🌈 Print Code: H(1)



Pizzak

5351

Air Mattress. PVC. Special Folded for Printing.
Luftmatratze. PVC. Spezielle Faltung für Einfachen Aufdruck.
Matelas. PVC. Plîée Spécial pour Impression.
Luchtbed. PVC. Speciaal Gevouwen voor Bedrukking.

📏 100 × 172 × 16 cm 📦 10

🌈 Print Code: H(1)



Flit

5349

Air Mattress. PVC. Special Folded for Printing.
Luftmatratze. PVC. Spezielle Faltung für Einfachen Aufdruck.
Matelas. PVC. Plîée Spécial pour Impression.
Luchtbed. PVC. Speciaal Gevouwen voor Bedrukking.

📏 64 × 164 × 15 cm 📦 10

🌈 Print Code: H(1)



1013



WHOOOP



DROPWAVE



05
BIG SIZE



19

01

03



01

07

19



03

07

19

Monvar 6602

Air Mattress. PVC. Special Folded for Printing.
Luftmatratze. PVC. Spezielle Faltung für Einfachen Aufdruck.
Matelas. PVC. Pliée Spécial pour Impression.
Luchtbed. PVC. Speciaal Gevouwen voor Bedrukking.

75 × 185 × 25 cm 15
Print Code: H(1)

Pumper 9961

Air Mattress. PVC. Special Folded for Printing.
Luftmatratze. PVC. Spezielle Faltung für Einfachen Aufdruck.
Matelas. PVC. Pliée Spécial pour Impression.
Luchtbed. PVC. Speciaal Gevouwen voor Bedrukking.

55 × 170 × 18 cm 25
Print Code: H(1)

Wave 9417

Air Mattress. PVC.
Luftmatratze. PVC.
Matelas. PVC.
Luchtbed. PVC.

31 × 68 × 10 cm
Print Code: H(1)

100 / 10



Berton

5615

Holder. PVC. Special Folded for Printing.
 Halter. PVC. Spezielle Faltung für Einfachen Aufdruck.
 Support. PVC. Plîée Spécial pour Impression.
 Houder. PVC. Speciaal Gevouwen voor Bedrukking.

Ø 17 × 5 cm 200 / 100

Print Code: E(1)



POOL
Accessories

1014



Rechel

5616

Holder. PVC. Special Folded for Printing.
 Halter. PVC. Spezielle Faltung für Einfachen Aufdruck.
 Support. PVC. Plîée Spécial pour Impression.
 Houder. PVC. Speciaal Gevouwen voor Bedrukking.

16.5 × 19 × 22 cm 200 / 100

Print Code: E(1)

Swing

9208

Holder. PVC.
 Halter. PVC.
 Support. PVC.
 Houder. PVC.

30 × 7 × 18 cm 200 / 100

Print Code: E(1)

Pelmax

4818

Table. PVC.
 Tisch. PVC.
 Table. PVC.
 Tafel. PVC.

60 × 7 × 46 cm 100 / 50

Print Code: F(1)





Pillow beach



03

TRANSPARENT
TRANSPARENTE



07



19



11

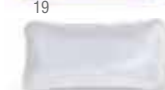

01



05



04

Blisit

5619

Pillow. PVC.
Kissen. PVC.
Coussin. PVC.
Kussen. PVC.

30 x 12 x 15.5 cm 200 / 100

Print Code: E(1)

1015



11

Egeo

3254

Pillow. PVC.
Kissen. PVC.
Coussin. PVC.
Kussen. PVC.

28.5 x 7 x 19 cm 200 / 100

Print Code: E(1)



03

OPAQUE
OPACO

Cancún

9589

Pillow. PVC.
Kissen. PVC.
Coussin. PVC.
Kussen. PVC.

30 x 7 x 15 cm 200 / 100

Print Code: E(1)



Perle

3914

Keyring: EVA.
Schlüsselanhänger: EVA.
Porte-Clés: EVA.
Sleutelhanger: EVA.

3.3 × 8 × 2.3 cm 1000 / 50

Print Code: D(1)



Komber

5115

Keyring: EVA/ PVC.
Schlüsselanhänger: EVA/ PVC.
Porte-Clés: EVA/ PVC.
Sleutelhanger: EVA/ PVC.

4 × 7.2 × 3.6 cm 500 / 10

Print Code: D(1)



special Keyring
Summer



Soke

3583

Keyring: EVA.
Schlüsselanhänger: EVA.
Porte-Clés: EVA.
Sleutelhanger: EVA.

3.3 × 6.8 × 1.4 cm 1000 / 50

Print Code: E(1)



Islan

4420

Keyring: PU.
Schlüsselanhänger: PU.
Porte-Clés: PU.
Sleutelhanger: PU.

3.5 × 8.2 × 1.9 cm 500 / 100

Print Code: E(1)



03



02



09



19



04

Berko

5696

Pocket Ashtray. PVC/ Aluminium.
Tasche Aschenbecher. PVC/ Aluminium.
Cendrier Poche. PVC/ Aluminium.
Zak-Asbak. PVC/ Aluminium.

8 x 8 x 1.1 cm 500 / 50

Print Code: C(1)



02



03



04



19

Kyan

3843

Pocket Ashtray. PVC/ Aluminium.
Tasche Aschenbecher. PVC/ Aluminium.
Cendrier Poche. PVC/ Aluminium.
Zak-Asbak. PVC/ Aluminium.

7.5 x 8.5 x 1.2 cm 500 / 50

Print Code: C(1)



04



Cleansand

2453

Ashtray.
Aschenbecher.
Cendrier.
Asbak.

Ø 5.8 x 8.1 cm 500 / 50

Print Code: C(4)



1017



04



Bluck

5646

Waste Bag Dispenser. 15 Bags Included.
Abfall Bag Spender. 15 Beutel Inklusiv.
Distributeur de Sacs. 15 Sacs Inclus.
Zakjes Dispenser. 15 Tassen Inclusief.

5 x 7.6 x 3.2 cm 200 / 50

Print Code: C(4)

01



03



19



Cart

2429

Trash Bag Holder.
Mülltütenhalter.
Support pour Sac Plastique.
Vuiliszakkenhouder.

30 x 41 x 20 cm 30 / 15

Print Code: E(1)



1018

The Best Price
UV PROTECTION

RECLINABLE



EQUA

19

03

Ø200 CM
BIG SIZE

04

07

05

11

03

05

04

07

19



Taner

3951

Beach Umbrella. Nylon. UV Protection.
Sonnenschirm. Nylon. UV Schutz.
Parasol. Nylon. Protection Rayons UV.
Strandparasol. Nylon. UV Bescherming.

12

Print Code: H(1), N(8)

Sandok

5490

Beach Umbrella. Nylon. Reclinable. UV Protection.
Sonnenschirm. Nylon. Grössenverstellbar. UV Schutz.
Parasol. Nylon. Inclinable. Protection Rayons UV.
Strandparasol. Nylon. Verstellbare. UV Bescherming.

12

Print Code: H(1), N(8)



Mojácar

8448

Beach Umbrella. Nylon.

Sonnenschirm. Nylon.

Pare-Soleil. Nylon.

Strandparasol. Nylon.

📏 Ø 150 cm 📦 12

🎨 Print Code: H(1), N(8), R



1019



Nukel

6412

Beach Umbrella. Nylon.

Sonnenschirm. Nylon.

Pare-Soleil. Nylon.

Strandparasol. Nylon.

📏 Ø 150 cm 📦 12

🎨 Print Code: H(1), N(8), R





Beach Picnic

Zorlax 5635

Beach Mat. Polyester 190T 50 g/ m2.
Strandmatte. Polyester 190T 50 g/ m2.
Natte de Plage. Polyester 190T 50 g/ m2.
Strandmat. Polyester 190T 50 g/ m2.

105 x 145 cm 100 / 50
Print Code: F(1), G(1)



1020



Reset 9963

Armchair. PVC. Special Folded for Printing.
Stuhl. PVC. Spezielle Faltung für Einfachen Aufdruck.
Fauteuil. PVC. Plîée Spécial pour Impression.
Armstoel. PVC. Speciaal Gevouwen voor Bedrukking.

70 x 45 x 70 cm 30
Print Code: H(1)



Xana 3571

Chair Cool Bag. Polyester 600D/ Aluminium. Foldable.
Stuhl Kühltasche. Polyester 600D/ Aluminium. Faltbar.
Chaise Glacière. Polyester 600D/ Aluminium. Pliable.
Stoel-koeltas. Polyester 600D/ Aluminium. Opvouwbaar.

26.5 x 34.5 x 32 cm 20
Print Code: H(8)





06

Mediterráneo

9175

Chair. Polyester 600D. Foldable. Extralight.
 Stuhl. Polyester 600D. Faltpar. Superleicht.
 Chaise. Polyester 600D. Pliable. Super Légère.
 Stoel. Polyester 600D. Opvouwbaar. Extralight.

📏 47 × 52 × 56 cm



🎨 Print Code: H(8)



07



03



05

1021



03

Bonsix

5488

Chair. Polyester 600D. Foldable.
 Stuhl. Polyester 600D. Faltpar.
 Chaise. Polyester 600D. Pliable.
 Stoel. Polyester 600D. Opvouwbaar.

📏 83 × 79 × 49 cm



🎨 Print Code: H(8)



19



02



04

Flentul

5489

Chair. Polyester 600D. Foldable.
 Stuhl. Polyester 600D. Faltpar.
 Chaise. Polyester 600D. Pliable.
 Stoel. Polyester 600D. Opvouwbaar.

📏 45 × 70 × 45 cm



🎨 Print Code: H(8)



02

03

04

19





19

05

03



Baldux 5458

Jarapa Beach. 50% Cotton/ 50% Polyester 300 g/ m2.
 Strandmatte Jarapa Strand. 50% Baumwolle/ 50% Polyester 300 g/ m2.
 Natte Jarapa de Plage. 50% Coton/ 50% Polyester 300 g/ m2.
 Strandmat Jarapa. 50% Katoen/ 50% Polyester 300 g/ m2.

70 x 180 cm 25
 Print Code: F(1), G(1), N(8), P

beach
RELAX



1022



03

Hansier 5415

Beach Mat. 100% Cotton 125 g/ m2.
 Strandmatte. 100% Baumwolle 125 g/ m2.
 Natte de Plage. 100% Coton 125 g/ m2.
 Strandmat. 100% Katoen 125 g/ m2.

Ø 143 cm 50 / 10
 Print Code: F(1), N(8), O, P



05

Waky 4426

Peg.
 Klammer.
 Pince.
 Knijper.

7.5 x 15 x 3 cm 500 / 250
 Print Code: D(1)

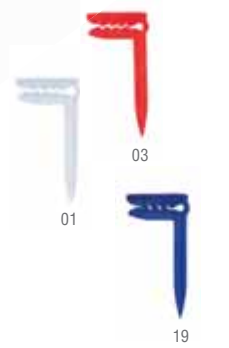

01

03

19



SIZE XL

Reiven

5511

Beach Mat. PP Plastic.
Strandmatte. Plastik PP.
Natte de Plage. PP Plastique.
Strandmat. PP Plastic.

70 × 180 cm 50

Print Code: F(1)



1023



03

Buren

5704

Beach Mat. Laminated Non-Woven.
Strandmatte. Laminiertes Non-Woven.
Natte de Plage. T.N.T. Lamine.
Strandmat. Gelamineerd Non-Woven.

70 × 180 cm 100 / 50

Print Code: F(1), G(1)



07

SIZE XL



Kassia

5512

Beach Mat. PP Plastic.
Strandmatte. Plastik PP.
Natte de Plage. PP Plastique.
Strandmat. PP Plastic.

60 × 180 cm 50

Print Code: F(1)



**THE BEST PRICE
ULTRA ABSORBENT**

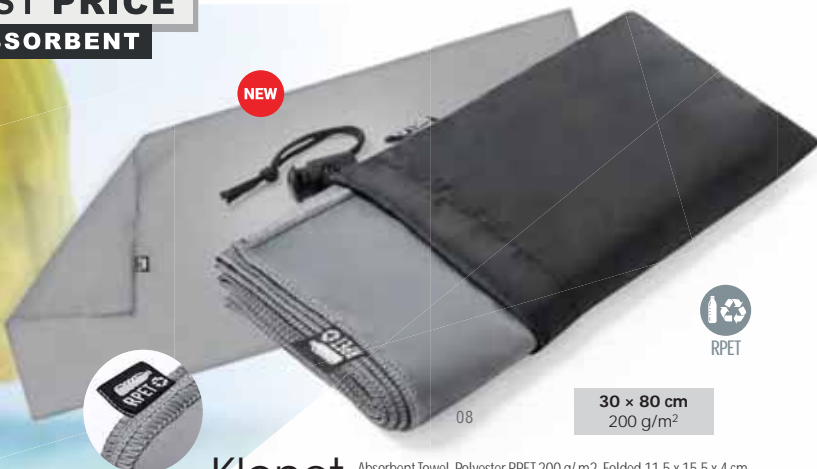

NEW



30 x 80 cm
200 g/m²

Klonet

6851

Absorbent Towel. Polyester RPET 200 g/ m². Folded 11,5 x 15,5 x 4 cm.
Saugfähiges Handtuch. Polyester RPET 200 g/ m². Faltung 11,5 x 15,5 x 4 cm.
Serviette Absorbante. Polyester RPET 200 g/ m². Plîée 11,5 x 15,5 x 4 cm.
Absorbierende Handdoek. Polyester RPET 200 g/ m². Gevouwen 11,5 x 15,5 x 4 cm.

30 x 80 cm 200 / 100
Print Code: F(1), N(8), O, P



XXL SIZE



75 x 150 cm
260 g/m²

03



90 x 170 cm
310 g/m²

03

05

04

19

06



75 x 150 cm
345 g/m²

1025

03

11

07

19

04

02

Romid

6046

Absorbent Towel. Microfibre 260 g/ m².
Saugfähiges Handtuch. Mikrofaser 260 g/ m².
Serviette Absorbante. Microfibre 260 g/ m².
Absorbierende Handdoek. Microfiber 260 g/ m³.

75 x 150 cm 50
Print Code: F(1), N(8), P, R

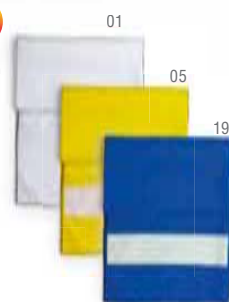

01

05

19

Bayalax

5919

Absorbent Towel. Microfibre 310 g/ m².
Saugfähiges Handtuch. Mikrofaser 310 g/ m².
Serviette Absorbante. Microfibre 310 g/ m².
Absorbierende Handdoek. Microfiber 310 g/ m².

90 x 170 cm 30
Print Code: F(1), N(8), P, R



01

07

11

02

Lypso

4553

Absorbent Towel. Microfibre 345 g/ m².
Saugfähiges Handtuch. Mikrofaser 345 g/ m².
Serviette Absorbante. Microfibre 345 g/ m².
Absorbierende Handdoek. Microfiber 345 g/ m².

75 x 150 cm 30
Print Code: F(1), N(8), O, P



180 x 70 cm
110 g/m²

Yanex
6056

Towel Pareo. 100% Cotton 110 g/ m2.
Handtuch Pareo. 100% Baumwolle 110 g/ m2.
Paréo Serviette. 100% Coton 110 g/ m2.
Omslag Handdoek. 100% Katoen 110 g/ m2.

Print Code: G(1), N(8)

50

PAREO

1026



03

01

02

11

Duma
3944

Pareo. Viscose/ Polyester.
Pareo. Viskose/ Polyester.
Paréo. Viscose/ Polyester.
Pareo-Rok. Viscose/ Polyester.

Print Code: F(1), N(8)

100 / 10



11

05

02

03

19

01

Rosix
4831

Foulard Pareo. Viscose/ Polyester. Beauty Bag Included.
Foulard Pareo. Viskose/ Polyester. Kosmetik Tasche Inklusive.
Paréo Foulard. Viscose/ Polyester. Nécessaire Inclus.
Foulard. Viscose/ Polyester. Toilettes Inclusief.

Print Code: F(1), N(8), G(1)

50



ORGANIC

180 x 90 cm
110 g/m²

03



19

08

11

Yistal 6427

Towel Pareo. 100% Organic Cotton 110 g/ m².
Handtuch Pareo. 100% Organische Baumwolle 110 g/ m².
Paréo Serviette. 100% Coton Organique 110 g/ m².
Omslag Handdoek. 100% Organisch Katoen 110 g/ m².

180 x 90 cm

50

Print Code: F(1), N(8), O, P

1027



180 x 70 cm
110 g/m²

03

21



Minerva 5721

Towel Pareo. 50% Cotton/ 50% Polyester 180 g/ m².
Handtuch Pareo. 50% Baumwolle/ 50% Polyester 180 g/ m².
Paréo Serviette. 50% Coton/ 50% Polyester 180 g/ m².
Omslag Handdoek. 50% Katoen/ 50% Polyester 180 g/ m².

180 x 90 cm

30 / 5

Print Code: F(1), N(8), O, P

Suntan 4885

Towel Pareo. 100% Cotton 110 g/ m².
Handtuch Pareo. 100% Baumwolle 110 g/ m².
Paréo Serviette. 100% Coton 110 g/ m².
Omslag Handdoek. 100% Katoen 110 g/ m².

180 x 70 cm

50

Print Code: F(1), N(8)



05

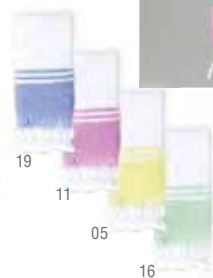

19

11

05

16

TERRY TOWEL
TOALLA DE RIZO



180 x 90 cm
180 g/m²

03





Farus

5726

Bag. Jute/ Cotton.
Tasche. Jutestoff/ Baumwolle.
Sac. Jute/ Coton.
Tas. Jute/ Katoen.

48 x 35 x 15 cm 100 / 10

Print Code: F(6), N(8)

Natural
JUTE



1028



Cekon

5725

Bag. Laminated Jute/ Cotton.
Tasche. Laminiertes Jutestoff/ Baumwolle.
Sac. Jute Laminé/ Coton.
Tas. Gelamineerd Jute/ Katoen.

44.5 x 34 x 15 cm 50 / 10

Print Code: F(6), N(8)



Rotin

6387

Bag. Laminated Jute/ Laminated Cotton.
Tasche. Laminiertes Jutestoff/ Laminiertes Baumwolle.
Sac. Jute Laminé/ Coton Laminé.
Tas. Gelamineerd Jute/ Gelamineerd Katoen.

39 x 31.5 x 16 cm 50 / 10

Print Code: F(6)



Bitalex

6388

Bag. Jute/ Cotton.
Tasche. Jutestoff/ Baumwolle.
Sac. Jute/ Coton.
Tas. Jute/ Katoen.

48 x 35 x 15 cm 50 / 10

Print Code: F(6), N(8), P

NATURAL JUTE & COTTON

NEW



NEW



1029

NEW



POCKET



Marnel

6818

Backpack. Jute/ Cotton.
Rucksack. Jutesstoff/ Baumwolle.
Sac à Dos. Jute/ Coton.
Rugzak. Jute/ Katoen.

32 x 40 x 7 cm

Print Code: F(1), N(8), 0

50 / 10



Ponix

6816

Cool Bag. Laminated Jute/ Cotton/ Aluminium.
Kühltasche. Laminierter Jutesstoff/ Baumwolle/ Aluminium.
Glacière. Jute Laminé/ Coton/ Aluminium.
Koeltas. Gelamineerd Jute/ Katoen/ Aluminium.

21 x 23 x 16 cm

Print Code: F(1), N(8)

50



Lopso

6817

Duffel Bag. Jute/ Cotton.
Seesack. Jutesstoff/ Baumwolle.
Balluchon. Jute/ Coton.
Plunjezak. Jute/ Katoen.

Ø 23 x 45 cm

Print Code: F(1), N(8)

50 / 10

NEW



Ramet

6819

Bag. Jute/ Cotton.
Tasche. Jutestoff/ Baumwolle.
Sac. Jute/ Coton.
Tas. Jute/ Katoen.

48 x 35 x 15 cm

50 / 10

Print Code: F(1)



Triex

6820

Bag. Laminated Jute/ Cotton.
Tasche. Laminiertes Jutestoff/ Baumwolle.
Sac. Jute Lamine/ Coton.
Tas. Gelamineerd Jute/ Katoen.

44.5 x 35 x 14 cm

50 / 10

Print Code: F(1)

1030



03



21

Kalkut

5808

Bag. Jute/ Cotton.
Tasche. Jutestoff/ Baumwolle.
Sac. Jute/ Coton.
Tas. Jute/ Katoen.

38 x 41 cm

100 / 10

Print Code: F(1)

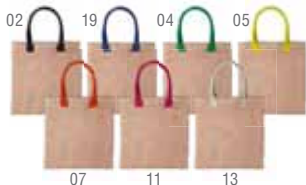

07

11

13

Hintol

4883

Bag. Laminated Jute/ Cotton.
Tasche. Laminiertes Jutestoff/ Baumwolle.
Sac. Jute Lamine/ Coton.
Tas. Gelamineerd Jute/ Katoen.

44.5 x 35 x 14 cm

60 / 5

Print Code: F(1)



02

11

07

19

03

05

13



NEW

Helpy
6836

Bag. 100% Cotton 140 g/ m2.
Tasche. 100% Baumwolle 140 g/ m2.
Sac. 100% Coton 140 g/ m2.
Tas. 100% Katoen 140 g/ m2.

140 g/m²

||||||| 45 x 38 x 11 cm

📦 100 / 10

🌈 Print Code: F(6), N(8), O, P

Beach BAGS

1031



NEW

Martha
6834

Bag. 100% Cotton 170 g/ m2.
Tasche. 100% Baumwolle 170 g/ m2.
Sac. 100% Coton 170 g/ m2.
Tas. 100% Katoen 170 g/ m2.

📦 150 / 50

||||||| 39 x 41 x 8 cm

🌈 Print Code: F(6), N(8), P

Trobax
6572

Bag. 100% Cotton 220 g/ m2.
Tasche. 100% Baumwolle 220 g/ m2.
Sac. 100% Coton 220 g/ m2.
Tas. 100% Katoen 220 g/ m2.

📦 100 / 10

||||||| 41 x 45 cm

🌈 Print Code: F(6), N(8)

220 g/m²



170 g/m²

Daryan

5586

Bag. Polyester 600D.
Tasche. Polyester 600D.
Sac. Polyester 600D.
Tas. Polyester 600D.

44 × 36 × 11 cm 50

Print Code: F(1), N(8)



ZIPPER
CREMALLERA

16



19

11

05

03

beach BAGS

ZIPPER
CREMALLERA

1032



03

01

07

11

16

19



03

07

19



03



03



01

19

02

Vargax

5237

Bag. Polyester 210D. Padded. With Inner Lining.
Tasche. Polyester 210D. Gepolstert. Mit Innenfutter.
Sac. Polyester 210D. Rembouré. Avec Doublure Antérieure.
Tas. Polyester 210D. Gewatteerd. Met Voering aan de Binnenzijde.

48 × 41 × 11 cm 50

Print Code: G(1)



Drago

9973

Bag. Polyester 600D.
Tasche. Polyester 600D.
Sac. Polyester 600D.
Tas. Polyester 600D.

50 × 38 × 21 cm 50

Print Code: F(1), N(8)

07

19

Holfox

5728

Bag. Polyester/ Cotton.
Tasche. Polyester/ Baumwolle.
Sac. Polyester/ Coton.
Tas. Polyester/ Katoen.

47 × 38 × 10 cm 100 / 10

Print Code: F(1), N(8)

02

13

19

Magil

5379

Bag. Laminated Non-Woven/ PVC.
Tasche. Laminiertes Non-Woven/ PVC.
Sac. T.N.T. Lamine/ PVC.
Tas. Gelamineerd Non-Woven/ PVC.

50 × 35 × 15 cm 100 / 5

Print Code: F(1)



Beach BAGS

Purse

9975

Bag. Polyester 600D. Beauty Bag Included.
 Tasche. Polyester 600D. Kosmetik Tasche Inklusive.
 Sac. Polyester 600D. Nécessaire Inclus.
 Tas. Polyester 600D. Toiletas Inclusief.

47 × 34 × 12.5 cm 50

Print Code: F(1), N(8)



ZIPPER
 CREMALLERA



03

ZIPPER
 CREMALLERA



07

ZIPPER
 CREMALLERA



11

1033

Nirfe

4863

Bag. Synthetic. With Inner Lining.
 Tasche. Synthetisch. Mit Innenfutter.
 Sac. Synthétique. Avec Doublure Antérieure.
 Tas. Synthetisch. Met Voering aan de Binnenzijde.

43.5 × 36.5 × 22.5 cm 50

Print Code: F(1)



18

11

21

13

Maxize

9974

Bag. Polyester 600D. Beauty Bag Included.
 Tasche. Polyester 600D. Kosmetik Tasche Inklusive.
 Sac. Polyester 600D. Nécessaire Inclus.
 Tas. Polyester 600D. Toiletas Inclusief.

53 × 36.5 × 16 cm 50

Print Code: F(1), N(8)



19

03

Maxi

9384

Bag. Polyester 600D. Beauty Bag Included.
 Tasche. Polyester 600D. Kosmetik Tasche Inklusive.
 Sac. Polyester 600D. Nécessaire Inclus.
 Tas. Polyester 600D. Toiletas Inclusief.

52.5 × 38.5 × 18 cm 30

Print Code: F(1), N(8)



16

19

07

03



Babit

5879

Beauty Bag. Cotton/ Polyester. With Inner Lining.
 Kosmetik Tasche. Baumwolle/ Polyester. Mit Innenfutter.
 Nécessaire. Coton/ Polyester. Avec Doublure Antérieure.
 Toilettas. Katoen/ Polyester. Met Voering aan de Binnenzijde.

20 × 11 × 5.5 cm 200 / 10

Print Code: E(1), N(8)

Beach BEAUTY BAG



02



02

Karoky

5164

Beauty Bag. 100% Cotton.
 Kosmetik Tasche. 100% Baumwolle.
 Nécessaire. 100% Coton.
 Toilettas. 100% Katoen.

22 × 15 × 7.5 cm

300 / 50

Print Code: E(1), N(8), 0



01



04

13

03

07

19

Lendil

6120

Beauty Bag. 100% Cotton.
 Kosmetik Tasche. 100% Baumwolle.
 Nécessaire. 100% Coton.
 Toilettas. 100% Katoen.

23 × 18 × 8 cm

300 / 50

Print Code: E(1), N(8)



1034

03



02

11

13

19

Conakar

5729

Beauty Bag. Polyester.
 Kosmetik Tasche. Polyester.
 Nécessaire. Polyester.
 Toilettas. Polyester.

22 × 14 × 6.5 cm 500 / 10

Print Code: E(1), N(8)



JUTE & cotton



Lindak

6626
Beauty Bag. Laminated Jute.
Kosmetik Tasche. Laminiertes Jutestoff.
Nécessaire. Jute Laminé.
Toiletta. Gelamineerd Jute.

25 × 16 × 6 cm 200 / 50
Print Code: E(1), N(8)

1035



Tays

6827

Beauty Bag. Laminated Jute/ Cotton.
Kosmetik Tasche. Laminiertes Jutestoff/ Baumwolle.
Nécessaire. Jute Laminé/ Coton.
Toiletta. Gelamineerd Jute/ Katoen.

21.5 × 16.5 × 5 cm 250 / 50
Print Code: E(1), N(8)



Halim

6826

Beauty Bag. Laminated Jute/ Cotton.
Kosmetik Tasche. Laminiertes Jutestoff/ Baumwolle.
Nécessaire. Jute Laminé/ Coton.
Toiletta. Gelamineerd Jute/ Katoen.

21 × 12 × 8 cm 250 / 50
Print Code: E(1), N(8)



Ringok

6828

Beauty Bag. Laminated Jute/ Cotton.
Kosmetik Tasche. Laminiertes Jutestoff/ Baumwolle.
Nécessaire. Jute Laminé/ Coton.
Toiletta. Gelamineerd Jute/ Katoen.

20 × 15 × 6 cm 250 / 50
Print Code: E(1), N(8)



11

Rastek
4985

Bag. PVC.
Tasche. PVC.
Sac. PVC.
Tas. PVC.

29 × 33 × 8 cm 50 / 10

Print Code: F(1)

Beach BEAUTY BAG



1036



02

Losut
4778

Beauty Bag. PVC.
Kosmetik Tasche. PVC.
Nécessaire. PVC.
Toiletas. PVC.

29 × 21 × 9 cm 200 / 50

Print Code: F(1)



01

19

03



11

Bracyn
5933

Beauty Bag. PVC.
Kosmetik Tasche. PVC.
Nécessaire. PVC.
Toiletas. PVC.

24.5 × 20 × 6 cm 200 / 10

Print Code: F(1)



03

19

07

01

04



Iriam

5064

Beauty Bag. PVC.
Kosmetik Tasche. PVC.
Nécessaire. PVC.
Toiletas. PVC.

17 x 12.5 x 4.5 cm 400 / 50

Print Code: E(1)



Lobe

3431

Beauty Bag. PVC.
Kosmetik Tasche. PVC.
Nécessaire. PVC.
Toiletas. PVC.

17 x 12.5 x 4.5 cm 400 / 50

Print Code: E(1)



Saeki

5378

Beauty Bag. EVA.
Kosmetik Tasche. EVA.
Nécessaire. EVA.
Toiletas. EVA.

16.5 x 14 x 5 cm

Print Code: E(1)

300 / 25

01



Claris

5377

Beauty Bag. EVA.
Kosmetik Tasche. EVA.
Nécessaire. EVA.
Toiletas. EVA.

16 x 18 x 6 cm

Print Code: E(1)

300 / 25

01

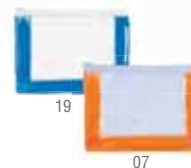



03

Kardil 6285

Cool Bag. Polyester 600D/ PEVA.
Kühltasche. Polyester 600D/ PEVA.
Glacière. Polyester 600D/ PEVA.
Koeltas. Polyester 600D/ PEVA.

31 × 24.5 × 20 cm 30

Print Code: G(1), N(8)



19

04

01

COOL BAG



1038



02

Bemel 4364

Cool Bag. Polyester 600D/ PEVA.
Kühltasche. Polyester 600D/ PEVA.
Glacière. Polyester 600D/ PEVA.
Koeltas. Polyester 600D/ PEVA.

25 × 24 × 15 cm 20

Print Code: G(1), N(8)



19

03



03

Artirian 5298

Cool Bag. Polyester 210D/ PEVA.
Kühltasche. Polyester 210D/ PEVA.
Glacière. Polyester 210D/ PEVA.
Koeltas. Polyester 210D/ PEVA.

26 × 27 × 17.5 cm 50

Print Code: G(1), N(8)



19

01

07



03

Listak 5593

Cool Bag. Polyester 210D/ PEVA.
Kühltasche. Polyester 210D/ PEVA.
Glacière. Polyester 210D/ PEVA.
Koeltas. Polyester 210D/ PEVA.

20 × 27 × 13 cm 50

Print Code: G(1), N(8)



04

19

02

RPET

i The fabric used in the manufacturing process of this product is made of recycled plastic (RPET). Like this, the emission of plastic residues to our planet and the consumption of energy is drastically reduced, resulting in a much more eco-friendly process.

El material de este producto está fabricado con plástico reciclado (RPET), que, además de ayudar en la disminución de residuos plásticos en el planeta, utiliza menos energía en el proceso de fabricación, haciendo que sea mucho menos dañino para el medio ambiente.

STOP PLASTIC POLLUTING THE OCEAN



Botum
6849

Cool Bag. Polyester 600D RPET/ PEVA.
Kühltasche. Polyester 600D RPET/ PEVA.
Glacière. Polyester 600D RPET/ PEVA.
Koeltas. Polyester 600D RPET/ PEVA.

31 x 24.5 x 20 cm
Print Code: G(1), N(8)

30



BPA FREE

1039



03

Sindy
6813

Cool Bag. Polyester 420D/ PEVA.
Kühltasche. Polyester 420D/ PEVA.
Glacière. Polyester 420D/ PEVA.
Koeltas. Polyester 420D/ PEVA.

37 x 29 x 21 cm
Print Code: G(1), N(8)

20



BPA FREE

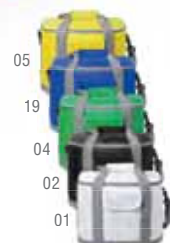

05

19

04

02

01

POCKET



NEW

ALUMINIUM

Ponix
6816

Cool Bag. Laminated Jute/ Cotton/ Aluminium.
Kühltasche. Laminierter Jutestoff/ Baumwolle/ Aluminium.
Glacière. Jute Laminé/ Coton/ Aluminium.
Koeltas. Gelamineerd Jute/ Katoen/ Aluminium.

21 x 23 x 16 cm
Print Code: F(1), N(8)

50



BPA FREE





05

Nipex 5234

Drawstring Cool Bag. Polyester 210D/ Aluminium.
Kühltasche Rucksack. Polyester 210D/ Aluminium.
Sac à Dos Glacière. Polyester 210D/ Aluminium.
Koeltas-Rugzak. Polyester 210D/ Aluminium.

32 x 42 cm 200 / 10

Print Code: G(1), N(8)



Video

COOL BAG



1040



03

Polys 5419

Cool Bag Backpack. Polyester 600D/ Aluminium. Padded Shoulder Straps.
Kühltasche Rucksack. Polyester 600D/ Aluminium. Gepolsterte Schultergurte.
Sac à Dos Glacière. Polyester 600D/ Aluminium. Bretelles Rembourrées.
Koeltas-Rugzak. Polyester 600D/ Aluminium. Gewatteerde Schouderbanden.

31 x 40 x 18.5 cm 50

Print Code: G(1), N(8)



03

Yonner 6277

Thermal Picnic Basket. Polyester 600D/ Aluminium. Foldable.
Wärme Tasche. Polyester 600D/ Aluminium. Fallbar.
Sac Thermique. Polyester 600D/ Aluminium. Pliable.
Thermo-Tasje. Polyester 600D/ Aluminium. Opvouwbaar.

47 x 25 x 28 cm

Print Code: G(1), N(8)



03

Buck 3073

Cool Bag. PVC/ Aluminium.
Kühltasche. PVC/ Aluminium.
Glacière. PVC/ Aluminium.
Koeltas. PVC/ Aluminium.

Ø 25 x 29 cm 80

Print Code: G(1), N(8)





COOL BAG



19
Coolcan
3072

Cool Bag. PVC/ Aluminium.
Kühltasche. PVC/ Aluminium.
Glacière. PVC/ Aluminium.
Koeltas. PVC/ Aluminium.

21 x 15 x 15 cm 200 / 25
Print Code: F(1), N(8)



1041

19
Hertum
5737

Cool Bag. Non-Woven/ Aluminium.
Kühltasche. Non-Woven/ Aluminium.
Glacière. T.N.T./ Aluminium.
Koeltas. Non-Woven/ Aluminium.

21 x 15 x 15 cm 200 / 25
Print Code: F(1), N(8)



Lans
5173

Cool Bag. Non-Woven/ Aluminium.
Kühltasche. Non-Woven/ Aluminium.
Glacière. T.N.T./ Aluminium.
Koeltas. Non-Woven/ Aluminium.

27 x 31 x 15 cm 100 / 25
Print Code: G(1), N(8)



Tivex
4147

Cool Bag. PVC/ Aluminium.
Kühltasche. PVC/ Aluminium.
Glacière. PVC/ Aluminium.
Koeltas. PVC/ Aluminium.

15 x 13 x 15 cm 200 / 25
Print Code: F(1), N(8)





FOLDABLE
PLEGABLE



19

Daniels

3311

Cool Bag. Polyester 190T/ Aluminium.
Kühltasche. Polyester 190T/ Aluminium.
Glacière. Polyester 190T/ Aluminium.
Koeltas. Polyester 190T/ Aluminium.

45 x 36 x 9 cm 100 / 20

Print Code: G(1)



COOL
BAG

1042



11

Hobart

4690

Cool Bag. Laminated Non-Woven/ Aluminium.
Kühltasche. Laminiertes Non-Woven/ Aluminium.
Glacière. T.N.T. Lamine/ Aluminium.
Koeltas. Gelamineerd Non-Woven/ Aluminium.

37 x 34 x 15 cm 200 / 50

Print Code: G(1)



COOL BAG CONVERTS
INTO PICNIC BLANKET
BOLSA NEVERA CONVERTIBLE
EN MANTA DE PICNIC

19

Klab

4644

Cool Bag. Polyester 600D/ Aluminium.
Kühltasche. Polyester 600D/ Aluminium.
Glacière. Polyester 600D/ Aluminium.
Koeltas. Polyester 600D/ Aluminium.

44 x 39 cm 50

Print Code: G(1), N(8)





6 L



Opener

Blake 5332

Bucket. Metal. 6 L. Opener Included.
Eimer. Metall. 6 L. Flaschenöffner Inklusive.
Seau. Métal. 6 L. Ouvrir Bouteille Inclus.
Emmer. Metaal. 6 L. Opener Inclusief.

Ø 22.5 × 18.5 cm 20

Print Code: G(1)

1043



Fresher 3074

Cool Bottle. Polyester 600D/ PVC. Suitable for Bottle 1,5 l.
Flaschenkühltasche. Polyester 600D/ PVC. Flaschen bis Größe 1,5 l.
Glacière Bouteille. Polyester 600D/ PVC. Bouteilles Jusqu'à 1,5 l.
Flessenkoeler. Polyester 600D/ PVC. Geschikt voor 1,5 l Fles.

Ø 11 × 33.5 cm 100 / 20

Print Code: F(1), N(8)

Blesk 5636

Pouch. Soft Shell.
Estojo. Soft Shell.
Étui. Soft Shell.
Hoes. Soft Shell.

Ø 7.5 × 10.5 cm 500 / 50

Print Code: E(1), N(8)



19

North

3382

Barbecue Set. Stainless Steel/ Polyester 600D. 7 Accessories.
Grillset. Rostfreier Stahl/ Polyester 600D. 7 Teile.

Set Barbecue. Acier Inox/ Polyester 600D. 7 Accessoires.

Barbecue Set. Roestvrij Staal/ Polyester 600D. 7 Accessoires.

 43 x 60 cm  20

 Print Code: I(8)



1044



Duvinax



6040

Barbecue Set. Stainless Steel. 6 Functions.

Grillset. Rostfreier Stahl. 6 Funktionen.

Set Barbecue. Acier Inox. 6 Fonctions.

Barbecue Set. Roestvrij Staal. 6 Functies.

 8.8 x 27 x 2.2 cm  20

 Print Code: E(1), L2



Tucco

4500

Air Blower.

Gebblase.

Souffleur.

Aanblazer Barbecue.

 25 x 8 x 4.5 cm  50 / 25

 Print Code: F(1)



Bary



4501

Barbecue Grill Cleaner. 3 Accessories.

Grillputzer. 3 Teile.

Brosse Nettoyante Barbecue. 3 Accessoires.

Barbecue Grill Cleaner. 3 Accessoires.

 7.1 x 12 x 10 cm  100 / 50

 Print Code: F(2)

05



Vissla

4504

Barbecue. Metal.
Grill. Metall.
Barbecue. Métal.
Barbecue. Metaal.

▬▬▬▬▬▬ 0 36 × 36 cm 📦 4

🌈 Print Code: J(1)



1045

Rosser

2553

Kitchen Lighter.
Küchen Feuerzeug.
Briquet Cuisine.
Keuken Aansteker.

▬▬▬▬▬▬ 2.7 × 12.3 × 1.4 cm 📦 600 / 50

🌈 Print Code: B(4)



01



02

Vurcex

6295

Apron. 100% Cotton/ PU.
Schürze. 100% Baumwolle/ PU.
Tablier. 100% Coton/ Similicuir.
Schort. 100% Katoen/ PU.

▬▬▬▬▬▬ 68 × 80 cm 📦 50

🌈 Print Code: E(4), N(8), P



14



02





Aston

8101

Steering Wheel Sunshade. Aluminium.
Lenkrad Abdeckung. Aluminium.
Couvre Volant. Aluminium.
Stuur-Zonnescher. Aluminium.

Ø 43 cm 100
Print Code: F(1)

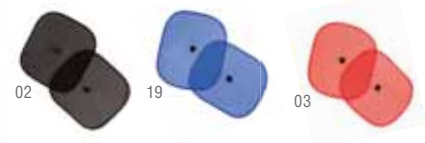

WHITE COLOUR IDEAL FOR SUBLIMATION
COLOR BLANCO IDEAL PARA SUBLIMACION

01



Vent

8102

Sunshade. Polyester. 2 Pieces.
Autosonnenschutz. Polyester. 2 Stück.
Pare-Soleil. Polyester. 2 Pièces.
Zonnescher. Polyester. 2 Stuks.

44 x 37 cm 120 / 20
Print Code: F(1), R



1046



Belgiox

5709



Sunshade. Two Bubble Aluminium Sides.
Autosonnenschutz. Aluminium Luftblasen Beidseitig.
Pare-Soleil. Aluminium Bulles Deux Faces.
Zonnescher. Tweezijdig Aluminium Bubbelfolie.

180 x 90 cm 50
Print Code: H(1)



Vagón

9173

Sunshade. Two Bubble Aluminium Sides.
Autosonnenschutz. Aluminium Luftblasen Beidseitig.
Pare-Soleil. Aluminium Bulles Deux Faces.
Zonnescher. Tweezijdig Aluminium Bubbelfolie.

143 x 74 cm 100
Print Code: H(1)





130 x 60 CM

03



130 x 60 CM



19



02

Fussion

8100

Sunshade. Aluminium One Side.
Autosonnenschutz. Aluminium Einseitig.
Pare-Soleil. Aluminium Un Côté.
Zonnescherm. Aluminium Eenzijdig.



Car

130 x 60 cm 100
Print Code: H(1)

Cavalier

9889

Sunshade. Two Bubble Aluminium Sides.
Autosonnenschutz. Aluminium Luftblasen Beidseitig.
Pare-Soleil. Aluminium Bulles Deux Faces.
Zonnescherm. Tweezijdig Aluminium Bubbelfolie.



Car

130 x 60 cm 100
Print Code: H(1)



130 x 70 CM



130 x 80 CM



Car

Van

Jumbo

9124

Sunshade. Aluminium One Side.
Autosonnenschutz. Aluminium Einseitig.
Pare-Soleil. Aluminium Un Côté.
Zonnescherm. Aluminium Eenzijdig.

130 x 70 cm 100
Print Code: H(1)

Falnit

5708

Sunshade. Two Bubble Aluminium Sides.
Autosonnenschutz. Aluminium Luftblasen Beidseitig.
Pare-Soleil. Aluminium Bulles Deux Faces.
Zonnescherm. Tweezijdig Aluminium Bubbelfolie.

130 x 80 cm 100
Print Code: H(1)



Car



Van

CA- PS & HATS





04



13

Zelio
4930

Hat. Straw.
Hut. Stroh.
Chapeau. Paille.
Hoed. Stro.

 Consult.  250
 Print Code: Consultar



Inner Band

NEW



08



06



02

Hetul

6854

Hat. Polyester RPET.
Hut. Polyester RPET.
Bonnet. Polyester RPET.
Muts. Polyester RPET.

Consult.

Print Code: N(8), O, P



250 / 25

RPET STOP PLASTIC POLLUTING THE OCEAN

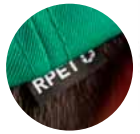

02



04



01



03



19



Keinfox

6420

Cap. Polyester RPET. 5 Panels.
Mütze. Polyester RPET. 5 Panels.
Casquette. Polyester RPET. 5 Panneaux.
Pet. Polyester RPET. 5 Panelen.

Consult.

Print Code: E(1), N(8), O, P, R

300 / 30



Zonner

6421



Cap. 100% Organic Cotton. 5 Panels.
Mütze. 100% Organische Baumwolle. 5 Panels.
Casquette. 100% Coton Organique. 5 Panneaux.
Pet. 100% Organisch Katoen. 5 Panelen.

Consult.

Print Code: E(1), N(8), O, P

300 / 30

100% ORGANIC COTTON



02

IDEAL FOR SCREEN PRINTING AND SUBLIMATION
IDEAL PARA SERIGRAFÍA Y SUBLIMACIÓN



19

04

05

03

11

Zodak
4828

Cap. Polyester. 5 Panels.
Mütze. Polyester. 5 Panels.
Casquette. Polyester. 5 Panneaux.
Pet. Polyester. 5 Panelen.



5 Panels



Ideal
Sublimation

Consult.

200 / 25

Print Code: E(1), N(8), O, P, R



1050



19



05F

FLUORESCENT



5 Panels



04



02



03



05



07



01



Ideal
Sublimation



02



Dowan
4560

Cap. Polyester. 5 Panels.
Mütze. Polyester. 5 Panels.
Casquette. Polyester. 5 Panneaux.
Pet. Polyester. 5 Panelen.

Consult. 200 / 25

Print Code: E(1), N(8), O, P



5 Panels



07F



04F



11F



Clipak
6337

Cap. Polyester. 5 Panels.
Mütze. Polyester. 5 Panels.
Casquette. Polyester. 5 Panneaux.
Pet. Polyester. 5 Panelen.

Consult. 200 / 25

Print Code: E(1), N(8), O, P, R

Yobs
5360

Cap. Polyester. 5 Panels.
Mütze. Polyester. 5 Panels.
Casquette. Polyester. 5 Panneaux.
Pet. Polyester. 5 Panelen.

Consult. 200 / 25

Print Code: E(1), N(8), O, P, R



5 Panels



19



11



05



04



01



03



Ideal
Sublimation



TRENDS CAPS



5 Panels

Loriok

6439

Cap. Natural Cork/ Polyester. 5 Panels.

Mütze. Naturkork/ Polyester. 5 Panels.

Casquette. Bouchon Naturel/ Polyester. 5 Panneaux.

Pet. Natuurlijk Kurk/ Polyester. 5 Panelen.

Consult. 200 / 25

Print Code: E(1)

1051



02

Harum

6208



5 Panels

Cap. Microfibre/ Polyester. 5 Panels.

Mütze. Mikrofaser/ Polyester. 5 Panels.

Casquette. Microfibre/ Polyester. 5 Panneaux.

Pet. Microfiber/ Polyester. 5 Panelen.

Consult. 200 / 50

Print Code: E(1), N(8), O, P, R



19



03



01



Ideal
Sublimation



02

01



06



6 Panels

Danix

6618

Cap. Polyester. 6 Panels.

Mütze. Polyester. 6 Panels.

Casquette. Polyester. 6 Panneaux.

Pet. Polyester. 6 Panelen.

Consult. 200 / 50

Print Code: E(1), N(8), O, P



04



02 01 21 19 05 07 03 11

Karif
5227

Cap. Microfibre/ Polyester. 5 Panels.
Mütze. Mikrofaser/ Polyester. 5 Panels.
Casquette. Microfibre/ Polyester. 5 Panneaux.
Pet. Microfibre/ Polyester. 5 Panelen.

Consult. 300 / 50

Print Code: E(1), N(8), O, P, R

Microfibre/ Polyester



1052



02



11 03 07 05 04 19 06 01

Blazok
5226

Cap. Microfibre/ Polyester. 6 Panels.
Mütze. Mikrofaser/ Polyester. 6 Panels.
Casquette. Microfibre/ Polyester. 6 Panneaux.
Pet. Microfibre/ Polyester. 6 Panelen.

Consult. 300 / 50

Print Code: E(1), N(8), O, P, R



03



01 07 05 04 11 19 06 02

Krox
5225

Cap. Microfibre/ Polyester. 5 Panels.
Mütze. Mikrofaser/ Polyester. 5 Panels.
Casquette. Microfibre/ Polyester. 5 Panneaux.
Pet. Microfibre/ Polyester. 5 Panelen.

Consult. 300 / 50

Print Code: E(1), N(8), O, P, R



The Best PRICE

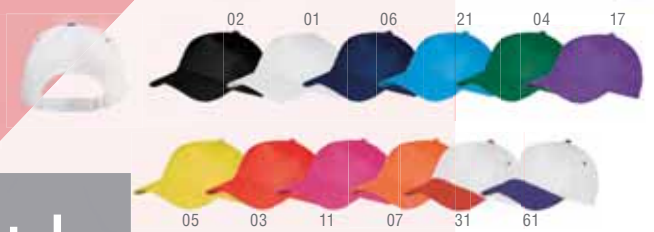

Sport 8072

Cap. 100% Cotton. 5 Panels.
Mütze. 100% Baumwolle. 5 Panels.
Casquette. 100% Coton. 5 Panneaux.
Pet. 100% Katoen. 5 Panelen.



Consult.

Print Code: E(1), N(8), O, P

300 / 30

IDEAL FOR SCREEN PRINTING AND SUBLIMATION
IDEAL PARA SERIGRAFÍA Y SUBLIMACIÓN



Sodel 4479

Cap. Polyester. 5 Panels.
Mütze. Polyester. 5 Panels.
Casquette. Polyester. 5 Panneaux.
Pet. Polyester. 5 Panelen.

Consult. 200 / 25

Print Code: E(1), N(8), O, P, R



Line 8544

Cap. 100% Cotton. 5 Panels.
Mütze. 100% Baumwolle. 5 Panels.
Casquette. 100% Coton. 5 Panneaux.
Pet. 100% Katoen. 5 Panelen.

Consult. 300 / 30

Print Code: E(1), N(8), O, P





Kurtel

6308

Cap. Cotton/ Polyester. 5 Panels.
Mütze. Baumwolle/ Polyester. 5 Panels.
Casquette. Coton/ Polyester. 5 Panneaux.
Pet. Katoen/ Polyester. 5 Panelen.

Consult. 200 / 25
Print Code: E(1), N(8), O, P



5 Panels



1054



03



02



19



08

19

07



03

01

19



02

13

06

04

03

07

Bayet

5799

Cap. Polyester. 6 Panels.
Mütze. Polyester. 6 Panels.
Casquette. Polyester. 6 Panneaux.
Pet. Polyester. 6 Panelen.



6 Panels

Consult. 200 / 25
Print Code: E(1), N(8), O, P

Lorenz

3945

Cap. Cotton/ Thick Polyester. 5 Panels.
Mütze. Baumwolle/ Groß Polyester. 5 Panels.
Casquette. Coton/ Polyester Epais. 5 Panneaux.
Pet. Katoen/ Dikke Polyester. 5 Panelen.



5 Panels

Consult. 200 / 50
Print Code: E(1), N(8), O, P

Five

3281

Cap. 100% Brushed Cotton. 5 Panels.
Mütze. 100% Gebürstete Baumwolle. 5 Panels.
Casquette. 100% Coton Peigné. 5 Panneaux.
Pet. 100% Geborsteld Katoen. 5 Panelen.



5 Panels

Consult. 200 / 25
Print Code: E(1), N(8), O, P



100% BRUSHED COTTON HIGH QUALITY



Bayon
4901

Cap. 100% Brushed Cotton. 5 Panels.
Mütze. 100% Gebürstete Baumwolle. 5 Panels.
Casquette. 100% Coton Peigné. 5 Panneaux.
Pet. 100% Geborsteld Katoen. 5 Panelen.



Consult. 200 / 50
Print Code: E(1), N(8), O, P

1055



04



03



02



05

07

03

11



02

06

19

01

04

05

11

07



01

04

19

06

05

11

03

07

Rittel
4902

Cap. 100% Brushed Cotton. 6 Panels.
Mütze. 100% Gebürstete Baumwolle. 6 Panels.
Casquette. 100% Coton Peigné. 6 Panneaux.
Pet. 100% Geborsteld Katoen. 6 Panelen.



Consult. 200 / 50
Print Code: E(1), N(8), O, P

Rubec
4675

Cap. 100% Brushed Cotton. 6 Panels.
Mütze. 100% Gebürstete Baumwolle. 6 Panels.
Casquette. 100% Coton Peigné. 6 Panneaux.
Pet. 100% Geborsteld Katoen. 6 Panelen.



Consult. 200 / 50
Print Code: E(1), N(8), O, P

Kisse
4676

Cap. 100% Brushed Cotton. 5 Panels.
Mütze. 100% Gebürstete Baumwolle. 5 Panels.
Casquette. 100% Coton Peigné. 5 Panneaux.
Pet. 100% Geborsteld Katoen. 5 Panelen.



Consult. 200 / 50
Print Code: E(1), N(8), O, P



19

REFLECTIVE BAND



07



03



05



Tarea

3120



5 Panels

Cap. 100% Cotton. 5 Panels. Reflective.
Mütze. 100% Baumwolle. 5 Panels. Reflektierend.
Casquette. 100% Coton. 5 Panneaux. Réfléchissant.
Pet. 100% Katoen. 5 Panelen. Reflecterend.

Consult. 300 / 30

Print Code: E(1), N(8), O, P



1056



04



02



14

Saigón

9678

Cap. 100% Brushed Cotton.
Mütze. 100% Gebürstete Baumwolle.
Casquette. 100% Coton Peigné.
Pet. 100% Geborsteld Katoen.

Consult. 300 / 50

Print Code: E(1), N(8), O, P



06



01

Iberia

3282

Cap. 100% Brushed Cotton. 6 Panels.
Mütze. 100% Gebürstete Baumwolle. 6 Panels.
Casquette. 100% Coton Peigné. 6 Panneaux.
Pet. 100% Geborsteld Katoen. 6 Panelen.



6 Panels

Consult. 200 / 25

Print Code: E(1), N(8), O, P



IDEAL FOR SPORT



02



05

03

11

07



01

19

04

Laimbur
5565

Cap. Microfibre.
Mütze. Mikrofaser.
Casquette. Microfibre.
Pet. Microfibrer.

Consult. 200 / 25

Print Code: E(1), N(8), O, P, R

1057



01



Gonnax
4900

Sun Visor. Polyester.
Sonnenblende. Polyester.
Visière. Polyester.
Zonneklep. Polyester.

Consult. 250 / 25

Print Code: E(1), N(8), O, P, R



03

02

19

05



03

SOFTCOOL EXTREME
UV PROTECTION



Cold

Fandol
5554

Cap. 55% Nylon/ 45% Polyester. UV50 Protection.
Mütze. 55% Nylon/ 45% Polyester. UV50 Schutz.
Casquette. 55% Nylon/ 45% Polyester. Protection UV50.
Pet. 55% Nylon/ 45% Polyester. UV50 Bescherming.

Consult. 200 / 25

Print Code: E(1), N(8), O, P



08 DARK

08

16

19

11





01



03



05



19



Sportkid

3329



5 Panels

Kids Cap. 100% Cotton. 5 Panels.
Kinder Mütze. 100% Baumwolle. 5 Panels.
Casquette Enfant. 100% Coton. 5 Panneaux.
Kinder Pet. 100% Katoen. 5 Panelen.

Consult. 300 / 30
Print Code: E(1), N(8), O, P



S
P
I
K

1058



Ideal Sublimation



19



03



01



Modiak

5239



5 Panels

Kids Cap. Microfibre/ Polyester. 5 Panels.
Kinder Mütze. Mikrofaser/ Polyester. 5 Panels.
Casquette Enfant. Microfibre/ Polyester. 5 Panneaux.
Kinder Pet. Microfibre/ Polyester. 5 Panelen.

Consult. 300 / 50
Print Code: E(1), N(8), O, P, R

Tolvex

4838

Kids Hat. Polyester.
Kinder Hut. Polyester.
Chapeau Enfant. Polyester.
Kinder Hoedje. Polyester.

Consult. 200 / 25
Print Code: E(1)



Timón

3342

Kids Hat. 100% Cotton.
Kinder Hut. 100% Baumwolle.
Bonnet Enfant. 100% Coton.
Kinder Muts. 100% Katoen.

Consult. 200 / 50
Print Code: E(1), N(8), O, P





SUNVISOR



03

Gonnax 4900

Sun Visor. Polyester.
Sonnenblende. Polyester.
Visière. Polyester.
Zonneklep. Polyester.

Consult. 250 / 25
Print Code: E(1), N(8), O, P, R



01

02

19

05

1059



05



19



19



03

07

19

02



02

04

03

07



01

Sunday 9705

Sun Visor. EVA.
Sonnenblende. EVA.
Visière. EVA.
Zonneklep. EVA.

Consult. 1000 / 50
Print Code: D(1), N(8)

Narim 6358

UV PROTECTION

Sun Visor. PVC. UV Protection.
Sonnenblende. PVC. UV Schutz.
Visière. PVC. Protection UV.
Zonneklep. PVC. UV Bescherming.

Consult. 200 / 10
Print Code: D(1)



05

04

03

Tiger 3330

Sun Visor. 100% Cotton.
Sonnenblende. 100% Baumwolle.
Visière. 100% Coton.
Zonneklep. 100% Katoen.

Consult. 250 / 25
Print Code: E(1), N(8), O, P



04



Safari

9335

Hat. 100% Cotton.
Hut. 100% Baumwolle.
Bonnet. 100% Coton.
Muts. 100% Katoen.

||||| Consult. 200 / 50

Print Code: F(1), N(8), O, P



14

ADVENTURE



1060



Draken

6207

Hat. Microfibre.
Hut. Mikrofaser.
Bonnet. Microfibre.
Muts. Microfibrer.

||||| Consult. 200 / 50

Print Code: F(1), N(8), O, P



Rambo

8080

Camouflage Cap. Cotton/ Polyester. 5 Panels.
Camouflage Mütze. Baumwolle/ Polyester. 5 Panels.
Casquette Camouflage. Cotton/ Polyester. 5 Panneaux.
Camouflage Pet. Katoen/ Polyester. 5 Panelen.

||||| Consult. 300 / 30

Print Code: E(1), N(8), O, P





02

Marvin

8538

Hat. 100% Cotton.
Hut. 100% Baumwolle.
Bonnet. 100% Coton.
Muts. 100% Katoen.

Consult. 200 / 50

Print Code: E(1), N(8), O, P



03

Vacanz

4599

Hat. Microfibre.
Hut. Mikrofaser.
Bonnet. Microfibre.
Muts. Microfibre.

Consult. 200 / 10

Print Code: F(1), N(8), O



13

06

1061



02

19

05

03

07

Garfy

9212

Bandana. Cotton/ Polyester.
Kopftuch. Baumwolle/ Polyester.
Bandana. Coton/ Polyester.
Bandana. Katoen/ Polyester.

Consult. 600 / 10

Print Code: E(1), N(8), O



2in1
Multi-function

120 x 80 cm

100 x 70 cm



Kozma

4834

Neckerchief Wrap. Polyester 170T.
Halstuch. Polyester 170T.
Foulard Tissu. Polyester 170T.
Bandana. Polyester 170T.

120 x 80 cm 1000 / 10

Print Code: E(1), N(8), R

BIG
SIZE



Plus

3029

Neckerchief. Polyester 170T.
Halstuch. Polyester 170T.
Foulard. Polyester 170T.
Bandana. Polyester 170T.

100 x 70 cm 1000 / 10

Print Code: E(1), N(8), R

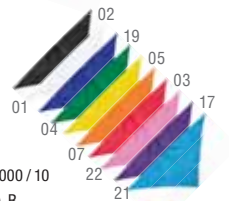



Helbik

5712



Hat. Straw.
Hut. Stroh.
Chapeau. Paille.
Hoed. Stro.

||||||| Consult. 250
🌈 Print Code: Consultar



HAT STRAW



1062



Dimsa

5711



Hat. Straw.
Hut. Stroh.
Chapeau. Paille.
Hoed. Stro.

||||||| Consult. 250
🌈 Print Code: Consultar



Palviz

5713



Hat. Straw.
Hut. Stroh.
Chapeau. Paille.
Hoed. Stro.

||||||| Consult. 250
🌈 Print Code: Consultar

Dabur

5714



Hat. Straw.
Hut. Stroh.
Chapeau. Paille.
Hoed. Stro.

||||||| Consult. 250
🌈 Print Code: Consultar



the BEST SELLER



04



Inner Band

13

Zelio
4930

Hat. Straw.
Hut. Stroh.
Chapeau. Paille.
Hoed. Stro.

Consult. 250
Print Code: Consultar

1063



Vita
8086

Hat. Straw.
Hut. Stroh.
Chapeau. Paille.
Hoed. Stro.



Inner Band



Ventilation

Consult. 250
Print Code: Consultar



Lúa
8085

Hat. Straw.
Hut. Stroh.
Chapeau. Paille.
Hoed. Stro.



Inner Band



Ventilation

Consult. 250
Print Code: Consultar



Licem
5915



Hat. Synthetic.
Hut. Synthetisch.
Chapeau. Synthétique.
Hoed. Synthetisch.

Consult. 100 / 25

Print Code: Consultar



Chizzer
6103



Hat. Synthetic.
Hut. Synthetisch.
Chapeau. Synthétique.
Hoed. Synthetisch.

Consult. 100 / 25

Print Code: Consultar

1064



SCREEN PRINTING/
SERIGRAFIA

BAND INCLUDED
CINTA INCLUIDA

Kaobex
5912

Hat. Synthetic.
Hut. Synthetisch.
Chapeau. Synthétique.
Hoed. Synthetisch.

Consult. 100 / 25

Print Code: E(1)



01



Likos
4557

Hat. Cotton/ Polyester.
Hut. Baumwolle/ Polyester.
Chapeau. Coton/ Polyester.
Hoed. Katoen/ Polyester.

Consult. 100 / 25

Print Code: E(1), N(8), O, P

hiQ
HIGH QUALITY



11



HIGH QUALITY



117



18



13

Bauwens
5504

Hat. Synthetic.
Hut. Synthetisch.
Chapeau. Synthétique.
Hoed. Synthetisch.



Consult. 100 / 25
Print Code: Consular

1065



08



01



Hindyp
4600

Hat. Synthetic.
Hut. Synthetisch.
Chapeau. Synthétique.
Hoed. Synthetisch.

Consult. 100 / 25
Print Code: Consular



Timbu
3574

Hat. Synthetic.
Hut. Synthetisch.
Chapeau. Synthétique.
Hoed. Synthetisch.

Consult. 100 / 25
Print Code: Consular



01



13



02

13

08



Texas 5505

Hat. Synthetic.
Hut. Synthetisch.
Chapeau. Synthétique.
Hoed. Synthetisch.



Inner Band



Ventilation

Consult. 100 / 25
Print Code: Consultar



Bull 4190

Hat. Straw.
Hut. Stroh.
Chapeau. Paille.
Hoed. Stro.



Inner Band



Ventilation

Consult. 250
Print Code: Consultar

1066



Yuca 8549

Hat. Straw.
Florentiner Hut. Stroh.
Capeline. Paille.
Hoed. Stro.

Consult. 250
Print Code: Consultar



13



02



19



03

Filagarchado 8088

Hat. Straw.
Hut. Stroh.
Chapeau. Paille.
Hoed. Stro.

Consult.
Print Code: Consultar

250



Inner Band



Ventilation



21

theBEST PRICE

Braz
3575



Hat. Polyester.
Hut. Polyester.
Chapeau. Polyester.
Hoed. Polyester.

Consult. 200 / 25
Print Code: E(1)

1067



02



01

Splash
9195

Hat. Straw.
Hut. Stroh.
Chapeau. Paille.
Hoed. Stro.

Consult. 250
Print Code: Consultar



Osdel
4839

Hat. Polyester.
Hut. Polyester.
Chapeau. Polyester.
Hoed. Polyester.

Consult. 100 / 25
Print Code: Consultar



02

18



Sprint

2008C

Hatband. Non-Woven.
Hut Band. Non-Woven.
Ruban Chapeau. T.N.T.
Hoedenband. Non-Woven.

67 x 3 cm 3000 / 50

Print Code: Consult.

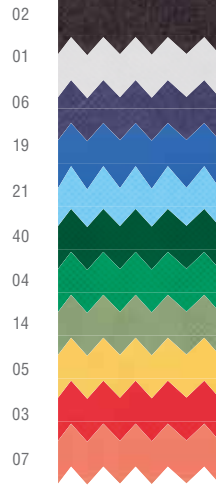

Polyester

5447

Hatband. Polyester.
Hut Band. Polyester.
Ruban Chapeau. Polyester.
Hoedenband. Polyester.

67 x 2.7 cm 3000

Print Code: Consult.

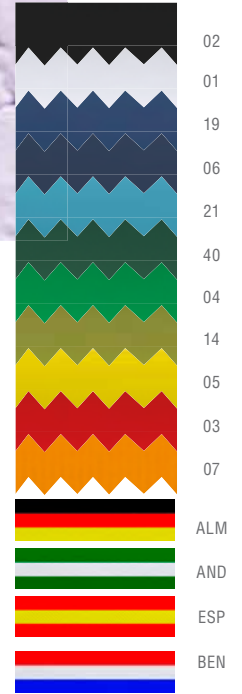

FULL ROLL ONLY
VENTA EN ROLLO COMPETO

1068

IDEAL FOR PRINTING



Plancha 10 cintas
Plate 10 ribbons

Menas

5730

Hatband. Non-Woven.
Hut Band. Non-Woven.
Ruban Chapeau. T.N.T.
Hoedenband. Non-Woven.

67 x 2.7 cm 5000

Print Code: Consult.



CHECK FOR 100 Pcs. - CONSULTAR PARA 100 uDS.
SET UP NOT INCLUDED - CLICHÉ NO INCLUIDO

Nwovenband

2008

Hatband. Non-Woven.
Hut Band. Non-Woven.
Ruban Chapeau. T.N.T.
Hoedenband. Non-Woven.

67 x 3 cm

Print Code: Consult.



Non-woven band

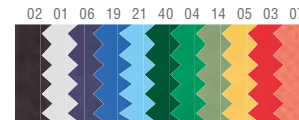

Check for more than one color printing
Consultar impresión a más de un color

Polyesterband

5465

Hatband. Polyester.
Hut Band. Polyester.
Ruban Chapeau. Polyester.
Hoedenband. Polyester.

67 x 2.7 cm

Print Code: Consult.



Polyester band

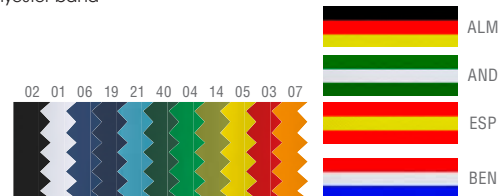

Check for more than one color printing
Consultar impresión a más de un color

Sublimationband

4435

Hatband. Polyester.
Hut Band. Polyester.
Ruban Chapeau. Polyester.
Hoedenband. Polyester.

67 x 2.7 cm

Print Code: Consult.



Polyester band

SUBLIMATION PRINTING FULL COLOUR INCLUDED
IMPRESIÓN EN SUBLIMACIÓN A TODO COLOR INCLUIDA



Inner Band

CINTA INTERIOR PARA UNA MAYOR COMODIDAD AL TIEMPO QUE GARANTIZA UNA MAYOR DURACIÓN DEL SOMBRERO.

INNER BAND, GUARANTEEING MORE COMFORT AND LONGER DURABILITY.

RUBAN INTÉRIEUR POUR UN MEILLEUR CONFORT, QUI GARANTIT UNE MEILLEURE CONSERVATION DU SOMBRERO.

INNENBAND GELIEFERT FÜR OPTIMALEN TRAGEKOMFORT UND LÄNGERE LEBENSDAUER.

NASTRO INTERNO PER CONSENTIRE AL CAPPELLO SIA UNA PIÙ COMODA VESTIBILITÀ CHE UNA PIÙ LUNGA DURATA.

CINTA INTERIOR PARA MAIOR COMODIDADE E DURABILIDADE DO CHAPÉU.

HEBBEN EENBINNENBAND, EEN GARANTIE VOOR MEER COMFORT EN DUURZAAMHEID.





Reflective

Terban

6440

Hat. Outside: Acrylic. Inside: Polar Fleece. Reflective.
Hut. Außere: Acryl. Innen: Polar Fleece. Reflektierender.
Bonnet. Extérieur: Acrylique. Intérieur: Polaire. Réflécteur.
Muts. Buitenzijde: Acryl. Binnenzijde: Polar Fleece. Reflecterende.

Consult. 100 / 10

Print Code: N(8), O, P

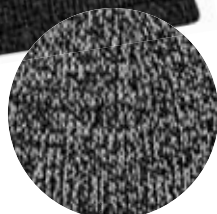

ULTRA
REFLECTIVE
EXTRA
REFLECTANTE



Light



Blink

02

Koppy

6558

Hat. Acrylic. 4 Leds. 4 Light Modes. USB Rechargeable.
Hut. Acryl. 4 Leds. 4 Leuchtfunktionen. USB Wiederaufladbar.
Bonnet. Acrylique. 4 Leds. 4 Modes de Lumière. Rechargeable USB.
Muts. Acryl. 4 Leds. 4 Licht Posities. USB Opladbaar.

Consult. 100 / 50

Print Code: N(8)



08



BLINK
LIGHT
LUZ
INTERMITENTE

IDEAL FABRIC
FOR PRINTING
TEJIDO IDEAL
PARA IMPRESION



POLYESTER / SPANDEX

CORAL FLEECE

1070



08

WHITE COLOUR IDEAL FOR SUBLIMATION
COLOR BLANCO IDEAL PARA SUBLIMACION



Folten

5914

Hat. Outside: Polyester/ Spandex. Inside: Coral Fleece. 280 g/ m2.
Hut. Außere: Polyester/ Spandex. Innen: Coral Fleece. 280 g/ m2.
Bonnet. Extérieur: Polyester/ Spandex. Intérieur: Coral Fleece. 280 g/ m2.
Muts. Buitenzijde: Polyester/ Spandex. Binnenzijde: Coral Fleece. 280 g/ m2.

Consult. 100 / 10

Print Code: F(1), N(8), O, P, R



01



06



Seyer

5364

Hat. Polyester. Bluetooth Connection. USB Rechargeable. Cable Included.
Hut. Polyester. Bluetooth Anschluss. USB Wiederaufladbar. Kabel Inklusive.
Bonnet. Polyester. Connexion Bluetooth. Rechargeable USB. Câble Inclus.
Muts. Polyester. Bluetooth Verbindung. USB Opladbaar. Kabel Inclusief.

Consult. 100 / 50

Print Code: N(8), O, P



Bluetooth

Hands-free



02

REVERSIBLE
POLAR FLEECE

Nesy

9066

Reversible Hat. Outside: Nylon. Inside: Polar Fleece. Anti-Pilling.
Wendehut. Außere: Nylon. Innen: Polar Fleece. Anti-Pilling.
Bonnet Réversible. Extérieur: Nylon. Intérieur: Polaire. Anti-Pilling.
Omkeerbare Muts. Buitenzijde: Nylon. Binnenzijde: Polar Fleece. Anti-Pilling.

Consult. 200 / 50

Print Code: F(1), N(8), O



03



20



06



19

NEW



08

Hetul

6854

Hat. Polyester RPET.
Hut. Polyester RPET.
Bonnet. Polyester RPET.
Muts. Polyester RPET.

Consult.

Print Code: N(8), O, P



RPET



06

02

250 / 25

IDEAL FOR PRINTING



06

02

08

04

03

11

01



19

Holsen

5817

Hat. Acrylic.
Hut. Acryl.
Bonnet. Acrylique.
Muts. Acryl.

Consult.

200 / 10

Print Code: E(1), N(8)



02



06

19

04

03

05

Lana

8017

Hat. Acrylic.
Hut. Acryl.
Bonnet. Acrylique.
Muts. Acryl.

Consult. 250 / 25

Print Code: N(8), O, P



08



03

19

02

06

Baikof

5592

Hat. Acrylic.
Hut. Acryl.
Bonnet. Acrylique.
Muts. Acryl.

Consult. 100 / 10

Print Code: N(8), O, P



19

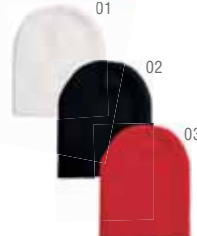

01

02

03

Jive

9781

Hat. Acrylic.
Hut. Acryl.
Bonnet. Acrylique.
Muts. Acryl.

Consult. 250 / 10

Print Code: N(8), O, P

TEXTILE

environmentally
conscious

RPET



The fabric used in the manufacturing process of this jacket is made of recycled plastic (RPET). Like this, the emission of plastic residues to our planet and the consumption of energy is drastically reduced, resulting in a much more eco-friendly process.

El material de esta chaqueta está fabricado con plástico reciclado (RPET), que, además de ayudar en la disminución de residuos plásticos en el planeta, utiliza menos energía en el proceso de fabricación, haciendo que sea mucho menos dañino para el medio ambiente.

STOP PLASTIC
POLLUTING
THE OCEAN

amfori 
Trade with purpose



SMETA 



ORGANIC
COTTON



RECYCLED
COTTON



1073



ECO textile RPET FABRIC

NEW

NEW

1074

UNISEX



RPET FABRIC



LIGHTWEIGHT & WARM GARMENT



WATER & WIND RESISTANT



UNISEX



POUCH INCLUDED

Mitens 6756

Jacket. 100% Polyester RPET. Wind and Water Resistant. RPET Pouch Included.
Jacke. 100% Polyester RPET. Beständig Gegen Wind und Wasser. RPET Etui Inklusiv.
Veste. 100% Polyester RPET. Résistant au Vent et à l'Eau. Etui RPET Inclus.
Jas. 100% Polyester RPET. Bestand Tegen Wind en Water. RPET Zakje Inclusief.

S, M, L, XL, XXL

Print Code: N(8), P

15



02

08

06

04



RPET FABRIC



LIGHTWEIGHT & WARM GARMENT



WATER & WIND RESISTANT



UNISEX



POUCH INCLUDED

Rostol 6757

Vest. 100% Polyester RPET. Wind and Water Resistant. RPET Pouch Included.
Weste. 100% Polyester RPET. Beständig Gegen Wind und Wasser. RPET Etui Inklusiv.
Gilet. 100% Polyester RPET. Résistant au Vent et à l'Eau. Etui RPET Inclus.
Vest. 100% Polyester RPET. Bestand Tegen Wind en Water. RPET Zakje Inclusief.

S, M, L, XL, XXL

Print Code: N(8), P

15



02

08

06

04

ECO textile TECHNICAL RPET FABRIC



135 gsm.

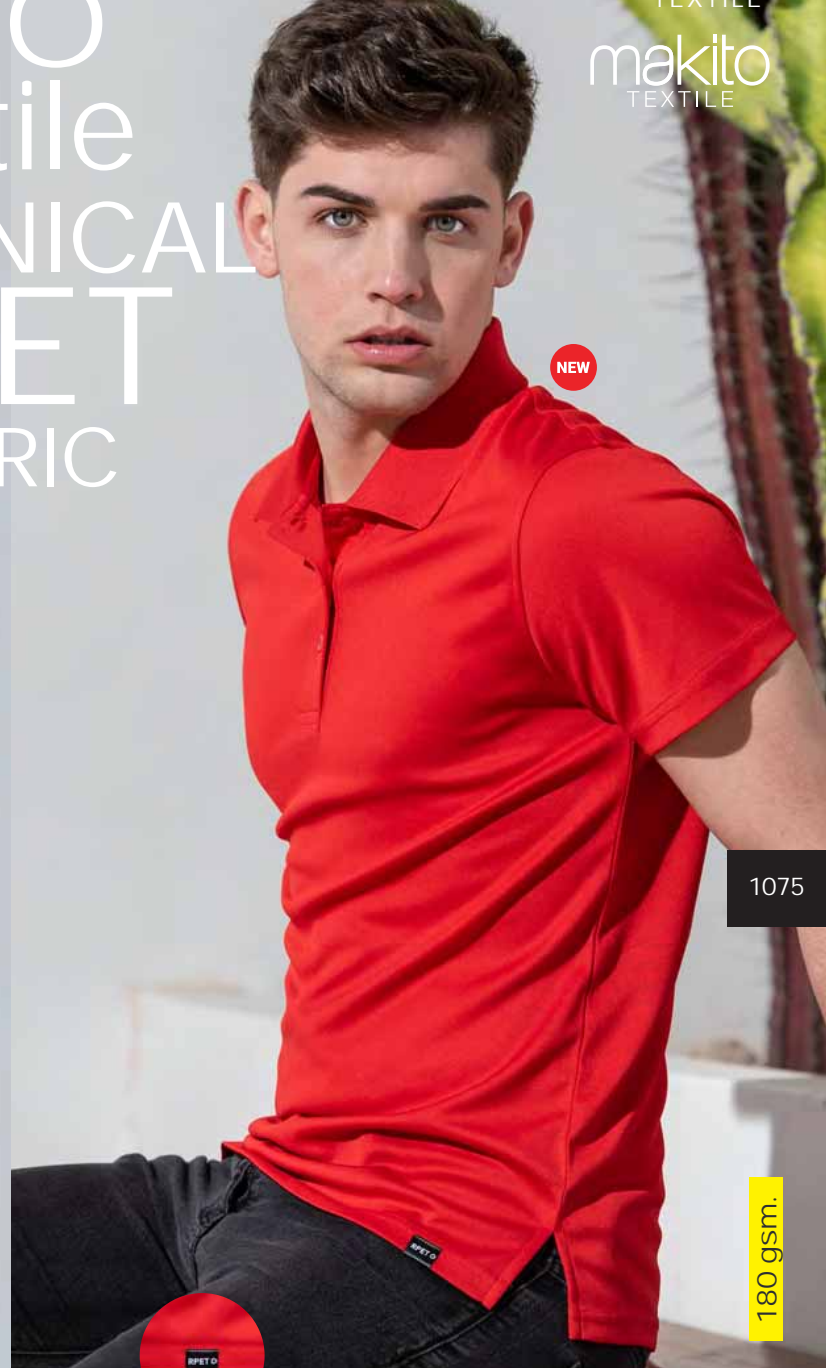

1075

180 gsm.



- RPET FABRIC
- TECHNICAL FABRIC
- BREATHABLE
- ACTION DRY
- CREASE FREE
- REMOVABLE LABEL
- WHITE COLOUR SUITABLE FOR SUBLIMATION
- UNISEX

**Tecnic
Markus**
6461

Adult T-Shirt. 100% Polyester RPET 135 g/ m2. Breathable.
Erwachsene T-Shirt. 100% Polyester RPET 135 g/ m2. Atmungsaktiv.
T-Shirt Adulte. 100% Polyester RPET 135 g/ m2. Respirant.
T-Shirt Volwassenne. 100% Polyester RPET 135 g/ m2. Ademend.

XS, S, M, L, XL, XXL 80 / 10
 Print Code: F(6), M, N(8), O, P, R



04 01 02 03 19

Dekrom
6755

- RPET FABRIC
- TECHNICAL FABRIC
- BREATHABLE
- ACTION DRY
- CREASE FREE

Polo Shirt. 100% Polyester RPET 180 g/ m2. Breathable.
Polo-Shirt. 100% Polyester RPET 180 g/ m2. Atmungsaktiv.
Polo. 100% Polyester RPET 180 g/ m2. Respirant.
Polo Shirt. 100% Polyester RPET 180 g/ m2. Ademend.

S, M, L, XL, XXL 60
 Print Code: F(6), N(8), O, P, R

- REMOVABLE LABEL
- WHITE COLOUR SUITABLE FOR SUBLIMATION
- UNISEX



06 10 00 01 02 04

ORGANIC
COTTON

NEW

1076



ORGANIC COTTON



UNISEX

150 gsm.

Organic
Natural

6630

S, M, L, XL, XXL

100

Print Code: F(6), M, N(8), O, P

Adult T-Shirt "keya". 100% Organic Cotton, Single Jersey 150 g/ m2.
Erwachsene T-Shirt "keya". 100% Organische Baumwolle, Single Jersey 150 g/ m2.
T-Shirt Adulte "keya". 100% Coton Organique, Single Jersey 150 g/ m2.
T-Shirt Volwassenene "keya". 100% Organisch Katoen, Single Jersey 150 g/ m2.

Organic Color

6760



ORGANIC COTTON



UNISEX

150 gsm.

Organic Color

S, M, L, XL, XXL

100

Print Code: F(6), N(8), O, P

Adult T-Shirt "keya". 100% Organic Cotton, Single Jersey 150 g/ m2.
Erwachsene T-Shirt "keya". 100% Organische Baumwolle, Single Jersey 150 g/ m2.
T-Shirt Adulte "keya". 100% Coton Organique, Single Jersey 150 g/ m2.
T-Shirt Volwassenene "keya". 100% Organisch Katoen, Single Jersey 150 g/ m2.



19 08 04 03 02



RECY CLED C OTTON



UNISEX



02 19 03 13

Vienna

6758

Adult T-Shirt. Recycled Cotton, Single Jersey 150 g/ m2.

Erwachsene T-Shirt. Recycling Baumwolle, Single Jersey 150 g/ m2.

T-Shirt Adulte. Coton Recycle, Single Jersey 150 g/ m2.

T-Shirt Volwassene. Gerecycled Katoen, Single Jersey 150 g/ m2.

S, M, L, XL, XXL

100 / 10

Print Code: F(6), N(8), O, P

makito
TEXTILE

ECO textile

TEXTILE

RECYCLED COTTON

150 gsm.



1077

NEW



Keya

EXCLUSIVE DISTRIBUTOR:
SPAIN, FRANCE,
NETHERLANDS & BELGIUM

100%
COTTON
150 gsm.

1078



21 19 06 04 05 23



07 03 08 62 02



21 19 06 04 05 23



07 03 22 08 62 02



YC150

5874

Kids Colour T-Shirt "keya". 100% Cotton Ring Spun, Single Jersey 150 g/ m2.

Kinder Farbe T-Shirt "keya". 100% Baumwolle Ring Spun, Single Jersey 150 g/ m2.

T-Shirt Enfant Couleur "keya". 100% Cotton Ring Spun, Single Jersey 150 g/ m2.

Kleuren Kinder T-Shirt "keya". 100% Katoen Ring Spun, Single Jersey 150 g/ m2.

XS (5-6), S (7-8), M (10-11),

L (12-13), XL (14-15)

100 / 10

Print Code: F(6), N(8), O, P

YC150

5873

Kids White T-Shirt "keya". 100% Cotton Ring Spun, Single Jersey 150 g/ m2.

Kinder Weiß T-Shirt "keya". 100% Baumwolle Ring Spun, Single Jersey 150 g/ m2.

T-Shirt Enfant Blanc "keya". 100% Cotton Ring Spun, Single Jersey 150 g/ m2.

Wit Kinder T-Shirt "keya". 100% Katoen Ring Spun, Single Jersey 150 g/ m2.

XS (5-6), S (7-8), M (10-11),

L (12-13), XL (14-15)

100 / 10

Print Code: F(6), N(8), M, O, P

WCS150

5868

Women Colour T-Shirt "keya". 100% Cotton Ring Spun, Single Jersey 150 g/ m2.

Frauen Farbe T-Shirt "keya". 100% Baumwolle Ring Spun, Single Jersey 150 g/ m2.

T-Shirt Femme Couleur "keya". 100% Cotton Ring Spun, Single Jersey 150 g/ m2.

Kleuren Dames T-Shirt "keya". 100% Katoen Ring Spun, Single Jersey 150 g/ m2.

S, M, L, XL, XXL

100 / 10

Print Code: F(6), N(8), O, P

WCS150

5867

Women White T-Shirt "keya". 100% Cotton Ring Spun, Single Jersey 150 g/ m2.

Frauen Weiß T-Shirt "keya". 100% Baumwolle Ring Spun, Single Jersey 150 g/ m2.

T-Shirt Femme Blanc "keya". 100% Cotton Ring Spun, Single Jersey 150 g/ m2.

Wit Dames T-Shirt "keya". 100% Katoen Ring Spun, Single Jersey 150 g/ m2.

S, M, L, XL, XXL

100 / 10

Print Code: F(6), N(8), M, O, P

THE BEST PRICE

Keya

EXCLUSIVE DISTRIBUTOR:
SPAIN, FRANCE,
NETHERLANDS & BELGIUM



100%
COTTON
the best seller

1079

150 gsm.



MC150
5857

Adult Colour T-Shirt "keya". 100% Cotton Ring Spun, Single Jersey 150 g/ m2.
Erwachsene Farbe T-Shirt "keya". 100% Baumwolle Ring Spun, Single Jersey 150 g/ m2.
T-Shirt Adulte Couleur "keya". 100% Coton Ring Spun, Single Jersey 150 g/ m2.
Volwassene Kleuren T-Shirt "keya". 100% Katoen Ring Spun, Single Jersey 150 g/ m2.

|||||| S, M, L, XL, XXL, 3XL 100 / 10
 Print Code: F(6), N(8), O, P

MC150
5856

Adult White T-Shirt "keya". 100% Cotton Ring Spun, Single Jersey 150 g/ m2.
Erwachsene Weiß T-Shirt "keya". 100% Baumwolle Ring Spun, Single Jersey 150 g/ m2.
T-Shirt Adulte Blanc "keya". 100% Coton Ring Spun, Single Jersey 150 g/ m2.
Volwassene Wit T-Shirt "keya". 100% Katoen Ring Spun, Single Jersey 150 g/ m2.

|||||| S, M, L, XL, XXL, 3XL 100 / 10
 Print Code: F(6), N(8), M, O, P





1080

100% COTTON

135 gsm.

Hecom

4199

Adult White T-Shirt. 100% Cotton Ring Spun, Single Jersey 135 g/ m2.
Erwachsene Weiß T-Shirt. 100% Baumwolle Ring Spun, Single Jersey 135 g/ m2.
T-Shirt Adulte Blanc. 100% Coton Ring Spun, Single Jersey 135 g/ m2.
Wit T-Shirt Volwassene. 100% Katoen Ring Spun, Single Jersey 135 g/ m2.

S, M, L, XL, XXL

100 / 10

Print Code: F(6), N(8), M, O, P



Hecom

4197

Adult Color T-Shirt. 100% Cotton Ring Spun, Single Jersey 135 g/ m2.
Erwachsene Farbe T-Shirt. 100% Baumwolle Ring Spun, Single Jersey 135 g/ m2.
T-Shirt Adulte Couleur. 100% Coton Ring Spun, Single Jersey 135 g/ m2.
Kleuren T-Shirt Volwassene. 100% Katoen Ring Spun, Single Jersey 135 g/ m2.

S, M, L, XL, XXL

100 / 10

Print Code: F(6), N(8), O, P



135 gsm.



Hecom

4198



Kids Colour T-Shirt. 100% Cotton Ring Spun, Single Jersey 135 g/ m2.
Kinder Farbe T-Shirt. 100% Baumwolle Ring Spun, Single Jersey 135 g/ m2.
T-Shirt enfant Couleur. 100% Coton Ring Spun, Single Jersey 135 g/ m2.
Kleuren Kinder T-Shirt. 100% Katoen Ring Spun, Single Jersey 135 g/ m2.

4-5, 6-8, 10-12

100 / 10

Print Code: F(6), N(8), O, P



Hecom

4200



Kids White T-Shirt. 100% Cotton Ring Spun, Single Jersey 135 g/ m2.
Kinder Weiß T-Shirt. 100% Baumwolle Ring Spun, Single Jersey 135 g/ m2.
T-Shirt enfant Blanc. 100% Coton Ring Spun, Single Jersey 135 g/ m2.
Wit Kinder T-Shirt. 100% Katoen Ring Spun, Single Jersey 135 g/ m2.

4-5, 6-8, 10-12

100 / 10

Print Code: F(6), N(8), M, O, P



Premium 4482

Adult White T-Shirt. 100% Cotton Ring Spun, Single Jersey 150 g/ m2.
Erwachsene Weiß T-Shirt. 100% Baumwolle Ring Spun, Single Jersey 150 g/ m2.
T-Shirt Adulte Blanc. 100% Coton Ring Spun, Single Jersey 150 g/ m2.
Wit T-Shirt Volwassene. 100% Katoen Ring Spun, Single Jersey 150 g/ m2.

S, M, L, XL, XXL 100 / 10
Print Code: F(6), N(8), M, O, P



makito
TEXTILE

100% COTTON

150 gsm.

1081



Premium 4481

Adult Color T-Shirt. 100% Cotton Ring Spun, Single Jersey 150 g/ m2.
Erwachsene Farbe T-Shirt. 100% Baumwolle Ring Spun, Single Jersey 150 g/ m2.
T-Shirt Adulte Couleur. 100% Coton Ring Spun, Single Jersey 150 g/ m2.
Kleuren T-Shirt Volwassene. 100% Katoen Ring Spun, Single Jersey 150 g/ m2.

S, M, L, XL, XXL 100 / 10
Print Code: F(6), N(8), O, P



02





WCS180

5869

Women White T-Shirt "keya". 100% Cotton Ring Spun, Single Jersey 180 g/ m2.
Frauen Weiß T-Shirt "keya". 100% Baumwolle Ring Spun, Single Jersey 180 g/ m2.
T-Shirt Femme Blanc "keya". 100% Coton Ring Spun, Single Jersey 180 g/ m2.
Wit Dames T-Shirt "keya". 100% Katoen Ring Spun, Single Jersey 180 g/ m2.

||||| S, M, L, XL, XXL  100 / 10

 Print Code: F(6), N(8), M, O, P



WCS180

5870

Women Colour T-Shirt "keya". 100% Cotton Ring Spun, Single Jersey 180 g/ m2.
Frauen Farbe T-Shirt "keya". 100% Baumwolle Ring Spun, Single Jersey 180 g/ m2.
T-Shirt Femme Couleur "keya". 100% Coton Ring Spun, Single Jersey 180 g/ m2.
Kleuren Dames T-Shirt "keya". 100% Katoen Ring Spun, Single Jersey 180 g/ m2.

||||| S, M, L, XL, XXL  100 / 10

 Print Code: F(6), N(8), O, P

100% COTTON

180 gsm.

1082



Keya

EXCLUSIVE DISTRIBUTOR:
SPAIN, FRANCE,
NETHERLANDS & BELGIUM



100%
COTTON
180 gsm.

1083



MC180
5859

Adult Colour T-Shirt "keya". 100% Cotton Ring Spun, Single Jersey 180 g/ m2.
Erwachsene Farbe T-Shirt "keya". 100% Baumwolle Ring Spun, Single Jersey 180 g/ m2.
T-Shirt Adulte Couleur "keya". 100% Coton Ring Spun, Single Jersey 180 g/ m2.
Volwassen Kleuren T-Shirt "keya". 100% Katoen Ring Spun, Single Jersey 180 g/ m2.

■■■■ S, M, L, XL, XXL, 3XL 📦 100 / 10

🌈 Print Code: F(6), N(8), O, P



MC180
5858

Adult White T-Shirt "keya". 100% Cotton Ring Spun, Single Jersey 180 g/ m2.
Erwachsene Weiß T-Shirt "keya". 100% Baumwolle Ring Spun, Single Jersey 180 g/ m2.
T-Shirt Adulte Blanc "keya". 100% Coton Ring Spun, Single Jersey 180 g/ m2.
Volwassen Wit T-Shirt "keya". 100% Katoen Ring Spun, Single Jersey 180 g/ m2.

■■■■ S, M, L, XL, XXL, 3XL 📦 100 / 10



🌈 Print Code: F(6), N(8), M, O, P



MC180-OE

5860

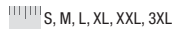
Adult White T-Shirt "keya". 100% Heavy Cotton Ring Spun, Single Jersey 180 g/ m2.
Erwachsene Weiß T-Shirt "keya". 100% Dickes Baumwolle Ring Spun, Single Jersey 180 g/ m2.
T-Shirt Adulte Blanc "keya". 100% Coton Épais Ring Spun, Single Jersey 180 g/ m2.
Volwassene Wit T-Shirt "keya". 100% Dicke Katoen Ring Spun, Single Jersey 180 g/ m2.



 S, M, L, XL, XXL, 3XL
  100 / 10
 Print Code: F(6), N(8), M, O, P



MC180-OE

5861

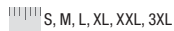
Adult Colour T-Shirt "keya". 100% Heavy Cotton Ring Spun, Single Jersey 180 g/ m2.
Erwachsene Farbe T-Shirt "keya". 100% Dickes Baumwolle Ring Spun, Single Jersey 180 g/ m2.
T-Shirt Adulte Couleur "keya". 100% Coton Épais Ring Spun, Single Jersey 180 g/ m2.
Volwassene Kleuren T-Shirt "keya". 100% Dicke Katoen Ring Spun, Single Jersey 180 g/ m2.

 S, M, L, XL, XXL, 3XL
  100 / 10
 Print Code: F(6), N(8), O, P

100% HEAVY COTTON

180 gsm.



MC130

5854

Adult White T-Shirt "keya". 100% Cotton Ring Spun, Single Jersey 130 g/ m2.
Erwachsene Weiß T-Shirt "keya". 100% Baumwolle Ring Spun, Single Jersey 130 g/ m2.
T-Shirt Adulte Blanc "keya". 100% Coton Ring Spun, Single Jersey 130 g/ m2.
Volwassen Wit T-Shirt "keya". 100% Katoen Ring Spun, Single Jersey 130 g/ m2.

||||| S, M, L, XL, XXL  100 / 10

 Print Code: F(6), N(8), M, O, P



03

05

06

62

02

MC130

5855

Adult Colour T-Shirt "keya". 100% Cotton Ring Spun, Single Jersey 130 g/ m2.
Erwachsene Farbe T-Shirt "keya". 100% Baumwolle Ring Spun, Single Jersey 130 g/ m2.
T-Shirt Adulte Couleur "keya". 100% Coton Ring Spun, Single Jersey 130 g/ m2.
Volwassen Kleuren T-Shirt "keya". 100% Katoen Ring Spun, Single Jersey 130 g/ m2.

||||| S, M, L, XL, XXL  100 / 10

 Print Code: F(6), N(8), O, P

100%
COTTON

130 gsm.



1085

100% COTTON PIQUE FABRIC

180 gsm.



Bartel Blanco

4771

Polo Shirt. 100% Ring Spun Cotton, Pique 180 g/ m2.
Polo-Shirt. 100% Baumwolle Ring Spun, Pique 180 g/ m2.
Polo. 100% Coton Ring Spun, Pique 180 g/ m2.
Polo Shirt. 100% Katoen Ring Spun, Pique 180 g/ m2.

S, M, L, XL, XXL

50 / 10

Print Code: F(6), N(8), O, P



Bartel Color

4756

Polo Shirt. 100% Cotton Ring Spun, Pique 180 g/ m2.
Polo-Shirt. 100% Baumwolle Ring Spun, Pique 180 g/ m2.
Polo. 100% Coton Ring Spun, Pique 180 g/ m2.
Polo Shirt. 100% Katoen Ring Spun, Pique 180 g/ m2.

S, M, L, XL, XXL

50 / 10

Print Code: F(6), N(8), O, P



Keya

EXCLUSIVE DISTRIBUTOR:
SPAIN, FRANCE,
NETHERLANDS & BELGIUM

TEXTILE



100% COTTON PIQUE FABRIC

180 gsm.

1087



06 19 21 04 05 23 07 03 08 62 02

MPS180

5863

Adult Colour Polo Shirt "keya". 100% Ring Spun Cotton, Pique 180 g/ m2.
Erwachsene Farbe Polo-Shirt "keya". 100% Ring Spun Baumwolle, Pique 180 g/ m2.
Polo Adulte Couleur "keya". 100% Coton Ring Spun, Pique 180 g/ m2.
Volwassene Kleuren T-Shirt "keya". 100% Ring Spun Katoen, Pique 180 g/ m2.

||||| S, M, L, XL, XXL, 3XL  50 / 10

 Print Code: F(6), N(8), O, P

MPS180

5862

Adult White Polo Shirt "keya". 100% Ring Spun Cotton, Pique 180 g/ m2.
Erwachsene Weiß Polo-Shirt "keya". 100% Ring Spun Baumwolle, Pique 180 g/ m2.
Polo Adulte Blanc "keya". 100% Coton Ring Spun, Pique 180 g/ m2.
Volwassene Wit Polo Shirt "keya". 100% Ring Spun Katoen, Pique 180 g/ m2.

||||| S, M, L, XL, XXL, 3XL  50 / 10

 Print Code: F(6), N(8), M, O, P



Keya®

EXCLUSIVE DISTRIBUTOR:
SPAIN, FRANCE,
NETHERLANDS & BELGIUM

180 gsm.

100% COTTON
PIQUE FABRIC

1088



YPS180

5876

Women Colour Polo Shirt "keya". 100% Ring Spun Cotton, Pique 180 g/ m2.
Frauen Farbe Polo-Shirt "keya". 100% Ring Spun Baumwolle, Pique 180 g/ m2.
Polo Femme Couleur "keya". 100% Coton Ring Spun, Pique 180 g/ m2.
Dames Kleuren Polo Shirt "keya". 100% Ring Spun Katoen, Pique 180 g/ m2.

XS (5-6), S (7-8), M (10-11), L (12-13), XL (14-15) 50 / 10
Print Code: F(6), N(8), O, P



YPS180

5875

Women White Polo Shirt "keya". 100% Ring Spun Cotton, Pique 180 g/ m2.
Frauen Weiß Polo-Shirt "keya". 100% Ring Spun Baumwolle, Pique 180 g/ m2.
Polo Femme Blanc "keya". 100% Coton Ring Spun, Pique 180 g/ m2.
Dames Wit Polo Shirt "keya". 100% Ring Spun Katoen, Pique 180 g/ m2.

XS (5-6), S (7-8), M (10-11), L (12-13), XL (14-15) 50 / 10
Print Code: F(6), N(8), M, O, P



EXCLUSIVE DISTRIBUTOR:
SPAIN, FRANCE,
NETHERLANDS & BELGIUM

100% COTTON PIQUE FABRIC

180 gsm.



1089



06 19 21 04 42 05 23 07 03 22 08 62 02

WPS180
5872

Women Colour Polo Shirt "keya". 100% Ring Spun Cotton, Pique 180 g/ m2.
Frauen Farbe Polo-Shirt "keya". 100% Ring Spun Baumwolle, Pique 180 g/ m2.
Polo Femme Couleur "keya". 100% Coton Ring Spun, Pique 180 g/ m2.
Dames Kleuren Polo Shirt "keya". 100% Ring Spun Katoen, Pique 180 g/ m2.

■ ■ ■ ■ S, M, L, XL, XXL 50 / 10
 Print Code: F(6), N(8), O, P



WPS180
5871

Women White Polo Shirt "keya". 100% Ring Spun Cotton, Pique 180 g/ m2.
Frauen Weiß Polo-Shirt "keya". 100% Ring Spun Baumwolle, Pique 180 g/ m2.
Polo Femme Blanc "keya". 100% Coton Ring Spun, Pique 180 g/ m2.
Dames Wit Polo Shirt "keya". 100% Ring Spun Katoen, Pique 180 g/ m2.

■ ■ ■ ■ S, M, L, XL, XXL 50 / 10
 Print Code: F(6), N(8), M, O, P

TECHNICAL
180 gsm.
100% polyester
PIQUE FABRIC

1090

RPET
ECO
textile



NEW



Dekrom

6755

Polo Shirt. 100% Polyester RPET 180 g/ m2. Breathable.

Polo Shirt. 100% Polyester RPET 180 g/ m2. Atmungsaktiv.

Polo. 100% Polyester RPET 180 g/ m2. Respirant.

Polo Shirt. 100% Polyester RPET 180 g/ m2. Ademend.

||||| S, M, L, XL, XXL

60

Print Code: F(6), N(8), O, P, R

RPET



The fabric used in the manufacturing process of this polo shirt is made of recycled plastic (RPET). Like this, the emission of plastic residues to our planet and the consumption of energy is drastically reduced, resulting in a much more eco-friendly process.

El material de este polo está fabricado con plástico reciclado (RPET), que, además de ayudar en la disminución de residuos plásticos en el planeta, utiliza menos energía en el proceso de fabricación, haciendo que sea mucho menos dañino para el medio ambiente.

STOP PLASTIC
POLLUTING
THE OCEAN

TECHNICAL
100% polyester
PIQUE FABRIC

180 gsm.



02 06 19 04



11 07 03



TECHNICAL
FABRIC



ACTION DRY



BREATHABLE



UNISEX



CREASE FREE

Tecnic Plus

4187

Polo Shirt. 100% Polyester 180 g/ m2. Breathable.
Polo-Shirt. 100% Polyester 180 g/ m2. Atmungsaktiv.
Polo. 100% Polyester 180 g/ m2. Respirant.
Polo Shirt. 100% Polyester 180 g/ m2. Ademend.

||||| S, M, L, XL, XXL

Print Code: F(6), N(8), O, P, R

60



01



WHITE COLOUR
SUITABLE
FOR SUBLIMATION

TECHNICAL
100% polyester
fabric

180 gsm.

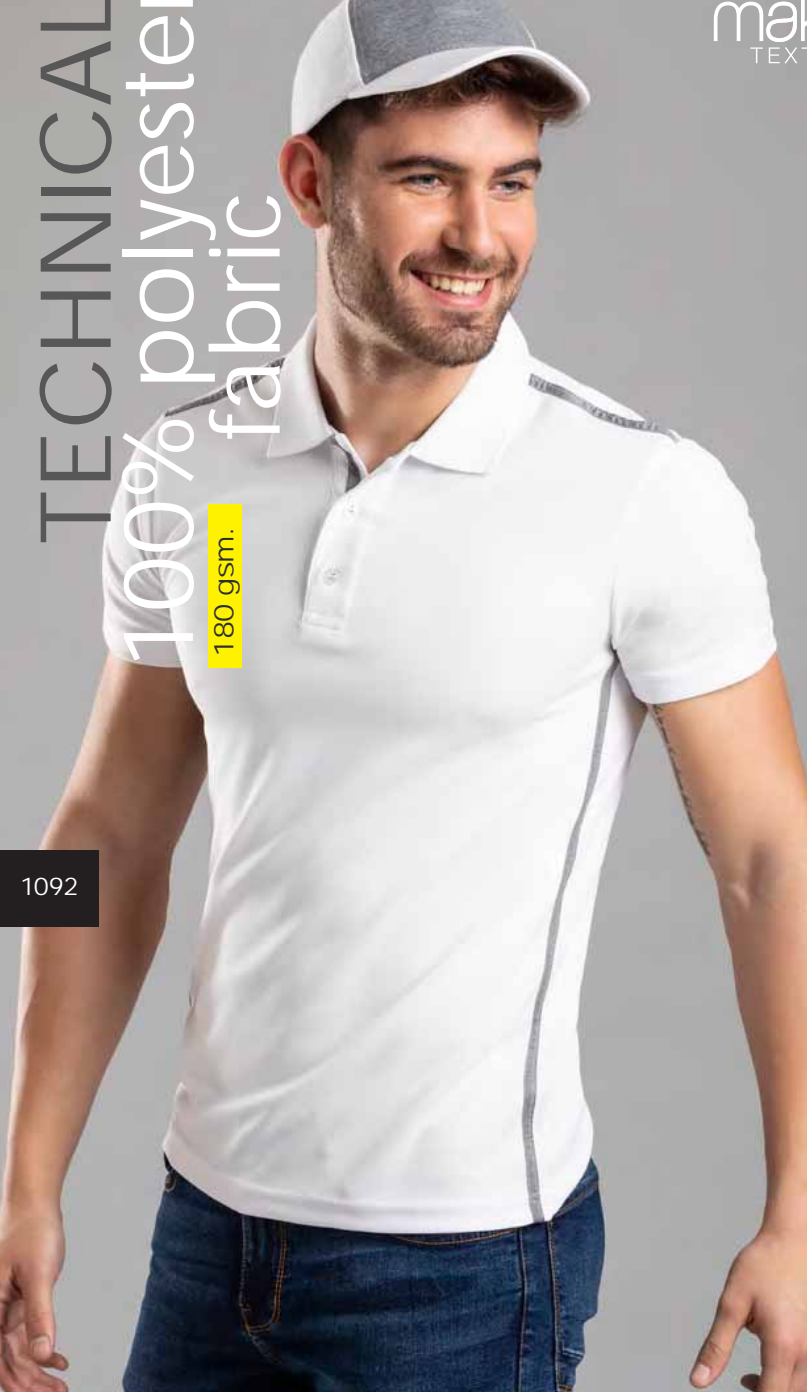

1092

TECHNICAL
100% polyester
fabric



135 gsm.





- 
TECHNICAL FABRIC
- 
BREATHABLE
- 
ACTION DRY
- 
CREASE FREE
- 
REMOVABLE LABEL
- 
WHITE COLOUR SUITABLE FOR SUBLIMATION

- 
TECHNICAL FABRIC
- 
BREATHABLE
- 
ACTION DRY
- 
CREASE FREE
- 
REMOVABLE LABEL
- 
WHITE COLOUR SUITABLE FOR SUBLIMATION

**Tecnic
Barclex**
6460

Polo Shirt. 100% Polyester 180 g/ m2. Breathable.
Polo-Shirt. 100% Polyester 180 g/ m2. Atmungsaktiv.
Polo. 100% Polyester 180 g/ m2. Respirant.
Polo Shirt. 100% Polyester 180 g/ m2. Ademend.
S, M, L, XL, XXL  50
 Print Code: F(6), M, N(8), O, P, R

**Tecnic
Troser**
6459

Adult T-Shirt. Polyester/ Elastane 135 g/ m2. Breathable.
Erwachsene T-Shirt. Polyester/ Elastan 135 g/ m2. Atmungsaktiv.
T-Shirt Adulte. Polyester/ Elasthane 135 g/ m2. Respirant.
T-Shirt Vollwassene. Polyester/ Elastaan 135 g/ m2. Ademend.
S, M, L, XL, XXL  80 / 10
 Print Code: F(6), M, N(8), O, P, R





RPET FABRIC



TECHNICAL FABRIC



BREATHABLE



ACTION DRY



CREASE FREE



REMOVABLE LABEL



WHITE COLOUR SUITABLE FOR SUBLIMATION



UNISEX

Tecnic Markus

6461

Adult T-Shirt. 100% Polyester RPET 135 g/m². Breathable.
Erwachsene T-Shirt. 100% Polyester RPET 135 g/m². Atmungsaktiv.
T-Shirt Adulte. 100% Polyester RPET 135 g/m². Respirant.
T-Shirt Vollwässene. 100% Polyester RPET 135 g/m². Ademend.

XS, S, M, L, XL, XXL 80 / 10

Print Code: F(6), M, N(8), O, P, R



04 01 02 03 19



RPET FABRIC



TECHNICAL FABRIC



BREATHABLE



ACTION DRY



CREASE FREE



REMOVABLE LABEL



WHITE COLOUR SUITABLE FOR SUBLIMATION



UNISEX

Tecnic Layom

6462

Adult T-Shirt. Polyester/ Elastane 135 g/m². Breathable.
Erwachsene T-Shirt. Polyester/ Elastan 135 g/m². Atmungsaktiv.
T-Shirt Adulte. Polyester/ Elasthane 135 g/m². Respirant.
T-Shirt Vollwässene. Polyester/ Elastaan 135 g/m². Ademend.

XS, S, M, L, XL, XXL 80 / 10

Print Code: F(6), M, N(8), O, P, R



01 02 03 04 05 19

TECHNICAL 100% polyester fabric

135 gsm.



1094

RAGLAN
SLEEVE



135 gsm.



Tecnic Plus 4186

Women T-Shirt. 100% Polyester 135 g/ m2. Breathable.
Frauen T-Shirt. 100% Polyester 135 g/ m2. Atmungsaktiv.
T-Shirt Femme. 100% Polyester 135 g/ m2. Respirant.
Dames T-Shirt. 100% Polyester 135 g/ m2. Ademend.

Print Code: F(6), N(8), M, O, P, R



Tecnic Plus 4185

Kids T-Shirt. 100% Polyester 135 g/ m2. Breathable.
Kinder T-Shirt. 100% Polyester 135 g/ m2. Atmungsaktiv.
T-Shirt Infant. 100% Polyester 135 g/ m2. Respirant.
Kinder T-Shirt. 100% Polyester 135 g/ m2. Ademend.

Print Code: F(6), N(8), M, O, P, R

THE BEST PRICE
& THE **BEST-SELLER**

RAGLAN
SLEEVE

TECHNICAL
100% polyester
135 gsm.

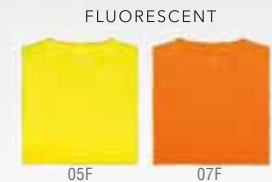

1095

Tecnic Plus

4184

Adult T-Shirt. 100% Polyester 135 g/ m2. Breathable.
Erwachsene T-Shirt. 100% Polyester 135 g/ m2. Atmungsaktiv.
T-Shirt Adulte. 100% Polyester 135 g/ m2. Respirant.
T-Shirt Volwassene. 100% Polyester 135 g/ m2. Ademend.

S, M, L, XL, XXL 80 / 10
Print Code: F(6), N(8), M, O, P, R



TECHNICAL
100% polyester
POINTEL-HONEYCOMB FABRIC

135 gsm.

1096



TECHNICAL
FABRIC



BREATHABLE



ACTION DRY



CREASE FREE



REMOVABLE
LABEL



WHITE COLOUR
SUITABLE
FOR SUBLIMATION



UNISEX



TECHNICAL
FABRIC



BREATHABLE



ACTION DRY



CREASE FREE



REMOVABLE
LABEL



WHITE COLOUR
SUITABLE
FOR SUBLIMATION



02

01

19

04

05

07

03

11

Tecnic Rox
5249

Kids T-Shirt. 100% Polyester 135 g/ m2. Breathable.
Kinder T-Shirt. 100% Polyester 135 g/ m2. Atmungsaktiv.
T-Shirt Enfant. 100% Polyester 135 g/ m2. Respirant.
Kinder T-Shirt. 100% Polyester 135 g/ m2. Ademend.

4-5, 6-8, 10-12

100 / 10

Print Code: F(6), N(8), M, O, P, R



02

01

07

16

11

21

03

Tecnic Rox
5248

Women T-Shirt. 100% Polyester 135 g/ m2. Breathable.
Frauen T-Shirt. 100% Polyester 135 g/ m2. Atmungsaktiv.
T-Shirt Femme. 100% Polyester 135 g/ m2. Respirant.
Dames T-Shirt. 100% Polyester 135 g/ m2. Ademend.

S, M, L, XL

100 / 10

Print Code: F(6), N(8), M, O, P, R

TECHNICAL
100% polyester
POINTEL-HONEYCOMB FABRIC

135 gsm.



Tecnic Rox

5247

Adult T-Shirt. 100% Polyester 135 g/ m2. Breathable.

Erwachsene T-Shirt. 100% Polyester 135 g/ m2. Atmungsaktiv.

T-Shirt Adulte. 100% Polyester 135 g/ m2. Respirant.

T-Shirt Vollwassene. 100% Polyester 135 g/ m2. Ademend.

S, M, L, XL, XXL

80 / 10

Print Code: F(6), N(8), M, O, P, R



TECHNICAL
FABRIC



BREATHABLE



ACTION DRY



CREASE FREE



REMOVABLE
LABEL



WHITE COLOUR
SUITABLE
FOR SUBLIMATION



UNISEX

Tecnic Dynamic Comby

6079

Adult T-Shirt. 100% Polyester 135 g/m2. Breathable.
Erwachsene T-Shirt. 100% Polyester 135 g/m2. Atmungsaktiv.
T-Shirt Adulte. 100% Polyester 135 g/m2. Respirant.
T-Shirt Volwassenne. 100% Polyester 135 g/m2. Ademend.

S, M, L, XL, XXL

80 / 10

Print Code: F(6), N(8), M, O, P, R

RAGLAN
SLEEVE

TECHNICAL
100% polyester 135 gsm.
DYNAMIC FABRIC

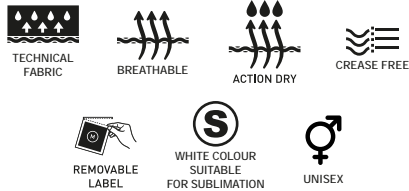

Tecnic Dynamic

6221

Adult T-Shirt. 100% Polyester 135 g/ m2. Breathable.
 Erwachsene T-Shirt. 100% Polyester 135 g/ m2. Atmungsaktiv.
 T-Shirt Adulte. 100% Polyester 135 g/ m2. Respirant.
 T-Shirt Volwassenne. 100% Polyester 135 g/ m2. Ademend.

S, M, L, XL, XXL 80 / 10

Print Code: F(6), N(8), M, O, P, R

RAGLAN SLEEVE

1099

TECHNICAL 100% polyester DYNAMIC FABRIC

135 gsm.



Tecnic Dynamic
6222

RAGLAN SLEEVE



Tecnic Dynamic

6222

Kids T-Shirt. 100% Polyester 135 g/ m2. Breathable.
 Kinder T-Shirt. 100% Polyester 135 g/ m2. Atmungsaktiv.
 T-Shirt Enfant. 100% Polyester 135 g/ m2. Respirant.
 Kinder T-Shirt. 100% Polyester 135 g/ m2. Ademend.

4-5, 6-8, 10-12 100 / 10

Print Code: F(6), N(8), M, O, P, R



RAGLAN
SLEEVE

1100

TECHNICAL
100% polyester
fabric
135 gsm.

RAGLAN
SLEEVE



05F

19

03

02



TECHNICAL
FABRIC



BREATHABLE



ACTION DRY



CREASE FREE



REFLECTIVE
GARMENT



UNISEX

Tecnic Fleser

4471

Adult T-Shirt. 100% Polyester 135 g/ m2. Breathable.
Erwachsene T-Shirt. 100% Polyester 135 g/ m2. Altmungsaktiv.
T-Shirt Adulte. 100% Polyester 135 g/ m2. Respirant.
T-Shirt Volwassenne. 100% Polyester 135 g/ m2. Ademend.

||||| S, M, L, XL, XXL

📦 100 / 10

🌈 Print Code: F(6), N(8), O, P



02

19

04

05F

03



TECHNICAL
FABRIC



BREATHABLE



ACTION DRY



CREASE FREE



WHITE COLOUR
SUITABLE
FOR SUBLIMATION



UNISEX

Tecnic Combi

4473

Adult T-Shirt. 100% Polyester 135 g/ m2. Breathable.
Erwachsene T-Shirt. 100% Polyester 135 g/ m2. Altmungsaktiv.
T-Shirt Adulte. 100% Polyester 135 g/ m2. Respirant.
T-Shirt Volwassenne. 100% Polyester 135 g/ m2. Ademend.

||||| S, M, L, XL, XXL

📦 100 / 10

🌈 Print Code: F(6), N(8), M, O, P, R

TECHNICAL
100% polyester
fabric

135 gsm.

MAKILU
TEXTILE



TECHNICAL
FABRIC



BREATHABLE



ACTION DRY



CREASE FREE



WHITE COLOUR
SUITABLE
FOR SUBLIMATION



UNISEX

Tecnic Sunit

4725

Adult T-Shirt. 100% Polyester 135 g/ m2. Breathable.

Erwachsene T-Shirt. 100% Polyester 135 g/ m2. Atmungsaktiv.

T-Shirt Adulte. 100% Polyester 135 g/ m2. Respirant.

T-Shirt Volwassene. 100% Polyester 135 g/ m2. Ademem.

S, M, L, XL, XXL

100 / 10

Print Code: F(6), N(8), M, O, P, R

1101



180 gsm.



TECHNICAL
FABRIC



BREATHABLE



REFLECTIVE
GARMENT



UNISEX

Lowis

4913

Shorts. 92% Polyester/ 8% Elastane 180 g/ m2. Unisex.

Sporthose. 92% Polyester/ 8% Elastan 180 g/ m2. Unisex.

Short Sportif. 92% Polyester/ 8% Elasthanne 180 g/ m2. Unisex.

Sportbroek. 92% Polyester/ 8% Elastaan 180 g/m2. Unisex.

S, M, L, XL, XXL

50

Print Code: F(1), N(8)

TECHNICAL
100% polyester
fabric

135 gsm.

1102

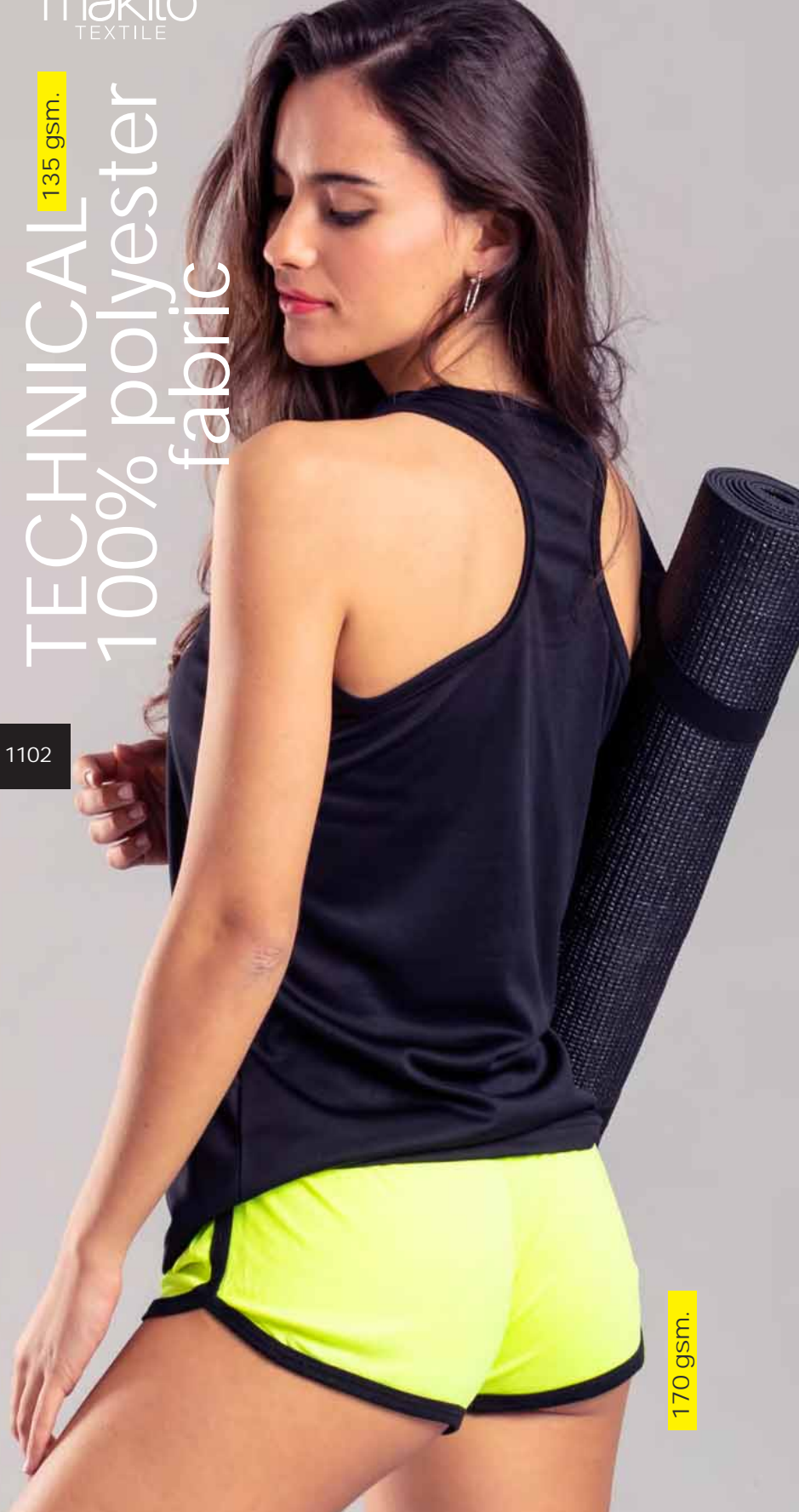

170 gsm.



02



11F



01



05F



TECHNICAL
FABRIC



BREATHABLE



ACTION DRY



CREASE FREE



WHITE COLOUR
SUITABLE
FOR SUBLIMATION

Tecnic Lemery

4731

Women T-Shirt. 100% Polyester 135 g/ m2. Breathable.
Frauen T-Shirt. 100% Polyester 135 g/ m2. Atmungsaktiv.
T-Shirt Femme. 100% Polyester 135 g/ m2. Respirant.
Dames T-Shirt. 100% Polyester 135 g/ m2. Ademend.

S, M, L

100 / 10

Print Code: F(6), N(8), M, O, P, R



05F



TECHNICAL
FABRIC



CREASE FREE



11F

Bizax

4718

Shorts. 100% Polyester 170 g/ m2.
Shorts. 100% Polyester 170 g/ m2.
Short. 100% Polyester 170 g/ m2.
Shorts. 100% Polyester 170 g/ m2.

S, M, L

100 / 10

Print Code: F(6), N(8), O, P

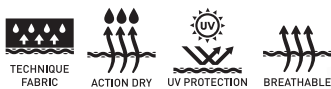

Kraley

5747

T-Shirt. 100% Polyester 120 g/m².
T-Shirt. 100% Polyester 120 g/m².
T-Shirt. 100% Polyester 120 g/m².
T-Shirt. 100% Polyester 120 g/m².

8-10, 4-5, 6-8 / 10-12, S, M, L, XL, XXL 80 / 10

Print Code: F(6), M, N(8), O, P, R 100 / 10



ADULT

Kraley

5748

KID



Duttier

5125

Arm Sleeves. Polyester/ Elastane.
Armelschoner. Polyester/ Elastan.
Manchon Bras. Polyester/ Elasthanne.
Arm Warmer. Polyester/ Elastaan.

43 cm

200 / 100

Print Code: F(1), N(8), R



120 gsm.
TECHNICAL
100% polyester

SOFT COOL EXTREME

New fabric SoftCool Extreme with UV protection. Quick and instant cooling at contact with moisture and movement.

Nuevo tejido SoftCool Extreme con protección UV, de enfriamiento rápido e instantáneo al contacto con la humedad y el movimiento.



1103



145
GSM

Tecnic Gerox

4472

Shorts. 100% Polyester 145 g/m². Breathable.
Shorts. 100% Polyester 145 g/m². Atmungsaktiv.
Shorts. 100% Polyester 145 g/m². Respirant.
Shorts. 100% Polyester 145 g/m². Ademend.

8-10, 12-14, S, M, L, XL 100 / 10

Print Code: F(6), N(8), O, P, R





1104



01

05F

02

07F

11F

130
GSM

Slem
4720

Women T-Shirt. 100% Polyester 130 g/ m2.
Frauen T-Shirt. 100% Polyester 130 g/ m2.
T-Shirt Femme. 100% Polyester 130 g/ m2.
Dames T-Shirt. 100% Polyester 130 g/ m2.

S, M, L



Print Code: F(6), N(8), M, O, R



TECHNICAL
FABRIC



CREASE FREE



WHITE COLOUR
SUITABLE
FOR SUBLIMATION



UNISEX



03

01

19

02

05F

160
GSM



TECHNICAL
FABRIC



UNISEX

Yuk
4719

Adult T-Shirt. TC. 15% Cotton/ 85% Polyester 160 g/ m2.
Erwachsene T-Shirt. TC. 15% Baumwolle/ 85% Polyester 160 g/ m2.
T-Shirt Adulte. TC. 15% Coton/ 85% Polyester 160 g/ m2.
T-Shirt Volwassene. TC. 15% Katoen/ 85% Polyester 160 g/ m2.

S, M, L, XL



Print Code: F(6), N(8), M, O, P, R



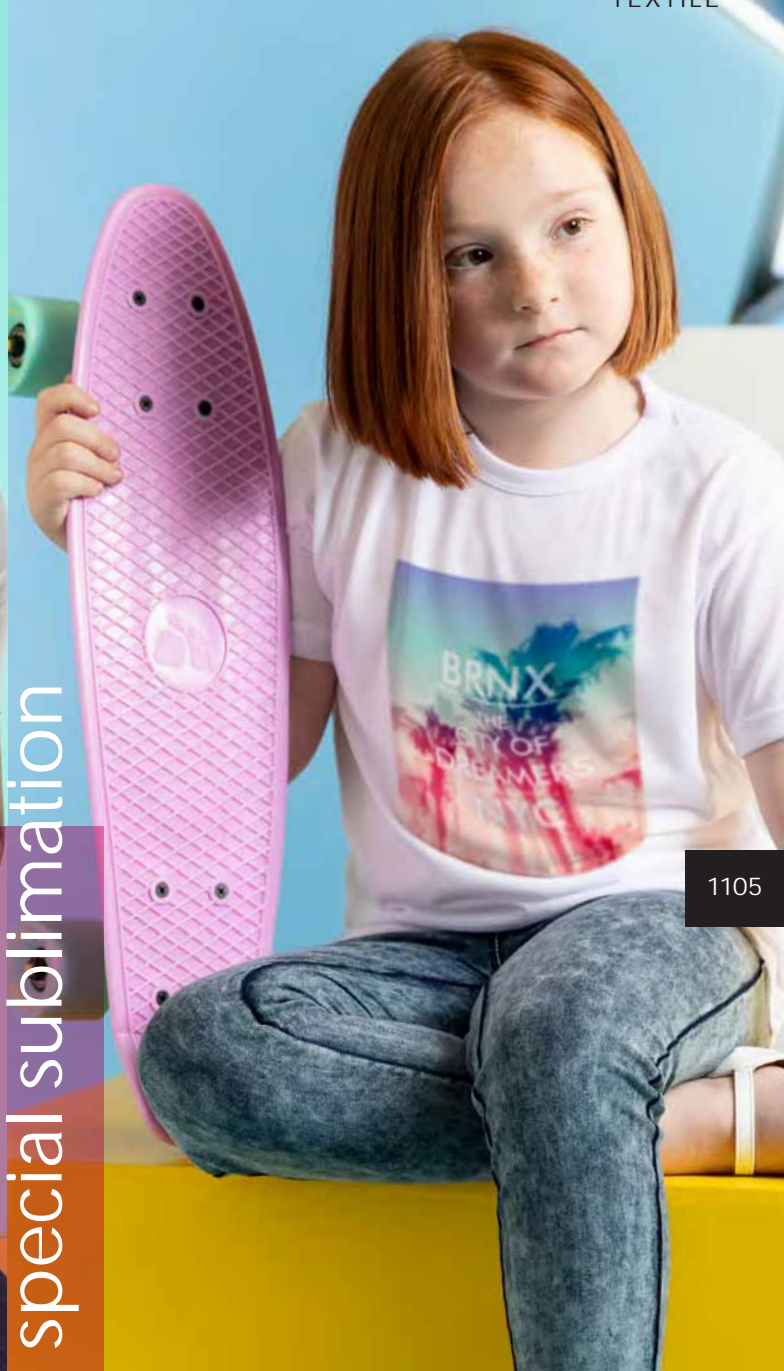

100% POLYESTER
COTTON TOUCH
special sublimation

1105



Krusly
5250

Adult T-Shirt. 100% Polyester 140 g/ m2. Cotton Touch. Breathable.
Erwachsene T-Shirt. 100% Polyester 140 g/ m2. Cotton Touch. Atmungsaktiv.
T-Shirt Adulte. 100% Polyester 140 g/ m2. Cotton Touch. Respirant.
T-Shirt Vollwassene. 100% Polyester 140 g/ m2. Cotton Touch. Ademend.

||| S, M, L, XL, XXL 📦 80 / 10
🖨️ Print Code: F(6), N(8), M, O, P, R

Krusly
5251

Kids T-Shirt. 100% Polyester 140 g/ m2. Cotton Touch. Breathable.
Kinder T-Shirt. 100% Polyester 140 g/ m2. Cotton Touch. Atmungsaktiv.
T-Shirt Enfant. 100% Polyester 140 g/ m2. Cotton Touch. Respirant.
Kinder T-Shirt. 100% Polyester 140 g/ m2. Cotton Touch. Ademend.

||| 4-5, 6-8, 10-12 📦 100 / 10
🖨️ Print Code: F(6), N(8), M, O, P, R

-  TECHNICAL FABRIC
-  LIGHTWEIGHT & WARM GARMENT
-  BREATHABLE
-  ACTION DRY
-  CREASE FREE
-  WHITE COLOUR SUITABLE FOR SUBLIMATION
-  UNISEX

1106



135 gsm.

.....● RAGLAN SLEEVE

TECHNICAL
100% polyester
FABRIC

-  LIGHTWEIGHT & WARM GARMENT
-  CREASE FREE
-  WHITE COLOUR SUITABLE FOR SUBLIMATION
-  UNISEX



Kroby
4722



265 gsm.



Kroby
4769

Tecnic Maik 4726

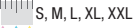
Adult T-Shirt. 100% Polyester 135 g/ m2. Breathable.
Erwachsene T-Shirt. 100% Polyester 135 g/ m2. Atmungsaktiv.
T-Shirt Adulte. 100% Polyester 135 g/ m2. Respirant.
T-Shirt Vollwassene. 100% Polyester 135 g/ m2. Ademend.

 S, M, L, XL, XXL  60 / 10
 Print Code: F(6), N(8), M, O, P, R





- 19 04
- 02 11
- 03 01
- 05 07

Adult
4722

Kid
4769

Kroby

Adult Technical Sweatshirt. 100% Polyester 265 g/ m2.
Erwachsene Technische Sweatshirt. 100% Polyester 265 g/ m2.
Sweat-Shirt Technique Adulte. 100% Polyester 265 g/ m2.
Volwassenen Technisch Sweatshirt. 100% Polyester 265 g/ m2.

 4-5, 6-8, 10-12 / S, M, L, XL, XXL  30
 Print Code: F(6), M, N(8), O, P, R





- LIGHTWEIGHT & WARM GARMENT
- CREASE FREE
- WHITE COLOUR SUITABLE FOR SUBLIMATION
- UNISEX

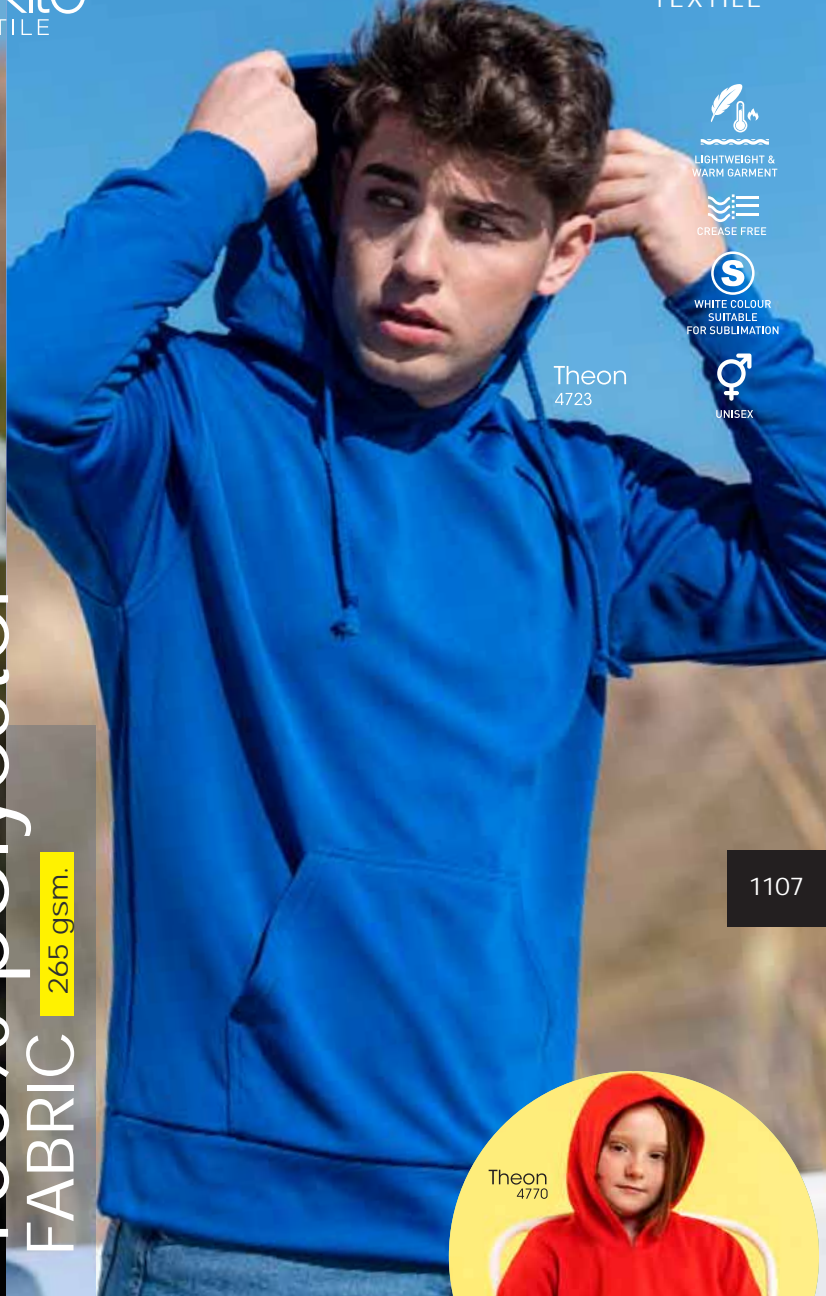

- LIGHTWEIGHT & WARM GARMENT
- CREASE FREE
- WHITE COLOUR SUITABLE FOR SUBLIMATION
- UNISEX

Theon 4723

TECHNICAL
100% polyester
FABRIC 265 gsm.

1107



Theon 4770



Klusten
4724

- Technical Jacket. 100% Polyester 265 g/ m2.
- Technische Jacke. 100% Polyester 265 g/ m2.
- Veste Technique. 100% Polyester 265 g/ m2.
- Technische Jas. 100% Polyester 265 g/ m2.

S, M, L, XL, XXL 30
 Print Code: F(6), N(8), M, O, P, R

Theon

- Technical Sweatshirt. 100% Polyester 265 g/ m2.
- Technische Sweatshirt. 100% Polyester 265 g/ m2.
- Sweat-Shirt Technique. 100% Polyester 265 g/ m2.
- Technisch Sweatshirt. 100% Polyester 265 g/ m2.

4-5, 6-8, 10-12, / S, M, L, XL, XXL 30
 Print Code: F(6), N(8), M, O, P, R

Adult
4723



Kid
4770



Theon 4770



1108

280 gsm.
50% COTTON
50% POLYESTER
 fleece, one side brushed



SWZ280
 5866

Adult Hooded + Zipper Sweatshirt "keya". 50% Cotton/ 50% Polyester 280 g/ m2.
 Erwachsene Sweatshirt mit Kapuze + Reißverschluss "keya". 50% Baumwolle/ 50% Polyester 280 g/ m2.
 Sweat-Shirt à Capuche + Crémaillère Adulte "keya". 50% Coton/ 50% Polyester 280 g/ m2.
 Volwassen Hooded + Rits Sweatshirt "keya". 50% Katoen/ 50% Polyester 280 g/ m2.

S, M, L, XL, XXL, 3XL 25 / 5
 Print Code: F(6), N(8), O, P



SWP280
 5865

Adult Hooded Sweatshirt "keya". 50% Cotton/ 50% Polyester 280 g/ m2.
 Erwachsene Sweatshirt mit Kapuze "keya". 50% Baumwolle/ 50% Polyester 280 g/ m2.
 Sweat-Shirt à Capuche Adulte "keya". 50% Coton/ 50% Polyester 280 g/ m2.
 Volwassen Hooded Sweatshirt "keya". 50% Katoen/ 50% Polyester 280 g/ m2.



S, M, L, XL, XXL, 3XL 25 / 5
 Print Code: F(6), N(8), O, P



SWC280
 5864

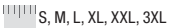

Adult Sweatshirt "keya". 50% Cotton/ 50% Polyester 280 g/ m2.
 Erwachsene Sweatshirt "keya". 50% Baumwolle/ 50% Polyester 280 g/ m2.
 Sweat-Shirt Adulte "keya". 50% Coton/ 50% Polyester 280 g/ m2.
 Volwassene Sweatshirt "keya". 50% Katoen/ 50% Polyester 280 g/ m2.

 S, M, L, XL, XXL, 3XL  30 / 5

 Print Code: F(6), N(8), O, P

50% COTTON
 50% POLYESTER
 fleece, one side brushed
 280 gsm.



1110



Cornal

6466



Jacket. Soft Shell/ Polyester. Wind and Water Resistant.
Jacke. Soft Shell/ Polyester. Beständig Gegen Wind und Wasser.
Veste. Soft Shell/ Polyester. Résistant au Vent et à l'Eau.
Jas. Soft Shell/ Polyester. Bestand Tegen Wind en Water.

||||| S, M, L, XL, XXL
Print Code: N(8), P



Bordy

6465



Vest. Soft Shell/ Polyester. Wind and Water Resistant.
Weste. Soft Shell/ Polyester. Beständig Gegen Wind und Wasser.
Gilet. Soft Shell/ Polyester. Résistant au Vent et à l'Eau.
Vest. Soft Shell/ Polyester. Bestand Tegen Wind en Water.

||||| S, M, L, XL, XXL
Print Code: N(8), P



NEW



1111

Kimpal

6759



Jacket. 100% Polyester. Wind and Water Resistant.
Jacke. 100% Polyester. Beständig Gegen Wind und Wasser.
Veste. 100% Polyester. Résistant au Vent et à l'Eau.
Jas. 100% Polyester. Bestand Tegen Wind en Water.

||||| S, M, L, XL, XXL



Print Code: N(8), P



Belsan

6080



Vest. 100% Polyester. Wind and Water Resistant. Polyester Pouch Included.
Weste. 100% Polyester. Beständig Gegen Wind und Wasser. Polyester Etui Inklusiv.
Gilet. 100% Polyester. Résistant au Vent et à l'Eau. Etui Polyester Inclus.
Vest. 100% Polyester. Bestand Tegen Wind en Water. Zakje Inclusief.

||||| S, M, L, XL, XXL



Print Code: N(8), P



POUCH INCLUDED





1112



03



19



02



LIGHTWEIGHT &
WARM GARMENT



WATER & WIND
RESISTANT



UNISEX

Luzat

4917

Jacket. 100% Polyester. Wind and Water Resistant.
Jacke. 100% Polyester. Beständig Gegen Wind und Wasser.
Veste. 100% Polyester. Résistant au Vent et à l'Eau.
Jas. 100% Polyester. Bestand Tegen Wind en Water.

S, M, L, XL, XXL

Print Code: N(8), P



10



04



19



05



03



01



02



LIGHTWEIGHT &
WARM GARMENT



UNISEX

Tansy

4717

Vest. Nylon/ Polyester.
Weste. Nylon/ Polyester.
Gilet. Nylon/ Polyester.
Vest. Nylon/ Polyester.

M, L, XL, XXL

Print Code: N(8), P



15

ECO textile RPET FABRIC

NEW

NEW

UNISEX

1113



RPET FABRIC



LIGHTWEIGHT & WARM GARMENT



WATER & WIND RESISTANT



UNISEX



POUCH INCLUDED

Mitens 6756

Jacket. 100% Polyester RPET. Wind and Water Resistant. RPET Pouch Included.
Jacke. 100% Polyester RPET. Beständig Gegen Wind und Wasser. RPET Etui Inklusiv.
Veste. 100% Polyester RPET. Résistant au Vent et à l'Eau. Etui RPET Inclus.
Jas. 100% Polyester RPET. Bestand Tegen Wind en Water. RPET Zakje Inclusief.

S, M, L, XL, XXL
Print Code: N(8), P

15



RPET FABRIC



LIGHTWEIGHT & WARM GARMENT



WATER & WIND RESISTANT



UNISEX



POUCH INCLUDED

Rostol 6757

Vest. 100% Polyester RPET. Wind and Water Resistant. RPET Pouch Included.
Weste. 100% Polyester RPET. Beständig Gegen Wind und Wasser. RPET Etui Inklusiv.
Gilet. 100% Polyester RPET. Résistant au Vent et à l'Eau. Etui RPET Inclus.
Vest. 100% Polyester RPET. Bestand Tegen Wind en Water. RPET Zakje Inclusief.

S, M, L, XL, XXL
Print Code: N(8), P

15





LIGHTWEIGHT &
WARM GARMENT



WATER & WIND
RESISTANT



UNISEX

300
GSM



1114



03 04 16 19 02 06

Baidok

4716

Jacket. Outside: Soft Shell, 92% Polyester/ 8% Elastane. Inside: 100% Polyester Microfleece. 300 g/ m². Wind and Water Resistant.

Jacke. Außere: Soft Shell, 92% Polyester/ 8% Elastan. Innen: 100% Polyester Microfleece. 300 g/ m². Beständig Gegen Wind und Wasser.

Veste. Extérieur: Soft Shell, 92% Polyester/ 8% Elasthanne. Intérieur: 100% Polyester Microfleece. 300 g/ m². Résistant au Vent et à l'Eau.

Jas. Buitenzijde: Soft Shell, 92% Polyester/ 8% Elastaan. Binnenzijde: 100% Polyester Microfleece. 300 g/ m². Bestand tegen Wind en Water.

||||| S, M, L, XL, XXL



Print Code: N(8), P



LIGHTWEIGHT &
WARM GARMENT



WATER & WIND
RESISTANT



UNISEX

300
GSM



02 06 19 04 16 03

Balmax

4715

Vest. Outside: Soft Shell, 92% Polyester/ 8% Elastane. Inside: 100% Polyester Microfleece. 300 g/ m². Wind and Water Resistant.

Weste. Außere: Soft Shell, 92% Polyester/ 8% Elastan. Innen: 100% Polyester Microfleece. 300 g/ m². Beständig Gegen Wind und Wasser.

Gilet. Extérieur: Soft Shell, 92% Polyester/ 8% Elasthanne. Intérieur: 100% Polyester Microfleece. 300 g/ m². Résistant au Vent et à l'Eau.

Vest. Buitenzijde: Soft Shell, 92% Polyester/ 8% Elastaan. Binnenzijde: 100% Polyester Microfleece. 300 g/ m². Bestand tegen Wind en Water.

||||| S, M, L, XL, XXL



Print Code: N(8), P

300
GSM



LIGHTWEIGHT &
WARM GARMENT



WATER & WIND
RESISTANT



UNISEX



02 19 08 03

Molter

3854

Jacket. Outside: Soft Shell, 92% Polyester/ 8% Elastane. Inside: 100% Polyester Microfleece. 300 g/ m². Wind and Water Resistant.

Jacke. Außere: Soft Shell, 92% Polyester/ 8% Elastan. Innen: 100% Polyester Microfleece. 300 g/ m². Beständig Gegen Wind und Wasser.

Veste. Extérieur: Soft Shell, 92% Polyester/ 8% Elasthanne. Intérieur: 100% Polyester Microfleece. 300 g/ m². Résistant au Vent et à l'Eau.

Jas. Buitenzijde: Soft Shell, 92% Polyester/ 8% Elastaan. Binnenzijde: 100% Polyester Microfleece. 300 g/ m². Bestand tegen Wind en Water.

||||| S, M, L, XL, XXL



Print Code: N(8), P

SOFT SHELL

1115

Blear

6463



LIGHTWEIGHT &
WARM GARMENT



WATER & WIND
RESISTANT



UNISEX

300
GSM

Jacket. Outside: Soft Shell, 92% Polyester/ 8% Elastane. Inside: 100% Polyester Microfleece. 300 g/ m2. Wind and Water Resistant.

Jacke. Außere: Soft Shell, 92% Polyester/ 8% Elastan. Innen: 100% Polyester Microfleece. 300 g/ m2. Beständig Gegen Wind und Wasser.

Veste. Extérieur: Soft Shell, 92% Polyester/ 8% Elasthanne. Intérieur: 100% Polyester Microfleece. 300 g/ m2. Résistant au Vent et à l'Eau.

Jas. Buitenzijde: Soft Shell, 92% Polyester/ 8% Elastaan. Binnenzijde: 100% Polyester Microfleece. 300 g/ m2. Bestand tegen Wind en Water.

||||| S, M, L, XL, XXL



Print Code: N(8), P, R

Persol

6464



LIGHTWEIGHT &
WARM GARMENT



WATER & WIND
RESISTANT



UNISEX

300
GSM

Vest. Outside: Soft Shell, 92% Polyester/ 8% Elastane. Inside: 100% Polyester Microfleece. 300 g/ m2. Wind and Water Resistant.

Weste. Außere: Soft Shell, 92% Polyester/ 8% Elastan. Innen: 100% Polyester Microfleece. 300 g/ m2. Beständig Gegen Wind und Wasser.

Gilet. Extérieur: Soft Shell, 92% Polyester/ 8% Elasthanne. Intérieur: 100% Polyester Microfleece. 300 g/ m2. Résistant au Vent et à l'Eau.

Vest. Buitenzijde: Soft Shell, 92% Polyester/ 8% Elastaan. Binnenzijde: 100% Polyester Microfleece. 300 g/ m2. Bestand tegen Wind en Water.

||||| S, M, L, XL, XXL



Print Code: N(8), P, R

UNISEX

280 gsm.

1116



02 06 03 07 04 08 19



19 01 08 02 04 11 03 06

Forest
8662

Vest. Polar Fleece 280 g/ m2. Anti-Pilling Treatment.
Weste. Polar Fleece 280 g/ m2. Anti-Pilling Behandlung.
Gilet. Polaire 280 g/ m2. Traitement Anti-Pilling.
Vest. Polar Fleece 280 g/ m2. Anti-Pilling Behandeling.

||||| M, L, XL, XXL



Print Code: N(8), P



UNISEX

Hizan
4755

Jacket. Polar Fleece 280 g/ m2. Anti-Pilling Treatment.
Jacke. Polar Fleece 280 g/ m2. Anti-Pilling Behandlung.
Veste. Polaire 280 g/ m2. Traitement Anti-Pilling.
Jas. Polar Fleece 280 g/ m2. Anti-Pilling Behandeling.

||||| S, M, L, XL, XXL



Print Code: N(8), P



UNISEX

MICROPOLAR UNISEX

155 gsm.



1117

Peyten

4841

Polar Fleece. 100% Polyester Micropolar 155 g/ m2. Anti-Pilling Treatment.
 Vlies. 100% Polyester Mikropolare 155 g/ m2. Anti-Pilling Behandlung.
 Veste. 100% Polyester Micropolaire 155 g/ m2. Traitement Anti-Pilling.
 Polar Fleece. 100% Polyester Micropolar 155 g/m2. Anti-Pilling Behandelung.

S, M, L, XL, XXL
 Print Code: N(8), P

25





1118



03

19

02

04

Zylka

3874

Parka. Pongee Ripstop. Waterproof Treatment. Inside Zipper for Printing.
 Parka. Pongee Ripstop. Wasserdichte Behandlung. Innen Reißverschluss für Drucken.
 Parka. Pongee Ripstop. Imperméable. Fermeture Intérieure pour l'Impression.
 Parka. Pongee Ripstop. Waterproof Behandeld. Ritssluiting Binnenkant Voor Bedrukking.

||||| S, M, L, XL, XXL
 Print Code: N(8), P

10



06

02

03

19

Flogox

4805

Parka. Outside: Polyester. Inside: Polyester/ Polar Fleece. Waterproof Treatment. Inside Zipper for Printing.
 Parka. Außere: Polyester. Innen: Polyester/ Polar Fleece. Wasserdichte Behandlung. Innen Reißverschluss für Drucken.
 Parka. Extérieur: Polyester. Intérieur: Polyester/ Polaire. Imperméable. Fermeture Intérieure pour l'Impression.
 Parka. Buitenzijde: Polyester. Binnenzijde: Polyester/ Polar Fleece. Waterproof Behandeld. Ritssluiting Binnenkant Voor Bedrukking.

||||| S, M, L, XL, XXL
 Print Code: N(8), P

10



RAINC/OAT



1119



19

04

03



19

03

04

07

Garu 3875

Raincoat. Polyester 190T.
Regenjacke. Polyester 190T.
Imperméable. Polyester 190T.
Regenjas. Polyester 190T.

||||| M, L, XL, XXL
Print Code: G(1)



Grid 9497

Raincoat. Polyester 190T.
Regenjacke. Polyester 190T.
Imperméable. Polyester 190T.
Regenjas. Polyester 190T.

||||| M-L, XL-XXL
Print Code: G(1)



RAINCcoat

1120



03

19

02

09



02

03

04

05

19

Natsu
4552

Raincoat. Polyester 210T.
Regenjacke. Polyester 210T.
Imperméable. Polyester 210T.
Regenjas. Polyester 210T.

M, L, XL, XXL
Print Code: G(1)



Hinbow
4551

Raincoat. PVC.
Regenjacke. PVC.
Imperméable. PVC.
Regenjas. PVC.

M-L, XL-XXL
Print Code: G(1)



CE



1121



03

06

13

Soviet

9487

Vest. 35% Cotton/ 65% Polyester.
Weste. 35% Baumwolle/ 65% Polyester.
Gilet. 35% Coton/ 65% Polyester.
Vest. 35% Katoen/ 65% Polyester.

||||| L, XL, XXL

Print Code: G(6), N(8), O, P



50



UNISEX



07F

05F



UNISEX

Kross

8025

Reflective Vest. Polyester. One Size. Adult. Homologated.
Warnweste. Polyester. Einheitsgröße. Erwachsene. Genehmigt.
Gilet Réfléchissant. Polyester. Taille Unique. Adulte. Homologué.
Reflectorend Vest. Polyester. Eén Maat. Volwassen. Gehomologiseerd.

65 x 70 cm

Print Code: F(6)

100 / 20

RAIN

&

CO

LD

RPET



The fabric used in the manufacturing process of these products is made of recycled plastic (RPET). Like this, the emission of plastic residues to our planet and the consumption of energy is drastically reduced, resulting in a much more eco-friendly process.

El material de estos productos está fabricado con plástico reciclado (RPET), que, además de ayudar en la disminución de residuos plásticos en el planeta, utiliza menos energía en el proceso de fabricación, haciendo que sea mucho menos dañino para el medio ambiente.

STOP PLASTIC POLLUTING THE OCEAN



NEW

120 x 150 cm
200 g/m²

Kayla

6748

Blanket. Polyester RPET 200 g/ m2.
Decke. Polyester RPET 200 g/ m2.
Couverture. Polyester RPET 200 g/ m2.
Deken. Polyester RPET 200 g/ m2.

120 x 150 cm

20

Print Code: F(1), G(1), N(8), O, P

06



02

08

13





NEW



08



02



RPET

06

Hetul

6854

Hat. Polyester RPET.
Hut. Polyester RPET.
Bonnet. Polyester RPET.
Muts. Polyester RPET.

Consult.

Print Code: N(8), O, P

250 / 25

RPET

STOP PLASTIC POLLUTING THE OCEAN



1123



NEW



RPET

06

Suanix

6856

Neck Warmer. Polyester RPET.
Nacken Wärmer. Polyester RPET.
Tour de Cou. Polyester RPET.
Colsjaal. Polyester RPET.

25 x 50 cm

Print Code: F(1), N(8)

300 / 100



08



02



NEW

08

Despil

6855

Touchscreen Gloves. Polyester RPET. One Size. Adult.
Touchpad Handschuhe. Polyester RPET. Einheitsgröße. Erwachsene.
Gant Tactile. Polyester RPET. Taille Unique. Adulte.
Touchscreen Handschoenen. Polyester RPET. Een Maat. Volwassen.

Consult.

Print Code: N(8)

200 / 10



Tactile



RPET



06



02

THREE TOUCH SCREEN FINGERTIPS



Bonaf

02

Bonaf

6316

Ø 105 cm



Umbrella. Pongee 190T RPET. Automatic. Wood Pole and Handle.
 Regenschirm. Pongee 190T RPET. Automatisch. Holz Stange und Griff.
 Parapluie. Pongée 190T RPET. Automatique. Poignée et Tige en Bois.
 Paraplu. Pongee 190T RPET. Automatisch. Houten stok en Handvat.

Print Code: G(1), N(8), L2



Brosian

06



19 06 03

Brosian

6315

Ø 97 cm



Umbrella. Pongee 190T RPET. Windproof. Wood Handle.
 Regenschirm. Pongee 190T RPET. Antiwindsystem. Holz Griff.
 Parapluie. Pongée 190T RPET. Système Anti-Vent. Poignée en Bois.
 Paraplu. Pongee 190T RPET. Windbestendig. Houten Handvat.

Print Code: G(1), N(8), L2

VOLUNTEER

RPET
 STOP PLASTIC
 POLLUTING THE OCEAN



19 02 03



The Best PRICE



1125

WOOD
MADERA

Ø 105 cm

03



Ø 105 cm

119

40

Korlet
6414

Umbrella. Automatic. Wood Handle.
Regenschirm. Automatisch. Holz Griff.
Parapluie. Automatique. Poignée en Bois.
Paraplu. Automatisch. Houten Handvat.

Ø 105 cm

Print Code: G(1), L2, N(8), R



124



125

Santy
9215

Umbrella. Wood Pole and Handle.
Regenschirm. Holz Stange und Griff.
Parapluie. Poignée et Tige en Bois.
Paraplu. Houten stok en Handvat.

Ø 105 cm

Print Code: G(1), N(8), R

25

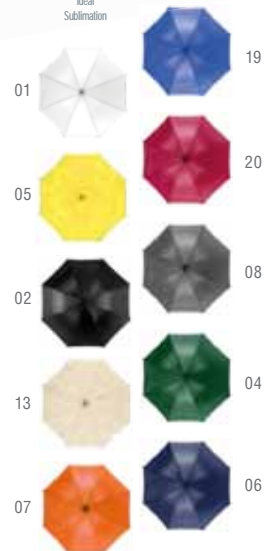

01

05

02

13

07

19

20

08

04

06



03

Ø 105 cm



INNER RIBS IN
MATCHING COLOUR
VARILLAS MECANISMO
INTERIOR EN MISMO COLOR

PADDED HANDLE
MANGO ACOLCHADO



Cladok

5888

Umbrella. Pongee. Automatic. Windproof. EVA Handle.
Regenschirm. Pongee. Automatisch. Antiwindsystem. EVA Griff.
Parapluie. Pongée. Automatique. Système Anti-Vent. Poignée Eva.
Paraplu. Pongee. Automatisch. Windbestendig. EVA Handvat.

Ø 105 cm 25

Print Code: G(1), N(8), L2



19



04



05



11

1126



03

Ø 105 cm

02

01

19



Kanan

3834

Umbrella. Ergonomic EVA Handle.
Regenschirm. Ergonomischer Griff EVA.
Parapluie. Poignée Ergonomique. EVA.
Paraplu. Ergonomisch EVA Handvat.

Ø 105 cm 30 / 10

Print Code: G(1), N(8), R

PADDED HANDLE
MANGO ACOLCHADO

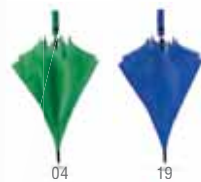

04



19



03



11

PADDED HANDLE
MANGO ACOLCHADO



05

Ø 105 cm

Dropex

4229

Umbrella. Automatic. EVA Handle.
Regenschirm. Automatisch. EVA Griff.
Parapluie. Automatique. Poignée Eva.
Paraplu. Automatisch. EVA Handvat.

Ø 105 cm 25

Print Code: G(1), N(8), L2



TBS AUTOMATIC UMBRELLA



Ø 105 cm

Meslop

4674

Umbrella. Automatic.
Regenschirm. Automatisch.
Parapluie. Automatique.
Paraplu. Automatisch.

Ø 105 cm 25
Print Code: G(1), N(8), R



Ideal
Sublimation

01 02 19 04 05 07 03 11

1127

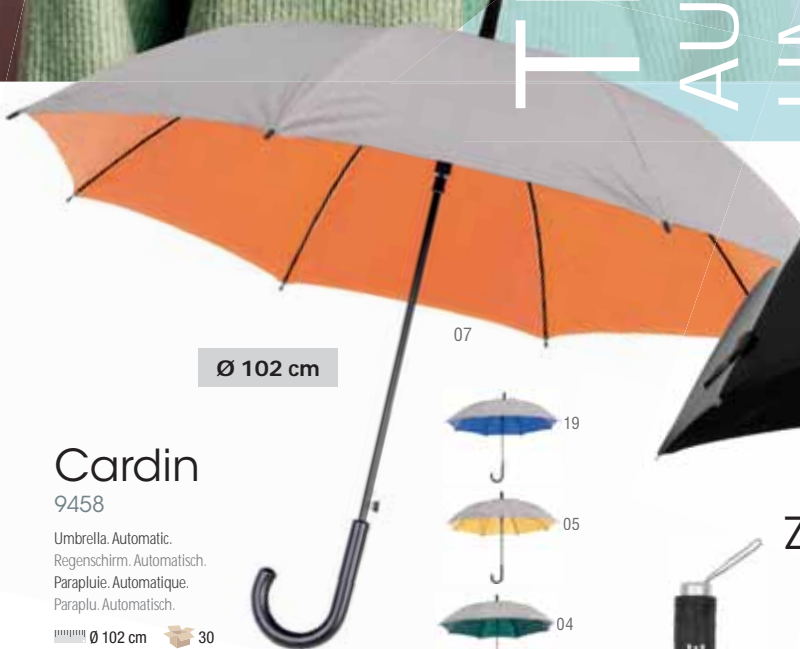

Ø 102 cm

07



19
05
04
03

Cardin

9458

Umbrella. Automatic.
Regenschirm. Automatisch.
Parapluie. Automatique.
Paraplu. Automatisch.

Ø 102 cm 30
Print Code: G(1), N(8)



Ø 96 cm

Ziant

4673

Umbrella.
Regenschirm.
Parapluie.
Paraplu.

Ø 96 cm 60
Print Code: G(1), N(8), R



Ideal
Sublimation

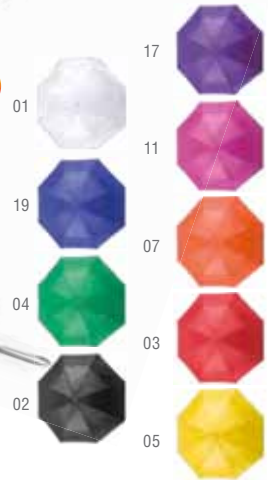

17
11
19
07
04
03
05



Panan XL 6105



Umbrella. Automatic. Windproof. EVA Handle.
Regenschirm. Automatisch. Antiwindsystem. EVA Griff.
Parapluie. Automatique. Système Anti-Vent. Poignée Eva.
Paraplu. Automatisch. Windbestendig. EVA Handvat.

☰ 130 cm 📦 30 / 10

🌈 Print Code: G(1), N(8), R

Ø 130 cm

02

PADDED HANDLE
MANGO ACOLCHADO



XXL SIZE AUTOMATIC UMBRELLA



PONGEE



02



IDEAL EXTENSION FOR
BACKPACK
PROLONGACIÓN IDEAL
PARA MOCHILAS

Kolper 6155

Extendable Umbrella. Pongee. Automatic. Windproof.
Ausziehbarer Regenschirm. Pongee. Automatisch. Antiwindsystem.
Parapluie Extensible. Pongée. Automatique. Système Anti-Vent.
Uitbreidbare Paraplu. Pongee. Automatisch. Windbestendig.

☰ 104 × 118 cm 📦 30 / 10

🌈 Print Code: G(1), N(8)



02

Ø 100 cm

PONGEE

Brosmon 5707

Umbrella. Pongee. Windproof.
Regenschirm. Pongee. Antiwindsystem.
Parapluie. Pongée. Système Anti-Vent.
Paraplu. Pongee. Windbestendig.

Ø 98 cm 30 / 10

Print Code: G(1), N(8), R



03

Ø 105 cm

Altis 3719

Umbrella. Windproof.
Regenschirm. Antiwindsystem.
Parapluie. Système Anti-Vent.
Paraplu. Windbestendig.

Ø 105 cm 25

Print Code: G(1), N(8), R



19



Ø 105 cm



Halrum 5706

Umbrella. Automatic. Windproof.
Regenschirm. Automatisch. Antiwindsystem.
Parapluie. Automatique. Système Anti-Vent.
Paraplu. Automatisch. Windbestendig.

Ø 105 cm 30 / 10
Print Code: F(1), G(1), N(8), L2, R



Hands-free
POSITION
SPECIAL HANDLE

1130

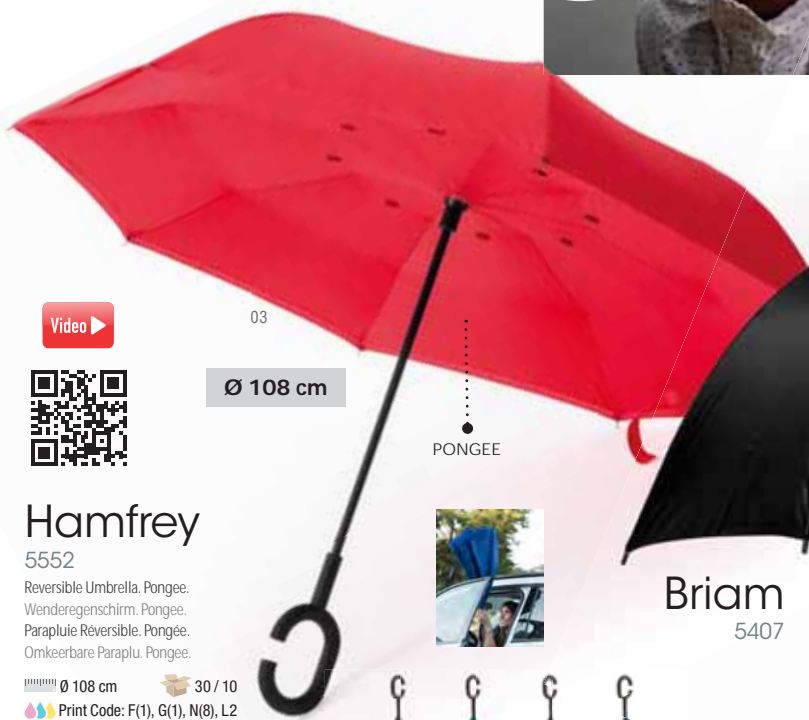

03

Ø 108 cm

PONGEE



Hamfrey 5552

Reversible Umbrella. Pongee.
Wenderegenschirm. Pongee.
Parapluie Réversible. Pongée.
Omkeerbare Paraplu. Pongee.

Ø 108 cm 30 / 10
Print Code: F(1), G(1), N(8), L2



Ø 105 cm

02

Briam 5407

Umbrella. Automatic. Windproof.
Regenschirm. Automatisch. Antiwindsystem.
Parapluie. Automatique. Système Anti-Vent.
Paraplu. Automatisch. Windbestendig.

Ø 105 cm 30
Print Code: F(1), G(1), N(8)



FOR CUP
PORTA VASO

NEW

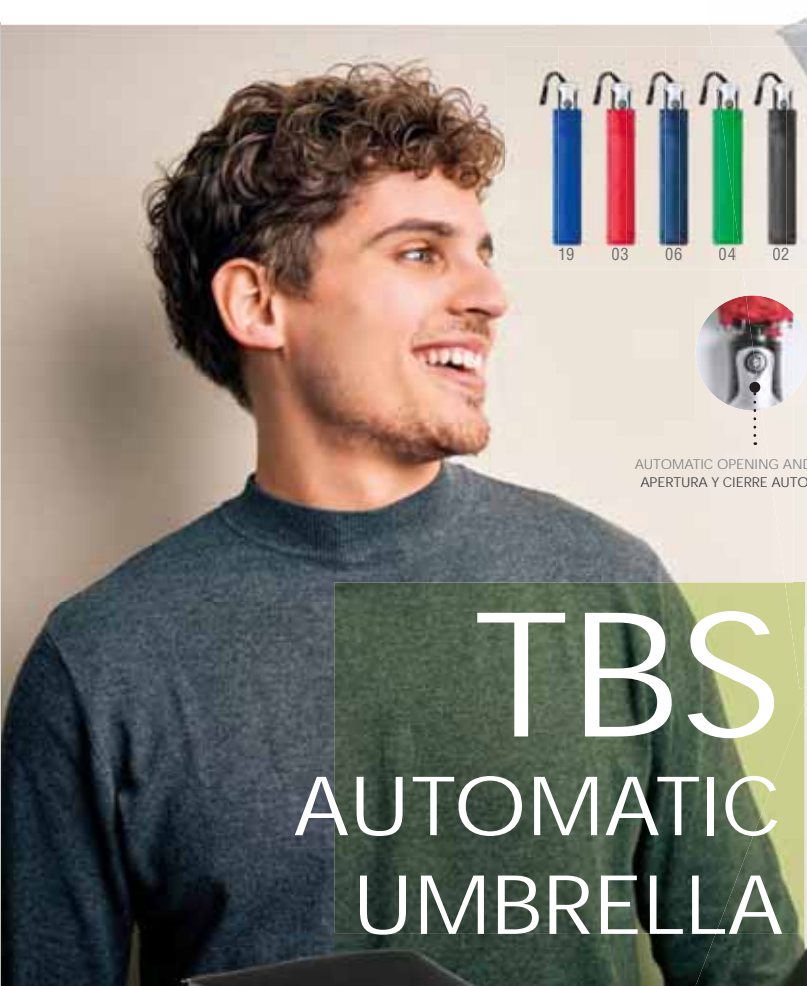

AUTOMATIC OPENING AND CLOSING
APERTURA Y CIERRE AUTOMÁTICOS

TBS AUTOMATIC UMBRELLA



Ø 98 cm

08

Alexon 6787

Umbrella. Automatic Opening and Closing. Windproof.
Regenschirm. Automatisch Öffnen und Schließen. Antiwindsystem.
Parapluie. Ouverture et Fermeture Automatiques. Système Anti-Vent.
Paraplu. Automatisch Openen en Sluiten. Windbestendig.

Ø 98 cm

30 / 10

Print Code: G(1), N(8)



Windproof

1131



Ø 100 cm

PONGEE

Ø 98 cm



Hebol 4601

Umbrella. Pongee. Automatic.
Regenschirm. Pongee. Automatisch.
Parapluie. Pongée. Automatique.
Paraplu. Pongee. Automatisch.

Ø 100 cm

30 / 10

Print Code: G(1), N(8), V

Elmer 3553

Umbrella. Pongee. Automatic. EVA Ergonomic Handle.
Regenschirm. Pongee. Automatisch. EVA Ergonomischer Griff.
Parapluie. Pongée. Automatique. Poignée Ergonomique EVA.
Paraplu. Pongee. Automatisch. EVA Ergonomisch Handvat.

Ø 98 cm

30 / 10

Print Code: G(1), N(8)



1132



Ø 92 cm

PONGEE

HANDS FREE
MANOS LIBRES



Babylon

5553

Umbrella. Pongee/ POE.
Regenschirm. Pongee/ POE.
Parapluie. Pongée/ POE.
Paraplu. Pongee/ POE.

☂️ Ø 92 cm 📦 30 / 10
🌈 Print Code: F(1), G(1), N(8), L2, R



Video ▶



Ø 100 cm

03

Fantux

5988



Umbrella. POE. Automatic. Windproof.
Regenschirm. POE. Automatisch. Antiwindsystem.
Parapluie. POE. Automatique. Systeme Anti-Vent.
Paraplu. POE. Automatisch. Windbestendig.

☂️ Ø 100 cm 📦 25
🌈 Print Code: H(1)



Ø 100 cm

Rantolf

4689

Umbrella. POE. Automatic.
Regenschirm. POE. Automatisch.
Parapluie. POE. Automatique.
Paraplu. POE. Automatisch.

☂️ Ø 100 cm 📦 25
🌈 Print Code: Consult.



Que lluvia!
que lluvia!

Montello

Hydrus

1133



03



19

03

05



01

03

19

WAISTBAG
CONVERTIBLE
CONVERTIBLE
EN RIÑONERA

Hips
9862



04

06

19

Raincoat. PVC. Waistbag Convertible.
Regenjacke. PVC. Verwandelbar in Gürteltasche.
Imperméable. PVC. Convertible en Pochette.
Regenjas. PVC. Veranderbaar in Heuptas.

■■■■■■ M-L, XL-XXL 50
🌈 Print Code: F(1), H(1)

Montello
9486

Raincoat. PVC. One Size. Adult. 127 x 100 cm.
Poncho. PVC. Einheitsgröße. Erwachsene. 127 x 100 cm.
Poncho. PVC. Taille Unique. Adulte. 127 x 100 cm.
Regenjas. PVC. Een Maat. Volwassen. 127 x 100 cm.

■■■■■■ 22.5 x 18 cm 50
🌈 Print Code: F(1), H(1)

Hydrus
3880

Raincoat. EVA. One Size. Adult.
Regenjacke. EVA. Einheitsgröße. Erwachsene.
Imperméable. EVA. Taille Unique. Adulte.
Regenjas. EVA. Een Maat. Volwassen.

■■■■■■ Ø 10 x 27 cm 50 / 10
🌈 Print Code: F(1), H(1)





Birtox

6357

Raincoat. LDPE. One Size. Adult. 127 x 102 cm.
 Poncho. LDPE. Einheitsgröße. Erwachsene. 127 x 102 cm.
 Poncho. LDPE. Taille Unique. Adulte. 127 x 102 cm.
 Regenjas. LDPE. Eén Maat. Volwassen. 127 x 102 cm.

📏 Ø 5.5 x 5.1 cm 📦 200 / 50

🎨 Print Code: D(4), W

RAINCOAT

RAIN PROTECTION



Domin

5810

Raincoat. LDPE. One Size. Adult. 120 x 95 cm.
 Poncho. LDPE. Einheitsgröße. Erwachsene. 120 x 95 cm.
 Poncho. LDPE. Taille Unique. Adulte. 120 x 95 cm.
 Regenjas. LDPE. Eén Maat. Volwassen. 120 x 95 cm.

📏 9 x 11 x 5 cm 📦 200 / 25

🎨 Print Code: F(1)



Zaril

4262

Raincoat. PEVA. One Size. Adult. 127 x 102 cm.
 Poncho. PEVA. Einheitsgröße. Erwachsene. 127 x 102 cm.
 Poncho. PEVA. Taille Unique. Adulte. 127 x 102 cm.
 Regenjas. PEVA. Eén Maat. Volwassen. 127 x 102 cm.

📏 Ø 6 x 19 cm 📦 100 / 50

🎨 Print Code: G(1), H(1)



05

PLA



This raincoat is manufactured with PLA material, from renewable raw materials, with important qualities such as versatility and strength, but prevailing all, it is compostable.

**USE ME,
I AM ECO-FRIENDLY
100% COMPOSTABLE**

Este poncho está fabricado con material PLA, procedente de materias primas renovables, con importantes propiedades como la versatilidad y la resistencia pero prevaleciendo entre ellas la de compostabilidad.



Reizon

6589

Raincoat. PLA 100% Compostable. One Size. Adult. 127 x 102 cm.

Poncho. PLA 100% Kompostierbar. Einheitsgröße. Erwachsene. 127 x 102 cm.

Poncho. PLA 100% Compostable. Taille Unique. Adulte. 127 x 102 cm.

Regenjas. PLA 100% Composteerbaar. Een Maat. Volwassen. 127 x 102 cm.

10 x 13.5 cm

200 / 20

Print Code: E(1)

1135



Remo

3503

Raincoat. HDPE. One Size. Adult. 127 x 102 cm.

Poncho. HDPE. Einheitsgröße. Erwachsene. 127 x 102 cm.

Poncho. HDPE. Taille Unique. Adulte. 127 x 102 cm.

Regenjas. HDPE. Een Maat. Volwassen. 127 x 102 cm.

10 x 13.5 cm

200 / 20

Print Code: E(1)



03

05

19

01



05



03



19



01



Rany

3149

Keyring Raincoat. LDPE. One Size. Kids. 88 x 63 cm.
Schlüsselanhänger Poncho. LDPE. Einheitsgröße. Kinder. 88 x 63 cm.
Porte-Clés Poncho. LDPE. Taille Unique. Enfant. 88 x 63 cm.
Sleutelhanger Regenjas. LDPE. Eén Maat. Kind. 88 x 63 cm.

📏 Ø 6.4 cm 📦 200 / 25

🌈 Print Code: D(4)

KIDS RAIN PROTECTION



Ø 71 cm

Espinete

8754

Umbrella. Automatic.
Regenschirm. Automatisch.
Parapluie. Automatique.
Paraplu. Automatisch.

📏 Ø 71 cm 📦 60 / 12

🌈 Print Code: G(1), N(8)



03

Teo

3221

Raincoat. PVC. One Size. Kids. 90 x 64 cm.
Poncho. PVC. Einheitsgröße. Kinder. 90 x 64 cm.
Poncho. PVC. Taille Unique. Enfant. 90 x 64 cm.
Kinder-Regenjas. PVC. Eén Maat. Kind. 90 x 64 cm.

📏 18 x 15 cm 📦 100 / 25

🌈 Print Code: F(1), H(1)



19



05





KIDS COLD



05



02

19

04

03

07

11



01



Ideal
Sublimation

SPECIAL WHITE COLOUR FOR SUBLIMATION
COLOR BLANCO VALIDO PARA SUBLIMACIÓN

Holiam

Neck Warmer. Polyester.
Schlauchschal. Polyester.
Tour de Cou. Polyester.
Colsjaal. Polyester.

5506

21 x 40 cm 500 / 100

Print Code: F(1), N(8), R

1137



21

04

19

22

05



03

Anut

3721

Scarf. Polar Fleece 180 g/ m2.
Schal. Polar Fleece 180 g/ m2.
Écharpe. Polaire 180 g/ m2.
Sjaal. Polar Fleece 180 g/ m2.

91 x 12 cm 400 / 10

Print Code: N(8), O, P



19

Siku

3720

Mitten. Polar Fleece 180 g/ m2. One Size. Kids.
Handschuh. Polar Fleece 180 g/ m2. Einheitsgröße. Kinder.
Gant. Polaire 180 g/ m2. Taille Unique. Enfant.
Wanten. Polar Fleece 180 g/ m2. Een Maat. Kind.

8 x 12 cm 400 / 10

Print Code: N(8), O

05



03



03

TWO TOUCH SCREEN FINGERTIPS
DOS DEDOS TÁCTILES

Pigun

5132

Touchscreen Gloves. Acrylic. One Size. Kids.
Touchpad Handschuhe. Acryl. Einheitsgröße. Kinder.
Gant Tactile. Acrylique. Taille Unique. Enfant.
Touchscreen Handschoenen. Acryl. Een Maat. Kind.

Consult. 500 / 10

Print Code: N(8)



05

19

04



Tactile



02



Articos

8016

Neck Warmer and Hat. Polar Fleece 200 g/ m2. Anti-Pilling.
Schlauchschal und Hut. Polar Fleece 200 g/ m2. Anti-Pilling.
Tour de Cou et Bonnet. Polaire 200 g/ m2. Anti-Pilling.
Colsjaal en Muts. Polar Fleece 200 g/ m2. Anti-Pilling.

24.5 × 25.5 cm

100 / 10

Print Code: F(1), N(8), O, P



03



Nostal

4608

Neck Warmer. Polar Fleece 200 g/ m2. Anti-Pilling.
Schlauchschal. Polar Fleece 200 g/ m2. Anti-Pilling.
Tour de Cou. Polaire 200 g/ m2. Anti-Pilling.
Colsjaal. Polar Fleece 200 g/ m2. Anti-Pilling.

24.5 × 25.5 cm

100 / 10

Print Code: F(1), N(8), O, P



1138



08

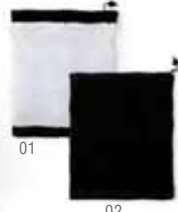

Arick

7053

Neck Warmer. Polyester/ Polar Fleece 200 g/ m2. Anti-Pilling.
Schlauchschal. Polyester/ Polar Fleece 200 g/ m2. Anti-Pilling.
Tour de Cou. Polyester/ Polaire 200 g/ m2. Anti-Pilling.
Colsjaal. Polyester/ Polar Fleece 200 g/ m2. Anti-Pilling.

25 × 29 cm 200 / 10

Print Code: F(1), N(8), O, P



02

Ponkar

5913

Neck Warmer and Hat. Outside: Polyester/ Spandex. Inside: Coral Fleece. 280 g/ m2.
Schlauchschal und Hut. Äußere: Polyester/ Spandex. Innen: Coral Fleece. 280 g/ m2.
Tour de Cou et Bonnet. Extérieur: Polyester/ Spandex. Intérieur: Coral Fleece. 280 g/ m2.
Colsjaal en Muts. Buitenzijde: Polyester/ Spandex. Binnenzijde: Coral Fleece. 280 g/ m2.

25 × 28 cm

100 / 10

Print Code: F(1), N(8), O, P, R

CORAL FLEECE
INSIDE



NECK WARMER TBS & TBP



01

SPECIAL WHITE COLOUR
FOR SUBLIMATION/
COLOR BLANCO IDEAL PARA
SUBLIMACIÓN



02

Cherin 4215

Neck Warmer. Polyester.
Schlauchschal. Polyester.
Tour de Cou. Polyester.
Colsjaal. Polyester.

25 x 50 cm 300 / 100

Print Code: F(1), N(8), R



1139



POLAR FLEECE



POLYESTER

BLA/GRI

FLUORESCENT



05F

Meifar

5130

Neck Warmer. Polyester/ Polar Fleece.
Schlauchschal. Polyester/ Polar Fleece.
Tour de Cou. Polyester/ Polaire.
Colsjaal. Polyester/ Polar Fleece.

25 x 65 cm 200 / 10

Print Code: F(1), N(8), O, P, R



04

03

11



02

19

06

Becks

4559

Neck Warmer. Polyester.
Schlauchschal. Polyester.
Tour de Cou. Polyester.
Colsjaal. Polyester.

25 x 50 cm 300 / 100

Print Code: F(1), N(8)





Antibacterial material specially processed to inhibit and prevent bacterial growth, due to the incorporation of permanent static microbial agents, which are highly effective in the control against bacterial contamination.

Material antibacteriano, especialmente procesado para inhibir y prevenir las cargas bacterianas, gracias a la incorporación de agentes microbianos permanentes estáticos, con alta efectividad contra la contaminación bacteriana.

ANTIBACTERIAL items



1140



THREE TOUCH
SCREEN FINGERTIPS
TRES DEDOS TÁCTILES

NEW



Tenex
6703

Antibacterial Touchscreen Gloves. Acrylic. One Size. Adult.
Antibakteriell Touchpad Handschuhe. Acryl. Einheitsgröße. Erwachsene.
Gant Tactile Antibactérien. Acrylique. Taille Unique. Adulte.
Antibacterieel Touchscreen Handschoenen. Acryl. Eén Maat. Volwassen.

Consult.

200 / 10

Print Code: N(8)



NEW

Nical
2599

Antibacterial Neck Warmer. Polyester.
Antibakteriell Schlauchschal. Polyester.
Tour de Cou Antibactérien. Polyester.
Antibacterieel Colsjaal. Polyester.

26 x 48 cm

300 / 10

Print Code: F(1), N(8), R



ANTIBACTERIAL AND WATER
RESISTANT FABRIC
TEJIDO ANTIBACTERIANO
E HIDRÓFUGO



NEW



06

Hetul

6854

Hat. Polyester RPET.
Hut. Polyester RPET.
Bonnet. Polyester RPET.
Muts. Polyester RPET.

Consult.

250 / 25

Print Code: N(8), O, P

08



02

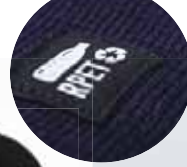

RPET

STOP PLASTIC POLLUTING THE OCEAN



1141

NEW



08

Despil

6855

Touchscreen Gloves. Polyester RPET. One Size. Adult.
Touchpad Handschuhe. Polyester RPET. Einheitsgröße. Erwachsene.
Gant Tactile. Polyester RPET. Taille Unique. Adulte.
Touchscreen Handschoenen. Polyester RPET. Eén Maat. Volwassen.

Consult.

200 / 10

Print Code: N(8)

THREE TOUCH SCREEN FINGERTIPS



Tactile



RPET



06



02

Suanix

6856

Neck Warmer. Polyester RPET.
Nacken Warmer. Polyester RPET.
Tour de Cou. Polyester RPET.
Colsjaal. Polyester RPET.

25 x 50 cm

Print Code: F(1), N(8)



RPET



06



08



02



08



03 19 02 06

Baikof
5592

Hat. Acrylic.
Hut. Acryl.
Bonnet. Acryllique.
Muts. Acryl.

Consult.

Print Code: N(8), O, P

100 / 10

WINTER UNISEX HAT



POLYESTER / SPANDEX OTUSIDE



08 CORAL FLEECE INSIDE

Folten
5914

IDEAL FABRIC FOR PRINTING/
TEJIDO IDEAL PARA IMPRESIÓN

Hat. Outside: Polyester/ Spandex. Inside: Coral Fleece. 280 g/ m2.
Hut. Außere: Polyester/ Spandex. Innen: Coral Fleece. 280 g/ m2.
Bonnet. Extérieur: Polyester/ Spandex. Intérieur: Coral Fleece. 280 g/ m2.
Muts. Buitenzijde: Polyester/ Spandex. Binnenzijde: Coral Fleece. 280 g/ m2.

Consult.

100 / 10

Print Code: F(1), N(8), O, P, R



01

SPECIAL WHITE COLOUR
FOR SUBLIMATION
COLOR BLANCO IDEAL
PARA SUBLIMACION



02

06

POLYESTER / SPANDEX OUTSIDE



08

Ponkar
5913

Neck Warmer and Hat. Outside: Polyester/ Spandex.
Inside: Coral Fleece. 280 g/ m2.

Schlauchschal und Hut. Außere: Polyester/ Spandex.
Innen: Coral Fleece. 280 g/ m2.

Tour de Cou et Bonnet. Extérieur: Polyester/ Spandex.
Intérieur: Coral Fleece. 280 g/ m2.

Colsjaal en Muts. Buitenzijde: Polyester/ Spandex.
Binnenzijde: Coral Fleece. 280 g/ m2.

25 x 28 cm

100 / 10

Print Code: F(1), N(8), O, P, R

CORAL FLEECE
INSIDE



WINTER unisex HAT



19

Jive
9781

Hat. Acrylic.
Hut. Acryl.
Bonnet. Acrylique.
Muts. Acryl.

Consult. 250 / 10

Print Code: N(8), O, P

01

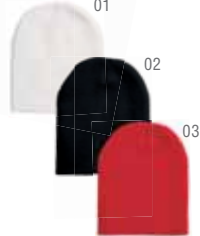

02

03

1143



02



19

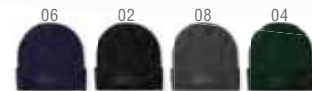

06

02

08

04



03



11



01

IDEAL FOR
PRINTING

Holsen
5817

Hat. Acrylic.
Hut. Acryl.
Bonnet. Acrylique.
Muts. Acryl.

Consult. 200 / 10

Print Code: E(1), N(8)

200 / 10

Lana
8017

Hat. Acrylic.
Hut. Acryl.
Bonnet. Acrylique.
Muts. Acryl.

Consult. 250 / 25

Print Code: N(8), O, P



06

19

04



03



05



Reflective



ULTRA
REFLECTIVE
EXTRA
REFLECTANTE

Terban
6440

Hat. Outside: Acrylic. Inside: Polar Fleece. Reflective.
Hut. Äußere: Acryl. Innen: Polar Fleece. Reflektierender.
Bonnet. Extérieur: Acrylique. Intérieur: Polaire. Réflécteur.
Muts. Buitenzijde: Acryl. Binnenzijde: Polar Fleece. Reflecterende.

Consult.

100 / 10

Print Code: N(8), O, P

WINTER unisex HAT

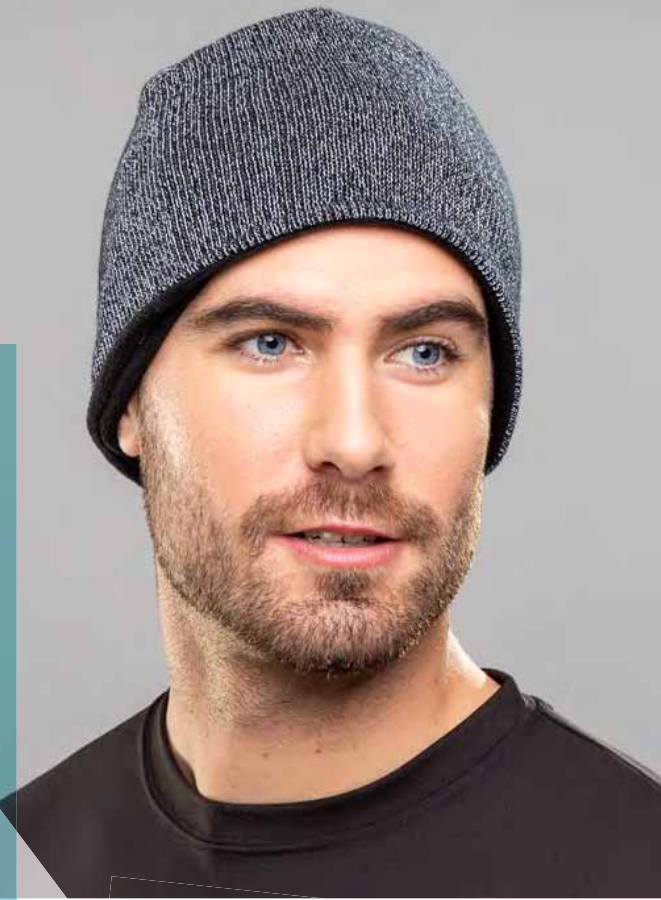

1144



08



Light



Blink



02



Koppy
6558

Hat. Acrylic. 4 Leds. 4 Light Modes. USB Rechargeable.
Hut. Acryl. 4 Leds. 4 Leuchtfunktionen. USB Wiederaufladbar.
Bonnet. Acrylique. 4 Leds. 4 Modes de Lumière. Rechargeable USB.
Muts. Acryl. 4 Leds. 4 Licht Posities. USB Oplaadbaar.

Consult.

100 / 50

Print Code: N(8)

Bluetooth®



Seyer
5364

Hat. Polyester. Bluetooth Connection. USB Rechargeable. Cable Included.
Hut. Polyester. Bluetooth Anschluss. USB Wiederaufladbar. Kabel Inklusiv.
Bonnet. Polyester. Connexion Bluetooth. Rechargeable USB. Câble Inclus.
Muts. Polyester. Bluetooth Verbinding. USB Oplaadbaar. Kabel Inclusief.

Consult.

100 / 50

Print Code: N(8), O, P



Bluetooth



Hands-free

TOUCH SCREEN GLOVES

THREE TOUCH SCREEN FINGERTIPS
TRES DEDOS TÁCTILES



Tactile

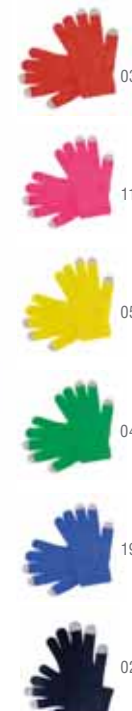

Actium
4010

Touchscreen Gloves. Acrylic. One Size. Adult.
Touchpad Handschuhe. Acryl. Einheitsgröße. Erwachsene.
Gant Tactile. Acrylique. Taille Unique. Adulte.
Touchscreen Handschoenen. Acryl. Eén Maat. Volwassen.

Consult. 200 / 10

Print Code: N(8)

1145

ALL TOUCH SCREEN FINGERTIPS
TODOS LOS DEDOS TÁCTILES



Tactile



02



08

Tellar
5131

Touchscreen Gloves. Acrylic. One Size. Adult.
Touchpad Handschuhe. Acryl. Einheitsgröße. Erwachsene.
Gant Tactile. Acrylique. Taille Unique. Adulte.
Touchscreen Handschoenen. Acryl. Eén Maat. Volwassen.

Consult. 200 / 10

Print Code: N(8)

TWO TOUCH SCREEN FINGERTIPS
DOS DEDOS TÁCTILES
IDEAL FOR SPORT
IDEAL PARA DEPORTE



08



Tactile



Anti Slip

ANTI SLIP



03

19

Vanzox
5917

Touchscreen Sport Gloves. Polyester/ Lycra. One Size. Adult.
Touchpad Sport Handschuhe. Polyester/ Lycra. Einheitsgröße. Erwachsene.
Gant Sportif Tactile. Polyester/ Lycra. Taille Unique. Adulte.
Touchscreen Sport Handschoenen. Polyester/ Lycra. Eén Maat. Volwassen.

Consult. 200 / 10

Print Code: E(1), N(8)



POLAR FLEECE



02

NYLON



REVERSIBLE
POLAR FLEECE



06

19

03

20

Nesy
9066

Reversible Hat. Outside: Nylon. Inside: Polar Fleece. Anti-Pilling.
Wendehut. Äußere: Nylon. Innen: Polar Fleece. Anti-Pilling.
Bonnet Réversible. Extérieur: Nylon. Intérieur: Polaire. Anti-Pilling.
Omkeerbare Muts. Buitenzijde: Nylon. Binnenzijde: Polar Fleece. Anti-Pilling.

Consult. 200 / 50

Print Code: F(1), N(8), O



03

2 PIECES + BAG



19



02

Duvel
5133

Set. Polyester/ Acrylic. 2 Pieces. One Size. Adult.
Set. Polyester/ Acryl. 2 Stück. Einheitsgröße. Erwachsene.
Set. Polyester/ Acrylique. 2 Pièces. Taille Unique. Adulte.
Set. Polyester/ Acryl. 2 Stuks. Eén Maat. Volwassen.

18 × 25 × 1.8 cm 100 / 50

Print Code: N(8), O, P

1146



02

Katoy
9348

Earmuffs. Polar Fleece.
Ohrwärmer. Polar Fleece.
Oreillette. Polaire.
Oorwarmers. Polar Fleece.

Ø 11 cm 300 / 10

Print Code: N(8), O



03



07



19



02

Polar
8012

Scarf. Polar Fleece 200 g/ m2. Anti-Pilling.
Schal. Polar Fleece 200 g/ m2. Anti-Pilling.
Echarpe. Polaire 200 g/ m2. Anti-Pilling.
Sjaal. Polar Fleece 200 g/ m2. Anti-Pilling.

160 × 29 cm 100 / 20

Print Code: N(8), O, P



06



13



03

WINTER unisex accessories



Alexluca
Italy

Boccaccio

9802

Hat. Polyester.
Hut. Polyester.
Chapeau. Polyester.
Hoed. Polyester.

📏 56-58 📦 60 / 30

🌈 Print Code: Consultar

1147



19



02

01

04



17

03

11

22

13

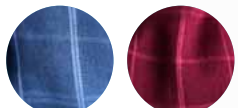

06

20

Mirtox

4830

Scarf. Cotton/ Polyester.
Schal. Baumwolle/ Polyester.
Foulard. Coton/ Polyester.
Sjaal. Katoen/ Polyester.

📏 180 × 50 cm 📦 200 / 10

🌈 Print Code: F(1), N(8)

08

Ribban

5916

Foulard. Viscose.
Foulard. Viskose.
Foulard. Viscose.
Sjaaltje. Viscose.

📏 180 × 70 cm 📦 100 / 10

🌈 Print Code: F(1), N(8)



08



120 x 150 cm
200 g/m²

Kayla

6748

Blanket. Polyester RPET 200 g/ m2.
Decke. Polyester RPET 200 g/ m2.
Couverture. Polyester RPET 200 g/ m2.
Deken. Polyester RPET 200 g/ m2.

120 x 150 cm

Print Code: F(1), G(1), N(8), O, P



20



13

06

02

NEW



HOME
sweet home



08

120 x 150 cm
180 g/m²

Menex

4358

Blanket. Polar Fleece 180 g/ m2. Anti-Pilling.
Decke. Polar Fleece 180 g/ m2. Anti-Pilling.
Couverture. Polaire 180 g/ m2. Anti-Pilling.
Deken. Polar Fleece 180 g/ m2. Anti-Pilling.

120 x 150 cm



20

Print Code: N(8), O, P



02

06

04

07

03

HOME
sweet home



130 x 160 cm
200 g/m²



Mountain 9248

Blanket. Polar Fleece 200 g/ m2. Anti-Pilling.
Decke. Polar Fleece 200 g/ m2. Anti-Pilling.
Couverture. Polaire 200 g/ m2. Anti-Pilling.
Deken. Polar Fleece 200 g/ m2. Anti-Pilling.

130 x 160 cm

Print Code: F(1), N(8), O, P

25

1149



120 x 150 cm
180 g/m²



Thiago 5213

Blanket. Polar Fleece 180 g/ m2.
Decke. Polar Fleece 180 g/ m2.
Couverture. Polaire 180 g/ m2.
Deken. Polar Fleece 180 g/ m2.

120 x 150 cm

Print Code: F(1), G(1), N(8), O, P

20

85 × 115 cm
180 g/m²



IDEAL SIZE FOR TRAVEL /
TAMAÑO IDEAL PARA VIAJE



Elowin

5744

Blanket. Polar Fleece 180 g/ m2. Anti-Pilling.
Decke. Polar Fleece 180 g/ m2. Anti-Pilling.
Couverture. Polaire 180 g/ m2. Anti-Pilling.
Deken. Polar Fleece 180 g/ m2. Anti-Pilling.

85 × 115 cm

20

Print Code: N(8), O, P



02 08 06 19 04 03

1150

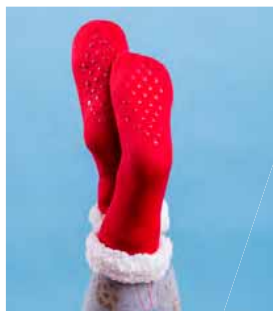

Molbik

5507

Sock. Polyester. One Size 36-43. Anti-Slip.
Socken. Polyester. Einheitsgröße 36-43. Rutschfest.
Chaussette. Polyester. Taille Unique 36-43. Antiderapante.
Sok. Polyester. Een Maat 36-43. Anti-Slip.

Consult.

100 / 10

Print Code: N(8)



02

ANTI SLIP /
ANTIDESLIZANTE



Anti Slip



03

19

11



130 × 160 cm
260 g/m²

Bifrost

3881

Blanket. Polar Fleece 260 g/ m2. Anti-Pilling.
Decke. Polar Fleece 260 g/ m2. Anti-Pilling.
Couverture. Polaire 260 g/ m2. Anti-Pilling.
Deken. Polar Fleece 260 g/ m2. Anti-Pilling.

130 × 160 cm

20

Print Code: F(1), N(8), O, P



03

13

06



130 x 160 cm
240 g/m²

Konjor 4359

Blanket. Microfibre 240 g/ m2.
Decke. Mikrofaser 240 g/ m2.
Couverture. Microfibre 240 g/ m2.
Deken. Microfiber 240 g/ m2.

130 x 160 cm 📦 20

Print Code: F(1), N(8), O, P



19

03
02
01

1151



120 x 160 cm
280 g/m²

03

Yelix

5217

Blanket. Polar Fleece 280 g/ m2.
Decke. Polar Fleece 280 g/ m2.
Couverture. Polaire 280 g/ m2.
Deken. Polar Fleece 280 g/ m2.

120 x 160 cm

Print Code: N(8), O, P



13

06

📦 20



CORAL FLEECE &
SHERPA

08

Lerten

6045

Blanket. Coral Fleece/ Sherpa 380 g/ m2.
Decke. Coral Fleece/ Sherpa 380 g/ m2.
Couverture. Coral Fleece/ Sherpa 380 g/ m2.
Deken. Coral Fleece/ Sherpa 380 g/ m2.

125 x 160 cm
380 g/m²

125 x 160 cm

Print Code: F(1), N(8), O, P

📦 10



06

TOOLS

BRICCO

&

CARE



NEW

Behox 6806

Weather Station. Bamboo. 2 Batteries AAA Not Included.
Wetterstation. Bambus. 2 AAA Batterien Nicht im Lieferumfang.
Station Météo. Bambou. 2 Piles AAA Non Inclus.
Weerstation. Bamboe. 2 Batterijen AAA Niet Inclusief.

13 × 13 × 2.4 cm

50 / 25

Print Code: F(4), L2, W



Temperature



Alarm



Time & Date



Humidity



NEW

Titan

6803

Multifunction Pocket Knife. Bamboo/ Stainless Steel. 9 Functions.
Multifunktionstaschenmesser. Bambus/ Rostfreier Stahl. 9 Funktionen.
Canif Multi-Usages. Bambou/ Acier Inox. 9 Fonctions.
Multifunctioneel Zakmes. Bamboe/ Roestvrij Staal. 9 Functies.

9.4 x 2.5 x 1.4 cm

100 / 10

Print Code: E(4), L1

LOVE BAMBOO



NEW

Folnax

6805

Multitool. Bamboo/ Stainless Steel. 12 Functions.
Multiwerkzeug. Bambus/ Rostfreier Stahl. 12 Funktionen.
Multi Outils. Bambou/ Acier Inox. 12 Fonctions.
Multitool. Bamboe/ Roestvrij Staal. 12 Functies.

5 x 10.5 x 1.7 cm

100 / 10

Print Code: E(4), L1



NEW

Sultan

6804

Pocket Knife. Bamboo/ Stainless Steel. Safety Lock Included.
Taschenmesser. Bambus/ Rostfreier Stahl. Sicherheitsverschluss.
Canif. Bambou/ Acier Inox. Avec Cran d'Arrêt.
Zakmes. Bamboe/ Roestvrij Staal. Met Veiligheidsblokkade.

9.8 x 2.5 x 1.4 cm

120 / 12

Print Code: E(4), L1



Blizen 4305

Multitool. Aluminium. 6 Accessories.
 Multiwerkzeug. Aluminium. 6 Teile.
 Multi Outils. Aluminium. 6 Accessoires.
 Multitool. Aluminium. 6 Accessoires.

📏 Ø 1.3 × 11 cm 📦 200 / 50
 🌈 Print Code: D(1), L1

TOOL SET

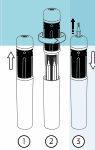

1154



Congus 5675



Tool Set. 19 Accessories.
 Werkzeug Set. 19 Teile.
 Set Outils. 19 Accessoires.
 Gereedschaps Set. 19 Accessoires.

📏 15 × 9 × 2 cm 📦 40
 🌈 Print Code: F(1)



Nespum 5678

Multitool. 6 Accessories.
 Multiwerkzeug. 6 Teile.
 Multi Outils. 6 Accessoires.
 Multitool. 6 Accessoires.

📏 2.1 × 10.2 × 1.7 cm 📦 200 / 50
 🌈 Print Code: D(4)



6 ACCESSORIES



3 ACCESSORIES

Block 9729



Multitool. 1 Led. 3 Accessories. Button Batteries Included.
 Multiwerkzeug. 1 Led. 3 Teile. Knopfzellen Inklusiv.
 Multi Outils. 1 Led. 3 Accessoires. Piles Bouton Inclus.
 Multitool. 1 Led. 3 Accessoires. Knoopcelbatterij Inclusief.

📏 14 × 2 × 2.6 cm 📦 200 / 50
 🌈 Print Code: D(4)





TOOL SET



15 ACCESSORIES



Bregox 4511

Tool Set. 15 Accessories.
 Werkzeug Set. 15 Teile.
 Set Outils. 15 Accessoires.
 Gereedschaps Set. 15 Accessoires.

11 x 15.5 x 3.5 cm 40
 Print Code: E(1)



Light



24 ACCESSORIES

Vizcaya 8534

Tool Set. 1 Led. 24 Accessories. 4 Batteries AA Not Included.
 Werkzeug Set. 1 Led. 24 Teile. 4 AA Batterien Nicht im Lieferumfang.
 Set Outils. 1 Led. 24 Accessoires. 4 Piles AA Non Inclus.
 Gereedschaps Set. 1 Led. 24 Accessoires. 4 Batterijen AA Niet Inclusief.

19 x 9.5 x 12.5 cm 20
 Print Code: F(2)



Mostik 5677

Tool Set. 4 Leds. 21 Accessories. Button Batteries Included.
 Werkzeug Set. 4 Leds. 21 Teile. Knopfzellen Inklusive.
 Set Outils. 4 Leds. 21 Accessoires. Piles Bouton Inclus.
 Gereedschaps Set. 4 Leds. 21 Accessoires. Knoopcel Batterijen Inclusief.

20 x 12 x 4.6 cm 20
 Print Code: F(2)



Light



21 ACCESSORIES



20 ACCESSORIES



Wheels 5676

Tool Set. 20 Accessories.
 Werkzeug Set. 20 Teile.
 Set Outils. 20 Accessoires.
 Gereedschaps Set. 20 Accessoires.

12.9 x 4.9 cm 30
 Print Code: F(2)

3M



Lukom 3m

5544

Tape Measure. Clip Included.
Maßband. Gürtelclip Inklusiv.
Mètre Grade. Clip Inclus.
Meetlint. Clip Inclusief.

6.1 × 6 × 3.7 cm  100 / 10

 Print Code: E(4)

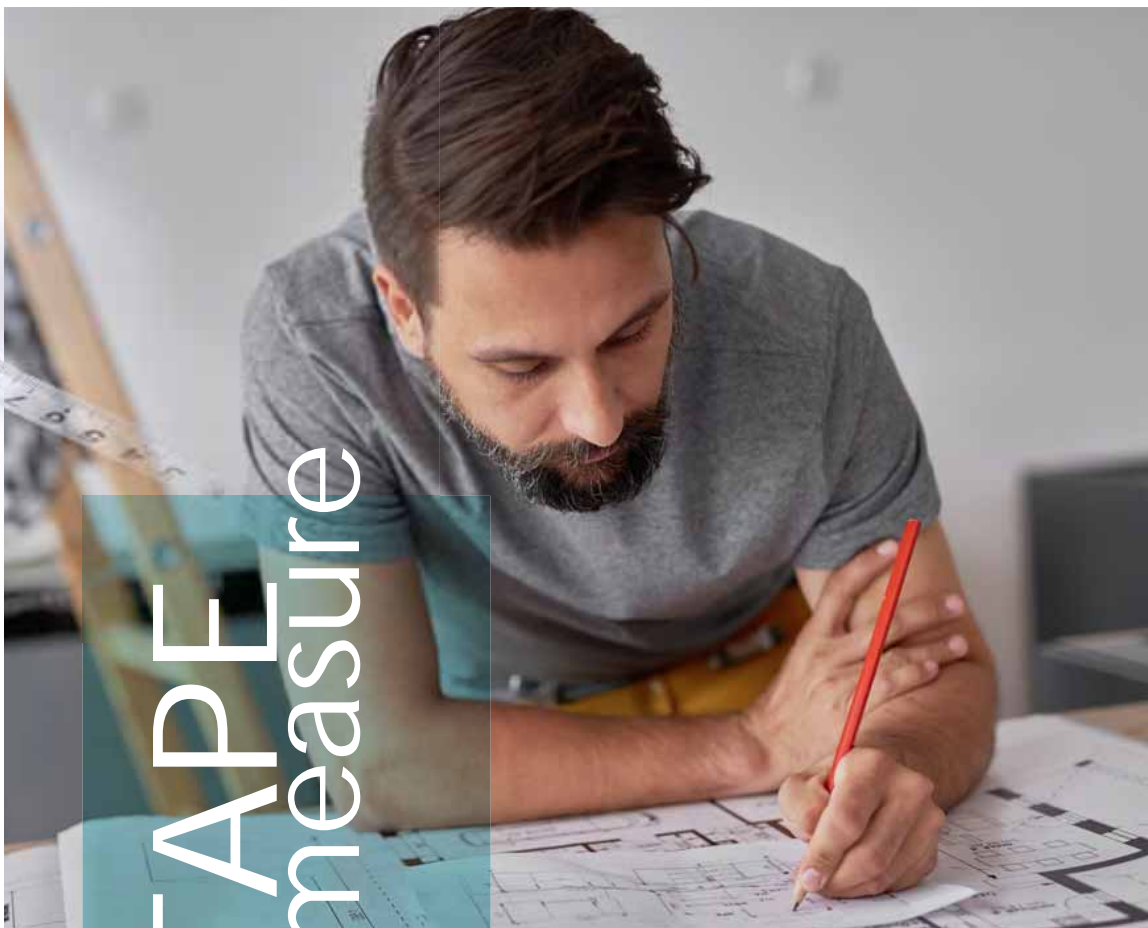

TAPE
measure

1156

Lukom 5m

5545

Tape Measure. Clip Included.
Maßband. Gürtelclip Inklusiv.
Mètre Grade. Clip Inclus.
Meetlint. Clip Inclusief.

6.8 × 6.7 × 4.2 cm  100 / 10

 Print Code: E(4)



5M

Lukom 7,5m

5546

Tape Measure. Clip Included.
Maßband. Gürtelclip Inklusiv.
Mètre Grade. Clip Inclus.
Meetlint. Clip Inclusief.

7.7 × 7.6 × 5 cm  50

 Print Code: E(4)



7.5M



TAPF measure



3M

05

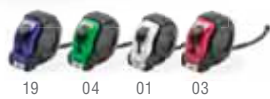

19 04 01 03

Grade 3m

3020

Tape Measure. Clip Included.
Maßband. Gürtelclip Inklusiv.
Metre Grade. Clip Inclus.
Meetlint. Clip Inclusief.

6 x 6 x 3 cm 120 / 12

Print Code: E(1), V

1157



01 19 05

Grade 5m

4643

Tape Measure. Clip Included.
Maßband. Gürtelclip Inklusiv.
Metre Grade. Clip Inclus.
Meetlint. Clip Inclusief.

7 x 7 x 3.5 cm 50 / 10

Print Code: E(1), V



1M

19



03 04 02

Harrol 1m

5547

Tape Measure.
Maßband.
Metre Grade.
Meetlint.

4.3 x 4.1 x 1.5 cm 500 / 50

Print Code: D(1), V

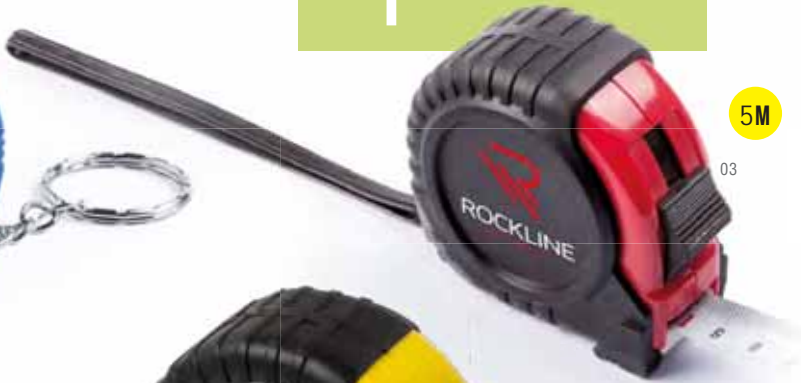

5M

03



7.5M

05

Grade 7,5m

6411

Tape Measure. Clip Included.
Maßband. Gürtelclip Inklusiv.
Metre Grade. Clip Inclus.
Meetlint. Clip Inclusief.

8.5 x 8.5 x 4.5 cm 40 / 10

Print Code: E(1), V



03 01 19



Unsharpened

19 02 05 04

Carpintero

8876

Pencil. Wood.
Bleistift. Holz.
Crayon. Bois.
Potlood. Hout.

Ø 1.2 × 17.6 cm 1000 / 100

Print Code: A(4), L1

03



special brico PEN & PENCIL

1158

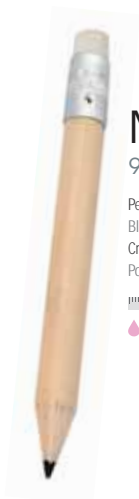

Miniature

9607

Pencil. Wood.
Bleistift. Holz.
Crayon. Bois.
Potlood. Hout.



Sharpened

Ø 0.5 × 10 cm 2000 / 100

Print Code: A(4), L1



03



09 01 02

Sauris

4402

Pen. 4 Accessories.
Kugelschreiber. 4 Teile.
Stylo. 4 Accessoires.
Pen. 4 Accessoires.

Ø 1 × 14.9 cm 1000 / 50

Print Code: B(4)

19



Contal

5119

Pen.
Kugelschreiber.
Stylo.
Pen.

Ø 1.1 × 14.8 cm 1000 / 50

Print Code: B(4)



19



7in1
Multifunction



09 04 02 03

Payro

5791

7 in 1 Pen. 7 Accessories.
7 in 1 Kugelschreiber. 7 Teile.
Stylo 7 en 1. 7 Accessoires.
7 in 1 Pen. 7 Accessoires.

1.6 × 15.5 × 1.2 cm 500 / 50

Print Code: B(4)



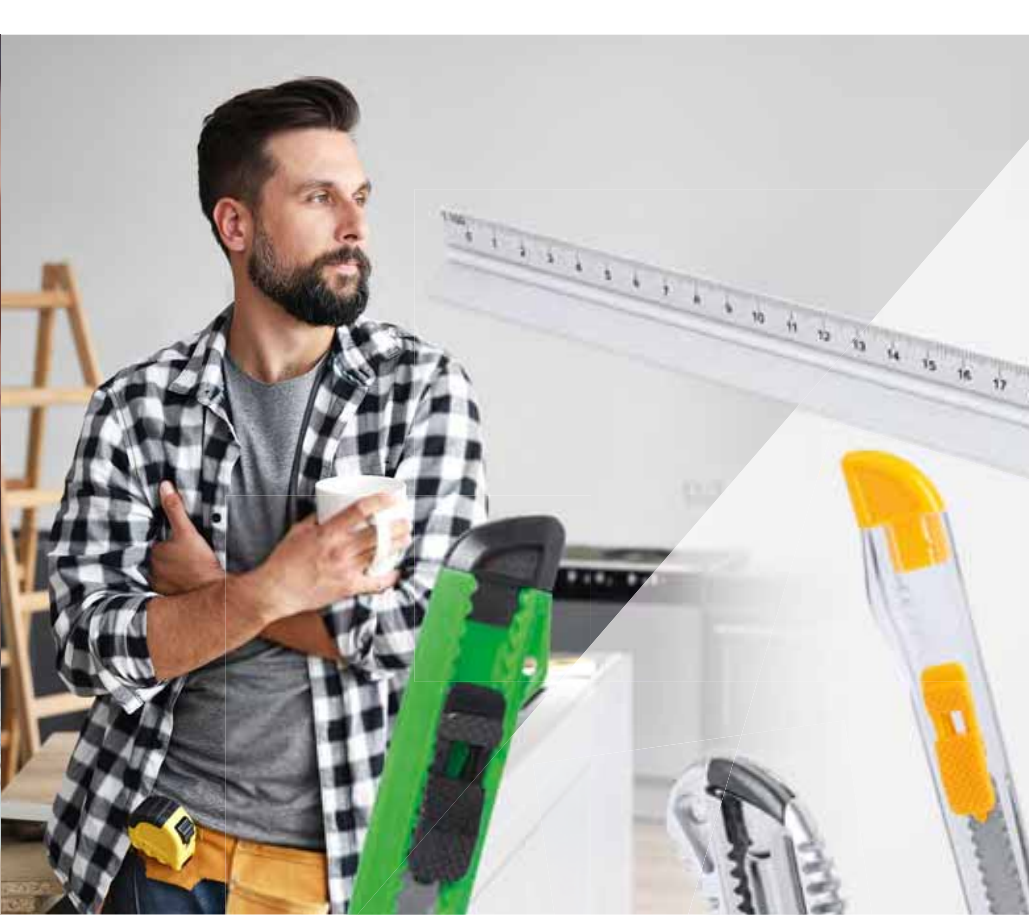

Thirty

9774

Scalimeter. Aluminium. 30 cm. Scales: 1:20, 1:25, 1:50, 1:75, 1:100.

Maßstab. Aluminium. 30 cm. Skala: 1:20, 1:25, 1:50, 1:75, 1:100.

Règle. Aluminium. 30 cm. Echelle: 1:20, 1:25, 1:50, 1:75, 1:100.

Lineaal. Aluminium. 30 cm. Schaal: 1:20, 1:25, 1:50, 1:75, 1:100.

32 x 2 x 2 cm 200 / 20

Print Code: F(4), L1



ALUMINIUM



Mars

9510

Cutter.

Cutter.

Cutter.

Cutter.



19

02

03

2 x 13.5 x 0.8 cm 1000 / 50

Print Code: C(4)



04



05



Koltom

5548

Cutter.

Cutter.

Cutter.

Cutter.



03

05

01

19

3 x 15.5 x 1.4 cm 500 / 100

Print Code: C(4)

Gruesly

5549

Cutter. Aluminium/ Stainless Steel.

Cutter. Aluminium/ Rostfreier Stahl.

Cutter. Aluminium/ Acier Inox.

Cutter. Aluminium/ Roestvrij Staal.

4 x 15.5 x 2.2 cm 100 / 25

Print Code: C(1)

Fainel

5550

Cutter. Stainless Steel.

Cutter. Rostfreier Stahl.

Cutter. Acier Inox.

Cutter. Roestvrij Staal.

1.2 x 12.7 x 1.1 cm 800 / 100

Print Code: L1



05

REFLECTIVE BAND



5 Panels



07



03



19

Tarea

3120

Cap. 100% Cotton. 5 Panels. Reflective.
Mütze. 100% Baumwolle. 5 Panels. Reflektierend.
Casquette. 100% Coton. 5 Panneaux. Réfléchissant.
Pet. 100% Katoen. 5 Panelen. Reflectorend.

Consult.

300 / 30

Print Code: E(1), N(8), O, P

BRICO accessories



03



04

05

11

19

Panoss

4677

Earplugs. EVA.
Ohrstöpsel. EVA.
Bouchons Antibruit. EVA.
Oordopjes. EVA.

Ø 2.2 x 6.4 cm 1000 / 200

Print Code: C(1)



08

Hetson

6500

Gloves. Nylon. One Size. Adult.
Handschuhe. Nylon. Einheitsgröße. Erwachsene.
Gant. Nylon. Taille Unique. Adulte.
Handschoenen. Nylon. Eén Maat. Volwassen.

Consult. 500 / 10

Print Code: N(8)



04



19



03



03

Enox

3758

Gloves. TC. 65% Cotton/ 35% Polyester. One Size. Adult.
Handschuhe. TC. 65% Baumwolle/ 35% Polyester. Einheitsgröße. Erwachsene.
Gant. TC. 65% Coton/ 35% Polyester. Taille Unique. Adulte.
Handschoenen. TC. 65% Katoen/ 35% Polyester. Eén Maat. Volwassen.

Consult. 200 / 10

Print Code: N(8)



07



19



04



Hezal 6636

Safety Glasses. PC.
Schutzbrille. PC.
Lunettes de Protection. PC.
Veiligheidsbril. PC.

15.5 × 5.7 × 15 cm
Print Code: D(4)



200 / 10



LIFT UP / ABATIBLE



Bison 6635

Safety Glasses. PC/PVC.
Schutzbrille. PC/PVC.
Lunettes de Protection. PC/PVC.
Veiligheidsbril. PC/PVC.

17 × 8 × 6 cm
Print Code: D(4)



200 / 10



Derol 2574

Face Shield. PET/PP. Adjustable and Lift Up.
Gesichtsmaske. PET/PP. Verstellbar und Falten.
Visière de Protection. PET/PP. Ajustable et Pilage.
Gezichtschermer. PET/PP. Aanpasbaar en Vouwen.

35 × 23.7 cm
Print Code: D(1)

COMFORTABLE
PADDING INSIDE
COMFORTABLE
ALMOHADILLA INTERIOR

75



03



03



Vilox 6246

Torch. 8 COB Lights. 3 Light Modes. 3 Batteries AAA Not Included.
Lampe. 8 COB Lichter. 3 Leuchtfunktionen. 3 AAA Batterien Nicht im Lieferumfang.
Lampe. 8 Lumières COB. 3 Modes de Lumière. 3 Piles AAA Non Inclus.
Zaklamp. 8 COB Lichten. 3 Licht Posities. 3 Batterijen AAA Niet Inclusief.

6.1 × 4 × 1.7 cm
Print Code: E(1)



19

02

01

04



Lokys 5148

Torch. Aluminium. 5 Leds. 3 Light Modes. 3 Batteries AAA Not Included.
Lampe. Aluminium. 5 Leds. 3 Leuchtfunktionen. 3 AAA Batterien Nicht im Lieferumfang.
Lampe. Aluminium. 5 Leds. 3 Modes de Lumière. 3 Piles AAA Non Inclus.
Zaklamp. Aluminium. 5 Leds. 3 Licht Posities. 3 Batterijen AAA Niet Inclusief.

6 × 4.5 × 3.8 cm
Print Code: F(1)



09

19



19

MAGNET



Biddick

5625



Torch. Aluminium. 6 COB Lights. Magnetic. Button Batteries Included.
 Lampe. Aluminium. 6 COB Lichter. Magnetisch. Knopfzellen Inklusive.
 Lampe. Aluminium. 6 Lumières COB. Magnétique. Piles Bouton Inclus.
 Zaklamp. Aluminium. 6 COB Lichten. Magnetisch. Knoopcel Batterijen Inclusief.

██████████ Ø 1.6 × 13 cm ██████████ 200 / 50

🌈 Print Code: D(4), L1

SPECIAL TORCH



1162



19

MAGNET



Nadiak

5679

Torch. 6 COB Lights. Magnetic. 3 Light Modes. Button Batteries Included.
 Lampe. 6 COB Lichter. Magnetisch. 3 Leuchtfunktionen. Knopfzellen Inklusive.
 Lampe. 6 Lumières COB. Magnétique. 3 Modes de Lumière. Piles Bouton Inclus.
 Zaklamp. 6 COB Lichten. Magnetisch. 3 Licht Posities. Knoopcel Batterijen Inclusief.

██████████ 3.3 × 7 × 2.1 cm ██████████ 500 / 100

🌈 Print Code: D(1)



02

19



03

08

Koren

9264

Torch. 2 Leds. Hand Charge.
 Lampe. 2 Leds. Dynamo.
 Lampe. 2 Leds. Chargement Manuel.
 Zaklamp. 2 Leds. Hand oplaadbaar Zaklantaarn.

██████████ 10 × 5.5 × 2.9 cm ██████████ 200 / 20

🌈 Print Code: D(4)



03

Triled

3255

Torch. 3 Leds. Hand Charge.
 Lampe. 3 Leds. Dynamo.
 Lampe. 3 Leds. Chargement Manuel.
 Zaklamp. 3 Leds. Hand Oplaadbaar Zaklantaarn.

██████████ 10.5 × 5 × 2.5 cm ██████████ 200 / 25

🌈 Print Code: D(4), V



TORCH aluminium



Conny
5331

Torch. Aluminium. 9 Leds. 3 Batteries AAA Not Included.
Lampe. Aluminium. 9 Leds. 3 AAA Batterien Nicht im Lieferumfang.
Lampe. Aluminium. 9 Leds. 3 Piles AAA Non Inclus.
Zaklamp. Aluminium. 9 Leds. 3 Batterijen AAA Niet Inclusief.

Ø 2.4 × 8.4 cm 200 / 50
Print Code: D(4), L1



Delbin
3737

Torch. Aluminium. 6 Leds. Button Batteries Included.
Lampe. Aluminium. 6 Leds. Knopfzellen Inklusive.
Lampe. Aluminium. 6 Leds. Piles Bouton Inclus.
Zaklamp. Aluminium. 6 Leds. Knopcelbatterij Inclusief.

Ø 2.5 × 5 cm 200 / 100
Print Code: D(4), L1



Zaro
4982

Torch. Aluminium. 3 Leds. Button Batteries Included.
Lampe. Aluminium. 3 Leds. Knopfzellen Inklusive.
Lampe. Aluminium. 3 Leds. Piles Bouton Inclus.
Zaklamp. Aluminium. 3 Leds. Knopcel Batterijen Inclusief.

Ø 1.7 × 7.1 cm 500 / 50
Print Code: D(4), L1

Zola
3406

Torch. Aluminium. 1 Led. Button Batteries Included.
Lampe. Aluminium. 1 Led. Knopfzellen Inklusive.
Lampe. Aluminium. 1 Led. Piles Bouton Inclus.
Zaklamp. Aluminium. 1 Led. Knopcel Batterijen Inclusief.

Ø 1.5 × 6 cm 600 / 100
Print Code: D(4), L1

Kinley
5992

Torch. Aluminium. 1 Led. Button Batteries Included.
Lampe. Aluminium. 1 Led. Knopfzellen Inklusive.
Lampe. Aluminium. 1 Led. Piles Bouton Inclus.
Zaklamp. Aluminium. 1 Led. Knopcelbatterij Inclusief.

Ø 1.3 × 5.5 cm 500 / 100
Print Code: D(4), L1



Fairox

5172

Torch. Aluminium. 1 Led. Button Batteries Included.
Lampe. Aluminium. 1 Led. Knopfzellen Inklusive.
Lampe. Aluminium. 1 Led. Piles Bouton Inclus.
Zaklamp. Aluminium. 1 Led. Knoopcel Batterijen Inclusief.

11111111 Ø 1.3 x 5.9 cm 200 / 50

Print Code: E(1), L1



19 02 09

Demil

6250

Lamp. 30 COB Lights. 3 Batteries AAA Not Included.
Lampe. 30 COB Lichter. 3 AAA Batterien Nicht im Lieferumfang.
Lampe. 30 Lumières COB. 3 Piles AAA Non Inclus.
Lamp. 30 COB Lichter. 3 Batterijen AAA Niet Inclusief.

11111111 Ø 6.9 x 13.9 cm 100 / 50

Print Code: F(1)



COB Led

TORCH & MULTITOOLS

1164



02



03

Sufli

3484

Set. Aluminium/ Stainless Steel. 1 Led. Pocket Knife 7 Functions. Button Batteries Included.
Set. Aluminium/ Rostfreier Stahl. 1 Led. Taschenmesser 7 Funktionen. Knopfzellen Inklusive.
Set. Aluminium/ Acier Inox. 1 Led. Canif 7 Fonctions. Piles Bouton Inclus.
Set. Aluminium/ Roestvrij Staal. 1 Led. Zakmes 7 Functies. Knoopcelbatterij Inclusief.

11111111 13.5 x 2.7 x 9 cm 100 / 10

Print Code: E(1), L1

19

Talos

3687

Multitool. 4 Leds. 12 Functions. 3 Batteries AAA Not Included.
Multiwerkzeug. 4 Leds. 12 Funktionen. 3 AAA Batterien Nicht im Lieferumfang.
Multi Outils. 4 Leds. 12 Fonctions. 3 Piles AAA Non Inclus.
Multitool. 4 Leds. 12 Functies. 3 Batterijen AAA Niet Inclusief.

11111111 Ø 4.5 x 14 cm 50 / 25

Print Code: E(1), L1

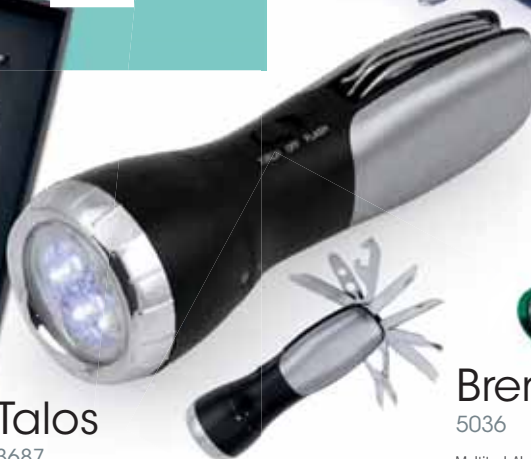

19

Brerax

5036

Multitool. Aluminium/ Stainless Steel. 1 Led. 9 Functions. 1 Battery AAA Not Included.

Multiwerkzeug. Aluminium/ Rostfreier Stahl. 1 Led. 9 Funktionen. 1 Batterie AAA Nicht im Lieferumfang.

Multi Outils. Aluminium/ Acier Inox. 1 Led. 9 Fonctions. 1 Pile AAA Non Inclus.

Multitool. Aluminium/ Roestvrij Staal. 1 Led. 9 Accessoires. 1 Batterij AAA Niet Inclusief.

11111111 Ø 3.2 x 12.5 cm 50 / 25

Print Code: E(1), L1



04

03

02

SWISSENT
ORIZONS[®]
adventure

1165



Yunaz

7338

Set. Aluminium/ Stainless Steel. 1 Led. 3 Light Modes. Pocket Knife 15 Functions. 3 Batteries AAA Not Included.

Set. Aluminium/ Rostfreier Stahl. 1 Led. 3 Leuchtfunktionen. Taschenmesser 15 Funktionen. 3 AAA Batterien Nicht im Lieferumfang.

Set. Aluminium/ Acier Inox. 1 Led. 3 Modes de Lumière. Canif 15 Fonctions. 3 Piles AAA Non Inclus.

Set. Aluminium/ Roesstrijf Staal. 1 Led. 3 Licht Posities. Zakmes 15 Functies. 3 Batterijen AAA Niet Inclusief.

15 x 4.7 x 9.7 cm 50 / 10

Print Code: F(4), L1



Norfolk

7288

Torch. Aluminium. 28 Leds. 3 Batteries AAA Not Included.

Lampe. Aluminium. 28 Leds. 3 AAA Batterien Nicht im Lieferumfang.

Lampe. Aluminium. 28 Leds. 3 Piles AAA Non Inclus.

Zaklamp. Aluminium. 28 Leds. 3 Batterijen AAA Niet Inclusief.

Ø 4.7 x 11.2 cm 100 / 50

Print Code: E(4), L1



Lumosh

7287

Torch. Aluminium. 9 Leds. 3 Batteries AAA Not Included.

Lampe. Aluminium. 9 Leds. 3 AAA Batterien Nicht im Lieferumfang.

Lampe. Aluminium. 9 Leds. 3 Piles AAA Non Inclus.

Zaklamp. Aluminium. 9 Leds. 3 Batterijen AAA Niet Inclusief.

Ø 3.2 x 10 cm 100 / 50

Print Code: E(4), L1





BAMBOO

NEW

Folnax

6805

Multitool. Bamboo/ Stainless Steel. 12 Functions.
 Multiwerkzeug. Bambus/ Rostfreier Stahl. 12 Funktionen.
 Multi Outils. Bambou/ Acier Inox. 12 Fonctions.
 Multitool. Bamboe/ Roestvrij Staal. 12 Functies.

5 × 10.5 × 1.7 cm

100 / 10

Print Code: E(4), L1

MULTI-TOOLS

1166



19

Blauden

3450

Multitool. Aluminium/ Stainless Steel. 12 Functions.
 Multiwerkzeug. Aluminium/ Rostfreier Stahl. 12 Funktionen.
 Multi Outils. Aluminium/ Acier Inox. 12 Fonctions.
 Multitool. Aluminium/ Roestvrij Staal. 12 Functies.

5 × 10.5 × 1.7 cm

100 / 10

Print Code: E(4), L1



03

02

Roseca

5660

Multitool. Aluminium/ Stainless Steel. 13 Functions.
 Multiwerkzeug. Aluminium/ Rostfreier Stahl. 13 Funktionen.
 Multi Outils. Aluminium/ Acier Inox. 13 Fonctions.
 Multitool. Aluminium/ Roestvrij Staal. 13 Functies.

3.9 × 8.1 × 1 cm

300 / 50

Print Code: D(1)



09

11 FUNCTIONS

Wicax

4208

Multitool. Stainless Steel. 11 Functions.
 Multiwerkzeug. Rostfreier Stahl. 11 Funktionen.
 Multi Outils. Acier Inox. 11 Fonctions.
 Multitool. Roestvrij Staal. 11 Functies.

8 × 5.5 × 0.3 cm

400 / 100

Print Code: D(1), L1



02



Kolmi
3451

Multifunction Pocket Knife. Aluminium/ Stainless Steel. 10 Functions.
 Multifunktionstaschenmesser. Aluminium/ Rostfreier Stahl. 10 Funktionen.
 Canif Multi-Usages. Aluminium/ Acier Inox. 10 Fonctions.
 Multifunctioneel Zakmes. Aluminium/ Roestvrij Staal. 10 Functies.

9 x 2.5 x 1.5 cm 100 / 10
 Print Code: E(4), L1



I LOVE BAMBOO

NEW

BAMBOO

Titan
6803

Multifunction Pocket Knife. Bamboo/ Stainless Steel. 9 Functions.
 Multifunktionstaschenmesser. Bambus/ Rostfreier Stahl. 9 Funktionen.
 Canif Multi-Usages. Bambou/ Acier Inox. 9 Fonctions.
 Multifunctioneel Zakmes. Bamboe/ Roestvrij Staal. 9 Functies.

9.4 x 2.5 x 1.4 cm 100 / 10
 Print Code: E(4), L1



1167



02

Castilla
9855

Mini Multifunction Pocket Knife. Stainless Steel. 6 Functions.
 Mini Multifunktionstaschenmesser. Rostfreier Stahl. 6 Funktionen.
 Mini-Canif Multi-Usages. Acier Inox. 6 Fonctions.
 Mini Multifunctioneel Zakmes. Roestvrij Staal. 6 Functies.

5.8 x 1.8 x 0.8 cm 600 / 20
 Print Code: D(4)



03 19



Campello
8225

Multifunction Pocket Knife. Aluminium/ Stainless Steel. 6 Functions.
 Multifunktionstaschenmesser. Aluminium/ Rostfreier Stahl. 6 Funktionen.
 Canif Multi-Usages. Aluminium/ Acier Inox. 6 Fonctions.
 Multifunctioneel Zakmes. Aluminium/ Roestvrij Staal. 6 Functies.

7.2 x 2 x 0.8 cm 240 / 12
 Print Code: E(4), L1



03

Shakon
4586

Multifunction Pocket Knife. Stainless Steel. 10 Functions.
 Multifunktionstaschenmesser. Rostfreier Stahl. 10 Funktionen.
 Canif Multi-Usages. Acier Inox. 10 Fonctions.
 Multifunctioneel Zakmes. Roestvrij Staal. 10 Functies.

7.3 x 2.1 x 1.3 cm 100 / 10
 Print Code: D(4)



05 04 19





04

19

02

03

Thiam

5457

Pocket Knife. Aluminium/ Stainless Steel. Safety Lock Included.
 Taschenmesser. Aluminium/ Rostfreier Stahl. Sicherheitsverschluss.
 Canif. Aluminium/ Acier Inox. Avec Cran d'Arrêt.
 Zakmes. Aluminium/ Roestvrij Staal. Met Veiligheidsblokkade.

8.9 × 2.6 × 1.2 cm 100 / 10

Print Code: E(4), L1

HQ
HIGH QUALITY



POCKETKNIVES

1168

Acer

8232

Pocket Knife. Aluminium/ Stainless Steel. Safety Lock Included.
 Taschenmesser. Aluminium/ Rostfreier Stahl. Sicherheitsverschluss.
 Canif. Aluminium/ Acier Inox. Avec Cran d'Arrêt.
 Zakmes. Aluminium/ Roestvrij Staal. Met Veiligheidsblokkade.

8.7 × 3 × 0.6 cm 240 / 12

Print Code: E(4), L1



02

04

Selva

9298

04

Pocket Knife. Stainless Steel. Safety Lock Included.
 Taschenmesser. Rostfreier Stahl. Sicherheitsverschluss.
 Canif. Acier Inox. Avec Cran d'Arrêt.
 Zakmes. Roestvrij Staal. Met Veiligheidsblokkade.

11 × 3 × 1.5 cm 120 / 12

Print Code: D(4)



02

19

03

Bomber

9579

Pocket Knife. Stainless Steel. Safety Lock Included.
 Taschenmesser. Rostfreier Stahl. Sicherheitsverschluss.
 Canif. Acier Inox. Avec Cran d'Arrêt.
 Zakmes. Roestvrij Staal. Met Veiligheidsblokkade.

9 × 1.9 × 1 cm 240 / 12

Print Code: D(1)



Clip

8230



Pocket Knife. Stainless Steel.
 Taschenmesser. Rostfreier Stahl.
 Canif. Acier Inox.
 Zakmes. Roestvrij Staal.

11.2 × 1.5 × 1.4 cm 360 / 10

Print Code: D(4)

WOODEN POCKETKNIVES



NEW

BAMBOO

Sultan
6804

Pocket Knife. Bamboo/ Stainless Steel. Safety Lock Included.
Taschenmesser. Bambus/ Rostfreier Stahl. Sicherheitsverschluss.
Canif. Bamboo/ Acier Inox. Avec Cran d'Arrêt.
Zakmes. Bamboe/ Roestvrij Staal. Met Veiligheidsblokkade.

9.8 × 2.5 × 1.4 cm

120 / 12

Print Code: E(4), L1

WOOD

1169

HQ
HIGH QUALITY

Dertam
5456

Pocket Knife. Wood/ Stainless Steel. Safety Lock Included.
Taschenmesser. Holz/ Rostfreier Stahl. Sicherheitsverschluss.
Canif. Bois/ Acier Inox. Avec Cran d'Arrêt.
Zakmes. Hout/ Roestvrij Staal. Met Veiligheidsblokkade.

10.1 × 2.9 × 1.4 cm

100 / 10

Print Code: E(4), L1

WOOD

Campaña
9562

Pocket Knife. Wood/ Stainless Steel.
Taschenmesser. Holz/ Rostfreier Stahl.
Canif. Bois/ Acier Inox.
Zakmes. Hout/ Roestvrij Staal.

9.4 × 1.6 × 1.6 cm

240 / 12

Print Code: E(4), L1

Woon
8235

Pocket Knife. Wood/ Stainless Steel. Safety Lock Included.
Taschenmesser. Holz/ Rostfreier Stahl. Sicherheitsverschluss.
Canif. Bois/ Acier Inox. Avec Cran d'Arrêt.
Zakmes. Hout/ Roestvrij Staal. Met Veiligheidsblokkade.

9.1 × 2.4 × 1.4 cm

120 / 12

Print Code: E(4), L1

WOOD



03



02

04

19



Klent

7292

Multifunction Pocket Knife. Aluminium/ Stainless Steel. 10 Functions.
 Multifunktionstaschenmesser. Aluminium/ Rostfreier Stahl. 10 Funktionen.
 Canif Multi-Usages. Aluminium/ Acier Inox. 10 Fonctions.
 Multifunctioneel Zakmes. Aluminium/ Roestvrij Staal. 10 Functies.

10.1 × 2.7 × 1.3 cm 100 / 10

Print Code: E(1), L1

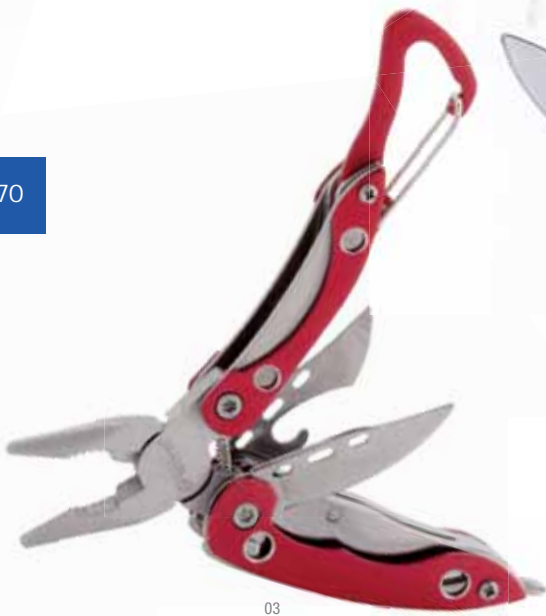

03



19



04



02

Borth

7291

Multitool. Aluminium/ Stainless Steel. 6 Functions.
 Multiwerkzeug. Aluminium/ Rostfreier Stahl. 6 Funktionen.
 Multi Outils. Aluminium/ Acier Inox. 6 Fonctions.
 Multitool. Aluminium/ Roestvrij Staal. 6 Functies.

2.8 × 8.4 × 1.5 cm 100 / 10

Print Code: E(1), L1



Korgon

7339

Multifunction Pocket Knife. Stainless Steel. 8 Functions.
 Multifunktionstaschenmesser. Rostfreier Stahl. 8 Funktionen.
 Canif Multi-Usages. Acier Inox. 8 Fonctions.
 Multifunctioneel Zakmes. Roestvrij Staal. 8 Functies.

11 × 3 × 1.5 cm 100 / 10

Print Code: E(4), L1



Light

Damok

7340

Pocket Knife. Metal/ Stainless Steel. 1 Led. Safety Lock Included. Button Batteries Included.
 Taschenmesser. Metall/ Rostfreier Stahl. 1 Led. Sicherheitsverschluss. Knopfzellen Inklusiv.
 Canif. Métal/ Acier Inox. 1 Led. Avec Cran d'Arrêt. Piles Bouton Inclus.
 Zakmes. Metaal/ Roestvrij Staal. 1 Led. Met Veiligheidsblokkade. Knopcel Batterijen Inclusief.

11.4 × 3 × 1 cm 100 / 10

Print Code: E(1), L1

swiscent
ORIZANS[®]
 adventure

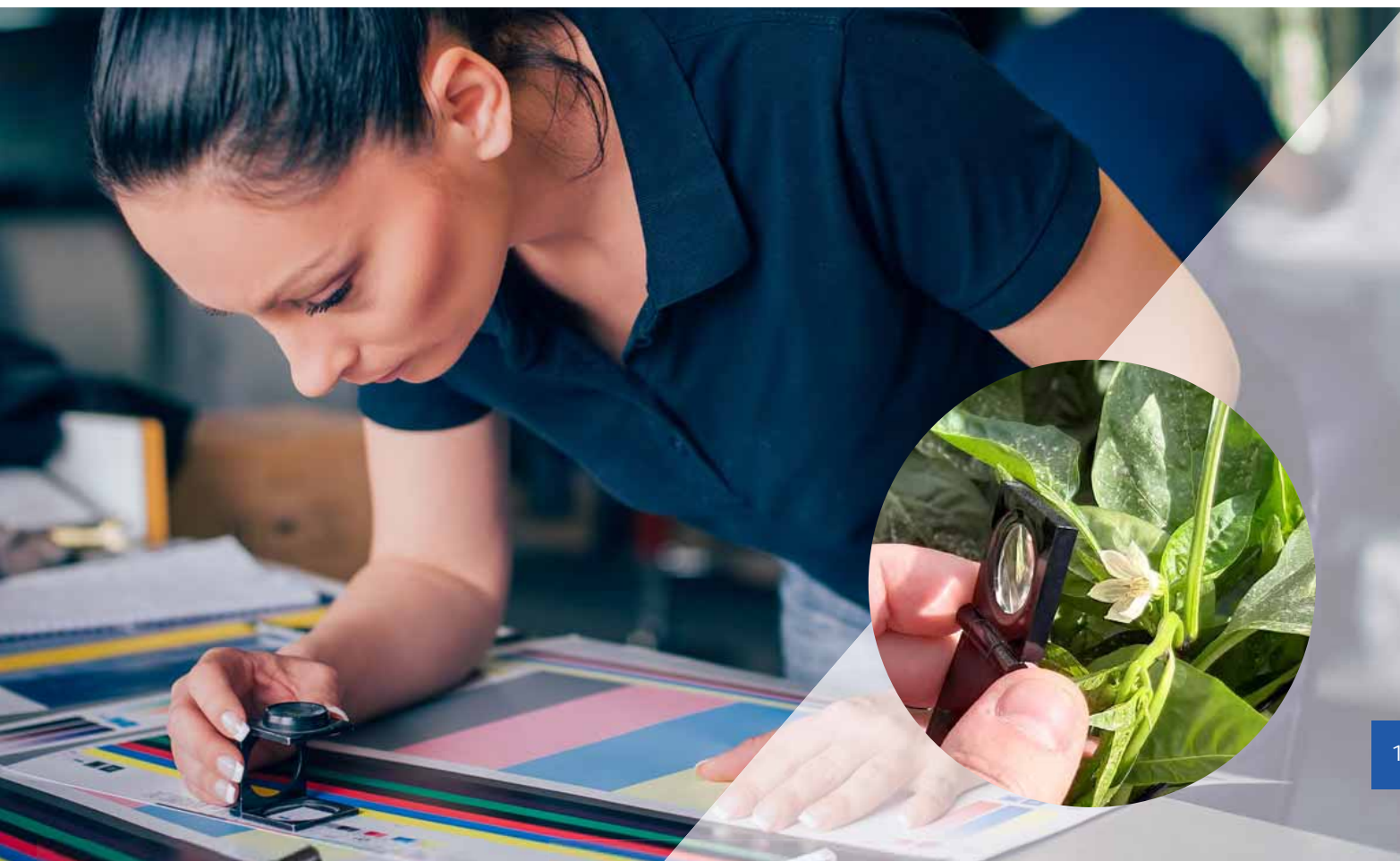

1171



Mauran 7X
8530

Magnifier. With Ruler for Measurement.
Lupe. Lineal Inhalten für Abmessung.
Loupe Compte-Fils. Avec Règle de Mesure.
Vergrootglas. Linaal met Maat Verdelling.

3 x 4.5 x 4.6 cm  600 / 200

 Print Code: C(4)



Biologic 8X
9618

Magnifier. With Ruler for Measurement.
Lupe. Lineal Inhalten für Abmessung.
Loupe Compte-Fils. Avec Règle de Mesure.
Vergrootglas. Linaal met Maat Verdelling.

3 x 4.5 x 4.2 cm  400 / 50

 Print Code: C(4)



Court 10X
9521

Magnifier. Metal. With Ruler for Measurement.
Lupe. Metall. Lineal Inhalten für Abmessung.
Loupe Compte-Fils. Métal. Avec Règle de Mesure.
Vergrootglas. Metaal. Linaal met Maat Verdelling.

2.3 x 2.5 x 3 cm  200 / 50

 Print Code: E(4), L1

40 L/ m2

2050

Rain Meter. Scale Measurement: 1 Line = 1 l/m².
Niederschlagsmesser. Messbereich: 1 Strich = 1 l/m².
Pluviomètre. Graduation: 1 Trait = 1 l/m².
Regenmeter. Schaal: 1 Lijn = 1 l/m².

📏 8 × 44 cm 📦 200
🌈 Print Code: C(1)

Paty

5276

Kneeling Mat. EVA.
Gartenkissen für die Knie. EVA.
Cousin Protège-Genoux. EVA.
Kniebeschermingsmat. EVA.

📏 16 × 30 × 1.5 cm 📦 100
🌈 Print Code: F(1)



60X

Dicson 60X

5134

Microscope. ABS/ Metal. 2 Leds. Ultraviolet Light. Button Batteries Included.
Mikroskop. ABS/ Metall. 2 Leds. Ultraviolettes Licht. Knopfzellen Inklusive.
Microscope. ABS/ Métal. 2 Leds. Ultraviolets. Piles Bouton Inclus.
Microscop. ABS/ Metaal. 2 Leds. Ultraviolet Licht. Knopcel Batterijen Inclusief.

📏 7 × 8 × 2.2 cm 📦 300 / 100

🌈 Print Code: D(4)



Video ▶



05



19

03

04

WEATHER STATION



NEW

Behox 6806

Weather Station. Bamboo. 2 Batteries AAA Not Included.
Wetterstation. Bambus. 2 AAA Batterien Nicht im Lieferumfang.
Station Météo. Bambou. 2 Piles AAA Non Inclus.
Weerstation. Bamboe. 2 Batterijen AAA Niet Inclusief.

13 x 13 x 2.4 cm 50 / 25
Print Code: F(4), L2, W



1173



Helein 6516

Weather Station. Bamboo. 2 Batteries AAA Not Included.
Wetterstation. Bambus. 2 AAA Batterien Nicht im Lieferumfang.
Station Météo. Bambou. 2 Piles AAA Non Inclus.
Weerstation. Bamboe. 2 Batterijen AAA Niet Inclusief.

8.5 x 12 x 6 cm 50 / 25
Print Code: F(4), L1, W



Etna 3740

Weather Station. Button Battery Included.
Wetterstation. Knopfzelle Inklusiv.
Station Météo. Pile Bouton Inclus.
Weerstation. Knoopcel Batterij Inclusief.

7 x 11 x 1.5 cm 100 / 20
Print Code: E(4), W



02

200 ml



Trudy 6127

Humidifier. Led Lights. 200 ml. 2 Steam Modes. USB Connection. Cable Included.
Luftbefeuchter. Led Lichter. 200 ml. 2 Dampf Funktionen. USB Anschluss. Kabel Inklusive.
Humidificateur. Lumières Led. 200 ml. 2 Modes de Vapeur. Connexion USB. Câble Inclus.
Luchtbevochtiger. Led Lichten. 200 ml. 2 Stoom Posities. USB Verbinding. Kabel Inclusief.

📏 6 x 14.9 cm 📦 50
🎨 Print Code: E(1)



Gamp 5287

Alcohol Tester. 2 Batteries AAA Not Included.
Alkoholtester. 2 AAA Batterien Nicht im Lieferumfang.
Alcool Test. 2 Piles AAA Non Inclus.
Alcohol Tester. 2 Batterijen AAA Niet Inclusief.

📏 3.6 x 9.5 x 1.7 cm 📦 200 / 50
🎨 Print Code: E(4)



CAR accessories



Remlux 6137

Camera. 1080P. 2.4" LCD Screen. Multilingual. USB Rechargeable. Cable Included.
Kamera. 1080P. 2.4" LCD Screen. In Mehreren Sprachen. USB Wiederauffadbar. Kabel Inklusive.
Camera. 1080P. Ecran LCD 2.4". Multilingue. Rechargeable USB. Cable Inclus.
Camera. 1080P. 2.4" LCD Scherm. Meertalig. USB Oplaaadbaar. Kabel Inclusief.

📏 13 x 9 x 9.6 cm 📦 40
🎨 Print Code: J(1)



HDMI



OZONE GENERATOR



Trick
6653

Ozone Generator. USB Rechargeable. Cable Included.
Ozon-Generator. USB Wiederaufladbar. Kabel Inklusiv.
Générateur d'Ozone. Rechargeable USB. Cable Inclus.
Ozon Generator. USB Oplaadbaar. Kabel Inclusief.

11.5 x 4.3 x 11.5 cm
Print Code: F(4)

30



NEW



Nurek
6654

UV Sterilizer Lamp. Ultraviolet Light. USB Rechargeable. Cable Included.
UV Sterilisateur Lampe. Ultraviolettes Licht. USB Wiederaufladbar. Kabel Inklusiv.
Lampe Stérilisateur UV. Ultraviolets. Rechargeable USB. Cable Inclus.
UV Sterilisorator Lamp. Ultraviolet Licht. USB Oplaadbaar. Kabel Inclusief.

3 x 12.5 x 1.4 cm
Print Code: E(4), W

100 / 50



UV STERILIZER



NEW



Klas
6649

UV Sterilizer Lamp. Ultraviolet Light. 2 Batteries AAA Not Included.
UV Sterilisateur Lampe. Ultraviolettes Licht. 2 AAA Batterien Nicht im Lieferumfang.
Lampe Stérilisateur UV. Ultraviolets. 2 Piles AAA Non Inclus.
UV Sterilisorator Lamp. Ultraviolet Licht. 2 Batterijen AAA Niet Inclusief.

3.1 x 17.5 x 3.1 cm
Print Code: E(4)

200 / 100



1175



Bluetooth



Hands-free



SIMULTANEOUS CONNECTION
CONEXIÓN SIMULTÁNEA



Lacoust

5527

Earphone Car Charger. Aluminium. Bluetooth Connection. 2 USB Outputs. 2100 mA.
Kopfhörer Ladegerät. Aluminium. Bluetooth Anschluss. 2 USB Ausgänge. 2100 mA.
Chargeur Écouteur. Aluminium. Connexion Bluetooth. 2 Sorties USB. 2100 mA.
Oordopje Oplader. Aluminium. Bluetooth Verbinding. 2 USB Outputs. 2100 mA.

📏 2.1 x 9.7 cm 📦 50

🖨️ Print Code: E(4), L1

Video ▶



CAR accessories

1176



COMPATIBLE WITH
ANDROID & iOS

GPS Tracker



PARKING SITE SEARCHING
LOCALIZADOR DE APARCAMIENTO



Breter

5823



GPS USB Car Charger. Bluetooth Connection. 2 USB Outputs. 2400 mA.
GPS USB Autoladegerät. Bluetooth Anschluss. 2 USB Ausgänge. 2400 mA.
GPS Chargeur Voiture USB. Connexion Bluetooth. 2 Sorties USB. 2400 mA.
GPS USB Auto Oplader. Bluetooth Verbinding. 2 USB Outputs. 2400 mA.

📏 2.6 x 5.7 x 3.2 cm 📦 200 / 50

🖨️ Print Code: C(4)



Video ▶

2 USB OUTPUTS
2 SALIDAS USB



IDEAL FOR BACK PASSENGERS
IDEAL PARA PASAJEROS DE ATRÁS

Yofren

5209

USB Car Charger. 4 USB Outputs. 3100 mA.
USB Autoladegerät. 4 USB Ausgänge. 3100 mA.
Chargeur Voiture USB. 4 Sorties USB. 3100 mA.
USB Auto Oplader. 4 USB Outputs. 3100 mA.

📏 180 cm 📦 50

🖨️ Print Code: E(4)

Video ▶



Video ▶



Kerub

5534

Holder Charger. 2 USB Outputs. 3100 mA.
Halter Ladegerät. 2 USB Ausgänge. 3100 mA.
Chargeur Support. 2 Sorties USB. 3100 mA.
Houder Oplader. 2 USB Outputs. 3100 mA.

📏 8.2 x 11 x 9.4 cm 📦 50

🖨️ Print Code: F(1)



USB car CHARGER

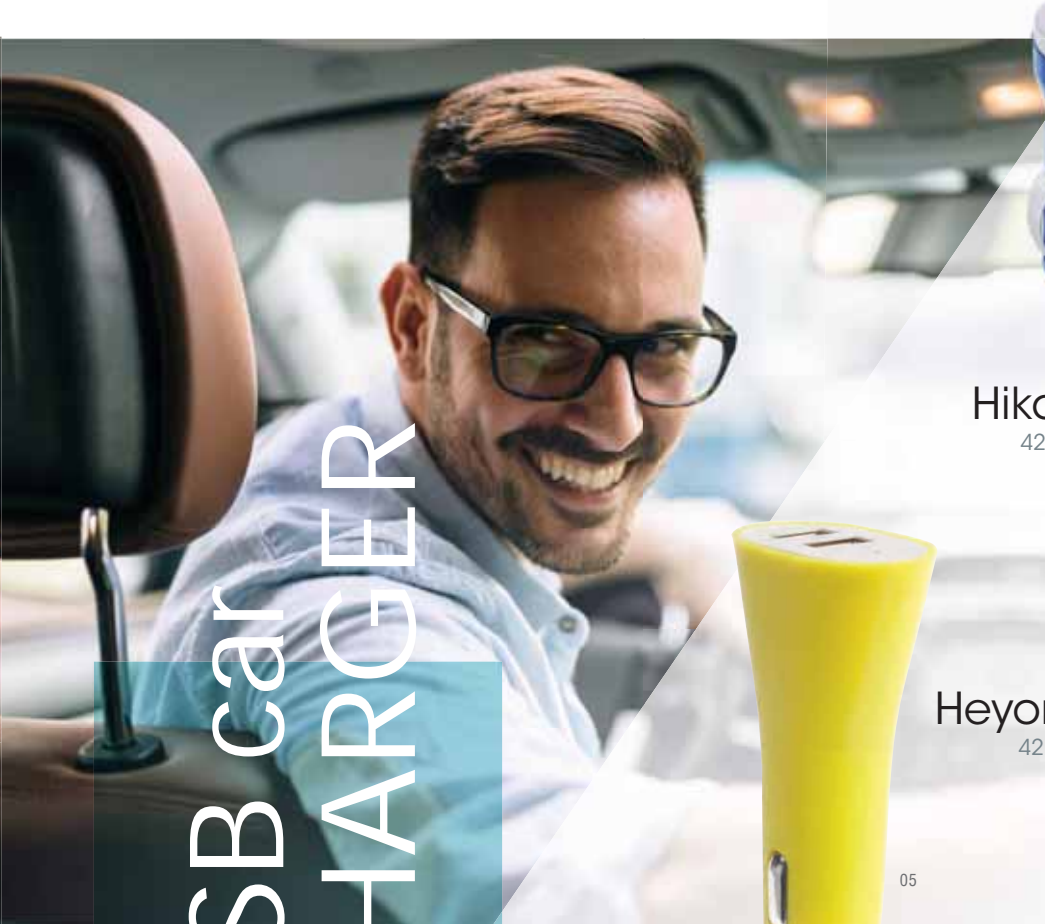

19

02

01

04

05



07

03

11

Hikal
4210

USB Car Charger. 1000 mA.
USB Autoladegerät. 1000 mA.
Chargeur Voiture USB. 1000 mA.
USB Auto Oplader. 1000 mA.

📏 2.3 × 5.6 cm 📦 500 / 50

🎨 Print Code: C(4)



Heyon
4211

USB Car Charger. 2 USB Outputs. 2100 mA.
USB Autoladegerät. 2 USB Ausgänge. 2100 mA.
Chargeur Voiture USB. 2 Sorties USB. 2100 mA.
USB Auto Oplader. 2 USB Outputs. 2100 mA.

📏 2.6 × 8 × 3.7 cm 📦 500 / 50

🎨 Print Code: C(4)



01

19



03

04

1177

BELT CUTTER
CORTACINTURONES

GLASS BREAKER
ROMPECRISTALES



Santer
5333

USB Car Charger. 2 USB Outputs. 3000 mA. 3 Functions.
USB Autoladegerät. 2 USB Ausgänge. 3000 mA. 3 Funktionen.
Chargeur Voiture USB. 2 Sorties USB. 3000 mA. 3 Fonctions.
USB Auto Oplader. 2 USB Outputs. 3000 mA. 3 Functies.

📏 2.3 × 8.5 × 5.1 cm 📦 100 / 50

🎨 Print Code: C(4), L1



01

02



Ridekal
5968

Set. USB Car Charger 2 USB Outputs 2100 mA. Holder Adhesive and Magnetic.
Set. USB Autoladegerät 2 USB Ausgänge 2100 mA. Halter Haftend und Magnetisch.
Set. Chargeur Voiture USB 2 Sorties USB 2100 mA. Support Adhésif et Magnétique.
Set. USB Auto Oplader 2 USB Uitgangen 2100 mA. Houder Klevend en Magnetisch.

📏 9.6 × 3.6 × 9.2 cm 📦 100 / 50

🎨 Print Code: E(1), F(1), L2

CAR HOLDER



Aragor 5540

Holder. Aluminium. Adhesive and Magnetic.
 Halter. Aluminium. Haftend und Magnetisch.
 Support. Aluminium. Adhésif et Magnétique.
 Houder. Aluminium. Klevend en Magnetisch.

Ø 3.3 × 3 cm 200 / 50
 Print Code: F(1), L1

1178

Kruzol 5954



Holder. Aluminium. Adhesive and Magnetic.
 Halter. Aluminium. Haftend und Magnetisch.
 Support. Aluminium. Adhésif et Magnétique.
 Houder. Aluminium. Klevend en Magnetisch.

Ø 3.5 × 5 cm 200 / 50
 Print Code: F(1), L1



AREA NO IMPRIMIBILE
 NOT PRINTING AREA



Atosh 6270

Holder. Metal. Adhesive.
 Halter. Metall. Haftend.
 Support. Métal. Adhésif.
 Houder. Metaal. Klevend.

3.2 × 4.8 × 1.2 cm 500 / 100
 Print Code: C(1), L1



Glatix 6224

Holder.
 Halter.
 Support.
 Houder.

Ø 3.6 × 5.3 cm 200 / 50
 Print Code: F(1)





Gumbol

6785

Holder. Adjustable.
Halter. Verstelbaar.
Support. Ajustable.
Houder. Aanpasbaar.

7.7 x 3.2 x 7.4 cm
Print Code: E(1)

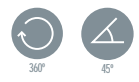

ROTATING AND
ADJUSTABLE

300 / 50

car HOLDER



ADJUSTABLE
ADJUSTABLE

1179

Daminus

5281

Holder. Adjustable.
Halter. Verstelbaar.
Support. Ajustable.
Houder. Aanpasbaar.

9.7 x 2.8 x 5 cm
Print Code: D(4), W

ADJUSTABLE
AJUSTABLE
IDEAL TO MOBILE
PHONES XXL



02

ADJUSTABLE
AJUSTABLE



Seinox

5798

Holder. Aluminium. Adjustable.
Halter. Aluminium. Verstelbaar.
Support. Aluminium. Ajustable.
Houder. Aluminium. Aanpasbaar.

11.2 x 9.5 x 5.5 cm
Print Code: E(1), L1



09

Lietor

6483

Holder. Adjustable.
Halter. Verstelbaar.
Support. Ajustable.
Houder. Aanpasbaar.

9.2 x 8.9 x 5.5 cm
Print Code: E(1)

100 / 50





Wireless
Charger

Tecnox 6180

Charger Holder. Wireless. Adjustable. Cable Included.
Ladegerät Halter. Drahtlos. Verstellbar. Kabel Inklusive.
Support Chargeur. Sans Fil. Ajustable. Câble Inclus.
Oplader Houder. Draadloos. Aanpasbaar. Kabel Inclusief.

9.2 × 11 × 6.2 cm 100 / 50

Print Code: E(1)

ADJUSTABLE
AJUSTABLE



CAR HOLDER

1180

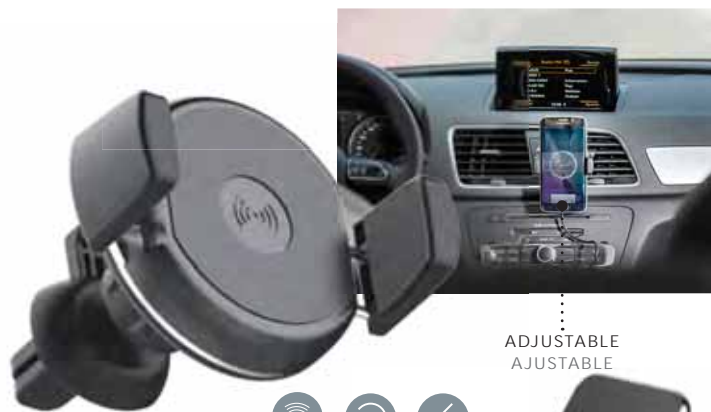

Wireless
Charger



360°



45°

Vualax 6135

Charger Holder. Wireless. Adjustable. Cable Included.
Ladegerät Halter. Drahtlos. Verstellbar. Kabel Inklusive.
Support Chargeur. Sans Fil. Ajustable. Câble Inclus.
Oplader Houder. Draadloos. Aanpasbaar. Kabel Inclusief.

7.8 × 10.5 × 6.8 cm 50

Print Code: E(1)

ADJUSTABLE
AJUSTABLE



Wantol 5749

Dashboard Holder. Sticky Surface.
Bildschirmträger. Selbsthaftende Oberfläche.
Ecran Support. Surface Adhésive.
Dashboard Houder. Zelfklevende Oppervlakte.

15 × 11 × 10 cm 50

Print Code: D(1)

ANTI SLIP
ANTIDESLIZANTE





Razter

5648

Holder Pouch. Polyester 600D.
 Halter Hülle. Polyester 600D.
 Etui Support. Polyester 600D.
 Houder Hoes. Polyester 600D.

28 x 22 x 2.5 cm 30
 Print Code: G(1), N(8)

1181



Domky

5772

Bluetooth Receiver. Bluetooth Connection. 3,5 mm Jack Socket. USB Connection. Retractable Cable.
 Bluetooth-Empfänger. Bluetooth Anschluss. 3,5 mm Klinkestecker. USB Anschluss. Ausziehbar Kabel.
 Récepteur Bluetooth. Connexion Bluetooth. Connexion Jack 3,5 mm. Connexion USB. Câble Extensible.
 Ontvanger Bluetooth. Bluetooth Verbinding. 3,5 mm Jack Aansluiting. USB Verbinding. Verlengbare Kabel.

2.2 x 5.6 x 1.1 cm 200 / 100
 Print Code: E(4)

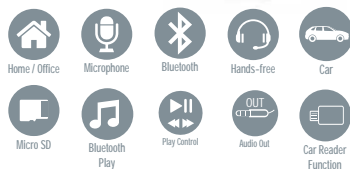

Osorix

5780

Holder. Adjustable.
 Halter. Verstellbar.
 Support. Ajustable.
 Houder. Aanpasbaar.

18 x 7 x 14 cm 50
 Print Code: E(1)



12" Tablet Compartment

CAR accessories



Krosly

5160

Tracker. Bluetooth Connection. Button Battery Included.
Piepser. Bluetooth Anschluss. Knopfzelle Inklusive.
Traqueur. Connexion Bluetooth. Pile Bouton Inclus.
Locator. Bluetooth Verbinding. Knoopcel Batterij Inclusief.

3.1 x 5.2 x 1 cm 200 / 50

Print Code: C(4)



COMPATIBLE WITH
ANDROID & iOS



1182



COMPATIBLE WITH
ANDROID & iOS

GPS TRACKER



TAKE ME TO MY PARKING LOCATION
GUÍAME A LA LOCALIZACIÓN
DE MI APARCAMIENTO

Jackson

5965

GPS Tracker. Bluetooth Connection. Button Battery Included.
GPS Piepser. Bluetooth Anschluss. Knopfzelle Inklusive.
GPS Traqueur. Connexion Bluetooth. Pile Bouton Inclus.
GPS Locator. Bluetooth Verbinding. Knoopcel Batterij Inclusief.

2.9 x 6 x 1 cm 200 / 50

Print Code: C(4), W



Britian

5786

Charger. Aluminium. Micro USB, Type C and Lightning Connection.
Ladegerät. Aluminium. Anschluss Micro USB, Typ C und Lightning.
Chargeur. Aluminium. Connexion Micro USB, Type C et Lightning.
Oplader. Aluminium. Micro USB, Type C en Lightning Connectie.

120 x 1.8 x 0.8 cm 200 / 50

Print Code: D(1), L1



Hedul

5969

Charger Synchronizer. Micro USB, Type C and Lightning Connection.
Ladegerät Sincro. Anschluss Micro USB, Typ C und Lightning.
Chargeur Synchroniseur. Connexion Micro USB, Type C et Lightning.
Oplader Synchronizer. Micro USB, Type C en Lightning Connectie.

1.2 x 6.7 x 1 cm 500 / 250

Print Code: C(4)





Dasha

3760

Ice Scraper. Polyester 210T.
Eiskratzer. Polyester 210T.
Gratte-Glace. Polyester 210T.
Ijskrabber. Polyester 210T.

17 × 25 × 1.5 cm 100 / 20

Print Code: E(1), N(8)



03

19

01

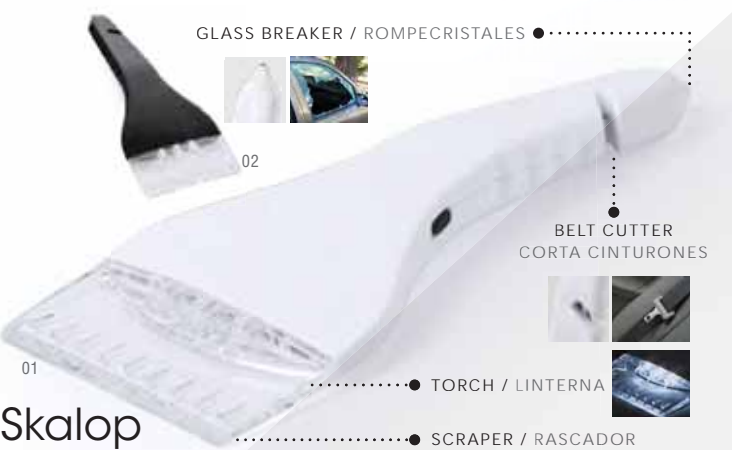

Skalop

5692

Ice Scraper. 3 Leds. 4 Functions. Button Batteries Included.
Eiskratzer. 3 Leds. 4 Funktionen. Knopfzellen Inklusive.
Gratte-Glace. 3 Leds. 4 Fonctions. Piles Bouton Inclus.
Ijskrabber. 3 Leds. 4 Functies. Knoopcel Batterijen Inclusief.

9.8 × 26 × 3.5 cm 100 / 50

Print Code: E(4)



Skabix

6041

Snow Shovel. Carbon Steel. Foldable.
Schneeschaufel. Kohlenstoff Stahl. Falten.
Pelle à Neige. Acier Carbone. Pliable.
Sneeuwschep. Carbon-Staal. opvouwbaar.

11.5 × 46.5 × 5 cm 20

Print Code: I(8), L2



Feniok

5259

Ice Scraper.
Eiskratzer.
Gratte-Glace.
Ijskrabber.

8.8 × 21.2 × 1.3 cm 200 / 50

Print Code: D(4)

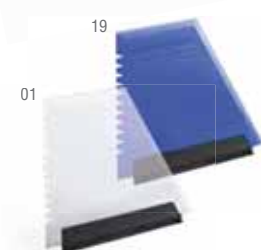

Baira

3407

Ice Scraper.
Eiskratzer.
Gratte-Glace.
Ijskrabber.

12 × 11 × 0.3 cm

Print Code: D(2)

400 / 25

1183



Oness
5649

Car Bin.
Papierkorb.
Poubelle pour Voiture.
Auto Prullenbak.

Ø 9.7 × 16.8 cm 50 / 25
Print Code: D(1)



CAR accessories

1184



19

01

03



04

15 BAGS
15 BOLSAS

Bluck
5646

Waste Bag Dispenser. 15 Bags Included.
Abfall Bag Spender. 15 Beutel Inklusiv.
Distributeur de Sacs. 15 Sacs Inclus.
Zakjes Dispenser. 15 Tassen Inclusief.

5 × 7.6 × 3.2 cm 200 / 50
Print Code: C(4)



19



02

03

04



FOLDABLE



Nardelly
5624

Organizer. Non-Woven.
Ordner. Non-Woven.
Organiseur. T.N.T.
Organizer. Non-Woven.

34 × 28 × 25 cm 40
Print Code: F(1), N(8)

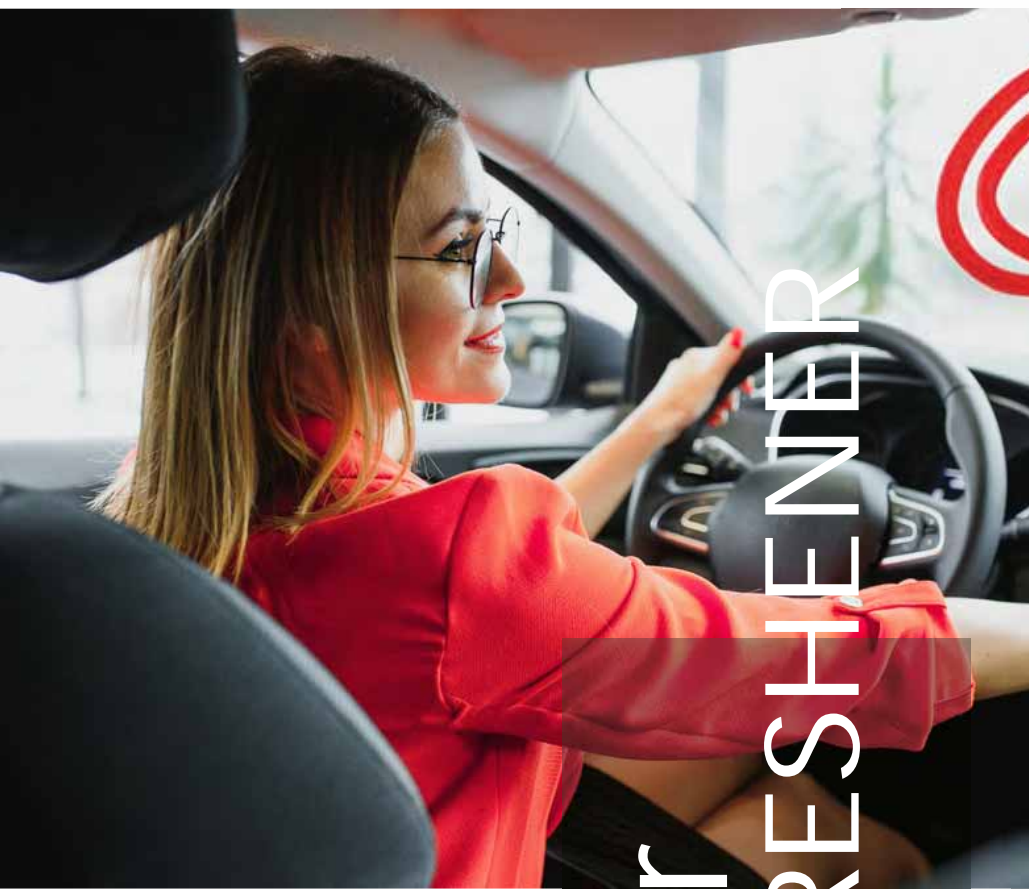

air FRESHENER



03
Ocean
Telox
4250



Air Freshener. Glass. 5 ml. Ocean Aroma.
Lufterfrischer. Glas. 5 ml. Ozeanduft.
Parfum Ambiance. Verre. 5 ml. Arôme Océan.
Luchtfriërser. Glas. 5 ml. Ocean Aroma.
Ø 2.2 x 4.5 cm 400 / 100
Print Code: D(4)



Rafum
5268

Air Freshener Holder. Lemon Aroma. Sticky Surface.
Lufterfrischer Halter. Zitronenduft. Selbsthaftende Oberfläche.
Support Parfum Ambiance. Arôme Citron. Surface Adhésive.
Luchtfriërser Houder. Citroen Aroma. Zelfklevende Oppervlakte.
4.3 x 5.7 x 4.5 cm 400 / 50
Print Code: D(4), W



Scrib
4276

Air Freshener. Lemon Aroma.
Lufterfrischer. Zitronenduft.
Parfum Ambiance. Arôme Citron.
Luchtfriërser. Citroen Aroma.
Ø 5.2 x 3.8 cm 400 / 50
Print Code: D(4), V



Becrux
6292

Air Freshener. Aluminium/ABS. Lemon Aroma.
Lufterfrischer. Aluminium/ABS. Zitronenduft.
Parfum Ambiance. Aluminium/ABS. Arôme Citron.
Luchtfriërser. Aluminium/ABS. Citroen Aroma.
5.7 x 4.2 x 3 cm 400 / 50
Print Code: D(4), L1



CE

05F



07F

CAR safety

1186

Kross 8025

Reflective Vest. Polyester. One Size. Adult. Homologated.
Warnweste. Polyester. Einheitsgröße. Erwachsene. Genehmigt.
Gilet Réfléchissant. Polyester. Taille Unique. Adulte. Homologué.
Reflectorend Vest. Polyester. Een Maat. Volwassen. Gehomologiseerd.

65 x 70 cm 100 / 20

Print Code: F(6)



Trend 5693

Emergency Light. 15 Leds. 9 Light Modes. Magnetic. 3 Batteries AAA Not Included.
Notlicht. 15 Leds. 9 Leuchtfunktionen. Magnetisch. 3 AAA Batterien Nicht im Lieferumfang.
Lumière Urgence. 15 Leds. 9 Modes de Lumière. Magnétique. 3 Piles AAA Non Inclus.
Noodlicht. 15 Leds. 9 Licht Posities. Magnetisch. 3 Batterijen AAA Niet Inclusief.

10 x 3.5 cm 100 / 50

Print Code: E(4)

MAGNET



Wen 3761

Pressure Gauge. Aluminium.
Reifendruckmesser. Aluminium.
Mesureur Pression. Aluminium.
Drukmeter. Aluminium.

0.8 x 8 cm

1000 / 100

Print Code: D(1), L1



02

03



19



TORCH, GLASS BREAKER AND BELT CUTTER
LINTERNA, ROMPECRISTALES Y CORTACINTURONES

MAGNET



Laguel

5815

Emergency Hammer. 1 Led. 4 COB Lights. 3 Light Modes. 3 Functions. Magnetic. Button Batteries Included.
Nothammer. 1 Led. 4 COB Lichter. 3 Leuchtfunktionen. 3 Funktionen. Magnetisch. Knopfzellen Inklusive.
Marteau de Secours. 1 Led. 4 Lumières COB. 3 Modes de Lumière. 3 Fonctions. Magnétique. Piles Bouton Inclus.
Nood Hamer. 1 Led. 4 COB Lichten. 3 Licht Posities. 3 Functies. Magnetisch. Knoopcel Batterijen Inclusief.

📏 2.7 × 12.3 × 1.5 cm 📦 200 / 50

🌈 Print Code: E(4)



Seleter

5437

Emergency Hammer. 1 Led. 3 Functions. Button Batteries Included.
Nothammer. 1 Led. 3 Funktionen. Knopfzellen Inklusive.
Marteau de Secours. 1 Led. 3 Fonctions. Piles Bouton Inclus.
Nood Hamer. 1 Led. 3 Functies. Knoopcel Batterijen Inclusief.

📏 7.6 × 13.3 × 2.4 cm 📦 50 / 25

🌈 Print Code: E(4)



TORCH, GLASS BREAKER
AND BELT CUTTER
LINTERNA, ROMPECRISTALES
Y CORTACINTURONES

1187



03



19

Redcross

9496

Emergency Kit. Polyester 600D. 17 Accessories.
Erste Hilfe Set. Polyester 600D. 17 Teile.
Kit Urgence. Polyester 600D. 17 Accessoires.
Ehbo-Set. Polyester 600D. 17 Accessoires.

📏 18 × 12 × 6 cm 📦 100 / 20

🌈 Print Code: E(1)



Quint

4915

Space Blanket. Metallized PET.
Rettingsdecke. Aluminiumiertes PET.
Couverture Thermique. PET Aluminiumisé.
Heelal Deken. Aluminium Coated PET.

📏 130 × 210 cm 📦 200 / 50

🌈 Print Code: D(1)

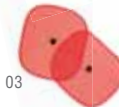
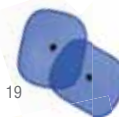

Aston

8101

Steering Wheel Sunshade. Aluminium.
Lenkrad Abdeckung. Aluminium.
Couvre Volant. Aluminium.
Stuur-Zonnescherm. Aluminium.

Ø 43 cm 100

Print Code: F(1)



Vent

8102

Sunshade. Polyester. 2 Pieces.
Autosonnenschutz. Polyester. 2 Stück.
Pare-Soleil. Polyester. 2 Pièces.
Zonnescherm. Polyester. 2 Stuks.

44 x 37 cm 120 / 20

Print Code: F(1), R



Car

CAR SUNSHADE

1188



Truck



Belgiox

5709

Sunshade. Two Bubble Aluminium Sides.
Autosonnenschutz. Aluminium Luftblasen Beidseitig.
Pare-Soleil. Aluminium Bulles Deux Faces.
Zonnescherm. Tweezijdig Aluminium Bubbelfolie.

180 x 90 cm 50

Print Code: H(1)

Vagón

9173

Sunshade. Two Bubble Aluminium Sides.
Autosonnenschutz. Aluminium Luftblasen Beidseitig.
Pare-Soleil. Aluminium Bulles Deux Faces.
Zonnescherm. Tweezijdig Aluminium Bubbelfolie.

143 x 74 cm 100

Print Code: H(1)



Car



Van





130 x 60 CM

03

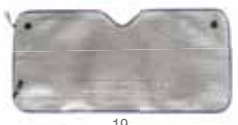

19



02



Fussion 8100

Sunshade. Aluminium One Side.
Autosonnenschutz. Aluminium Einseitig.
Pare-Soleil. Aluminium Un Côté.
Zonnescherm. Aluminium Eenzijdig.

130 x 60 cm 100

Print Code: H(1)



Car



130 x 60 CM

Cavalier 9889

Sunshade. Two Bubble Aluminium Sides.
Autosonnenschutz. Aluminium Luftblasen Beidseitig.
Pare-Soleil. Aluminium Bulles Deux Faces.
Zonnescherm. Tweezijdig Aluminium Bubbelfolie.

130 x 60 cm 100

Print Code: H(1)



Car



1189



130 x 70 CM



Car



Van



Jumbo 9124

Sunshade. Aluminium One Side.
Autosonnenschutz. Aluminium Einseitig.
Pare-Soleil. Aluminium Un Côté.
Zonnescherm. Aluminium Eenzijdig.

130 x 70 cm 100

Print Code: H(1)

Falnit 5708

Sunshade. Two Bubble Aluminium Sides.
Autosonnenschutz. Aluminium Luftblasen Beidseitig.
Pare-Soleil. Aluminium Bulles Deux Faces.
Zonnescherm. Tweezijdig Aluminium Bubbelfolie.

130 x 80 cm 100

Print Code: H(1)



130 x 80 CM



Car



Van



BEST FRIENDS PET PRODUCTS



NEW

Wabik
6681



Antibacterial

Antibacterial Waste Bag Dispenser. 15 Biodegradable Bags Included.
Antibakteriell Abfall Bag Spender. 15 Kompostierbarer Beutel Inklusive.
Distributeur de Sacs Antibactérien. 15 Sacs Biodégradable Inclus.
Antibacterieel Zakjes Dispenser. 15 Biologisch Afbreekbare Tassen Inclusief.

🗑️ Ø 4 x 10 cm 📦 200 / 20

🌈 Print Code: D(4)

15 BIODEGRADABLE
BAGS INCLUDED



BAMBOO FIBRE

15 BIODEGRADABLE BAGS INCLUDED



Leiren

6378

Waste Bag Dispenser. Bamboo Fibre/ PP. 15 Biodegradable Bags Included.
Abfall Bag Spender. Bambusfaser/ PP. 15 Kompostierbarer Beutel Inklusive.
Distributeur de Sacs. Fibre Bambou/ PP. 15 Sacs Biodegradable Inclus.
Zakjes Dispenser. Bamboe Fibre/ PP. 15 Biologisch Afbreekbare Tassen Inclusief.

8.2 x 5.4 x 4.1 cm 200 / 50

Print Code: D(4)

15 BAGS INCLUDED



Rucin

5641

Waste Bag Dispenser. 15 Bags Included.
Abfall Bag Spender. 15 Beutel Inklusive.
Distributeur de Sacs. 15 Sacs Inclus.
Zakjes Dispenser. 15 Tassen Inclusief.

8.2 x 5.4 x 4.1 cm 200 / 50

Print Code: D(4)



15 BAGS INCLUDED



Yoan

3780

Waste Bag Dispenser. 15 Bags Included.
Abfall Bag Spender. 15 Beutel Inklusive.
Distributeur de Sacs. 15 Sacs Inclus.
Zakjes Dispenser. 15 Tassen Inclusief.

Ø 4 x 10 cm 200 / 20

Print Code: D(4)



15 BAGS INCLUDED



Muller

4618

Waste Bag Dispenser. 1 Led. 15 Bags Included. Button Batteries Included.
Abfall Bag Spender. 1 Led. 15 Beutel Inklusive. Knopfzellen Inklusive.
Distributeur de Sacs. 1 Led. 15 Sacs Inclus. Piles Bouton Inclus.
Zakjes Dispenser. 1 Led. 15 Tassen Inclusief. Knopcelbatterij Inclusief.

Ø 4.1 x 10.4 cm 200 / 50

Print Code: D(4)

KEEP YOUR CITY CLEAN

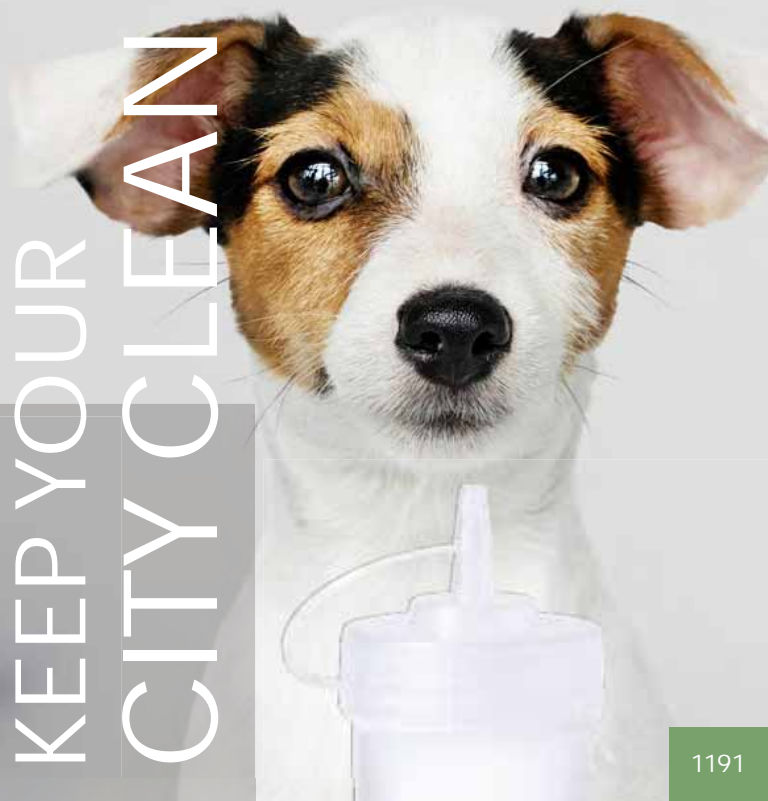

300 ml



Taxlen

2556

Dispenser Bottle. PP. 300 ml.
Austeiler Flasche. PP. 300 ml.
Bouteille Doseur. PP. 300 ml.
Dispenser Fles. PP. 300 ml.

Ø 6.4 x 18.5 cm

Print Code: F(1)

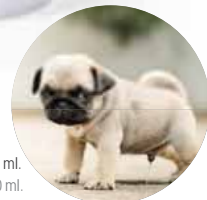

1191

150



19



04



03

Weton

5936

Pets Hairbrush. PVC.
Haustier Bürste. PVC.
Brosse Animaux de Compagnie. PVC.
Dieren Haarborstel. PVC.

8.7 × 12.8 cm 200 / 10

Print Code: D(1)

1192

Pet CARE



19

Misbiz

5127

Mat. PE.
Mokett. PE.
Tapis. PE.
Mat. PE.

45 × 45 cm 100 / 10

Print Code: G(1)



19



03

FOLDABLE · IDEAL
FOR TAKE AWAY ·
SUITABLE FOR LIQUID
AND FOOD
PLEGABLE · IDEAL
PARA LLEVAR ·
VÁLIDO PARA
LÍQUIDOS Y SÓLIDOS

Flux

9825

Foldable Bowl. Nylon/ Polyester.
Faltbare Schüssel. Nylon/ Polyester.
Bol Pliabile. Nylon/ Polyester.
Opvouwbare Voerbak. Nylon/ Polyester.

Ø 16.5 × 10 cm 200 / 10

Print Code: F(1), N(8)



03



05



11



01

Take AWAY



FOLDABLE/
PLEGABLE

16

FOLDABLE · IDEAL
FOR TAKE AWAY ·
SUITABLE FOR LIQUID
AND FOOD
PLEGABLE · IDEAL
PARA LLEVAR ·
VALIDO PARA
LÍQUIDOS Y SÓLIDOS

Baloyn 5935

Foldable Bowl. TPR.
Faltbare Schüssel. TPR.
Bol Pliabile. TPR.
Opvouwbare Voerbak. TPR.

11111111 Ø 12.9 x 5.2 cm 📦 200 / 50

🌈 Print Code: L2



03



19



1193



900 ml



19

FOLDABLE · IDEAL
FOR TAKE AWAY ·
VALID FOR LIQUID
AND FOOD
PLEGABLE · IDEAL
PARA LLEVAR ·
VALIDO PARA
LÍQUIDOS Y SÓLIDOS

FOLDABLE/
PLEGABLE



03

Matsen

6171

Pets Set. PP/TPR. 900 ml.
Haustier Set. PP/TPR. 900 ml.
Set Animaux de Compagnie. PP/TPR. 900 ml.
Dieren Set. PP/TPR. 900 ml.

11111111 Ø 11.3 x 23 cm 📦 20

🌈 Print Code: E(1), L2



01

Flybit

3061

Frisbee. Cotton/ Polyester.
Frisbie. Baumwolle/ Polyester.
Frisbee. Coton/ Polyester.
Frisbie. Katoen/ Polyester.

📏 Ø 20 cm 📦 150 / 10

🖨️ Print Code: F(1), N(8), R



03



19



Ideal
Sublimation

LET'S PLAY!



1194

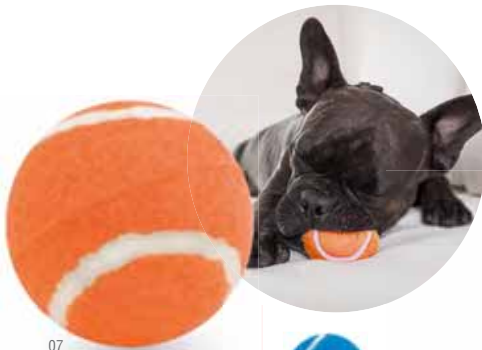

07

Niki

9964

Ball.
Ball.
Balle.
Bal.

📏 Ø 6.4 cm 📦 200 / 20

🖨️ Print Code: L1, N(8)



03

19



19

Tauron

4216

Hair Clip. Velvet.
Haarspange. Wildleder.
Barrette. Suédine.
Haar Clip. Fluweel.

📏 Ø 5.5 x 2.4 cm 📦 1200 / 120

🖨️ Print Code: D(1)



03

05

11

02



03



04

19



02

Kenny

5789

Drawstring Bag. 15% Cotton/ 85% Polyester.
Rucksack. 15% Baumwolle/ 85% Polyester.
Sac à Dos. 15% Coton/ 85% Polyester.
Rugzak. 15% Katoen/ 85% Polyester.

📏 Ø 26 x 62 cm 📦 50

🖨️ Print Code: F(1), N(8), O, P



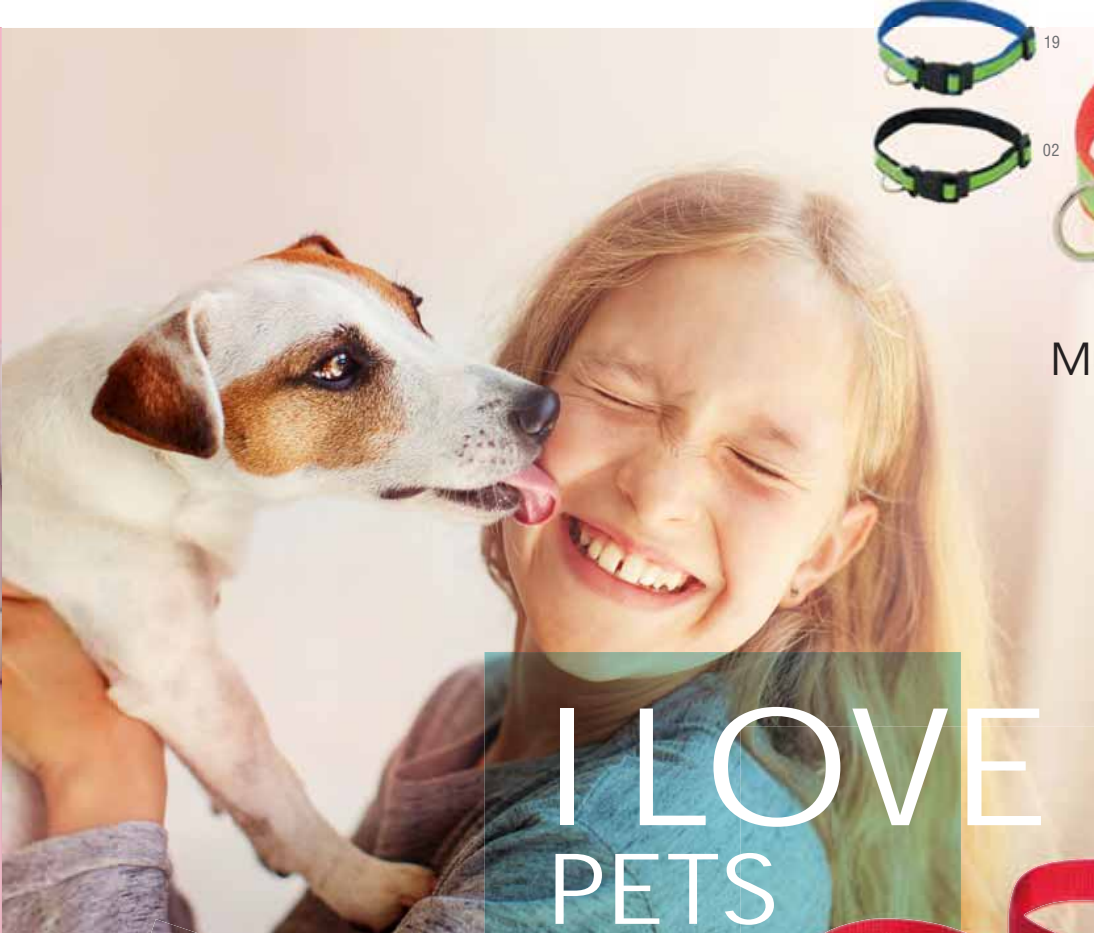

I LOVE PETS



Muttley
3063

Pet Collar. Polyester. Reflective. Adjustable.
Hundeohalsband. Polyester. Reflektierender. Verstellbar.
Collier. Polyester. Réfléchissant. Ajustable.
Halsband. Polyester. Reflecterende. Aanpasbaar.

50 x 1.8 cm 500 / 20
Print Code: F(1)



19 04 02



03

HQ
HIGH QUALITY

Fronuk
6195

Pet Lead. Polyester.
Hundeleine. Polyester.
Laisse pour Animaux. Polyester.
Dierenriem. Polyester.

127 x 2.5 cm 100
Print Code: E(1), N(8)



REFLECTIVE

Bipols
5826

Bandana Pet Collar. Polyester. Reflective. Adjustable.
Kopftuch Hundeohalsband. Polyester. Reflektierender. Verstellbar.
Collier Bandana. Polyester. Réfléchissant. Ajustable.
Dieren Halsdoek-Halsband. Polyester. Reflecterende. Aanpasbaar.

23 x 15.5 cm 400 / 20
Print Code: E(1)



Roco
3062

Bandana Pet Collar. Polyester. Adjustable.
Kopftuch Hundeohalsband. Polyester. Verstellbar.
Collier Bandana. Polyester. Ajustable.
Dieren Halsdoek-Halsband. Polyester. Aanpasbaar.

20 x 14 cm 400 / 20
Print Code: E(1), R



Ideal Sublimation



03
01
19

1195

EVE- NTS & PARTY



NEW

Yoksy
6705

Tally Counter.
Taschenrechner.
Compteur.
Teller.

 4 x 5.1 x 3.2 cm

 200 / 50

 Print Code: C(4)

TALLY COUNTER
CONTADOR DE AFORO





1197



TYVEK® MATERIAL

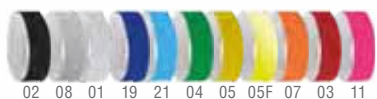

Events

3841

Bracelet. Tyvek® Material. One Size. Adult.
 Armband. Tyvek® Material. Einheitsgröße. Erwachsene.
 Bracelet. Tyvek® Material. Taille Unique. Adulte.
 Armband. Tyvek® Material. Eén Maat. Volwassen.

25.8 x 2.7 cm 20000 / 1000
 Print Code: A(1)



ALUMINIUM

Drentox

5067

Roll Up. Aluminium.
 Roll Up. Aluminium.
 Roll Up. Aluminium.
 Roll Up. Aluminium.

85 x 208 cm 6
 Print Code: Consult.





07

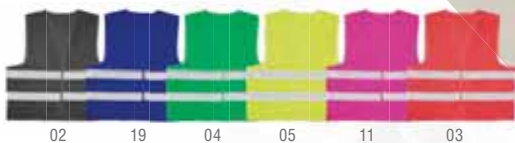

02 19 04 05 11 03

Tirez

4648

Vest. Polyester. One Size. Adult. This Item is Not Considered to be Personal Protective Equipment.
 Weste. Polyester. Einheitsgröße. Erwachsene. Dieser Artikel Kann man Nicht als Persönlichen Schutzausrüstungen Betrachtet Werden.
 Gilet. Polyester. Taille Unique. Adulte. Cet Article Ne se Considere pas Comme un Équipements de Protection Individuelle.
 Vest. Polyester. Eén Maat. Volwassen. Dit artikel kan Niet Worden Beschouwd als Persoonlijke Beschermingsmiddelen.

Print Code: F(1) 60 x 69 cm 100 / 20

Print Code: F(1)

1198



Cambex

4531

Vest. Non-Woven. One Size. Adult.
 Weste. Non-Woven. Einheitsgröße. Erwachsene.
 Plastron. T.N.T. Taille Unique. Adulte.
 Vest. Non-Woven. Eén Maat. Volwassen.

Print Code: F(1) 53 x 66 cm 200 / 25

Print Code: F(1)



04



03



04

19

05

Sporter

3316

Vest. Polyester 190T. One Size. Adult.
 Weste. Polyester 190T. Einheitsgröße. Erwachsene.
 Plastron. Polyester 190T. Taille Unique. Adulte.
 Vest. Polyester 190T. Eén Maat. Volwassen.

Print Code: F(1) 52 x 63 cm 300 / 25

Print Code: F(1)



04



Dambor 6200

Flag, Polyester 170D.
Fahne, Polyester 170D.
Drapeau, Polyester 170D.
Vlag, Polyester 170D.

100 x 70 cm 200 / 10
Print Code: G(1)

XL SIZE
80 x 30 CM

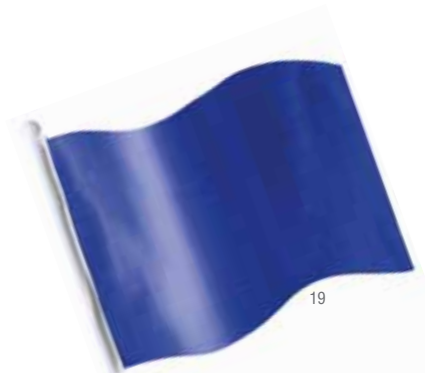

Rolof 4835

Pennant Flag, Polyester 170T.
Fähnchen, Polyester 170T.
Fanion, Polyester 170T.
Vlag op Stok, Polyester 170T.

21 x 30 cm 2000 / 10
Print Code: D(6)

Portel 6450

Pennant Flag, Polyester 210D.
Fähnchen, Polyester 210D.
Fanion, Polyester 210D.
Vlag op Stok, Polyester 210D.

80 x 60 cm 500 / 10
Print Code: F(1), R

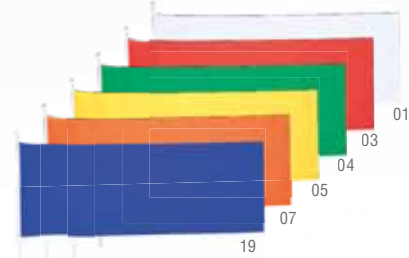



Colour

9768

Painting Set.
Fan Schminkset.
Set Peinture.
Schilder Set.

9.2 x 5 x 0.9 cm 400 / 50

Print Code: D(4)



1200



03

ROLL-UP
ENROLLABLE

Oé

9566

Banner. Roll Up.
Animation Band. Rollbar.
Bande Animation. Enroulées.
Banner. Oprolbaar.

70 x 26 cm 500 / 250

Print Code: G(1)



02

04

05

07

01

19



07

Yopet

4649

Whistle.
Pfeife.
Sifflet.
Fluitje.

1.9 x 5 x 2.4 cm 1000 / 250

Print Code: C(1)



03

04

19

05

01

02



Maracaná

8774

Animation Hand.
Klatschhand.
Main Animation.
Animatie-Hand.

8.5 x 18.5 x 2 cm 200 / 100

Print Code: E(4)



Stick

9075

Cheering Sticks. LDPE. Reusable. Inflating Valve Included.
Klatschstange. LDPE. Wiederverwendbar. Inflation Ventil Inklusive.
Tap Tap. LDPE. Réutilisable. Valve pour Gonfler Inclus.
Cheering Sticks. LDPE. Herbruikbaar. Opblaasrictje Inclusief.

60 x 10 cm 500 / 25

Print Code: G(1)

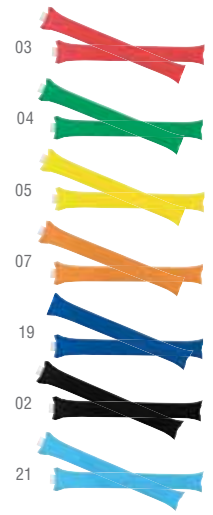

1201



Zacky

6066

Animation Hand. EVA.
Klatschhand. EVA.
Main Animation. EVA.
Animatie-Hand. EVA.

25 x 50 cm 200 / 20

Print Code: F(1)

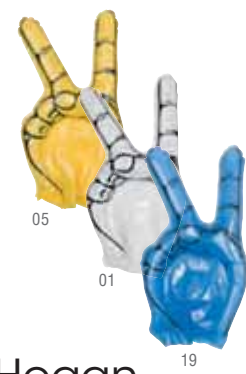

Hogan

9664

Animation Hand. LDPE. Reusable. Inflating Valve Included.
Klatschhand. LDPE. Wiederverwendbar. Inflation Ventil Inklusive.
Main Animation. LDPE. Réutilisable. Valve pour Gonfler Inclus.
Animatie-Hand. LDPE. Herbruikbaar. Opblaasrictje Inclusief.

33.5 x 57 cm 500 / 50

Print Code: G(1)

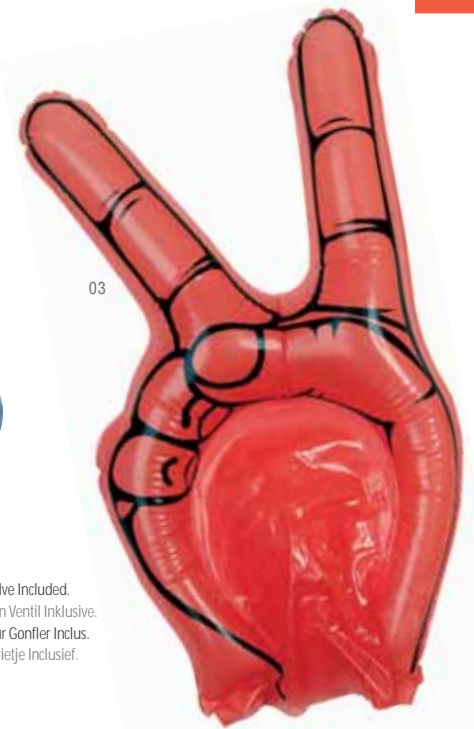



21



05 07 11 19 01 02 03 04 17 22

Tela 8096

Hand Fan. PP/ Polyester.
Fächer. PP/ Polyester.
Eventail. PP/ Polyester.
Waaier. PP/ Polyester.

43 x 23 cm

250 / 25

Print Code: D(1), E(2)



1202

BIG SIZE



100X70 CM

Kozma 4834

Neckerchief Wrap. Polyester 170T.
Halstuch. Polyester 170T.
Foulard Tissu. Polyester 170T.
Bandana. Polyester 170T.

120 x 80 cm

1000 / 10

Print Code: E(1), N(8), R

120X80 CM



02
01
19
04
05
07
03
11



02
01
19
04
05
07
03
22
17
21

Plus 3029

Neckerchief. Polyester 170T.
Halstuch. Polyester 170T.
Foulard. Polyester 170T.
Bandana. Polyester 170T.

100 x 70 cm

1000 / 10

Print Code: E(1), N(8), R



TALLY COUNTER
CONTADOR DE AFORO

NEW

Yoksy 6705

Tally Counter.
Taschenrechner.
Compteur.
Teller.

4 x 5.1 x 3.2 cm
Print Code: C(4)

200 / 50

NEW

Dolim 6691

Tally Counter. Button Battery Included.
Taschenrechner. Knopfzelle Inklusiv.
Compteur. Pile Bouton Inclus.
Teller. Knopcel Batterij Inclusief.

3.4 x 6.2 x 2 cm
Print Code: C(4)

200 / 50



1203



BACK PART DETAIL
DETALLE PARTE TRASERA

Lessep 5066

X-Banner. Steel and Fibreglass.
X-Banner. Stahl und Fiberglass.
X-Banner. Acier et Fibre de Verre.
X-Banner. Staal en Glasvezel.

60 x 160 cm 50
Print Code: Consult.



Drentox 5067

Roll Up. Aluminium.
Roll Up. Aluminium.
Roll Up. Aluminium.
Roll Up. Aluminium.

85 x 208 cm 6
Print Code: Consult.

ALUMINIUM





11



Plasker 5061

Bracelet. Polyester. Adjustable. Safety Catch.
Armband. Polyester. Verstellbaar. Sicherheitsverschluss.
Bracelet. Polyester. Ajustable. Fermeture Sécurité.
Armband. Polyester. Aanpasbaar. Veiligheidsluiting.

35 x 1.5 cm 2000 / 500

Print Code: D(1), R



1204



19



Festak 6199

Bracelet. Polyester. Adjustable. Safety Catch.
Armband. Polyester. Verstellbaar. Sicherheitsverschluss.
Bracelet. Polyester. Ajustable. Fermeture Sécurité.
Armband. Polyester. Aanpasbaar. Veiligheidsluiting.

35 x 1.5 cm 2000 / 500

Print Code: D(1)



05



Mendol 5060

Bracelet. Polyester. Adjustable.
Armband. Polyester. Verstellbaar.
Bracelet. Polyester. Ajustable.
Armband. Polyester. Aanpasbaar.

34.5 x 1.2 cm 2000 / 500

Print Code: D(1), R

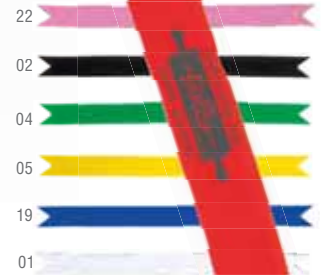

Neliam 4313

Multipurpose Bracelet. Polyester.
Mehrzweck Armband. Polyester.
Bracelet Multi-Usages. Polyester.
Multifunctionele Armband. Polyester.

40 x 3 cm 20000 / 1000

Print Code: D(1), R

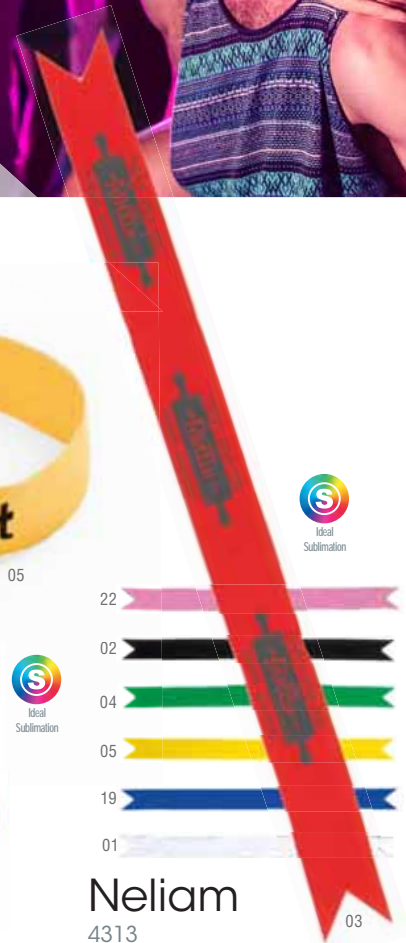



TYVEK®
MATERIAL

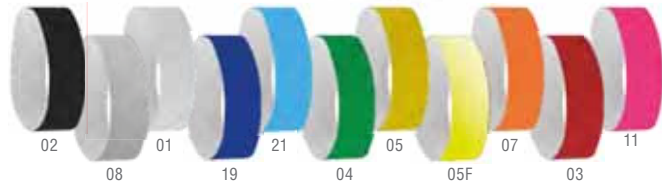

IDEAL FOR PRINTING - 10 PIECES
IDEAL PARA IMPRESIÓN - 10 PIEZAS

Events

3841

Bracelet. Tyvek® Material. One Size. Adult.
Armband. Tyvek® Material. Einheitsgröße. Erwachsene.
Bracelet. Tyvek® Material. Taille Unique. Adulte.
Armband. Tyvek® Material. Een Maat. Volwassen.

25.8 × 2.7 cm

20000 / 1000

Print Code: A(1)

Ankaran

6203

Bracelet. Tyvek® Material. One Size. Adult.
Armband. Tyvek® Material. Einheitsgröße. Erwachsene.
Bracelet. Tyvek® Material. Taille Unique. Adulte.
Armband. Tyvek® Material. Een Maat. Volwassen.

25.5 × 1.9 cm

20000 / 1000

Print Code: A(1)



Multi

9096

Bracelet. PVC. Adjustable. Safety Catch.
Armband. PVC. Verstellbar. Sicherheitsverschluss.
Bracelet. PVC. Ajustable. Fermeture Sécurité.
Armband. PVC. Aanpasbaar. Veiligheidsluiting.

24.3 × 2 cm

5000 / 100

Print Code: B(1)

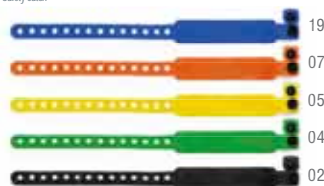

Mawi

3842

Bracelet. Tyvek® Material. One Size. Kids.
Armband. Tyvek® Material. Einheitsgröße. Kinder.
Bracelet. Tyvek® Material. Taille Unique. Enfant.
Armband. Tyvek® Material. Een Maat. Kind.

23 × 2.5 cm

20000 / 1000

Print Code: A(1)



TYVEK®
MATERIAL



IDEAL FOR PRINTING - 10 PIECES
IDEAL PARA IMPRESIÓN - 10 PIEZAS

Nopak

5454

Sublimation Lanyard. Polyester.
Sublimations Schlüsselband. Polyester.
Lanyard Sublimation. Polyester.
Sublimatie Lanyard. Polyester.

2.5 x 50 cm

500 / 100

Print Code: R

1206

Waylen

5852

Sublimation Bracelet. Polyester.
Sublimations Armband. Polyester.
Bracelet Sublimation. Polyester.
Sublimatie Armband. Polyester.

30 x 1.5 cm

Print Code: R



THE BEST PRICE
& THE BEST-SELLER



07 19 01 04 05 03

Kunel
6415

Lanyard. Polyester.
Schlüsselband. Polyester.
Lanyard. Polyester.
Lanyard. Polyester.

2 x 55 cm 600 / 100
Print Code: F(1), N(8), R



02



02 06 19 21 04 16 05 07 11 22 01 17

Neck
8780

Lanyard. Polyester.
Schlüsselband. Polyester.
Lanyard. Polyester.
Lanyard. Polyester.

2 x 50 cm 800 / 100
Print Code: F(1), N(8), R



1207



03



01 02 04 05 19

Alter
4344

Id Badge. PVC.
Namensschild. PVC.
Badge. PVC.
Id Badge. PVC.

11 x 9.5 cm 1000 / 100
Print Code: C(1)

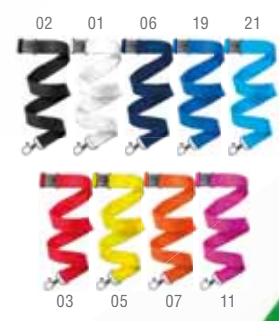

02 01 06 19 21
03 05 07 11



SAFETY CATCH / CIERRE
SEGURIDAD



04

Kappin
6102

Lanyard. Polyester. Safety Catch.
Schlüsselband. Polyester. Sicherheitsverschluss.
Lanyard. Polyester. Fermeture Sécurité.
Lanyard. Polyester. Veiligheidssluiting.

2 x 50 cm 800 / 100
Print Code: F(1), N(8), R



Zornit

5930

Id Badge Lanyard. Polyester/ PU. Safety Catch.
 Namensschild Schlüsselband. Polyester/ PU. Sicherheitsverschluss.
 Lanyard Porte-Badge. Polyester/ Similicuir. Fermeture Sécurité.
 Badge Lanyard. Polyester/ PU. Veiligheidsluiting.

7 × 60 cm 500 / 20

Print Code: D(1), F(1), N(8), R



01

ID BADGE INCLUDED
 IDENTIFICADOR INCLUIDO



02

SAFETY CATCH / CIERRE
 SEGURIDAD

EXTENDABLE 58 CM
 58 CM EXTENDIDO

1208



19

ID BADGE INCLUDED
 IDENTIFICADOR INCLUIDO

Maes

3709

Id Badge Lanyard. Polyester/ PVC.
 Namensschild Schlüsselband. Polyester/ PVC.
 Lanyard Porte-Badge. Polyester/ PVC.
 Badge Lanyard. Polyester/ PVC.

11 × 58 cm 1000 / 100

Print Code: G(1), D(1)



03



05



04



01



07

Lemer

6169

Lanyard. Polyester. Extendable. Safety Catch.
 Schlüsselband. Polyester. Ausziehbar. Sicherheitsverschluss.
 Lanyard. Polyester. Extensible. Fermeture Sécurité.
 Lanyard. Polyester. Verlengbaar. Veiligheidsluiting.

1.5 × 55 cm 600 / 50

Print Code: D(4), F(1), N(8), R, V



02



01





NEW



SAFETY CATCH / CIERRE SEGURIDAD

Merul

6885

Lanyard. Natural Cork/ Wheat Straw/ PP. Safety Catch.
 Schlüsselband. Naturkork/ Weizenstroh/ PP. Sicherheitsverschluss.
 Lanyard. Bouchon Naturel/ Paille de Blé/ PP. Fermeture Sécurité.
 Lanyard. Natuurlijk Kurk/ Tarwestro/ PP. Veiligheidsluiting.

2 x 50 cm
 Print Code: D(1)

1000 / 100



SAFETY CATCH / CIERRE SEGURIDAD



NEW

SAFETY CATCH / CIERRE SEGURIDAD

NEW

Bespal

6779

Lanyard. Natural Cork/ Wheat Straw/ PP. Safety Catch.
 Schlüsselband. Naturkork/ Weizenstroh/ PP. Sicherheitsverschluss.
 Lanyard. Bouchon Naturel/ Paille de Blé/ PP. Fermeture Sécurité.
 Lanyard. Natuurlijk Kurk/ Tarwestro/ PP. Veiligheidsluiting.

2 x 48 cm
 Print Code: F(1), N(8)

600 / 100

Troix

6778

Lanyard. 100% Cotton/ Wheat Straw/ PP. Safety Catch.
 Schlüsselband. 100% Baumwolle/ Weizenstroh/ PP. Sicherheitsverschluss.
 Lanyard. 100% Coton/ Paille de Blé/ PP. Fermeture Sécurité.
 Lanyard. 100% Katoen/ Tarwestro/ PP. Veiligheidsluiting.

2 x 52 cm
 Print Code: F(1), N(8)

500 / 100

Nespon

6416

Lanyard. Polyester RPET.
 Schlüsselband. Polyester RPET.
 Lanyard. Polyester RPET.
 Lanyard. Polyester RPET.

2 x 50 cm
 Print Code: F(1), N(8)

800 / 100

1209





Edward

5387

Plaque. Stainless Steel.
Plakette. Rostfreier Stahl.
Plaque. Acier Inox.
Plaque. Roestvrij Staal.

9 x 16 x 8 cm  50

 Print Code: F(4), L2

1210



Depor

4981

Keyring. Metal.
Schlüsselanhänger. Metall.
Porte-Clés. Métal.
Steutelhanger. Metaal.

2.2 x 5.5 x 0.4 cm  200 / 50

 Print Code: D(1), L1



Corum

3743

Medal. Metal.
Medaille. Metall.
Medaille. Métal.
Medaille. Metaal.

Ø 5 x 48 cm  500 / 50

 Print Code: F(1), L1



RO/PLATA

RO/BRONCE

ESP/PLATA

ESP/BRONCE



Solidario

9740

Pin Loop.
Soltschleife.
Pin's Ruban.
Speld.

Ø 1.8 cm 5000 / 1000

Print Code: B(1)



Timpax

6068

Keyring.
Schlüsselanhänger.
Porte-Clés.
Sleutelhanger.

4 × 6.2 × 0.3 cm 1000 / 100

Print Code: D(4)

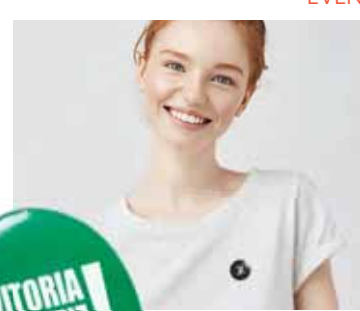

Turmi

3741

Pin.
Pin.
Pin.
Speld.

Ø 3 cm 4000 / 200

Print Code: B(1)

1211

PIN DOMING



minimum 300 pcs - mínimo 300 pcs
Full colour printing + Doming included,
set up cost not included.
Impresión a todo color + Doming incluido
cliché no incluido.



Batler

4607

Pin. Metal.
Pin. Metall.
Pin. Metal.
Speld. Metaal.

Consult. 1000 / 500

Print Code: Consult.



minimum 300 pcs - mínimo 300 pcs
Full colour printing + Doming included,
set up cost not included.
Impresión a todo color + Doming incluido
cliché no incluido.

Formix

4762

Pin.
Pin.
Pin.
Speld.

Consult. 5000 / 100

Print Code: Consult.

Roldus

5421

Flag Holder. Steel and Fibreglass/ Polyester.
 Fahnenträger. Stahl und Fibreglass/ Polyester.
 Support Drapeau. Acier et Fibre de Verre/ Polyester.
 Vlag Houder. Staal en Glasvezel/ Polyester.

120 x 220 cm 5

Print Code: H(1), R



19



GRAPHIC
55 x 115

COMPLETE STAND INCLUDED IN PRICE
 BASE COMPLETA INCLUIDA EN EL PRECIO



GRAPHIC
95 x 200



19

01

03

05



19

01

05



03



Heldex

5422

Backpack Flag. Aluminium and Fibreglass/ Polyester. Padded Back and Shoulder Straps.
 Fahne Rucksack. Aluminium und Fibreglass/ Polyester. Gepolsterter Rücken und Schultergurte.
 Sac à Dos Drapeau. Aluminium et Fibre de Verre/ Polyester. Dos et Bretelles Rembourrées.
 Vlag Rugzak. Aluminium en Glasvezel/ Polyester. Gewatteerde Achterzijde en Schouderbanden.

70 x 170 cm 10

Print Code: Consult.



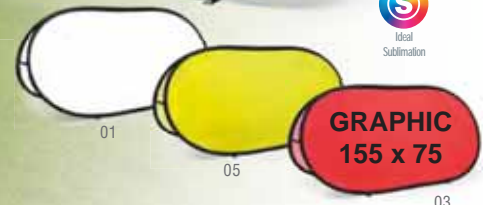

Seincop 5423

Banner. Steel/ Polyester.
Banner. Stahl/ Polyester.
Banner. Acier/ Polyester.
Banner. Staal/ Polyester.

161 x 82 cm 5
Print Code: Consult.

1213

REPLACEMENT - RECAMBIO - REPLACEMENT - RECAMBIO - REPLACEMENT - RECAMBIO

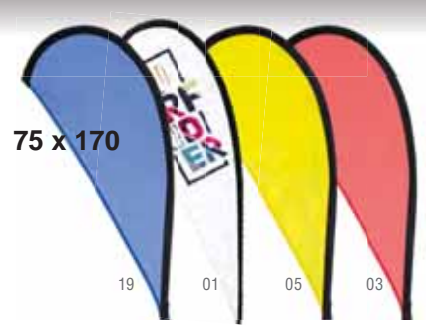

Roldus 5460

Flag. Polyester.
Fahne. Polyester.
Drapeau. Polyester.
Vlag. Polyester.

75 x 170 cm 50
Print Code: Consult.

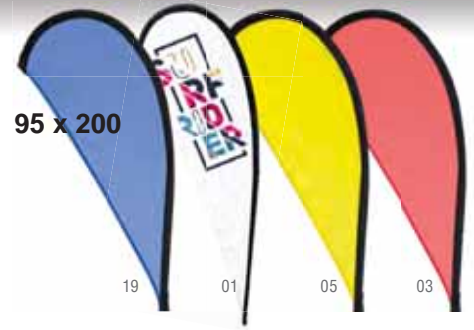

Pentho 5459

Flag. Polyester.
Fahne. Polyester.
Drapeau. Polyester.
Vlag. Polyester.

95 x 200 cm 50
Print Code: Consult.

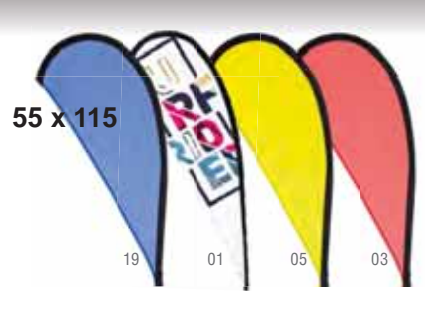

Heldex 5461

Flag. Polyester.
Fahne. Polyester.
Drapeau. Polyester.
Vlag. Polyester.

55 x 115 cm 50
Print Code: Consult.

FOLDABLE
PLEGABLE



480 ml



Match 5296

Bottle. PET. 480 ml.
Trinkflasche. PET. 480 ml.
Bidon. PET. 480 ml.
Fles. PET. 480 ml.

16 x 21 x 3.3 cm 400 / 50

Print Code: E(1)



1214

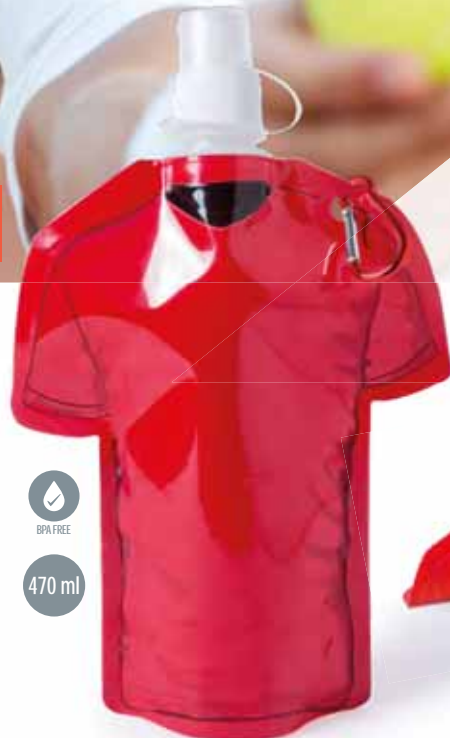

470 ml



FOLDABLE
PLEGABLE

Zablex 5297

03

Bottle. PET. 470 ml.
Trinkflasche. PET. 470 ml.
Bidon. PET. 470 ml.
Fles. PET. 470 ml.

17 x 25.5 x 3.3 cm 400 / 50

Print Code: E(1)



19

05

04

01



03

01

07

19

04

Basley 6443

Pen.
Kugelschreiber.
Stylo.
Pen.

Ø 2 x 15.3 cm 1000 / 50

Print Code: B(4)





Naiper
5889

Drawstring Bag. Polyester 210D.
Rucksack. Polyester 210D.
Sac à Dos. Polyester 210D.
Rugzak. Polyester 210D.

42 x 43 cm

Print Code: F(1), N(8)

300 / 20



C



G



30 x 30 cm
245 g/m²

TOWEL

D



C

G

B

Spica
5292

Towel. 100% Cotton 245 g/ m². Folded Ø 4,5 cm.
Handtuch. 100% Baumwolle 245 g/ m². Faltung Ø 4,5 cm.
Serviette. 100% Coton 245 g/ m². Pliée Ø 4,5 cm.
Handdoek. 100% Katoen 245 g/ m². Gevouwen Ø 4,5 cm.

30 x 30 cm

Print Code: D(1), N(8)

300

1215



KIDS

19

03

05

04

02

01



03

Trokyn
6449

Drawstring Bag. Polyester 210D.
Rucksack. Polyester 210D.
Sac à Dos. Polyester 210D.
Rugzak. Polyester 210D.

31.5 x 42 cm

Print Code: F(1), R

300 / 10

Paxer
6632

Drawstring Bag. Polyester 210D.
Rucksack. Polyester 210D.
Sac à Dos. Polyester 210D.
Rugzak. Polyester 210D.

56 x 42 cm

Print Code: F(1), N(8), R

300 / 10



01

02

04

05

07

19



PHOTO BOOTH



SET 5 PIECES

Carrey
5471

Selfie Set. 5 Pieces.
Selfie Set. 5 Stuks.
Set Selfie. 5 Pieces.
Selfie Set. 5 Stuks.

20 × 25 cm 200 / 20

Print Code: B(1)



A



Registered design

Emoty
5406

Selfie Pai Pai.
Selfie Pai Pai.
Selfie Pai Pai.
Selfie Pai Pai.

18 × 27 cm 200 / 20

Print Code: B(1)

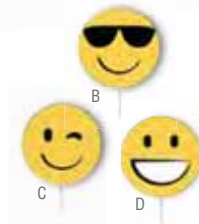

B

C

D

Kraliem

5472

Selfie.
Selfie.
Selfie.
Selfie.

17 × 21 cm 2000 / 200

Print Code: B(1)





21



01

Braz
3575

Hat. Polyester.
Hut. Polyester.
Chapeau. Polyester.
Hoed. Polyester.

Consult.
Print Code: E(1)

200 / 25

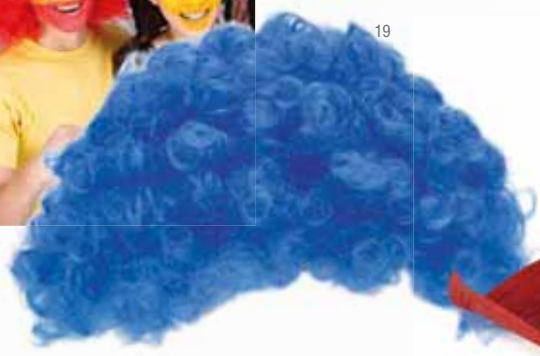

19



13

1217



03

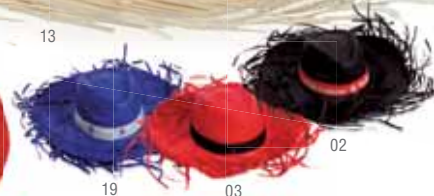

02

19

03

Genax

4127

Wig. Polyester.
Perücke. Polyester.
Perruque. Polyester.
Pruik. Polyester.

Consult.
Print Code: Consult.

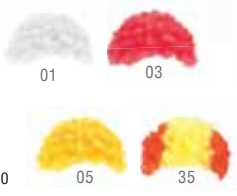

01

03

05

35

Splash

9195

Hat. Straw.
Hut. Stroh.
Chapeau. Paille.
Hoed. Stro.

Consult.
Print Code: Consultar

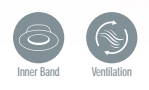

250



19

05

02

04

Filagarchado

8088

Hat. Straw.
Hut. Stroh.
Chapeau. Paille.
Hoed. Stro.

Consult.
Print Code: Consultar



250

IDEAL FOR DIGITAL PRINTING
IDEAL PARA IMPRESIÓN DIGITAL



Zamur

4234

Glasses.
Brille.
Lunettes.
Bril.

Consult. 300 / 10

Print Code: D(4), W



1218



03

Lenny

4653

Binoculars. Cardboard.
Fernglas. Pappe.
Jumelles. Carton.
Verrekijker. Karton.

10.3 x 4.5 x 8 cm 500 / 100

Print Code: C(1)

FOLDABLE/
PLEGABLE



19

01

05

Galvis

4803

Sunglasses. UV400 Protection.
Sonnenbrille. UV400 Schutz.
Lunettes de Soleil. Protection UV400.
Zonnebril. UV400 Bescherming.

Consult.

Print Code: D(2)

300 / 10



03



22

WITHOUT LENSES
SIN CRISTALES



02



01

WITHOUT LENSES
SIN CRISTALES

Martyns

3609

No Lens Glasses.
Brillengestell.
Monture Lunettes.
Glasloze Brill.

Consult. 400 / 10
Print Code: D(4)

POUCH INCLUDED
FUNDA INCLUIDA



01

19

03

Floid

7004

No Lens Glasses.
Brillengestell.
Monture Lunettes.
Glasloze Brill.

Consult. 400 / 10
Print Code: D(4)



05

03

19

1219



Options

5049

Frame.
Brillengestell.
Monture de Lunettes.
Brillemontuur.

Consult. 300 / 10
Print Code: D(4)

300 / 10



Video

2 PIECES



03



Options

5050

Lenses. UV400 Protection.
Lente. UV400 Schutz.
Lentilles. Protection UV400.
Lenzen. UV400 Bescherming.

Consult.
Print Code: Consult.

300 / 10

Video



COMBINE AS YOU PLEASE
COMBINALAS COMO QUIERAS

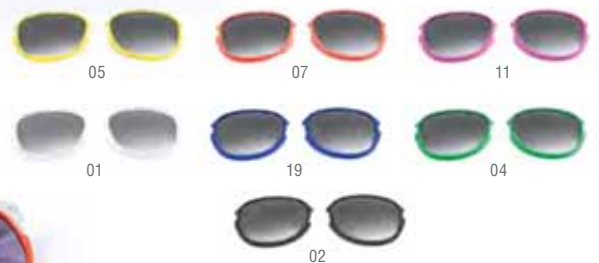

05

07

11

01

19

04

02



Manek

6107

Coin.
Münze.
Monnaie.
Muntstuk.

Ø 3 × 0.2 cm 10000 / 2000

Print Code: A(1)



FLEXIBLE ●●●●

Frinly

6595

Lanyard Cup Holder. Polyester/ Sillicone.
Schlüsselband Getränkehalter. Polyester/ Silikon.
Lanyard Porte Verre. Polyester/ Sillicone.
Lanyard Getränkehalter. Polyester/ Silliconen.

6 × 45 cm 800 / 100

Print Code: F(1), N(8), R



1220



Yobok

4521

Multipurpose Bag. Non-Woven.
Mehrzwecktasche. Non-Woven.
Fourre-Tout. T.N.T..
Multifunctioneel Tasje. Non-Woven.

17 × 22 × 6.2 cm 500 / 100

Print Code: D(1)



19

650 ml



BPA FREE



Party's

4702

Cup. PET. 650 ml.
Trinkbecher. PET. 650 ml.
Verre. PET. 650 ml.
Beker. PET. 650 ml.

Ø 8.9 × 42 cm 50

Print Code: D(1)



18



100% BIODEGRADABLE
AND COMPOSTABLE



13

500 ml



FROSTED



500 ml



400 ml

FROSTED

Hecox
6161

Cup. Paper/ PLA 100% Compostable. 500 ml.
Trinkbecher. Papier/ PLA 100% Kompostierbar. 500 ml.
Verre. Papier/ PLA 100% Compostable. 500 ml.
Beker. Paper/ PLA 100% Composteerbaar. 500 ml.

📏 09 × 13.6 cm

📦 1000 / 50

🌈 Print Code: C(1)

Nirmal
2554

Cup. PP. 500 ml.
Trinkbecher. PP. 500 ml.
Verre. PP. 500 ml.
Beker. PP. 500 ml.

📏 08.7 × 11.8 cm

📦 384 / 16

🌈 Print Code: C(1)

Yonrax
2555

Cup. PP. 400 ml.
Trinkbecher. PP. 400 ml.
Verre. PP. 400 ml.
Beker. PP. 400 ml.

📏 07.5 × 14 cm

📦 490 / 14

🌈 Print Code: C(1)

1221



500 ml



Ginbert
2494

Cup. PP. 500 ml.
Trinkbecher. PP. 500 ml.
Verre. PP. 500 ml.
Beker. PP. 500 ml.

📏 09.2 × 11.6 cm 📦 500 / 25

🌈 Print Code: C(1)



300 ml

Pevic
2493

Long Drink Glass. PP. 300 ml.
Longdrinkglas. PP. 300 ml.
Verre. PP. 300 ml.
Long Drink Glas. PP. 300 ml.

📏 05.9 × 15.2 cm 📦 500 / 10

🌈 Print Code: C(1)



19

03

CHRISTMAS



Helfox
6289

Cup. Ceramic/ Silicone. 400 ml. Individual Presentation.
Trinkbecher. Keramik/ Silikon. 400 ml. Individuelle Präsentation.
Verre. Céramique/ Silicone. 400 ml. Présentation Individuelle.
Beker. Keramiek/ Siliconen. 400 ml. Individuele Presentatie.

■■■■■■■■ 0 9.5 × 14.9 cm

■■■■■■■■ Print Code: F(1)

📦 36



Sokin
6663

Christmas Tree. Wood.
Weihnachtsbaum. Holz.
Arbre de Noël. Bois.
Kerstboom. Hout.

■■■■■■■■ 11.5 × 17.7 × 3.1 cm

■■■■■■■■ Print Code: D(4), L1

📦 400 / 100



NEW

790 ml

BrandName
THE COMPANY GROUP



Yalok
 6665

Bottle. Stainless Steel. 790 ml. Individual Presentation.
 Trinkflasche. Rostfreier Stahl. 790 ml. Individuelle Präsentation.
 Bidon. Acier Inox. 790 ml. Présentation Individuelle.
 Fles. Roestvrij Staal. 790 ml. Individuele Presentatie.

||||||| Ø 7.4 × 25.7 cm

📦 50

🌈 Print Code: F(1)



1223



NEW

400 ml

BrandName
THE COMPANY GROUP



Raven
 6664

Bottle. Aluminium. 400 ml. Individual Presentation.
 Trinkflasche. Aluminium. 400 ml. Individuelle Präsentation.
 Bidon. Aluminium. 400 ml. Présentation Individuelle.
 Fles. Aluminium. 400 ml. Individuele Presentatie.

||||||| Ø 6.6 × 17.5 cm

📦 100 / 20

🌈 Print Code: F(1)



370 ml

Sorbux

5193

Mug. Ceramic. 370 ml. Individual Presentation.
Tasse. Keramik. 370 ml. Individuelle Präsentation.
Tasse. Céramique. 370 ml. Présentation Individuelle.
Mok. Keramik. 370 ml. Individuelle Presentatie.

Ø 8.5 × 10 cm

36

Print Code: F(4)



350 ml

Nuglex

5192

Mug. Ceramic. 350 ml. Individual Presentation.
Tasse. Keramik. 350 ml. Individuelle Präsentation.
Tasse. Céramique. 350 ml. Présentation Individuelle.
Mok. Keramik. 350 ml. Individuelle Presentatie.

Ø 9.1 × 10.2 cm

36

Print Code: F(4)



1224

SPECIAL LASER ENGRAVING

i This cup has an outer coating specially designed for laser engraving, which will ensure that your advertising or brand is perfectly engraved in an elegant and durable way.

Este taza tiene un recubrimiento exterior especialmente diseñado para grabado láser, con el que conseguirá que su publicidad o marca quede perfectamente grabada de forma elegante y duradera.



Renkur

350 ml

23

09

Renkur

5984

Mug. Ceramic. 350 ml. Individual Presentation.
Tasse. Keramik. 350 ml. Individuelle Präsentation.
Tasse. Céramique. 350 ml. Présentation Individuelle.
Mok. Keramik. 350 ml. Individuelle Presentatie.

Ø 8.2 × 9.6 cm

36

Print Code: F(4), L2

SPECIAL LASER ENGRAVING CO2 & SUBLIMATION

i

This glass has an external coating specially designed for laser engraving and sublimation printing, with which you will see your advertising or brand printed in a striking and lasting way.

Este vaso tiene un recubrimiento exterior especialmente diseñado para grabado láser e impresión en sublimación, con las que conseguirá que su publicidad o marca quede impresa de forma impactante y duradera.



Raptol

480 ml

09

23

SUBLIMATION PRINTING /
RESULTADO EN SUBLIMACIÓN

LASER ENGRAVING /



HQ
HIGH QUALITY

Cestilox

5900

Christmas Hat. Polyester.
Weihnachtsmütze. Polyester.
Bonnet Papa Noël. Polyester.
Kerstmutz. Polyester.

30 x 42 cm

200 / 10

Print Code: D(1), N(8)



23

Shiny

9833

Christmas Hat. Polyester.
Weihnachtsmütze. Polyester.
Bonnet Papa Noël. Polyester.
Kerstmutz. Polyester.

28 x 40 cm

250 / 10

Print Code: D(1), N(8)



09



03

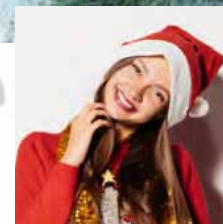

07

19

04

02

01

05

Papa Noel

8622

Christmas Hat. Polyester.
Weihnachtsmütze. Polyester.
Bonnet Papa Noël. Polyester.
Kerstmutz. Polyester.

30 x 43 cm

200 / 10

Print Code: D(1), N(8)



Huntix

4802

Glasses. UV400 Protection.
Brille. UV400 Schutz.
Lunettes. Protection UV400.
Bril. UV400 Bescherming.

Consult.

300 / 10

Print Code: E(4)



4 PIECES
+ CHRISTMAS CARD
+ BAG



Zilea

5568

Selfie Set. 4 Pieces.
Selfie Set. 4 Stück.
Set Selfie. 4 Pièces.
Selfie Set. 4 Stuks.

20.3 x 15.3 cm

200 / 20

Print Code: C(1)





Fantasy

9537

Figures. Polyester.
Figuren. Polyester.
Figurines. Polyester.
Beeldjes. Polyester.

9 × 9 × 0.3 cm
Print Code: C(1)

500 / 100



SET
2 PIECES



Rimol

5898

Christmas Decoration Set. Non-Woven. 2 Pieces.
Ornament Set. Non-Woven. 2 Stück.
Set Ornement Noël. T.N.T. 2 Pièces.
Kerstdecoratie Set. Non-Woven. 2 Stuks.

8 × 8 × 0.8 cm
Print Code: C(1)

1000 / 100



SET
12 PIECES

Artball

3360

Christmas Decoration Set. 12 Pieces. 4 Colours.
Ornament Set. 12 Stück. 4 Farben.
Set Ornement Noël. 12 Pièces. 4 Couleurs.
Kerstdecoratie Set. 12 Stuks. 4 Kleuren.

11.8 × 3 × 9 cm

200 / 20

Print Code: D(1)



SET 2 PIECES



Tainox

5105

Christmas Decoration Set. Polyester. 2 Pieces.
Ornament Set. Polyester. 2 Stück.
Set Ornement Noël. Polyester. 2 Pièces.
Kerstdecoratie Set. Polyester. 2 Stuks.

15 × 17 × 1.5 cm

1000 / 100

Print Code: C(1)



SET
6 PIECES

308



Yenkit

5107

Christmas Decoration Set. 6 Pieces.
Ornament Set. 6 Stück.
Set Ornement Noël. 6 Pièces.
Kerstdecoratie Set. 6 Stuks.

10 x 18 x 5 cm
Print Code: C(1)

100



01



B

F

9,5 X 9,5 X 0,5 CM

8,8 X 10 X 0,5 CM

Vondix

6349

Christmas Decoration. Slate.
Ornament. Schiefer.
Ornement Noël. Ardoise.
Kerstdecoratie. Leisteen.

Consult.
Print Code: C(1)

100 / 25



1227



Lupok

6249

Bottle Lights. 10 Leds. Button Batteries Included.
Lichtstecker. 10 Leds. Knopfzellen Inklusiv.
Bec Lumineux. 10 Leds. Piles Bouton Inclus.
Sfeerlichtjes. 10 Leds. Knopcel Batterijen Inclusief.

Ø 2.2 x 4.8 cm
Print Code: C(1)

500 / 100



Rupol

6276

Christmas Decoration. Wood.
Ornament. Holz.
Ornement Noël. Bois.
Kerstdecoratie. Hout.

Ø 10 x 1 cm
Print Code: C(4), L1

200 / 100

i PIEZAS UNICAS PROCEDENTES DE CORTE DE MADERA NATURAL. SU TEXTURA, COLOR, TAMAÑO Y GROSOR PUEDEN VARIAR
UNIQUE PIECES FROM NATURAL CUTS OF WOOD. THE TEXTURE, COLOR, SIZES AND THICKNESS MAY VARY.



Shoilen

6310

Wish Bottle. Glass.
Wunsch-Dose. Glas.
Bouteille à Souhaits. Verre.
Wens fles. Glas.

Ø 3 x 7.4 cm
Print Code: E(1), L1

200 / 50



WRITE YOUR MESSAGES AND WISHES /
ESCRIBE TUS MENSAJES Y DESEOS

BACK SIDE /
PARTE TRASERA

A

B

C



Sasky

3800

Ball. Glass.
Kugel. Glas.
Sphere. Verre.
Sneeuw-Bol. Glas.

Ø 5 × 6.5 cm

Print Code: E(1)

100 / 25



Poxtal

4666

Christmas Card.
Weihnachtskarte.
Lettre Noël.
Kerstkaart.

16 × 11 cm

Print Code: C(1)

1000 / 50

Goslak

5503

Christmas Gift Tag.
Weihnachtsverzierung.
Ornement Noël.
Kerstcadeau Aanhang Kaartje.

7 × 10 cm

Print Code: A(4)

2000 / 200



19

Pines

3363

Christmas Tree.
Weihnachtsbaum.
Arbre de Noël.
Kerstboom.

Ø 15 × 30 cm

Print Code: E(1)

03

02

01

200 / 50



H

APPLE/ CINNAMON

F



100 / 25

Krum

6284

Aromatic Diffuser. Glass. Apple Cinnamon Aroma. 30 ml.
Duft Diffusor. Glas. Zimtapfel-Aroma. 30 ml.
Diffuseur Aromatique. Verre. Senteur Pomme Cannelle. 30 ml.
Luchtverfrisser. Glas. Appel Cinnamon Aroma. 30 ml.

3.7 × 14 × 3.7 cm

Print Code: E(1)

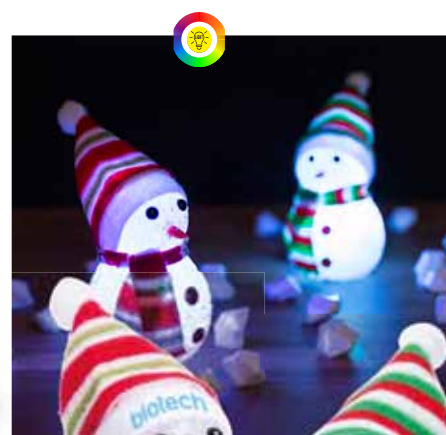

03



04

Fadon

5896

Figure. Led Lights. Button Batteries Included.
Figure. Led Lichter. Knopfzellen Inklusiv.
Figurine. Lumières Led. Piles Bouton Inclus.
Beeldje. Led Lichten. Knopcel Batterijen Inclusief.

Ø 5.9 × 13 cm

Print Code: D(1)

300

Video





Trivak

6792

Aromatic Candle. Glass/ Bamboo. Vanilla Aroma.
 Duftkerze. Glas/ Bambus. Vanille Duft.
 Bougie Aromatique. Verre/ Bambou. Arôme Vanille.
 Geurkaars. Glas/ Bamboe. Vanille Aroma.

Ø 7 × 8.7 cm

50

Print Code: E(1), L1



Vanilla



9,5 X 1,5 X 8,8 CM

F

9,5 X 1,5 X 9,5 CM

Deram

6279

Candle. Wood.
 Kerze. Holz.
 Bougie. Bois.
 Kaars. Hout.

Consult.

Print Code: E(1), L1

200 / 100



19



Ocean

Tepor

6348

Aromatic Candle. Glass/ Natural Cork.
 Duftkerze. Glas/ Naturkork.
 Bougie Aromatique. Verre/ Bouchon Naturel.
 Geurkaars. Glas/ Natuurlijk Kurk.

Ø 5.6 × 7.6 cm

100 / 25

Print Code: E(1), L1



01



Vanilla

03



Strawberry

1229



23



02

Coffee



09

Pine



Strawberry



01

Lavander



23

Zamir

5595

Candle. Glass.
 Kerze. Glas.
 Bougie. Verre.
 Kaars. Glas.

Ø 5.6 × 6.8 cm

Print Code: E(1)

100



Snifik

5166

Candle Set. Glass. 8 Pieces.
 Kerzen Set. Glas. 8 Stück.
 Set Bougies. Verre. 8 Pièces.
 Kaarsen Set. Glas. 8 Stuks.

19.5 × 2.5 × 10.2 cm

Print Code: E(1)

50

Nettax

5828

Aromatic Candle. Glass.
 Duftkerze. Glas.
 Bougie Aromatique. Verre.
 Geurkaars. Glas.

Ø 5.6 × 6.7 cm

Print Code: F(1), L1

50



Betox

4667

Advent Calendar. Non-Woven.
Adventskalender. Non-Woven.
Calendrier Avent. T.N.T.
Advent Kalender. Non-Woven.

38 x 40 cm

Print Code: D(1)

250 / 10



Saspi

3797

Sock. Polyester.
Socle. Polyester.
Chaussette. Polyester.
Sok. Polyester.

20 x 32 cm

Print Code: D(1), N(8)

200 / 10



03



19



04



02

Zisuk

4258

Pouch. Polyester.
Hülle. Polyester.
Étui. Polyester.
Hoes. Polyester.

8 x 19 cm

Print Code: D(1), N(8)

1000 / 50



130 x 160 cm
200 g/m²

Landak

3882

Blanket. Polar Fleece 200 g/ m2. Anti-Pilling.
Decke. Polar Fleece 200 g/ m2. Anti-Pilling.
Couverture. Polaire 200 g/ m2. Anti-Pilling.
Deken. Polar Fleece 200 g/ m2. Anti-Pilling.

130 x 160 cm

Print Code: G(1), N(8), O, P

20



Camiz

5918

Sock. Polyester. One Size 36-43. Anti-Slip.
Socken. Polyester. Einheitsgröße 36-43. Rutschfest.
Chaussette. Polyester. Taille Unique 36-43. Antidérapante.
Sok. Polyester. Een Maat 36-43. Anti-Slip.

Consult.

Print Code: N(8)

100 / 10

ANTI SLIP /
ANTIDESLIZANTE



Anti Slip



Rupler

5598

Kids Christmas Hat. Polyester/ Non-Woven. 4 Crayons Included.

Kinder Weihnachtsmütze. Polyester/ Non-Woven. 4 Wachsmalstifte Inklusiv.

Bonnet Papa Noël Enfant. Polyester/T.N.T.. 4 Crayons Inclus.

Kinder Kerstmuts. Polyester/ Non-Woven. 4 Krijtjes Inclusief.

27 × 40.5 cm

300 / 50

Print Code: F(1), N(8)

SET
6 PIECES



Bancax

5899

Set. Wood. 3 Pieces. 3 Markers Included.

Set. Holz. 3 Stück. 3 Marker Inklusiv.

Set. Bois. 3 Pièces. 3 Marqueurs Inclus.

Set. Hout. 3 Stuks. 3 Stiften Inclusief.

7.2 × 9.2 × 1.6 cm

500 / 50

Print Code: C(1)

1231



Wistick

5140

Bag. Non-Woven. 5 Crayons Included.

Tasche. Non-Woven. 5 Wachsmalstifte Inklusiv.

Sac. T.N.T.. 5 Crayons Inclus.

Tas. Non-Woven. 5 Krijtjes Inclusief.

20.5 × 22 cm

100 / 50

Print Code: G(1)



Plicom

5141

Stocking. Non-Woven. 5 Crayons Included.

Socken. Non-Woven. 5 Wachsmalstifte Inklusiv.

Chaussette. T.N.T.. 5 Crayons Inclus.

Sok. Non-Woven. 5 Krijtjes Inclusief.

19 × 29.5 cm

100 / 50

Print Code: G(1)



Kertran

5941

Drawstring Bag. Non-Woven. 4 Crayons Included.

Rucksack. Non-Woven. 4 Wachsmalstifte Inklusiv.

Sac à Dos. T.N.T.. 4 Crayons Inclus.

Rugzak. Non-Woven. 4 Krijtjes Inclusief.

25 × 30 cm

200 / 50

Print Code: G(1)





Miffet

5940

Pencil. Wood. Eraser Included.
Bleistift. Holz. Radiergummi Inklusiv.
Crayon. Bois. Gomme Inclus.
Potlood. Hout. Gum Inclusief.

1111111 2.7 x 19 x 1.3 cm

300 / 50

Print Code: B(4)



Unsharpened



Flop

5219

Eraser Set. 4 Pieces.
Radiergummi Set. 4 Stück.
Set Gommies. 4 Pièces.
Gummen Set. 4 Stuks.

1111111 10 x 10.5 x 0.7 cm

300 / 50

Print Code: D(1)



03

Lirex

3992

Pencil. Wood.
Bleistift. Holz.
Crayon. Bois.
Potlood. Hout.



Unsharpened

1111111 3.5 x 22.5 x 0.7 cm

500 / 50

Print Code: B(4)



04

1232



Yule

4067

Pen.
Kugelschreiber.
Stylo.
Pen.

1111111 Ø 1 x 14.5 cm

1000 / 50

Print Code: A(4)



Light

Galiz

4289

Pen. Led Lights. Button Batteries Included.
Kugelschreiber. Led Lichter. Knopfzellen Inklusiv.
Stylo. Lumières Led. Piles Bouton Inclus.
Pen. Led Lichten. Knoopcel Batterijen Inclusief.

1111111 Ø 3.3 x 20.3 cm

500 / 50

Print Code: B(4)



03



04

Zarki

4794

Pen Keyring.
Schlüsselanhänger Kugelschreiber.
Porte-Clés Stylo.
Pen-Sleutelhanger.

1111111 5 x 13.5 x 0.6 cm

1000 / 100

Print Code: B(1)



B

Tidil

5466

Pen.
Kugelschreiber.
Stylo.
Pen.

1111111 Consult.

Print Code: B(4)



C

1000 / 100



Miltok

5470

Pen. Polyester.
Kugelschreiber. Polyester.
Stylo. Polyester.
Pen. Polyester.

7 x 17 x 3 cm

Print Code: N(8)

1000 / 100



1233



Glenda

5110

Keyring Teddy. Polyester.
Schlüsselanhänger Teddy. Polyester.
Porte-Clés Peluche. Polyester.
Sleutelhanger Teddybeer. Polyester.

9 x 10 x 6 cm

Print Code: E(1)

500 / 20



Tridux

4814

Keyring. PVC.
Schlüsselanhänger. PVC.
Porte-Clés. PVC.
Sleutelhanger. PVC.

4.2 x 5.8 x 0.3 cm

Print Code: E(1)

1000 / 50



Pudox

5892

Opener Keyring. Aluminium.
Schlüsselanhänger Flaschenöffner. Aluminium.
Porte-Clés Ouvre Bouteille. Aluminium.
Sleutelhanger Opener. Aluminium.

5.5 x 5.3 x 0.3 cm

Print Code: D(4), L1

1000 / 200



Hansen

5469

Keyring. Polyester.
Schlüsselanhänger. Polyester.
Porte-Clés. Polyester.
Sleutelhanger. Polyester.

6 x 7.3 x 3.2 cm

Print Code: N(8)

1000 / 100





Cheers

3543

Glass Identifier. Metal. 6 Pieces.
Glas Bezeichner. Metall. 6 Stück.
Identificateur de Verres. Métal. 6 Pièces.
Glas Herkenner. Metaal. 6 Stuks.

19.5 × 2.2 × 6.2 cm 100 / 20
Print Code: F(1), L1



Kandax

4844

Glass Identifier. Silicone. 9 Pieces.
Glas Bezeichner. Silikon. 9 Stück.
Identificateur de Verres. Silicone. 9 Pièces.
Glas Herkenner. Siliconen. 9 Stuks.

10 × 18.5 × 1.4 cm 300 / 50
Print Code: D(1)



Pressox

4499

Stencil. Stainless Steel.
Untersetzer. Rostfreier Stahl.
Pochoir. Acier Inox.
Sjabloon. Roestvrij Staal.

8.1 × 0.9 × 8.1 cm 150 / 25
Print Code: F(1), L1

1234



Kunax

4260

Chair Cover. Polyester.
Stuhlhülle. Polyester.
Housse de Chaise. Polyester.
Stoel Hoes. Polyester.

50 × 62 cm 100 / 20
Print Code: F(1), N(8)



Mandi

3754

Coaster Set. Polyester. 4 Pieces.
Untersetzer Set. Polyester. 4 Stück.
Set Sous-Verre. Polyester. 4 Pièces.
Onderzetter Set. Polyester. 4 Stuks.

10 × 0.3 cm 500 / 50
Print Code: N(8)



Douki

4261

Bottle Set. Polyester.
Flaschen Set. Polyester.
Set Bouteilles. Polyester.
Flessenset. Polyester.

15 × 28 × 0.5 cm 250 / 10
Print Code: D(1), N(8)



Palmi

3375

Foldable Bag. Polyester 190T.
 Falltbare Tasche. Polyester 190T.
 Sac Pliable. Polyester 190T.
 Opvouwbare Tas. Polyester 190T.

■■■■■■ 38 x 39 cm

🎁 Print Code: E(1), G(1), H(1), R



🎁 400 / 10

Rous

3380

Foldable Bag. Polyester 190T.
 Falltbare Tasche. Polyester 190T.
 Sac Pliable. Polyester 190T.
 Opvouwbare Tas. Polyester 190T.

■■■■■■ 40 x 42 cm

🎁 Print Code: F(1), G(1)



🎁 400 / 10



MAGNET



Kairos

4810

Magnet. 40 Sheets Notepad. Pencil Included.
 Magnet. 40 Seiten Notizblock. Bleistift Inklusiv.
 Magnet. Bloc 40 Feuilles. Crayon Inclus.
 Magneet. 40 Blaadjes Notepad. Potlood Inclusief.

■■■■■■ 10 x 20 cm

🎁 Print Code: C(2)

🎁 200 / 50

Berna

3984

Mold. Silicone. Maximum Temperature 240°C.
 Backform. Silikon. Maximale Temperatur. 240°C.
 Moule. Silicone. Température Maxi 240°C.
 Vorm. Siliconen. Maximum Temperatur 240°C.

■■■■■■ 10 x 2.2 x 13.5 cm

🎁 Print Code: F(1)

🎁 500 / 100

Krocان

5151

Timer.
 Eieruhr.
 Minuteur.
 Eierwekker.

■■■■■■ Ø 5.5 x 9.2 cm

🎁 Print Code: E(4)



🎁 100 / 20

Hadock

5467

Magnet. Polyester.
 Magnet. Polyester.
 Magnet. Polyester.
 Magneet. Polyester.

■■■■■■ 7 x 12 cm

🎁 Print Code: N(8)



MAGNET

🎁 1000 / 50

OUTLET

SENSATIONAL

SINGLE PRICES FOR ANY QUANTITY

Smart Watch. Silicone Strap. Bluetooth Connection. 1,44" LCD Screen. Multilingual. USB Rechargeable. Cable Included.

25.5 × 4 × 1 cm 50 Print Code: I(1), L2

Daril
5143



Earphones. Aluminium. Bluetooth Connection. USB Rechargeable. Cable Included.

9.5 × 3.7 × 2.8 cm 50 Print Code: E(4), L1

Flister
6225



Charger. Wireless. Cable Included.

10.5 × 10.4 × 9 cm 20 Print Code: F(4)

Lersen
5770



Speaker. Bluetooth Connection. Power 3W. USB Rechargeable. Cable Included.

4.3 × 5.4 cm 100 / 50 Print Code: F(4)

Tidian
4954



Power Bank Speaker. 4200 mAh. USB Output. Micro USB Input. Bluetooth Connection. Power 3W. USB Rechargeable. Cable Included.

4.4 × 10 cm 50 Print Code: J(1)

Liornel
5161



Speaker Microphone. Smart Leds. Bluetooth Connection. Power 3W. USB Rechargeable. Cable Included.

9 × 26 cm 30 Print Code: J(1)

Varelion
5323

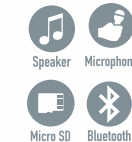

Charger. Wireless. Fast Charger. 3 USB Outputs and 1 Type C Output. 10000 mA. Cable Included.

22 x 7.2 x 15 cm

20

Print Code: G(1)

Volution

5768



FAST CHARGE

TYPE C



Charger. 4 USB Outputs. 6800 mA. Cable Included.

15.5 x 7.8 x 12.7 cm

20 / 10

Print Code: G(4)

Zealand

5769



Power Bank. 2000 mAh. USB Output. Micro USB Input. Cable Not Included.

3.1 x 8.6 x 3.9 cm

100 / 25

Print Code: E(4)

Versile

5327



05

01

03

19



2000 mAh

Power Bank. 20000 mAh. Fast Charger. 3 USB and 1 Type C Output. Micro USB, Type C and Lightning Inputs. Cable Not Included.

9.6 x 20 x 1.4 cm

30 / 10

Print Code: F(1)

Bradfor

5784



01

02

20000 mAh

MICRO USB

TYPE-C IN / OUT

OUTPUT 2



LIGHTNING

FAST CHARGE

OUTPUT 3



Power Bank. 2200 mAh. USB Output. Micro USB Input. Cable Included.

2.5 x 9.9 x 2.5 cm

100 / 25

Print Code: D(4), W

Kinsper

5241



2200 mAh



Video

Power Bank. Wood. 2200 mAh. USB Output. Micro USB Input. Cable Included.

2.4 x 10.2 x 2.4 cm

100 / 25

Print Code: E(4)

Roblex

4957

2200 mAh



Power Bank. Aluminium. 6 Leds. 2600 mAh. USB Output. Micro USB Input. Cable Included.

2.1 x 7 x 3.4 cm

50 / 25

Print Code: E(4), L2

Rockal

4943

2000 mAh



23

Power Bank. 1 Led. 2200 mAh. USB Output. Micro USB Input. Cable Included.

2.6 x 11 x 2.3 cm

100 / 25

Print Code: D(4)

Hicer

4741

2200 mAh



01

03

11

19

05

Power Bank Set. Power Bank 2200 mAh, USB Output, Micro USB Input. USB Chargers 1000 mA. Cable Included.

11.5 x 4 x 7.5 cm

100 / 50

Print Code: E(1)

Rebex

4849

2200 mAh



07

01

02

03

11

19

04

05

Charger. Micro USB Connection.

50 x 1.5 x 0.8 cm 500 / 50 Print Code: D(4)

Yancop

4952



Keyring Charger. Micro USB Connection.

1.5 x 11 x 1.1 cm 300 / 50 Print Code: C(1)

Pirten

5065



Charger Synchronizer. Micro USB and Type C Connection.

16.5 x 3 x 1.6 cm 500 / 50 Print Code: E(4)

Sanwel

5365



Charger Synchronizer.

9 x 2 x 2.5 cm 200 / 50 Print Code: D(4)

Enio

3748

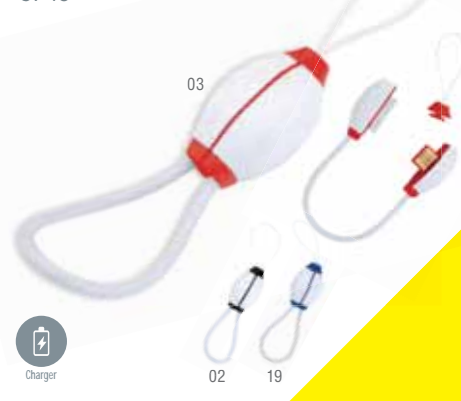

MP3.

4 x 5.5 x 8.8 cm 200 / 50 Print Code: E(1)

Halfon

4392



USB Car Charger. Aluminium. 2 USB Outputs. 2100 mA. 2 Functions.

Ø 2.6 x 6.5 cm 200 / 50

Print Code: C(4), L1

Hesmel

5587



USB Car Charger. Aluminium. 1000 mA.

Ø 2.3 x 5.2 cm 500 / 50

Print Code: C(4), L1

Bozix

4951



USB Car Charger. 1000 mA.

2.2 x 6.3 x 1.5 cm 500 / 50

Print Code: C(4), W

Hanek

4631



Telephone. Volume Button. Connection cables: 2 Jack 3,5 mm/USB.

4.5 x 10.5 x 1.3 cm 50 / 25

Print Code: E(4), W

Conect

9527



USB Hub. 4 Hubs. USB 2.0.

5.2 x 1 x 4.1 cm

200 / 50

Print Code: D(4), W

Glorik

5577



USB Memory. Metal. Individual Presentation.

2.1 x 6.5 x 0.9 cm

200 / 50

Print Code: L1

Nerox 16GB

6227 16GB



USB Memory. Individual Presentation.

3.4 x 5.2 x 0.8 cm

300 / 50

Print Code: D(4), V

Nanuk 8GB

5435 8GB



19

01

02

03

05

USB Stylus Touch Ball Pen. Metal. Individual Presentation.

1.4 x 14 cm

100 / 20

Print Code: E(4), L1

Sivart 8GB

4760 8GB



07

02

19

04

05

11

03

01

USB



Card Reader. Cards: M2, MS Duo, MicroSD, SD.

2.2 x 6 x 1.6 cm

500 / 100

Print Code: C(4)

Mika

3972



03

19

02

Card Reader. USB 2.0. MicroSD Cards.

3 x 0.6 cm

1000 / 100

Print Code: C(4)

Apek

3398



19

01

02

03

Memory Card Pouch. PVC. Cards: MMC, CF, SD, SIM.

6.1 x 9.4 cm

1000 / 50

Print Code: E(1)

Multicard

9702



02

01

Card Case. Aluminium. Cards: SIM, SD, MiniSD.

6 x 4.5 x 0.5 cm

800 / 50

Print Code: C(4), L1

Digit

3475



19

09

03

Smart Watch. TPU Strap. Bluetooth Connection. 1.54" LCD Screen. Multilingual. USB Rechargeable. Cable Included.

27 x 3.9 x 1 cm 50 Print Code: I(1), L2

Harling

5145



Magnifier. Metal. 3 Leds. With Ruler for Measurement. 2 Batteries AA Not Included.

18 x 4.8 x 5.9 cm 40 / 20 Print Code: E(4), L1, N(8)

Nouk 10X

5344



Desk Clock. Button Battery Included.

5.5 x 8.5 x 2.5 cm 200 / 50 Print Code: D(4), W

Sfera

3232



Virtual Reality Glasses.

10.9 x 8.4 x 6.3 cm 200 / 50 Print Code: D(4)

Bolnex

5329



Virtual Reality Glasses. ABS/Silicone.

15 x 8.9 x 8 cm 100 / 50 Print Code: D(1)

Bruck

5362



Adapter. Double Output 3,5 mm Jack Socket.

1.7 x 16.5 x 1 cm 1000 / 100 Print Code: C(1)

Dupli

3401



Flash. 4 Leds. Button Batteries Included.

3.5 x 5.4 x 1.3 cm 1000 / 100 Print Code: C(4)

Fotovidex

5368



FLASH IDEAL FOR VIDEO



Remote Shutter. Bluetooth Connection. Button Battery Included.

3.3 x 5.2 x 1 cm 500 / 50 Print Code: C(1)

Dankof

4626



Selfie Stick. Stainless Steel. 3.5 mm Jack Socket. 4 Positions.

Ø 1.8 × 52 cm 100 / 50 Print Code: E(4), L1

Rontiver

5392



Selfie Stick. Stainless Steel. 3.5 mm Jack Socket. 7 Positions.

Ø 1.7 × 106 cm 50 Print Code: E(4), L1

Nefix

4627



Selfie Stick. Stainless Steel. 7 Positions.

Ø 1.7 × 106 cm 50 Print Code: E(1), L1

Self

4625



Speaker. 3.5 mm Jack Socket. Power 2W. 4 Batteries AAA Not Included.

20 × 3.2 × 15 cm 20 Print Code: F(2)

Nix

3745



Multipurpose Holder Speaker. PU. 3.5 mm Jack Socket. Touch Screen. Power 2W. 3 Batteries AAA Not Included.

9.5 × 16.5 × 4.5 cm 40 Print Code: F(4)

Scaly

4124



Speaker. Silicone.

11 × 4.5 × 4.5 cm 300 / 10 Print Code: F(1)

Superbass

4189



Speakers. USB Connection. 3.5 mm Jack Socket.

13 × 6.5 × 6.5 cm 40 / 20 Print Code: F(4)

Zeek

4083



Speaker Earphones. Bluetooth Connection. Power 3W. USB Rechargeable. Cable Included.

Ø 5.9 × 7.8 cm 50 Print Code: F(1)

Sharon

6192



Headphones. 3.5 mm Jack Socket.

14.8 × 20 × 9 cm

20

Print Code: F(1)

Rem
7027



Earphones. 3.5 mm Jack Socket.

8 × 7.8 × 1.2 cm

500 / 50

Print Code: E(1)

Celter
4837



05

Earphones. 3.5 mm Jack Socket.

9.5 × 15.5 × 3 cm

100 / 25

Print Code: E(1)

Roymed
4944



Earphones. 3.5 mm Jack Socket.

8.2 × 10 × 8.2 cm

100 / 50

Print Code: E(1)

Madox
4212



EARPHONE

Earphones. 3.5 mm Jack Socket.

6 × 6 × 2 cm

500 / 50

Print Code: E(1)

Kemet
3973



Earphones. 3.5 mm Jack Socket.

6.5 × 6.1 × 1.7 cm

500 / 50

Print Code: D(1), W

Surix
4447



Earphones. Bluetooth Connection. USB Rechargeable. Cable Included.

9.5 × 10 × 1.2 cm

500 / 50

Print Code: Consult.

Terens
6897



Earphones. 3.5 mm Jack Socket.

9.5 × 10 × 1.2 cm

1000 / 200

Print Code: E(1), N(8)

Cimex
4209



Pouch. PVC.

8.3 x 13.2 cm

600 / 100

Print Code: F(1)

Drima

4016



Mobile Pouch. Silicone.

6 x 11.5 x 1.5 cm

500 / 10

Print Code: F(1)

Zora

3964



Multipurpose Bag. Polyester 600D.

7.5 x 11 cm

1000 / 10

Print Code: D(1), N(8)

Ozores

9807



Pouch. Microfibre.

8 x 13 cm

1000 / 10

Print Code: E(1), N(8)

Momo

3670



Pouch. Microfibre.

8.5 x 13.5 cm

500 / 50

Print Code: E(1), N(8)

Mim

3732



Pouch. Felt.

8.5 x 14.5 cm

800 / 100

Print Code: E(1), N(8), T

Xera

4115



Multipurpose Bag. Polyester.

6 x 10.6 x 3.2 cm

1000 / 10

Print Code: E(1), N(8)

Misu

9258



Armband. Polyester 600D.

8 x 12 x 2 cm

200 / 25

Print Code: D(1), N(8)

Amstrong

3635



Speaker Holder. Sticky Surface.

10.9 × 8.3 × 7.5 cm

200 / 50 Print Code: D(1)

Amadix

4324



03

Holder. Stainless Steel/ABS. Screen Cleaner Included.

10 × 11 × 11 cm

200 / 50

Print Code: D(4)

Orlok

4991

SCREEN CLEANER
LIMPIA PANTALLAS



01

02

Mobile Holder. Polyester.

12 × 6 × 12 cm

400 / 20

Print Code: N(8)

Kenzi

3697

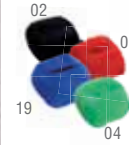

07

Holder. Stylus Touch Ball Pen Included.

9.5 × 2.4 × 9.5 cm

1000 / 100

Print Code: C(4), W

Kiloro

5267



1244

HOLDER



Mobile Holder. Sticky Surface. Stylus Touch Ball Pen Included.

7 × 9.5 × 7 cm

200 / 50

Print Code: D(4)

Toki

4151



03

08

19

Mirror Holder. Cleaning Cloth Included.

Ø 7 × 1.3 cm

400 / 50

Print Code: D(4), W

Senet

4275



Holder. PU.

7.6 × 4.5 × 6.7 cm

200 / 50

Print Code: E(4), L1

Chicago

9638



01

02

Holder. Aluminium.

8 × 9 × 6.5 cm

200 / 50

Print Code: F(4)

Guard

3476



09

02

Cord Winder. Magnetic.

Ø 4.2 × 1.2 cm

300 / 50

Print Code: D(4)

Kail

3705

MAGNET



Cord Winder.

4 × 10 × 0.3 cm

1000 / 200

Print Code: C(4)

Bael

4267



Charger Holder.

3 × 4 × 6.2 cm

500 / 50

Print Code: C(4)

Fonex

4328



Holder. Silicone.

Ø 2.4 × 4.2 cm

1000 / 100

Print Code: D(1)

Puck

3689



Holder.

Ø 3.8 × 4 cm

600 / 100

Print Code: D(4)

Rumy

4103



Screen Cleaner. Cleaning Cloth Included.

3.9 × 7.4 × 1.5 cm

500 / 50

Print Code: D(4)

Kiur

4332



Screen Cleaner Holder.

4.5 × 3.3 × 4.5 cm

1000 / 100

Print Code: C(4), W

Tout

3926



Cleaner Cloth. ABS/ Microfibre.

9 × 0.9 × 4.5 cm

400 / 50

Print Code: D(4)

Prain

3416

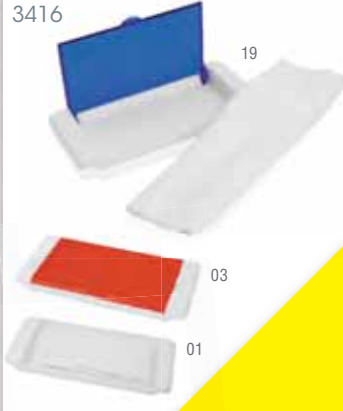

Screen Cleaner.

Ø 2.8 cm

5000 / 200

Print Code: C(1)

Saki

3435

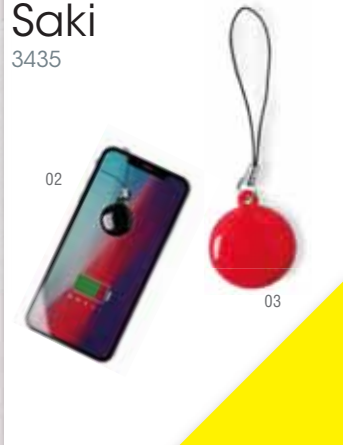

Cleaner Cloth. Microfibre.

5 × 6.5 × 0.5 cm

1000 / 50

Print Code: E(1), R

Yindex

4385



Stylus Touch Screen Cleaner.

6 x 3 x 1 cm 1000 / 200 Print Code: C(4), W

Lyptus

4107



03

SCREEN CLEANER
LIMPIA PANTALLAS



TOUCH
PUNTERO



01

02

19

Antistress Lanyard. Polyester.

Ø 5 x 50 cm 600 / 100 Print Code: E(1)

Rodio

3291



03



01

ANTISTRESS

19

02

Lanyard. Silicone.

1.5 x 40 cm 500 / 50 Print Code: D(1)

Sigex

4213



19

03



02

05

04

01

Mobile Holder. 5 Pieces. Sticky Surface. Cleaning Cloth Included.

6 x 13 x 2.2 cm 200 / 50

Print Code: D(4)

Fenix

4020



03



02

19

Stylus Touch Pen.

Ø 1 x 12 cm 1000 / 50

Print Code: A(4)

Fion

4006



19

04



02

01

09

03

Stylus Touch Pen. Aluminium.

Ø 0.8 x 11.2 cm 1000 / 100

Print Code: B(4), L1

Tap

3690



19

03

09

Stylus Touch Pen.

Ø 0.8 x 4.8 cm 2000 / 100

Print Code: B(4)

Eolo

4038



09



19

04

07

03

02

Ball Pen Stylus Touch.

Ø 1 x 8.6 cm 1000 / 100

Print Code: B(4)

Traxer

4241



19



02

03

04

Stylus Touch Pen Mobile Holder. Aluminium.

Ø 0.8 x 8 cm 2000 / 200

Print Code: B(4), L1

Adair

4333



19

02

03

04

09

Stylus Touch Ball Pen.

Ø 1 x 5.7 cm 2000 / 100

Print Code: B(4)

Nossa

4651



02

09

16

05

07

03

08

11

19

Stylus Touch.

2.2 x 4 x 0.9 cm 2000 / 100

Print Code: B(1), V

Downey

4440



03

19

01

05

02



BE conscious

Pen. Wheat Straw/PP.
 Ø 1 × 14 cm 1000 / 50 Print Code: A(4)

Trudex
6212

Pen. Natural Cork.
 Ø 1 × 13.8 cm 1000 / 50 Print Code: A(1), L1

Hebon
5976

01 19 04

1247

Pen. Natural Cork. Jumbo Refill.
 Ø 1.2 × 13.9 cm 1000 / 50 Print Code: B(1), L1

Rodwen
6021

Pen. Recycled Cardboard. Pouch Included.
 Ø 0.9 × 14.5 cm 600 / 50 Print Code: C(4)

Natura
3341

09 02

Pen. Recycled Cardboard.
 Ø 0.9 × 14 cm 1000 / 50 Print Code: A(4), W

Ecolour
3214

13 03 04 02 07

Stylus Touch Ball Pen.

Ø 1.2 × 14.6 cm

1000 / 50

Print Code: A(4)

Clurk

4657

+10.000 pcs
PRINTING 30% DIS



01 02 19 04 05 07 11



03

Stylus Touch Ball Pen.

Ø 1.5 × 14 cm

1000 / 50

Print Code: A(4)

Sury

4101



19



02 03 09

Stylus Touch Ball Pen.

Ø 1 × 14 cm

1000 / 50

Print Code: A(4)

Yori

5007



19



02 03 09 04

+10.000 pcs
PRINTING 30% DIS

Stylus Touch Ball Pen.

Ø 1 × 13.5 cm

1000 / 50

Print Code: A(4)

Lampo

5039



05



19 02 03 01 04

Stylus Touch Ball Pen. Aluminium/ABS. 1 Led. Button Batteries Included.

Ø 1.2 × 12.5 cm

500 / 50

Print Code: B(4), L1

Corlem

5222



03



02 05 09 19



Holder Pen.

Ø 1.1 × 13.7 cm

1000 / 50

Print Code: A(4)

Segax

5212



03

Video



02 09 19

Pen. EVA/Metal. Jumbo Refill.

Ø 1.2 × 11.2 cm

500 / 100

Print Code: C(1), L1

Crom

3026



19



02



03

Pen. Metal. Jumbo Refill.

Ø 1.3 × 13.9 cm

40

Print Code: D(1), L1

Yannis

5382



Pen. PU/Metal.

Ø 1.4 × 11.6 cm

200 / 50

Print Code: C(4), L1

Cosmos

3528



03



02 05 19

Pen. Jumbo Refill.

Ø 1 × 13.7 cm

1000 / 50

Print Code: A(4)

Hytal
4448



+10.000 pcs
PRINTING 30% DIS

Pen.

Ø 1 × 14.5 cm

1000 / 50

Print Code: A(4)

Bicon
5004



02

Pen.

Ø 1 × 14 cm

1000 / 50

Print Code: A(4)

Faktu
5011



+10.000 pcs
PRINTING 30% DIS



07

03

Pen.

1 × 13.2 × 1 cm

1000 / 50

Print Code: C(1)

Quarex
4728



Mini Pen. Metal.

Ø 1 × 10.5 cm

1000 / 50

Print Code: B(4), L1

Hesia
3848



MINI PEN



19 07 22

Pen.

Ø 1.1 × 15.2 cm

1000 / 50

Print Code: A(4)

Bendon
4314



05

Pen. Metal. Extendable.

Ø 1.1 × 12 cm

500 / 50

Print Code: C(4), L1

Extensy
3495



02 03

EXTENDABLE
EXTENSIBLE



Pen. Metal. Jumbo Refill. PU Pouch Included.

Ø 1.1 × 13 cm

500 / 50

Print Code: C(4), L1

Servan
3217



05 03 01



19



02

Pen.

Ø 1 × 14 cm

1000 / 50

Print Code: A(4)

Visok
5009



19 02 04 05 09 11

03

+10.000 pcs
PRINTING 30% DIS

Multitool Pen. 1 Led. 5 Accessories. Button Batteries Included.

Ø 1.8 x 15 cm 300 / 50 Print Code: B(1)

Mintrix

5414



Laser Pen. 1 Led. Button Batteries Included.

Ø 1.5 x 14 cm 500 / 50 Print Code: C(4)

Rikku

4174

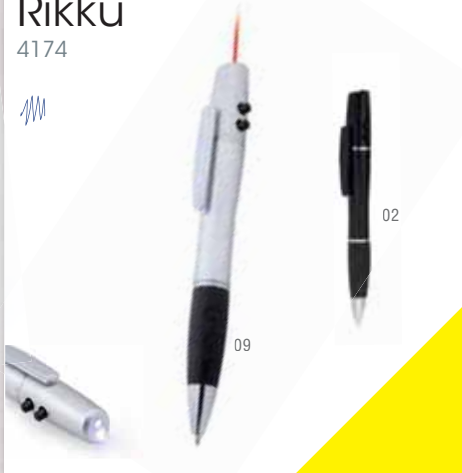

Retractable Pen. Retractable System. Clip Included.

Ø 1.4 x 10.6 cm 1000 / 50 Print Code: B(4), V

Barman

9429



Set. Pen. Mechanical Pencil: 0,5 mm Leads Included.

Ø 1.1 x 13.5 cm 200 / 20 Print Code: C(4)

Soyer

3280



Set. Interchangeable Leads.

5.5 x 15.5 x 3 cm 400 / 100 Print Code: B(4), C(4)

Zibo

3474



Mechanical Pencil. 0,7 mm Leads Included.

Ø 0.8 x 15 cm 2000 / 100 Print Code: A(4)

Ziron

4617



Set. 4 Pieces.

5.2 x 13 x 1.2 cm 250 / 50 Print Code: D(4), W

Kalem

3809



Marker Set. 12 Pieces.

11 x 9 x 0.8 cm 400 / 25 Print Code: C(1)

Boni

3853



1250

Notepad Case. PU. 100 Sheets.

15.7 x 22.7 x 2 cm 20 Print Code: E(1), T

Roliven

5380



100 Sheets Plain



AN IDEAL COVER FOR THE CILUX AND CILUXLIN FUNDA IDEAL PARA CILUX Y CILUXLIN

16



19

03

02

Notepad. Aluminium. 50 Sheets. Pen Included.

7.3 x 11.2 x 0.8 cm 100 / 20 Print Code: D(4), B(4), L1

Serim

3539



PEN INCLUDED BOLIGRAFO INCLUIDO



ALUMINIUM

19

03

02

Notebook. PP Plastic. 70 Sheets. Pen Included. Jumbo Refill.

15.5 x 18 x 1.8 cm 50 / 25 Print Code: E(4), B(4)

Dymas

4795



70 Sheets Lined



19



11

04

05

03

Sticky Notepad Holder. PU. 100 Sticky Notes 7,5 x 7,5 cm.

9.3 x 2.8 x 9 cm 120 / 60 Print Code: D(2), L2

Posit

9391



03

02

07

04

19

Sticky Note Set. Cardboard. 25 Sticky Notes 4 x 4 cm. 125 Mini Sticky Notes 1,8 x 4,5 cm.

16 x 4.1 x 0.1 cm 800 / 100 Print Code: C(4)

Nolar

3808



Sticky Notepad. Cardboard. 100 Sheets Notepad. 125 Sticky Notes 1,5 x 5 cm. Recycled Cardboard Pen Included.

8 x 10.5 x 1.2 cm 200 / 50 Print Code: D(4), B(4)

Tropox

4931



100 Sheets Plain

Notepad Holder. Recycled Cardboard. 180 Sheets 7,2 x 11,5 cm.

13 x 3 x 8.5 cm 100 / 50 Print Code: D(2)

Legu

3463



03

02

Pencil Case. PU.

21 x 7.5 cm 100 / 25 Print Code: E(1), L1

Zinq

4322



19

01

03

05

Multipurpose Bag. PU.

6.5 x 17 cm 500 / 10 Print Code: D(1)

Balkeis

5040



19

01

02

05

03

Calculator. PVC. Magnetic. Button Batteries Included.

14.5 x 19.5 x 0.8 cm

60 / 30

Print Code: E(4)

Roll Up

3088

FLEXIBLE

MAGNET



Ruler Calculator. Button Battery Included.

20.8 x 5.2 x 1 cm

200 / 50

Print Code: D(4)

Profex

4544



Ruler Calculator. Solar. Magnifier Included.

13.3 x 4.5 x 0.4 cm

400 / 100

Print Code: D(4)

Mensor

3749



Ruler Bookmark. Aluminium.

3.5 x 17.1 cm

500 / 25

Print Code: D(4), L1

Contek

4549



Aluminium

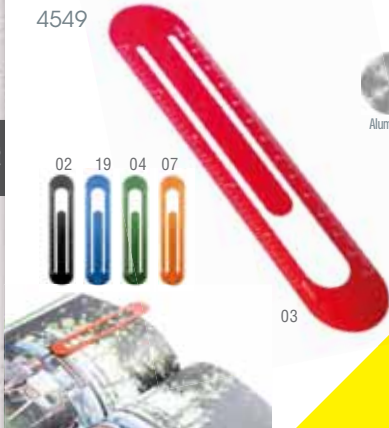

Desk Clock. Clips Included. Button Batteries Included.

9.4 x 9.4 x 2.5 cm

100 / 50

Print Code: D(4), W

Soret

4292



Adhesive Tape Set. 3 Pieces.

8 x 7 x 1.7 cm

500 / 20

Print Code: C(1)

Xilon

4809



Clip.

3.6 x 5.5 x 1 cm

1200 / 600

Print Code: C(4)

Doc

9547



Clip Bookmark. Wood.

5 x 7 x 0.4 cm

2000 / 200

Print Code: C(4)

Tura

3577



Sticky Notepad Holder. Magnetic. 30 Sticky Notes 2 x 5 cm.

3.5 x 7.5 x 4 cm

250 / 50

Print Code: C(4)

Magna

3285

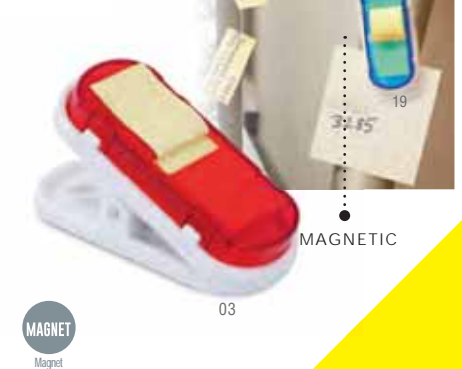

Mousepad Keyboard. 3 Hubs. USB 2.0.

32 x 21.5 cm



Print Code: F(1)

Negu

3755



Computer Set. Nylon 1680D. 4 Accessories.

8 x 4.5 x 13 cm



Print Code: G(6), W

Weis

3733



Mouse. Optical. Ergonomic.

9.4 x 3.3 x 5.2 cm



Print Code: E(1)

Keita

3547



Folder. Microfibre. 20 Sheets Notepad. Pencil Case Included.

20.5 x 26 x 2.5 cm



Print Code: G(1)

Patrix

4375

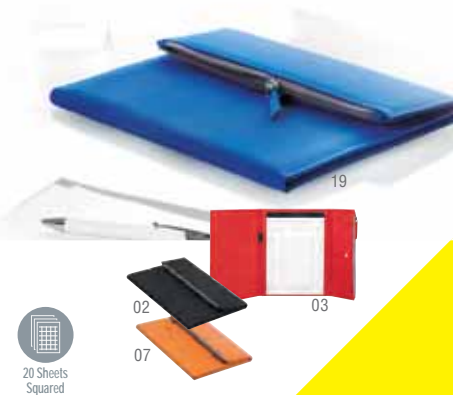

Document Bag. Polyester 420D. Padded Laptop Compartment.

35 x 28 x 5.5 cm



Print Code: G(1), N(8)

Tempo

3259



Briefcase. PU.

40 x 29 x 4 cm



Print Code: J(1)

Sidney

3524



Document Bag. Polyester 600D.

36 x 25.5 cm



Print Code: F(1), N(8)

Tico

3104



Folder. Polyester 600D. 20 Sheets Notepad.

23.5 x 31 x 1.5 cm



Print Code: F(1), N(8), L1

Dalgox

5028



Shoulder Bag. Polyester 600D.

38 x 27 x 12 cm



Print Code: G(1), N(8)

Shamby

5030



Card Holder. Silicone. 7 Compartments.

11 x 7.5 x 2 cm

200 / 50

Print Code: F(1)

Vitox

4583



05
03
02
08

ACCESSORIES



Card Holder. PP Plastic. 6 Compartments.

11 x 7.5 x 2 cm

200 / 50

Print Code: D(4)

Terun

4268



03
19
02
01

Card Holder. PU. 10 Compartments.

8 x 10.7 x 1 cm

200 / 100

Print Code: D(1)

Top

4572



02
03 11 07 05 19

Card Holder. Aluminium. 1 Compartment.

9.4 x 6 x 0.7 cm

400 / 50

Print Code: D(4), L1, W

Gilber

5198



03
19
02

Id Badge. Aluminium.

7 x 2.7 x 0.7 cm

1000 / 100

Print Code: C(4),

L1

Donpok

5515



Lanyard. Polyester. Safety Catch.

2 x 55 cm

600 / 100

Print Code: F(1), N(8), R

Edain

4480



05
11

Lanyard. Polyester. Safety Catch.

1.2 x 50 cm

1000 / 100

Print Code: F(1), N(8),

R

Briol

4218

SAFETY CATCH
CIERRE SEGURIDAD

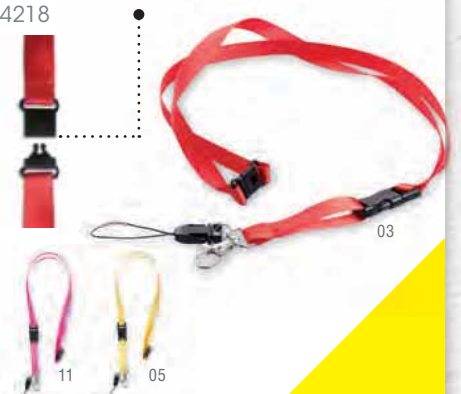

03
11
05



Bottle. 500 ml.

Ø 6.5 × 19.5 cm

100

Print Code: F(1)

Kabort

5497

500 ml



02



03 19 05 01



Bottle. 580 ml.

Ø 6.5 × 21.2 cm

100 / 50

Print Code: F(1), L2

Parux

5931

580 ml



19 07 03



04

Bottle. Stainless Steel/PS. 600 ml. Individual Presentation.

Ø 7 × 23.5 cm

50

Print Code: F(1), L1

Gorko

4164

600 ml



05 19

03



Mug. PP. 450 ml. Individual Presentation.

Ø 8 × 17 cm

50

Print Code: F(1)

Shana

3786



19 03



02

Cup. Stainless Steel. 500 ml. Individual Presentation.

Ø 8.2 × 19.5 cm

50

Print Code: F(1), L2

Katel

5340

500 ml



07 11 19



03



16

Cup. Stainless Steel. 500 ml. Individual Presentation.

Ø 8.2 × 19.5 cm

50

Print Code: F(1), L2

Nozem

5339

500 ml



03 04 05



19

Multipurpose Bag. Felt.

8.5 × 14.5 cm

500 / 100 Print Code: F(1), N(8)

Cisco

4092



Shoulder Bag. Polyester 600D.

10 × 11 × 8 cm

200 / 10 Print Code: E(1), N(8), 0

Criss

9999



Multipurpose Bag. Polyester.

12 × 5.5 × 2.5 cm

500 / 10 Print Code: E(1), N(8)

Nila

9235



Backpack. Polyester 600D.

32 × 44 × 12 cm

50 Print Code: F(1), N(8)

Kenedy

8888



BAGS



Backpack. Polyester 210D.

37 × 41 × 15.5 cm

100 / 20 Print Code: F(1), N(8)

Southpack

3084



Shoulder Bag. PVC.

26 × 31 × 12 cm

40 Print Code: G(1)

Otto

7071



Shoulder Bag. PVC.

33 × 27 × 10 cm

30 Print Code: G(1)

Rock

7018



Shoulder Bag. Polyester 600D.

38 × 25 × 11.5 cm

40 Print Code: G(1), N(8)

Kobe

3629



Backpack. Polyester 240D/ PU Coating. Padded Back and Shoulder Straps.

33 x 43 x 22 cm 20 Print Code: G(1), P

Meridien

3953



Backpack. Polyester 600D. Padded Back and Shoulder Straps. Shoe Compartment.

31.5 x 42.5 x 22 cm 25 Print Code: G(1), N(8)

Nitro

3036



Backpack. Polyester 600D. Padded Laptop Compartment. Padded Back and Shoulder Straps.

29 x 39 x 19 cm 30 Print Code: G(1), N(8)

Doplar

5231



Drawstring Bag. Cotton/ Polyester.

34 x 42 cm 200 / 10 Print Code: F(4)

Zabex

5878



Drawstring Bag. Polyester 190T.

33 x 41.5 cm 350 / 50 Print Code: F(1), N(8)

Lequi

9281



Drawstring Bag. Polyester 210T.

33 x 42 cm 200 / 10 Print Code: F(1), N(8), R

Keisy

4339



Shoulder Bag. Polyester 600D.

17.5 x 22 x 6 cm 50 Print Code: F(6), N(8), R

Maycos

4920



Backpack. Polyester 600D. Padded Laptop Compartment. Padded Back and Shoulder Straps.

30 x 39 x 11.5 cm 30 Print Code: F(6), N(8), R

Layrul

4919



Trolley. Polyester 600D.

35.5 x 50 x 16.5 cm

2

Print Code: K(8)

Versity

4732



Bag. Polyester 600D. Shoe Compartment.

57 x 33 x 30 cm

20

Print Code: G(1), N(8)

Beto

4177



05

03

19

02



Trolley. EVA. Semi-Rigid.

43 x 55 x 16 cm

2

Print Code: K(8)

Nao

3204



19

07



03

Foldable Drawstring Bag. Polyester 210T.

34 x 42 cm

300 / 10

Print Code: F(1), G(1), H(1)

Thais

4351



FOLDABLE



05

19

04

03

07

11

01



Beauty Bag. Polyester 600D.

20.5 x 35 cm

100 / 20

Print Code: F(1), N(8), O

Yeka

4178



03

08

19

02

Translator. 7 Languages. Calculator. Button Battery Included.

11.8 x 1 x 7.2 cm

120 / 60

Print Code: D(4), W

Elam

3744



TRANSLATOR 7 LANGUAGES
TRADUCTOR 7 IDIOMAS

Luggage Porter. Polyester.

34 x 2.5 cm

500 / 50

Print Code: F(1), N(8)

Kuyax

4280



03



19

02

01

Luggage Tag. Pen Included.

9 x 5.5 x 0.7 cm

500 / 50

Print Code: D(4)

Yeq

9878



19

03

Padlock. Metal/Plastic.

1.7 x 6 cm

1000 / 100

Print Code: D(4)

Ikun

3725



03



01

02

19

Pillow. Microfibre.

33.5 x 14 x 26 cm

200 / 20

Print Code: F(1), N(8)

Bangala

4997



06

04

03

08

Keyring. Aluminium/ Polyester.

2.8 x 6.5 x 0.4 cm

300 / 50

Print Code: D(4), L1

Akua

3937

04



Keyring. Metal/ PU.

2 x 6.2 x 0.6 cm

500 / 50

Print Code: D(1), L1

Dines

4317

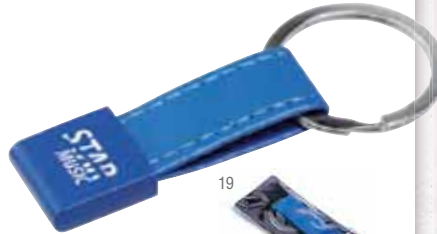

19



Keyring. Metal/ Silicone.

2.8 x 5.9 x 0.8 cm

300 / 50

Print Code: D(4), L1

Kaelis

5357

ALUMINIUM/ SILICONE



16



Whistle Keyring. Aluminium.

Ø 1 x 5.9 cm

1000 / 200

Print Code: D(4), L1

Debrant

5893

WHISTLE / SILBATO



19



KEYRING OPENER



Opener Keyring. Aluminium.

3.7 x 8 x 0.3 cm

800 / 200

Print Code: D(4), L1

Sailor

5356



Opener



02



09

03



19

Opener Keyring. Aluminium.

2.5 x 6.7 x 0.3 cm

800 / 200

Print Code: D(1), L1

Ria

3902



19



03



02

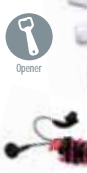

09



Opener

Opener Keyring. Aluminium.

2.5 x 10.5 x 0.7 cm

800 / 200

Print Code: D(4), L1

Murdock

3903



02



19



01



03



Opener

Opener Keyring. Aluminium.

1.5 x 7.6 x 1.5 cm

1000 / 200

Print Code: D(4), L1

Skater

5890



03



02

09

19



Opener

Keyring. Metal/Silicone.

Ø 2 × 3.2 cm

400 / 50

Print Code: D(1), L1

Doggo

5653



Keyring. Metal/Silicone.

Ø 2 × 3.4 cm

400 / 50

Print Code: D(1), L1

Catter

5654



Keyring. Aluminium.

3.8 × 3.5 × 0.1 cm

2000 / 200

Print Code: D(4), L1

Noax

4587



Keyring. PVC.

8.5 × 6.5 × 0.5 cm

1000 / 50

Print Code: C(4)

Tee

9941



Stylus Touch Pen Keyring.

Ø 0.9 × 4.8 cm

1000 / 50

Print Code: C(4)

Indur

4036



Keyring.

2.5 × 6.2 × 0.6 cm

1000 / 50

Print Code: C(1)

Fallet

4337



Holder Keyring. Aluminium/Stainless Steel.

1.7 × 6.7 × 0.3 cm

250 / 50

Print Code: D(1), L1

Dulco

4152

HOLDER
SOPORTE



Keyring. Silicone/Metal.

1.2 × 10 × 0.5 cm

1000 / 100

Print Code: E(1)

Zemix

4167



Keyring Torch. 1 Led. Button Batteries Included.

3 × 7.6 × 1.2 cm 500 / 50 Print Code: C(1)

Scam

4380



Keyring Torch. 1 Led. Button Batteries Included.

∅ 2.9 × 5.3 cm 500 / 50 Print Code: C(1)

Blesak

5210



Torch. Aluminium. 6 Leds. Button Batteries Included.

∅ 2.6 × 6.5 cm 200 / 50 Print Code: D(4), L1

Liarek

4989



Torch. Aluminium. 1 Led. Button Batteries Included.

∅ 1.5 × 5.6 cm 500 / 100 Print Code: D(1), L1

Sacai

4139



Torch. Aluminium. 1 Battery AAA/ R03 Included.

∅ 2 × 8.3 cm 100 / 25 Print Code: E(1), L1

Traveller

3493



Security Light. 2 Leds. Button Batteries Included.

4.7 × 3 × 1.6 cm 500 / 100

Print Code: C(1)

Savera

5698

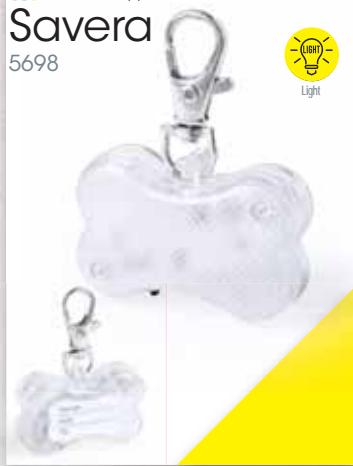

Light

Torch. PVC. 1 Led. Button Batteries Included.

9 × 6 cm 300 / 50

Print Code: D(4)

Bent

3310



ULTRA SLIM
ULTRA FINO

Torch Carabiner. 1 Led. Button Batteries Included.

5 × 7.4 × 1.4 cm 500 / 50

Print Code: D(4)

Mansour

5025



Security Light. 6 Leds. 7 Light Modes. 2 Batteries AAA Not Included.

∅ 5.5 × 2.4 cm 200 / 100

Print Code: E(1)

Masi

4205



Light



Blink

Cap. Cotton/Thick Polyester. 6 Panels.

Consult. 200 / 25 Print Code: E(1), N(8), O, P

Mision

3947



19

HQ
HIGH QUALITY



Cap. Microfibre.

Consult. 200 / 25 Print Code: E(1), N(8), O, P, R

Lenders

4566



19



11

07

05

Cap. Microfibre/Polyester. 6 Panels.

Consult. 300 / 50 Print Code: E(1), N(8), O, P, R

Himol

5191



03



04

21

19

11

07

05

01

02



6 Panels

Ideal Sublimation

Cap. Microfibre. 6 Panels.

Consult. 150 / 25 Print Code: E(1), N(8), O, P

Lediem

5464



6 Panels



02



19



01



04



03



Cap. 100% Brushed Cotton.

Consult. 200 / 50 Print Code: E(1), N(8), O, P

Country

3121



ITA

FRA

Hat. 100% Cotton.

Consult. 200 / 50 Print Code: E(1), N(8), O, P

Patriot

3123



FRA

ITA

POR

Hat. Polyester.

Consult. 100 / 25 Print Code: F(1), N(8), O

Tosep

4558



02



Inner Band



19

01

03

Hat. Cotton/Polyester.

Consult. 200 / 20 Print Code: F(1)

Shelly

9828



21



07



03

Hat. Polyester.
Consult. 200 / 50 Print Code: E(1)

Barlow

3510



02



03



19

Hat. Synthetic.
Consult. 100 / 25 Print Code: E(1), N(8), O

Get

7054



18



02



13

Cap. Straw. Foldable.
Consult. 250 / 10 Print Code: E(1)

Hawaian

9861



04



03



07



19



02

Hat. Synthetic.
Consult. 100 / 25 Print Code: D(1)

Kalos

3236



01



13



02



Inner Band



Sun Visor. 100% Cotton.
Consult. 200 / 50 Print Code: D(1), N(8), O

Inlady

3122



07



19



03

Aqua Shoes. Soft Shell.
36-38, 42-44 200 / 10 Print Code: E(1), N(8)

Hiren

4404



19



02

size

36-38, 42-44



03



05

Flip Flops. EVA/PVC.
36-38, 42-44 60 / 10 Print Code: E(1)

Sunset

3114



19

size

36-38, 42-44



03



01

Flip Flops. EVA/Polyester.
36-38, 42-44 60 / 10 Print Code: E(1), N(8)

Mele

7049

size

36-38, 42-44



03



19



02

Bag. Polyester/PVC.

38 x 40 cm

200 / 10

Print Code: F(1)

Marex

4465



03

05

11

19



Bag. Non-Woven.

42 x 38 x 14 cm

50 / 10

Print Code: F(1)

Palmer

3273



07

04

03

19



Bag. Non-Woven.

38 x 40 x 8 cm

200 / 20

Print Code: F(1)

Sorak

4316



03

11

19

04

07

Bag Holder.

4 x 7.5 x 3.4 cm

1000 / 50

Print Code: C(4)

Taker

3936



04



05

19

03

01

Bag. Laminated Non-Woven.

40 x 36 x 15 cm

200 / 20

Print Code: F(1)

Zakax

4416

FLUORESCENT



11 F

07F

05F

04F

Shoulder Bag. Non-Woven.

45 x 37 x 8 cm

100

Print Code: F(1)

Sira

3769



07



03

04

02

19

Hand Fan. Bamboo/ Polyester.

42 x 23 cm

250 / 50

Print Code: D(1), E(2), L1

Kertex

4079



03

01

02

19

04

BAGS & accessories



Sunglasses. UV400 Protection.

Consult.

300 / 10

Print Code: D(1)

Hortax

4414



Sunglasses. UV400 Protection.

Consult.

300 / 10

Print Code: D(4)

Lyoko

3950



Sunglasses. UV400 Protection.

Consult.

300 / 10

Print Code: D(1)

Herea

4220



Sunglasses. Metal. UV400 Protection.

Consult.

300 / 10

Print Code: E(1)

Kindux

4800



METALLIC

Glasses Strap. Polyester.

63 x 1 cm

2000 / 100

Print Code: F(1)

Birt

5463



Tube. PVC.

Ø 6.5 x 126 cm

250 / 50

Print Code: E(1)

Suen

3081



Armchair. PVC. Special Folded for Printing.

48 x 36 x 48 cm

50

Print Code: H(1)

Mewi

3940



Pillow. PVC.

27 x 9.5 x 22.5 cm

300 / 100

Print Code: E(1)

Leos

3251



19



05

03

Beach Rackets. Wood.

24 x 38 x 0.7 cm

24

Print Code: F(1)

Point

9174

WOODEN

HQ
HIGH QUALITY

BIG SIZE



19



03

02

UV Meter. Measuring Rank: 1-15 UV. Button Batteries Included.

5 x 6.4 x 1.3 cm

100 / 25

Print Code: F(4), W

Mercury

3089



1266



Fan. 2 Batteries AA Not Included.

10 x 10.4 x 2.7 cm

200 / 50

Print Code: D(4)

Vanur

4158



03



19



05

Multipurpose Holder.

Ø 9 x 14 cm

200 / 100

Print Code: D(1)

Darovy

4445



03

11



19

05



01

04



Cool Bottle. Polyester/ Aluminium. Suitable for Cans 330 ml and Bottles 500 ml.

Ø 8 x 24.5 cm

400 / 10

Print Code: E(1), N(8)

Extensible

3017

EXTENDABLE
EXTENSIBLE



19

03

07

Vacuum Drinking Jug. 2L.

Ø 16 x 23 cm

12

Print Code: F(1)

Pacam

4252

2L



BPA FREE



19



04



03

Laces.
 110 x 0.8 cm 500 / 100 Print Code: B(1)
Woltex
 4564



Mask Holder Wristband. Polyester 210D.
 24 x 7 cm 1000 / 100 Print Code: E(1)
Benix
 4315



Headband. 55% Nylon/ 45% Polyester. UV50 Protection.
 24 x 6 cm 500 / 50 Print Code: F(1), N(8), O, P, R
Wetux
 5746



Thermal Band. Cold and Warm. Reusable.
 70 x 6 cm 200 / 50 Print Code: E(1), N(8)
Zore
 3775



Yoga Balls. Natural Rubber.
 Ø 6.3 x 12.5 cm 50 Print Code: E(1)
Relax
 4996



Pedometer. Calculates Steps. Button Battery Included.
 4 x 5.5 x 2.5 cm 200 / 100 Print Code: C(4)
Peytin
 3839

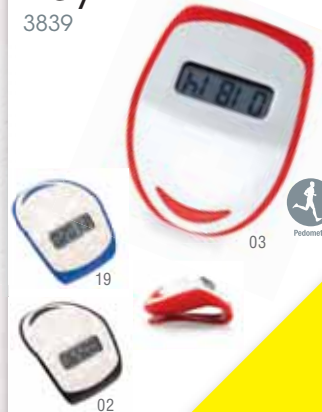

Stopwatch. 3 Functions. Button Battery Included.
 5 x 7.5 x 2.1 cm 200 / 50 Print Code: D(4)
Kailen
 4451

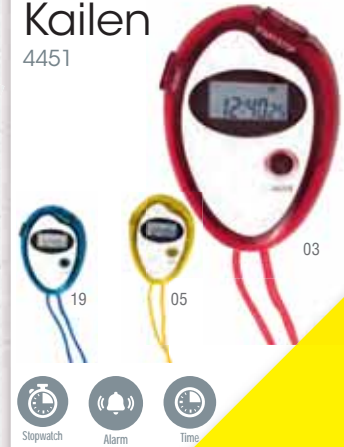

Compass. Whistle Included.
 4.5 x 6.5 x 1.1 cm 500 / 50 Print Code: C(1)
Rasko
 4438



Binoculars. ABS.
 11.5 x 3.6 x 6.5 cm 200 / 50 Print Code: D(4)
Sodor
 5271



Torch. Silicone. 1 Led. Button Batteries Included.
 3.4 x 39.5 x 2 cm 200 / 100 Print Code: G(1)
Hozon
 4206



TOOLS



Keyring Ruler.

1.3 × 6.6 × 2.4 cm

400 / 50

Print Code: D(4)

Tembel
5694

0'5M



Multifunction Pocket Knife. Stainless Steel. 1 Led. 9 Functions. Button Batteries Included.

9 × 2.3 × 2 cm

120 / 10

Print Code: E(4), L1

Tobarra
9512



Light



SPECIAL AREA FOR LOGO
ESPACIO PARA LOGO



Weather Station. Indoor/ Outdoor Temperature Sensor. 2 Batteries AAA Not Included.

11.6 × 13.5 × 4 cm

50

Print Code: E(4)

Ceres
3739



1268

Torch. Aluminium. 3 Leds. 3 Batteries AAA Not Included.

∅ 2.3 × 8.2 cm

300 / 50

Print Code: D(4), L1

Virago
9817



Torch. Aluminium. 6 Leds. Button Batteries Included.

2.8 × 3.9 × 2.8 cm

200 / 100

Print Code: D(4), L1

Zartax
4494



Torch. Magnetic Base. 2 Batteries AA Included.

∅ 3.6 × 19 cm

100 / 25

Print Code: F(1)

Stroke
3608



Light



Blink



Magnet



Holder.
 6.3 × 2.6 × 7.8 cm 200 / 50 Print Code: D(1)
Manfrek
 5366

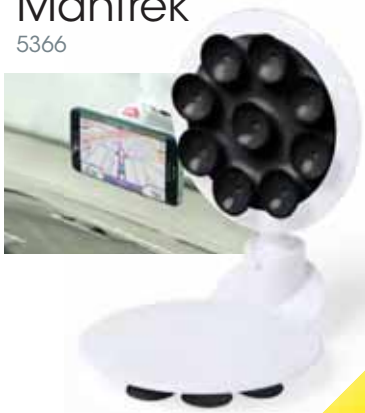

Holder. Adjustable.
 7.8 × 4 × 2.5 cm 400 / 50 Print Code: C(4)
Hanirus
 4851



Multitool. 6 Accessories.
 8.3 × 3.7 × 1.6 cm 200 / 50 Print Code: D(4)
Kenza
 4444



Window Cleaner. Refillable. Liquid Not Included.
 25.5 × 25.5 × 5 cm 100 / 50 Print Code: D(1)
Turbon
 5270



License Plate Frame.
 53 × 14 × 0.5 cm 150 Print Code: E(4)
Hescol
 2539



1269

Sunshade. Two Bubble Aluminium Sides.
 130 × 60 cm 100 Print Code: H(1)
Pangot
 4642



CAR
 accessories

Watch. Silicone Strap.

25.5 x 4 x 1.2 cm

200 / 50

Print Code: F(1)

Trepid

3588



Watch. PVC Strap.

23.2 x 3.2 x 1 cm

200 / 50

Print Code: F(1)

Suva

3589



Watch. Silicone Strap.

26.5 x 5 x 1.5 cm

200 / 20

Print Code: L1

Lenix

3970



Watch.

23.3 x 4 x 0.8 cm

400 / 20

Print Code: F(1)

Kibol

3677



Watch. Silicone Strap.

41.5 x 2.7 x 0.8 cm

600 / 100

Print Code: E(1)

Sirel

3969



Belt. Silicone.

117 x 3.3 x 0.3 cm

100 / 10

Print Code: E(1)

Kyiss

4594



Pendant.

2.5 x 26.5 cm

1000 / 10

Print Code: L1

Telmo

7042



Bracelet. Leather. Adjustable.

7.5 x 1.8 cm

500 / 10

Print Code: D(1), L1

Karim

3917



Bracelet. PU. Adjustable.

8 x 1 cm

1000 / 10

Print Code: D(1)

Luson

5481



Bracelet. Silicone. Button Batteries Included.

Ø 6.5 × 2.1 cm 1000 / 100 Print Code: D(1)

Kelen
4495

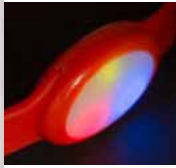

02



Bracelet Set. Silicone.

6 × 11 cm 4000 / 1000 Print Code: C(1)

Form
3656



Bracelet. PVC. Adjustable.

21.5 × 0.8 cm 3000 / 500 Print Code: Consultar

Tonis
4399



11F

FLUORESCENT



Tie. Polyester.

5 × 145 cm 500 / 50 Print Code: N(8), R

Ming
7058



01

08



02



Bracelet Set. Silicone.

6 × 11 cm 4000 / 1000 Print Code: C(1)

Form
3656



Selfie Photo Frame.

68 × 46 × 0.5 cm 40 Print Code: E(1)

Heylo
5473



IDEAL FOR TWO PERSON

Selfie Photo Frame.

38.5 × 59 × 0.5 cm 40 Print Code: E(1)

Rayxel
5474



Bag. Velvet.

7.5 × 13 cm 1000 / 20

Print Code: D(1), N(8)

Mirka
9253



02

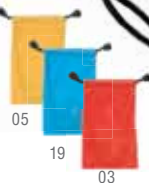

Candy Dispenser. About 20 Sugar-Free Mints (3 gr.).

4.6 × 4.6 × 0.6 cm 2000 / 100

Print Code: C(4), W

Mintus
4033



03



Pouch. Soft Shell.

4.8 × 9.5 cm 2000 / 100

Print Code: E(1), N(8)

Fit
3596



19



Multipurpose Bag. Nylon/ Polyester.

9 × 10 cm 1000 / 100

Print Code: D(1), N(8)

Rast
4491



02



Keyring Purse. PVC.

5 × 5 × 3.5 cm

1000 / 100

Print Code: D(1)

Darnex

5111



Keyring Purse. PU.

6.5 × 10 × 2 cm

500 / 50

Print Code: E(1)

Brody

3492



Purse. PVC.

8.3 × 6.7 × 0.4 cm

800 / 100

Print Code: E(1)

Crux

4015



Purse and Card Holder. PU. 5 Compartments.

10.3 × 7.4 × 0.6 cm

500 / 50

Print Code: E(1), L1

Colik

4980

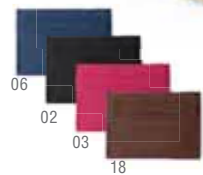

Purse. PVC.

13.5 × 8 × 0.6 cm

1000 / 250

Print Code: E(1)

Brilla

3175



Purse. Polyester 420D.

8 × 9 × 1.8 cm

600 / 100

Print Code: D(1)

Dodge

3604



Purse. Microfibre.

10 × 7.5 × 2 cm

500 / 10

Print Code: E(1)

Volex

3943





Bag. Polyester.

32 x 21 x 13 cm

100 / 10

Print Code: F(1)

Nira

7012

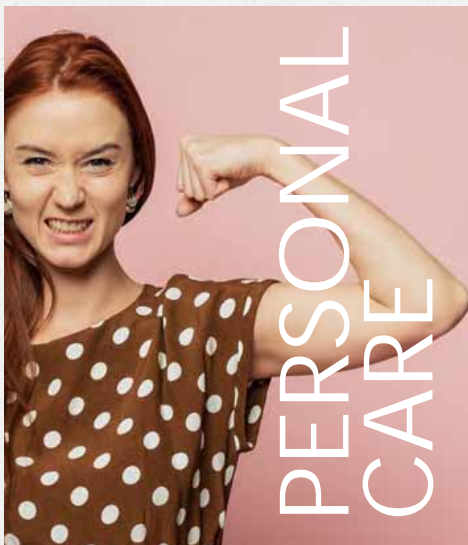

PERSONAL CARE

Purse. PVC. With Inner Lining.

9.5 x 7.5 x 0.8 cm

500 / 10

Print Code: D(1)

Liz

9811



Purse. PVC.

15 x 9 x 3.5 cm

500 / 10

Print Code: F(1)

Kinsa

4773



Purse. PVC.

10.5 x 7 x 1 cm

1000 / 10

Print Code: D(1)

FLUORESCENT

Tentox

4400



Beauty Bag. Microfibre.

17 x 11 x 4 cm

400 / 10

Print Code: E(1)

Lanka

3176



Beauty Bag. PVC.

18 x 18.5 x 7 cm

200 / 50

Print Code: E(1)

Aquarium

8573



Foulard. Cotton/Polyester.

170 × 25 cm 200 / 20 Print Code: F(1), N(8)

Volga
3202



Headband.

49 × 3.8 × 0.1 cm 1000 / 100 Print Code: E(1)

Cecil
7035



Hairbrush with Mirror.

7.5 × 15 × 4 cm 200 / 20 Print Code: D(4)

Dubix
5410



Cosmetic Pencil Sharpener.

3.7 × 2.4 × 2.9 cm 1000 / 50 Print Code: B(1)

Sandor
5409



PERSONAL
CARE

Pocket Mirror.

6.7 × 7.5 × 0.6 cm 200 / 50 Print Code: D(4), W

Marma
4421



Holder. Silicone.

4.6 × 5 × 7 cm 300 / 100 Print Code: F(1)

Blanys
4850



Nail File.

1.9 × 16 × 0.3 cm 1000 / 50 Print Code: B(4)

Sormix
4857



Nail File Set. 6 Pieces.

5.6 × 6.3 × 0.4 cm 800 / 50 Print Code: C(1)

Catys
3849



Wrist Blood Pressure Monitor. 2 Batteries AAA Not Included.

7.8 × 6.5 × 2.8 cm 20 Print Code: F(1)

Health
9683



Massage Stones. 4 Stones. Presentation Bag and User Manual Included.

10 × 14.5 cm 60 / 20 Print Code: E(1), N(8)

Thermax
4064



Heat Pack. Reusable.

8 × 10 × 1 cm 150 / 50 Print Code: C(1)

Grup
3423



Absorbent Towel Set. Microfibre 200 g/m². 6 Pieces. Folded Ø 10 x 10 cm.

30 × 30 cm 40 Print Code: N(8), P

Tekla
4005

30 × 30 cm
200 g/m²

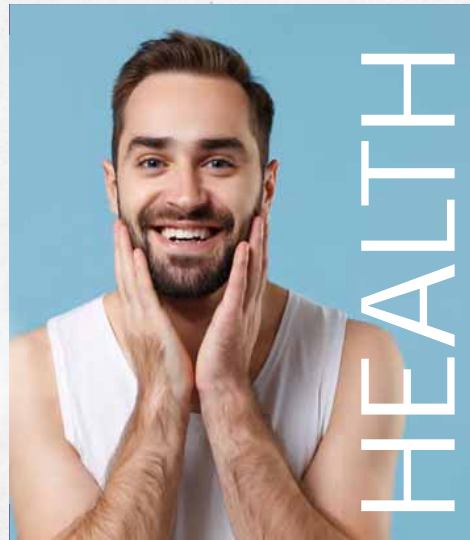

Clip Memo Holder. Polyresin.

3.5 × 11 × 3 cm 500 / 50 Print Code: E(1)

Sanus
3821



Antistress.PU.

8.5 × 4.4 × 6.5 cm 400 / 10 Print Code: E(1)

Bocad
5700



Antistress Ball. PU.

Ø 6.2 cm 400 / 10 Print Code: E(1)

Dilpak
5393



Photo Frame. Wood.

8 × 18 × 4.4 cm 100 / 50 Print Code: D(1)

Gardim
4796



Clip Memo Holder Sharpener. Wood.

6 x 11.5 x 3.5 cm 400 / 50 Print Code: C(4), L1

Hood

9479

SHARPENER / SACAPUNTAS



Photo Frame. Laminated Cardboard. Photos Size: 7,5 x 6 cm.

10.8 x 12 x 0.3 cm 400 / 50 Print Code: C(4)

Torquis

3832



Photo Frame. Wood. Photos Size: 3,5 x 3,5 cm.

5 x 5 x 0.7 cm 1000 / 50 Print Code: C(4), L1

Loto

3447



Skill Game. Wood.

Ø 2.5 x 9.4 cm 300 / 50 Print Code: C(1), L1

Rondux

5720



Video



Multipurpose Box.

8.5 x 5 x 6.4 cm 300 / 50 Print Code: C(1)

Harcal

4493



Pencil Holder. Wood.

5 x 11.5 x 5.5 cm 200 / 20 Print Code: C(2), L1

Plumi

9481

PENCILS NOT INCLUDED / LÁPICES NO INCLUIDOS



Eraser.

2.6 x 5.5 x 1.2 cm 800 / 50 Print Code: B(4)

Pulsy

4789



Pillow Notebook. PVC. 70 Sheets.

15.5 x 18.5 x 1.1 cm 50 / 25 Print Code: F(1)

Komod

4462



Video



INFLATABLE / INFLABLE



Vest. Elastic Polyester. One Size. Kids.

28 × 44 cm

500 / 50

Print Code: E(1)

Enfant

3016



Bottle. Tritan. 480 ml.

Ø 6.8 × 18.3 cm

100 / 50

Print Code: F(1)

Mancex

5885

480 ml



tritan

tritan

tritan

tritan

tritan

tritan

tritan

tritan

tritan

tritan

tritan

tritan

tritan

tritan

tritan

tritan

tritan

tritan

tritan

tritan

tritan

tritan

tritan

tritan

tritan

tritan

tritan

tritan

tritan

tritan

tritan

tritan

tritan

tritan

tritan

tritan

tritan

tritan

tritan

tritan

tritan

tritan

tritan



Thermal Bag. PET/Aluminium.

18 × 17 × 6.5 cm

200 / 10

Print Code: E(1)

Liord

5033



Ice Mold. Silicone.

4.7 × 20 × 4 cm

100

Print Code: F(1)

Lowell

4417



Mold Set. 2 Pieces.

12.2 × 12 × 5.7 cm

60

Print Code: D(1)

Thade

4145

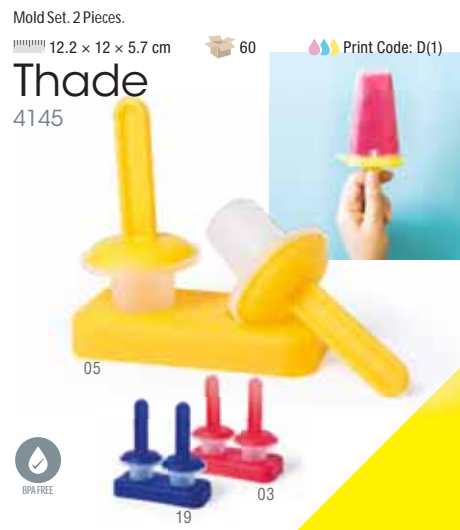

Mold Set. 5 Pieces.

Ø 11.3 × 5 cm

100

Print Code: E(1)

Asper

4007

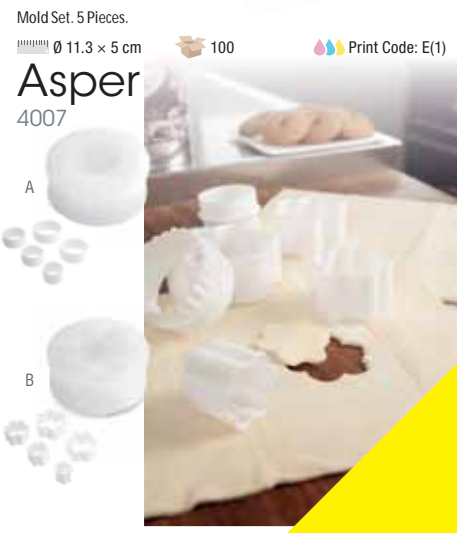

Mold. Silicone. Maximum Temperature 240°C.

15 × 3.3 × 15 cm

200 / 100

Print Code: F(1)

Nela

3986



Mold. Silicone.

Ø 10.5 × 2 cm

300 / 10

Print Code: E(1)

Baldix

5496



Frying Pan. Aluminium/ Ceramic. 24 cm. Suitable for all Kinds of Hobs.

11111111 024 × 4.5 cm  10  Print Code: G(1)

Clunix
4256



19



03





05



01



Spaghetti Measurer. Stainless Steel.

11111111 6.2 × 18.4 cm  150 / 25  Print Code: E(1), L1

Pivik
4507



Pot Holder. Silicone.

11111111 10 × 7 × 8 cm  300 / 50  Print Code: F(1)

Milo
3998



19



Pot Holder. 100% Cotton. One Flat Side for Printing.

11111111 16.5 × 16.5 cm  500 / 50  Print Code: E(1), N(8)

Pot
9064

ONE FLAT SIDE
FOR PRINTING
UNA CARA LISA
PARA IMPRESIÓN

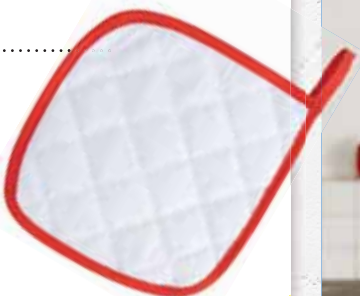

01



06



03

Set. 2 Pieces.

11111111 9.6 × 5.3 × 5.7 cm  400 / 50  Print Code: D(1)

Trepy
4018



03

01



19

Fruits.

11111111 Consult.  200 / 10  Print Code: C(1)

Mixty
3364



D

A

B

Set. Ceramic. 2 Pieces.

11111111 9.7 × 10 × 5 cm  50  Print Code: F(4)

Masia
3439



19

01

03

Sauce Dishes. Ceramic.

6 × 5.6 × 6 cm

80 / 20

Print Code: F(4)

Bumi

3443



Serving Dishes. Ceramic.

20.7 × 2.5 × 8.2 cm

60 / 10

Print Code: F(4)

Galena

9871



Serving Dish. Bamboo.

18 × 0.9 × 6 cm

300 / 50

Print Code: C(4), L1

Clevix

5195



Fondue. Ceramic. 2 Services.

Ø 8.8 × 10 cm

40

Print Code: F(4)

Kenux

4154



HOME



Multipurpose Holder. Ceramic.

7.2 × 12 × 8.4 cm

60

Print Code: F(4)

Teurus

4156



Kitchen Ladle.

10.6 × 30 × 9.5 cm

180 / 45

Print Code: D(1)

Cofil

2502



Kitchen Tongs.

3 × 16.3 × 0.7 cm

500

Print Code: E(4)

Karel

2486



Kitchen Set. Bamboo/Silicone. 3 Pieces.

12 × 22 × 1.5 cm

200 / 20

Print Code: C(4), L1

Bacet

5179



Server Knife.

5.8 x 29 x 0.9 cm

300 / 25

Print Code: D(1)

Klou

3997



Kitchen Set. Ceramic. 3 Pieces.

24.5 x 3.4 x 14.7 cm

40 / 20

Print Code: F(1)

Taywell

3929



Kitchen Set. 2 Pieces. Flexible Board.

21.3 x 38 x 0.2 cm

40 / 10

Print Code: F(1)

Hiwa

3782



FOLDABLE



Knife Set. Stainless Steel. 6 Pieces.

28.5 x 28.5 x 8.5 cm

12

Print Code: G(1)

Gemini

3381



HOME



Kitchen Cutting Board.

14 x 23.8 x 0.4 cm

150 / 25

Print Code: E(1)

Baria

4004

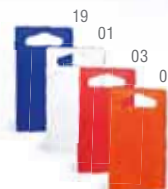

Jar. Glass. 650 ml. Individual Presentation.

8.5 x 12 x 12 cm

24 / 6

Print Code: F(1), L2

Hadar

4254

650 ml

03

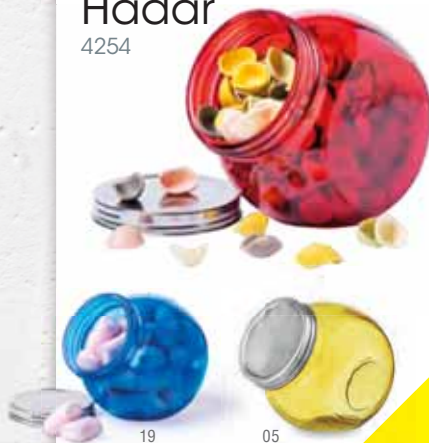

Multipurpose. Glass. 175 ml.

5.9 x 20 cm

48 / 6

Print Code: F(1), L2

Karly

4255

175 ml

05



Jug. Glass. 1 L.

8.6 x 24.5 cm

12

Print Code: F(1), L2

Naimel

4257

1 L



Coaster. Felt.

10 × 10 × 0.6 cm

1000 / 100 Print Code: E(1), N(8)

Tanzak

4701



11

19

03

05

04

02

Salad Bowl. 4 L.

26 × 12.6 × 26 cm

100 / 25

Print Code: E(1)

Belix

2498



19



05



03



01

4 L



BPA FREE

Lunch Box. 800 ml.

19 × 5.5 × 23.2 cm

40

Print Code: E(1)

Maynax

4293



04

800 ml



05



19

Spoon Set. 5 Pieces.

15 × 1 × 15 cm

400 / 100

Print Code: D(1), C(4)

Anpao

3738



Mug. Ceramic. 400 ml. Individual Presentation.

Ø 8.8 × 12 cm

36

Print Code: F(4)

Yuri

7050



400 ml

02

19

03

Jug. PP. 1 L.

Ø 11.3 × 16.5 cm

120 / 10

Print Code: C(1)

Garix

2492



1 L



BPA FREE

01

03

19

Multipurpose Cloths. Microfibre. 4 Pieces.

16.5 × 15.5 × 3 cm

100

Print Code: E(1), N(8), P

Cornus

3990

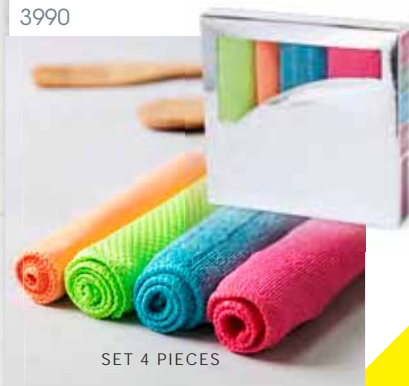

SET 4 PIECES

Fly Swatter.

12 × 40 × 0.6 cm

500 / 50

Print Code: D(1)

Trax

5274



19

03

Incense and Candle Set. Aromatic.

11.5 × 3 × 9.4 cm 100 / 50 Print Code: E(1)

Nikel

4138

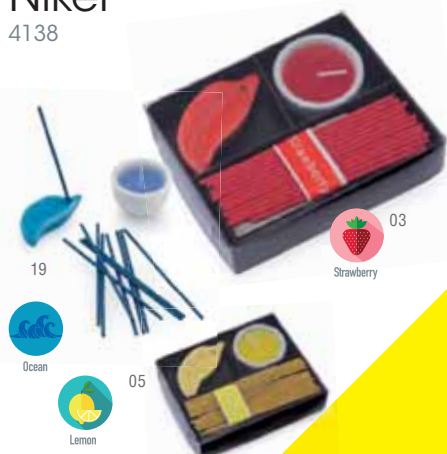

Aromatic Diffuser. 10 ml.

3 × 12.8 × 3 cm 200 / 50 Print Code: E(1)

Kampur

4022



Vase. Ceramic.

Ø 7.1 × 14 cm 50 / 10 Print Code: F(1)

Celane

3031

CERAMIC



Electric Candle. 1 Led. Button Battery Included.

Ø 4.5 × 3 cm 300 / 50 Print Code: C(1)

Liwa

3762

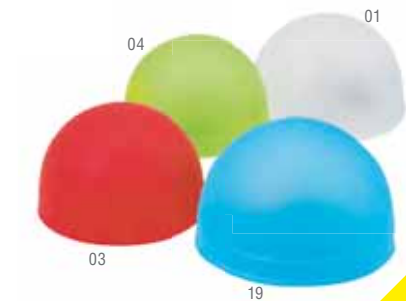

Aromatic Candle. Metal. Vanilla Aroma.

Ø 4.6 × 1.4 cm 400 / 50 Print Code: E(4), L1

Klire

4881



Hanger.

44.5 × 25 × 0.4 cm 100 / 10

Print Code: C(1)

Merchel

4434



Towel Set. 100% Cotton 400 g/m². 1 Piece 70 x 140 cm. 2 Pieces 40 x 70 cm.

37.4 × 6 × 26.5 cm 20

Print Code: E(1), N(8), P

Crater

3999



Coin Tray. PVC.

12 × 12 × 4 cm 300 / 50

Print Code: F(1)

Flot

3430



Multipurpose Basket. PVC.

Ø 10.2 × 11 cm 400 / 20

Print Code: G(1)

Domi

3785



Slippers. Polyester.

37-39, 41-43

60 / 10

Print Code: E(1), N(8)

Cholits

4540



Slippers. Cotton.

37-39, 41-43

100 / 20

Print Code: E(1), N(8)

Gemex

9499



Apron. 100% Polyester.

55 × 29.5 cm

120 / 20

Print Code: F(1), N(8)

Brinka

4110



Display Stand. Acrylic.

11.4 × 19.6 × 6 cm

200 / 10

Print Code: E(1)

Myles

4825

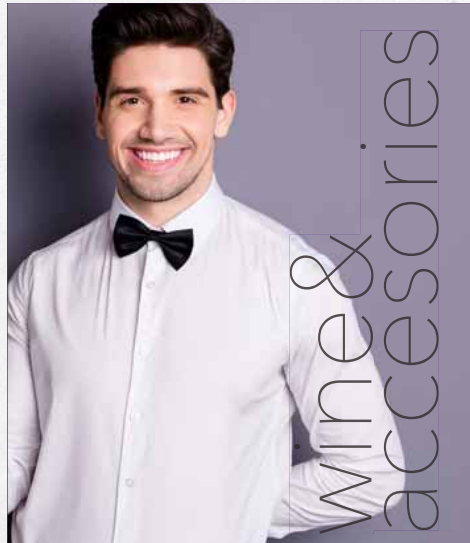

Ice Bucket. PVC.

12 × 23.5 × 12 cm

100 / 25

Print Code: F(1)

Cezil

4236

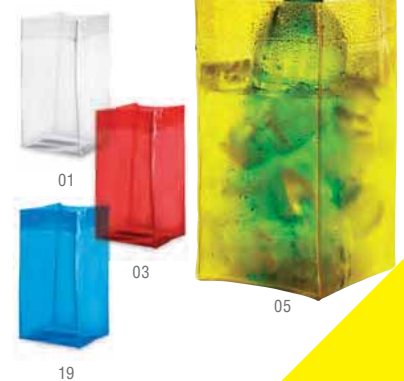

Drip Stop Ring.

Ø 4 × 1.9 cm

500 / 50

Print Code: D(1), L1

Spot

8649



Cap Holder.

5 × 7 × 3.2 cm

500 / 50

Print Code: C(4)

Kolsi

4856



Corkscrew Set. 2 Accessories.

20 × 11.5 × 6.2 cm

12

Print Code: F(1)

Perfecto

2425



Umbrella. Pongee. Ergonomic EVA Handle.

122 x 95.5 cm 30 / 10 Print Code: G(1), N(8)

Siam

3835



03



01

04

19

POUCH INCLUDED
FUNDA INCLUIDA

Umbrella.

Ø 95 cm 60 / 10 Print Code: G(1), N(8)

Mint

3186



Ø 95 cm

19



07

04

03

02

Umbrella.

72 x 72 cm 60 Print Code: G(1), N(8), R

Square

9457



01



03



19



07



04



05

Set. Polar Fleece Scarf 22,5 x 150 cm. Anti-Pilling 180 g/m². Umbrella Ø 95 cm.

26.8 x 5 x 18.7 cm 30 / 10 Print Code: G(1),

N(8), O

Bitem

3185



03



SET 2 PIECES
SET 2 PIEZAS

Ø 95 cm



19



02



WINTER

Set. Polar Fleece 180 g/m². 2 Pieces. Anti-Pilling.

9.5 x 27 x 9.5 cm 100 Print Code: N(8), O, P

Estepa

3212



19



2 PIECES + BAG

13

02

03

Keyring Raincoat. LDPE. One Size. Adult. 127 x 102 cm.

Ø 6.3 cm 200 / 25 Print Code: D(4)

Storm

3222



19

05

01

03



02

Keyring Hat. Polyester. Waterproof.

Ø 6.4 cm 200 / 25 Print Code: D(1), F(1)

Telco

3502



03

19

02

Lanyard. Nylon 190T. Waterproof. Safety Catch.

2 x 55 cm 300 / 50 Print Code: F(1)

Bob

9937



01

03

07

02

19

Cap. Polar Fleece 220 g/m2. 6 Panels.

Consult.

200 / 50

Print Code: N(8), O, P

Vinka

3877



6 Panels



Cap. Polar Fleece 250 g/m2.

Consult.

200 / 50

Print Code: N(8), O, P

Navy

3224



Hat. Polar Fleece 200 g/m2.

Consult.

200 / 50

Print Code: N(8), O, P

Aden

3876



Gloves. Polar Fleece 200 g/m2. Anti-Pilling. Men's and Women's Size.

Consult.

250 / 25

Print Code: N(8), O

Monti

9241



Set. Polar Fleece 190 g/m2. One Size. Adult.

20 x 25 x 7 cm

100 / 5

Print Code: N(8), O, P

Glen

9365



3 PIECES

Blanket. Polar Fleece 200 g/m2. Blanket 80 x 120 cm. Pillow 27 x 24 cm. Anti-Pilling.

27 x 24 cm

30

Print Code: N(8), O, P

Yelmo

3521



BLANKET / PILLOW
MANTA / ALMOHADILLA

27 x 24 cm
200 g/m²



2in1
Multifunction

Parka. Outside: Nylon/ Microfibre. Inside: Polar Fleece.

M, L, XL, XXL

25

Print Code: N(8), P

Wear

9959



Parka. Outside: Nylon/ Microfibre. Inside: 100% Polyester.

M, L, XL, XXL

30

Print Code: N(8), P

Canadá

8029



Jacket. Polar Fleece 280 g/m2. Anti-Pilling Treatment.

M, L, XL, XXL

30

Print Code: N(8), P

Siberia

9394



Vest. Outside: Polyester. Inside: Polar Fleece.

Print Code: N(8), O, P

Premier

9070



Vest. 35% Cotton/ 65% Polyester.

Print Code: N(8), O, P

Málaga

8664



Vest. Outside: Soft Shell, 92% Polyester/ 8% Elastane. Inside: 100% Polyester Microfleece. 300 g/ m2. Wind and Water Resistant.

Print Code: N(8), P

Litman

3855



Adult Color T-Shirt. 100% Cotton 195 g/ m2.

Print Code: F(6), N(8), O, P

Heavy-T

9451

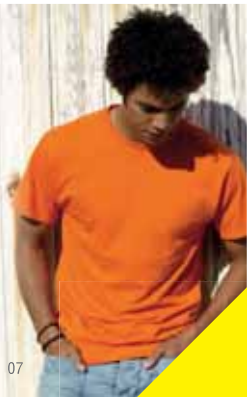

Adult Color T-Shirt. 100% Cotton 145 g/ m2.

Print Code: F(6), N(8), O, P

Original

3278



Women Polo Shirt. Cotton/ Polyester 180 g/ m2.

Print Code: F(6), P

65/ 35

3248



Women Colour T-Shirt. 100% Cotton 165 g/ m2.

Print Code: F(6), N(8), O, P

Valueweight

3297



Sweatshirt. 80% Cotton/ 20% Polyester 280 g/ m2.

Print Code: F(6), N(8), O, P

Raglan

3567



Adult T-Shirt. 100% Polyester 145 g/m2. Breathable.

XS, S, M, L, XL 80 Print Code: F(6), N(8), O, P, R

Tecnic

3579



Adult T-Shirt. 100% Polyester 135 g/m2. Breathable.

S, M, L, XL, XXL 80 / 10 Print Code: F(6), N(8), O, P, R

Tecnic Slefy

4753



Polo Shirt. 100% Polyester 180 g/m2. Breathable.

S, M, L, XL 60 Print Code: F(6), N(8), O, P, R

Tecnic

3580



Polo Shirt. Cotton/Polyester 180 g/m2.

M, L, XL, XXL 60 / 10 Print Code: F(6), N(8), O, P

Cerve

9207



19

Polo Shirt. 95% Cotton/ 5% Lycra 215 g/m2.

M, L 100 / 10 Print Code: F(6), N(8), O, P

Cristin

9197



02

03 07

T-Shirt. Cotton/Lycra 220 g/m2.

M, L 100 / 10 Print Code: F(6), N(8), M, O, P

Woman

9205



07

02

Polo Shirt. 100% Cotton 220 g/m2.

S, M, L, XL, XXL 40 Print Code: F(6), N(8), O, P

Embassy

3125



03



02



01

Alexluca
Italy

Adult T-Shirt. 100% Polyester 145 g/m2. Breathable.

XS, S, M, L, XL 80 Print Code: F(6), N(8), O, P, R

Tecnic Bandera

3581



02

01

06

Polo Shirt. 100% Polyester 180 g/m2. Breathable.

S, M, L, XL 60 Print Code: F(6), N(8), O, P, R

Tecnic Bandera

3578

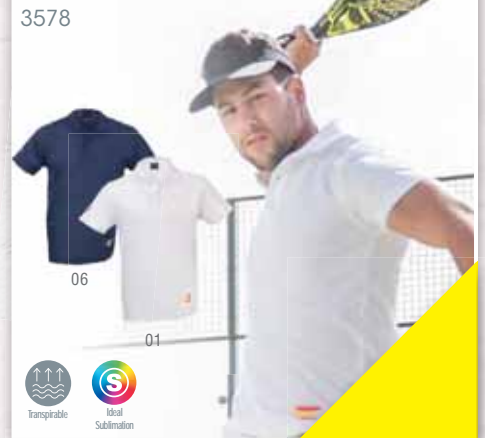

06

01



2008	1068, 1069	3020	1157	3306	584	3583	675, 1016, 1238	3834	1126	4057	348, 510	4271	617
2050	1172	3025	983	3307	581, 730	3584	448, 962	3835	1288	4060	163	4272	292
2101	251	3026	1252	3310	1265	3585	948	3837	447, 507	4064	1279	4273	772, 820
2233	810	3029	736, 1061, 1202	3311	473, 589, 1042	3586	1270	3838	636	4067	1232	4275	1248
2251	205	3031	1286	3316	501, 1198	3589	1274	3839	1271	4070	1268	4276	1276
2308	138	3036	261	3317	501, 972	3589	1274	3841	1197, 1205	4083	1245	4278	531, 535
2309	138	3038	342	3321	570	3593	1002	3842	975, 1205	4084	304	4279	868
2320	250	3040	324	3322	569	3596	1275	3843	649, 1017	4086	502, 972, 1010	4280	1262
2321	250	3041	173	3323	338	3599	1002	3847	293	4090	223	4281	316
2420	180	3042	133, 1005	3324	349	3602	242	3848	1253	4091	658	4283	130
2421	243	3047	564	3325	340	3604	1276	3849	1278	4092	1260	4290	775
2425	1287	3050	782	3329	975, 1058	3608	1272	3850	320, 944	4094	991	4291	774
2428	807	3052	896	3330	1059	3619	1219	3851	320	4096	297	4292	1256
2427	594, 786	3055	949	3335	697	3620	909	3853	1254	4097	1005	4293	1285
2436	1017	3057	293	3337	946	3613	908	3854	1114	4098	774	4294	461
2433	687	3061	1194	3338	314	3616	953	3855	1290	4101	1252	4295	288
2451	670	3062	1195	3339	182	3618	489	3856	296	4103	1249	4297	290
2453	649, 1017	3063	1195	3340	311, 728	3625	863	3857	667	4107	1250	4298	480
2469	299	3068	830	3341	1251	3627	348	3861	292, 1236	4108	127	4299	245
2483	647	3072	469, 1041	3342	1058	3629	1260	3862	222	4110	1287	4300	769
2486	1283	3073	472, 1040	3356	1239	3630	342	3869	161	4111	960	4301	618, 792
2492	1285	3074	449, 1043	3357	1239	3632	376, 551	3871	222	4112	220	4302	504, 861
2493	451, 1221	3081	1069	3360	1226	3635	1247	3873	240	4115	1247	4303	358
2494	451, 1221	3084	1260	3363	1228	3638	378	3874	1118	4119	672	4304	772, 820
2495	452, 963	3086	120, 536	3364	1282	3639	1256	3875	1119	4120	225	4305	1201
2497	251	3088	1256	3365	575	3640	180	3876	1289	4123	642	4307	300
2498	1285	3089	1270	3368	760	3641	326, 940	3877	1289	4124	1245	4308	471
2500	460, 961	3095	329, 944	3369	618, 800	3643	322, 943	3878	1237	4127	1217	4310	990, 1238
2502	1283	3103	227	3374	657	3646	241	3880	1133	4129	953	4313	643, 1203
2503	773	3104	1257	3375	1235	3649	314	3881	1150	4130	222	4314	1254
2509	250	3107	234	3380	575, 1235	3656	1275	3882	1230	4131	672	4315	1271
2511	818	3112	563	3381	1284	3658	615, 871	3886	588	4132	783, 825	4316	1268
2513	818	3114	1267	3382	784, 1044	3661	638	3887	967	4133	587	4317	1263
2513	818	3115	502, 972, 1010	3385	117	3665	126, 789	3892	250	4134	221	4319	2319
2515	401	3120	1056, 1160	3384	426	3668	359	3893	395, 744	4137	220	4322	1255
2519	640, 778	3121	1266	3385	214	3670	1247	3894	395, 744	4138	1286	4323	1206
2520	640, 778	3122	1267	3386	323, 943	3671	923	3895	1236	4139	1265	4324	248
2521	633	3123	1266	3388	172, 954	3674	873	3896	162	4145	1281	4326	302
2522	633	3125	1291	3389	172, 954	3676	139	3897	754	4146	785	4327	612, 976
2523	633	3128	287	3390	318, 911	3677	1274	3898	214	4147	469, 1041	4328	1249
2525	250	3131	276	3392	612, 970	3678	637	3899	214	4149	483	4331	79
2526	647	3132	1001	3393	163	3679	636	3900	669	4150	379	4332	1249
2528	640, 776	3136	974	3398	1243	3680	636	3901	667	4153	1248	4333	1250
2529	190	3139	938	3401	1244	3685	496, 982	3902	1263	4152	1264	4336	1264
2530	190	3142	185	3402	230	3687	527, 1164	3903	1263	4154	1283	4337	1264
2531	191	3143	654	3403	779	3689	1249	3906	646, 1236	4156	1283	4339	1261
2532	191	3144	389, 391	3406	645, 1163	3690	1250	3907	690	4158	1270	4340	249, 330
2533	191	3147	294, 836	3407	1183	3693	117	3911	669	4159	535	4342	164
2534	190	3149	978, 1136	3410	201	3694	40	3914	675, 1016	4163	444	4343	624
2535	190	3154	686	3416	1249	3696	865	3917	1274	4164	1259	4344	199, 1207
2536	647	3157	240	3423	1279	3697	1248	3920	972	4167	1264	4345	268
2537	646	3164	341, 741	3424	243	3701	244, 953	3921	223	4168	755	4348	315
2538	3713	3165	987	3425	946	3704	613, 933	3922	777	4169	754	4349	315
2541	298	3168	666, 870	3429	921	3705	1249	3926	1249	4170	581	4351	1262
2542	298	3171	452, 962	3430	1286	3707	293	3927	535	4171	532	4352	180
2543	298	3173	867	3431	921, 1037	3708	332, 875	3929	1284	4173	321, 945	4353	314
2544	299	3174	703	3435	1249	3709	197, 1208	3931	379	4174	1254	4355	294
2545	299	3175	1276	3437	173, 955	3714	332, 872	3932	242, 948	4177	1262	4356	294
2546	251	3176	1277	3439	1282	3715	333, 875	3933	773	4178	1262	4357	314
2547	250	3178	512, 540, 919	3440	761	3719	1129	3936	1268	4182	512, 544	4358	1148
2548	646	3179	615	3443	1283	3720	979, 1137	3937	1263	4184	1095	4359	343, 741
2549	648	3184	577	3444	761, 824	3721	979, 1137	3938	635	4185	1094	4362	4364
2552	647	3185	1288	3445	1280	3722	904	3940	1269	4186	1094	4364	466, 438
2553	646, 1045	3186	1288	3446	577, 1166	3724	673	3943	1276	4187	1091	4365	286
2554	451, 1221	3189	393	3451	1167	3725	1262	3944	1026	4189	1245	4366	290
2555	451, 1221	3190	173	3453	243, 793	3726	200	3945	1054	4190	1066	4367	236, 653
2556	1191	3191	184	3457	139	3727	920	3947	1266	4197	1080	4371	225
2557	188	3192	896	3460	293	3730	120, 536	3949	333, 875	4198	1080	4372	372, 511
2558	188	3195	793	3461	687	3731	220	3950	1269	4199	1080	4373	548
2560	188	3200	581	3463	1255	3732	1247	3951	1018	4200	1080	4374	380, 485
2561	189	3201	249, 331	3470	903	3733	1257	3953	1261	4203	656, 922	4375	1257
2562	189	3202	1278	3472	902	3737	644, 1163	3956	997	4205	1265	4376	235
2564	189	3204	1262	3473	902	3738	1285	3958	286	4206	1271	4377	545
2565	189	3205	238	3474	1254	3739	1272	3959	325	4207	667	4380	1265
2566	189	3208	226	3475	1243	3740	794, 1173	3960	278, 303	4208	526, 1166	4381	448
2567	188	3209	582	3476	1248	3741	641, 1211	3961	332, 872	4209	1246	4385	1249
2569	188	3210	573	3477	227	3743	500, 1210	3963	393	4210	137, 1177	4386	736
2570	188	3211	954	3480	811	3744	1262	3964	1247	4211	137, 1177	4387	205, 746
2571	867, 891	3212	1288	3481	811	3745	1245	3967	657	4212	1246	4389	216, 793
2572	891	3213	777	3484	1164	3746	113, 203	3969	1274	4213	1250	4390	726, 736, 997
2573	881	3214	1251	3488	235, 369, 549	3748	1242	3970	1274	4214	995	4392	1242
2574	882, 1161	3216	178, 969	3492	1216	3749	1256	3971	1243	4215	491, 740, 1139	4393	488
2575	883	3217	1253	3493	1265	3754	1234	3973	1246	4216	900, 1194	4394	344
2576	885	3218	308	3495	1253	3755	1257	3974	105	4217	993	4396	922
2577	879	3221	978, 1136	3498	117	3758	1160	3976	575	4218	1258	4397	615
2578	883	3222	1288	3501	587	3760	1183	3980	304	4220	1269	4398	642
2579	884	3223	825	3502	1288	3761	1186	3982	441, 453	4221	727	4399	1275
2580	884	3224	1289	3503	1135	3762	1286	3983	771, 966	4222	311, 728	4400	1276
2583	882	3227	778	3505	466	3767	1239	3984	1235	4223	311, 728	4402	317, 1158
2584	883	3228	591, 787	3509	117	3768	228	3986	1281	4224	201, 655	4403	498
2586	886	3229	591	3510	1267	3769	1268	3987	951	4225	201, 655	4404	

4447	1246	4612	591, 787	4762	641, 1211	4912	274	5067	1197, 1203	5228	349, 511, 741	5376	585
4448	1253	4613	226	4763	831	4913	490, 1101	5068	770	5229	350	5377	1037
4449	288	4615	968	4769	1106	4914	484	5069	770	5231	1261	5378	918, 1037
4450	139, 800	4616	496, 982	4770	1107	4915	518, 1187	5070	102	5232	359	5379	1032
4451	1271	4617	1254	4771	1086	4916	499	5071	913	5233	382	5380	1255
4452	997	4618	1191	4772	311, 728	4917	1112	5083	709	5234	346, 470, 1040	5381	346
4453	316	4621	570	4773	1277	4918	382, 746	5090	923	5235	346, 470, 960	5382	1252
4455	937	4622	581	4774	588, 811, 835	4919	1261	5091	353, 959	5236	348	5384	315
4456	327, 941	4624	113, 203	4775	585	4920	1261	5092	345	5237	589, 1032	5385	315
4460	686	4625	1245	4776	586	4921	746, 953	5095	658	5238	234	5386	797
4462	1280	4626	1244	4777	1005	4922	350	5096	658	5239	1058	5387	500, 1210
4465	1268	4627	1245	4778	541, 918, 1036	4923	584	5097	920	5240	75	5388	127
4466	377, 510	4628	52	4779	377	4925	594, 786	5098	588	5241	1241	5389	216, 793
4467	577	4630	729	4780	340, 741	4926	447, 507	5099	423	5242	74, 208	5390	948
4468	577	4631	1242	4781	577, 739	4929	445	5100	445	5243	653, 922	5391	544, 652
4470	225	4633	131, 623	4782	903	4930	1048, 1063	5101	445	5244	123	5392	1245
4471	1100	4635	212	4783	903	4931	1255	5102	657	5246	41, 521	5393	1279
4472	490, 1103	4636	131, 623	4784	648	4932	124	5105	1226	5247	1097	5395	102
4473	1100	4637	670	4785	648	4934	54	5107	1227	5248	1096	5396	236
4474	1001	4639	476, 973	4787	125	4935	115, 207	5109	969	5249	1096	5397	148
4475	637	4640	519	4788	352, 959	4936	53	5110	1233	5250	738, 1105	5399	328
4477	920	4642	1273	4789	1280	4938	63	5111	1276	5251	738, 1105	5400	351
4478	583, 739	4643	1157	4792	319	4939	66, 514	5113	619, 801	5252	580	5402	319, 628, 977
4479	609, 740, 1053	4644	472, 1042	4793	319	4940	124	5114	1011	5253	582	5403	628
4480	1258	4645	716	4794	1232	4941	69	5115	675, 1016	5254	342	5406	629, 1001, 1216
4481	1081	4646	301	4795	1255	4942	75	5117	613, 933	5255	279	5407	1130
4482	1081	4647	270	4796	1279	4943	1241	5118	178, 955	5256	617	5408	902
4491	1275	4648	1198	4798	308	4944	1246	5119	317, 1158	5257	616, 871	5409	1278
4492	771, 966	4649	505, 1200	4799	993	4947	125	5120	276	5258	617	5410	1278
4493	1280	4651	1250	4800	1269	4948	127	5121	278, 305	5259	1183	5411	900
4494	1272	4653	1218	4802	1225	4950	137	5122	304	5260	261	5412	649
4495	1275	4654	215	4803	996, 1218	4951	1242	5123	164	5261	260	5413	460, 961
4496	201, 654	4656	413, 519	4804	1007	4952	1242	5124	164	5262	260	5414	1254
4497	644	4657	1118	4805	1118	4954	1240	5125	495, 1103	5263	535	5415	1087
4499	1234	4658	301	4807	504	4955	73	5126	972, 1006	5265	864	5416	287
4500	1044	4659	304	4808	946	4956	72	5127	484, 1192	5267	1248	5417	301
4501	1044	4660	305	4809	1256	4957	1241	5128	329, 944	5268	1185	5418	279
4503	812	4661	187, 316	4810	1235	4958	72	5129	224	5270	1273	5419	346, 470, 1040
4504	784, 1045	4662	275	4811	777	4959	70	5130	1139	5271	1271	5420	1212
4507	1282	4663	275	4812	246	4960	70	5131	132, 1145	5272	542, 858	5421	1212
4508	445	4666	1228	4814	1233	4962	74	5132	132, 979, 1137	5273	768	5422	1212
4509	413, 519	4667	1230	4816	907	4963	70	5133	1146	5274	1285	5423	1213
4513	862, 964	4669	914	4817	969	4964	66	5134	124, 1172	5275	853, 965	5424	574, 628
4514	44	4670	178, 957	4818	1014	4966	72	5135	908	5276	1172	5425	396, 628, 977
4515	778	4671	772	4819	630, 798	4967	77	5136	634	5277	768	5435	1243
4516	239	4672	820	4820	450	4970	504, 861	5139	328, 942	5278	862	5437	1187
4517	239	4673	749, 1127	4821	426	4971	861	5140	1231	5280	131, 891	5438	358, 730
4519	584	4674	749, 1127	4822	112	4972	274	5141	1231	5281	1179	5439	935
4520	344	4675	1055	4823	112, 216	4973	309	5142	104, 789	5282	991	5440	320, 499
4521	385, 1220	4676	1055	4824	199	4975	807	5143	1240	5283	995	5441	499
4524	317, 947	4677	533, 1160	4825	1287	4976	420	5144	76, 310	5284	994	5442	498
4525	820	4678	982	4826	199	4977	1000	5145	1244	5285	112	5443	499
4526	905	4679	128, 625	4828	1050	4978	662	5146	105	5286	129	5444	498
4527	385	4680	782, 814	4829	862, 964	4979	677	5148	520, 1161	5287	122, 1174	5445	359
4528	446, 478	4681	971	4830	635, 1147	4980	1276	5149	868	5288	195	5446	232, 360
4529	447	4682	971	4831	908, 1026	4981	500, 666, 1210	5151	1235	5289	197	5447	1068
4530	344, 980	4683	974, 1011	4832	909	4982	645, 1163	5152	54	5290	397	5448	576
4531	501, 1198	4686	974	4833	178	4984	496, 982	5153	55	5291	397	5449	292
4533	385	4687	860, 1002	4834	1061, 1202	4985	1036	5154	52	5292	503, 964, 1215	5451	571
4535	757	4688	452, 962	4835	1199	4987	74	5155	359	5293	287	5452	573
4536	756	4689	1132	4837	1246	4989	1265	5156	230	5294	287	5453	185
4537	757	4690	472, 1042	4838	1058	4990	520	5157	123, 976	5296	448, 506, 1214	5454	194, 737, 1206
4538	532	4691	444	4839	1067	4991	248	5158	981	5297	448, 506, 1214	5455	1169
4539	830	4692	446, 478	4840	618, 792	4992	478, 590, 787	5160	122, 1182	5298	468, 1038	5456	1169
4540	1287	4696	820	4841	1117	4993	130	5161	1240	5299	162	5457	526, 1168
4541	517	4698	120, 536	4842	772	4995	103	5162	116	5300	162	5458	1022
4543	775	4701	1285	4843	819	4996	1271	5163	534	5301	161	5459	1213
4544	1256	4702	450, 1220	4844	1234	4997	1262	5164	914, 1034	5302	161	5460	1213
4545	308	4703	665	4845	646	4998	533	5165	396, 963	5303	120, 537	5461	1213
4546	308	4704	664	4847	1004	4999	74	5166	1229	5305	115, 207	5463	1213
4548	242	4705	392	4848	523, 1004	5001	307	5167	268	5306	368	5464	1266
4549	1256	4706	392, 764	4849	1241	5006	284	5168	270	5307	232, 368	5465	1069
4551	1120	4707	329, 947	4850	1278	5007	1252	5170	860	5311	131, 483	5466	1232
4552	1120	4708	246	4851	1273	5009	1253	5171	76, 821	5313	38, 481	5467	1235
4553	1025	4709	322, 943	4852	624	5010	289	5172	645, 1164	5314	38	5469	1233
4554	493, 964	4710	328, 942	4853	671	5011	1253	5173	468, 1041	5317	125	5470	1233
4557	1064	4711	321, 945	4855	124	5012	309	5174	345	5320	797	5471	629, 1216
4558	1266	4712	295, 325	4856	1287	5013	307	5175	639	5323	1240	5472	629, 1216
4559	1139	4714	309	4857	1278	5014	270	5176	639	5324	46	5473	1275
4560	1050	4715	1114	4858	100, 216	5015	270	5178	767	5325	68	5474	1275
4563	492, 1024	4716	1114	4859	183	5016	303	5179	1283	5326	71	5478	598
4564	131	4717	1112	4860	1085	5017	4660	5180	760	5327	111	5479	826, 938
4565	772	4718	1102	4861	769	5018	176	5181	758	5328	73	5480	642
4566	1266	4719	1104	4862	761, 824	5019	158	5182	391	5329	1244	5481	1274
4567	493, 748	4720	1104	4863	1033	5021	756	5183	395, 744	5331	1163	5482	579
4569	673	4721	969	4865	167	5022	625	5184	395, 744, 764	5332	819, 1043	5483	579
4571	653	4722	1106	4866	485	5024	249, 330, 946	5187	110, 650	5333	136, 1177	5484	579
4572	1258	4723	1107	4867	168	5025	1265	5188	109, 651	5334	131	5485	579
4573	166	4724	1107	4868	236	5026	480	5189	123	5335	114, 206	5486	579
4574	243	4725	1101	4869	237	5027	176	5190	586	5336	545	5487	579, 811
4575	951	4726	1106	4870	828	5028	1257	5191	1266	5337	1		

5522	133, 483	5657	615	5800	111, 976	5933	918, 1036	6068	674, 1211	6197	559, 735	6321	264
5523	494	5659	676, 980	5801	111, 202	5934	656, 898	6069	165, 283	6198	431	6322	256
5524	1005	5660	526, 1166	5802	100, 212	5935	1193	6070	321, 945	6199	1204	6323	427
5525	601, 932	5661	172, 954	5803	81	5936	1192	6071	279	6200	1199	6324	857, 899
5527	33, 1176	5663	229	5804	482	5937	632	6072	261	6201	947, 920	6325	543, 826, 888
5528	41, 521	5664	229	5805	614	5938	587	6073	277	6203	1205	6326	147, 221
5529	40, 521	5665	229	5806	443	5939	167	6074	270	6204	660	6327	147
5530	51	5667	186	5807	88, 284	5940	1232	6075	270	6205	661	6328	146
5531	62	5668	183	5808	592, 1030	5941	1231	6076	301	6206	753	6329	372, 514
5532	368	5669	184	5809	372, 495	5942	857, 899	6077	307	6207	524, 1060	6330	524, 514
5533	42, 790	5670	183	5810	522, 1134	5943	974	6078	282	6208	487, 1051	6331	259
5534	136, 1176	5671	171	5811	674, 910	5944	102, 486	6079	1098	6209	248, 331, 874	6332	265
5536	39	5672	164	5812	291	5945	62, 607	6080	1111	6210	297	6333	267
5537	67	5675	1154	5814	814	5946	205	6081	258	6211	284	6334	256
5538	68	5676	1155	5817	1155	5947	384	6082	334, 873	6212	212	6335	257
5540	135, 1178	5677	1155	5816	614, 970	5948	113, 203	6083	326, 940	6213	257	6336	276
5541	103	5678	1154	5817	1071, 1143	5949	364	6084	128, 627	6214	264	6337	740, 1050
5544	1156	5679	1162	5818	108, 652	5953	103	6085	111, 202	6215	232, 362	6338	159
5545	1156	5680	983	5819	60, 403	5954	135, 1178	6086	53	6216	231, 362	6339	354, 604
5546	1156	5681	130	5820	477	5955	45, 211	6087	83	6217	363	6340	559
5547	1157	5682	104, 486	5822	108, 652	5956	80, 89, 622	6088	83, 622	6218	363, 381, 553	6341	558
5548	1159	5684	500	5823	136, 1176	5957	80	6089	80	6219	381, 553	6342	552
5549	247, 1159	5685	393	5824	616, 970	5958	50	6090	79, 538	6220	363	6343	349, 511
5550	247, 1159	5686	393	5825	291, 614	5959	64	6091	79	6221	1099	6344	340
5551	129, 627	5688	892	5826	1195	5960	68	6092	465, 960	6222	1099	6345	365
5552	1130	5689	819	5827	421	5961	82	6093	813	6223	619, 801	6346	277
5553	1132	5690	784, 826	5828	631, 798, 1229	5962	100, 212	6094	780, 813	6224	135, 1178	6347	61, 217, 797
5554	479, 1057	5691	639	5829	900	5964	101, 211	6095	780, 813	6225	1240	6348	631, 799, 1229
5555	437	5692	1183	5830	835	5965	122, 1182	6097	807	6226	39	6349	1227
5556	532	5693	1186	5831	565	5966	78, 538	6098	803	6227	1243	6350	277, 296
5557	253, 269	5694	1272	5832	295	5967	77	6099	805	6228	91	6351	36
5558	286	5695	441, 509	5833	289	5968	137, 1177	6100	805	6229	90	6354	988
5559	438	5696	649, 1017	5834	89	5969	83, 622, 1182	6101	806	6230	97	6355	998
5560	441, 452, 962	5698	1265	5835	160	5971	106, 370	6102	194, 1207	6231	97	6356	448, 928
5561	761	5699	616, 871	5836	397	5972	371, 497	6103	1064	6232	94	6357	522, 1134
5562	62	5700	1279	5837	394, 745	5973	88, 285	6104	531, 541	6233	94	6358	1059
5563	614, 970	5701	352, 935	5840	806	5974	285	6105	749, 1128	6234	86, 97	6359	415, 743
5564	323, 610	5702	825, 934	5841	806	5975	283	6106	590, 786	6235	86, 97	6360	934
5565	487, 1057	5703	935	5843	81	5976	1251	6107	1220	6236	93	6361	464
5566	54	5704	1023	5844	33	5977	280	6108	170, 955	6237	96	6362	833, 855, 859
5567	347	5705	352, 959	5845	284	5978	413	6109	174	6238	96	6363	110, 650
5568	1225	5706	1130	5846	92	5979	440, 509	6110	185	6239	96	6364	277
5571	413	5707	1129	5847	95	5980	158	6111	415, 743	6240	95	6365	300
5572	449, 460, 961	5708	1047, 1189	5848	92	5981	611, 796	6112	600	6241	95	6366	281
5573	611	5709	1046, 1188	5849	94, 310	5982	338	6113	601	6242	92	6367	281
5574	288	5711	1062	5850	92	5983	564	6114	747, 755	6243	86, 97	6368	281
5575	305	5712	1062	5852	643, 737, 1206	5984	397, 1224	6115	583, 739	6245	121, 537	6369	258
5576	270	5713	1062	5854	1085	5985	400, 745, 1224	6116	747, 783, 825	6246	496, 520, 1161	6370	354
5577	1243	5714	1062	5855	1085	5986	427, 508	6117	512, 919	6247	208, 610, 938	6371	354
5578	116	5715	930	5856	1079	5988	1132	6118	569	6249	632, 796, 1227	6372	473, 589
5579	137	5716	932	5857	1079	5989	1000	6119	339	6250	519, 1164	6373	476
5580	342	5717	613, 933	5858	1083	5990	611	6120	914, 1034	6251	371, 497	6374	475, 517
5581	224	5718	600, 932	5991	1083	5991	165	6121	229, 312, 950	6252	32	6375	300, 405
5582	226	5719	930	5860	1084	5992	645, 1163	6122	574	6253	32	6376	466
5584	284	5720	1280	5861	1084	5993	86, 211	6123	574, 739	6254	55	6377	767
5586	590, 1032	5721	1027	5862	1087	5994	88	6124	91	6255	61, 796, 821, 1003	6378	1191
5587	1242	5722	659	5863	1087	5996	165, 282	6125	90	6256	32	6379	929, 968
5588	340	5723	339	5864	1109	5997	323, 937	6126	44, 206	6257	34	6380	929
5589	350	5724	339	5865	1108	5998	436	6127	119, 1174	6258	129, 626	6381	929, 1006
5590	358	5725	593, 1028	5866	1108	5999	129	6128	106, 370	6259	48, 219	6382	869
5591	230	5726	593, 1028	5867	1078	6001	898	6129	44, 114, 206	6260	48	6383	869
5592	1071, 1142	5728	1032	5868	1078	6003	936	6130	84	6261	64	6384	405
5593	468, 1038	5729	916, 1034	6004	5869	6004	33, 403, 539	6131	50	6262	68	6385	405
5594	628, 977	5730	1068	6005	1082	6005	766, 817	6132	85	6263	65	6386	338
5595	1229	5732	412, 822	6006	870	6006	870	6135	134, 1180	6264	45, 602	6387	592, 1028
5597	410, 822	5733	412, 822	6007	1089	6007	110, 553, 651	6136	42	6265	119, 791	6388	1000
5598	1231	5734	654	6008	1078	6009	416	6137	42, 1174	6266	63	6389	560
5599	36, 481	5735	319, 947	6010	1078	6010	416, 730	6139	65	6267	32	6390	336
5600	166	5736	592	6011	1088	6011	284	6140	205	6268	44, 217, 797	6391	560
5601	286	5737	469, 1041	6012	1088	6012	406	6141	44, 121, 539	6269	56	6392	336
5602	291	5738	571	6013	1261	6013	406	6142	84	6270	135, 1178	6393	561
5604	261	5739	115, 207	6014	5879	6014	1002	6143	16	6271	84	6394	158
5605	258	5740	202	6015	660, 810	6015	660, 810	6145	82, 218	6272	64	6395	169
5606	264	5741	83, 622	6016	547	6016	547	6146	51	6273	19	6396	169
5608	297	5742	238, 746	6017	177	6017	177	6147	39	6274	344, 496, 983	6397	168
5609	332, 875	5744	533, 1150	6018	177	6018	177	6148	33	6275	766, 817	6398	170
5610	332, 874	5746	1271	6019	306	6019	306	6149	84	6276	1227	6399	171, 955
5612	246	5747	479, 1103	6020	453, 936, 963	6020	453, 936, 963	6150	19	6277	473, 589, 787, 1040	6400	184
5613	246	5748	479, 1103	6021	1251	6021	1251	6151	968	6278	834, 859, 965	6401	177
5615	1014	5749	134, 1180	6022	300	6022	300	6152	407, 765, 928	6279	799, 1229	6402	482
5616	1014	5755	687	6023	148	6023	148	6153	456	6280	428, 508	6403	482
5617	309	5756	687	6024	148	6024	148	6154	407	6281	416	6404	248, 874, 874
5618	1009	5757	92	6025	149	6025	149	6155	372, 1128	6282	462	6405	122, 905
5619	1015	5761	95	6026	306	6026	306	6156	424	6283	462	6406	998
5620	341	5762	518, 862, 975, 1002	6027	291	6027	291	6157	177	6284	792, 1228	6407	999
5621	340, 511	5764	46	6028	292	6028	292	6158	563	6285	467, 1038	6408	631, 799
5622	309	5765	82, 218	6029	295	6029	295	6159	160	6286	390, 745	6409	414, 742
5623	997	5766	58	6030	283	6030	283	6160	918	6287	394, 745	6410	269
5624	1184	5767	58	6032	280	6032							

6444	60, 1003	6567	256, 832	6694	272, 848	6817	355, 985, 1029	7092	706	7357	688	9457	1288
6445	90	6568	204	6695	458	6818	355, 1029	7093	706	7358	688	9458	1127
6446	667	6569	404	6697	542, 677, 877,	6819	593, 1030	7096	706	7359	690	9459	392, 764
6447	856	6570	566	6698	118, 155, 790,	6820	593, 1030	7100	721	8012	1146	9464	392
6449	959, 1215	6571	543, 866, 898	6701	8	6821	568	7101	720	8013	721	9476	634
6450	1199	6572	567, 1031	6702	8	6822	568	7102	723	8017	1071, 1143	9479	1280
6451	356	6573	27	6699	15	6823	572, 724	7104	720	8025	1121, 1186	9481	1280
6452	356	6574	27, 213	6700	8	6824	572, 724	7109	683	8029	1289	9482	933
6453	361	6575	26, 202	6702	8	6825	833, 914	7111	722	8072	1053	9483	971
6454	361	6576	18, 219	6703	845, 1140	6826	895, 915, 1035	7114	704	8080	1060	9486	1133
6455	361	6577	567	6704	153, 367, 843	6827	915, 1035	7115	704	8085	1063	9487	524, 1121
6456	426, 609	6578	432	6705	890, 1196, 1203	6828	915, 1035	7121	711	8086	1063	9496	518, 863, 1187
6457	165, 606	6579	531, 605, 795	6706	408, 765, 847	6829	565	7122	711	8088	1066, 1217	9499	1287
6458	341, 608	6580	398, 762, 809	6707	408, 847	6830	565	7123	546, 701	8094	1009, 1238	9497	1287
6459	1092	6581	431	6708	459, 846	6831	751, 754, 827	7124	703	8095	620, 996, 1202	9510	247, 1159
6460	1092	6582	431	6709	28, 145	6832	914	7127	696	8097	998	9512	1272
6461	734, 1075, 1093	6583	432	6710	781, 815	6833	335, 336, 561	7134	711	8100	1047, 1189	9514	780, 812
6462	1093	6584	440	6711	880	6834	567, 1031	7140	715, 978	8101	1046, 1188	9521	1171
6463	1115	6585	399, 763	6716	196, 885	6835	567, 560	7145	708	8102	749, 1046, 1188	9523	214
6464	1115	6586	388, 399, 763	6717	833, 867, 891,	6836	571, 1031	7147	715, 978	8114	676, 980	9527	1242
6465	1110	6587	56	6718	543, 866, 876,	6837	171	7149	709	8225	1167	9528	209, 402
6466	1110	6588	175	6719	889, 962	6838	159	7150	709	8230	1168	9537	1226
6467	912, 999	6589	522, 1135	6720	543, 889	6839	163	7153	705	8232	1168	9543	864
6468	620, 912, 985,	6590	605, 795	6721	855, 866, 889	6840	334, 357, 381,	7155	705	8235	1169	9547	1254
6469	999	6591	129, 626	6722	849, 865	6841	375, 513, 551	7157	705	8448	749, 1019	9550	482, 980
6470	90	6592	26	6723	157	6842	540, 917	7160	681	8530	1155	9554	810
6471	182	6593	774	6724	542, 849	6843	597, 659, 917	7161	710	8534	1155	9562	1169
6472	407	6594	541	6725	43, 209, 459	6844	151, 237	7162	680	8538	1061	9566	1200
6473	365	6595	451, 1220	6726	475, 494	6845	141, 151, 231	7163	680	8544	1053	9574	245
6474	913	6596	360, 467	6727	565	6846	150, 223	7164	704	8547	384	9576	1008
6475	959, 923	6597	371, 497	6728	564	6847	150, 221	7166	680	8549	1066	9579	1168
6476	912, 999	6598	362	6729	267	6848	152, 357	7169	699	8573	1277	9587	237
6477	781, 815	6599	809	6729	159	6849	467, 1039	7170	708	8584	327, 941	9588	241
6478	781, 815	6600	462	6730	254	6850	349, 510	7171	710	8585	327, 941	9589	1015
6479	819	6601	834, 859	6731	252, 254	6851	492, 1025	7175	710	8587	321, 945	9607	320, 836, 1158
6481	398, 762	6602	1013	6735	23, 144	6852	556, 566, 747	7181	702	8622	1225	9618	1171
6482	398, 762	6603	424	6736	12	6853	495	7183	702	8649	1287	9638	1248
6483	134, 1179	6604	175	6737	45, 210	6854	1049, 1071,	7184	702	8652	228	9639	380
6484	619, 801	6605	257, 837	6738	7, 15	6855	1123, 1141	7185	718	8662	1116	9641	677
6485	630, 798	6606	265	6739	15	6856	491, 1123, 1141	7186	718	8664	1290	9642	664
6486	660	6607	322	6740	10	6857	389, 419	7188	716	8719	327, 940	9647	804
6487	766, 817	6608	259	6741	11	6858	418	7193	719	8722	326, 940	9648	804
6488	672	6609	259	6742	10	6859	418	7195	719	8735	247, 949	9653	290
6489	198, 873	6610	259	6743	11	6860	418	7196	719	8754	978, 1136	9654	1201
6490	198	6611	260, 311, 728	6744	9	6861	413	7199	719	8772	532	9670	971
6491	494	6612	261	6745	9	6862	417	7204	684	8774	505, 1201, 1239	9675	384
6492	517	6613	240	6746	37	6863	417	7207	697	8780	195, 1207	9678	1056
6493	374, 550	6614	259	6747	37	6864	431	7218	707	8781	870	9683	1279
6494	377, 852	6615	14, 142	6748	788, 1122, 1148	6865	398, 762	7224	703	8846	195	9690	480
6495	258	6616	14, 142	6749	152, 335, 357	6866	430	7225	703	8850	612, 971	9691	808
6496	263	6617	167	6750	107, 153, 367,	6867	433	7227	707	8854	1011	9696	262
6497	969	6618	1051	6751	881	6868	433	7230	717	8863	620, 998	9702	1243
6498	758	6619	913	6752	880	6869	411	7236	680	8864	683	9705	1001
6500	1160	6620	233, 366	6753	881	6870	389, 415, 430,	7237	680	8876	1158	9710	939
6501	832	6621	570	6754	668	6871	332, 743	7240	700	8884	987	9711	245
6502	835	6622	572, 725	6755	734, 1075, 1090	6872	437	7241	699	8888	1260	9718	630, 798
6503	834, 901	6623	572, 725	6756	1074, 1113	6873	437	7242	697	8946	534	9726	355
6504	833, 901	6624	424, 572, 725	6757	1074, 1113	6874	434	7246	700	8948	227	9727	339
6505	381	6625	566	6758	1074, 1113	6875	425	7247	546, 701	8950	239	9728	588
6506	59	6626	913, 1035	6759	1077	6876	425	7248	711	9012	351	9729	1154
6507	55	6627	17	6759	1111	6877	422	7249	708	9046	290	9735	872
6508	59	6628	205	6760	1076	6878	422	7250	708	9063	756	9736	245
6509	233, 366	6629	988	6762	889	6879	388, 423	7254	718	9064	1282	9740	1211
6510	25	6630	1076	6763	156, 851	6880	388, 423	7257	715, 1000	9066	1070, 1146	9751	224
6511	34	6631	1001	6764	154, 842	6881	429	7263	715, 952	9070	1290	9765	228
6512	45	6632	345, 503, 1215	6765	272, 850	6882	429	7264	715, 952	9075	505, 1201	9768	505, 1200, 1238
6513	523, 1004	6633	90	6766	272, 321, 832,	6883	429	7266	721	9096	1205	9771	562
6514	758	6634	880	6767	850, 927, 945	6884	155, 842	7270	722	9124	1047, 1189	9774	247, 1159
6515	119, 791	6635	882, 1161	6768	557, 562, 844	6885	193, 912, 1209	7271	722	9139	512	9776	953
6516	20, 603, 794,	6636	882, 1161	6769	408, 846	6886	260	7283	714	9146	376, 552	9777	288
6517	20, 602, 795	6637	888	6770	408, 507, 846	6887	454, 464	7285	529, 713	9147	919	9781	1071, 1143
6518	18, 213	6638	888	6771	255	6888	81	7286	529, 713	9156	1006	9780	260
6519	46	6639	888	6772	253, 256	6889	49, 840	7287	528, 713, 1165	9161	328, 939	9799	910
6520	47	6640	273, 848	6773	263	6890	51	7288	528, 713, 1165	9162	326, 941	9800	533, 860
6521	22, 144	6641	677, 893	6774	265	6891	35	7291	529, 712, 1170	9169	199	9802	704, 1147
6522	23	6642	885	6775	13, 140, 145	6892	67	7292	712, 1170	9173	1046, 1188	9804	704
6523	22	6643	841, 1175	6776	17	6893	6, 47	7293	684	9174	1270	9807	1277
6524	22	6644	841, 1175	6777	35	6894	6, 47	7294	684	9175	1021	9811	1277
6525	14, 142	6645	36, 481	6778	193, 1209	6895	23	7295	373, 515, 714	9188	534	9817	1272
6526	14, 142	6646	38, 865, 890	6779	118, 790, 841,	6897	1246	7296	696	9195	1067, 1217	9825	1192
6527	21, 143	6647	118, 790, 841,	6780	129, 627	7000	621, 991	7299	700	9197	1291	9828	1266
6528	16	6648	114, 841, 1175	6781	597, 598, 931	7001	994	7300	691	9205	1291	9830	338, 942
6529	18	6649	598, 931	6782	855, 861, 871	7003	975	7309	696	9207	1291	9831	328, 942
6530	423	6650	857, 899	6783	135, 1179	7004	1219	7311	681	9208	1014	9833	1225
6531	420	6651	857, 899	6784	857, 899	7010	904	7312	716	9212	829, 1061	9843	383
6532	121, 537	6652	857, 899	6785	857, 899	7011	694	7313	716	9215	1125	9844	571
6533	43, 209, 402	6653	857, 899	6786	135, 1179	7012	1277	7314	716	9235	1260	9848	559
653													

names	pages
360° Camera	40
3D Lens	123
4 Batteries Pack 1,5V	138
7 in 1 Pen	317, 1158
Absorbent Towel	492, 493, 748, 862, 964, 1024, 1025
Absorbent Towel Set	1279
Action Camera	41, 521
Action Camera 360°	40, 521
Adapter	82, 218, 1244
Adhesive Tape Set	1256
Adjustable Ring	716, 719, 721, 722
Adult Color T-Shirt	1080, 1081, 1290
Adult Colour Polo T-Shirt "keya"	1087
Adult Colour T-Shirt "keya"	1079, 1083, 1084, 1085
Adult Hooded + Zipper Sweatshirt "keya"	1108
Adult Hooded Sweatshirt "keya"	1108
Adult Sweatshirt "keya"	1109
Adult Technical Sweatshirt	1106, 1107
Adult T-Shirt	479, 734, 738, 1075, 1076, 1077, 1092, 1093, 1095, 1097, 1098, 1099, 1100, 1101, 1103, 1104, 1105, 1106, 1237, 1291, 1076
Adult T-Shirt "Keya"	1076
Adult White Polo Shirt "keya"	1087
Adult White T-Shirt	1080, 1081
Adult White T-Shirt "keya"	1079, 1083, 1084, 1085
Advent Calendar	1230
Air Blower	1044
Air Freshener	618, 676, 792, 1185
Air Freshener Holder	1185
Air Mattress	1012, 1013
Aircraft	971
Alarm Clock Charger	45, 602
Alcohol Tester	122, 1174
Animation Hand	505, 1201, 1239
Antibacterial Backpack	153, 367, 843
Antibacterial Bag	557, 562, 844
Antibacterial Bottle	408, 507, 846
Antibacterial Cup	408, 847
Antibacterial Drawstring Bag	343, 844
Antibacterial Earphones	31, 839
Antibacterial Holder	30, 626, 627, 852
Antibacterial Keyring	852, 893
Anticontact	
Antibacterial Keyring Coin	590, 671, 852
Antibacterial Lanyard	155, 842
Antibacterial Lunch Box	459, 846
Antibacterial Mouse	31, 113, 154, 839
Antibacterial Mousepad	154, 842
Antibacterial Mug	408, 765, 847
Antibacterial Neck Warmer	491, 845, 1140
Antibacterial Notebook	156, 851, 927, 956
Antibacterial Notepad	156, 851
Antibacterial Opener	782, 815, 853
Antibacterial Pen	273, 836, 848, 849, 865
Antibacterial Pencil	272, 321, 832, 850, 927, 945
Antibacterial Pillbox	853, 854, 869
Antibacterial Ruler	155, 850, 927, 949
Antibacterial Set	272, 850
Antibacterial Straw	462, 816, 847
Antibacterial Stylus Touch	272, 848
Ball Pen	
Antibacterial Touchscreen Gloves	845, 1140
Antibacterial Waste Bag	
Dispenser	853, 1190
Antibacterial Webcam Cover	30, 111, 155, 842
Antibacterial Yoyo	853, 927
Antistress	616, 617, 871, 1279
Antistress Ball	616, 617, 970, 1279
Antistress Keyring	615, 871
Antistress Lanyard	1250
Antistress Pen	291, 614
Anti-Theft Backpack	152, 357, 363, 364, 365
Apron	751, 752, 753, 754, 755, 785, 827, 828, 934, 967, 1045, 1287, 1267
Aqua Shoes	1267
Arm Sleeves	490, 1103
Arm Strap	133, 482, 483, 1247
Armbands	1011
Armchair	1020, 1269
Aromatic Candle	630, 631, 750, 798, 799, 1229, 1286
Aromatic Diffuser	618, 792, 1228, 1286
Ashtray	649, 1017
Auto Filtering Mask FFP2	881
Color Auto Filtering Mask FFP2	881
White Automatic Dispenser	118, 155, 790, 890
504	504
Back Support Belt	152, 232, 335, 348, 349, 350, 351, 353, 354, 355, 356, 357, 358, 359, 360, 361, 362, 363, 365, 368, 373, 377, 467, 510, 511, 515, 523, 604, 698, 699, 714, 741, 958, 1004, 1029, 1260, 1261
Backpack	377, 552
Backpack Bag	372, 495
Backpack Cover	1212
Backpack Flag	197
Badge Lanyard	152, 357, 363, 364, 365
Anti-Theft Backpack	
Apron	751, 752, 753, 754, 755, 785, 827, 828, 934, 967, 1045, 1287
Aqua Shoes	1267

names	pages
339, 358, 374, 375, 376, 379, 513, 523, 550, 551, 552, 557, 558, 559, 560, 561, 562, 563, 564, 565, 566, 567, 568, 569, 570, 571, 572, 573, 578, 579, 580, 581, 582, 583, 584, 585, 586, 587, 588, 589, 590, 592, 593, 700, 711, 724, 725, 727, 730, 735, 786, 811, 835, 904, 906, 935, 1004, 1028, 1030, 1031, 1032, 1033, 1036, 1231, 1262, 1268, 1275, 1277	
722	
Bag	
Bag Hanger	905
Bag Hanger Key Finder	1268
Bag Holder	556, 566, 594, 747, 786
Bag Set	502, 638, 972, 1010, 1194, 1228
Ball	1250
Ball Pen Stylus Touch	829, 1061
Bandana	1195
Bandana Pet Collar	1200, 1213
Banner	784, 1045
Barbecue	1044
Barbecue Grill Cleaner	784, 1044
Barbecue Set	973
Basket	1008, 1009, 1238
Beach Ball	1020, 1022, 1023
Beach Mat	1007, 1270
Beach Rackets	749, 1018, 1019
Beach Umbrella	512, 540, 541, 700, 718, 833, 895, 913, 914, 915, 916, 917, 918, 919, 920, 921, 1034, 1035, 1036, 1037, 1262, 1277
Beauty Bag	531, 541
Beauty Bag Travel	632
Bell	634, 1274
Belt	475, 494
Bike Bag	1218, 1271
Binoculars	533, 711, 788, 969, 1122, 1148, 1149, 1150, 1151, 1230, 1289, 136, 1181
Blanket	864
Bluetooth Receiver	184, 242, 707, 948
Body Tape Measure	388, 389, 398, 410, 415, 420, 421, 422, 423, 424, 426, 427, 428, 429, 430, 431, 432, 433, 434, 435, 436, 437, 438, 439, 440, 441, 446, 447, 448, 452, 453, 478, 506, 507, 508, 509, 609, 732, 743, 762, 809, 822, 962, 1214, 1223, 1259, 1281
Bookmark	424, 572, 725
Bottle	
Bottle Bag	448, 808
Bottle Cooler	808
Bottle Holder	632, 796, 1227
Bottle Lights	1234
Bottle Set	482, 504, 642, 643, 717, 719, 720, 721, 736, 907, 975, 980, 1197, 1204, 1205, 1274, 1275
Bracelet	83, 622
Bracelet Charger	1275
Bracelet Set	634
Braces	228, 230, 697, 698, 1257
Briefcase	771, 966
Brush	974
Bubbles	819, 1043
Bucket	245, 1256
Calculator	42, 1174
Camera	1060
Camouflage Cap	618, 800
Can	799, 1229
Candle	618, 792, 1229
Candle Set	633
Candy	1275
Candy Dispenser	479, 487, 604, 609, 735, 740, 904, 1049, 1050, 1051, 1052, 1053, 1054, 1055, 1056, 1057, 1160, 1237, 1266, 1267, 1289
Cap	1287
Cap Holder	1184
Car Bin	667
Carabiner	1243
Card Case	108, 109, 110, 201, 241, 650, 651, 652, 653, 654, 655, 703, 706, 1258
Card Holder	706
Card Holder Mirror	108, 652, 654, 703
Card Holder Wallet	117, 692, 1243
Card Reader	1021
Chair	830
Chair Band	1020
Chair Cool Bag	1234
Chair Cover	326, 940
Chalk Set	6, 8, 9, 10, 12, 15, 18, 19, 22, 23, 28, 29, 32, 45, 46, 47, 48, 80, 81, 82, 84, 89, 144, 210, 211, 219, 1182, 1240, 1241, 1242
Charger	106, 370, 372, 514
Charger Backpack	43, 209, 402
Charger Cup Warmer	35
Charger Earphones	146
Charger Folder	134, 1180, 1249
Charger Holder	44, 114, 206
Charger Keyboard	14, 142, 205
Charger Mousepad	14, 142, 146
Charger Noteepad	147, 221
Charger Organizer	13, 140, 145
Charger Pencil Holder	13, 17, 51
Charger Speaker	27, 82, 83, 218, 622, 1182, 1242
Charger Synchronizer	49, 840
Charger UV Sterilizer Box	49, 841
Charger UV Sterilizer Lamp	505, 1201, 1239
Cheering Sticks	761
Cheese Knife Set	829
Chef Hat	760
Chopsticks Set	1228
Christmas Card	1227
Christmas Decoration	1226, 1227
Christmas Decoration Set	1220
Christmas Gift Tag	1226
Christmas Hat	1222, 1228
Christmas Tree	

names	pages
Cigarette Pack Cover	649
Cleaner Cloth	131, 736, 1249
Cleaning Set	244, 783
Clip	246, 774, 1256
Clip Bookmark	707, 1256
Clip Memo Holder	1279
Clip Memo Holder	1280
Sharpener	779
Clip Opener	246
Clips Holder	766, 817, 1285
Coaster	759, 766, 803, 817, 1234
Coaster Set	820
Cocktail Set	819, 820
Cocktail Shaker	1220
Coin	1286
Coin Tray	323, 610
Colouring Book	833, 834, 901
Comb	516, 529, 713, 1271
Compass	1257
Computer Set	455, 465, 466, 467, 468, 469, 471, 472, 473, 589, 960, 1029, 1038, 1039, 1040, 1041, 1042
Cool Bag	346, 470, 1040
Cool Bag Backpack	449, 1043, 1270
Cool Bottle	860
Cool Eye Mask	1249
Cord Winder	779, 780, 812
Corkscrew	780, 813
Corkscrew Opener	1287
Corkscrew Set	1278
Cosmetic Pencil	902
Sharpener	327, 328, 939, 940, 942
Cosmetic Set	396, 401, 404, 405, 406, 407, 409, 411, 413, 425, 442, 443, 445, 449, 450, 451, 452, 460, 961, 962, 963, 1220, 1221, 1222, 1259
Crayon Set	209, 402
Cup	454, 464, 773, 928
Cup Warmer	247, 1159
Cutlery Set	973
Cutter	134, 1180
Dartball Board	139, 1244, 1256
Dashboard Holder	250
Desk Clock	250, 251
Desktop Calendar	865
Diary	1191
Digital Thermometer	774
Dispenser Bottle	1287
Dispenser Clip	498
Display Stand	499
Divot	141, 150, 151, 181, 222, 223, 224, 225, 226, 227, 228, 229, 230, 231, 362, 698, 1257
Divot Indicator	233, 366
Document Bag	222
Document Bag Backpack	600, 932
Document Holder	335, 336, 337, 338, 339, 340, 341, 342, 343, 344, 345, 741, 935, 959, 1194, 1215, 1231, 1261
Dominoes	352, 353, 354, 378, 503, 511, 561, 604, 608, 714, 735, 741, 935, 959, 1194, 1215, 1231, 1261
Drawstring Bag	492, 1024
Drawstring Cool Bag	818, 819
Drawstring Towel Bag	1287
Drink Stirrer	42
Drip Stop Ring	968
Drone	378
Duck	355, 378, 985, 1029
Duffel Backpack	710
Duffel Bag	1146
Ear/ Nose Trimmer	33
Earmuffs	33, 1176
Earphone	7, 17, 25, 34, 35, 102, 103, 104, 486, 695, 1240, 1246
Earphone Car Charger	33, 403, 539
Earphones	533, 1160
Earphones Bottle	718, 721, 722, 723
Earplugs	863
Earrings	1286
Ears Cleaner	43, 209, 459
Electric Candle	1187
Electric Lunch Box	518, 863, 1187
Emergency Hammer	1186
Emergency Kit	248, 946, 1280
Emergency Light	628, 946, 977, 1232
Eraser	243
Eraser Set	184
Everlasting Calendar	477
Everlasting Diary	477
Exercise Band	477
Exercise Bands Set	591
Extendable Bag	372, 1128
Extendable Umbrella	860, 1002
Eye Protector	902
Eyeshadow Applicator Set	892
Face Mask Hanger	885
Face Mask Strap	882, 1161
Face Shield	216, 793, 1270
Fan	317, 640, 776
Felt Tip Pen	614, 970
Fidget Spinner	1228
Figure	1226
Figures	648
Filling Machine	474
Fitness Set	1199, 1213, 1239
Flag	1212
Flag Holder	

names	pages
Flash	1244
Flip Flops	604, 710, 835, 986, 987, 1267
Flowerpot	618, 619, 800, 801, 968
Flowerpot Set	619, 801
Fly Swatter	1285
Foldable Apron	755
Foldable Backpack	347, 373, 515
Foldable Bag	379, 558, 560, 564, 565, 567, 569, 574, 575, 576, 577, 905
Foldable Bag Hanger	578, 628, 735, 739, 1235
Foldable Bottle	447
Foldable Bowl	1192, 1193
Foldable Cup	407, 870
Foldable Drawstring Bag	352, 959, 1262
Foldable Trolley	548
Folder	151, 176, 180, 181, 236, 237, 238, 239, 240, 241, 696, 697, 746, 837, 1257
Fondue	1283
Fork Set	709
Foulard	895, 908, 909, 1147, 1278
Foulard Pareo	908, 1026
Frame	996, 1219
Frisbee	929, 1006, 1194
Fruits	1282
Frying Pan	1282
Game	599, 612, 930, 931, 970, 971
Game Set	601, 972, 1006
Gamepad	123, 976
Garment Bag	544
Gift Box	726, 729
Glass	400, 745, 1224
Glass Identifier	1234
Glasses	505, 996, 1218, 1225
Glasses Strap	997, 1269
Globe	531, 605, 795
Gloves	1160, 1289
Goal Post	502, 972, 1010
Golf Ball	499
Golf Set	498
Golf Tee	499
Golf Tee Card	499
Golf Towel	498
Golf Umbrella	498
GPS Tracker	122, 1182
GPS USB Car Charger	136, 1176
Grater	773
Grinder	648
Grow Pouch	619, 801
Hair Clip	900, 1194
Hair Straightener	710
Hairbrush	898, 900, 901
Hairbrush with Mirror	900, 1278
Ham Cover	588
Hand Fan	620, 715, 912, 985, 998, 999, 1000, 1202, 1268
Hanger	1286
Hanging Screen	892
Hat	104, 488, 497, 524, 704, 740, 829, 904, 1048, 1049, 1060, 1061, 1062, 1063, 1064, 1065, 1066, 1067, 1070, 1071, 1123, 1141, 1142, 1143, 1144, 1147, 1217, 1237, 1266, 1267, 1289
Hatband	1068, 1069
Headband	104, 488, 489, 1271, 1278
Headphones	17, 25, 62, 63, 104, 105, 607, 694, 789, 1246
Heat Pack	504, 855, 861, 871, 1279
Highlighter	249, 318, 330, 331, 332, 874, 911
Highlighter Set	248, 249, 330, 331, 874, 946
Holder	26, 88, 126, 127, 128, 129, 134, 135, 138, 144, 244, 478, 494, 538, 590, 625, 626, 627, 751, 770, 772, 787, 789, 1014, 1178, 1179, 1181, 1248, 1249, 1273, 1278
Holder Bottle	440, 509
Holder Charger	136, 1176
Holder Keyring	131, 596, 623, 1264
Holder Lamp	127
Holder Pen	259, 270, 274, 278, 1252
Holder Pouch	130, 138, 220, 976, 1181
Hot-Cold Pack	504, 861
Humidifier	119, 791, 1174
Hydroalcoholic Gel	543, 855, 866, 876, 888, 889, 965
Hygienic Mask	880
Ice Bucket	1287
Ice Bucket Speaker	61, 796, 821, 1003
Ice Grippers	516
Ice Mold	1281
Ice Scraper	1183
Id Badge	199, 200, 1207, 1258
Id Badge Lanyard	197, 1208
Id Holder	198, 873
Incense and Candle Set	1286
Indicator Backpack	371, 497
Infuser	772, 820
Insulated Bottle	389, 418, 419, 420
Insulated Cup	418
IPhone Pouch	706
Jacket	1074, 1110, 1111, 1112, 1113, 1114, 1115, 1116, 1289
Jar	410, 412, 449, 450, 460, 822, 1284
Jarapa Beach	1022
Jewellery Wrap	906
Jigger	819
Jug	412, 822, 1284, 1285
Juicer	820
Juicer Bottle	436, 437

names	pages
Keyboard	115, 207
Keyboard Holder	115, 207
Keyring	500, 611, 660, 661, 662, 663, 664, 665, 666, 667, 668, 672, 673, 674, 675, 676, 677, 810, 910, 980, 1016, 1210, 1211, 1233, 1236, 1238, 1263, 1264
Keyring Anticontact	542, 677, 877, 893
Keyring Charger	10, 12, 18, 27, 80, 81, 89, 622, 1242
Keyring Coin	590, 664, 665, 670, 671, 677
Keyring Hat	1288
Keyring Pillbox	666, 870
Keyring Purse	657, 923, 1276
Keyring Raincoat	978, 1136, 1288
Keyring Ruler	1272
Keyring Teddy	969, 1233
Keyring Torch	644, 645, 1265
Kids Cap	975, 1058
Kids Christmas Hat	1231
Kids Colour Polo T-Shirt	1088
"keya"	
Kids Colour T-Shirt	1080
Kids Colour T-Shirt	1078
"keya"	
Kids Face Shield	883
Kids Hat	1058
Kids Sunglasses	975
Kids Technical Sweatshirt	1106, 1107
Kids T-Shirt	479, 738, 1094, 1096, 1099, 1103, 1105
Kids White Polo Shirt	1088
"keya"	
Kids White T-Shirt	1080
Kids White T-Shirt "keya"	1078
Kitchen Cutting Board	759, 767, 802, 824, 1284
Kitchen Ladle	1283
Kitchen Lighter	646, 1045
Kitchen Mitten	708, 747, 752, 756, 757
Kitchen Set	709, 756, 768, 1283, 1284
Kitchen Skimmer	773
Kitchen Tongs	773, 1283
Kite	934
Kneeling Mat	1172
Knife	768
Knife Peeler Set	768
Knife Set	769, 1284
Laces	1271
Lamp	112, 519, 520, 797, 948, 1164
Lamp Speaker	61, 217, 797
Lanyard	130, 192, 193, 194, 195, 196, 198, 872, 912, 1207, 1208, 1209, 1250, 1258, 1288
Lanyard Charger	82, 218
Lanyard Cup Holder	451, 1220
Laptop Pouch	150, 221
Laser Keyboard	114, 206
Laser Pen	215, 1254
Laser Pointer	215
LCD Writing Tablet	208, 610, 938
Lenses	996, 1219
Letter Opener	707
License Plate Frame	1273
Light Box	611, 796
Lighter	646, 647, 648, 1236
Lip Balm	856, 857, 899
Long Drink Glass	451, 1221
Luggage Porter	1262
Luggage Scales	545
Luggage Strap	545
Luggage Tag	531, 535, 1262
Lunch Box	455, 456, 457, 458, 459, 460, 461, 961, 1285
Magic Mechanical Pencil	324
Magnet	640, 776, 777, 778, 1235
Magnet Calendar	250
Magnetic Whiteboard	777
Magnifier	1171, 1244
Mandala Set	323, 610, 937
Manicure Set	903
Map	605, 795
Marker Set	1254
Mask Case	886
Mask Case XL	887
Mask Holder Lanyard	196, 737, 885
Mask Holder Wristband	1271
Mask Pouch	726, 887
Massage Stones	1279
Massager	863
Mat	476, 484, 1192
Measurer	864
Measuring Set	771, 966
Meat Branding Iron	784, 826
Mechanical Pencil	324, 1254
Medal	500, 1210
Memo Block	188, 191
Memory Card Pouch	1243
Message Board	611
Message Hanger	611, 796
Microscope	124, 1172
Mini Fan	216, 793
Mini Mouse	113, 203
Mini Multifunction Pocket Knife	1167
Mini Notebook	178, 956
Mini Pen	256, 294, 832, 836, 1253
Mini Puzzle	970
Mirror Holder	1248

names	pages
Mitten	979, 1137
Mobile Holder	116, 1248, 1250
Mobile Pouch	1247
Mold	1235, 1281
Mold Set	771, 966, 1281
Money Box	929, 968
Monocular	529, 713
Mosquito Repellent	518, 863, 975, 1002
Bracelet	113, 203, 1257
Mouse	250
Mousepad	204, 205, 746
Mousepad Calendar	250
Mousepad Keyboard	1257
Mousepad Photo Frame	204
Mouth-Nose Shield	881
MP3	1242
Muddler	820
Mug	388, 389, 390, 391, 392, 393, 396, 397, 398, 399, 407, 409, 411, 412, 413, 425, 444, 445, 452, 453, 519, 628, 762, 763, 764, 765, 823, 928, 936, 963, 977, 1224, 1259, 1285
Multifunction	273, 542, 849, 873
Antibacterial Pen	
Multifunction Arm Strap	475, 517
Multifunction Charger	18, 623
Multifunction Lamp	44, 217, 797
Multifunction Mousepad	44, 206
Multifunction Notepad	149
Multifunction Pencil	21, 28, 45, 145, 210, 603
Holder	
Multifunction Pocket Knife	525, 712, 1153, 1167, 1170, 1272
Multifunction Travel Adapter	44, 121, 539
Multipurpose	1284
Multipurpose Bag	133, 385, 460, 534, 715, 770, 916, 923, 952, 961, 1005, 1220, 1247, 1255, 1260, 1275
Multipurpose Bag Purse	923
Multipurpose Basket	1286
Multipurpose Box	1280
Multipurpose Bracelet	643, 1204
Multipurpose Cloths	1285
Multipurpose Glasses Strap	997
Multipurpose Holder	1270, 1283
Multipurpose Holder Speaker	1245
Multipurpose Hook	774
Multipurpose Pouch	128, 130, 625
Multitool	525, 526, 527, 529, 712, 1153, 1154, 1164, 1166, 1170, 1273
Multitool Pen	1254
Nail File	1278
Nail File Set	903, 1278
Napkin Ring	830
Neck Warmer	491, 740, 979, 1123, 1137, 1138, 1139, 1141
Neck Warmer and Hat	740, 1138, 1142
Neckerchief	736, 1061, 1202
Neckerchief Wrap	1061, 1202
Necklace	717, 719, 720, 723
No Lens Glasses	1219
Notebook	170, 171, 172, 173, 175, 176, 177, 178, 179, 189, 190, 628, 715, 952, 954, 955, 956, 957, 977, 1255
Notebook	157, 158, 159, 160, 161, 162, 163, 164, 165, 166, 167, 182, 186, 189, 282, 283, 606, 690, 910, 952, 1255
Notebook	1255
Notebook Case	264, 1255
Notebook Holder	264, 1255
Opener	774, 779, 781, 782, 814, 815
Opener Coaster	783
Opener Fidget Spinner	814
Opener Keyring	667, 668, 669, 814, 1233, 1263
Organizer	141, 240, 1184
Organizer Band	244, 953
Organizer Charger	14, 21, 142, 143
Organizer Keyring	666
Ozone Generator	118, 790, 841, 1175
Padlock	494, 545, 1262
Pai Pai	1001
Pai Pai Pen	319
Painting Set	505, 1200, 1238
Paperweight	638
Pareo	1026
Parka	1118, 1289
Pashmina	908
Passport Holder	535
Pedometer	480, 1271
Peg	1022
Pen	187, 252, 253, 254, 255, 256, 257, 258, 259, 261, 262, 263, 264, 265, 266, 267, 268, 269, 270, 276, 277, 279, 280, 281, 282, 283, 286, 287, 288, 289, 290, 291, 292, 293, 294, 295, 298, 299, 306, 307, 308, 309, 315, 316, 317, 318, 319, 329, 330, 332, 333, 503, 606, 628, 680, 682, 683, 686, 687, 688, 689, 837, 875, 898, 911, 947, 974, 977, 1158, 1214, 1232, 1233, 1236, 1251, 1252, 1253
Pen Bookmark	242
Pen Keyring	1232
Pen Pouch	260, 311, 728
Pen Torch	317, 332, 644, 872, 947
Pencil	264, 295, 320, 321, 325, 329, 333, 499, 836, 875, 933, 944, 945, 1158, 1232
Pencil Case	176, 229, 312, 313, 328, 684, 746, 935, 939, 942, 950, 951, 953, 1255
Pencil Case Set	953
Pencil Holder	243, 1280

names	pages
Pencil Set	323, 325, 327, 328, 683, 941, 942, 943
Pendant	1274
Pennant Flag	1199
Personal Alarm	122, 905
Pet Collar	1195
Pet Lead	1195
Pets Hairbrush	1192
Pets Set	1193
Photo Frame	243, 777, 793, 1279, 1280
Pillbox	868, 869, 870
Pillbox Bottle	446, 870
Pillow	532, 1015, 1262, 1270
Pillow Notebook	1280
Pin	641, 1211
Pin Loop	1211
Pizza Cutter	773
Place Mat	760, 772, 783, 825, 830, 934
Place Mat Set	708
Plaque	500, 639, 1210
Plastic Bag Holder	594, 786
Plastic Pouch	311, 728
Platter Plate	761, 824
Plug Adapter	120, 121, 536, 537
Pocket Ashtray	649, 1017
Pocket Knife	525, 526, 529, 712, 1153, 1168, 1169, 1170
Pocket Mirror	894, 896, 897, 1278
Pocket Protector	333, 873
Polar Fleece	1117
Polo Shirt	734, 1075, 1086, 1090, 1091, 1092, 1237, 1291
Pot Desk Clock	139, 800
Pot Holder	708, 747, 757, 1282
Pouch	416, 449, 726, 729, 730, 736, 889, 988, 997, 1043, 1230, 1272, 1270, 1275
Power Bank	11, 12, 19, 22, 28, 32, 64, 65, 66, 67, 68, 69, 70, 71, 72, 73, 74, 75, 84, 814, 692, 1241
Power Bank Backpack	106, 370
Power Bank Charger	64
Power Bank Display	76, 821
Stand	34, 539
Power Bank Earphones	87, 148, 149, 691
Power Bank Folder	545
Power Bank Luggage	87, 148
Scales	147
Power Bank Notepad	76, 538
Power Bank Organizer	77, 78, 538, 1241
Power Bank Selfie Stick	51, 1240
Power Bank Set	76, 310
Power Bank Speaker	1186
Power Bank Stylus Touch	128, 625
Ball Pen	110, 553, 651
Pressure Gauge	597, 656, 657, 658, 659, 718, 898, 917, 922, 923, 1276, 1277
Protector Holder	1276
Protector Pouch	482
Purse	613, 930, 933, 936
Purse and Card Holder	484
Purse Holder	20, 602, 795
Puzzle	1172
Race Number Holder	522, 978, 1119, 1120, 1133, 1134, 1135, 1136
Waistbag	1121, 1186
Radio Alarm Clock	1244
Rain Meter	1254
Raincoat	877, 878, 879
Reflective Vest	883
Remote Shutter	1070, 1146
Retractable Pen	704
Reusable Hygienic Mask	1130
Reusable Kids Hygienic Mask	906
Reversible Hat	1197, 1203
Reversible Scarf	277, 296, 297, 298, 680
Reversible Umbrella	247, 949
Ring Holder	184, 1256
Roll Up	1256
Roller	242, 948
Ruler	495, 741
Ruler Bookmark	882, 1161
Ruler Calculator	981
Ruler Magnifier	1285
Bookmark	461
Saddle Cover	471, 961
Safety Glasses	457, 460, 928, 961
Safety Set	791, 826, 892
Salad Bowl	884
Salad Container	891
Sandwich Holder	867, 891
Sandwich Lunch Box	833, 867, 891, 964
Sanitizer Doormat	1283
Sanitizer Set	247, 1159
Sanitizer Spray	635, 704, 908, 979, 1137, 1146, 1147, 1239
Sanitizer Wipe	131, 1249
Sanitizer Wipes	1249
Sauce Dishes	344, 496, 982, 983, 1265
Scalimeter	629, 1216
Scarf	629, 1001, 1216
Screen Cleaner	1275
Screen Cleaner Holder	1275
Security Light	131, 1249
Selfie	1249
Selfie Pai Pai	344, 496, 982, 983, 1265
Selfie Photo Frame	629, 1216, 1225
Selfie Set	124, 1245
Selfie Stick	490, 1103
Arm Sleeves	

names	pages
Server Knife	1284
Serving Dish	1283
Serving Dishes	761, 785, 824, 1283
Set	103, 124, 137, 168, 169, 260, 314, 315, 316, 322, 323, 326, 328, 398, 528, 684, 686, 688, 690, 691, 713, 762, 785, 858, 936, 937, 940, 941, 942, 943, 946, 953, 965, 967, 1146, 1164, 1165, 1177, 1231, 1254, 1282, 1288, 1289
Sharpener	946
Shoe Bag	512, 544
Shoe Polisher	862
Shoehorn Polisher	544, 862
Shopping Trolley	591, 787
Shorts	490, 1101, 1102, 1103
Shoulder Bag	228, 363, 381, 382, 383, 384, 553, 746, 1257, 1260, 1261, 1268
Skill Game	597, 598, 600, 613, 931, 932, 933, 1280
Skill Games	612, 971
Skill Games Set	598, 601, 932
Skipping Rope	476, 973
Sleeping Bag	517
Slippers	832, 835, 1287
Smart Bracelet	36, 38, 39, 481
Smart Camera	42, 790
Smart Watch	37, 39, 693, 1240, 1244
Snow Shovel	526, 1183
Sock	788, 1150, 1230
Space Blanket	518, 1187
Spaghetti Measurer	1282
Spatula	758, 771
Speaker	7, 8, 9, 11, 13, 15, 16, 24, 32, 52, 53, 54, 55, 56, 57, 58, 59, 60, 85, 607, 608, 695, 1003, 1240, 1245
Speaker Bottle	60, 403
Speaker Earphones	1245
Speaker Holder	1248
Speaker Keyring	85, 131, 623
Speaker Microphone	1240
Speaker Multipurpose Bag	60, 1003
Speaker Sunglasses	50
Speakers	50, 1245
Speakers Headphones	50
Spinning Top	971
Spoon	758
Spoon Set	1285
Sports Backpack	372, 511
Spray	131, 891
Spray Pen	333
Steering Wheel Sunshade	1046, 1188
Stencil	1234
Sticky Note Set	1255
Sticky Notepad	166, 171, 174, 182, 183, 184, 185, 186, 188, 189, 190, 1255
Sticky Notepad Holder	1255, 1256
Stocking	1231
Stopwatch	1271
Strap Keyring	344, 980
Straw	462
Straw Set	463, 816
Stylus Touch	1250
Stylus Touch Ball Pen	88, 187, 260, 262, 270, 275, 276, 277, 278, 281, 282, 283, 284, 285, 286, 290, 300, 301, 302, 303, 304, 305, 306, 307, 308, 310, 316, 318, 681, 685, 688, 910, 911, 1250, 1252
Stylus Touch Pen	612, 624, 706, 976, 1250
Stylus Touch Pen Keyring	1264
Stylus Touch Pen Mobile Holder	624, 1250
Stylus Touch Pencil	324
Stylus Touch Screen Cleaner	131, 624, 1250
Sublimation Apron	747, 755
Sublimation Bag	583, 733, 739
Sublimation Beauty Bag	733, 916
Sublimation Bottle	414, 742
Sublimation Bracelet	643, 737, 1206
Sublimation Drawstring Bag	343, 733
Sublimation Lanyard	194, 737, 1206
Sublimation Mug	390, 394, 395, 415, 743, 744, 745, 764
Sublimation Place-Mat	747, 783, 825
Sublimation Vacuum	414, 742
Flask	487, 1057, 1059, 1267
Sun Visor	621, 984, 988, 989, 990, 991, 992, 993, 994, 995, 996, 1218, 1238, 1269
Sunglasses	749, 1046, 1047, 1188, 1189, 1273
Sunshade	880
Surgical Mask IIR	1290
Sweatshirt	484, 1024
Swim Hat	1014
Table	831
Table Runner	831
Tablecloth	220, 221
Tablet Case	220
Tablet Folder Case	890, 1196, 1203
Tally Counter	864, 1156, 1157
Tape Measure	1107
Technical Jacket	969
Teddy	1242
Telephone	465, 473, 504, 589, 861, 960, 1281
Thermal Bag	1271
Thermal Band	473, 589, 787, 1040
Thermal Picnic Basket	1060
Camouflage Cap	

names	pages
Thermometer Watch	38, 865, 890
Tie	634, 704, 1275
Timer	775, 858, 862, 965, 1235
Tissues	867
Tongs	818
Tool Set	1154, 1155
Toothbrush	542, 833, 834, 855, 858, 859, 965
Torch	89, 496, 519, 520, 528, 644, 645, 713, 779, 872, 982, 1161, 1162, 1163, 1164, 1165, 1265, 1271, 1272
Torch Carabiner	1265
Torch Pen	947
Touchscreen Gloves	132, 979, 1123, 1137, 1141, 1145
Touchscreen Sport Gloves	482, 1145
Towel	479, 503, 964, 1215
Towel Pareo	985, 1026, 1027
Towel Set	1286
Tracker	122, 1182
Translator	1262
Trash Bag Holder	594, 786, 1017
Travel Document Holder	534
Travel Eye Mask	533, 860
Travel Set	532, 533, 541
Trolley	234, 235, 530, 546, 547, 700, 701, 1262
Trolley Backpack	235, 369, 549, 958
Trolley Bag	548
T-Shirt	1291
Tube	1011, 1269
Tweezers	903
Umbrella	705, 715, 749, 978, 1124, 1125, 1126, 1127, 1128, 1129, 1130, 1131, 1132, 1136, 1288
Universal Camera Lens	125
Universal Lenses	125
Universal Tripod	40
USB Car Charger	136, 137, 1176, 1177, 1242
USB Charger	116
USB Chargers Set	79, 538
USB Hub	18, 27, 86, 100, 211, 212, 213, 214, 692, 1243
USB Hub Lamp	100, 216
USB Hub Pencil Holder	101, 211
USB Lamp	112, 216
USB Memory	86, 90, 91, 92, 93, 94, 95, 96, 97, 1243
USB Notepad	94, 208
USB Power Bank	74, 208
UV Stylus Touch Ball Pen	94, 310, 690, 1243
UV Meter	1002, 1270
UV Sterilizer Backpack	107, 153, 367, 843
UV Sterilizer Box	840
UV Sterilizer Lamp	114, 841, 1175
UV Sterilizer Organizer	107, 153, 843
Vacuum Bottle	708
Vacuum Bottle Stopper	807
Vacuum Drinking Jug	1270
Vacuum Flask	416, 417, 424
Vaporizer	772, 820, 1002
Vaporizer Fan	1002
Vase	1286
Vest	501, 524, 972, 981, 1074, 1110, 1111, 1112, 1113, 1114, 1115, 1116, 1121, 1198, 1281, 1290
Virtual Reality Glasses	123, 1244
Waistbag	133, 334, 357, 380, 381, 483, 485, 553
Walking Poles Set	517
Wall Clock	139, 774
Wall Clock Timer	775
Wallet	236, 635, 653, 657, 703
Waste Bag Dispenser	1017, 1184, 1191
Watch	38, 480, 481, 636, 637, 702, 873, 1274
Watch Set	635
Water Pistol	974, 1011
Weather Station	20, 603, 794, 1152, 1173, 1272
Webcam Cover	26, 111, 202
Webcam Cover Joystick	111, 976
Weighing Scales	758
Whistle	505, 516, 983, 1200
Whistle Keyring	1263
Whiteboard	826, 938
Wig	1217
Window Cleaner	1273
Wine Aerator	807
Wine Decanter	807, 809
Wine Rack	810
Wine Set	709, 803, 804, 805, 806
Wineskin	810
Wipes	830
Wish Bottle	632, 1227
Women Colour Polo T-Shirt "keya"	1089
Women Colour T-Shirt	1290
Women Colour T-Shirt "keya"	1078, 1082
Women Polo Shirt	1290
Women T-Shirt	1094, 1096, 1102, 1104
Women White Polo Shirt "keya"	1089
Women White T-Shirt "keya"	1078, 1082
Wrist Blood Pressure Monitor	1279
Wristband	489
X-Banner	1203
Yoga Balls	1271
Yoyo	929, 930, 971

names	SEITE
3D Lente	123
7 in 1 Kugelschreiber	317, 1158
Abfall Bag Spender	1017, 1184, 1191
Adapter	82, 218, 1244
Adventskalender	1230
Aktentasche	228, 230, 697, 698, 1257
Alkoholtester	122, 1174
Anhänger	1274
Animation Band	1200
Anspitzer	946
Antibakteriell Abfall Bag Spender	853, 1190
Antibakteriell Bleistift	272, 321, 832, 850, 927, 945
Antibakteriell	782, 815, 853
Flaschenöffner	30, 626, 627, 852
Antibakteriell Halter	31, 839
Antibakteriell Kopfhörer	273, 836, 848, 849, 865
Antibakteriell	
Kugelschreiber	272, 848
Antibakteriell Pointer	155, 850, 927, 949
Antibakteriell Lineal	459, 846
Antibakteriell Lunch Box	31, 113, 154, 839
Antibakteriell Maus	154, 842
Antibakteriell Mauspad	491, 845, 1140
Antibakteriell Nackenwärmer	156, 851
Antibakteriell Notizblock	156, 851, 927, 956
Antibakteriell Notizbuch	853, 854, 869
Antibakteriell Pillendose	153, 367, 843
Antibakteriell Rucksack	343, 844
Antibakteriell Rucksacktasche	
Antibakteriell	852, 893
Schlüsselanhänger	
Anticontact	
Antibakteriell	590, 671, 852
Schlüsselanhänger	
EK-Chip	
Antibakteriell	155, 842
Schlüsselband	
Antibakteriell Set	272, 850
Antibakteriell Strohhalm	462, 816, 847
Antibakteriell Tasche	557, 562, 844
Antibakteriell Tasse	408, 765, 847
Antibakteriell Touchpad	845, 1140
Handschuhe	
Antibakteriell	408, 847
Trinkbecher	
Antibakteriell	408, 507, 846
Trinkflasche	
Antibakteriell Webcam-Blocker	30, 111, 155, 842
Antibakteriell Yoyo	853, 927
Anti-Diebstahl Rucksack	152, 357, 363, 364, 365
Anti-Mücken-Armband	518, 863, 975, 1002
Antirutsch Greifer	516
Antistress	616, 617, 871, 1279
Antistress Ball	616, 617, 970, 1279
Antistress Kugelschreiber	291, 614
Antistress	615, 871
Schlüsselanhänger	
Antistress Schlüsselband	1250
Aqua Schuhe	1267
Armband	133, 482, 483, 504, 642, 643, 717, 719, 720, 721, 736, 907, 975, 980, 1197, 1204, 1205, 1247, 1274, 1275
Armband Ladegerät	83, 622
Armband Set	1275
Armbandtasche	489
Armschoner	490, 1103
Aschenbecher	649, 1017
Augenschutz	860, 1002
Austeller Flasche	1191
Ausziehbare Regenschirm	372, 1128
Ausziehbare Tasche	591
Automatisch Spender	118, 155, 790, 890
Autosonnenschutz	749, 1046, 1047, 1188, 1189, 1273
Backform	1235, 1281
Backform Set	771, 966, 1281
Badekappe	484, 1024
Ball	502, 972, 1010, 1194
Banner	1213
Basketball	973
Besteckset	454, 464, 773, 928
Bilderrahmen	243, 777, 793, 1279, 1280
Bildschirmträger	134, 1180
	264, 295, 320, 321, 325, 329, 333, 499, 836, 875, 933,
Bleistift	944, 945, 1158, 1232
Bleistift Pointer	324
Bleistift Set	683
Bleistiftbox	323, 325, 327, 328, 941, 942, 943
Bliester 4 Batterien 1,5V	138
Blitzlicht	1244
Bluetooth-Empfänger	136, 1181
Blumentopf	618, 619, 800, 801, 968
Blumentopf Set	619, 801
Blumentopf Tischuhr	139, 800
BMI Maßband Messer	864
Bonbon	633
Bonbon Spender	1275
Bratpfanne	1282
Brett	759, 761, 767, 802, 824, 1284
Briefbeschwerer	638
Brieföffner	707
Brieftasche	236, 635, 653, 657, 703
Brille	505, 996, 1218, 1225
Brillensband	997, 1269
Brillengestell	996, 1219
Buroklammerhalter	246

names	SEITE
Bürste	898, 900, 901
Bürste mit Spiegel	900, 1278
Camouflage Mütze	1060
Chirurgische Maske IIR	880
Clip	246, 1256
Clip Anspitzer	1280
Clip Flaschenöffner	779
Clip Leesezeichen	707
Clip Memo	1279
Cocktail Set	820
Collier	717, 719, 720, 723
Computer Zubehör Set	1257
Cutter	247, 1159
Dartschreibe	973
Decke	533, 711, 788, 969, 1122, 1148, 1149, 1150, 1151, 1230,
	1289,
Deckel Halter	1287
Deckel Vakuumpumpe	807
Desinfektionsmatte	791, 826, 892
Diadem	1278
Digitales Thermometer	865
Displayreiniger	131, 1249
Displayreiniger Halter	1249
Divot	498
Divot Indikator	499
Dokumententasche	141, 150, 151, 181, 222, 223, 224, 225, 226, 227, 228,
	229, 230, 231, 362, 698, 1257
Dokumententasche	233, 366
Rucksack	600, 932
Domino	618, 800
Dose	1270
Dosenkühltasche	934
Drachen	818, 819
Drink Rührer	42
Drohne	618, 792, 1228, 1286
Duft Diffusor	630, 631, 750, 798, 799, 1229, 1286
Duftkerze	775, 858, 862, 965, 1235
Eleruhr	819, 1043
Elmer	
Einatmungs	
Abwehrschild für Nase und Mund	881
Einkaufstasche Halter	1268
Einkaufstrolley	591, 787
Einnachglas	410, 412, 449, 450, 460, 822, 1284
Eis Backform	1281
Eiskratzer	1183
Eiskübel	1287
Elektrische Kerze	1286
Elektrische Lunch Box	43, 209, 459
Ernte	968
Erkugel	531, 605, 795
Erste Hilfe Set	518, 863, 1187
Erwachsene Farbe Polo-Shirt "keya"	1087
Erwachsene Farbe T-Shirt	1080, 1081, 1290
Erwachsene Farbe T-Shirt	1079, 1083, 1084, 1085
"keya" Erwachsene Sweatshirt	1109
"keya" Erwachsene Sweatshirt	1108
Erwachsene Sweatshirt mit Kapuze "keya"	1108
Erwachsene Sweatshirt mit Kapuze + Reißverschluss "keya"	1108
Erwachsene Technische Sweatshirt	1106, 1107
Erwachsene T-Shirt	479, 734, 738, 1075, 1076, 1077, 1092, 1093, 1095, 1097, 1098, 1099, 1100, 1101, 1103, 1104, 1105, 1106, 1237, 1291
Erwachsene T-Shirt	1076
"Keya" Erwachsene Weiß Polo-Shirt "keya"	1087
"keya" Erwachsene Weiß T-Shirt	1080, 1081
Erwachsene Weiß T-Shirt	1079, 1083, 1084, 1085
"keya"	449, 889, 1043
Estojto	243
Ewiger Kalender	1254
Extender Kugelschreiber	620, 715, 912, 985, 998, 999, 1000, 1202, 1268
Fächer	1199
Fähnchen	1199
Fahne	1199, 1213, 1239
Fahne Rucksack	1212
Fahnenträger	1212
Fahrradattel Hülle	495, 741
Fahrradtasche	475, 494
Faltbar Rucksack	347, 1262
Faltbare Schurze	755
Faltbare Schusel	1192, 1193
Faltbare Tasche	379, 558, 560, 564, 565, 567, 569, 574, 575, 576, 577, 578, 628, 735, 739, 1235
Faltbare Trinkflasche	447
Faltbarer	905
Handtaschenhalter	347, 352, 373, 515, 959
Faltbarer Rucksack	407, 870
Faltbarer Trinkbecher	548
Faltbarer Trolley	505, 1200, 1238
Fan Schminke	176, 229, 312, 313, 328, 684, 746, 935, 939, 942, 950,
Federmappe	951, 953, 1255
Federmappe Set	953
Fensterreiniger	1273
Fernaussender	1244
Fernglas	1218, 1271
Feuchttücher	830
Feuerzeug	646, 647, 648, 1236
Fidget Spinner	614, 970

names	SEITE
Figure	1228
Figuren	1226
Filzstift	317, 640, 776
Filzstift Set	1254
Fitness Set	474
Flaschen Set	1234
Flaschenhalter	808, 810
Flaschenkühler	808
Flaschenkühltasche	449, 1043
Flaschenöffner	779, 781, 782, 814, 815
Flaschenöffner Fidget	814
Spinner	
Flaschenöffner	783
Unter-setzer	784, 826
Fleisch-Marker	1285
Fliegenklatsche	604, 710, 835, 986, 987, 1267
Flip Flop	1066, 1266
Florentiner Hut	1283
Fondue	895, 908, 909, 1147, 1278
Foulard	908, 1026
Foulard Pareo	1089
Frauen Farbe Polo-Shirt	1290
"keya"	1078, 1082
Frauen Farbe T-Shirt	1290
Frauen Farbe T-Shirt	1078, 1082
"keya"	1290
Frauen Polo-Shirt	1094, 1096, 1102, 1104
Frauen T-Shirt	1089
Frauen Weiß Polo-Shirt	1089
"keya"	1078, 1082
Frauen Weiß T-Shirt	1078, 1082
"keya"	929, 1006, 1194
Frisbie	1282
Fruchte	820
Fruchtsaftpresse	709
Gabelset	709
Gamepad	123, 976
Gartenkissen für die Knie	1172
Gebläse	1044
Gehstocke	517
Gepäckwaage	545
Geschenk-Box	726, 729
Geschicklichkeitsspiel	597, 598, 600, 613, 931, 932, 933, 1280
Geschicklichkeitsspiele	612, 971
Geschicklichkeitsspiele	598, 601, 932
Set	882, 1161
Gesichtsmaske	400, 745, 1224
Glas	1234
Glas Bezeichner	774
Glasöffner	710
Glätteisen	498
Golf Handtuch	498
Golf Regenschirm	498
Golf Set	499
Golf Tee	499
Golf Tee Karten	499
Golfball	122, 1182
GPS Plepser	136, 1176
GPS USB Autoladegerät	1287
Graphic Rahmen	784, 1045
Grill	1044
Grillputzer	784, 1044
Grillset	648
Grinder	477
Gummiband	477
Gummiband Set	634, 1274
Gürtel	133, 334, 357, 380, 381, 483, 485, 553
Gürteltasche	900, 1194
Haarspange	174, 183, 188, 190
Haftender Notizblock	1255
Haftnotizen Set	1256
Haftnotizspender	710
Hals/ Nase Trimmer	736, 1061, 1202
Halstuch	26, 88, 126, 127, 128, 129, 134, 135, 138, 144, 244, 478, 494, 538, 590, 625, 626, 627, 751, 770, 772, 787, 789, 1014, 1178, 1179, 1181, 1248, 1249, 1273, 1278
Halter	130, 138, 220, 976, 1181
Halter Hülle	127
Halter Ladegerät	726, 886, 887
Halter Lampe	1271
Halterung für Maske	1271
Halterung für Maske	196, 737, 885
Armbandtasche	
Halterung für Maske	887
Schlüsselband	885
Halterung für Maske XL	1279
Halterung für Schutzmaske	979, 1137
Handgeleink	1160, 1289
Blutdruckmessgerät	722
Handschuh	479, 503, 964, 1215
Handschuhe	985, 1026, 1027
Handtaschenhalter	1286
Handtuch	1247
Handtuch Pareo	116, 1248, 1250
Handtuch Set	1192
Handy Hülle	1193
Handyhalter	634
Haustier Bürste	416, 726, 729, 730, 736, 988, 997, 1230, 1243, 1247, 1270, 1275
Haustier Set	1195
Hosenträger	1195
Hose	1195
Hülle	1195
Hundehalsband	1195
Hundeleine	1195

names	SEITE
Hut	104, 488, 497, 524, 704, 740, 829, 904, 1048, 1049, 1060, 1061, 1062, 1063, 1064, 1065, 1066, 1067, 1070, 1071, 1123, 1141, 1142, 1143, 1144, 1147, 1217, 1237, 1266, 1267, 1289
Hut Band	1068, 1069
Hydroalkoholisches Gel	543, 855, 866, 876, 888, 889, 965
Hygienemaske	880
Hygienisch Feuchttuch	867, 891
Hygienisch	833, 867, 891, 964
Feuchttücher	
Hygienisch Set	884
Hygienisch Spray	891
Intelligente Armband	36, 481
Intelligente Uhr	36, 37, 38, 39, 481, 693, 1240, 1244
iPhone Hülle	706
Jacke	1074, 1110, 1111, 1112, 1113, 1114, 1115, 1116, 1289
Kamera	42, 1174
Kamera 360°	40
Kamm	833, 834, 901
Karabiner	667
Karte	605, 795
Karten Leser	117, 692, 1243
Kase Set	761
Kerze	799, 1229
Kerzen Set	618, 792, 1229
Kinder Farbe Polo-Shirt	1088
"keya"	
Kinder Farbe T-Shirt	1080
Kinder Farbe T-Shirt	1078
"keya"	
Kinder Gesichtsmaske	883
Kinder Hut	1058
Kinder Mütze	975, 1058
Kinder Technische	
Sweatshirt	1106, 1107
Kinder T-Shirt	479, 738, 1094, 1096, 1099, 1103, 1105
Kinder Weihnachtsmütze	1231
Kinder Weiß Polo-Shirt	1088
"keya"	
Kinder Weiß T-Shirt	1080
Kinder Weiß T-Shirt	1078
"keya"	
Kindersonnenbrille	975
Kissen	532, 1015, 1262, 1270
Kissen Notizbuch	1280
Klammer	774, 1022
Klatschhand	505, 1201, 1239
Klatschstange	505, 1201, 1239
Klebebands Set	1256
Kleiderbügel	1286
Kleider tasche	544
Kleinteilablage	1286
Klingel	632
Kochmütze	829
Koffer Band	545
Kofferanhänger	531, 535, 1262
Koffergurt	1262
Kofferschloss	494, 545, 1262
Kompass	516, 529, 713, 1271
Kopfhörer	7, 17, 25, 33, 34, 35, 62, 63, 102, 103, 104, 105, 486, 607, 694, 695, 789, 1240, 1246
Kopfhörer Ladegerät	33, 1176
Kopfhörer Trinkflasche	33, 403, 539
Kopftuch	829, 1061
Kopftuch Hundehalsband	1195
Korkenzieher	779, 780, 812
Korkenzieher	
Flaschenöffner	780, 813
Korkenzieher Set	1287
Körpermaßband	864
Kosmetik Set	902
	512, 540, 541, 700, 718, 833, 895, 913, 914, 915, 916, 917, 918, 919, 920, 921, 1034, 1035, 1036, 1037, 1262, 1277
Krawatte	634, 704, 1275
Kreiden Set	326, 940
Kreisel	971
Krug	412, 822, 823, 1284, 1285
Küchen Feuerzeug	646, 1045
Küchen Set	709, 756, 768, 1283, 1284
Küchenhandschuh	708, 747, 752, 756, 757
Küchenkelle	758
Küchenzange	773, 1283
Kugel	638, 1228
	187, 252, 253, 254, 255, 256, 257, 258, 259, 261, 262, 263, 264, 285, 286, 266, 267, 268, 269, 270, 276, 277, 279, 280, 281, 282, 283, 286, 287, 288, 289, 290, 291, 292, 293, 294, 295, 298, 299, 306, 307, 308, 309, 315, 316, 317, 318, 319, 329, 330, 332, 333, 503, 606, 628, 680, 682, 683, 686, 687, 688, 689, 837, 875, 898, 911, 947, 974, 977, 1158, 1214, 1232, 1233, 1236, 1251, 1252, 1253
Kugelschreiber	259, 270, 274, 278, 1252
	260, 311, 728
Kugelschreiber Halter	317, 332, 644, 872, 947
Kugelschreiber Hülle	215, 1254
Kugelschreiber Lampe	88, 187, 260, 262, 270, 275, 276, 277, 278, 281, 282, 283, 284, 285, 286, 290, 300, 301, 302, 303, 304, 305, 306, 307, 308, 310, 316, 318, 681, 685, 688, 910, 911, 1250, 1252
Kugelschreiber Pointer	94, 310, 690, 1243
Kugelschreiber Pointer USB	
Kühl Augenmaske	860
Kühl tasche	455, 465, 466, 467, 468, 469, 471, 472, 473, 589, 960,
Kühl tasche Rucksack	346, 470, 960, 1040
	6, 8, 9, 10, 12, 15, 18, 19, 22, 23, 28, 29, 32, 45, 46, 47, 48, 80, 81, 82, 84, 89, 144, 210, 211, 219, 1182, 1240, 1241, 1242
Ladegerät	

names	SEITE
Ladegerät Halter	134, 1180
Ladegerät Kopfhörer	35
Ladegerät Lautsprecher	13, 17, 44, 51, 217, 797
Ladegerät Mappe	146
Ladegerät Mauspad	14, 142, 205
Ladegerät Notizblock	14, 142, 146
Ladegerät Ordner	147, 221
Ladegerät Rucksack	106, 370, 372, 514
Ladegerät Sincro	27, 82, 83, 218, 622, 1182, 1242
Ladegerät Stifthalter	13, 140, 145
Ladegerät Tastatur	44, 114, 206
Ladegerät UV Sterilisator	49, 840
Kasten	
Ladegerät UV Sterilisator	49, 841
Lampe	
Ladehilfe	1249
Lampe	89, 112, 496, 519, 520, 528, 644, 645, 713, 779, 797, 872, 948, 982, 1161, 1162, 1163, 1164, 1165, 1265, 1271, 1272
Lampe Karabiner	1265
Lampe Kugelschreiber	947
Lampe Lautsprecher	61, 217, 797
Laptop-Tasche	150, 221
Laser Pointer	215
Laser Tastatur	114, 206
Lautsprecher	7, 8, 9, 11, 13, 15, 16, 24, 32, 50, 52, 53, 54, 55, 56, 57, 58, 59, 60, 85, 607, 608, 695, 1003, 1240, 1245
Lautsprecher Brillen	50
Lautsprecher Eiskübel	61, 796, 821, 1003
Lautsprecher Halter	1248
Lautsprecher Kopfhörer	50, 1245
Lautsprecher	60, 1003, 1245
Mehrzweck tasche	1240
Lautsprecher Mikrofon	
Lautsprecher	85, 131, 623
Schlüsselanhänger	
Lautsprecher Trinkflasche	60, 403
LCD-Schreibtablett	208, 610, 938
Lenkrad Abdeckung	1046, 1188
Lente	996, 1219
Lesezeichen	184, 242, 707, 948
Lesezeichen Clip	1256
Lesezeichen	
Kugelschreiber	242
Leuchtkasten	611, 796
Lichtstecker	632, 796, 1227
Lineal	247, 949
Lineal Lesezeichen	184, 1256
Lineal Lupe Lesezeichen	242, 948
Lineal Taschenrechner	1256
Lippenbalsam	856, 857, 899
Löffel	758
Löffel Set	1285
Longdrinkglas	451, 1221
Luftbefeuchter	119, 791, 1174
Lufterfrischer	618, 676, 792, 1185
Lufterfrischer Halter	1185
Luftmatratze	1012, 1013
Lunch Box	455, 456, 457, 458, 459, 460, 461, 961, 1285
Lunch Box Tasche	471, 961
Lupe	1171, 1244
Magischer Mechanischer Bleistift	324
Magnet	640, 776, 777, 778, 1235
Magnet Kalender	250
Magnet Tafel	777
Make-up Bleistiftspitzer	1278
Malbuch	323, 610
Mandala Set	323, 610, 937
Maniküre Set	903
Mappe	151, 176, 180, 181, 236, 237, 238, 239, 240, 241, 696, 697, 746, 837, 1257
Mappe Tablet Tasche	220
Maskenhalter	892
Massage Steine	1279
Massagegerät	863
Maßband	1156, 1157
Maßstab	247, 1159
Matte	476, 760, 772, 783, 825, 830, 934
Matte Set	708
Maus	113, 203, 1257
Mauspad	204, 205, 746
Mauspad Bilderrahmen	204
Mauspad Kalender	250
Mauspad Tastatur	1257
Mechanischer Bleistift	324, 1254
Medaille	500, 1210
Mehrzweck	1284
Mehrzweck Armband	643, 1204
Mehrzweck Brillenband	997
Mehrzweck Haken	774
Mehrzweck Tücher	1285
Mehrzweckkasten	1280
Mehrzweckhalter	1270, 1283
Mehrzweckhülle	128, 130, 625
Mehrzweckkorb	1286
Mehrzwecktasche	133, 385, 460, 534, 715, 770, 916, 923, 952, 961, 1005, 1220, 1247, 1255, 1260, 1275
Mehrzwecktasche	923
Portemonnaie	
Meldungstafel	611
Memo Block	188, 191
Messbecher	864
Messbecher für Alkohol	819
Messbecher	771, 966
Messer	768
Messer Set	769, 1284
Mikroskop	124, 1172
Mini Kugelschreiber	256, 294, 832, 836, 1253
Mini Maus	113, 203

names	SEITE
Mini	1167
Mini Notizbuch	178, 956
Mini Puzzle	970
Mini Ventilator	216, 793
Mokett	484, 1192
Monokulare	529, 713
Monopod	124, 1245
MP3	1242
Mülltütenhalter	594, 786, 1017
Multifunktion	
Antibakteriell	273, 542, 849, 873
Kugelschreiber	
Multifunktion Armband	475, 517
Multifunktion Ladegerät	18, 623
Multifunktion Mauspad	44, 206
Multifunktion Notizblock	149
Multifunktion Reise	
Adapter	44, 121, 539
Multifunktion Stifthalter	21, 28, 45, 145, 210, 603
	525, 712, 1153, 1167, 1170, 1272
	525, 526, 527, 529, 712, 1153, 1154, 1164, 1166, 1170,
Multiwerkzeug	1273
Multiwerkzeug	1273
Kugelschreiber	1254
Münze	1220
	479, 487, 604, 609, 735, 740, 904, 1049, 1050, 1051, 1052, 1053, 1054, 1055, 1056, 1057, 1160, 1237, 1266,
Mütze	1267, 1289
Nachrichtenaufhänger	611, 796
Nackten Wärmer	491, 979, 1123, 1137, 1138, 1139, 1141
Nackten Wärmer und Hut	740, 1138, 1142
Nagelplatte	1278
Nagelpfellen Set	903, 1278
Namensschild	199, 200, 1207, 1258
Namensschild Halter	198, 873
Namensschild	197, 1208
Schlüsselband	
Niederschlagsmesser	1172
Nothammer	1187
	157, 158, 159, 160, 161, 162, 163, 164, 165, 166, 167, 171, 174, 182, 183, 184, 185, 186, 189, 282, 283, 606, 690,
Notizblock	910, 952, 1255
Notizblock Hülle	1255
Notizbuch	170, 171, 172, 173, 175, 176, 177, 178, 179, 189, 190, 628,
Notizzettelbox	715, 952, 954, 955, 956, 957, 977, 1255
Notlicht	1186
Nummernschildhalter	1273
Ohrenreiniger	863
Ohrhinge	718, 721, 722, 723
Ohrstoppel	533, 1160
Ohrwärmer	1146
Ordner	141, 240, 1184
Ordner Band	244, 953
Ordner Ladegerät	14, 21, 142, 143
Ordner	
Schlüsselanhänger	666
Ornament	1227
Ornament Set	1226, 1227
Ozon-Generator	118, 790, 841, 1175
Pantoffeln	832, 835, 1287
Papierkorb	1184
Parco	1026
Parka	1118, 1289
Pashmina	908
Pay-Pay	1001
Pay-Pay Kugelschreiber	319
Persönlicher Alarm	122, 905
Perücke	1217
Pfeife	505, 516, 983, 1200
Piepsper	122, 1182
Pillendose	868, 869, 870
Pin	641, 1211
Pinself	771, 966
Pinzette	903
Pizzamesser	773
Plakette	500, 639, 1210
Plastik Hülle	311, 728
Pointer Kugelschreiber	1250
Polo-Shirt	734, 1075, 1086, 1090, 1091, 1092, 1237, 1291
Poncho	522, 978, 1133, 1134, 1135, 1136
Portemonnaie	597, 656, 657, 658, 659, 718, 898, 917, 922, 923, 1276,
	1277
Portemonnaie Halter	482
Portemonnaie	1276
Visitenkartenetui	11, 12, 19, 22, 28, 32, 64, 65, 66, 67, 68, 69, 70, 71, 72, 73,
Power Bank	74, 75, 84, 514, 692, 1241
Power Bank	
Gepäckwaage	545
Power Bank Graphic	
Rahmen	76, 821
Power Bank Kopfhörer	34, 539
Power Bank	
Kugelschreiber Pointer	76, 310
Power Bank Ladegerät	64
Power Bank Lautsprecher	51, 1240
Power Bank Mappe	87, 148, 149, 691
Power Bank Monopod	76, 538
Power Bank Notizblock	87, 148
Power Bank Ordner	147
Power Bank Rucksack	106, 370
Power Bank Set	77, 78, 538, 1241
Putztuch	131, 736, 1249
Puzzle	613, 930, 933, 936
Radiergummi	248, 946, 1280
Radiergummi Set	628, 946, 977, 1232
Radio Tischuhr	20, 602, 795

NAMES	PAGES
Recycling Tasche	594, 786
Regenjacke	1119, 1120, 1133
Regenschirm	705, 715, 749, 978, 1124, 1125, 1126, 1127, 1128, 1129,
Reibe	1130, 1131, 1132, 1136, 1288
Reife	773
Reifendruckmesser	1186
Reinigungsset	244, 783
Reise Augenmaske	533, 860
Reise Dokumententasche	534
Reise Kosmetik Tasche	531, 541
Reise Set	532, 533, 541
Reisepasshülle	535
Rettingsdecke	518, 1187
Ringhalter	906
Roll Up	1197, 1203
Roller Pen	277, 296, 297, 298, 680
Rückenstutzgürtel	504
	152, 232, 335, 336, 337, 338, 339, 340, 341, 342, 343,
	344, 345, 348, 349, 350, 351, 352, 353, 354, 355, 356,
	357, 358, 359, 360, 361, 362, 363, 365, 368, 373, 377,
	378, 467, 503, 510, 511, 515, 523, 561, 604, 608, 698,
	699, 714, 735, 741, 935, 958, 959, 1004, 1029, 1194, 1215,
	1231, 1260, 1261
Rucksack Handtuch	492, 1024
Rucksack Hülle	372, 495
Rucksack Tasche	377, 552
Rucksack Anzeiger	371, 497
Salatbehälter	461
Salatschüssel	1285
Sandwich Lunch Box	457, 460, 928, 961
Saugfähiges Handtuch	492, 493, 748, 862, 964, 1024, 1025
Saugfähiges Handtuch	1279
Set	635, 704, 908, 979, 1137, 1146, 1147, 1239
Schal	1283
Schalmesser	768
Schaumöffel	773
Schinken Hülle	588
Schlafsack	517
Schlauschal	491, 740, 1139
	344, 500, 611, 660, 661, 662, 663, 664, 665, 666, 667,
	668, 672, 673, 674, 675, 676, 677, 810, 910, 980, 1016,
	1210, 1211, 1233, 1236, 1238, 1263, 1264
Schlüsselanhänger	542, 677, 877, 893
Schlüsselanhänger	590, 664, 665, 670, 671, 677
Anticontact	667, 668, 669, 814, 1233, 1263
Schlüsselanhänger	131, 596, 623, 1264
EK-Chip	1288
Schlüsselanhänger	1232
Flaschenöffner	1232
Schlüsselanhänger Halter	10, 12, 18, 27, 80, 81, 89, 622, 1242
Schlüsselanhänger Hut	
Schlüsselanhänger	
Kugelschreiber	
Schlüsselanhänger	
Ladegerät	
Schlüsselanhänger	644, 645, 1265
Lampe	1272
Schlüsselanhänger Lineal	1263
Schlüsselanhänger Pfeife	666, 870
Schlüsselanhänger	
Pillendose	978, 1136, 1288
Schlüsselanhänger	657, 923, 1276
Poncho	969, 1233
Schlüsselanhänger Teddy	130, 192, 193, 194, 195, 196, 198, 872, 912, 1207, 1208,
Schlüsselband	1209, 1250, 1258, 1288
Schlüsselband	451, 1220
Getränkehalter	82, 218
Schlüsselband Ladegerät	906
Schmuckbox	526, 1183
Schneeschaufel	1249
Schnur Winder	1271
Schnursenkel	480, 1271
Schrittzähler	544, 862
Schuhanzieher Putzer	862
Schuhputzer	512, 544
Schuhtasche	751, 752, 753, 754, 755, 785, 827, 828, 934, 967, 1045,
Schürze	1287
Schutzbrille	882, 1161
Schwimmflügel	1011
Seesack	355, 378, 985, 1029
Seesack Rucksack	378
Selbenblasen	974
Selbstfilternde Maske	881
FFP2 Farbe	881
Selbstfilternde Maske	881
FFP2 Weiß	881
Selvie	629, 1216
Selvie Pai Pai	629, 1001, 1216
Selvie Rahmen	1275
Selvie Set	629, 1216, 1225
Serviermesser	1284
Serviettenring	830
	103, 124, 137, 168, 169, 260, 314, 315, 316, 322, 323,
	326, 328, 398, 528, 684, 686, 688, 690, 691, 713, 762,
	785, 858, 936, 937, 940, 941, 942, 943, 946, 953, 965,
	967, 1146, 1164, 1165, 1177, 1231, 1254, 1282, 1288, 1289
	902
Set Make-up Pinsel	819, 820
Shaker	490, 1102, 1103
Shorts	110, 553, 651
Sicherheit Hülle	981
Sicherheits Set	344, 496, 982, 983, 1265
Sicherheitslicht	42, 790
Smart Kamera	1230
Socke	1230

names	SEITE
Socken	788, 1150, 1230, 1231
Solischleife	1211
Sonnenblende	487, 1057, 1059, 1267
Sonnenbrille	621, 984, 988, 989, 990, 991, 992, 993, 994, 995, 996,
	1218, 1238, 1269
Sonnenschirm	749, 1018, 1019
Sossenschüssel	1283
Spaghettimissel	1282
Sparschwein	929, 968
Spätel	771
Speicherkartenetui	1243
Spender Clip	774
Spiegel Halter	1248
Spiel	599, 612, 930, 931, 970, 971
Spiel Set	601, 972, 1006
Sport Rucksack	372, 511
Sportflugzeug	971
Sportthose	490, 1101
Sportkamera	41, 521
Sportkamera 360°	40, 521
Sprungseil	476, 973
Stäbchen Set	760
Stange	1011, 1269
Startnummerträger	484
Steckeradapter	120, 121, 536, 537
Stifthalter	243, 1280
Stirnband	104, 488, 489, 1271
Stopuhr	1271
Stoßel	820
Strahlpumpe	648
Strand Schläger	1007, 1270
Strandball	1008, 1009, 1238
Strandfussballtor	502, 972, 1010
Strandmatte	1020, 1022, 1023
Strandmatte Jarapa	1022
Strand	462
Strohalm	463, 816
Strohalm Set	1020, 1021, 1269
Stuhl	830
Stuhl Band	1020
Stuhl Kühltasche	1024
Stuhlhülle	1234
Sublimations Armband	643, 737, 1206
Sublimations Kosmetik	733, 916
Tasche	747, 783, 825
Sublimations Matte	343, 733
Sublimations Rucksack	194, 737, 1206
Sublimations	747, 755
Schlüsselband	583, 733, 739
Sublimations Schürze	390, 394, 395, 415, 743, 744, 745, 764
Sublimations Tasche	414, 742
Sublimations Tasse	414, 742
Sublimations	1283
Thermoskanne	1290
Sublimations Trinkflasche	220, 221
Suppenkelle	826, 938
Sweatshirt	184, 250, 251
Tablet Hülle	339, 358, 374, 375, 376, 379, 513, 523, 550, 551, 552,
Tafel	557, 558, 559, 560, 561, 562, 563, 564, 565, 566, 567,
Tagebuch	568, 569, 570, 571, 572, 573, 578, 579, 580, 581, 582,
	583, 584, 585, 586, 587, 588, 589, 590, 592, 593, 700,
	711, 724, 725, 727, 730, 735, 786, 811, 835, 904, 906,
	935, 1004, 1028, 1030, 1031, 1032, 1033, 1036, 1231,
	1262, 1268, 1275, 1277
Tasche Aschenbecher	649, 1017
Taschen Set	556, 566, 594, 747, 786
Taschenhalter	905
Schlüsselanhänger	525, 526, 529, 712, 1153, 1168, 1169, 1170
Taschenmesser	245, 890, 1196, 1203, 1256
Taschenrechner	333, 873
Taschenschutz	894, 896, 897, 1278
Taschenspiegel	867
Taschentuch	504, 855, 861, 871, 1279
Taschenwärmer	388, 389, 390, 391, 392, 393, 396, 397, 398, 399, 407,
	409, 411, 413, 425, 444, 445, 452, 453, 519, 628, 762,
	763, 764, 765, 823, 928, 936, 963, 977, 1224, 1259, 1285
Tasse	209, 402
Tasse Wärmer	43, 209, 402
Tasse Wärmer Ladegerät	115, 207
Tastatur	115, 207
Tastatur Halter	1107
Technische Jacke	969
Teddy	772, 820
Teesieb	1242
Telefon	249, 318, 330, 331, 332, 874, 911
Textmarker	248, 249, 330, 331, 874, 946
Textmarker Set	1271
Thermisches Band	504, 861
Thermisches Tasche	38, 865, 890
Thermometer Uhr	416, 417, 424, 708, 1270
Thermoskanne	1014
Tisch	831
Tischdecke	250
Tischkalender	831
Tischläufer	139, 1244, 1256
Tischuhr	45, 602
Tischuhr Ladegerät	708, 747, 757, 1282
Topflappen	132, 979, 1123, 1137, 1141, 1145
Touchpad Handschuhe	482, 1145
Touchpad Sport	
Handschuhe	
Touchpad Stiff	624, 1250
Handyhalter	

names	SEITE
Touchpad Stiff	612, 624, 706, 976, 1250
Touchpad Stiff	131, 624, 1250
Displayreinger	
Touchpad Stiff	1264
Schlüsselanhänger	
Transparente Trennwand	892
	396, 401, 404, 405, 406, 407, 409, 411, 413, 425, 442,
	443, 445, 449, 450, 451, 452, 460, 961, 962, 963, 1220,
Trinkbecher	1221, 1222, 1259
	388, 389, 398, 410, 415, 420, 421, 422, 423, 424, 426,
	427, 428, 429, 430, 431, 432, 433, 434, 435, 436, 437,
	438, 439, 440, 441, 446, 447, 448, 452, 453, 478, 506,
	507, 508, 509, 609, 732, 743, 762, 809, 822, 962, 1214,
	1223, 1259, 1281
Trinkflasche	
Trinkflasche	436, 437
Fruchtsaftpresse	440
Trinkflasche Halter	446, 870
Trinkflasche Pillendose	424, 572, 725
Trinkflasche Tasche	448
Trinkflaschen Kühler	234, 235, 530, 546, 547, 700, 701, 1262
Trolley	235, 369, 549, 958
Trolley Rucksack	548
Trolley Tasche	1287
Tröpfing	1291
T-Shirt	1262
Übersetzer	38, 480, 481, 636, 637, 702, 873, 1274
Uhr	635
Uhrenset	228, 363, 381, 382, 383, 384, 553, 746, 1257, 1260,
	1261, 1268
Umhängetasche	125
Universal Objektiv	125
Universal Objektive Lente	40
Universal Stativ	766, 817, 1234, 1285
Übersetzer	759, 766, 803, 817, 1234
Übersetzer Set	128, 625
Unterstützungsschutz	136, 137, 1176, 1177, 1242
USB Autoladegerät	18, 27, 86, 100, 101, 211, 212, 213, 214, 692, 1243
USB Hub	100, 216
USB Hub Lampe	101, 211
USB Hub Stifthalter	116
USB Ladegerät	79, 538
USB Ladegerät Set	112, 216
USB Lampe	94, 208
USB Notizblock	74, 208
USB Power Bank	86, 90, 91, 92, 93, 94, 95, 96, 97, 1243
USB Speicher	840
UV Sterilisator Kasten	114, 841, 1175
UV Sterilisator Lampe	107, 153, 843
UV Sterilisator Ordner	107, 153, 367, 843
UV Sterilisator Rucksack	1002, 1270
UV-Strahlmesser	1286
Vase	216, 793, 1270
Ventilator	716, 719, 721, 722
Verstellbarer Ring	123, 1244
Virtual-Reality Brille	108, 109, 110, 201, 241, 650, 651, 652, 653, 654, 655,
Visitenkartenetui	703, 706, 1258
Visitenkartenetui	108, 652, 654, 703
Brieftasche	706
Visitenkartenetui Spiegel	1117
Vlies	785
Vorspeisen Schale	761, 824, 1283
Vorspeisenteller	758
Waage	327, 328, 940, 942
Wachsmalstifte Set	328, 939
Wachsmalstifttee	139, 774
Wanduhr	775
Wanduhr Timer	389, 418, 419, 420
Wärme Flasche	685, 473, 589, 787, 960, 1040, 1281
Wärme Tasche	418
Wärme Trinkbecher	504, 861
Wärme-Kälte Pflaster	1121, 1186
Warmweste	974, 1011
Wasserpistole	26, 111, 202
Webcam-Blocker	111, 976
Webcam-Blocker Joystick	1222, 1228
Weihnachtsbaum	1228
Weihnachtskarte	1225
Weihnachtsmütze	1228
Weihnachtsverzierung	1286
Weihnachtsmütze	807
Weihnachtsbaum	807, 809
Weihnachtskarte	709, 803, 804, 805, 806
Weihnachtsmütze	810
Weihnachtsbaum	1070, 1146
Weihnachtskarte	1130
Weihnachtsbaum	704
Weihnachtsbaum	1154, 1155
Weihnachtsbaum	501, 524, 972, 981, 1074, 1110, 1111, 1112, 1113, 1114,
Weihnachtsbaum	1115, 1116, 1121, 1198, 1281, 1290
Weihnachtsbaum	20, 603, 794, 1152, 1173, 1272
Wetterstation	877, 878, 879
Wiederverwenbar	883
Hygienemaske	632, 1227
Wiederverwenbar Kinder	1203
Hygienemaske	1271
Wunsch-Dose	929, 930, 971
X-Banner	542, 833, 834, 855, 858, 859, 965
Yoga Kugeln	818
Yoyo	131, 772, 820, 891, 1002
Zahnbürste	333
Zange	1002
Zerstäuber	649
Zerstäuber	
Kugelschreiber	
Zerstäuber Ventilator	
Zigaretten Hülle	

names	BLADZIJDE
Kinder Zonnebril	975
Kinderen Technisch	1106, 1107
Sweatshirt	978, 1136
Kinder-Regenjas	544
Kledinghoes	323, 610
Kleurboek	1290
Kleuren Dames T-Shirt	1078, 1082
Kleuren Dames T-Shirt	1080
"keya"	1078
Kleuren Kinder T-Shirt	1080, 1081, 1290
Kleuren Kinder T-Shirt	139, 775, 1244, 1256
Volwassene	45, 602
Klok	1172
Klok Oplader	774, 1022
Kniebeschermingsmat	455, 465, 466, 467, 468, 469, 471, 472, 473, 589, 960,
Knijper	1029, 1038, 1039, 1040, 1041, 1042
Koeltas	346, 470, 960, 1040
Koeltas-Rugzak	545
Koffer Riem	829
Koksmuts	516, 529, 713, 1271
Kompas	17, 25, 62, 63, 104, 105, 607, 694, 789, 1246
Koptelefoon	326, 940
Krijtjes Set	779, 780, 812
Kurkentrekker	780, 813
Kurkentrekker Opener	1287
Kurkentrekker Set	532, 1015, 1262, 1270
Kussen	1280
Kussen-Notitieboek	771, 966
Kwast	112, 519, 520, 797, 948, 1164
Lamp	61, 217, 797
Lamp Luidspreker	130, 192, 193, 194, 195, 196, 198, 872, 912, 1207, 1208,
Lanyard	1209, 1250, 1258, 1288
Lanyard Getrankehalter	451, 1220
Lanyard Oplader	82, 218
Laptoptasje	150, 221
Lapzak	810
Laser Keyboard	114, 206
Laser Pen	215, 1254
Laser Pointer	215
LCD Tablet om te	208, 610, 938
Schrijven	996, 1219
Lenzen	758
Lepel	1285
Lepel Set	864
Lichaam Meetlint	864
Lichaam-Meetlint	611, 796
Lightbox	247, 1159
Lineaal	247, 949
Liniaal	184, 1256
Liniaal Bladwijzer	1256
Liniaal Rekenmachine	242, 948
Liniaal Vergrootglas	856, 857, 899
Bladwijzer	122, 1182
Lippenbalsem	451, 1221
Locator	1012, 1013
Long Drink Glas	119, 791, 1174
Luchtbed	618, 676, 792, 1185, 1228, 1286
Luchtbevochtiger	1185
Luchtverfrisser	7, 8, 9, 11, 13, 15, 16, 24, 32, 52, 53, 54, 55, 56, 57, 58, 59,
Luchtverfrisser Houder	60, 85, 607, 608, 695, 1003, 1240, 1245
Luidspreker	50
Luidspreker Brill	60, 403
Luidspreker Fles	1248
Luidspreker Houder	61, 796, 821, 1003
Luidspreker Ijs Emmer	1245
Luidspreker Koptelefoon	60, 1003
Luidspreker	85, 131, 623
Multifunctioneel Tasje	50, 1245
Luidspreker	50
Sleutelhanger	50, 1245
Luidsprekers	50
Luidsprekers	50
Koptelefoon	455, 456, 457, 458, 459, 460, 461, 961, 1285
Lunch Box	324
Magisch Vulpotlood	640, 776, 777, 778, 1235
Magneet	250
Magneet Kalender	777
Magnetisch Whiteboard	973
Mand	323, 610, 937
Mandala Set	903
Manicure Set	151, 176, 180, 181, 236, 237, 238, 239, 240, 241, 605,
Map	696, 697, 746, 795, 837, 1257
Map Tablet Hoes	220
Marker	249, 318, 330, 331, 332, 874, 911
Marker Set	1254
Markers Set	248, 249, 330, 331, 874, 946
Maskerhouder	726, 886, 887, 892
Maskerhouder Armband	1271
Maskerhouder Lanyard	196, 737, 885
Maskerhouder XL	887
Massage Stenen	1279
Massage-Vorm	863
Mat	476, 484, 1192
Medaille	500, 1210
Meet Set	771, 966
Meetlint	1156, 1157
Memo Block	188, 191
Memory Kaartjes Hoes	1243
Mes	768
Messen Set	769, 1284
Microscop	124, 1172
Mini Muis	113, 203

names	BLADZIJDE
Mini Multifunctioneel	1167
Zakmes	178, 956
Mini Notitieboek	970
Mini Puzzel	216, 793
Mini Ventilator	256, 294, 832, 836, 1253
Minipen	116, 1248, 1250
Mobiele Houder	388, 389, 390, 391, 392, 393, 396, 397, 398, 399, 407,
Mok	409, 411, 413, 425, 444, 445, 452, 453, 519, 628, 762,
	763, 764, 765, 823, 928, 936, 963, 977, 1224, 1259, 1285
MP3	1242
Mug Afstotende	518, 863, 975, 1002
Armband	113, 203, 1257
Muis	204, 205, 746
Muispad	204
Muispad Fotolijst	250
Muispad Kalender	1257
Muispad Toetsenbord	273, 542, 849, 873
Multifunctioneel	475, 517
Antibacterieel Balpen	1245
Multifunctioneel Etui-	44, 206
Luidspreker	149
Multifunctioneel Muispad	18, 623
Multifunctioneel	21, 28, 45, 145, 210, 603
Notitieblokje	44, 121, 539
Multifunctioneel Oplader	133, 385, 460, 534, 715, 770, 916, 923, 952, 961, 1005,
Multifunctioneel	1220, 1247, 1255, 1260, 1275
Adapter	923
Multifunctioneel Tasje	923
Portemonnee	525, 712, 1153, 1167, 1170, 1272
Multifunctioneel Zakmes	1284
Multifunctionele	643, 1204
Multifunctionele	997
Armband	1285
Multifunctionele	774
Multifunctionele Doekjes	128, 130, 625
Multifunctionele Haak	1270, 1283
Multifunctionele Hoes	1280
Multifunctionele Houder	1286
Multifunctionele Kist	525, 526, 527, 529, 712, 1153, 1154, 1164, 1166, 1170,
Multifunctionele Mand	1273
Multitool	1254
Multitool Pen	1286
Munt-Schaaltje	590, 664, 665, 670, 671, 677
Munt-Sleutelhanger	1220
Muntstuk	104, 488, 497, 524, 704, 740, 829, 904, 1049, 1060,
Muts	1061, 1070, 1071, 1123, 1141, 1142, 1143, 1144, 1237,
	1266, 1267, 1289
Nagelvijl	1278
Nagelvijl Set	903, 1278
Nierband	504
Nood Hamer	1187
Noedlicht	1186
Notitieblok Zelfklevend	174, 183, 188, 190
Notitieblokjes	157, 158, 159, 160, 161, 162, 163, 164, 165, 166, 167, 189,
Notitieblokjes	1255
Notitieblokjes Hoes	282, 283, 606, 690, 910, 952, 1255
Notitieblokjeshouder	264, 1255
Notitieboek	170, 171, 172, 173, 175, 176, 177, 178, 179, 189, 190, 628,
Notitieboek	715, 952, 954, 955, 956, 957, 977, 1255
Omkeerbare Muts	1070, 1146
Omkeerbare Paraplu	1130
Omkeerbare Sjaal	704
Omslag Handdoek	985, 1026, 1027
Onderzetter	766, 817, 1285
Onderzetter Set	759, 766, 803, 817, 1234
Ontvanger Bluetooth	136, 1181
Oogbeschermer	860, 1002
Oogschaduw Kwasten	902
Set	710
Oor/Neus Trimmer	718, 721, 722, 723
Oorbellen	33, 403, 539
Oordop Fles	33, 1176
Oordopje Oplader	7, 17, 25, 33, 34, 35, 102, 103, 104, 486, 533, 695, 1160,
Oordopjes	1240, 1246
Oorschoonmaker	863
Oorwarmers	1146
Opener	774, 779, 781, 782, 814, 815
Opener Fidget Spinner	814
Opener Onderzetter	783
Oplader	6, 8, 9, 10, 12, 15, 18, 19, 22, 23, 28, 29, 32, 45, 46, 47,
Oplader	48, 80, 81, 82, 84, 89, 144, 210, 211, 219, 1182, 1240,
Oplader	1241, 1242
Oplader Houder	134, 1180
Oplader Luidspreker	13, 17, 44, 51, 217, 797
Oplader Map	146
Oplader Muispad	14, 142, 205
Oplader Notitieblokjes	14, 142, 146
Oplader Oordopjes	35
Oplader Organizer	147, 221
Oplader Pennebakje	13, 140, 145
Oplader Rugzak	106, 370, 372, 514
Oplader Synchronizer	27, 82, 83, 218, 622, 1182, 1242
Oplader Toetsenbord	44, 114, 206
Oplader UV Sterilisator	49, 840
Kist	49, 841
Oplader UV Sterilisator	49, 841
Lamp	407, 870
Opvouwbare Beker	

names	BLADZIJDE
Opvouwbare Fles	447
Opvouwbare Rugzak	347, 352, 373, 515, 959, 1262
Opvouwbare Schort	755
Opvouwbare Tas	379, 558, 560, 564, 565, 567, 569, 574, 575, 576, 577,
Opvouwbare	578, 628, 735, 739, 1235
Opvouwbare	905
Tassenhanger	548
Opvouwbare Troley	1192, 1193
Organizer	141, 240, 1184
Organizer Band	244, 953
Organizer Oplader	14, 21, 142, 143
Organizer Sleutelhanger	666
Ovenwant	708, 747, 752, 756, 757
Ozon Generator	118, 790, 841, 1175
Pai Pai	1001
Pai Pai Pen	319
Pannenlap	708, 747, 757, 1282
Paperclipshaaltje	246
Paraplu	705, 715, 749, 978, 1124, 1125, 1126, 1127, 1128, 1129,
Paraplu	1130, 1131, 1132, 1136, 1288
Pareo-Rok	1026
Parka	1118, 1289
Paspoorthouder	535
	187, 252, 253, 254, 255, 256, 257, 258, 259, 261, 262,
	263, 264, 265, 266, 267, 268, 269, 270, 276, 277, 279,
	280, 281, 282, 283, 286, 287, 288, 289, 290, 291, 292,
	293, 294, 295, 298, 299, 306, 307, 308, 309, 315, 316,
	317, 318, 319, 329, 330, 332, 333, 503, 606, 628, 680,
	682, 683, 686, 687, 688, 689, 837, 875, 898, 911, 947,
	974, 977, 1158, 1214, 1232, 1233, 1236, 1251, 1252,
	1253, 1254
Pen-Bladwijzer	242
Pen-Houder	259, 270, 274, 278, 1252
Pennehoes	260, 311, 728
Pennenbakje	243, 1280
Pen-Sleutelhanger	1232
Pen-Zaklamp	317, 332, 644, 872, 947
Persoonlijk Alarm	122, 905
	479, 487, 604, 609, 735, 740, 904, 1049, 1050, 1051,
Pet	1052, 1053, 1054, 1055, 1056, 1057, 1160, 1237, 1266,
	1267, 1289
Pillendoosje	868, 869, 870
Pincet	903
Pizza Snijder	773
Plaat	761, 824
Placemat	760, 772, 783, 825, 830, 934
Placemat Set	708
Plakmemo Set	1255
Plakmemo-Blokje	166, 171, 174, 182, 183, 184, 185, 186, 189, 1255
Plakmemohouder	182, 186, 1255, 1256
Plaque	500, 639, 1210
Plastic Zak	311, 728
Plunje-Rugzak	378
Plunjezak	355, 378, 985, 1029
Poetsdoekjes	830
Polar Fleece	1117
Polo Shirt	734, 1075, 1086, 1090, 1091, 1092, 1237, 1291
	236, 597, 635, 653, 656, 657, 658, 659, 703, 718, 898,
Portemonnee	917, 922, 923, 1276, 1277
Portemonnee en	1276
Kaartjeshouder	482
Portemonnee Houder	410, 412, 449, 450, 460, 822, 1284
Pot	264, 295, 320, 321, 325, 329, 333, 499, 836, 875, 933,
Potlood	944, 945, 1158, 1232
Potlood Set	323, 325, 327, 328, 683, 941, 942, 943
Potlood Slijper	946
Potlood Slijper voor	1278
Make-up	11, 12, 19, 22, 28, 32, 64, 65, 66, 67, 68, 69, 70, 71, 72, 73,
Power Bank	74, 75, 84, 514, 692, 1241
Power Bank Bagage	545
Weegschaal	76, 821
Power Bank Display	76, 821
Standaard	51, 1240
Power Bank Luidspreker	87, 148, 149, 691
Power Bank Map	87, 148
Power Bank Notitieblokjes	34, 539
Power Bank Oordopjes	64
Power Bank Oplader	147
Power Bank Organizer	106, 370
Power Bank Rugzak	76, 538
Power Bank Selfie Stick	77, 78, 538, 1241
Power Bank Set	76, 310
Power Bank Touch-Screen	638
Balpen	1217
Presse-Papier	613, 930, 933, 936
Pruik	484
Puzzel	484
Racenummerhouder	484
Heuratas	20, 602, 795
Radio Klok	773
Rasp	594, 786
Recycle Tas	1121, 1186
Reflecterend Vest	522, 1119, 1120, 1133, 1134, 1135
Regenjas	1172
Regenmeter	532, 533, 541
Reis Set	534
Reisdocumentenhouder	245, 1256
Rekenmachine	634, 1274
Riem	462
Rietje	463, 816
Rietjes Set	906
Ring Houder	818, 819
Roerstaafje	

names	BLADZIJDE
Roll Up	1197, 1203
Roller	277, 296, 297
	152, 232, 335, 336, 337, 338, 339, 340, 341, 342, 343,
	344, 345, 348, 349, 350, 351, 352, 353, 354, 355, 356,
Rugzak	357, 358, 359, 360, 361, 362, 363, 365, 368, 373, 377,
	378, 467, 503, 510, 511, 515, 523, 552, 561, 604, 608,
	698, 699, 714, 735, 741, 935, 958, 959, 1004, 1029, 1194,
	1215, 1231, 1260, 1261
Rugzak Hoes	372, 495
Rugzak Richtingaangever	371, 497
Ruitenwisser	1273
Salade-Bakje	461, 1285
Saladebestek	773, 1283
Sausborden	1283
Schaaltjes	761, 785, 824, 1283
Scherm Schoonmaker	131, 1249
Scherm schoonmaker	1249
Houder	
Schilder Set	505, 1200, 1238
Schoenentas	512, 544
Schooltuit	953
Schoonmaak Set	244, 783
Schoonmaakdoekje	131, 736, 1249
Schort	751, 752, 753, 754, 755, 785, 827, 828, 934, 967, 1045,
	1287
	1288, 363, 381, 382, 383, 384, 553, 746, 1257, 1260,
Schoudertas	1261, 1268
Schuimspaan	773
Selfie	629, 1216
Selfie Lijst	1275
Selfie Pai Pai	629, 1001, 1216
Selfie Set	629, 1216, 1225
Selfie Stick	124, 1245
Serveermes	1284
Serveerplatform	831
Servetten Ring	830
	103, 124, 137, 168, 169, 260, 314, 315, 316, 322, 323,
	326, 328, 398, 528, 684, 686, 688, 690, 691, 713, 762,
	785, 858, 936, 937, 940, 941, 942, 943, 946, 953, 965,
	967, 1146, 1164, 1165, 1177, 1231, 1254, 1282, 1288, 1289
Set	632, 796, 1227
Sfeerlichtjes	819, 820
Shaker	544, 862
Shoenelepel met	
Shoepoets	862
Shoepoets	490, 1102, 1103
Shorts	906
Sieradendoosje	649
Sigaretten Hoes	820
Sinaasappelpers	
Sjaal	635, 704, 908, 979, 1137, 1146, 1147, 1239
Sjaaltje	895, 908, 909, 1147, 1278
Sjabloon	1234
Sjawi	908
Slaapmasker	533, 860
Slaapzak	517
	500, 611, 660, 661, 662, 663, 664, 665, 666, 667, 668,
	672, 673, 674, 675, 676, 677, 810, 910, 980, 1016, 1210,
	1211, 1233, 1236, 1238, 1263, 1264
Sleutelhanger	542, 677, 877, 893
Anticontact	1263
Sleutelhanger Fluitje	131, 596, 623, 1264
Sleutelhanger Houder	1272
Sleutelhanger Lijnlaal	1288
Sleutelhanger Muts	
Sleutelhanger Opener	667, 668, 669, 814, 1233, 1263
Sleutelhanger Oplader	10, 12, 18, 27, 80, 81, 89, 622, 1242
Sleutelhanger	666, 870
Pillendoosje	
Sleutelhanger Regenjas	978, 1136, 1288
Sleutelhanger Teddybeer	969, 1233
Sleutelhanger Zaklamp	644, 645, 1265
Sleutelhanger-Tasje	657, 923, 1276
Slippers	832, 835, 1287
Smart Armband	36, 38, 39, 481
Smart Camara	42, 790
Smartwatch	37, 39, 693, 1240, 1244
Sneeuw-Bol	1228
Sneeuwschep	526, 1183
Snoep	633
Snoep Dispenser	1275
Soeplepel	1283
Sok	788, 1150, 1230, 1231
Spaarpot	929, 968
Spaghetti Meter	1282
Spatel	771
Speaker Microfoon	1240
Spel	599, 612, 930, 931, 970, 971
Spel Set	601, 972, 1006
Speld	641, 1211
Spiegel Houder	1248
Sport Camara	41, 521
Sport Camara 360°	40, 521
Sport Rugzak	372, 511
Sportbroek	490, 1101
Springtouw	476, 973
Sproeier	131, 772, 820, 891, 1002
Sproeier Pen	333
Sproeier Ventilator	1002
Stamper	820
Stang	1011, 1269
Stappenteller	480, 1271
Steelpan	1282
Stekker Adapter	120, 121, 536, 537
Stoel	1021
Stoel Hoes	1234
Stoel-koeltas	1020

names	BLADZIJDE
Stop Vacuum Pomp	807
Stopwatch	1271
Strand Rackets	1007, 1270
Strandbal	1008, 1009, 1238
Strandmat	1020, 1022, 1023
Strandmat Jarapa	1022
Strandparasol	749, 1018, 1019
Stropdas	634, 704, 1275
Stuur-Zonnescherm	1046, 1188
Sublimatie Armband	643, 737, 1206
Sublimatie Fles	414, 742
Sublimatie Lanyard	194, 737, 1206
Sublimatie Mok	390, 394, 395, 415, 743, 744, 745, 764
Sublimatie Placemat	747, 783, 825
Sublimatie Rugzak	343, 733
Sublimatie Schort	747, 755
Sublimatie Tas	583, 733, 739
Sublimatie Thermosfles	414, 742
Sublimatie Toiletta's	733, 916
Sweatshirt	1290
Tablet Hoes	220, 221
Tafel	1014
Tafelkleed	831
Tandenborstel	542, 833, 834, 858, 858, 859, 965
Tape Set	1256
Tapijdesinfectiemiddel	791, 826, 892
	339, 358, 374, 375, 376, 379, 513, 523, 550, 551, 552,
	557, 558, 559, 560, 561, 562, 563, 564, 565, 566, 567,
	568, 569, 570, 571, 572, 573, 578, 579, 580, 581, 582,
	583, 584, 585, 586, 587, 588, 589, 590, 592, 593, 700,
	711, 724, 725, 727, 730, 735, 786, 811, 835, 904, 906,
	935, 1004, 1028, 1030, 1031, 1032, 1033, 1036, 1231,
	1262, 1268, 1275, 1277
Tas	722
Tas Hanger	
Tas Set	556, 566, 747
Tas Sleutelhanger	905
Tassen Houder	1268
Tassen Set	594, 786
Technische Jas	1107
Teddybeer	969
Telefoon	1242
Telefoon Hoes	1247
Telefoon Houder Oplader	1249
Teller	890, 1196, 1203
Thee-Ei	772, 820
Thermisch Pakket	504, 861
Thermische Band	1271
Thermische Tas	504, 861
Thermo Drinkfles	1270
Thermometer Horloge	38, 865, 890
Thermosfles	416, 417, 424
Thermoskan	708
Thermoskan-Fles	389, 418, 419, 420
Thermo-Tasje	465, 473, 589, 787, 960, 1040, 1281
Toetsenbord	115, 207
Toetsenbord Houder	115, 207
	512, 531, 540, 541, 700, 718, 833, 895, 913, 914, 915,
	916, 917, 918, 919, 920, 921, 1034, 1035, 1036, 1037,
	1262, 1277
Toiletta's	1262, 1277
Tol	971
	88, 187, 260, 262, 270, 275, 276, 277, 278, 281, 282,
	283, 284, 285, 286, 290, 300, 301, 302, 303, 304, 305,
	306, 307, 308, 310, 316, 318, 681, 685, 688, 910, 911,
	1250, 1252
Touchscreen	132, 979, 1123, 1137, 1141, 1145
Handschoenen	
Touch-Screen Potlood	324
Touchscreen Sport	482, 1145
Handschoenen	
Touchscreen-Pen	612, 624, 706, 976, 1250
Touchscreen-Pen Houder	624, 1250
Touchscreen-Pen	131, 624, 1250
Scherm schoner	
Touchscreen-Pen	1264
Sleutelhanger	
Trolley	234, 235, 530, 546, 547, 700, 701, 1262
Trolley Rugzak	235, 369, 549, 958
Trolley Tas	548
T-Shirt	1291
	479, 734, 738, 1075, 1076, 1077, 1092, 1093, 1095,
	1097, 1098, 1099, 1100, 1101, 1103, 1104, 1105, 1106,
	1237, 1291
T-Shirt Volwassene	1076
"Keya"	
Uitbreidbare Paraplu	372, 1128
Uitbreidbare Tas	591
Universeel Statief	40
Universele Camara Lens	125
Universele Lenzen	125
USB Auto Oplader	136, 137, 1176, 1177, 1242
USB Hub	18, 27, 86, 100, 101, 211, 212, 213, 214, 692, 1243
USB Hub Lamp	100, 216
USB Hub Pennenbakje	101, 211
USB Lamp	112, 216
USB Memory	86, 90, 91, 92, 93, 94, 95, 96, 97, 1243
USB Notitieblokje	94, 208
USB Oplader	116
USB Opladers Set	79, 538
USB Power Bank	74, 208
USB Touch-Screen Balpen	94, 310, 690, 1243
UV Meter	1002, 1270
UV Sterilisator Kist	840
UV Sterilisator Lamp	114, 841, 1175
UV Sterilisator Organizer	107, 153, 843
UV Sterilisator Rugzak	107, 153, 367, 843

names	BLADZIJDE
Vaas	1286
Veiligheid Hoes	110, 553, 651
Veiligheids Set	981
Veiligheidsbril	882, 1161
Veiligheidslicht	344, 496, 982, 983, 1265
Ventilator	216, 793, 1270
Ver grootglas	1171, 1244
Verkoelend Oogmasker	860
Verrekijker	1218, 1271
Vertaler	1262
	501, 524, 972, 981, 1074, 1110, 1111, 1112, 1113, 1114,
Vest	1115, 1116, 1121, 1198, 1281, 1290
Veters	1271
Vetmeter	864
Virtuele Reality Bril	123, 1244
Vlag	1199, 1213, 1239
Vlag Houder	1212
Vlag op Stok	1199
Vlag Rugzak	1212
Vlees Brandmerker	784, 826
Vliegenneppeer	1285
Vlieger	934
Vliegtuig	971
Voetbal	502, 972, 1010
Volwassene Hooded +	
Rits Sweatshirt "keya"	1108
Volwassene Hooded	
Sweatshirt "keya"	1108
Volwassene Kleuren	
T-Shirt "keya"	1079, 1083, 1084, 1085, 1087
Volwassene Sweatshirt	
"keya"	1109
Volwassene Wit Polo	1087
Shirt "keya"	
Volwassene Wit T-Shirt	1079, 1083, 1084, 1085
"keya"	
Volwassenen Technisch	1106, 1107
Sweatshirt	
Vorken Set	709
Vorm	1235, 1281
Vormen Set	771, 966, 1281
Vulliszakkenhouder	594, 786, 1017
Vulmachine	648
Vulpotlood	324, 1254
Waaier	620, 715, 912, 985, 998, 999, 1000, 1202, 1268
Wandelsokken	517
Wandklok	139, 774
Wanten	979, 1137
Warmhoudplaatje	209, 402
Warmhoudplaatje	
Oplader	43, 209, 402
Warmte Pakket	504, 855, 861, 871, 1279
Wasco Set	327, 328, 939, 940, 942
Waterpistool	974, 1011
Waterschoenen	1267
Webcam Blocker	26, 111, 202
Webcam Blocker Joystick	111, 976
Weegschaal	758
Werkstation	20, 603, 794, 1152, 1173, 1272
Wens fles	632, 1227
Wereldbol	638
Wereldbol Globe	531, 605, 795
Whiteboard	826, 938
Wierook en Kaarsen Set	1286
Wijn Set	709, 803, 804, 805, 806
Wijnrek	810
Wit Dames T-Shirt "keya"	1078, 1082
Wit Kinder T-Shirt	1080
Wit Kinder T-Shirt "keya"	1078
Wit T-Shirt Volwassene	1080, 1081
X-Banner	1203
Yoga-Ballen	1271
Zadel Hoes	495, 741
Zak-Asbak	649, 1017
Zakbeschermer	333, 873
Zakdoekjes	867
Zakjes Dispenser	1017, 1184, 1191
Zaklamp	89, 496, 519, 520, 528, 644, 645, 713, 779, 872, 982,
	1161, 1162, 1163, 1164, 1165, 1265, 1271, 1272
Zaklamp Pen	947
Zakmes	525, 526, 529, 712, 1153, 1168, 1169, 1170
Zakspiegel	894, 896, 897, 1278
Zelf Filterende Masker	881
FFP2 Kleuren	
Zelf Filterende Masker	881
FFP2 Wit	
Zonnebril	621, 984, 988, 989, 990, 991, 992, 993, 994, 995, 996,
	1218, 1238, 1249
Zonneklep	487, 1057, 1059, 1267
Zonnescherm	749, 1046, 1047, 1188, 1189, 1273
Zwemmuts	484, 1024



Reservados todos los derechos. La información contenida en este documento y/o alguna derivación de sus partes, y/o en conexión con las mismas, no puede ser reproducida ni usada en forma o medio alguno. El uso no sujeto a lo aquí estipulado derivará en la aplicación de las medidas legales que se estimen pertinentes.

All rights reserved. The information contained in the present document and/or any of its derivations and/or in connection with them shall not be reproduced, nor used, in any form or media. A use not subject to the former stipulations should derive in the applying of the legal measures considered appropriate.

Podemos suministrar todos nuestros artículos impresos, en un plazo y coste mínimos

We offer printing service for all our collection, in short delivery time and very competitive price

Nous offrons un service d'impression pour tous nos articles, en temps minimum et à prix très compétitifs.

Wir Veredeln alle unsere Produkte in sehr kurzer Zeit, zu sehr günstigen Preisen

Offriamo un servizio di stampa per tutti i nostri articoli, in tempi brevi di consegna e prezzo molto competitivo.

Podemos imprimir todos os artigos da nossa coleção, num prazo de entrega reduzido e a preços competitivos.

Wij bieden een print service voor onze gehele collectie, met een korte leveringstijd en enorme concurrerende prijzen.

01 BLANCO WHITE BLANC WEISS BRANCO BRANCO WIT	02 NEGRO BLACK NOIR SCHWARZ NEGRO PRETO ZWART	03 ROJO RED ROUGE ROT ROSSO VERMELHO ROOD	04 VERDE GREEN VERT GRÜN VERDE VERDE GROEN	05 AMARILLO YELLOW JAUNE GELB GIALLO AMARELO GEEL
06 AZUL NAVY BLUE AZUL MARINO DONKELBLAU AZUL MARINO AZUL MARINO AZUL MARINO AZUL MARINO AZUL MARINO	07 NARANJA ORANGE ORANGE ORANGE ARANCO LARANJA ORANJE	08 GRIS GREY GRIS GRAU GRIGIO CHIZZOTTI GRIS	09 PLATA SILVER ARGENT SILBER ARGENTO PRATA ZILVER	11 FUCSIA FUCHSIA FUCHSIA FUCHSIA FUCHSIA VIOLETTA FUCHSIA
13 NATURAL NATURAL NATUREL NICE NATURALE NATURAL NATUREL	14 KHAKI KHAKI KAKI KHAKI CACA CAQUI KHAKI	15 ARENA SAND SABLE SAND SABBIA AREIA ZAND	16 PISTACHO GREEN PISTACHE PISTACHE VERDE ACIDO PISTACHO PISTACHE	17 ULTRAVIOLETA ULTRAVIOLETT ULTRAVIOLETT ULTRAVIOLETT ULTRAVIOLETT ULTRAVIOLETT ULTRAVIOLETT
18 MARRON BRAUN MARRON BRAUN MARRONE CASTANHO BRON	19 AZUL BLUE BLEU BLAU BLU AZUL BLAUW	20 BURDEOS BURGUNDY BORDEAUX WEINROT BORDEAUX BORDEAUX BORDEAUX BORDEAUX	21 AZUL CLARO LIGHT BLUE BLEU CLAIR HELLBLAU BLU CHIARO AZUL CLARO LICHT BLAUW	22 ROSA PINK ROSE ROSA ROSA ROSA ROSE
33 DORADO GOLDEN DORE GOLD ORO DOURADO GULD	FLUORESCENT CODES			04 F VERDE GREEN VERT GRÜN VERDE VERDE GROEN
11 F FUCSIA FUCHSIA FUCHSIA FUCHSIA FUCHSIA VIOLETTA FUCHSIA	07 F NARANJA ORANGE ORANGE ORANGE ARANCO LARANJA ORANJE	05 F AMARILLO YELLOW JAUNE GELB GIALLO AMARELO GEEL		

Todos los logotipos publicados en este catálogo sólo son ejemplos de marcaje. Quedan exentos de beneficio comercial. En la reproducción gráfica de los productos de este catálogo se puede producir alguna diferencia de matiz o color con la realidad.

All logos published in this catalogue are only customization examples. The shades or colours shown in this catalogue can look different from the reality.

- Los precios publicados en este catálogo pueden sufrir variaciones durante el transcurso del presente año.

- Prices published in this catalog are subject to changes in the current year.

PRINTING PRICES *

Todos los precios de marcaje mostrados en este catálogo incluyen **1 color / 1 posición** en la técnica recomendada y más económica (otras técnicas a consultar), **Manipulación incluida**. Fotolito y pantalla no incluido. **Consultar descuento** en caso de no necesitar reenvasado final del producto en su presentación original.

Todos os valores de impressão presentes neste catálogo incluem **1 cor / 1 posição** na técnica recomendada e mais económica (outras técnicas a consultar), **Manipulação incluída**. Fotolito e abertura de quadro não incluídos, **Consultar desconto** em caso de não necessitar da reenvasagem do produto na sua bolsa ou caixa de origem.

Die Druckkosten die in diesen Katalog angezeigt sind, enthalten **einen einfarbigen Druck auf einer Position**, mit der empfohlenen und günstigeren Druck Technik (für andere Druck Techniken bitte nachfragen), **Manipulation enthalten**, Vorkosten nicht enthalten.

Nach Discount nachfragen wenn man den individuellen Polybeutel oder original Etui von dem Artikel nicht benötigt.

De prijzen van het printkader vermeld in deze catalogus, zijn inclusief **1 kleur / 1 positie**, door de aanbevolen en meest economische techniek (vraag naar de andere technieken) **manipulatie inclusief**. Fotolito en afdruk zijn niet inclusief. **Korting bespreekbaar**, indien er geen veranderingen nodig zijn als de standard verpakking van het eindproduct.

I prezzi stampa comprendono **1 colore / 1 posizione** nella tecnica consigliata e più economica (altre tecniche consultare), **Manipolazione compresa**. Cliché e telaio no compreso. **Consultare sconto** nel caso in cui non ci sia bisogno di rimballare l'articolo nel suo polybag o confezione originale.

All the printing prices in this catalogue include **1 color / 1 position** in the recommended and most economical technique (consult other techniques), **Handling included**. Films and set up costs are not included. **Check for discounts** if you do not need the product repacked in its original packaging.

PROTECT&PROMOTE

THE WORLD'S LARGEST CATALOGUE 2021

promotional products