

**New for  
2025**

**2025-26  
TEAM  
SPORTS AND  
PARK & REC  
EQUIPMENT**



**BASEBALL & SOFTBALL**



**SOCCER & FIELD SPORTS**



**VOLLEYBALL & NET GAMES**



**INDOOR & OUTDOOR BASKETBALL**



**A GOAL FOR EVERY GAME**



**800-247-7668**

**WWW.BISONINC.COM**

**WARNING:** Cancer and Reproductive Harm  
[www.P65Warnings.ca.gov](http://www.P65Warnings.ca.gov)





Bison and IPI are proud to be Official Corporate Partners of the National High School Federation, the governing body of all high school sports and activities. Bison has a long history of partnering with NFHS dating back over 25 years.

**PARTNER**

Our partnership not only confirms our commitment to safe and durable team sports equipment that meets or exceeds all NFHS rules but also helps financially support the mission of the NFHS and its state member associations across the US.

## Quick View Index

Backboard Dimensions . . . . .	90-91, 97
Badminton . . . . .	65
Ball & Equipment Carts . . . . .	27, 57, 65
Baseball & Softball . . . . .	37-43
Competition Basketball . . . . .	4-24
Competition Soccer . . . . .	68-74
Competition Volleyball . . . . .	44-64
Court & Field Diagrams . . . . .	98-100
Custom Graphics, Lettering & Logos . . . . .	9, 28-36, 58, 75, 102
Divider Nets . . . . .	25
Field Hockey . . . . .	76
Football . . . . .	73, 75
Futsal . . . . .	77
Gym Construction & Renovation . . . . .	3, 13-20, 61
Lacrosse . . . . .	76
<b>Model Number Index . . . . .</b>	<b>103-106</b>
Multi-Game Bases & Standards . . . . .	12
Outdoor Basketball . . . . .	81-94
Outdoor Sand/Beach Volleyball . . . . .	63-64
Pickleball . . . . .	67
Portable Basketball Systems . . . . .	4-12, 82
Portable Soccer Goals . . . . .	68-71, 73
Portable Volleyball Standards . . . . .	53-56
Residential Basketball . . . . .	95-97
Scorers & Activity Tables . . . . .	28-31
Seating . . . . .	78-80
Team Handball . . . . .	77
Tennis . . . . .	66
Tetherball . . . . .	65
Wall Mounted Basketball Systems . . . . .	13-16
Wall Padding (Indoor & Outdoor) . . . . .	32-37
Warranty & Return Policies . . . . .	101
Youth Basketball . . . . .	12, 26, 82



800-247-7668  
www.bisoninc.com

## NEW BASEBALL AND SOFTBALL LINEUP

See Pages 37-43.

**New for 2025**

Recent Bison dealer surveys and regular inquiries from Athletic Directors, facility managers, and coaches over the years have resulted in Bison introducing an initial lineup of popular baseball and softball equipment with the expectation that we will continue to grow this line over the next few years. Designed and built with the same high quality, durability, and safety that you have come to expect from Bison, we hope you will consider Bison when making choices regarding baseball and softball equipment needs.

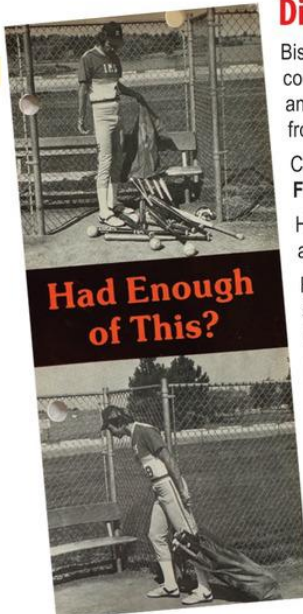

**PROBLEM**

### Did You Know??

Bison had its start in 1985 when our employee softball team manager complained about the dirty duffel bag and wanted a better way to store and transport team bats, balls, scorebooks, and other equipment to and from games and practices.

Co-founder Elmer Wessel designed a better mousetrap that we called **Fielder's Choice Baseball and Softball Caddies**.

He approached partner Nick Cusick about marketing the products and a new company called Bison Recreational Products was born!

Fielder's Choice, sold through independent sales reps, was the springboard that launched Bison into the team sports equipment industry.

It seems fitting then, decades later, Bison is going back to its roots, introducing a baseball and softball product line that it hopes to expand in the upcoming years.

Bison customers have come to trust Bison for quality team equipment and dealers can expect the same from our new baseball and softball lineup.



**SOLUTION**



National Recreation and Park Association



# GYM CONSTRUCTION/RENOVATION EQUIPMENT



Bison's IPI division serves the gym construction and renovation market through a separate network of professional, experienced regional dealers who can assess your needs, specify the right equipment and provide quality and safe installation and after the sale inspections and service.

IPI dealers provide only quality Bison gym equipment that is designed for safety, durability and superior elite competition play. When you have needs for installed wall or ceiling suspended basketball systems, divider curtains, wall padding, volleyball systems or other gym equipment, you can count on IPI.

## Facility Owners, Architects and Contractors

Full product specifications for all IPI by Bison products are available online at [www.IPIbyBison.com](http://www.IPIbyBison.com). Call 800-637-7968 for the name of an IPI dealer in your area.



800-247-7668



[www.bisoninc.com](http://www.bisoninc.com)



# T-REX® PORTABLE BASKETBALL SYSTEMS

Bison now offers a T-Rex portable basketball system for every level of play from elite level, FIBA sanctioned international to intramural and recreational play. All T-Rex portables feature industry leading extension spring counterbalance technology making raising, lowering and storage simple, safe and fast. All pivot locations operate freely on zero maintenance, self-lubricating bearings and chrome plated steel pivot axels. Weight ballast is hidden from sight in a covered weight containment cell. Narrow profile uprights reduce visual interference for fans or media behind the base. Floor friendly 8" x 2" wide casters in a variety of configurations depending on the T-Rex model you select, make moving your T-Rex easy and worry free. All T-Rex portables, when in the transport position, will roll through any doorway that is at least 84" high and 78" wide. T-Rex International is approved for FIBA LEVEL 1 competition. T-Rex Americana and T-Rex Competition are approved for FIBA LEVEL 2 competition. T-Rex International and T-Rex Americana also meet all NCAA and NFHS equipment rules. T-Rex Competition meets all NFHS rules. See page 13 for FIBA Level 2 wall mounted basketball systems and contact us for FIBA Level 2 ceiling suspended systems.

**NOTE: Contact Bison for Factory Assembly and Installation options.**

Shown with Optional Graphics



## BA8910IGA T-Rex® International

Some programs desire the added 32" of safe play area found on our T-Rex International. Whenever possible, with today's aggressive style of play, we recommend International for the added measure of player safety if court space and budget allows. Floor space limitations between the court end line and the end court bleachers or wall will determine if this T-Rex with a 10'8" safe play area is right for your program.

In addition to being approved for FIBA Level 1 play T-Rex International also meets all NCAA and NFHS equipment rules. Approximately 400# of additional rear ballast and additional springs are designed to offset the additional 32" forward extension.

T-Rex International features the same premium glass backboard, 180° breakaway goal, backboard, beam and base padding, an automatic base control system and other features found on T-Rex Americana above.

All steel base components have a standard bright white powder coated finish but can be ordered in a wide array of colors at an additional cost. Request BAFIBA to obtain a FIBA certificate at no extra cost.

**NOTE: NOT WARRANTED FOR OUTDOOR USE.**

Forklift or dock required for delivery. Contact Bison for other off-loading options.



**Note:** Safe Play Area decreases significantly as the rim is lowered for play.

**Note:** T-Rex Americana and T-Rex International Portables usually require factory installation not included in price list. Cost depends on location, quantity and other factors. Call for a quote.



**LEVEL 1**

**FIBA**  
APPROVED  
EQUIPMENT

**\*CONSULT A BISON PRODUCT SPECIALIST FOR OPTIONAL MANUAL ABC SYSTEM (BA8910IGM) IF SPACE AVAILABLE BEHIND BASE IS LESS THAN SHOWN.**

INTERNATIONAL GAME STATS	
Safe Play Area at 10'	128" (See Note)
Glass Backboard Size	42" x 72"
Breakaway Rim	BA3180S
Beam Size	6" Sq.
Ballast Weight	1500#
Total Weight	3228#
Padded Base Dimension	52"(w) x 80"(l)
Total 8" (d) x 2" (w) Wheels	4 (F), 6 (R)
Stored Dimensions	76"(w) x 204"(l) x 83"(h)
Beam Padding	Included
Rear Hold Down	Included
Deadlock Device	Included
Backboard Padding	17 colors
Front Base Padding (16 colors)	4" Thick Premium Sewn
Base Color	Bright White
Front Levelers	Automatic
Floor Load Transport	386# (F); 421# (R)
Floor Load Playing	634# (F); 173# (R)
Min. Required Floor Space Outside Court	202**



# T-REX® PORTABLE BASKETBALL SYSTEMS

**BISON IS THE EXCLUSIVE NFHS PARTNER FOR BASKETBALL EQUIPMENT**



**NOTE: Contact Bison for Factory Assembly and Installation options.**

Shown with Optional Graphics



## BA898AGA T-Rex Americana

Americana™ offers all the features desired by most Division I college programs and meets or exceeds all NCAA and National High School Federation rules. Americana portables feature an 8' safe play area and our Automatic Base Control System that makes set up and transport as easy as ABC. Just "A" roll the unit to its predetermined location on the playing surface and raise the backboard into its playing position, "B" insure that the front locator pins are properly inserted into the floor and "C" attach the rear safety hold down system. Manual base control system also available when wall, bleachers or other obstacles are present at rear of base.

In addition to being approved for FIBA Level 2 play T-Rex Americana also meets all NCAA and NFHS equipment rules.

Americana comes complete with a lifetime warranty official glass backboard, direct beam mount Baseline™ 180° breakaway goal, DuraSkin® backboard padding, high density vinyl upholstered base and beam padding, rear safety hold down system and a vibration deadening device to maximize system rigidity.

All steel base components have a standard bright white powder coated finish but can be ordered in a wide array of additional colors at an additional cost. Request BAFIBA to obtain a FIBA certificate at no extra cost.

**NOTE: NOT WARRANTED FOR OUTDOOR USE.**

### AMERICANA GAME STATS

Safe Play Area at 10'	96" (See Note)
Glass Backboard Size	42" x 72"
Breakaway Rim	BA3180S
Beam Size	6" Sq.
Ballast Weight	1100#
Total Weight	2686#
Padded Base Dimension	52"(w) x 80"(l)
Total 8" (d) x 2" (w) Wheels	4 (F), 6 (R)
Stored Dimensions	76"(w) x 176"(l) x 83"(h)
Beam Padding	Included
Rear Hold Down	Included
Deadlock Device	Included
Backboard Padding	17 colors
Front Base Padding (16 colors)	4" Thick Premium Sewn
Base Color	Bright White
Front Levelers	Automatic
Floor Load Transport	330# (F); 342# (R)
Floor Load Playing	535# (F); 137# (R)
Min. Required Floor Space Outside Court	169"

Forklift or dock required for delivery. Contact Bison for other off-loading options.



**Note:** T-Rex Americana and T-Rex International Portables usually require factory installation not included in price list. Cost depends on location, quantity and other factors. Call for a quote.

**Note:** Safe Play Area decreases significantly as the rim is lowered for play.



**FIBA APPROVED EQUIPMENT**

**\*CONSULT A BISON PRODUCT SPECIALIST FOR OPTIONAL MANUAL ABC SYSTEM (BA898AGM) IF SPACE AVAILABLE BEHIND BASE IS LESS THAN SHOWN.**

## LEVEL 2

### Standard Features on T-Rex Americana & T-Rex International Portables



One Person Setup and Storage



Automatic Base Control System



Lowered For Play

Raised For Transport (2" Clearance)



Baseline™ 180° Breakaway



Vibration Dampening Device



800-247-7668



www.bisoninc.com





# T-REX® PORTABLE BASKETBALL SYSTEMS

COMPETITION GAME STATS	
Safe Play Area at 10'	96" (See Note)
Glass Backboard Size	42" x 72"
Breakaway Rim	BA3180S
Beam Size	4" Sq.
Ballast Weight	1000#
Total Weight	2350#
Padded Base Dimension	40"(w) x 74"(l)
Total 8" (d) x 2" (w) Wheels	2 (F), 4 (R)
Stored Dimensions	76"(w) x 160"(l) x 78"(h)
Beam Padding	Included (BA898GBPAD)
Rear Hold Down	Included
Deadlock Device	Included (BA898GDL)
Backboard Padding	17 colors
Front Base Padding	2" Thick Sewn 4" on FIBA Models
Base Color	Bright White
Floor Load Transport	450# (F); 725# (R)
Floor Load Playing	700# (F); 475# (R)
Min. Required Floor Space Outside Court	130"

## BA898G T-Rex® Competition

Budget conscious programs who still desire the 8' safe play area found on our T-Rex Americana but have limited space behind the court end line and limited budgets will find T-Rex Competition the perfect choice. T-Rex Competition meets all NFHS equipment rules.

Designed with many of the same features as our Americana and International portables, Competition raises for play and lowers for transport and storage with the same extension spring counterbalance technology as its big brothers.

While designed for value, the competition backboard, direct beam mount Baseline™ 180° breakaway goal and DuraSkin® backboard padding are identical to other models and guarantee rigid, durable and safe play year after year.

Competition is the perfect system for small programs, high schools, rec centers or side courts that require the safety of an 8' safe play area but at a value price. Order BA898GFIBA for FIBA Level 2 Play.



Shown with  
Optional  
Lettering and  
Graphics



THUNDER



**NOTE: NOT WARRANTED FOR OUTDOOR USE.**

Forklift or dock required for delivery. Contact Bison for other off-loading options.



## BA895G T-Rex® Side Court

For some programs, the 5½' safe play setback of T-Rex Side Court is a great solution. The shorter extension still allows durable, rigid play but requires less room for storage, less space outside the court end line and is a perfect practice or recreational portable.

T-Rex Side Court has most of the key design features of its larger T-Rex Competition unit including the same glass backboard, DuraSkin backboard padding and spring assist technology but the reduction in safe play area, the substitution of our traditional BA35S breakaway goal and making the vibration deadening device, beam padding and rear hold down kit optional make a standard T-Rex Side Court cost up to 10% less than T-Rex Competition.

**NOTE: NOT WARRANTED FOR OUTDOOR USE.**

SIDE COURT GAME STATS	
Safe Play Area at 10'	66" (See Note)
Glass Backboard Size	42" x 72"
Breakaway Rim	BA35S
Beam Size	4" Sq.
Ballast Weight	800#
Total Weight	1900#
Padded Base Dimension	40"(w) x 74"(l)
Total 8" (d) x 2" (w) Wheels	2 (F), 2 (R)
Stored Dimensions	76"(w) x 130"(l) x 78"(h)
Deadlock Device	Optional
Beam Padding	Included
Rear Hold Down	Optional
Backboard Padding	17 colors
Base Padding (16 colors)	2" Thick Sewn
Base Color	Bright White
Floor Load Transport	350# (F); 600# (R)
Floor Load Playing	575# (F); 375# (R)
Min. Required Floor Space Outside Court	100"



Shown with  
Optional  
Lettering

Note: Safe Play Area decreases significantly as the rim is lowered for play.



## T-Rex Zip Crank Portables

To order T-Rex BA898G with a Zip Crank Height Adjuster (see page 8 for details) order BA898GZC.

To order T-Rex BA895G with a Zip Crank Height Adjuster (see page 8 for details) order BA895GZC.



Bison's popular Competition™ and Side Court™ T-Rex Portables just got better. Lowering to playing position and preparing for transport is now just an ergonomic hand lever movement away. Removable handle lowers wheels for transport and retracts wheels for play with entire portable resting securely on front floor friendly feet.





# T-REX® PORTABLE BASKETBALL SYSTEMS

**BISON IS THE EXCLUSIVE NFHS PARTNER FOR BASKETBALL EQUIPMENT**



Forklift or dock required for delivery. Contact Bison for other off-loading options.



Shown with Optional Lettering

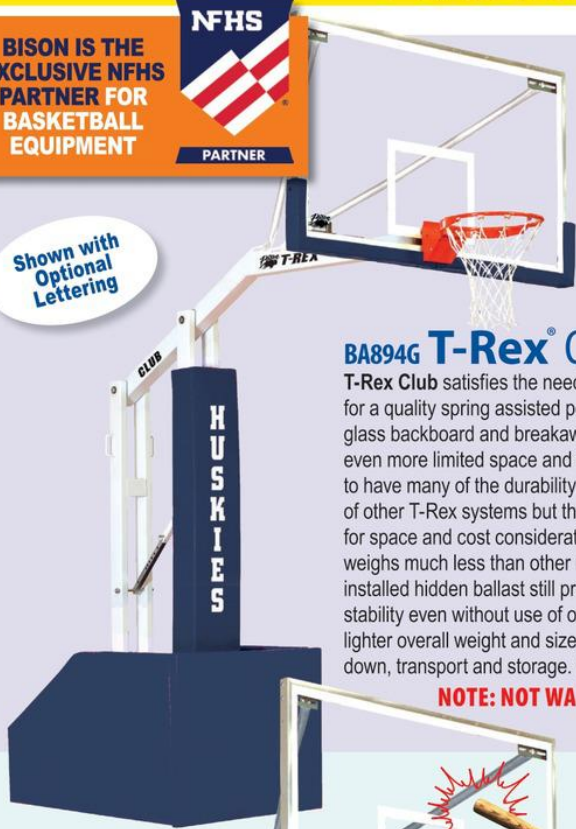

## BA894G T-Rex® Club

T-Rex Club satisfies the need of many programs looking for a quality spring assisted portable system with a full size glass backboard and breakaway goal but are dealing with even more limited space and budgets. Club is designed to have many of the durability, stability and safety features of other T-Rex systems but the base has been downsized for space and cost considerations. While Club costs and weighs much less than other models, its 950# of factory installed hidden ballast still provides superior tip over stability even without use of optional rear hold downs. Its lighter overall weight and size allow easier set up, tear down, transport and storage. Not warranted for outdoor use.

**NOTE: NOT WARRANTED FOR OUTDOOR USE.**

Safe Play Area at 10'	54" (See Note)
Backboard Size	42" x 72"
Backboard Type	Glass
Breakaway Rim	BA35S
Beam Size	4" Sq.
Ballast Weight	950#
Total Weight	1700#
Padded Base Dimension	40"(w) x 60"(l)
Total 8" (d) x 2" (w) Wheels	2 (F), 2 (R)
Stored Dimensions	76"(w) x 124"(l) x 78"(h)
Beam Padding	Included
Rear Hold Down	Optional
Backboard Padding	17 colors
Base Padding (16 colors)	1" Thick
Base Color	Bright White
Front Levelers	Lead Screw
Min. Required Floor Space Outside Court	72"

Note: Safe Play Area decreases as the rim is lowered for play.

Glass or Unbreakable Polycarbonate

Shown with Optional Lettering

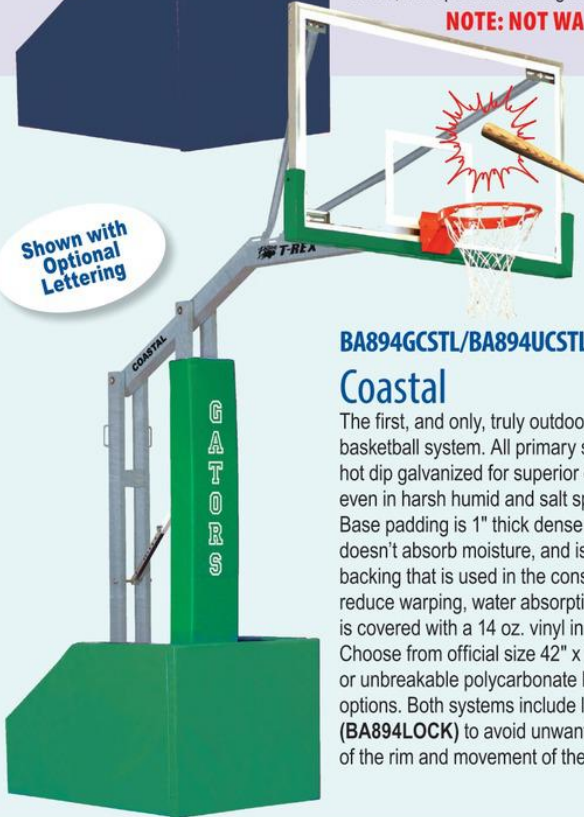

## BA894GCSTL/BA894UCSTL T-Rex® Coastal

The first, and only, truly outdoor durable T-Rex portable basketball system. All primary steel components are hot dip galvanized for superior corrosion resistance even in harsh humid and salt spray environments. Base padding is 1" thick dense polyethylene foam that doesn't absorb moisture, and is adhered to a non-wood backing that is used in the construction industry to reduce warping, water absorption, and rotting. Padding is covered with a 14 oz. vinyl in your choice of 16 colors. Choose from official size 42" x 72" glass BA894GCSTL or unbreakable polycarbonate BA894UCSTL options. Both systems include locking mechanisms (BA894LOCK) to avoid unwanted raising and lowering of the rim and movement of the base.

Safe Play Area at 10'	54" (See Note)
Backboard Size	42" x 72"
Backboard Type	Glass or Polycarbonate
Breakaway Rim	BA35S
Beam Size	4" Sq.
Ballast Weight	950#
Total Weight	1700#
Padded Base Dimension	40"(w) x 65"(l)
Total 8" (d) x 2" (w) Wheels	2 (F), 2 (R)
Stored Dimensions	76"(w) x 124"(l) x 78"(h)
Beam Padding	Optional
Rear Hold Down	Optional
Backboard Padding	BA68U, BA72U
Base Padding (16 colors)	1" Thick
Base Finish	Galvanized
Front Levelers	Lead Screw
Min. Required Floor Space Outside Court	72"

Forklift or dock required for delivery. Contact Bison for other off-loading options.



### Standard Features on T-Rex Club & T-Rex Coastal Portables



Hidden Ballast Compartment



Ratchet Style Front Foot Leveling



Folds For Easy Storage



Play at Lower Rim Heights



Unbreakable Polycarbonate Backboard (BA894UCSTL)



Galvanized Base on Coastal Portables



800-247-7668



www.bisoninc.com





# T-REX® PORTABLE BASKETBALL SYSTEMS

## WARNING!

All Sport systems require installation of 20 4" x 8" x 16" solid concrete cap blocks prior to use. The ballast tray is designed specifically for use of the specified ballast. Failure to install the specified weight could result in serious player injury and invalidate all warranties. While the specified blocks are available at most lumber or home centers for a nominal cost, Bison can ship ballast package BA893BLST for an additional cost.



One Person Setup



Easy To Use Transport Dolly



Proven Counterbalance Spring Technology



Smooth Rim Height Adjustment



Shown with Optional ABC50 Logo

## BA893G T-Rex® Sport

T-Rex Sport...is the perfect blend of spring assisted counterbalanced technology, and easy rim height adjustment from 10' down to 7½'. Unlike other spring assist portables that move the backboard closer to the base when the rim is lowered, T-Rex Sport allows rim height adjustment while the base is in the play position without significantly sacrificing safe play area under the basketball when young players are using at lowered rim heights. The base is fully padded with 2" thick polyurethane foam on sides and on the front to a height of 72".

At official 10' rim height, the approximate safe play area is 50" and 42" at 7½'. When lowered for transport and storage, the total storage height is 76" to fit through most storage room double doors or garage doors.

Choose from 36" x 60" clear glass (BA893G), 36" x 60" smoked glass (BA893GS), or 36" x 60" clear unbreakable polycarbonate backboard (BA893U).

Base padding is covered with 16-ounce black leather grain vinyl, but can be ordered in other colors (see page 102) at an additional cost using BA893UP for orders of 2 or more.

Rear enclosed ballast box holds 20 each 4" x 8" x 16" solid cap blocks (customer supplied).

**NOTE: NOT WARRANTED FOR OUTDOOR USE.**

## BA893BLST T-Rex® Sport Ballast Kit

20 each 4" x 8" x 16" solid concrete cap blocks to properly eliminate tipover on all T-Rex Sport Goals. Approx. 660#.

SPORT GAME STATS	
Safe Play Area at 10'	50", 46" at 8'
Backboard Size	36" x 60"
Backboard Options	Clear Tempered Glass BA893G Smoked Tempered Glass BA893GS Unbreakable Clear Polycarbonate BA893U
Breakaway Rim	BA32
Beam Size	4" Sq.
Ballast Weight	660#
Total Weight	1510#
Padded Base Dimension	42"(w) x 51"(l)
Stored Dimensions	62"(w) x 112"(l) x 77"(h)
Backboard Padding	Included
Base Padding	2" Thick Polyurethane with Black 16oz. Vinyl Cover (other colors available at an additional charge)
Base Color	Bright White
Min. Required Floor Space Outside Court	54"

## BA980P ZipCrank Height Adjuster for T-Rex® Portables

Increase your T-Rex portable rim height flexibility with the addition of a ZipCrank Goal Height Adjuster system...Do you wish you didn't need to lose safe play area under the basket as you lower the rim on your T-Rex portables? Now you can adjust rim height on any T-Rex portable from 8' to 10' without major loss of distance from the face of the backboard to the front of the base.

Rim height is easily adjusted straight up and down with an awning style hand crank.

This feature is perfect for facilities that regularly need lowered rim heights for young players, but that don't want to sacrifice safe play area common with most portables.

BA980P must be added at time of order. Do not order without contacting Bison for technical assistance.





## Full Color Graphics

Your T-Rex portable basketball systems (or your Arena Portable volleyball systems) can be not only highly functional, they can also promote team and school spirit, promote a sponsor, or inspire team greatness, with Bison full color printed graphic padding options. There is no limit to the creative designs that can be added to front and side protective base padding. Add **ABC50** to your order for full color graphics. Bison's talented art staff can work from your rough concept, from your finished artwork, or provide you ideas to choose from. Once design is finalized, Bison's 6 color ultraviolet ink cure process will create a vivid and durable image that won't peel, crack, or fade, even after years of indoor use.



## BA898GRP Optional Rear Padding

In large facilities with many courts, efficient court layout sometimes calls for portable bases being located side-by-side facing opposite directions with the rear of one base exposed to players on the adjacent court • **BA898GRP** provides protection for players who might contact the rear of the adjacent base • Padding is easily removable without tools when portables are moved • Padding is 2" thick with a vinyl covering to match your portable padding.



## SCBK2 Folding Shot Clock Bracket

This sturdy bracket is specifically designed to allow installation of beam mounted shot clock brackets on T-Rex portables • Folds to the rear to allow passage through doorways and halls when T-Rex is collapsed for storage in off season.



## SCBK6 Rear Shot Clock Bracket

Two-sided rear shot clocks have gained in popularity...this bracket will mount most rear shot clocks to most manufacturers' portables • Easy angle adjustment • May require minor field modification on some portables or with some rear shot clocks • 5-Year limited warranty.



## BA898HD Optional Rear Hold-Down Kit

For all T-Rex portables...Meets NCAA and High School Federation rules requiring rear floor attachment for competition portable goals • Kit includes brass floor plate, threaded floor anchor, eyebolt and turnbuckle to attach to built-in eye on rear of all T-Rex portables • Included standard with T-Rex Competition, Americana and International portables • Adds a measure of stability and safety • One required per goal.



800-247-7668



[www.bisoninc.com](http://www.bisoninc.com)





# PORTABLE/ADJUSTABLE BASKETBALL SYSTEMS

## Max™ Portable Basketball Systems

Maximum versatility, maximum safety, maximum playability and maximum value...makes one of our Max portable systems just right for your facility •

Choose Super Max with 60" tempered glass backboard and 50" safe play area, Glass Max with 54" tempered glass backboard and 30" safe play area or Acrylic Max™ with 48" acrylic backboard and 30" safe play area.

No matter which Max you choose, you'll get features not found on similar systems offered by other manufacturers including:

- Infinite Goal Height Adjustment from 5' to Official 10'
- Durable Breakaway Goals
- Black Front Base and Pole Padding. Other Colors Available on Orders of 2 or more at an Additional Cost using **BA853UP**. (see page 102)
- Over 850# of Hidden, Customer Supplied Ballast to Eliminate Tip Over Risk (see **BA853BLST** below)
- Ballast is Totally Enclosed and Safety Padded
- Single-Lever Lift Handle to Allow Easy Transport and Set Up
- Goal Mounts Through Backboard Directly to Structure to Eliminate Backboard Stress
- Non Marking Transport Wheels
- When Lowered, Fits through 78" High Double Doors for Storage
- Standard Black Backboard Edge Padding on Super Max and Glass Max



Smooth Operating Right Angle Crank

**New!**

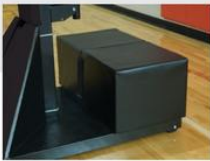

Padded Weight Box Cover

Special liftgate delivery charge or extreme manual lifting required if dock/forklift not available.

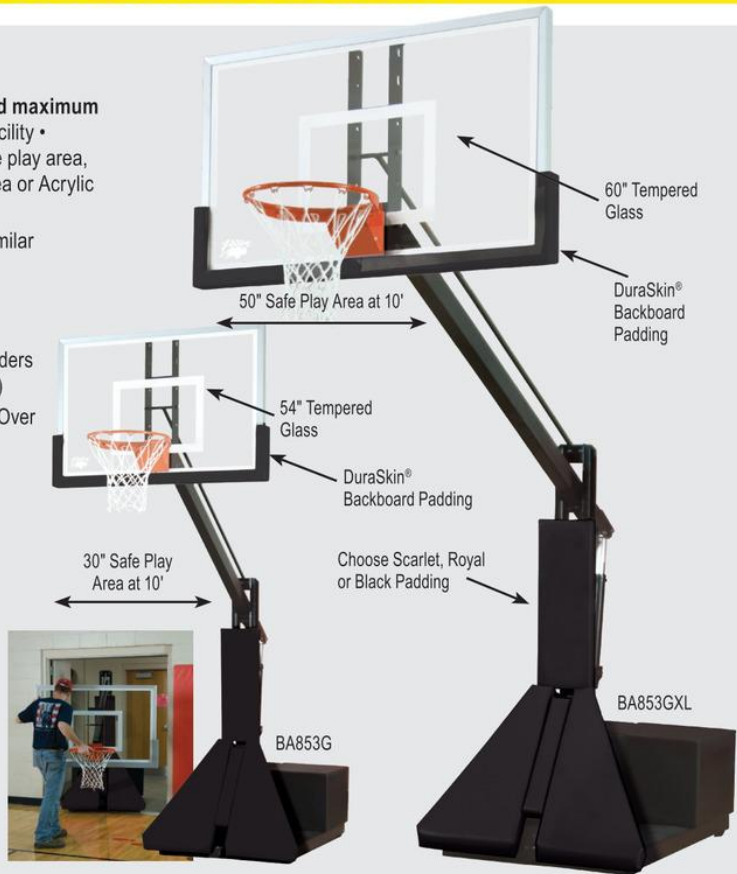

	BA853A Acrylic Max	BA853G Glass Max	BA853GXL Super Max
Backboard Size	32" x 48"	36" x 54"	36" x 60"
Backboard Type	Acrylic	Glass	Glass
Goal Type	BA29JR	BA32	BA32
Backboard Padding	N/A	Standard	Standard
Total System Weight (with ballast)	1400#	1450#	1550#
Customer Supplied Ballast Weight	850#	850#	850#
Padded Base Size	42" (w) x 50" (l)	42" (w) x 50" (l)	42" (w) x 50" (l)
Total Stored Dimensions	48" (w) x 128" (l) x 78" (h)	58" (w) x 128" (l) x 78" (h)	64" (w) x 139" (l) x 78" (h)
Setback at	10' - 30" 9' - 40" 8' - 48"	10' - 30" 9' - 40" 8' - 48"	10' - 50" 9' - 60" 8' - 68"
Lowest Playing Height	5'	5'	5'
Min. Required Floor Space Outside End Line	N/A	N/A	54"
Warranties			
Base	5-Year Limited	5-Year Limited	5-Year Limited
Padding	2-Year Limited	2-Year Limited	2-Year Limited
Goal	1-Year Limited	1-Year Limited	1-Year Limited
Backboard	2-Year Limited	10-Year Limited	10-Year Limited

### BA853BLST Max™ Ballast Kit

Twenty-five 4" x 8" x 16" solid concrete cap blocks to properly eliminate tip over on all Max portable goals. Approx. 850#.

#### WARNING!

All Max systems require installation of 25 4" x 8" x 16" solid concrete cap blocks prior to use. The ballast tray and padded safety cover are designed specifically for use of the specified ballast. Failure to install the specified weight could result in serious player injury and invalidate all warranties. While the specified blocks are available at most lumber or home centers for a nominal cost, Bison can ship ballast package BA853BLST for an additional cost.

### Portable Rear Hold-Down Kits

Additional stability...Add stability to any Bison Max portable system with these floor anchors and brackets.



#### BA800 For Concrete, Tile or Synthetic Floors

Kit includes two each of VB25 floor anchors and brackets...Requires core drilling into existing floors.

#### BA800FL For Floating Wood Floors

Kit includes two each of VB25FL floor anchors and brackets for floating floors...Requires core drilling and routing into existing floors.





# PORTABLE/ADJUSTABLE BASKETBALL SYSTEMS



## Club Court™ Portable Basketball Systems

Choose **Super Glass Club Court** with 54" tempered glass backboard and 48" safe play area, **Acrylic Club Court** with 48" clear acrylic backboard and 36" safe play area, or **Graphite Club Court** with 48" molded graphite fan backboard and 36" safe play area.

All Club Court portables come standard with the following features:

- Spring Assisted Infinite Goal Height Adjustment from 6½' to Official 10'
- 1½" Thick, Black Padded Front Base and Riser
- Easy Flip Down Front Panel for Transport
- Fully Enclosed Oversized Ballast Enclosure to Hold Customer Supplied Ballast (see chart and **BA833BLST** below)
- Goal Mounts Directly to Extension Arm, Eliminating Stress on Backboard During Play
- Easily Folds Without Tools for Movement Through 78" High Double Doors
- Order **ABC52** for Optional Front Pad Lettering (see page 102)
- Easy-to-Read Goal Height Indicator Labels
- Non Marking Transport Casters



	BA832 Graphite	BA833 Acrylic	BA833XL Super Glass
Backboard Size	36" x 48" Fan	32" x 48" Rectangle	36" x 54" Rectangle
Backboard Type	Molded Graphite	Acrylic	Glass
Goal Type	BA26	BA29JR	BA32
Total System Weight (with ballast)	840#	855#	1400#
Customer Supplied Ballast Weight	425#	425#	850#
Padded Base Size	29" (w) x 41" (l)	29" (w) x 41" (l)	34" (w) x 46" (l)
Total Stored Dimensions	48" (w) x 78" (l) x 78" (h)	48" (w) x 78" (l) x 78" (h)	54" (w) x 84" (l) x 78" (h)
Setback at	10' - 36" 9' - 32" 8' - 28"	10' - 36" 9' - 32" 8' - 28"	10' - 48" 9' - 44" 8' - 40"
Lowest Playing Height	6½'	6½'	6½'
<b>Warranty</b>			
Entire System	1-Year Limited	1-Year Limited	1-Year Limited



Special liftgate delivery charge or extreme manual lifting required if dock/torklift not available.



### BA833BLST Club Court Ballast Kit

Approximately 425# (11 each) of solid concrete 4" x 8" x 16" cap blocks to properly eliminate tip over on all Club Court portable goals. Order one **BA833BLST** for each **BA832** and **BA833** • Order two for each **BA833XL**.

### WARNING!

Club Court portables are designed for customer installation of solid concrete cap blocks prior to use. Failure to install the specified ballast could result in serious player injury and invalidation of all warranties. While specified blocks are available at most lumber or home centers for a nominal cost, Bison can ship ballast package **BA833BLST** for an additional cost.



800-247-7668



www.bisoninc.com





# PORTABLE/ADJUSTABLE BASKETBALL SYSTEMS

## Playtime™ Elementary Portables

Playtime complete basketball standards roll in and out of the gym or multipurpose room with ease...Formed steel base provides sturdy foundation for tubular structure

- Telescoping structure easily adjusts goal height from 8' to 6½' in 6" increments
- White powder coated finish
- Choose 36" x 48" fan-shaped backboard of molded graphite or 32" x 48" rectangular backboard of clear acrylic
- Official size, 5/8" solid steel goal
- Playtime systems are for physical education, elementary school or shooting practice only and are not intended for aggressive competitive play
- **Safe Stuff structure padding included**
- Lower base trim protects your floor from damage
- Some assembly required
- Factory installed 100# ballast hidden in base.



Special liftgate delivery charge or extreme manual lifting required if dock/torklift not available.



Playtime	BA803	BA803A
Backboard Size	36" x 48"	32" x 48"
Backboard Type	Molded Graphite	Clear Acrylic
Goal Type	BA26	BA26
Total System Weight (with ballast)	330#	350#
Ballast Weight	Built-in	Built-in
Total Stored Dimensions	48" x 48" x 84"	48" x 48" x 84"
Lowest Playing Height	6½'	6½'
<b>Warranty</b>		
Entire System	1-Year Limited	1-Year Limited



## PORTABLE GAME BASES AND ACCESSORIES

### PB130 Portable Game Base



Indoors or outdoors, these portable weighted bases support a wide range of PE games...Use for volleyball, badminton, pickle ball, tennis, tetherball, paddle tennis, hoop games, jump rope or other creative games

- 24" diameter royal blue powder coated bases are factory weighted
- Durable non-marking wheels and molded urethane bottom ring protect floors during transport and use
- Includes 1¼" diameter x 10' galvanized steel upright
- Order nets, base padding and other accessories separately
- Includes one pair of game attachment collars
- 1-Year limited warranty.



**BM10N Badminton Net**  
Official 20' x 2½' size.



**SVB08 Volleyball Net**  
Official 32' x 36" size with fluorescent top tape for maximum visibility.



**PB100BP Base Padding**

Improve safety with this specially designed pad that covers 360° around the PB130 portable game bases...1" thick foam with sewn cover in black vinyl • Hook and loop attachment.

### PB050 Universal Portable Base

Versatile portable base...This base can be used for a variety of purposes including low cost PE net games

- Base can be weighted with optional SC50B ballast bag
- 12" x 16" base has floor friendly feet
- Post is 60" high
- Net not included
- 90-day limited warranty.



PB050

### PB150BB Basketball Accessory

Easy slip-on ring creates a goal for elementary shooting games...15" diameter ring with net hooks

- Adjusts to any height for thumbscrew tightening
- Ring and net only, order base with pole separately.





# IN-STOCK WALL MOUNT STRUCTURE PACKAGES



## Stationary and Side Fold

Complete wall mount structure packages  
in-stock for immediate delivery.

**CAUTION!**  
Wall structure purchaser assumes all mounting liability. See BACK PAGES OF CATALOG for safety Warning.

### Stationary

Structures adjust backboard face anywhere from 48" to 144" from wall at time of installation...Easy-to-order and install telescoping structures • Available for immediate delivery • Extra heavy steel tubular design with silver powder coated finish • Packages include structure, wall boards, support chains, Unbreakable 42" x 72" glass backboard, breakaway goal, DuraSkin backboard padding (choose from 17 colors), instructions and all mounting hardware except that required to anchor wall boards to wall • If you need rim height adjustability see page 24 for optional goal height adjusters • **Lifetime limited warranty on wall mount structures.**

**IN-STOCK**

### Side Fold

Swing left or right for storage close to wall without tools or ladders...Structures position backboard face anywhere from 48" to 144" from wall at time of installation without field modification • Available for immediate delivery • Extra heavy, steel tubular design with silver powder coated finish • Heavy, solid steel, machined pivot bushings with 5/8" grade 5 pivot bolts (not just a hole drilled into tubing!) • Slotted mounting brackets for fine tuning goal height • Packages include structure, wall boards, support chains, Unbreakable 42" x 72" glass backboard, breakaway goal, DuraSkin backboard padding (choose from 17 colors), release hook, instructions and all mounting hardware except that required to anchor wall boards to wall • If you need rim height adjustability see page 24 for optional goal height adjusters • **Lifetime limited warranty on wall mount structures.**

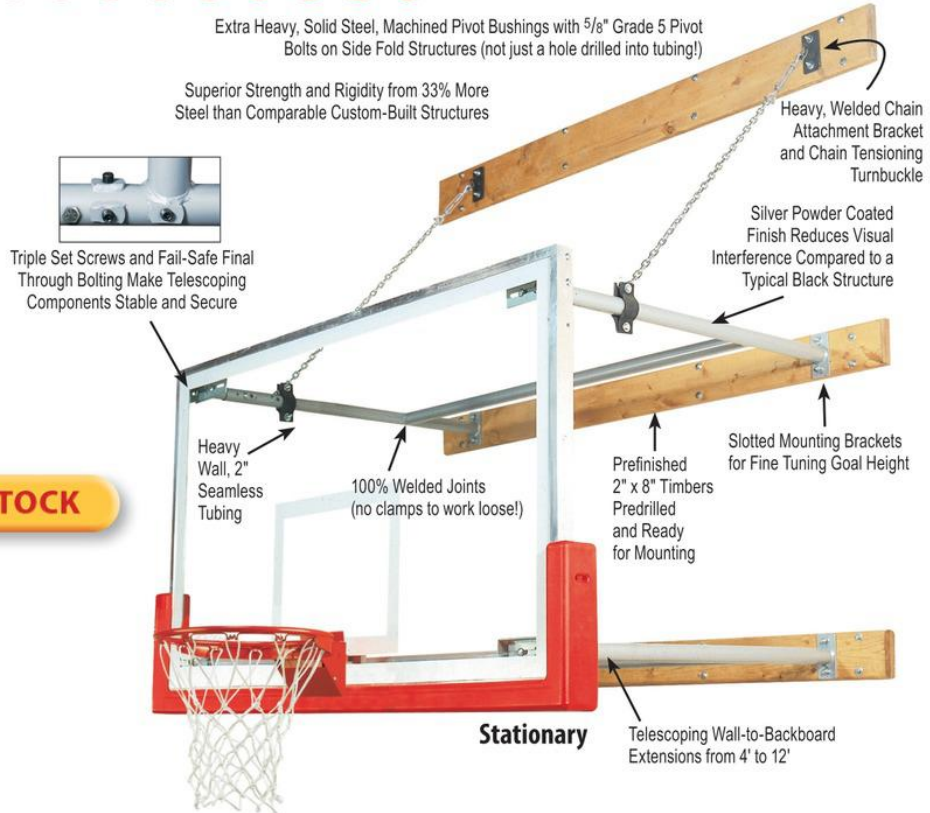

Side Fold

**Telescoping Structures for Fail-Safe Measuring... There is no need to compute exact extension requirements before ordering wall mounted structures from Bison. Our structures are specially designed to allow adjustment within a specified range at installation. You'll also avoid costly field modifications caused by measurement mistakes.**

Package Model #	Wall-to-Backboard Extension Range	Components Included
<b>STATIONARY</b>		
PKG46STRG	48" to 72"	BA42XL Official Unbreakable Short Glass Rectangular Competition Backboard, BA35S ProTech Competition Breakaway Goal, BA68U DuraSkin Padding
PKG68STRG	72" to 96"	BA42XL Official Unbreakable Short Glass Rectangular Competition Backboard, BA35S ProTech Competition Breakaway Goal, BA68U DuraSkin Padding
PKG82STRG	96" to 144"	BA42XL Official Unbreakable Short Glass Rectangular Competition Backboard, BA35S ProTech Competition Breakaway Goal, BA68U DuraSkin Padding
<b>SIDE FOLD</b>		
PKG46SFRG	48" to 72"	BA42XL Official Unbreakable Short Glass Rectangular Competition Backboard, BA35S ProTech Competition Breakaway Goal, BA68U DuraSkin Padding
PKG68SFRG	72" to 96"	BA42XL Official Unbreakable Short Glass Rectangular Competition Backboard, BA35S ProTech Competition Breakaway Goal, BA68U DuraSkin Padding
PKG82SFRG	96" to 144"	BA42XL Official Unbreakable Short Glass Rectangular Competition Backboard, BA35S ProTech Competition Breakaway Goal, BA68U DuraSkin Padding

Bison strongly recommends the installation of BA950LR Aut-O-Loc™ Safety Belt on all wall mounted structures, especially when installed above bleachers.

**FIBA APPROVED EQUIPMENT**

**LEVEL 2**

**BISON STATIONARY AND SIDE FOLD UNITS ARE APPROVED FOR FIBA LEVEL 2 PLAY UP TO A 89" EXTENSION FROM THE WALL. ADD BAFIBA TO ORDER AT NO EXTRA COST TO COMPLY.**



800-247-7668



www.bisoninc.com





# IN-STOCK SHOOTING STATION™ PACKAGES

## CAUTION!

Wall structure purchaser assumes all mounting liability. See PAGE 101 for Safety Warning.



PKG500

12" to 48" Safe Play Area

Bison Shooting Stations provide a wall mount system to match any budget and level of need. Prior to purchase, verify that your wall is suitable in construction, size and layout to support the package weight and stress from use.

### Field Modifiable Wall Mounted Structure Packages

These complete kits provide all the necessary components (except wall mounting fasteners) to install a rigid, durable basketball system to the wall of your existing facility...Choose from 1'-4' or 4'-8' extensions and different backboard options shown in chart below. Cut and drill extension tubes at desired extension length • See page 21 for optional backboard padding and page 24 for optional goal height adjusters • 5-year warranty on structures.

Package Model #	Wall to Backboard Extension Range	Backboard	Breakaway Goal	Optional Backboard Padding
PKG14STFS	12" to 48"	BA495 Fan Steel	BA32	N/A
PKG48STFS	48" to 96"	BA495 Fan Steel	BA32	N/A
PKG14STRG	12" to 48"	BA42XL 42" x 72" Glass	BA35S	BA68U
PKG48STRG	48" to 96"	BA42XL 42" x 72" Glass	BA35S	BA68U
PKG500	12" to 48"	BA407G 42" x 54" Glass	BA35S	BA54U-BK

**NOTE: OPTIONAL BACKBOARD PADDING IS STRONGLY RECOMMENDED ON ALL RECTANGULAR BACKBOARDS.**

### PKG650 Adjustable Height Glass Shooting Station™

Tempered glass backboard...Same heavy-duty wall structure and wall mounting boards as PKG600 below except includes 54" x 42" unbreakable side court tempered glass backboard (BA407C) for competition look and ball rebound • Approximately 36" extension at 10' rim height • Adjustable from 8' to 10' • Official size breakaway goal (BA32) with 1-Year limited warranty • 10-Year limited warranty on structure • **Unconditional lifetime warranty on backboard.**

### PKG675 Official Adjustable Height Glass Shooting Station (not shown)

Same structure and rim as PKG650 above but with official size 72" x 42" "Unbreakable" (BA42XLC) glass backboard • **Unconditional lifetime warranty on backboard.**



36" Safe Play Area at 10'



PKG600

36" Safe Play Area at 10'

### PKG600 Adjustable Height Steel Shooting Station™

Convenient, cost effective system for players of all ages...All the components necessary to mount a durable, playable, institutional quality fan-shaped steel backboard and official size institutional breakaway goal to a structure that will allow goal height adjustment from 10' to 8' • Removable hand crank allows easy adjustment without ladder • Safe play area is approximately 36" at official 10' goal height and 40" at 8' • Use of 2" x 8" wall boards for load spreading wall attachment is superior to similar systems where the steel is mounted directly to the wall • All steel structure is heavy gauge tube with a 1/8" minimum wall thickness and silver powder coated finish • All pivot points are 1/2" diameter • Customer provides wall mounting hardware • 10-Year limited warranty on backboard and structure • 1-Year limited warranty on goal.







## CAUTION!

Wall structure purchaser assumes all mounting liability.  
See PAGE 101 for Safety Warning.

When traditional competition wall structures are more than your facility requires, choose from fixed height or adjustable packages with steel, glass, molded graphite, acrylic or smoked backboard options.

### PKG300 ZipCrank™ Adjustable Shooting Station™

Hand crank moves this 54" x 36" glass backboard with ease... Easy-to-operate removable hand crank adjusts goal height from official 10' to as low as 7½' for play by kids of all ages • Official size breakaway goal and direct goal mount design make backboard virtually unbreakable during normal play • Steel structure mounts to wall by means of three load spreading struts • Customer provides wall mounting anchors • Order PKG300S for 54" x 36" smoked glass backboard • Order PKG350 for larger 60" x 36" clear glass backboard • Mounts indoors/outdoors • 30" safe play area at 10' • 5-Year limited warranty on board and structure.



PKG300S



PKG300

30" Safe Play Area at 10'



PKG275

### PKG275 QwikChange™ Acrylic Shooting Station™

For the look of a professional court at a budget price... Official size flex goal raises and lowers with ease on this system that features a 32" x 48" clear rectangular backboard • Order PKG275S for smoked acrylic backboard • Direct mount goal design • No ladders or tools • 7½' to 10' goal height adjusts from the playing surface • Entire system mounts easily to the wall with two load spreading struts • Customer supplies suitable wall mounting hardware • Mounts indoors/outdoors • 22" safe play area at 10' • 1-Year limited warranty on system.

22" Safe Play Area at 10'



PKG275S



PKG250

22" Safe Play Area at 10'

### PKG250 QwikChange™ Graphite Shooting Station™

Our lowest cost adjustable wall mount system... Move the goal height from 7½' to 10' in 6" increments with a broom handle from the floor • 36" x 48" molded graphite fan-shaped backboard and official size flex goal are direct mounted to the steel structure for superior backboard durability • QwikChange structure is attached to wall with two struts to spread load on wall • Customer provides wall mounting anchors • Mount indoors/outdoors • 22" safe play area at 10' • 1-Year limited warranty on system.



800-247-7668



www.bisoninc.com





BA42XL



BA42XLC

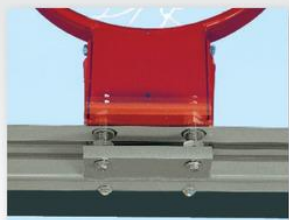

Rear Stabilizer Bar Eliminates Stress on Glass

## Unbreakable "XL" Glass Backboards

Built-in support structure absorbs over 98% of the stress from goal contact without transferring it to the glass... Goal is mounted "off glass" so even excessive hanging and abuse will not cause stress • Never again be concerned about the risk of injury or inconvenience of glass breakage • We are so confident of our "XL" design durability that for over 5-Years we have offered a \$250 installation reimbursement in addition to our unconditional replacement warranty without a single request for reimbursement • Every "XL" unbreakable backboard features a polished aluminum extrusion framework, glass cushioning gasket, high strength steel support structure, 1/2" tempered glass with fire impregnated bright white border and shooters square and unconditional lifetime warranty • All Bison glass backboards on this page are predrilled for quick installation of original DuraSkin backboard padding.

### BA42XL 42" Short Unbreakable "XL" Glass Backboard

The 42" x 72" short board version of our "XL" backboard line... This backboard has the industry standard 35 1/2" x 62" structure mounting design and 5" x 4" goal hole pattern to make upgrade retrofitting to any manufacturer's short board ceiling or wall mount structure foolproof • Unconditional lifetime warranty.

### BA42E Standard 42" Short Backboard

Excellent value...Meets or exceeds all NCAA and National High School Federation rules • Predrilled for original DuraSkin backboard padding • 42" x 72" x 1/2" tempered glass with fire impregnated, bright white border and shooters square • Polished aluminum framework • 36" x 62" structure and 5" x 4" rim mounting pattern • 5-year limited warranty.

### BA48XL 48" Tall Unbreakable "XL" Glass Backboard

Same as BA42XL except 48" x 72" size...With 42" x 62" structure mounting pattern and 5" x 5" goal mounting pattern • Compatible with all manufacturer's tall board structures • BA48XL is the only unbreakable 48" backboard in the industry and is the perfect solution to upgrading old traditional 48" glass boards that are now in use in thousands of gyms across the country • Unconditional lifetime warranty.



### BA48 Standard 48" Tall Backboard

Traditional size, improved quality...This 48" x 72" board is a common fixture in gyms across the US and meets all appropriate rules for competition play • Board features 42" x 62" structure mounting pattern and 5" x 5" goal mounting pattern and will replace virtually any manufacturer's original tall glass backboard • 5-year limited warranty.

See page 97 for Backboard Drawings

### BA42XLC 42" Short Unbreakable "XL" Glass Conversion Backboard

Make the transition...Go from old fan-shaped steel or glass backboards to popular 42" x 72" rectangular glass backboards normally without modification or relocation of your existing wall or ceiling support structures • The 35" wide x 20" high rear structure mounting pattern is the standard in the industry for most fan-shaped gym backboards and structures • Unconditional lifetime warranty.

### BA48XLC 48" Tall Unbreakable "XL" Glass Conversion Backboard

This board is intended primarily for replacement of broken, existing 48" boards, mounted on fan style, wall or ceiling structures (35" x 20") common in older gyms...If you are replacing fan steel or glass backboards on both ends of a court, Bison recommends use of BA42XLC short backboards • Consult a Bison Product Specialist for selection of the right board for your application • Unconditional lifetime warranty.

Bison is confident you will never need to replace our Unbreakable XL boards – so confident that we offer a \$250 installation reimbursement for any broken BA42XL, BA42XLC, BA48XL or BA48XLC backboard replaced under Bison's lifetime warranty!

#### CAUTION!

Studies have demonstrated that 42" x 72" glass backboards reduce the risk of player injury from backboard contact. BA42XL and BA42XLC are recommended for all new installations and fan-to-rectangle conversions. Bison makes 48" x 72" backboards (BA48, BA48XL and BA48XLC) available ONLY for replacement applications.







See pages 90, 91, and 97  
for Backboard Drawings

## OTHER GYMNASIUM BACKBOARDS



BA407C

### BA407C Side Court Conversion Glass

The most affordable glass option available...This backboard is identical to our full-sized, official conversion backboard (BA42XLC) except its 42" x 54" size makes it the most affordable glass option for side courts, recreation centers or other applications where weight or size is a serious consideration • Play is identical except board has 9" per side less glass to hit on errant shot • ½" tempered glass • Simply remove an existing fan board and bolt up this board for a low cost conversion from steel fan to rectangular glass • **Unconditional lifetime warranty.**



BA44XL

### BA44XL Extended Life Competition Fan-Shaped Glass

Unbeatable warranty because this is a better built fan-shaped glass backboard...Built-in support strut greatly improves durability • Official size 39" x 54" • Cushioned ½" tempered glass • Heavy-duty aluminum framework • Fire-impregnated white border and shooter's square • Industry standard 20" x 35" mounting brackets • **Unconditional lifetime warranty.**



BA407G

### BA407G Unbreakable Glass Side Court

A scaled down version of our popular unbreakable 42" x 72" competition glass backboard...Reduced to 42" x 54" to reduce weight and cost without sacrificing features • Goal is mounted "off glass" so even excessive hanging will not cause stress • **Unconditional lifetime warranty.**



BA456

### BA456 Molded Rectangular Backboard

Suitable for indoor or outdoor use... official size 42" x 72" white injection molded resin with extensive rear ribbing for superior playability and durability • Mounts to typical 62" wide x 35½" high wall or ceiling suspended structures • Also compatible with Bison 4½" and 5⅞" diameter gooseneck outdoor pole systems • Steel mounting corner brackets • Orange shooter's square and border • 5" (w) x 4" (h) rim mounting pattern • 10-year limited warranty.



BA495

### BA495 Dura Steel™ Fan-Shaped

Steel, and lots of it, highlight this 39" x 54" official size backboard...Great option to replace rear mount side court backboards for greater durability • 12 ga. skin • Heavy-duty mounting support structure • 5" x 5" hole pattern • Standard 20" x 35" fan-type backboard mounting holes • Superior front mount design • Heaviest backboard of its type • White powder coated finish • Official orange shooter's square and border • 10-Year limited warranty.



800-247-7668



www.bisoninc.com

17





# COLLEGE/HIGH SCHOOL BREAKAWAY GOALS



No two programs are alike and Bison offers the widest range of breakaway goal options on the market. All Bison breakaway goals are designed with durability, player safety and consistent ball rebound in mind. Most Bison breakaways meet NCAA rules regarding rebound elasticity testing. Regardless of which Bison breakaway is right for you, count on Bison to provide quality at a price that meets your needs and budget.

**The ONLY true 180° Breakaway Goal with a Positive Lock Release Mechanism!**

## Baseline™ 180° Breakaway Goals

From the left baseline, right baseline, down the lane or any angle in between, Baseline will provide consistent breakaway pressure even during the most aggressive slam dunk action...This is the most technologically advanced breakaway goal available today with the ring assembly floating on 13 hardened chromium steel ball bearings for smooth flexibility from any direction • Pressure release mechanism is field adjustable to insure the preferred feel and adherence to NCAA ring testing rule for the life of the goal • Meets National High School Federation and NCAA standards • Includes anti-whip net and mounting hardware.

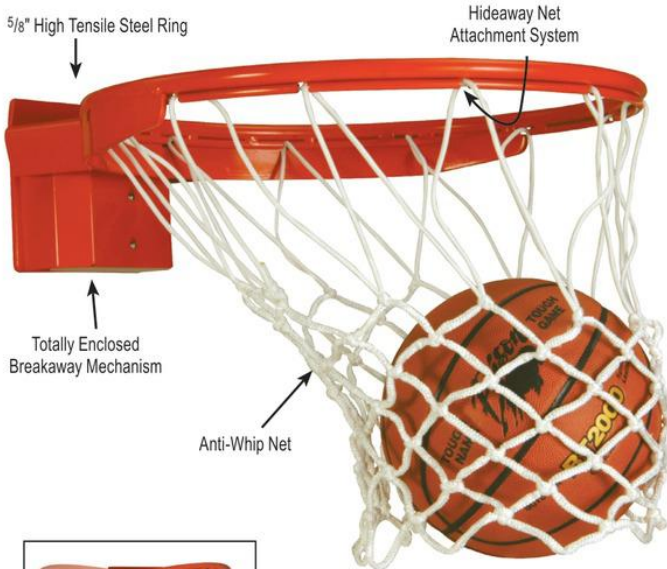

Meets **NCAA Rule** regarding rebound elasticity

### BA3180S Baseline™ Collegiate 180°

For 42" x 72" backboards...The preferred goal to use on all short 42" glass backboards at any level of play • Four-year repair or replacement warranty.

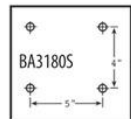

### BA3180T Baseline™ Universal Prep 180°

Universal board mounting design...Same mechanism as Collegiate above but fits both 48" x 72" and 42" x 72" glass boards • Use at all levels of play • 2-Year repair or replacement warranty.

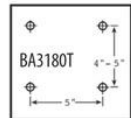

**Now with Popular Hideaway Net Attachment**

## BA35E Elite Plus Breakaway

Bison Elite is now even better...Always one of our most popular breakaway goals for high school and college play, we now include our **super safe and durable hideaway net attachment system** previously found only on our Baseline 180° Breakaway • Other features include safety padded cover plate, AcuFlex™ adjustable tension release mechanism, 4-point lubrication system and extra heavy, fully welded 1/4" rim support and antiwhip net • Elite Plus mounts to any 42" or 48" high glass backboard with hardware included and meets all National High School Federation and NCAA standards. 5-Year limited warranty.

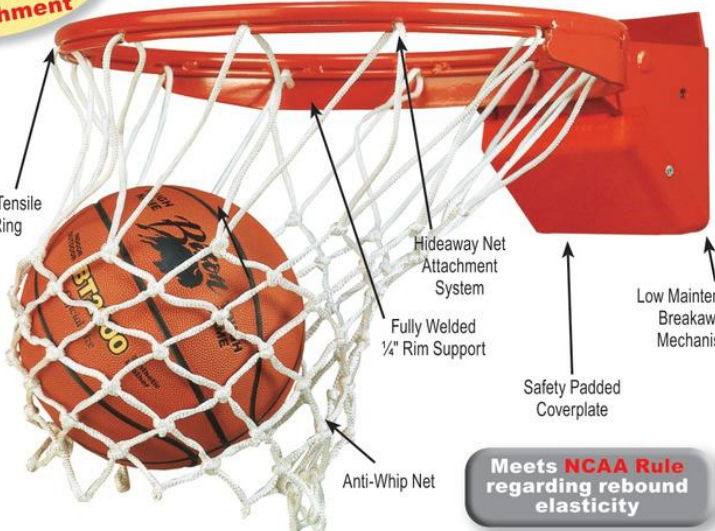

Meets **NCAA Rule** regarding rebound elasticity



**AcuFlex™ Adjustable Tension Breakaway Mechanism**



**Hideaway Net Attachment**





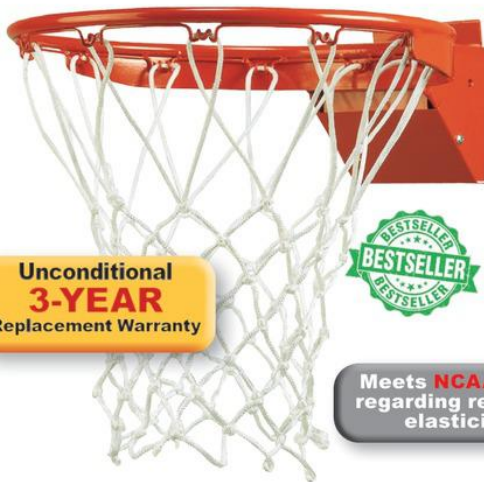

**Unconditional  
3-YEAR  
Replacement Warranty**



Meets **NCAA Rule**  
regarding rebound  
elasticity

## BA35 ProTech™ Breakaway

Bison's original breakaway goal is still the best value...Heat treated ball and socket, positive lock mechanism provides excellent rebound consistency over the life of the goal • ¼" rim support • Simple, maintenance-free design • Steel coverplate • Backplate fits all hole patterns on 42" and 48" rectangular and fan-shaped glass backboards • Continuous netlocks • Meets National High School Federation and NCAA standards • Includes mounting hardware and competition net • Unconditional three-year replacement warranty.



## BA35S ProTech™ Breakaway for 42" Short Backboards

For 42" glass backboards only...Same features as BA35 above except rim mounting hole pattern is 5" x 4" only • Results in bottom of backplate being approximately 1" higher on backboard • Order BA35STT for same rim but with Hideaway net lock system • Unconditional three-year replacement warranty.



**1-YEAR  
Limited Warranty**

Meets **NCAA Rule**  
regarding rebound  
elasticity

## BA34 TruFlex™ Breakaway

**Economical yet durable...**Meets or exceeds NCAA and National High School Federation standards • Same breakaway mechanism as Bison's BA35 ProTech goal • Steel coverplate • Backplate mounting pattern fits 42" and 48" high glass backboards • Includes competition net and mounting hardware • 1-Year limited warranty.

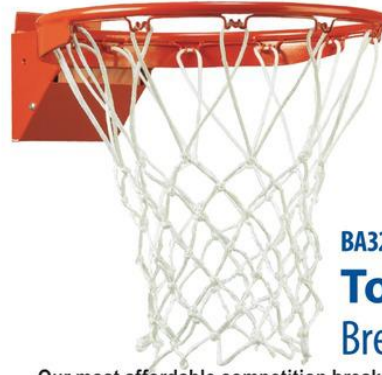

## BA32XL Hang Tough™ Breakaway

**Our most affordable competition breakaway goal...**Same heavy-duty construction as ProTech but with simplified breakaway mechanism that provides consistent and long life for programs at all levels • Universal backplate • Meets National High School Federation standards • Includes competition net and mounting hardware • 90-day limited warranty.



## BA32 Heavy-Duty Side Court and Recreational Flex Goal

**An affordable flex goal that can take heavy use and abuse...**Simple, low-maintenance design can be used indoors or outdoors • 5/8" steel rim with 3/16" x 1 1/2" support • 15° deflection, auto return • Universal backplate mounts to all standard boards • Durable powder coated finish • Not recommended for interscholastic high school or collegiate play • Continuous netlocks • Order BA32S for backboards with 5" (w) x 4" (h) rim hole pattern • Includes mounting hardware and nylon net • 1-Year limited warranty.



## BA32RXT FlexCourt™ Rear Mount Flex Goal

**Rear mount backboard protection with same proven mechanism as Bison's popular BA32 flex goal...**Fits all brands of rear mount steel backboards • Fully enclosed mechanism • Continuous netlocks • High tensile strength 5/8" rim • Includes mounting hardware and nylon net • 1-Year limited warranty.



800-247-7668



www.bisoninc.com

19





## OTHER BASKETBALL GOALS/NETS



BA27A

### BA27A Front Mount Super Goal

Excellent upgrade from standard front mount goals at a lower cost than double rim or breakaway goals...Full 5/8" computer designed reinforcing bar gives "super support" when a player suspends from the goal • Additional 5/8" brace strengthens the vulnerable joint between rim and backplate • Continuous netlocks • 1/4" thick **universal backplate** • Packaged two goals per carton • Includes mounting hardware and nylon net • 2-Year limited warranty.

BA27 (not shown)

### Standard Front Mount Competition Goal

Standard 5/8" steel rim...3/16" thick **universal backplate** for mounting to virtually all boards • 1/2" reinforcing bar, computer engineered for maximum support • Continuous netlocks • High-penetration continuous welded joints • Durable powder coated finish • Packaged two goals per carton • Includes mounting hardware and nylon net • 1-Year limited warranty.



BA21A

### BA21A Rear Mount Super Goal

Stronger than other manufacturers' standard rear mount goals...1/4" continuous welded support ring for over half of the rim circumference • Continuous netlocks • Heavy-duty 3/16" thick **universal backplate** mounts to all rear mount boards • Additional bracing at the backplate joint gives greater strength when player suspends from goal • Durable, baked powder coated finish • Packaged two goals per carton • Includes mounting hardware and nylon net • 2-Year limited warranty.



BA51H-PK

BA51H

### BA51H Anti-Whip Net

Competition grade, affordable price...Heavy braided nylon to reduce net whip common with lighter weight nets • Bright white • Use for competition or as upgrade to normal residential or playground string nets. **Note: Pink nets for non-competition indoor use only.**



BA35ARC

### BA35ARC Replacement Hideaway Net Attachment Cables

Nylon coated replacement cables are compatible with Bison BA3180S, BA3180T, BA35E and BA35STT Breakaway Goals • Sold in pairs.

## Removable Goal Adapters



### TR75 Removable Goal Package

Excellent option to add shooting stations to areas where a permanent goal would interfere with other activities...Official size goal slides easily into mounting track for quick on and off • Bracket can be mounted directly to wall or any flat surface • **Not suitable for slam dunk action** • Select wall mounting anchors (not included) based on wall construction • **Only adults should install or remove rims from bracket** • 1-Year limited warranty.



### BA26 Economy Goal

Our most affordable

goal... Affordable, yet features official size and powder coated finish • Multiple hole pattern fits many common, low cost backboards • Complete with nylon net and hardware • Use with TR74 and TR76 • **Note: Will not fit 5" x 5" and 5" x 4 1/2" mounting patterns** • 90-day limited warranty.



### TR74 Removable Goal Bracket

Includes wall bracket only... Same bracket as TR75 • Use with BA26 goal only • **Not suitable for slam dunk action** • Customer provides wall mount anchors • **Only adults should install or remove rims from bracket** • 1-Year limited warranty.



### TR76 Double Height Removable Goal Bracket

Allows 12" goal height adjustment... Wall bracket only • Mount goal higher for upper grades and lower for younger kids • Use with BA26 goal only • **Not suitable for slam dunk action** • Customer provides wall mount anchors • **Only adults should install or remove rims from bracket** • 1-Year limited warranty.



### TR70RP Rim Removal Pole and Bushing

Remove the rim from TR75, TR76, TR95 or TR96 without leaving the ground...Just screw pole into threaded bushing in rim and lift for safe and easy rim removal to avoid unwanted use, vandalism or theft • **For use by adults only.**







PARTNER

## OFTEN IMITATED — NEVER EQUALED



# BISON'S ORIGINAL DURASKIN

### BA68U DuraSkin® Indoor Backboard Padding

Are you old enough to remember when no one could jump high enough to contact the bottom of the backboard? Do you remember the old glue-on gray foam padding that constantly needed repair or reattachment with duct tape or replacement? If so, you also may remember that Bison revolutionized backboard safety padding in 1990 when it first introduced durable, bolt-on DuraSkin padding, now available in industry leading 17 colors.

DuraSkin mounts to all 72" wide glass backboards regardless of manufacturer with eight 1/4" bolts and its thick skin, durable inner foam and molded in steel inserts allow Bison to offer an industry leading **10-Year unlimited warranty**.

While other manufacturers have tried to copy DuraSkin, it remains the standard in the industry with over 150,000 sets sold since its 1990 introduction.

 Black	 Gray
 Kelly Green	 Purple
 Scarlet	 Navy
 Royal	 Vegas Gold
 Orange	 Cardinal
 Forest Green	 Brown
 Columbia Blue	 Burnt Orange
 Maroon	 Pink
 Gold	

Actual colors are not guaranteed to match printed catalog images.



Bison strongly recommends the installation of BA950LR Aut-O-Loc™ Safety Belt on all wall mounted structures, especially when installed above bleachers.

### BA950LR Gym Overhead Aut-O-Loc™ Safety Belt

Protect fans, players, floors and bleachers from damage if any overhead apparatus fails due to improper installation, maintenance or other failures...

Use on ceiling suspended basketball or volleyball systems, wrestling mats, batting cages or any equipment that could cause injury or damage • Also commonly used on wall mounted basketball systems • **Required in some states and in some circumstances by NCAA and NFHS rules** • Each BA950LR includes mounting clamps to connect to 3 1/2" outside diameter ceiling supported structure and comes with retractable 34" of safety belt attached to equipment structure • Patented single use design improves safety by eliminating the reuse of a unit that has been activated by a gym equipment attachment failure • Device prevents equipment free fall by sensing both speed and acceleration engaging its catch mechanism only when it is serving its intended safety purpose • Operates much like an automotive seat belt • Recommended for 100% of the overhead equipment in every facility • 5-Year limited warranty.



### BA973LR BA974LR Electric Backstop Winches

Lightweight, but not lightweight when it comes to power, safety and durability • 3/4 HP instantly reversible motor develops 1250# of cable lift at a speed of 9 feet per minute • 1/4" diameter, 7000# aircraft cable winds on a 4 1/2" diameter grooved aluminum drum

• Hardened, positive locking, steel worm gears are designed with a 200:1 reduction to eliminate backlash and slippage common on belt driven winches • Additional features include easy to set limit switches, cable take up tension roller, UL listing and optional remote control operation • Includes key switch, cord and 110 volt plug • Order **BA973LR** for 3/4 HP Electric Backstop Winch or **BA974LR** for 1 HP Electric Backstop Winch • Order **SUCBLFT** for cut to length 1/4" aircraft cable.



### BA975KS Electric Key Switch

Traditional key operated single key switch with cover...Up-Down labeled cover plate.



BA950LR

Use on ceiling suspended basketball or volleyball systems, wrestling mats, batting cages or any equipment that could cause injury or damage • Also commonly used on wall mounted basketball systems • **Required in some states and in some circumstances by NCAA and NFHS rules** • Each BA950LR includes mounting clamps to connect to 3 1/2" outside diameter ceiling supported structure and comes with retractable 34" of safety belt attached to equipment structure • Patented single use design improves safety by eliminating the reuse of a unit that has been activated by a gym equipment attachment failure • Device prevents equipment free fall by sensing both speed and acceleration engaging its catch mechanism only when it is serving its intended safety purpose • Operates much like an automotive seat belt • Recommended for 100% of the overhead equipment in every facility • 5-Year limited warranty.



BA925LR

### BA925LR Manual Backstop Winch

Many retractable swing up basketball backstop installations do not require electric backstop winches...BA925LR mounts to the wall and comes with an easy-to-operate hand crank with 3/4" square drive • Can easily be adapted to replace existing tired and difficult to operate manual winches • Order **SUCBLFT** 1/4" aircraft cable and any needed cable pulleys and brackets separately • Wood wall mount board included • 5-Year limited warranty.



800-247-7668



www.bisoninc.com



# GYM UPGRADE PACKAGES



## Gym Upgrade Packages

When it's time to upgrade your basketball court, Bison's Official Gym Upgrade Packages will save you money and guarantee single source compatibility...There is a package to fit your existing wall or ceiling mount structure regardless of manufacturer • All components are designed and built by Bison for guaranteed compatibility • Premium and standard upgrade packages available, all with backboard, goal and backboard padding • All packages contain one of each of the listed Bison basketball components • **Order two packages to upgrade both ends of the court.**



OFC4234-RY

Package Description	Backboard		Goal		Padding		
	Model/Size	Warranty	Model	Warranty	Model	Warranty	Color
OFX423180 Official Premium 180° Short Board Upgrade Package	BA42XL 42" x 72"	Unconditional Lifetime	BA3180S	Four-Year Limited	BA68U	10-Year Replacement	17 Colors Please Specify
OFX4235E Official Premium Short Board Upgrade Package	BA42XL 42" x 72"	Unconditional Lifetime	BA35S	Three-Year Limited	BA68U	10-Year Replacement	17 Colors Please Specify
OFS4234 Official Standard Short Board Upgrade Package	BA42E 42" x 72"	10-Year Limited	BA34	1-Year Limited	BA68U	10-Year Replacement	17 Colors Please Specify
OFC4235E Official Premium Conversion Board Upgrade Package	BA42XLC 42" x 72" Conversion	Unconditional Lifetime	BA35S	Three-Year Limited	BA68U	10-Year Replacement	17 Colors Please Specify
OFC4234 Official Standard Conversion Board Upgrade Package	BA42XLC 42" x 72" Conversion	Unconditional Lifetime	BA34	1-Year Limited	BA68U	10-Year Replacement	17 Colors Please Specify
OFX483180 Official Premium 180° Tall Board Upgrade Package	BA48XL 48" x 72"	Unconditional Lifetime	BA3180T	2-Year Limited	BA68U	10-Year Replacement	17 Colors Please Specify
OFX4835E Official Premium Tall Board Upgrade Package	BA48XL 48" x 72"	Unconditional Lifetime	BA35E	5-Year Limited	BA68U	10-Year Replacement	17 Colors Please Specify
OFS4834 Official Standard Tall Board Upgrade Package	BA48 48" x 72"	10-Year Limited	BA34	1-Year Limited	BA68U	10-Year Replacement	17 Colors Please Specify



## Center Strut Backboard and Height Adjuster Adapters

If your existing center strut ceiling mount structure is not designed to mount to backboard corners...these adapters allow installation of Bison backboards and/ or ZipCrank height adjusters to your existing center strut structures • Sold in pairs, one pair required for each backboard • **Caution! May reposition face of backboard in relationship to court lines** • Select from the chart below.

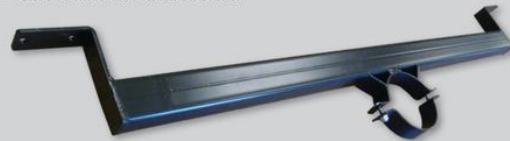

Model #	Center Strut Diameter	Backboard Mounting Pattern
BA600YF	6"	35" (w) x 20" (h) (fan)
BA600YR	6"	62" (w) x 36" (h) or 62" (w) x 42" (h)
BA658YF	6 <sup>5</sup> / <sub>8</sub> "	35" (w) x 20" (h) (fan)
BA658YR	6 <sup>5</sup> / <sub>8</sub> "	62" (w) x 36" (h) or 62" (w) x 42" (h)





# WIRELESS SHOT CLOCK AND LED SYSTEMS

Coming to a High School near you...In April 2021 the Basketball Rules Committee of the National Federation of State High School Associations authorized State Associations to adopt a 35 second shot clock beginning in the 2022-2023 season. One-by-one State Associations have adopted rules for use and shot clocks will soon be the norm just like at colleges and professional levels. New use of shot clocks has also increased the interest in compatible LED backboard lighting systems. Bison now offers convenient wireless shot clocks and integrated backboard LED lighting systems that require no expensive interface with existing scoreboards.



## SHCLK300 In Time™ Wireless Shot Clock System

This wireless system requires no interface with existing scoreboards and only requires 110-volt power to each shot clock and the control panel • Shot clocks have 12" high bright LED numerals in a sturdy 19" wide x 15" high metal cabinet • Control panel sends wireless signal direct to the shot clocks • System includes 2 shot clocks, control panel, integrated antennae, and 30' 110-volt extension plugs • **Order mounting brackets separately.**



SHCLK300

## BALED2.0 Bison Correct Call™ 2.0

Redesigned to connect directly to Bison SHCLK300 Shot Clocks with no need to interface with the existing scoreboard • 6-piece LED strip design with high tack, self-adhesive mounting tape ensures ability to mount on the rear face of any manufacturer's 72" x 48" or 72" x 42" glass backboard without tools • **Includes components for 2 backboards** • If being used without SHCLK300, requires a 24-volt signal from existing scoreboard or shot clocks • Order **BALED2.0T** for 120-volt to 24-volt transformers with enclosure if necessary.



BALED2.0

### SHCLKBKTFS Freestanding Stanchions

In some cases, mounting shot clocks to moveable stanchions best fits the facility needs • These weighted stanchions are easy to move on 2 floor friendly wheels, yet sturdy • Includes 2 stanchions and hardware to mount shot clocks to stanchion shelf.



SHCLKBKTFS

### SHCLKBKTBB Backboard Mounting Brackets

The most common placement is above and to the rear of the backboard face • Includes 2 brackets, all necessary hardware, and mounting instructions.



SHCLKBKTBB

### SHCLKBKTTT Tabletop Mounting Brackets

Make your shot clocks easy to move with these stable yet lightweight table top stands • Sold in pairs.



SHCLKBKTTT



SHCLKPS

### SHCLKBKTW Wall Mount Brackets

Occasionally a wall near the basketball system is the best place to mount shot clocks • Includes 2 brackets and shot clock mounting hardware • Customer supplies wall mounting hardware depending on wall construction.



SHCLKBKTW

### SHCLKBKT600 Center Mast Shot Clock Mounting Brackets

When your ceiling suspended structure has a single center drop down mast use these brackets to mount Bison shot clocks • Compatible with 6" diameter masts • Order **SHCLKBKT658** if your mast is 6<sup>5</sup>/<sub>8</sub>" diameter • Sold in pairs.



SHCLKBKT600/SHCLKBKT658

### SHCLKPS Shot Clock Protective Shields

These unbreakable polycarbonate shields absorb the shock from erratic ball contact especially when clocks are mounted to the top of backboards • May require field drilling to mount • All hardware included • Sold in pairs.

Item #	Description
SHCLK400	Combination In Time™ Shot Clocks and Correct Call™ 2.0 Backboard LED System (2 backboards)
SHCLK300	In Time™ Shot Clock System only (2 backboards)
BALED2.0	Correct Call™ 2.0 Backboard LED System only (2 backboards)
BALED2.0T	Transformer with enclosure to reduce scoreboard 120-volt signal to require 24-volt for BALEDX (pr)



800-247-7668



www.bisoninc.com

23





# 4 CORNER ZIP CRANK™ HEIGHT ADJUSTER



## ZipCrank™ Goal Height Adjusters

From adult to youth play in 60 seconds...ZipCrank corner mount rim height adjusters are designed to avoid reduced backboard and rim rigidity common with other height adjustable goal systems

- Movable framework slides up and down on two chrome plated 1" diameter rods riding in machined steel bushings
- Height adjusters are installed between the backboard and the backboard support structure and when retrofitted on existing courts moves face of backboard 4¼" toward the free throw line
- May require minor field drilling on some existing retrofit applications
- Adjusts rim infinitely from official 10' to 8' heights and includes easy-to-read height indicator labels
- Operated with the hand crank provided or with optional BA931 Cordless Winch Winder
- See chart below for ordering details including use on center strut structures
- 5-Year limited warranty.

Backboard Type	Manual Operation
42" x 72" backboard with 4 corner mounts	BA980RS
48" x 72" backboard with 4 corner mounts	BA980RT
Fan shaped backboard	BA980F
Other backboards with approximate 35" (w) x 20" rear mounting patterns	BA980F
Backboards that mount to single 6" or 6 <sup>5</sup> / <sub>8</sub> " diameter support structures	See page 22 for adapters and consult a Bison Product Specialist
Backboards on certain T-Rex portable backstops	BA980P
See page 6 and 8 for details	

## Operation Options



Standard Manual Crank Operation

### Standard Manual Crank Operation

Each ZipCrank Height Adjuster is supplied with one manual adjustment rod that allows easy up and down operation from the gym floor.



Optional BA931 Cordless Winch Winder Operation

### BA935 ZipCrank Height Adjuster Drive Shaft Only (not shown)

Order BA935 to raise and lower Bison ZipCrank™ rim height adjusters with customer supplied cordless power tool

- Includes drill drive socket.



### BA931 Cordless Winch Winder Kit

Increase the ease and speed of adjusting Bison ZipCrank Goal Height Adjusters with this cordless, rechargeable winch winder • Kit includes cordless drill, battery charger and BA935 extension with ½" square drive adapter drive rod.



### BA975KS Electric Key Switch

Traditional key operated single key switch with cover...Up-Down labeled cover plate.







## DN1250 Portable Divider Net System

Separate courts for safe play without expensive ceiling mounted divider curtains...14' high, 50' long black mesh net has durable reinforced vinyl edges and stores in a zippered storage bag when not in use • Net is supported by two factory weighted bases with telescoping poles for easy set up and storage • So versatile it can be used in any indoor or outdoor location • Portable bases and posts can also be used for P.E. net games at any height, including volleyball, badminton and tennis with purchase of SVB08 recreational volleyball net • Extend the divider net in 50' increments with purchase of additional DN12 bases and DN50 nets • 1-Year limited warranty.

### DN12 Divider Net System Adder Base Extend divider net... Add bases and nets

- Same weighted base and 12' telescoping net support pole as DN1250 system above.



### DN50 14' x 50' Divider Net

Add additional nets...Extend divider system • 3 ply, 1 1/4" square mesh • Includes zippered storage bag and pole attachment hardware.

### BA801BP Portable Base Padding

Improve player safety...Specially designed pad that covers 360° around the divider net base • 1" thick foam with black vinyl sewn cover • Hook and loop attachment.



800-247-7668



www.bisoninc.com

25



# YOUTH BASKETBALL

## Easy-Up™ Youth Mini Goals

**New Reduced Weight  
for Easier Installation**

Over 40,000 Easy-Up™ Mini Goals are in service in youth camps, YMCAs, YWCAs, elementary schools, church recreation centers, basketball camps and city recreation facilities.

For over 30 years, Easy-Up has put the rim within reach and helped to teach aspiring young basketball players proper shooting techniques...Equipment with official 10' goal height can be converted in less than five minutes with no use of tools • Only Easy-Up will fit on virtually any style of single-ring goal, breakaway or non-breakaway, regardless of manufacturer, age or condition • An Easy-Up goal lowers rim and moves rim 24" closer to free throw line • The full size rim allows play with either full sized or reduced size balls depending upon player age • Standing as low as 2' above the floor, one person can easily attach the tubular frame to a 10' goal with a unique cam operated lever • Total system weight is less than 40# • 48" x 32" backboard is molded of high impact ABS plastic • Ships completely assembled • Not suitable for dunking or hanging from goal • 1-Year limited warranty on structure and goal, **lifetime limited warranty on backboard.**

### TR86 6-in-1 Adjustable Easy-Up™

Age appropriate goal height for kids of all ages now available in a single adjustable unit...This one model can be set at 6½', 7', 7½', 8', 8½' or 9' goal height for kids as young as four years old • Two minute height adjustment without tools.

**Now with  
SIX  
HEIGHT  
SETTINGS**



6-in-1 Adjustment is Quick and Easy



TR86

6-in-1 Adjustable 6½' to 9' Goal for Any Age



Video



New lighter weight design for easier installation.



For Transport or Storage Folds with three thumb screws to 48" x 32" x 7" and has built-in carrying handle.



7½' Goal Height for Ages 3-5



8' Goal Height for Ages 5-7



8½' Goal Height for Ages 8-10

**WARNING!**  
Easy-Up Youth Mini Goals are not for residential or outdoor institutional use. Adult installation is required. Use in supervised play only. **ABSOLUTELY NO HANGING OR DUNKING.**







## Heavy-Duty Ball Carts

### These May Be the Last Ball Carts You'll Ever Buy

PARTNER

Possibly the last ball cart you'll ever need to buy...Designed and tested to support up to 250#, these carts might last forever • Constructed of welded 1" square heavy wall tubing with 3/4" steel chrome plated, horizontal ball supports • Choose from standard or lockable model with ball capacities to match your program's needs • Carts are available in six popular colors and can be customized with optional ABC92 lettering • Fits men's or women's basketballs • Floor-friendly casters • Some assembly required • 5-Year limited warranty.



5-YEAR Limited Warranty

BESTSELLER

BA185-SC with Optional ABC92 Lettering

BA125-RY with Optional ABC92 Lettering

5-YEAR Limited Warranty

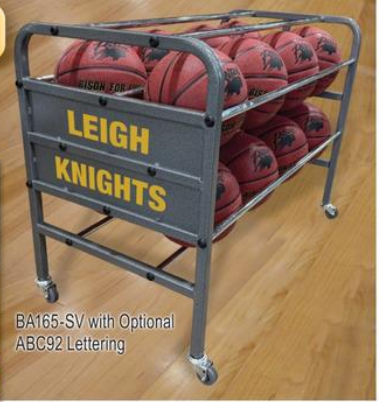

BA165-SV with Optional ABC92 Lettering

### Ball Carts

Choose a cart for 12 or 18 balls...Choice of six colors shown below • Optional ABC92 lettering can be applied on both ends • The best ball carts you'll ever own • 5-Year limited warranty.

#### BA125 Ball Cart

Holds 12 balls.

#### BA185 Ball Cart

Holds 18 balls.



5-YEAR Limited Warranty



### BA187 SharpShooter™ Ball Cart

Built for rapid fire shooting practice...Durable ball cart holds a total of 19 women's or men's basketballs including 7 on the top row that gravity feed to one end for maximum shots per minute • Choice of six colors shown below • 5-Year limited warranty.

### BA175 25 Ball Security Locker

Secure your investment in inflatables...Sturdy black coated wire and tubular locker • Hinged, lockable top (lock not included) • Overall dimensions 26" (w) x 46" (l) x 43" (h) • Easy to roll with convenient handle and heavy-duty swivel casters • Holds approximately 25 basketballs, volleyballs, footballs, soccer or miscellaneous game balls and equipment • 1-Year limited warranty.



### Lockable Ball Carts

Carts now have capacity for 16 or 24 balls...

Lock to protect your basketball investment • Customer provides padlock • 23" width for easy storage • Six color options shown below • Optional ABC92 lettering can be applied on one end (two lines) • 5-Year limited warranty.

#### BA165 Ball Cart

16 ball capacity.

#### BA245 Ball Cart

24 ball capacity.

5-YEAR Limited Warranty

New!

### SpaceSaver™ Lockable Vertical Ball Carts

When storage space is limited, SpaceSaver™ Vertical Ball Carts might be the answer...Only 22" x 22" wide • Same heavy duty tubular framework and casters as our other popular ball carts • Top loading and lockable • Customer provides padlock • Available in 6 colors shown below • 5-Year limited warranty.



#### BA165V Vertical Ball Cart

16 ball capacity, 44" high

#### BA245V Vertical Ball Cart (shown)

24 ball capacity, 62" high

### ABC92 Custom Lettering

Custom lettering for your school name or nickname...up to 10 letters per side or line • See page 102 of catalog for available lettering colors and styles • Customer applies lettering at assembly.

### Color options for all Ball Carts except BA175.



800-247-7668



www.bisoninc.com



# SPORT PRIDE™ GYM AND FIELD SPORTS PRODUCTS



Maximize school, team or program spirit by including Bison Sport Pride™ equipment in your plans when you redecorate, renovate or build your facility. Bison's design team will work with you using your existing logos or artwork, work from your rough concept or show you a variety of awesome stock standard team logos.

Choose from a wide variety of Bison sport and event related equipment, all designed taking advantage of our full color printing resulting in color photo quality images.



Design



Print

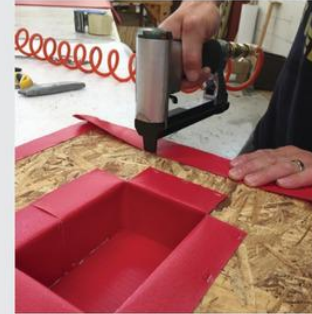

Assemble



Graphic Wall Padding



Goalpost Padding



Scorers Table



Scorers Tables in Bleachers



Graphic Outdoor Padding



Lettering and Logos



Graphic Wall Padding



Volleyball Padding



Graphic Wall Padding







# ILLUMINATED SPORT PRIDE™ SCORING TABLES

Now Upgraded to LED for Longer Life & Energy Savings

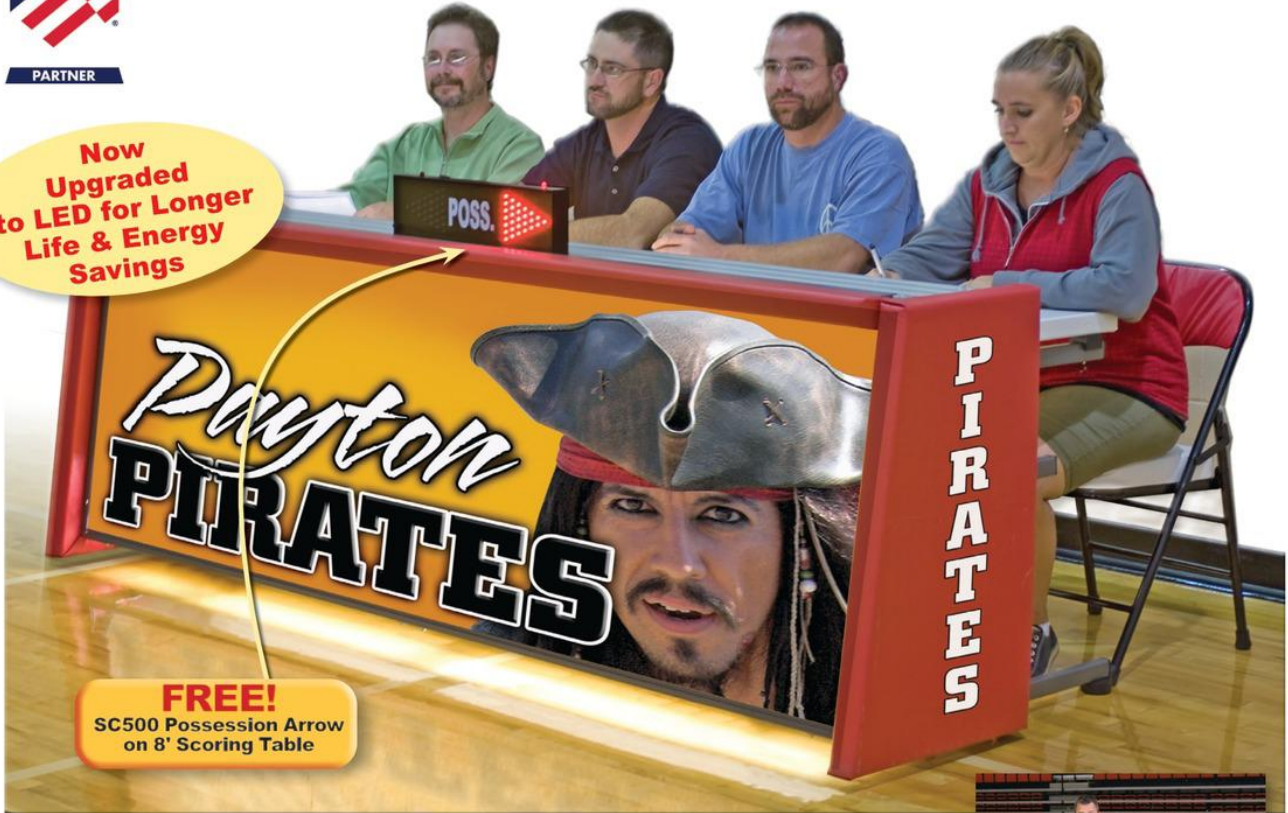

**FREE!**  
SC500 Possession Arrow on 8' Scoring Table

## ST85FI Sport Pride™ Illuminated Scorers Tables

ST85FI 8' Table

Let the light shine through with Bison Sport Pride Illuminated Scoring Tables...Tables have profile identical to Bison's full color graphic models so tables can be configured in any length and in any combination of styles to meet your facility's needs and budget • Support legs and 16" deep table top fold for easy transport and storage on built-in, non-marking casters • Front graphics are printed on a durable, translucent substrate and protected by unbreakable clear polycarbonate for a lifetime of sharp, bright images • Can be used either on the floor with chairs or mounted on a customer fabricated platform a few rows up in most bleachers • Ends are fully padded and can be lettered with school name • Top edge has matching safety padding • Each table includes a 120 volt power strip with surge protector • See Convertible drawing below for profile information • Requires 20 amp, 120 volt service • Illumination is provided by three LED tubes (included) • 5-Year limited warranty on tables except lamps.

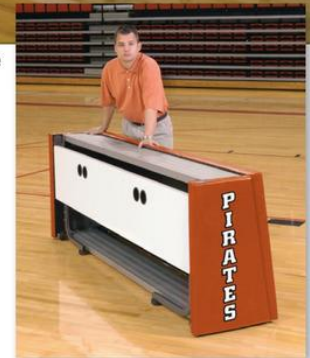

Compact For Easy Transport and Storage

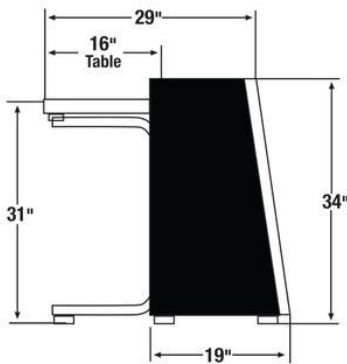

Convertible Table on Floor

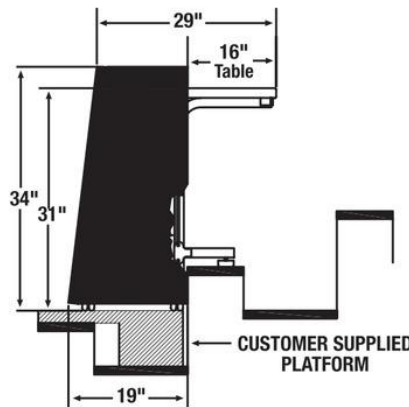

Convertible Table in Bleachers

Style	8' Convertible
Approx. Graphic Size	31" x 96" (20 sq. ft.)
Actual Overall Dimensions	34" (w) x 34" (h) x 102" (l)
Power Requirement	120 Volt AC, 20 AMP
Table Depth and Height	16" (d) x 31" (h)
Stored Dimensions	20" (w) x 34" (h) x 102" (l)
Possession Arrow Included	Yes

Special liftgate delivery charge or extreme manual lifting required if dock/forklift not available.



800-247-7668



www.bisoninc.com



# GRAPHIC SPORT PRIDE™ SCORING TABLES



ST85F 8' Convertible Table on Floor

"The Bison scorers table we purchased was more than we bargained for! The graphics were outstanding, the quality was excellent and the price was reasonable. I was impressed with the turnaround time and how well it was constructed. It has had a positive impact on our school spirit. Anyone who walks into the gym notices the table right away. When people ask who we got it from, I direct them to Bison with positive recommendations."

**Rob Murphy**  
St. Ignatius High School,  
Thunder Bay, Ontario



ST85F in Bleachers

## Sport Pride™ Full Color Graphic Scorers Tables

The perfect blend of safety, function and school pride...Realistic color graphics, same as found on our popular Sport Pride wall padding, cover the entire front and sides of these scorers tables • Available in 12' or 8' models • Any number of 12' and 8' tables can be placed side-by-side with graphics coordinated to create any length of continuous scorers table capacity • Tables fold easily for transport and storage • Choose from Convertible or Space Saver models • See selection chart and profile information below • Includes full color printed graphics on front panel and mascot or school name on each side pad • Super narrow storage width • Full color printing process allows infinite color selection • Folding 16" deep table with drink holders • Padded front and sides have 14 oz. anti-mildew, UV protected and fire-retardant vinyl over 2" thick urethane foam • Built-in, floor-friendly transport casters • 110 volt receptacles for computer, shot clock, etc. • 1-Year limited warranty.

Sport Pride™ Graphic Scorers Tables			
	ST125F	ST85F	ST85B
Style (Seats)	12' Convertible (6)	8' Convertible (4)	8' Space Saver (4)
Approx. Graphic Size	34" x 144" (36 sq. ft.)	34" x 96" (24 sq. ft.)	46" x 96" (32 sq. ft.)
Approx. Overall Dimensions	34" (w) x 34" (h) x 144" (l)	34" (w) x 34" (h) x 96" (l)	34" (w) x 46" (h) x 96" (l)
Graphics	Full Color	Full Color	Full Color
Table Depth and Height	16" (d) x 31" (h)	16" (d) x 31" (h)	16" (d) x 41" (h)
Stored Dimensions	20" (w) x 34" (h) x 144" (l)	20" (w) x 34" (h) x 96" (l)	20" (w) x 46" (h) x 96" (l)
Possession Arrow Included	Yes	Yes	Yes

### ST85F/ST125F Convertible Scorers Table (Freestanding on Floor)

The most common use of our convertible 8' (ST85F) or 12' (ST125F) scoring tables is setup on the floor with chairs providing the seating.

### ST85F Convertible Scorers Table (Installed in Bleachers)

When space between the court and the bleachers is limited, Bison convertible scoring tables can be used at any height in the bleachers using a wooden field constructed platform • This allows scoring and statistical personnel to sit on existing bleacher seats • Bison will provide a universal design platform drawing on request.

### ST85B Space Saver Scorers Table (Up Against Bleachers)

This extra tall table allows the table to be positioned on the gym floor, up against the first row of bleacher seats • The height is designed to allow personnel to sit comfortably on the second row of bleacher seats • Space Saver is the best choice if the gym does not want to put scoring tables in the bleachers but has limited floor space outside the sidelines • Normally requires at least 48" of space between front of bleachers and court sidelines.



ST85B Space Saver Table

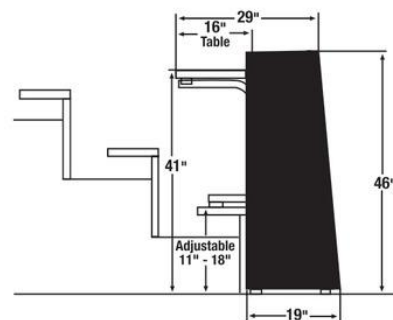

Space Saver Tables







ST84F Shown with Optional SC500 Possession Arrow

**ST84F 8' School Spirit™ Activity Table**

Step up to the big leagues...But at a little league price • Great for use as a basketball or volleyball scorers table but equally at home at speech and debate, wrestling matches, bake sales or anywhere school spirit is alive and well • Front and side panels are fully padded for player protection • Printing of full color graphics on the front panel and mascot or school name on side panels is included in price of ST84F • Easy to store, all panels attach with hook and loop fasteners • Padded front panel is approximately 30" x 96" • 2" thick front and 1" thick side padding • Seats four comfortably • 5 minute set up and tear down • Stores in area 8' x 3' x 1' • Full 30" x 96" table top • 1-Year limited warranty.



Easy Transport and Storage



Hook and Loop Front and Side Panel Attachment



**SC500 Slimline Possession Arrow**

Space saving thin design... Leaves more room for scorekeeper duties • Bright red illuminated electronic arrows  
 • 120 volt, 15' power cord  
 6" (h) x 20" (w) x 2" (d) enclosure  
 • 1-Year limited warranty.



**Drew Logan**, High School Basketball Coach  
 Mt. Olive High School, Mt. Olive, IL

"Mt. Olive is a small school and it was nice to have someone pay attention to every detail to make our scorers table the very best. Our Sports Boosters donated the money to purchase a Bison Sport Pride scorers table and they wanted our table to mirror the Wildcat painting in our gym. The customer service I received was second to none and the artwork is amazing!"



800-247-7668



www.bisoninc.com



# INDOOR PADDING OPTIONS



If you need safety padding...we've got you covered. Bison has the perfect team to design and construct padding to protect players from virtually any surface from simple flat walls to columns, doorways and overhead obstructions. With a wide variety of foams, fabrics, backing substrates and mounting methods, we will help you provide the padding system that best satisfies your program's needs. Let our graphic design staff work with you to make your padding system not only offer superior safety but also exhibit your program pride with full color, durable graphic designs.



Full Color Graphic Wall Padding

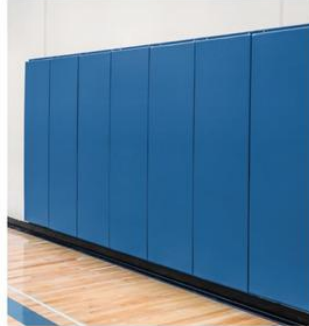

Solid Color Wall Padding

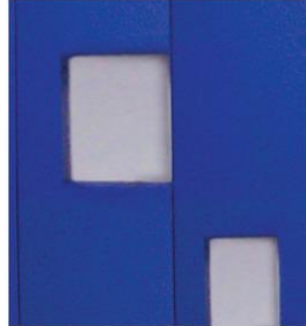

Custom Factory Cutouts (WP25)



Molded Outlet Openings (Single or Duplex)



Flange Mounting System



Hidden Z Track Mounting System (WPZ)



Wood Backed Hook and Loop Fastener Track Mounting System



Soft Back Hook and Loop Fastener Track Mounting System (WPVS)



J Track Mounting System



Custom Entry Padding



Square Column Padding

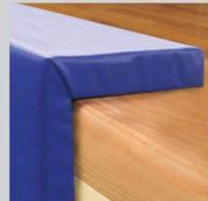

Stage Padding



Corner Padding (WP26)



Hook and Loop or Laced Pole Wraps



Beam Padding (WP27)

## Specialty Wood Backed Padding Applications

Protect players from injury...columns, beams, entry ways, corners, stages and other protruding surfaces need special padding systems • Bison can provide custom designed padding for virtually any application • Work with our padding design staff to pad your most challenging surface • Available to meet either Protector™ 2" polyurethane or Firewall™ 2" neoprene specifications (see page 35).



## Custom Sewn Soft Backed Padding

Virtually any size, virtually any flat design...Soft backed sewn padding can be designed in a wide variety of foam thickness and specifications • 18 color options (see page 35) and multiple hanging and mounting methods • Contact our padding design specialists to design soft backed sewn padding to fit your needs.

## Custom Soft Backed Pole Wraps

Wrap around design can use lace or hook and loop closure...available in 1" or 2" thick Protector™ polyurethane foam or Firewall™ neoprene foam • Can be sized to fit virtually any size posts • Bison padding design department will help you determine the right design and specification for your facility.



Measuring Video







**Sport Pride™ Graphic Wall and Stage Padding**

There is no limit to the design options available to enhance your gym's sex appeal... options are limited only by you and our art department's imaginations • Our digital printing process can provide photo quality, full color graphics and bright letters and logos in a near infinite range of colors • Recognize a significant program donor, honor past championship teams, communicate an important program theme or just make your wall padding pop • Durable images that will look good for years • Sport Pride graphic padding can be provided in any size or configuration built to our standard Protector™ specifications, our Firewall™ specifications (see page 35) or any of our wall padding upgrade options on page 36.



Measuring Video







Wall Padding



Stage Padding



## Solid Color Wall Padding

While full color graphic wall padding continues to grow in popularity, solid color padding is still the most common option, especially when padding large sections of walls or where tight budgets demand. Solid color padding also has the advantage of being able to more easily cover beams, doors, corners, and surfaces that would be impractical to design full color graphic padding for.

It is also possible to mix and match solid color padding with graphic padding, to take advantage of the relatively low cost of solid color padding, but add that extra something special to certain high visibility areas.

Like graphic padding, solid color padding is available in a wide range of colors shown on the following page, and can be ordered to meet any architectural or code specifications for fire resistance, thickness, foam density, or mounting preference.

See following pages for options.



Wrestling Room Padding



Measuring Video





## Wall Padding Solid Color Vinyl Options

- DR-Dark Royal
- RY-Royal
- SC-Scarlet
- BK-Black
- NY-Navy
- PK-Pink
- FG-Forest Green
- GL-Athletic Gold
- PR-Purple
- MR-Maroon
- OR-Orange
- KL-Kelly Green
- CL-Columbia Blue
- GR-Gray
- BR-Brown
- BO-Burnt Orange
- CD-Cardinal
- VG-Vegas Gold

**NOTE: ALL COLORS ARE NOT AVAILABLE ON FIREWALL PADDING**



## Protector™ Wall Padding Specifications (Standard Specs)

All full color graphic and solid color Protector wall padding including custom corner, column, door and stage padding is constructed of polyurethane foam with an Indentation Load Deflection (ILD) of 43-53 pounds per 50 cubic inches and 1.50 pounds per cubic foot density per ASTM Tests B1 and A • Foam conforms to California Fire Code TIB 117:2013 Section 3 and FMVSS 302 • Foam also conforms to ISO 20743:2007 Antibacterial and AATCC 30 Antifungal Standards • 14 ounce vinyl covering has a ASTM D2261 tear strength of 92 x 83 pounds per inch and has been treated for mildew and UV protection • Vinyl conforms to NFPA-701 CSFM and has a Class A fire rating per ASTM E-84 • Wood backed padding is mounted on 7/16" OSB composite board with the foam attached to the OSB with water based adhesive.

## Firewall™ Wall Padding Specifications (Standard Specs)

Full color graphic and solid color Firewall padding including custom corner, column, door and stage padding is constructed of neoprene foam with Indentation Load Deflection (ILD) of 25-45 pounds ASTM D3574 Test B1 and a density of 6.2 pounds per cubic foot per ASTM D3574 Test A • Firewall Neoprene foam passes California Fire Code TIB 117:2013 • 18 ounce matte finish vinyl has a touge tear strength of 75 x 75 pounds per inch, has been treated with anti-mildew, anti-microbial and UV protection; Conforms to NFPA-701, CSFM and has a Class A fire rating per ASTM E-84 • Wood backed padding is mounted on 7/16" OSB composite board with the foam attached to the OSB with water based adhesive • Assembled padding has been tested and passes NFPA 286 fire test for wall coverings • **Firewall is available in limited solid color vinyl colors** • Call for details.

*These colors do not exactly reflect actual solid color vinyl. Request a vinyl sample for color match if needed.*



**PARTNER**



800-247-7668



www.bisoninc.com



# INDOOR WALL PADDING ORDERING CHART

Bison offers a wide range of wall padding options to match every facility's needs, and meet every local and state code. Choose from our basic Protector™ 2" thick polyurethane foam, or our Firewall™ 2" neoprene, with or without wood backing. Bison offers 4 wall mounting options, and any padding can be upgraded to meet more stringent specifications and codes with the options outlined below.

In most cases, all wall padding is priced by the square foot, but the most common size is 2' wide and 6' high. See chart below for all standard, and upgrade options. Solid vinyl colors are shown on page 35.



PARTNER

## Custom Wall Padding Options

Model Number	Style	Foam	Backing	Vinyl Cover	Mounting System
WP2USFW	Protector™	2" Polyurethane	7/16" OSB	14 oz. Solid Color	Flange
WP2USZW	Protector™	2" Polyurethane	7/16" OSB	14 oz. Solid Color	Z-Track
WP2USJW	Protector™	2" Polyurethane	7/16" OSB	14 oz. Solid Color	J-Track
WP2USVW	Protector™	2" Polyurethane	7/16" OSB	14 oz. Solid Color	Hook & Loop
WP2USVS	Protector™	2" Polyurethane	Soft Back	14 oz. Solid Color	Hook & Loop
WP2UGFW	Protector™	2" Polyurethane	7/16" OSB	14 oz. Graphic	Flange
WP2UGZW	Protector™	2" Polyurethane	7/16" OSB	14 oz. Graphic	Z-Track
WP2UGJW	Protector™	2" Polyurethane	7/16" OSB	14 oz. Graphic	J-Track
WP2UGVW	Protector™	2" Polyurethane	7/16" OSB	14 oz. Graphic	Hook & Loop
WP2UGVS	Protector™	2" Polyurethane	Soft Back	14 oz. Graphic	Hook & Loop
WP2NSFW	Firewall	2" Neoprene	7/16" OSB	18 oz. Solid Color	Flange
WP2NSZW	Firewall	2" Neoprene	7/16" OSB	18 oz. Solid Color	Z-Track
WP2NSJW	Firewall	2" Neoprene	7/16" OSB	18 oz. Solid Color	J-Track
WP2NSVW	Firewall	2" Neoprene	7/16" OSB	18 oz. Solid Color	Hook & Loop
WP2NSVS	Firewall	2" Neoprene	Soft Back	18 oz. Solid Color	Hook & Loop
WP2NGFW	Firewall	2" Neoprene	7/16" OSB	18 oz. Graphic	Flange
WP2NGZW	Firewall	2" Neoprene	7/16" OSB	18 oz. Graphic	Z-Track
WP2NGJW	Firewall	2" Neoprene	7/16" OSB	18 oz. Graphic	J-Track
WP2NGVW	Firewall	2" Neoprene	7/16" OSB	18 oz. Graphic	Hook & Loop
WP2NGVS	Firewall	2" Neoprene	Soft Back	18 oz. Graphic	Hook & Loop



## EASY TO ORDER!

### 2' wide x 6' high Standard Wall Padding Options

Model Number	Style	Foam	Backing	Vinyl Cover	Mounting System
WP62UF	Protector™	2" Polyurethane	7/16" OSB	14 oz. Solid Color	Flange
WP62UZ	Protector™	2" Polyurethane	7/16" OSB	14 oz. Solid Color	Z-Track
WP62NF	Firewall	2" Neoprene	7/16" OSB	18 oz. Solid Color	Flange
WP62NZ	Firewall	2" Neoprene	7/16" OSB	18 oz. Solid Color	Z-Track

# PADDING UPGRADE OPTIONS



### WPUP3U

Upgrade any 2" polyurethane foam wall padding to 3" polyurethane foam for added player protection or to meet local codes or project specifications.



### WPUP3N

Upgrade any 2" neoprene foam wall padding to 3" neoprene foam for added player protection or to meet local codes or project specifications.



### WPUPFRC

Upgrade any wood backed wall padding to add a fire retardant coating to the 7/16" OSB backing to meet local codes or project specifications.



### WPUP2HD

Upgrade any 2" polyurethane foam wall padding to 2" high density foam for added player protection or to meet local codes or project specifications.



### WPZ3 Third Row Z-Track

Occasionally specifications call for 3 rows of Z channel mounting tracks due to padding height or other conditions. Call for details on how to add the 3rd row to your padding needs.





## All Weather™ Outdoor Padding

Neither snow nor rain or heat nor gloom of night...Oh wait, that's the US Postal Service motto, but it also applies to our All Weather Outdoor Padding and you can add humidity, hail, sleet, wind, sunlight, frost and virtually any other common weather term to describe our padding's durability

- All Weather Padding features ½" ACRE® wood substitute composite eliminating rot, pests and the decay that impacts wood products, 100% rust-proof stainless steel, brass or aluminum hardware and fittings, 3" thick mildew-resistant polyurethane foam and heavy outdoor durable vinyl coverings
- Choose from sunfast solid color or full color graphic options
- Each assembled panel, regardless of size, is vented at the bottom to allow moisture to escape, increasing both functional and aesthetic longevity
- Outdoor padding is available in many sizes, styles, custom configuration and in colors shown on page 102. All Weather padding comes standard with flange style mounting but consult our Bison Padding Specialists to determine if "Z" Track Mounting, Chain Link or Hook and Loop Mounting better fits your specific needs for part or all of your installation.



Chain Link Fence Mounting Option

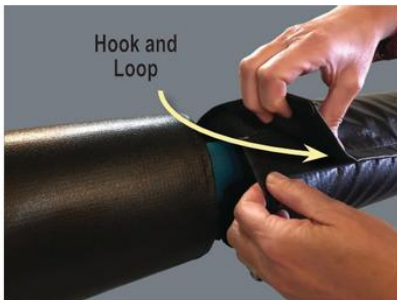

Hook and Loop



### Tubular Hook and Loop Rail/Pole Wraps

Neat, Easy, Safe, Durable...describes the 1" thick semi rigid urethane foam wraps

- 14 oz. sewn vinyl cover with full length heavy-duty hook and loop fastening to use indoors or outdoors
- Available in 18 colors (see page 102)
- Priced by the lineal foot, 6' minimum
- Standard length 6' (custom lengths available). See chart below for sizes.

Model #	Inside Diameter	Foam Thickness	Fits Schedule 40 Pipe Size
WPRAIL200	2"	1"	1½"
WPRAIL238	2⅜"	1"	2"
WPRAIL350	3½"	1"	3"
WPRAIL450	4½"	1"	4"

### WPRAIL Fence Rail and Dugout Padding

Easy to order, easy to install...8" wide x 1" thick polyurethane foam is covered in 14 oz. vinyl in your choice of 17 popular colors

- Standard length is 6' but can be made in shorter lengths as desired
- Designed to wrap around typical chain link style fence with top rail up to 2½" diameter and attached with WPRAILCT cable ties (order separately)
- Will flex around corners if needed
- Brass attachment grommets are spaced 6" apart for secure attachment
- Padding is 100% sewn construction with high tensile outdoor thread
- Priced by the lineal foot.

## Outdoor Padding Specifications

Unless otherwise indicated, all outdoor Full-Color Graphic and Solid Color vinyl outdoor padding is constructed of ½" ACRE® wood substitute composite eliminating rot, pests and the decay that impacts wood products with 3" anti-microbial polyurethane foam. All outdoor padding is covered with fabric backed, flame retardant, mildew and UV resistant 18 oz. leather grained vinyl. All vinyl is tightly stretched around the foam and stapled to the backing with rust-proof stainless steel staples no less than 2" apart. Mounting styles will vary depending upon specific requirements. Specifications may vary on custom sizes, shapes, and configurations to meet site-specific requirements.

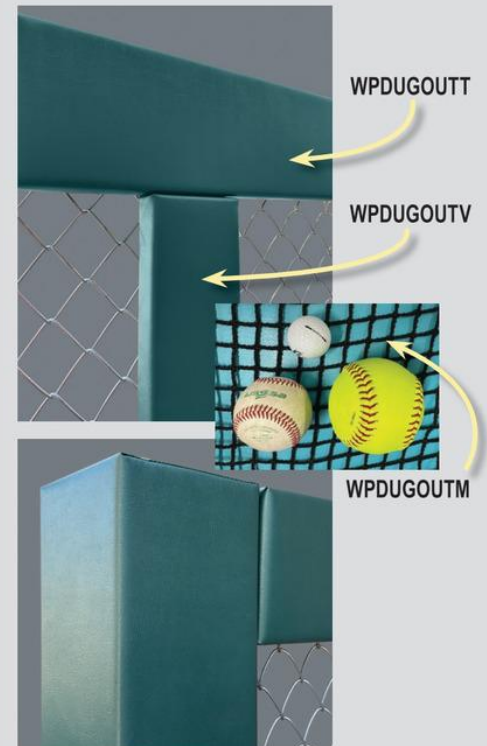

### WPDUGOUTT Premium Top Rail Dugout Padding

For a professional look and maximum safety...this rigid wood frame design is covered with 1" thick high density, closed cell foam, wrapped in your choice of 13 colors of 18 oz. outdoor durable vinyl

- Inside dimension of wood frame is 4" wide and 5½" deep to cover any dugout fencing up to 4" wide
- Standard section length 4' but shorter custom lengths and end caps available
- Order WPDUGOUTV for vertical post covers that have 5½" wide rigid wood backing with 1" thick high density, closed cell foam, wrapped in vinyl in your choice of 17 colors
- Mounting hardware is included
- Priced by the lineal foot
- Order WPDUGOUTM Dugout Mesh in 4' high x 25' bundles.



800-247-7668



www.bisoninc.com

37





# BASEBALL/SOFTBALL FOUL AND FAIR POLES™

New for 2025

Bison Foul and Fair™ Poles are designed to satisfy every level of play from recreational through high school and small college. The modular design makes shipping, handling, and installation easy and less costly. Choose from rust proof aluminum or steel, and direct bury, pedestal base, or semi-permanent mounting. All poles powder coated with durable high visibility yellow polyester. Welded 16" expanded metal wings allow wind to pass through without impacting pole stability and durability. All Bison Foul and Fair™ Poles are sold in pairs.

## Aluminum Poles

All Bison aluminum Foul and Fair™ Poles are constructed of custom 4" square, rust proof 6061-T6 aluminum extrusions with extra internal ribbing for rigidity. Wings extend 16" and are fabricated of aluminum flattened expanded metal with an aluminum tubular frame. 12' poles are fully welded one-piece, 16' poles are 2-piece, and 20' poles are 3-piece with dependable connection hardware that adds rigidity to the poles. Choose **direct bury** mounting or **semi-permanent** removable mounting options.

Aluminum Foul and Fair™ Pole			
Model Number	Height	Mounting Style	Pole Sections
BBSB12FPDBA	12'	Direct Bury	1
BBSB12FPSPA	12'	Semi-Permanent	1
BBSB16FPDBA	16'	Direct Bury	2
BBSB16FPSPA	16'	Semi-Permanent	2
BBSB20FPDBA	20'	Direct Bury	3
BBSB20FPSPA	20'	Semi-Permanent	3



12'



16'



20'



Direct Bury



Semi-Permanent



## BBSB08FPDBS Recreational Foul and Fair™ Poles

Perfect for recreational fields, these Foul and Fair™ Poles are constructed of 3/2" diameter, zinc coated steel tubing and are finished ready to install with a high visibility yellow textured polyester powder. Poles are 132" long allowing for 36" bury and 8' of extension above the ground. Includes matching steel rain cap.

## Steel Poles

All Bison steel Foul and Fair™ Poles are constructed of 4" square, 11 ga. steel tubing for excellent stability and lasting durability. Steel expanded metal wings with tubular frames extend 16" and are designed to reduce wind load. 12' poles are fully welded 1-piece, 16' poles are 2-piece, and 20' poles are 3-piece with heavy connection hardware at the connecting points for superior rigidity. Choose **direct bury** or **removable pedestal base**.

Steel Foul and Fair™ Pole			
Model Number	Height	Mounting Style	Pole Sections
BBSB12FPPBS	12'	Pedestal Base	1
BBSB12FPDBS	12'	Direct Bury	1
BBSB16FPPBS	16'	Pedestal Base	2
BBSB16FPDBS	16'	Direct Bury	2
BBSB20FPPBS	20'	Pedestal Base	3
BBSB20FPDBS	20'	Direct Bury	3



12'



16'



20'



Pedestal Base



Direct Bury





**New for 2025**

## Extreme™ Batting Cages

As the name implies, the frame of this batting cage is heavier than most similar cages on the market...Uprights are 2<sup>3</sup>/<sub>8</sub>" OD heavy wall galvanized tubing and cross members are 1<sup>5</sup>/<sub>8</sub>" OD galvanized tubing • All hardware and fittings are galvanized for long life • Extreme™ batting cages are 12' (w) x 12' (h) x 70' (l) with uprights spaced on approximately 10' centers • Mesh is 4mm knotless PE with 1<sup>1</sup>/<sub>8</sub>" squares so the cage can be used for a wide variety of sports practice including golf • Netting has a hook and loop closure walk through opening on one end for entry and is suspended from the framework with spring clips provided • Choose from Direct Bury uprights that mount in 36" deep concrete footings, (BBSBCAGE1270DB), or Pedestal Mount that have an 8" square base mounting plate that allows attachment to concrete slabs with customer supplied concrete anchors, (BBSBCAGE1270PM).

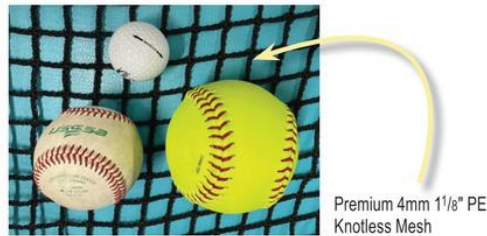

## BBSBCAGE1270I Indoor Multi Sport Cages

Ideal for baseball, softball, golf, tennis, or other sport practices indoor...Provides safety protection from other simultaneous activities in the facility • Mesh is knotless 1<sup>1</sup>/<sub>8</sub>" square black PE • Cage mesh is suspended from a 1<sup>5</sup>/<sub>8</sub>" galvanized steel pipe frame with cast iron connector fittings • Entire cage assembly is raised and lowered by means of a 3/4" HP, 115-volt single phase reversible winch and can be operated by key switch or other control device • Contact a Bison Product Specialist for design details • Cage is 12' (w) x 12' (h) x 70' (l).

Indoor Multi-Sport Cages are Custom designed to match building design.



Key Switch Operation



Touch Screen Operation

## Multi Sport Cage Operation

Bison Indoor Multi Sport Cages are raised and lowered with a ceiling suspended 3/4 HP, 110-volt power winch • Winch can be operated with a simple key switch or using a touchscreen that is capable of operating other gym equipment • Installation of Bison Indoor Multi Sport Cages requires experienced professional installer.



Power Winch



800-247-7668



www.bisoninc.com

39





# SPORTS FIELD NETTING SYSTEMS

New for  
2025

Bison Sports Field Netting Systems can be used in a wide variety of circumstances to separate activity areas or to keep game balls from escaping the field of play. There is no limit to the length or shape of the net system that can be designed using these easy to design and install systems.



## Cable Suspended Net Systems

All upright posts are 3½" diameter heavy wall galvanized capped tubing suitable for a full 48" of direct ground bury and extending 20' above the field. A tensioned ¼" steel aircraft cable stretches between the posts and serves as the suspension cable to support the extra heavy duty 4mm black mesh. The 1⅛" square mesh openings allow the netting to be used for all sports including golf. The mesh comes in 20' high x 25' wide sections with heavy edge rope bindings. See **How To Order** information below to design and order all components necessary to satisfy your field netting needs.



Premium 4mm 1⅛" PE  
Knotless Mesh



## Pulley Suspended Net Systems

In some circumstances it is desirable to lower or even remove net systems during the off season or when other activities do not require the netting. In these cases, the addition of a rope and pulley system allow the top of the mesh to be lowered and secured at any height or completely removed for future reinstallation. Each 20' upright post is fitted with a top rope pulley, an outdoor durable lifting rope and a lower tie off rope cleat. To add raising and lowering features to new systems order one **BBSB2025LIFT** for each upright post. **BBSB2025LIFT** must be included at time of original order.



### BBSB2025N Replacement 20' x 25' Mesh Netting

20' x 25', black, 4mm, PE, 1⅛" square opening, multi-sport mesh. Heavy woven rope mesh edges for easy and dependable attachment.

## How to Order

Bison Sports Field Netting Systems can be configured in any length including corners or angles divisible by 25' as the mesh net sections are 20' high and 25' wide.

Order **BBSB2025SFS** for the starter section that will include two uprights, one 20' (H) x 25' (W) mesh net and all necessary cable and hardware. Order one **BBSB2025SFEXT** for each additional 25' section that you want to add to the initial 25' length. This will include all necessary components.

**EXAMPLE:** Project requires a straight section of Sports Field fencing that is 100' long and then another 25' on each end at a 90° angle. This would require one **BBSB2025SFS** plus five additional **BBSB2025SFEXT**. See drawing to left.

CONSULT A BISON PRODUCT SPECIALIST FOR ASSISTANCE.

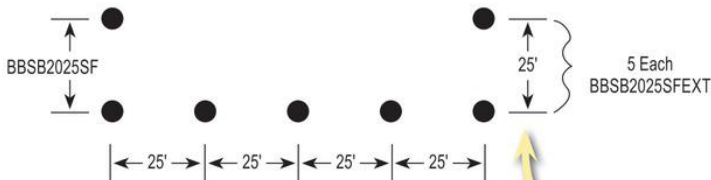

EXAMPLE ORDER





# BASEBALL/SOFTBALL PORTABLE SPORTS FENCING

**New for  
2025**

Make the most of your baseball and softball fields without sacrificing a professional look. Super Fence™ allows outfield fences to cater to little league on the same field one day and high school or collegiate play the next day avoiding flimsy, cheap looking portable fence options that are on the market today. 4' high x 8' long sections roll on ballasted No Tip rear drums for easy movement on natural or artificial turf and pin together to create fences of any length and radius.

Choose from full graphic padded, solid color padded, wire mesh graphic windscreen or solid windscreen options or any combination. Since there is no protruding hardware or sharp top edges like on chain-link fences there is no need for separate top protective padding.



Any Length... Any Radius

One Person Setup

All Super Fence models are designed with fully welded 1 5/8" round aluminum front frames, 1 5/8" galvanized steel rear support structure, and roll easily on two 11" diameter molded ballast drums that are filled with sand in the field for stability and safety. 4' high by 8' long sections are connected by two pins and allow sections to be placed in straight lines or in typical outfield radius. All Super Fence models can be used in combination with other Super Fence models to form a single outfield fence. **Some field assembly is required.**

## Graphic Padded Super Fence

Fence face is constructed of 1" thick weatherproof polyethylene foam bonded to 1/2" thick rigid ACRE composite construction sheeting and covered with a full color graphic image printed on 18 oz. vinyl to add flair to your outfield fencing. Bison art department will work with you to design appropriate images. Order **BBSB4X8SFG**.



Graphic Padded



Solid Color Padded

## Solid Color Padded Super Fence

Same structural design as Graphic Padded Super Fence above but with solid color 18 oz. vinyl in your choice of colors found on page 102. Order **BBSB4X8SFS**.

## Graphic Windscreen Super Fence

On many ballfields a heavy printed windscreen is the appropriate face on the outfield fence. Windscreens mesh comes in many colors and can be printed with full color images with the help of Bison's talented art department staff. Windscreens are supported with rear structural members to avoid excessive wind impact. Order **BBSB4X8SFGW**.



Graphic Windscreen



Solid Color Windscreen

## Solid Color Windscreen Super Fence

Same design as Graphic Windscreen Super Fence above except with solid color windscreen. This is our lowest cost Super Fence option. Order **BBSB4X8SFSW**.

## Wire Mesh Super Fence

These sections have a front face of 2" x 2" square, 11 ga., powder coated, welded wire mesh panels and frames that can be powder coated in any one of the colors found on page 102. Order **BBSB4X8SFM**.



Wire Mesh

## How to Order

Bison Super Fence™ comes in sections that are 8' in length and are priced by the section • Baseball and softball fields vary based on level of play and actual field layout so each fence requirement is different • Always purchase enough sections of fencing to accommodate the highest level of play when fencing is being moved for different levels of play • If the distance to the centerfield fence from the back of home plate is the same in left field and right field, multiply that number by 1.6 to get the total length of the outfield fence • For example, a typical High School baseball fence measures 300' from the back of home plate to center field so 300' x 1.6 = 480 feet • 480 feet divided by 8 feet per section indicates a need for 60 sections • By comparison, the distance for Little League Major Division is 200' resulting in the need for 40 sections • Irregular fields require additional information to confirm sections needed • Consult your field architect or measure your existing field for exact outfield fence requirements.



800-247-7668



www.bisoninc.com

41



# BASEBALL/SOFTBALL BACKSTOPS

**New for 2025**

Bison Baseball and Softball Backstops are super heavy and built to last. The unique 3/2" diameter galvanized gooseneck "hooded" design eliminates connection points that add complexity to installation and are prone to failure. The vertical height is approximately 12' and the 45° "hood" extends approximately 7' for excellent ball retainment and safety. Horizontal support tubes are 1 5/8" diameter galvanized tubing. Order Backstop Safety Padding separately. All vertical and hood sections are covered with commercial 9 ga. galvanized chain link mesh attached with 100% galvanized hardware. See chart for design options including PE fabric mesh options.



Gooseneck 45° Hood



## Straight Backstops

As the name implies, Bison Straight Backstops are the same as Bison Winged Backstops but without the wings. Straight Backstops satisfy the needs of many field designs at a lower cost. All Straight Backstops include 12' vertical height with approximately 7', 45° hood completely covered with commercial grade 9 ga. chain link mesh. See chart to choose between 18' and 24' options.

## Winged Backstops

Bison Winged Backstops add 6', 45° wings to each end of the straight section for added safety and foul ball retainment. All straight sections, including the 45° hood, are covered with 9 ga. chain link mesh. Wings are approximately 12' high without hoods. See chart to choose between 18' straight length or 24' straight length winged backstops.

## Backstop Safety Padding

Protect players with 3" thick polyurethane foam covered with outdoor durable 18 oz. vinyl in a wide range of solid colors, or let Bison's Art Department design an eye-popping, full color graphic image. Priced by the square foot.



Premium 4mm 1 1/8" PE Knotless Mesh



Bison Backstop Chart NOTE: ALL DIMENSIONS ARE APPROXIMATE.						
Model Number	Vertical Height	45° Hood Extension	Straight Length	Approx. Upright Spacing	Wings	Wing Width (ea.)
BBSBSTOP30W	12'	7'	18'	6'	Yes	6'
BBSBSTOP36W	12'	7'	24'	6'	Yes	6'
BBSBSTOP18S	12'	7'	18'	6'	No	N/A
BBSBSTOP24S	12'	7'	24'	6'	No	N/A
BBSBSTOP25MS	20'	N/A	25'	25'	No	N/A
BBSBSTOP75MW	20'	N/A	25'	25'	Yes	25'

## Mesh Backstops

Many facilities prefer fabric mesh backstop netting. Bison's 4mm knotless PE mesh has 1 1/8" square openings and is superior to many other mesh netting systems. The support structure includes 3/2" diameter galvanized vertical posts on approximately 25' and 1/4" aircraft support cable. Bison PE Mesh Backstops are all 20' high and 25' wide. Select with or without additional 25' wide wings on each side. See the chart for design options.

Bison offers a variety of indoor and outdoor portable bleachers and permanent and portable player benches. Details can be found on pages 78-80.



## Approximate Backstop Upright Placement





**New for 2025**



**BBSBBASE Premium Molded Base Set**

Dense foam interior has a permanently molded  $\frac{3}{16}$ " thick exterior white rubber cover for maximum durability • Galvanized steel subframe fits securely in ground anchors permanently embedded in the field • Set includes three official size 15" x 15" x 3" bases with subframes, 3 ground anchors, and 3 ground plugs for when bases are not in use to keep out dirt and rain.



**BBSBHPLATE Premium Molded Home Plate Kit**

Official size and shape, hard molded rubber • White with black edge trim • Galvanized steel under carriage • Includes ground anchor that gets permanently installed in the field for easy removal of home plate.



**BBSBPMOUND Four Square Pitcher's Mound**

White Shore A 90 durometer molded urethane • Official 6" x 6" x 24" size • 4 usable surfaces to allow rotation to extend life even with extraordinary use • Includes center tubular steel core to maintain shape in all weather.



**BBSBSCREEN Baseball Pitcher's Safety Screen**

Protect your pitcher during batting practice either on the field or in a practice cage • 7' x 7' with  $3\frac{1}{2}$ ' x  $3\frac{1}{2}$ ' opening in the top corner • Reversible for LH and RH pitchers • Heavy galvanized steel framework and legs • Easy to install 2.5mm black polyethylene mesh net.



**BBSBSCREEN Softball Pitcher's Safety Screen**

Protective screen with relief on one side to account for all softball pitcher's throwing motion • Reversible for LH or RH pitchers • Heavy galvanized 7' x 7' steel framework and legs • 2.5mm black polyester mesh net.



**BBSBSCREENWK Wheel Kit for Bison Pitcher's Safety Screens**

Add 2 wheels to any Bison protection screen for added transport convenience.



**BBSBDM Infield Drag Mat**

Heavy galvanized steel mat is constructed of  $\frac{3}{8}$ " x  $\frac{1}{16}$ " steel and is 72" wide and 36" long to make grooming of infield fast and efficient • Includes 6' drag bar and rope for pulling behind field vehicle or manual use • Rolls up easily for storage when not in use.



800-247-7668



www.bisoninc.com





# HOW TO SELECT YOUR NEXT VOLLEYBALL SYSTEM



Measuring Video

With 13 options to choose from if Bison doesn't offer the perfect option for your facility, it probably doesn't exist. Consider these factors before you buy.

**Net Height Adjustment Ease** Fine tuning of the net height to meet volleyball rules can be time consuming and irritating especially for inexperienced net system setup staff. Some manufacturers including Bison offer net systems that allow small net height adjustments with an integrated hand operated adjustment lead screw with only minor or no reduction in net tension. See Bison VB1100 and VB7000 for Bison options.

**Winch Durability** The winch is the "heart" of a volleyball system and is critical to providing proper net tensioning, smooth operation, and long-term durability. Bison has always offered a **lifetime warranty** on the winches we include with all 3" diameter carbon fiber, aluminum, and steel posts and we recently made additional design and assembly improvements to this winch to further reduce the risk of failure in the field. We have also expanded our in-house testing to insure that every winch that leaves our facility will match the quality that our customers deserve. Is there any reason to buy a volleyball system that doesn't have a lifetime post and winch warranty?

**Floor Attachment** Most programs want the convenience of posts that drop into floor sockets permanently mounted in the floor. Some gymnasiums, such as upper level gyms, facilities with portable floors or ice refrigerant lines in the sub floor, however, are difficult if not impossible to fit with floor sockets. In these cases, portables that only require floor anchors might be preferable. Truly portable systems (no floor anchoring) are available and generally have a higher price tag and/or require significantly more storage area.

**Post Weight** Starting in the 1990's, lightweight aluminum posts gained popularity due to their relative ease of set up and storage. Some buyers have, however, become disenchanted with their aluminum systems due to lack of durability and rigidity. The value of lightweight posts will depend upon how often you set up and tear down your equipment and, in the case of many manufacturers, your tolerance for excess post deflection when the net is tensioned. Some aluminum systems outperform those from other manufacturers. The newest technology available uses carbon fiber to achieve lighter than aluminum, as stiff as steel results.

**Deflection** For ideal playability, the top rope of a competition net is usually tensioned between 150# and 250#, depending on the system. This tension causes some inward deflection of even the most rigid steel posts. Excessive deflection makes net tensioning and net height adjustment difficult and results in unsightly bent posts. Choose a system that you feel balances weight, features and deflection. Steel and carbon fiber posts are most rigid. Aluminum posts are less rigid and deflection varies greatly from manufacturer to manufacturer.

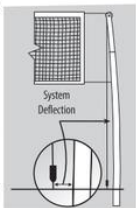

**Program Level** Your needs will vary depending upon the intended level of play. Systems with telescoping net height adjustment, where the top of the net is always level with the top of the posts, are most popular with collegiate and elite high school programs. Other systems that offer features like tennis to volleyball height adjustment are common for programs that want to use the same systems for competition power volleyball one day and recreation and physical education classes the next. Generally these systems offer not only versatility but also tight budget affordability.

**Post Size** If you are installing a new system including floor sockets, the size of the selected posts will automatically match your new sockets. Retrofitting new systems into existing sockets, however, requires purchasing posts to match your sockets. There are three competition sizes in the industry: 3", 3 1/2" and 4" (100mm). Most manufacturers offer adapters which allow you to put smaller posts into bigger sockets. Some are free (including Bison's), others are at an additional cost. Installation of large posts in small sockets is possible but not ideal. Check with the manufacturer before you buy. Totally replacing existing sockets is an undesirable and expensive option in most cases. See page 62 for options.

**Transport and Storage** In a perfect world, you would snap your fingers and your volleyball system would magically appear. While it's not a perfect world, your equipment selection will, in large part, determine your future set up time and efforts. If you are selecting from the wide range of other transportable pole systems, consider issues such as pole weight, available storage and transport dollies to make the best decision for your program.

**Budget** There is a wide range of systems that meet all applicable NCAA, National High School Federation and USVBA rules. Like any equipment, the amount you wish to spend depends upon your budget and the features your program needs. Generally, you pay more for the convenience of lightweight aluminum. New high tech carbon fiber systems are priced above aluminum but have many additional features including superior resistance to deflection.

**Post Padding** Most programs want padding to match their school or facility colors. Some manufacturers offer limited colors or charge extra for expanded color options. Adding lettering to the padding is now very popular as it helps increase school spirit and improves the look of your courts. By and large, stick-on vinyl letters are not a good long-term lettering option as they will curl over time. **Most complete Bison systems ordered offer printed lettering or, in some cases, full color graphic padding at no extra charge. Bison also offers optional full color graphic padding as an upgrade option.**

**Warranty** You'll want to know that the manufacturer will stand behind the product in the event of needed repairs or part replacement. Look for written warranties and buy from manufacturers who have a strong reputation for dependable customer service. **Purchasing through a local dealer is not only friendly to the local economy but improves your service when you need help.**





# VOLLEYBALL COMPARISON CHART

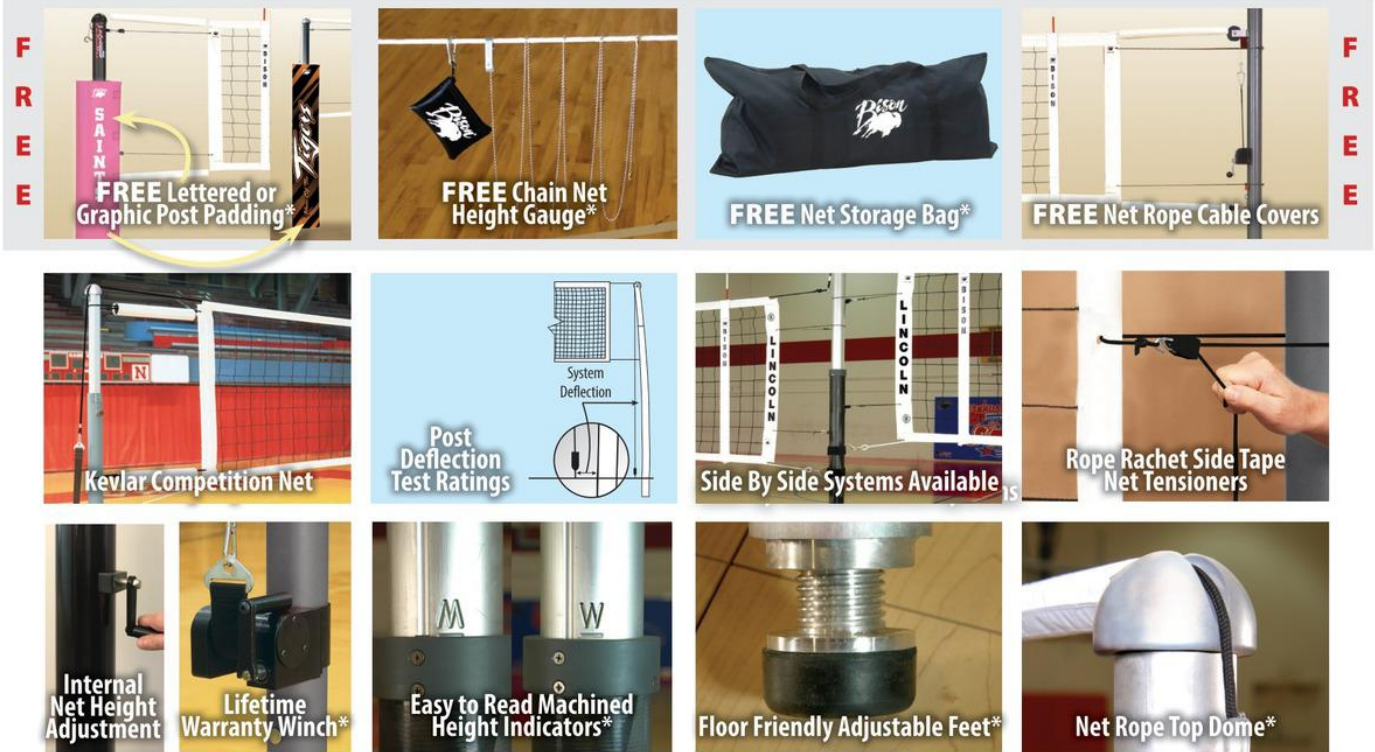

**F  
R  
E  
E**

**F  
R  
E  
E**

**FREE Lettered or Graphic Post Padding\***

**FREE Chain Net Height Gauge\***

**FREE Net Storage Bag\***

**FREE Net Rope Cable Covers**

**Kevlar Competition Net**

**Post Deflection Test Ratings**

**Side By Side Systems Available**

**Rope Ratchet Side Tape Net Tensioners**

**Internal Net Height Adjustment**

**Lifetime Warranty Winch\***

**Easy to Read Machined Height Indicators\***

**Floor Friendly Adjustable Feet\***

**Net Rope Top Dome\***

*\*on most systems*

## COMPARE FEATURES BEFORE YOU BUY YOUR NEXT SYSTEM



Video

	CarbonLife VB7222	CarbonMax VB7000	Lady CarbonMax VB3000	Centerline Aluminum VB1000	Centerline Aluminum EZ VB1100	Centerline Steel Hybrid VB2000	Match Point Aluminum VB6000	Arena II Portable VB8100	Arena JR Portable VB8100JR	QwikCourt Portable VB8200	QwikCourt Portable VB8250
<b>Post Material</b>	Carbon Fiber	Carbon Fiber	Carbon Fiber	Aluminum	Aluminum	Steel/Aluminum	Aluminum	Steel	Steel	Aluminum	Aluminum
<b>Post Diameter</b>	3"	3½" above floor	3½" above floor	3"	3"	3"	3½"	3"	3"	3"	3½"
<b>Post Weight w/o Winch</b>	16#	32#	19#	34#	39#	61#	39#	N/A	N/A	N/A	N/A
<b>Post Weight w/ Winch</b>	21#	37#	24#	39#	44#	66#	43#	N/A	N/A	N/A	N/A
<b>Net Height Range (Approx.)</b>	72" to 98"	78" to 98"	87" to 89"	72" to 98"	72" to 96"	72" to 98"	42" to 96"	80" to 98"	84" to 98"	72" to 98"	72" to 98"
<b>Net Height Adjustment</b>	Telescoping	Internal Lead Screw	Foot Pad Only	Spring Assisted Telescoping	Internal Lead Screw	Spring Assisted Telescoping	Slider Bar	Spring Assisted Telescoping	Spring Assisted Telescoping	Spring Assisted Telescoping	Sliding Track
<b>Approx. Deflection*</b>	1.50"	.98"	1.25"	1.97"	1.35"	1.25"	2.81"	.50"	1.25"	2.00"	2.00"
<b>Side-by-Side Option Available</b>	Yes	Yes	Yes	Yes	Yes	Yes	Yes	Yes	Yes	No	No
<b>Pole and Winch Warranty</b>	Lifetime Limited	Lifetime Limited	Lifetime Limited	Lifetime Limited	Lifetime Limited	Lifetime Limited	10-Year Limited	Lifetime Limited	Lifetime Limited	Lifetime Limited	10-Year Limited
<b>Relative Cost</b>	\$\$\$\$\$	\$\$\$\$\$	\$\$\$\$	\$\$\$	\$\$\$	\$\$\$	\$\$	\$\$\$\$\$\$\$\$\$	\$\$\$\$\$\$\$\$\$	\$\$\$\$\$	\$\$\$\$

\*Compare to some popular aluminum systems with 3"+ of deflection.



800-247-7668



www.bisoninc.com

45





Bison Exclusive Top Rope Dome

Special 2½" Aluminum Extrusion Shape



Centerline Aluminum Standard



Common Aluminum Standard

Spring Assisted Telescoping Net Height Adjustment

Permanently Engraved Net Height Indicators

Lock Pin at Junior, Women's and Men's Height

Lock Knob for Infinite Height Adjustment

34# Non-Winch Post Weight  
39# Winch End Post Weight

Adjustable Velcro Bottom Rope Strap

Bottom Rope Ratchet Tensioner

Forever™ Lifetime Warranty Winch

Special 3" Aluminum Extrusion Shape

Durable Silver-Gray Powder Coated Finish

1.97" Post Deflection at 250# Net Tension

Floor Friendly Adjustment Feet

## VB1000 Centerline® Elite Aluminum

Division I college and elite high school programs that desire the perfect balance between weight, cost and post deflection have made this a top seller. The most rigid aluminum system on the market, this 34# telescoping post fits any 3" floor sockets.

### Additional Popular Features on Complete Systems:

- Kevlar Competition Net
- VB13 Antennas and Boundary Tapes
- Rope Ratchet Side Tape Tensioners
- Available as Side-by-Side Court Option
- Free 1 Color Lettered Post Padding
- Free Net Storage Bag
- Free Net Rope Cable Covers
- Free Chain Net Height Gauge
- Free Socket Adapters (on request)
- Substitute VB10C and VB100C Posts for use in Existing 17/8" Floor Sockets
- Order VB51PGUP to Upgrade to Graphic Post Padding



Video



"Steel is great in cars or buildings, but when the University of Arizona volleyball team practices in the Wildcats basketball arena, we got tired of hauling the heavy systems in and out. I'd never considered aluminum systems because of negative comments from other coaches. I am now a firm believer that weight alone is not the measure of a quality volleyball system. While Centerline Elite aluminum standards won't make our team better, it has made our equipment managers happier."



**Dave Rubio**, Head Women's Volleyball Coach  
University of Arizona

Model #	Description
VB1000	Complete system includes posts with padding, net tensioning winch, VB1250K competition net with cable covers, antennas with boundary tapes, and VB23 floor sockets.
VB1000NS	Same as VB1000 without floor sockets.
VB1002	Complete side-by-side double court system includes 3 posts with padding, 2 winches, 2 nets, 2 pairs of antennas, and 3 floor sockets.
VB1002NS	Same as VB1002 without floor sockets.
VB10	Posts and winch only. Order padding, net, antennas, and floor sockets separately.
VB100	Court adder increases the number of side-by-side courts and includes post and winch only. Order other components separately. Call for details.





## VB1100 Centerline® Aluminum EZ

EZ features the same basic design as our popular VB1000 telescoping aluminum Centerline System but with the added convenience of an internal lead screw that allows fine tuning of the net height with the simple turn of a handle on the pole usually with minimal or no net tension reduction. 39# post fits in all manufacturers' 3" floor sockets.



### Additional Popular Features on Complete Systems:

- Kevlar Competition Net
- VB13 Antennas and Boundary Tapes
- Rope Ratchet Side Tape Tensioners
- Available as Side-by-Side Court Option
- Free 1 Color Lettered Post Padding
- Free Net Storage Bag
- Free Net Rope Cable Covers
- Free Chain Net Height Gauge
- Free Socket Adapters (on request)
- Order VB51PGUP to Upgrade to Graphic Post Padding



Video



"When bringing the volleyball program back to our school after many years without, we were in need of a modern, reliable, and easy to set up system. Working with our local dealer, we chose Bison VB1100, Centerline EZ system for its lightweight aluminum standards, easy internal net height adjustment system, and free lettered padding. It's great to have volleyball back at Elba Central School, and to be using a great Bison system."



**Mark Beehler**, Athletic Director  
Elba Central School, Elba, New York

Model #	Description
VB1100	Complete system includes posts with padding, net tensioning winch, VB1250K competition net with cable covers, antennas with boundary tapes, and VB23 floor sockets.
VB1100NS	Same as VB1100 without floor sockets.
VB1102	Complete side-by-side double court system includes 3 posts with padding, 2 winches, 2 nets, 2 pairs of antennas and 3 floor sockets plus.
VB1102NS	Same as VB1102 without floor sockets.
VB11	Posts and winch only. Order padding, net, antennas and floor sockets separately.
VB110	Court adder increases the number of side-by-side courts and includes post and winch only. Order other components separately. Call for details.

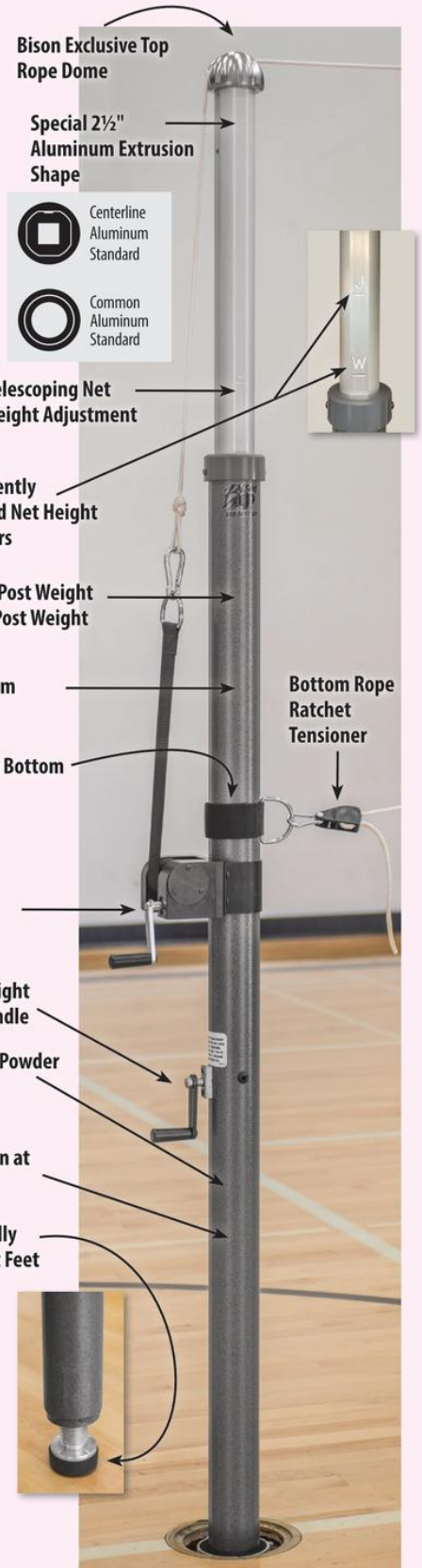





# CENTERLINE™ STEEL HYBRID VOLLEYBALL SYSTEMS



Bison Exclusive Top Rope Dome

Spring Assisted Telescoping Net Height Adjustment

2 1/2" Diameter Aluminum Inner Tube

Permanently Engraved Net Height Indicators

Lock Pin at Junior, Women's and Men's Height

Lock Knob for Infinite Height Adjustment

61# Non-Winch Post Weight  
66# Winch End Post Weight

Adjustable Velcro Bottom Rope Strap

Bottom Rope Ratchet Tensioner

Forever™ Lifetime Warranty Winch

3" Diameter Steel Outer Tube

Durable Silver-Gray Powder Coated Finish

1.25" Post Deflection at 250# Net Tension

Floor Friendly Adjustment Feet



## VB2000 Centerline® Elite Steel Hybrid

Some programs set up and tear down courts infrequently and prefer the maximum rigidity of a heavy steel system. At 61#, this 3" telescoping post design allows the least pole deflection possible at a cost below comparable carbon fiber or aluminum systems.

### Additional Popular Features on Complete Systems:

- Kevlar Competition Net
- VB13 Antennas and Boundary Tapes
- Rope Ratchet Side Tape Tensioners
- Available as Side-by-Side Court Option
- Free 1 Color Lettered Post Padding
- Free Net Storage Bag
- Free Net Rope Cable Covers
- Free Chain Net Height Gauge
- Free Socket Adapters (on request)
- Order VB51PGUP to Upgrade to Graphic Post Padding



Video



Model #	Description
VB2000	Complete system includes posts with padding, net tensioning winch, VB1250K competition net with cable covers, antennas with boundary tapes, and VB23 floor sockets.
VB2000NS	Same as VB2000 without floor sockets.
VB2002	Complete side-by-side double court system includes 3 posts with padding, 2 winches, 2 nets, 2 pairs of antennas, and 3 floor sockets.
VB2002NS	Same as VB2002 without floor sockets.
VB20	Posts and winch only. Order padding, net, antennas, and floor sockets separately.
VB200	Court adder increases the number of side-by-side courts and includes post and winch only. Order other components separately. Call for details.





## VB7222 CarbonLite™ Composite

At 16#, the lightest weight competition volleyball post on the market making it perfect for facilities where set up is frequent. The 3" outer post and telescoping inner post are constructed of computer wound carbon fiber resulting in a superior weight to post rigidity ratio. Fits all manufacturers' 3" floor sockets.



### Additional Popular Features on Complete Systems:

- Kevlar Competition Net
- VB13 Antennas and Boundary Tapes
- Rope Ratchet Side Tape Tensioners
- Available as Side-by-Side Court Option
- Free Full Color Graphic Post Padding
- Free Net Storage Bag
- Free Net Rope Cable Covers
- Free Chain Net Height Gauge
- Free Socket Adapters (on request)



Video

"As a long time Bison dealer, we have always appreciated the quality they design into every product. As the volleyball industry moved toward light weight carbon fiber poles, we looked to Bison to fill our needs. The Bison CarbonLite Volleyball System has more than satisfied our customers who are looking for an extremely light weight yet rigid and durable system for their courts."

**Paul Speth**, President  
Badger Sporting Goods, Madison, WI



Model #	Description
VB7222	Complete system includes posts with padding, net tensioning winch, VB1250K competition net with cable covers, antennas with boundary tapes, and VB23 floor sockets.
VB7222NS	Same as VB7222 without floor sockets.
VB7202	Complete side-by-side double court system includes 3 posts with padding, 2 winches, 2 nets, 2 pairs of antennas, and 3 floor sockets.
VB7202NS	Same as VB7202 without floor sockets.
VB72	Posts and winch only. Order padding, net, antennas, and floor sockets separately.
VB722	Court adder increases the number of side-by-side courts and includes post and winch only. Order other components separately. Call for details.

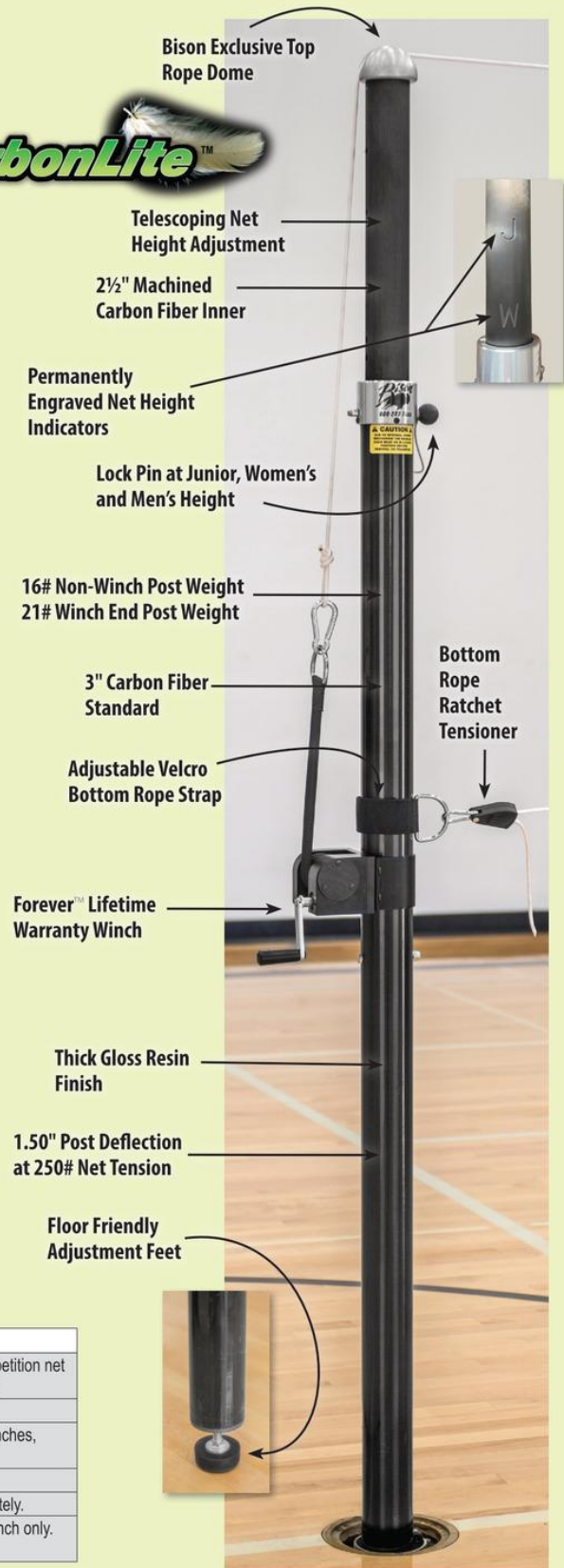

800-247-7668



www.bisoninc.com

49





## VB7000 CarbonMax® Composite

The only carbon fiber volleyball system with a crank style internal net height adjustment feature for easy and accurate net fine tuning. 32# post fits in 3" floor sockets.

### Additional Popular Features on Complete Systems:

- Kevlar Competition Net
- VB13 Antennas and Boundary Tapes
- Rope Ratchet Side Tape Tensioners
- Available as Side-by-Side Court Option
- Free Full Color Graphic Post Padding
- Free Net Storage Bag
- Free Net Rope Cable Covers
- Free Chain Net Height Gauge
- Free Socket Adapters (on request)



Video



"Our Division I program is a perennial National Championship contender, and we work hard to provide our players with superior equipment. As a longtime user of Bison Centerline Elite Aluminum Systems, we thought we had the best...that was until we discovered CarbonMax. Our equipment manager loves the lightweight design that doesn't compromise on rigidity. The ability to adjust the net height with the turn of a crank without loosening the net is an added bonus."

**John Cook** Head Women's Volleyball Coach,  
University of Nebraska 2017 NCAA Division I  
Champions, and AVCA Hall of Fame Member

Model #	Description
VB7000	Complete system includes posts with padding, net tensioning winch, VB1250K competition net with cable covers, antennas with boundary tapes, and VB23 floor sockets.
VB7000NS	Same as VB7000 without floor sockets.
VB7002	Complete side-by-side double court system includes 3 posts with padding, 2 winches, 2 nets, 2 pairs of antennas, and 3 floor sockets.
VB7002NS	Same as VB7002 without floor sockets.
VB70	Posts and winch only. Order padding, net, antennas, and floor sockets separately.
VB700	Court adder increases the number of side-by-side courts and includes post and winch only. Order other components separately. Call for details.





## VB3000 Lady CarbonMax® Composite

This one-piece 100% carbon fiber post is the popular choice for facilities that want a system exclusively for use at women's net height. With no net height adjustment to worry about, set up is quick and foolproof. 19# post installs in any 3" floor sockets.



### Additional Popular Features on Complete Systems:

- Kevlar Competition Net
- VB13 Antennas and Boundary Tapes
- Rope Ratchet Side Tape Tensioners
- Available as Side-by-Side Court Option
- Free 1 Color Lettered Post Padding
- Free Net Storage Bag
- Free Net Rope Cable Covers
- Free Chain Net Height Gauge
- Free Socket Adapters (on request)
- Order VB51PGUP to Upgrade to Graphic Post Padding



Video



"Our volleyball coach loves Bison's Lady CarbonMax composite volleyball system. We've used this system for a few seasons now and are pleased with its trouble-free performance. The standards are very easy to set up, they're lightweight and dependable."

**Bill Clements** Activities Director,  
Dakota Valley High School  
North Sioux City, SD



Model #	Description
VB3000	Complete system includes posts with padding, net tensioning winch, VB1250K competition net with cable covers, antennas with boundary tapes, and VB23 floor sockets.
VB3000NS	Same as VB3000 without floor sockets.
VB3002	Complete side-by-side double court system includes 3 posts with padding, 2 winches, 2 nets, 2 pairs of antennas, and 3 floor sockets plus.
VB3002NS	Same as VB3002 without floor sockets.
VB30	Posts and winch only. Order padding, net, antennas, and floor sockets separately.
VB300	Court adder increases the number of side-by-side courts and includes post and winch only. Order other components separately. Call for details.

Bison Exclusive Top Rope Dome

19# Non-Winch Post Weight  
24# Winch End Post Weight

3½" Carbon Fiber Standard

Adjustable Velcro Bottom Rope Strap

Forever™ Lifetime Warranty Winch

Thick Gloss Resin Finish

1.25" Post Deflection at 250# Net Tension

Floor Friendly Adjustment Feet

3" Aluminum Floor Insert

Bottom Rope Ratchet Tensioner



800-247-7668



www.bisoninc.com

51





- Durable Silver-Gray Powder Coated Finish
- Top Rope Net Pulley
- Tennis to Men's Volleyball Net Height Adjustment
- Field Installed Net Height Label
- Backlash Free Winch
- Lock Knob for Infinite Height Adjustment
- Bottom Rope Ratchet Tensioner
- 39# Non-Winch Post Weight  
43# Winch End Post Weight
- 3 1/2" Aluminum Extrusion Standard
- 2.81" Post Deflection at 250# Net Tension
- Floor Protection Cap

## VB6000 Match Point™ Aluminum

Designed for high schools on a budget, rec centers or any facility that wants a lightweight yet durable power volleyball system. The unique 43" to 96" infinite net height adjustment track allows competition volleyball and PE tennis or pickleball on the same system. The 39# post fits in all 3 1/2" diameter floor sockets.

\* Ask about adapters for smaller existing floor sockets.

### Additional Popular Features on Complete Systems:

- Kevlar Competition Net
- VB13 Antennas and Boundary Tapes
- Rope Ratchet Side Tape Tensioners
- Available as Side-by-Side Court Option
- Free 1 Color Lettered Post Padding
- Free Socket Adapters (on request)
- Substitute VB60C and VB600C Posts for use in Existing 17/8" Floor Sockets
- Order VB51PGUP to Upgrade to Graphic Post Padding



Video

"When we were looking for an affordable yet durable, versatile, and easy to set up volleyball system for our volleyball program, we stumbled onto the Bison VB6000 Match Point, aluminum system. Our volleyball coaches are extremely pleased with the performance, and it is the perfect fit for our program and our budget."

**Jeff Hines**  
Dean of Students, Chambers Academy  
Lafayette, Alabama



Model #	Description
VB6000	Complete system includes posts with padding, net tensioning winch, VB1250KU competition net, antennas with boundary tapes, and VB26 floor sockets.
VB6000NS	Same as VB6000 without floor sockets.
VB6050	Recreational system includes posts, net tensioning winch, VB1250KU competition net, and VB21 floor sockets for tile, concrete, or synthetic floors (upgrade to VB26 floor sockets for floating floors at an additional cost).
VB6050NS	Same as VB6050 without floor sockets.
VB6002	Complete side-by-side double court system includes 3 posts with padding, 2 winches, 2 nets, 2 pairs of antennas, and 3 VB26 floor sockets.
VB6002NS	Same as VB6002 without floor sockets.
VB60	Posts and winch only. Order padding, net, antennas, and floor sockets separately.
VB600	Court adder increases the number of side-by-side courts and includes post and winch only. Order other components separately. Call for details.





## VB8100 Arena II™ Freestanding Portable

Large arenas and multiuse facilities where elite level volleyball is played but where floor sockets or anchors are difficult, expensive or impossible due to ice rink refrigerant lines, portable flooring systems, upper floor location or other constraints may find this system an excellent option.

### Popular Features on Complete Systems:

- Factory Ballasted (700# ) for Maximum Net Tension
- Kevlar Competition Net
- VB13 Antennas and Boundary Tapes
- Rope Ratchet Side Tape Tensioners
- Available as Side-by-Side Court Option
- Free 1 Color Lettered Padding
- Free Net Storage Bag
- Free Net Rope Cable Covers
- Free Chain Net Height Gauge
- Meets NCAA and NFHS Rules

**NOTE: NOT WARRANTED FOR OUTDOOR USE.**



VB8102 Side-by-Side



Video



**Forklift or dock required for delivery. Contact Bison for other off-loading options.**



## VB810 Arena™ Court Adder

Want more side-by-side courts?...Order as many Arena Court Adder center posts as you wish • Each court adder includes base, pole, net tensioning winch and transport dolly • Order net, antennae and VB810P padding system (specify color) separately • Only for use as center post on Arena II, Arena Jr and QwikCourt Volleyball Systems • **Lifetime limited warranty** on post and winch (no pole or padding) • **Order VB810P for complete Arena Court Adder base and post padding** • **Order VB810BASE for base only.**

"We've used the Bison Centerline Aluminum Volleyball System for years in our program and have loved it. A major facility renovation forced us to move to temporary quarters for a season and we faced the dilemma of using a portable floor in a facility with no floor sleeves. Bison's Arena II Volleyball System worked perfectly for us. It provided us the free standing portability needed without sacrificing net rigidity, ease of set up, player safety or overall quality. And, it looks AWESOME!"

**Debbie Brown**  
Former Head Volleyball Coach,  
University of Notre Dame and AVCA Hall of Fame Member



Model #	Description
VB8100	Complete system includes internally-ballasted "down official" and "platform" end bases with padding, net tensioning winch, VB1250K competition net with cable covers, and antennae with boundary tapes.
VB8102	Complete side-by-side double court system includes end bases with padding, padded center post with transport dolly, 2 winches, 2 nets, and 2 pairs of antennae.
VB8102DJ	Same as VB8102 except both end bases have built-in official's platforms.
VB810	Center post and winch with transport dolly. Add any number of side-by-side courts to VB8100, VB8102, or VB8102DJ. Order VB810P center post padding, nets, and antennae separately.



VB810

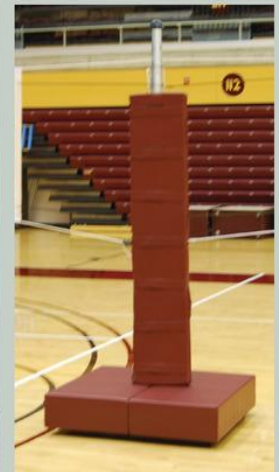

VB810



800-247-7668



www.bisoninc.com

53



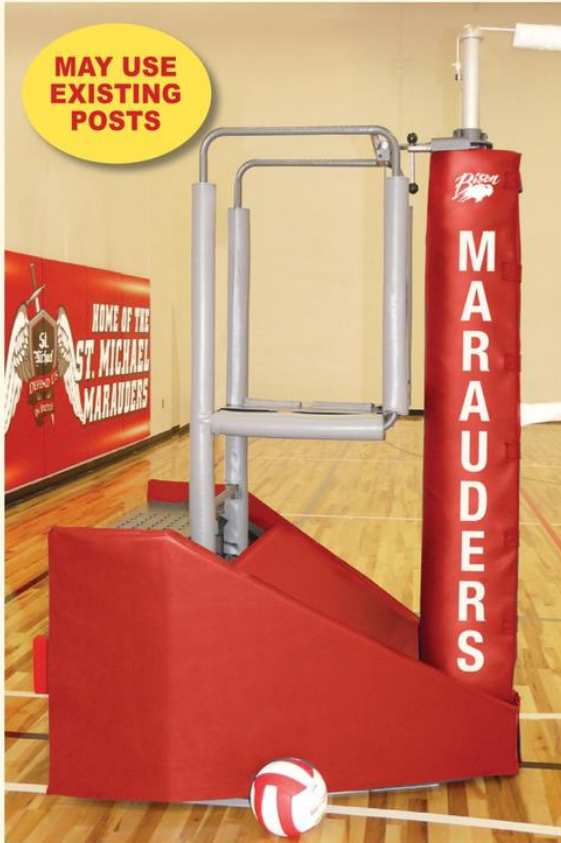

Order optional VB73A Officials Platform (shown) separately.

## VB8100JR Arena™ JR Freestanding Portable

Truly portable with no anchor or loose ballast and a super streamlined base. Complete system includes 3" Centerline® aluminum pole system that can be used both in the bases and in gym floor sockets. Order just the VB80JR padded bases to use with your own 3", 3½" or 4" poles.

**Substitute VB10T/VB100T for shortened posts if you intend to use posts only in the portable bases.**

### Popular Features on Complete Systems:

- Kevlar Competition Net
- VB13 Antennas and Boundary Tapes
- Rope Ratchet Side Tape Tensioners
- Available as Side-by-Side Court Option
- Free 1 Color Lettered Post Padding
- Free Net Storage Bag
- Free Net Rope Cable Covers
- Free Chain Net Height Gauge



Video

**NOTE: NOT WARRANTED FOR OUTDOOR USE.**

Forklift or dock required for delivery. Contact Bison for other off-loading options.



Transport Dolly

## VB810 Arena™ Court Adder

Want more side-by-side courts?...Order as many Arena Court Adder center posts as you wish • Each court adder includes base, pole, net tensioning winch and transport dolly • Order net, antennae and VB810P padding system (specify color) separately • Only for use as center post on Arena II, Arena Jr and QwikCourt Volleyball Systems • **Lifetime limited warranty** on post and winch (no pole or padding) • Order VB810P for complete Arena Court Adder base and post padding • Order VB810BASE for base only.



VB810



VB810P

"The Nebraska School Activities Association highly recommends Bison's Arena Jr. portable system. The system is perfect for the NSAA State Volleyball Championships held at Pinnacle Bank Arena as there is no need for anchors or loose ballast, is easy to setup, and provides great net tension with an unobstructed view for fans and coaches."

**Jennifer Schwartz**  
NSAA Associate Director



Model #	Description
VB8100JR	Complete system includes 2 end bases with transport dolly, 2 posts, net tensioning winch, VB1250K competition net with cable covers, and antennas with boundary tapes.
VB8102JR	Complete side-by-side double court system includes 2 padded end bases with transport dolly, 1 padded center post with transport dolly, 3 posts with padding, 2 winches, 2 nets, and 2 pairs of antennas.
VB810JR	Center post base, post and winch only. Add any number of side-by-side courts to VB8100JR. Order VB810P padding, nets, and antennas separately.
VB80JR	One pair of bases with base and post padding only. Customer supplies posts, net, and antennas.





## VB8200/VB8250 QwikCourt™ Portable

Bison's lowest cost self-contained portable volleyball base system. Perfect for use where socket installation is not feasible but an affordable competition or recreational volleyball system is needed for long term or temporary use. Bases can be used with virtually any post system.

### VB8200 QwikCourt™ Centerline

When your facility needs a relatively low cost competition system in areas where floor sockets are impractical or impossible.

### VB8250 QwikCourt™ Match Point

When you want a reliable portable volleyball system for recreational use when floor sockets are not available.

### VB82P Optional Colored Padding System for QwikCourt

Substitute one of the colors of padding found on page 102 of catalog for the standard black padding on QwikCourt at an additional cost.

### Popular Features on Complete Systems:

- Kevlar Competition Net
- VB13 Antennas and Boundary Tapes
- Rope Ratchet Side Tape Tensioners
- Free 1 Color Lettered Post Padding
- Free Net Storage Bag
- Free Net Rope Cable Covers
- Free Chain Net Height Gauge
- Free Socket Adapters (on request)
- Order VB73A or VB76 for compatible officials platforms

### VB8200BLST QwikCourt™ Ballast Kit

Eighteen 4" x 8" x 16" solid concrete cap blocks to properly ballast QwikCourt™ volleyball systems.

**NOTE: NOT WARRANTED FOR OUTDOOR USE.**

### WARNING!

All QwikCourt Portable Volleyball Systems require installation of eighteen 4" x 8" x 16" solid concrete cap blocks prior to use. Failure to install the specified weight could result in serious player injury and unsatisfactory net tensioning. While specified blocks are available at most lumber yards and home improvement centers for a nominal cost, Bison can ship ballast package VB8200BLST for an additional cost.



Model #	Description
VB8200	Complete system includes 2 end bases with padding, 2 3" Centerline Aluminum posts with padding, net tensioning winch, VB1250K competition net with cable covers, and antennas with boundary tapes.
VB8250	Same as VB8200 except includes 3½" Match Point Aluminum volleyball posts.
VB82	One pair of bases with base and post padding only. Customer supplies posts, net, and antennas.







## VB1000T Centerline™ Portable Systems

Perfect for programs that want all the features of an elite system but find floor socket installation is impossible or impractical. This system only requires installation of four easy-to-install threaded floor anchors.

## VB6000T Match Point™ Portable Systems

Budget conscious programs that need portability but won't sacrifice playability. Floor anchors are easier and less costly to install than floor sleeves required on typical in-floor systems.

### Popular Features on Complete Systems:

- Kevlar Competition Net
- VB13 Antennas and Boundary Tapes
- Rope Ratchet Side Tape Tensioners
- Free 1 Color Lettered Post Padding
- 4 each VB25FL Floor Anchors (Substitute VB25 or VB25TF below at no extra cost)
- Includes Reduced Height Posts
- Gray Base Padding



Video

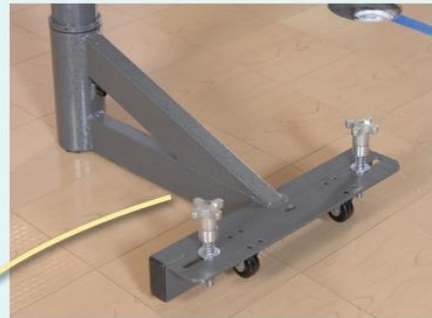

### VBTBASE T-Base Adapter Only

Convert virtually any 3", 3½" or 4" volleyball standards into a portable system...Without sacrificing net tensioning

- Purchase separately or in complete systems VB1000T or VB6000T above
- Eliminates the need to install costly and sometimes impractical or impossible floor sockets for traditional posts
- Order four Bison floor anchors separately (VB25, VB25FL or VB25TF) based on gym flooring system
- Features heavy steel construction, floor friendly transport wheels, easy-to-use, built-in floor attachment knobs and durable powder coated finish
- If ordered without poles, customer will need to order two **VB354** sleeve adapters for any 3½" pole system or two **VB340** sleeve adapters for any 3" pole system
- Order **VBTBASEP** for Base and Pole Padding separately.

## T-BASE ADAPTOR FLOOR ANCHOR OPTIONS



### VB25 Standard Drill-In Floor Anchor

Allows anchoring of portable volleyball or basketball systems to existing concrete, synthetic or tile floors without major concrete excavation...Provides ½" threaded hole with spring loaded plug • Requires core drilling and grouting.



### VB25FL Drill-In Anchor for Common Floating Floors

Same as VB25 except with flange to add additional anchor support when installed on floating maple floor systems... Includes all necessary hardware • Requires concrete core drilling, routing of wood floor and grouting of anchor into concrete • Provides ½" threaded hole with spring loaded plug • Includes concrete anchors and mounting hardware for most applications.



### VB25TF Thin Slab Drill-In Floor Anchor

Wide range of thin slab applications... Use on athletic floors that have

playing surface installed directly over a concrete surface such as tile or synthetic and where the concrete is too thin to allow the use of VB25 or VB25FL • Same ½" threaded insert hole with spring loaded plug • Includes concrete anchors and mounting hardware for most applications • Consult a Bison Product Specialist.







## SVB5050W Match Point™ Post or Wall Mounted Volleyball System

All the features of Bison's popular Match Point systems on a convenient track system...Track system mounts to customer's supplied posts, walls or any surface strong enough to support desired net tensioning • Net can be infinitely adjusted from 42" (tennis) to 96" (men's volleyball) net height • System includes VB1250K competition volleyball net, net tensioning winch, net storage bag and net cable covers • Order VB13 boundary antennae separately • Tracks must be mounted between 34' and 40' apart to be compatible with net provided • With customer supplied net rope extension tracks could be mounted wider but net might sag or require additional supports to maintain net height • 5-Year limited warranty on track and winch.



## VB9130, VB9135, VB9140 Volleyball Pole Caddies

Make transport of your volleyball poles easy and safe...fits any manufacturer's poles • 3" floor friendly wheels and 8" tall receiver socket • Choose VB9130 for 3" poles, VB9135 for 3½" poles or VB9140 for 4" poles.



## VB94 Volleyball Four Post Transport Cart

Heavy-duty design allows compact and easy storage and transport of up to two complete volleyball systems... Compatible with any brand of 3", 3½" or 4" outside diameter posts • Non-marking, 4" swivel casters • Bonus storage for net and padding • Durable, white powder coated finish • Reduces damage to posts and floor • Total width when loaded is 30", allowing transport through most doors • Eliminates multiple trips from storage to set up equipment • 1-Year limited warranty.



## VB96 Six Post Deluxe Volleyball Cart

Easy loading, easy transport, easy storage...For all your volleyball program's needs • Safely and securely holds 6 padded posts or up to 12 without padding • Versatile fabric cradle holds nets, antennae, cable covers, balls or padding • Top storage rack can hold officials stand or padding allowing everything you need to be wheeled through a 36" wide door • Sturdy powder coated steel structure with 4" floor friendly, swivel casters for easy movement • 5-Year limited warranty.



## VB92 Volleyball Standard Wall Storage Rack

Keep any 3" to 4" diameter volleyball standards safely stored without damage...Order one VB92 for each pair of standards • Mount to any wall with customer supplied mounting hardware.



800-247-7668



www.bisoninc.com

57





VB51P



VB51PL



VB51PG

## Volleyball Post Padding

Multiple options to protect your players...all meeting NCAA, National High School Federation, USVBA and FIVB rules • All padding is constructed of 1" thick high density foam, sewn vinyl and hook and loop closures and covers posts to a height of 6' • Designed to fit Bison volleyball standards but will fit most other manufacturers' floor socket style posts • Sold in pairs except VB510P Center Post Padding • 5-Year limited warranty.

### VB51P Solid Color Padding

Choose any of the colors of vinyl shown on page 102.

### VB51PL Universal Lettered Padding

Choose from any of our vinyl colors shown on page 102 then add up to 10 letters on all four sides of the padding in your choice of lettering styles shown on page 102 • Far superior to vinyl lettering adhered to padding.

### VB51PG Full Color Graphic Padding

Virtually any color or design can be created with the assistance of our Art Department staff • Durable UV inks on 16 oz. vinyl • May require a BNART artwork design charge • Allow 3-4 weeks for delivery • Order **VB51PGUP** to upgrade free lettered padding included in some complete Bison volleyball packages.

### VB510P Center Post Padding

Designed specifically to cover the center post on side-by-side courts when nets are attached to both sides of post • Due to design, center post padding cannot be lettered or graphically printed • Choose from colors on page 102 • Sold individually.



### VB1250SP Sport Pride™ Volleyball Net Band

See your program's name or logo on the sports page...Customize this add-on white net tape • Attaches onto any manufacturer's net in less than five minutes with hook and loop fasteners • Now with improved flexibility and print durability • Full-color logo or lettering on a white background • Permanent ink for lasting school spirit • Remove and reinstall as you replace nets • Complete with off season storage reel • 1-Year limited warranty.

### VB1250TR In the Zone™ Training Net Tape

Position players and every set in easy to read colored zones during practice to get the most of every ball possession...Hook and loop band installs and is removed easily from any manufacturer's competition net when not in use • Complete with storage reel • 1-Year limited warranty.



Net Band Storage Reel



### VB1250ST School Spirit™ Side Tape Covers

Show your school pride...See your school name on the sports page or TV highlights • Hook and loop attached side tapes have a white background • Select from letter styles below • See page 102 for color options (one color only) • 10 letters maximum, 24" x 2" imprint area • Printed on both sides • Sold in pairs (per net) • Fits most manufacturers' competition nets • 1-Year limited warranty.





## VB1250K Kevlar Competition Volleyball Net

Designed specifically to install easily and bowstring tight on most Bison competition volleyball systems...features include no stretch Kevlar top rope, tenex bottom rope with rope ratchet tensioner, knotless woven webbing, heavy white vinyl side tapes, ratchet style side tape tensioning devices and extra-long top and bottom ropes to allow use on volleyball systems with posts spaced from 35' to 45' apart

- Official size 32' x 1 meter net meets all NCAA, USVBA, FIVB and National High School Federation rules
- Net includes four top and bottom rope cable covers and a zippered storage bag
- 2-Year limited warranty.



**FREE Zippered Net Storage Bag**  
with purchase of a VB1250K Net



## VB1250KU Universal Competition Kevlar Volleyball Net

Similar design as VB1250K Competition net above...great spare net for practice or competition • Compatible with not only Bison systems but also can be used on most other manufacturers' net systems • Use on volleyball systems with posts spaced from 35' to 45' apart • Features include heavy white side tapes, knotless mesh, Kevlar top rope, bottom rope with rope ratchet and set of four ratchet style side tape tensioners • 1-Year limited warranty.

## SVB1250K Official Kevlar Sand Volleyball Net

Same high quality competition net as VB1250K above except...official 8.5 m (28') long • 1-Year outdoor warranty.

## VB123 NetSet™ Volleyball Net Tensioning Gauge

Never guess at proper net top rope tension again...Find the best tension setting for your system and count on an exact repeat every time

- Gauge installs between the winch and the top rope on all Bison and most manufacturers' competition systems
- Easy-to-read 1-2-3 tension indicators
- Mark your desired setting with a permanent marker so no matter who sets up the system, it will be the same as the last time
- Anodized aluminum body, chromium steel spring, red line indicator, plated steel internal plunger and heavy-duty spring clip connectors
- 2-Year limited warranty.



VB123 Video



VB98HG Video

## VB98HG Chain Net Height Gauge

Eliminate the need for tape measures or bulky poles with this easy-to-use chain net gauge... Multiple indicators for all common net heights • Complete with small zippered storage bag, instructions and spring clip to store gauge behind padding attached to the pole or net rope.



## VB13 SideLine™ Antennas

Clearly mark court boundaries with this combination antennas and bright white boundary tape...Attaches easily with hook and loop fasteners • Two-piece antennas self-store in boundary tape storage pocket allowing antennas to remain attached to net when removed from posts

- Fits both 1 meter and 36" high nets
- Meets all NCAA, National High School Federation, FIVB and USVBA rules
- Order **VB13SL** for replacement boundary tapes (without antennas) • 90-day limited warranty.



## VB17 International Volleyball Net Antenna

The net antenna preferred by some coaches and equipment managers...This antenna attaches easily and securely by means of two threaded tensioners • Fiberglass red/white rods • Adjustable to fit both 36" and 1 meter (39.37") nets • Meets all NCAA, NF and FIVB rules

- Sold in pairs • 90 day limited warranty.



800-247-7668



www.bisoninc.com

59





Clamp in Storage Position



Clamp in Use Position



VB73A Video



VB76 Video



## VB73A Adjustable Clamp-On Officials Platform

Popular design is compatible with most manufacturers' volleyball systems... whether 3", 3½" or 4" • Integrated ratchet style clamp device attaches platform to pole quickly and securely • Comfortable width platform adjusts in 1" increments from 47" to 53" height for officials and play at all net heights • Standard gray 1" thick player protection padding meets all NCAA, National High School Federation, USBA and FIVB rules • Transports on two floor friendly urethane wheels and rests on non-skid rubber floor pads when in use • Powder coated 1" heavy wall tube construction • Black, Maroon, Navy, Royal and Scarlet padding is available at no additional cost • Order **SVB73** for use on sand volleyball courts • 5-Year limited warranty.

## VB76 Freestanding Folding Officials Platform

The perfect balance of stability and storability...meets all NCAA, National High School Federation, USVBA and FIVB rules • Easy pull pin folding design • Powder coated heavy-duty steel construction • Floor friendly wheels and floor pads • Standard gray padding system but substitute Black, Maroon, Navy, Royal and Scarlet at no additional cost • 1-Year limited warranty.



## VB73LOGO Official's Platform Graphics

Add pizzazz to your Bison VB73A or SVB73 official's platform • Full color graphics is printed on 16 oz. vinyl to mount securely with hook and loop tape to each side of the official's platform • Printed area is approximately 18" (w) x 30" (h), big enough for team logos, sponsors, or other messages • Easily removable for practice if desired.



## VB1253W Net Storage Winder

Tired of wadded up, dirty, and tangled volleyball nets?... Here is your answer • Roll and store nets when not in use • 24" dome base has non marking wheels to roll easily to and from storage • Nets hang neatly and dependably on rotating top spider • Stores up to 3 nets.







VB23, VB26, VB27  
Hinged Brass



VB235, VB21, VB22  
Plated Aluminum



VB23CH, VB26CH, VB27CH  
Chrome Plated Steel



VB23LK, VB26LK,  
VB27LK Lockable  
Hinged Brass



BM21  
Small Hinged Brass



## Bison Premium Floor Sockets

Volleyball and badminton systems come in multiple sizes, all gym flooring systems are not the same and every facility has different floor cover priorities. Bison has a premium floor socket for every application. All Bison floor sockets start with Bison's exclusive aluminum extrusion that not only eliminates rust but eliminates the sloppy fit found with other manufacturers' welded steel floor sockets. Bison now offers 3" and 3½" steel floor sockets if preferred (see below).

A unique shimming system allows Bison volleyball floor sockets to easily install in the floor at an approximate 2% outward angle to compensate for post deflection found on even the most rigid steel systems. Floor plates are available in four different styles including our most popular hinged brass, lockable hinged brass, swiveling chrome plated steel and plated aluminum. With our mini hinged brass badminton socket cover, you won't have to have oversize covers in your gym floor.



VB23-CV Hinged  
Brass

VB23CH-CV Chrome  
Plated Steel

VB23LK-CV Lockable  
Hinged Brass

BM30-CV Small  
Hinged Brass

### Floor Socket Cover Plates Only

Replace existing worn out or damaged floor plates or install to provide easy access to subfloor electrical plugs, anchors or other hidden components. Choose from four options.

### VB23ST/VB26ST Steel Floor Sockets with Hinged Brass Covers

Bison now offers steel 3" (VB23ST) and 3½" (VB26ST) floor sockets as a substitute for our preferred extruded "proper fit" aluminum sockets

- Same hinged brass floor plate as VB23 and VB26
- You can now choose either aluminum or steel sockets at the same cost.

### Floor Socket Selection Chart

Floor Plate Style	Floor Type	Cover OD	Cover Opening	Cover Only	1¼" Square Socket	2¾" Diameter Socket	Aluminum 3" Diameter Socket	Steel 3" Diameter Socket	Aluminum 3½" Diameter Socket	Steel 3½" Diameter Socket	Aluminum 4" Diameter Socket
Large Hinged Brass	Floating Wood	8"	6"	VB23-CV	N/A	N/A	VB23	VB23ST	VB26	VB26ST	VB27
Large Lockable Hinged Brass	Floating Wood	8"	6"	VB23LK-CV	N/A	N/A	VB23LK	N/A	VB26LK	N/A	VB27LK
Large Swivel Chrome Plated Steel	Floating Wood	8"	4½"	VB23CH-CV	N/A	N/A	VB23CH	N/A	VB26CH	N/A	VB27CH
Large Plated Aluminum	Non Floating Tile, Concrete, Synthetic	7½"	4"	N/A	N/A	VB24	VB235	N/A	VB21	N/A	VB22
Small Hinged Brass	Floating Wood	4½"	3"	BM30-CV	BM21	N/A	N/A	N/A	N/A	N/A	N/A
Socket Depth	N/A	N/A	N/A	N/A	12"	12.5"	10"	10"	10"	10"	13"



### Replacement 26:1 Centerline™ Volleyball Winch

Replace your net top rope tensioning winch on your Bison system or on other manufacturers' 3" or 3½" outside diameter volleyball systems • Computer machined backlash free winch with folding handle will provide up to 250# of top rope net tension on any manufacturer's net • Includes post attachment clamp • Order **VB10W30** to mount to 3" diameter posts, order **VB10W35** to mount to 3½" diameter posts • 5-Year limited warranty.



### VB60W Replacement Match Point™ Volleyball Winch

Replace your net top rope tensioning device...on Bison Match Point™ volleyball systems. 1-Year limited warranty.



### VB35P Replacement Volleyball Net Cable Covers

Includes set of 4.



### VB1200RR Rope Ratchet Net Tensioning Kit

Replace or supplement side tape tensioning devices...set of four rope ratchet tensioners will provide bowstring tight net tensioning on Bison or many other manufacturers' competition volleyball nets • Pull rope through ratchet to tension and easily release without tools.



### VB1250KRR Replacement Bottom Rope Ratchet for Bison Volleyball Nets

Pull rope through ratchet...release without tools.



### VBHOOK/LOOP Replacement Bottom Net Rope Collars

Use to replace lost collars that came with most Bison volleyball systems. Sold in pairs.



800-247-7668



www.bisoninc.com

61





## FREE! Upon Request

(with complete system orders, some restrictions apply)

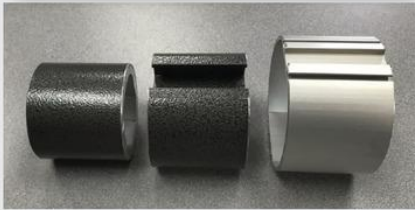

### VBGAUGE Floor Socket Gauge Kit

Aren't 100% sure of your existing volleyball floor socket size?...these FREE sample pole sizes will guarantee that you select the right size poles to fit your sockets. Set of 3 (3", 3½", 4").



### Volleyball Sleeve Reducers

Install 3" diameter or 3½" diameter volleyball posts in any manufacturer's 4" or 3½" floor sockets...Machined aluminum for a rattle free fit, each sleeve has two setscrews to allow it to be affixed to either the floor sleeve or to the pole depending on the facility's preference • Select **VB354** to install 3½" posts in 4" sockets, select **VB340** to install 3" posts in 4" sockets, select **VB335** to install 3" posts in 3½" sockets, select **VB340F** to install 3" posts in 4" diameter sockets that are in excess of 10" deep.

### VBSS Socket Depth Adapter (not shown)

If your existing sockets are extra deep...You may need depth adapters to allow proper installation of your volleyball poles

• Bison will provide, free of charge, custom depth adapters with the purchase of any Bison volleyball system • Provide diameter and depth of existing sockets and model of Bison system.



### Oversize Volleyball Post Adapters

You can now install 3½" or 4" diameter volleyball posts in gyms with 3" or 3½" existing floor sockets...3 models to choose from • Welded steel construction • Powder coated finish • Select **VB4035** to install 4" posts in 3½" sockets • Select **VB4030** to install 4" posts in 3" sockets • Select **VB3530** to install 3½" posts in 3" sockets • Sold in eases • Note that since the bottom of the pole will now be at the approximate height of the gym floor, the pole will extend 8" – 10" more than usual above the floor • 1-Year limited warranty.

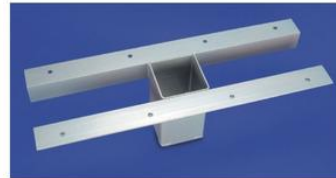

### VB230 Second Story Volleyball Socket Form

Just what you need to install volleyball sockets in floors with lower level or crawl space directly below volleyball court...Prefabricated form can be used as is or field modified • Use in conjunction with any Bison floor socket • Heavy welded steel with powder coated finish • Requires experienced installer for proper use.



### VB25 Standard Drill-In Floor Anchor

Allows anchoring of portable volleyball or basketball systems to existing concrete, synthetic or tile floors without major concrete excavation...Provides ½" threaded hole with spring loaded plug • Requires core drilling and grouting.



### VB25FL Drill-In Anchor for Common Floating Floors

Same as VB25 except with flange to add additional anchor support when installed on floating maple floor systems... Includes all necessary hardware • Requires concrete core drilling, routing of wood floor and grouting of anchor into concrete • Provides ½" threaded hole with spring loaded plug.



### VB25TF Thin Slab Drill-In Floor Anchor

Wide range of thin slab applications... Use on athletic floors that have playing surface

installed directly over a concrete surface such as tile or synthetic and where the concrete is too thin to allow the use of VB25 or VB25FL • Same ½" threaded insert hole with spring loaded plug • Includes concrete anchors and mounting hardware for most applications • Consult a Bison Product Specialist.

### VB231K Hinged Brass Floor Plate Cover Installation Kit

Install Bison Hinged Brass Floor Socket Covers with professional results...Two-piece router template kit can be used over and over for perfectly sized pockets in floating wood floors • One ¼" shank router bit included • Customer supplies router • Order **VB231KRB** for replacement router bits.

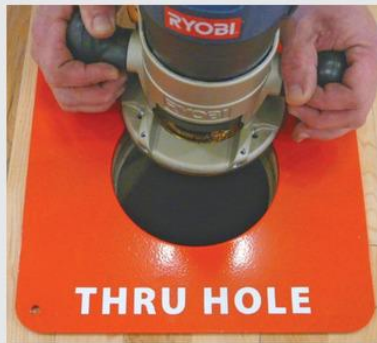

Thru Hole Template



Step Bore Template





## SVB1000 Centerline® Elite Sand Volleyball System

**You supply the sand...** Bison will supply the rest • You won't need to sacrifice ease of setup, safety or net tensioning with Bison's Centerline Elite Sand Volleyball Systems • Bison's exclusive TwistLock™ removable stainless steel sand sockets not only allow easy removal of posts when not in use but also eliminate the problem of sand or water filling the socket • Centerline Sand Volleyball posts have all the great features that have made Centerline Elite a standard in the industry plus special features for outdoor and indoor sand court use including stainless steel hardware and other weather and sand proofing features • As an added bonus, the same 3" Centerline posts can be used indoors on your hardwood floor court and outdoors without modifications for maximum equipment utilization • Complete system includes special Centerline 3" sand aluminum posts, **lifetime warranty** net tensioning winch, competition TwistLock stainless steel sockets, player safety padding (see page 102 for color options), competition Kevlar top rope net (substitute SVB1250K for VB1250K for installation at official 8.5M 2 on 2 sand volleyball play) antennae, net and antennae storage bag, net rope cover and net height indicator • You'll also get **FREE** post pad lettering on all complete system orders • Order **SVB73** Sand Volleyball Officials Stand and boundary kit separately • Systems meet all applicable high school and college rules.

### SVB1250K Competition Sand Volleyball Net

Our VB1250K top quality Kevlar top rope net with heavy white side tapes except shortened to 8.5 meters for official NCAA 2-on-2 sand volleyball • 1-Year limited warranty.

### SVB1002 Centerline Side-by-Side Double Court Sand Volleyball Systems

**Need two courts but want to save money?...** Bison side-by-side courts are the answer • Three posts, two net tensioning winches, three TwistLock sand ground sockets, two nets, two antenna and post padding are all included in this complete package • As an added bonus, free pad lettering on the outside end posts, free net and antenna storage bag and free net chain net height indicator makes this a truly complete package.

### SVB100 Centerline Sand Volleyball Court Adder

**Need even more side-by-side courts?...** Purchase one court adder plus additional VB1250K nets, VB510P post padding, VB13 antennae/boundary markers and SVB27 sand ground sockets to string as many courts together as desired • Each SVB100 includes one Centerline Elite Sand Volleyball post and **lifetime warranty** net tensioning winch • Order **SVB10** for replacement pair of Centerline sand volleyball posts with winch only.

### SVB27 TwistLock™ Sand Volleyball Sockets

**Now you see it...Now you don't** • Unique twist lock design allows the socket to be installed or removed from a permanent concrete base foundation in a matter of seconds • No more water or sand filled sockets or sockets that protrude above the sand • These stainless steel sockets will not rust even if left installed year round • The unique concrete foundation with embedded base plate design has a leveling feature to allow precise post leveling and eliminate installation errors • TwistLock sockets come standard with Centerline Elite single and side-by-side systems but can be ordered separately to use with any other indoor competition volleyball systems for maximum utilization of existing equipment • Fits 4" posts • Order **VB354** adapters for use of SVB27 sockets with 3½" posts or **VB340** adapters for use of SVB27 socket with 3" posts.

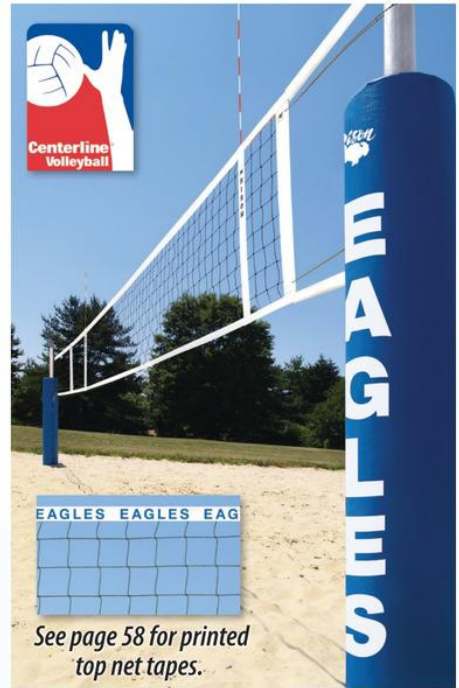

See page 58 for printed top net tapes.

### SVB73 Sand Volleyball Official's Platform with Padding

**Perfect for sand courts...** Same great features as our indoor Clamp-On Officials Platform but with special sand skids instead of wheels to avoid sinking into the sand • Not compatible with SVB5000 Sand Volleyball Systems • Includes gray padding system conforming to all NCAA, National High School Federation and USVBA rules • Substitute padding in black, maroon, navy, royal or scarlet • 5-Year limited warranty on stand.



### SVB28 Premium Sand Boundary Kit

**Kit comes complete with ½" yellow rope spliced into a continuous loop to mark the outer boundary of an**



**official sand volleyball court...** Includes galvanized ground anchors that screw below the playing surface for maximum player safety • 2-Year limited warranty.

### SVB26 Boundary Kit

**Mark your sand volleyball court boundaries...** Kit includes 2" wide black web boundary lines, sand anchors and ground stakes • Adjustable for any size court.



24" Diameter x 30" Deep Concrete Footing



800-247-7668



www.bisoninc.com

63





## SVB5000A Match Point™ Competition Outdoor Volleyball System

Sand volleyball can now be played at the same level as on the hardwood court...Rugged system designed for California-style power volleyball • Extruded Aluminum 3½" posts are powder coated silver/gray • Net is infinitely adjustable to insure exact net height for competition or recreational volleyball • Tightens with the same mechanism found on our Match Point indoor competition systems • **Includes post padding, net and antennas** • Optional padding lettering or logo available for team or sponsor recognition (see page 102 for color options) • Install permanently in concrete or use optional **SVB210** ground sleeves • 5-Year limited warranty.



Strap Style  
Worm Gear Winch

### SVB5050A Outdoor Volleyball System

Same system as SVB5000A except without antennas and padding...5-Year limited warranty.

### SVB500A Court Adder for SVB5000A or SVB5050A

Designed for adding additional courts with a single post...Includes post, net tensioning and adjustment mechanism • Nets and other components sold separately • One SVB500A adds one side-by-side court, order multiple SVB500A to add more courts • 5-Year limited warranty.

### SVB210 Ground Sleeve (not shown)

For removable installation of SVB5000A, SVB5050A or SVB500A...This steel sleeve, buried in concrete, allows for easy removal of posts when not in use • When installed according to instructions, the top of the sleeve is approximately 6" below the top of the sand, so sand can be safely used for other activities • Powder coated steel cap keeps rain and sand out when posts are removed • Each post requires one sleeve.



SVB2000A

## SVB2000A Aluminum Recreational Volleyball System

The perfect volleyball system for playing in the sand or grass whenever the goal is fun... Recreational leagues, beach resorts, campgrounds, playgrounds, parks, school yards, any place where a group gathers to play volleyball • 3½" diameter aluminum extruded posts permanently install in a 30" deep x 8" diameter concrete footings or can be installed using VB21 ground sleeves (optional) to allow easy removal of the poles when not in use • Rigid, lightweight aluminum is 100% rust-proof • Net is infinitely adjustable from men's competition volleyball height, 7' 11½", to as low as 42" tennis height • Poles are capped to keep out moisture • Crankless net tightening • Powder coated finish • Includes net with fluorescent top tape and all necessary hardware • 2-Year limited warranty on standards.



### SVB08 Recreational Volleyball Net

Official size  
32' x 36" nylon net  
with fluorescent

top tape for maximum visibility...

Nylon top rope • Black webbing • Fits SVB2000A and most net games

• Weather-resistant • Net color subject to change • 90-day limited warranty.



### VB21 3½" Round Ground Sleeve

These aluminum ground sleeves allow removal of your SVB2000A aluminum volleyball system...Sleeves mount permanently in a 30" deep x 10" diameter hole filled with concrete • Cap keeps out rain, snow and dirt • SVB2000A requires two sleeves, each sold individually.





## TB300 Indoor/Outdoor Portable Tetherball Set

Play anywhere....1 $\frac{3}{4}$ " diameter, 10' galvanized steel one-piece pole mounted to 24" diameter steel base with 130# of built in ballast for stability • Easy roll wheels • Includes ball, rope and top ring • Non-marking rubber ring on bottom of base • Quick set up with no hole to dig or loose weight bags to carry • 1-Year limited warranty on pole and base.

## TB200 Premium In-Ground Tetherball Set

Super heavy duty....2 $\frac{3}{8}$ " one-piece galvanized pole • TB50-B tetherball/rope assembly • 2 year pole warranty • Order **TB200GS** for optional ground sleeve for easy pole removal • Requires truck shipment.

## TB200P Premium In-Ground Tetherball Pole Only

Order ball and ground sleeve separately.

## TB100 In-Ground Tetherball Set

Outdoor durable...includes 2-piece 1 $\frac{7}{8}$ " diameter galvanized steel pole • TB50-B tetherball/rope assembly • 1 year warranty • Order **TB100GS** for optional ground sleeve for easy pole removal • Ships small package.

## TB100P In-Ground Tetherball Pole Only

Order ball and ground sleeves separately.

## Tetherball Ground Sleeves

Rust proof...PVC tube with drop-in aluminum top plug when post is removed • Order **TB200GS** for use with TB200 and **TB100GS** for use with TB100.



TB300



TB100



## TB50-B Tetherball

Ready to install on pole...Quality official tetherball • Includes 30" long top chain, pole attachment clip and lower rope • Rope clips to bottom of chain for easy ball removal.

# BADMINTON SYSTEMS

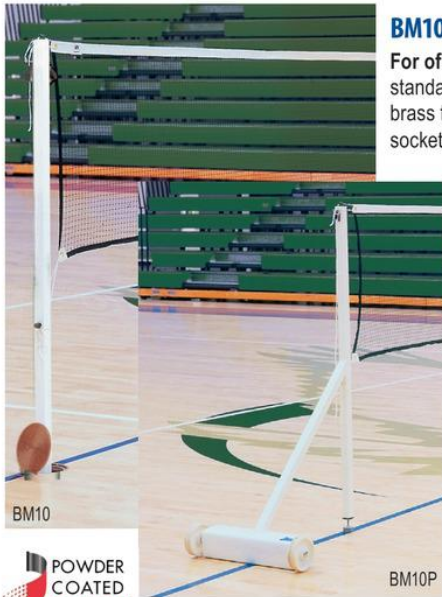

BM10

## BM10 Competition Badminton System

For official competition or physical education class...Suits every level of play • 1 $\frac{11}{16}$ " square aluminum standards designed to set up and tear down quickly • System includes official net • Order **BM21** sockets and brass floor plates separately • Consult with a Bison product specialist for replacement systems for existing sockets • Order optional **BM10PKHDWR** to allow multi sport use for pickleball • 2-Year limited warranty.

## BM10P Portable Badminton System

Competition play without sockets or floor anchors...Portable yet sturdy • Each end support is designed with a 1 $\frac{11}{16}$ " square post with built-in ballast outrigger and floor friendly transport wheels • Quick and easy set up, tear down and storage • 2-Year limited warranty.

## BM10N Official Badminton Net

Nylon competition badminton net...Official 20' x 2 $\frac{1}{2}$ ' size • Fits any standard badminton system • 90-day warranty.

## BM21 Standard Badminton Floor Socket for 1 $\frac{11}{16}$ " Square Badminton Posts (not shown)

Compact hinged brass cover...hides 12" deep socket designed for 1 $\frac{11}{16}$ " square badminton or other game posts • 4 $\frac{1}{2}$ " outside and 3" opening diameter.



BM21  
Small Hinged  
Brass



## Pickleball and Badminton Post Adapters

Use Bison 1 $\frac{11}{16}$ " pickleball or badminton posts in existing volleyball sockets • Specify **BM300A** for 3" sockets, **BM350A** for 3 $\frac{1}{2}$ " sockets or **BM400A** for 4" existing sockets • Aluminum adapters install without tools for quick setup.

## BM1016 Badminton Post Cart

Transport and store...up to 16 Bison BM10 competition badminton posts • Floor friendly casters • Compact 22" x 22" footprint • Stores posts upright • 1-Year warranty.



**New!**



800-247-7668



www.bisoninc.com

65





Modern tennis was first played in Birmingham, England, in approximately 1860 and has grown to worldwide popularity. Tennis can be played on grass, clay or hard surfaced courts. Equipment and rules have changed since the origins of the sport but today's game requires quality equipment regardless of the level of play.



TN10

## TN10 Competition Tennis System

Indoors or outdoors...

Competition system for any level  
• 42' net with 49' coated top cable (TN10N) • 3" round, high tensile aluminum posts with textured green powder coated finish  
• Chrome plated internal winch to tension top cable • Removable handle • System includes posts, indoor/outdoor official net and center court net hold down strap and anchor • Order optional TN23 or TN235 sockets separately for easy post removal • Consult with a Bison product specialist for replacement systems for existing sockets • 2-Year limited warranty.



TN05

## TN05 Recreational Tennis System

These 2<sup>7</sup>/<sub>8</sub>" diameter 3<sup>3</sup>/<sub>16</sub>" wall steel posts have 1/4" diameter welded steel net side lacing loops and dome net cable guides for durability...

textured green powder coated finish • Includes backlash free net cable tensioner, TN10N net and TN10CS center court hold down strap • Use as permanent posts or order optional TN23 or TN235 sockets for easy removal • 1-Year limited warranty.



TN10P

## TN10P Portable Tennis System

Now you can set up a quality tennis court anywhere with an appropriate playing surface...Popular TN10 style 3" diameter aluminum posts with lacing bars, dome net cable guides and backlash free internal winch • Freestanding post assemblies are connected at the bottom by a three-piece, 42" rigid but lightweight 4" square aluminum tubing spreader • Entire system including posts and spreader bar are easily assembled and disassembled • Breaks down for easy transport and storage into five pieces, longest piece being 15' • Textured green powder coated finish • System includes TN10NP net • Three-year limited warranty (excluding net).

## TN10N Premium Tennis Net

For net replacement on any tennis court...Use indoor or outdoors • Includes center court net hold down straps and all required net attachment ropes  
• 42' x 42" net with 49' coated top cable • Order TN10NP for net for portable tennis system • 1-Year limited warranty.

## TN10CS Center Court Hold Down Straps

For net replacement on any tennis court...Replacement center strap assembly  
• Includes ground anchor • Order TN10SCP for strap only.

## TN23 Indoor Tennis Floor Socket/Floor Plate

Remove tennis posts with ease...10" deep socket installs into court surface  
• Hinged brass floor plate covers socket when posts are removed.

## TN235 Outdoor Tennis Ground Socket/Ground Plate

Same as above but made for the outdoor court...100% removable aluminum cover.





Pickleball is the fastest growing net game in sports and combines elements of tennis, badminton and ping pong. Played indoors or outdoors on competition or recreational courts. Great game for players of all ages and skills. Played with paddles and a plastic ball as singles or doubles. Bison systems are available for all levels of play, indoors and outdoors, permanent installation, removable installation or portable.

## PK10XL Competition Pickleball System

Can be used indoors or outdoors either permanently installed in concrete or installed in floor/ground sockets

- 3" round tempered, extruded aluminum posts with a green textured powder coated finish
- Chrome plated internal winch to tension top cables
- Removable handle to reduce vandalism or net theft
- Meets all IFP and USAPA rules
- System includes posts, indoor/outdoor **PK10NXL** net and **TN10CS** court net hold down strap and anchor
- Order **PK23** or **PK235** sockets separately for easy removable installation
- 2-Year limited warranty.



PK10XL

## PK05XL Recreational Pickleball System

3" diameter, 3/16" wall steel standards have 1/4" diameter welded steel net side lacing bar and dome net cable guides

- Textured green powder coated finish
- Meets all IFP and USAPA rules
- Includes backlash free net cable tensioner, **PK10NXL** net and **TN10CS** center court hold down strap
- Install for permanent use or order optional **PK23** or **PK235** sockets for easy removable installation
- 1-Year limited warranty.

## PK23 Indoor Pickleball Floor Socket/Cover Plate

Remove pickleball posts with ease

- 3" diameter x 10" deep socket installs into court surface
- Hinged brass floor plate covers socket when posts are removed
- Requires two per system.

## PK235 Outdoor Pickleball Ground Sockets/Cover Plate

Same as **PK23** but designed for outdoor courts

- 100% removable aluminum cover
- Requires two per system.



PK10XL

PK05XL

## PK10NXL Competition Pickleball Net

Official 21'9" x 36" high net with 1 3/4" mesh

- 4mm nylon coated top cable
- Meets all IFP and USAPA rules
- 1-Year limited warranty.

## PK10 PE Pickleball System

Pickleball has grown in popularity and this system can be installed in sockets indoors or outdoors for recreational use by players of all ages

- 1 1/16" square aluminum standards have a white powder coated finish and include easy-to-use crankless net tensioning system, a **PK10N** net and **PK10CS** center net hold down weights
- Compatible with **PK21** floor sockets (sold separately)
- Can also be used in existing indoor 3", 3 1/2" or 4" volleyball floor sockets for PE use with adapters shown on page 65
- 2-Year limited warranty.



PK10

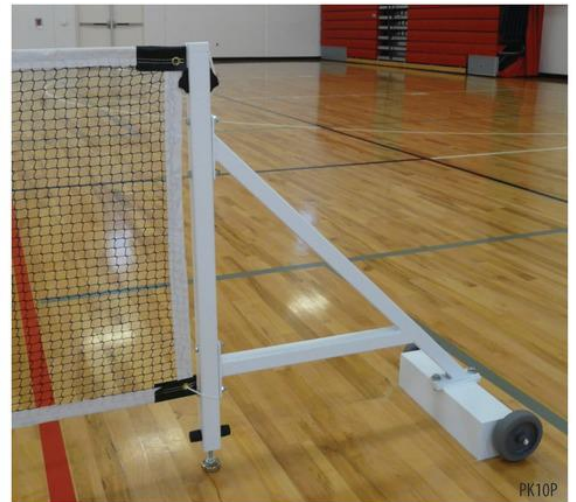

PK10P

## PK10P Portable PE Pickleball System

Heavy weighted base with integrated transport wheels makes set up easy and fast in any indoor or outdoor location

- System includes 1 1/16" square, white powder coated aluminum uprights, crankless net tensioning system, **PK10N** net and weighted center net hold downs.

## PK10N PE Pickleball Net

20' high with white top tape

- 90 day limited warranty.

## PK21 PE Pickleball Floor Sockets

For installation in all types of playing surfaces

- Rust free aluminum sockets with hinged brass floor plate
- Requires 2 per system.

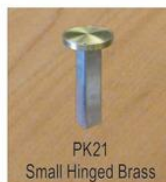

PK21  
Small Hinged Brass



PK10CS Weighted Center Hold Down



800-247-7668



www.bisoninc.com

67





# HOW TO SELECT YOUR NEXT SOCCER GOALS

## Special Features of Bison Portable Aluminum Soccer Goals



**Eliminate Weld Failure!**

Torque Tested™ Backstay Attachment



**Reduce Risk of Tip Over!**

No-Tip Transport/Ballast System On Many Styles



QwikTrack™ Easy and Dependable Net Attachment



Football Field Compatibility



**No Sharp Edges!**

Large Corner Safety Radius on Square Post Options

Your program is not just like everyone else's. Your level of play, playing surface, goal removal requirements and budget all define your needs. Many programs that use brand name alone as their selection criterion often miss out on features that better fit their requirements. Bison offers a wide range of goals to meet the needs of college, high school, club, recreation and youth programs. Consider the following design features before you invest in your next pair of goals.



### Manufactured or Locally Produced Goals

Over 80% of all portable goal tip over injuries and deaths reported in a recent study occurred with the use of homemade goals produced in shop class or at a local fabrication facility. Failure to understand and follow guidelines and testing requirements found in ASTM F2950-14 and ASTM F1938-98 leads to lack of adequate tip over ballast or ground anchoring, unsuitable goal depth and heavy materials and construction that make goals top heavy. Off the shelf tubing commonly has sharp corners that affect safety. It is critical to purchase goals that have proper warning labels that also certify the goal meets the ASTM safety standards to reduce liability risk for your program.

### Portability

Since many soccer fields serve double duty, portable goals make up a large percentage of the market. Even if the goal is not permanently attached to the ground, it might not be truly portable. Overall weight, use of rear stabilizing bars, transport systems and the quality of construction all contribute to the true portability. Common problems with hard to move portables include premature failure of welded corners and the potential for staff or player injury. Aluminum is the material of choice for portable goals. There are some lower cost steel portables but they are heavy, hard to move, prone to rust, and worst of all, dangerous if they tip over.

If you have full-time soccer fields, permanent or semi-permanent goals might fit your needs best. Generally, they offer a lower cost alternative with either steel or aluminum as viable options. Bison No-Tip portable soccer goals are the perfect balance between portability, durability and safety.

### Football Gooseneck Post Compatibility

Many high schools and collegiate soccer programs share facilities with football and other activities. It is vital that portable soccer goals are compatible with permanently installed football goalposts, allowing quick and easy conversion from football to soccer and back. Most official size (24' x 8') Bison Shootout portable goals, **excluding those with the No-Tip feature**, allow placement in front of permanent football goal posts using the same goal line for both sports by moving the rear horizontal stabilizer bar forward or backward. This is especially critical for fields with permanently painted field markings.

### Post Size Compatibility

NCAA, National High School Federation and FIFA rules require that front uprights and crossbars be no less than 4" and no more than 5" wide for official play. Round, square, rectangular or oval shaped materials are all permitted. Round goals are often selected by clubs that play by FIFA rules but many other programs like round as well. If you choose square or rectangular goals, pay attention to the corners on the tubes. The bigger the radius, the greater the player safety. Bison offers round or square goals with large corner radii.

Competition 24' x 8'	U12 and up, high school, collegiate, international
Club Plus 21' x 7'	U10 - U12
Club 18½' x 6½'	U8 - U10
Youth 12' x 6½'	U6 - U8 and short-sided play
Bantam 9' x 4½'	U4 - U6 and short-sided play

### Goal Size

Official play at high school, college and many club levels requires 24' wide and 8' high goals. These are the goal opening dimensions. Youth goals are available in a variety of sizes and often local club rules, field availability or other factors will determine goal width. Generally, younger players use smaller fields and goals.

### Post Safety

Over the past few years, there has been an increasing awareness of soccer player injury statistics. While most injuries occur in the open field, injuries including concussions, broken bones, cuts and damaged teeth caused by player contact with goals are common.

If you prefer square or rectangular goals, look for manufacturers who use a large corner radius on all upright and crossbar tubes. Choose portable goals with the greatest back depth (10' on 24' x 8' goals) and provide premium anchoring or built-in ballast systems as a part of the package. To assure safety and avoid unnecessary liability, NEVER purchase goals that do not meet ASTM F2950-14 and ASTM F1938-98 safety standards.

### Convenience

It's always easiest to buy in complete, ready-to-play packages. This insures all components are compatible. Features like transport systems and built-in safety ballast on portable goals make goal movement easier and safer. Net attachment methods are not all the same. Avoid systems that have loose clips or hook and loop straps that get lost and goals with protruding net attachment hardware that presents a safety issue. Most programs prefer goals with built-in net attachment tracks like Bison's QwikTrack. Bison soccer goal crossbars, backstays and rear spreader bars are shipped in two pieces for ease of handling, reduced freight costs and damage protection.

### Durability/Warranty

When you invest in soccer goals, you want to be confident they will provide maintenance free service for many years. Aluminum goals have the advantage of a lifetime of rust free use. Some common aluminum goals, however, are prone to failure of welds where backstays attach to uprights. Big bulky goals get dragged across the field, putting stress on joints and resulting in the need for costly repairs. Bison's unique Torque Tested backstay attachment system, standard rear stabilizer bar and the inclusion of built-in transport and ballast systems on many goals allow Bison to offer an industry leading, eight-year limited warranty on 4" round and 4" square No-Tip goals. Compare standard features and published warranties to get the most value for your investment.

**Purchasing through a local dealer is not only friendly to your local economy but improves your service when you need help.**





# NO-TIP™ PORTABLE ALUMINUM SOCCER GOALS



## No-Tip™ Portable Aluminum Soccer Goals

No Loose Ballast

No Ground Anchors



As the name implies, Bison No-Tip goals eliminate the need for dependable and inconvenient ground anchors, ballast bags or other goal tip over safety options that rely on human behavior to insure safety. Once properly filled with sand and installed, these No-Tip drums not only eliminate the threat of forward tipping onto players hanging on the goal crossbar but also allows easy transport on and off the field and the reduction in the stress on vulnerable welded goal joints that can cause premature goal deterioration. The combination of our No-Tip transport system and our torque tested backstay attachments system allow us to offer an industry leading eight-year limited warranty on all No-Tip goals.

Additional standard No-Tip goal features include extra deep goal depth, competition net, QwikTrack net attachment system, net storage bag and a super thick textured white powder coated finish. See chart below for aluminum opening extrusion shapes and overall goal size options.



US Patent #8,579,736

NO-TIP MATCH STATS	
Portable	Yes
Goal Opening Material	Aluminum extrusions
Extrusion Size/Shape	4" round or 4" square
Number of Goal Sizes	3
Extra Rear Depth	Standard
No-Tip Ballast/Transport System	Standard
Competition Net	Included
Net Storage Bag	Included
QwikTrack Net Attachment System	Standard
Meets ASTM F2950-14/ F1938-98	Yes
Meets NCAA, NF and FIFA Standards	Yes
Powder Coated Finish	Yes
Warranty	Eight-year limited



No-Tip Transport/Ballast System  
Now With Net Retention Bar

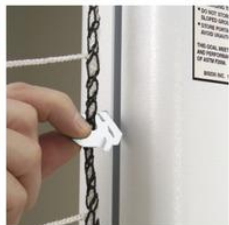

QwikTrack™  
Net Attachment Included



Competition Net Included



Net Storage Bag Included



Video

**MEETS  
ASTM F2950-14 and  
ASTM F1938-98**

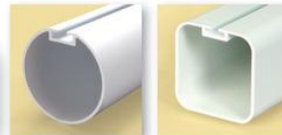

### No-Tip™ Soccer Package Chart

	Age Range	Width	Height	Top Depth	Bottom Depth	4" Round Model #	4" Square Model #
Official Competition	U12+	24'	8'	4'	10'	SC2480PA40NT	SC2480PA44NT
Club Plus	U10-U12	21'	7'	4'	7'	SC2170PA40NT	SC2170PA44NT
Club	U8-U10	18½'	6½'	4'	6½'	SC1865PA40NT	SC1865PA44NT



Supplemental  
Installation Video



800-247-7668



www.bisoninc.com

69





# SHOOTOUT™ PORTABLE ALUMINUM SOCCER GOALS

**5-YEAR**  
Limited Warranty



**NEW!**

**BISON IS THE  
EXCLUSIVE  
SOCCER GOAL  
PARTNER OF THE  
NFHS**

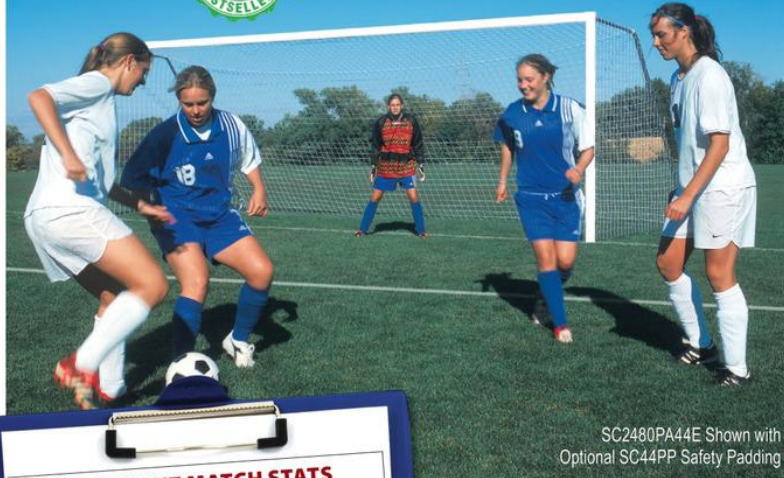

SC2480PA44E Shown with  
Optional SC44PP Safety Padding

## ShootOut™ Portable Aluminum Soccer Goals

All Bison ShootOut soccer goals are constructed with special aluminum extrusions in either 4" round or 4" square with rounded safety corners and our exclusive torque tested backstay attachment system reducing the stress on vulnerable joints that often result in premature goal weld failure. Available in three sizes. All ShootOut soccer goals feature extra rear depth for reduced tip over risk and a rear horizontal stabilizer bar that can be positioned closer to the goal face for compatibility with football goal posts on shared sport fields. Nets attach easily with our QwikTrack net clip system.

Additional standard features include ground anchor kit, competition net and super thick textured white powder coated finish, optional features include vertical post padding and ballast bags for use on artificial turf. ShootOut goals carry a 5-Year limited warranty. See chart below for aluminum opening extrusion and overall goal size selection. Wheel kit options available on page 74.

**MEETS  
ASTM F2950-14 and  
ASTM F1938-98**

SHOOTOUT MATCH STATS	
Portable	Yes
Goal Opening Material	Aluminum extrusions
Extrusion Size/Shape	4" round or 4" square
Number of Goal Sizes	3 (4" round), 5 (4" square)
Extra Rear Depth	Standard
No-Tip Ballast/Transport System	Optional
Rear Ground Anchors	Included
Rear Ballast Bags	Optional
Competition Net	Included
Net Storage Bag	Included
QwikTrack Net Attachment System	Standard
Meets ASTM F2950-14/ F1938-98	Yes
Meets NCAA, NF and FIFA Standards	Yes
Powder Coated Finish	Yes
Warranty	5-Year limited

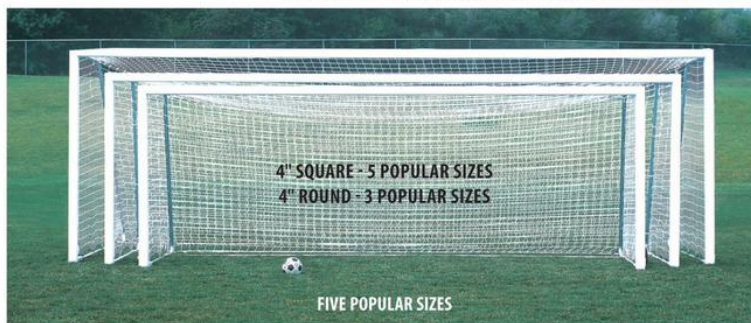

Qwik Track™  
Net Attachment Included



Ground Anchor Kit Included



Optional No-Tip Transport/  
Ballast System Now With  
Net Retention Bar  
(see page 74)



Competition Net and Storage  
Bag Included



Football Field Compatibility  
(shown with optional SC04WK  
wheel kit)



Supplemental  
Installation Video



### ShootOut™ Soccer Package Chart

	Age Range	Width	Height	Top Depth	Bottom Depth	4" Round Model #	4" Square Model #
Official Competition	U12+	24'	8'	4'	10'	SC2480PA40E	SC2480PA44E
Club Plus	U10-U12	21'	7'	4'	7'	SC2170PA40E	SC2170PA44E
Club	U8-U10	18½'	6½'	4'	6½'	SC1865PA40E	SC1865PA44E
Youth	U6-U8	12'	6½'	4'	6½'	N/A	SC1265PA44E
Bantam	U4-U6	9'	4½'	2'	4½'	N/A	SC0945PA44E





# ALL ALUMINUM NO-TIP™ PORTABLE SOCCER GOALS

**8-YEAR**  
Limited Warranty



**MEETS**  
ASTM F2950-14 and  
ASTM F1938-98

**NEW!**  
**BISON IS THE EXCLUSIVE SOCCER GOAL PARTNER OF THE NFHS**



## All Aluminum No-Tip™ Portable Soccer Goal



Video

**100% Aluminum...And a whole lot more** • The latest development in Bison's super strong line of super safe soccer goals • Aluminum 4" square uprights and 2" square backstay assemblies feature extra welded gusset plates at critical corner connections to make them virtually unbreakable • Bison's QwikTrack™ net attachment system allows easy net attachment to upright, crossbar, bottom sides and rear of goal • Only Bison offers patented No-Tip™ integrated ballast and transport system insuring both safety and easy goal movement without ground anchors or loose ballast • All Aluminum No-Tip goals meet all NCAA, National High School Federation, FIFA, **ASTM F2950-14 and ASTM F1938-98** rules and specifications • Specially designed extrusions have extra heavy wall thickness and large corner safety radii to guarantee both durability and safety • These Bison soccer goals feature a super thick bright white textured powder coated finish and carry an eight-year limited warranty • 12" wide molded polyethylene drums roll easily even in tall, wet or muddy grass and provide permanent safe ballast when properly filled with sand by customer at the time of installation • **Goals include nets, net storage bag, net attachment system and No-Tip system** • Sold in pairs • Eight-year limited warranty.



2" Square QwikTrack™ Side and Rear Rails



4" Square Large Corner Safety Radius



No-Tip Transport/Ballast System Now With Net Retention Bar

	Age Range	Width	Height	Top Depth	Bottom Depth	Model #
Official Competition	U12+	24'	8'	4'	10'	SC2480PA44XL

# EURO™ FUTBOL GOALS

**8-YEAR**  
Limited Warranty



## Euro™ Portable Futbol Goal

**Euro styling...** makes Euro goal a popular choice for soccer purists • Official 24' x 8' competition goal is constructed almost entirely of 4" diameter white aluminum powder coated extrusions with Bison exclusive QwikTrack net attachment system allowing net to be attached to uprights, crossbar and ground components • European style backstays support net at top • Meets or exceeds **ASTM F2950-14 and ASTM F1938-98** • **Goals include nets, net storage bag, net attachment clips and ground anchor kit** • Sold in pairs • Eight-year limited warranty.



QwikTrack™ Net Attachment Included



Ground Anchor Kit Included

	Age Range	Width	Height	Top Depth	Bottom Depth	Model #
Official Competition	U12+	24'	8'	4'	10'	SC2480PA40EURO

**MEETS**  
ASTM F2950-14 and  
ASTM F1938-98



800-247-7668



www.bisoninc.com





# ALL ALUMINUM PERMANENT/SEMI-PERMANENT SOCCER GOALS



**BISON IS THE EXCLUSIVE SOCCER GOAL PARTNER OF THE NFHS**



## ShootOut™ 4" Square Aluminum Permanent/Semi Permanent Soccer Goals

Just what you would expect from Bison, goals that are durable, affordable and easy to install.

Bison permanent/semi permanent 4" square, powder coated soccer goals are constructed of aluminum extrusions for a lifetime of rustproof service...These goals include Bison's premium QwikTrack net attachment system popular on our aluminum portable goals eliminating loose hook and loop net attachment • Goals can be permanently installed in concrete or be removable with the purchase of SC44S ground sleeves • Order optional SCIGAID for installation aid for in-ground soccer goals • Available in five sizes • Standard European 4' backstays to add top depth to goals (except SC0945IGA Bantam) • Competition nets and net storage bags included • Sold in pairs • All in-ground soccer goals have a 5-Year limited warranty.

SC2480IGA

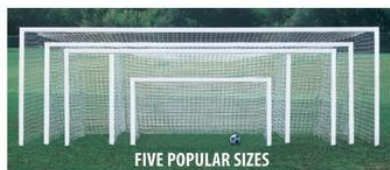

FIVE POPULAR SIZES



4" Square Large Corner Safety Radius



European Style Backstays Included

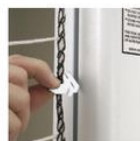

QwikTrack™ Easy and Dependable Net Attachment

Model	Goal Size
SC2480IGA	Competition 24'(w) x 8'(h)
SC2170IGA	Club Plus 21'(w) x 7'(h)
SC1865IGA	Club 18½'(w) x 6½'(h)
SC1265IGA	Youth 12'(w) x 6½'(h)
SC0945IGA	Bantam 9'(w) x 4½'(h)



### SC44S Ground Sleeves

4" square, 24" deep sockets install in 8" diameter minimum 30" deep concrete footing for easy removal of goals when not in use...Sockets are extruded aluminum and include cap to keep out debris • Order two sleeves per goal (four per field).



## Knotless HTPP Soccer Nets

These premium nets are designed specifically for Bison soccer goals but can be used on any soccer goal with comparable top and bottom depth...Constructed of heavy super high tenacity polypropylene (HTPP) multifilament rachel knotless hexagon netting, these nets are non-abrasive for superior durability and safety • These white mesh nets have heavy rope edges to facilitate proper attachment to goal • Sold in pairs • Each pair of nets comes with a free mesh carry bag for easy transport or storage between games or during the off season • Ninety-day warranty • Sport nets are not returnable once open.

**FREE!**  
Mesh Storage Bag with Each Pair of Nets

Model	Mesh Diameter	Width	Height	Top Depth	Bottom Depth
SC100N	4mm	24'	8'	4'	10'
SC106N	4mm	24'	8'	4'	6'
SC080N	4mm	21'	7'	4'	7'
SC072N	4mm	18.5'	6.5'	4'	6.5'
SC060N	4mm	12'	6.5'	4'	6.5'
SC050N	4mm	9'	4.5'	2'	4.5'
SC045N	4mm	9'	4.5'	0'	4.5'





## ShootOut™ Aluminum Combo Football/Soccer Goals

When soccer and football teams share space...Combo Goals are the answer • Constructed of weatherproof 4" square aluminum extrusions • Nets attach with popular Bison exclusive QwikTrack system • 4" square upright and crossbar extrusions have large corner radii for superior player safety and have a bright white, textured powder coated finish • Official 24' (w) x 8' (h) soccer goals and official 10' high football crossbar and 10' uprights that can be installed either at 23' 4" high school width or 18' 6" college width • Order **FB10EXT-WT** to extend uprights from 10' to 20' height • Choose in-ground permanent/semi permanent or portable (see details below) • 5-Year limited warranties • Sold in pairs.

### SC2480IGA FB Permanent Semi Permanent Combo Goals

Install goals permanently in concrete footings or install using optional **SC44S** ground sleeves to allow easy removal...Includes European Style backstays, competition nets and net storage bags • Order **SCIGAID** for installation aid for in-ground soccer goals.



SC2480IGA FB

### SC2480PA44 FB Portable Combo Goals

Add the convenience of portability and built-in No-Tip ballast system to the versatility of Combo Goals...Bison No-Tip system insures safety without the inconvenience of ballast bags, ground anchors or other anchor systems that are often forgotten, lost, discarded or ineffective • The rear ballasts double as transport wheels allowing movement on and off the field to improve space utilization. Note: Due to the added weight of the football crossbar and uprights, goal transport typically requires four people • Includes soccer nets.



SC2480PA44 FB



### SC44S Ground Sleeves

4" square, 24" deep sockets install in 8" diameter minimum 30" deep concrete footing for easy removal of goals when not in use...Sockets are extruded aluminum and include cap to keep out debris • Order two sleeves per goal (four per field).



800-247-7668



www.bisoninc.com

73





SC1260PERM

## PermaGoal™ Soccer Goal



Video

Tired of replacing nets and repairing broken welds on portable goals?...

PermaGoal is the perfect answer • 11'6" wide x 6' high x 6' deep youth size • Heavy galvanized framework covered with commercial grade 9 ga galvanized chain link mesh • Frame installs in five concrete footings for a lifetime of playground soccer fun • Perfect for elementary schools, summer camps, unsupervised parks and anywhere young soccer enthusiasts gather • Sold as single goal, order 2 for a full field • Goal ships as a kit with all components ready to assemble and install • Limited lifetime warranty.



### Soccer Corner Flags

Official corner flags in zippered storage bag... Choose SC06CF with ground spikes for natural turf or SC06CFW with sand fillable base for artificial turf or indoor use • Sets of 4.

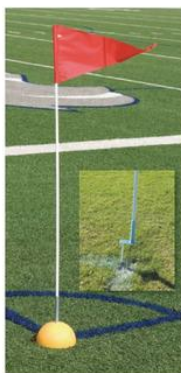

### SC72NC QwikTrack™ Replacement Net Attachment Clips

Compatible with all Bison aluminum soccer, futsal, field hockey and team handball goals...72 clips attaches two nets to two goals.



### SC10 Soccer Net Attachment Kit

Attach any manufacturer's nets to any manufacturer's goals...Zip ties and ground stakes make net attachment easy • Attaches nets to two goals • Kit does not satisfy applicable rules for portable goal tipover safety.



### SC04GA Ground Anchor Kit

Auger style anchors are superior to straight ground anchors...Proper use complies with NCAA and NFHS rules regarding anchoring and tip over of portable soccer goals • Set of 4 (two per goal).



### SCNOTIP No-Tip™ Retrofit Kit

Retrofit Bison and most other brands and styles of portable soccer goals to improve tip over and transport safety...12" wide molded polyethylene drums each hold approximately 60# of customer supplied sand for ballast and act as rollers for easy transport • Contact Bison for information on compatibility with existing goals • One kit retrofits two goals.



### SC06DK Soccer Skill Practice Disks

8" diameter durable orange plastic • Set of 24.



### SC04WK Tip and Roll Wheel Retrofit Kit

Add a front transport system to most Bison soccer goals...10" wheels flip forward for use and back for play • One kit retrofits two goals.



### SC50B Ballast Bag

Safety first...Use in place of ground anchors on artificial turf fields or as preferred anchoring method • Requires two per goal • Black vinyl bag with zippered sides • Capacity for 70# of sand or gravel (customer provided).







Bison offers a full line of popular gooseneck style football goal posts for all levels of play and budget. Heavy powder coated steel tubing construction with installation friendly features make Bison football goal posts the perfect choice for any application. Choose 5<sup>9</sup>/<sub>16</sub>" diameter with 72" or 96" setback or 4<sup>1</sup>/<sub>2</sub>" diameter with 60" setback. Each available in either bright white or safety yellow powder coated finish. Ground attachment options include direct bury in concrete footings, pivot mount, or installation with the use of adjustable height ground sleeves. See chart for ordering details.



Video



## 5<sup>9</sup>/<sub>16</sub>" Direct Bury Gooseneck Goalposts

These are the heaviest Bison goalposts...Choose 96" or 72" setback • 48" ground bury • 5<sup>9</sup>/<sub>16</sub>" O.D. schedule 40 pipe is bent then powder coated • All Bison gooseneck goalposts feature Bison's exclusive PerfectGoal design for precise vertical and horizontal alignment and uncommon ease of installation • 4<sup>1</sup>/<sub>2</sub>" steel tube crossbar and 20' long, 2<sup>3</sup>/<sub>8</sub>" diameter aluminum uprights • Order **FB10EXT** to increase upright height from 20' to 30' • Use with **FB55S** ground sleeves if desired • Sold in pairs • 5-Year limited warranty.

## 4<sup>1</sup>/<sub>2</sub>" Direct Bury Gooseneck Goalposts

Popular 4<sup>1</sup>/<sub>2</sub>" gooseneck styling and Bison's exclusive PerfectGoal design makes these goalposts an excellent value...Posts bury 48" into the ground for stability or use **FB45S** ground sleeves for removable installation • Posts have 60" setback and 20' long aluminum uprights • Crossbars are 4<sup>1</sup>/<sub>2</sub>" steel tube • Sold in pairs • 5-Year limited warranty.

**New for 2025**

## Swing Up Goal Posts

New for 2025...Bison now offers popular Swing Up pivot mount goal posts which allow convenient goal assembly on the ground then pivoting into position for final attachment • Includes ground anchors • Goals can be tipped forward toward the field of play and removed, if desired, during the off season or for other field uses • See chart for ordering details.

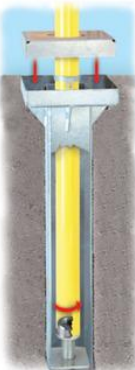

## PerfectGoal™ Adjustable Height Ground Sleeves

These sleeves allow the removal of gooseneck style goalposts on multi-purpose fields...The only goalpost sleeve in the industry that allows accurate adjustment of the crossbar height to official 10' • Hot dip galvanized heavy wall steel base • 4" of total crossbar height adjustment • Built-in anti-rotation device • Aluminum cover to finish socket both when installed and removed • Requires minimum 30" diameter x 53" deep excavation • Order two per field • Some assembly required • Use only with Bison goalposts • Order **FB55S** for 5<sup>9</sup>/<sub>16</sub>" goal posts and **FB45S** for 4<sup>1</sup>/<sub>2</sub>" goal posts.

## Football Goal Post Chart

Direct Bury Model #	Swing Up Model #	Level of Play	Post Diameter	Safety Setback	Color
FB55HS-SY	FB55HSPM-SY	High School	5 <sup>9</sup> / <sub>16</sub> "	72"	Safety Yellow
FB55HS-WT	FB55HSPM-WT	High School	5 <sup>9</sup> / <sub>16</sub> "	72"	White
FB55CG-SY	FB55CGPM-SY	College	5 <sup>9</sup> / <sub>16</sub> "	72"	Safety Yellow
FB55CG-WT	FB55CGPM-WT	College	5 <sup>9</sup> / <sub>16</sub> "	72"	White
FB58HS-SY	FB58HSPM-SY	High School	5 <sup>9</sup> / <sub>16</sub> "	96"	Safety Yellow
FB58HS-WT	FB58HSPM-WT	High School	5 <sup>9</sup> / <sub>16</sub> "	96"	White
FB58CG-SY	FB58CGPM-SY	College	5 <sup>9</sup> / <sub>16</sub> "	96"	Safety Yellow
FB58CG-WT	FB58CGPM-WT	College	5 <sup>9</sup> / <sub>16</sub> "	96"	White
FB45HS-SY	FB45HSPM-SY	High School	4 <sup>1</sup> / <sub>2</sub> "	60"	Safety Yellow
FB45HS-WT	FB45HSPM-WT	High School	4 <sup>1</sup> / <sub>2</sub> "	60"	White



800-247-7668



www.bisoninc.com

75

## FBCPPG Full Color Graphic Football Goalpost Padding

Virtually any color or design can be created...with the assistance of our Art Department • 5" thick high density foam covered with weatherproof 14 oz. vinyl digitally printed and clear laminated for extended life • Protects players to a height of 72" • Meets all NCAA and National High School Federation rules • Hook and loop closures • Designed to fit all goal posts to 5<sup>9</sup>/<sub>16</sub>" diameter and 4" square • Sold in eases • Order **FBCPP** for solid color padding • 2-Year limited warranty.



## FBWDS Wind Direction Streamers

Official 4" wide x 42" long, weather resistant streamers... Includes hardware to attach to 2<sup>3</sup>/<sub>8</sub>" diameter uprights without drilling • Durable orange outdoor flag material, double stitched • Can be used on other size uprights by drilling and bolting • Sold in sets of four.



## Upright Extensions for Football Gooseneck Goalposts (not shown)

Increase the upright height from 20' to 30' on 5<sup>9</sup>/<sub>16</sub>" Gooseneck Goalposts or from 10' to 20' on Aluminum Combination Soccer/Football Goals with these 10' extensions...Includes four 10' aluminum upright extenders and adapter hardware • Order one kit per field • Specify white (**FB10EXT-WT**) or safety yellow (**FB10EXT-SY**) • Contact your Bison Product Specialist for details.



## COMPETITION LACROSSE GOALS

### LC200 Official Steel Competition Lacrosse Goals

These goals meet all NCAA and National High School Federation rules for competition play... Popular flat iron style base allows use indoors or outdoors on any surface • 1½" (1.9" O.D.) schedule 40 pipe framework has thick ground bars allowing sturdy ground staking or use of ballast bags to stabilize • Orange powder coated finish • Includes four ground anchors • 6' (h) x 6' (w) x 7' (d) opening meets all governing body rules • Sold in pairs • **Nets and net attachment kit included** • 1-Year limited warranty.

### LC050N Official Lacrosse Nets

Designed to fit Bison lacrosse goals but will fit **most official lacrosse goals...**6mm white knotless webbing • Sold in pairs • 90-day limited warranty • **Sports nets are not returnable once opened.**



LC200

## COMPETITION FIELD HOCKEY GOALS

### FH200 Outdoor Field Hockey Goals

Durable design for high level competition...100% rustproof aluminum with premium black weatherproof ¼" UHMW Polyethylene kick boards • 5 cm (2") square extrusion face • White powder coated finish • Easy and dependable QwikTrack net attachment • Official size meets all USFHA and National High School Federation and NCAA rules • **Nets and net attachment kit included** • 2-Year limited warranty.

### FH200N Field Hockey Nets

Meets all association rules for official goals... 12' (w) x 7' (h) x 4' (t) x 4' (b) square mesh with heavy braided corners and edges • Replacement net for FH200 • Sold in pairs • **Sports nets are not returnable once opened** • 90-day limited warranty.

### FH200WK Wheel Kit for Field Hockey Goals (not shown)

Transport with ease...Take your goals to and from the field • 10" diameter wheels mount permanently to the back of field hockey goal frames to increase convenience and reduce risk of player injury or goal damage • Some drilling of goal required for installation • Includes wheels and hardware for two goals.



5 cm (2" Square)  
QwikTrack Front Rails



QwikTrack Net Attachment



FH200WK Wheel Kit



## COMPETITION FUTSAL GOALS

### SCFUTSAL Official Futsal Goal

A great goal for a great game...2 meter (approximately 6'7") high and 3 meter (approximately 9'10") wide goal meets official rules • 100% aluminum construction with a durable white powder coated finish • 8 cm square (approximately 3" x 3") aluminum extrusion uprights and crossbars have large corner radii for player safety and Bison's exclusive QwikTrack net mounting system • Standard rear horizontal stabilizer bar adds durability and stability • Complete package includes two goals with rear stabilizer bars, two nets, QwikTrack net clips, indoor rubber floor protectors and two ballast bags • Meets all governing body rules • Sold in pairs • 2-Year limited warranty.

### SC03PP Futsal Safety Padding

Protect futsal players from contact with the corner posts...Vinyl-covered, ½" thick padding covers full 79" height of posts • Hook and loop attachment • Sold in kits to protect one goal • Order two kits per court.

### SCFUTSALN Futsal and Team Handball Net

Net is designed for Bison futsal goal but can be used on any futsal goal with the same dimensions...4" octogon mesh constructed of 3mm diameter netting • 3 meter (9' 10") wide and 2 meter (6' 7") high • 80cm (31½") top depth and 100cm (39¾") bottom depth • Sold in pairs • 90-day limited warranty • Sports nets are not returnable once opened.

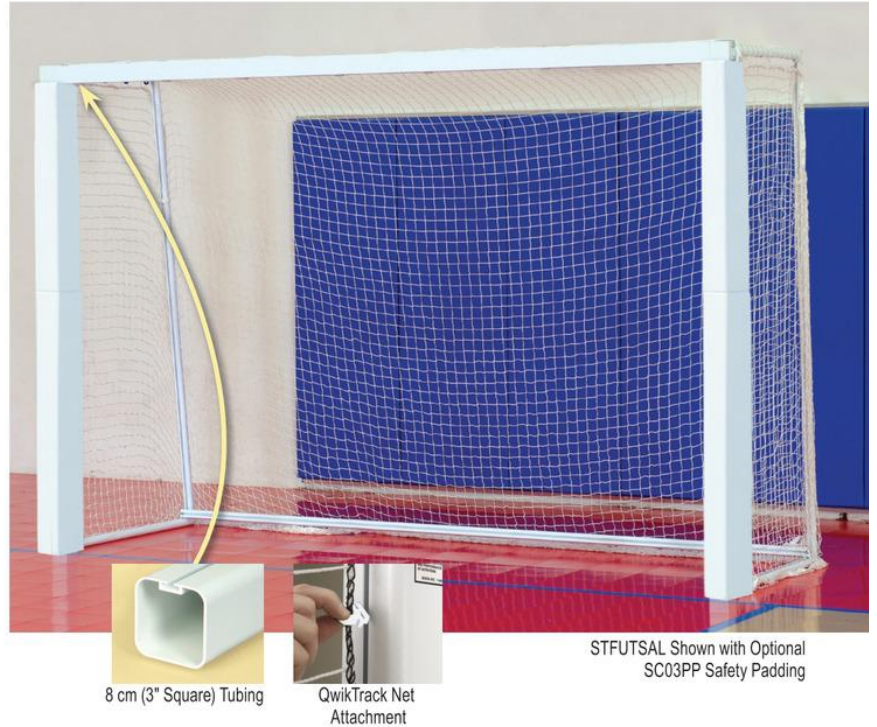

STFUTSAL Shown with Optional SC03PP Safety Padding

8 cm (3" Square) Tubing

QwikTrack Net Attachment

## COMPETITION HANDBALL GOALS

### SCTEAMHB Official Team Handball Goal

Goal meets all official handball rules...2 meter x 3 meter opening • Constructed of 3" square aluminum extrusion tubing • Large safety radii on all corners of tubing corners • Features fast and easy QwikTrack net attachment • Anti-skid floor protectors and portable ballast bags and net included • Meets all governing body rules • Sold in pairs • 2-Year limited warranty.



### SC50B Ballast Bag

Safety first...Black vinyl bag with zippered sides • Capacity for 70# of sand or gravel (customer provides) • One ballast bag included with each Bison futsal and team handball goal.

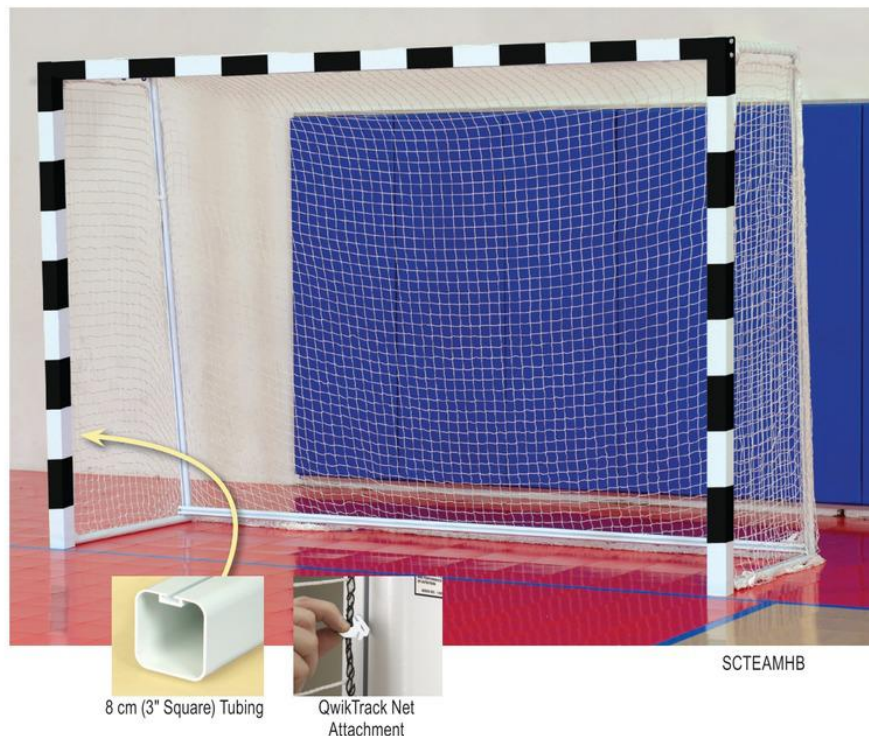

SCTEAMHB

8 cm (3" Square) Tubing

QwikTrack Net Attachment



800-247-7668



www.bisoninc.com

77



# INDOOR BLEACHERS

## Easy Store™ Indoor Portable Bleachers



BLI1503



BLI1503 Transport Mode

### Easy Store™ Indoor Bleachers

Portable indoor bleachers provide a mobile solution to seating needs in a wide range of indoor applications and can be used outdoors when desired... When in use, Easy Store bleachers rest on non-marking rubber feet • Just lift front to tilt bleachers onto stable 3" diameter transport casters • Choose from 7½, 15' or 21' lengths in various heights • Heavy-duty 2" x 10" anodized aluminum seat planks • 100% aluminum structure • Planks have end caps for a finished look without sharp edges • High grade zinc plated hardware • See page 80 for information on powder coated seat planks • 5-Year limited warranty.

Length	Tiers	Seating Capacity	Approx. Overall Dimension	Model #
7½'	2	10	2' 2" (h) x 3' (d) x 7½' (l)	BLI0702
7½'	3	15	2' 6" (h) x 5' 6" (d) x 7½' (l)	BLI0703
7½'	4	20	3' 6" (h) x 7' 8" (d) x 7½' (l)	BLI0704
15'	2	20	2' 2" (h) x 3' (d) x 15' (l)	BLI1502
15'	3	30	2' 6" (h) x 5' 6" (d) x 15' (l)	BLI1503
15'	4	40	3' 6" (h) x 7' 8" (d) x 15' (l)	BLI1504
21'	2	28	2' 2" (h) x 3' (d) x 21' (l)	BLI2102
21'	3	42	2' 6" (h) x 5' 6" (d) x 21' (l)	BLI2103

### Approximate Indoor/Outdoor Bleacher Dimensions

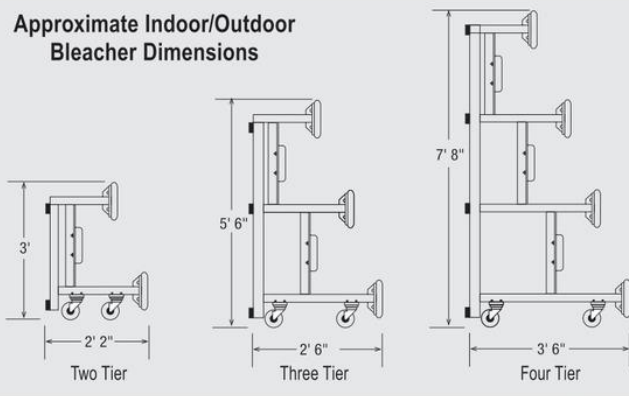

### WARNING!

All Bison bleachers are designed and manufactured to meet or exceed ICC300-2023 when correctly installed and maintained in accordance with the instructions provided. Local codes vary and Bison bleachers may not meet all local or state codes. Bison assumes no responsibility for customer selection of bleachers that do not meet local codes.



## Weatherbeater™ Outdoor Portable Bleachers



BLO1503



BLO1503 Shown with Optional Powder Coated Seat Planks

### Weatherbeater™ Outdoor Bleachers

These outdoor bleachers are built for a lifetime of dependable, trouble-free sports seating...

Weatherbeater bleachers come with recycled plastic ground runners to keep support framework raised from grass or dirt

- Recycled runners will not rot like wood runners used by other manufacturers
- Available in 7½, 15' or 21' lengths in 2, 3 or 4 tier heights
- 2 tier bleachers are only available in 15' lengths
- Heavy-duty 2" x 10" anodized aluminum seat planks
- 100% aluminum structure
- Planks have end caps for a finished look without sharp edges
- High grade zinc plated hardware
- See page 80 for information on powder coated seat planks
- 5-Year limited warranty.

### WARNING!

All Bison bleachers are designed and manufactured to meet or exceed ICC300-2023 when correctly installed and maintained in accordance with the instructions provided. Local codes vary and Bison bleachers may not meet all local or state codes. Bison assumes no responsibility for customer selection of bleachers that do not meet local codes.



BLO1504AXL



BLO1504AXL Shown with Optional Powder Coated Seat Planks

### Weatherbeater™ Premium Outdoor Bleachers

An extra measure of comfort and safety... Same basic features as outlined above

- The addition of an extra foot rest plank and heel kick panel not only improve safety but also provide comfort, child control and reduced dropped or lost loose objects like jackets, purses and backpacks
- Add powdered coated seat color planks (see page 80) to customize your field
- 5-Year limited warranty.

Length	Tiers	Seating Capacity	Approx. Overall Dimension	Standard Structure Model #	Premium Structure Model #
7½'	3	15	2' 6" (h) x 5' 6" (d) x 7½' (l)	BLO0703	BLO0703AXL
7½'	4	20	3' 6" (h) x 7' 8" (d) x 7½' (l)	BLO0704	BLO0704AXL
15'	2	20	2' 2" (h) x 3' (d) x 15' (l)	BLO1502	BLO1502AXL
15'	3	30	2' 6" (h) x 5' 6" (d) x 15' (l)	BLO1503	BLO1503AXL
15'	4	40	3' 6" (h) x 7' 8" (d) x 15' (l)	BLO1504	BLO1504AXL
21'	3	42	2' 6" (h) x 5' 6" (d) x 21' (l)	BLO2103	BLO2103AXL
21'	4	56	3' 6" (h) x 7' 8" (d) x 21' (l)	BLO2104	BLO2104AXL

### Approximate Bleacher Dimensions

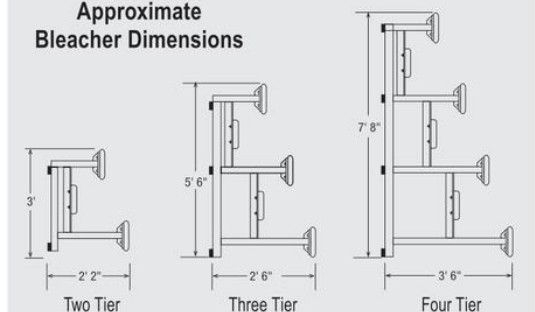

800-247-7668



www.bisoninc.com

79



# INDOOR/OUTDOOR BENCHES

## Player Benches

Benches are available as either in-ground fixed models or wide-base, freestanding portables...Select benches with or without a backrest

- 100% aluminum structure • 21' length for fourteen player capacity, 15' for ten players or 7½' for five players • Four 2" square leg supports on 21', three leg supports on 15' and two leg supports on 7½' • 2" x 10" x .08" minimum cross section anodized aluminum seats and backs • Planks have end caps for a finished look without sharp edges • Fixed models require a 30" deep concrete footing to install in-ground for lasting, safe, weatherproof seating • Portable models are constructed to provide a nearly tip-proof bench to transfer from football field to soccer, baseball or softball fields as seasons change • Portable benches can be used with or without rubber feet provided, can be anchored to ground or can be bolted down to courtside surfaces • 5-Year limited warranty.



### Player Benches with Backrest



Length	Seating	Fixed or Portable	Backrest	Legs/ Supports	Model #
21'	14	Portable	Yes	4	BNP2101B
21'	14	Fixed	Yes	4	BNF2101B
15'	10	Portable	Yes	3	BNP1501B
15'	10	Fixed	Yes	3	BNF1501B
7½'	5	Portable	Yes	2	BNP0701B
7½'	5	Fixed	Yes	2	BNF0701B

### Player Benches without Backrest



Length	Seating Capacity	Fixed or Portable	Backrest	Legs/ Supports	Model #
21'	14	Portable	No	4	BNP2101
21'	14	Fixed	No	4	BNF2101
15'	10	Portable	No	3	BNP1501
15'	10	Fixed	No	3	BNF1501
7½'	5	Portable	No	2	BNP0701
7½'	5	Fixed	No	2	BNF0701

### Powder Coated Aluminum Planks

Show your school colors on Bison's benches or bleachers...Simply substitute your choice of royal, scarlet, navy or forest green planks for standard anodized aluminum seats that are included with Bison aluminum player benches, Weatherbeater bleachers and Easy Store bleachers • Choose any combination of colors for any quantity of seat planks • Order one **BL07SEAT1-XX** for each colored 7½' seat plank and order one **BL15SEAT1-XX** for each colored 15' seat plank • Orders of 25 or more planks can be powder coated in a wider variety of colors (allow six weeks).





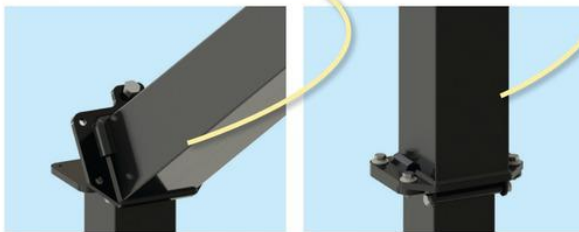

EZ SwingUp Base Installation Position

EZ SwingUp Base Ready For Play

## HangTime™ Adjustable Systems

Want playground durability in an adjustable rim height system? Ultimate HangTime provides maximum flexibility for use by players of all ages • The heavy-duty right angle crank can be locked to avoid unauthorized height adjustment with optional **BALOCKHT** HangTime rim height locking device • 6" square heavy wall steel poles and unbreakable clear polycarbonate, tempered glass or steel backboards • All HangTime adjustable systems come standard with outdoor breakaway goal but Bison Ultimate fixed goal (BA39U) may be substituted at no extra cost • Pole system features 56" safe play area and textured black powder coated finish • Other features include New **EZ SwingUp** installation base and easy-to-read height indicator to make installation and rim height adjustment from approximately 7½' to 10' easy • Requires 2 or more adults for installation • 10 year limited warranty on pole and backboard • 1 year on rim, padding and crank • See chart below.



PR98SHT

Model #	Pole Size	Backboard Size	Backboard Type	Rim	Optional Pole Padding	Optional Backboard Padding
PR98UHT	6" Square	42" x 72"	Polycarbonate (Lifetime Warranty on Board)	BA32S Breakaway	BA870PP	BA72U
PR98GHT	6" Square	42" x 72"	Glass	BA32S Breakaway	BA870PP	BA72U
PR98SHT	6" Square	42" x 60"	Steel	BA32 Breakaway	BA870PP	BA60U
PR98SXLHT	6" Square	42" x 72"	Steel	BA32 Breakaway	BA870PP	BA72U
PR98UHTJR	6" Square	36" x 60"	Polycarbonate (Lifetime Warranty on Board)	BA32 Breakaway	BA870PP	BA60U
PR98GHTJR	6" Square	36" x 60"	Glass	BA32 Breakaway	BA870PP	BA60U
PR98GHTJRS	6" Square	36" x 60"	Smoked Glass	BA32 Breakaway	BA870PP	BA68U



Smooth Operating Right Angle Crank



Easy to Read Rim Height Indicator

### HangTime™ Redesigned

HangTime installation no longer takes wobbly ladders, heavy lifting, contract installers or 3-4 adults. • Unlike similar systems, HangTime **EZ SwingUp** base system allows all assembly to happen safely and easily at ground level • When all assembly is complete, just swing the complete system into vertical position, lock in place with four bolts and you are ready to play.

### HTADPT HangTime™ Pedestal Adapter Plate

Use to mount HangTime 6" poles to existing threaded j-bolt style footings with 9" x 9" mounting pattern.



Supplemental Installation Video



Optional Backboard Padding



Optional Crank Lock (BALOCKHT)



800-247-7668



www.bisoninc.com





# ADJUSTABLE PLAYGROUND BASKETBALL SYSTEMS

## ZipCrank™ Playground Adjustable Systems

The perfect outdoor system for facilities that desire durable adjustable systems at an affordable price • These ZipCrank systems feature clear, unbreakable 3/8" polycarbonate backboards, outdoor breakaway goals, 30" safe play area, removable awning style crank handle and textured black powder coat finish • Choose 4" square or 5" square, 1/8" wall 2-piece direct bury pole each with an easy-to-read rim height indicators • Rim can be adjusted from 7½' to 10' • Order **BA870JRPXSUB** to substitute a removable pedestal base pole for the direct bury pole on **PR95UZZ** only.



PR95UZZ shown with optional pole padding



PR94UZZ



Direct Bury Pole



Easy Height Adjustment

Model #	Pole Size	Backboard Size	Backboard Type	Rim	Optional Pole Padding	Optional Backboard Padding	Warranties
PR95UZZ	5" Square	36" x 60"	Polycarbonate	BA32 Breakaway	BA870JRPXP	BA60U-BK	2-Year Limited on Pole and Rim, Limited Lifetime on Backboard
PR94UZZ	4" Square	36" x 54"	Polycarbonate	BA32 Breakaway	BA79UXX	BA54U-BK	2-Year Limited on Pole and Rim, Limited Lifetime on Backboard

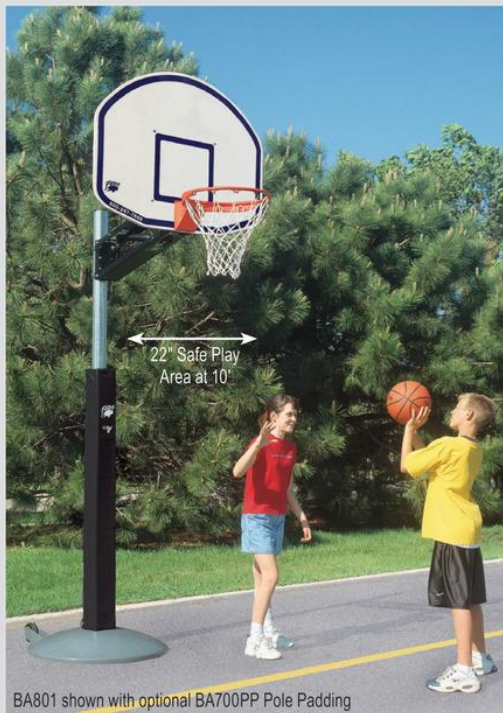

BA801 shown with optional BA700PP Pole Padding



PR12

## QwikChange™ Playground Systems

Popular playground features at a popular price... Heavy galvanized 3½" steel pole • 36" x 48" molded graphite backboard and flex goal adjusts from 7½' to 10' in 6" increments • QwikChange design requires only a pole to change height from the ground • Choose permanent in-ground or portable system • Great for camps, daycares, church parking lots or anywhere kids of all ages gather to play basketball • 1-Year limited warranty.

### BA801 QwikChange™ Portable

Factory installed 350# of ballast...Built-in transport wheels • Order **BA801BP** and **BA700PP** for base and pole safety padding.

### PR12 QwikChange™ Permanent

36" ground bury...Optional **BA700PP** pole safety padding.



### BA801BP Base Padding

Improve safety with this specially designed pad that covers 360° around the base of the BA801 portable... 1" thick foam with sewn cover in black vinyl • Hook and loop attachment.



Tilt and Roll



Easy Height Adjustment





## Fixed Height Ultimate™ Series

Try the Ultimate on your most demanding outdoor court and you'll never need to buy another basketball system...From the massive 6" square, 3/16" wall 2-piece pole and extension arm that buries a full 40" into the ground for incredible stability to the tip of the Ultimate goal that carries an **unconditional lifetime warranty**, these systems are designed to take the abuse common on today's playgrounds • Choose the standard 60" safe play area or upgrade to an extended 72" safe play area on any system by adding model **BA870AXL-BK** • Order **BA870PXSUB** to substitute a removable pedestal base pole for the direct bury pole • Backboard choices include 42" x 60" or 42" x 72" steel or 42" x 72" perforated steel with white powder coated finish, 42" x 72" clear tempered glass or 42" x 72" clear unbreakable polycarbonate • Systems with steel boards come standard with Bison's Ultimate fixed goal • Glass and polycarbonate systems include outdoor breakaway goals • See page 93 for backboard and pole safety padding options • Double sided options are available on each system to get more play for less money • See chart below for options.

**LIFETIME Warranty**

**Unbreakable Polycarbonate**

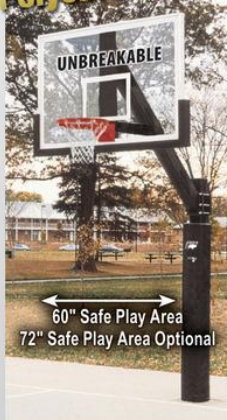

BA873U Shown with Optional BA870PP-BK Pole Padding and BA72U-BK Backboard Padding

**Perforated Steel**



BA874-BK Shown with Optional BA870PP-BK Pole Padding

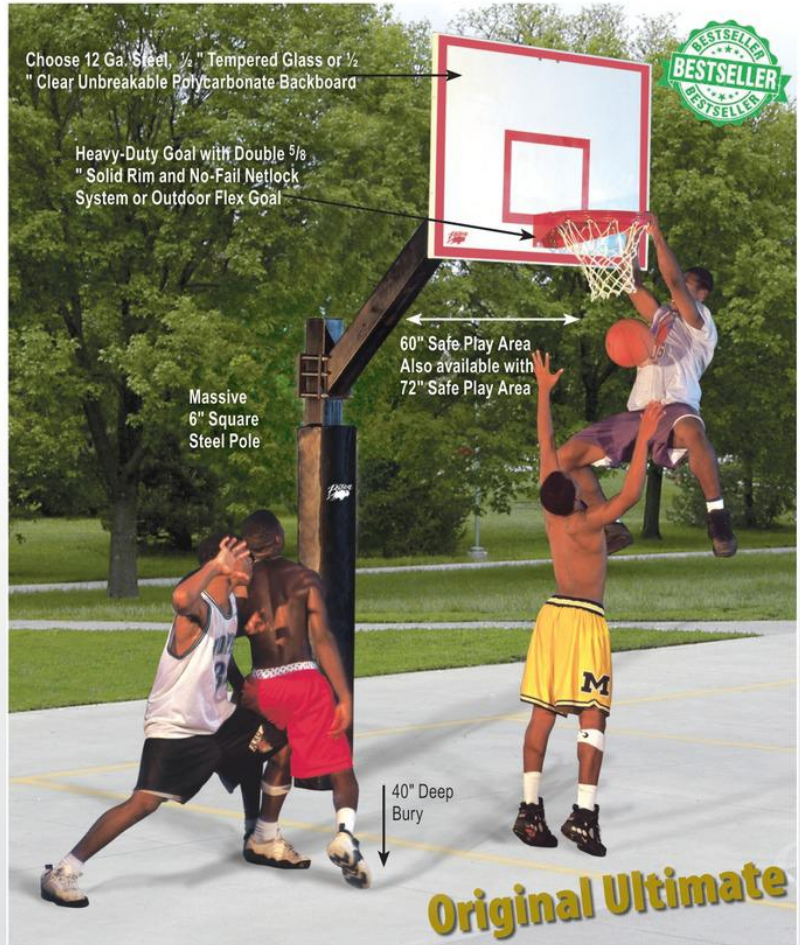

BA871-BK Shown with Optional BA870PP-BK Pole Padding



Any Ultimate playground system can be double-sided. Contact Bison for details.

**The Ultimate for durability, playability and value!**

See next page for similar features on a downsized system perfect for smaller budgets.

Ultimate Model	Double-Sided Option	Safe Play Area	Backboard Size	Backboard Type	Goals	Pole Finish	Optional Backboard Padding	Warranty
BA871-BK	BA872-BK	60"	42" x 60"	Steel	BA39U Ultimate	Black	BA60U-BK	Lifetime Limited Functional
BA871XL-BK	BA872XL-BK	72"	42" x 72"	Steel	BA39U Ultimate	Black	BA72U-BK	Lifetime Limited Functional
BA874-BK	Available on Request	60"	42" x 72"	Perforated Steel	BA39U Ultimate	Black	BA72U-BK	Lifetime Limited Functional
BA873-BK	Available on Request	60"	42" x 72"	Glass	BA32S Breakaway	Black	BA72U-BK	Pole: Lifetime Limited Functional Goal: 1-Year Limited
BA873U-BK	Available on Request	60"	42" x 72"	Polycarbonate	BA32S Breakaway	Black	BA72U-BK	Pole: Lifetime Limited Functional Goal: 1-Year Limited

Order BA870PP-BK for optional pole padding on single sided systems, BA872PP-BK for optional padding on double sided systems.



800-247-7668



www.bisoninc.com

83





## Ultimate™ Junior Playground Systems

Designed with many of the premium features found on its big brother Ultimate Fixed Systems, but with a smaller price tag and different backboard options. **Ultimate Jr. systems** feature a 5" square, 1/8" wall 2-piece steel pole that buries a full 36" into the ground. The 4" square extension arm places the face of the backboard approximately 36" from the front surface of the pole and provides a stable and rigid support for one of three different backboard and goal options shown below. Rim is direct mounted through the backboard into the extension arm so eliminates virtually all stress placed on the backboard during aggressive playground play. Backboards are also supported by the extension arm at the top

- Order **BA870JRPP** for optional pole padding
- Order **BA870JRPXSUB** to substitute a removable pedestal base pole for direct bury pole.

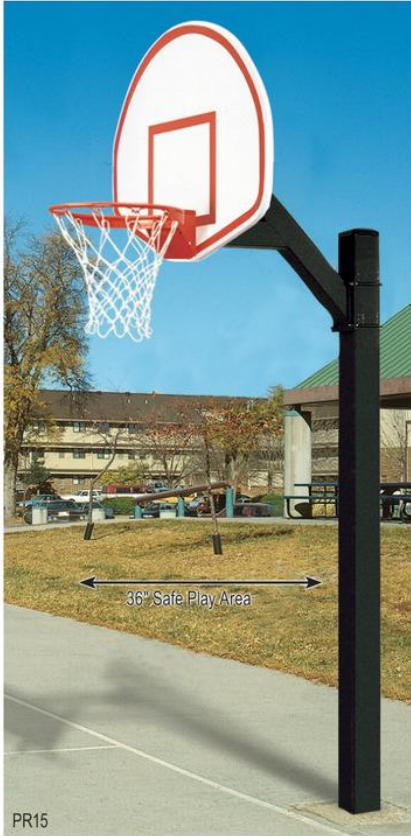

### PR15 Ultimate™ JR Fan Aluminum Playground System

Fan shaped aluminum backboards are the most popular playground backboard in the industry...and will never rust • BA475SS 36" x 54" cast aluminum features heavy rear ribbing, white powder coated finish and orange shooter square and border • Includes Bison BA32 outdoor breakaway goal and premium nylon net. 10-Year limited warranty on system.

### PR17 Ultimate™ JR Rectangular Steel Playground System

Same popular 42" x 60" steel backboard as found on our 6" Ultimate system...but at a reduced cost

- BA47 backboard is constructed of 12 ga. steel playing surface with all edges safety rolled to eliminate sharp edges and provide extra rigidity
- Additional welded rear structure makes this backboard nearly indestructible especially with mounted on Ultimate Jr. direct mount pole
- System includes BA32 outdoor breakaway goal and premium nylon net • 10-year warranty on system.



### PR18 Ultimate™ JR Unbreakable Polycarbonate Playground System

Want a backboard that is bullet proof... PR18 is the answer • 36" x 60" clear polycarbonate backboard has heavy aluminum frame and rear support structure to insure that this system will hold up even in the toughest of conditions • Polycarbonate is the material used in bullet proof windows • System includes Bison BA32 outdoor breakaway goal and premium nylon net • 10-Year limited warranty on system.



### PR19 Ultimate™ JR Glass Playground System

Experience the ball rebound of tempered glass...Same features as PR18 except substitutes outdoor durable clear glass for clear polycarbonate • 36" x 60" backboard • BA32 outdoor breakaway goal • 10-year limited warranty.

Model #	Pole Size	Safe Play Area	Backboard Size	Backboard Type	Optional Backboard Padding	Optional Pole Padding	Goal
PR15	5"	36"	36" x 54"	Aluminum Fan	N/A	BA870JRPP	BA32 Breakaway
PR17	5"	36"	42" x 60"	Steel	BA60U-BK	BA870JRPP	BA32 Breakaway
PR18	5"	36"	36" x 60"	Clear Polycarbonate	BA60U-BK	BA870JRPP	BA32 Breakaway
PR19	5"	36"	36" x 60"	Glass	BA60U-BK	BA870JRPP	BA32 Breakaway





All packages on this page have a 72" or 96" safe play area, 48" ground bury and lifetime limited pole warranty.

## BA780 Mega-Duty 59/16" Gooseneck Pole

Superior rigidity, superior durability and greater safe play area make this pole a must where play is rough...59/16" O.D., hot dip galvanized steel pipe • 72" or 96" safe play area • Goal mounts directly through backboard to pole to virtually eliminate stress on backboard when hanging occurs • Heavy-duty 1 5/8" backboard braces • 48" in-ground bury • Add optional **FBCPP** pole padding for increased player safety • Order pole and components separately or in complete packages described below • **Lifetime limited warranty** on pole.



**PR74 package includes...**BA780 Mega-Duty 59/16" O.D., hot dip galvanized steel pipe with 72" safe play area, heavy 1 5/8" support braces, 48" in-ground bury pole (**Lifetime limited warranty**); **BA42UC** official 42" x 72" backboard made of clear, bulletproof polycarbonate with heavy extruded aluminum framework, official white shooter's square and border (**Lifetime limited warranty**); and **BA32** outdoor flex goal designed to withstand playground abuse (1-year limited warranty).

**PR75 package includes...**BA780 Mega-Duty 59/16" O.D., hot dip galvanized steel pipe with 72" safe play area (or order **PR75XL** for 96" safe play area), heavy 1 5/8" support braces, 48" in-ground bury pole (**Lifetime limited warranty**); **BA475SS** fan-shaped 35 1/2" x 54" durable, rust-free aluminum backboard with heavy support ribs, white powder coated finish and orange shooter's square and border (**Lifetime limited warranty**); and **BA39U** Ultimate playground goal with double 5/8" steel rim and No-Fail netlock system to add strength and eliminate netlock breakage plus 3/16" thick steel box-style backplate and rim supports, accepts nylon or optional chain nets (**Unconditional lifetime replacement warranty**).

**PR76 package includes...**BA780 Mega-Duty 59/16" O.D., hot dip galvanized steel pipe with 72" safe play area, heavy 1 5/8" support braces, 48" in-ground bury pole (**Lifetime limited warranty**); **BA495** fan-shaped 39" x 54" backboard with heavy-duty mounting support structure, 12 ga. steel skin, and white powder coated finish (10-year limited warranty); and **BA39U** Ultimate playground goal with double 5/8" steel rim and No-Fail netlock system to add strength and eliminate netlock breakage plus 3/16" thick steel box-style backplate and rim supports, accepts nylon or optional chain nets (**Unconditional lifetime replacement warranty**).

**PR77 package includes...**BA780 Mega-Duty 59/16" O.D., hot dip galvanized steel pipe with 72" safe play area (or order **PR77XL** for 96" safe play area), heavy 1 5/8" support braces, 48" in-ground bury pole (**Lifetime limited warranty**); **BA47** Ultimate rectangular 42" x 60" playground backboard made of heavy-duty 12 ga. steel skin with safety rolled edges and white powder coated finish (**Lifetime limited warranty**); and **BA39U** Ultimate playground goal with double 5/8" steel rim and No-Fail netlock system to add strength and eliminate netlock breakage plus 3/16" thick steel box-style backplate and rim supports, accepts nylon or optional chain nets (**Unconditional lifetime replacement warranty**).

**PR78 package includes...**BA780 Mega-Duty 59/16" O.D., hot dip galvanized steel pipe with 72" safe play area, heavy 1 5/8" support braces, 48" in-ground bury pole (**Lifetime limited warranty**); **BA407U** rectangular 42" x 54" backboard made of unbreakable bulletproof clear polycarbonate and extruded aluminum framework with white shooter's square and border (**Lifetime limited warranty**); and **BA32** outdoor flex goal designed to withstand playground abuse (1-year limited warranty).

**PR79 package includes...**BA780 Mega-Duty 59/16" O.D., hot dip galvanized steel pipe with 72" safe play area (or order **PR79XL** for 96" safe play area), heavy 1 5/8" support braces, 48" in-ground bury pole (**Lifetime limited warranty**); **BA472PC** official 42" x 72" size backboard made of perforated steel popular on inner city playgrounds, 12 ga. steel skin with heavy steel rear framework with safety rolled edges and white powder coated finish (10-year limited warranty); and **BA39U** Ultimate playground goal with double 5/8" steel rim and No-Fail netlock system to add strength and eliminate netlock breakage plus 3/16" thick steel box-style backplate and rim supports, accepts nylon or optional chain nets (**Unconditional lifetime replacement warranty**).

**PR87 (not shown) package includes...**BA780 Mega-Duty 59/16" O.D., hot dip galvanized steel pipe with 72" safe play area (or order **PR87XL** for 96" safe play area), heavy 1 5/8" support braces, 48" in-ground bury pole (**Lifetime limited warranty**); **BA472** rectangular official size 42" x 72" backboard made of heavy-duty 12 ga. steel skin with safety rolled edges and white powder coated finish (**Lifetime limited warranty**); and **BA39U** Ultimate playground goal with double 5/8" steel rim and No-Fail netlock system to add strength and eliminate netlock breakage plus 3/16" thick steel box-style backplate and rim supports, accepts nylon or optional chain nets (**Unconditional lifetime replacement warranty**).



PR76

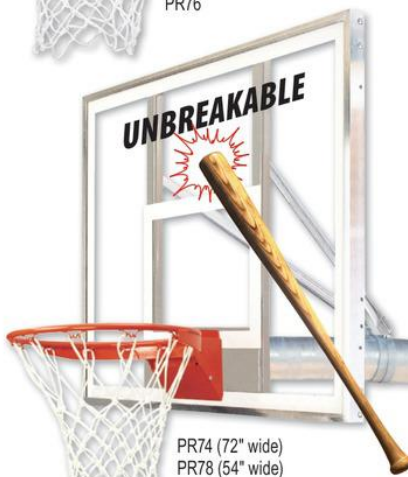

PR74 (72" wide)  
PR78 (54" wide)



PR75



PR79



800-247-7668



www.bisoninc.com

85





# 4 1/2" HEAVY-DUTY PLAYGROUND BASKETBALL SYSTEMS

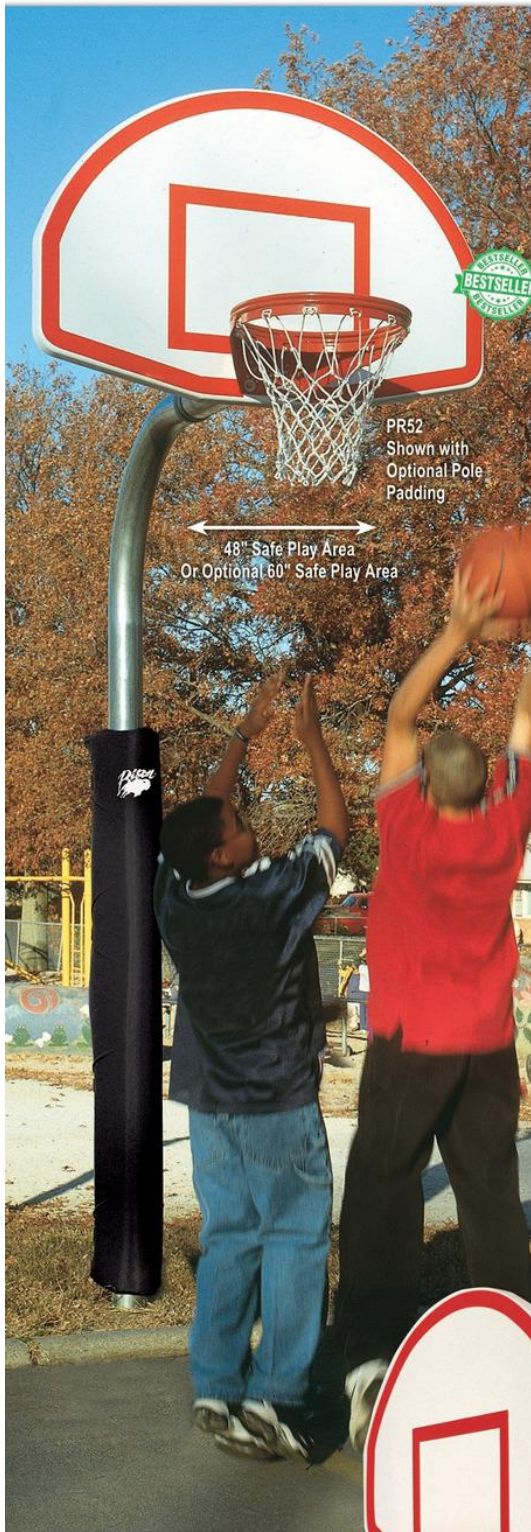

All packages on this page have a 48" or 60" safe play area, 48" ground bury and 25-year pole warranty.

## BA777 Heavy-Duty 4 1/2" Gooseneck Pole

This 4 1/2" O.D. pole provides 48" or 60" safe play area...Direct goal mount design improves backboard durability • Includes heavy-duty 1 5/8" backboard support braces • 48" ground bury for stability even in deep frost regions • Galvanized pole and zinc plated hardware • 5" x 5" goal mounting pattern • 25-year limited warranty • Add optional BA700PP pole padding for increased player safety • Order pole and components separately or in popular packages described below • 25-year limited warranty on pole.

**PR52 package includes...**BA777 Heavy-Duty 4 1/2" O.D., hot dip galvanized steel pipe with 48" safe play area (or order PR52XL for 60" safe play area), heavy 1 5/8" support braces, 48" in-ground bury pole (25-year limited warranty); **BA475SS** fan-shaped 35 1/2" x 54" durable, rust-free aluminum backboard with heavy support ribs, white powder coated finish and orange shooter's square and border (**Lifetime limited warranty**); and **BA39U** Ultimate playground goal with double 5/8" steel rim and No-Fail netlock system to add strength and eliminate netlock breakage plus 3/16" thick steel box-style backplate and rim supports, accepts nylon or optional chain nets (**Unconditional lifetime replacement warranty**).

**PR55 package includes...**BA777 Heavy-Duty 4 1/2" O.D., hot dip galvanized steel pipe with 48" safe play area (or order PR55XL for 60" safe play area), heavy 1 5/8" support braces, 48" in-ground bury pole (25-year limited warranty); **BA495** fan-shaped 39" x 54" backboard with heavy-duty mounting support structure, 12 ga. steel skin, and white powder coated finish (10-year limited warranty); and **BA39U** Ultimate playground goal with double 5/8" steel rim and No-Fail netlock system to add strength and eliminate netlock breakage plus 3/16" thick steel box-style backplate and rim supports, accepts nylon or optional chain nets (**Unconditional lifetime replacement warranty**).

**PR60 package includes...**BA777 Heavy-Duty 4 1/2" O.D., hot dip galvanized steel pipe with 48" safe play area (or order PR60XL for 60" safe play area), heavy 1 5/8" support braces, 48" in-ground bury pole (25-year limited warranty);

**BA47** Ultimate rectangular 42" x 60" playground backboard made of heavy-duty 12 ga. steel skin with safety rolled edges and white powder coated finish (**Lifetime limited warranty**); and **BA39U** Ultimate playground goal with double 5/8" steel rim and No-Fail netlock system to add strength and eliminate netlock breakage plus 3/16" thick steel box-style backplate and rim supports, accepts nylon or optional chain nets (**Unconditional lifetime replacement warranty**).

**PR70 package includes...**BA777 Heavy-Duty 4 1/2" O.D., hot dip galvanized steel pipe with 48" safe play area (or order PR70XL for 60" safe play area), heavy 1 5/8" support braces, 48" in-ground bury pole (25-year limited warranty);

**BA407U** rectangular 42" x 54" backboard made of unbreakable bulletproof clear polycarbonate and extruded aluminum framework with white shooter's square and border (**Lifetime limited warranty**); and **BA32** outdoor flex goal designed to withstand playground abuse (1-year limited warranty).

**PR70G package includes...**BA777 Heavy-Duty 4 1/2" O.D., hot dip galvanized steel pipe with 48" safe play area, heavy 1 5/8" support braces, 48" in-ground bury pole (25-year limited warranty); **BA407G** rectangular 42" x 54" backboard made of 3/8" thick tempered glass with an extruded aluminum framework and white shooter's square and border (5-year limited outdoor warranty); and **BA32** outdoor flex goal designed to withstand playground abuse (1-year limited warranty).

PR52  
Shown with  
Optional Pole  
Padding

48" Safe Play Area  
Or Optional 60" Safe Play Area

PR55

PR70  
PR70G

PR60





All packages on this page have a 36" safe play area, 36" ground bury and 10-year pole warranty.

## BA775 Tough-Duty 3½" Gooseneck Pole

Galvanized 3½" O.D. pole comes with zinc plated hardware... Provides 36" safe play area • 36" ground bury • Direct goal mount design • Heavy-duty 1½" diameter braces to support backboard are included • 5" x 5" goal mounting pattern • Add optional **BA700PP** pole padding for increased player safety • Order pole and components separately or in complete packages as described below • 10-year limited warranty on pole.

### PR20 package includes...BA775

Tough-Duty 3½" O.D., hot dip galvanized steel pipe with 36" safe play area, heavy 1½" support braces, 36" in-ground bury pole (10-year limited warranty); **BA495** fan-shaped 39" x 54" backboard with heavy-duty mounting support structure, 12 ga. steel skin, and white powder coated finish (10-year limited warranty); and **BA27** standard 5/8" steel rim goal with ½" braces and continuous netlocks (1-year limited warranty).



### PR29 package includes... BA775

Tough-Duty 3½" O.D., hot dip galvanized steel pipe with 36" safe play area, heavy 1½" support braces, 36" in-ground bury pole (10-year limited warranty); **BA475SS** fan-shaped 35½" x 54" durable, rust-free aluminum backboard with heavy support ribs, white powder coated finish and orange shooter's square and border (**Lifetime limited warranty**); and **BA27** standard 5/8" steel rim goal with ½" braces and continuous netlocks (1-year limited warranty).

### PR31 package includes...BA775

Tough-Duty 3½" O.D., hot dip galvanized steel pipe with 36" safe play area, heavy 1½" support braces, 36" in-ground bury pole (10-year limited warranty); **BA454** rectangular 39" x 54" backboard made of 12 ga. carbon steel with a white powder coated finish and perforated shooter's square (10-year limited warranty); and **BA27** standard 5/8" steel rim goal with ½" braces and continuous netlocks (1-year limited warranty).

### PR33 package includes...BA775

Tough-Duty 3½" O.D., hot dip galvanized steel pipe with 36" safe play area, heavy 1½" support braces, 36" in-ground bury pole (10-year limited warranty); **BA475SS** fan-shaped 35½" x 54" white rust-free cast aluminum backboard with heavy ribbing for maximum rigidity and orange border with shooter's square (**Lifetime limited warranty**); removable rim bracket and removal pole and **BA27** standard 5/8" steel rim goal with ½" braces and continuous netlocks (1-year limited warranty). For use by adults only.

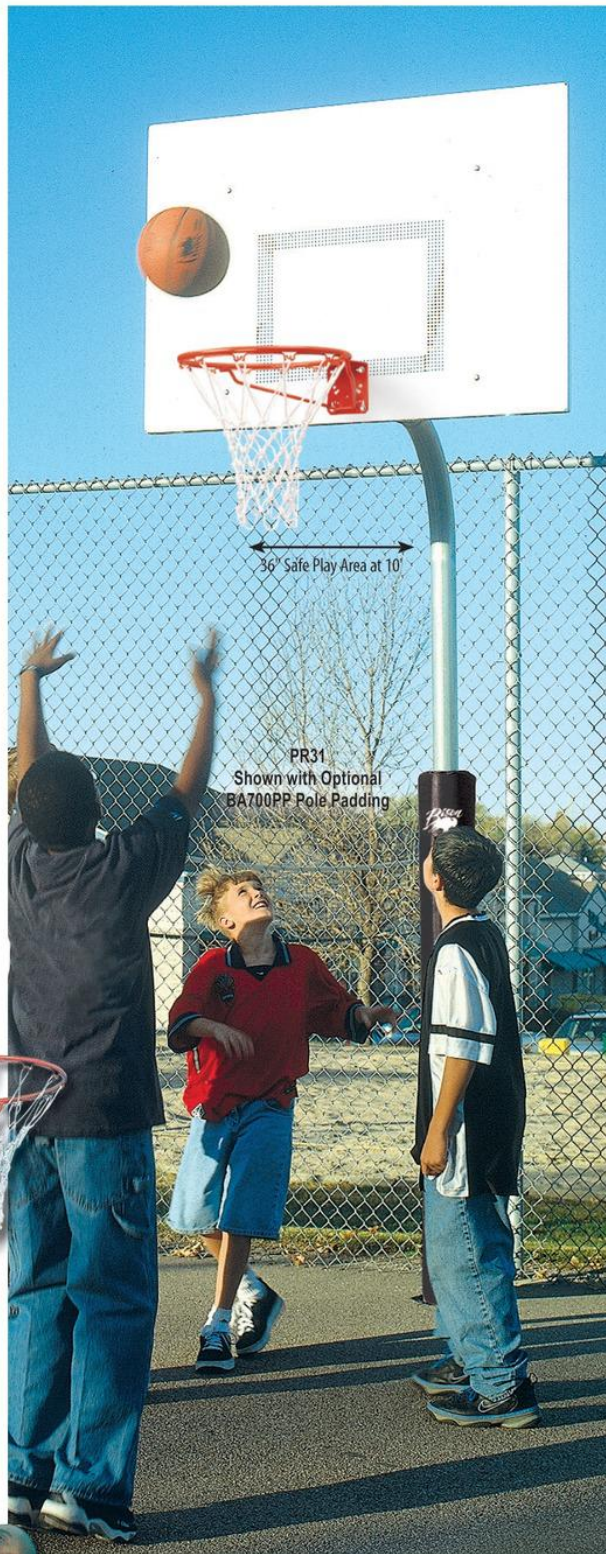

800-247-7668



www.bisoninc.com

87





## Playground Basketball Packages

Model #	Adjustable	Safe Play Area	Pole Finish	Backboard Material	Backboard Size/ Shape	Goal Style
<b>4" Square Pole</b> <i>See details on page 82.</i>						
PR94UZC	Yes	30"	Black	Polycarbonate	36" x 54" Rectangular	Breakaway
<b>5" Square Pole</b> <i>See details on pages 82 and 84.</i>						
PR15	No	36"	Black	Aluminum	39" x 54" Fan	Breakaway
PR17	No	36"	Black	Steel	42" x 60" Rectangular	Breakaway
PR18	No	36"	Black	Polycarbonate	36" x 60" Rectangular	Breakaway
PR19	No	36"	Black	Glass	36" x 60" Rectangular	Breakaway
PR95UZC	Yes	30"	Black	Polycarbonate	36" x 60" Rectangular	Breakaway
<b>6" Square Pole</b> <i>See details on pages 81 and 83.</i> <span style="float: right;">*Ask about available 72" Safe Play Area</span>						
BA871-BK	No	60**	Black	Steel	42" x 60" Rectangular	Double Rim Fixed
BA871XL-BK	No	72"	Black	Steel	42" x 72" Rectangular	Double Rim Fixed
BA873-BK	No	60**	Black	Glass	42" x 72" Rectangular	Breakaway
BA873U-BK	No	60**	Black	Polycarbonate	42" x 72" Rectangular	Breakaway
BA874-BK	No	60"	Black	Perforated Steel	42" x 72" Rectangular	Double Rim Fixed
PR98UHT	Yes	54"	Black	Polycarbonate	42" x 72" Rectangular	Breakaway
PR98GHT	Yes	54"	Black	Glass	42" x 72" Rectangular	Breakaway
PR98SHT	Yes	54"	Black	Steel	42" x 60" Rectangular	Breakaway
PR98SXLHT	Yes	54"	Black	Steel	42" x 72" Rectangular	Breakaway
PR98UHTJR	Yes	54"	Black	Polycarbonate	36" x 60" Rectangular	Breakaway
PR98GHTJR	Yes	54"	Black	Glass	36" x 60" Rectangular	Breakaway
PR98GHTJRS	Yes	54"	Black	Smoked Glass	36" x 60" Rectangular	Breakaway
<b>5<sup>9</sup>/<sub>16</sub>" Round</b> <i>See details on page 85.</i>						
PR74	No	72"	Galvanized	Polycarbonate	42" x 72" Rectangular	Breakaway
PR75/PR75XL	No	72"/96"	Galvanized	Aluminum	35½" x 54" Fan	Double Rim Fixed
PR76	No	72"	Galvanized	Steel	39" x 54" Fan	Double Rim Fixed
PR77/PR77XL	No	72"/96"	Galvanized	Steel	42" x 60" Rectangular	Double Rim Fixed
PR78	No	72"	Galvanized	Polycarbonate	42" x 54" Rectangular	Breakaway
PR79/PR79XL	No	72"/96"	Galvanized	Perforated Steel	42" x 72" Rectangular	Double Rim Fixed
PR87/PR87XL	No	72"/96"	Galvanized	Steel	42" x 72" Rectangular	Double Rim Fixed
<b>4½" Round Pole</b> <i>See details on page 86.</i>						
PR52/PR52XL	No	48"/60"	Galvanized	Aluminum	35½" x 54" Fan	Double Rim Fixed
PR55/PR55XL	No	48"/60"	Galvanized	Steel	39" x 54" Fan	Double Rim Fixed
PR60/PR60XL	No	48"/60"	Galvanized	Steel	42" x 60" Rectangular	Double Rim Fixed
PR70/PR70XL	No	48"/60"	Galvanized	Polycarbonate	42" x 54" Rectangular	Breakaway
PR70G	No	48"	Galvanized	Glass	42" x 54" Rectangular	Breakaway
<b>3½" Round Pole</b> <i>See details on pages 82 and 87.</i>						
PR12	Yes	22"	Galvanized	Graphite	36" x 48" Fan	Breakaway
PR20	No	36"	Galvanized	Steel	39" x 54" Fan	Fixed
PR29	No	36"	Galvanized	Aluminum	35½" x 54" Fan	Fixed
PR31	No	36"	Galvanized	Steel	39" x 54" Rectangular	Fixed
PR33	No	36"	Galvanized	Aluminum	35½" x 54" Fan	Removable
BA801	Yes	22"	Galvanized	Graphite	36" x 48" Fan	Breakaway

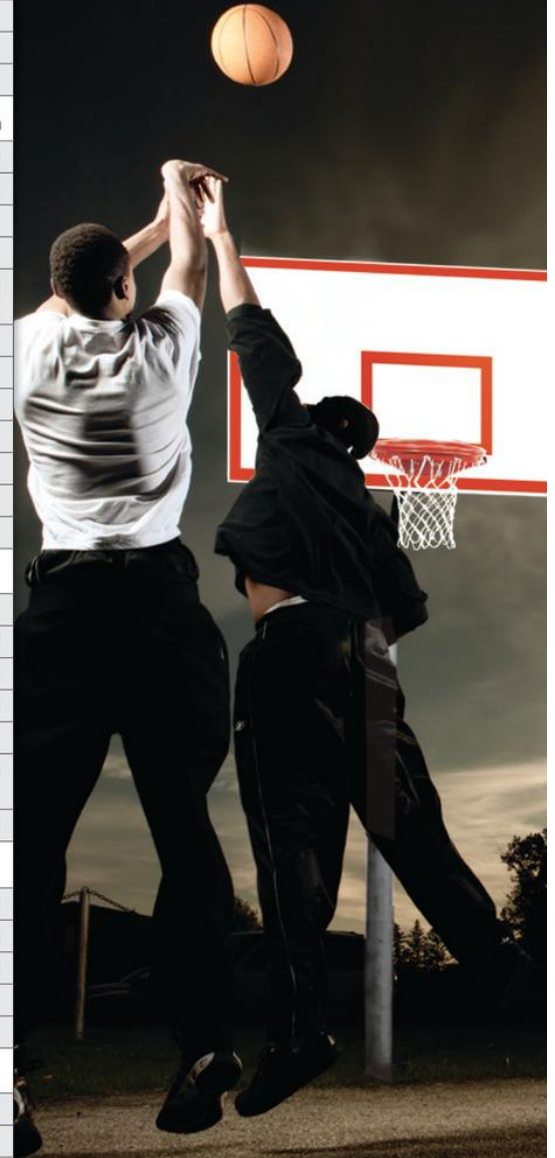



## BA39U **Ultimate™** Front Mount Playground Goal

The first and still the **ONLY** unconditional lifetime replacement warranty on a basketball goal!



**Unconditional Functional Lifetime Warranty**

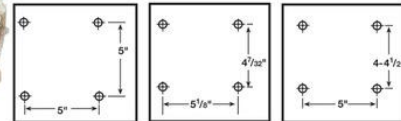

BA39U fits backboards with any of these hole patterns.

The **Ultimate** goal for tough playgrounds...Double, 5/8", solid rim design • 3/16" x 1" No-Fail netlock adds to strength of goal and eliminates netlock breakage • 3/16" thick "box" design backplate and rim supports • Includes high tensile strength mounting hardware and premium nylon net • **Unconditional functional lifetime warranty.**



### BA33U **Double-Rim, Heavy-Duty Flex Goal**

The industry's first **double-rim flex goal**...Low maintenance design can be used indoors or outdoors • 5/8" solid steel rings supported by 3/16" x 1 1/2" rim support • 15° of deflection, auto return • **Universal backplate** • No-Fail netlock system for chain, nylon or web nets • The best of breakaway and double-rim goal designs • Includes mounting hardware and nylon net • 1-Year limited warranty.

### BA32 **Heavy-Duty Side Court and Recreational Flex Goal**

The only affordable flex goal built to take the abuse of playground, gym or home use...Simple, low-maintenance design can be used indoors or outdoors • 5/8" steel rim supported by 3/16" x 1 1/2" support • 15° deflection, auto return • Durable, orange, baked powder coated finish • Not approved for interscholastic high school or collegiate play • Order BA35S for backboard with 5" wide x 4" high rim mounting holes • **Universal backplate** • Includes mounting hardware and nylon net • 1-Year limited warranty.

### BA37N **Front Mount Double-Rim Goal with No-Tie Netlocks**

**Super strong, super goal**...Double 5/8" steel ring for extra durability • Twelve no-tie netlocks to accept nylon net • 3/16" thick **universal backplate** • Packaged two goals per carton • Includes mounting hardware and nylon net • 1-Year limited warranty.

### BA37 **Front Mount Double-Rim Goal**

**Double rim for durability, two rim support braces for added strength**...3/16" steel **universal backplate** fits all front mount boards • Bottom ring is 1/2" diameter and formed to accept either BA53 chain net (included) or BA50 premium steel net (optional) • Packaged two goals per carton • Includes mounting hardware • 1-Year limited warranty.

### BA27A **Front Mount Super Goal**

**Excellent upgrade from standard front mount goals at lower cost than double rim or breakaway goals**...Full 5/8" computer designed reinforcing bar gives "super support" when player suspends from goal • Additional 5/8" brace at the vulnerable joint between rim and backplate • Continuous netlocks • 1/4" thick steel **universal backplate** • Durable, baked powder coated finish • Packaged two goals per carton • Includes mounting hardware and nylon net • 2-Year limited warranty.

### BA27 **Standard Front Mount Competition Goal** (not shown)

**Universal backplate of 3/16" steel for mounting to virtually all boards, institutional and home**...1/2" reinforcing bar, computer engineered for maximum support • Continuous netlocks • High-penetration continuous welded joints • Durable, powder coated finish • Packaged two goals per carton • Includes mounting hardware and nylon net • 1-Year limited warranty.

### BA32RXT **FlexCourt™ Rear Mount Flex Goal**

**Ideal for outdoor playgrounds or indoor courts with rear mount fan-shaped steel backboards**...Same heavy-duty design as Bison BA32 front mount flex goal • Double steel die spring action • Built to absorb stress from aggressive action around the rim • Helps protect vulnerable steel backboards from damage • **Universal backplate** mounts to all rear mount backboards • Official 5/8" diameter ring • Heavy 3/4" thick rim support • Includes mounting hardware and nylon net • 1-Year limited warranty.

### BA21A **Rear Mount Super Goal**

**Stronger than other manufacturers' standard rear mount goals**...1/4" continuous welded support ring for over half of the rim circumference • Continuous netlocks • Additional bracing at the backplate joint gives greater strength when player suspends from goal • 3/16" **universal backplate** mounts to all rear mount backboards • Durable powder coated finish • Packaged two goals per carton • Includes mounting hardware and nylon net • 2-Year limited warranty.



800-247-7668



www.bisoninc.com

89





BA495



BA47

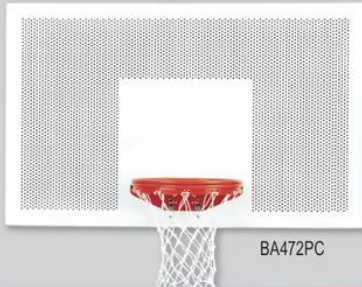

BA472PC



BA472



BA454



BA485

## BA495 Fan-Shaped Dura Steel™ Backboard

Updated design allows for rim height flexibility...39" x 54" official size fan steel backboard • 12 ga. skin with  $\frac{3}{16}$ " support structure • 5" x 5" front mount rim hole pattern • White powder coated finish with official orange shooters square and border • **Unique rear vertical mounting channel slots allows backboard and rim to be installed lower on typical gooseneck type poles for younger players** • 10-Year limited warranty.

## BA47 Ultimate™ Rectangular Steel Backboard

Our most popular rectangular playground backboard...42" x 60" playing surface • Standard 20" x 35" mounting brackets allow easy attachment to any current fan-shaped ceiling or wall mounting structure • All edges safety rolled to eliminate sharp edges, increase strength and rigidity • Excellent rebound • Orange border and shooter's square • Durable white powder coated finish • Heavy-duty 12 ga. skin • 7 ga. steel support structure • 5" x 5" goal mounting hole pattern • Designed for Bison Ultimate pole structures, but will also fit most manufacturers' outdoor pole systems • 10-Year limited warranty • **Lifetime limited warranty** when included on a Bison Ultimate system.

## BA472PC Perforated 72" Official Size Steel Backboard

Popular style preferred for use by many inner city playgrounds...No painted-on shooter's square or border to wear off • Official 42" x 72" size • All edges on the 12 ga. skin are triple bent to eliminate sharp edges and improve rigidity and durability • Heavy tubular frame is mounted to the rear for excellent playability not found on some steel backboards • White powder coated finish • 5" x 4" goal mounting pattern • Check drawing before purchasing to mount on existing pole structures • 10-Year limited warranty.

## BA472 Ultimate™ Official Size Rectangular Steel Backboard

Our most popular steel backboard is now available in official 42" x 72" size...All edges safety rolled to eliminate sharp edges, increase strength and rigidity • Excellent rebound • Orange border and shooter's square • Durable white powder coated finish • Heavy-duty 12 ga. skin • 7 ga. steel support structure • 5" x 4" goal mounting hole pattern • Designed for Bison Ultimate pole structures, but will also fit Bison's  $5\frac{9}{16}$ " gooseneck and most manufacturers' outdoor pole systems • 10-Year limited warranty • **Lifetime limited warranty** when included on a Bison Ultimate system.

## BA454 Perpetual™ Steel Backboard

Perforated shooter's square provides a permanent target that won't deteriorate...39" x 54" rectangular backboard • 12 ga. carbon steel skin • White powder coated finish • 5" x 5" goal mounting pattern • 10-Year limited warranty.

## BA485 Ruff Play™ Rear Mount Steel Backboard

Replace your bent and rusty rear mount backboards...Popular rear mount goal design • Same 20" x 35" mounting structure as all rear mount backboards • 12 ga. skin • Universal goal mounting hole pattern • Recommended for replacement use only • New installations should use BA495 front mount board for maximum fan-steel durability • Extra heavy support structure • White powder coated finish • Official 35" x 54" size • Not compatible with any Bison outdoor pole systems • 5-Year limited warranty.

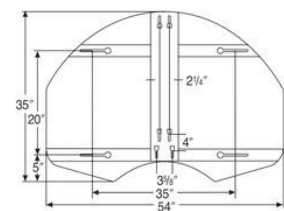
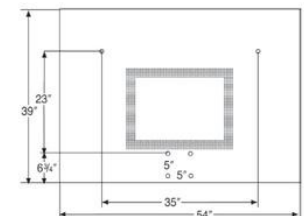
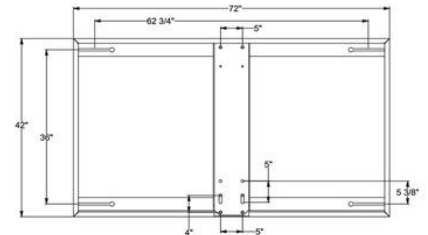
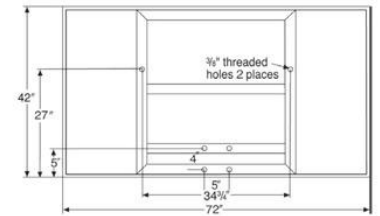
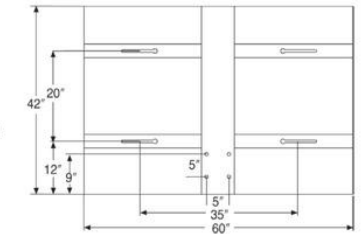
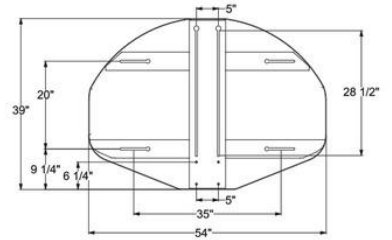

### WARNING!

All backboard warranties are invalid when not mounted properly on pole systems or structure with direct rim mount supports.

Order Goals Separately



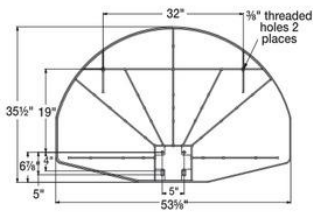

## BA475SS Lifeguard™ White Aluminum Backboard With Shooter's Square



Official shooter's square and orange border on cast aluminum...White powder coated finish  
 • Orange border and shooter's square • 5" x 5" goal mounting hole pattern • 35½" x 54" • Requires direct mount pole system • Lifetime limited warranty.



BA475SS

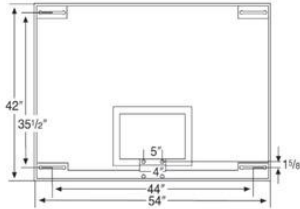

## BA407G Unbreakable Glass Side Court

A scaled down version of our popular unbreakable 42" x 72" competition glass backboard...Reduced to 42" x 54" to reduce weight and cost without sacrificing features • Goal is mounted "off glass" so even excessive hanging will not cause stress • 5-Year limited warranty.



BA407G

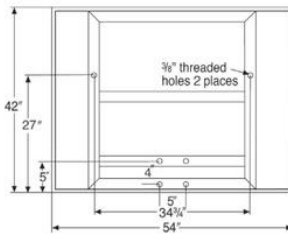

## BA407U Unbreakable Polycarbonate Backboard

This backboard repels vandalism...Clear, ½" thick polycarbonate material is virtually bulletproof • Top quality appearance for outdoor systems • Extruded aluminum framework is identical to that used on our premium competition glass backboards • Powder coated steel structure absorbs stress of player contact with the goal • 42" x 54" with white shooter's square and border • Lifetime limited warranty.



BA407U

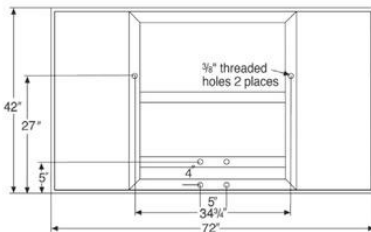

## BA42UC Unbreakable 72" Official Size Polycarbonate Backboard

Clear, full sized yet bulletproof...72" x 42" clear polycarbonate is a full ½" thick and supported by a heavy-duty aluminum frame and steel rear support structure • Looks exactly like a competition glass backboard with white shooter's square and border • Steel components have a durable powder coated finish • 5" x 4" goal mounting pattern • Check drawing before purchasing to mount on existing pole structures • Lifetime limited warranty.



BA42UC

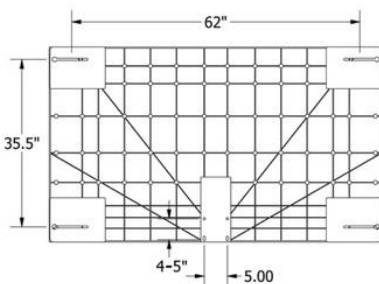

## BA456 Molded Rectangular Backboard

Suitable for indoor or outdoor use...official size 42" x 72", 2" thick white injection molded resin with extensive rear ribbing for superior playability and durability • Mounts to typical 62" wide x 35½" high wall or ceiling suspended structures • Also compatible with Bison 4½" and 5⁹⁄₁₆" diameter gooseneck outdoor pole systems • Steel mounting corner brackets • Orange shooter's square and border • 5" (w) x 4-5" (h) rim mounting pattern • 10-year limited warranty.



BA456

**WARNING!**  
 All backboard warranties are invalid when not mounted properly on pole systems or structure with direct rim mount supports.

Order Goals Separately



800-247-7668



www.bisoninc.com

91





# BUILD YOUR OWN PLAYGROUND BASKETBALL SYSTEM

Standard Gooseneck Pole shown with Optional Pole Padding



## 1

## Choose a Pole System

Build your own playground basketball system...using premium Bison pole systems, backboards and rims • Choose from one of 11 different pole systems from 3½" to 5⁹⁄₁₆" in diameter • 36" to 96" safe play area options • Choose single sided or double sided for more efficient court utilization • Charts below will confirm which backboards and rims are compatible with which poles • **With Bison what you want is what you get.**

Pole Model Number	Diameter	Extension	Style	Bury Depth	Pole Warranty
BA780	5⁹⁄₁₆"	72"	Gooseneck Pole	48"	Lifetime
BA780XL	5⁹⁄₁₆"	96"	Gooseneck Pole	48"	Lifetime
BA777	4½"	48"	Gooseneck Pole	48"	25 Years
BA777XL	4½"	60"	Gooseneck Pole	48"	25 Years
BA775	3½"	36"	Gooseneck Pole	36"	10 Years
BA781	5⁹⁄₁₆"	72"	Adjustable Arm Pole	48"	Lifetime
BA778	4½"	48"	Adjustable Arm Pole	48"	25 Years
BA776	3½"	36"	Adjustable Arm Pole	36"	10 Years
BA781DB	5⁹⁄₁₆"	72"	Double Sided Adjustable Arm Pole	48"	Lifetime
BA778DB	4½"	48"	Double Sided Adjustable Arm Pole	48"	25 Years
BA776DB	3½"	36"	Double Sided Adjustable Arm Pole	36"	10 Years
BA781A	5⁹⁄₁₆"	72"	Arm/Braces	N/A	25 Years
BA778A	4½"	48"	Arm/Braces	N/A	2 Years
BA776A	3½"	36"	Arm/Braces	N/A	2 Years
BA77XBR	3½", 4½"	N/A	Braces Only	N/A	2 Years

## 2

## Choose a Backboard

(See pages 90-91)



Compatibility	Backboard
Compatible with all Pole Systems Above	BA495, BA475SS (shown), BA454 and BA495P
Compatible with only 4½" and 5⁹⁄₁₆" Pole Systems Above	BA47 and BA407U
Compatible with only 5⁹⁄₁₆" Pole Systems Above	BA472PC and BA42UC

## 3

## Choose a Rim

(See page 89)



Compatibility	Rims
Compatible with all Poles/Backboards and Combinations Above	BA39U (shown), BA33U, BA32, BA37, BA37N, BA27A and BA27



Low



Lower



Lowest



## Upgrade Existing Playground Poles

Facilities that have existing 3½", 4½" or 5⁹⁄₁₆" outside diameter steel poles and want to install replacement backboards and support braces at the desired rim height can use these retrofit kits to refresh outdoor courts. Rim height can be adjusted to approximately 24" below the current top of the previously installed pole. The specially designed fan steel backboard features rear mounting slots allowing the rim mounting location to be lowered to position the rim at official 10' or as low as 8½" in most cases depending on the distance from the top of the horizontal pole to the playing surface. Retrofit kits each include BA495 fan steel backboard, 2 backboard support braces, pole mounting bracket and all necessary hardware. **Order rim separately.**

**BA495A3 Retrofit Kit for 3½" diameter poles**

**BA495A4 Retrofit Kit for 4½" diameter poles**

**BA495A5 Retrofit Kit for 5⁹⁄₁₆" diameter poles**







## Outdoor Safe Stuff™ Pole Padding

Protect players from injury caused by contact with the pole...Bison makes pole padding to fit every pole system we offer • Many styles will also fit other manufacturers' poles, refer to pole description • Hook and loop attachment straps • Thick foam covered with all-weather vinyl • 1-Year limited warranty • See page 102 of catalog for vinyl colors and lettering options.

Model	Fits Pole Size/Style	Padding Style	Color	Thickness	Height
BA870PP-BK	All 6" Square Poles	Fitted	Black	2"	70"
BA872PP-BK	All 4 Sides of 6" Square Poles	Fitted	Black	2"	74"
BA870JRPP	All 5" Square Poles	Fitted	Black	1"	68"
BA700PP	Any Round or Square Pole to 5 <sup>9</sup> / <sub>16</sub> " Dia.	Wrap-Around	Black	1"	72"
BA79UPP-BK	All 4" Square Poles	Fitted	Black	1"	72"
FBCPP (see page 75)	Any Round or Square Pole to 5 <sup>9</sup> / <sub>16</sub> " Dia.	Fitted	See Colors on page 102	5"	72"

BA870PP-BK Shown with Optional ABC52 Lettering



BA700PP



## Outdoor Backboard Padding

This molded DuraSkin padding is similar to that used in high schools, colleges and pro arenas across the country, but designed specifically for outdoor durability...Black padding provides protection from player contact with front and side of backboard • Fits most rectangular backboards • Bolt-on design requires backboard frame drilling • Order **BA54U-BK** for 54" wide backboards, **BA60U-BK** for 60" backboards, or **BA72U-BK** for 72" backboards • 1-Year limited warranty.

## TR96 Court Protector™ Removable Goal Package

Complete with goal, bracket, hardware and removal pole to make outdoor basketball systems usable only when desired...Bison BA27 goal and nylon net can be removed from the specially designed bracket without tools or ladders using the special telescoping pole provided • If desired, goal can be locked in place using padlock (not included) • Package will retrofit to any front mount backboard that uses a 5" x 5" or 5" x 4" goal mounting hole pattern • Order **TR95** for bracket, pole and hardware (order BA27 goal with net separately) • Use with Bison 3<sup>1</sup>/<sub>2</sub>" and 4<sup>1</sup>/<sub>2</sub>" gooseneck poles only • 1-Year limited warranty.

**WARNING: Rim Removal and Installation By Adults Only!**



Gooseneck Pole and Backboard Not Included



800-247-7668



www.bisoninc.com

93





# OUTDOOR BASKETBALL ACCESSORIES



## CM200 Three-Point Reusable Steel Court Stencil

No more flimsy paper or plastic stencils that tear or blow in the wind...Easy-to-use stencil kit marks court after court with sharp straight lines

- Minor cleaning of paint build up will allow stencils to last virtually forever
- Kit includes 20 gauge galvanized steel stencils to paint 1½" wide base line, lane, free-throw line, top of key and official high school three-point line
- Requires 2 to 3 cans of Parking Lot Spray Paint for each complete court
- Stencil kit is ideal for park departments, school district maintenance departments, playground installation crews or anyone wanting a quality outdoor basketball court.



BA50

### BA50 Premium Steel Playground Safety Net

This chain net will virtually eliminate the risk of loose and dangling chain links found on other chain nets... All links are welded into closed loops to eliminate separation caused when chains are stretched during play • Extra heavy-duty "S" hooks are used for attachment to any style or make of goal • Zinc plated and three times heavier than normal chain nets • 2-Year limited warranty.

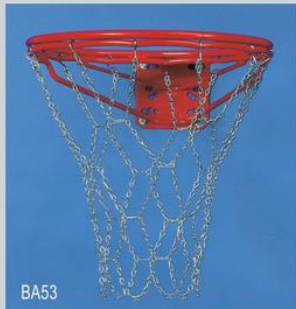

BA53

### BA53 Standard Chain Net

Heavier than most other manufacturers' chain playground nets...Outperforms common nylon nets • The heavy-duty "S" hooks attach to any style of goal • This is the standard net provided with Bison BA37 goal • Zinc plating provides protection from the weather.



BA51H

### BA51H Anti-Whip Net

Competition grade, affordable price...Heavy braided nylon to reduce net whip common with lighter weight nets • Bright white • Use for competition or as upgrade to normal residential or playground string nets.



BA501H

### BA501H Standard Competition Net

Heavier than nets generally supplied with goals...Braided nylon • Bright white • Excellent value.



### BA10 Replacement Shooter's Square

Ready-to-apply, official size, vinyl shooter's square will renew the look of your painted steel, wood or fiberglass backboards...Applies easily without messy adhesive or paint • Makes backboards good as new • Same heavy-duty, self-adhesive vinyl used for exterior automotive detailing • Installs in five minutes • Instructions and applicator included.

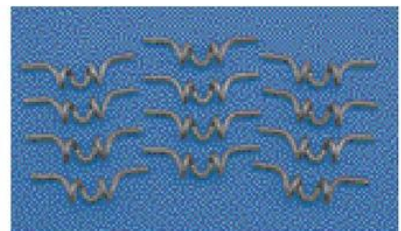

### BA56W Weld-On Repair Netlocks

A must for every park and recreation maintenance department...Low cost standard netlocks can be welded on in the shop • 12 per package.







## HangTime™ Adjustable Basketball Systems

Hangtime adjustable home basketball systems include all the most popular features at an affordable price...6" square, 1/4" wall pole now includes a new convenient hinged base allowing easy assembly to ground level without a ladder or heavy lifting

- Choose 60" clear or smoked glass or 72" clear glass backboards
- Requires 2 or more adults to install.

### Popular Features:

- Truglass Tempered Backboard
- EZ SwingUp Hinged Base
- 54" Safe Play Area at 10'
- 7½' - 10' Rim Height Adjustment
- Free Backboard Padding
- Free Fitted Pole Padding
- Gym Quality Heavy-Duty Breakaway Goal
- Easy-to-Read Rim Height Indicator
- Lockable Right Angle Rim Height Crank
- Textured Black Powder Coated Finish
- Limited Lifetime Warranty on Pole and Backboard
- 1-Year on Rim, Padding and Crank

### 3 Models to Choose From:

- HT6072G** 42" x 72" Clear Glass Backboard
- HT6060G** 36" x 60" Clear Glass Backboard
- HT6060GS** 36" x 60" Smoked Glass Backboard

Now with  
EZ SwingUp  
Hinged Base



EZ SwingUp Base  
Installation Position



EZ SwingUp Base Ready  
For Play



Supplemental Installation  
Video



Smooth Operating Right Angle  
Crank

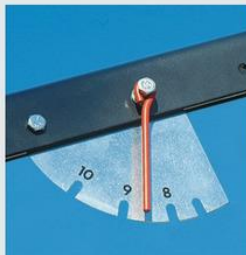

Easy to Read Rim Height Indicator



Standard Backboard Padding



Optional Crank Lock (BALOCKHT)



800-247-7668



www.bisoninc.com

95





## 4" & 5" ZipCrank™ Adjustable Basketball Systems

You'll see and feel the difference between Bison ZipCrank systems and other manufacturers' systems...Bison uses our experience as a manufacturer of competition grade equipment to offer TruGlass tempered glass backboards that give players a more realistic rebound

- Every backboard has an aluminum frame much like those in the gym
- The extra heavy poles and front crank style height adjustment are designed to change the height of the breakaway goal from 7½' to 10' with the turn of the removable crank handle
- As an added bonus, Bison ZipCrank systems can be mounted closer to fences, walls or other obstacles than rear height adjustment systems
- All systems include free fitted pole padding
- Limited lifetime warranties on backboard and pole system (1-Year on rim, crank and padding).

### Popular Features:

- Clear TruGlass Tempered Glass Backboard
- Choose 4" or 5" Direct Bury 2-Piece Pole
- Removable Pedestal Base Pole Available on 5" Zip-Crank
- Gymnasium Quality Heavy-Duty Competition Flex Goal
- Backboard Protecting Direct Goal Mounting
- Textured Black Powder Coated Pole Finish
- 30" Safe Play Area at 10'
- Aluminum Backboard Frame
- ZipCrank Front Crank Height Adjustment
- Removable Hand Crank Prevents Unwanted Adjustment
- Goal Height Indicator
- FREE Fitted Pole Padding
- Optional Backboard Padding
- 7½' to 10' Rim Height Adjustment
- 10-Year Limited Warranty on Pole and Backboard
- 1-Year on Rim, Padding and Crank

### 6 Models to Choose From:

- BA9350** 5" Direct Bury Pole, 36" x 60" Clear Glass Backboard
- BA9350S** 5" Direct Bury Pole, 36" x 60" Smoked Glass Backboard
- BA9350X** 5" Pedestal Base Pole, 36" x 60" Clear Glass Backboard
- BA9350SX** 5" Pedestal Base Pole, 36" x 60" Smoked Glass Backboard
- BA8350** 4" Direct Bury Pole, 36" x 54" Clear Glass Backboard
- BA8350S** 4" Direct Bury Pole, 36" x 54" Smoked Glass Backboard

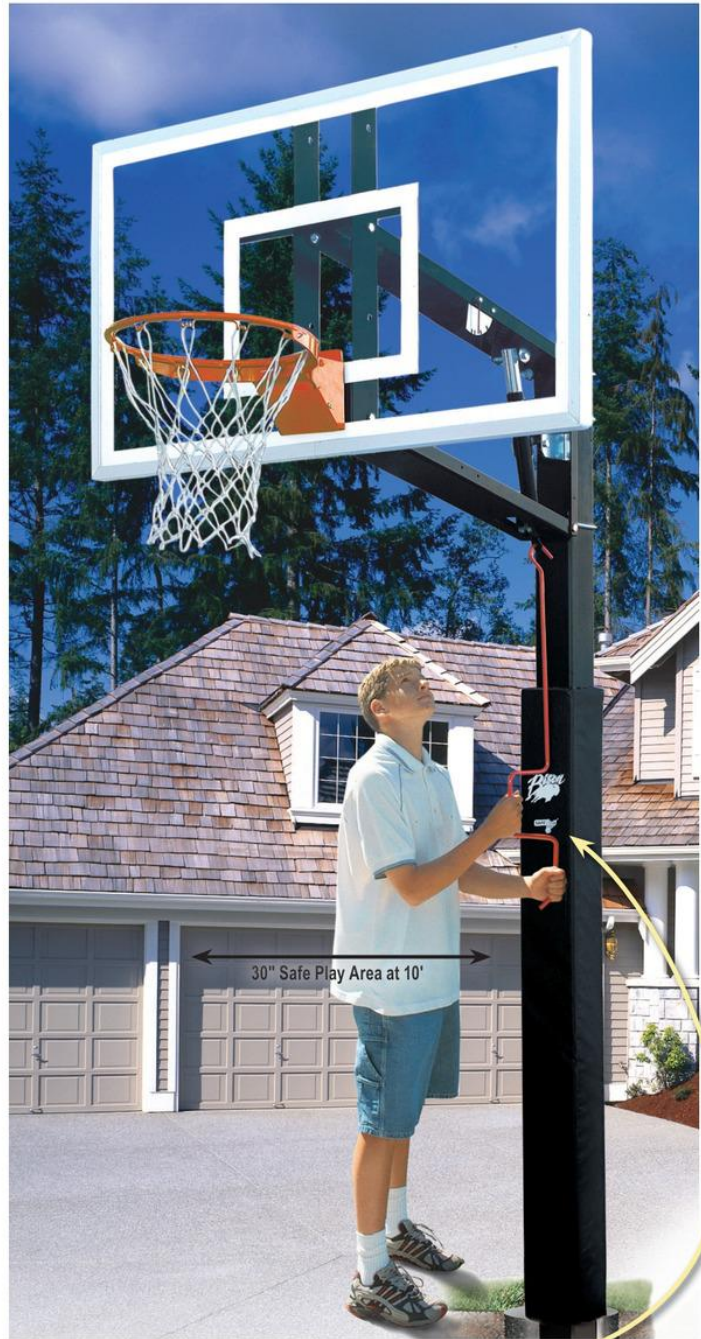

Easy to Read Rim Height Indicator



Optional Backboard Padding



Removable Ergonomic Awning Style Height Adjust Crank



Supplemental Installation Video





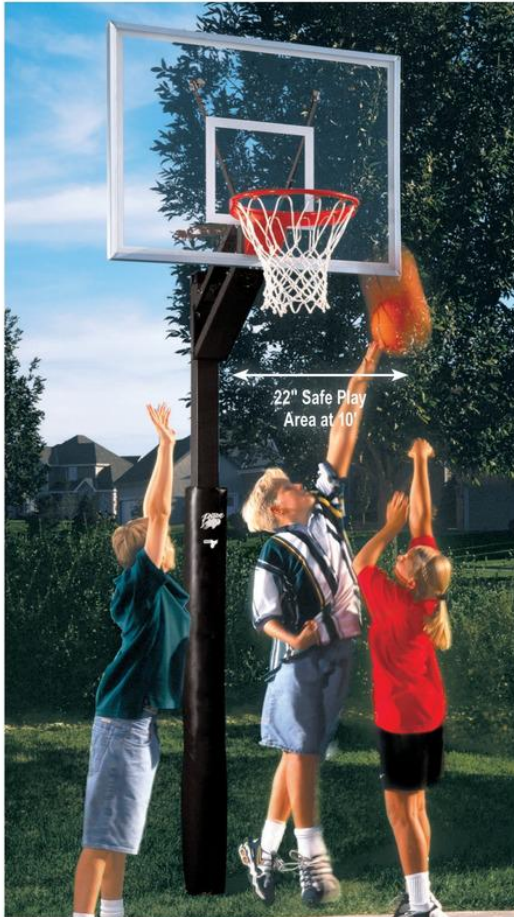

## 4" QwikChange™ Adjustable Basketball System

Hard work and dedication pay off on the court and in the design and manufacture of quality equipment as well...Bison's 4" square QwikChange 2-piece poles have 75% more steel than common round poles • One of these systems is going to look great in your driveway for years to come! • It's going to grow with your kids, too. Height adjusts from 7½' to 10' in 6" increments. • The height adjustment mechanism has over ten times the pivot contact area of commonly compared round pole systems, so go ahead and let them slam dunk! • The mounting design for the pro-style flexible goal transfers playing stress to the pole, protecting the backboard.



Supplemental Installation Video

### 2 Models to Choose From:

**BA89QC-AW** 32" x 48" Clear Acrylic Backboard

**BA89QC-BK** 32" x 48" Smoked Acrylic Backboard



Easy Rim Height Adjustment

### Popular Features:

- 32" x 48" Backboard
- Clear or Smoked Acrylic Backboard
- 22" Safe Play Area at 10'
- Aluminum Backboard Frame
- QwikChange Height Adjustment
- Fast Break Flex Goal
- Backboard Protecting Direct Goal Mounting
- Four Backboard Braces for Added Support
- Textured Black Powder Coated Pole Finish
- Approx. 30" Deep Bury
- **FREE** Fitted Pole Padding
- 2-Year Limited Warranty

## INSTITUTIONAL BACKBOARD DRAWINGS

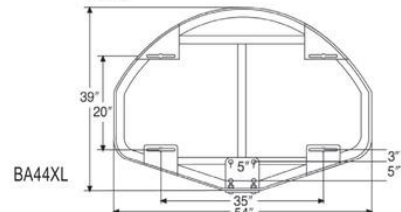
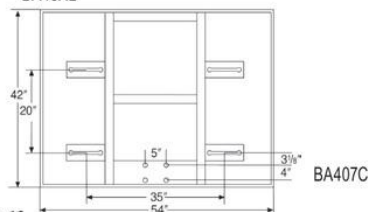
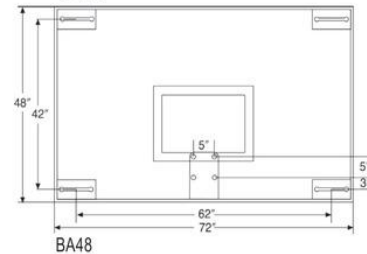
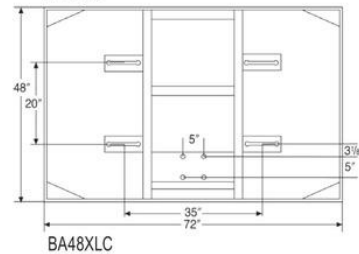
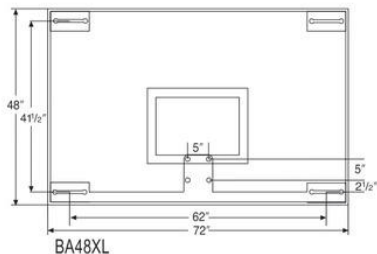
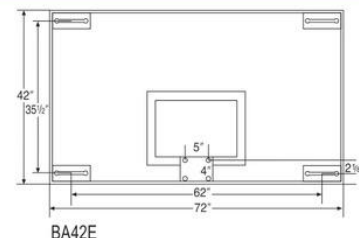
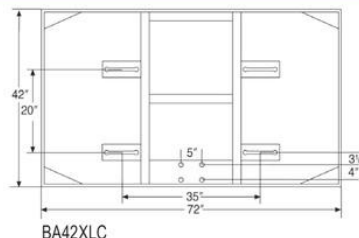
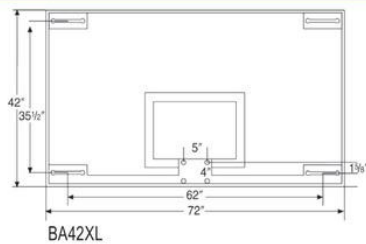

See pages 90-91 for other backboard drawings.



800-247-7668



www.bisoninc.com



# COURT AND FIELD DIAGRAMS

Note: Court and Field Diagrams are meant for reference only. Consult the appropriate rules book for additional information and exact details. Never build a court or playing field using exclusively these diagrams.

## College Basketball

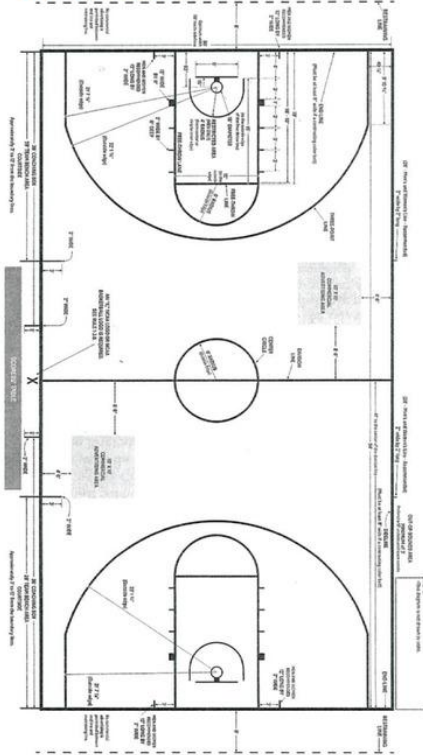

## Volleyball

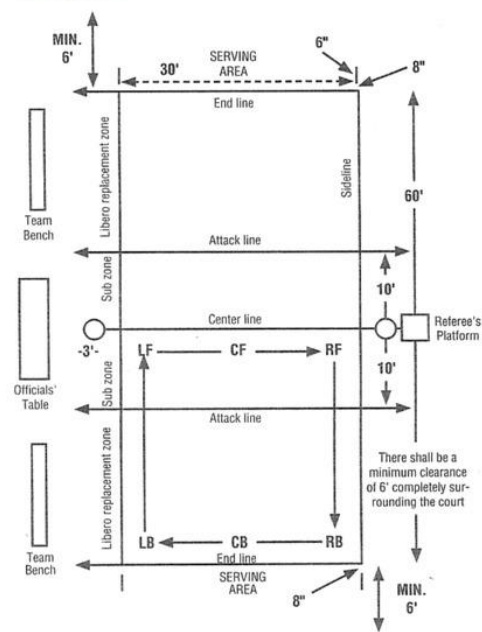

## High School Basketball

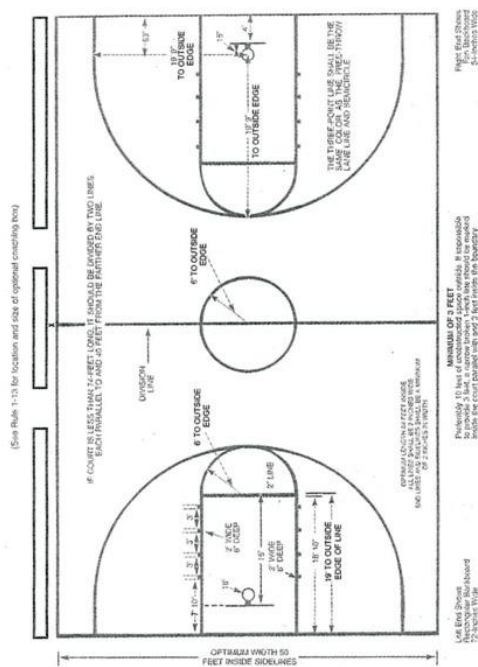

## Football

11-player Football Field Diagram

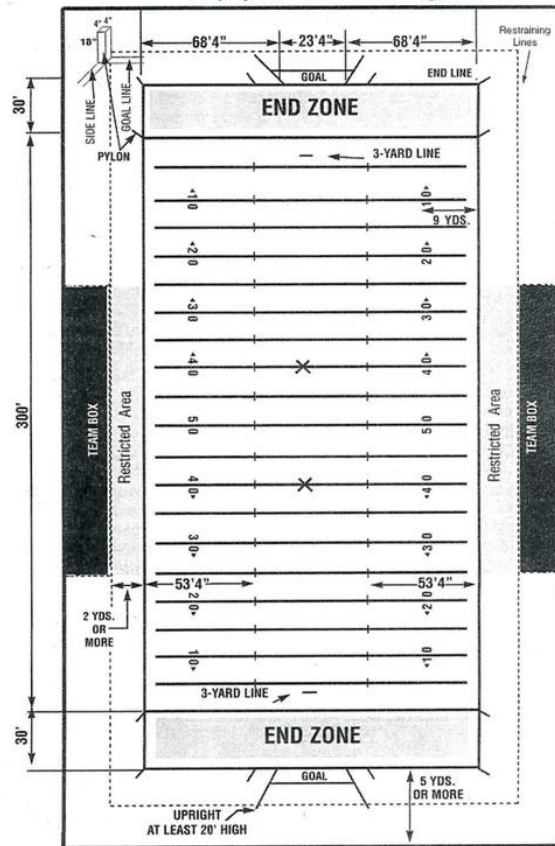



# COURT AND FIELD DIAGRAMS

**Note: Court and Field Diagrams provided are meant for reference only. Consult the appropriate rules book for additional information and exact details. Never build a court or playing field using exclusively these diagrams.**

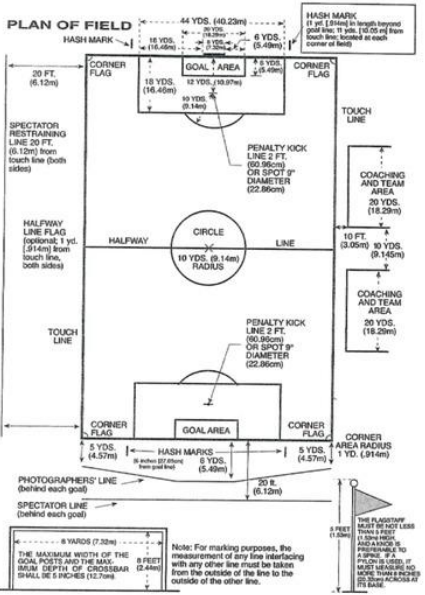

Soccer

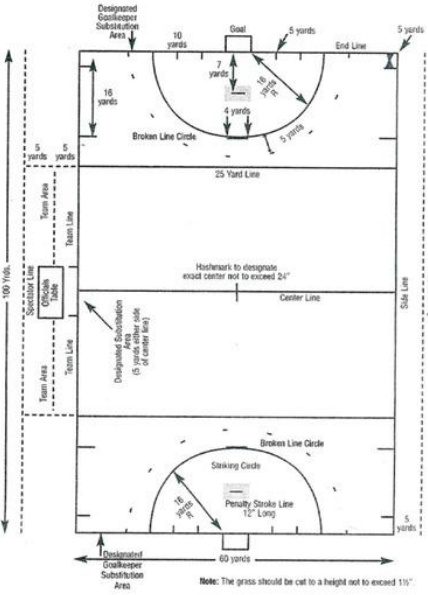

Field Hockey

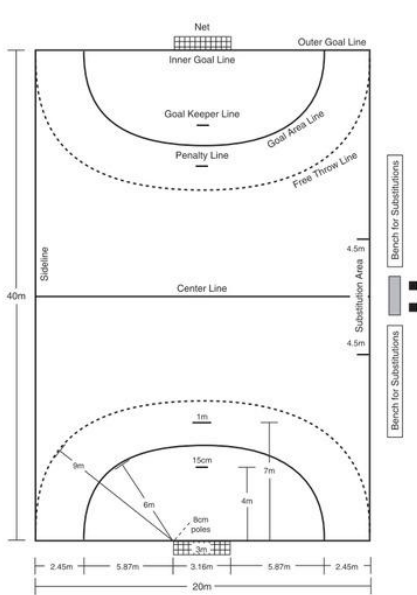

Team Handball

Tennis

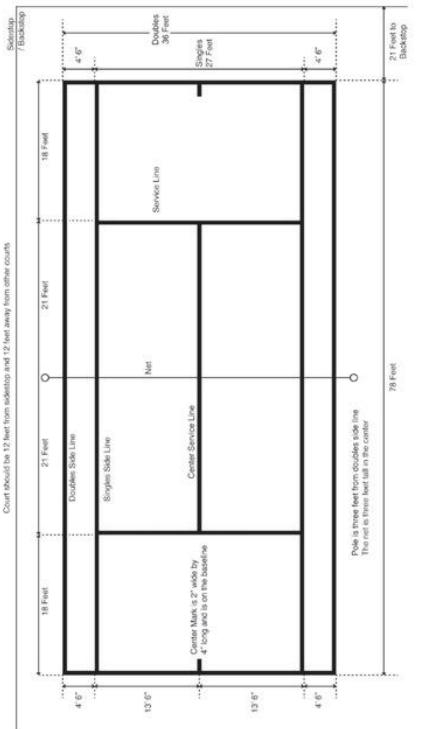

Pickleball

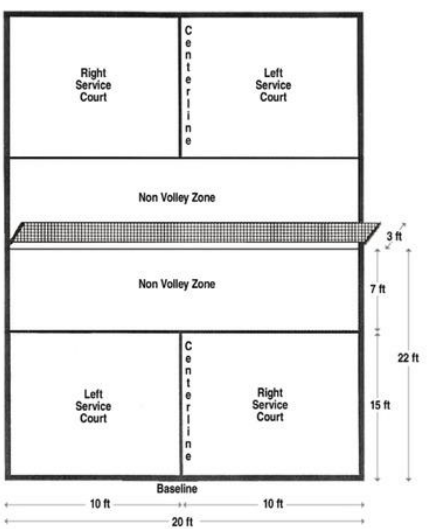

Badminton

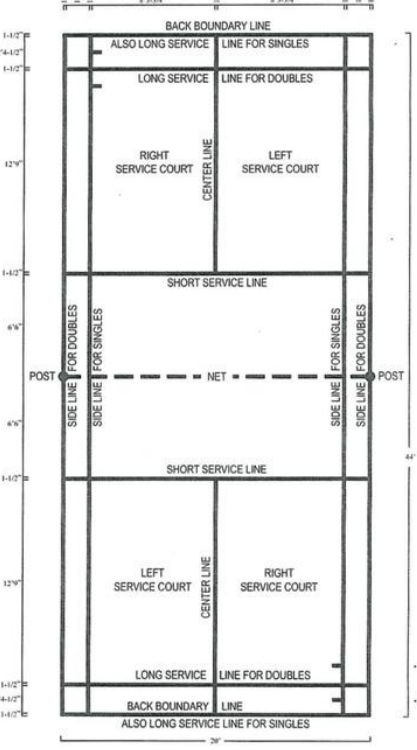

800-247-7668



www.bisoninc.com



# COURT AND FIELD DIAGRAMS

Note: Court and Field Diagrams provided are meant for reference only. Consult the appropriate rules book for additional information and exact details. Never build a court or playing field using exclusively these diagrams.

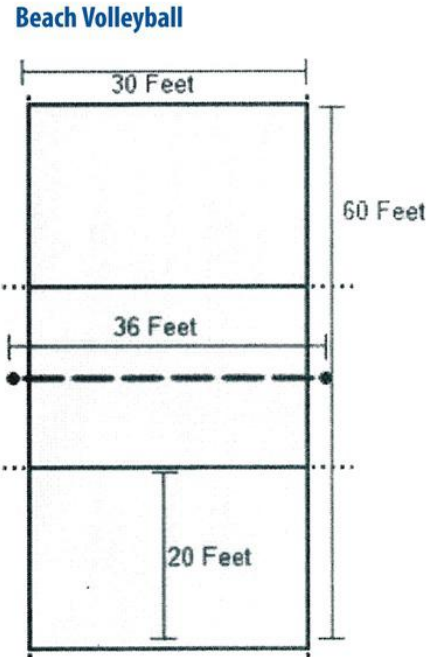
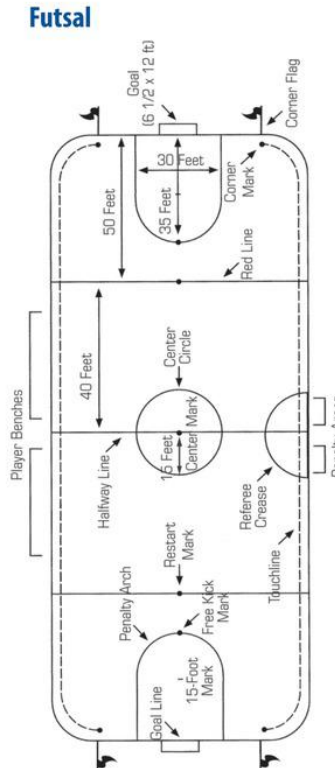
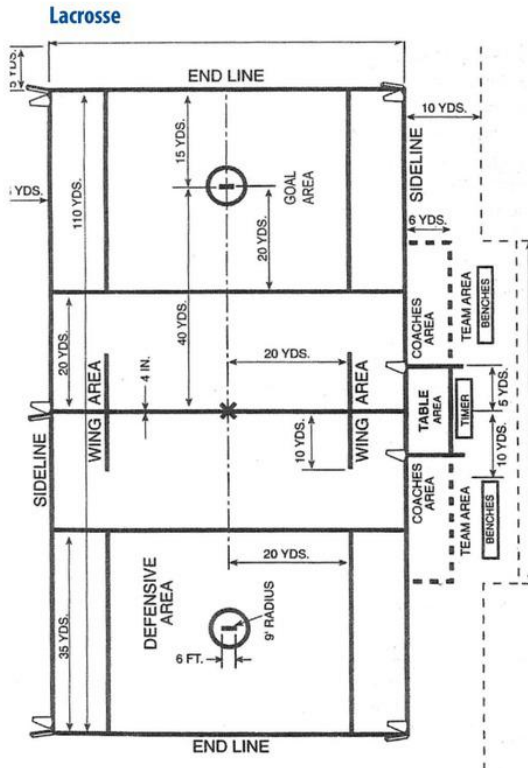

### Baseball

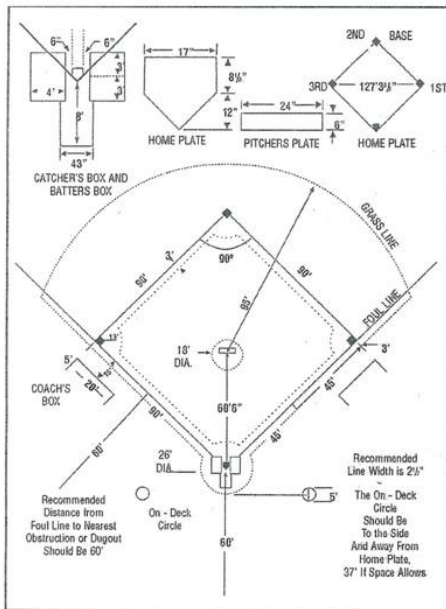

### Softball

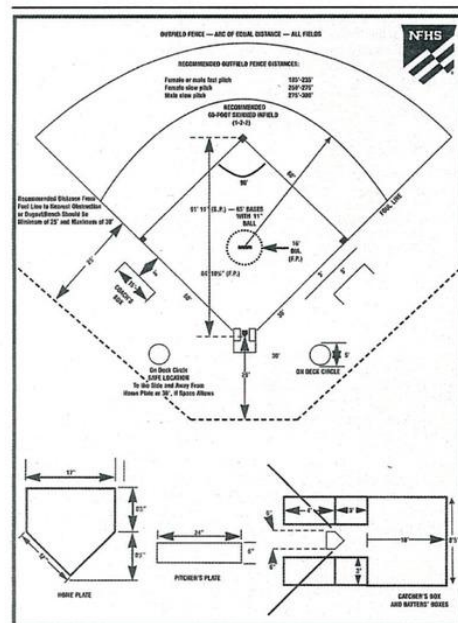



## Wall Mount Structure SAFETY WARNING!

Due to the aggressive nature of basketball today it is likely, regardless of the level of supervision and facility rules, play will include hanging on the goal either intentionally or in the course of play. The structural failure of any component will put players or fans in danger of grave injury or even death should the structure fail. For this reason, Bison has designed all mounting brackets, hardware and structure to be of the highest quality. Your facility can feel confident installing Bison wall structures in conjunction with Bison goals, backboards and padding, assuming the safety guidelines outlined below are followed.

1. Install structure only to walls capable of supporting the load placed on the wall by the weight of the structure and the potential for additional weight of players hanging and bouncing. Generally, the further the backboard is extended from the wall the more load that is applied. Poured concrete or concrete block walls are superior. It is inadvisable to mount structure to walls with wooden or steel studs unless additional work approved by an engineer is done to provide additional support.
2. Due to the differences in wall construction, Bison does not provide the anchors to mount the wall boards to the wall. Consult a professional architect, engineer or contractor to determine safe methods for installation to your facility's walls unless you are confident in your internal facility abilities. Bison will not assume liability for the installation of any wall mount structure shown in this catalog.
3. If the wall mount structure is being installed above bleachers it is strongly recommended (but not required) by NCAA and National High School Federation rules to install a safety device similar to the Bison BA950LR Structure Catch. The BA950LR acts as a safety belt to "catch" the structure before it falls in case of failure of the wall mounting anchors or other structural components. The device mounts to the ceiling structural components.
4. It is always wise to pad the bottom of the backboard for all levels of play. NCAA and National High School Federation rules require backboard padding similar to Bison's BA68U DuraSkin for all games governed by their rules.
5. If your wall is less than 10' from the face of the backboard, it is highly recommended that the wall is padded to avoid player contact injuries. See Bison Wall Padding options on pages 32-36.
6. Always follow all installation instructions carefully. Do not omit hardware or take shortcuts.
7. Once structure is installed it is advisable to inspect annually for loose bolts as the vibration of basketball play may eventually loosen wall mount anchors and the hardware.
8. Studies have shown that 42" x 72" glass backboards reduce the risk of player injury from backboard contact. Bison manufactures 48" x 72" backboards only for replacement applications.
9. Many manufacturers now produce glass backboards that are nearly impossible to break during play. The small additional cost will provide peace of mind. See Bison BA42XL, BA44XL or BA48XL on pages 16-17.

### Caution!

Wall mount structure requires a minimum ceiling and wall height as well as an acceptable wall mounting surface. Generally, brick or block walls are superior. It is inadvisable to mount structure to walls with wooden or steel studs unless additional work approved by an engineer is done to provide additional support. Bison does not provide wall anchors with any structure. The purchaser assumes all liability for proper selection of anchors, supporting of walls, and installation. Bison will not assume liability for the installation of any wall mounting structure shown in this catalog. Consult a professional architect, engineer or contractor to determine safe methods for installation to your facility's wall construction.

## Bison Limited Warranties

All Bison products are warranted against manufacturing defects at the time of delivery. In addition, most products are covered by warranty periods stated in the description of the product. Where listed as "limited", warranties cover damage or failure that occurs during the course of "normal or intended use" of the warranted product. Normal or intended use is described as activity that is necessary for the participation in the sport for which the equipment is designed. Bison Limited Warranties do not cover any damage or failure that is the direct or indirect result of any use that is not deemed in the sole discretion of Bison to be "normal and intended use". When warranties are stated as "unconditional" or "unconditional replacement", the above stated limitations do not normally apply except in cases where damage was obviously the result of a malicious act of vandalism. Where no specific length or type of warranty is listed in the catalog, the product is warranted to be free from manufacturer's defects and for the intended purpose at the time of shipment. Whether or not stated as such, all Bison warranties allow Bison to repair or replace warranted products at Bison's sole option. Normal deterioration of products due to weather, wear and tear, or other causes that do not affect functional use are not covered by Bison warranties, regardless of type of stated warranty. All warranties are valid only when product is used in the intended application as outlined in Bison's printed literature, when installed according to Bison's instructions and when matched with compatible components as described in Bison's literature. Under no circumstances will product shown in the Residential Basketball section of this catalog be warranted for commercial or institutional use. Due to the abusive nature of pay-to-play facilities, unless specifically agreed to in writing, Bison products carry no warranty except for obvious manufacturing defects when used in a facility where players pay an individual or group fee to use Bison equipment. Bison will pay ground freight only to repair or replace defective merchandise. Unless otherwise stated, Bison will not assume any liability for labor costs incurred for removal or replacement of product replaced or repaired under warranty.

## Bison Return Policy

No merchandise may be returned without prior authorization by calling 800-247-7668. Merchandise returned without a return authorization number clearly visible on the packaging will be held for no more than 10 days at which time all return credit is forfeited. Upon receipt of request for return, an authorization number will be issued by Bison and must appear on all return shipping labels. All returns must be shipped prepaid (UPS, FedEx or truck preferred) to 1100 SW 6th Street, Lincoln NE 68522. Collect returns will not be accepted. Credit for defective merchandise will be issued only when our inspection department determines the merchandise to be covered by our warranty. All salable merchandise returned is subject to a 35% restocking charge and all freight costs with a minimum restocking charge of \$100. Due to their custom design, scoring tables and wall padding are not returnable. Sport nets are not returnable once opened.

## Catalog Disclaimer

Photos and descriptions in this catalog are for reference only and are not intended to be used as technical specifications or for installation purposes. Some product photos may not exactly represent actual product shipped. Products are subject to change without notice. Any major changes in function or design will be communicated by Bison customer service if possible at time of order.



800-247-7668



www.bisoninc.com

101



# BISON COLOR AND LETTERING OPTIONS

Colors below are a computer representation and may vary from the actual colors.



## Full Color Graphic Printing Options

While it is theoretically possible to print any color with our 5-color Sport Pride graphic printing process, refer to the chart as a basic guide to color selection. Our graphic designers will work with you for a final color and design selection. Sport Pride graphic printing is available on gym and outdoor wall padding, scoring tables and some additional padding products. Inquire about custom color availability.

Colors are a computer representation and may vary from the actual colors.

\*Field verify all pad/cutout measurements before releasing for fabrication. Bison is not responsible for measurement errors after an order has been released.

\*\*Colors in art proofs do not represent actual printed/vinyl colors. Request print sample for color match if needed.



## Solid Color Vinyl Padding Options

Single solid color, vinyl padding can be selected from the 18 colors at right. Product examples include: volleyball post and base padding, football post padding, T-Rex and other portable basketball padding, solid color indoor/outdoor wall padding and scoring table padding.



Note: Pink is only available on wall padding and volleyball post padding.



## Lettering Colors on Padding

Add any one color shown at right to print on solid color vinyl padding.



## ABC52 Lettering Styles



## Ready to Apply (RTA) Adhesive Vinyl Lettering Colors

Select from vinyl colors on right to add custom lettering to ball carts, equipment carts and other powder coated steel sports equipment surfaces. See ABC92 on page 27 for details.



## Color Options for Aluminum Bench and Bleacher Seats and Super Fence

Aluminum seats and backs can be finished in any of the colors shown at right.





# MODEL NUMBER INDEX WITH PRODUCT WEIGHTS

All weights listed are approximate and subject to change. They do not include additional pallets or other shipping materials.

Model.....Page.....UOM.....Weight	Model.....Page.....UOM.....Weight	Model.....Page.....UOM.....Weight	Model.....Page.....UOM.....Weight
ABC50.....9.....EA.....NA	BA475SS.....91.....EA.....40	BA800FL.....10.....EA.....19	BA895G.....6.....EA.....2367*
ABC52.....11.....EA.....NA	BA48.....16.....EA.....221*	BA801.....82.....EA.....438*	BA895GZC.....6.....EA.....2500*
ABC92.....27.....EA.....1	BA485.....90.....EA.....90*	BA801BP.....25, 82.....EA.....10	BA898AGA.....5.....EA.....3473*
BA10.....94.....EA.....1	BA48XL.....16.....EA.....221*	BA803.....12.....EA.....276*	BA898AGM.....5.....EA.....3500*
BA125.....27.....EA.....40	BA48XLC.....16.....EA.....220*	BA803A.....12.....EA.....300*	BA898G.....6.....EA.....2582*
BA165.....27.....EA.....70	BA495.....17, 90.....EA.....100*	BA832.....11.....EA.....415*	BA898GBPAD.....6.....EA.....5
BA165V.....27.....EA.....70	BA495A3.....92.....EA.....130*	BA833.....11.....EA.....444*	BA898GDL.....6.....EA.....5
BA175.....27.....EA.....50**	BA495A4.....92.....EA.....135*	BA833BLST.....11.....EA.....500*	BA898GFIBA.....6.....EA.....25
BA185.....27.....EA.....45	BA495A5.....92.....EA.....140*	BA833XL.....11.....EA.....658*	BA898GRP.....9.....EA.....100**
BA187.....27.....EA.....45	BA50.....94.....EA.....3	BA8350.....96.....EA.....269*	BA898GZC.....6.....EA.....2710*
BA21A.....20, 89.....EA.....20	BA501H.....94.....EA.....1	BA8350S.....96.....EA.....269*	BA898HD.....9.....EA.....3
BA245.....27.....EA.....85	BA51H.....20, 94.....EA.....1	BA853A.....10.....EA.....640*	BA89QC-AW.....97.....EA.....150*
BA245V.....27.....EA.....85	BA53.....94.....EA.....2	BA853BLST.....10.....EA.....850*	BA89QC-BK.....97.....EA.....150*
BA26.....20.....EA.....11	BA54U-BK.....93.....KIT.....6	BA853G.....10.....EA.....682*	BA925LR.....21.....EA.....28
BA27.....20, 89.....EA.....13	BA56W.....94.....SET.....1	BA853GXL.....10.....EA.....697*	BA931.....24.....EA.....19
BA27A.....20, 89.....EA.....17	BA600YF.....22.....PR.....40	BA853UP.....10.....EA.....NA	BA935.....24.....EA.....5
BA3180S.....18.....EA.....28	BA600YR.....22.....PR.....60	BA870AXL-BK.....83.....EA.....20	BA9350.....96.....EA.....302*
BA3180T.....18, 20.....EA.....29	BA60U-BK.....93.....KIT.....8	BA870JRPP.....84, 93.....EA.....6**	BA9350S.....96.....EA.....302*
BA32.....89.....EA.....22	BA658YF.....22.....PR.....40	BA870JRPXSUB.....82, 84.....EA.....1	BA9350SX.....96.....EA.....311*
BA33U.....89.....EA.....29	BA658YR.....22.....PR.....60	BA870PP-BK.....93.....EA.....11**	BA9350X.....96.....EA.....311*
BA34.....19.....EA.....24	BA68U.....21.....KIT.....12	BA870PXSUB.....83.....EA.....1	BA950LR.....21.....EA.....20
BA35ARC.....20.....PR.....24	BA700PP.....82, 93.....EA.....6	BA871-BK.....83.....EA.....494*	BA973LR.....21.....EA.....80
BA35E.....18.....EA.....25	BA72U-BK.....93.....KIT.....8	BA871XL-BK.....83.....EA.....525*	BA974LR.....21.....EA.....90*
BA35S.....19.....EA.....24	BA775.....92.....EA.....103*	BA872-BK.....83.....EA.....800*	BA975KS.....21, 24.....EA.....3
BA37.....89.....EA.....19	BA776.....92.....EA.....130*	BA872PP-BK.....93.....EA.....14**	BA980F.....24.....EA.....90*
BA37N.....89.....EA.....20	BA776A.....92.....EA.....45	BA872XL-BK.....83.....EA.....864*	BA980P.....8.....EA.....130*
BA39U.....86, 89.....EA.....28	BA776DB.....92.....EA.....180*	BA873-BK.....83.....EA.....544*	BA980RS.....24.....EA.....130*
BA407C.....17.....EA.....140*	BA777.....92.....EA.....150*	BA873U-BK.....83.....EA.....480*	BA980RT.....24.....EA.....138*
BA407G.....17, 91.....EA.....130*	BA777XL.....92.....EA.....160*	BA874-BK.....83.....EA.....491	BAFIBA.....4, 5.....EA.....1
BA407U.....91.....EA.....130*	BA778.....92.....EA.....183*	BA8910IGA.....4.....EA.....4200*	BALED2.0.....23.....PR.....20
BA42E.....16.....EA.....190*	BA778A.....92.....EA.....67	BA8910IGM.....4.....EA.....4200*	BALED2.0T.....23.....PR.....5
BA42UC.....91.....EA.....126*	BA778DB.....92.....EA.....253*	BA893BLST.....8.....EA.....650*	BALOCKHT.....81.....EA.....2
BA42XL.....16.....EA.....190*	BA77XBR.....92.....EA.....13	BA893G.....8.....EA.....850*	BBSB08FPDBS.....38.....PR.....130*
BA42XLC.....16.....EA.....187*	BA780.....85, 92.....EA.....285*	BA893GS.....8.....EA.....850*	BBSB12FPDBA.....38.....PR.....125*
BA44XL.....17.....EA.....116*	BA780XL.....92.....EA.....311*	BA893U.....8.....EA.....825*	BBSB12FPDBS.....38.....PR.....300*
BA454.....90.....EA.....112*	BA781.....92.....EA.....340*	BA893UP.....8.....EA.....NA	BBSB12FPPBS.....38.....PR.....330*
BA456.....17, 91.....EA.....130*	BA781A.....92.....EA.....119*	BA894G.....7.....EA.....1916*	BBSB12FPSPA.....38.....PR.....145*
BA47.....90.....EA.....145*	BA781DB.....92.....EA.....462*	BA894GCSTL.....7.....EA.....1920*	BBSB16FPDBA.....38.....PR.....175*
BA472.....90.....EA.....160*	BA79UPP-BK.....93.....EA.....4**	BA894LOCK.....7.....EA.....10	BBSB16FPDBS.....38.....PR.....400*
BA472PC.....90.....EA.....135*	BA800.....10.....EA.....17	BA894UCSTL.....7.....EA.....1895*	BBSB16FPPBS.....38.....PR.....430*



800-247-7668



www.bisoninc.com

103

\* Ships by Truck \*\* Ships Small Package Oversize



# MODEL NUMBER INDEX WITH PRODUCT WEIGHTS

All weights listed are approximate and subject to change. They do not include additional pallets or other shipping materials.

Model.....Page.....UOM.....Weight	Model.....Page.....UOM.....Weight	Model.....Page.....UOM.....Weight	Model.....Page.....UOM.....Weight
BBSB16FPSPA .....38 .....PR .....195*	BLO0703 .....79 .....EA .....155*	FB10EXT-SY .....75 .....KIT .....60*	OFX423180.....22 .....EA .....229*
BBSB2025LIFT .....40 .....EA .....20*	BLO0703AXL .....79 .....EA .....218*	FB10EXT-WT .....75 .....KIT .....60*	OFX4235E.....22 .....EA .....223*
BBSB2025N .....40 .....EA .....40*	BLO0704 .....79 .....EA .....210*	FB45HSPM-SY .....75 .....PR .....1150*	OFX483180 .....22 .....EA .....262*
BBSB2025SFEXT .....40 .....EA .....225*	BLO0704AXL .....79 .....EA .....310*	FB45HSPM-WT .....75 .....PR .....1150*	OFX4835E.....22 .....EA .....258*
BBSB2025SFS .....40 .....EA .....400*	BLO1502 .....79 .....EA .....166*	FB45HS-SY .....75 .....PR .....1050*	PB050 .....12 .....EA .....13
BBSB20FPDBA .....38 .....PR .....225*	BLO1502AXL .....79 .....EA .....229*	FB45HS-WT .....75 .....PR .....1050*	PB100BP .....12 .....EA .....10
BBSB20FPDBS .....38 .....PR .....500*	BLO1503 .....79 .....EA .....262*	FB45S .....75 .....EA .....120*	PB130.....12 .....EA .....200*
BBSB20FPBBS .....38 .....PR .....530*	BLO1503AXL .....79 .....EA .....400*	FB55CGPM-SY .....75 .....PR .....1175*	PB150BB .....12 .....EA .....10
BBSB20FPSPA .....38 .....PR .....245*	BLO1504 .....79 .....EA .....370*	FB55CGPM-WT .....75 .....PR .....1175*	PK05XL.....67 .....EA .....80
BBSB4X8SFG .....41 .....EA .....200*	BLO1504AXL .....79 .....EA .....568*	FB55CG-SY .....75 .....PR .....1075*	PK10 .....67 .....EA .....15
BBSB4X8SFGW .....41 .....EA .....120*	BLO2103 .....79 .....EA .....358*	FB55CG-WT .....75 .....PR .....1075*	PK10CS.....67 .....EA .....4
BBSB4X8SFM .....41 .....EA .....130*	BLO2103AXL .....79 .....EA .....546*	FB55HSPM-SY .....75 .....PR .....1300*	PK10N .....67 .....EA .....3
BBSB4X8SFS .....41 .....EA .....200*	BLO2104 .....79 .....EA .....500*	FB55HSPM-WT .....75 .....PR .....1300*	PK10NXL .....67 .....EA .....12
BBSB4X8SFSW .....41 .....EA .....120*	BLO2104AXL .....79 .....EA .....774*	FB55HS-SY .....75 .....PR .....1200*	PK10P .....67 .....EA .....174*
BBSBBASE .....43 .....SET .....50	BM10 .....65 .....EA .....19	FB55HS-WT .....75 .....PR .....1200*	PK10XL .....67 .....EA .....53
BBSBCAGE1270DB .....39 .....EA .....1100*	BM1016 .....65 .....EA .....60	FB55S .....75 .....EA .....125*	PK21 .....67 .....EA .....9
BBSBCAGE1270I .....39 .....EA .....600*	BM10N .....12, 65 .....EA .....4	FB58CGPM-SY .....75 .....PR .....1125*	PK23 .....67 .....EA .....9
BBSBCAGE1270PM .....39 .....EA .....1050*	BM10P .....65 .....EA .....180*	FB58CGPM-WT .....75 .....PR .....1125*	PK235 .....67 .....EA .....9
BBSBCSCREEN .....43 .....EA .....60*	BM10PKHDWR .....65 .....EA .....1	FB58CG-SY .....75 .....PR .....1125*	PKG14STFS .....14 .....EA .....219*
BBSBDM .....43 .....EA .....35*	BM21 .....65 .....EA .....5	FB58CG-WT .....75 .....PR .....1125*	PKG14STRG.....14 .....EA .....331*
BBSBHPLATE .....43 .....EA .....35	BM300A .....65 .....EA .....5	FB58HSPM-SY .....75 .....PR .....1350*	PKG250.....15 .....EA .....90**
BBSBLSCREEN .....43 .....EA .....60*	BM30-CV .....61 .....EA .....4	FB58HSPM-WT .....75 .....PR .....1350*	PKG275.....15 .....EA .....105**
BBSBPMOUND .....43 .....EA .....25	BM350A .....65 .....EA .....5	FB58HS-SY .....75 .....PR .....1250*	PKG275S .....15 .....EA .....105**
BBSBSCREENWK .....43 .....SET .....15*	BM400A .....65 .....EA .....5	FB58HS-WT .....75 .....PR .....1250*	PKG300 .....15 .....EA .....210*
BBSBSTOP18S .....42 .....EA .....1200*	BNF0701 .....80 .....EA .....25*	FBCPP .....75, 93 .....EA .....18**	PKG300S.....15 .....EA .....210*
BBSBSTOP24S .....42 .....EA .....1600*	BNF0701B .....80 .....EA .....45*	FBCPPG .....75 .....EA .....18**	PKG350 .....15 .....EA .....225*
BBSBSTOP25MS .....42 .....EA .....400*	BNF1501 .....80 .....EA .....45*	FBWDS .....75 .....SET/4 .....2	PKG46SFRG .....13 .....EA .....442*
BBSBSTOP30W .....42 .....EA .....1700*	BNF1501B .....80 .....EA .....86*	FH200 .....76 .....PR .....291*	PKG46STRG .....13 .....EA .....441*
BBSBSTOP36W .....42 .....EA .....2100*	BNF2101 .....80 .....EA .....60*	FH200N .....76 .....PR .....30	PKG48STFS .....14 .....EA .....295*
BBSBSTOP75MW .....42 .....EA .....750*	BNF2101B .....80 .....EA .....118*	FH200WK .....76 .....SET/4 .....40	PKG48STRG .....14 .....EA .....413*
BL07SEAT1 .....80 .....EA .....NA	BNP0701 .....80 .....EA .....30*	HT6060G .....95 .....EA .....466*	PKG500 .....14 .....EA .....272*
BL15SEAT1 .....80 .....EA .....NA	BNP0701B .....80 .....EA .....45*	HT6060GS .....95 .....EA .....466*	PKG600 .....14 .....EA .....248*
BLI0702 .....78 .....EA .....84*	BNP1501 .....80 .....EA .....55*	HT6072G .....95 .....EA .....569*	PKG650 .....14 .....EA .....310*
BLI0703 .....78 .....EA .....130*	BNP1501B .....80 .....EA .....89*	HTADPT .....81 .....EA .....33	PKG675 .....14 .....EA .....357*
BLI0704 .....78 .....EA .....190*	BNP2101 .....80 .....EA .....76*	LC050N .....76 .....PR .....26	PKG68SFRG .....13 .....EA .....487*
BLI1502 .....78 .....EA .....195*	BNP2101B .....80 .....EA .....89*	LC200 .....76 .....PR .....198*	PKG68STRG .....13 .....EA .....464*
BLI1503 .....78 .....EA .....154*	CM200 .....94 .....EA .....55	OFC4234 .....22 .....EA .....223*	PKG82SFRG .....13 .....EA .....585*
BLI1504 .....78 .....EA .....241*	DN12 .....25 .....EA .....343*	OFC4235E .....22 .....EA .....223*	PKG82STRG .....13 .....EA .....542*
BLI2102 .....78 .....EA .....334*	DN1250 .....25 .....EA .....70	OFS4234 .....22 .....EA .....226*	PR12 .....82 .....EA .....165*
BLI2103 .....78 .....EA .....212*	DN50 .....25 .....EA .....15	OFS4834 .....22 .....EA .....233*	PR15 .....84 .....EA .....254*

\* Ships by Truck \*\* Ships Small Package Oversize





# MODEL NUMBER INDEX WITH PRODUCT WEIGHTS

All weights listed are approximate and subject to change. They do not include additional pallets or other shipping materials.

Model.....	Page.....	UOM.....	Weight	Model.....	Page.....	UOM.....	Weight	Model.....	Page.....	UOM.....	Weight	Model.....	Page.....	UOM.....	Weight
PR17.....	84	EA	338*	SC050N.....	72	PR	6	SCFUTSAL.....	77	PR	192*	TB200.....	65	EA	37
PR18.....	84	EA	268*	SC060N.....	72	PR	14	SCFUTSALN.....	77	PR	8	TB200GS.....	65	EA	2
PR19.....	84	EA	275*	SC06CF.....	74	SET/4	8	SCIGAID.....	72	SET	10	TB200P.....	65	EA	35
PR20.....	87	EA	215*	SC06CFW.....	74	SET/4	12	SCNOTIP.....	74	PR	50	TB300.....	65	EA	201*
PR29.....	87	EA	156*	SC06DK.....	74	SET	3	SC04WK.....	74	SET OF 4	65	TB50-B.....	65	EA	2
PR31.....	87	EA	235*	SC072N.....	72	PR	17	SCTEAMHB.....	77	PR	186*	TN05.....	66	EA	85*
PR33.....	87	EA	164*	SC080N.....	72	PR	12	SHCLK300.....	23	PR	25	TN10.....	66	EA	40
PR52.....	86	EA	220*	SC0945IGA.....	72	PR	190*	SHCLK400.....	23	SET	50	TN10CS.....	66	EA	4
PR52XL.....	86	EA	229*	SC0945PA44E.....	70	PR	333*	SHCLKBKT600.....	23	PR	50	TN10N.....	66	EA	16
PR55.....	86	EA	275*	SC10.....	74	EA	4	SHCLKBKT658.....	23	PR	50	TN10NP.....	66	EA	14
PR55XL.....	86	EA	285*	SC100N.....	72	PR	23	SHCLKBKTBB.....	23	PR	25	TN10P.....	66	EA	207*
PR60.....	86	EA	320*	SC106N.....	72	PR	22	SHCLKBKTF5.....	23	PR	190*	TN10SCP.....	66	EA	2
PR60XL.....	88	EA	330*	SC1260PERM.....	74	EA	500*	SHCLKBKTTT.....	23	PR	5	TN23.....	66	EA	9
PR70.....	86	EA	300*	SC1265IGA.....	72	PR	336*	SHCLKBKTW.....	23	PR	25	TN235.....	66	EA	6
PR70G.....	86	EA	307*	SC1265PA44E.....	70	PR	427*	SHCLKPS.....	23	PR	5	TR70RP.....	20	EA	5
PR70XL.....	86	EA	310*	SC1865IGA.....	72	PR	418*	ST125F.....	30	EA	475*	TR74.....	20	EA	2
PR74.....	85	EA	437*	SC1865PA40E.....	70	PR	427*	ST84F.....	31	EA	130*	TR75.....	20	EA	12
PR75.....	85	EA	360*	SC1865PA40NT.....	69	PR	450*	ST85B.....	30	EA	360*	TR76.....	20	EA	4
PR75XL.....	85	EA	379*	SC1865PA44E.....	70	PR	461*	ST85F.....	30	EA	315*	TR86.....	26	EA	49
PR76.....	85	EA	405*	SC1865PA44NT.....	69	PR	482*	ST85FI.....	29	EA	400*	TR95.....	94	EA	8
PR77.....	85	EA	450*	SC2170IGA.....	72	PR	435*	SUCBLFT.....	21	FT	2	TR96.....	93	EA	21
PR77XL.....	85	EA	490*	SC2170PA40NT.....	69	PR	448*	SVB08.....	12, 64	EA	3	VB10.....	46	PR	89*
PR78.....	85	EA	440*	SC2170PA44E.....	70	PR	461*	SVB10.....	63	PR	100*	VB100.....	46	EA	55*
PR79.....	85	EA	452*	SC2170PA44NT.....	69	PR	500*	SVB100.....	63	EA	50*	VB1000.....	46	EA	145*
PR79XL.....	85	EA	478*	SC2170PA40E.....	70	PR	427*	SVB1000.....	63	EA	258*	VB1000NS.....	46	EA	130*
PR87.....	85	EA	492*	SC2480IGA.....	72	PR	460*	SVB1002.....	63	EA	401*	VB1000T.....	56	EA	210*
PR87XL.....	85	EA	515*	SC2480IGAFB.....	73	PR	696*	SVB1250K.....	53, 59	EA	12	VB1002.....	46	EA	230*
PR94UZC.....	82	EA	240*	SC2480PA40E.....	70	PR	525*	SVB2000A.....	64	EA	90*	VB1002NS.....	46	EA	198*
PR95UZC.....	82	EA	261*	SC2480PA40EURO.....	71	PR	677*	SVB210.....	64	EA	21	VB100C.....	46	EA	55*
PR98GHT.....	81	EA	550*	SC2480PA40NT.....	69	PR	550*	SVB26.....	63	EA	10	VB100T.....	54	EA	50*
PR98GHTJR.....	81	EA	447*	SC2480PA44E.....	70	PR	561*	SVB27.....	63	EA	62	VB10C.....	52	PR	100*
PR98GHTJRS.....	81	EA	447*	SC2480PA44FB.....	73	PR	818*	SVB28.....	63	EA	26	VB10T.....	54	PR	80*
PR98SHT.....	81	EA	525*	SC2480PA44NT.....	69	PR	582*	SVB5000A.....	64	EA	138*	VB10W30.....	61	EA	5
PR98SXLHT.....	81	EA	590*	SC2480PA44XL.....	71	PR	642*	SVB500A.....	64	EA	62*	VB10W35.....	61	EA	5
PR98UHT.....	81	EA	486*	SC44S.....	72, 73	EA	5	SVB5050A.....	64	EA	115*	VB11.....	47	EA	99*
PR98UHTJR.....	81	EA	411*	SC500.....	31	EA	5	SVB5050W.....	57	EA	59*	VB110.....	47	EA	60*
SC03PP.....	77	KIT	6	SC50B.....	74, 77	EA	3	SVB73.....	63	EA	90*	VB1100.....	45, 47	EA	146*
SC045N.....	72	PR	5	SC72NC.....	74	PKG	2	TB100.....	65	EA	25	VB1100NS.....	47	EA	128*
SC04GA.....	74	SET/4	5	SCBKT2.....	9	EA	44	TB100GS.....	65	EA	2	VB1102.....	47	EA	240*
SC04WK.....	74	SET/4	65	SCBKT6.....	9	EA	23	TB100P.....	65	EA	23	VB1102NS.....	47	EA	213*



800-247-7668



www.bisoninc.com

105

\* Ships by Truck \*\* Ships Small Package Oversize



# MODEL NUMBER INDEX WITH PRODUCT WEIGHTS

All weights listed are approximate and subject to change. They do not include additional pallets or other shipping materials.

Model.....Page.....UOM.....Weight	Model.....Page.....UOM.....Weight	Model.....Page.....UOM.....Weight	Model.....Page.....UOM.....Weight
VB1200RR.....61...SET/4.....1	VB27CH.....61.....EA.....8	VB7202.....49.....EA.....171*	WP2NGVW.....36.....SQFT.....3
VB123.....59.....EA.....2	VB27LK.....61.....EA.....9	VB7202NS.....49.....EA.....144*	WP2NGZW.....36.....SQFT.....3
VB1250K.....59.....EA.....12	VB30.....51.....PR.....62*	VB722.....49.....EA.....37*	WP2NSFW.....36.....SQFT.....3
VB1250KRR.....61.....EA.....1	VB300.....51.....EA.....52*	VB7222.....49.....EA.....100*	WP2NSJW.....36.....SQFT.....3
VB1250KU.....59.....EA.....9	VB3000.....45.....EA.....109*	VB7222NS.....49.....EA.....82*	WP2NSVS.....36.....SQFT.....3
VB1250SP.....58.....EA.....3	VB3000NS.....51.....EA.....91*	VB73A.....60.....EA.....94*	WP2NSVW.....36.....SQFT.....3
VB1250ST.....58.....PR.....5	VB3002.....51.....EA.....195*	VB73LOGO.....60.....EA.....15	WP2NSZW.....36.....SQFT.....3
VB1250TR.....58.....EA.....5	VB3002NS.....51.....EA.....168*	VB76.....60.....EA.....104*	WP2SUGVS.....36.....SQFT.....2.2
VB1253W.....60.....EA.....53	VB335.....62.....EA.....5	VB80JR.....54.....PR.....2600*	WP2UGFW.....36.....SQFT.....2.2
VB13.....59.....PR.....4	VB340.....62, 63.....EA.....7	VB810.....53.....EA.....568*	WP2UGJW.....36.....SQFT.....2.2
VB13SL.....59.....PR.....3	VB340F.....62.....EA.....5	VB8100.....53.....EA.....2870*	WP2UGVW.....36.....SQFT.....2.2
VB17.....59.....PR.....10	VB3530.....62.....EA.....19	VB8100JR.....54.....EA.....2750*	WP2UGZW.....36.....SQFT.....2.2
VB20.....48.....PR.....123*	VB354.....62, 63.....EA.....7	VB8102.....53.....EA.....3500*	WP2USFW.....36.....SQFT.....2.2
VB200.....48.....EA.....60*	VB35P.....61...SET.....1	VB8102DJ.....53.....EA.....3650*	WP2USJW.....36.....SQFT.....2.2
VB2000.....48.....EA.....170*	VB4030.....62.....EA.....15	VB8102JR.....54.....EA.....3350*	WP2USVS.....36.....SQFT.....2.2
VB2000NS.....48.....EA.....152*	VB4035.....62.....EA.....15	VB810BASE.....53, 54.....EA.....500*	WP2USVW.....36.....SQFT.....2.2
VB2002.....48.....EA.....250*	VB510P.....58.....EA.....10	VB810JR.....54.....EA.....570*	WP2USZW.....36.....SQFT.....2.2
VB2002NS.....48.....EA.....220*	VB51P.....58.....PR.....20	VB810P.....53, 54.....EA.....52	WP62NF.....36.....EA.....30
VB21.....64.....EA.....9	VB51PG.....58.....PR.....20	VB82.....55.....PR.....684*	WP62NZ.....36.....EA.....30
VB22.....61.....EA.....7	VB51PGUP.....58.....PR.....NA	VB8200.....55.....PR.....792*	WP62UF.....36.....EA.....30
VB23.....61.....EA.....9	VB51PL.....58.....PR.....20	VB8250.....55.....PR.....803*	WP62UZ.....36.....EA.....30
VB230.....62.....EA.....23	VB60.....52.....PR.....89*	VB82P.....55.....PR.....NA	WPDUGOUTM.....37.....EA.....2
VB235.....61.....EA.....6	VB600.....52.....EA.....60*	VB9130.....57.....EA.....7	WPDUGOUTT.....37...LIN. FT.....5
VB23CH.....61.....EA.....7	VB6000.....52.....EA.....136*	VB9135.....57.....EA.....9	WPDUGOUTV.....37...LIN. FT.....5
VB23CH-CV.....61.....EA.....5	VB6000NS.....52.....EA.....118*	VB9140.....57.....EA.....11	WPRAIL.....37...LIN. FT.....0.5
VB23-CV.....61.....EA.....6	VB6000T.....56.....EA.....218*	VB92.....57...SET.....7	WPRAIL200.....37...LIN. FT.....NA
VB23IK.....62.....EA.....7	VB6002.....52.....EA.....228*	VB94.....57.....EA.....87**	WPRAIL238.....37...LIN. FT.....NA
VB23IKRB.....62.....EA.....1	VB6002NS.....52.....EA.....201*	VB96.....57.....EA.....90	WPRAIL350.....37...LIN. FT.....NA
VB23LK.....62.....EA.....9	VB600C.....52.....EA.....65*	VB98HG.....59.....EA.....1	WPRAIL450.....37...LIN. FT.....NA
VB23LK-CV.....61.....EA.....5	VB6050.....52.....EA.....113*	VBDSS.....62.....EA.....1	WPRAILCT.....37.....SQFT.....1
VB23ST.....61.....EA.....10	VB6050NS.....52.....EA.....101*	VBGauge.....62...SET.....10	WPUP2HD.....36...SQFT.....1
VB24.....61.....EA.....5	VB60C.....52.....EA.....110*	VBHOOK/LOOP.....61.....PR.....1	WPUP3N.....36.....SQFT.....0.4
VB25.....56, 62.....EA.....2	VB60W.....61.....EA.....5	VBTBASE.....56.....EA.....30	WPUP3U.....36...SQFT.....0.4
VB25FL.....56, 62.....EA.....3	VB70.....50.....PR.....85*	VBTBASEP.....56.....EA.....5	WPUPFRC.....36...SQFT.....NA
VB25TF.....56, 62.....EA.....2	VB700.....50.....EA.....50*	WP25.....32.....EA.....NA*	WPVS.....32.....FT.....0.5
VB26.....61.....EA.....9	VB7000.....50.....EA.....129*	WP26.....32.....EA.....NA*	WPZ.....32.....FT.....1
VB26CH.....61.....EA.....7	VB7000NS.....50.....EA.....111*	WP27.....32.....EA.....NA*	WPZ3.....36...LIN. FT.....1
VB26LK.....61.....EA.....9	VB7002.....50.....EA.....213*	WP2NGFW.....36.SQFT.....3	
VB26ST.....61.....EA.....12	VB7002NS.....50.....EA.....186*	WP2NGJW.....36.SQFT.....3	
VB27.....61.....EA.....10	VB72.....49.....PR.....57*	WP2NGVS.....36.SQFT.....3	

\* Ships by Truck \*\* Ships Small Package Oversize





## OUR STAFF & SALES REPS



**Nick Cusick**  
President  
402-474-3353



**Chris Livingston**  
Sales Manager  
402-817-1293



**Lee Ramirez**  
International Sales Agent  
708-835-5026



**Carrie Hoyt**  
Accounts Receivable  
402-817-1315

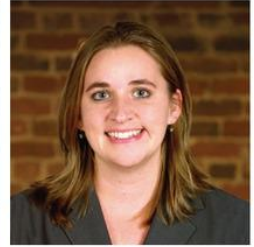

**Jennifer Rawlinson**  
Marketing and  
Communication Manager  
402-817-1295



**Kelly Bouwens**  
Product Specialist and  
Traffic Coordinator  
402-817-1732



**Matt Duchek**  
Graphic Product Specialist  
402-817-3703



**Tyce Lilienthal**  
Product Specialist  
402-858-4765



**Dillon Ertz**  
Product Specialist  
402-858-4649



**Jaxon Haas**  
Product Specialist  
402-817-4572

### Sales Reps



**Ken Hunt**  
(NE, IA)  
Lincoln, NE  
C: 402-770-5676  
huntkenj@gmail.com



**Dave Gignac**  
(MI, OH)  
Davisburg, MI  
P/C: 248-625-8326  
F: 248-625-3469  
dgignac.basales@gmail.com



**Chris Hellenkamp**  
(NC, VA, WV)  
Cary, NC  
C: 919-345-2544  
chrishellenkamp@yahoo.com



**Tommy Wilson**  
(So. TX, So. LA)  
Houston, TX  
F: 832-328-8440  
C: 832-746-8973  
tommywilson03@aol.com



**Steve Schwabe**  
(IL, IN)  
Moline, IL  
P: 309-235-2764  
F: 309-788-2685  
Schwabestev@gmail.com



**David Mollica**  
(CT, MA, VT, NH, ME)  
Stratham, NH  
F: 603-319-1792  
C: 603-204-4548  
Email: dave@ne6sales.com



**Derreck Cole**  
(GA, SC, TN, KY)  
Cumming, GA  
P/C: 770-331-6143  
F: 678-828-5997  
bamawabbit67@yahoo.com



**Scott Anderson**  
(OK, AR)  
Goldsby, OK  
F: 405-288-3317  
C: 405-795-2600  
scotta2525@aol.com



**Mark Roekle**  
(MN, WI, ND, SD)  
Eau Claire, WI  
C: 715-829-6401  
mroekle@aol.com



**Todd Kausrud**  
(CA, NV, HI, AZ, NM)  
Merced, CA  
C: 909-851-1103  
todd.kausrud@verizon.net



**Eric Bell**  
(FL)  
Oviedo, FL  
F: 321-235-1131  
C: 321-663-3680  
ebell90@yahoo.com



**Chris Bruegge**  
(KS, MO)  
C: 913-238-3655  
chris.bruegge92@gmail.com



**Bill Greig**  
(NJ)  
Neptune, NJ  
P/C: 908-217-6540  
billgreig@verizon.net



**Jay Nero**  
(NY, PA, MD, DE)  
Tonawanda, NY  
P: 716-694-3713  
F: 716-694-3298  
C: 716-308-9260  
jnero30935@aol.com



**Monte Robertson**  
(No. TX, No. LA)  
Corinth, TX  
P: 940-321-7903  
F: 940-497-0111  
C: 940-367-5228  
mhrob57@charter.net



**John Brady**  
(ID, MT, UT)  
Boise, ID  
P: 208-867-4412  
F: 208-939-7476  
johnbrady.jbsinc@gmail.com



**Maxie Kizzire**  
(AL, MS, TN, KY)  
Tuscaloosa, AL  
F: 205-758-9922  
C: 205-792-1500  
maxie2304@aol.com



800-247-7668



www.bisoninc.com

107





645 L STREET  
LINCOLN, NE 68508



800-247-7668  
WWW.BISONINC.COM



FIBA  
APPROVED  
EQUIPMENT

PARTNER

30M/10-24



**SAFETY PADDING & GRAPHICS**



**BLEACHERS & BENCHES**



**RESIDENTIAL BASKETBALL**

 **WARNING:** Cancer  
and Reproductive Harm  
[www.P65Warnings.ca.gov](http://www.P65Warnings.ca.gov)