

FRP Grating Catalogue



Changing the way
we use fibreglass



gratingfrpaustralia.com.au

WA, NT & SA
(08) 9584 2500
wa-sales@gratingfrpaustralia.com.au

NSW, QLD, VIC, TAS & ACT
(02) 4244 1008
nsw-sales@gratingfrpaustralia.com.au



 **grating** frp
AUSTRALIA



Table of Contents



Company Overview	4
About FRP	5
Applications	6
Surface Finishes & Grit Options	7
Industries We Work With	8
Moulded Grating FRP Products	9 - 14
Pultruded Grating FRP Products	14 - 22
Structural Profile FRP Products	23 - 26
Anti-Slip FRP Products	27 - 28
FRP Ladders	29 - 30
FRP Handrails	31
Clips	32 - 34
Moulded Grating Load Tables	35 - 53
Pultruded Grating Load Tables	54 - 60
Chemical Resistance Data Charts	61 - 63



Grating FRP Australia is a division of Scavenger Supplies who have been an Australian owned and trusted supplier of high performance industrial products for more than two decades.

We are the only FRP supplier in Australia with ISO9001 quality assurance and OH&S45001 certified practices and BAL-40 certification.

We provide Fibre Reinforced Polymer (FRP) products that meet the requirements of industrial, marine, civil and architectural applications. Our FRP range offers lightweight, corrosion resistant, high strength and low-maintenance solutions.



Setting the benchmark in Australia for FRP, with certified quality, robust safety systems, and BAL-40 compliance.



**ISO 9001:2015 Certified
Quality Management System**



**BAL-40 Certified
Bushfire compliant**

Our national distribution network provides specialist technical expertise and in-house fabrication. We assist with product selection through to installation and ensure compliance, performance and durability in diverse environments.





Grating FRP (Fibre-Reinforced Polymer) is a composite material that combines a resin matrix with reinforced fibres. This produces a lightweight and high-strength structure which is ideal for harsh environments.

FRP does not corrode, is non-conductive and requires minimal maintenance unlike its steel, timber or aluminium counterparts. It can be cut and fabricated using common hand tools, making installation easy and cost-effective.

Key Advantages:



Lightweight
Easy to handle and install

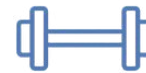

High Strength
High strength, Light weight



Corrosion Resistant
Performs in harsh environments



Fire Resistant
Fire-retardant, Resin options available



Non-conductive
Safe for electrical environments



Slip Resistant
Reliable grip options available



Cost Effective
Low maintenance



Design Friendly
Can be customised



Durable
Long service life



Colour Stable
UV and weather resistant

Compliance and Certification



ISO 9001:2015 Certified
ISO 45001:2018 Certified
Quality Management System



AS 1657-2018
Designed with reference to AS 1657 for access and safety.



BAL-40 Certified
Bushfire compliance



ASTM E-84
Flame spread rating ≤25 (Class 1)



AS/NZS 4586:2013 Certified
Slip resistance classification

FRP products are manufactured and supplied in accordance with rigorous Australian and International standards.



Grating FRP (Fibre-Reinforced Polymer) provides a corrosion-resistant, non-slip surface for safe access in industrial, commercial and public environments. It is suitable for wet, chemical and high-traffic areas. Our composite materials are suitable for all locations.



Marine and Coastal

Jetties, Pontoons, Ferry Terminals and Marinas



Industrial & Mining

Platforms, Walkways, Trench and Electrical Sub Station Covers



Public Infrastructure

Pedestrian Bridges, Ramps and Boardwalks



Commercial Facilities

Rooftop Plant Decks and Accessways



Architectural

Screening, Rooftop Terraces and Shade Structures



Utilities

Wastewater Treatment Plants and Rail Platforms

Surface Finishes & Grit Options



Smooth
Minimal slip resistance.

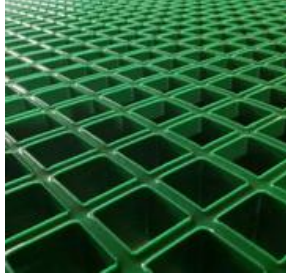

Concave
Moderate slip resistance, comfortable underfoot.

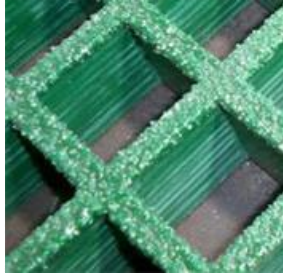

Gritted
Maximum slip resistance for wet and oily surfaces.

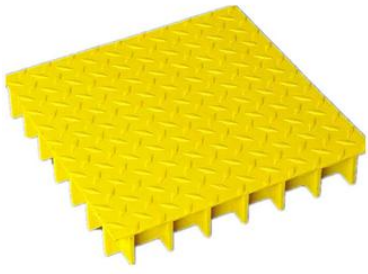

Checker
Slip resistance with a patterned raised surface.



GRIT SIZE KEY

1	2	3	4	5	6	7	8	9	10
Heavy Duty 3.8mm	Heavy Duty 3.2mm	Medium Duty 2.8mm	Medium Duty 2.5mm	Medium Duty 2.2mm	Medium Duty 1.5mm	Light Duty 1.25mm	Light Duty 0.8mm	Light Duty 0.6mm	Light Duty 0.3mm

Surface finish and grit size selection should be based on the environment, slip resistance requirements and cleaning considerations. All finishes are available across most FRP products unless otherwise noted in the specifications.

Please note: Not all grit types are held in stock. Some items may require additional lead time depending on availability and procurement logistics.

5,6,7 = Commonly Stocked Grits



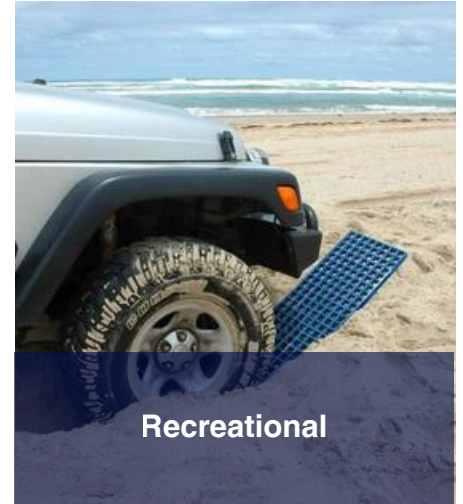
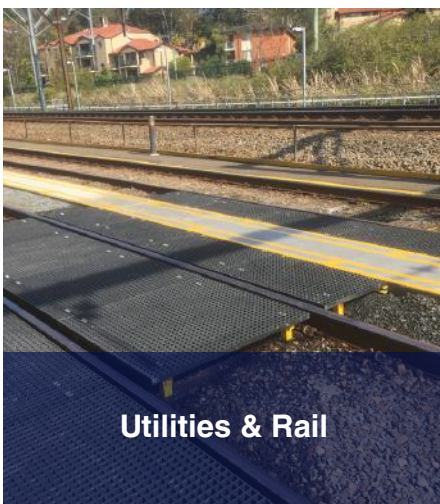
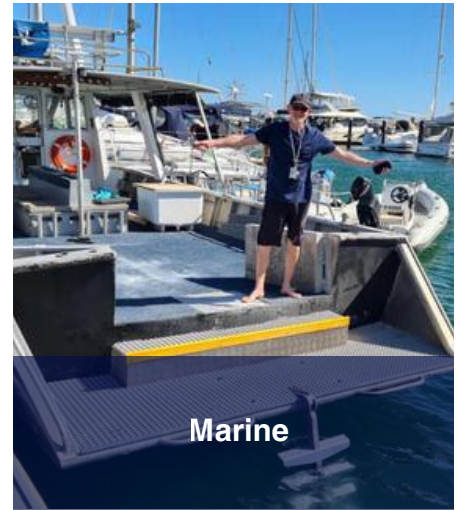

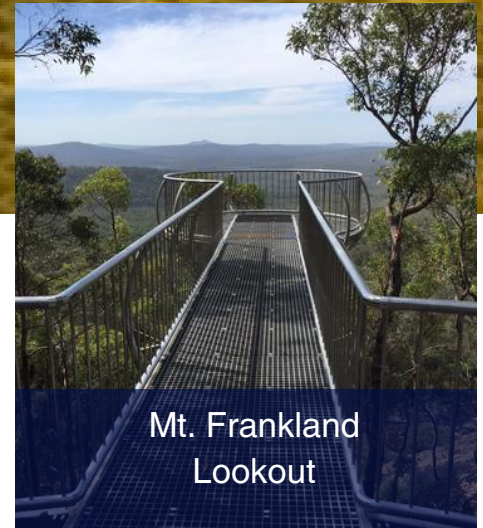
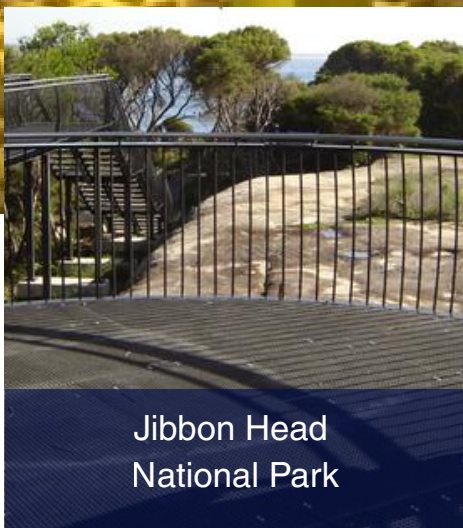
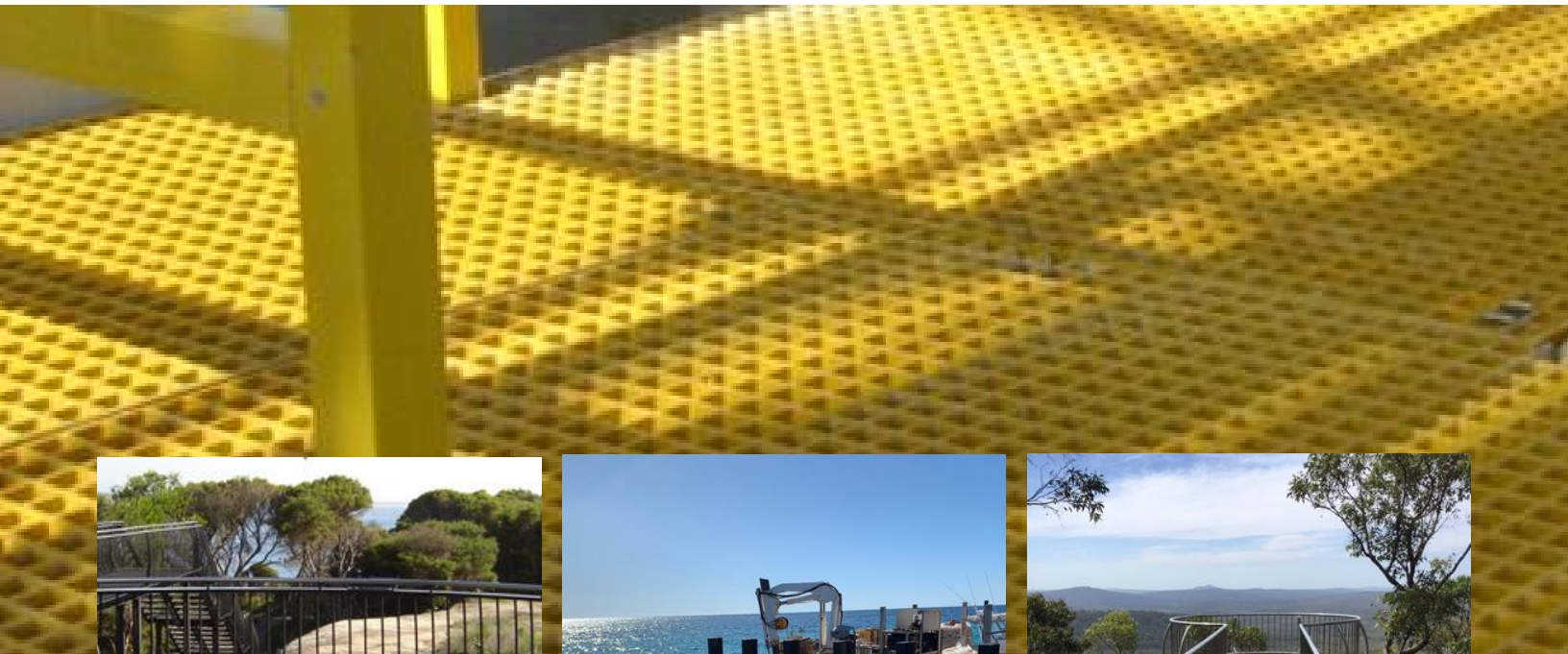

FRP Moulded Grating

FRP moulded grating is ideal for industrial flooring, walkways, ramps and platforms. The product can be used in areas such as wastewater treatment, chemical processing plants and marine environments.

Grating FRP Australia's FRP Moulded Grating is manufactured as a single-piece moulding with continuous fibreglass reinforcement. It offers a strong, corrosion-resistant and fire-retardant solution for demanding environments.

Available in a variety of mesh sizes, thicknesses, and resin systems. Some of the options include standard 38 × 38 mm square mesh, reduced-aperture, mini and micro mesh for public access areas. The grating contains 30–35% fibreglass and includes fire-retardant additives. It provides a Class 1 flame spread rating under 25 (ASTM E-84) with UV inhibitors for long-term outdoor durability.



38.1 x 38.1 Mesh

Unit: mm

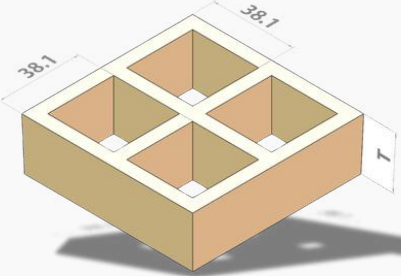
Image	Depth	Bar Thickness	Standard Dimension	Weight (kg/m ²)	Open Ratio %
	14	6.0/ 5.0	1524 x 4000 1220 x 3660* 1220 x 2440 921 x 3050 610 x 3660*	6.1	78
	15	6.0/ 5.0	1524 x 4000 1220 x 3660 1220 x 2440 921 x 3050	7.1	78
	20	6.5/ 5.0	1524 x 4000 1220 x 3660 1220 x 2440 921 x 3050	9.6	68
	25	6.5/ 5.0	998 x 3015* 998 x 2025* 1524 x 4000 1220 x 3660* 1220 x 2440 921 x 3050	12.3	68
	30	6.5/ 5.0	1524 x 4000 1220 x 3660* 1220 x 2440 921 x 3050	14.6	68
	38	7.0/ 5.0	998 x 2025* 1524 x 4000 1220 x 3660* 1220 x 2440 921 x 3050	19.5	68
	40	7.0/ 5.0	1524 x 4000 1220 x 3660 1220 x 2440 921 x 3050	20.6	68
	50 (HD)	9.5/ 7.5	1220 x 3660* 1220 x 2440 921 x 3050	40.0	56
	60 (HD)	10.5/ 8.5	1220 x 3660 1220 x 2440 921 x 3050	48.0	54
	65 (HD)	11.0/ 9.0	1220 x 3660 1220 x 2440 921 x 3050	52.0	52

40 x 40 Mesh

Unit: mm

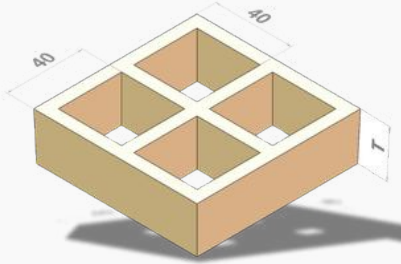
Image	Depth	Bar Thickness	Standard Dimension	Weight (kg/m ²)	Open Ratio %
	25	7.0/ 5.0	1007 x 3007 1007 x 4007 1247 x 3687 1527 x 4047	12.3	67
	30	7.0/ 5.0	1007 x 3007 1007 x 4007 1247 x 3687 1527 x 4047	14.5	67
	40	7.0/ 5.0	1007 x 3007 1007 x 4007 1247 x 3687 1527 x 4047	19.2	67

83 x 83 Mesh

Unit: mm

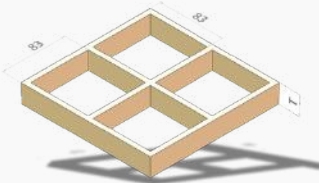
Image	Depth	Bar Thickness	Standard Dimension	Weight (kg/m ²)	Open Ratio %
	25	7.0/ 5.0	1007 x 4007	6.1	84
	40	7.0/ 5.0	1007 x 4007	9.6	84

***COMMONLY STOCKED ITEM**

FRP Moulded Grating Specifications

50.8 x 50.8 Mesh

Unit: mm

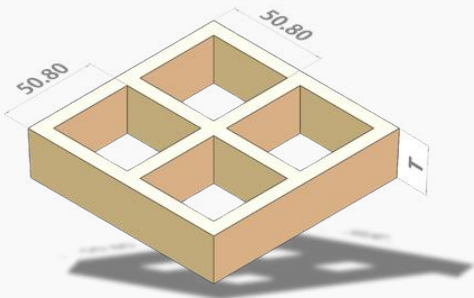
Image	Depth	Bar Thickness	Standard Dimension	Weight (kg/m ²)	Open Ratio %
	13	6.0/ 5.0	1524 x 4000 1220 x 3660 1220 x 2440 921 x 3050	5.8	82
	15	7.0/ 6.0	1524 x 4000 1220 x 3660 1220 x 2440 921 x 3050	6.8	82
	25	7.5/ 6.0	1524 x 4000 1220 x 3660 1220 x 2440 921 x 3050	11.8	78
	38	7.0/ 5.0	1524 x 4000 <u>1220 x 3660*</u> 1220 x 2440 921 x 3050	17.8	78
	50	7.5/ 5.0	1524 x 4000 1220 x 3660 1220 x 2440 921 x 3050	21.5	78
	50	8.0/ 6.0	1524 x 4000 <u>1220 x 3660*</u> 1220 x 2440 921 x 3050	23.5	78

25 x 100 Mesh

Unit: mm

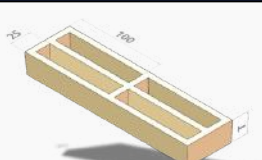
Image	Depth	Bar Thickness	Standard Dimension	Weight (kg/m ²)	Open Ratio %
	25	7.0/ 5.0	1007 x 4007 1007 x 3007	13.0	67
	30	7.0/ 5.0	1007 x 4007 1007 x 3007	15.6	67

25.4 x 101.6 Mesh

Unit: mm

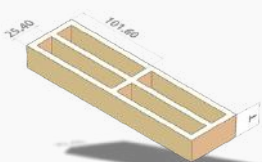
Image	Depth	Bar Thickness	Standard Dimension	Weight (kg/m ²)	Open Ratio %
	25	6.5/ 5.0	1220 x 3660 921 x 3050	13.0	67
	25 HD	9.5/ 8.0	1220 x 3660 921 x 3050	15.6	67

38.1 x 101.6 Mesh

Unit: mm

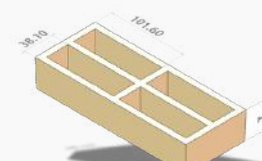
Image	Depth	Bar Thickness	Standard Dimension	Weight (kg/m ²)	Open Ratio %
	38	8.0/ 6.0	1220 x 3660 921 x 3050	13.0	65

25.4 x 152.4 Mesh

Unit: mm

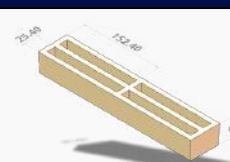
Image	Depth	Bar Thickness	Standard Dimension	Weight (kg/m ²)	Open Ratio %
	38	9.0/ 6.5	1220 x 3660 921 x 3050	22.5	63

*COMMONLY STOCKED ITEM.



38.1 x 152.4 Mesh

Unit: mm

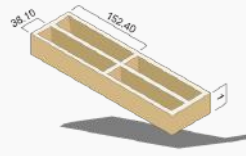
Image	Depth	Bar Thickness	Standard Dimension	Weight (kg/m ²)	Open Ratio %
	38	8.0/ 6.0	1220 x 3660 921 x 3050	15.9	67

25.4 x 50.8 Mesh

Unit: mm

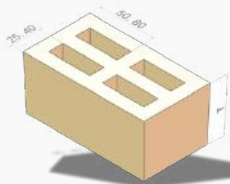
Image	Depth	Bar Thickness	Standard Dimension	Weight (kg/m ²)	Open Ratio %
	38	11.0/ 9.0	1220 x 1830	30.7	49
	50	12.0/ 9.0	1220 x 1830 1220 x 3660	41.8	48

60 x 100 Mesh

Unit: mm

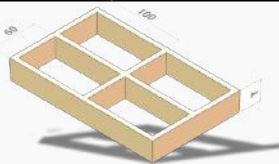
Image	Depth	Bar Thickness	Standard Dimension	Weight (kg/m ²)	Open Ratio %
	28	6.5/ 5.0	1500 x 4000 1500 x 2000	7.2	78

60 x 220 Mesh

Unit: mm

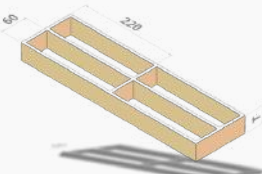
Image	Depth	Bar Thickness	Standard Dimension	Weight (kg/m ²)	Open Ratio %
	40	6.3/ 5.0	1788 x 4476 1788 x 2238	8.8	67

25.4 x 101.6 Mesh (Disability Friendly)

Unit: mm

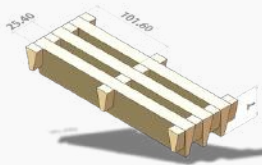
Image	Depth	Bar Thickness	Standard Dimension	Weight (kg/m ²)	Open Ratio %
	38	15.0/ 5.0	1220 x 3660	21.0	62

38.1 x 101.6 Mesh

Unit: mm

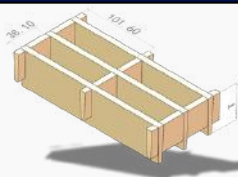
Image	Depth	Bar Thickness	Standard Dimension	Weight (kg/m ²)	Open Ratio %
	50	8.0/ 5.0	1220 x 3660	15.3	68

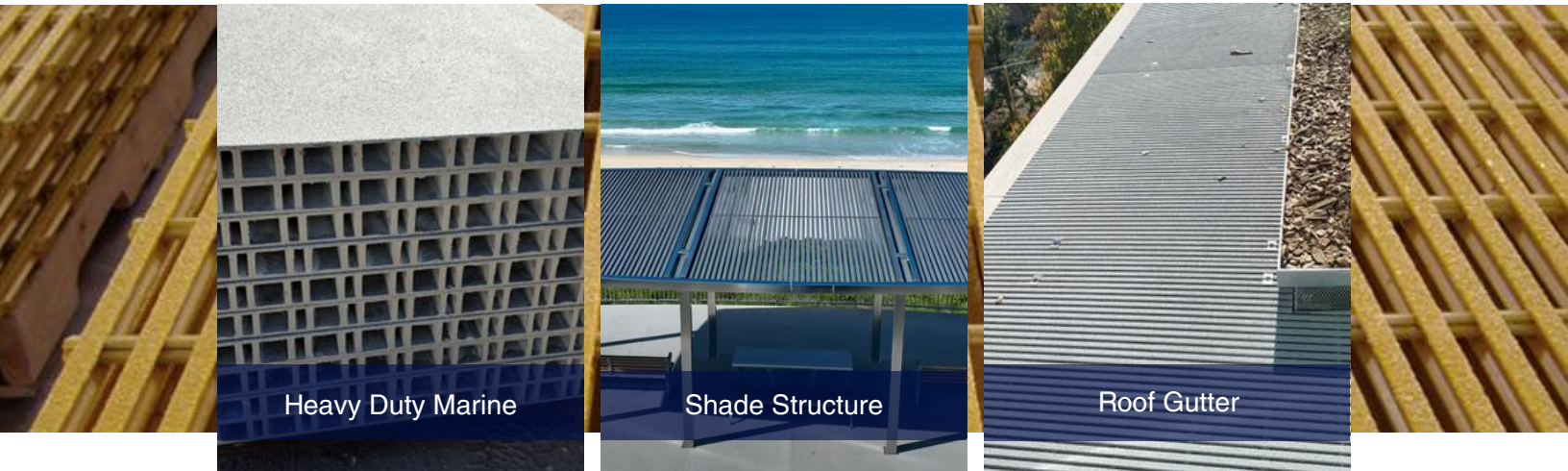

FRP pultruded grating is ideal for industrial walkways, platforms, ramps, trench covers and marine structures such as piers and boat docks, providing long service life and low maintenance.

Grating FRP Australia’s FRP Pultruded Grating is engineered for applications that demand longer spans, higher load capacity and reduced deflection, offering a high-strength alternative to traditional materials.





Manufactured through a continuous pultrusion process, the grating features I-bar or T-bar profiles with 60–65% fibreglass content, mechanically locked and epoxy-bonded with cross rods to create a rigid, corrosion-resistant panel. This robust construction delivers outstanding durability and performance in harsh environments, making it a proven substitute for steel or aluminium in corrosive or marine conditions.











Pedestrian Series

The Pedestrian Series is ideal for public walkways, access platforms, ramps and other pedestrian areas.

Grating FRP Australia’s Pedestrian Series features wide T-bar profiles designed to provide a stable, slip-resistant surface for safe and comfortable foot traffic.

This series is engineered to meet stringent accessibility requirements, with selected profiles compliant with ADA (US) and DDA (UK) standards, ensuring ease of access for all users.

Type	Thickness	Bearing Bar Centre	Cross Bar Center (mm)	Open Area %	Weight kg/m2
T-1210 	25	43.4	152.4	12	14.5
T-1810 	25	50.8	152.4	18	13.8
T-2510 	25	50.8	152.4	25	13.6
T-3310	25	61.0	152.4	33	11.2
T-3810	25	61.0	152.4	38	10.2
T-1215 	38	43.3	152.4	12	19.6
T-2515 	38	50.8	152.4	25	16.7
T-3815	38	61.0	152.4	38	14.2

Type	Thickness	Bearing Bar Centre	Cross Bar Center (mm)	Open Area %	Weight kg/m2
T-1210 	25	43.4	152.4	12	14.5
T-1810 	25	50.8	152.4	18	13.8
T-2510 	25	50.8	152.4	25	13.6
T-3310	25	61.0	152.4	33	11.2
T-3810	25	61.0	152.4	38	10.2
T-1215 	38	43.3	152.4	12	19.6
T-2515 	38	50.8	152.4	25	16.7
T-3815	38	61.0	152.4	38	14.2
I-4010 	25	25.4	152.4	40	17.1
I-50125	25	30.0	152.4	50	14.2
I-6010	25	38.1	152.4	60	11.2
I-40125 	30	25.4	152.4	40	19.8
I-50125	30	30.5	152.4	50	17.4
I-60125	30	37.1	152.4	60	13.5
I-4015 	38	38.1	152.4	40	22.0
I-5015	38	50.8	152.4	50	19.1
I-6015	38	30.2	152.4	60	16.1
T-3320 	50	30.2	152.4	33	20.3
T-5020	50	30.2	152.4	50	15.7
HI-4710	25	30.2	152.4	47	27.6
HI-4715	38	30.2	152.4	47	40.0
HI-4720	50	30.2	152.4	47	54.5
HI-4725	64	30.2	152.4	47	61.6
HI-4730	76	30.2	152.4	47	73.6
HI-5810	25	38.1	152.4	58	21.0
HI-5815	38	38.1	152.4	58	31.8
HI-5820	50	38.1	152.4	58	42.5
HI-5825	64	38.1	152.4	58	48.9
HI-5830	76	38.1	152.4	58	58.6
HL-4020 	50	25.4	152.4	40	70.4
HL-5020	50	30.0	152.4	50	52.2
HL-6020	50	38.1	152.4	60	43.5
SI-7310	25	30.2	152.4	73	13.2
SI-7315	38	30.2	152.4	73	18.6
SI-8310	25	47.6	152.4	83	8.5
SI-8315	38	47.6	152.4	83	12.0



	T-1210 - 25mm Height 12% Open Area			ADA Compliant
	No. of bars per 1 meter width	23	Opening C	5.4mm
	Bearing bar width T/B	38mm / 15mm	Weight	17.9kg/m ²
	Bearing bar center. A	43.3mm	Max size (w x l)	1524 x 6100mm
	T-1810 - 25mm Height 18% Open Area			ADA Compliant
	No. of bars per 1 meter width	19	Opening C	9.5mm
	Bearing bar width T/B	41.3mm/ 15mm	Weight	13.8kg/m ²
	Bearing bar center. A	50.8mm	Max size (w x l)	1524 x 6100mm
	T-2510 - 25mm Height 25% Open Area			ADA Compliant
	No. of bars per 1 meter width	19	Opening C	12.7mm
	Bearing bar width T/B	38mm/ 15mm	Weight	13.6kg/m ²
	Bearing bar center. A	50.8mm	Max size (w x l)	1524 x 6100mm
	T-3310 - 25mm Height 33% Open Area			
	No. of bars per 1 meter width	16	Opening C	19.7mm
	Bearing bar width T/B	41.3/ 15mm	Weight	11.2kg/m ²
	Bearing bar center. A	61mm	Max size (w x l)	1524 x 6100mm
	T-3810 - 25mm Height 38% Open Area			
	No. of bars per 1 meter width	16	Opening C	23mm
	Bearing bar width T/B	38mm/ 15mm	Weight	11.6kg/m ²
	Bearing bar center. A	61mm	Max size (w x l)	1524 x 6100mm
	T-1215 - 38mm Height 12% Open Area			ADA Compliant
	No. of bars per 1 meter width	23	Opening C	5.4mm
	Bearing bar width T/B	38mm/15mm	Weight	19.6kg/m ²
	Bearing bar center. A	43.3mm	Max size (w x l)	1524 x 6100mm
	T-2515 - 38mm Height 25% Open Area			ADA Compliant
	No. of bars per 1 meter width	19	Opening C	12.7mm
	Bearing bar width T/B	38mm/ 15mm	Weight	16.7kg/m ²
	Bearing bar center. A	50.8mm	Max size (w x l)	1524 x 6100mm
	T-3815 - 38mm Height 38% Open Area			
	No. of bars per 1 meter width	16	Opening C	23mm
	Bearing bar width T/B	38mm/15mm	Weight	14.2kg/m ²
	Bearing bar center. A	61mm	Max size (w x l)	1524 x 6100mm

Grating FRP Australia's Industrial Series is engineered for strength and corrosion resistance in demanding industrial environments. It is ideal for platforms, cooling tower walkways and areas requiring wide spans with minimal deflection. Open mesh designs provide excellent airflow and drainage. Selected profiles meet ADA (US) and DDA (UK) accessibility standards.

Type	Thickness	Bearing Bar Centre	Cross Bar Center (mm)	Open Area %	Weight kg/m ²
I-4010	25	25.4	152.4	40	17.1
I-5010	25	30.0	152.4	50	14.2
I-6010	25	38.1	152.4	60	11.2
I-40125	30	25.4	152.4	40	19.8
I-50125	30	30.5	152.4	50	17.4
I-60125	30	37.1	152.4	60	13.5
I-4015	38	25.4	152.4	40	22.0
I-5015	38	30.5	152.4	50	19.1
I-6015	38	37.1	152.4	60	16.1
T-3320	50	38.1	152.4	33	20.3
T-5020	50	50.8	152.4	50	15.7

	I-4010 - 25mm Height 40% Open Area			ADA Compliant
	No. of bars per 1 meter width	40	Opening C	10mm
	Bearing bar width T/B	15mm/ 15mm	Weight	17.8kg/m ²
	Bearing bar center. A	25mm	Max size (w x l)	1524 x 6100mm

	I-5010 - 25mm Height 50% Open Area			
	No. of bars per 1 meter width	33	Opening C	15mm
	Bearing bar width T/B	15mm/ 15mm	Weight	15.1kg/m ²
	Bearing bar center. A	30mm	Max size (w x l)	1524 x 6100m2

	I-6010 - 25mm Height 60% Open Area			
	No. of bars per 1 meter width	26	Opening C	23mm
	Bearing bar width T/B	15mm / 15mm	Weight	12.2kg/m ²
	Bearing bar center. A	38mm	Max size (w x l)	1524 x 6100mm

	I-40125 - 32mm Height 40% Open Area			ADA Compliant
	No. of bars per 1 meter width	40	Opening C	10mm
	Bearing bar width T/B	15mm / 15mm	Weight	19.8kg/m ²
	Bearing bar center. A	25mm	Max size (w x l)	1524 x 6100mm

	I-50125 - 32mm Height 50% Open Area			
	No. of bars per 1 meter width	33	Opening C	23mm
	Bearing bar width T/B	15mm / 15mm	Weight	13.5kg/m ²
	Bearing bar center. A	38mm	Max size (w x l)	1524 x 3100mm

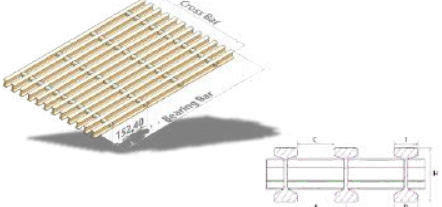

	I-60125 - 32mm Height 60% Open Area			
	No. of bars per 1 meter width	26	Opening C	23mm
	Bearing bar width T/B	15mm /15mm	Weight	13.5kg/m ²
	Bearing bar center. A	38mm	Max size (w x l)	1524 x 6100m ²

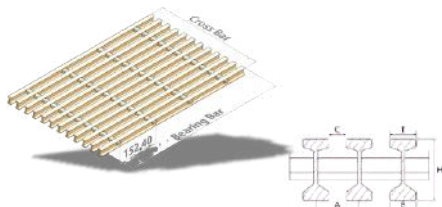
	I-4015 - 38mm Height 40% Open Area			ADA Compliant
	No. of bars per 1 meter width	40	Opening C	10mm
	Bearing bar width T/B	15mm / 15mm	Weight	22kg/m ²
	Bearing bar center. A	25mm	Max size (w x l)	1524 x 6100mm

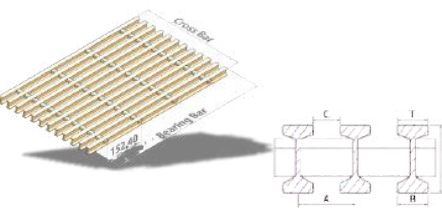
	I-5015 - 38mm Height 40% Open Area			
	No. of bars per 1 meter width	33	Opening C	10mm
	Bearing bar width T/B	15mm/ 15mm	Weight	22kg/m ²
	Bearing bar center. A	30mm	Max size (w x l)	1524 x 6100mm

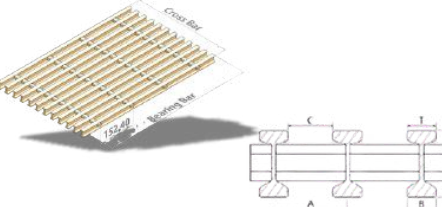
	I-6015 - 38mm Height 50% Open Area			
	No. of bars per 1 meter width	26	Opening C	23mm
	Bearing bar width T/B	15mm/ 15mm	Weight	16.2kg/m ²
	Bearing bar center. A	38mm	Max size (w x l)	1524 x 6100mm

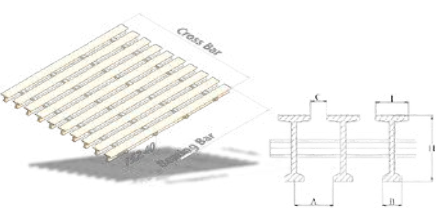
	T-3320 - 50mm Height 33% Open Area			ADA Compliant
	No. of bars per 1 meter width	26	Opening C	12.7mm
	Bearing bar width T/B	25.4mm/ 15mm	Weight	21.7kg/m ²
	Bearing bar center. A	38mm	Max size (w x l)	1524 x 6100mm

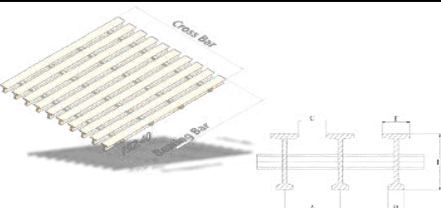
	T-5020 - 50mm Height 50% Open Area			
	No. of bars per 1 meter width	20	Opening C	25.4mm
	Bearing bar width T/B	25.4mm/ 15mm	Weight	17.2kg/m ²
	Bearing bar center. A	50.85mm	Max size (w x l)	1524 x 6100mm

High Load Capacity Series Grating



Grating FRP Australia's High Load Capacity Series Grating is engineered for extreme loads, including forklifts, heavy vehicles and large equipment. Made from heavy duty materials, it delivers superior durability and strength for demanding applications. Ideal for loading docks, service yards and heavy transport access, this series offers various profiles meeting accessibility standards.

Type	Thickness	Bearing Bar Centre	Cross Bar Center (mm)	Open Area %	Weight kg/m ²
HI-4710	25	30.2	152.40	47	27.6
HI-4715	38	30.2	152.40	47	40.0
HI-4720	50	30.2	152.40	47	54.5
HI-4725	64	30.2	152.40	47	61.6
HI-4730	76	30.2	152.40	47	73.6
HI-5810	25	38.1	152.40	58	21.0
HI-5815	38	38.1	152.40	58	31.8
HI-5820	50	38.1	152.40	58	42.5
HI-5825	64	38.1	152.40	58	48.9
HI-5830	76	38.1	152.40	58	58.6
HL-4020 	50	5.4	152.40	40	70.4
HL-5020	50	30.0	152.40	50	52.2
HL-6020	50	38.1	152.40	60	43.5

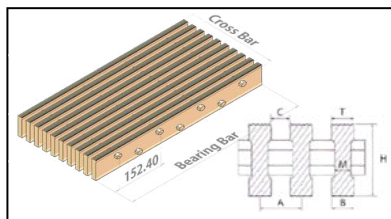

HI-4710 - 25mm Height 47% Open Area			
No. of bars per 1 meter width	33	Opening C	14.3mm
Bearing bar width T/B	15.9/ 14.4/ 15.9mm	Weight	27.6kg/m ²
Bearing bar center. A	30.2mm	Max size (w x l)	1524 x 6100mm

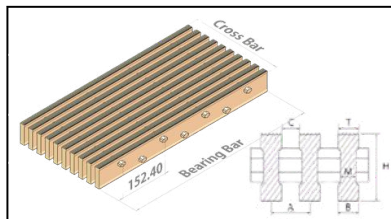

HI-4715 - 38mm Height 47% Open Area			
No. of bars per 1 meter width	33	Opening C	14.3mm
Bearing bar width T/B	15.9/ 14.4/ 15.9mm	Weight	40kg/m ²
Bearing bar center. A	30.2mm	Max size (w x l)	1524 x 6100mm

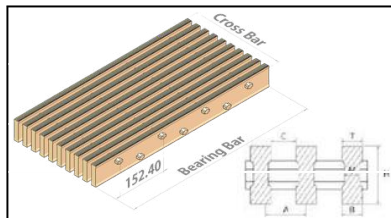

HI-4720 - 50mm Height 47% Open Area			
No. of bars per 1 meter width	33	Opening C	14.3mm
Bearing bar width T/B	15.9/ 14.4/ 15.9mm	Weight	54.5kg/m ²
Bearing bar center. A	30.2mm	Max size (w x l)	1524 x 6100mm

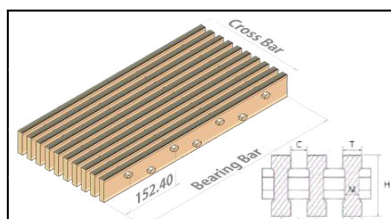

HI-4725 - 64mm Height 47% Open Area			
No. of bars per 1 meter width	33	Opening C	14.3mm
Bearing bar width T/B	15.9/ 14.4/ 15.9mm	Weight	61.6kg/m ²
Bearing bar center. A	30.2mm	Max size (w x l)	1524 x 6100mm

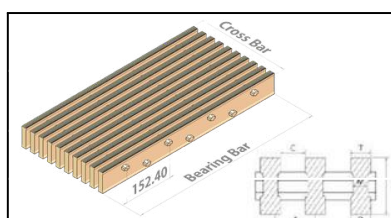

HI-4720 - 50mm Height 47% Open Area			
No. of bars per 1 meter width	33	Opening C	14.3mm
Bearing bar width T/B	15.9/ 14.4/ 15.9mm	Weight	54.5kg/m ²
Bearing bar center. A	30.2mm	Max size (w x l)	1524 x 6100mm

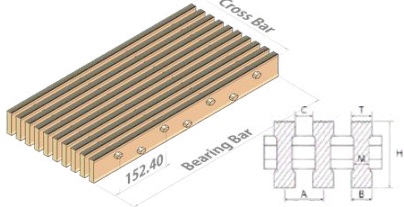

	HI-4725 - 64mm Height 47% Open Area			
	No. of bars per 1 meter width	33	Opening C	14.3mm
	Bearing bar width T/B	15.9/ 14.4/ 15.9mm	Weight	61.6kg/m ²
Bearing bar center. A	30.2mm	Max size (w x l)	1524 x 6100mm	

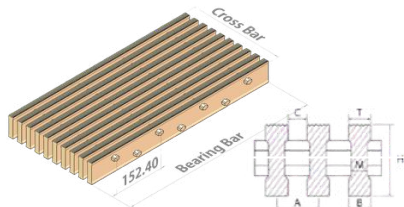
	HI-4730 - 76mm Height 47% Open Area			
	No. of bars per 1 meter width	33	Opening C	14.3mm
	Bearing bar width T/B	15.9/ 14.4/ 15.9mm	Weight	61.6kg/m ²
Bearing bar center. A	30.2mm	Max size (w x l)	1524 x 6100mm	

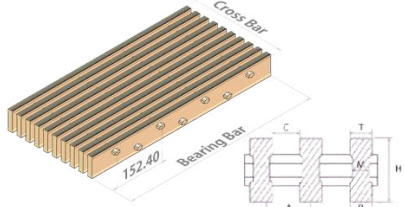
	HI-5810 - 25mm Height 58% Open Area			
	No. of bars per 1 meter width	26	Opening C	22.2mm
	Bearing bar width T/B	15.9/ 14.4/ 15.9mm	Weight	21.0kg/m ²
Bearing bar center. A	38.1mm	Max size (w x l)	1524 x 6100mm	

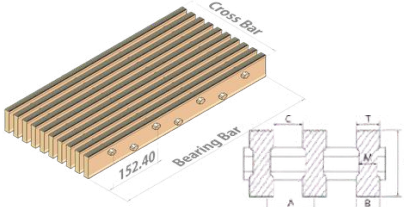
	HI-5815 - 38mm Height 58% Open Area			
	No. of bars per 1 meter width	26	Opening C	22.2mm
	Bearing bar width T/B	15.9/ 14.4/ 15.9mm	Weight	31.8kg/m ²
Bearing bar center. A	38.1mm	Max size (w x l)	1524 x 6100mm	

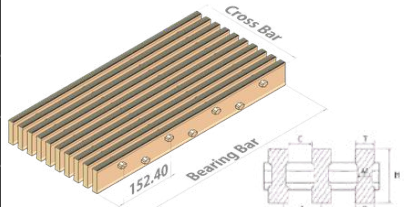
	HI-5820 - 50mm Height 58% Open Area			
	No. of bars per 1 meter width	26	Opening C	22.2mm
	Bearing bar width T/B	15.9/ 14.4/ 15.9mm	Weight	42.5kg/m ²
Bearing bar center. A	38.1mm	Max size (w x l)	1524 x 6100mm	

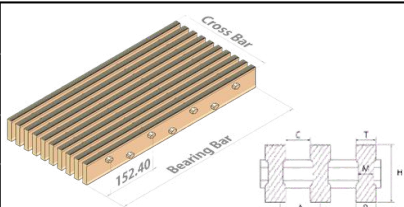
	HI-5825 - 64mm Height 58% Open Area			
	No. of bars per 1 meter width	26	Opening C	22.2mm
	Bearing bar width T/B	15.9/ 14.4/ 15.9mm	Weight	48.9kg/m ²
Bearing bar center. A	38.1mm	Max size (w x l)	1524 x 6100mm	

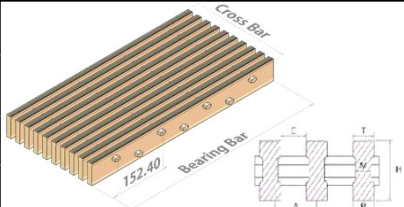
	HI-5830 - 76mm Height 58% Open Area			
	No. of bars per 1 meter width	26	Opening C	22.2mm
	Bearing bar width T/B	15.9/ 14.4/ 15.9mm	Weight	58.6kg/m ²
Bearing bar center. A	38.1mm	Max size (w x l)	1524 x 6100mm	

High Load Capacity Series Grating



	HL-4020 - 50mm Height 40% Open Area			ADA Compliant
	No. of bars per 1 meter width	40	Opening C	10mm
	Bearing bar width T/B	15mm/ 15mm	Weight	70.4kg/m ²
	Bearing bar center. A	25mm	Max size (w x l)	1524 x 6100mm

	HL-5020 - 50mm Height 50% Open Area			
	No. of bars per 1 meter width	33	Opening C	15mm
	Bearing bar width T/B	15mm/ 15mm	Weight	52.2kg/m ²
	Bearing bar center. A	25mm	Max size (w x l)	1524 x 6100mm

	HL-5020 - 50mm Height 50% Open Area			
	No. of bars per 1 meter width	26	Opening C	23mm
	Bearing bar width T/B	15mm/ 15mm	Weight	43.5kg/m ²
	Bearing bar center. A	25mm	Max size (w x l)	1524 x 6100mm

Maximum Traffic Conditions

Design Load		 AASHTO standard truck 14,285kg Dual Wheels	 Automobile traffic 2,270kg vehicle 681kg load 55% drive axle load	 5 tonne capacity forklift 6,583kg vehicle 11,075kg total load 85% drive axle load	 3 tonne capacity forklift 4,449kg vehicle 7,173kg total load 85% drive axle load	 1 tonne capacity forklift 1,907kg vehicle 2,815kg total load 85% drive axle load
Wheel Load (kg) (1/2 Axle Load + 30% Impact)		9,443	1,008	6,120	3,963	1,555
Load Distribution	Parallel to Axle	508 + 60mm	203 + 60mm	279 + 60mm	178 + 60mm	102 + 60mm
	Perpendicular to Axle	203mm	203mm	279mm	178mm	102mm
Allow Span	HI-4710	229mm	406mm	203mm	203mm	229mm
	HI-4715	356mm	711mm	330mm	330mm	406mm
	HI-4720	635mm	1194mm	533mm	533mm	838mm
	HI-4725	737mm	1448mm	635mm	635mm	991mm
	HI-4730	965mm	1778mm	813mm	813mm	1295mm
Load Distribution	Parallel to Axle	508 + 76mm	203 + 76mm	279 + 76mm	178 + 76mm	102 + 76mm
	Perpendicular to Axle	203mm	203mm	279mm	178mm	102mm
Allow Span	HI-5810	203mm	356mm	203mm	178mm	203mm
	HI-5815	305mm	584mm	279mm	254mm	330mm
	HI-5820	533mm	991mm	457mm	457mm	686mm
	HI-5825	584mm	1194mm	533mm	508mm	787mm
	HI-5830	787mm	1473mm	686mm	660mm	1067mm

Notes:

1. Load is carried by the grating load bars immediately under the wheel, plus two additional load bars, one on each side of each wheel.
2. Allowable span is based on a 6.4 mm deflection and a factor of safety of 3.0. Other criteria may be required by certain construction codes; check code requirements to determine design criteria.
3. Allowable span is strongly dependent on wheel width and vehicle weight/load capacity.
4. Load is based on the AASHTO standard truck load as defined in the AASHTO LRFD Bridge Design Specifications, 2nd Edition. This does not imply that the allowable span meets the deflection requirements of the specifications.



Grating FRP Australia's SI Series pultruded grating is engineered for applications requiring maximum open area combined with strong, stable footing. Available in 73% and 83% open mesh profiles, it provides excellent drainage and airflow, making it ideal for pedestrian traffic areas in high moisture or corrosive environments. The SI Series offers a low maintenance, corrosion resistant alternative with a close visual match to steel or aluminium profiles.

Type	Thickness	Bearing Bar Centre	Cross Bar Center (mm)	Open Area %	Weight kg/m ²
SI-7310	25	30.2	152.40	73	13.2
SI-7315	38	30.2	152.40	73	18.6
SI-8310	25	47.6	152.40	73	8.5
SI-8315	38	47.6	152.40	73	12.0

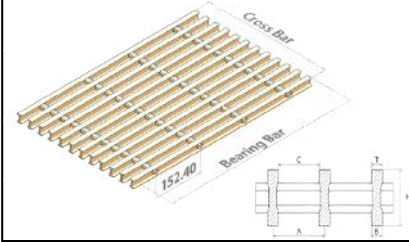
SI-7310 - 25mm Height 73% Open Area				
	No. of bars per 1 meter width	33	Opening C	22.2mm
	Bearing bar width T/B	7.9mm/ 7.9mm	Weight	13.2kg/m ²
	Bearing bar center. A	30.2mm	Max size (w x l)	1524 x 6100mm

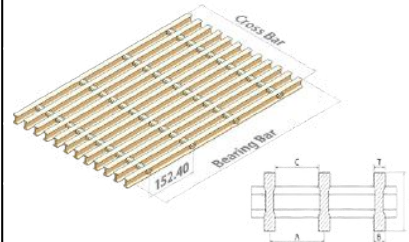
SI-7315 - 38mm Height 73% Open Area				
	No. of bars per 1 meter width	33	Opening C	22.2mm
	Bearing bar width T/B	7.9mm/ 7.9mm	Weight	18.6kg/m ²
	Bearing bar center. A	30.2mm	Max size (w x l)	1524 x 6100mm

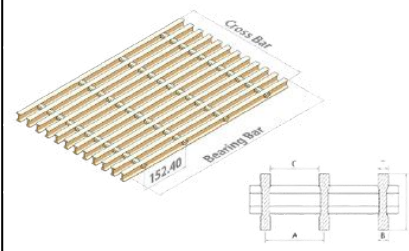
SI-8310 - 25mm Height 83% Open Area				
	No. of bars per 1 meter width	21	Opening C	39.6mm
	Bearing bar width T/B	7.9mm/ 7.9mm	Weight	8.5kg/m ²
	Bearing bar center. A	47.6mm	Max size (w x l)	1524 x 6100mm

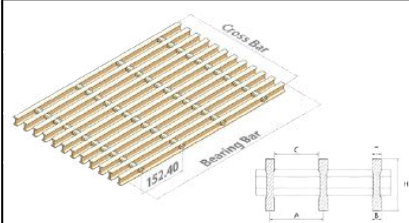
SI-8315 - 38mm Height 83% Open Area				
	No. of bars per 1 meter width	21	Opening C	39.6mm
	Bearing bar width T/B	7.9mm/ 7.9mm	Weight	12.0kg/m ²
	Bearing bar center. A	47.6mm	Max size (w x l)	1524 x 6100mm

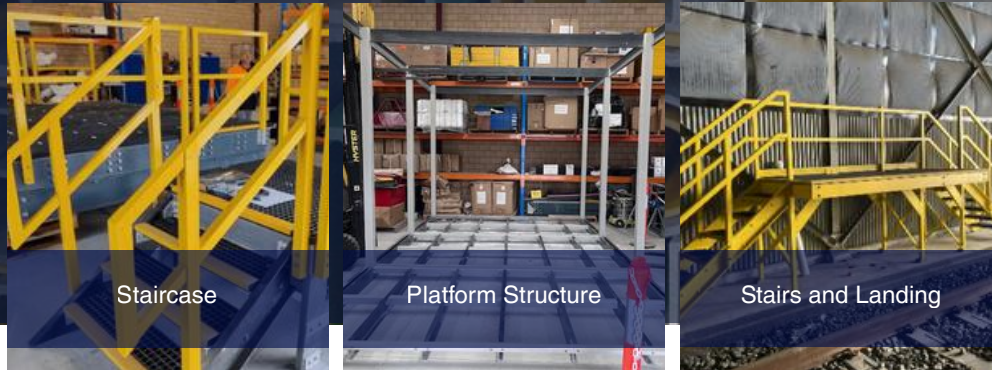

Structural Profiles

Grating FRP Australia’s pultruded structural profiles are manufactured with 60–65% fibreglass content and a resin-rich surface for maximum durability. Engineered for structural applications requiring high strength, fire-retardance, corrosion resistance and low maintenance materials, they offer a dependable alternative to steel, aluminum or timber.

These profiles are widely used across offshore and marine facilities, oil and gas operations, water treatment plants and chemical processing environments.

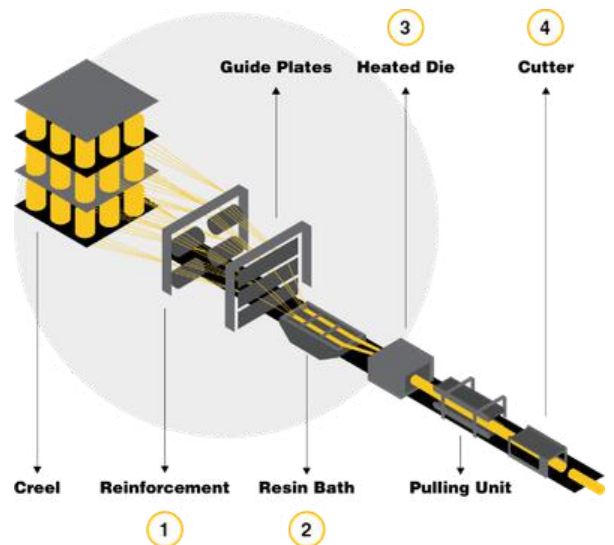

Pultrusion Process Diagram

Equal Angle	Thickness	Bearing Bar Centre
	50 x 14 x 3.2	0.44
	76 x 22 x 6.4	1.31
	76 x 38 x 6.4	1.70
	102 x 29 x 4.8	1.42
	102 x 44 x 4.8	1.65
	102 x 44 x 6.4	2.10
	120 x 25 x 5.0	1.52
	120 x 30 x 5.0	1.62
	120 x 40 x 5.0	1.81
	152 x 42 x 4.8	2.03
	152 x 42 x 6.4*	2.72
	152 x 42 x 9.5*	3.95
	203 x 56 x 6.4	3.68
	203 x 56 x 9.5*	5.34
	210 x 55 x 5.0	2.95
	210 x 80 x 5.0	3.42
	210 x 85 x 5.0	3.52
	254 x 70 x 12.7	8.90
	260 x 76.2 x 12.7	9.42
	290 x 70 x 12.7	9.60
	305 x 76 x 12.7	9.60

Equal Angle	Thickness	Bearing Bar Centre
	25 x 3.2*	0.33
	25 x 6.4	0.56
	30 x 50	0.57
	38 x 3.2	0.46
	38 x 4.8	0.65
	38 x 6.4	0.85
	50 x 3.2	0.61
	50 x 4.8	0.86
	50 x 6.4*	1.14
	76 x 6.4*	1.77
	76 x 9.5*	2.57
	76 x 12.7	3.40
	101 x 6.4	2.50
	101 x 9.5*	3.48
	101 x 12.7	4.57
	152 x 6.4	3.62
	152 x 9.5	5.42
	152 x 12.7	7.01
	25 x 3.2*	0.33
	25 x 6.4	0.56
	30 x 50	0.57

*COMMONLY STOCKED ITEM

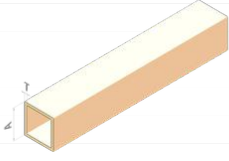
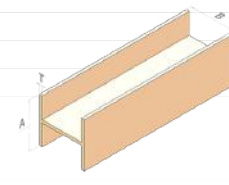
Square Tube	Dimension (mm) A x T	Weight (kg/m)
	25 x 3.2	0.53
	25 x 6.4	0.90
	32 x 3.2	0.70
	32 x 6.4	1.24
	38 x 3.2	0.85
	38 x 6.4	1.54
	44 x 3.2*	1.01
	44 x 4.8	1.53
	44 x 6.4*	1.83
	50 x 3.2	1.14
	50 x 4.0	1.42
	50 x 4.8	1.74
	50 x 6.4*	2.12
	54 x 4.8*	1.78
	64 x 3.2	1.48
	64 x 6.4	2.80
	76 x 3.2	1.77
	76 x 5.0	2.70
	76 x 6.4	3.39
	76 x 9.5	5.29
	101 x 3.2	2.38
	101 x 5.0	3.61
	101 x 6.4*	4.61
	125 x 6.4	5.76
	125 x 9.5	8.55
	125 x 12.7	11.43
	152 x 6.4	7.10
	152 x 9.5	10.40
	152 x 12.7	13.50
Wide Flange Beam	Dimension (mm) A x B x T	Weight (kg/m)
	76 x 76 x 6.4	2.67
	102 x 102 x 6.4	3.59
	102 x 102 x 6.4	4.50
	102 x 102 x 8.0	5.43
	152 x 152 x 6.4*	8.10
	152 x 152 x 9.5	10.80
	203 x 203 x 12.7	14.36
	254 x 254 x 12.7	13.80
	254 x 254 x 12.7	18.04
	305 x 305 x 12.7	21.50

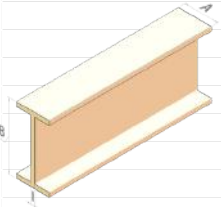
I Beam	Dimension (mm) A x B x T	Weight (kg/m)
	38 x 76 x 6.4	1.77
	50 x 102 x 6.4	2.40
	76 x 152 x 6.4	3.59
	76 x 152 x 9.5	5.32
	102 x 203 x 9.5	7.20
	102 x 203 x 12.7	9.50
	127 x 254 x 9.5	9.00
	127 x 254 x 12.7	11.90
	152 x 305 x 9.5	10.74
	152 x 305 x 12.7	14.30

Fluted Tube	Dimension (mm) D1 x D2 x T	Weight (kg/m)
	19 x 32 x 6.4	1.20
	25 x 32 x 3.5	0.66
	28 x 45 x 8.5	1.86
	32 x 45 x 6.4*	1.10

Kick Plate	Dimension (mm) A x B x T	Weight (kg/m)
	100 x 14 x 3.0 M Type	1.20
	100 x 14 x 3.0 W Type*	0.66
	150 x 15 x 3.2 W Type	1.86
	200 x 15 x 3.2	1.10

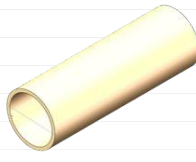
Round Tube	Dimension (mm) D1 x T	Weight (kg/m)
	25 x 3.2	0.44
	25 x 6.4	0.88
	32 x 3.2	0.55
	32 x 6.4	.10
	38 x 3.2	0.65
	38 x 6.4	1.30
	42 x 6.4	1.45
	44 x 6.4	1.61
	48 x 5.0	1.40
	50 x 3.2	0.84
	50 x 4.0	1.10
	50 x 5.0	1.34
	50 x 6.4	1.67

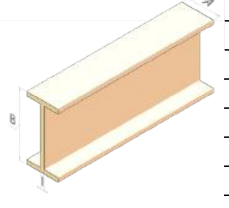
Equal Angle	Thickness	Bearing Bar Centre
	38 x 76 x 6.4	1.77
	50 x 102 x 6.4	2.40
	76 x 152 x 6.4	3.59
	76 x 152 x 9.5	5.32
	102 x 203 x 9.5	7.20
	102 x 203 x 12.7	9.50
	127 x 254 x 9.5	9.00
	127 x 254 x 12.7	11.90
	152 x 305 x 9.5	10.74
	152 x 305 x 12.7	14.30

Rectangular Tube	Thickness	Bearing Bar Centre
	38 x 25 x 5.0	1.20
	50 x 25 x 3.2	0.87
	50 x 25 x 6.4	1.54
	50 x 38 x 6.4	2.08
	76 x 25 x 5.0	2.33
	91 x 38 x 4.0	1.78
	100 x 50 x 5.0	2.72
	100 x 75 x 5.0	3.15
	112 x 91 x 6.4	4.46
	125 x 75 x 5.0	4.32
	150 x 100 x 6.4	5.76
	186 x 32 x 5.0	3.95
	197 x 44 x 5.0	4.34
	250 x 100 x 8.0	10.36

Embedded Angle	Thickness	Bearing Bar Centre
	25 x 38 x 6.4	1.40
	38 x 38 x 6.4	1.60
	38 x 50 x 6.4	1.70

T-Shape	Thickness	Bearing Bar Centre
	54 x 32 x 6.0	0.93
	54 x 32 x 5.0	0.78
	54 x 45 x 6.0	1.10
	60 x 55 x 5.0	1.08
	60 x 46 x 6.0	1.20
	78 x 44 x 6.0	1.08

*COMMONLY STOCKED ITEM

Stair Covers	Dimension (mm) A x B x T	Weight (kg/m)
	55 x 55 x 3.0	0.80
	65 x 10 x 3.0	0.44
	70 x 30 x 3.0*	0.71
	100 x 30 x 3.0	0.85
	150 x 20 x 3.0	0.92
	152 x 30 x 3.0	1.20
	200 x 20 x 5.0	2.00
	230 x 30 x 3.0	1.45
	230 x 55 x 4.0	2.10
	250 x 55 x 4.0	2.20
	280 x 55 x 4.0	2.42
	305 x 55 x 3.2	2.10
	345 x 55 x 4.0	2.88

* COMMONLY STOCKED ITEM

Flat Strip & Flat Sheet	Dimension (mm) A x T	Weight (kg/m)
	15 x 2.5	0.06
	10 x 2.5	0.05
	19 x 6.4	0.23
	38 x 5.0	0.35
	50 x 3.0	0.27
	50 x 4.0	0.36
	90 x 3.0	0.50
	120 x 3.0	0.65
	120 x 10.0	2.16
	615 x 3.2	3.55
	1220 x 3.2	7.03
	1220 x 6.4	14.06
	1220 x 9.5	20.86
	1220 x 12.7	29.50
	1524 x 6.4	7.60
	1524 x 12.7	36.80

Decking Panel	Dimension (mm)	Weight (kg/m)
	500 x 40 x 5.0	9.86
	500 x 57 x 5.0	14.70
	403.2 x 101.6 x 6.75	18.30
	381 x 120 x 6 x 7.54	19.60
	500 x 48 x 6.0 x 9.0	18.50
	725 x 45 x 4.5	18.20
	900 x 48.5 x 9.0	31.50

Mud Mat	Dimension (mm) A x B x T	Weight (kg/m)
	305 x 47.5 x 6.4	8.65
	305 x 82 x 6.4	11.60



Mechanical Properties		ASTM	UNITS	VALUE
Tensile Strength LW	D-638	MPA	207	
Tensile Strength CW	D-638	MPA	48	
Tensile Modulus LW	D-638	GPA	17.2	
Tensile Modulus CW	D-638	GPA	5.5	
Compressive Strength LW	D-695	MPA	207	
Compressive Strength CW	D-695	MPA	103	
Compressive Modulus LW	D-695	GPA	17.2	
Compressive Modulus CW	D-695	GPA	6.9	
Flexural Strength LW	D-790	MPA	207	
Flexural Strength CW	D-790	MPA	69	
Flexural Modulus LW	D-790	GPA	12.4	
Flexural Modulus CW	D-790	GPA	5.5	
Modulus of Elasticity E	Full Section	GPA	19.3	
Shear Modulus	/	GPA	3.1	
Short Beam Sheer	D-2344	MPA	31	
Punch Shear	D-256	MPA	69	
Bearing Strength LW	D-953	MPA	207	
Notched Izod Impact LW	D-256	KJ/m	1.33	
Notched Izod Impact CW	D-256	KJ/m	0.21	
Physical Properties		ASTM	UNITS	VALUE
Barcol Hardness	D-495	/	45	
24 Hours Water Absorption	D-570	% max	0.45	
Density	D-792	g/cm	1.72 ~ 1.94	
Coefficient of Thermal Expansion	D-696	10 in/ in/ degrees celcius	8	
Electrical Properties		ASTM	UNITS	VALUE
Arc Resistance LW	D-495	Seconds	120	
Dielectric Strength LW	D-149	Kv/ in	35	
Dielectric Strength CW	D-149	Volts/ mil	200	
Dielectric Strength PF	D-150	@ 60hz	5	
Polyester & Vinyl Ester Fire-Retardant Structural Profiles				
Flammability Properties		ASTM	UNITS	VALUE
Tunnel Test	E-84	Flame Speed	25 Max	
Flammability	D-635	/	Non-Burning	

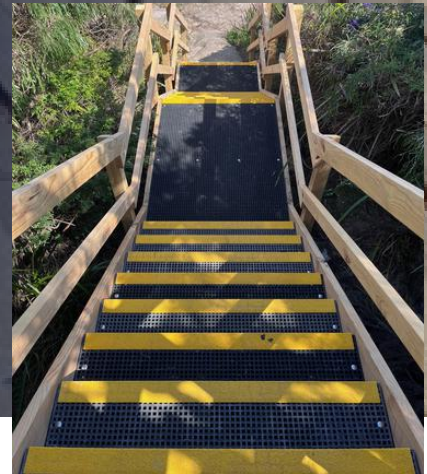
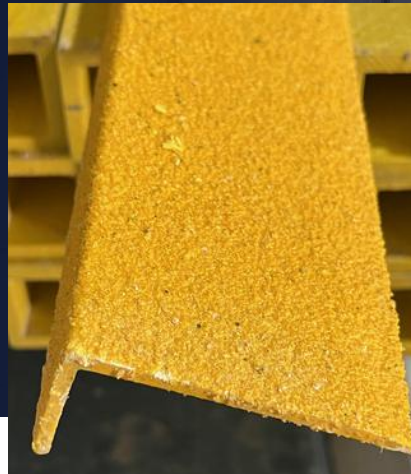
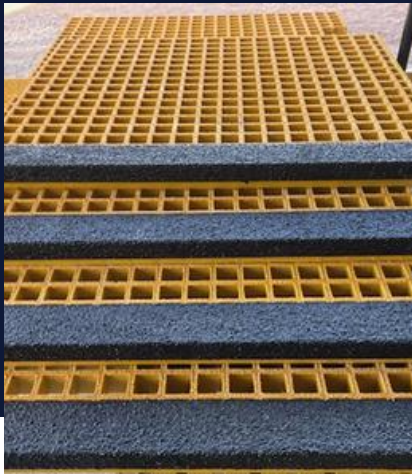

Anti Slip Products

The Anti Slip Products applications include walkways, stairs, ramps, loading zones, platforms and other access areas.

Grating FRP Australia's Anti-Slip Product Series is designed to reduce slip hazards in industrial, commercial and public access environments.

Manufactured from durable FRP grating and profiles, these products can provide targeted slip protection with various surface finishes to aid with traction in wet, oily and high traffic areas.

Moulded Stair Tread Cover

Grating FRP Australia's moulded stair tread covers combine durable grating with optional angle or strip-edge grip nosing for anti-slip performance. They are designed to meet OSHA requirements, featuring a gritted surface and a contrasting colour for clear visibility. Available to suit common mesh patterns (square and mini).

An alternative solution is the moulded stair tread panel, which is manufactured with inlay nosing directly in the mould.

This design includes a special smaller mesh between the regular mesh pattern, allowing for easier cutting to size without the need for additional hand finishing on the edges.

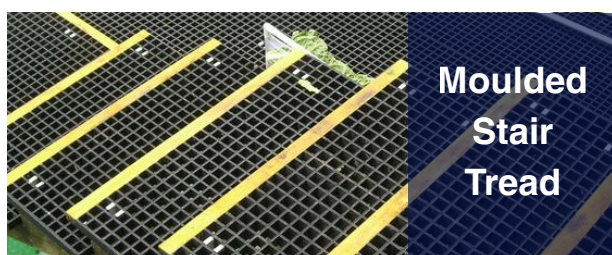

Stair Covers

Grating FRP Australia's Stair Covers are manufactured from moulded FRP panels with a hard-wearing aluminum oxide (A/O) grit finish, delivering superior slip resistance and durability.

The waterproof, UV-stable surface performs reliably in wet, oily, and high-traffic conditions without warping or delaminating.

Quick to install over concrete, timber, or steel, with options for DDA-compliant 55 mm contrasting nosing (yellow or white) and glow-in-the-dark surfaces for improved low-light visibility.



Pultruded Stair Tread Cover

Grating FRP Australia's Pultruded Stair Tread Covers are designed for high-traffic environments. Manufactured by combining pultruded FRP grating panels with a rectangular or square tube nosing, they provide a strong, integrated anti-slip leading edge.

Available in I-bar or T-bar profiles, they offer design consistency across projects and can be matched to surrounding platforms, walkways and access structures to ensure visual and structural cohesion.



**Pultruded
Stair
Tread
Cover**

Dimensions (mm)
55 x 55 x 3.0
65 x 10 x 3.0
70 x 30 x 3.0
100 x 30 x 3.0
150 x 20 x 3.0
152 x 30 x 3.0
200 x 20 x 5.0
230 x 30 x 3.0
230 x 55 x 4.0
250 x 55 x 4.0
280 x 55 x 4.0
305 x 55 x 3.2
345 x 55 x 4.0

Flat Sheet & Strip

Designed for fast installation over existing surfaces such as timber decks, ramps and platforms, they provide immediate slip resistance in wet, oily, or high-traffic conditions.

Flat sheet and strip panels are manufactured from FRP with a durable anti-slip grit surface applied to one side.

Available in multiple grit grades to meet specific safety requirements, they are ideal for walkways, stairs, jetties, platforms and other access areas where additional traction is required.



Flat Sheet & Strip

Grating Edge Ramp

Grating edge ramps are designed to provide a smooth, safe transition between floor levels or surface materials. Manufactured from durable FRP, they aid accessibility for wheelchairs, mobility aids, trolleys, as well as light vehicles.

Standard profiles are 25 mm or 50 mm thick, 122 mm wide, with the sloped section finished in a flat strip for added strength.

Ramps can be customised to meet specific project requirements, ensuring long-term durability and performance.

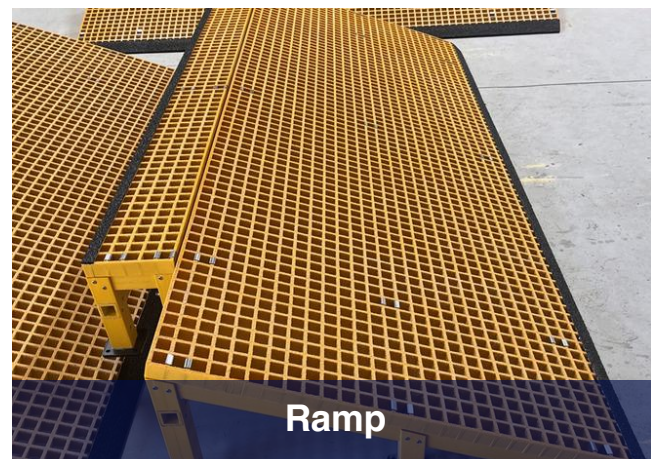

Ramp

Common applications include utility and power stations, industrial access towers, platforms, domestic and commercial jetty system, food processing facilities and agricultural operations.

Grating FRP Australia's fibreglass ladders are engineered for safe, long-term performance in environments where corrosion, moisture and chemical exposure present ongoing challenges. Ladders are manufactured using a precision pultrusion process, and deliver exceptional strength-to-weight ratios, making them ideal for industrial and commercial applications.

With a high fibreglass content and superior structural integrity, they provide a dependable alternative to steel or aluminum in situations requiring low maintenance, fire-retardance and chemical resistance.

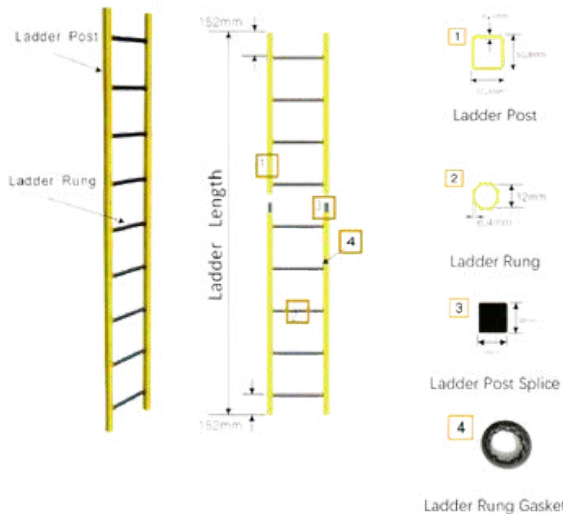

Description	Dimension
Maximum length without splice	7300mm
Ladder Post Splice, Solid Square Bar	38mm x 38mm, 200mm long
Maximum Ladder Length with Cage	10200mm
Outside Width (outside rail to rail)	500mm
Rung Spacing (Centre to Centre)	300mm
Outside Diameter of Rung, Fluted Tube	32mm
Wall Thickness of Rung	6.4mm
Ladder Post Square Tube	50.8 x 50.8 x 6.4mm
Ladder Rung Gasket	Black Rubber
Rivet to Fix Rings to Ladder Post	4 x 20mm

Description	Dimension
Ladder Hoop	76mm wide x 13mm thick, hand lay-up with predrilled holes (with necessary bolt assemblies)
Hoop Bracket	75mm x 140mm, 10mm thick, U Shape, Predrilled Holes (with necessary bolt assemblies)
Cage Strip	C Channel, 50mm x 14mm x 3mm, Made by Pultrusion
Wall Mount Bracket	76mm x 200mm x 9.5mm angle, 457mm Long, Made by Pultrusion
Floor Mount	102mm x 102mm x 9.5mm angle, made by pultrusion. Two per set (with necessary bolt assemblies)
Foot Base Mount (Optional)	Foot Base made by BMC

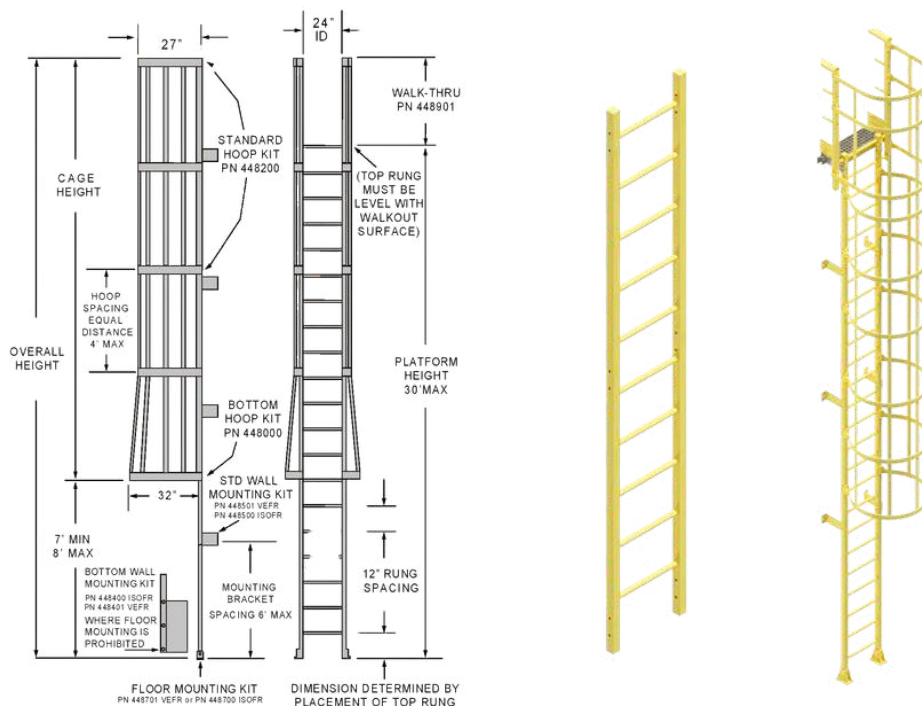



Ideal for marine, offshore, chemical processing, and water treatment facilities, offering a cost-effective upgrade without the need for a full ladder replacement.

Grating FRP Australia's ladder rung covers are manufactured from FRP with a durable anti-slip grit surface, providing improved traction and safety on existing steel or timber ladders.

Designed for quick installation, the product can be bonded directly over existing rungs to deliver long-lasting slip resistance in wet, oily and corrosive environments.

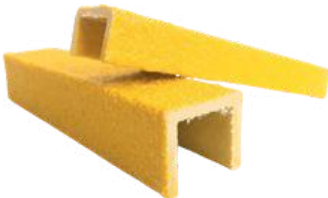

C Shape Ladder Rung	Dimension (mm) D x T
	20 x 3.0mm
	25 x 3.0mm
	30 x 3.0mm
	35 x 3.0mm

U Shape Ladder Rung	Dimension (mm) A x B x C x T
	20 x 20 x 20 x 3.0mm
	25 x 25 x 25 x 3.0mm
	30 x 30 x 30 x 3.0mm
	38 x 38 x 38 x 3.0mm

Description	Dimension
Ladder Hoop	76mm wide x 13mm thick, hand lay-up with predrilled holes (with necessary bolt assemblies)
Hoop Bracket	75mm x 140mm, 10mm thick, U Shape, Predrilled Holes (with necessary bolt assemblies)
Cage Strip	C Channel, 50mm x 14mm x 3mm, Made by Pultrusion
Wall Mount Bracket	76mm x 200mm x 9.5mm angle, 457mm Long, Made by Pultrusion
Floor Mount	102mm x 102mm x 9.5mm angle, made by pultrusion. Two per set (with necessary bolt assemblies)
Foot Base Mount (Optional)	Foot Base made by BMC
Ladder Hoop	76mm wide x 13mm thick, hand lay-up with predrilled holes (with necessary bolt assemblies)
Hoop Bracket	75mm x 140mm, 10mm thick, U Shape, Predrilled Holes (with necessary bolt assemblies)
Cage Strip	C Channel, 50mm x 14mm x 3mm, Made by Pultrusion
Wall Mount Bracket	76mm x 200mm x 9.5mm angle, 457mm Long, Made by Pultrusion

Handrails

With inherent fire-retardant and chemical resistant properties, FRP handrails are well suited to applications such as water treatment facilities, seaside walkways, industrial platforms and offshore structures.

Grating FRP Australia's FRP handrails are manufactured from high-strength pultruded structural profiles, providing a lightweight, durable, and corrosion-resistant safety solution.

Designed for ease of installation and long-term performance, the handrails provide reliable protection in wet, corrosive and chemically exposed environments.



Description	Dimension
Distance Between Posts	1500mm as a maximum
Height of Handrail	1220mm as a maximum
Top Rail, Square Tube	50 x 50 x 6.4mm
Middle Rail, Square Tube	50 x 50 x 6.4mm
Insert Splice, Square Tube	38 x 38 x 6.4mm
Kick Plate	100 x 14 x 3mm
Kick Plate Splice, Plate	45mm wide x 101mm long x 6mm thick
90 Degree Kick Plate Splice, Angle	54 x 29 x 6.4mm
90 Degree Handrail Fitting	3 pieces of 152 x 152 x 13mm FRP Angle, 38mm long
Adjustable Handrail Fitting Plastic	39 degrees to 180 degrees
Rivet Connection	4 x 20mm

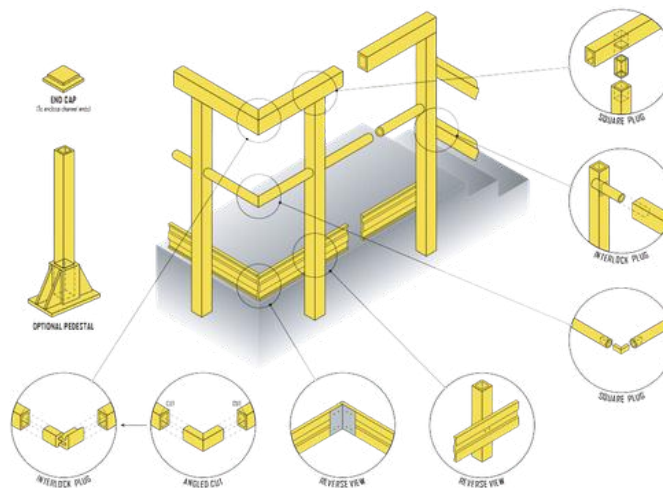

Description	Dimension
Distance Between Post	1500mm as a maximum
Height of Handrail	1220mm as a maximum
Handrail Post, Round Tube	50 x 5mm
Handrail Top Rail, Round Tube	50 x 5mm
Handrail Middle Rail, Round Tube	50 x 5mm
Kick Plate	101 x 14 x 3mm
Kick Plate Splice	45mm wide x 10mm long x 6mm thick
Elbow, BMC	-
Tee, BMC	-
Cross, BMC	-
Foot Base, BMC	-
Screws, M5 x 55	2 for Elbow, 2 for Tee, 3 for Cross
Anchor Bolt, M6 x 90	2 Bolts for Foot Base

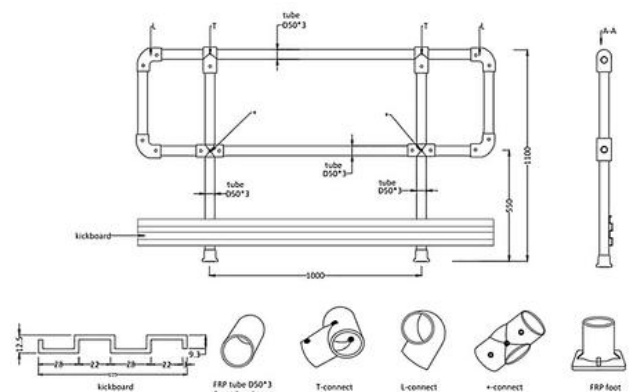



Pultruded / Moltruded Clip

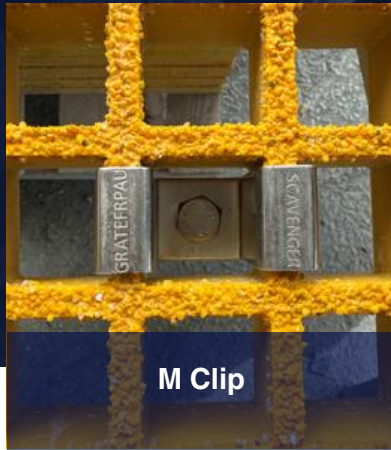

M Clip

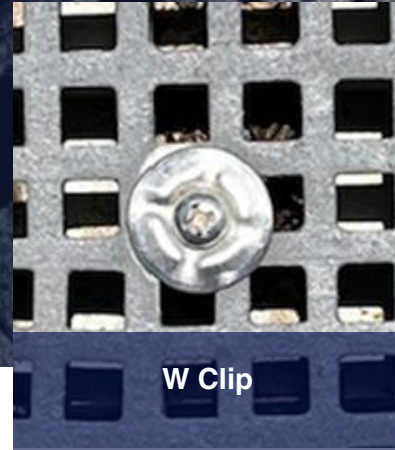

W Clip

Grating clips are available in multiple configurations to suit various grating types and surface profiles suited for industrial, marine and commercial projects.

Grating FRP Australia's grating clips provide a quick, secure and low-maintenance method for fastening FRP grating panels or cover plates to their supporting structures.

Manufactured from stainless steel, these clips offer corrosion resistance, ensuring long-term reliability in wet or coastal environments.

Grating Clips are available in multiple configurations to suit various grating types and surface profiles.

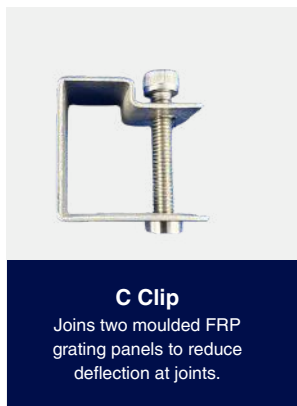

C Clip

Joins two moulded FRP grating panels to reduce deflection at joints.



L Clip

Light-duty clip securing one FRP grating load bar to base support.

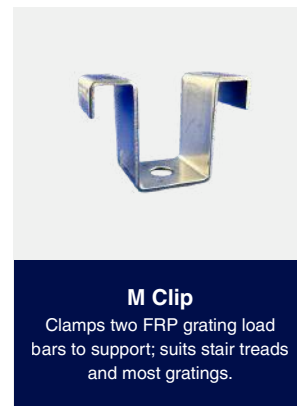

M Clip

Clamps two FRP grating load bars to support; suits stair treads and most gratings.

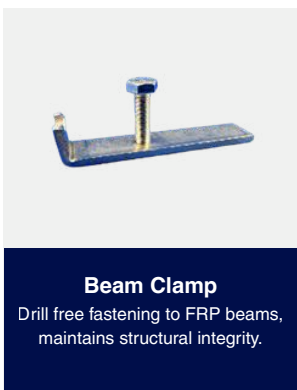

Beam Clamp

Drill free fastening to FRP beams, maintains structural integrity.

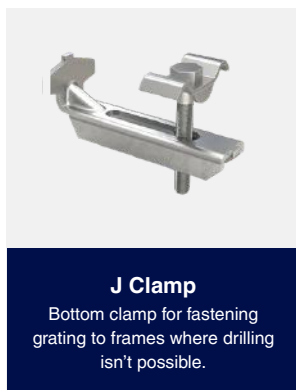

J Clamp



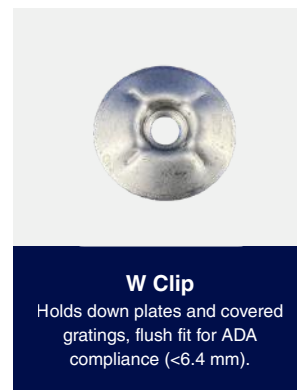



Bottom clamp for fastening grating to frames where drilling isn't possible.



W Clip





Holds down plates and covered gratings, flush fit for ADA compliance (<6.4 mm).

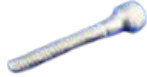

Our Most Common Use Clips & Accessories

	Beam Clamp	Beam Clamp M8 Threaded Hole SS316 c/w Bolt M8	100 x 20 x 5	All Mesh Types
	C251919	C-Clip SS316 Complete with Bolt	32L x 12W x 30H	Suitable for 25Tx19x19 Mini Mesh
	C253838	C-Clip SS316 Complete with Bolt	38L x 25W x 29H	Suitable for 25Tx38x38 Square Mesh
	C303838	C-Clip SS316 Complete with Bolt	39L x 25W x 32H	Suitable for 30Tx38x38 Square Mesh
	C383838	C-Clip SS316 Complete with Bolt	*Lx*Wx*H	Suitable for 38Tx38x38 Square Mesh
	M133838	M Clip SS316 - Clip Only	50L x 25W x 10H	Suitable for 13Tx38x38 Square Mesh
	M171919	M Clip SS316 - Clip Only	35L x 12W x 6H	Suitable for 25Tx19x19 Mini Mesh

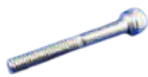
	M251919	M Clip SS316 - Clip Only	35L x 12W x 25H	Suitable for 25Tx19x19 Mini Mesh
	M381919	M Clip SS316 - Clip Only	35L x 12W x 35H	Suitable for 38Tx19x19 Mini Mesh
	M253838	M Clip SS316 - Clip Only	52L x 25W x 21H	Suitable for 25Tx38x38 Square Mesh
	M382626	M Clip SS316 - Clip Only	40L x 15W x 25H	Suitable for 38Tx26x26 Square Mesh
	M383838	M Clip SS316 - Clip Only	52L x 25W x 35H	Suitable for 38Tx38x38 Square Mesh
	M503838	M Clip SS316 - Clip Only	55L x 20W x 40H	Suitable for 50Tx38x38 Square Mesh
	M505050	M Clip SS316 - Clip Only	63L x 30W x 45H	Suitable for 50Tx50x50 Square Mesh



	L253838	L Clip SS316 - Clip Only	28L x 25W x 25H	Suitable for 25Tx38x38 Square Mesh
	530MG316SCS	Socket Cap Screw SS316 Bolt Only	M5 x 30mm	Suitable for M171919, M251919 and M381919 Clips
	550MG316SCS	Socket Cap Screw SS316 Bolt Only	M5 x 50mm	Suitable for M171919, M251919 and M381919 Clips
	560MG316SCS	Socket Cap Screw SS316 Bolt Only	M5 x 60mm	Suitable for M171919, M251919 and M381919 Clips
	M6x35KH	Knurled Socket Head SS316 Bolt Only	M6 x 35mm	Suitable for C251919 and C253838 Clip
	M6x45KH	Knurled Socket Head SS316 Bolt Only	M6 x 45mm	Suitable for C381919 and C383838 Clip

	830MG316SS	Set Screw SS316 Bolt Only	Set Screw SS316 Bolt Only	Suitable for 38x38 Square Mesh
	SQUARE453838	Square Clip SS316 - Clip Only	45L x 45W x 9H	Suitable for 38x38 Square Mesh
	W30x6.5Ø	30mmx6.5mm Aperture SS316	N/A	Suitable for 19x19 and 13x13 Square Mesh
	W45x8Ø	45mmx8mm Aperture SS316	N/A	Suitable for 38x38 Square Mesh
	SD75+BOLT	Storm Disk Complete with Bolt SS316	75mm diameter (M8x70mm Countersunk)	Suitable for 19x19, 38x38 and 50x50 Square Mesh
	Fold Down Handle	Fold Down Handle with Backing Plate & Screws SS316	140 x 100mm	Typically Used with Solid Top

Moulded Grating Load Tables



The following load tables provide deflection and allowable load data for Pultruded FRP grating under static load conditions at ambient temperature. Values are derived from testing in accordance with the ANSI Standard: FRP Composites Grating Manual for Pultruded and Moulded Grating and Stair Treads.

Deflection is in mm.

Walking loads, typically 65-80kg maximum are recommended for pedestrian traffic. Deflections for worker comfort are typically limited to the lesser of 10mm or **Clear Span** divided by 125; for a firmer feel, limit deflection to the lesser of 6.4mm or **Clear Span** divided by 200.

The allowable Loads in this table are for **Static Load Conditions** at ambient temperatures only. Allowable loads for impact or dynamic conditions should be a maximum of **One-Half** the values shown. Long term loads will result in added deflection due to the creep in the material and will also require higher safety factors to ensure acceptable performance. For applications at elevated temperatures, please consult with Grating FRP Australia. The design is further referenced to the ASCE Structural Plastics Design Manual.

Temperature Considerations: For applications at elevated temperatures, consult the manufacturer for adjusted load ratings.

All Gratings were tested in accordance with ANSI Standard; FRP Composites Grating Manual for Pultruded and Moulded Grating and Stair Treads.

These tables serve as a guide to assist designers and engineers in selecting the correct grating profile for their specific span, load and deflection requirements.



Concentrated Line Load

38 x 38mm mesh

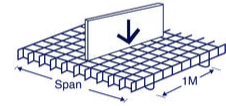

Span (mm)	Height (mm)	Load kg/m of width							Max Load (kg/m)
		75	150	300	450	600	750	1500	
300	20	0.25	0.53	1.12	1.71	2.38	2.86	/	4,470
	25	<0.25	0.42	0.88	1.45	2.27	2.62	/	5,970
	30	<0.25	0.28	0.52	0.78	1.17	1.54	3.12	9,924
	38	/	<0.25	0.29	0.51	0.66	0.77	1.57	17,120
	50	/	/	/	0.35	0.49	0.65	1.34	25,328
450	20	0.76	0.62	3.34	5.02	/	/	/	2,980
	25	0.56	1.15	2.16	3.08	4.16	4.76	/	3,910
	30	0.28	0.51	1.13	1.53	2.09	2.63	/	4,828
	38	<0.25	0.47	0.91	1.36	1.86	2.33	4.81	12,980
	50	/	<0.25	0.45	0.67	0.89	1.14	2.35	19,445
600	20	1.79	3.61	7.36	/	/	/	/	2,235
	25	0.87	1.71	3.51	5.2	6.72	/	/	2,924
	30	0.53	1.29	2.31	3.62	4.82	5.96	/	4,089
	38	0.36	0.65	1.25	1.35	2.47	3.08	6.36	8,720
	50	<0.25	0.31	0.63	0.92	1.2	1.49	3.01	13,391
750	20	2.79	5.6	11.4	/	/	/	/	1,788
	25	1.36	4.47	9.37	/	/	/	/	2,287
	30	1.27	2.61	4.91	7.44	11.06	/	/	3,175
	38	0.63	1.14	2.17	3.24	4.36	5.45	11.94	7,270
	50	0.35	0.71	1.38	2.11	2.81	3.49	7.03	11,331
900	20	5.33	10.81	/	/	/	/	/	1,490
	25	2.91	5.92	12.12	/	/	/	/	1,948
	30	1.79	3.91	7.76	11.51	/	/	/	2,641
	38	0.87	1.81	3.68	5.56	7.42	9.31	/	5,817
	50	0.47	0.97	1.89	2.87	3.82	4.74	9.51	9,266
1200	20	14.77	/	/	/	/	/	/	/
	25	5.72	11.64	/	/	/	/	/	1,431
	30	3.61	7.91	14.37	/	/	/	/	1,286
	38	2.26	4.75	9.68	14.63	/	/	/	3,755
	50	1.08	2.18	4.42	6.62	8.79	11.02	22.15	6,366

Moulded Grating Load Tables

Uniform Load

38 x 38mm mesh

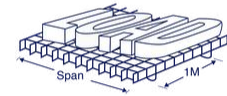

Span (mm)	Height (mm)	Load kg/m ²							Max Load (kg/m ²)
		150	350	500	750	1000	1500	2500	
300	20	<0.25	<0.25	0.25	0.51	0.76	1.02	1.53	25,300
	25	<0.25	<0.25	<0.25	<0.25	0.26	0.31	0.64	31,625
	30	<0.25	<0.25	<0.25	<0.25	<0.25	0.26	0.53	33,000
	38	<0.25	<0.25	<0.25	<0.25	<0.25	<0.25	0.42	41,800
	50	/	/	/	/	/	/	/	
450	20	0.38	1.02	1.53	2.29	3.05	4.58	7.62	16,608
	25	0.30	0.38	0.62	0.94	1.22	1.85	2.75	20,759
	30	0.25	0.32	0.52	0.78	1.02	1.54	2.29	21,662
	38	0.20	0.25	0.41	0.62	0.81	1.22	1.81	27,439
	50	/	/	0.41	0.61	0.82	1.22	2.03	60,654
600	20	1.23	3.08	4.57	7.12	9.41	/	/	9,951
	25	0.98	1.24	1.85	2.75	3.35	5.18	8.86	12,439
	30	0.82	1.03	1.54	2.29	2.79	4.32	7.38	12,980
	38	0.65	0.81	1.22	1.81	2.20	5.64	14.10	16,441
	50	0.33	0.41	0.62	0.92	1.12	2.86	7.14	36,344
750	20	1.61	5.84	8.89	/	/	/	/	6,360
	25	1.28	3.05	4.57	6.86	9.15	/	/	7,950
	30	1.07	2.54	3.81	5.72	7.62	11.69	/	8,296
	38	0.48	2.01	3.01	4.51	/	/	/	10,508
	50	0.43	1.02	1.52	2.29	4.75	7.13	/	23,229
900	20	3.21	8.91	12.03	/	/	/	/	4,414
	25	2.57	7.13	9.62	/	/	/	/	5,518
	30	2.14	4.58	7.11	10.67	/	/	/	5,758
	38	1.69	3.62	5.61	8.42	/	/	/	7,293
	50	0.68	1.83	2.84	4.27	6.41	9.62	/	16,122
1200	20	8.87	12.37	/	/	/	/	/	2,262
	25	7.10	9.90	12.46	/	/	/	/	2,827
	30	5.91	8.25	11.78	/	/	/	/	3,392
	38	4.67	6.51	9.30	13.95	/	/	/	4,297
	50	2.37	3.30	4.71	7.07	9.43	14.15	/	9,499



Concentrated Point Load

38 x 38mm mesh

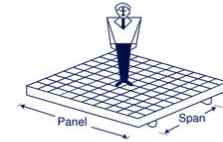

Span (mm)	Height (mm)	Load k/g							
		150	350	500	750	1000	1500	2500	3000
300	20	/	0.55	0.74	1.29	1.72	2.23	3.53	4.36
	25	/	0.44	0.59	1.03	1.37	1.78	2.82	3.49
	30	/	0.37	0.49	0.86	1.14	1.48	2.35	2.91
	38	/	0.29	0.39	0.68	0.90	1.17	1.86	2.29
	50	/	/	/	/	/	/	/	/
450	20	0.33	0.83	1.11	1.94	2.58	3.34	5.29	6.54
	25	0.26	0.66	0.89	1.55	2.06	2.67	4.23	5.23
	30	/	0.55	0.74	1.29	1.72	2.23	3.53	4.36
	38	/	0.43	0.59	1.02	1.36	1.76	2.78	3.44
	50	/	/	/	0.37	0.49	0.64	1.01	1.25
600	20	0.93	1.94	2.53	3.98	5.65	7.65	/	/
	25	0.74	1.55	2.02	3.18	4.52	6.12	/	/
	30	0.62	1.29	1.68	2.65	3.77	5.10	8.37	/
	38	0.49	1.02	1.33	2.09	2.97	4.03	6.71	/
	50	/	0.37	0.48	0.76	1.08	1.46	2.43	2.92
750	20	1.58	3.68	4.73	7.49	10.99	/	/	/
	25	1.26	2.94	3.78	5.99	8.79	/	/	/
	30	1.05	2.45	3.15	4.99	7.33	/	/	/
	38	0.83	1.93	2.49	3.94	5.78	7.84	/	/
	50	0.30	0.70	0.90	1.43	2.09	2.84	4.73	5.68
900	20	2.23	5.40	6.91	11.01	16.33	/	/	/
	25	1.78	4.32	5.53	8.81	13.06	/	/	/
	30	1.48	3.60	4.61	7.34	10.88	/	/	/
	38	1.17	2.84	3.64	5.80	8.59	11.65	/	/
	50	0.42	1.03	1.32	2.10	3.11	4.22	7.03	8.44
1200	20	3.69	9.28	12.98	/	/	/	/	/
	25	2.95	7.42	10.38	15.06	/	/	/	/
	30	2.46	6.18	8.65	12.55	/	/	/	/
	38	1.94	4.88	6.83	9.91	14.56	/	/	/
	50	0.70	1.77	2.47	3.59	5.27	7.16	11.39	/

Moulded Grating Load Tables



Concentrated Line Load

40 x 40mm mesh

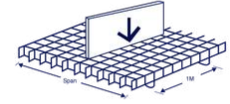

Span (mm)	Height (mm)	Load kg/m of width							Max Load (kg/m)
		75	150	300	450	600	750	1500	
300	25	<0.25	0.44	0.89	1.44	2.28	2.61	/	5,687
	30	<0.25	0.29	0.54	0.81	1.29	1.68	3.42	9,724
	40	/	<0.25	0.3	0.52	0.67	0.78	1.58	17,010
450	25	0.57	1.17	2.14	3.12	4.16	4.79	/	3,878
	30	0.3	0.53	1.07	1.63	2.13	2.82	5.81	4,733
	40	<0.25	0.48	0.92	1.37	1.87	2.35	4.84	12,680
600	25	0.86	1.73	3.53	5.19	6.75	/	/	2,864
	30	0.52	1.31	2.33	3.65	4.86	6.03	/	3,898
	40	0.38	0.67	1.28	1.89	2.51	3.38	6.86	8,498
750	25	1.34	4.49	9.41	/	/	/	/	2,094
	30	1.29	2.63	4.91	7.47	11.36	/	/	2,871
	40	0.65	1.18	2.23	3.36	4.24	5.49	/	6,970
900	25	2.94	5.95	12.25	/	/	/	12.07	1,784
	30	1.89	3.95	7.83	11.73	/	/	/	2,442
	40	0.91	1.84	3.75	5.69	7.57	9.71	/	5,537
1200	25	5.81	11.96	/	/	/	/	/	1,358
	30	3.63	7.96	14.67	/	/	/	/	1,235
	40	2.35	5.02	9.87	15.01	/	/	/	3,455

Uniform Load

40 x 40mm mesh

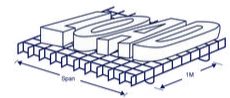

Span (mm)	Height (mm)	Load kg/m ²							Max Load (kg/m ²)
		150	350	500	750	1000	1500	2500	
300	25	<0.25	<0.25	<0.25	<0.25	0.27	0.33	0.67	30,044
	30	<0.25	<0.25	<0.25	<0.25	<0.25	0.27	0.56	31,350
	40	<0.25	<0.25	<0.25	<0.25	<0.25	<0.25	0.42	39,710
450	25	0.32	0.40	0.66	0.99	1.29	1.95	2.89	19,721
	30	0.26	0.34	0.55	0.82	1.07	1.62	2.41	20,579
	40	0.20	0.25	0.41	0.62	0.81	1.22	1.81	26,067
600	25	1.04	1.30	1.95	2.89	3.52	5.46	9.32	11,817
	30	0.86	1.08	1.62	2.41	2.94	4.55	7.77	12,331
	40	0.65	0.81	1.22	1.81	2.20	6.43	/	15,619
750	25	1.35	3.21	4.81	7.22	9.63	/	/	7,553
	30	1.13	2.67	4.01	6.02	8.02	12.31	/	7,881
	40	0.84	2.01	3.01	4.51	8.91	/	/	9,983
900	25	2.70	7.51	10.13	/	/	/	/	5,242
	30	2.25	4.82	7.48	11.23	/	/	/	5,470
	40	1.69	3.62	5.61	8.42	11.18	/	/	6,929
1200	25	7.74	10.42	14.88	/	/	/	/	2,686
	30	6.22	8.68	12.40	/	/	/	/	5,470
	40	1.69	3.62	5.61	8.32	11.18	/	/	6,929



Concentrated Point Load

40 x 40mm mesh

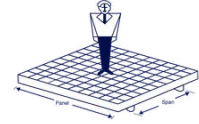

Span (mm)	Height (mm)	Load kg							
		150	350	500	750	1000	1500	2500	3000
300	25	/	0.46	0.62	1.08	1.44	1.87	2.96	3.66
	30	/	0.35	0.47	0.82	1.08	1.41	2.23	2.75
	40	/	0.26	0.35	0.61	0.81	1.05	1.67	2.06
450	25	0.27	0.69	0.93	1.63	2.16	2.80	4.44	5.49
	30	0.25	0.58	0.78	1.36	1.81	2.34	3.71	4.59
	40	/	0.43	0.59	1.02	.36	1.76	2.78	3.44
600	25	0.78	1.63	2.12	3.34	4.75	6.43	/	/
	30	0.65	1.36	1.77	2.79	3.96	5.37	8.81	/
	40	0.49	1.02	1.33	2.09	2.97	4.03	6.61	/
750	25	1.32	3.09	3.97	6.29	9.23	/	/	/
	30	1.11	2.58	3.32	5.25	7.71	/	/	/
	40	0.83	1.93	2.49	3.94	5.78	7.82	/	/
900	25	1.87	4.54	5.81	9.25	13.71	/	/	/
	30	1.56	3.79	4.85	7.73	11.46	/	/	/
	40	1.17	2.84	3.64	.80	8.59	/	/	/
1200	25	3.10	7.79	10.90	15.81	/	/	/	/
	30	2.59	6.51	9.11	13.21	/	/	/	/
	40	1.94	4.88	6.83	9.91	13.22	/	/	/

Concentrated Line Load

50 x 50mm mesh

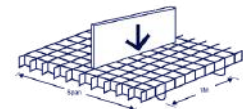

Span (mm)	Height (mm)	Load kg/m of width							Max Load (kg/m)
		75	150	300	450	600	750	1500	
300	25	<0.25	<0.25	0.43	0.62	0.82	0.94	1.93	15,138
	30	0.29	0.32	0.43	0.49	0.65	0.75	1.51	18,922
	40	0.28	0.31	0.41	0.47	0.63	0.72	1.45	22,526
450	25	0.27	0.56	1.03	1.47	2.13	2.89	5.96	11,467
	30	0.32	0.45	0.82	1.17	1.69	2.29	4.72	14,346
	40	0.31	0.42	0.74	0.92	1.22	.21	4.52	17,078
600	25	0.45	0.79	1.48	2.29	2.87	3.54	7.18	7,710
	30	0.36	0.62	1.16	1.81	2.27	2.81	5.65	9,638
	40	0.35	0.58	1.06	.76	2.16	2.56	5.23	11,473
750	25	0.64	1.33	2.37	3.61	4.69	6.08	12.21	6,412
	30	0.51	1.06	1.88	.81	3.71	4.83	9.69	8,040
	40	0.46	0.91	1.58	2.36	3.46	4.57	9.14	9,566
900	25	1.93	2.11	4.23	5.46	6.49	7.73	1.58	5,148
	30	0.74	1.87	3.67	4.63	5.56	6.63	12.86	6,443
	40	1.51	1.67	3.37	4.33	5.16	6.13	12.46	7,780
1200	25	2.09	4.27	8.68	10.92	13.17	/	/	3,421
	30	1.71	3.58	7.12	8.97	11.13	14.06	/	4,276
	40	1.67	3.41	6.94	8.72	10.52	13.32	/	5,843

Moulded Grating Load Tables

Uniform Load

50 x 50mm mesh

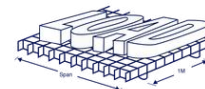

Span (mm)	Height (mm)	Load kg/m ²							Max Load (kg/m ²)
		150	350	500	750	1000	1500	2000	
300	40lt	<0.25	<0.25	<0.25	<0.25	<0.25	<0.25	0.53	31,268
	50lt	<0.25	<0.25	<0.25	<0.25	<0.25	<0.25	0.43	39,085
	50	<0.25	<0.25	<0.25	<0.25	<0.25	<0.25	0.39	53,602
450	40lt	0.25	0.32	0.51	0.77	1.01	1.52	2.26	20,525
	50lt	<0.25	<0.25	0.41	0.62	0.81	1.22	1.81	25,656
	50	<0.25	<0.25	0.30	0.45	0.59	0.89	1.32	35,186
600	40lt	0.81	1.02	1.52	2.26	2.75	8.04	/	12,299
	50lt	0.65	0.81	1.22	1.81	2.20	6.33	/	15,373
	50	0.47	0.59	0.89	1.32	1.61	4.69	6.13	21,083
750	40lt	1.06	2.51	3.76	5.64	11.14	/	/	7,861
	50lt	0.84	2.01	3.01	4.51	8.91	/	/	9,826
	50	0.62	1.46	2.19	3.29	6.50	9.23	/	13,475
900	40lt	2.11	4.52	7.02	10.52	13.98	/	/	5,456
	50lt	1.69	3.62	5.61	8.42	11.18	/	/	6,820
	50	1.23	2.64	4.09	6.14	8.15	/	/	9,353
1200	40lt	2.11	4.52	7.02	10.52	13.98	/	/	5,456
	50lt	4.67	6.51	9.30	12.56	/	/	/	4,018
	50	3.40	4.75	6.78	9.16	12.07	/	/	5,510

Concentrated Point Load

50 x 50mm mesh

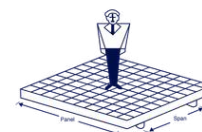

Span (mm)	Height (mm)	Load kg							
		150	350	500	750	1000	1500	2500	3000
300	40lt	/	0.47	0.62	0.97	1.38	1.86	3.06	/
	50lt	/	0.46	0.60	0.95	1.35	1.82	2.99	/
	50	/	0.37	0.48	0.76	1.08	1.47	2.41	2.89
450	40lt	0.38	0.79	1.03	1.61	2.29	3.11	5.10	/
	50lt	0.33	0.69	0.90	1.42	2.02	2.73	4.49	/
	50	0.27	0.56	0.73	1.14	1.63	2.20	3.61	4.34
600	40lt	0.56	1.17	1.52	2.39	3.40	4.60	7.55	/
	50lt	0.49	1.03	1.34	2.10	2.99	4.05	6.65	/
	50	0.39	0.83	1.08	1.69	2.41	3.26	5.35	6.42
750	40lt	0.95	2.21	2.84	4.50	6.61	8.94	/	/
	50lt	0.83	1.95	2.50	3.96	5.82	7.87	/	/
	50	0.67	1.57	2.01	3.19	4.68	6.33	9.87	/
900	40lt	1.34	3.25	4.16	6.62	9.82	/	/	/
	50lt	1.18	2.26	3.66	5.83	8.64	/	/	/
	50	0.95	2.30	2.95	4.69	6.96	10.11	/	/
1200	40lt	2.22	5.58	7.81	11.32	15.11	/	/	/
	50lt	1.95	4.91	6.87	9.97	13.30	/	/	/
	50	1.57	3.95	5.53	8.02	10.71	15.53	/	/



Concentrated Line Load

25 x 100mm mesh

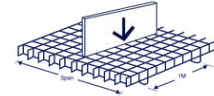

Span (mm)	Height (mm)	Load kg/m of width							Max Load (kg/m)
		75	150	300	450	600	750	1500	
300	25	0.33	0.49	0.74	0.99	1.29	1.52	3.06	9,442
	30	<0.25	0.25	0.63	0.87	1.15	1.44	2.74	10,143
	25HD	<0.25	0.25	0.63	0.86	1.13	1.46	2.76	10,058
	38	<0.25	<0.25	0.56	0.67	0.87	1.04	1.85	13,442
450	25	0.61	1.11	2.11	3.09	4.11	5.15	/	6,878
	30	0.51	.76	1.79	2.57	3.30	4.3	/	7,329
	25HD	0.52	0.77	1.78	2.56	3.31	4.32	/	7,265
	38	0.41	0.73	1.41	2.21	2.74	3.42	4.31	10,454
600	25	0.87	1.73	3.47	5.19	6.92	/	/	4,305
	30	0.74	1.63	3.17	5.04	6.73	/	/	5,903
	25HD	0.76	1.62	3.17	5.02	6.71	/	/	5,775
	38	0.59	1.15	2.31	3.51	4.61	5.35	6.28	6,544
750	25	1.41	2.72	5.12	7.18	9.56	/	/	3,589
	30	1.35	2.22	4.83	6.71	8.89	/	/	4,926
	25HD	1.36	2.24	4.84	6.69	8.96	/	/	4,844
	38	0.94	.81	3.39	5.13	6.32	7.74	/	5,456
900	25	2.42	4.73	8.83	12.42	/	/	/	3,216
	30	2.27	4.15	7.64	9.35	/	/	/	4,289
	25HD	2.29	4.14	7.67	/	/	/	/	4,172
	38	1.61	3.12	5.83	8.21	9.17	10.23	/	4,889
1200	25	4.23	6.29	11.76	16.52	/	/	/	2,431
	30	3.35	5.47	/	/	/	/	/	3,674
	25HD	3.49	5.48	/	/	/	/	/	3,504
	38	2.84	4.15	7.79	11.01	/	/	/	3,967

Moulded Grating Load Tables

Uniform Load

25 x 100mm mesh

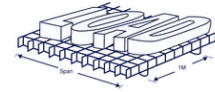

Span (mm)	Height (mm)	Load kg/m ²							Max Load (kg/m ²)
		150	350	500	750	1000	1500	2500	
300	25	/	0.28	0.37	0.51	0.63	0.73	1.04	26,350
	30	/	/	0.31	0.43	0.53	0.61	0.87	31,620
	25HD	/	/	/	0.26	0.53	0.79	1.32	32,940
	38	/	/	/	0.34	0.41	0.48	0.68	40,052
450	25	0.53	0.72	1.36	2.16	2.86	3.54	7.22	15,128
	30	0.44	0.61	1.13	1.80	2.38	2.95	6.02	18,154
	25HD	0.29	0.51	0.76	1.27	1.53	2.29	3.82	18,910
	38	0.35	0.47	0.89	1.42	1.88	2.33	4.75	22,995
600	25	0.73	0.92	1.86	2.46	3.68	5.54	9.22	12,688
	30	0.16	0.77	1.55	2.05	3.07	3.62	7.68	15,226
	25HD	0.89	1.27	2.03	3.30	4.32	6.35	/	15,860
	38	0.48	0.61	1.22	.62	2.42	3.64	6.07	19,286
750	25	1.65	2.86	3.71	5.63	8.32	/	/	10,150
	30	1.38	2.38	3.09	4.69	6.93	/	/	12,180
	25HD	1.87	3.06	4.57	7.12	9.41	/	/	12,688
	38	1.09	1.88	2.44	3.70	5.47	7.87	/	15,428
900	25	2.13	3.64	6.61	9.87	12.57	/	/	7,289
	30	1.78	3.03	5.51	8.23	10.48	/	/	8,747
	25HD	3.87	5.84	8.89	/	/	/	/	9,111
	38	1.40	2.39	4.35	6.49	8.27	12.16	/	11,079
1200	25	5.62	8.37	14.91	/	/	/	/	4,587
	30	4.71	6.98	12.43	/	/	/	/	5,504
	25HD	7.62	12.71	/	/	/	/	/	5,734
	38	3.72	5.51	9.81	13.47	/	/	/	6,972



Concentrated Point Load

25 x 100mm mesh

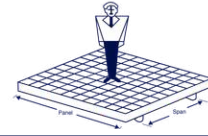

Span (mm)	Height (mm)	Load kg/m ²							
		150	350	500	750	1000	1500	2500	3000
300	25	0.29	0.69	0.99	1.50	2.13	2.89	4.74	/
	30	/	0.58	0.83	1.25	1.78	2.41	3.95	/
	25HD	/	0.52	0.74	1.13	1.60	2.17	3.56	/
	38	/	0.46	0.66	.01	1.43	1.94	3.18	/
450	25	0.47	1.10	1.43	2.25	3.20	4.33	/	/
	30	0.39	0.91	1.19	1.88	2.67	3.61	4.83	/
	25HD	0.35	0.82	1.07	1.69	2.40	3.25	4.39	/
	38	0.32	0.74	0.96	1.51	2.15	2.91	3.89	4.85
600	25	0.69	1.63	2.12	3.34	4.74	6.42	/	/
	30	0.58	1.35	1.77	2.78	3.95	5.35	/	/
	25HD	0.52	1.22	1.59	2.50	3.56	4.81	7.36	/
	38	0.46	1.09	1.42	2.24	3.18	4.31	5.82	/
750	25	1.32	3.08	3.97	6.28	9.22	/	/	/
	30	1.10	2.57	3.30	5.24	7.68	/	/	/
	25HD	0.99	2.31	2.97	4.71	6.92	9.34	/	/
	38	0.89	2.07	2.66	4.22	6.19	8.35	/	/
900	25	1.87	4.53	5.80	9.24	/	/	/	/
	30	1.56	3.78	4.83	7.70	10.27	/	/	/
	25HD	1.40	3.40	4.35	6.93	9.23	/	/	/
	38	1.25	3.04	3.89	6.20	8.27	/	/	/
1200	25	3.09	7.78	10.89	15.80	/	/	/	/
	30	2.58	6.49	9.07	13.17	/	/	/	/
	25HD	2.32	5.84	8.17	11.85	/	/	/	/
	38	2.08	5.22	7.31	10.60	13.25	/	/	/

Moulded Grating Load Tables

Concentrated Line Load

Slot Mesh

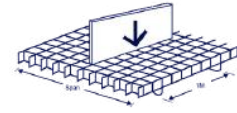

Span (mm)	Type		Load kg/m of width							Max Load (kg/m)
	Height (mm)	Mesh (mm)	75	150	300	450	600	750	1500	
300	38	38 x 100	<0.25	0.25	0.59	0.75	1.02	1.32	2.53	11,882
	38	25 x 125	<0.25	0.33	0.61	0.89	1.16	1.42	2.46	11,796
	38	38 x 152	/	<0.25	0.25	0.52	0.63	.78	1.62	12,628
	50	25 x 50	/	/	/	/	/	<0.25	0.27	69,741
	28	60 x 100	0.39	0.54	1.08	1.38	1.86	2.4	4.62	6,507
	40	60 x 220	0.53	0.89	2.09	2.66	3.61	/	/	3,366
450	38	38 x 100	0.49	0.76	1.67	2.43	3.17	3.96	5.61	9,657
	38	25 x 125	0.33	0.56	0.97	1.32	1.65	1.98	3.35	9,737
	38	38 x 152	<0.25	0.25	0.78	1.12	1.55	1.79	.24	9,946
	50	25 x 50	/	/	/	/	/	0.26	0.54	48,574
	28	60 x 100	1.04	/1.62	3.04	4.43	/	/	/	5,288
	40	60 x 220	0.89	2.69	1.67	3.91	5.19	/	/	2,736
600	38	38 x 100	0.71	1.51	2.86	4.37	5.86	6.21	8.58	6,039
	38	25 x 125	0.54	0.79	1.32	1.81	2.31	2.82	5.11	6,109
	38	38 x 152	0.25	0.78	1.55	2.29	3.05	3.81	5.17	8,253
	50	25 x 50	/	/	0.27	0.39	0.48	0.55	1.29	40,530
	28	60 x 100	1.51	3.21	5.21	7.98	/	/	/	3,307
	40	60 x 220	0.76	4.36	6.13	8.92	/	/	/	1,711
750	38	38 x 100	1.18	2.02	6.62	6.45	7.48	8.68	/	5,176
	38	25 x 125	0.77	1.07	1.96	2.82	3.69	4.57	8.34	5,243
	38	38 x 152	0.76	1.28	2.81	4.07	5.34	6.62	8.68	7,104
	50	25 x 50	/	/	0.51	0.77	1.03	1.28	2.29	32,346
	28	60 x 100	2.5	4.29	7.82	/	/	/	/	2,834
	40	60 x 220	3.38	6.08	9.19	/	/	/	/	1,466
900	38	38 x 100	2.02	3.67	6.94	9.23	11.17	/	/	4,429
	38	25 x 125	1.09	2.08	2.91	4.63	5.56	6.48	12.09	4,435
	38	38 x 152	1.04	2.29	.32	6.61	8.64	10.92	/	6,146
	50	25 x 50	/	/	0.75	1.18	1.63	2.05	4.13	26,969
	28	60 x 100	4.19	6.68	9.22	/	/	/	/	2,452
	40	60 x 220	4.51	7.67	10.23	/	/	/	/	1,255
1200	38	38 x 100	3.55	4.69	9.12	12.06	/	/	/	3,816
	38	25 x 125	2.06	2.95	5.77	.56	/	/	/	3,834
	38	38 x 152	2.28	4.83	9.66	12.87	/	/	/	5,145
	50	25 x 50	/	/	1.46	2.09	2.74	3.35	6.37	23,095
	28	60 x 100	7.52	8.24	11.67	/	/	/	/	2,090
	40	60 x 220	6.55	11.69	/	/	/	/	/	1,081



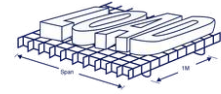

Uniform Load

Slot Mesh

Span (mm)	Type		Load kg/m ²							Max Load (kg/m ²)
	Height (mm)	Mesh (mm)	150	350	500	750	1000	1500	2500	
300	38	38 x 100	/	/	0.34	0.50	0.62	0.72	1.03	26,701
	38	25 x 125	/	/	0.37	0.53	0.65	0.76	1.08	25,366
	38	38 x 152	/	0.37	0.56	0.79	0.98	1.14	1.62	16,911
	50	25 x 50	/	/	/	/	/	/	/	456,768
	28	60 x 100	0.28	0.59	0.78	1.08	1.33	1.54	2.19	11,456
	40	60 x 220	0.36	0.84	1.26	1.81	2.23	2.59	3.68	7,439
450	38	38 x 100	0.52	0.71	1.34	2.13	2.82	3.49	7.13	15,330
	38	25 x 125	0.55	0.75	1.41	2.24	2.97	3.68	7.5	14,563
	38	38 x 152	0.83	1.12	2.12	3.37	4.46	5.52	1.25	9,709
	50	25 x 50	/	/	/	/	/	/	/	212,280
	28	60 x 100	1.12	1.52	2.87	4.56	/	/	/	6,577
	40	60 x 220	1.88	2.55	4.82	7.65	/	/	/	4,271
600	38	38 x 100	0.72	0.91	1.84	2.43	3.63	5.47	9.10	12,857
	38	25 x 125	0.76	0.96	1.93	2.56	3.82	7.75	9.58	12,214
	38	38 x 152	1.14	1.43	2.90	3.83	5.73	8.63	/	8,143
	50	25 x 50	/	/	0.31	0.51	0.62	0.77	0.95	132,736
	28	60 x 100	1.54	1.94	3.92	5.19	7.76	/	/	5,516
	40	60 x 220	2.59	3.26	6.59	/	/	/	/	3,582
750	38	38 x 100	1.63	2.82	3.66	5.56	8.21	11.81	/	10,285
	38	25 x 125	1.71	2.97	3.85	8.85	8.64	12.43	/	9,771
	38	38 x 152	2.57	4.46	5.78	8.77	/	/	/	6,514
	50	25 x 50	/	0.74	1.02	1.53	1.63	1.78	2.02	84,912
	28	60 x 100	3.48	6.03	7.82	/	/	/	/	4,413
	40	60 x 220	5.84	10.13	/	/	/	/	/	2,865
900	38	38 x 100	2.10	3.59	6.52	9.74	12.40	/	/	7,386
	38	25 x 125	2.21	3.78	6.87	10.25	13.06	/	/	7,017
	38	38 x 152	3.32	5.67	10.30	/	/	/	/	4,678
	50	25 x 50	0.76	1.52	2.28	3.06	3.63	3.81	4.17	42,944
	28	60 x 100	4.49	7.68	13.94	/	/	/	/	3,169
	40	60 x 220	7.54	12.89	/	/	/	/	/	2,058
1200	38	38 x 100	5.58	8.26	14.71	/	/	/	/	4,678
	38	25 x 125	5.87	8.69	15.49	/	/	/	/	4,416
	38	38 x 152	8.80	13.04	/	/	/	/	/	2,944
	50	25 x 50	2.79	3.02	4.86	5.61	6.34	7.13	8.12	32,912
	28	60 x 100	11.92	17.65	/	/	/	/	/	1,994
	40	60 x 220	/	/	/	/	/	/	/	1,295

Moulded Grating Load Tables

Concentrated Point Load

Slot Mesh

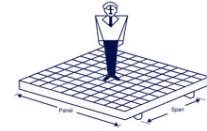

Span (mm)	Type		Load kg							
	Height (mm)	Mesh (mm)	150	350	500	750	1000	1500	2500	3000
300	38	38 x 100	0.27	0.68	0.98	1.48	2.10	2.85	4.68	/
	38	25 x 125	0.28	0.66	.95	1.44	2.04	2.76	4.53	/
	38	38 x 152	0.38	0.97	1.39	2.11	3.00	4.06	/	/
	50	25 x 50	/	/	/	0.38	0.54	0.73	1.20	1.45
	28	60 x 100	0.57	1.43	2.05	3.08	/	/	/	/
	40	60 x 220	0.87	2.20	3.16	/	/	/	/	/
450	38	38 x 100	0.46	1.08	1.41	2.22	3.16	4.27	/	/
	38	25 x 125	0.45	1.05	1.37	2.15	3.06	4.14	5.54	/
	38	38 x 152	0.66	1.54	2.01	3.17	4.50	/	/	/
	50	25 x 50	/	0.28	0.36	0.57	0.81	1.10	1.81	2.17
	28	60 x 100	0.98	2.28	2.97	4.34	/	/	/	/
	40	60 x 220	1.50	3.51	4.57	/	/	/	/	/
600	38	38 x 100	0.68	1.60	2.09	3.29	4.68	6.33	/	/
	38	25 x 125	0.66	1.55	2.03	3.19	4.53	6.14	/	/
	38	38 x 152	0.97	2.29	2.98	4.69	6.67	/	/	/
	50	25 x 50	/	0.41	0.54	0.85	1.20	1.63	2.68	3.21
	28	60 x 100	1.43	3.37	4.40	5.52	/	/	/	/
	40	60 x 220	2.20	5.20	6.77	/	/	/	/	/
750	38	38 x 100	1.30	3.04	3.91	6.20	9.10	/	/	/
	38	25 x 125	1.26	2.95	3.79	6.01	8.82	/	/	/
	38	38 x 152	1.86	4.34	5.57	8.83	/	/	/	/
	50	25 x 50	0.34	0.78	1.01	1.60	2.34	3.17	4.94	5.93
	28	60 x 100	2.74	6.40	7.69	/	/	/	/	/
	40	60 x 220	4.22	9.86	/	/	/	/	/	/
900	38	38 x 100	1.84	4.47	5.72	9.12	/	/	/	/
	38	25 x 125	1.79	4.33	5.55	8.84	11.78	/	/	/
	38	38 x 152	2.62	6.37	8.15	/	/	/	/	/
	50	25 x 50	0.47	1.15	1.47	2.35	3.48	5.06	6.83	8.21
	28	60 x 100	3.87	9.40	/	/	/	/	/	/
	40	60 x 220	5.97	14.48	/	/	/	/	/	/
1200	38	38 x 100	3.05	7.78	10.74	15.58	/	/	/	/
	38	25 x 125	2.96	7.44	10.41	15.11	/	/	/	/
	38	38 x 152	4.35	10.94	15.31	/	/	/	/	/
	50	25 x 50	0.79	1.98	2.77	4.01	5.35	7.77	10.49	12.59
	28	60 x 100	6.42	16.15	/	/	/	/	/	/
	40	60 x 220	9.89	24.87	/	/	/	/	/	/



Concentrated Line Load

Mini Mesh/ Micro Mesh

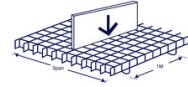

Span (mm)	Type		Load kg/m of width							Max Load (kg/m)
	Height (mm)	Mesh (mm)	75	150	300	450	600	750	1500	
300	25	19 x 19/ 38 x 38	<0.25	0.26	0.47	0.71	1.05	1.41	2.95	10,916
	38		<0.25	<0.25	0.36	0.45	0.58	0.69	1.41	19,373
	30	20 x 20/ 40 x 40	<0.25	0.26	0.49	0.74	1.26	1.57	3.13	10,696
	40		/	/	0.26	0.49	0.61	0.71	1.44	18,711
	38		26 x 26/ 52 x 52	<0.25	<0.25	0.38	0.56	0.73	0.85	1.73
	50	25 x 25/ 50 x 50	/	<0.25	0.28	0.43	0.58	0.66	1.33	23,877
	40	13 x 13/ 40 x 40	<0.25	<0.25	0.32	0.48	0.82	1.02	2.03	14,481
450	25	19 x 19/ 38 x 38	0.27	0.47	0.94	1.39	1.93	2.41	5.02	5,311
	38		<0.25	0.42	0.82	1.21	1.65	2.08	4.24	14,688
	30	20 x 20/ 40 x 40	0.26	0.48	0.96	1.46	1.91	2.49	5.12	5,206
	40		/	0.43	0.83	1.24	1.68	2.13	4.36	13,631
	38		26 x 26/ 52 x 52	<0.25	0.51	0.93	1.34	1.92	2.60	5.34
	50	25 x 25/ 50 x 50	<0.25	0.39	0.69	0.85	1.12	2.04	4.26	18,103
	40	13 x 13/ 40x40	<0.25	0.35	0.70	1.06	1.39	1.81	3.73	7,048
600	25	19 x 19/ 38 x 38	0.49	1.2	2.16	3.34	4.39	5.45	/	4,498
	38		0.32	0.58	1.12	1.69	2.27	2.84	5.76	9867
	30	20 x 20/ 40 x 40	0.47	1.17	2.07	3.22	4.29	5.33	9.41	4,289
	40		0.34	0.61	1.16	1.71	2.26	3.06	6.21	9,135
	38		26 x 26/ 52 x 52	.41	0.72	1.32	2.05	2.57	3.18	6.43
	50	25 x 25/ 50 x 50	0.32	.53	0.98	1.62	2.02	2.38	4.93	12,161
	40	13 x 13/ 40 x 40	0.34	0.85	1.51	2.34	3.12	3.88	6.85	5,807
750	25	19 x 19/ 38 x 38	1.2	2.45	4.52	6.81	10.06	/	/	3,493
	38		0.56	1.02	1.94	2.98	3.88	5.02	10.87	8,227
	30	20 x 20/ 40 x 40	1.14	2.31	4.34	6.58	9.99	/	/	3,158
	40		0.59	1.07	2.11	3.05	3.83	4.96	10.83	7,492
	38		26 x 26/ 52 x 52	0.58	1.21	2.14	3.19	4.21	5.47	10.96
	50	25 x 25/ 50 x 50	0.42	0.84	1.45	2.15	3.17	4.21	8.48	10,131
	40	13 x 13/ 40x40	.83	1.68	3.16	4.79	7.27	/	/	4,275
900	25	19 x 19/ 38x 38	1.68	3.63	7.09	10.54	/	/	/	2,907
	38		0.77	1.59	3.31	5.16	6.75	8.29	14.58	6,568
	30	20 x 20/ 40 x 40	1.66	3.48	6.89	10.32	/	/	/	2,686
	40		0.83	1.63	3.31	5.12	6.82	8.74	/	6,093
	38		26 x 26/ 52 x 52	0.84	1.89	3.82	4.89	5.83	6.95	14.08
	50	25 x 25/ 50 x 50	0.47	1.54	3.13	4.01	4.84	5.71	11.64	8,246
	40	13 x 13/ 40x40	1.21	2.53	5.02	7.51	8.64	/	/	3,636
1200	25	19 x 19/ 38x 38	3.31	7.21	13.06	/	/	/	/	1,424
	38		2.11	.23	8.81	13.31	/	/	/	4,249
	30	20 x 20/ 40 x 40	3.21	7.01	12.93	/	/	/	/	1,362
	40		2.12	4.52	8.89	13.51	/	/	/	3,801
	38		26 x 26/ 52 x 52	1.89	3.87	7.84	9.87	11.92	/	/
	50	25 x 25/ 50 x 50	1.54	3.14	6.39	8.03	9.68	12.21	/	6,289
	40	13 x 13/ 40x40	2.34	5.10	9.41	12.71	/	/	/	/

Moulded Grating Load Tables

Uniform Load

Mini Mesh/ Micro Mesh

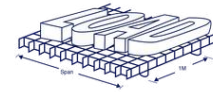

Span (mm)	Type		Load kg/m ²							Max Load (kg/m ²)
	Height (mm)	Mesh (mm)	150	350	500	750	1000	1500	2500	
300	25	19 x 19/ 38 x 38	<0.25	0.32	0.42	0.63	0.82	1.23	2.05	56,530
	38		<0.25	<0.25	0.28	0.41	0.54	0.81	1.35	85,930
	30	20 x 20/ 40 x 40	<0.25	<0.25	<0.25	<0.25	<0.25	0.25	0.51	34,037
	40		<0.25	<0.25	<0.25	<0.25	<0.25	<0.25	0.38	35,383
	38		26 x 26/ 52 x 52	<0.25	<0.25	<0.25	<0.25	0.28	0.37	0.50
	50	25 x 25/ 50 x 50	<0.25	<0.25	<0.25	<0.25	<0.25	<0.25	0.37	59,818
	40	13 x 13/ 40 x 40	/	/	/	0.31	0.42	0.61	0.97	46,081
450	25	19 x 19/ 38 x 38	<0.25	0.47	0.63	0.94	0.23	1.85	3.08	37,690
	38		<0.25	0.31	0.41	0.62	0.81	1.22	2.03	57,290
	30	20 x 20/ 40 x 40	<0.25	0.31	0.50	0.75	0.98	1.47	2.19	22,343
	40		<0.25	<0.25	0.37	0.56	0.73	1.11	1.64	29,790
	38		26 x 26/ 52 x 52	<0.25	0.28	0.39	0.58	0.76	1.14	1.70
	50	25 x 25/ 50 x 50	<0.25	<0.25	0.28	0.42	0.55	0.84	1.24	37,297
	40	13 x 13/ 40x40	/	/	0.36	0.54	0.71	1.07	1.60	30,249
600	25	19 x 19/ 38 x 38	0.58	1.33	1.92	2.87	3.73	5.59	9.32	16,360
	38		0.38	0.88	1.26	1.89	2.45	3.68	6.13	24,870
	30	20 x 20/ 40 x 40	0.78	0.99	1.47	2.19	2.67	4.13	7.06	13,388
	40		0.59	0.74	1.11	1.64	2.00	3.10	5.30	17,851
	38		26 x 26/ 52 x 52	0.61	0.77	1.14	1.70	2.07	6.05	7.91
	50	25 x 25/ 50 x 50	0.45	0.56	0.84	1.24	1.52	4.42	5.78	22,348
	40	13 x 13/ 40 x 40	0.57	0.72	1.07	1.60	1.94	3.01	5.14	18,125
750	25	19 x 19/ 38 x 38	0.73	1.66	2.40	3.59	4.66	6.99	11.65	10,910
	38		0.48	1.09	1.58	2.36	3.07	4.60	7.66	16,580
	30	20 x 20/ 40 x 40	1.02	2.43	3.65	5.47	7.29	/	/	8,557
	40		0.77	1.82	2.73	4.10	5.47	8.16	/	11,409
	38		26 x 26/ 52 x 52	0.80	1.89	2.83	4.25	8.39	/	/
	50	25 x 25/ 50 x 50	0.58	1.38	2.07	3.10	6.13	8.71	/	14,284
	40	13 x 13/ 40x40	0.75	1.77	2.65	3.98	5.31	7.17	/	11,584
900	25	19 x 19/ 38x 38	2.89	7.01	9.23	/	/	/	/	4,770
	38		1.90	4.61	6.07	9.03	/	/	/	7,250
	30	20 x 20/ 40 x 40	2.05	4.38	6.80	10.21	/	/	/	5,939
	40		1.54	3.29	5.10	7.5	10.08	/	/	7,919
	38		26 x 26/ 52 x 52	1.59	3.40	5.28	7.93	10.52	/	/
	50	25 x 25/ 50 x 50	1.16	2.49	3.86	5.79	7.69	9.46	/	9,914
	40	13 x 13/ 40x40	1.49	3.19	4.95	7.43	8.54	/	/	8,040
1200	25	19 x 19/ 38x 38	3.85	9.35	12.31	/	/	/	/	3,600
	38		2.53	6.15	8.10	12.09	/	/	/	5,470
	30	20 x 20/ 40 x 40	5.66	7.89	11.27	/	/	/	/	3,499
	40		4.24	5.92	8.45	12.37	/	/	/	4,665
	38		26 x 26/ 52 x 52	4.39	6.13	8.75	11.82	/	/	4,268
	50	25 x 25/ 50 x 50	3.21	4.48	6.40	8.64	11.39	/	/	5,841
	40	13 x 13/ 40x40	1.61	4.06	5.68	8.24	9.23	12.45	/	/



Moulded Grating Load Tables

Concentrated Point Load

Mini Mesh/ Micro Mesh

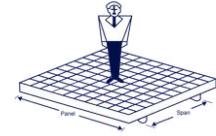

Span (mm)	Type		Load kg								
	Height (mm)	Mesh (mm)	150	350	500	750	1000	1500	2500	3000	
300	25	19 x 19/ 38 x 38	/	0.29	0.39	0.68	0.90	1.17	1.85	2.29	
	38		/	/	0.31	0.54	0.72	0.93	1.48	1.82	
	30	20 x 20/ 40 x 40	/	0.33	0.45	0.78	1.03	1.34	.12	2.62	
	40		/	.25	0.33	0.58	0.77	1.00	1.59	1.97	
	38		26 x 26/ 52 x 52	/	0.48	0.63	0.99	1.41	1.91	3.13	/
	50		25 x 25/ 50 x 50	/	0.34	0.45	0.70	1.00	1.36	2.22	2.67
	40		13 x 13/ 40 x 40	/	/	0.32	0.57	0.75	0.97	1.54	1.91
450	25	19 x 19/ 38 x 38	0.39	0.47	0.64	1.11	1.47	1.91	3.02	3.74	
	38		/	0.38	0.52	0.90	1.20	1.55	2.46	3.04	
	30	20 x 20/ 40 x 40	0.38	0.50	0.67	1.17	1.55	2.01	3.18	3.93	
	40		0.25	0.37	0.50	0.87	1.16	1.51	2.39	2.95	
	38		26 x 26/ 52 x 52	0.39	0.81	1.05	1.65	2.35	3.18	5.22	/
	50		25 x 25/ 50 x 50	0.25	0.51	0.67	1.06	1.50	2.03	3.34	4.01
	40		13 x 13/ 40x40	/	0.36	0.49	0.85	1.13	1.46	2.32	2.86
600	25	19 x 19/ 38 x 38	0.53	1.11	1.44	2.27	3.23	4.37	7.17	/	
	38		0.43	0.90	1.17	1.85	2.63	3.56	5.93	/	
	30	20 x 20/ 40 x 40	0.56	1.17	1.52	2.39	3.40	4.60	7.55	/	
	40		0.42	0.87	1.14	1.79	2.55	3.45	5.66	/	
	38		26 x 26/ 52 x 52	0.57	1.19	1.55	2.45	3.48	4.71	7.73	/
	50		25 x 25/ 50 x 50	0.36	0.76	0.99	1.57	2.22	3.01	4.94	5.93
	40		13 x 13/ 40 x 40	0.41	0.85	1.11	1.74	2.47	3.35	5.50	/
750	25	19 x 19/ 38 x 38	0.90	2.10	2.70	4.28	6.28	8.47	/	/	
	38		0.73	1.71	2.20	3.48	5.11	6.93	/	/	
	30	20 x 20/ 40 x 40	0.95	2.21	2.84	4.50	6.61	8.92	/	/	
	40		0.71	1.66	2.13	3.38	4.96	6.69	10.23	/	
	38		26 x 26/ 52 x 52	0.97	2.26	2.91	4.61	6.77	9.15	/	/
	50		25 x 25/ 50 x 50	0.62	1.45	1.86	2.95	4.33	5.85	9.12	/
	40		13 x 13/ 40x40	0.69	1.61	2.07	3.28	4.81	6.49	/	/
900	25	19 x 19/ 38x 38	1.27	3.09	3.95	6.29	9.33	/	/	/	
	38		1.03	2.51	3.22	5.12	7.59	10.30	/	/	
	30	20 x 20/ 40 x 40	1.34	3.25	4.16	6.62	9.82	/	/	/	
	40		1.00	2.44	3.12	4.97	7.36	9.94	/	/	
	38		26 x 26/ 52 x 52	1.37	3.33	4.26	6.78	10.05	/	/	/
	50		25 x 25/ 50 x 50	0.88	2.13	2.72	4.34	6.43	9.34	/	/
	40		13 x 13/ 40x40	0.97	2.36	3.03	4.82	7.15	9.65	/	/
1200	25	19 x 19/ 38x 38	2.11	5.30	7.41	10.76	13.45	/	/	/	
	38		1.72	4.31	6.03	8.76	12.87	/	/	/	
	30	20 x 20/ 40 x 40	2.22	5.58	7.80	11.32	/	/	/	/	
	40		1.66	4.18	5.85	8.49	11.32	/	/	/	
	38		26 x 26/ 52 x 52	2.27	5.71	7.99	11.55	15.47	/	/	/
	50		25 x 25/ 50 x 50	1.45	3.65	5.11	7.41	9.98	14.34	/	/
	40		13 x 13/ 40x40	1.61	4.06	5.68	8.24	9.23	12.45	/	/

Moulded Grating Load Tables

Concentrated Line Load

HLC Mesh

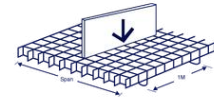

Span (mm)	Type		Load kg/m of width							Max Load (kg/m)
	Height (mm)	Mesh (mm)	75	150	300	450	600	750	1500	
300	60	38 x 38	/	/	/	0.35	0.49	0.65	1.34	25,328
	50	25 x 25 / 50 x 50	/	<0.25	0.28	0.43	0.58	0.66	1.33	23,877
	25	25 x 100	<0.25	0.25	0.63	0.86	1.13	1.46	2.76	10,058
	50	25 x 50	/	/	/	/	/	<0.25	0.27	69,741
450	60	38 x 38	/	<0.25	0.45	0.67	0.89	1.14	2.35	19,445
	50	25 x 25 / 50 x 50	<0.25	0.39	0.69	0.85	1.12	2.04	4.26	18,103
	25	25 x 100	0.52	0.77	1.78	2.56	3.31	4.32	/	7,265
	50	25 x 50	/	/	/	/	/	0.26	0.54	48,574
600	60	38 x 38	<0.25	0.31	0.63	0.92	1.2	1.49	3.01	13,391
	50	25 x 25 / 50 x 50	0.32	0.53	0.98	1.62	2.02	2.38	4.93	12,161
	25	25 x 100	0.76	1.62	3.17	5.02	6.71	/	/	5,775
	50	25 x 50	/	/	0.27	0.39	0.48	0.55	1.29	40,530
750	60	38 x 38	0.35	0.71	1.38	2.11	2.81	3.49	7.03	11,331
	50	25 x 25 / 50 x 50	0.42	0.84	1.45	2.15	3.17	4.21	8.48	10,131
	25	25 x 100	1.36	2.24	4.84	6.69	8.96	/	/	4,844
	50	25 x 50	/	/	0.51	0.77	1.03	1.28	2.29	32,346
900	60	38 x 38	0.47	0.97	1.89	2.87	3.82	4.74	9.51	9,266
	50	25 x 25 / 50 x 50	0.47	1.54	3.13	4.01	4.84	5.71	11.64	8,246
	25	25 x 100	2.29	4.14	7.67	/	/	/	/	4,172
	50	25 x 50	/	/	0.75	1.18	1.63	2.05	4.13	26,969
1200	60	38 x 38	1.08	2.18	4.42	6.62	8.79	11.02	22.15	6,336
	50	25 x 25 / 50 x 50	1.54	3.14	6.39	8.03	9.68	12.21	/	6,289
	25	25 x 100	3.49	5.48	/	/	/	/	/	3,504
	50	25 x 50	/	/	1.46	2.09	2.74	3.35	6.37	23,095



Uniform Load

HLC Mesh

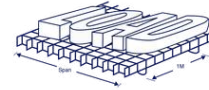

Span (mm)	Type		Load kg/m ²							Max Load (kg/m ²)
	Height (mm)	Mesh (mm)	150	350	500	750	1000	1500	2500	
300	60	38 x 38	/	/	/	/	/	/	/	/
	50	25 x 25 / 50 x 50	<0.25	<0.25	<0.25	<0.25	<0.25	<0.25	0.37	59,818
	25	25 x 100	/	/	/	0.26	0.53	0.79	1.32	32,940
	50	25 x 50	/	/	/	/	/	/	/	456,768
450	60	38 x 38	/	/	0.41	0.61	0.82	1.22	2.03	60,654
	50	25 x 25 / 50 x 50	<0.25	<0.25	0.28	0.42	0.55	0.84	1.24	37,297
	25	25 x 100	0.29	0.51	0.76	1.27	1.53	2.29	3.82	18,910
	50	25 x 50	/	/	/	/	/	/	/	212,280
600	60	38 x 38	0.33	0.41	0.62	0.92	1.12	2.86	7.14	36,344
	50	25 x 25 / 50 x 50	0.45	0.56	0.84	1.24	1.52	4.42	5.78	22,348
	25	25 x 100	0.89	1.27	2.03	3.30	4.32	6.35	/	15,860
	50	25 x 50	/	/	0.31	0.51	0.62	0.77	0.95	132,736
750	60	38 x 38	0.43	1.02	1.52	2.29	4.75	7.13	/	23,229
	50	25 x 25 / 50 x 50	0.58	1.38	2.07	3.10	6.13	8.71	/	14,284
	25	25 x 100	1.87	3.06	4.57	7.12	9.41	/	/	12,688
	50	25 x 50	/	0.74	1.02	1.53	1.63	1.78	2.02	84,912
900	60	38 x 38	0.68	1.83	2.84	4.27	6.41	9.62	/	16,122
	50	25 x 25 / 50 x 50	1.16	2.49	3.86	5.79	7.69	9.46	/	9,914
	25	25 x 100	3.87	5.84	8.89	/	/	/	/	9,111
	50	25 x 50	0.76	1.52	2.28	3.06	3.63	3.81	4.17	42,944
1200	60	38 x 38	2.37	3.30	4.71	7.07	9.43	14.15	/	9,499
	50	25 x 25 / 50 x 50	3.21	4.48	6.40	8.64	11.39	/	/	5,841
	25	25 x 100	7.62	12.71	/	/	/	/	/	5,734
	50	25 x 50	2.79	3.02	4.86	5.61	6.34	7.13	8.12	32,912

Moulded Grating Load Tables

Uniform Load

HLC Mesh

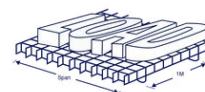

Span (mm)	Type		Load kg							
	Height (mm)	Mesh (mm)	150	350	500	750	1000	1500	2500	3000
300	60	38 x 38	/	/	/	/	/	/	/	/
	50	25 x 25 / 50 x 50	/	0.34	0.45	0.70	1.00	1.36	2.22	2.67
	25	25 x 100	/	0.52	0.74	1.13	1.60	2.17	3.56	/
	50	25 x 50	/	/	/	0.38	0.54	0.73	1.20	1.45
450	60	38 x 38	/	/	/	0.37	0.49	0.64	1.01	1.25
	50	25 x 25 / 50 x 50	0.25	0.51	0.67	.06	1.50	2.03	3.34	4.01
	25	25 x 100	0.35	0.82	1.07	1.69	2.40	3.25	4.39	/
	50	25 x 50	/	0.28	.36	.57	0.81	1.10	1.81	2.17
600	60	38 x 38	/	0.37	0.48	0.76	1.08	1.46	2.43	2.92
	50	25 x 25 / 50 x 50	0.36	0.76	0.99	1.57	2.22	3.01	4.94	5.93
	25	25 x 100	0.52	1.22	1.59	2.50	3.56	4.81	7.36	/
	50	25 x 50	/	0.41	0.54	0.85	1.20	1.63	268	3.21
750	60	38 x 38	0.30	0.70	0.90	1.43	2.09	2.84	4.73	5.68
	50	25 x 25 / 50 x 50	0.62	1.45	1.86	2.95	4.33	5.85	9.12	/
	25	25 x 100	0.99	2.31	2.97	4.71	6.92	9.34	/	/
	50	25 x 50	0.34	0.78	1.01	1.60	2.34	3.17	4.94	5.93
900	60	38 x 38	0.42	1.03	1.32	2.10	3.11	4.22	7.03	8.44
	50	25 x 25 / 50 x 50	0.88	2.13	2.72	4.34	6.43	9.34	/	/
	25	25 x 100	1.40	3.40	4.35	6.93	9.23	/	/	/
	50	25 x 50	0.47	1.15	1.47	2.35	3.48	5.06	6.83	8.21
1200	60	38 x 38	0.70	1.77	2.47	3.59	5.27	7.16	11.39	/
	50	25 x 25 / 50 x 50	1.45	3.65	5.11	7.41	9.89	14.34	/	/
	25	25 x 100	2.32	5.84	8.17	11.85	/	/	/	/
	50	25 x 50	0.79	1.98	2.77	4.01	5.35	7.77	10.49	12.59



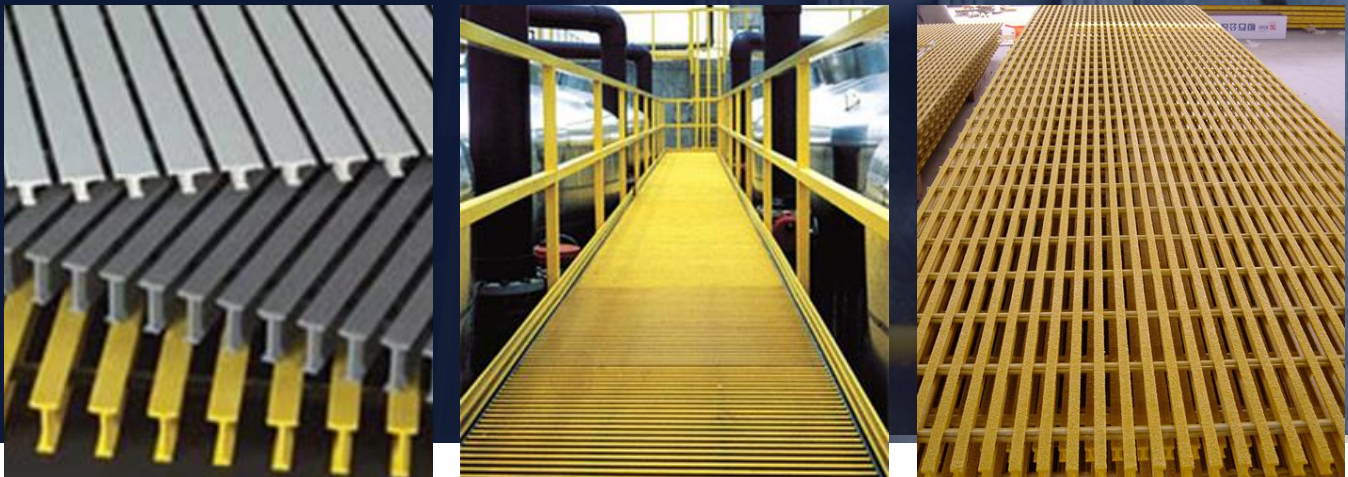

The following load tables provide deflection and allowable load data for Pultruded FRP grating under static load conditions at ambient temperature. Values are derived from testing in accordance with the ANSI Standard: FRP Composites Grating Manual for Pultruded and Moulded Grating and Stair Treads.

1. Deflection is in mm.
2. Walking loads, typically 65-80kg maximum are recommended for pedestrian traffic. Deflections for worker comfort are typically limited to the lesser of 10mm or
3. **Clear Span** divided by 125; for a firmer feel, limit deflection to the lesser of 6.4mm or **Clear Span** divided by 200.
4. The allowable Loads in this table are for **Static Load Conditions** at ambient temperatures only. Allowable loads for impact or dynamic conditions should be a maximum of **One-Half** the values shown. Long term loads will result in added deflection due to the creep in the material and will also require higher safety factors to ensure acceptable performance. For applications at elevated temperatures, please consult with Grating FRP Australia. The design is further referenced to the ASCE Structural Plastics Design Manual.
5. Temperature Considerations: For applications at elevated temperatures, consult the manufacturer for adjusted load ratings.
6. All Gratings were tested in accordance with ANSI Standard; FRP Composites Grating Manual for Pultruded and Moulded Grating and Stair Treads.

These tables serve as a guide to assist designers and engineers in selecting the correct grating profile for their specific span, load and deflection requirements.

Pultruded Grating Load Tables

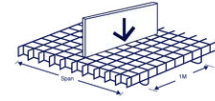

Concentrated Line Load

Type	Span (mm)	Load kg/m of width						Max Load (kg/m)
		300	450	750	1500	3000	5950	
I-4010	450	/	/	1.02	2.03	4.06	7.62	16,593
	600	/	/	2.54	4.57	8.89	17.53	12,959
	900	2.80	4.06	6.60	13.46	26.90	53.85	8,639
	1200	5.84	8.89	14.73	29.46	59.20	118.10	6,420
I-5010	450	/	/	1.02	2.03	4.06	7.62	13,808
	600	/	/	2.54	4.85	9.40	18.8	10,799
	900	2.54	4.06	6.86	13.46	27.20	54.1	7,194
	1200	7.37	10.9	18.28	36.58	73.20	146.0	5,362
I-6010	450	/	/	1.52	2.54	4.83	9.65	11,067
	600	/	/	3.05	5.59	11.2	22.10	8,639
	900	3.30	4.83	7.87	15.75	31.5	62.99	5,750
	1200	7.87	11.7	19.30	38.61	77.5	154.60	4,275
I-4015	450	/	0.25	0.51	0.76	1.52	2.79	26,215
	600	0.51	0.51	1.02	1.78	3.05	5.84	19,661
	900	1.02	1.27	2.29	4.32	8.38	16.76	12,705
	1200	2.03	2.79	4.57	9.40	19.1	37.85	9,086
I-5015	450	/	0.25	0.51	1.02	1.78	3.30	21,836
	600	0.51	0.51	1.02	1.78	3.56	6.86	16,385
	900	1.02	1.52	2.54	5.08	9.91	20.07	10,567
	1200	2.29	3.56	5.84	11.94	23.4	46.99	7,567
I-6015	450	/	0.25	0.51	0.76	2.03	3.81	17,472
	600	0.51	0.76	1.02	2.29	4.32	8.38	13,108
	900	1.27	2.03	3.30	6.10	12.50	25.15	8,460
	1200	2.79	4.32	7.11	14.22	28.50	56.90	6,047



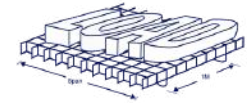

Uniform Load

Type	Span (mm)	Load kg/m ²						Max Load (kg/m ²)
		1000	1900	3900	7000	9500	19500	
I-4010	450	1.25	0.76	1.27	2.29	3.05	6.10	72,325
	600	1.01	1.27	3.56	6.86	8.89	/	42,515
	900	4.57	8.38	16.26	/	/	/	18,863
	1200	14.48	/	/	/	/	/	10,507
I-5010	450	0.51	0.76	.27	2.54	3.302	6.60	60,499
	600	1.27	2.29	4.06	5.08	7.62	15.24	35,429
	900	4.83	8.89	17.27	/	/	/	15,638
	1200	16.51	/	/	/	/	/	8,796
I-6010	450	0.76	1.52	.79	3.81	7.37	/	48,380
	600	2.29	4.57	8.38	11.18	/	/	28,344
	900	10.92	/	/	/	/	/	12,559
	1200	/	/	/	/	/	/	6,988
I-4015	450	0.25	0.25	0.76	1.27	1.52	3.3	114,645
	600	0.51	0.76	1.52	2.79	3.81	7.62	64,506
	900	1.52	2.79	5.33	10.20	3.46	/	27,757
	1200	/	8.64	/	/	/	/	14,905
I-5015	450	0.25	0.51	.76	1.27	1.778	3.56	95,537
	600	0.51	0.76	1.52	3.05	4.06	8.13	53,755
	900	1.78	3.30	6.10	11.17	5.49	/	23,164
	1200	5.59	10.63	/	/	/	/	12,422
I-6015	450	0.25	0.25	0.76	1.27	1.78	3.56	76,430
	600	0.51	1.02	1.789	3.30	4.57	8.89	43,004
	900	2.29	4.06	7.87	14.70	/	/	18,570
	1200	6.6	12.95	/	/	/	/	9920

Pultruded Grating Load Tables



Concentrated Line Load

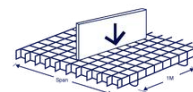

Type	Span (mm)	Load kg/m of width						Max Load (kg/m)
		300	450	750	1500	3000	5950	
T-1210	450	0.254	0.508	0.762	1.27	2.286	4.826	6,181.5
	600	0.50	1.01	1.52	2.28	1.82	9.05	4,857.4
	900	1.52	3.04	7.82	7.87	/	/	3,233.3
	1200	3.556	7.366	10.92	/	/	/	2,428.7
T-2510	450	0.254	0.508	0.762	1.27	2.794	5.588	4,619
	600	0.50	1.01	1.77	2.79	5.58	11.43	3,471.7
	900	1.77	3.55	5.58	9.14	/	/	2,309.5
	1200	2.032	4.318	8.382	12.7	/	/	1,728.4
T-3310	450	0.584	0.86	1.448	2.87	5.74	/	103.9
	600	1.27	1.95	3.22	6.45	/	/	7,731
	900	4.01	5.99	10.06	/	/	/	5,024
	1200	8.992	/	/	/	/	/	3,620
T-3810	450	0.71	1.02	1.727	3.454	6.91	/	8,600
	600	0.54	2.34	3.88	7.74	/	/	6,427
	900	4.82	7.21	/	/	/	/	4,180
	1200	0.77	/	/	/	/	/	3,018
T-1215	450	<0.254	0.254	0.254	0.508	1.061	1.778	8,791
	600	<0.254	0.254	0.508	0.762	1.778	3.556	7,032.8
	900	0.508	1.016	1.524	2.794	5.334	10.66	4,678.6
	1200	1.27	2.54	3.55	6.09	12.19	/	3,515.4
T-2515	450	<0.254	0.254	0.254	0.508	1.016	2.286	7,539.4
	600	0.254	0.508	0.508	1.016	1.064	2.032	6,079.6
	900	0.508	1.27	1.778	3.048	6.35	12.4	4,023
	1200	1.524	2.794	4.138	7.112	/	/	3009.8
T-3815	450	0.254	0.254	0.508	0.762	1.27	2.54	6,287.8
	600	0.254	0.508	0.762	1.27	2.296	4.826	5,021.3
	900	0.762	1.524	2.286	3.81	7.62	/	3,352.5
	1200	1.778	3.302	5.08	8.382	/	/	2,503.2
T-1810	450	0.4	0.67	1.07	2.0	2.67	3.34	5,900
	600	1.24	2.06	3.30	6.19	8.85	10.32	3,800
	900	2.76	4.59	7.35	13.78	/	/	2,300
	1200	5.16	8.60	13.76	/	/	/	2,200
T-3320	450	/	0.25	0.51	1.02	1.78	3.30	16,876
	600	0.51	0.76	1.27	2.29	4.57	9.40	7,492
	900	1.02	1.52	2.29	3.83	9.91	/	4,215
	1200	1.78	2.79	4.57	9.14	/	/	2,969
T-5020	450	0.25	0.51	0.76	1.27	2.29	4.57	12,657
	600	0.76	1.27	1.78	3.30	6.10	/	5,619
	900	1.52	2.29	3.56	6.60	/	/	3,161
	1200	2.54	3.81	6.35	12.45	/	/	2,022



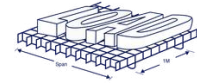

Uniform Load

Type	Span (mm)	Load kg/m ²						Max Load (kg/m ²)
		450	950	1450	2400	4850	9500	
T-1210	450	<0.254	0.254	0.762	1.016	2.286	4.572	14,932.8
	600	0.508	1.27	1.778	3.048	6.096	12.192	11,175.2
	900	2.794	5.842	8.89	/	/	/	7,076
	1200	9.144	/	/	/	/	/	3,562.4
T-2510	450	0.254	0.508	0.762	1.27	2.51	5.08	10,638.4
	600	0.762	1.524	2.032	3.556	7.112	/	8,003.2
	900	3.556	6.858	10.41	/	/	/	5,075.2
	1200	10.668	/	/	/	/	/	2,830.4
T-3310	450	0.56	1.069	2.134	4.039	5.23	/	45,076
	600	.63	3.226	6.542	12.12	/	/	25,363
	900	7.52	15.04	/	/	/	/	10,971
	1200	/	/	/	/	/	/	5,938
T-3810	450	0.66	1.295	2.616	5.004	6.53	/	37,624
	600	1.96	3.886	7.772	/	/	/	21,087
	900	9.02	/	/	/	/	/	9,158
	1200	/	/	/	/	/	/	4,940
T-1215	450	<0.254	0.254	0.254	0.508	1.106	1.778	19,227.2
	600	0.254	0.508	0.762	1.106	2.286	4.318	14,396
	900	1.016	2.032	3.048	5.08	0.16	/	9,613.6
	1200	3.048	6.096	9.144	/	/	/	5,758.4
T-2515	450	<0.254	0.254	0.254	0.508	1.016	2.032	10,638.4
	600	0.254	0.508	0.762	1.27	2.54	5.08	12,346.4
	900	1.27	2.286	3.556	5.842	11.68	/	8,247.2
	1200	3.556	7.112	10.66	/	/	/	4,928.8
T-3815	450	<0.254	0.254	0.254	0.508	1.27	2.54	13,712.8
	600	0.254	0.508	1.016	1.524	3.048	6.096	10,296.8
	900	1.524	2.794	4.318	7.112	/	/	6,880.8
	1200	4.318	8.382	12.70	/	/	/	4,099.3
T-1810	450	0.10	0.17	0.27	0.50	0.67	0.83	29,600
	600	0.46	0.77	1.24	2.32	3.10	3.87	12,700
	900	1.38	2.30	3.67	6.89	9.18	11.48	7,300
	1200	3.22	5.37	8.60	/	/	/	4,600
T-3320	450	0.25	0.51	0.76	1.52	2.03	4.06	55,368
	600	0.76	1.52	3.05	5.59	737	14.99	36,895
	900	2.29	4.57	9.40	/	/	/	27,659
	1200	5.08	9.91	/	/	/	/	22,137
T-5020	450	0.51	0.76	1.27	2.29	3.05	6.35	41,526
	600	1.02	2.03	3.81	6.86	9.40	/	27,671
	900	3.30	6.35	12.45	/	/	/	20,744
	1200	6.86	13.46	/	/	/	/	16,602

Pultruded Grating Load Tables

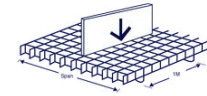

Concentrated Line Load

Type	Span (mm)	Load kg/m of width								
		150	300	450	750	1500	3000	4500	6000	7500
HL-4020	600	0.03	0.06	0.08	0.15	0.30	0.59	0.90	1.19	1.49
	750	0.05	0.10	0.17	0.27	0.54	1.08	1.63	2.19	2.73
	900	0.08	0.18	0.27	0.45	0.91	1.83	2.73	3.65	4.57
	1200	0.22	0.42	0.77	1.07	2.14	4.28	6.43	8.57	10.72
HL-5020	600	0.04	0.08	0.10	0.18	0.36	0.71	1.07	1.42	1.78
	750	0.06	0.12	0.20	0.32	0.65	1.30	1.95	2.62	3.27
	900	0.10	0.22	0.32	0.54	1.09	2.19	3.27	4.36	5.46
	1200	0.26	0.508	0.77	1.28	2.56	5.12	7.68	0.24	12.80
HL-6020	600	0.05	0.10	0.12	0.22	0.45	0.88	1.34	1.77	2.23
	750	0.07	0.15	0.25	0.40	0.81	1.62	2.43	3.27	4.08
	900	0.12	0.27	0.40	0.68	1.37	2.74	4.08	5.46	6.83
	1200	0.33	0.635	0.96	1.60	3.20	6.40	9.60	12.8	16.00
HI-4710	600	0.25	0.76	1.01	1.77	3.81	7.36	11.17	/	/
	750	0.76	1.52	2.28	3.55	7.36	/	/	/	/
	900	1.27	2.54	3.81	6.35	2.70	/	/	/	/
	1200	3.048	6.096	8.89	/	/	/	/	/	/
HI-4715	600	/	/	0.25	0.50	1.01	1.77	2.79	3.55	4.57
	750	/	0.25	0.50	0.76	1.77	3.55	5.33	6.85	8.63
	900	0.25	0.50	1.01	1.52	3.04	6.09	9.14	12.19	/
	1200	0.762	1.524	2.032	3.556	7.112	/	/	/	/
HI-4720	600	/	/	/	/	0.50	0.76	1.27	1.77	2.28
	750	/	/	/	0.50	0.76	1.77	2.54	3.30	4.06
	900	/	0.25	0.50	0.76	1.27	2.79	4.06	5.58	6.85
	1200	0.254	0.762	1.016	1.524	3.032	6.604	9.652	/	/
HI-4725	600	/	/	/	/	/	0.50	0.76	1.01	1.27
	750	/	/	/	/	0.50	1.01	1.27	1.70	2.28
	900	/	/	/	0.25	0.76	1.52	2.28	3.04	3.81
	1200	/	0.254	0.508	0.762	1.778	3.302	5.08	6.604	8.382
HI-4730	600	/	/	/	/	/	0.25	0.50	0.50	0.76
	750	/	/	/	/	0.25	0.50	0.76	1.01	1.52
	900	/	/	/	/	0.50	1.01	1.52	1.77	2.28
	1200	/	/	0.254	0.508	1.016	2.032	3.048	4.064	5.08



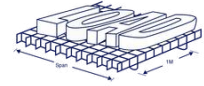

Uniform Load

Type	Span (mm)	Load kg/m ²								
		450	950	1450	2450	4850	9800	14500	19500	24400
HL-4020	600	0.034	0.068	0.119	0.187	0.374	0.748	1.123	1.497	1.854
	750	0.085	0.170	0.255	0.425	0.850	1.701	2.569	3.420	4.271
	900	0.170	0.340	0.510	0.850	1.718	3.043	5.139	6.858	8.577
	1200	0.544	1.072	1.061	2.688	5.360	0.72	/	/	/
HL-5020	600	0.040	0.081	0.142	0.223	0.447	0.894	1.341	1.788	2.214
	750	0.101	0.203	0.304	0.508	1.016	2.033	3.068	4.084	5.10
	900	0.203	0.406	0.609	1.016	2.523	4.104	6.136	8.188	10.241
	1200	0.650	1.280	1.930	3.210	6.400	12.80	/	/	/
HL-6020	600	0.050	0.101	0.177	0.279	0.558	1.117	1.676	2.235	2.768
	750	0.127	0.254	0.381	0.635	1.27	2.55	3.853	5.105	6.375
	900	0.254	0.508	0.762	1.27	2.654	5.130	7.670	10.236	12.801
	1200	0.812	1.600	2.413	4.013	8.001	16.00	/	/	/
HI-4710	600	0.508	1.016	1.524	1.778	2.286	2.794	3.302	3.81	4.318
	750	1.016	2.286	3.302	4.572	5.588	6.858	7.874	9.144	10.16
	900	2.286	4.826	7.12	9.398	11.68	/	/	/	/
	1200	7.366	/	/	/	/	/	/	/	/
HI-4715	600	/	/	0.254	0.508	0.508	0.762	0.762	1.016	1.016
	750	0.254	0.508	0.762	1.016	1.27	1.524	2.032	2.286	2.54
	900	0.508	1.016	1.778	2.286	2.794	3.302	4.064	4.572	5.08
	1200	1.778	3.556	5.334	7.112	8.89	10.66	12.44	/	/
HI-4720	600	/	/	/	/	0.254	0.254	0.508	0.508	0.508
	750	/	0.254	0.508	0.508	0.762	0.762	1.016	1.016	1.27
	900	0.254	0.508	0.762	.016	1.27	1.524	1.778	2.032	2.286
	1200	0.762	1.524	2.54	3.302	4.064	4.826	5.588	6.604	7.366
HI-4725	600	/	/	/	/	/	/	/	0.254	0.254
	750	/	/	/	0.254	0.254	0.508	0.508	0.508	0.762
	900	/	0.254	0.508	0.508	0.762	0.762	1.016	1.016	1.27
	1200	1.524	2.54	3.302	.778	2.032	2.54	3.048	3.302	0.03
HI-4730	600	/	/	/	/	/	/	/	/	/
	750	/	/	/	/	/	0.254	0.254	0.254	0.508
	900	/	/	0.254	0.254	0.508	0.508	0.508	0.762	0.762
	1200	/	0.508	0.762	1.016	1.27	1.524	1.778	2.032	2.286

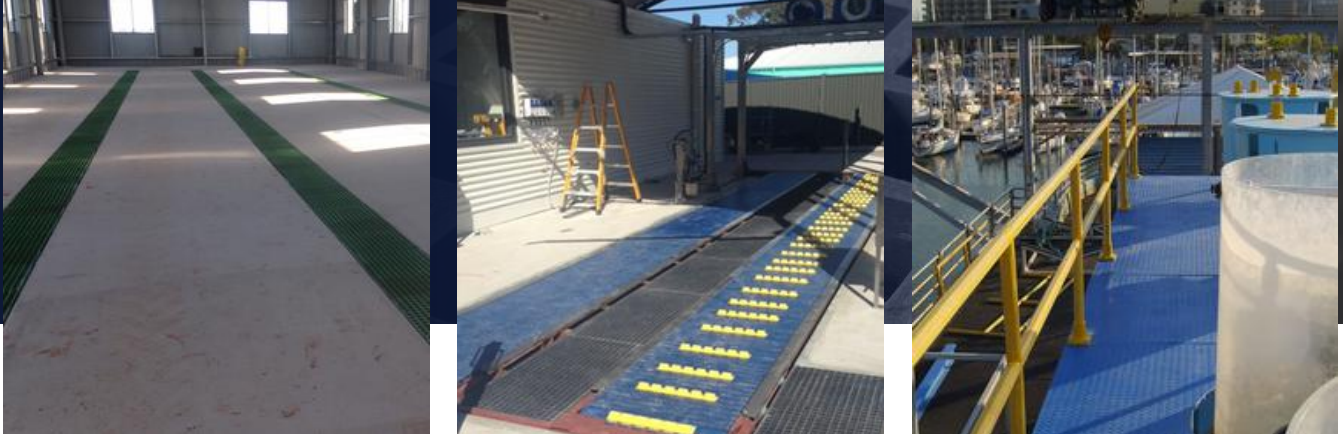

FRP grating is designed to maintain structural integrity and performance in harsh chemical environments. Using specialised resin systems, Vinyl Ester, Isophthalic or General Purpose, our products are tested against a wide range of chemicals, concentrations and temperatures.

The table on the following page provides guidance using the following classifications:

- C = Continuous exposure at the listed temperature
- F = Frequent exposure to splashes and spills
- I = Infrequent exposure, with immediate cleaning
- N = Not recommended for the conditions listed

Selecting the correct resin ensures maximum service life, safety and cost efficiency for your application.

Maximum Temperatures:

- 85°C for Vinyl Ester grating
- 70°C for Isophthalic grating
- 65°C for General Polyester grating

Data is provided as a general guide only. Performance may vary depending on conditions; testing in actual service is recommended. Liability is limited to the purchase price of the material supplied.



Chemical Environment	Concentration %	Temperature Degrees Celsius	Vinyl Ester	Isophthalic	General Purpose
Acetic Acid	50	MAX	C	F	C
Acetone	100	23	I	I	N
Aluminum Hydroxide	ALL	MAX	C	C	C
Aluminum Chloride	ALL	MAX	C	C	C
Ammonium Bicarbonate	ALL	48	C	C	C
Ammonium Bicarbonate	15	48	C	F	F
Ammonium Hydroxide	50	48	F	F	I
Ammonium Sulfate	20	26	I	N	N
Barium Sulfate	ALL	48	C	C	F
Benzene	ALL	MAX	C	C	C
Benzoic Acid (SAT)	100	65	I	N	N
Borax (SAT)	SAT	MAX	C	F	C
Calcium Carbonate	SAT	MAX	C	F	F
Calcium Hydroxide	ALL	MAX	C	F	C
Calcium Hypochlorite	25	MAX	F	F	I
Calcium Nitrate	ALL	MAX	I	I	N
Carbon Tetrachloride	ALL	26	C	C	C
Chlorine - Dry Gas	100	MAX	I	N	F
Chlorine Water (SAT)	ALL	48	C	F	N
Chromic Acid	SAT	65	I	N	N
Citric Acid	50	MAX	C	N	C
Copper Chloride	ALL	MAX	I	C	C
Copper Cyanide	ALL	60	I	C	I
Copper Nitrate	ALL	MAX	C	I	C
Crude Oil (Sweet or Sour)	ALL	MAX	C	C	C
Diesel Fuel	ALL	37	F	C	C
Ethanol	10	48	C	F	F
Ethanol	50	48	C	I	I
Ethanol Glycol	ALL	65	C	F	FI
Ferric Chloride	100	MAX	C	C	C
Ferric Nitrate	ALL	MAX	C	C	C
Ferrous Chloride	ALL	MAX	C	C	C
Fluorosilicic Acid	10	23	F	F	I
Formaldehyde (0-50%)	50	48	F	I	I
Gasoline	ALL	48	C	F	F
Glucose	ALL	48	C	C	C
Glycerin	100	MAX	C	F	F
Hydrobromic Acid	50	MAX	I	I	N
Hydrobromic Acid	10	MAX	F	F	F

Chemical Resistance

Chemical Environment	Concentration %	Temperature Degrees Celsius	Vinyl Ester	Isophthalic	General Purpose
Hydrobromic Acid	37	MAX	I	I	I
Hydrogen Peroxide	30	26	F	N	N
Lactic Acid	100	MAX	C	C	C
Lithium Chloride (SAT)	SAT	MAX	N	N	N
Magnesium Chloride	ALL	MAX	C	C	C
Magnesium Nitrate	ALL	MAX	C	C	C
Magnesium Sulphate	ALL	MAX	C	C	C
Mercuric Chloride	ALL	MAX	C	C	C
Mercurous Chloride	ALL	MAX	C	F	F
Nickle Chloride	ALL	MAX	C	C	C
Nickle Sulphate	ALL	MAX	C	C	C
Nitric Acid	20	48	I	I	I
Oxalic Acid	ALL	65	C	F	F
Perchloric Acid	30	32	I	I	I
Phosphoric Acid	80	MAX	C	C	F
Potassium Chloride	ALL	MAX	C	C	C
Potassium Dichromate	ALL	MAX	C	C	C
Potassium Nitrate	ALL	MAX	C	C	C
Potassium Sulfate	ALL	MAX	C	C	C
Propylene Glycol	ALL	MAX	C	F	F
Sodium Acetate	ALL	MAX	C	C	C
Sodium Bisulfate	ALL	26	C	I	I
Sodium Bromide	ALL	26	C	C	C
Sodium Cyanide	ALL	26	F	I	I
Sodium Hydroxide	10	MAX	I	N	N
Sodium Hydroxide	50	MAX	N	N	N
Sodium Nitrate	ALL	MAX	C	C	C
Sodium Sulfate	ALL	MAX	C	C	C
Sulfuric Acid	10	MAX	C	F	F
Sulfuric Acid	25	MAX	F	F	F
Sulfuric Acid	75	37	I	I	I
Tartaric Acid	ALL	MAX	C	F	F
Vinegar	ALL	MAX	C	F	F
Water (Distilled)	ALL	MAX	C	C	C
Zinc Nitrate	100	MAX	C	C	C
Zinc Sulfate	100	MAX	C	C	C





**Contact us
for further
enquiries**

gratingfrpaustralia.com.au

**WA, NT & SA
(08) 9584 2500**

wa-sales@gratingfrpaustralia.com.au

**NSW, QLD, VIC, TAS, ACT & NZ
(02) 4244 1008**

nsw-sales@gratingfrpaustralia.com.au