

GET SMART

# THE CONNECTED SHOP



**SMART DOOR LOCK**  
**USER MANUAL**

Welcome to the Smart Door Lock User Manual. Your easy, step-by-step guide to install, set up, and connect your Sliding Door Smart Lock. The device is designed to be easy to use and to replace all modern door locks—be it on the main door, bedroom door knobs, and so on— with the new, Sliding Door Smart Lock. The locks can also be a smart lock for traditional swing doors.



# SUMMARY

---

## I. Device Installation



1. Installation Guide
  - a) Installation Video

## II. Initialization



2. Initial State of your Smart Lock
  - a) Language Setting
  - b) Access door lock settings
  - c) Add Administrator
  - d) Delete Administrator
  - e) Add User
  - f) Delete User
  - g) Time Setting
  - h) Volume Adjustment
  - i) Factory Reset

## III. Mobile App Connection



3. Registering on the Mobile App
  - a) Downloading the Mobile App
  - b) Logging In & Registering
  - c) Resetting your Password
  - d) Adding Devices

## IV. Device Functions



### 4. Functions

- a) Remote Functions over Mobile App
- b) Connect to WiFi Gateway
- c) One-time Passcode
- d) Timed Passcode
- e) Remote Unlock

## V. Additional Information



### 5. Other Notes

## PACKAGING DETAILS

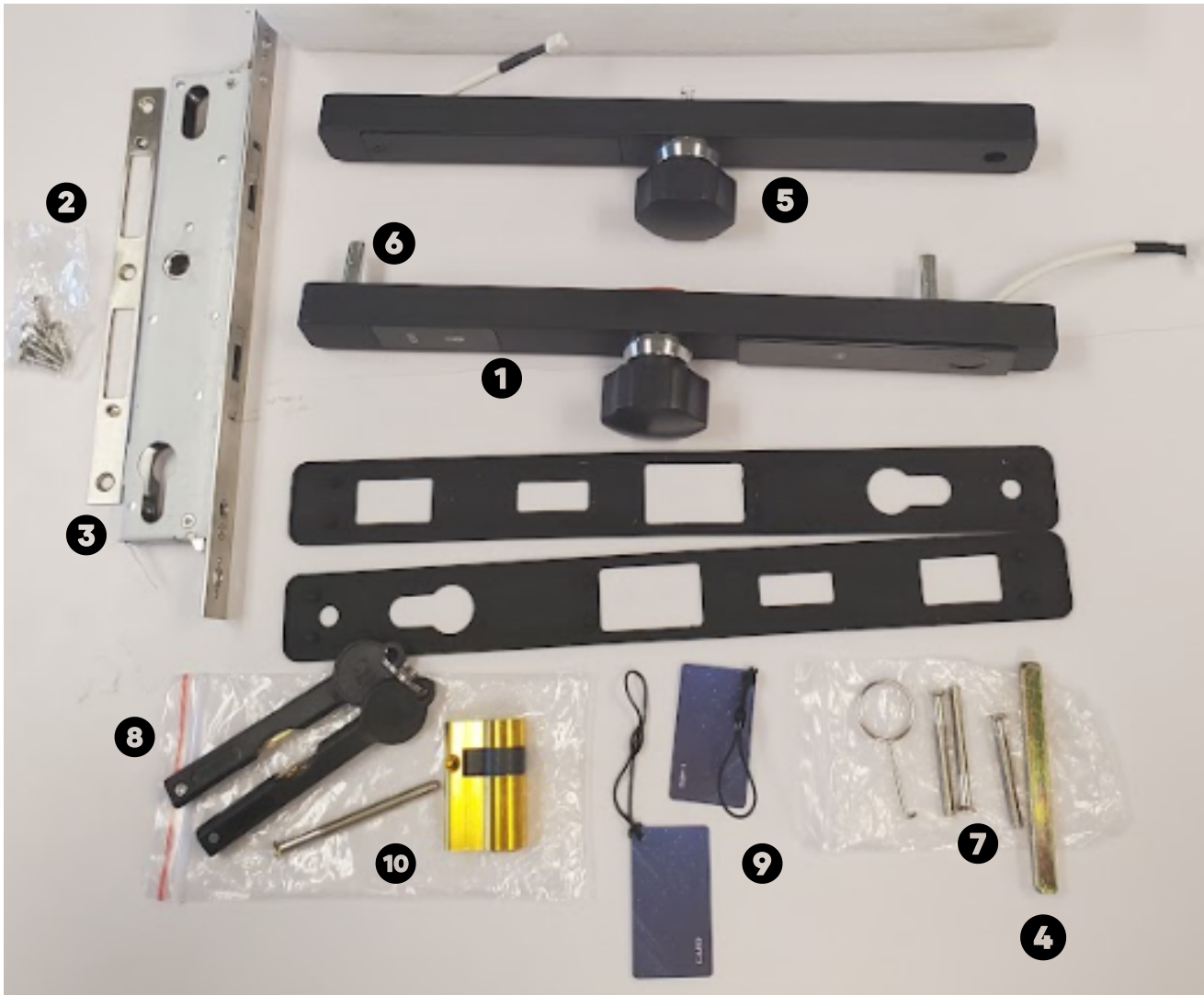

1	Front Smart Lock Handle	6	Lock Body Screws
2	Mortise and Mortise Screws	7	M5 Countersunk Head Screws
3	Strike Plate	8	Mechanical Key
4	Metal Rod	9	Key Fobs/Cards
5	Back Smart Lock Handle	10	Cylinder Lock and Fixing Screw

## STEP BY STEP SMART LOCK INSTALLATION GUIDE

---

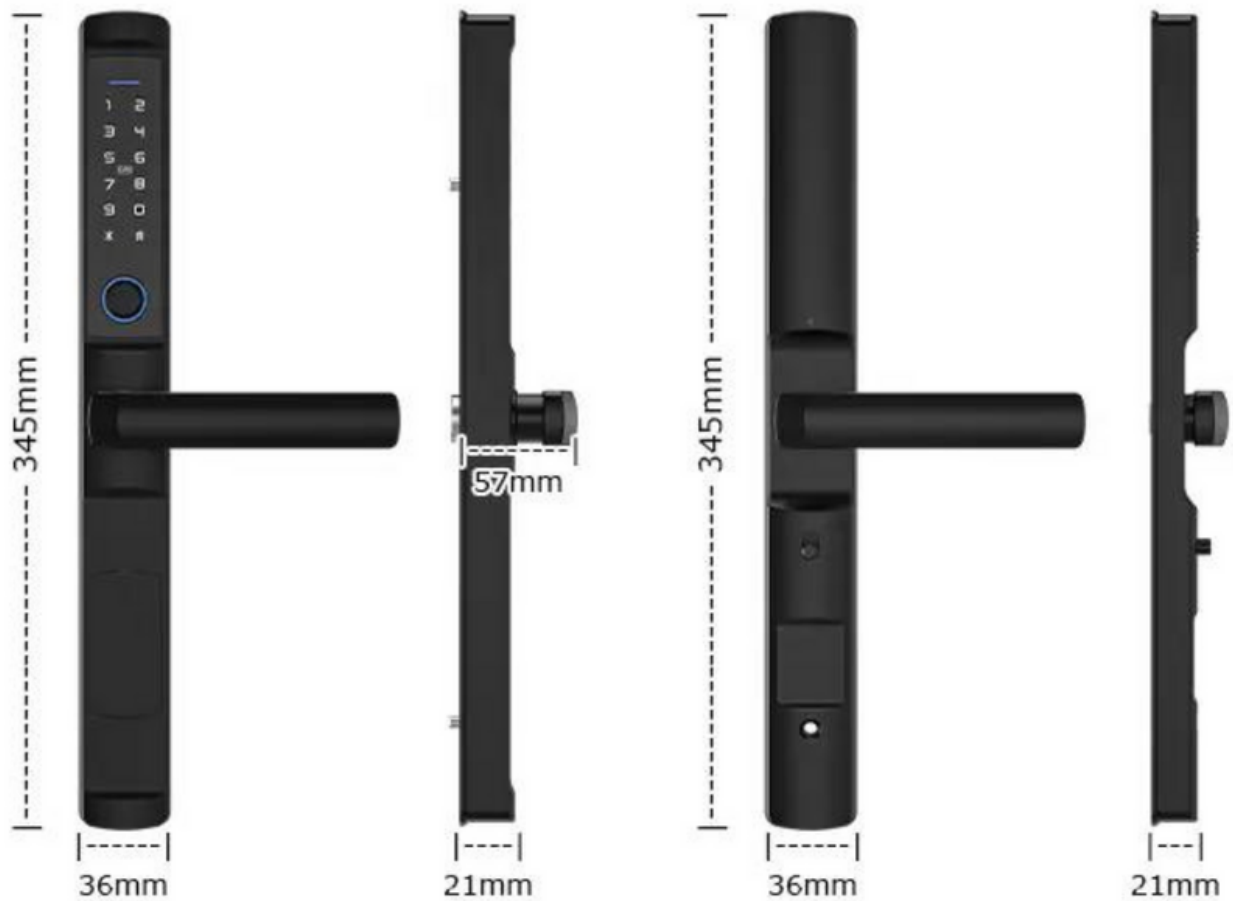

## 1. BEFORE INSTALLATION



### Change Clutch Direction (Required)

Before you install all the parts, you have to make sure that you **ADJUSTED THE CLUTCH DIRECTION** accordingly. The clutch is found at the back of the front/outside lock panel where the keypad is located.

This is to make sure that the smart lock will lock properly. It should be according to the direction of their front/outside door handle. If they have the door handle to the Right, then the arrow should point to the **RIGHT** and vice versa.



### Important Notes:

If the clutch direction is not adjusted correctly, the smart lock will not lock properly even though it will say it is "locked".

To know that you have adjusted it correctly, the smart door lock cannot be opened when you push the handle downward from the outside unless you input a user information (i.e. fingerprint/passcode/card/wrist band).

## 1. INSTALLATION

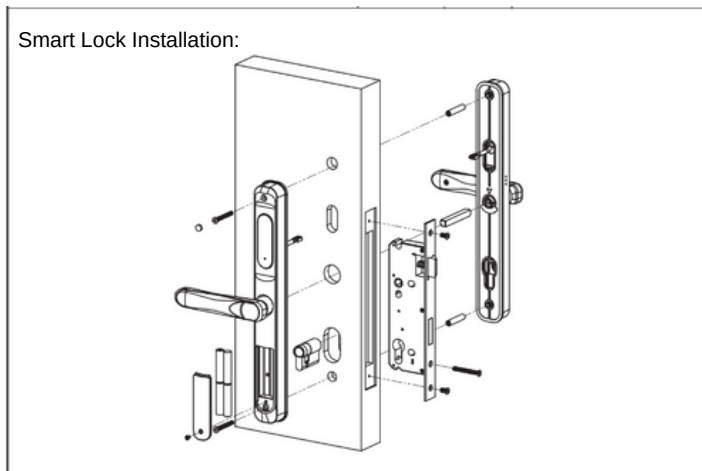

a. Start by removing your current lock. This is generally done by unscrewing the bolts and pulling out your current door knob.

b. Insert your new (2) Mortise and (3) Strike Plate into the door frame. Tighten the (2) Mortise Screws on the top and bottom sides. Making sure the latch bolt is on the top side of the lock.

c. Insert the (10) Cylinder Lock with the (10) Cylinder Fixing Screws as shown in the diagram on the right.  
 d. Make sure the keyhole is facing the exterior side of the door. Insert and rotate the keyhole to make sure the bolt is retracted smoothly, and then fix the screw.

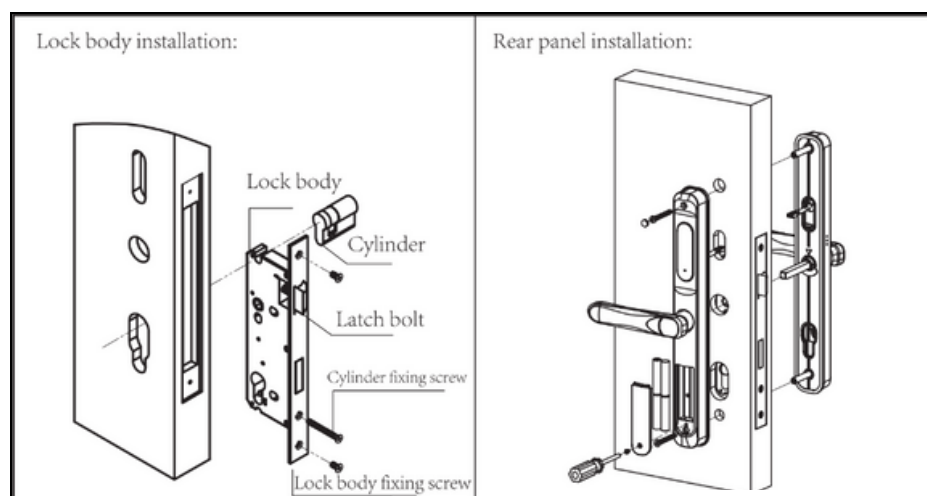



## 1. INSTALLATION



- e. Affix the (1) Front Door Handle/Panel unto the door. Insert the (4) Metal Rod into the middle hole behind the handle/panel. The positioning pin will pop out and hold in place. Install the handle by passing the Metal Rod through the door with the use of the (6) Lock Body Screws.
- f. Insert the power cord of the Front Panel through the door to connect it to the (5) Back Door Handle/Panel.
- g. After both handles are fixed with the (7) M5 Countersunk Head Screws, install the batteries in its compartment. Place the cover on top and close it with the screws.

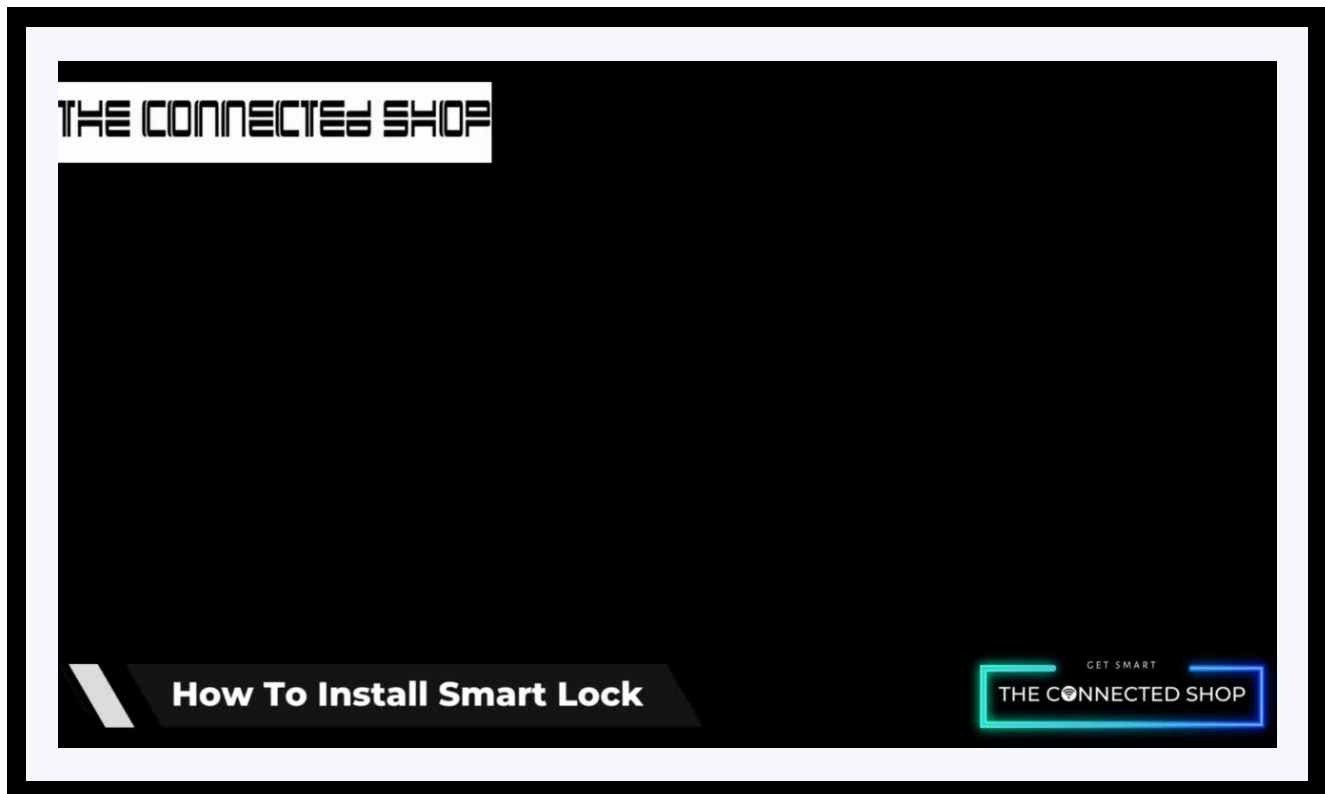

## 2. INITIAL STATE OF YOUR SMART LOCK



### A) Language Setting (optional)

#### **NOTE:**

When the lock is in its factory state or when the lock is reset, the default language is Chinese. So, you can follow the steps below to change the language to English.

You can use the formula below to change the language while following the video below for the correct timing:

- Touch anything on the keypad to turn it on. Then put your finger on the sensor to light up numbers 2, 3, 6, 7, 0 and the lock keys. Wait for it to turn off and slide your finger on the keypad to turn on ALL keys.
- Then when all the keys are lit up, press \* + 39 + # then it has a voice prompt. After the voice, press 123456 and # then press 2 and #.

## 2. INITIAL STATE OF YOUR SMART LOCK



### Legend:

**\*** = to go back or return.

**#** = to enter or confirm everytime you input a code

123456 = the default administrator information.

### Note:

Under the initial state, any fingerprint, keycard, and password can unlock or open the smart lock.

### B) Access Door Lock Settings

- Activate your Smart Lock
- Press '\*' "39" and then press '#'—\*39#
- You will hear the voice prompt to enter the Administrator Information (For first-time users, enter 123456#)

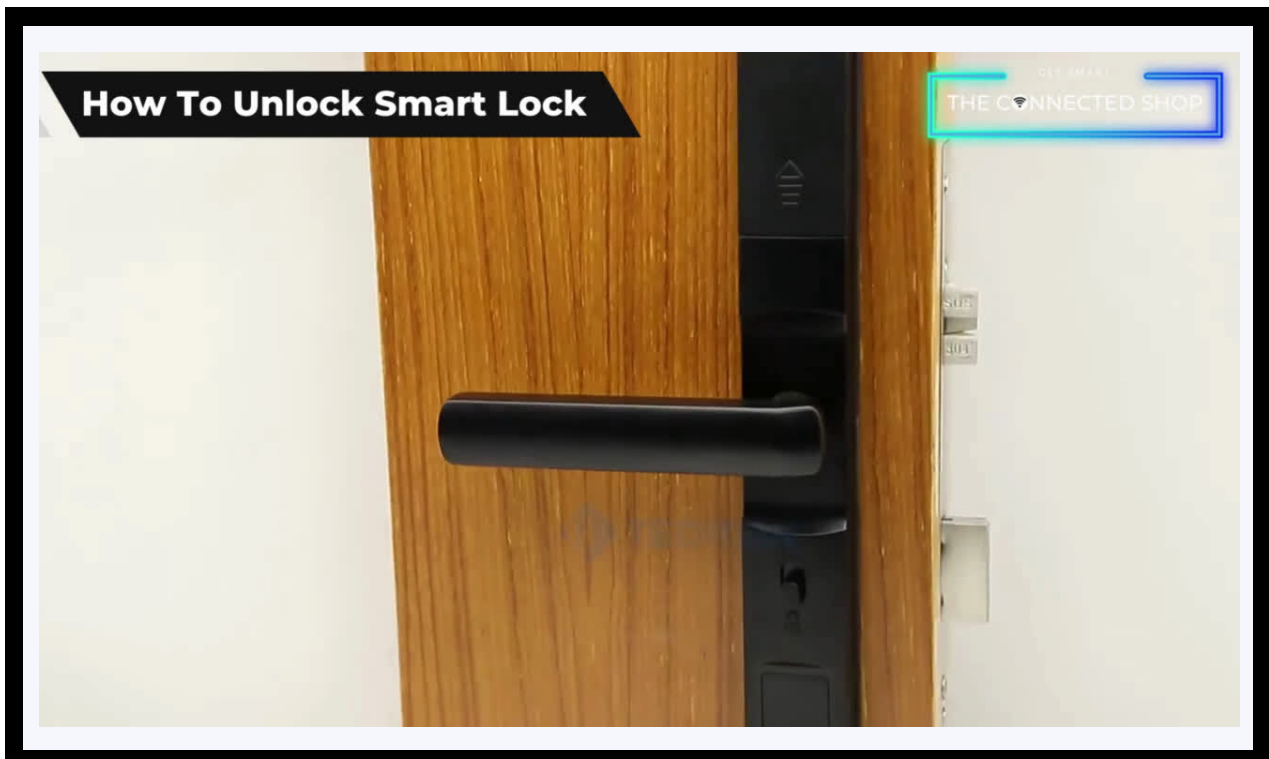

## 2. INITIAL STATE OF YOUR SMART LOCK



### C) Add Administrator

- Activate your Smart Lock
- When the administrator password is not yet set (initial state), the user will be prompted to enter Bluetooth Administrator
- Here, the factory administrator initial password is: 123456
- Follow the voice command and continue adding a new administrator in the mobile app
  - Input the intended Fingerprint 4 times or;
  - Input a 6-8 digit password 2 times or;
  - Input an Keycard 1 time

## 2. INITIAL STATE OF YOUR SMART LOCK



### D) Delete Administrator

- Activate your Smart Lock and enter your Administration Information (if applicable)
- Open the mobile app
- Select the Administrator that needs to be deleted by going to either Passcodes, Cards, or Fingerprints
- Select the Administrator to be deleted and long press it until the delete option pops up
- Click 'Delete' to confirm

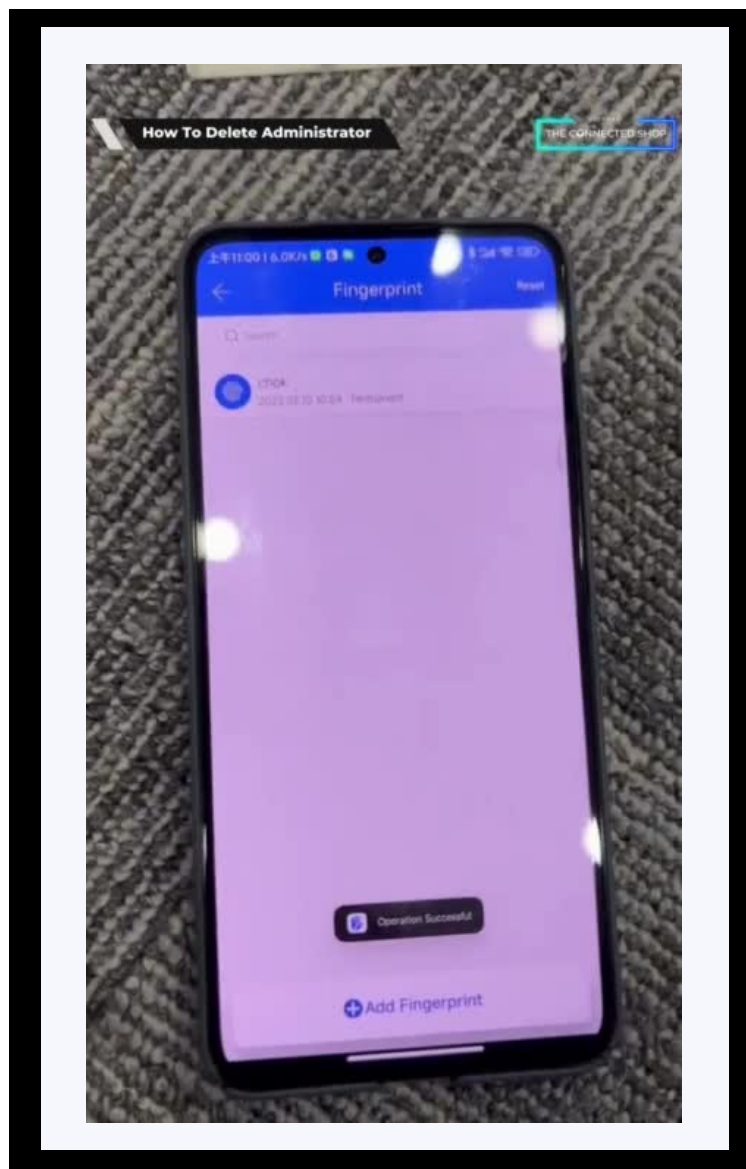

## 2. INITIAL STATE OF YOUR SMART LOCK



### E) Add User

- Activate your Smart Lock and enter your Administration Information (if applicable)
- Open the mobile app
- Go to 'Passcodes' or 'IC Cards' setting depending on what you will input
- To enter a new passcode, click Custom and set it to permanent
  - Input a 4/6-digit password
  - Name the new password
- To add a key card, click 'Add IC Card' and set it to permanent
  - Name the new key card

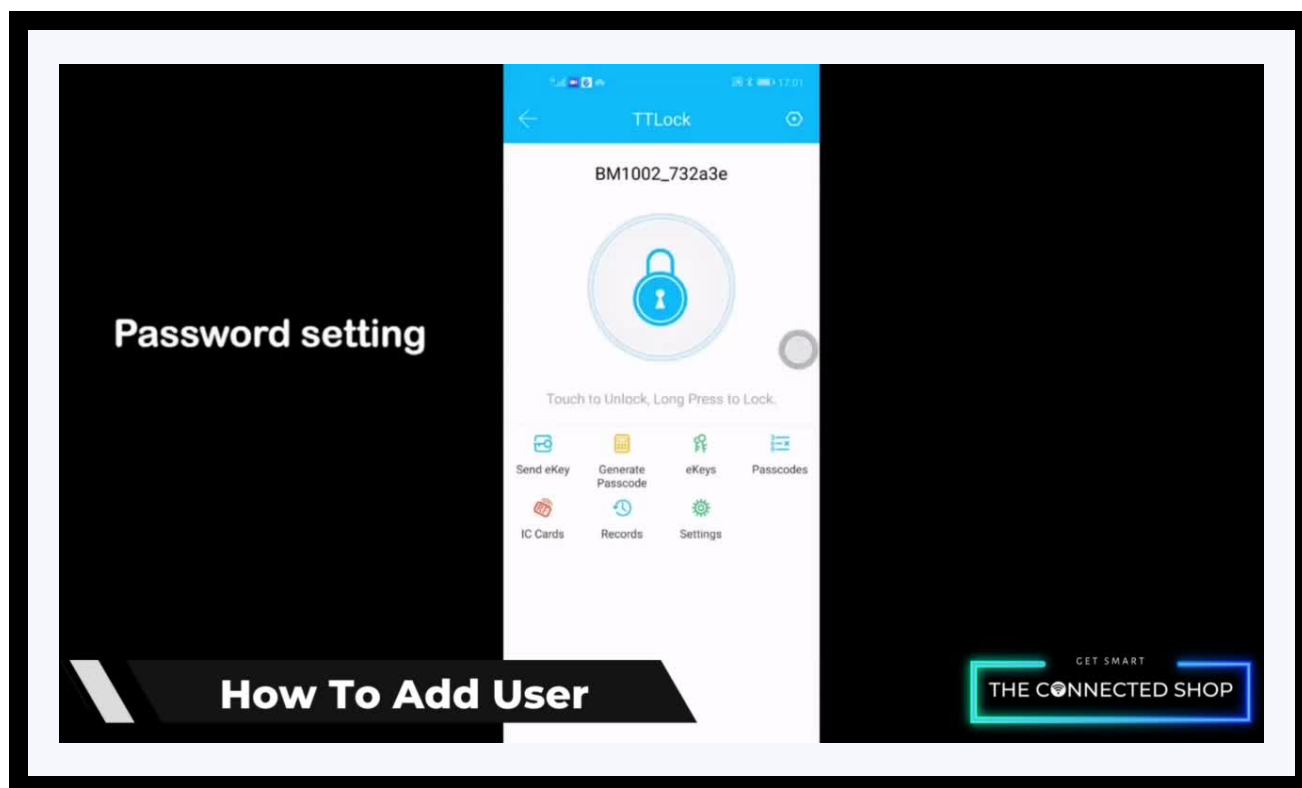

## 2. INITIAL STATE OF YOUR SMART LOCK



### F) Delete User

- Activate your Smart Lock and enter your Administration Information (if applicable)
- Open the mobile app
- Select the User that needs to be deleted by going to either Passcodes, Cards, or Fingerprints
- Select the User to be deleted and long press it until the delete option pops up
- Click 'Delete' to confirm

## 2. INITIAL STATE OF YOUR SMART LOCK



### G) Time Setting

- Activate your Smart Lock and enter your Administration Information (if applicable)
- Open the mobile app
- Go to Settings and select 'Lock Clock'
- Click the 'Calibrate Time' button to configure the time and date

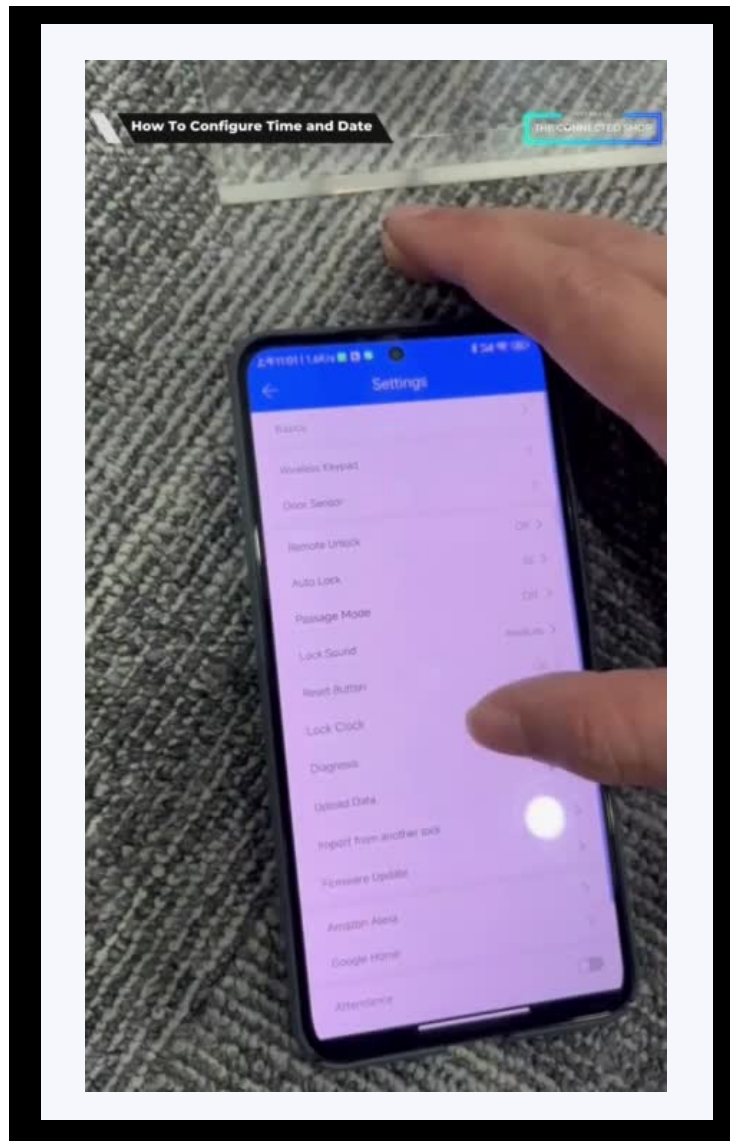



## 2. INITIAL STATE OF YOUR SMART LOCK



### H) Volume Adjustment

- Activate your Smart Lock and enter your Administration Information (if applicable)
- Open the mobile app
- Go to Settings and select 'Lock Sound'
- Select the desired volume and click Save

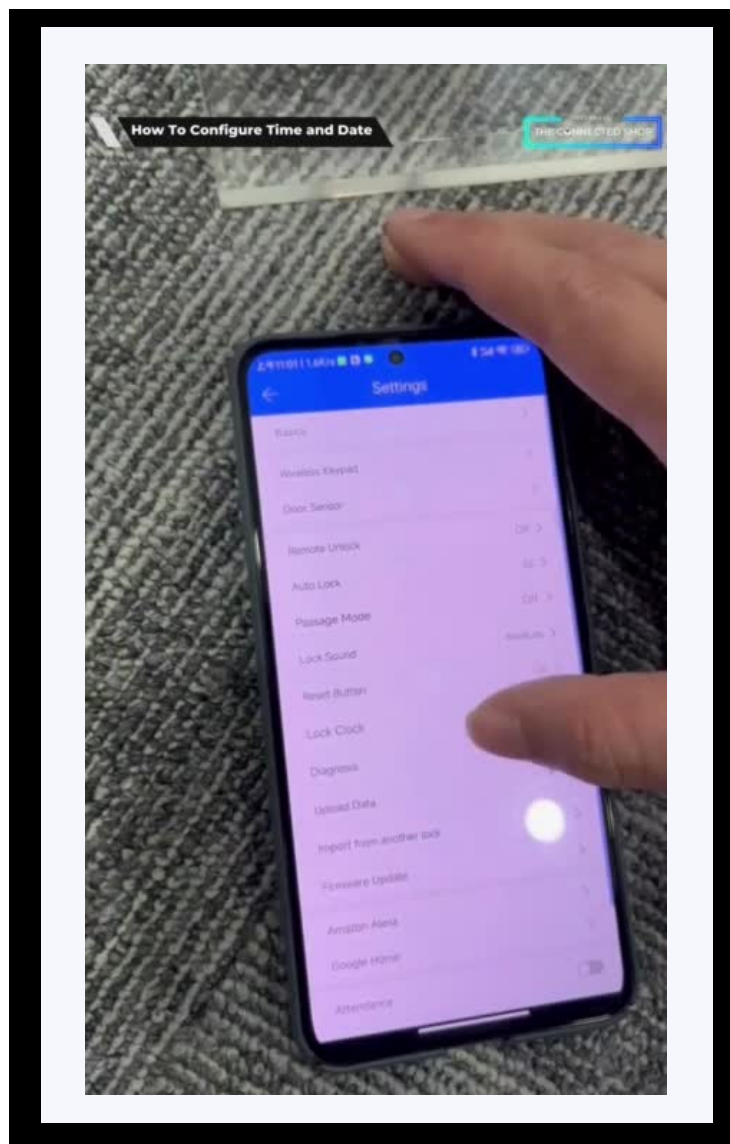

## 2. INITIAL STATE OF YOUR SMART LOCK



### I) Factory Reset

- Activate your Smart Lock and enter your Administration Information (if applicable)
- Open the mobile app
- Go to Settings and click the 'Delete' button found at the bottom of the page
- Confirm

### 3. MOBILE APP CONNECTION



#### a) Downloading the App

Download the application on the Google Play Store or Apple AppStore by searching “TTLock” or by scanning the QR code below:



#### b) Logging in and Registering

##### After Downloading the App

- You will be redirected to register your email address and/or mobile number where a verification code will be sent, and proceed to enter it on the app in the allotted time limit
- Once the verification code has been entered into the app, you will be asked to set your password
- You will then have full access to the TTLock app

### 3. MOBILE APP CONNECTION

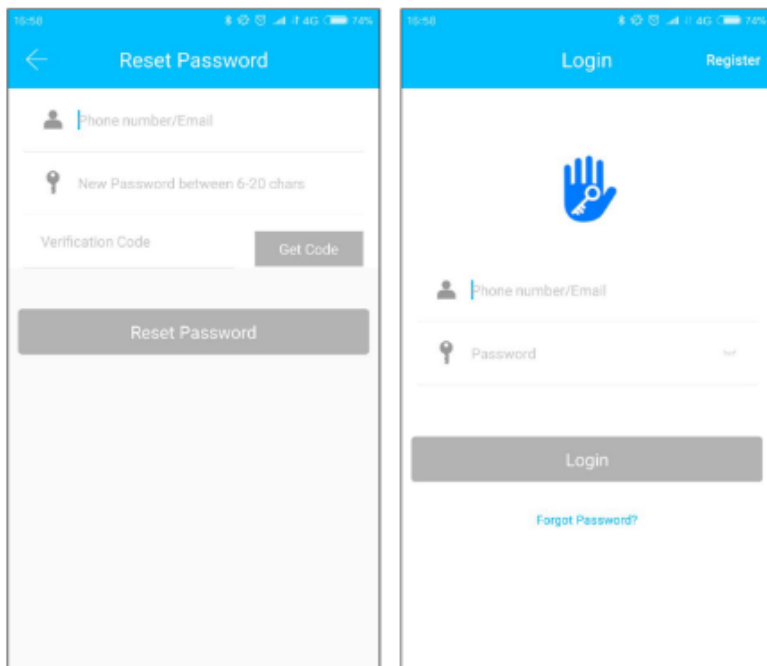

Should you be an existing user to the TTLock ap, log in using your email and password from the login page.

#### c) Resetting your Password

In case you have forgotten your password and need to reset it, please follow the steps below:

- On the Login Page, when prompted for your email & password, click the 'Forgot Password' option located below the 'Login' button
- Enter your email address or phone number, along with the new password.

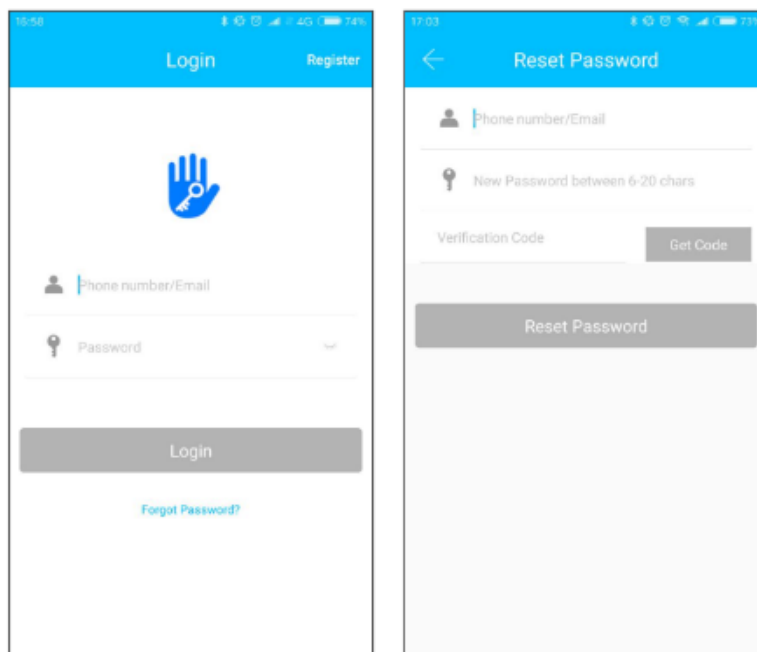

### 3. MOBILE APP CONNECTION

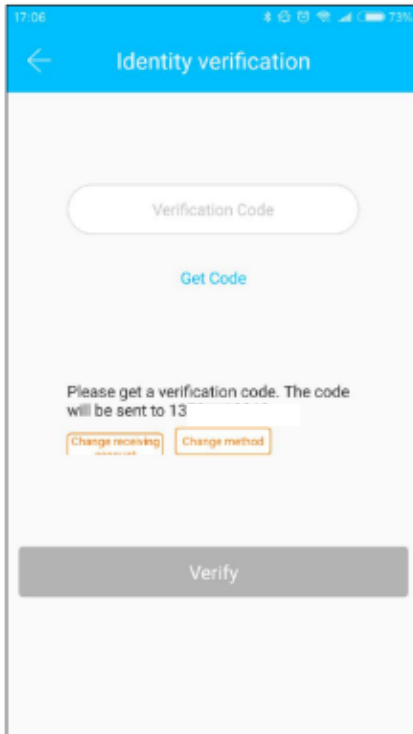

- You will be prompted to enter the verification code sent on your mobile number or email address. Proceed to enter it on the app in the allotted time limit
- You will then have full access to the TTLock app

- Once logged in and you already have a connected device/lock, you should see a home page such as the sample picture on the right with the lock name and all the available settings.
- Otherwise, you will see a main home page like the one on the left with only a '+' button found on the screen.

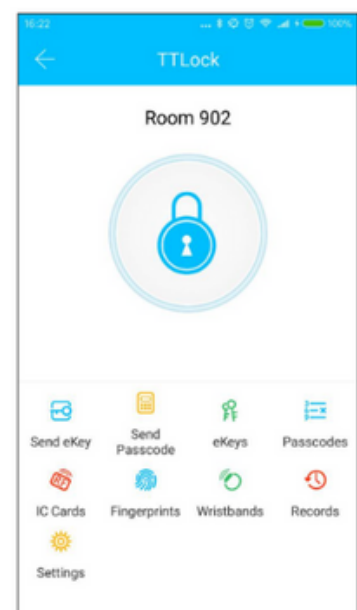

### 3. MOBILE APP CONNECTION



#### d) Adding Devices

To add devices on the app, please follow the instructions below. Your device and phone must be connected to the same 2.4GHz Wi-Fi network, as well as to keep them close to each other during the entire process, in order for this to work.

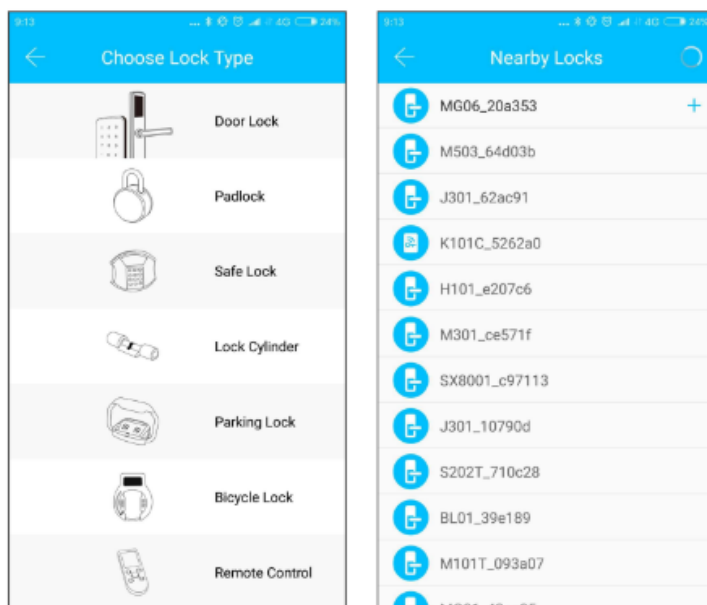

- To add the lock, choose the appropriate device (lock) type
- Then, initiate the search for any nearby locks. Remember to keep your phone near your smart lock in order for this to work

- Once detected, choose the correct nearby lock and name it
- Press 'Upload Data' button to complete the process

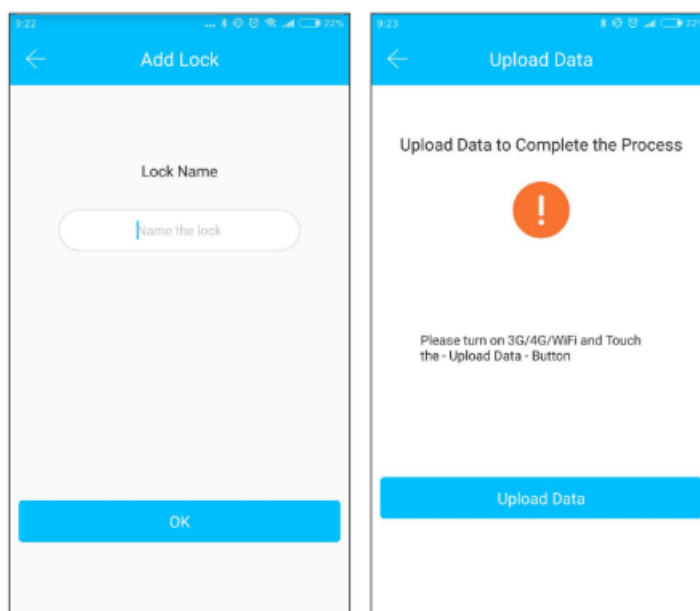

## 4. DEVICE FUNCTIONS



### a) Remote Functions via The Mobile App

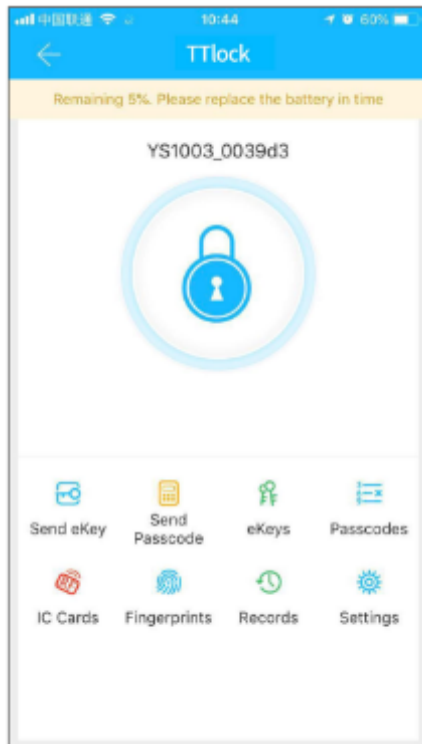

- Use the mobile app to remotely unlock or lock your device. This is only possible when the app and the smart lock is paired with a Wi-Fi Gateway. Otherwise, the app and the smart lock will only be connected via a Bluetooth connection; and to remotely unlock it using the app, you must remain within 5-10m from the smart lock.
- So, on the app, click the 'lock' icon on the home page to unlock it.

## 4. DEVICE FUNCTIONS



### b) Connect to WiFi Gateway

The smart lock is connected via Bluetooth and it is not connected to the network itself. Thus, the gateway serves as a bridge between the smart lock and the Wi-Fi network. When paired, the user can remotely view and configure several settings of the lock, access the unlock history, and delete or modify the password remotely.

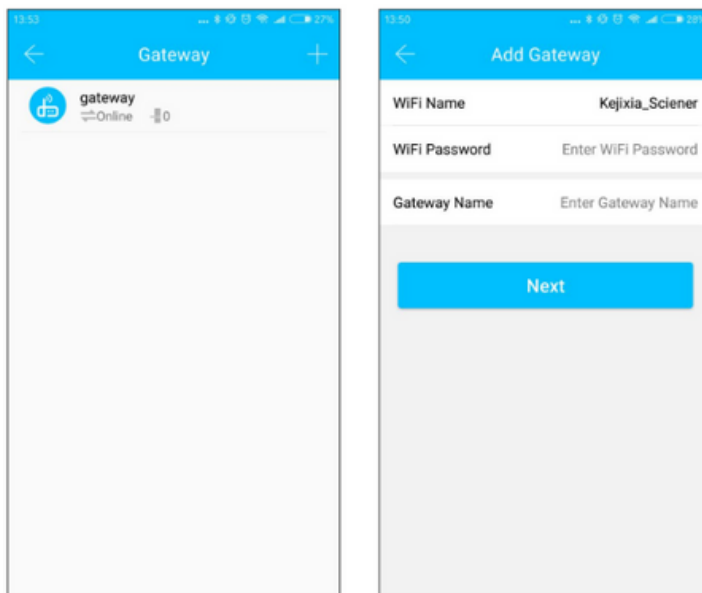

- First, make sure that your phone is connected to a Wi-Fi network
- Then, click the '+' button on the upper-right corner of the home page on the app to enter the Wi-Fi password and gateway name on the Add page
- Click 'Next' and enter your account password for authentication
- Press and hold the settings button on the gateway for 5 seconds. Both the red and blue lights should flash alternately to indicate that the gateway has entered into pairing mode with the app

- Once the gateway is added to the app, it will search for nearby locks. Afterwards, it should show a list of all nearby locks
- Once the lock is paired with the gateway, the lock can be remotely managed through the gateway

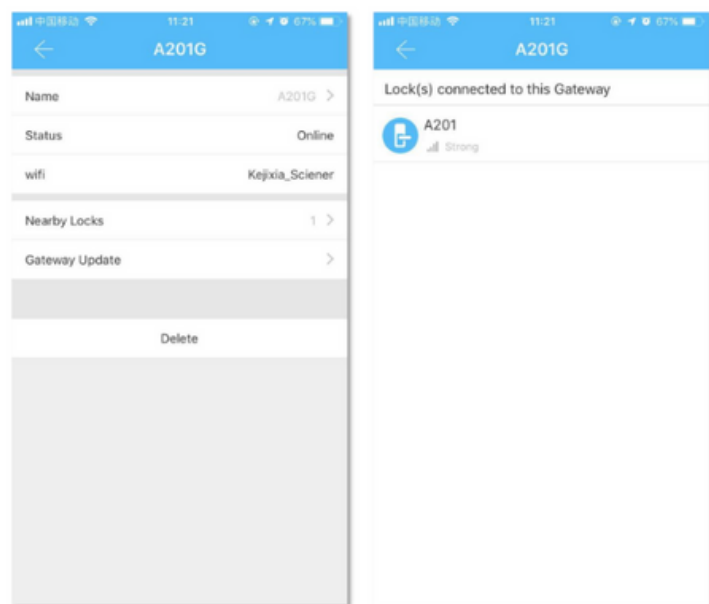



## 4. DEVICE FUNCTIONS



You may refer to the video demonstration below on how to properly pair your lock and app with a WiFi Gateway:



## 4. DEVICE FUNCTIONS



### c) One-time Password (optional)

- Open the app and go to Passcodes

- Select 'One-time' and click the 'Generate' button. Remember that this password is only valid for 6 hours from the time it was generated and can only be used once

- This is perfect for those who has guests arriving at their homes or for those who own rental properties

### d) Timed Password (optional)

- Open the app and go to Passcodes

- Select 'Timed'. Set your start and end time for the validity of this temporary passcode. Remember to use it once within 24 hours after the start date/time has began.

Otherwise, it will automatically expire

- This is perfect for those who has guests arriving at their homes or for those who own rental properties.

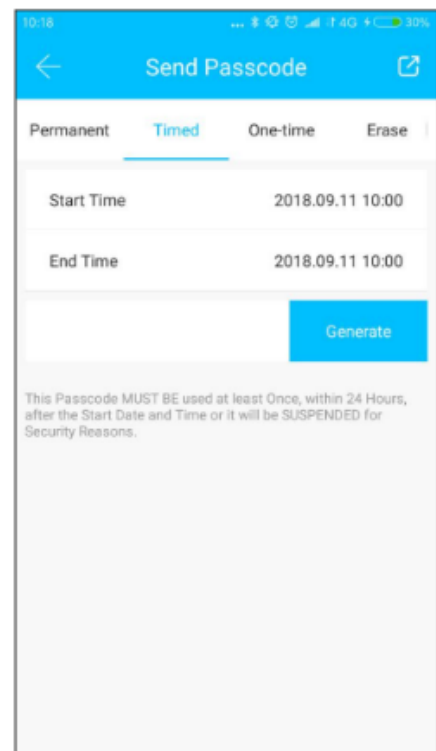

## 4. DEVICE FUNCTIONS



### e) Remote Unlock

- To grant access to someone when you are away, ensure first that the lock is paired with the WiFi Gateway and your mobile Bluetooth is enabled. Go to the app settings. Select 'Unlock Remotely' to turn it on. Go back to the home page of the app and click the "lock" icon to remotely unlock your door.

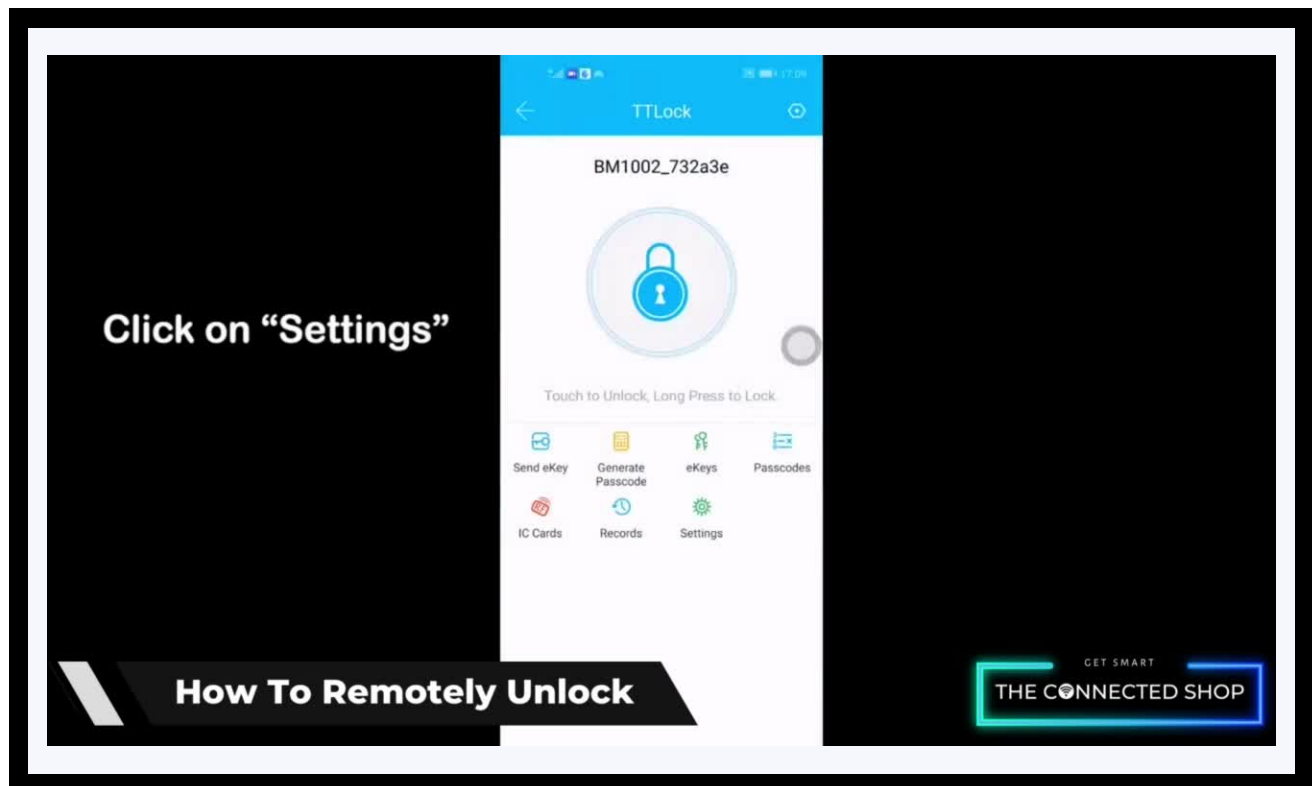

## 5. OTHER NOTES



Created by Design Circle

- If there is no operation for about **10 seconds** , the system will automatically exit or lock.
- **Once the battery is low**, the lock will either notify you every time it is opened or you will see a pop-up message on the app. After the alarm goes off, the lock can only be opened 200 times more. Afterwards, each attempt to unlock it, it will be delayed for 5 seconds. New batteries must be placed before the number of 200 unlocks is reached.

## 5. OTHER NOTES



Created by Design Circle

- **To enable and/or disable passage mode:** Go to the mobile app, select Settings and then Passage Mode. Toggle the switch right next to it and set a schedule of validity (time frame) to when the lock will remain unlocked. Save the preset settings after. Toggle the switch again to disable it and hit Save.
- Optionally, activate your Smart Lock and enter your Administration Information. Press "123#" to enable passage mode. When enabled, you will be able to keep the lock unlocked even when the door is closed. To disable it, simply enter your Administration Information after activating the Smart Lock.

## 5. OTHER NOTES



Created by Design Circle

- **To set up network:** Go to the mobile app and click the menu on the top-left corner. Select Add Lock. Click on All Locks and activate your Smart Lock. The app will then recognize a new nearby lock and show it on the screen, select the lock. Rename the new lock and hit the 'Ok' button.



## 5. OTHER NOTES



- **To pair your smart lock to Alexa/Google Home:** Stand near the lock and activate your Smart Lock. Follow the previous steps in setting up the network and WiFi gateway. Upon successful operation, the gateway will only flash a blue light. Afterwards, turn on your Echo Dot Alexa and go to its respective app. Input all Amazon login credentials. Select Skills & Games on the main menu and search for "TTLock" to enable it. Login to your TTLock account. Select Devices on the Alexa app and click the "+" icon on the upper-right corner. Choose Amazon Echo to set up your Echo Dot device. Press and hold the round button on the device until an orange light appears, then follow the voice command. Upon grouping the devices in one room/location, select the 'Locks' option to choose your paired lock. Go to the gear icon on the upper-right corner to toggle the switch and "unlock by voice" to create your own voice code.

**Pair your lock  
with TTLock App**

(Please stand by the lock and touch the lock panel to operate)

**How To Connect to Alexa**

GET SMART  
THE CONNECTED SHOP

Congratulations!

You have successfully installed your very own Sliding Door Smart Lock.

Thank you for being a valued customer of The Connected Shop.

[www.theconnectedshop.com](http://www.theconnectedshop.com)







# THE CONNECTED SHOP